

AUGUST 1976 \$1.00\*  
NZ \$1.15

# electronics

## TODAY

INTERNATIONAL

ELECTRONICS  
TECHNOLOGY

**Simple  
electronic organ**

**Microprocessors**

*Registered for posting as a periodical - Category C*

**FREE-**

**Applied Technology Catalogue!**





# A turntable with features you'd expect only on a more expensive unit

One feature you'll notice is the price; in fact we believe it to be 'the best buy' turntable available today.

With features only expected on more expensive units, such as wow and flutter of 0.05 WRMS thanks to the DC motor with FG (frequency generator) servo-controlled circuits.

How's this for a list of features. Practical, purposeful features like

- illuminated stroboscope
- elliptical stylus

- completely automatic tone arm return
  - viscous-damped cueing lever
  - anti-skating dial scale control
  - CD4 ready
  - audio insulated legs
- and the list just goes on.

Any way you want to look at it, you'll agree the Technics SL23 is a sound buy, with appearance and performance to match.



For a National Technics Catalogue please write to:  
National Technics Advisory Service, P. O. Box 49, Kensington, N.S.W. 2033.

 **Technics**  
by National

WT GD 105 T



# electronics TODAY

INTERNATIONAL



A MODERN MAGAZINES PUBLICATION

August 1976, Vol.6 No.8

Editorial Director Collyn Rivers  
Assistant Editor Steve Braidwood

Electronics Today International is Australian owned and produced. It is published both in Australia and Britain and is the fastest growing electronics magazine in each country.

## Special Offer:

Mini Tape Recorder  
see page 99

## New Regular Features:

\* Readers' Queries Answered  
see page 41

\* A WHOLE PAGE OF  
SPECIAL OFFERS  
SEE PAGE 42

\* Readers' Adverts  
see page 109

COVER: What lies beyond the door of the next century — more technological revolutions or a world similar to the one we know today? The question is asked on the cover by photographer George Hofsteters, and is answered on page 18 by Dr Peter Sydenham.

\* Recommended retail price only

## PROJECTS

REMOTE CONTROL RECEIVER . . . . .	48
<i>Description of the receiver section of our remote switch</i>	
ETI MINI ORGAN . . . . .	51
<i>Touch-keyboard, two-octaves, variable tremolo, two voices</i>	
AUDIO LIMITER . . . . .	57
<i>Increases dynamic range in many applications</i>	
NEO NIM . . . . .	63
<i>An electronic version of Nim, and new ways to play</i>	
DIGITAL DISPLAY . . . . .	68
<i>ETI533 modified to use FND500s instead of DL704s</i>	

## FEATURES

TOSHIBA COLOUR TV CONTEST RESULTS . . . . .	8
<i>The three winners and some of the answers</i>	
ELECTRONICS IN THE YEAR 2000 . . . . .	18
<i>Peter Sydenham looks at the future</i>	
MICROPROCESSORS: THE MICROCOMPUTER . . . . .	30
<i>Kevin Barnes looks at the revolution in electronics</i>	
MICROPROCESSORS: WHAT IS A MICROPROCESSOR? . . . . .	35
<i>Tim Hendtlass gives a simple explanation</i>	
BIORHYTHM CALCULATOR . . . . .	38
<i>A look at Casio's unique machine, the Biolator</i>	
CARBON COMPOSITION RESISTORS . . . . .	72
<i>A new subject in our components series</i>	
CMOS — A PRACTICAL GUIDE . . . . .	76
<i>Part two; switches, A-D &amp; D-A, and flip-flops</i>	
ELECTRONICS — IT'S EASY . . . . .	84
<i>CRTs and oscilloscopes</i>	

## DATA SHEETS

LM109, LM209, LM309, five-volt regulators . . . . .	44
LM340 & LM78XX series, voltage regulators . . . . .	45
LM78LXX series, voltage regulators . . . . .	45
LM3910/LM340L series, voltage regulators . . . . .	46

## NEWS & INFORMATION

News . . . . .	5	Audio facts . . . . .	101
Please explain . . . . .	41	Calculator contest . . . . .	17
Mark-down . . . . .	42	Mini-mart . . . . .	109
Ideas for experimenters . . . . .	93	Reader services . . . . .	110
Special offer . . . . .	99	Advertisers' Index . . . . .	110



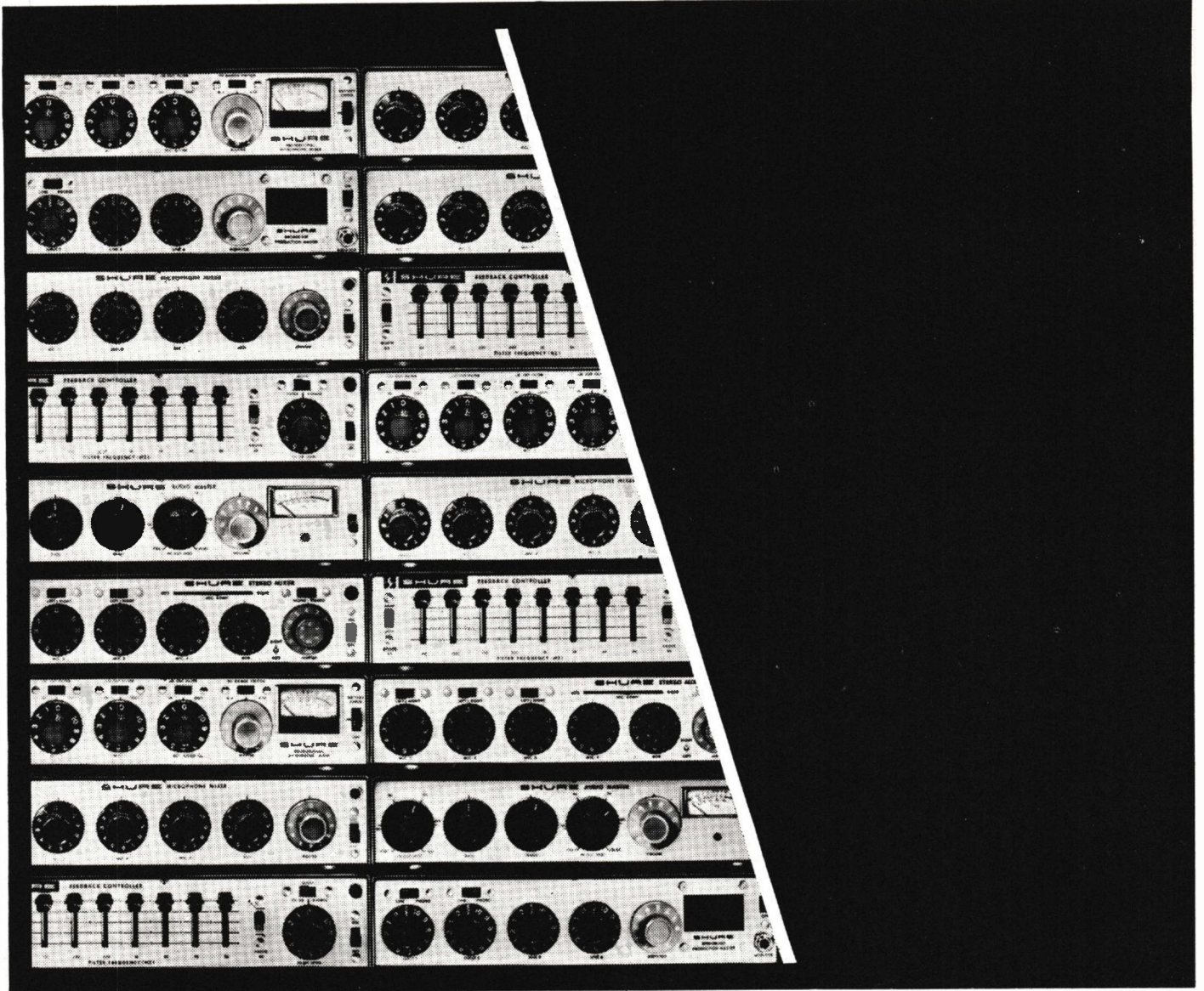

## It's a mod. mod. modular world.



Simplify, simplify! Instead of paying more for bigger, bulkier audio control components, pay less for compact Shure modular components that—singly or in combination—handle critical functions flawlessly. Cases in point: (1) the M67 and M68 Microphone Mixers, the original high-performance, low-cost mixers; (2) the M610 Feedback Controller, the compact component that permits dramatically increased gain before feedback; (3) the M63 Audio Master, that gives almost unlimited response shaping characteristics; (4) the M688 Stereo Mixer, for stereo recording and multi-source audio-visual work; (5) the M675 Broadcast Production Master, that works with our M67 to create a complete production console (with cuing!) for a fraction of the cost of conventional consoles; and (6) the SE30 Gated Compressor/Mixer, (not shown above) with the memory circuit that eliminates “pumping.” For more on how to “go modular,” write to:

AUDIO ENGINEERS PTY. LTD.  
342 Kent Street, Sydney.



AUDIO ENGINEERS (Vic.)  
2A Hill Street  
THORNBURY, 3071. Vic.

AUDIO ENGINEERS (Qld.)  
57 Castlemaine Street,  
MILTON, 4064. Qld.

ATHOL M. HILL PTY. LTD.  
1000 Hay Street,  
PERTH 6000 W.A.



# NEWS DIGEST

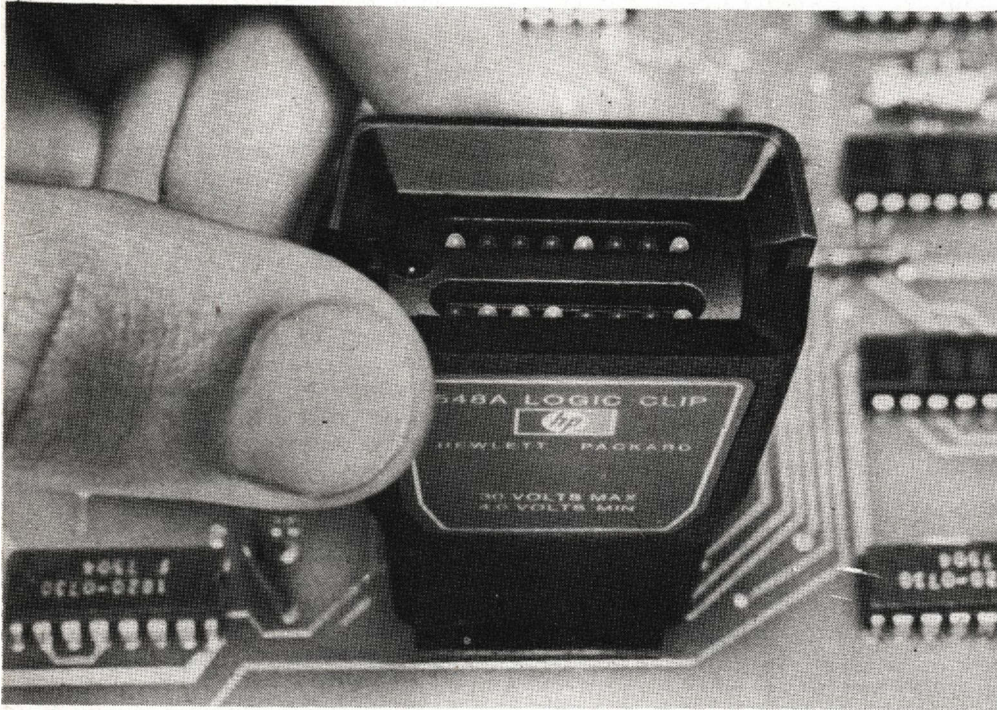

## HP Logic clip

New to Hewlett-Packard's family of integrated circuit logic testers is the 548A Logic Clip. Easy to use, the device simply clips on to a 16-pin DIP-packaged integrated circuit under test and its LEDs show logic states of each of the IC's pins simultaneously. It is automatic for all logic families from 4 to 18 volts dc which include TTL, DTL, RTL, CMOS, and HTL circuits. Three-volt CMOS is tested by connecting a 4.5 volt supply to an auxiliary power pin.

The 548A locates the supply and ground pins automatically; it can be placed on the IC 'upside down' or 'rightside up'. Total current drawn by the clip is less than 40 milliamperes with 15 LEDs on. Input current is less than 15 microamperes, assuring virtually no circuit loading. Inputs are protected to 30 volts dc for 1 minute.

Duty free price of the 548A Logic Clip is \$105. Duty and Sales tax are additional if applicable.

## IMPENDING BOOM

Japan's electronics industry, which is currently expanding only slowly, is expected to resume its former fast growth rate during the next few years.

An increase of 25% is forecast by Masaji Hino, Matsushita's senior MD — mainly in sales of colour TV, hi-fi etc. Mr Hino forecasts an increase of 6% per year for Japan's gross national product during the next five years.

## Amateur computer awards

A convention of users of Altair microcomputers was sponsored by MITS in Albuquerque recently. The highlight of the event was the presentation of awards for the best applications of Altair systems.

The first prize went to a radio amateur for a system developed to control his station during an RTTY contest. To the standard transmitter, receiver and Baudot Teletype he had added an Altair 8800 with 8K of memory, an ASCII keyboard, and a video display. The sys-

tem was used for ASCII keyboard, and a video display. The system was used for ASCII to Baudot translation, checking calls for duplication, automatically transmitting time and message number of the transmissions, and generating a hard-copy printout of the QSOs. The hardware was all home-constructed and the amateur wrote all his own software.

Other prize-winning systems were a computer chess demonstration, a speech synthesiser, and a backgammon game.

## AM/FM/CB

A combined AM/FM push button radio and 23 channel CB transceiver is shortly to be test-marketed in the USA West Coast. The unit which has been developed by Pioneer Electronics will be made by Alps-Motorola Corporation, sales however will be via Pioneer Electronics of America.

## Digital TV trial

In the UK the BBC and the Post Office have joined to carry out tests in the transmission of digital TV colour and sound signals via an Intelsat-4 satellite. Present systems use analogue FM transmission.

The digital signal is transmitted at 60 megabits per second split into two streams of 30 megabits per second. The BBC is still carrying out tests to find the optimum bandwidth, the initial trials used 36 MHz.

## Mend your own calculator

In the month of June, Unitrex had 437 calculators returned to their service department. There was nothing wrong with 333 of these — they had been returned with flat or wrongly oriented batteries. Unitrex ask you to please check your batteries before sending a non-functioning calculator back to them. They suggest punching up a row of eights, if these do not stay illuminated then your batteries need replacing.



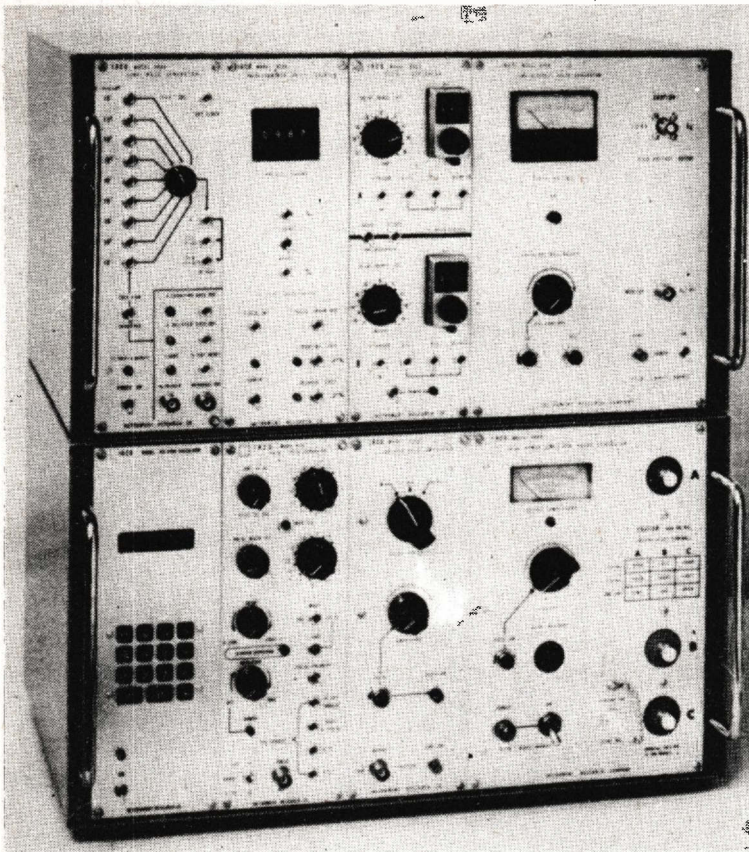

## Keeping the calculator out of the pocket

The Instrument Research Company have included an ordinary pocket-type calculator as part of an electronic instrument. The calculator — which is electrically independent — is provided simply as a convenience to the operator of the lab instrument. This equipment — the Model 909 — spans applications ranging from digital logic development to 100 kilowatt pulses for laser optical modulators, and its proper use requires calculating peak and average powers, duty cycles,

thermal effects, etc., all of which become increasingly important at higher power levels.

A 4 function, 8 digit pocket calculator was redesigned for flush panel mounting, and was supplied with a line operated power source to eliminate battery replacement.

The calculator is always there when needed, and can be switched on independently of the rest of the equipment. And a major point is that it won't walk off — it's bolted onto the instrument!

## If she looks into your eyes...

She won't be able to tell what you're thinking but she will know how your brain is working! Try it: find a nice young lady and get her to lie on your settee (this isn't vital to the experiment but it makes it more interesting). Then look into her eyes and note the size of her pupils. Now give her a seven-digit number to remember (you could experiment with poetry but most scientists prefer numbers) and tell her to wait ten seconds then give you back

the number. If you managed to keep interfering stimuli under control this is what you should have observed: the pupils expand as you say the number, contract during the pause, and expand again as she says the number. The effect has been studied by researchers at the University of Southern Colorado, who say the pupil size is not related to brain activity as such, rather to rate of encoding and decoding (memorising and retrieving) information.

## NEW ETI SERVICES

Two new reader services start in ETI this month. Firstly we're starting a free readers' classified advt section. So if you've anything you want to buy or sell see page 109 for details. There's only one catch — this service is for our private readers only.

Secondly we have a 'special offers' section in which our advertisers are invited (at our expense!) to offer readers their products or services at substantial discount prices. We hope that this will become a regular feature. Our first special offer section is on page 41 this issue.

Finally — don't miss our special introductory offer of pocket sized tape recorders. They're fantastic little devices and a real bargain at the special introductory price of \$74.45. Use one to record meetings, note ideas, record interviews, learn languages, take notes, rehearse speeches — or for just plain fun!

## IN $3 \times 10^6$ YEARS TIME, IT WILL BE ONE SECOND SLOW!

RCA are working for the US Navy to determine the feasibility of using hydrogen maser clocks — precise to one second in three million years — in Global Positioning Systems (GPS) satellites.

These satellites are part of a tri-service programme under Air Force direction. NTS-1 was launched in July 1974 and tested rubidium clocks. NTS-2 will test cesium clocks; NTS-3 will test hydrogen maser clocks.

The satellite-based GPS system, scheduled to become operational in the 1980s, will provide the precise position fixes in three dimensions — longitude, latitude and altitude. Transit, the current operational system, is two dimensional providing only longitudinal and latitude readings.

A planned constellation of 24 GPS satellites will be continuously transmitting time synchronized signals. A ship, airplane or land craft suitably equipped to receive the signals, will be able to determine its exact position anywhere on the globe.

Hydrogen atoms are employed because of an extremely stable fixed frequency generated under certain controlled conditions. The atoms are produced from hydrogen gas molecules by an electrical discharge and beamed into a special container in a microwave cavity. The hydrogen atoms undergo an energy state change and emit a frequency that can be used to very accurately control the output frequency.

## GRAPHICAL SYMBOLS

The Standards Association of Australia invites comments on the provisions of the draft DR76061 of a new Australian standard for graphical symbols for use on electrical and electronic equipment.

The purpose of the draft is to establish uniform principles for the standardisation of graphical symbols used for informative purposes on electrical and electronic equipment.

*Continued on page 11*



**Now we're open...  
so drop by and check us out**

# ELECTRONIC ENTHUSIASTS EMPORIUM

**E.E.E.  
AUGUST  
SPECIALS**

**THE HOME OF GOOD GEAR - MONEY BACK GUARANTEE**

**IN914 DIODE .....45c**  
The Real Thing

**220 MF 25 V .....35c**  
Electrolytics

**7490 DECADE COUNTERS .....\$5.40**  
A few left, a pack of 12, works out at  
45c each

**MPF102 FET .....58c**

**ALL 1/2W RESISTORS .....3c**

**IN4004 (EM404) .....15c**  
Rect 400 PIV 1A

**PA 40 DIODE BRIDGE .....\$5.40**  
400 PIV 8A

**SMALL RED DIFF L.E.D. ....27c**

**7400 NAND GATES .....38c**

**2N 3641 NPN .....38c**  
250 MHz. Gp. Amp & Sw

**PW 5 WIRE WOUND RESISTORS 35c**  
(All Values)

**CERAMICS .....8c**  
(All Values to .047)

**GREEN CAPS .....12c**  
(All Values To .047)

**TAG TANTALUMS .....27c**  
(All Values To 4.7uf)

## SOME OF THE LINEARS WE STOCK

MC 1496-	LM 319	LM 381	LM 1303
MC 1590G	LM 320	LM 382	LM 1458
LM 301	LM 339	LM 555	LM 1488
LM304	LM 340	LM 561	LM 1489
LM 305	LM 370	LM 565	LM 1496
LM 307	LM 371	LM 709	LM 3900
LM 308	LM 372	LM 710	CA 3012
LM 309	LM 373	LM 723	CA 3018
LM 310	LM 374	LM 725	CA 3028
LM 311	LM 375	LM 733	CA 3089
LM 312	LM 379	LM 741	CA 3090
LM 318	LM 380	LM 747	UA 706
			UA 720

**FULL RANGE OF T.T.L., CMOS, OPTO, TRANSISTORS Etc. Etc. SELECTED A.W.A. CRYSTALS & FILTERS,  
AMIDON TOROIDS AND MORE.**

**SHOPS 2 & 3 AT 7-10 JOYCE ST., PENDLE HILL (opp. RAILWAY) Ph. 636-6222**

**PLENTY OF PARKING AT REAR**

**MAIL ORDERS: P.O. Box 33 Pendle Hill, N.S.W. 2145 (Don't Forget P/P) C.O.D. — ADD \$2.40 TO P/P**

**ELECTRONIC ENTHUSIASTS EMPORIUM**



# Toshiba Colour TV Contest— Winners and Answers

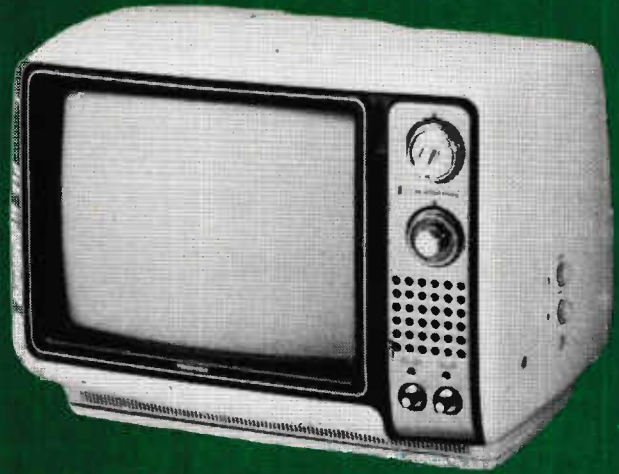

THE ETI-TOSHIBA GRAND Contest is now closed. Here are the answers to the questions and details of the three lucky winners, each of whom wins a Toshiba 'Black-stripe' colour TV.



The winner of the first contest is Geoff Cochrane of Canberra, ACT.



The winner of the second contest is Ron Rogers of Werribee, Victoria.

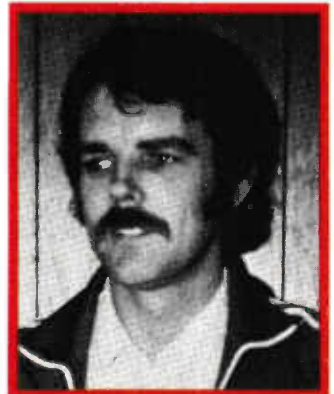

The winner of the third contest is Pat Cluse of Ingle Farm, South Australia.

## Who-What-Which -Why -When Contest No. 1

So we were wrong once again!

One day we'll learn that no contest devisable by man will attract other than almost perfect entries from our readers.

Question - A13, concerning galvanometers - was omitted in final judging as a number of readers felt it to be ambiguous.

Our prize winner is Dr. Geoff Cochrane of Canberra, ACT. Congratulations Dr. Cochrane - we're sure you'll enjoy the Toshiba colour TV now in your possession.

The definitive answers are shown on the right:

These people came very close -

D. Craig	V. L. Fisher
N.C. Mitchell	T.J. Mason
N. Redgrave	P.J. Dutschke
	G. Adcock

A1 - Why is a transistor so-called?

Answer - Contraction of the words Transfer Resistor.

A2 - Who invented the Wheatstone Bridge?

Answer - Samuel Hunter Christie in 1833 - subsequently published by Charles Wheatstone in 1843.

A3 - Who was this?

Answer - Baron Jean Baptiste Joseph Fourier.

A4 - Who said 'Evil communications corrupt good manners'?

Answer - Menander in Euripides - quoted by St Paul in New Testament I Corinthians XV33; also quoted in Cobbett's 'Advice to Young Men'.

A5 - Early moving coil patents.

Answers - Charles Cuttris & Jerome; Redding; E. W. Siemens; H. O. Taylor; A. E. Kennedy & Pierce; d'Arsonval; A. F. Spooner et al.

A6 - Who wrote 'The moment man cast off his age-long belief in magic, science bestowed on him the blessings of the Electric Current'?

Answer - Jean Giraudoux from the play Intermezzo, Act III (1933). The line quoted was actually from Valency's English adaption of 1950 - this version of the play was called The Enchanted.



A7 – Who opened the window to the study of what – and which unit appropriately bears his name?

*Answer – Wallace Clement Sabine who opened the window to the study of architectural acoustics. A Sabin is the unit of equivalent absorption – or 'open window' unit.*

A8 – What is The Comma of Pythagoras?

*Answer – The difference between twelve perfect fifths and seven octaves from a given note in music, i.e. 0.24 of a semitone (ratio 531441:524288).*

A9 – What is Barkhausen noise?

*Answer – Noise generated during magnetisation of a ferromagnetic material when domains of finite size reorientate in a random manner.*

A10 – This man is better known for his religious activities – who was he?

*Answer – John Wesley, founder of Methodism.*

A11 – By what title was John William Strutt better known – and in which field of endeavour did he primarily make his scientific reputation?

*Answer – Lord Rayleigh (3rd Baron) – Nobel Prize in physics for discovery of argon. He was also famous for his work in acoustics.*

A12 – From a mathematical viewpoint, mechanical mass, electrical inductance and a volume of air contained in an enclosure each represent the same quantity. What is this quantity?

*Answer – Inertia.*

A13 – Did the first galvanometer use electro-magnetic or electrostatic detection?

*Answer – This question was omitted from final judging. Intended answer was electrostatic – the term was coined by Bischof in 1802 to describe a gold-leaf electroscope. Today the name is reserved by common usage for electro-magnetic instruments.*

A14 – Who proposed the terms cation, anion and ion – and when?

*Answer – Dr William Whewell in a letter to Prof. Michael Faraday dated 5th May 1834. (Prof. Faraday was accepted as an alternatively correct answer).*

A15 – Who was the 'Princess of Parallelograms'?

*Answer – Anne Isabella Milbanke – later to become Lady Byron – so named in a letter from Lord Byron to Lady Melbourne.*

Who was her tutor?

*Answer – William Frend.*

What was her husband's name and title?

*Answer – Lord George Gordon (Noel) Byron – 6th Baron Byron of Rochdale.*

Who was her daughter's executor?

*Answer – Charles Babbage.*

What do all the above questions do with the picture below (Babbage's Difference Engine).

*Answer – All were mathematicians (except Lord Byron), all were friends of Babbage and all were interested in Babbage's machines. Lady Byron's daughter Ada, Countess of Lovelace, was taught by Augustus de Morgan (William Frend's son-in-law). She translated into English L. F. Meubrea's paper on Babbage's work 'Sketch of the Analytical Engine invented by Charles Babbage'. Ada Lovelace and Babbage combined talents to try to find an infallible system for backing horses! Ada is referred to in Byron's Childe Harold – Canto III "Ada, sole daughter of my house and heart!"*

# ... a pair of long-nosed fliers

## Contest No.2

CONTEST NO 2 was won by Ron Rogers of Werribee, Victoria. Ron successfully corrected all the printing errors and spotted that our typesetting department had themselves 'corrected' one of the literals that they had previously caused! That incidentally was the 'germanium devices' – the original faulty line was 'geranium devices'!

Only six contestants gave the correct answer to the last line – 'basic variable sin circuits'. Nearly everyone thought it should have been 'basic variable sine circuits'. Not so – it was simpler than that – it should have read 'basic variables in circuits'.

# Jumbo less six

## Contest No.3

The winner of our Jumbo less six (contest No 3) was Pat Cluse of Ingle Farm, South Australia.

A definitive solution is shown below – note that there are several acceptable alternative answers to 23 down.

Several readers have taken us to task for an unintentionally ambiguous answer to 7 Down – the voltage of a Weston cell. Many text books quote the voltage as being 1.0183 – this was the figure we used and is the only one that ties in with the remaining answers. However we overlooked the fact that there are two types of Weston cell – the unsaturated type has a voltage of 1.01836.

1	7	2	4	9	0			3	7		4	2	5		
6	4	1						7	1	0	5	9	5		
9	1	8	6	10	2	8	0				7		5		
			6		12	1	0	1	3	2	13		5		
14	1	8	15	3	6			8			16	9	5		
	4			1				17	3	0	18	5	5		
19	1	5	6	20	2	5			21	7	7				
22	4	0	2	7				23	3		24	7	1	2	
	2			27	3	1	28	4	1	29	5	9	2	7	
30	1	4				31	8	0	8	0			32	1	3



# the Elephant & the Ant



The old fable, of the ant bragging about how he was stronger than an elephant, is pretty well known. By simply taking residence in the trunk, he was able to make the elephant do precisely what he wanted. But, in spite of this, the tiny ant's ant-ics still didn't diminish by one jot the power and capabilities of his mammoth protagonist. Think of the Klipsch as the elephant. The speaker wires as the trunk; and the comparatively insignif-ant Marantz 1070 amplifier as the ant. The fortune you spend on the 'La Scala' could be the savings you make in the system. Because Klipsch speakers are *efficient*. So huge power ratings are totally unnecessary to drive them to perfection. The Klipsch 'La Scala' comes King-size in a speaker jungle of pygmies. But it's

not just dimension that makes it so awesome. Consider its low distortion system over a wide range of frequencies, with bass range extending solidly to 45 Hz usable to 40. And, although the woofer unit occupies only *8 cubic feet*, the response, range and efficiency equal or exceed systems of considerably larger size. So, when you're considering a music system—or upgrading your present gear, take a look at the TOTAL figure, and then see how economical one of the world's most expensive speakers can be! You'll never forget the experience of KLIPSCH! Available from highly selective Hi-Fi dealers or write for brochure to: Auriema (A'asia) Pty Ltd P.O. Box 604, BROOKVALE, N.S.W. 2100. Phone: 939 1900.

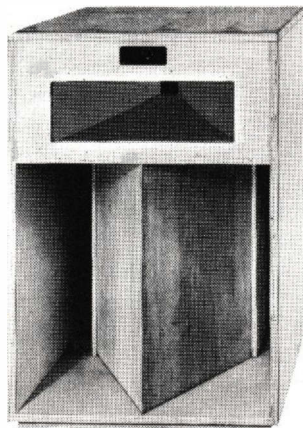

## Klipsch



## Do the burglar shuffle

A patent issued in the US recently will make life a little harder for burglars of the future. Honeywell engineers have invented a seismic footstep detector for use in intruder alarms. Previous attempts to develop systems for detecting the vibrations caused by an intruder have been plagued with false alarms. The identification is based on the characteristic pattern of human footsteps, duration less than 250 ms and period less than 1.6s. A small step for a man, a great step for a crafty burglar!

### Ralmar move

Ralmar Agencies will be at a new address from 1st September: 23 Atchison St., St. Leonards, NSW. The new phones will be 439 4352 and 439 6174.

### LONG STROKE

A  $\pm 300$ mm inductive displacement transducer — one of the longest stroke units manufactured anywhere in the world — is now being produced by Sangamo Weston Controls of North Bersted, Bognor Regis, England.

This equipment is available in Australia via agents: Selby Scientific Ltd., PO Box 121, North Ryde, Sydney.

### SAA WIRING RULES

The SAA Wiring Rules have been revised and metricated. The seventh edition is AS3000, Part 1-1976 which supersedes AS CC1, Part 1-1969.

Copies of the new edition at a price of \$12 each are available from any office of the SAA in the capital cities and Newcastle. Copies of a booklet (Doc. 3000N) detailing the changes between the new and superseded editions will be available from mid-July at a nominal charge.

The new edition will generally apply throughout Australia from 1 July, 1976 subject to qualification by local Regulations. However, any installation carried out in accordance with the superseded edition would normally be accepted up to 31 December 1976.

### SUBMINIATURE PUSH-BUTTON & ILLUMINATED ROCKER SWITCHES

A unique switch in C & K's comprehensive family is the 8531 SPST momentary sub-miniature pushbutton switch. By specifying the "C" terminal option, it is available as a printed circuit mounting switch.

The electrical life is 1,000,000 make-and-break cycles; contact rating is 1 amp resistive at 120 Vac, 28 Vdc or  $\frac{1}{2}$  amp resistive at 250 Vac. Model 8531 measures 9.52 mm dia. with overall height of 27 mm from top of plunger to bottom of terminal. The plunger is available in red or black.

Another new switch from C & K is the illuminated rocker switch with right angle pc mounting. It is available as a SPDT or DPDT illuminated rocker, offering display in white, red, orange, yellow or green.

The illuminated rocker is unique in that it offers this right angle mounting printed circuit terminal. The switch offers the designer greater scope where internal instrument design requires tighter assembly.

For further information contact C & K Electronics, Office 2, 6 McFarlane Street, Merrylands, NSW 2160. (P.O. Box 101, Merrylands NSW 2160) Phone 682-3144

## Computer Pager

An unusual new computerized pocket paging system, with electronic memory, is now available for the first time in Australia. The Multitone system relays stored messages to a large number of users connected to the main terminal.

Multitone's Australian agent, Watson Victor Limited, the marketer of electronic medical and scientific equipment, is currently conducting pre-installation checks on the system prior to delivery to a major hospital.

The Multitone system is a computer paging terminal with digital voice synthesis. It is the first radio paging terminal to incorporate an audio response system for transmission of paging messages.

Six calling parties can simultaneously enter their paging requests through a telephone exchange into the paging terminal, while a conventional system allows access to only one user at a time. The system responds to each caller in a manner similar to time-sharing computer systems. The computer accept data from all calling parties and respond with the appropriate acknowledgement signals in real time. As far as the caller is concerned, he has full access to the system and all six callers receive the same attention simultaneously.

The paging terminal accepts only standardised messages from the telephone system (telephone extensions or room numbers) thus minimising the amount of air-time used in transmitting paging calls. A caller gains access to the paging terminal by dialling the paging access number. He then receives a system ready "hello" tone, indicating that the system is ready to accept address and message paging information. Then the terminal generates a "good-bye" tone, acknowledging acceptance of the completed call.

The synthesizer electronically verbalises numerical information dialled from telephone extensions. Messages are of fixed length, clear and highly intelligible. Numbers zero to nine are spoken.

Watson Victor Limited. P.O. Box 100 North Ryde. 2113. Phone 888-6188.

### Your chip's in the oven, dear

Another area where microprocessors are taking over is cooking. The General Instrument MPU is being used to control a new microwave oven.

The device controls cooking and defrosting, and even decides how much time is needed to even out the temperature in between.

There's a calculator-style keyboard to set up the program and a display for the time or the timing. The controls are 100% electronic, from the beep to the touch-control keyboard.

But experts say this is only the beginning, soon microprocessors will take over areas previously considered beyond the possibility of electrical or electronic control.

Read about microprocessors on pages 30 and 35 of this issue.



Manufacturers of: Electrical/  
electronic equipment, wound  
components and lighting  
control equipment.

## BRANCHES IN ALL STATES

FERGUSON TRANSFORMERS  
PTY. LTD.  
HEAD OFFICE:  
331 High St., Chatswood, 2067  
P.O. Box 301,  
Chatswood, NSW, Australia 2067  
Phone: 02-407 0261



# STILL AVAILABLE!

THIRTY FIVE SIMPLE PROJECTS IN ONE GREAT VOLUME!  
PLUS A COMPLETE BEGINNER'S  
GUIDE TO PROJECT  
CONSTRUCTION.

## VOLUME 1 SIMPLE PROJECTS from electronics today INTERNATIONAL

CONSTRUCTING ELECTRONIC PROJECTS . . .	5	DRILL SPEED CONTROLLER . . . . .	58
CONSTRUCTIONAL METHODS . . . . .	6	ELECTRONIC WINDICATOR . . . . .	61
CRYSTAL RADIO . . . . .	11	HI-POWER STROBE . . . . .	62
THREE SIMPLE RECEIVERS . . . . .	12	LIGHT OPERATED SWITCH . . . . .	66
ONE-TRANSISTOR RADIO . . . . .	16	CAR ALARM . . . . .	68
KILL THAT GHOST! . . . . .	18	ELECTRONIC FLASH TRIGGER . . . . .	70
TV MASTHEAD AMPLIFIER . . . . .	20	CODE PRACTICE OSCILLATOR . . . . .	72
FM ANTENNA . . . . .	25	ETI UTILIBOARD . . . . .	75
SIMPLE SPEAKER . . . . .	26	TRANSISTOR TESTER . . . . .	77
SIMPLE AMPLIFIER . . . . .	28	CANNIBALS AND MISSIONARIES . . . . .	78
SIMPLE STEREO AMPLIFIER . . . . .	30	WHY DOESN'T IT WORK? . . . . .	81
BETTER SOUND FOR \$5 . . . . .	32	POOL ALARM . . . . .	82
AUTO-AMP . . . . .	34	COURTESY LIGHT EXTENDER . . . . .	85
SURROUND SOUND . . . . .	37	RESISTOR COLOUR CODE . . . . .	86
SIMPLE INTERCOMS . . . . .	38	STANDARD VALUES . . . . .	86
MONOPHONIC ORGAN . . . . .	40	POTENTIOMETERS . . . . .	87
TWO SIREN CIRCUITS . . . . .	45	TAG TANTALUM CAPACITORS . . . . .	87
SPRING REVERBERATION UNIT . . . . .	46	CERAMIC CAPACITORS . . . . .	88
SIMPLE LOUDHAILER . . . . .	51	POLY-CARBONATE CAPACITORS . . . . .	88
BASIC POWER SUPPLY . . . . .	52	HOW TO SOLDER . . . . .	89
RESISTORS IN PARALLEL . . . . .	53	BUYING COMPONENTS . . . . .	89
FET DC VOLTMETER . . . . .	54	TRANSISTOR CONNECTIONS . . . . .	90
THINGS WORTH KEEPING . . . . .	57		

Newsagents have virtually sold out — but some copies are still available directly from Electronics Today International, 15 Boundary St., Rushcutters Bay, NSW. 2011.

Price \$2.00 (Plus 40c postage)





## New DMM

The new HP 3435A, 3% digit multimeter from Hewlett-Packard has a unique 'touch-hold' probe available as an accessory. It lets the user 'freeze' the reading on the display — a convenience when probing closely-packed circuit boards. Accurate enough for both bench and field use, the new digital multimeter features autoranging on ac and dc volts and resistance. Ac and dc current ranges are selected manually. Lighted front panel annunciators display the function and its units.

The standard HP 3435A Digital Multimeter with internal ac power supply and rechargeable lead acid batteries is priced at \$400 duty free, \$496 duty paid. Option 001 (ac mains power only, in custom plastic case) is \$335 duty free, \$415 duty paid. Option 002 (ac mains power only in a "rack-and-stack" case) is \$365 duty free, \$453 duty paid. The "touch-hold" reading probe is \$40 duty free, \$50 duty paid. The RF probe is \$87 duty free, \$108 duty paid. The high voltage probe is \$75 duty free, \$93 duty paid. Sales tax, if applicable, is additional.

## A Christmas present from Texas?

Our London office has sent us news of a big expansion into the consumer electronics market by Texas Instruments. They are launching sixteen digital watches, and a range of calculators. The prices are very competitive: watches from £16 to £32 (\$23 to \$46), with 12 of the range in plastic cases. In the calculator range there are items like a scientific calculator with 15 levels of parenthesis for £20 (about \$29).

Already these products are flooding the US market but here in Australia we're going to have to wait — at least until Christmas according to the TI office in Sydney.

## PCB SCANNER

A Sydney company specialising in the production of PCBs has purchased a sophisticated scanning device capable of both magnified and microscopic checking.

Known as VISTA (visual inspection systematic traversing apparatus) the ingenious equipment is capable of projecting ten-fold magnification of PCBs on a large screen with a microscopic attachment for full definition.

The PCBs are shown in natural colour and in stereo to enable easy identification of flaws or errors. Holes plated through can be checked and track dimensions measured direct on the screen.

VISTA was announced only last year by its inventors, Plessey UK, and its first sale in Australia to Printronics Pty Ltd. of Gladesville, has been made by the Professional Components Division of Plessey Australia, Villawood, NSW.

# 8000

reasons for joining

## THE WIRELESS INSTITUTE OF AUSTRALIA

- INFORMATION
- EDUCATION
- FREE MONTHLY MAGAZINE "AMATEUR RADIO"
- VALUABLE MONEY-SAVING SERVICES:  
Components, disposals, surplus gear — Magazines and books  
QSL Bureaux — Sales and exchange facilities
- Modest membership target is 8000 for WARC 79.
- REPRESENTATION
- ADVICE
- SOCIAL ACTIVITIES
- CONTESTS
- AWARDS

## GET WITH IT — GET FACTS NOW

For further information send this coupon to-day:



ESTAB.  
1910

W.I.A.

P.O. Box 150, TOORAK, VIC. 3142

ETI

Please send me details of how to join

Name.....

Address.....

Postcode.....



## 760 mm colour TV

The newly developed Sony Trinitron 30-inch colour TV tube is the largest ever produced in quantity. It's picture area is 82.5% bigger than a 635 mm (25-inch) tube. The tubes will be used in monitors and consoles for Sony videocassette recorders.

## Watch these prices

LED watches have taken the same price dive as did calculators a year or two ago. There's now a wide choice of good LED watches for less than \$50 and quite a few around the \$29.90 mark. Shortly they'll be around \$20.

Meanwhile apart from some price cutting on unsold stock the potentially more attractive liquid crystal watches are still way up in price. But now there's positive signs that LCD watches too will soon be down to the \$25-\$50 region. National, Microma and Fairchild have all introduced LCD watches (US\$45, US\$30 and US\$45 respectively).

Fairchild say that eventually LCD watches will sell for the same price as LEDs. We may well see a US\$20 LCD watch this time next year.

One LCD watch that will not sell for \$20 however is Seiko's model DK001M. This \$250 plus unit is pre-programmed to show the day month and year for the next 40 years. It takes into account leap years, and 28, 30 and 31 day months.

Now if someones metricates the Gregorian calendar . . .

## SEEKING OVERSEAS AGENCIES?

An invaluable service for importers and exporters is the International Trade Opportunities newsletter produced by Elmatex International.

The monthly newsletter lists manufacturers, exporters, importers etc seeking to arrange representation in countries all over the world.

If your buying, selling or seeking to manufacture under licence anything to do with electronics this newsletter is almost literally worth its weight in gold. See page 107 of this issue for details.

## What's all this about microprocessors?

In this month's catalogue and the one last month there are many pages devoted to microprocessors and in this issue we have two articles about these devices and the systems they control. The article starting on page 30 looks at the new hobby of programming and operating your own computer, your own microcomputer, based on a microprocessor chip. Next month the same author is writing us another article about the microcomputers he has built and comparing the commercially available 'evaluation kits' from the beginner's point of view.

The article starting on page 35 looks at the microprocessor unit (or MPU) itself and what it has to offer to people who now work with ordinary logic chips. Next month this author will continue

with more technical details, enough information for you to start reading the manufacturers' literature (and there's reams and reams of it about for those interested).

For some time we have been looking at the possibility of our readers getting involved with microcomputers but it was not until now that we have considered the Australian importers ready for the potential demand. For six months now our subsidiary edition in the UK has had a regular column for MPU fans, and we would like to know the views of the Australian electronics public so we can decide how best to serve them. So give us a couple of months to get over the introductions and let us know if you want more.

## Computer talk

Widespread use of spoken words to communicate with computers is forecast by EMI following the introduction of a low-cost data terminal which is operated solely by the human voice.

The Threshold 500 is designed to replace or complement conventional intelligent video display units or keyboard terminals both in minicomputer applications and large multi-terminal data processing installations.

The Threshold 500 is a refinement of the voice recognition technology incorporated in EMI Threshold's VIP 100 general-purpose minicomputer system. The new terminal is half the price and size of its larger stable-mate — the cost savings being achieved by using microprocessor technology. The standard 500 machine has a minimum vocabulary of 32 words or short phrases which can be expanded as required.

The training time is less than 10 seconds for each word. The repetition of each word enables the terminal to obtain an average voice pattern from the slight variations which occur each time the speaker pronounces the word.

In use, each operator calls up his own voice pattern, identified by a reference number. As each word is spoken, it appears on a visual display unit allowing the user to verify, at a glance, that the terminal has correctly understood the communication. If, when checking the data on the visual display unit, the operator discovers he has made an error, this can be deleted simply by using a second control word such as 'erase' or 'mistake'. The offending words are then cancelled allowing the correct data to be inserted.

The unit costs 6,500 pounds sterling (about \$10,000).

## Fuel injection ICs

Lucas, the British automobile electric company, have had two ICs designed for a digital fuel-injection system. They offer a plug-in replacement for analogue controls and use analogue sensors to monitor engine speed, manifold pressure and temperature. Rather than the five plots used by the analogue system to draw the engine's speed curve, the digital system uses 16 plots. It also interpolates eight manifold pressure points to give a quick response to the car's demands.

## NEW MATV STANDARDS

The Standards Association of Australia has released a new standard on multiple outlet television systems.

It will be most easily implemented in new buildings, the standard provides guidance also for the upgrading of existing installations.

Although standard AS1367 concentrates on technical requirements for MATV systems it may also be applicable in the future to CATV (community antenna television) systems. Since Telecom Australia has the exclusive right to construct telecommunication cables which cross property boundaries, prior authorization must of course be obtained for such systems.

Copies of AS1367 (\$2.40) may be obtained from the offices of the Association in state capitals and Newcastle. (Postage and handling 50 cents extra)

Continued on page 17



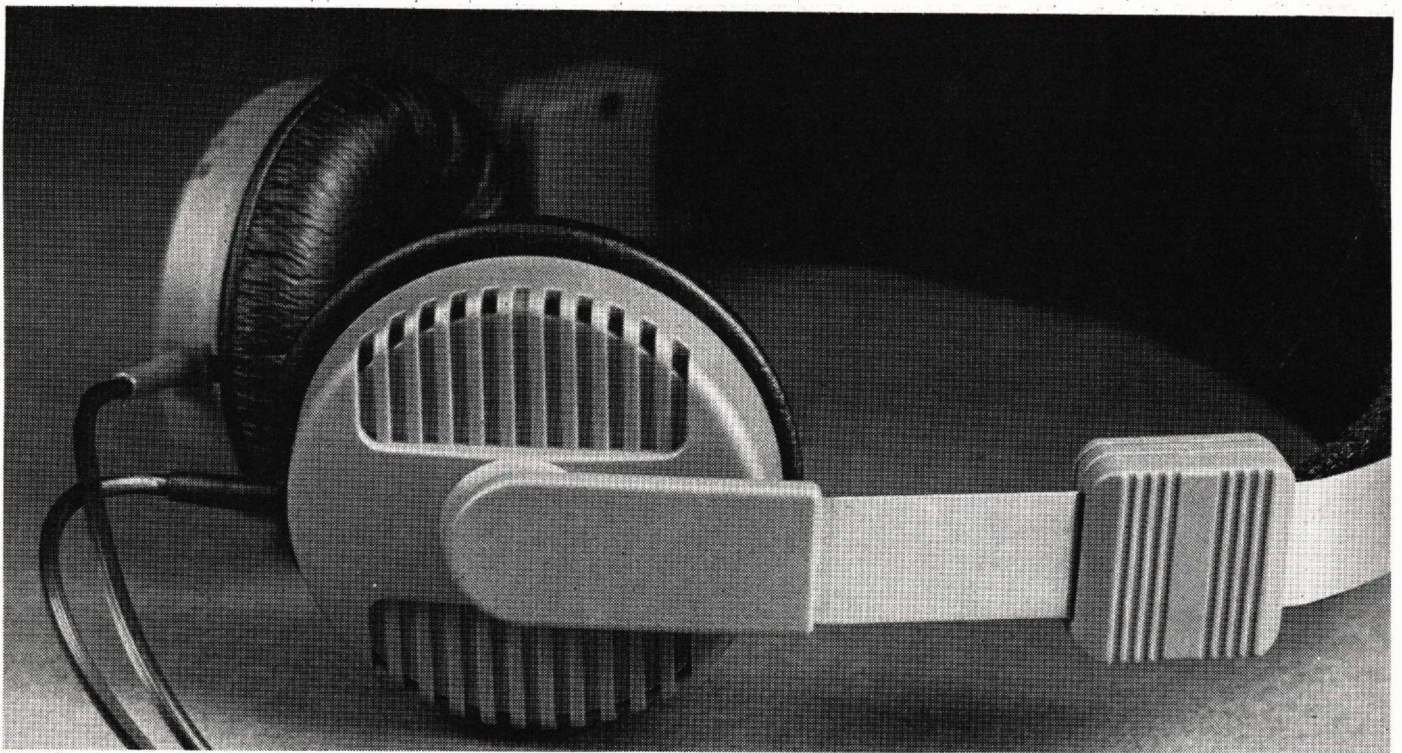

# Peerless PMB6 - remarkable realism equal to the best electrostatics

## New Peerless Orthodynamic principle - this is really living

With Peerless PMB6 headphones everything you hear is true. Based on the newly developed and patented Peerless Orthodynamic principle, PMB6 headphones deliver reproduced sounds equal in quality to the most sophisticated electrostatics. Peerless bring it back alive - sounds so real, you feel you're actually there.

## In one ear and in the other - in total comfort

There's nothing more annoying than headphones that clamp you in a head-lock. With Peerless featherweight construction, fine fit and pillow-soft ear pads, absolute comfort is certain over long time listening.

## Until you've heard it through Peerless - you just haven't heard it!

Between two perforated ferrite magnet discs lies an ultra thin diaphragm/voice coil. This light and very elastic diaphragm, whose total surface is put into motion, makes crystal clear high frequency reproduction possible. Its construction also ensures uniform phase characteristics and low distortion. The diagram below details this novel new design.

In your favourite piece of recorded music, you'll hear notes and nuances you'd never have believed existed.

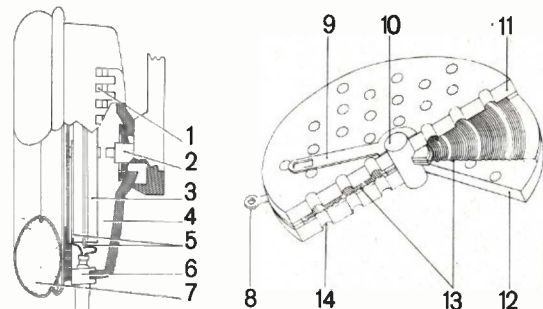

1. Air holes. 2. Ball joint suspension. 3. Drive unit. 4. Damping material. 5. Terminals. 6. Cable grip. 7. Ear pads. 8. Terminal. 9. Terminal. 10. Centre axle. 11. Magnet. 12. Magnet. 13. Diaphragm/voice coil. 14. Hole in magnet.

## Peerless PMB6 Technical Data

Frequency:	Range 16-20,000 Hz
Impedance:	140 Ohms
Max. Constant Load:	40 dB
Operating Power:	2.5 mW
Distortion:	1%
Rated Input:	2W (DIN)
Weight:	210 g
Colours:	Black, Red and Olive Green

**Peerless PMB6 \$49**

Electrostatic quality, superb comfort and a realistic price



Danish Hi Fi Shop 9, Southern Cross Hotel, Melbourne. Telephone 63 8930. Danish Hi Fi 698 Burke Road, Camberwell, Victoria. Telephone 82 4839. Convoy Sound 1 Maclean Street, Woolloomooloo, N.S.W. Telephone 357 2444. Convoy Sound 387 George Street, Sydney. Telephone 29 4466. Brisbane Agencies 72 Wickham Street, Fortitude Valley, Queensland. Telephone 221 9944. Danish Hi Fi 308 Walcott Street, Mt. Lawley, Western Australia. Telephone 71 0100.





## De-soldering problems?

The new Weller power vacuum desoldering station for printed circuit board repair. Famous Weller closed loop temperature control protects sensitive components while soldering or desoldering. See-through solder collector is easy to clean or replace. Non-burnable cord sets afford safety and longer life. Low voltage tool inputs give added safety margins. High impact resistant tool handles and stainless steel barrels mean longer tool usage.

Other members of The Cooper Group include Crescent, manufacturers of top quality electronic pliers; Lufkin, measuring equipment; Nicholson, precision files; and Xcelite, professional hand tools.

Whatever your requirements, you can choose Cooper products with confidence.

**Keep up the good work with a Cooper tool.**

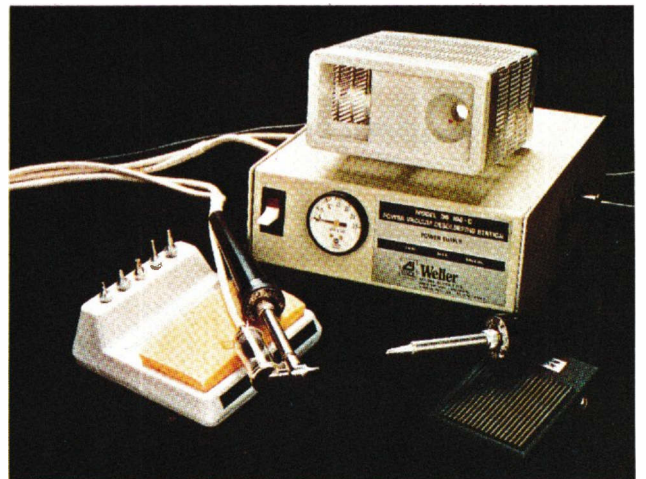

## The Cooper Group

CRESCENT · LUFKIN · NICHOLSON · WELLER · XCELITE

The Cooper Tool Group Limited, Nurigong Street. P.O. Box 366, Albury, NSW 2640. Telephone: 215511, Telex: 56995.





**NEW COMPANY IN MEASUREMENT**

Applied Measurement Australia Pty. Ltd. has been incorporated recently to manufacture and import electronic measuring equipment.

Sales and application enquiries will be handled in Sydney by Straintech Pty. Ltd. of 161 Galston Road, Hornsby Heights.

**CB's future**

The FCC says the expected expansion of the CB band in the US will not come before

next year. The present 23 channels could be expanded to 58 AM channels or, if SSB channels are allocated, possibly 99, 105 or even 115 channels. This expansion would be within the 27 MHz band but the FCC is looking at long term needs and the possibility of using much higher frequencies, like 600 MHz.

There are no signs of a Citizens Band being allocated in Australia just yet but we have heard of a recent increase here in the sales of CB gear imported from America.

**IC Sonar for \$10**

Engineers at National Semiconductor Corporation have developed a tiny-but-complete sonar system in the form of a special monolithic IC. The LM1812 transceiver contains a 12-watt ultrasonic transmitter and a selective receiver, including 10-watt display driver. Although such powers are relatively high for an integrated circuit, the package requires no heat sink.

Operating from a 12-volt battery, the LM1812 transmits pulses of about 200-kilohertz for approximately 800 microseconds through an external transducer. Between pulses, the receiver listens for an echo and drives a display with the resulting signal.

The LM1812 transceiver can be used in a number of applications that range from sonar (Sound Navigation and Ranging) to a kind of sonic radar known as "sodar" (Sonic Detection and Ranging). In a sonar system, the transceiver operates with a transducer immersed in water to detect submerged objects. Such a system can serve a fish finder to locate marine life, and it can accurately determine the depth of a body of water for keel clearance. In addition, it can be used for data transmission in hydro-acoustic communication links.

In a sodar system, the transceiver would operate with a dry transducer mounted in the atmosphere. A system of this kind can detect and track the level of a liquid that might harm an immersed transducer.

It can also be used in burglar alarm systems, intrusion detection equipment, and collision avoidance systems.

A single LC network is time-shared by the receiver and the transmitter to determine the exact frequency of operation.

This time-sharing arrangement eliminates expensive alignment procedures and permits the receiver and transmitter to track over the temperature range of the system.

The LM1812 transceiver can operate a variety of displays, including neon, LED (light-emitting diode) and CRT. The chip contains special circuitry to limit the maximum "on" time of the display driver. The transceiver also contains special access pins that permit the user to add an audible alarm that would indicate an echo within a desired depth or range.

The LM1812 is immediately available from stock in an 18-pin dual-in-line package. When purchased in lots of 100, the ICs sell for \$10.00 each.

For further information contact your nearest NS Electronics Office on Melbourne 729 6333; Sydney 93 0481; Adelaide 46 3928; Perth 25 5722; Brisbane 36 5061; Hobart 44 1336; Auckland 49 9448.

**ERRATUM**

Our advt dept made a bit of a mess of Logan Brae's advt on page 115 of our June issue. We inadvertently included their previously advertised Rambler Clock Radio which is no longer available.

Apologies to Logan Brae and also to readers who tried to purchase the radio.

**Write a limerick and win a calculator**

Permit number TC7578

In this month's ETI-Unitrex calculator contest we are giving everyone a chance. The calculator will go to the sender of the best limerick (the one that amuses us the most) about life in the next century. All entries must be in standard limerick form and the first line must be: 'In the year two thousand and one,' or something similar. Entries must be sent to Calculator Contest (August), ETI Magazine, 15 Boundary Street, Rushcutters Bay, NSW 2011, to arrive no later than September 10th, 1976.

The form of the limerick should be as in the following example:

There was a young lady named Bright,  
Whose speed was far faster than light,  
She went out one day,  
In a relative way,  
And returned the previous night.

By Prof A H Reginald Buller, FRS, first published in 'Punch'.

**This month's prize**

The winner of this month's contest will get a Unitrex 902RM 8-digit calculator. The features of this machine include square-root key, percentage key, four-key memory and green display.

**Result of the June contest**

The solution to this crossword is shown below. The winner of the Unitrex 901MR calculator is Gary Brunckhorst, of Brisbane. Clue 3 down seems to have puzzled many people, who knew of no telephone inventor other than Alexander Graham Bell.

The answer we wanted was Reis, Johan Philipp Reis, who was the first man to demonstrate the telephone publically. This he did in 1860 - a telephone made from a violin case, a barrel bung, and a sausage skin.

1	E	A	3	R	O	6	M
L			E				O
9	B	L	I	N	D		
O			S				E
W							M



# ELECTRONICS IN THE 2000 EVOLUTION OR By Peter S.

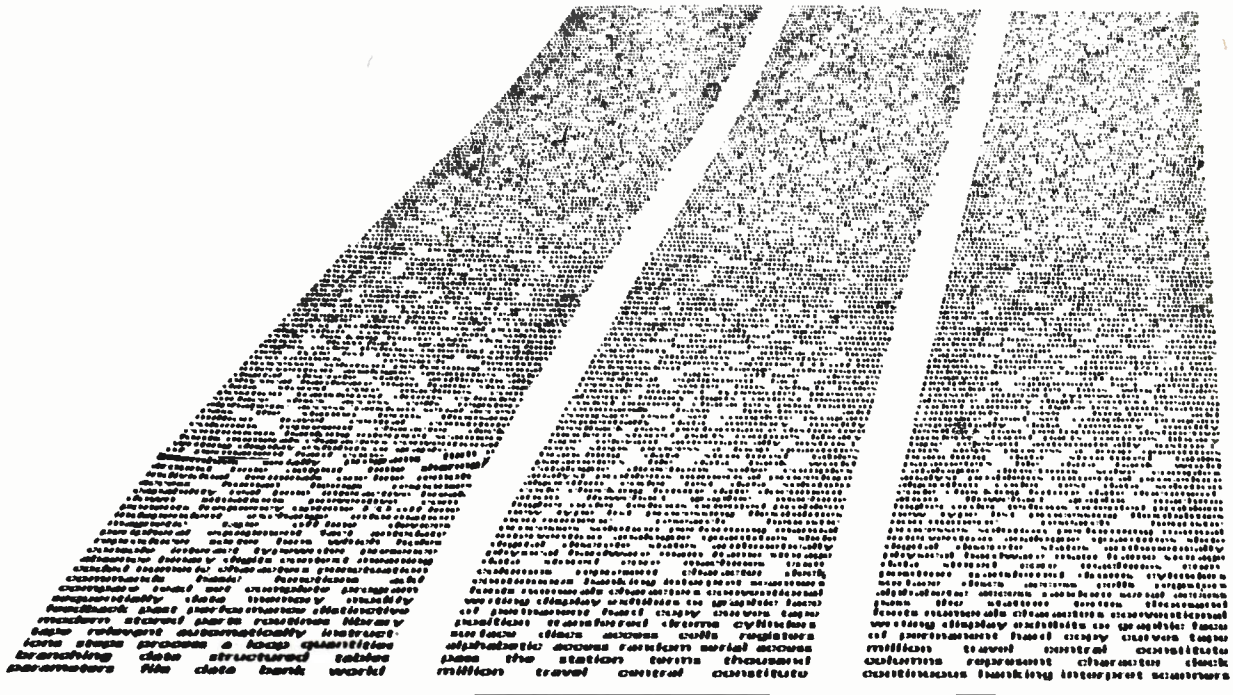

## YEAR 2000 A.D. — A LOOK INTO THE FUTURE OF ELECTRONICS

### Part 1. Forecasting — Fame and Fortune or Failure and Futility?

IT IS AN interesting and fascinating exercise to try and predict the future. Clairvoyance aside, this short series of articles investigates what we might expect to find ahead. It is a logical step to extrapolate into the future by studying the ideas of the past, but this does not necessarily produce correct answers. New inventions and discoveries markedly alter the pattern of progress.

### REASONS FOR FORECASTING

So why attempt a forecast? Many good reasons exist. One is to see if we like what we expect to see.

First we could go to the clairvoyant. Their history of correctness has often been amazingly good, nevertheless at our present state of understanding we can still put little faith in that method. A far more reliable way open to us at present is to systematically study the already proven possible, extending it to its naturally set limits.

This approach is logical and appears to have its roots in the late 17th and early 18th century writings of that great mathematician, philosopher and politician, Gottfried Wilhelm von Leibniz. His hypothesis about prediction was that events of the future are determined by the many events of today. We call this approach *determinism*.

Philosophers are still unable to resolve whether life is entirely deterministic or whether indeed there are factors that man will never

understand. Experience continues to demonstrate, however, that the more we look into processes the better we can determine the properties. It is safe to say a great deal can be predicted by using time extensions of current systems. The problem is the enormously large number of variables and interconnections; these make many a system virtually unmanageable as an accurate enough model. To illustrate this point, Fig. 2 is a copy of one of many simplified models proposed to simulate the economy of a country. The difficulties still to be overcome are to get correct and relevant input data and to ascertain if the model is detailed enough.

### ON BREAKTHROUGHS

Looking forward 25 years is not too great a step. Where a given currently existing state-of-the-art will evolve to



# 100 YEARS

YEAR

# 1900

# REVOLUTION

denham

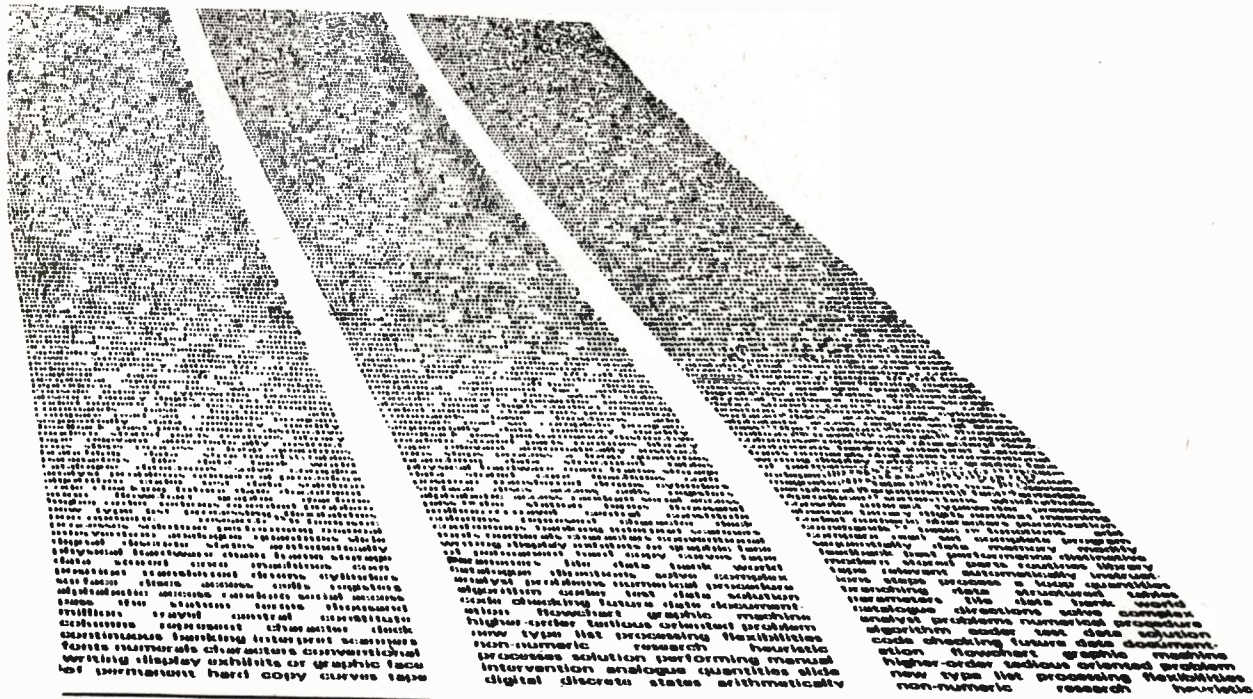

is often reasonably obvious to the adequately trained and involved person. The real unknown is the so-called "break-through" that changes the path of progress abruptly. Break-throughs are not usually brand-new concepts but ideas that materialise gradually from the maturing thoughts of many, finally coming to a head as an apparently "new idea".

Radio waves were predicted by mathematical means (that is they were seen to exist by studying a mathematical model of the physical situation) before they were demonstrated in practice. Even when we have the final stage of a new development within our grasp we may still be unable to harness it. Edison did not realise he had built the first vacuum-tube diode during his lamp experiments. Nearly twenty years had to pass before the idea was applied.

Faraday's experience illustrates that

breakthroughs are as much a release of man's mind into new areas of the possible as they are a really new discovery. The notice given in Fig.3 exemplifies changes in attitude. The late eminent scientist and Nobel Laureate, Sir George Thomson, skilled in physics, aviation and fuel research did not seem to conceive (in a 1955 prediction of his) inter-country communications without a massive network of waveguides or co-axial cables to convey the necessary bandwidth. And what about this futuristic statement on television from an earlier source:

*"It has been assumed by many and stated by some, that within a reasonable number of years, long-distance transmission, even across the Atlantic, will be broadcast regularly... so the sensational theories predict. The truth is that long-distance television of the type we*

know today is never likely to be practical or even possible."  
Alan Chappell, Discovery, February 1937.

Just as wild was this statement by Lee de Forest (who invented the triode around 1906). He stated in a New York Times article of 1928:

*"While theoretically and technically television may be feasible commercially and financially, I consider it an impossibility, a development of which we need waste little time dreaming."*

The art of the possible depends not only on human ingenuity but on the economic cost involved. Given a huge production run — great demand in other words — the cost per article falls remarkably. This, in turn, allows the basic idea to flow on into other areas of utility. The cheapness of domestic telephone components enabled many other sensors to be realised.



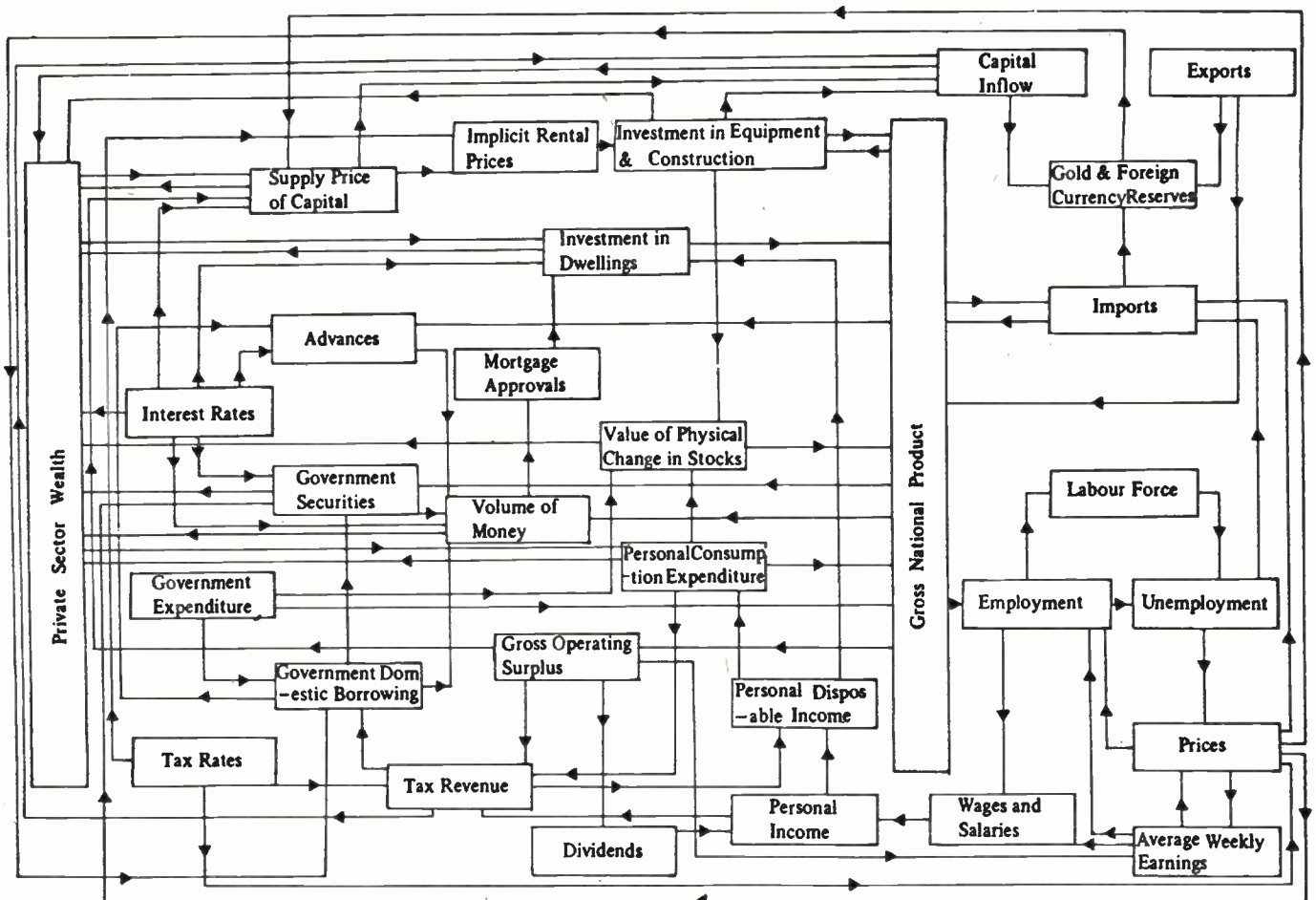

Fig. 1. A mathematical model — such as this one of an economy — provides predictions if the right input data can be fed into it.

**This Room Is Equipped With**

## Edison Electric Light

**Do not attempt to light with match, Simply turn key on wall by the door**

The use of Electricity for lighting is in no way harmful to health, nor does it affect the soundness of sleep.

BIRDWOOD MILL MUSEUM      BLUMBERG PIONEER PRESS

Fig. 2. This notice demonstrates how our minds need releasing to understand new ideas.

### ESTABLISHING THE STATE OF IGNORANCE

Another reason for attempting a forecast is because:

*"The first step to knowledge is to know that we are ignorant" — Cecil.*

By studying the likely new situations we usually reveal areas of ignorance. The subsequent process of research aiming to reduce this lack of knowledge often leads to improved development. We have a term for such studies — impact studies. A good historical example of this principle was the discovery of the more recently found chemical elements.

Antimony was discovered in 1450 A.D. by Valentine, a German alchemist. (Iron and several other common elements was known at that time, of course). A steady growth in the discovery of more elements continued. By 1900 about 90 were known to exist, many being added as the result of prediction based on the work of Mendelyev. In 1869 this

*Continued on page 22.*



# Top Disc Cutting Studios, like The Mastering Lab, rely on Stanton's 681-Calibration Standard in their Operations.

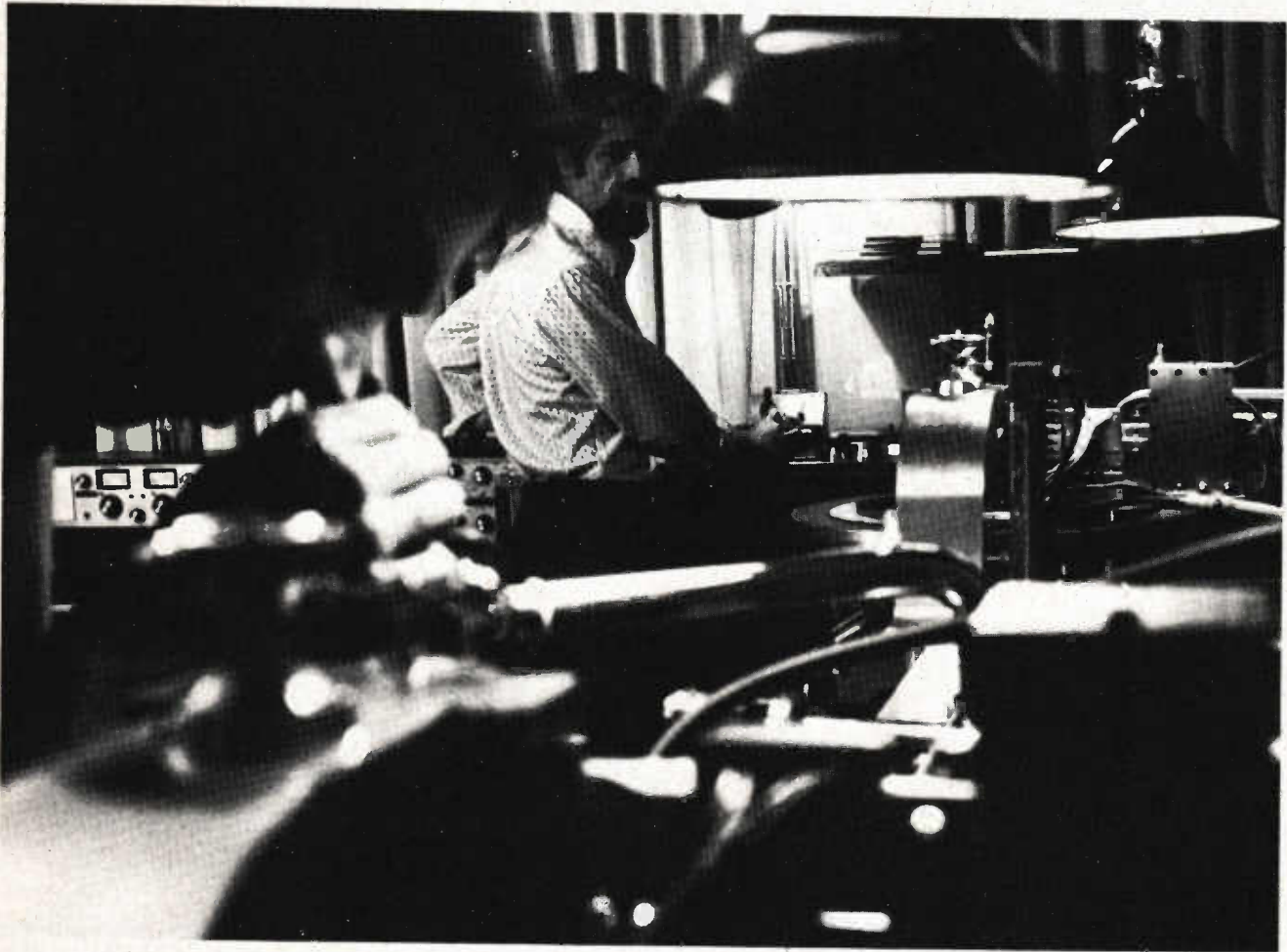

Not everyone who *plays* records needs the Stanton Calibration Standard cartridge, but everyone who *makes* records does!

At The Mastering Lab, one of the world's leading independent disc mastering facilities, the Stanton 681 Triple-E is the measuring standard which determines whether a "cut" survives or perishes into oblivion.

A recording lathe operator needs the most accurate playback possible, and his constant comparing of lacquer discs to their original source enables him to objectively select the most faithful cartridge. No amount of laboratory testing can reveal true musical accuracy. This accuracy is why the Stanton 681 Series is the choice of leading studios.

When Mike Reese, principal disc cutter at The Mastering Lab, plays back test cuts, he is checking the calibration of the cutting channel, the cutter head, cutting stylus, and the lacquer disc. The most stringent test of all, the evaluation of direct to disc recordings, requires an absolutely reliable playback cartridge... the 681 Triple-E.

All Stanton Calibration Standard cartridges are guaranteed to meet specification within exacting limits. Their warranty, an individual calibration test result, comes packed with each unit. For the technological needs of the recording and broadcast industries, and for the fullest enjoyment of home entertainment, you can rely on the professional-quality of Stanton products.



Sole Australian Distributors:



**LEROYA INDUSTRIES** PTY LTD

**Head Office:** 156 Railway Pde., Leederville, Western Australia 6007. Ph. 81 2930.

**N.S.W. Office:** 100 Walker St., North Sydney 2060. Phone 922 4037.

**VICTORIA Office:** 103 Pelham St., Carlton 3053. Phone 347 7620.

Available at quality conscious Hi-Fi dealers throughout Australia!





Colour TVs like this are possible now but they should be common to most households before the end of the century.

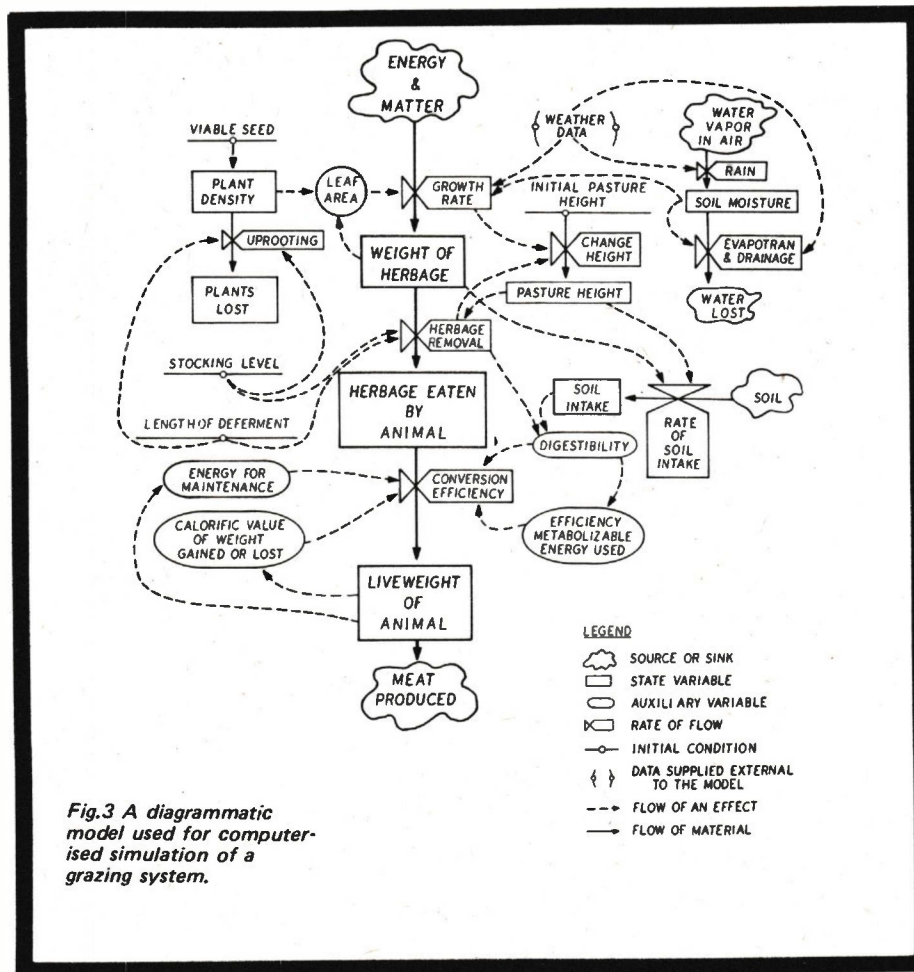

Russian chemist carefully studied the relation between all known elements of his time. He proposed the so-called periodic table which placed elements in the table according to certain properties. There resulted gaps in the table — such as the position of the noble gases (argon, krypton, etc.) where an element should be. Knowing the expected properties of these gases it was just a matter of time before they were isolated to further confirm the truth of the predictive framework proposed.

Germanium and gallium were predicted in the same way; before they were known to exist.

Knowing something about the fundamental properties of material before it is isolated in workable quantities does not always assure instant technological use. Silicon was discovered in 1823, germanium in 1886. Both were available to technology at the same time that the thermionic valve grew in importance (1910 onward) as the basis of a new discipline — electronics. It is not surprising that few people could realise in the 1950's that the germanium transistor, then just invented, would so enormously alter our visions by allowing the eventual use of mass produced dirt-cheap electronic systems.



## SCIENCE-FICTION

Good sci-fi writers — often come remarkably close to the truth about future developments. We cannot objectively assess how the writer arrives at the script but it is fairly safe to assert he or she does so largely by extrapolating current situations into time, throwing in innovations of their own.

Jules Verne and H.G. Wells wrote fiction that seemed fantasy in their time. Verne did it for amusement; Wells as a message. In 1865 Verne wrote "De la terre a la lune"; in 1901 Wells wrote "The First Men on the Moon". But even before then Cyrano de Bergerac had written two novels of journeys into space using jet propulsion — and that was around 1640.

These writers are able to throw off the bonds of the establishment, to imagine other societies, other uses of technology. Robots, in mechanical master form, go back at least to Mary Shelley's Frankenstein (1818). To the society of the day such figments of the imagination — they could be little else at that time — must have been a most frightening concept. Today we regard such horror tales more as humorous recreation than likely fact.

One major difficulty with science-fiction predictions is that we cannot begin to devise tests of confidence of their validity beforehand because this mode lacks an objective scientific basis of arriving at the result. Intuition can be so wrong and 'gut-feelings' are hard, extremely hard, to justify to others.

## THE ACADEMIC APPROACH TO FUTURE'S STUDIES

A significant number of Universities and other tertiary teaching institutions offer courses in the various aspects of what is collectively known as future's studies. Many topics qualify for inclusion — technology forecasting and assessment, cross impact analysis, policy studies, demographic projection, statistical prediction, economic forecasting, systems studies, peace studies, morphology, utopian literature, science fiction and even gaming are each relevant to prediction making.

Academic studies — many hundreds of courses exist — attempt to put forecasting on a firm objective basis. There is, however, as yet, little evidence that the various methods are indeed reliable enough to be entirely worth the effort. Key methods in vogue today include the following:



### NEW ATLANTIS

- |  |  |
|--|--|
| a. Wildfires burning in water                            | i. Gardens bearing more speedily than their nature       |
| b. Engine houses to study motion                         | j. Animals bred both greater and smaller than their kind |
| c. Ability to fly in air                                 | k. Fruit much larger than its nature                     |
| d. Instruments for seeing distant objects in the heavens | l. Aids to improve hearing                               |
| e. Light intensified and thrown great distances          | m. Sound houses for studying sound                       |
| f. Glasses to see small bodies perfectly                 | n. Sound conveyed in tubes over distances                |
| g. Perspective houses to study light and color           | o. Deep caves for refrigeration                          |
| h. Pools to strain fresh water out of salt               | p. Ships sailing under water                             |

"New Atlantis". Time-Life artist's recently drawn conception of inventions proposed by Bacon in his 17th Century work "New Atlantis" in which Bacon described his Utopia of the future.

**Technology forecasting and assessment (TF or TA):** This is used in military and business with interest arising in government and corporate planning. The methods employed relate to reasonably measurable quantities such as a business operation or advance in a certain kind of technology. It has the merit of being confirmable with time as its standards and norms remain much the same with time.

**Systems theory and analysis, dynamic modelling:** The system under study is progressively isolated from the rest of its environment. Black boxes are drawn and interconnected such that they represent the input to output changes of the variables flowing around in the total system. The system has inputs, outputs, transfer functions and measured variables as depicted by the example given in Fig.3 The next step is to transform this form of model

to a mathematical, rather than notional one, and begin computation to get the dynamic state of each part of the system.

Even the simplest systems handled this may soon tax human powers to handle the data conversions. Mammoth computing ability enables complicated systems to be set going into the future (the time scale being stepped up beyond real time). One example of the use of this form of simulation is when it is employed constantly to check the future stability of nuclear power stations — as based "on past to current" data. But such a system must have correct measurement inputs to give correct answers.

**Cross-Impact analysis:** This is, in essence, a type of systems analysis because it is based on the premise that



# Electronics 2000

"everything is connected to everything else" and has impact on each other.

The users of cross-impact analysis devise a "mathematical matrix that expresses the probability of occurrence of a number of possible developments and represents the direction and strength of the impact one occurrence would have upon the probability of another."

An example of an impact was when silicon became so significant to us as the transistor circuit element. The matrix contains all of the many impacts involved, expressed as probability values ranging from 0 to 1.

**Delphi technique:** Most people are familiar with the "think-tank" idea of generating ideas. A group of people, each expert in a specific area and each overlapping a little, meet to talk-out a scheme that will fulfil a stated need. Although this concept works reasonably well it only does so if the people involved blend satisfactorily from the human relations and sociological points of view. There is great risk that the individual views become influenced by those of the others.

In a Delphi study the experts do not meet, nor know who else is involved. Each answers questionnaires sent to them by the co-ordinator who has control over the feed-back between experts. The study passes through several 'rounds', as decided by the co-ordinator, until hopefully a consensus viewpoint emerges.

It was first developed in the 1950's by Olaf Helmer, who subsequently became Foundation President of the "Institute for the Future" in Connecticut, U.S.A. Delphi style studies have been used in education, sociology, science, weapons systems, customer choice plus many more. It is also the basis of assessing the worth of research-grant applications which by their nature, are predictions made by the applicant of what is felt should and can be achieved. It is essential that the experts are truly expert in the field of interest and that they have the flair for forecasting.

The Delphi method does, however, lack that competitive and inventive situation wherein an idea expands to a maturity by constant innovation working on the basic premise.

**Experimental Learning, Creativity, Scenarios, Simulations:** These are rather loose academic exercises (soft as opposed to hard thought processes are involved) wherein, as the names

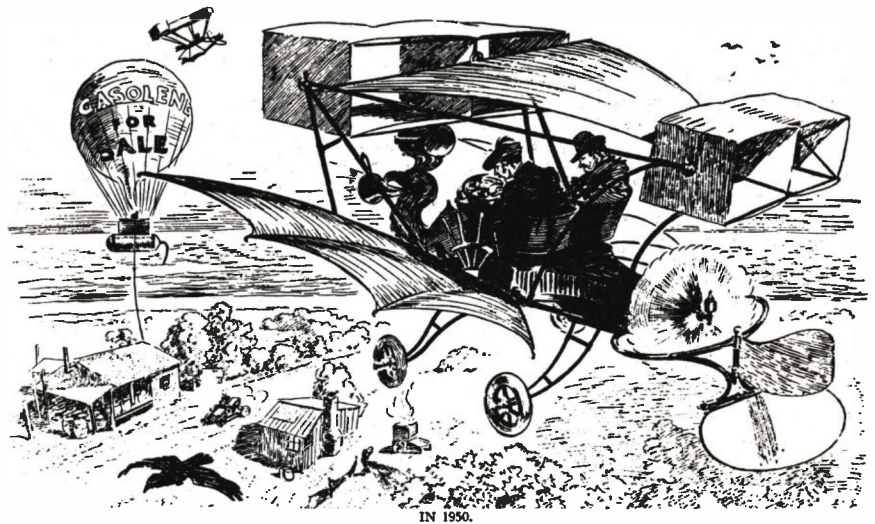

"Why, there's a car! How funny it looks!"  
"Yes. That's old fossil Jones—says he can't stand these newfangled notions."

Fig. 4. A 1907 cartoon predicts aircraft will replace the car by 1950.

suggest, participants exercise artistic, intuitive skills to create new situations. Mock-up models of future cities may be built to investigate their design. Museums of the future exist in Denmark and the U.S. These methods use speculation based on reason and judgement; a game of "if".

For all of the academic effort that has been put into the design of techniques and the now many courses, the situation has been summed up as "some past futurists were amazingly accurate, others amusingly inaccurate", Langley, 1975, U.S.A.

## FORECASTING SUCCESSFUL OR NOT?

Some forms of forecasting have been notably successful. Weather forecasts are more right than wrong today. Tides in the seas between Britain and the Continent can be predicted to a point where dangerously high tides can be forecast several days ahead. It was not so long ago that weather forecasting to such precision would have been regarded as fantasy. We must not lose sight of the fact that fantasy is only such because of ignorance of some aspect of physical manifestation. We are more likely, at this instant in time, to be able to correctly forecast well-known physical phenomenon than the ill-defined sociological issues because we have more knowledge about the deterministic variables.

In this first part, we have explained the various methods of forecasting. Very few of even the most objective methods will, however, tell us much about less tangible things such as the way of life ahead. The various methods are applicable to business and military ventures, to applications where enough parameters of the system are in close enough control of the forecaster.

We now look at some more successes and failures of past forecasting.

**Electric Lamp:** After a discourse on the difficulties of manufacturing incandescent electric lamps, James Swinburne had this to say in 1904:

"A new invention that wants a great deal of working out has against it all the experience and knowledge gained in old manufacture: so unless it is very much better on the face of it, it is not worthwhile troubling about it."

His article suggested that electric light was not worth the development effort!

**Telephone:** We all have witnessed how the telephone has changed the style of commerce, how it led to radio and then to the television. But did you know Bell was regarded as an "imposter", a "ventriloquist", "a crank who says he can talk through a wire". The Times, of London, said it was humbug. Lord Kelvin greatly helped Bell by issuing a statement that is regarded as the Charter of Telephony. In it Kelvin wrote:



"With somewhat more advanced plans and more powerful apparatus, we may confidently expect that Mr Bell will give us means of making spoken words audible through electric wire to an ear hundreds of miles distant."

**Rockets:** In 1955 Lord Thompson wrote:

"It is doubtful if such a large rocket (8000 tons to give one ton freedom of space was predicted) would be practical, though von Braun, the designer of the V<sub>2</sub>, has seriously proposed one."

Apollo missions use Saturn rockets weighing over 3000 tons to launch a comparable payload.

**Aircraft:** A reversible plane was devised in 1922 with two tails, two fuselages and which could reverse direction in flight. Later, in 1932 Captain Dibovsky, a Russian, designed a plane that could rise vertically into the air and could land on a roof-top, or a river. These ideas were not sound as presented then, but today we have the Hawker-Harrier jump-jet that achieves at least part of the aim of these earlier inventors. In 1907 the cartoon, shown in Fig.4, appeared predicting the decline of the car in favour of the airplane. It was drawn, however, just one year before the "Tin-Lizzie" put motor transport within the working-man's reach.

**Writing:** And who would have thought that the 1950's new-fangled writing pen of the Biro brothers would have found such overwhelming acceptance in our civilisations.

### THE VARYING PACE OF DEVELOPMENT

To illustrate the varying rate of change experienced in a development let us look at some pictorial views showing successive development of the pocket-sized calculator.

The pocket calculator begins its history with the Ancient Greeks who made a calendrical computer in the tradition of planetarium construction (known as the Antikythera mechanism and dated ca. 80 B.C.). The abacus is also extremely old in origin. Other mechanical machines, such as Pascal's many variations shown sketched in Fig.5a, followed — employing small degrees of innovation and change. The real change in attitude came with the Babbage engine developments starting in 1830's. His ideas were sound but machines such as that shown in Fig.5b could not be built at the time. By the

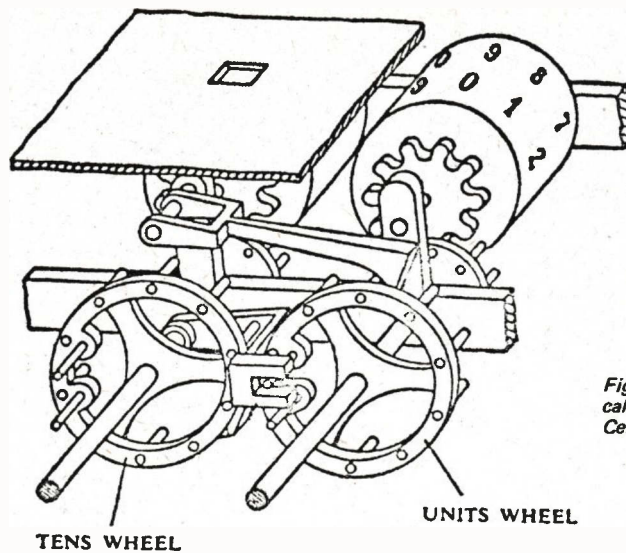

Fig. 5 (a). Sketch of a Pascal calculating mechanism (17th Century).

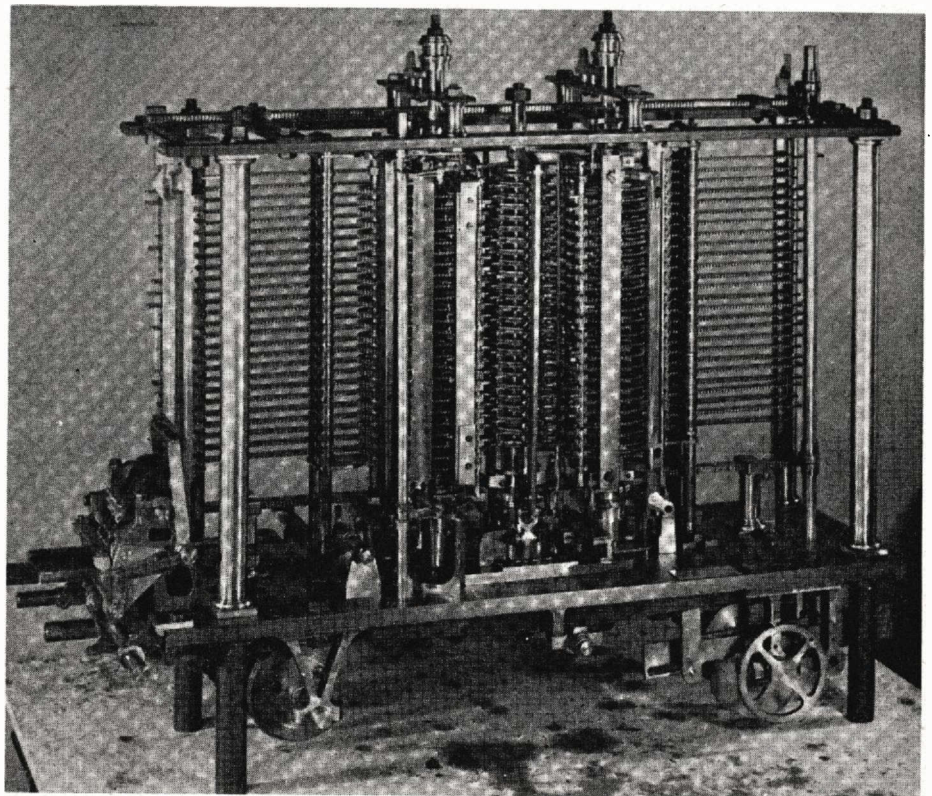

Fig. 5(b). A Babbage engine — by incorporating storage the design significantly advanced computer technology.



# Electronics 2000

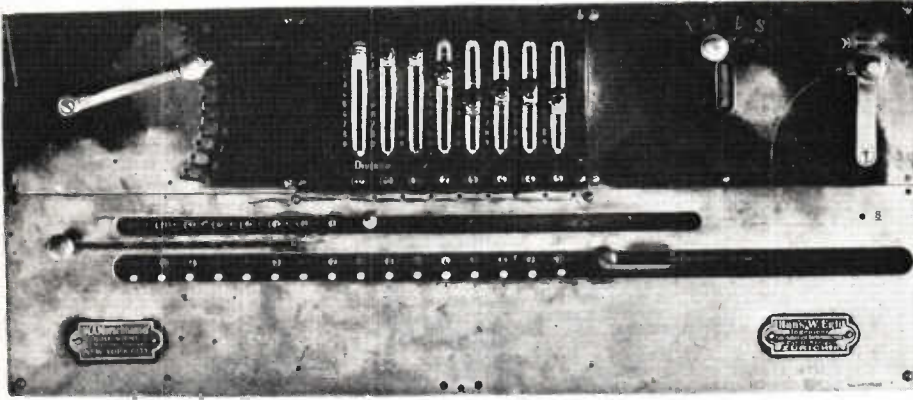

Fig. 5(c). Working face of "Millionaire" calculating machine (1890's).



Fig. 5(d). Handcranked mechanical calculators were commonplace in the early 19th Century.

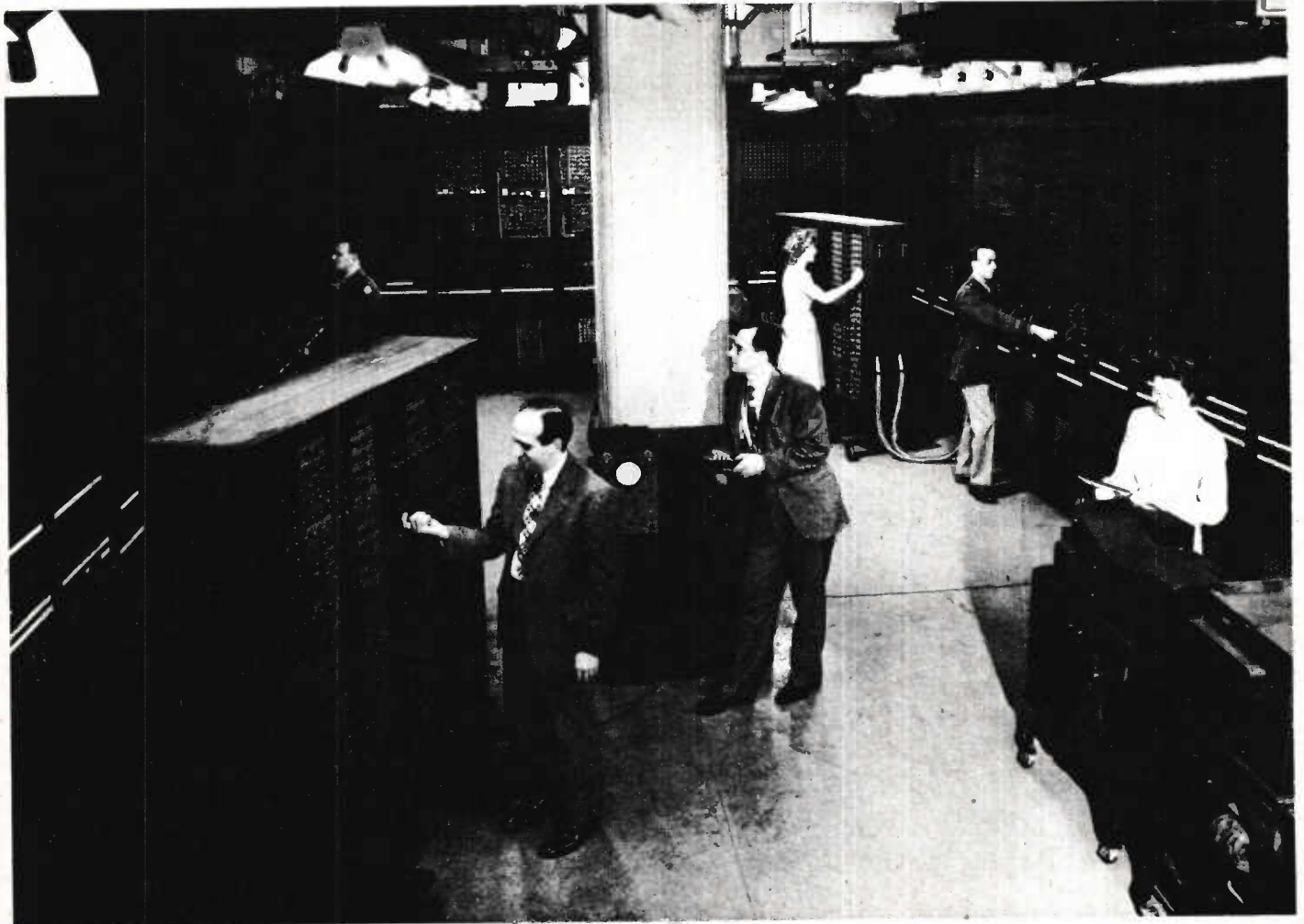

Fig. 5(e). The first electronic computer - ENIAC, at Moore School in the U.S. (dedicated 1946).



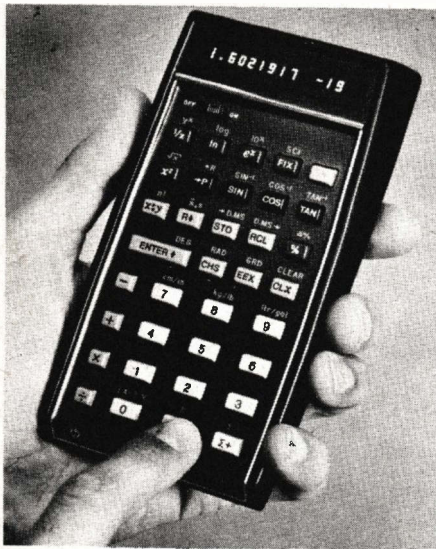

Fig. 5(f). Programmable pocket calculators have undreamed of computing power.

turn of the century workable mechanical calculators were in common use. Figure 5c shows the "Millionaire" which was first marketed in 1893. Until the 1950's mechanically cranked mechanical calculators, such as shown in Fig.5d were widely in use for all manner of calculation. Then came the electronic versions based on valve technology, Eniac being the first general-purpose electronic calculator. It was begun in 1944, and, as Fig.5e shows, was hardly portable but had much greater capacity to compute than any mechanical machine. Pocket electronic calculators became closer when integrated circuits enabled the release of the desk-top style, densely-packed (by the then standard) minicomputers of the late 60's. Then came, the truly pocket calculators of today. Today we need not regard complex calculation as a limitation of an objective. Half a week's wage now buys extraordinary capability, at least as much as cost many hundreds of year's wages just thirty years ago. Computers cannot become much more compact — or can they? We have yet to build replicas (see Fig.5g) of Nature's calculators using electro-chemical signal processing!

What were the breakthroughs? They seem to be when Babbage laid the ideas for improved and advanced computing machine structure, when electronics was able to do the mechanicals job, and later, when solid-state methods allowed extremely



Fig. 5(g). Further computer development maybe along electro-chemical lines — a section of physiological nerve cells in a slice of cortex. Cells are stained to show as black areas.

cheap, vastly complicated, circuits to be made.

#### Further reading:

##### Forecasting Techniques

"And Now the Future — A PEP Survey of Futures Studies" — C. de Hoghton, W. Page and G. Streatfield. PEP Broadsheet 529, Vol. XXXVII, August, 1971. (PEP — Political and Economic Planning).  
 "Delphi Critique — Expert Opinion Forecasting and Group Processes" — H. Sackman, 1975, Heath, Indianapolis, U.S.A.

##### Futures Studies Education

"University Education in Futures Studies" — H. Wentworth Eldredge, The Futurist, Vol. 9, no.2, April, 1975, p. 98-102.  
 "University Education in Futures

Studies — A Mark III Survey" — H. Wentworth Eldridge, Futures, February, 1975, p. 15-30.

"What is the Future of Futurology" — A.W. Black, Aust. Journal of Social Issues, Vol9, no.4, 1974, p. 262-272.

##### Futures Studies Journals

"Futurist" — a journal of forecasts, trends and ideas about the future (for the World Future Society, Washington DC, U.S.A.)

"Futures" — the journal of the "Institute of the Future" U.S.A. (published by I.P.C. Business Press, U.K.).

"Space Flight" published by the British Interplanetary Society, London, UK. It concentrates on spaceflight with occasional articles on futurists themes. An interesting article is "Just Good Friends?" A. Farmer (A



# Electronics 2000

review of speculative fiction and its influence on astronomical thought). *Space Flight*, Vol.17, no.11, November, 1975, p, 395-402.

## Breakthrough and invention

"Discovery by Chance", M. Batten, Funk and Wagnalls, New York, 1968.  
"Ideas and Invention", E. Larsen, Spring Books, London, 1960.  
"A Computer Perspective", C. and R.

Eames, Harvard University Press, Massachusetts, 1973. (A pictorial study of the development of data processing and computing hardware).

## Predictive Articles and Books

"The Foreseeable Future", Sir George Thomson, Cambridge Press, 1955, Cambridge, U.K.  
"The Scientist" — Chapter 7 — "The Bounty of Technology" — discusses the role of technology in the future

including a number of highly amusing cartoons taken from past magazines. *Time-Life*, 1966, Netherlands.

"Ideas and Inventions", (see above) has a concluding chapter on this theme.

"The World of Tomorrow", K.K. Goldstein, Collins, 1969, London. (A seriously compiled, profusely illustrated, discussion of many aspects of futurism).

***"Try this deal with anything less than a 4 x 5 format camera and you'll end up gladly preferring brake-failure on the Bulli pass!"  
A day in the life of our cover photographer, George Hofsteters.***

"Invention is one per cent inspiration and ninety nine per cent perspiration", some philosophical clown once muttered in his armchair. Had the author of that platitude been given this month's cover to attempt, I think he'd have ended up cutting out paper dolls as I almost did. It was more like ninety nine per cent inspiration, plus ninety nine per cent perspiration, plus ninety nine per cent frustration and a degree or two of infuriation. "But get to the technicalities and to hell with Art!" I hear you cry. So be it.

The cover concept: Symbolise electronics past the threshold of the twentieth century. Marvellous! Several fist fights and arguments with pliable editor and co-editor later, the dust settles and the idea clears the mangle. A groovy door, a superimposed circuitboard blend, and a nice pseudo hieroglyphic through the stonework for old/new flavour. A word of caution. Try this deal with anything less than a 4x5 format camera and you'll end up gladly preferring eye-strain, failure and insanity.

The first step was obvious. I got the doorway dimensions scaled down proportionally from cover size down to actual work size on a sheet of 4x5 paper. Then a sheet of clear acetate was placed over the pencil drawing of door and brick dimensions. After copying the pencil guide in ink, the acetate guide was locked in place over the ground glass viewing screen. At the door location I got the monorail in position, adjusted all rise/fall swing and tilt functions in place till the image size was in proportion to the cover dimensions. I then removed the acetate guide and replaced it with another clear sheet, and drew in the actual door image. Knowing I would be working with a mongrel lighting set up (mixture of daylight and artificial) I chose Extachrome Daylight 6115,50 ASA film, for the simple reason that I would get the mood (saturation) and colour shift away from normal balance that I was after. Type B (artificial) film with the appropriate filtering was not for this job, because it would have delivered correct and therefore sterile colours. In went the slide-holder, half a stop under for effect, a lightning quick sign of the cross, and click away went the shutter at f/32 (for depth of field). The easiest part was over.

Back in my studio, the black background, spot-meter, slide-projector and pocket calculator were at the ready.

Five hours or so later the place looked like a Nagasaki brothel after the event. I blacked out a piece of still card, fixed the pc board to it and angled it away from the camera. Isolating a small rectangle in an empty 35mm slide, I eventually got the light to just contain the pc board dimensions. The camera lens and light source were almost at right angles to each other, so no problems with glare, flare or extraneous complications. Now came the big gamble. Would the colour shift be acceptable? Would the exposure kill off either image at the expense of the other? To make the pc image convincing, I had no option but to shoot at no less than f/32. Very slow. Two more complications. Fully extended bellows and reciprocity failure. Out came the trusty calculator. Out came the trusty bellows correction formula:

$$\frac{\text{Indicated f-number} \times \text{focal length (inches)}}{\text{Bellows extension (in inches)}} = \text{effective f stop}$$

The manufacturer's recommendation for speeds longer than 10 seconds suggested an additional two stops for reciprocity failure. So, effectively, I had to allow for 4 stops extra for correct exposure, making it 30 seconds at f/45. But correct exposure would have made the board dominant, so I gambled on one stop less, making it 15 seconds at f/45, and one of the most insecure moments in my life. I just hoped that the board registration with the door hinge area would be compatible. Last but not least, the super of the diagram over the stone block. Darken the room, isolate the diagram with appropriate masking off a 35mm slide holder, eight seconds at f/32 (one stop under) and the whole trauma is in the can. A restless night's sleep, three hour's worth of cigarette butts on the processing lab's floor later I clawed open the package to reveal not the abortion I had imagined, but the product of a risky little gamble that paid off. The editor was pleased, my cat was pleased and even I, to some degree, was temporarily content. And to anyone who isn't all that thrilled by it all, if you don't like it, you can shove your f/stop right up your bellows extension and I hope it gives you eye strain and reciprocity failure.





## With these two there is scarcely a radio service job you couldn't handle

The Philips PM 6456 FM stereo signal generator and PM 5324 RF generator are fully compatible instruments for use in workshop or on call. They offer precision and versatility at a remarkably competitive price. With them you are equipped to diagnose practically every problem ever likely to be encountered in AM, FM and stereo servicing. Check these features for yourself:—

### Philips PM 6456 FM stereo generator

- complete stereo signal
- separate L and R signals
- internal LF modulation: 1 and 5 kHz
- external modulation facility
- X-tal controlled pilot
- adjustable amplitude of multiplex signal
- tunable 100 MHz RF signal

### Philips PM 5324 RF signal generator

- frequency range 100 kHz-110 MHz
- X-tal calibration
- special band spread ranges
- high frequency stability
- electronically stabilised output
- calibrated output attenuator
- facilities for internal and external AM and FM
- wobbling with sweep width control
- simultaneous AM and FM
- big easy to read illuminated dial with LEDs to read range

### And servicing TV too... ... with the PM 5334 sweep generator



This highly versatile TV sweep generator allows quick and easy alignment of colour or monochrome receivers in the workshop or on call. Its excellent specification makes it ideal for service and small production departments, as well as development and educational establishments.

**Features include:** ● radio and TV service equipment 8 frequency ranges, 3 MHz-860 MHz ● sweep frequency adjustable, 8-50 Hz ● one variable and three fixed markers ● signal frequency is highly accurate and thermally stable ● stabilised output into 75Ω load ● built-in floating bias source  
If you would like further information send in this coupon:

Philips Scientific and Industrial Equipment—  
Test & Measuring Instruments:  
P.O. Box 119, North Ryde, 2113.

Please send me further information on:

- PM 6456 FM stereo generator
- PM 5324 RF signal generator
- PM 5334 TV sweep generator

NAME \_\_\_\_\_

ADDRESS \_\_\_\_\_

TEL \_\_\_\_\_



**Test and  
Measuring  
Instruments**

# PHILIPS

38.2639



There is a new hobby sweeping America and it is now poised to invade Australia

# MICRO COMPUTERS

Operating and programming your own digital computer.

By Kevin Barnes

This article describes an area of electronics not yet established in this country. Consequently we have to use examples and photographs taken from overseas. But this is the kind of thing will soon be common in Australia and future ETIs will no doubt tell the tale . . . .

THANKS TO TECHNOLOGICAL advance in LSI manufacturing and the low costs of mass production, the micro-computer is now within the reach of the average person. At a cost of only two or three weeks wages, these machines are giving private individuals in America the means to exploit and enjoy a pastime that only two years ago was restricted to the very rich or privileged (i.e., those working in the industry).

It all started when minimum system microcomputers appeared on the market. They were more specifically aimed at companies that needed systems,

but didn't want the expense and worry of design and development. But many were sold to individuals who wanted first-hand experience of a new technology, or who were dedicated builders who had worked their way through radios, oscilloscopes, digital clocks and television sets and now relished the challenge of a digital computer. Realising the potential of a new market, several companies developed systems they thought would be suitable, and offered them for sale. The response was for thousands of Americans to buy and install them in their homes, boats and cars. Because of their high speeds

(in excess of 100,000 operations per second) and versatility, owners found uses almost too numerous to mention, and were rewarded with fun and profit. Some used their computers to run train sets. By having a number of train manoeuvres pre-programmed in the computer, they were able to direct their trains to more complex and realistic operations. Routines in the program were used to create hills, slopes, etc: conditions closely approaching those in real life.

The computer also allowed operation by one pair of hands where several pairs were needed before. For example,



No, you can't use it for your homework . . . I'm loading in tomorrow's runners at Randwick.

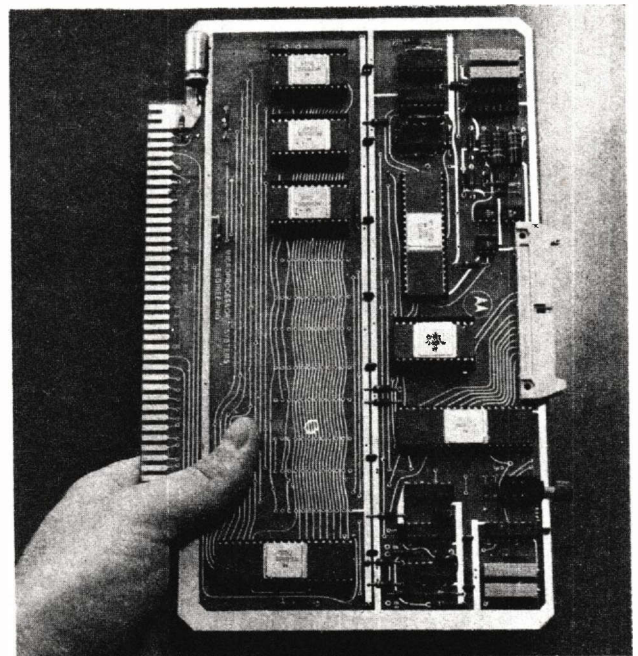

This is what an evaluation card looks like. This is built up from the Motorola evaluation kit (the MEK). You can see space on the board for adding extra memory or developing a system.



one man used his computer to control the stage lighting for his local drama club. With all the lighting set-ups pre-programmed, the transition from one set-up to another required pressing just one switch where before several switches were needed. This allowed more lighting changes with less chance of error.

There is also a growing group of amateur radio operators who communicate to one another via their computers. Their machines allow them to translate directly from morse to written text and from the keyboard to a modulating signal. They are also using program routines to look for errors and improve readability. With their high speed, these same devices monitor the operation of the radio shack and keep the log. Amateurs have also gained permission from the FCC to exchange information using the ASCII code (the most common general purpose code used in the computing industry). And there has been at least one report of a pair of amateurs communicating via their computers and ASCII through the OSCAR orbiting satellite.

### Complex games

Many people are using their microcomputers to play games. The computer can be used to play against or as a means of playing (as one would use a monopoly board or a pair of dice). The variety of games range from simple ones like Two Up or Roulette to more complex games like Poker or Checkers. But the most interesting games are the simulation games, where the program makes the computer behave as if it was a completely different machine, such as a car or an aeroplane. Here the switches on the front panel of the computer become the controls of the car or spaceship and the operator becomes the driver or astronaut whose skill must now be put to the test.

Simulation is not limited to mimicry of machines. It has also been used to reconstruct events. Popular games of this type include running horse races or playing a game of basketball. Then there are the popular war games like 'Tanks and Artillery'.

The hobbyists are also finding practical uses for their systems. The system used for playing poker during leisure time can become an elaborate burglar or fire alarm at night. Or it can be used to teach children maths. The computer can put a question to the student and later correct his answer before going to the next question. It can also keep a record of what questions could not be answered. Valuable feedback to act upon!

### Business

Business and engineering programs suitable for home machines are now starting to appear. They vary from simple programs to calculate interest to elaborate ones that are almost a complete accounts system. This allows the computer owner a chance to recover some of the cost of his machine. The engineering programs are equally varied and range from a simple random number generator to programs capable of performing circuit analysis of groupings

of over 100 components.

As the numbers of hobbyists have increased, computer clubs have sprung up to help them. Here individuals get together to share ideas and to swap software (programs) and to compare their efforts with those of others. Clubs have also been formed where all the members own the same brand of computer; this is a characteristic of the computer industry where they are called 'users groups'.

Three applications for microcomputers . . . these examples are taken from a Motorola ad which appeared in a US magazine. All these systems use the Motorola 6800 microprocessor.

#### HONEYWELL

*Vehicular traffic management is recognised as one of the great practical transportation problems. Honeywell attacked this problem with the programmable, multi-purpose, Type 140 controller for both intersection and freeway ramp applications. It has the speed, capacity, and versatility for uses from simple, fixed, time control to sophisticated, traffic responsive, centrally directed operation, yet it's low cost. The central processing unit is Motorola's MC 6800 microprocessor.*

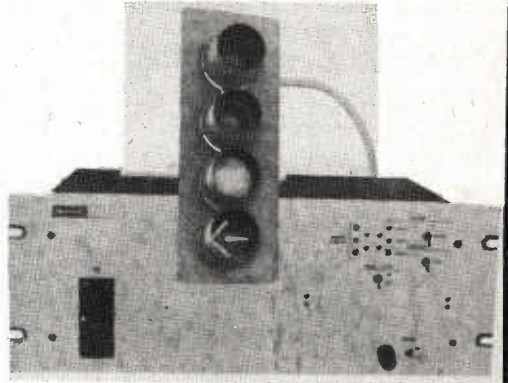

#### HYCEL

*It's a desk-size, 30-channel, automated blood analyzer for medical laboratories. It performs over 3,000 tests per hour, selectively and sequentially, while continuously tracking patient identity and sample status. Maximum test time is ten minutes, from sample pickup to completion. The HYCEL M is big news in the medical test instrument field, and HYCEL calls it the "ultimate analyzer". All machine functions are automatically controlled by the instrument's Motorola's MC6800 microprocessor.*

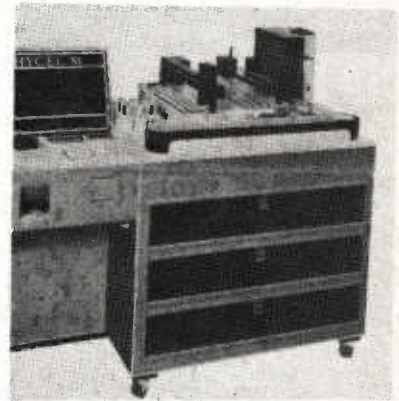

#### CHRYSLER

*Chrysler developed the lean burn system to permit engines operating in their cars to meet emission standards without catalysts, while giving improved fuel economy on either leaded or unleaded gas. Servicing this innovative system also called for an innovative new concept in diagnostic testing. Chrysler has called the MC6800 microprocessor based portable diagnostic tester they designed to meet this challenge "an ideal service tool" for its versatility and economy.*





# ELECTRONIC DISPOSALS

297 Lt. Lonsdale St., Melbourne. 3000  
Phone: 663-1785

TAPE RECORDER Microphones  
Dynamic 200 ohms Switched \$3.50  
P&P 50c.

PHILLIPS G.C.065.S Automatic  
Stereo Turntable complete with  
cartridge and stylus. Push button  
operation, lift and 10" platter. Brand  
new. ONLY \$29.50 each. P/P \$4.

S.C.R. BT100A — 300R. 300V. 4-5  
amp. R.M.S. 2 amp average. 60c each.  
P/P 25c.

PHILIPS Tuning Capacitors for AM.  
SW and FM. \$2. each. P/P 60c.

PHILIPS Beehive Trimmers. 4 to 25PF.  
10 for \$2. P/P 50c.

6.5mm Chassis Mount Switched  
Stereo Sockets. 40c each. P/P 25c.

Stereo Amplifier and R.F. Board 4  
watts RMS per channel including  
circuit diagram. Boards are complete  
with all transistors, capacitors —  
resistors, etc. and are brand new —  
famous make. Only \$6 set P/P 60c.

Stereo balance meters, 1½" x 7/8" x  
1¼" 200ua. \$2 ea P/P 40c

50Ω 3 watt wire wound pots. \$1 ea.  
P/P 25c.

10Ω 3 watt wire wound pots. \$75c ea.  
P/P 25c

6.8 μF 100v polyester capacitors for  
speaker networks. 75c ea. P/P 20c.

Dual 50k push pull switch pots.  
(Astor/Philips) car radio 60c ea. P/P 25c

M.S.P. 250v AC 3 AMP toggle switch.  
50c ea. P/P 25c

Paddle switch. D.P.D.T. 250v AC 5A.  
40c ea P/P 25c.

Transistors — AY 9150 PNP 60v 150w  
— AY 8110 NPN 60v 115 80c ea. AY  
8139 NPN — AY 9139 PNP 40v 10w  
45c ea. AY 6120 NPN — AY 6121 PNP  
50v 1A 40c ea. 2N5088 NPN PN 3694  
NPN 10c ea BF 198 — BF 199 NPN  
20c ea. P&P 30c.

A.3065 TV/FM Sound System. I.C.  
Silicone Dual In Line suitable for a  
wide variety of applications including  
T.V. sound channels — line operated  
and car F.M. radios and mobile  
communication equipment — brand  
new. Only \$1 ea. P/P 40c.

Balance Meters 1½" x 7/8" x 1¼"  
Deep 200 UA \$2.25 ea. P/P 40c.

M.S.P. 250V A.C. 3 AMP D.P. Toggle  
switches 50c ea. P/P 25c.

10Ω 3 Watt. Wire wound pots 75c ea.  
P/P 25c.

7" Dia. Alum. Fans 240V A.C. \$6 ea.  
P/P \$1.

Multiple Electrolytics. 200 μF — 50  
μF — 25 μF at 300V Plus 100 μF at  
325V. V.V. \$1 ea. P/P 30c.

LEVEL METERS 200 micro amp  
sensitivity size 1" x 1" x 3/4" \$1.50  
P/P 40c.

SOLENOIDS — tape recorder type.  
12V D.C. 5Ω coils. 1½" x 1½" x 3/4"  
\$2 ea. P/P 30c.

TRANSISTOR RADIO. 5k miniature  
switched pots. 30c ea. P/P 15c.  
Miniature 2 gang variable capacitors  
30c ea. P/P 15c.

Slide Pots. Single gang. 500ΩA, 20KA,  
25KA, 100KC, 200KA, 200KB,  
500KA, 500KB, 1 meg.D, 35c ea. P&P  
35c. Dual gang — 50KA, 250KB 1  
meg.C, 2 meg.C, 60c ea. P&P 35c.

Skeleton Preset Pots. 100Ω — 220Ω  
470Ω, 2.2K, 10K, 22K, 47K 10c ea.  
P&P 20c.

Phillips 8Ω dual cone 6" x 4" speakers  
\$2 ea. P&P 60c.

LARGE RANGE OF COMPONENTS  
— GOVERNMENT AND  
MANUFACTURERS DISPOSAL  
EQUIPMENT, ALSO STEREO AND  
HAM GEAR ALWAYS IN STOCK.

# MICRO COMPUTERS

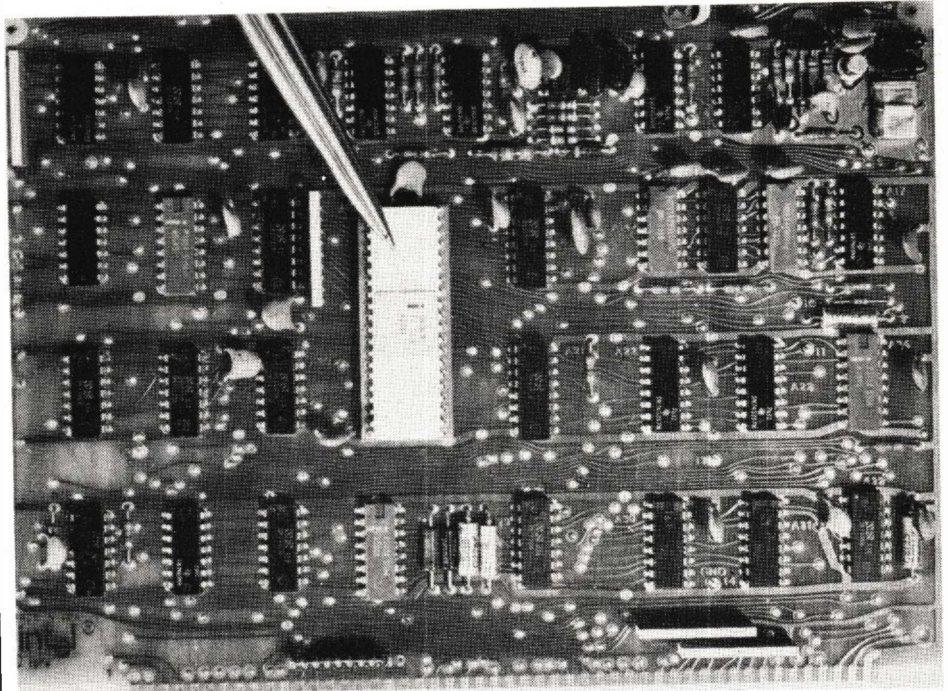

A close up of the CPU board with the actual microprocessor (in this case an Intel 8080) indicated by a pen. This board also has the clock on it and the clock crystal may be seen in the upper right hand corner.

These clubs are having an important effect on the hobby. Many people who want to own a computer come from outside the computer industry, and don't know what to ask for when shopping. They also find the jargon used very perplexing at first. By going to club meetings they meet people who are able and willing to answer their questions and advise them on things they should know. This is important because the initial purchase is almost always the Central Processing Unit (CPU) and its design and limitations dictate the development of the system.

## Australia

The computer hobby is about to invade Australia. Already a number of overseas designs are being offered on the local market. And some Australians are already dabbling with microcomputers in the form of the evaluation modules offered by the semiconductor manufacturers. These are usually single PC boards with just enough parts to get a minimum system going. But the big problem for most people is in-

formation, first about what's available and second about what each system can do.

On our part, we will publish information to give those interested as much help as possible, starting next month with a run down on the evaluation board microcomputers. If you have any suggestions, please write in. Yes, it's up to you!





# No. 1 rated!

In US by "Consumer Report"

## CORVUS

Thoroughly recommended in Australia by a major electronics publication. Electronic Concepts Pty. Ltd. is proud to introduce the exclusive Corvus 500.

With MOSTEK\* single chip technology, the new Corvus 500 is the first non-Hewlett-Packard calculator with Reverse Polish Notation. 10 addressable memories, 4 level roll down stack to be introduced. If you compare the Corvus 500 feature by feature with the HP45, you will find striking similarities. There are also some important differences.

\*MOSTEK is one of America's advanced LSI (Large Scale Integration) chip manufacturers.

	Corvus 500	HP-45
RPN (Reverse Polish Notation)	Yes	Yes
Memory Store and Recall 10 Registers	Yes	Yes
4 Level Stack, Rotate Stack	Yes	Yes
10 MEMORY EXCHANGE WITH X	Yes	No
Log. LN	Yes	Yes
Trig (Sine, Cosine, Tangent, INV)	Yes	Yes
HYPERBOLIC (SINH, COSINH, TANH, INV)	Yes	No
HYPERBOLIC RECTANGULAR ↔	Yes	No
y <sup>x</sup> , e <sup>x</sup> , 10 <sup>x</sup> , √ <sup>x</sup> , 1/x, x!, x←y, π, CHS	Yes	Yes
√ through INVERSE	Yes	No
GRADIANS	No	Yes
DEGREE-RADIAN CONVERSION	Yes	No
Degree Radian Mode Selection	Yes	Yes
DEC-DEG-MIN-SEC	No	Yes
Polar to Rectangular Conversion	Yes	Yes
Recall Last X	Yes	Yes
Scientific Notation, Fixed and Floating	Yes	Yes
Fixed Decimal Point Option (0-9)	Yes	Yes
DIGIT ACCURACY	12	10
DISPLAY OF DIGITS	12	10
% , %	Yes	Yes
GROSS PROFIT MARGIN %	Yes	No
Mean and Standard Deviation	Yes	Yes
Σ +, Σ -	Yes	Yes
Product - Memories	Yes	Yes
C.F. DIRECT CONVERSION	Yes	No
F.C. DIRECT CONVERSION	Yes	No
LIT-GAL. DIRECT CONVERSION	Yes	No
KG-LB. DIRECT CONVERSION	Yes	No
GAL-LIT. DIRECT CONVERSION	Yes	No
LB-KG. DIRECT CONVERSION	Yes	No
CM-INCH DIRECT CONVERSION	Yes	No
INCH-CM DIRECT CONVERSION	Yes	No

As you can see, the Corvus 500 is a lot more calculator for \$95.

**Price \$95.00**  
**Mail charge \$2.50**  
**Sales Tax exempt \$85.00**

For sales tax exempt purchases, please supply number or certificate.

We have listed some of the many features, but let's amplify on some highlights:  
 1. RPN (Reverse Polish Notation)  
 "COMPUTER LOGIC" and 4 LEVEL STACK.

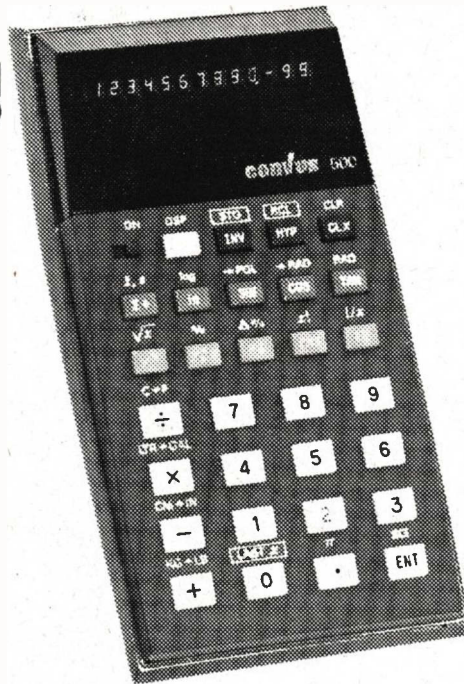

Your problem is solved the way it is written, left to right sequence, eliminating restructuring, unnecessary keystrokes, and the handicap of having to write down intermediate solutions. And all information is at your disposal — just roll the stack (R) to any intermediate information desired. You arrive at your solution faster, more simply and, therefore, more accurately.

Perhaps at this point we should address ourselves to the controversy between algebraic entry and RPN. One question we must ask is why proponents of algebraic entry always use an example of sum of products and never an example of product of sums:  
 $(2+3) \times (4+5) =$   
 Algebraic  $2+3 = MS 5+4 = X MR =$   
 TOTAL 12 keystrokes (SR51, add 2 more keystrokes)

RPN: 2 Enter 3 + 4 Enter 5 \* x  
 TOTAL 9 keystrokes

2. THE CORVUS 500 and HP-45 HAVE 10 ADDRESSABLE MEMORY REGISTERS, 4 LEVEL OPERATIONAL STACK, and a "LAST X" REGISTER (10th Mem. Reg.). With 10 addressable memories, you have access to more entries, or intermediate solutions; less remembering, or writing down. YOU have to do. And less chance for error. The stack design also permits X and Y register exchange, and roll-down to any entry to the display for review or other operation. The "last x" register permits error correction or multiple operations when a function is performed, the last input argument of the calculation is automatically stored in the "last

x" register, which can be quickly recalled to correct an error, or to perform another operation using the same number.

3. DIRECT HYPERBOLIC and HYPERBOLIC RECTANGULAR to POLAR, and INVERSE. For those of you electronic and computer science engineers who require access to this specialised application, the Corvus 500 solves "your" problems.

4. A WORD ABOUT CORVUS 500 12-DIGIT DISPLAY AND ACCURACY. Finally you have displayed 12 digit accuracy in business format and 10 + 2 in scientific notation. LED is manufactured by Hewlett Packard.

FOR THE FIRST TIME you can raise the number 10 to 199th power or calculate Factorial (x!) of up to 120. Unbelievable!

5. DIRECT FROM AND TO METRIC CONVERSION SAVES VALUABLE KEYSTROKES.

WHAT ABOUT CONSTRUCTION? With so many features, the next most obvious question must be in regard to the quality of the unit itself. We are proud to report the Corvus 500 to be double injected moulded, with "tactile" feedback keyboard. The compact, contoured case is 5½" long by 3" wide by 1¼" high and weighs just 8 oz. The COMPLETE CORVUS 500 for \$95.00 includes:

- Rechargeable and replaceable Nickel Cadmium batteries. Optional 3AA batteries.
- Adaptor/Charger.
- Owner's Handbook.
- Soft carrying case.

The Corvus 500 is warranted by the manufacturer against defects in materials and workmanship for one year from date of delivery.

For those of you who have the HP-21 or 45 or any other advanced calculator on order, aren't you glad you still have the opportunity to take advantage for the release of the Corvus 500 for \$95.00? Hurry! Order yours today.

AN INVITATION:

Electronic Concepts is proud to offer this exciting Corvus 500 as well as other Mostek based calculators and digital watches as exclusive importer of Corvus Brand products for Australia.

You, our discerning reader will no doubt recognise the tremendous price/performance value on offer. By mailing the order coupon today we can assure you of early delivery — and should you not be satisfied, you may return the unit to us with full money back guarantee within seven (7) days. Or better, convince yourself of the real quality and value of our Corvus range, just visit our conveniently located showroom in Cambridge House, Clarence Street, just behind Wynyard exit (York Street), or phone 02-29-3755 for more information.

**Other Corvus models on offer:**  
**Corvus 600 Financial Genius \$80.00**  
**Corvus 615 Business Statistician \$25.00**  
**Corvus Digital Watches** — but more about these in our next advertisement.



Ground floor, Cambridge House,  
 52-58 Clarence St., Sydney NSW 2000.  
 (02) 29 3753-4-5

Yes! I'd like to try the Corvus 500 for 7 days

CASH payment: Cheque or money order enclosed. \$95 plus \$2.50 postage.

NAME .....

ADDRESS .....

POST CODE .....

bankcard 1st time offered for your convenience BANK CARD mail order facility. Please complete

Please charge my bankcard.

BANKCARD NO .....

EXPIRY DATE .....

SIGNATURE .....



To own one of our new turntables,  
you may have to go without a few luxuries.



When it comes to good Hi-Fi equipment, it's often a question, not of how much your ears can take, but of how much your wallet can take.

Take the new belt drive AKAI AP003 (shown above) or the new fully auto AP005. At a recommended retail price of \$245\* and \$298\* respectively, they'll leave a pretty big hole in most people's wallets.

However, if you're one of those people who know the sound you want, one of these turntables is probably just what you're looking for. If you don't particularly wish to go as far as the man in the picture above, we

recommend the AP001C at \$168†

Like all AKAI Hi-Fi equipment distributed by AKAI Australia, all of these turntables are covered by our Complete Protection Plan\*. Which simply means 12 months full parts and labour warranty on all Tape Equipment, 2 years full parts and labour warranty on all Amplifiers, Turntables and Speakers and a lifetime warranty on all GX Tape Heads.

Make sure the Complete Protection Plan card is with your AKAI equipment.

The AKAI Hi-Fi Professionals are: **NEW SOUTH WALES — SYDNEY CITY AND METROPOLITAN.** Sydney: Douglas Hi-Fi, 338 George Street; Duty Free Travellers Supplies, 400 Kent Street; European Electronics, 187 Clarence Street; Instrol Hi-Fi, Cnr. Pitt & King Streets; Magnetic Sound Industries, 32 York Street; Jack Stein Audio, 275 Clarence Street. **Bankstown:** Selsound Hi-Fi, Cnr. North Terrace & Apan Way. **Burwood:** Electronic Enterprises, 11 Burwood Road; Edge Electric, 31 Burwood Road. **Concord:** Sonarta Music Services, 24 Cabarita Road. **Cremona:** Photo Art & Sound, 287 Military Road. **Crows Nest:** Allied Hi-Fi, 330 Pacific Highway. **Hurstville:** Hi-Fi House, 127 Forest Road. **Liverpool:** Miranda Stereo & Hi-Fi Centre, 166 Macquarie Street. **Miranda Fair:** Miranda Hi-Fi & Stereo Centre, Shop 67, Top Level, Mona Vale. **Warringah Hi-Fi:** Shop 5, Mona Vale Court. **Parramatta:** Gramophone Shop, Shop 151, Westfield Shoppingtown; Selsound Hi-Fi, 27 Darcey Street. **Roselands:** Roselands Hi-Fi, Gallery Level, South Hurstville. **Selsound Hi-Fi:** 803 King George's Road, Summer Hill; Fidela Sound Centre, 93B Liverpool Street. **Sutherland:** Sutherland Hi-Fi, 5 Bovle Street. **Waitara:** Hornsby Hi-Fi, 71 Pacific Highway. **Westleigh:** Sound Incorporated, 16 Westleigh Shopping Centre. **NEW SOUTH WALES COUNTRY.** Albury: Haberecht's Radio & TV, 610 Dean Street. **Bega:** Eastdowns, 187-191 Carp Street. **Bowral:** Fred Hayes, 293 Bong Bong Street. **Broken Hill:** Pee Jay Sound Centre, 364 Argent Street. **Gosford:** Gosford Hi-Fi, 163 Mann Street; Miranda Stereo & Hi-Fi, Shoalhaven Arcade. **Taree:** Taree Photographics, Graphic House, 105 Victoria Street. **Wagga Wagga:** Haberecht's Radio & TV, 128 Bavlis Street. **Wollongong:** Hi-Fi House, 268 Keira Street; Selsound Hi-Fi, 2-6 Crown Lane. **A.C.T. Civic:** Allied Hi-Fi, 122 Bunda Street. **Fyshwick:** Allied Hi-Fi, 3 Paragon Mall, Gladstone Street. **QUEENSLAND.** Brisbane: Chandler's, 120 Edward Street; Chandler's, 399 Montague Road, West End; Stereo Supplies, 95 Turbot Street, Tel Air Electronics, 187 George Street. **Nambour:** Custom Sound, Currie Street. **Mt. Isa:** The Sound Centre, West Street. **Rockhampton:** Chandler's, 144 Alma Street. **Southport:** Stokes Electronics, Scarborough Street. **SOUTH AUSTRALIA.** Adelaide: Ernsmiths, 48-50 King William Street; Flinders Trading Co., 55 Flinders Street; J.B. Electronics, 115 Gouger Street. **Blackwood:** Blackwood Sound Centre, 4 Coromandel Parade. **Glenside:** Steiner Electronics, Conygham Street. **Moana:** Bob Carmen, 185 Commercial Road. **VICTORIA.** Melbourne: Douglas Hi-Fi, 191 Bourke Street. **Warrnambool:** A. G. Smith, 159 Liebig Street. **WESTERN AUSTRALIA.** Perth: The Audio Centre, 883 Wellington Street. **Calista:** Hub Hi-Fi, Kwinana Hub, Gilmore Avenue. **East Victoria Park:** Japan Hi-Fi, 889 Albany Highway. **Nedlands:** Audio Distributors, Broadway Shopping Centre, Broadway. **Midland:** Midland Audio, 16B Great Northern Highway. **Mosman Park:** Audio Distributors, 14 Glyde Street. **W.A. COUNTRY.** Bunbury: Aabel Music, 130 Victoria Street. **Kalgoorlie:** Hambley's Hi-Fi, Shop 13, Central Arcade, Hannan Street. **TASMANIA.** Burnie: James Loughran & Sons, 29-31 Wilpot Street. **Hobart:** Quantum Electronics, 181 Collins Street. **Launceston:** Wills & Co., 7 Quadrant. **NORTHERN TERRITORY.** Darwin: Pfitzners Music House, Smith Street.

\*The Complete Protection Plan does not cover equipment purchased outside Australia. †Recommended retail price only.

**AKAI**  
The name you don't have to  
justify to your friends.



# WHAT IS A MICROPROCESSOR?

There is no shortage of technical information on microprocessors but most of it is rather daunting when you first see it. We asked Dr Tim Hendtlass of the Royal Melbourne Institute of Technology briefly to explain these devices to our readers, assuming only a basic knowledge of logic circuitry.

MY AIM IS TO SHOW WHAT A microprocessor is and how it relates to a microcomputer. I make no apology for treating the subject in a simple way and in particular for using analogies to non-electronic situations. When the general idea of what a microprocessor can do has been grasped then you can read the manufacturers' literature and some of it at least should make sense. As you get more familiar with a particular device (and nothing can beat hands-on experience for this) more and more will fit into place. Those strange letter groupings which seem so daunting at first are in reality a concise and powerful way of conveying information amongst the initiated. The problem, as usual, is how to be initiated.

One more thing before I get down to it: microprocessor is a long word and it just calls out to be abbreviated. The most common short form is MPU and I will use this often in the rest of the article. An MPU is a super logic chip that can be any one of a number of ordinary logic chips at any given time; this is not the same thing as having separate chips. It's rather like some children's

tool sets which consist of one handle and several attachments, each of which fits into the handle to give a particular tool: a hammer, a saw, etc. You can, in principle at least, do any job with this combination tool set that you could do with separate tools — but it will take longer because every time you want to use a different tool you have to take the old attachment off and put a new one on. The MPU is an electronic combination set.

## Impersonating digital circuits

The number of digital electronic tools you can make out of an MPU is fixed at the time of manufacture, but it will almost certainly include the ability to be an AND gate, an OR gate, a NOT or inverting gate, an ADDER, or a SHIFT REGISTER. (In order to be useful an MPU must be able to perform other types of operation, but we will meet these later when the need for them has become apparent.)

The type of digital circuit an MPU will impersonate at any time is determined by a set of voltages applied to certain of the pins on the IC. This set of voltages (each of which can have either of two

levels and is one bit of information) is referred to as the instruction. A typical MPU might have eight voltages (eight bits) to its instruction word, or byte, which gives 256 possible instructions (not all of which are used). Fifty to eighty instructions would make up a normal instruction set. Before I leave the tool kit analogue I must caution you not to take it too far. In particular, combination tool sets are often of inferior quality to the tools they replace; but an MPU is every bit as good as the individual logic ICs it replaces (except for speed).

One difference between using individual logic ICs and using an MPU is that the former are supplied in hardware form, often in parallel, and several operations can be happening at the same time. Consequently the solution is obtained very quickly — the only limit is gate propagation delay. The MPU can do only one thing at a time so the logic must be performed sequentially and this requires some extra steps compared to hardwired logic. Both Figure 1 and Figure 2 show ways of arriving at a decision about whether it is safe to cross the road at traffic lights.

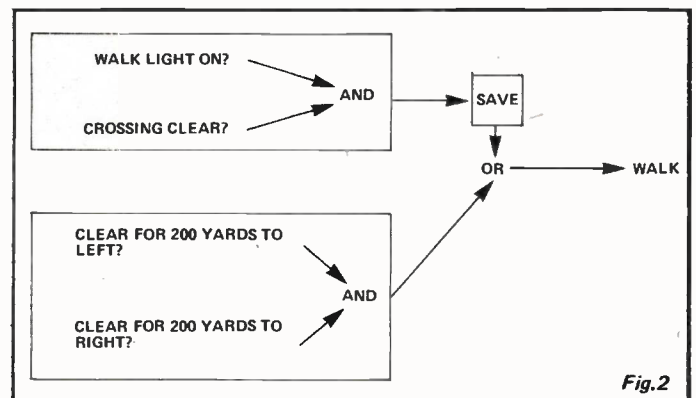
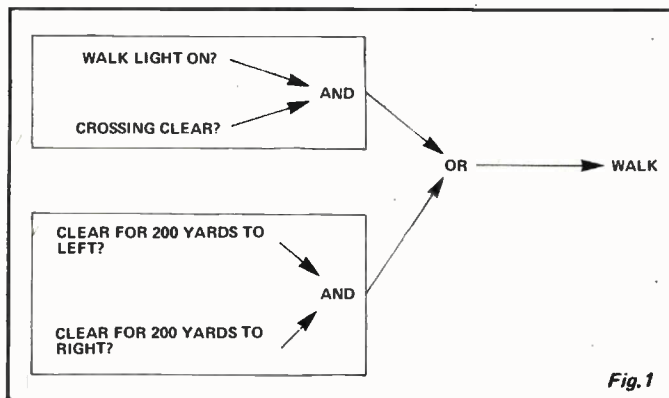



## MPU or hardwired logic

Figure one uses parallel logic and we consider 'is the walk light on?' AND 'is the crossing physically free of obstructions?' The resulting bit of information is ORed with the result of the less legal 'is the road clear for 200 yards to the left?' AND 'is the road clear for 200 yards to the right?' Note both AND functions are performed at once.

In Figure 2 we see that the MPU can't do two functions at once; we have to save or store the result of the first operation while we perform the second. This bit of information is recalled after the second AND operation has been completed and then the OR operation can be carried out as in Figure 1.

This storing and recalling, or generally moving around bits of information internally is a very important type of operation to a microprocessor.

The storage room inside the chip is very limited and often it is necessary for an MPU to store information outside and bring it back later.

### The IF instruction

When we looked at Figure 2 you might have noticed a redundancy in the logic. If the answer to the first ANDing is yes then there is no need to perform the second AND function at all, as the output from the OR gate is already decided. However we must still have the ability to perform the second AND, in case the answer to the first one is no. After the first AND we need to make a decision (based on the result) as to what to do next.

This is a **jump on condition** instruction — IF the answer is yes, go to the output; but IF the answer is no go to the second AND. This is shown diagrammatically in Figure 3; note there are two exits from the decision box, one showing the path taken if the answer is yes, the other showing the path if the answer is no. Also note we have told the microprocessor what to do if the answer to both ANDs is no (go back to the

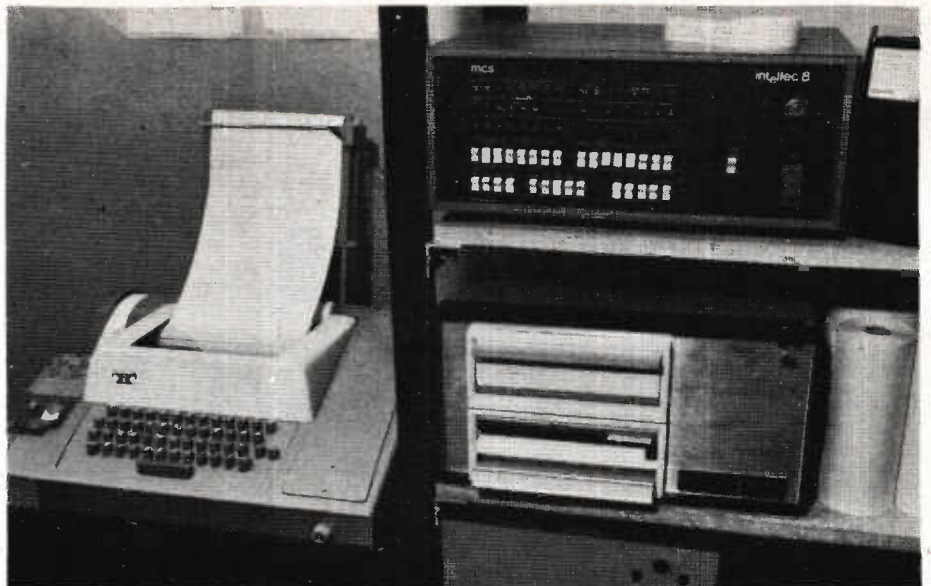

A complete microcomputer system comprising microcomputer, teletype, a twin floppy disk store and a EPROM programmer. The single diskette holds as much information as would be contained on 1.5 km of paper tape of the type shown on the top of the microcomputer (about 2.5 million bits).

beginning and go through it all again and keep doing this until the answer to one of the ANDs is yes). What we have just drawn is called a **flow chart**.

### MPU or Hard-wired logic?

Up to now it may seem that I have been stressing the overheads involved in using an MPU and you may be feeling that it wouldn't be worth it just to replace a few ICs. You would be quite correct; an MPU would be more bother than help. Remember, though, that this same MPU can, with the help of a set of instructions, do the same job as hundreds or thousands of ICs. Also, if you wanted to change the function performed by that array of hardwired ICs you would probably have a long job with the soldering iron and side cutters ahead of you. With the MPU the hardware changes will be minimal, if indeed any. Instead you change the series of instructions (in honesty let it be said that it can take a surprising

amount of time to get the instruction sequence correct so that the MPU does what you want it to!).

Once these series of instructions (called **programs**) are written they can be stored and one program can be changed for another in almost no time. Finding when it becomes profitable to use a microprocessor then is quite a complicated decision based on how many ICs it replaces and how many different jobs you would like the same hardware to do. As a rough rule of thumb, if you need thirty to fifty SSI and MSI packages to do the job — and you don't need the whole job done in microseconds but can afford milliseconds — then you should seriously look at using a microprocessor.

The idea of a program consisting of a series of instructions presented to the pins of the chip leads us to realise that a microprocessor chip is an incomplete unit on its own. Where do we store program for example? A microprocessor then is only a part of a greater whole and this greater whole is called a micro-computer.

## THE MICROCOMPUTER

Figure 4 is my personification of any digital computer in general and a micro-processor-based microcomputer in particular. I have changed my model of an MPU — now I think of it as a keen and eager clerk at a desk, able to ADD, SUBTRACT, AND, OR, X-OR, NOT, STORE, RECALL and TEST, and with baskets labelled "PENDING" to temporarily store the pieces of paper (data) on which to work. Someone has to give this MPU the input data on which to work — and take the finished

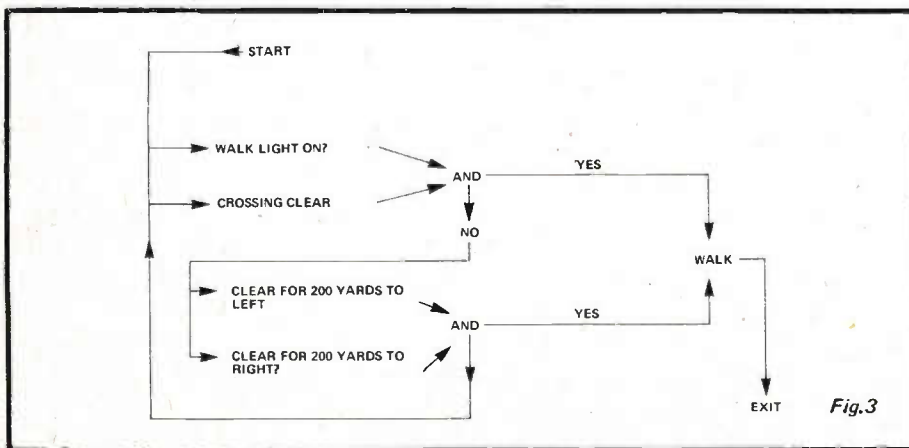



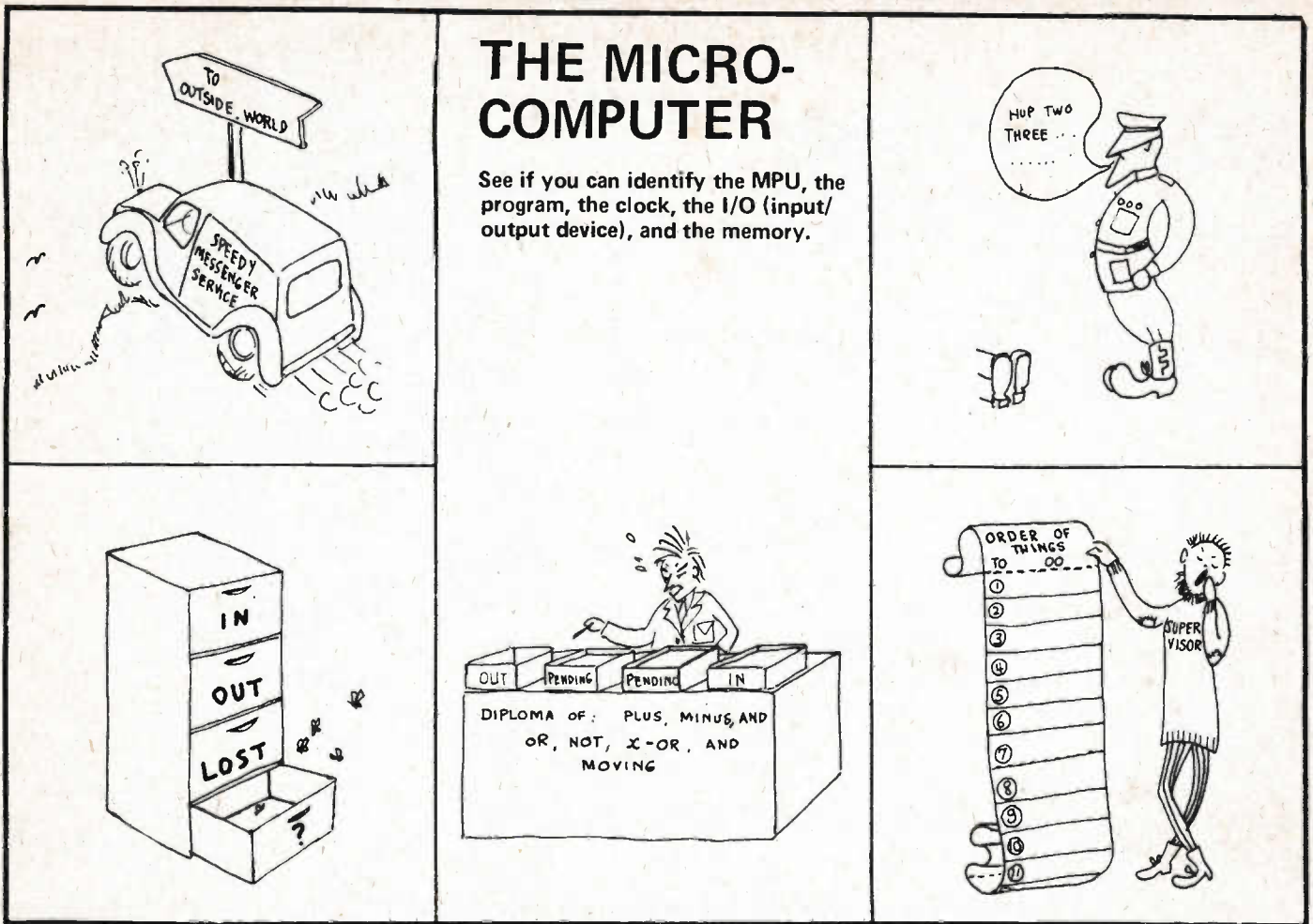

Fig. 4

data away again. This is the role of the input/output, the circuits which enable the MPU to communicate with the outside world.

**The Program.** Also, our MPU, although keen, cannot begin until someone tells it what jobs to do and in what order. The program we referred to before is the MPU's equivalent of the office supervisor and is stored in the microcomputer's memory where the MPU can get at it by a special kind of recall instruction (program fetch). The baskets referred to before can only hold one byte of information each and soon the MPU will have run out of space to store information unless provided with auxiliary storage (filing cabinet in an office, more memory in a microcomputer).

**The Master clock.** Although it might seem that our computer is complete, one potential problem remains. What if the MPU is getting information from the filing cabinet while the input/output is pouring data on one end of the desk and removing some from the other end and the supervisor (who has been calling instructions out far faster than they can be done) is already into tomorrow's

# THE MICRO-COMPUTER

See if you can identify the MPU, the program, the clock, the I/O (input/output device), and the memory.

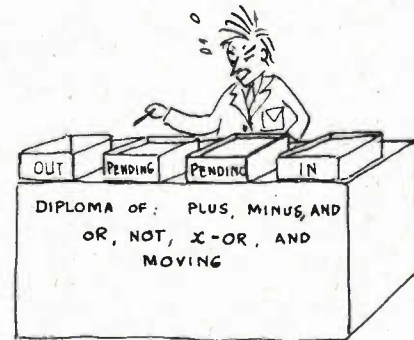

job? Clearly something is needed to keep everybody in step (personification — an army drill sergeant (in an office?); reality — a pulse generator called a master clock).

**Memory.** The program or list of instructions may be stored in read-only memory (ROM) where it is safe from being altered — in fact, if it is in ROM, you can't normally alter it even if you want to. The working memory or auxiliary storage must be in read/write memory (RWM). RWM is often (though rather confusingly) called random access memory (RAM) — we will bow to popular usage and also use this latter term.

Program may also be stored in RAM

### RWM or RAM

*Read/write memory is organised as a random access memory so you can address the various cells in it in any order (unlike a shift register, for example, where the cells must be addressed in a particular order). However, read only memory is also organised as a random access memory — hence the possibility of confusion with the common usage.*

along with the temporary storage — it is up to the programmer to see that the MPU does not accidentally write over its program or read some temporarily stored data thinking it to be program. If this latter should happen no physical damage will result, but it is hard to predict what the microprocessor will do — especially if the data happens to be one of the combinations of bits which does not correspond to a valid instruction. (Remember not all possible combinations of bits in the instruction word are used).

Also most, though not all, RAM is volatile — that is to say the contents are lost whenever the power supply is turned off. If you have program you will want again in a volatile RAM you must save it in some non-volatile form. (On paper tape or magnetic tape for example) before turning the power off.

**NEXT MONTH** Dr Hendtlass will finish this article with 'The microprocessor at work'. He will take you through a program step by step and explain what a subroutine is and how it can save time for the programmer.



Is this a high, low or a critical day in your life? Find out on this

# BIORHYTHM CALCULATOR

The Casio Biolator is an eight-digit calculator with built-in 99 year calendar and digital biorhythm computer.

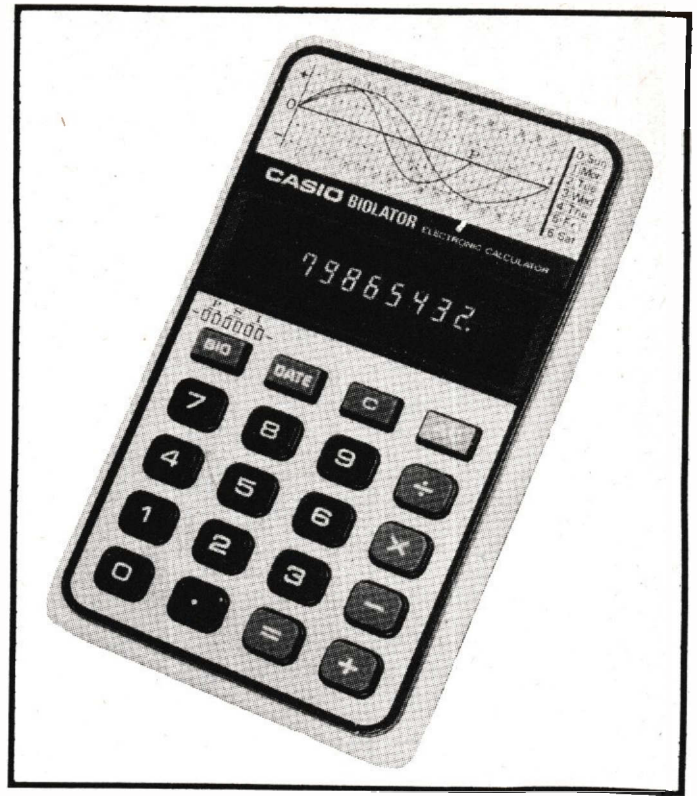

We all know of the monthly cycle of hormones in women, but did you know there are similar cycles in all people, irrespective of age or sex? At the beginning of this century a German doctor discovered that the body is regulated according to three cycles of differing periods. The 23-day cycle is the one that describes variations in physical health, strength, endurance, etc. In the first half of the cycle (days 2 to 11) the stamina is high and the body is in good shape. In the second half of the cycle (days 13 to 3) the body is more tired and prone to illness.

The theory puts special importance on the crossover days, the days between the positive and the negative halves of the cycle. On these days the condition of the body is undergoing its fastest rate of change and the likelihood of an accident or sudden worsening of an illness is higher than at any other time of the month. Days 1 and 12 of the physical cycle are critical days.

The two other cycles concern the condition of one's mental performance and this is looked at from two viewpoints - activity in the subconscious regions of the brain and activity in the fully-conscious regions.

The theory holds that there is a 28-day cycle in the activity of the mind's emotional, or instinctive, processes. For the first fourteen days of the cycle one's intuition is keenest, the artistic side of your personality is at its most creative and your natural charm is at a maximum. However for the next fourteen days life is more humdrum and you are advised to

be careful with your relationships with other people. On the critical days (1 and 15) your non-rational side is likely to dominate your normal restraints, resulting in 'irresponsible' behaviour, slips of the tongue, quarrels, etc. On the Casio machine this cycle is called the sensitivity cycle.

The third rhythm is the intellectual cycle of 33-day period. When the cycle is high, thinking power is at its greatest; judgement, wit and concentration are at their best. When the cycle goes low it is the time for mundane work, for activities low in their demands on concentration. Days 1 and 17 are the critical days when errors are likely, when the memory might fail, when accidents might result from silly mistakes.

These then are the three biorhythms, the physical (23-day) the sensitivity (28-day), and the intellectual (33-day). According to the theory all three rhythms start their upward half-cycle on the day you are born. And in the

first 58 years of your life each day will be under the influence of a unique combination of these three variables.

## How the Biolator works

The Biolator is based on a 4-function, 3-register, 8-digit, calculator with automatic constant. Readout is on a green digitron tube display. This section works just like an ordinary calculator of this type: algebraic logic is used, there is an overflow indicator, the decimal point is fully-floating and leading zeroes are suppressed.

Now to the interesting bit. This can be examined from two aspects: calendar calculation and biorhythm calculation. The calendar covers all dates from 1901 to 1999 inclusive. It is accessed by inputs in the format: 76.10.21. (for 21st October 1976) where the three decimal points are lit by pressing the DATE button after entering each pair of figures. The calendar then replies (instantaneously) by displaying 76.10.21-4, the 4 after the - signifying that the 21st of October 1976 lands on a Thursday. By this method the day of the week for any given date can be calculated.

If after one date has been entered the operator presses the - (minus) button and enters another date, then he can find the number of days between these two dates by pressing the = button. So 76.10.21-4 minus 73.02.09-3 equals 1716 days. This facility has obvious uses in calculating daily, weekly, or monthly rates when you

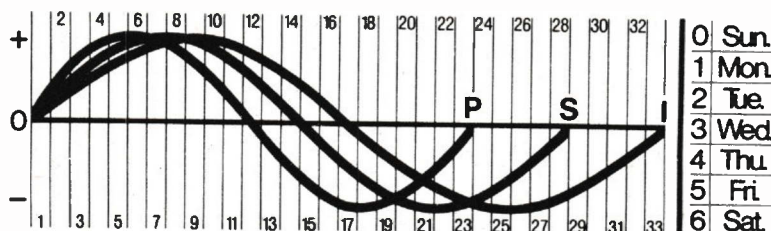

The biorhythm graph as printed on the front of the calculator. The P, S, and I waveforms represent the body's physical, sensitivity (emotional) and intellectual cycles.



### THE DESIRABLE AFFINITY CONDITIONS

	Physical	Sensitivity	Intellectual
SPOUSE	High	Medium	High
LOVER	—	High	—
FRIEND	—	High	High
CO-WORKER	High	Medium	High
TEACHER	—	High	High
SPORTS MATE	High	High	—
CO-ADMINISTRATOR	High	High	Medium
CO-RESEARCHER	—	—	High
SECRETARY	—	Low	High

know a specific quantity of a resource was expended between two given days.

#### Biorhythm calculation

To find a person's biorhythms on a given day you first enter that date and subtract the date of birth of the person in question (as if you were calculating their age in days). However, instead of pressing the equals button after entering the second date, you press the B10 button. The biorhythm computer now replies by displaying —PP.SS.II—, where PP gives the status of the physical rhythm, SS the status of the sensitivity rhythm, and II the status of the intellect rhythm. These numbers correspond to the day of the cycle for each rhythm, they do not show amplitude. To interpret the numbers there is a graph above the display and a chart on the back of the calculator.

The product of 23, 28, and 33 is 21252 which means that there are this many possible permutations of the three rhythms, and these permutations follow the same sequence for all people.

No matter when you were born your biorhythms on day 14610 of your life will be -06.23.25-. The Biolator works by calculating your position on its 21252-day biorhythm sequence.

#### Using the Biolator

In calculating your own biorhythms you can arrange your diary to avoid disappointment. Picking a day for a wedding, for an interview or a driving test, planning an expedition or training for sportsmen, warning your friends or family in advance of your 'off' days, etc., can be done with a simple calculation.

The Biolator can be used to calculate the daily condition of other people, too. Businessmen can forecast the good days for their key personnel (or the bad days of their rivals!), team managers can pick players as soon as they know fixture dates, and so on.

Interesting conclusions can be drawn when you consider the biorhythms

of two people, with respect to each other. The time difference between the individual rhythms of two people will always remain constant — if two people's emotional rhythms are in phase they'll always stay in phase. The difference between the rhythms can be calculated easily by finding the condition of the older person on the day the younger one was born. This then can be used to map the affinity of the two people: High affinity for one cycle is when the two waveforms are in phase (the difference numbers are high or low), low affinity is when the waveforms are out of phase (difference numbers around half a period), and medium affinity corresponds to a phase difference of about ninety degrees. On the physical biorhythm, for example, high affinity is shown by difference numbers like 1 to 5 and 20 to 23, low affinity is shown by numbers 9 to 16, and other numbers show medium affinity.

To interpret the significance of affinity the table above has been drawn up.

The Biolator comes with an instruction booklet and a simulated leather case. It is attractively styled in a plastic case with a brushed aluminium front panel. It is available from camera/hifi shops and department stores like David Jones'. It is priced at \$21.95.

**LIKE THE MANUFACTURERS OF THE BIOLATOR, THIS MAGAZINE EXPRESSES NO OPINION AS TO THE VALIDITY OF THE BIORHYTHM THEORY.**

# jaycar

PTY. Little Hay Street, HAYMARKET. NSW. 2000.  
LTD. Phone 211-5077. PO Box K39 Haymarket.

## EXCLUSIVE OFFER TO ETI READERS

*(You must produce this advertisement)*

- 100 only DUKE A100 AM/FM STEREO TUNERS to be sold at the best ever price of \$65.00 — a saving of \$34.00 on previous retail price!

- These Duke A100 Stereo Tuners give a remarkable performance on FM radio, and we fully guarantee them for 90 days. The purchase price will be fully refunded on request if returned in mint condition within 14 days.

- Mail orders sent by Air Parcel. Add \$5.50 for Vic, Qld, SA. \$9.00 for Tas. \$12.50 for WA & NT. (Don't forget to send this advertisement)

- For details and specifications send Stamped Addressed Envelope.



## SHEER SIMPLICITY!

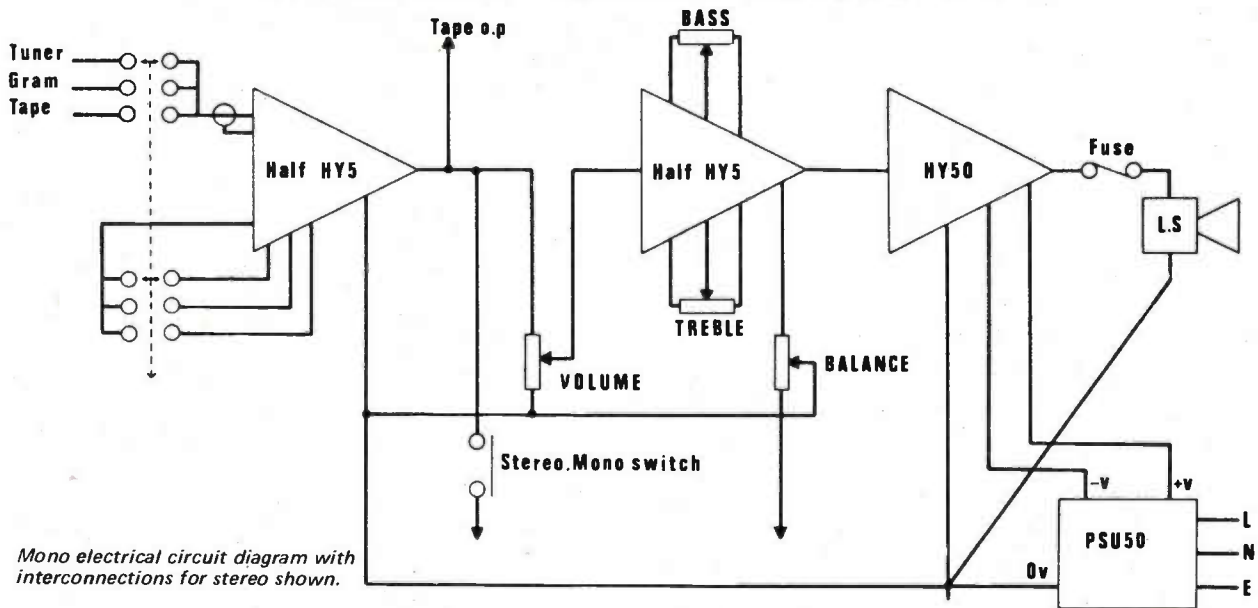

Mono electrical circuit diagram with interconnections for stereo shown.

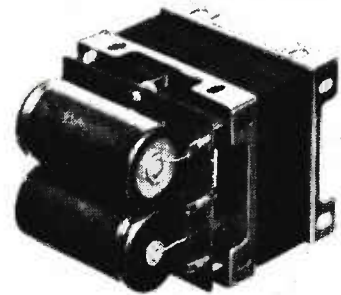
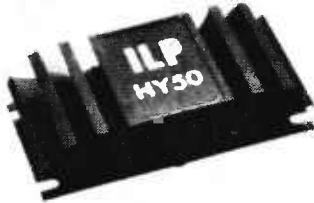
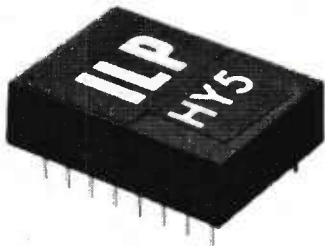

The HY5 is a complete mono hybrid preamplifier, ideally suited for both mono and stereo applications. Internally the device consists of two high quality amplifiers—the first contains frequency equalisation and gain correction, while the second caters for tone control and balance.

#### TECHNICAL SPECIFICATION

##### Inputs

Magnetic Pick-up 3mV, RIAA  
 Ceramic Pick-up 30mV  
 Microphone 10mV  
 Tuner 100mV  
 Auxillary 3-100mV  
 Input impedance 47k $\Omega$  at 1kHz.

##### Outputs

Tape 100mV  
 Main output Odb (0.775 volts RMS)

##### Active Tone Controls

Treble  $\pm 12$ db at 10kHz  
 Bass  $\pm 12$ db at 100Hz

Distortion 0.05% at 1kHz

Signal/Noise Ratio 68db

Overload Capability 40 db on most sensitive input

Supply Voltage  $\pm 16-25$  volts.

PRICE \$16.06 P&P \$0.30

The HY50 is a complete solid state hybrid Hi-Fi amplifier incorporating its own high conductivity heatsink hermetically sealed in black epoxy resin. Only five connections are provided: Input, output, power lines and earth.

#### TECHNICAL SPECIFICATION

Output Power 25 watts RMS into 8 $\Omega$

Load Impedance 4-16 $\Omega$

Input Sensitivity Odb (0.775 volts RMS)

Input Impedance 47k $\Omega$

Distortion Less than 0.1% at 25 watts typically 0.05%

Signal/Noise Ratio Better than 75db

Frequency Response 10Hz-50kHz  $\pm 3$ db

Supply Voltage  $\pm 25$  volts

Size 105 x 50 x 25 mm.

PRICE \$20.27 P&P \$0.40

P&P \$2.00 FOR 1 COMPLETE SET OF HY5 + HY50 + PSU50

The PSU50 incorporated a specially designed transformer and can be used for either mono or stereo systems.

#### TECHNICAL SPECIFICATIONS

Output voltage 50 volts (25-0-25)

Input voltage 210-240 volts

Size L.70, D.90, H.60 mm.

PRICE \$20.41 P&P \$2.00

**TWO YEARS GUARANTEE ON ALL OUR PRODUCTS**

**K. D. FISHER & CO.**  
 P. O. Box 34, Nailsworth, S.A. 5083.  
 Telephone 269-2544.

Please Supply \_\_\_\_\_  
 Total Purchase Price \_\_\_\_\_  
 Enclose Cheque  Postal Orders  Money Order   
 Name & Address \_\_\_\_\_  
 Signature \_\_\_\_\_



## Complements

In some of the articles in ETI you draw a line over certain symbols (in logic circuits especially). What is this for?

K.D., Sydney.

Often in logic circuits an inverting function is utilised, 00101 becomes 11010, 010101 becomes 101010, etc. The inverted bit pattern is known as the 'complement' of the original pattern. The complement of a particular function is written symbolically by drawing a line over the name of the function: the complement of

$(A.B)+(C.D.E)+(F.G.H)$

is written

$(A.B)+(C.D.E)+(F.G.H)$

flip-flop outputs are labelled Q and  $\bar{Q}$  (When Q is high,  $\bar{Q}$  is low; when Q is low,  $\bar{Q}$  is high), pins on an IC that have to be taken low to enable their nominated function are labelled Reset, Halt, Interrupt, Request, etc. In future articles on microprocessors these symbols will be used much more frequently.

## 200 W bridge amplifier

What would the power output of the ETI 200 W bridge amplifier (ETI 413x2) be, into 8 ohms, if I use only one transformer?

B.A.C., Enoggera.

If you use only one mains transformer to power two ETI 413 amplifiers you can still get a full 200 W output, providing the transformer can supply sufficient current (3A). If a smaller transformer is used this will limit the potential output power.

## Stereo & Speaker Phase

How can I check to see that my stereo's speakers are in phase? What difference does it make?

R.H., Indonesia.

To check the phasing of the speakers follow these steps:

(1) Switch your amplifier to mono. (2) Position the speakers face to face, so that the grille cloths are almost touching. (3) Listen. If the speakers are in phase the volume will be much lower than it was with the speakers in their correct positions. If you are uncertain try reversing the connections to one of the speakers — the correct phasing gives the quieter sounds.

If the speakers are out of phase the pressure waves from them will assist each other when they are positioned in this way. With the speakers correctly wired, the sound waves from the two sources will oppose each other, and little sound will be transmitted.

It is important to wire the speakers,

# Please Explain



This new feature is our response to the many requests we get from readers who want explanation or information on topics they read about in the magazine. If you have a question please send it to Please Explain, ETI Magazine, 15 Boundary Street, Rushcutters Bay, NSW. 2011.

correctly for normal listening, although the effects of out-of-phase channels are less dramatic than in the test set-up above. Loss of bass (due to destructive addition) and over-emphasised bass (due to constructive addition) are the common symptoms of incorrect speaker wiring — often both effects will be noticed as one moves around the listen-room.

## Triangles or squares?

Some of the ICs in your circuit diagrams are drawn as triangles and some are drawn as squares or oblongs. What is the difference?

K.M., Melbourne.

When we draw logic circuits we use standard logic symbols for the elements contained in the IC packages. When the ICs are so complex that we chose not to show their internal structure we use box outlines to show how the pins of the IC connect into the circuit.

One of the standard logic elements we use is the simple buffer; the symbol for this is a small triangle with one lead in and one lead out. Similarly the symbol for an inverter is a small triangle with a small circle at the output.

A larger triangle symbolises an amplifier. For an op-amp the two inputs are usually shown on the left, the output connections corresponds to the apex of the triangle on the right, and other connections are shown on the sloping sides of the triangle. The triangle can be used to symbolise any amplifier stage.

## PCB supply

Where can I get a ready-made pcb for the ETI 508 dimmer?

P.S., Newcastle.

There are many companies supplying boards for ETI projects, but we know of one company which has boards for most of our designs. This is RCS Radio of Forest Road, Bexley, NSW 2207. Their phone number is 587-3491.

## Hex

What does 'hex' mean?

P.K., Melbourne.

The term 'hex', as used in ETI, has two different meanings. From the Latin for six, the word is used to describe IC packages containing six independent elements, as in 'hex inverter' or 'hex buffer'.

In computer articles the word hex is an abbreviation of the Latin-derived word 'hexadecimal' meaning associated with the number sixteen. Hex codes are numbers counted to a base of 16. The sequence goes 0 1 2 3 4 5 6 7 8 9 A B C D E F 10 11 12 13 14 15 16 17 18 19 1A 1B 1C 1D 1E 1F 20, and so on. In computing any pattern of four bits can be represented by just one of the sixteen hex characters and any byte of eight bits can be written symbolically as two hex characters; A number like 5000 looks like an ordinary decimal number but it could equally well be a hex representation of the pattern 0101 0000 0000 0000. For this reason it is often written 5000H when in hexadecimal.



# NEW ETI FEATURE

# mark-down

This is an experiment. At present it works like this. We're offering advertisers free space each month to offer goods or services substantially cheaper than normal. 'Substantially' begins at 15% — there's no lower limit!

In theory everyone wins. You buy things cheaper — advertisers sell more at zero expense — with luck we sell more ETI's. Offers expire Sept. 30, 1976 unless otherwise specified.

If it works we'll make it regular. (Advertisers — ring Collyn Rivers on 33-4282 for details).



**SINGLE BEAM OSCILLOSCOPE**  
available at \$227.72.

This is \$87.00 below  
current list price of \$314.72,  
Salex Tax Included. Carriage Extra.  
Offer open till stock exhausted.

BWD Electronics Pty. Ltd.  
Miles St., Mulgrave, Vic 3170

## sabtronics

INTERNATIONAL

SAVE 15%

FND 503 COMMON CATHODE 0.5" DISPLAY  
FND 510 COMMON ANODE 0.5" DISPLAY  
5 for \$6.35  
FND 70 COMMON CATHODE .25" DISPLAY  
5 for \$3.35

THIS OFFER EXPIRES AUGUST 31st 1976.

P.O. Box 64683, DALLAS, TX.75206.  
U.S.A. TELEPHONE (214) 369-7309.

## IC SPECIALS

### MEMORIES

SPECIAL NORMALLY

1101	\$ .89	1.39
1702A	7.95	10.95
2102	1.69	2.95
5203	7.95	10.95
5260	.95	1.95
5261	.95	1.95

### LINEAR

SPECIAL NORMALLY

309K	\$ .89	1.35
741	.21	.32
3900	.33	.49

### TTL

7438	.20	.40
74165	.84	1.83
74193	.72	1.19

10% OFF WITH \$25 ORDER

15% OFF WITH \$100 ORDER

**INTERNATIONAL ELECTRONICS UNLIMITED**

See ADV. Page 94 for address

## AMATEUR COMMUNICATIONS ADVANCEMENTS

14 Rosebery St., Balmain 2041

**THE WHAT WHERE WHO HASSLES  
AND HOW MUCH BOOK** . . . the only  
buyers guide for electronic and  
communications hobbyists ever pro-  
duced in this country. Lists information  
on over 250 companies in 20 categories.

ONLY  
\$1.75  
+ 40c P&P  
SAVE 75c

**VHF/UHF CONVERTER KITS** for the  
144/432 MHz bands. See Feb. ETI,  
p.63, and our recent adverts.

Normally \$14  
OFFER PRICE  
\$10 + 60c P&P

**MA4060 POWER VARACTOR DIODE**  
(See ARRL VHF HANDBOOK)  
(nearest equivalent about \$17)

\$ 7.50

## Absolutely FREE!

SEND A 9" x 4" STAMPED ADDRESSED  
ENVELOPE FOR FREE OFFER OF 10  
SILICON DOUBLE DIODES TD772 FOR  
MAKING UP "AND" GATES. REMEMBER,  
TO QUALIFY YOU MUST SEND A 9" x 4"  
STAMPED SELF ADDRESSED ENVELOPE  
TO:

**MICRONICS** P.O. BOX 175  
RANDWICK, NSW,  
2031

FANE  
MUSICAL INSTRUMENT/P.A.  
LOUDSPEAKERS  
20% OFF NORMAL PRICE

15" Crescendo 15/100 Bass 100 watt  
Normal Price \$99 less 20% = \$79.20 each  
18" POP 100 100 watt  
Normal Price \$79 less 20% = \$63.20

OFFER LASTS UNTIL CURRENT STOCK SOLD OUT  
**CHALLENGE HI-FI STEREO PTY. LTD.**  
96 Pirie Street, ADELAIDE, S.A. Ph. 223 3599

STOCK  
CLEARANCE



# RAMBLER

CD 2910  
Front Loading  
Cassette Deck  
\$139.00

- Recording Level Meters.
- Digital Counter.
- CRO<sub>2</sub> Normal Tape Select Switch
- Stereo Headphone Output.
- Auto Stop.



Phone 89-3571  
309 Victoria Road, Gladesville

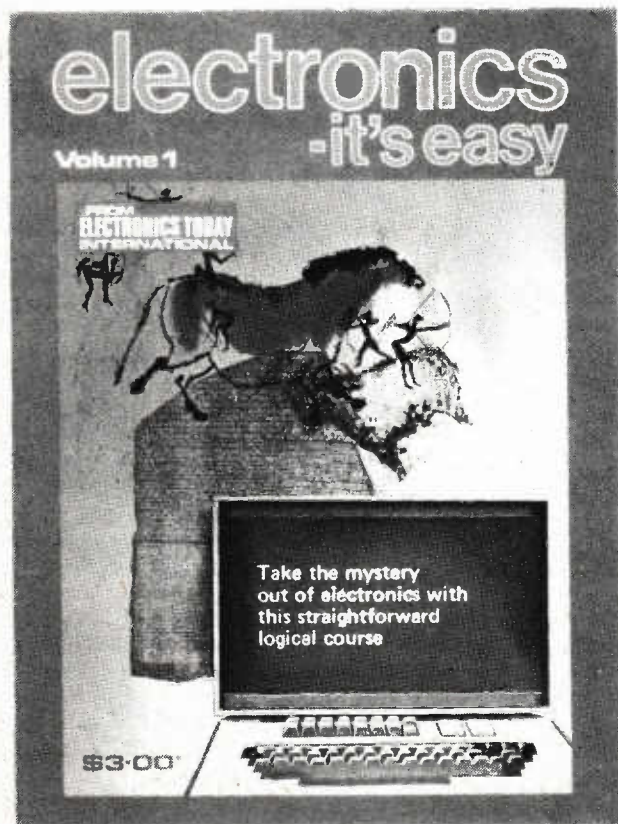

## ELECTRONICS -it's easy!

Take the mystery out of electronics with ETI's simple to follow three-volume course.

Volumes 1 and 2 are available directly from Electronics Today, 15 Boundary Street, Rushcutters Bay, NSW. 2011 — price is \$3.00 each volume plus 40 cents postage (each volume)

Volume 3 will be published in November/ December this year



A MODERN MAGAZINES PUBLICATION.



# ETI data sheet

## Three-terminal positive voltage regulators

This month's data sheets cover the more common positive three-terminal voltage regulators. The table immediately below is a summary of the information on the other tables. At the end of the data sheets we include notes on heatsinking and a warning on possible problems.

To see a voltage regulator used in a circuit, see the Neo Nim project on page 63 of this issue.

Data sheet summary — Three terminal voltage regulators							Device	Package	Rated $I_{OUT}$ (A)	Typ. $\theta_{JC}$ ( $^{\circ}C/W$ )	Typ. $\theta_{JA}$ ( $^{\circ}C/W$ )	Max. $P_D$ (W)
Device	$V_{OUT}$ (V)	Line regulation (mV/V)	Load regulation (mV/V)	Max. $V_{IN}$ (V)	Max. $I_Q$ (mA)	Dropout Voltage (V)						
LM109, LM209, LM309	5	10	20	35	10	1-2	LM109H series LM109K series	TO39 TO3	0.2 1	15 3	150 35	2 20
LM340 LM78XX	5,6,8,12,15,18 24	20 20	20 20	35 40	10 10	1.6-2 1.6-2	LM340K series LM340T series	TO3 TO220	1 1	4 4	35 50	18 18
LM78LXXAC	5 8,12,15,18 24	20 20	12 12	30 35 40	6 6 6	1.5-2 1.5-2 1.5-2	LM78LXXACH LM78LXXACZ	TO39 TO92	0.1 0.1	40 40	140 180	3 1
LM3910	5,6,8,10 12,15,18,24	13	5	40	4	1.5-2	LM3910H LM3910Z	TO39 TO92	0.1 0.1	40	140 180	3 1

## LM109, 209, 309 five-volt regulators

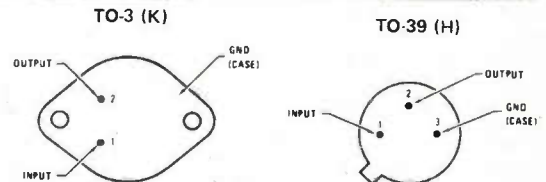

### LM109, LM209, LM309

Junction temperature	LM109	$T_J$	max. 150 $^{\circ}C$ min. -55 $^{\circ}C$
	LM209	$T_J$	max. 150 $^{\circ}C$ min. -25 $^{\circ}C$
	LM309	$T_J$	max. 125 $^{\circ}C$ min. +50 $^{\circ}C$
Thermal resistance	TO3		typ. 35 C/W
	TO5		typ. 150 C/W
Thermal resistance, junction-to-case	TO3	$\theta_{JC}$	typ. 15 $^{\circ}C/W$
	TO5	$\theta_{JC}$	typ. 3 $^{\circ}C/W$
Power dissipation (internally limited)	TO3	$P_{MAX}$	max. 2 W
	TO5	$P_{MAX}$	max. 20 W
Output current	TO3	$I_O$	max. 1 A typ. 0.5 A
	TO5	$I_O$	max. 0.2 A typ. 0.1 A
Input voltage		$V_I$	max. 35 V typ. 10 V
Output voltage ( $V_{IN} = 7$ to 25 V; $I_O = 5$ mA to $I_{MAX}$ )		$V_O$	typ. 5.05 V
Line regulation		$\Delta V_O$	typ. 4 mV
Load regulation	TO3 ( $I_O = 5$ to 1500 mA)		typ. 50 mV
	TO5 ( $I_O = 5$ to 500 mA)		typ. 20 mV
Quiescent current		$I_Q$	typ. 40 $\mu V$
Output noise voltage		$v_n$	typ. 40 $\mu V$

These voltage regulators are complete 5V regulators fabricated on a single silicon chip. They are designed for local regulation on digital logic cards, eliminating the distribution problems associated with single-point regulation. The devices are available in two common transistor packages. In TO-5 it can deliver output currents in excess of 200 mA, if adequate heat sinking is provided. With the TO-3 power package, the available output current is greater than 1A.

The regulators are essentially blow-out proof. Current limiting is included to limit the peak output current to a safe value in addition, thermal shut-down is provided to keep the IC from overheating. If internal dissipation becomes too great, the regulator will shut down to prevent excessive heating.

It is not necessary to bypass the output, although this does improve transient response somewhat. Input bypassing is needed, however, if the regulator is located very far from the filter capacitor of the power supply. Stability is also achieved by methods that provide very good rejection of load or line transients as are usually seen with TTL logic.



# LM340 & LM78XX series

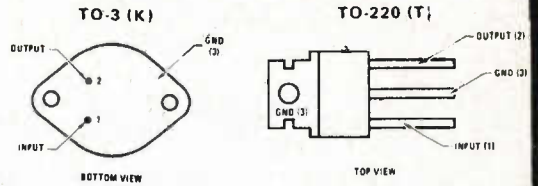

The LM340-XX and LM78XX series of three terminal regulators are available with several fixed output voltages.

The LM340 is available in two power packages. Both the plastic TO-220 and metal TO-3 packages allow these regulators to deliver over 1.0A if adequate heat sinking is provided. Current limiting is included to limit the peak output current to a safe value. Safe area protection for the output transistor is provided to limit internal power dissipation. If internal power dissipation becomes too high for the heat sinking provided, the thermal shutdown circuit takes over preventing the IC from overheating.

Input bypassing is needed only if the regulator is located far from the filter capacitor of the power supply.

LM340 -5, -6, -8, -12, -15, -18, -24  
LM7805, LM7806, LM7808, LM7812, LM7815, LM7818, LM7824

Output voltage	$V_O$	typ.	5	6	8	12	15	18	24	V
Input voltage (for $V_O \pm 4\%$ )	$V_{IN}$	typ.	10	11	14	19	23	27	33	V
		max.	20	21	23	27	30	33	38	V
		min.	7	8	10.5	14.5	17.5	21	27	V
Output current	$I_O$	typ.	500	500	500	500	500	500	500	mA
Line regulation ( $I_O = 100$ mA) ( $I_O = 500$ mA)	$\Delta V_O$	max.	50	60	80	120	150	180	240	mV
		max.	100	120	160	240	300	360	480	mV
Load regulation ( $I_O = 5$ to 1500 mA)		max.	100	120	160	240	300	360	480	mV
Quiescent current	$I_Q$	typ.	7	7	7	7	7	7	7	mA
Output noise voltage	$v_n$	typ.	40	45	52	75	90	110	170	$\mu$ V
Ripple rejection (120 Hz)	$\frac{\Delta V_{IN}}{\Delta V_{OUT}}$	typ.	60	57	55	52	50	48	44	dB
Dropout voltage ( $I_O = 1$ A)	$V_{IN} - V_{OUT}$	typ.	2	2	2	2	2	2	2	V

# LM78LXX series

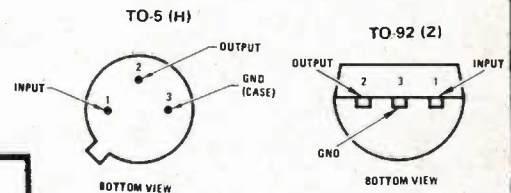

When used as a zener diode/resistor combination replacement, the LM78LXX usually results in an effective output impedance improvement of two orders of magnitude, and lower quiescent current. The regulators are available in the metal TO-5 (H) or in plastic TO-92 (Z) encapsulation. With adequate heat sinking the regulator can deliver 100 mA output current. Current limiting is included to limit the peak output current to a safe value. Safe area protection for the output transistor is provided to limit internal power dissipation. If internal power dissipation becomes too high for the heat sinking provided, the thermal shutdown circuit takes over preventing the IC from overheating.

The series features output voltage tolerances of approximately 5% (LM78LXXAC) and approximately 10% (LM78LXXC) over the temperature range.

LM78L05, LM78L08, LM78L12, LM78L15, LM78L18, LM78L24

Output voltage	$V_O$		5	8	12	15	18	24	V
Input voltage	$V_{IN}$	typ.	10	14	19	23	27	33	V
		max.	30	30	35	35	35	40	V
		min.	7	10.5	14.5	17.5	21.5	27.5	V
Output current	$I_O$	typ.	40	40	40	40	40	40	mA
Junction temperature	$T_J$	max.	150	150	150	150	150	150	$^{\circ}$ C
Thermal resistance " " " junction to case	TO5	typ.	140	140	140	140	140	140	$^{\circ}$ C/W
		TO92	typ.	180	180	180	180	180	$^{\circ}$ C/W
		TO5	typ.	40	40	40	40	40	$^{\circ}$ C/W
Line regulation ( $I_O$ low) (typ. $I_O$ )		typ.	10	12	20	25	27	30	mV
		typ.	18	20	30	30	32	35	mV
Load regulation ( $I_O \leq 40$ mA) ( $I_O \leq 100$ ma)		typ.	5	6	10	12	15	20	mV
		typ.	11	15	20	25	30	40	mV
Quiescent current	$I_Q$	typ.	3	3	3	3.1	3.1	3.1	mA
Output noise voltage (10 Hz to 10 kHz)	$v_n$	typ.	40	60	80	90	150	200	$\mu$ V
Ripple rejection (120 Hz)	$\frac{\Delta V_{IN}}{\Delta V_{OUT}}$	typ.	60	55	52	49	46	43	dB
Dropout voltage	$V_{IN} - V_{OUT}$	typ.	1.7	1.7	1.7	1.7	1.7	1.7	V

Continued on page 46



# ETI data sheet

Continued from page 45

## LM3910/LM340L series

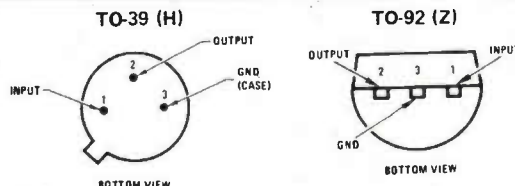

The LM3910 is an improved version of the LM78LXX series with a tighter output voltage tolerance, higher ripple rejection, better regulation and lower quiescent current. The LM3910 regulators have approximately 2%  $V_{out}$  specification, 0.04%/V line regulation, and 0.4% load regulation.

The LM3910 is available in the low profile metal TO39 (H) packages and the plastic TO-92 (Z) packages. With adequate heat sinking the regulator can deliver 100mA output current. Current limiting is included to limit the peak output current to a safe value. Safe area protection for the output transistor is provided to limit internal power dissipation. If internal power dissipation becomes too high for the heat sinking provided, the thermal shutdown circuit takes over preventing the IC from overheating.

LM3910, LM340L series (5, 6, 8, 10, 12, 15, 18, 24 V)

Output voltage	$V_{OUT}$	5	6	8	10	12	15	18	24 V		
Input voltage	$V_{IN}$	typ.	10	11	14	16	19	23	27	33 V	
		absolute max.	35	35	35	35	35	35	35	35	40 V
	(for $V_{OUT} \pm 2\%$ )	min.	7	8	10	12	14	17	20	27 V	
Output current	$I_{OUT}$	max.	20	21	23	25	27	30	33	38 V	
		typ.	40	40	40	40	40	40	40	40	40 mA
Junction temperature	$T_J$	max.	150	150	150	150	150	150	150	150 °C/W	
Thermal resistance	$\theta_{JA}$	T039	typ.	140	140	140	140	140	140	140	140 °C/W
		T092	typ.	180	180	180	180	180	180	180	180 °C/W
	(junction to case)	T039	typ.	40	40	40	40	40	40	40	40 °C/W
Line regulation ( $I_O = 40$ mA)	$\Delta V_O$	typ.	18	20	20	25	30	37	45	60 mV	
		( $I_O = 100$ mA)	typ.	18	20	20	25	30	37	45	60 mV
Load regulation ( $I_O = 40$ mA)	$\Delta V_O$	typ.	5	6	8	10	10	12	15	20 mV	
		( $I_O = 100$ mA)	typ.	11	13	15	20	20	25	30	40 mV
Quiescent current	$I_Q$	typ.	3	3	3	3	3	3.1	3.1	3.1 mA	
Output noise voltage (10 Hz to 10 kHz)	$v_n$	typ.	40	50	60	70	80	90	150	200 $\mu$ V	
Ripple rejection (120 Hz)	$\frac{\Delta V_{IN}}{4V_{OUT}}$	typ.	62	60	58	57	54	52	50	48 $\mu$ V	
Dropout voltage	$V_{IN} - V_{OUT}$	typ.	1.7	1.7	1.7	1.7	1.7	1.7	1.7	1.7 V	

### Heat sink selection for a voltage regulator

#### Compute total thermal resistance

Determine the total thermal resistance, junction to ambient, necessary to maintain steady state  $T_J$  below the maximum value.

$$\theta_{JA(TOT)} = \frac{T_J - T_{AOC/W}}{P_D}$$

Under the short circuit conditions, the internal thermal shutdown will limit  $T_J$  to about  $175 \pm 15^\circ\text{C}$ . Although this protects the device, prolonged operation at such temperatures can adversely affect device reliability.

#### Determine if heat sink is required

Refer to the thermal resistance,  $\theta_{JC}$  and  $\theta_{JA}$ , columns of the data sheet summary.

- $\theta_{JA(TOT)} > \theta_{JC}$  must be met, otherwise a higher wattage device must be used or a boost circuit employed.
- If  $\theta_{JA(TOT)} > \theta_{JA}$ , a heat sink is not required
- If  $\theta_{JC} < \theta_{JA(TOT)} < \theta_{JA}$ , a heat sink is required.

#### Select a heat sink

Choose a suitable heat sink from manufacturers' specification data. The neces-

sary conditions are that  $\theta_{JA}$  (TOT) and  $\theta'_{JA(TOT)}$  be less than  $\theta_{JA}$ .

The total thermal resistance is that from junction to case plus that from case to ambient or sink to ambient (neglecting that from case to sink, which is small).

$$\theta_{JA(TOT)} \approx \theta_{JC} + \theta_{SAOC}$$

#### Check the input ripple and input variations

Insure that full-load  $V_{IN(MIN)}$  does not allow  $V_{IN} - V_{OUT}$  to fall below the dropout voltage of about 2 V. Insure that no-load  $V_{IN(MAX)}$  does not exceed the value listed on the data sheets.

### When not to use a three-terminal voltage regulator

If you consider the voltage regulator as a black box you would not normally have any trouble, but there are occasions when these devices take off — here's the reason why.

The voltage regulator is essentially an amplifier with negative feedback. In this situation the gain varies with the load on the output. If the load is reactive then the feedback can become positive

at particular frequencies — and the regulator breaks into oscillation. These devices should be treated with the same care one would give to an audio amplifier — they work with the loads specified but you should think twice about using anything unusual (like long wires in burglar alarms).

If you feel that it is necessary to adjust the phase of the feedback signal you should not be using a three-terminal regulator; there are many other regu-

lators available which enable you to put a calculated value of capacitance in the feedback path.

Manufacturers recommend putting a 0.1  $\mu$ F capacitor across the output of their regulators and this is usually sufficient precaution against oscillation. You should always have two connections to the common terminal of the regulator — if you try to use one wire to carry both input and output currents you are asking for trouble.



# EDGE ELECTRIX

31 BURWOOD ROAD, BURWOOD, NSW 2134,  
PO BOX 1003 BURWOOD NORTH TELEPHONE 747 2931

## Country Customers Please Note

We are mail order specialists and would like to supply your requirements. For free quotation write or phone.

Concerto Kit SK3	\$279.00 pr.
Concerto Boxes	\$ 55.00 ea.
Kef Kit 3 — same as SK3 but with speakers already mounted on front baffle	\$319.00 pr.
Kef Kit 2 — Cadenza Baffle Kit	\$239.00 pr.
Kef Concerto complete	\$469.00 pr.
Kef Cadenza complete	\$339.00 pr.

### SPEAKERS

B139 Bass Driver	\$ 65.00 ea.
B110 Mid range/Bass	\$ 32.00 ea.
B200/SP1022 Bass	\$ 42.00 ea.
B200/SP1014 Bass	\$ 33.00 ea.
T15 Treble	\$ 24.00 ea.
T27 Treble	\$ 24.00 ea.
BD139 Passive Bass	\$ 22.00 ea.
DN12 Concerto Crossover	\$ 19.00 ea.
DN14 Cadenza Crossover	\$ 17.50 ea.



Please write for any information required on KEF Speakers and Kits, Remember 5 year warranty.

### Brand new AD12K12 Kit consisting of

- 2 — AD1265/W8 40w Woofer (in it's enclosure)
- 2 — AD5060/Sq8 Squawkers
- 2 — Brand new ADO140/T8 Dome Tweeter
- 2 — Crossovers

## PHILIPS

Also complete with 2 enclosures containing innerbond, speaker cloth etc. \$239.00 pr.

### MAGNAVOX

- 8/30... \$13.95 8" Woofer 30W
- 6J... \$7.50 6" midrange
- 8WR... \$11.50 8" twincone
- 6WR... \$10.50 6" twincone

### PHILIPS

- AD0160/T8-1" dometweeter \$12.00 ea.
- AD5060/Sq8-5" squawker now \$16.50 ea.
- AD0210/Sq8-2" dome squawker \$38.00 ea.
- AD8066/W8-8" 40W Woofer \$18.50 ea.
- AD12100/W8-12" 40W Woofer \$49.00 ea.
- ADF500/4500/8-3 way crossover \$14.50 ea.
- ADF 600/4000/8-3 way crossover \$29.00 ea.

### EDGE ELECTRIX SPECIAL PLAYMASTER 146 AM/FM TUNER KIT

\$135.00  
p&p \$3.00

including front panel but no metal work.

### SEMICONDUCTOR PRICES SLASHED

- BC107 20c metal can
- BC109 20c metal can
- BC108 20c metal can
- BCI48
- EM404 15c

## L & G HI-FI

a degree of excellence



### L-2800 Amplifier — 50 WATT RMS PER CHANNEL.

- Better than 0.05% distortion at 50 watts a channel. At 1 KHz.
- Better than 0.01% distortion at 40 watts RMS per channel. At 1 KHz.
- Tone defeat switching • Subsonic filter.

• PLUS INSTANTANEOUS L.E.D. PEAK LEVEL INDICATORS •

What other amplifier can offer this?

**\$419.00**

### T-1400 FM Tuner.

- Perfectly matched to L-2800 amplifier in style & quality.
- Extra large signal strength/centre tuning meters.
- Sensitive hi-blend and muting functions.
- Phase locked loop I.C. multiplex stereo circuit.
- FM distortion better than 2uV.

Is there another tuner as good as this?

**\$312.00**

for more details on L & G products send coupon to  
Edge Electrix  
P.O. Box 1003 Burwood North, NSW, 2134  
or phone 747 2931

NAME .....

ADDRESS .....

P/CODE .....

### Trading Hours

MON — FRI 8.30 am — 5.30 pm  
THURSDAY NIGHTS 'TILL 9pm  
SATURDAY 8 am — 12 MIDDAY.  
PRICES SUBJECT TO CHANGE WITHOUT NOTICE



# REMOTE CONTROL RECEIVER

A brief description of the receiver which is used in conjunction with the remote control switch transmitter described last month.

IT WAS ORIGINALLY INTENDED TO publish complete details of the Remote Control Receiver this month. However lost time due to a major fire in the building housing our laboratory made this impossible. We can however give a block diagram of the receiver and an explanation of how it works. Full constructional details will be given next month.

## The Receiver.

The receiver is a conventional superhet design which incorporates an RF filter and amplifier, a crystal-controlled oscillator, a mixer, a ceramic IF filter, IF amplifier, and a detector to recover the AM component. An AGC circuit is also incorporated to control the gain of the RF stage in order to prevent overload of the receiver when the transmitter is operated in close proximity to it.

## The decoder.

The output of the detector is squared up by a Schmitt-trigger circuit, the output of which is a pulse train in the transmitter which keys the oscillator. This output clocks a sixteen-bit shift register. The output from the Schmitt trigger is also fed to a pair of pulse-width detectors. The first of these is called the '1 ms' detector. If the pulse from the Schmitt is less than 1 ms the detector produces a '1', if the pulse from the Schmitt is greater than 1 ms it produces a '0'. Remember that the pulse train consists of a series of 0.5 or 1.5 ms pulses for the code word and



a 5 ms pulse for synchronisation. Thus the '1 ms' detector feeds a series of '1's or '0's into the shift register as determined by the received code word.

The output of the shift register is connected to 12 exclusive-OR gates which compare the received code with the receiver's particular 12-bit key code.



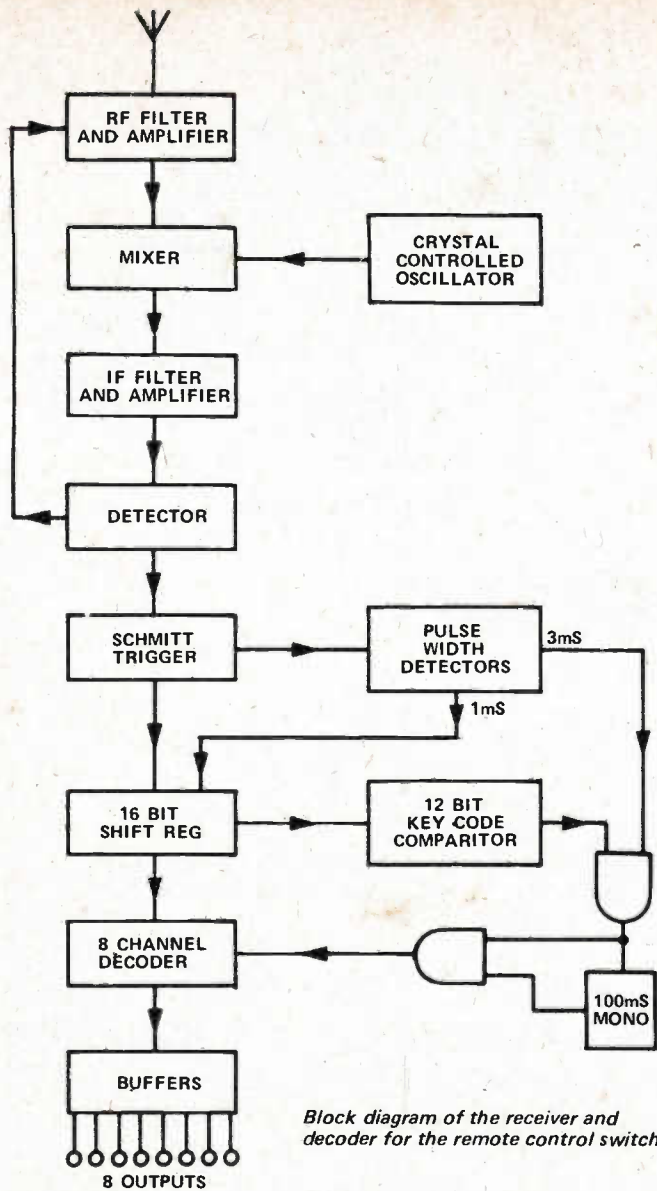

Block diagram of the receiver and decoder for the remote control switch

Whenever a match is found between the wired-key code and that received an output from the comparator goes low. As the output of the shift register is continuously changing there may be several points at which the key code is correct. For example a code of 1010101010 will be correct at every second step. However the correct sequence of pulses is now selected by means of the sync pulse. The sync pulse is detected by a 3 ms pulse detector which provides a '1' output whenever a pulse longer than 3 ms is detected, and a '0' when the input pulse is shorter than 3 ms.

Now if a sync pulse is detected and at the same time the output of the key-code comparator is low (indicating a key-code match has been detected) a 100 ms monostable will be triggered. When the next sync pulse is detected, providing that the comparator is still low, it will be connected to the input of the 8 channel decoder. The control signals, which determine to which of the 8 channels that the sync pulse is fed, come from three of the bits in the 16-bit code (see last month's description).

The sync pulse thus appears at one of the 8 outputs of the decoder, each output being buffered by a transistor. These individual outputs may be used to drive relays or any other device as required. However as it is only a pulse of about 1 ms duration, latching circuitry must be used.

Continued next month.

# MEMOREX Cassettes

Mail to **Bell-Tone**, P.O. Box 142, Neutral Bay Junction, 2089.

All prices are PER CASSETTE, when buying in these quantities.

If you buy ...	1-11	12-23	24 or more
FC 30	\$2.10	\$2.00	\$1.75
FC 45	\$2.15	\$2.05	\$1.90
FC 60	\$2.30	\$2.15	\$1.99
FC 90	\$3.00	\$2.95	\$2.85
FC 120	\$4.29	\$3.99	\$3.25
CC 90	\$4.29	\$3.99	\$3.25



**MEMOREX Recording Tape**  
*Is it live, or is it Memorex*

## TEST REPORT - MEMOREX RECORDING TAPE

Response curve as tested October 1974 - Louis A. Challis & Associates P/L, 158 Queen Street, Woollahra, 2025.

### MEMOREX 60 MRX2 OXIDE TAPE

- FREQUENCY RESPONSE:**  
0 VU 42 Hz to 9 kHz  $\pm 3$  dB  
-10 VU 40 Hz to 16 kHz  $\pm 3$  dB  
-20 VU 40 Hz to 20 kHz  $\pm 3$  dB
- RELATIVE SENSITIVITY:**  
-0.7 dB
- LINEARITY DEVIATION:**  
100 Hz 0.2 dB  
1 kHz 0.2 dB  
10 kHz 0.7 dB

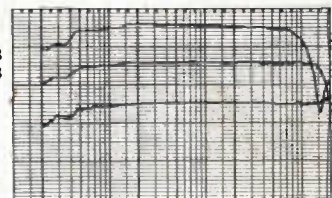

Postage Rates: Up to 6, 60c  
or N.S.W. \$1.20 plus 10c per doz. Vic.,  
S.A., \$1.75 plus 25c per doz. W.A., Tas.,  
N.T., \$1.90 plus 40c per doz.





# extend the audible possible

**Ferrochrom Cassettes give any recorder chromdioxide performance and a ferrochrom recorder performance like nothing else in the world at 17/8 i.p.s.**



Now — multilayered Ferrochrom; a dense layer of LH super quality maghemite for improved lower frequency performance across the full dynamic range; surfaced with a fine chromdioxide coating for brilliant high frequency sound. A formula that extends the audible possible for cassettes.

## What Ferrochrom offers in performance value for you

For owners of cassette recorders with ferrochrom bias switching BASF Ferrochrom offers the ultimate cassette sound. For owners of high quality standard recorders Ferrochrom offers performance comparable with chromdioxide cassettes. Even for owners of chromdioxide recorders, Ferrochrom offers advantages. BASF Ferrochrom is another major advance in cassette performance, quality and technology.

Write for the full fascinating story of how Ferrochrom extends the audible possible.

Please send me full details on BASF Ferrochrom cassettes.

My recorder is.....

Name.....

Address.....

.....

Maurice Chapman & Co. Pty. Ltd.  
P.O. Box 29, Camperdown, NSW. 2054.

BA5034



**BRINGS THE MUSIC BACK ALIVE!**

SOLE AUSTRALIAN DISTRIBUTORS: MAURICE CHAPMAN & COMPANY PTY. LTD. SYDNEY: HORDEN PLACE, DENISON ST., CAMPERDOWN. NSW. 2054. Tel. 516-3366. MELBOURNE: 146-150 BURWOOD ROAD, HAWTHORN. VIC. 3122. BRISBANE: 123 ABBOTSFORD ROAD, MAYNE, QLD. 4006. STATE DISTRIBUTORS: ADELAIDE: NEIL MULLER PTY. LTD. PERTH: M. J. BATEMAN PTY. LTD. LAUNCESTON: P & M DISTRIBUTORS. CANBERRA: SONNY COHEN & SON. DARWIN: PFITZNERS MUSIC HOUSE  
R BASF AKTIENGESSELLSCHAFT 6700 LUDWIGSHAFEN RHEIN. FEDERAL REPUBLIC OF GERMANY



# ETI MINI-ORGAN

With all the electronics on one pc board this organ is easy to build yet has features like touch keyboard, variable tremolo, two voices and a full two-octave range.

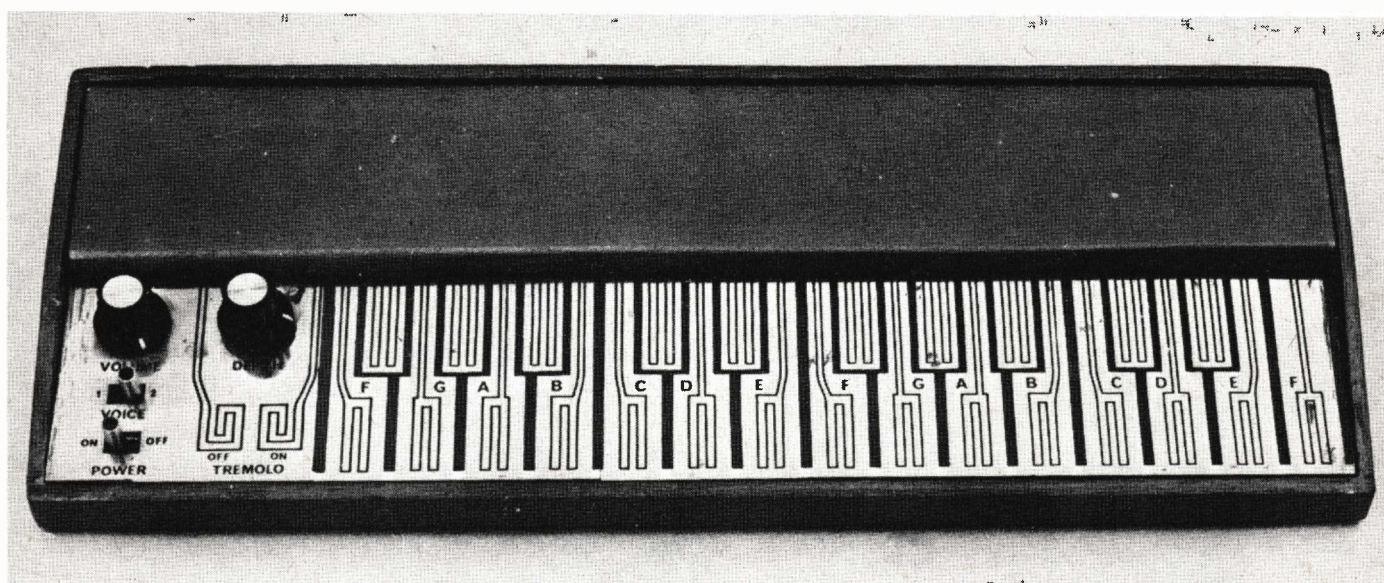

AN ELECTRONIC ORGAN IS A fascinating instrument which these days seems to be rapidly assuming the position in the home once occupied by the piano. Modern organs are, however, very expensive, ranging from around \$1000 to \$4000 — a price which puts them beyond the reach of most people. Lower down the scale in cost and performance are chord organs which although still polyphonic are fairly limited reed type instruments operated by a small blower. The name chord organ comes from the fact that the bass accompaniment is by means of buttons which generate the appropriate chord. Such instruments still may cost several hundred dollars.

The cheapest possible organ is the so called monophonic organ (only one note can be played at a time) which

is usually little more than pocket sized and is played with a stylus.

Such an organ was described in the May 1974 issue of ETI and was enormously popular with our younger readers. So popular that we have been asked to update and improve this instrument without adding to the cost too greatly.

The first obvious improvement required is to devise a better keyboard arrangement as the stylus operation can only be described as somewhat of a nuisance. However the \$100 of a full keyboard cost cannot be justified. As can be seen from the photographs the new keyboard is still of the touch type but has now been designed so that the organ is played simply by touching the appropriate key, as in a full scale instrument. Tremolo is also provided and this too is switched on and

off by means of touch switches and a control is provided to adjust tremolo depth.

The next improvement is in the accuracy of the tuning, which in the previous instrument varied over the keyboard due to the one-only resistor used to increment between each note. In our new version tuning over the keyboard is much improved by using two resistors, where necessary in series or parallel, to obtain the nearest possible to the correct value of resistance. Finally the instrument is provided with two voices or stops which add greatly to the variety of the music which can be produced.

This little organ is relatively inexpensive to build, should provide a great deal of enjoyment and is musically and electronically educational.

*Main text continues on page 56*



# ETI MINI-ORGAN

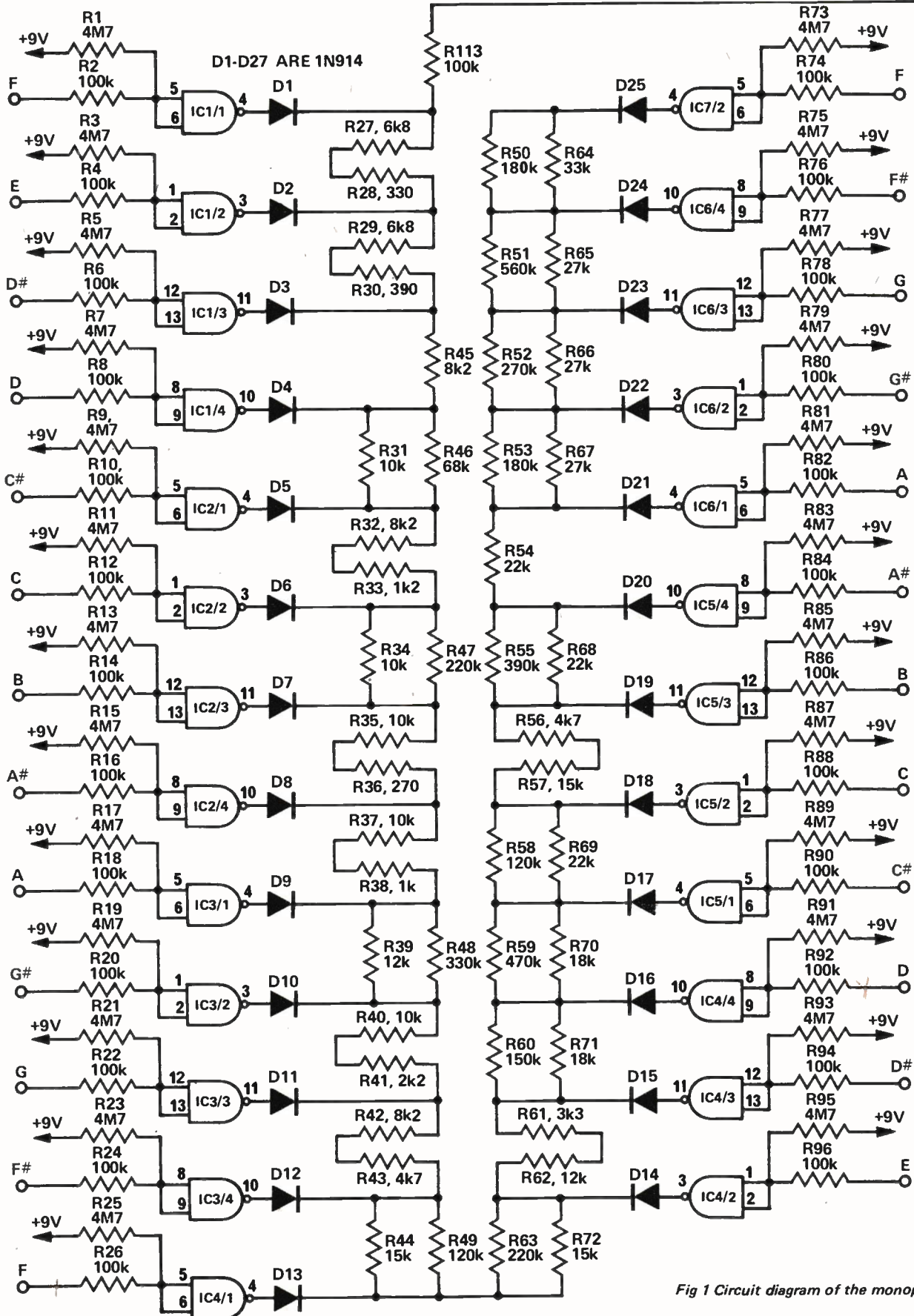

Fig 1 Circuit diagram of the monophonic organ



## How it works ETI 602

Operation of the organ will be described by considering separately the five sections of which it is composed. These are;—

- (a) Keyboard
- (b) Oscillator
- (c) Filter
- (d) Output amplifier
- (e) Tremolo circuit

**(a) Keyboard.** Unlike the previous organ the keyboard is operated by the contact resistance of the finger and not by a probe. Each key has a CMOS gate associated with it where both inputs to the gate are connected together and to the positive supply via a 4.7 megohm resistor. When the key is touched the inputs of the gate are pulled low (0V) via the 100 k resistor causing the output of the gate to go high. This pulls the corresponding point in the resistor chain high via the diode. Thus by selecting and touching different keys we connect various amounts of resistance between pins 2 and 6 of the 555 oscillator and the positive supply, thus enabling it and varying the frequency determining time constant circuit.

**(b) The Oscillator.** The oscillator is based on a 555 timer IC. The capacitor C1 is charged up via a section of the resistor chain (as by the keyboard) together with the resistor R113. When the voltage at pins 2 and 6 reaches that set at pin 5, the capacitor is discharged rapidly via R97 and an internal transistor connected to pin 7 of the 555. When the voltage across C1 has dropped to half that set at pin 5, the internal transistor turns off and the capacitor is allowed to charge up again — thus repeating the cycle and generating a sawtooth waveform across the capacitor. This waveform has a high harmonic content but is generated at a high-impedance point. A unity gain buffer is therefore used (IC8) to prevent this output from being loaded by the following circuitry. A second output of a narrow pulse waveform is available at pin 3 of the 555 and this is used to generate a second voice for the instrument.

**(c) Filter.** A number of different filters were tried but from a cost point of view it was difficult to justify anything more than a simple RC filter on the sawtooth which gives quite a pleasant flute-like effect. As the narrow pulse train sounds somewhat similar to strings

*Continued on page 55*

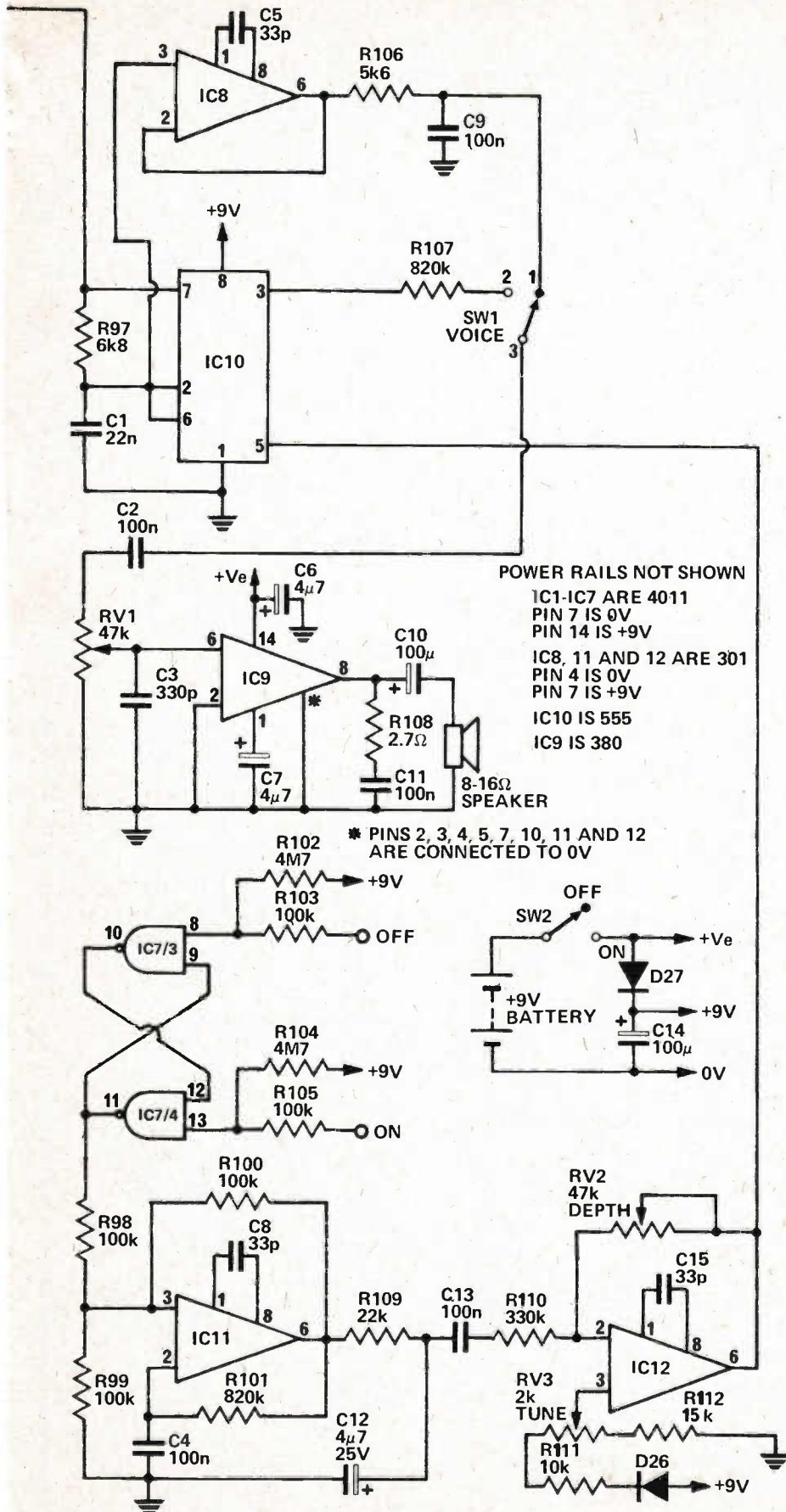



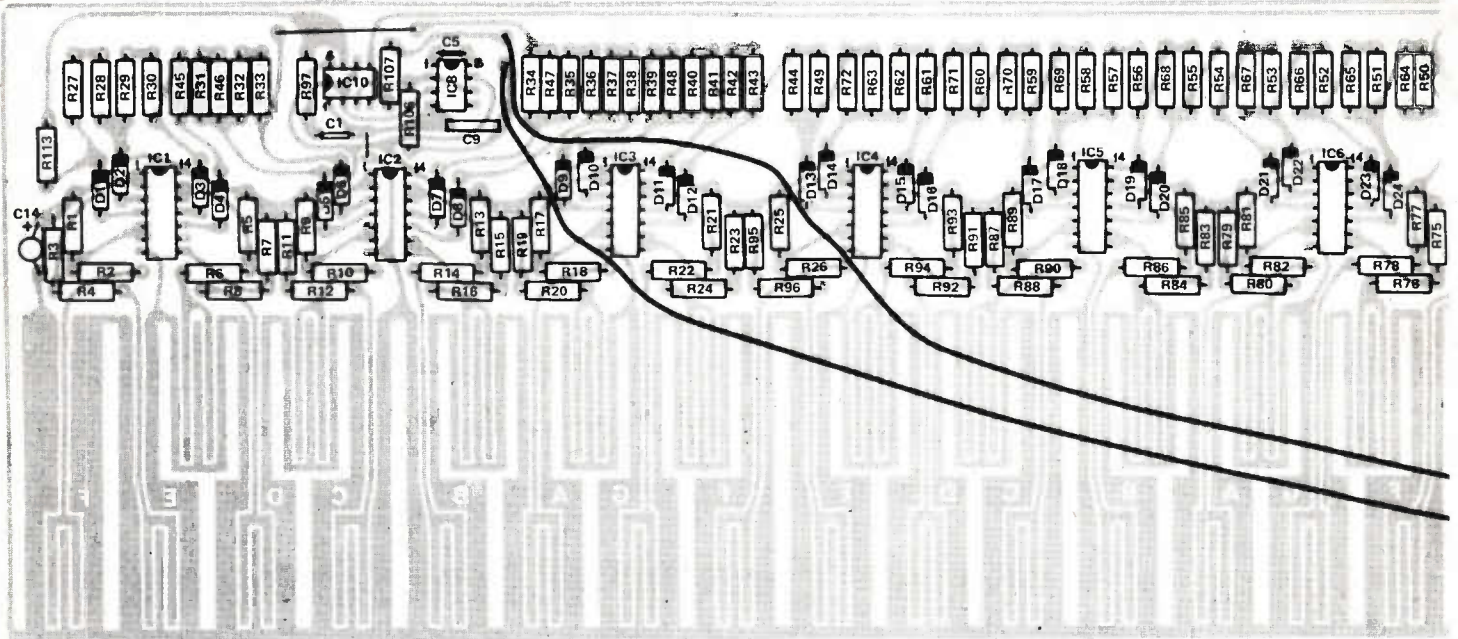

Fig 2 Component overlay and interconnection diagram

## Parts List ETI 602

### Resistors all 1/2W 5%

R1,3,5,7	4M7
R9,11,13	4M7
R15,17,19	4M7
R21,23,25	4M7
R2,4,6,8	100k
R10,12,14	100k
R16,18,20	100k
R22,24,26	100k
R27	6k8
R28	330
R29	6k8
R30	390
R31	10k
R32	8k2
R33	1k2
R34,35	10k
R36	270
R37	10k
R38	1k
R39	12k
R40	10k
R41	2k2
R42	8k2
R43	4k7
R44	15k
R45	8k2
R46	68k
R47	220k
R48	330k
R49	120k
R50	180k
R51	560k
R52	270k
R53	180k
R54	22k
R55	390k

R56	4k7
R57	15k
R58	120k
R59	470k
R60	150k
R61	3k3
R62	12k
R63	220k
R64	33k
R65,66,67	27k
R68,69	22k
R70,71	18k
R72	15k
R73,75,77	4M7
R79,81,83	4M7
R85,87,89	4M7
R91,93,95	4M7
R74,76,78	100k
R80,82,84	100k
R86,88,90	100k
R92,94,96	100k
R97	6k8
R98,99,100	100k
R101	820k
R102	4M7
R103	100k
R104	4M7
R105	100k
R106	5k6
R107	820k
R108	2.7Ω
R109	22k
R110	330k
R111	10k
R112	15k

### Potentiometers

RV1	47k log rotary
RV2	47k log rotary
RV3	2k trim

### Capacitors

C1	22n polyester
C2	100n polyester
C3	330p ceramic
C4	100n polyester
C5	33p ceramic
C6,7	4μ7 25V electro
C8	33p ceramic
C9	100n polyester
C10	100μ 16V electro
C11	100n polyester
C12	4μ7 25V electro
C13	100n polyester
C14	100μ 16V electro
C15	33p ceramic

### Semiconductors

D1-D27	1N914 or similar
IC1 - IC7	4011 (CMOS)
IC 8,11,12*	LM301 or 741
IC9	LM380,SL60745
IC10	NE555

\*if 741s are used delete C5,8,15

### Miscellaneous

SW1,2	single pole, 2 position slide switches
PC board ETI 602	
Two knobs	
6 way AA size battery holder	
Small 8 or 16 ohm speaker	
battery clip	
case to suit	



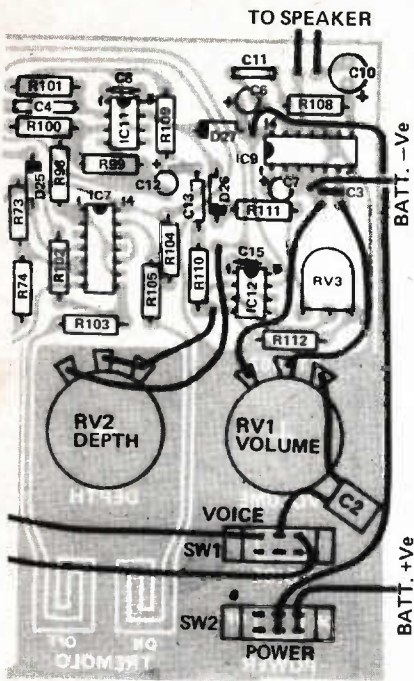

*How it Works, Continued from page 53*

it is merely attenuated to match the level of the filtered sawtooth.

**(d) The Output Amplifier,** The loudspeaker is driven by an LM380. Volume control is provided by means of potentiometers RV1 and the required voice is selected by means of switch SW1. The LM380 should be fitted with heatsink fins as detailed in the construction.

**(e) The Tremolo Circuit.** Tremolo is produced by means of a low frequency oscillator running at approximately 8 Hz (IC11). The oscillator can be turned on and off by means of the flip flop formed by gates IC7/3 and IC7/4. This flip flop is set to the 'on' or 'off' mode by means of touch switches which operate in exactly the same manner as the main keyboard. To increase tremolo frequency decrease R101 and vice versa.

The output from the tremolo

oscillator is filtered by C12 and R109 to give a smoother waveform and the resultant waveform buffered by IC12. The gain of IC12 is adjustable by means of RV2 and this control therefore adjusts the depth of the tremolo modulation. The potentiometer RV3 is a trim potentiometer which effectively sets the output from IC12 to pin 5 of the 555 and thus the frequency of the organ. If it is required to shift the keyboard up or down an octave or so this may be done by changing the value of C1 by a factor of two. If the keyboard tuning is found to be skewed (when tuned correctly at the centre one end of the keyboard is low whilst the other is high) this may be cured by changing the value of R97. If it is sharp at the low end decrease R97 while if flat at the low end increase R97.

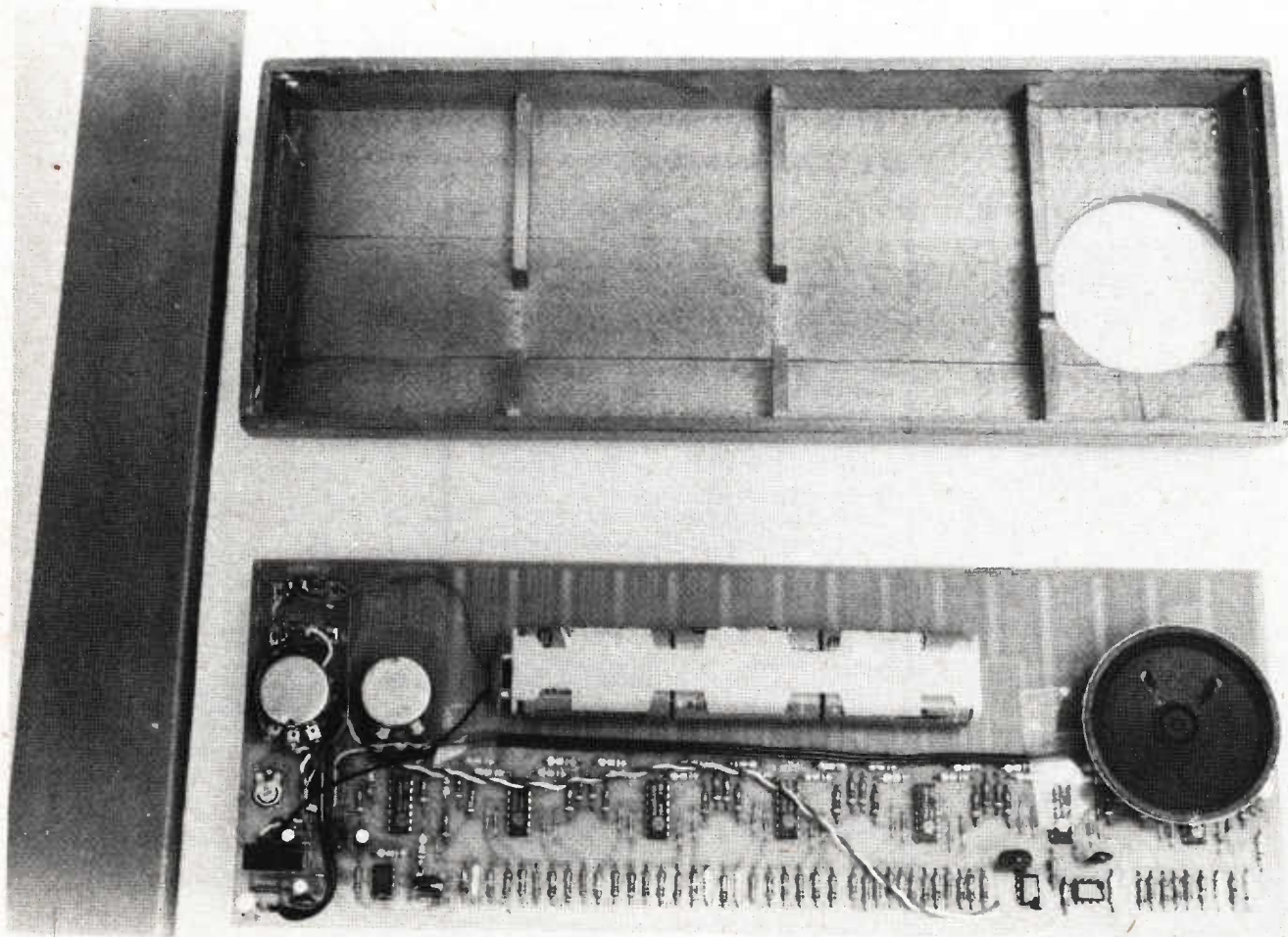



## Design Features

As said earlier the major improvement in the organ is in the implementation of the keyboard by means of a finger touch system rather than the probe type used in the previous organ. This means that some electronics must be associated with each key to detect that it has been touched. Touch control is usually effected by the capacitive, resistive or 50 Hz injection methods. Whilst the capacitive method is the best of these it is also the most expensive and for this reason is not used. The 50 Hz injection method is also complex and thus the resistive method was considered to be the only practical way from a cost point of view.

As the keyboard is now played by the finger it also needs to be larger than in the original organ although still not quite as large as a full-size keyboard.

In the original organ an OM 802 was used as the tone oscillator. This was replaced by a 555 timer IC as this is cheaper and easier to use. The 555 has two outputs which can be used, a sawtooth wave and a narrow pulse. Both of these outputs are used in our design to provide different voices for the instrument. The sawtooth is filtered by means of a simple RC filter to remove some of the harshness due to the harmonic structure and the resultant voice has a rich flute-like sound. The pulse output is matched in level to the sawtooth by means of a resistive attenuator but is otherwise unfiltered. This voice has a string-like sound.

Filtering has been kept very simple, again from a cost point of view. If the constructor desires he may experiment with different filters in order to achieve different sounds. With conventional organs the stop-filtering is done for every octave of the organ to prevent undue tone and level changes at different frequencies. With the two octave span of this organ some change in tone and level must be accepted over the range of the keyboard when using simple filters.

As attenuating filters are used in the organ plenty of gain is required in the audio stage and for this reason an LM380 is used in the audio output stage to drive the loudspeaker.

## Construction

The keyboard pattern is etched directly onto the printed-circuit board which also carries the rest of the electronics. As the copper of the keyboard would rapidly tarnish when continuously being touched with the finger it is necessary for the board to be either tinned or

protected with some other plating process that will prevent tarnishing.

Commence construction by mounting the LM380 into position and then fit small heatsink fins, as shown in the photograph, to either side of the IC. Solder them to pins 3,4,5 on one side and pins 10,11 and 12 on the other. This should be done first as there is little room in this area of the board once other components are in position. Fit the two wire links and assemble the low-height components to the board as shown on the overlay.

Mount the remaining ICs last of all and take particular care not to handle the CMOS ICs excessively before insertion. Check the polarities of polarised components such as ICs, capacitors and diodes before soldering them into position.

To avoid having screws showing on the keyboard we glued the two switches into position with five-minute epoxy. Use a piece of printed-circuit board or metal behind each mounting hole to obtain extra glueing surface and extra strength. Mount the potentiometers and wire the complete board as detailed in the overlay diagram.

The complete unit should now be tested to ensure that all notes and functions are operating correctly before mounting into a suitable cabinet. *Fig 4, (pcb design) is on page 98*

## Frequency of Notes used

F	698.5
E	659.3
D#	622.3
D	587.3
C#	554.4
C	523.3
B	493.9
A#	466.2
A	440.0
G#	415.3
G	392.0
F#	370.0
F	349.2
E	329.6
D#	311.1
D	293.7
C#	277.2
C	261.6
B	246.9
A#	233.1
A	220.0
G#	207.7
G	196.0
F#	185.0
F	174.6

## Playing the organ.

Although the new organ is played with the fingers as with a full instrument there are a few small playing differences which should be kept in mind.

Firstly the instrument is monophonic. That is, if two notes are touched simultaneously only the higher note will sound. Secondly, the fingers must be kept dry, as any moisture across a key will hold that note on when the finger is removed. If this does happen then the keyboard should be wiped with a clean dry rag. In stubborn cases a little methylated spirits on the rag will help.

Finally, it should be remembered that unlike a piano there is no "touch" to the instrument and hitting the key hard will not alter the sound. In this respect it is similar to a real organ and the player should get used to touching the keys smoothly and firmly with the flat part of the finger — not the extreme tip.



*Fig 3  
Details of heat sink  
shown full size,  
two required  
material tinfoil  
or thin copper.*



# AUDIO LIMITER

This simple but effective unit can be used as a limiter, automatic volume control or voltage controlled amplifier.

THE AUDIO COMPRESSOR/EXPANDER project described in the April 1976 issue of ETI has proved to be very popular with readers and we have since had many requests for a simpler limiter circuit. Whilst limiters and compressors are similar in operation they are used in completely different ways.

A compressor is normally used in a linear compression mode. That is, for say every 10 dB of input signal level change the output is arranged to change by, for example, 6 dB. The output will change this fixed amount of 6 dB for every 10 dB increment of input. The reverse of this procedure is called expansion. That is, for a 6 dB change in input signal level the output is caused to change by 10 dB.

A compressor/expander is typically used for improving the dynamic range (and hence signal-to-noise ratio) of tape recorders. The signal is first compressed so that its dynamic range can be handled by the tape. On subsequent replay the signal is expanded by a corresponding amount to restore the original dynamic range. As the amount of noise on the tape is constant and the level of signal has been effectively increased, the signal-to-noise ratio has also been increased.

A limiter is a form of compressor which operates only when the signal exceeds a certain predetermined level. For example signals which do not exceed say 80% of the predetermined maximum are not compressed at all and are amplified with their full dynamic range. For signals above the 80% level the limiter begins to operate and very large input signals are required to obtain the extra 20% of output.

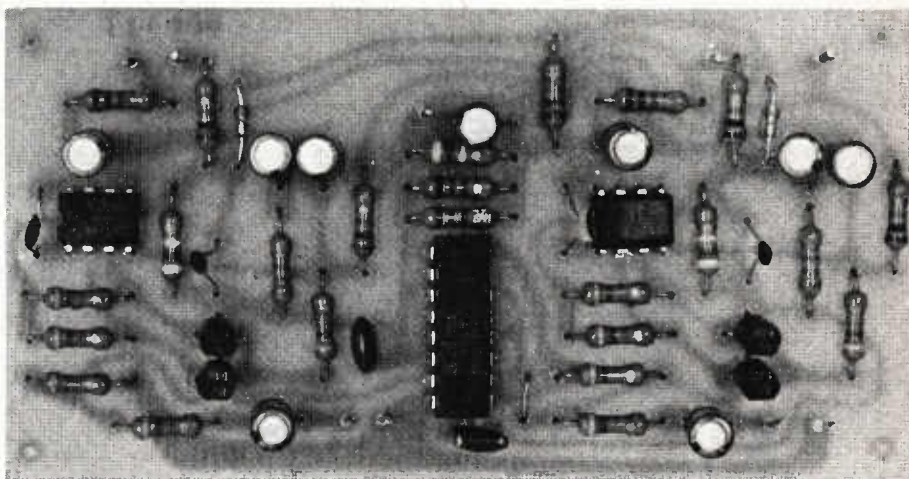

## Specification ETI 446

Input voltage range	1 mV – 10 V
Frequency response	± 3 dB 10 Hz – 20 kHz
Limiting point set by R2/16	3mV
Equivalent signal-to-noise ratio	70 dB re 1 V out
Distortion	see graph
Input impedance	47 k
Maximum gain	
R2/16 = 4k7	26 dB
R2/16 = 47k	40 dB
Maximum attenuation as voltage controlled amplifier	55 dB
Supply voltage	± 8 V to ± 16 V dc at 5 mA



# AUDIO LIMITER

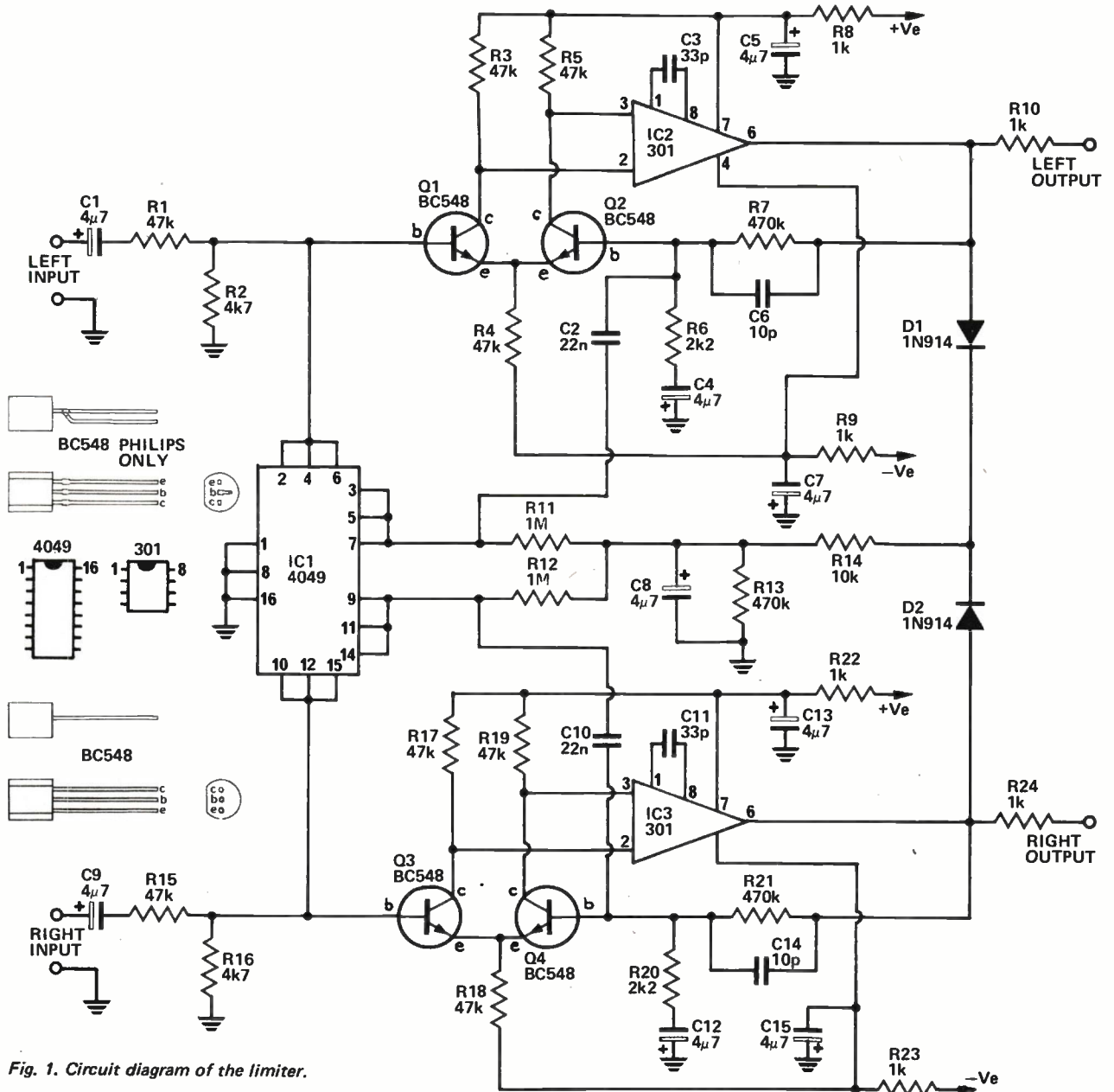

Fig. 1. Circuit diagram of the limiter.

The circuit basically consists of a voltage-controlled attenuator followed by a low-noise amplifier with a gain of 46 dB. The output of this amplifier is rectified to generate a dc voltage which is used to control the attenuator.

The variable element in the attenuator is an enhancement mode FET. This is made from a CMOS hex-inverter IC, the 4049, by special interconnection. The difference between enhancement mode FETs and the normally available depletion-mode junction FETs is as follows: The enhancement mode FET has

a high resistance between source and drain when the gate is at zero volts, but this decreases as the gate is taken more positive. A JFET (N type) is hard-on with the gate at zero volts and turns off as the voltage is taken negative.

The amplifier is required to have high open-loop gain and have fairly low noise. The gain requirement is provided by an LM301 operational amplifier and the low-noise requirement by a pair of transistors (connected as a differential pair) placed before the operational amplifier. The gain is set, by the

combination of resistors R6 and R7, to 215 (or 46 dB). The lower 3 dB point is set at 15 Hz by C4 and R6 whilst the upper 3 dB point is set at 33 kHz by C6 and R7.

The outputs of both channels are summed and rectified by diodes D1 and D2 to charge C8 via R14. The voltage on C8 is coupled to the gate of the FETs (three in parallel on each channel) via R11 and R12.

As the input voltage increases the output also tends to increase and voltage on capacitor C8 also increases and this increase is applied back to the gates of the FETs. This reduces



## PARTS LIST ETI 446

### Resistors

R1	47k	½ W	5%
R2	4k7	"	"
R3-R5	47k	"	"
R6	2k2	"	"
R7	470k	"	"
R8-R10	1k	"	"
R11,12	1M	"	"
R13	470k	"	"
R14	10k	"	"
R15	47k	"	"
R16	4k7	"	"
R17-R19	47k	"	"
R20	2k2	"	"
R21	470k	"	"
R22-R24	1k	"	"

### Capacitors

C1	4μ7 25 V electro
C2	22n polyester
C3	33p ceramic
C4,5	4μ7 25 V electro
C6	10p ceramic
C7-C9	4μ7 25 V electro
C10	22n polyester
C11	33p ceramic
C12,13	4μ7 25 V electro
C14	10p ceramic
C15	4μ7 25 V electro

### Semiconductors

Q1-Q4 Transistors BC548  
 D1,2 Diode 1N914  
 IC1 Integrated circuit 4049 \*  
 IC2,3 " " LM301

### Miscellaneous

PC board ETI 446  
 9 PC board pins

\*Do NOT substitute a 4009 or 4449 as the input protection is different.

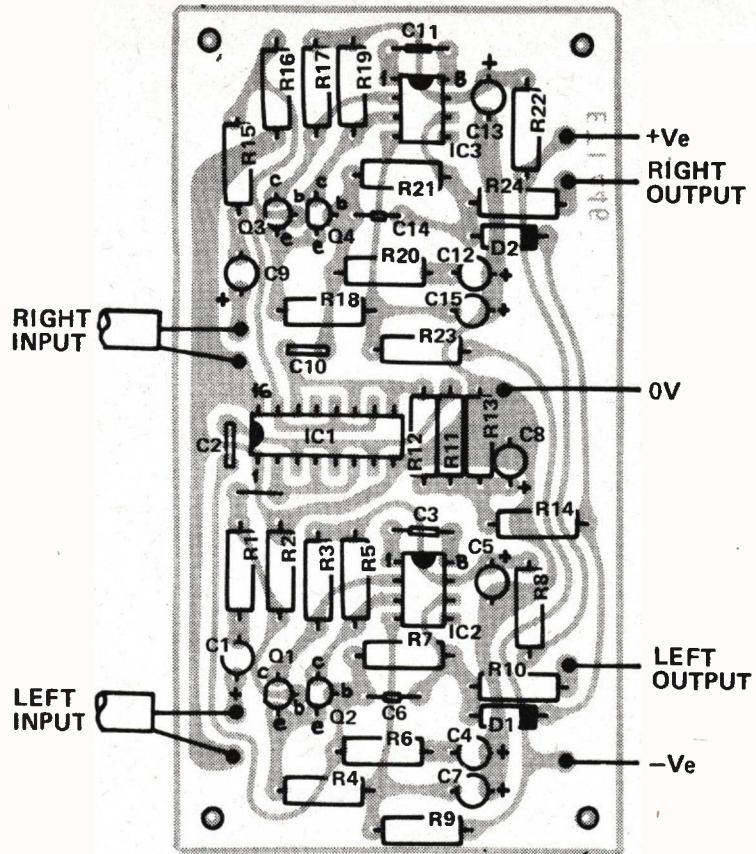
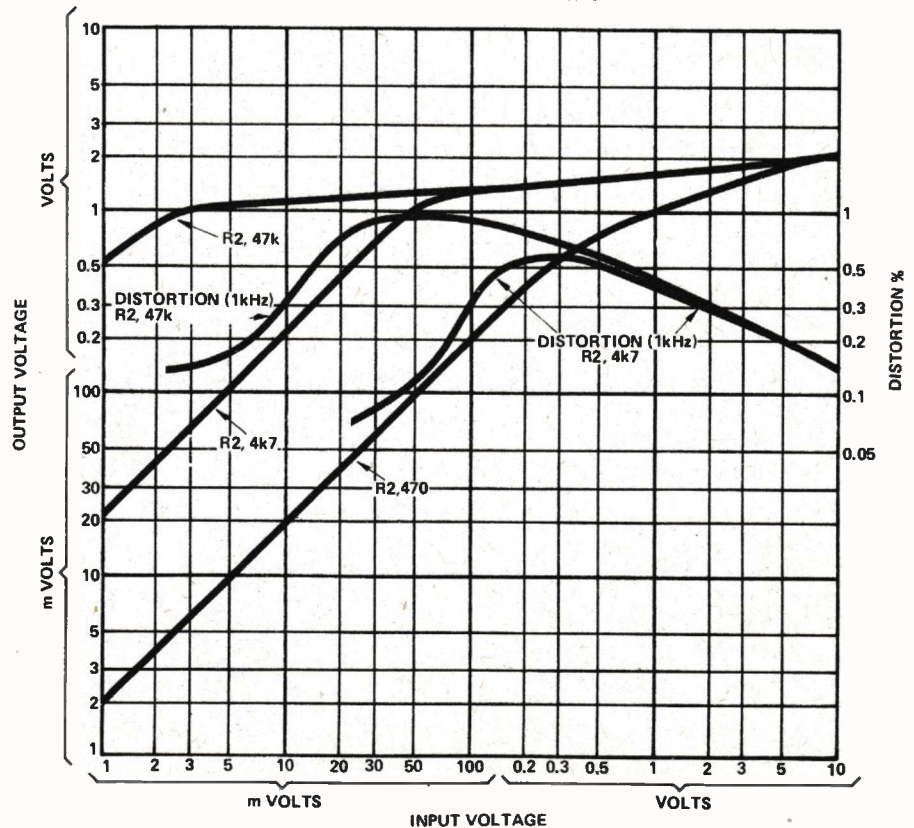

Fig. 2. Component overlay.

Fig. 3 Input versus output voltage for various values of R2 (and R16)  
 Distortion at 1kHz for R2=4K7 and R2=47K are also shown.



the resistance of the FETs and thus increases the attenuation, tending to prevent the output from changing as much as the input does.

With all FETs the resistance changes with applied voltage and this gives rise to distortion. However by modulating the gate voltage with a signal equivalent to the voltage across the FETs the distortion is greatly reduced (3.5% down to 0.8%).

The attack and release times can be adjusted by varying R14 for attack and R13 for release.



# Project 446

Another use of a limiter is in the continuous-limit mode such that it acts as an automatic volume control (AVC). In this mode a 60 dB change in input level can be limited to say, a 6 dB change in output level.

Finally the limiter may also be used as a voltage controlled amplifier having a range of about 55 dB. A typical application of such a device would be a remote volume control. It should be noted, however, that although the transfer function of such a voltage-controlled amplifier is fairly sharp, two of them may not necessarily track perfectly due to differences in the FETs in the ICs. Thus on our prototype the difference between channels when used as a stereo volume control was up to 5 dB at some points with any given input.

## Design Features

The first decision to be made when designing a limiter is what type of controlled resistive element to use. Common alternatives are FETs, LDRs, base-emitter junctions of transistors, thermistors or balanced modulator ICs. All of these have their respective advantages and disadvantages and all have been tried in our laboratory at one time or another. We selected FETs because we considered them the most cost effective.

When FETs are used in voltage controlled amplifiers it is essential that the voltage across them is kept as low as possible if the distortion is also to be kept low. This means that the FET must be used as an attenuator where the voltage across the FET can be kept low irrespective of input voltage. The most suitable type of FET for this purpose is the enhancement-mode device but these are not readily available. The commonly available types are junction FETs which unfortunately require a negative voltage to turn them off. However, there is a suitable alternative, the 4049 CMOS IC which contains six inverting buffers. By suitable interconnection the IC may be made to provide six enhancement-mode FETs and this is the approach we decided to use.

To restore the signal level an amplifier is required and originally we intended to use the LM382 but, because of cost and availability considerations, we finally decided to use an LM301 or 741 operational amplifier together with a transistor pair at the front end. The noise performance of this arrangement was found to be as good as the LM382's and supply voltage to be less critical (although a dual supply is required).

## USES OF A LIMITER

**Peak Limiting.** In this mode only signals above 85% of maximum level are attenuated. This is useful for preventing amplifier clipping (for pop groups or other live shows) which gives rise to objectionable distortion. It may also be used when tape recording the same type of programme material as above, to prevent the tape being saturated, which again would give rise to distortion.

**AVC.** In this mode, the limiter is used typically to drastically reduce the dynamic range of a programme being recorded. For example, when recording a lecture the 60dB dynamic range of lecture room speech may be compressed to 6dB.

**Voltage Controlled Amplifier.** As a voltage-controlled amplifier the unit lends itself to a variety of remote or automatic control applications. For example, it may be used as a remote control for stereo amplifier volume. Alternatively, it may be adjusted to increase car radio volume as ambient noise level rises.

**Special Effects.** The limiter may also be used to modify the sound of musical instruments. For example, such a limiter is often used to eliminate the attack transient on a bass guitar to give a smoother mellower sound.

The uses of such a circuit are wide indeed, and we are sure our readers will think of many more applications for this interesting circuit.

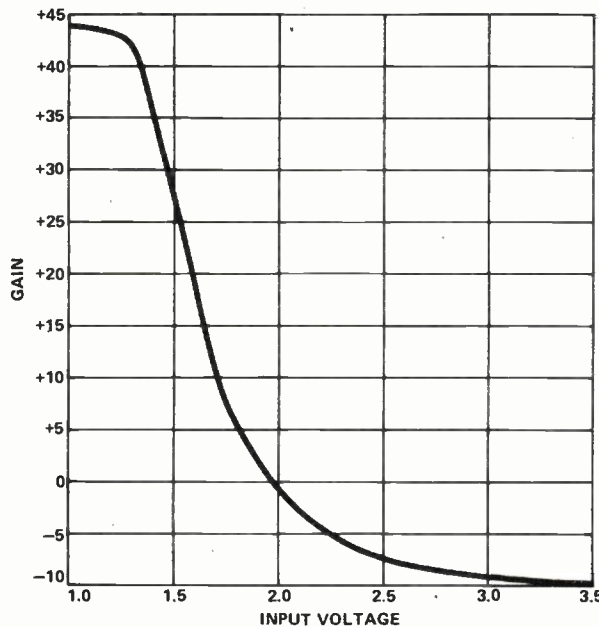

Fig. 4 Gain versus control voltage with  $R2 = 47k$

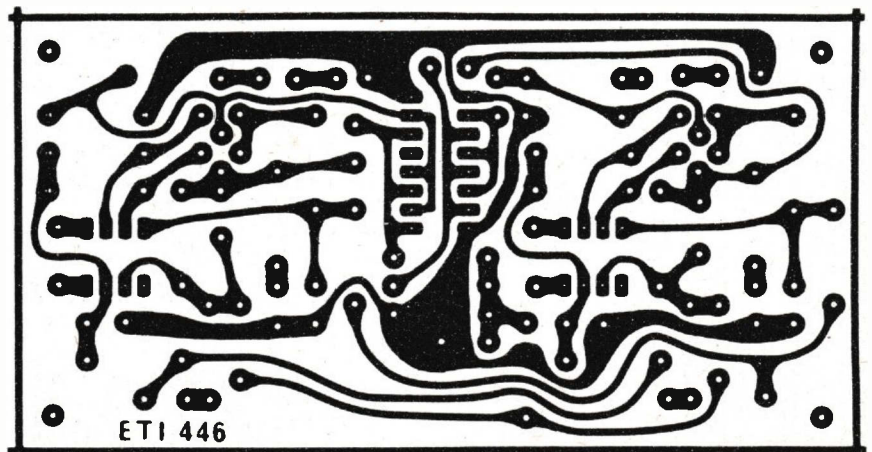

Fig. 5. Printed-Circuit layout for the limiter. Full size 58 mm x 110 mm.



If only a single-ended supply is available then a 382 may be used, although a different board layout would be required.

### Construction

Although a printed-circuit board is not essential it certainly makes construction very much easier. Before assembly decide whether a limiter or an AVC is required as the values of R2 and R16 will vary accordingly. Use 47k for R2 and R16 in the AVC mode and in limit mode, depending on limit point, between 470 and 4k7. The transistor type specified is available from a number of different manufacturers but pin connections are different — the overlay shows connections for the Philips type. If a different brand is used the transistor should be reversed (emitter and collector interchanged). The overlay also shows the arrangement for using the LM301 ICs — these may be directly replaced by 741s simply by omitting the 33 pF capacitors.

Although the CMOS ICs 4449 and 4009 are electrically similar to the 4049 and are interchangeable with it when the devices are used as hex-inverters, they cannot be used as replacements in this circuit. The 4049 must be used. The 4449 and 4009 have different circuitry and will not work in this mode.

As this unit will normally be used in association with another piece of equipment, and most likely built in to it, a case has not been described. When installing the unit make sure that the input cables are coaxial or shielded cable — outputs are not important and can be normal hookup wire.

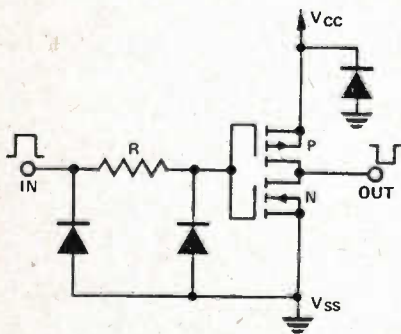
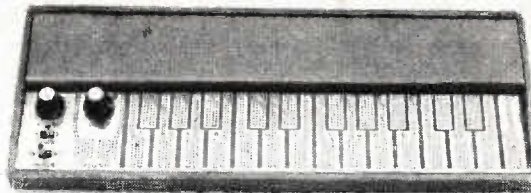

Fig. 6 Internal circuit diagram of one of the six inverter stages in the CMOS 4049 IC

## ETI Mini-Organ

All components including a tinned fibreglass PC Board excluding case

\$25.00 + \$1 P&P



## ETI 446

### Audio Limiter

All components including a fibreglass PC Board.

\$6.50 + 50c P&P

## ETI 444 5 Watt Stereo Amp.

(See June '76 ETI) Some kits still available.

A simple and inexpensive amplifier especially suited for construction by beginners. Five watts per channel is adequate for most inexpensive speaker systems.

Full Kit: \$45.00 plus \$3 P&P includes full metal work, front panel, fibreglass P.C. board, etc. Built and tested: \$60.00 plus \$3 P&P.



## ETI 514B Light/Sound Flash Trigger

(See May '76 issue of ETI). Kit of Parts — \$14.99 incl. P&P (Kit does not include flash cord or battery). Built and Tested — \$22.30 incl. P&P. (includes microphone, flash cord and battery).

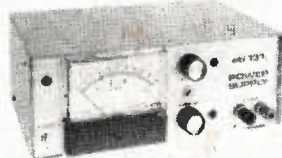

## ETI 131 Power Supply (See April '76 ETI)

Superb general purpose regulated power supply. 0-20V at 2.5 amps or 0-40V at 1.25 amps. Full Kit: \$70.00 plus \$5 P&P. Includes rescaled meter, silk screened front panel, all metalwork and heat-sinks. Specify which version is required when ordering. Built & Tested: \$90.00 + \$5 P&P; Complete metalwork: \$18.00 + \$2 P&P; Rescaled Meter: \$10.00 + \$1 P&P; PC Board (glass with overlay): \$2.50 + 50c P&P.

## ETI 445 Stereo Preamp.

All components plus fibreglass PC Board \$5.00 + 50c P&P. ETI 445 PC Board only \$1.50 + 20c P&P.

### Components

CMOS	4001	.....	35c	LINEAR	LM301 op amp	.....	65c
	4011	.....	35c		LM382 dual preamp	..	\$1.90c
	4027	.....	1.25c		NE555 timer	.....	90c
	4050	.....	80c		LM339 quad comparator	.....	\$2.75
	4511	.....	2.50c	DIODES	IN4004 (1A 400V)	.....	10c
	4518	.....	2.50c		IN5404 (3A 400V)	.....	35c
					LED HP5082-4855 (incl. mounting clips)	.....	40c

A&R 5755 Transformer 20-0-20V @ 2A \$12.50 as used in ETI 440 Amplifier and 131 power supply.

Prices include postage — min. order \$5.00. Components for all kits listed above are also available.

**nebula**  
ELECTRONICS PTY LTD

4th Floor, Ryrie House,  
15 Boundary St., Rushcutters Bay, 2011  
Phone 33-5850.



FANTASTIC OFFER TO ETI READERS . . . 3 "Command" Amplifiers at Incredible Prices

# 10 WATT STEREO AMPLIFIER

OR "Little Brother" 3W STEREO  
Only \$23 and with Tuner only \$31

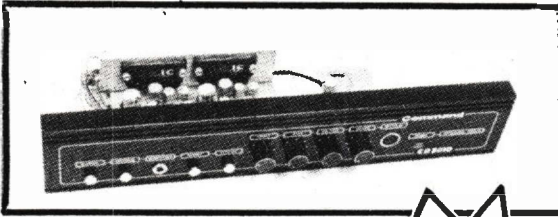

We are Pleased To Invite You To Call in and Listen

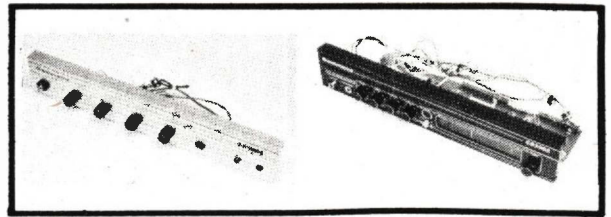

**\$34**

- Ready built, not a kit
- Ceramic cartridge input
- Headphone, tape sockets
- Hi-Fi sound performance
- Rumble, scratch switches
- Slumber, loudness switches
- Australian designed and made

### IC AMPLIFIER DESIGN

Latest up-to-date IC technology is used to give 20Hz - 50kHz response, tailored at the low and high frequency ends to optimise performance of modern ceramic cartridges so that the sound quality often surpasses that of cheap magnetic cartridges. This is achieved with the LM3900 pre-amp and dual STC TA-10B hybrid amplifiers giving maximum 15W/ch in 8-15 ohms. The attractively designed front panel features white lettering on extruded black anodised aluminium with a really professional finish. The PC board and front panel are already assembled simply wire in the power supply as directed. All parts supplied (including transformer and mains lead) - no extras to buy.

**THIS MUST BE GOOD VALUE AT \$34.00.** □

### SPECIAL OFFER NOW!

(Offer Open Until 11.9.76 or While Stocks Last)

**\$1 EXTRA BUYS THIS DE-LUXE BASE to suit.** □

Available only when purchasing any amplifier on this page. Choose BSR or GARRARD cut-out and nominate with order. Perspex covers and hinges available if required (Price \$10.50 set) □



### MATCHING TURNTABLE AND SPEAKERS GARRARD 6-200 CHANGER

Full-size 3 speed auto-changer, 11" platter, de-luxe aluminium trim, lowering device, complete with ceramic cartridge. ESPECIALLY SUITED TO THE AMPLIFIERS SHOWN ON THIS PAGE. Our normal price for this turntable is \$36.00, however, we want to make it easy for you to own one of these beaut systems, so with each order for an amplifier, we will knock \$7 off the price of this Garrard 6-200. IT'S A GOOD BUY AT \$29.00 □

**\$7 OFF**

### 8" 3 WAY SPEAKER KITS

Of course you can use any quality speaker system with these amplifiers, but we recommend these well-known brand Australian made speakers and they're at the RIGHT PRICE. 6 speakers for \$33.00. You get 8" woofers (with specially treated cones for low bass performance), 5" dual-cone sealed-back speakers for mid-range, and 3" cone tweeters for response to over 18kHz, plus crossovers consisting of capacitors and wire wound resistors plus a set of instructions and drawings to BUILD YOUR OWN CABINET AND SAVE \$\$\$.

**\$33 PAIR**

### CORAL SPEAKER KITS

8" 3 way 3 speaker kit 8SAI \$37.90 pr. □ 10" 3 way 3 speaker kit 10SAI \$61.75 pr. □ 12" 3 way 4 speaker kit 12SAI \$85.00 pr. □

### QUALITY AMPS FOR BUDGET CONSCIOUS MUSIC LOVERS

#### 3W STEREO AMPLIFIER \$23.00

With a similar appearance to the 10W amplifier, shown at left, this "little brother" features headphone and tape sockets, slumber switch, VOLUME, BASS, TREBLE, controls, latest IC designs, and ceramic cartridge input. Ready built, not a kit - simply add transformer and mains lead (both supplied). No extras to buy, and only \$1 extra buys the de-luxe base to suit. □

#### 3W STEREO WITH TUNER \$31.00

The addition of the AM BORADCAST TUNER makes this a versatile sound centre with all the features listed above. The styling is particularly attractive with the blue tinted-back-lighted dial and would grace the decor of any lounge room. □

#### 6" WIDE-RANGE SPEAKERS \$5.50 ea.

Fitted in a suitable cabinet (you can build your own with the drawings supplied), these 6" MAGNAVOX twin cone speakers offer very satisfactory performance with the 2 amplifiers above. Power handling is ample at 7W and the 60Hz - 15kHz response (in a suitable cabinet) is easily reproduced. □

### 'SUPA' SPECIALS - Only while stocks last.

- 195 BCD THUMBWHEEL SWITCHES Single pole, 0-9, latest mini, \$2 ea. or 4 for \$7.
- 199 600V 25A SIL RECTIFIERS International Rectifier 75c ea OR 10 for \$6.50 or 25 for \$15.
- 200 MECHANICAL FILTERS \$25 Were \$33, last few, 455kHz centre freq., bandwidth at atten 6dB (±1.3) 60dB (±1.9), 20K in/out Kokusai brand with full data, others available.
- 210 DESK MICROPHONE KIT \$6.50 PA, CB or Ham use, low imp. dynamic, made for Vinten 2 way.
- 208 PERMEABILITY TUNERS PRT 5 Manual, 3 coils, knob. \$1.00
- PRT 10 Manual, 3 coils C/W dial. \$1.50
- PRT 18 Push-button, 3 coils. \$2.50
- PRT 20 Push-button, 4 coils. \$2.50
- 201 2-12V 6A TRANSFORMERS \$8 Both 120V input, use series for 240V.
- 193 10 ASST SWITCHES \$2 Toggle, slide, rotary all new, useful.
- 205 VHF TRANS. TV TUNER \$6 Miniature Sharp 12 channels, 9 with biscuits, new in original package 2 for \$11.
- 209 NIXIE TUBE SALE \$1.50 Take your pick ZM1000 14 pins ZM1080 13 leads, GR-111 13 leads, each 170V oper., 2.5mA anode, 0-9 readout.
- 202 50 ASST. SEMIS \$3 Top grade, tested OK - 15 IC's, 15 trans, 20 diodes. All good, marked etc.
- 203 100 ASST TRANSISTORS \$5 Aust. ITT made, all good, tested OK, audio/RF, marked with data.
- 204 25 ASST IC's \$2 Mostly digital, all tested OK, marked.
- 206 10 TO5 NPN TRANS. 75c Silicon low voltage, sim to TT801.
- 198 50 TO-18 ASST TRANS \$2 PNP & NPN all tested OK, marked.
- 211 10 2N3055-1 TRANS \$3 All marked, tested OK, 40V Ce rating.
- 220 100 ASST 1/2W RESISTORS \$1 5%, 10% mixed carbon composition.
- 219 100 ASST 1W RESISTORS \$1.50 5%, 10% mixed carbon composition.
- 218 250 MIXED BULK RES \$2 1/8W, 1/4W, 1/2W etc. up to 10W.
- 196 30 ASST ELECTROS \$2 All top grade, low voltage.
- 207 DIGITAL IC SALE 7400, 7401, 25c each. 7441 95c, 7473 65c, 7490 60c.
- 217 10 TIC44 SCR'S \$2 40V, 600mA rating, mini plastic package.
- 170 4-14 PIN DIL SOCKETS \$1
- 171 3-16 PIN DIL SOCKETS \$1
- 180 5 WAFER SWITCHES \$2 MSP rotary, std. mtg. 1/4" shaft, 1 to 4 bank, various positions, all new.
- 216 10 TRIMMER CAPS \$2 Air-spaced, miniature 50pf, cer. base.
- 191 12V MINI-RELAY \$2 200 ohms, 5 amp contacts, sgle c/o plastic cover sealed.

**7 APECO T.V. CAMERAS**  
left!  
Last few at this price, c.w. adjustable lens. Video or RF output, use with ordinary home TV. Automatically adjusts to light conditions, uses interchangeable lens. ONLY \$159 □

**BONANZA JACKPOTS**  
For experimenters and constructors, a large assortment of new, high quality parts - samples, specials, end-of-line components incl. semi-conductors.  
**JACKPOT NO. 1**  
A 500gm (approx) Lucky-dip offer, all useable parts. Up to \$25 worth for only \$5. □  
**JACKPOT NO. 2**  
A 2K gm (approx) assortment in a 315 x 270 x 160mm box includes relays, edge connectors, pots, switches semis and many others too numerous to mention. ONLY \$10 □

**FREE GIFT**  
WITH EVERY ORDER \$20 AND OVER.  
*Guaranteed Useful - Let it be a SURPRISE!*

**Electronic Agencies**

Trading Hours - 12.00 - 6 pm Mon-Fri. 8.30-1pm Sat.  
Mail Orders - P.O. Box 1005 Burwood North 2134  
Post & Pack - Add 15% up to \$25 order value. 10% over.  
Minimum Order Value - \$3.00 C.O.D.'s Send \$3.00 pre-paid  
Prices & Availability - O.K. as at 21.7.76.

115-117 Parramatta Road, CONCORO, N.S.W. TELEPHONE (02) 747-6472

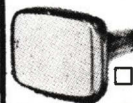

#### 5" B & W SHARP TV TUBE

Brand new, sealed in manufacturers carton. Ideal for servicemen, amateurs, experimenters etc. Were selling at \$11.95, now only \$5.95; sorry no yokes avail.

□ 8" B & W SHARP TV TUBE As above, great value, \$9.95.

Write your Name, Address, P/Code here and send your order to P.O. Box 1005, Burwood Nth. 2134.



# NEO NIM

Building this easy project will familiarise you with voltage regulators and give an updated version of the ancient game of NIM.

by A. J. Lowe

MAYBE YOU THINK THAT NIM IS A game only for children — because it can be won every time by knowledgeable players, thus making it trivial. That's true of NIM, but it's not true of NEW DIMENSION NIM.

New Dimension Nim is an electronic version of ordinary Nim, but with a new dimension added. It's still fun for kids, but this version will keep the 'egg-heads' busy as well.

## THE GAME

To go back a bit — for those not familiar with the game Nim is a game for two players. Between the players is a number of counters in one pile, or a small number of piles, or in a row. You can try the game with matches for counters. Players take it in turns to pick up and put aside any number of counters, up to an agreed maximum, from only one pile or from the row if the counters are laid out. The player who is left to pick up the last counter is the loser.

The single pile or row of counters versions can be understood and won by a player applying simple arithmetic. The multiple pile game involves understanding binary numbers and some nimble thinking for a player to win every time — but it can be done.

New Dimension Nim uses 21 lamps as counters (Fig. 1) set out in a circle. Once again two players take it in turns to pick up and remove counters or rather — turn lamps off, up to an agreed maximum. BUT there's an added rule — that lamps to be turned off must be in adjacent positions. If a particular lamp

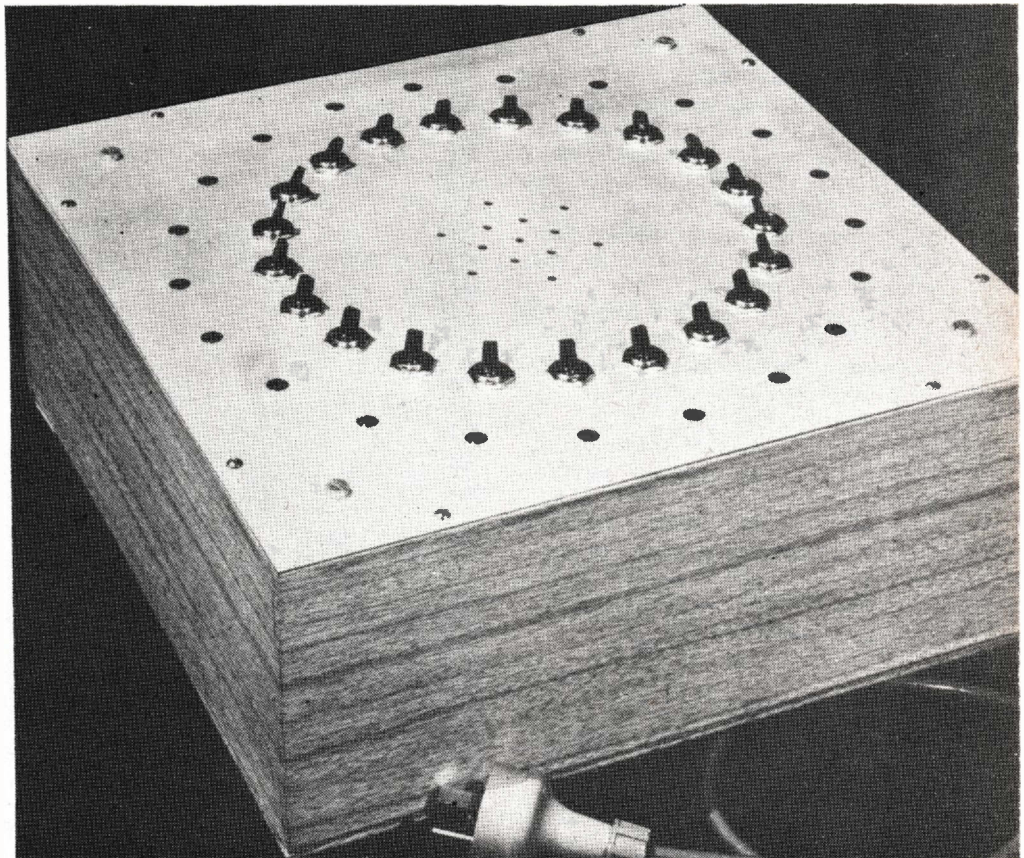

is already off it is not permissible, in one turn, to switch off lamps on both sides of that particular lamp. This does not mean that a player can operate only on lamps adjacent to those on which his opponent has just operated. It simply

means that he can operate only on lamps which are adjacent to one another in one group.

Experiment with say 21 matches set out evenly spaced round a circle, and you'll soon get the idea. You'll see that



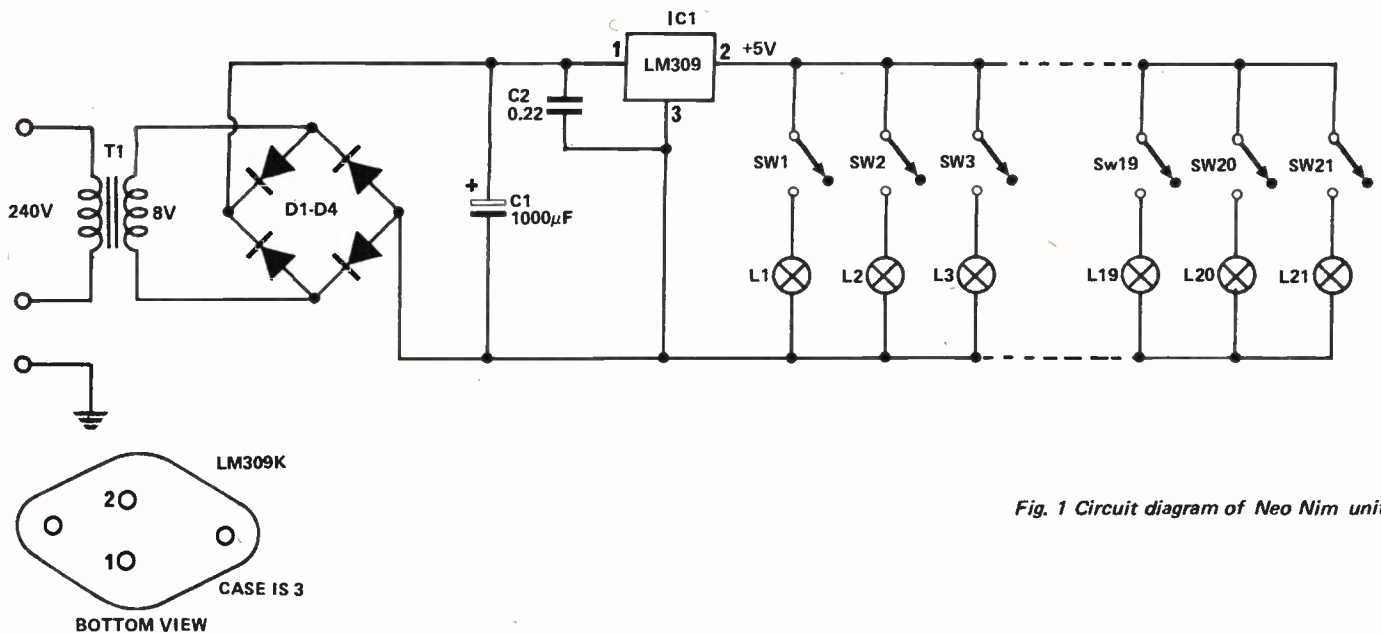

Fig. 1 Circuit diagram of Neo Nim unit

after a few moves you have a number of groups of matches. But, unlike the old Nim in which the number of groups (piles) was fixed, the number of groups in New Dimension Nim varies as the game proceeds. That's what makes it so difficult to see a winning strategy.

In this electric version you can start with all lamps on, and take it in turns to switch them off — the one who switches off the last lamp being the loser. Then simply reverse the game and turn the lamps on — the one who turns the last lamp on being the loser.

Another version is that the player who turns the last lamp off, or on depending on the way the game is being played, is the winner. This version involves quite a different strategy.

So that's four games — last on or last off is loser, and last on or last off is winner.

You can vary the maximum permissible pick up (switching operations) at one turn; say 3 or 4 or 5, and so you have altogether 12 different games — all for the price of one!

## CONSTRUCTION

The circuit is simplicity itself. See Fig. 2. We have a simple regulated power supply delivering 5 volts dc, and 21 lamps each with its own on/off switch. At a pinch the power supply could be dispensed with and the game run from two 6 volt lantern batteries connected in parallel. However when all lamps are on the current drain is about 1 amp so the batteries wouldn't last long if players dawdled over their moves. Also with a battery operated game or even one run from low voltage ac the brightness of the lamps would vary as lamps

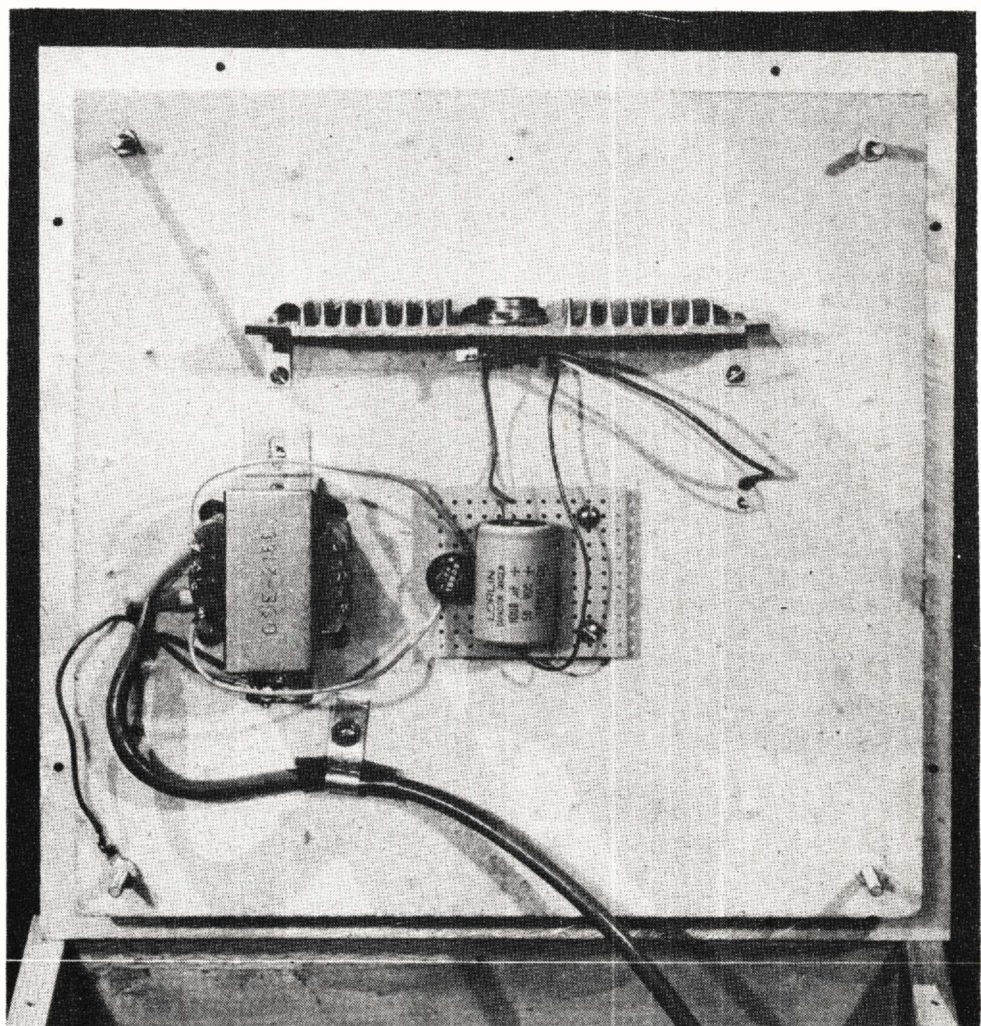

Fig. 2 Internal view of complete unit



are turned on and off. With the regulated dc power supply the voltage is held steady and lamp brightness is constant.

The prototype was built on a 20 gauge aluminium panel measuring 305 mm square. The size is determined mainly by the size of the switches used so constructors should obtain the switches first and then see how closely they can be mounted in a circle.

Large toggle switches were used in the prototype and spaced out in a circle of 180 mm diameter. 8 mm holes were drilled for the lamps to show through, on a circle of 250 mm diameter.

Naturally all lamps holes were on the same radii as the switches, as each lamp is controlled by its adjacent switch. All hole positions should be marked out very carefully before any drilling is done.

The aluminium was supported on a simple wooden plinth 120 mm deep made from 12 mm dressed timber, and 'prettied up' with wood grain Contact, and fitted with a three-ply bottom.

Suspended from the panel by four bolts 70 mm long is a 12 mm chip board sub-panel 275 mm square, which carries the power supply components and the lamp holders. Lamp holders are on top, power supply components underneath. The inside view is shown in the photograph Fig. 3, and the arrangement of one lamp and switch in Fig. 4.

The suspension bolts for the sub-panel are left long so that the sub-panel can be lowered sufficiently for lamp changing without its coming adrift from its bolts.

The space between the sub-panel and the top panel — 25 mm in the prototype, is determined by the heights of the lamps when in lamp holders. In the prototype it was necessary to cut off the lugs from the switches and solder wires to the residual brass strips — as otherwise the panel could not be raised sufficiently for the lamps to rest in the holes in the top panel.

Constructors should get together all their components and work out their own dimensions before starting construction. If small slide switches are used, and there's no reason why they shouldn't be, then the whole project could be much smaller. Of course there's much more work in cutting rectangular holes for slide switches. Mini toggle switches would be small too — and simple to mount.

There's nothing critical about the electrical side of the game — except perhaps that 0.22  $\mu$ F capacitor C2 across the regulator. Don't try to do without it, and do solder it right on the regulator terminals as in the prototype. Strange things happen in three terminal

regulators if that capacitor is ignored.

The regulator itself was mounted on a heatsink which was at hand, fixed at right angles to the sub-panel. As the regulators are internally protected against overheating the design of the heat sink is not critical and any reasonably substantial sheet of aluminium would do the trick.

An encapsulated bridge rectifier was used but four 1 amp diodes would do as well. The rectifier and 1000  $\mu$ F capacitor C1 were mounted on a piece of matrix board screwed to the sub-panel. Note the large holes drilled through the sub-panel adjacent to the transformer and heat sink to allow cooling air to pass these items. Small holes drilled in the plywood bottom of the plinth and a neat array of small holes in the aluminium panel provide for an adequate passage of cooling air. The bottom of the plinth is supported on four rubber feet so that air can get into the holes drilled there.

The mains cable is run into the plinth through one side and anchored securely to the sub-panel. The transformer core and aluminium panel are connected to the mains earth by solder tags under one of the longer mounting screws and on one of the long bolts supporting the sub-panel.

The ends of the mains cable are well sleeved for safety where they are soldered to the transformer primary terminals.

To simplify wiring, the common lead to all the switches should be run on the inner of the switch terminals. The same with the common lead of all the lamp holders — it should be run round the inner ends of the lamp holders. Before attaching the sub-panel a short lead should be soldered to the outer end of each switch. When the sub-panel is mounted on the long bolts these short leads should be soldered to the outer terminals of the lamp holders. The short leads must be long enough to reach the lamp holders when the sub-panel is in its lowered position — so that lamps can be changed without difficulty.

That's all there is to it. A quite inexpensive project which should provide hours of fun. Maybe our keen problem-solving readers will analyse the game and devise a sure fire winning strategy. (We'll give a free years subscription to the first reader who sends us one — Ed).



Modern Magazines (Holdings) Ltd.

The management and staff of Modern Magazines would like to thank the innumerable readers and advertisers who so generously offered assistance following the fire which swept through our premises last month.

In particular we thank the publishers and staff of several rival publishing companies for their very deeply appreciated offers of help.

Collyn Rivers,  
Editor/Publisher,  
Electronics Today International.

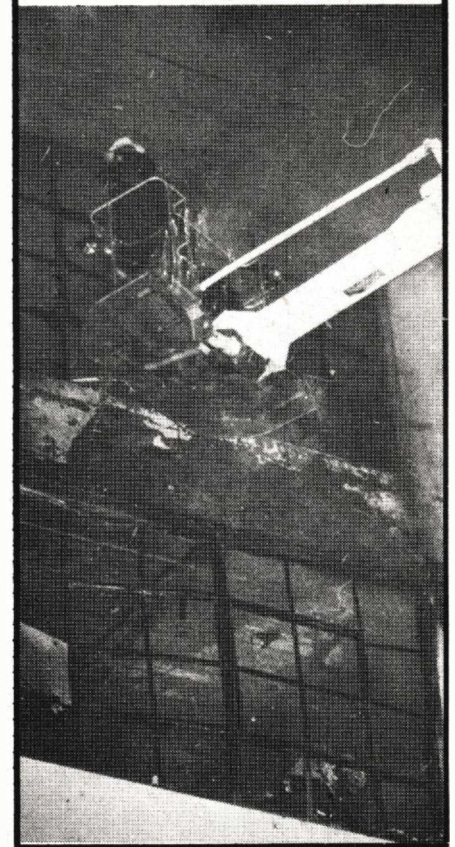



**"BUILD IT YOURSELF"**  
**THE PLAYMASTER**  
**'TWIN 25' AMPLIFIER KIT**

You have seen the beautiful Front Panels on the S500 *(imported)* amplifiers - the metal used for these panels is only available overseas. Now Dick Smith has paid to have made overseas the same quality panel for the Twin 25 amplifier. Only Dick has this one! He specially imports this EXCLUSIVE Bronzed Anodized Front Panel for use with the amazing Twin 25 amplifier. Normally costing \$3.50 extra - NOW INCLUDED FREE!

**\$89.50**

**EXCLUSIVE**  
 Power Transistor Sockets  
 At NO Extra Charge!

**EXCLUSIVE**  
 LEVEL  
 GRADUATIONS  
 ON TREBLE &  
 BASS CONTROLS

**EXCLUSIVE**  
 Simplified  
 complete  
 instruction  
 manual &  
 assembly  
 instructions.



**IT LOOKS  
 SO GOOD  
 YOUR FRIENDS  
 WON'T BELIEVE  
 YOU BUILT IT!**

"It is about half the price of an imported amplifier with the same power output." "The overall performance of the new Playmaster is equal to that of many amplifiers costing up to three & four times the price." Says Leo Simpson in the Electronics Australia for April 1976.

**EXCLUSIVE**  
 Special "Professional" Knobs to match the fully imported Front Panel

**SPECIAL**  
 Silk Screened component overlay on the Fibreglass PC Board for easy identification and assembly.  
 Single Board Construction

The Twin Twenty-five is the latest and the best in a long line of very popular Hi Fi amplifier kits. You really have to hear this amp. to believe that such quality is possible for such a low price. Even beginners can tackle this project! Dick has even arranged a special service offer for you. If the amp won't go - check the power transistors with a multimeter. If they are OK, return the completed circuit board together with \$10 and we will service, replace any faulty parts and return to you.

**SPECIFICATIONS**  
 Power Output: 25W/channel into 8 ohm with one channel driven.  
 Frequency Response: ±1dB from 25 Hz to 20 kHz with tone controls level.  
 Compensation: RIAA to within ±1dB.  
 Sensitivity: Phono 2mV into 50k for 25W output.  
 Other inputs 150mV into 35k minimum.  
 Overload: On phono 120mV.  
 Sig/Noise: 70dB (on phono) @ 10mV and 25W.  
 70dB (other inputs).  
 Crosstalk: Better than -45dB over 100 - 10kHz.  
 Distortion: Less than 0.05% at normal listening levels.  
 Bass / Treble Controls: ±13dB nom. at 50 Hz & 10kHz.  
 Stability: Unconditional.  
 Cat. K-3410... \$89.50  
 PACKING and POSTAGE... \$3.50

**SPEAKER PROTECTOR KIT FOR THE TWIN 25 PLAYMASTER AMPLIFIER \$10.75**

Give your valuable speakers that EXTRA protection from damage by amplifier malfunction and switch on/off switch thump. Exclusive printed instructions supplied with kit to enable simple attachment to the Twin 25 Playmaster. **ALSO NOTE:** This Speaker Protector Kit can be used with your existing amplifier or any other amplifier which does not have a built-in speaker protector system - easy to install.  
 Cat. K-3425... \$10.75



**BUILD YOUR OWN DIGITAL CLOCK**

Dick has pioneered the low cost Digital Clock in Australia and this unit is the latest and best kit based on his experience of selling over 2,500 kits. This kit has a much simplified construction and even the beginner can successfully put this one together. Advanced constructors should be telling the time in less than an hour. Just look at these features:-  
 Well spaced components on silk-screened and fully tinned board simplify construction.  
 Full hours, minutes and seconds display using 'big' (10mm) bright orange gas discharge display.  
 Panel type display is pre-wired; just plug into socket on PC Board.  
 Time is accurately derived from 50 Hz mains frequency 12/24 hour operation.  
 Circuit uses MMS314 IC, 13 transistors and 5 diodes.  
 Cat K-3364... \$24.90  
 or Complete with Plastic Case  
 Cat K-3368... \$29.90

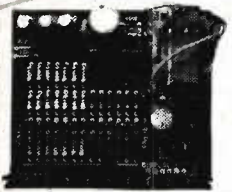

**6 DIGITS**  
**ONLY \$24.90**

**NEW REVERBERATION UNIT KIT \$14.75**

SEE E.A. MAY 1976

Fantastic for Electronic Organs, Amplifiers, P.A. Systems, Car Stereo Systems etc. Complete kit includes all components and Reverb Spring Unit.  
 Cat. K-3424... \$14.75



**DICK SMITH ELECTRONICS**  
 Head Office: Phone 439 5311. Telex AA20036. Crows Nest, N.S.W.  
 Mail Orders: P.O. Box 747, Crows Nest, N.S.W.  
 N.S.W. Branches: GORE HILL - 162 Pacific Highway, 439 5311.  
 SYDNEY - 125 York St., 29 1126. BANKSTOWN - 361 Hume Hwy., 709 6600.

**TV GAME KIT**  
 WAS \$89.50  
**NOW \$39.50**

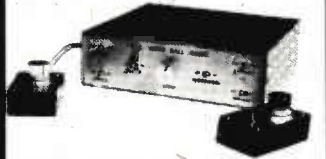

SEE E.A. MAY '76  
**SAVE \$50**

T.V. games open up a whole new vista of fun and this project must be the best of any yet! On the screen you get a net and top & bottom to the court. You can select bat or hole-in-the-wall. There are separate controls for each player plus an adjustable ball speed control. The ball bounces off the top and bottom edges. A special "interaction" control introduces a wobble on both sides for extra fun. We reckon there are 15 different games you can make up by adjusting the controls, some for 2 players and some you play against yourself. Circuit uses 13 IC's, 5 transistors and is battery powered with a separate modulator board and two control boxes. Highly recommended for the more advanced constructor.  
 Cat. K-3415 Build Yourself and SAVE... \$39.50

**NEW LED VU METER \$11.95**



SEE E.A. JUNE 1976  
 Latest solid state way to check levels. Uses 12 LED's. Much faster than moving coil meters for checking peaks overloads etc.  
 Indicates ALL transients. Green displays with yellow & red to indicate overloads. Instructions supplied.  
 Cat. K-3370... \$11.95

**SEMI CONDUCTORS SPECIALS for AUGUST ONLY**

TIL 220 LARGE RED LED. Cat. Z-4030 **20¢** Normally 35¢  
 C122 D 400 Volt 8 Amp SCR. Cat. Z-4330 **\$1.50** Normally \$2.20 (IDEAL FOR MOTOR SPEED CONTROL)  
 IN 4007 HUGE 1000 Volt 1 Amp 0100E **20¢** Normally 30¢  
 Cat. Z-3207 **20¢**  
 UA741 OIL IC. Cat. Z-6382 **50¢** Normally \$1.00

**SCOOP D.S.E. DRILL SPEED CONTROL \$9.75**

SEE E.A. JULY 76. This kit includes all the parts of the basic speed controller PLUS a small box with pre-punched and screened front panel and complete instructions. Easy to build. Makes your drill turn slow enough to be used as a screwdriver. E. A. Design. Cat. K-3080... \$9.75

**SPECIAL KIT PARTS**

RE-4 Reverb Spring. Used in Reverberation Unit. Details Below.	Cat. X-1035	\$9.75
UB-5 Zippy Box. Used in TV Game Kit. Details Above.	Cat. H-2755	\$1.10
76/VG5 Printed circuit board. Used in TV Game Kit. Details Above.	Cat. H-8308	\$5.50
76/M5 Printed circuit board. Used in TV Game Kit. Details Above.	Cat. H-8310	\$1.50
74C00 CMOS Integrated circuit. Used in TV Game Kit. Details Above.	Cat. Z-5410	\$0.50
74C02 CMOS Integrated circuit. Used in TV Game Kit. Details Above.	Cat. Z-5412	\$0.50
76/R4 Printed circuit board. Used in Reverberation Unit. Details Below.	Cat. H-8314	\$2.00
76/SA4 Printed circuit board. Used in Twin 25 Amplifier Kit. See Above.	Cat. H-8302	\$3.95
75/L11 Printed circuit board. Used in Twin 25 Amplifier Kit. See Above.	Cat. H-8275	\$1.75
Special LED Displays. 10 Green, 1 Yellow, 1 Red. Used in LED VU Meter above.	Cat. SE5M5	\$3.60
76/LM5 Printed circuit board. Used in LED VU Meter. Details Above.	Cat. H-8315	\$2.00

**\* THE FOLLOWING HY-GAIN AERIALS AVAILABLE EX STOCK**  
 14 AVQ 18 AVT TH3MK3 TH6DXX

**HOW HONEST CAN YOU GET?**

We here at Dick Smith's take pride in the knowledge that our range of test gear is the most comprehensive in Australia. At present we sell three brands of Digital Multimeters. Listed below is a brief comparison of them. (HOW HONEST CAN YOU GET?)

	SINCLAIR	NLS	TRIO
	<b>DM-2</b>	<b>LM-3</b>	<b>DL 703</b>
DC VOLTS	0-1000 V	0-1000 V	0-1000 V
AC VOLTS	0-500 V	0-1000 V	0-350 V
RESISTANCE	0-1 meg	0-10 meg	0-20 meg
DC CURRENT	0-1 Amp	SHUNTS ONLY	0-200 mA
AC CURRENT	0-1 Amp	SHUNTS ONLY	SHUNTS ONLY
DIGITS	3 1/2 LED	3 LED	3 1/2 LED
POWER	INT/EXT	INT/EXT	EXTERNAL ONLY
CARRYING CASE	YES	YES	NO
PRICE	\$140.00 Inc. Tax	\$129.00 Inc. Tax	\$177.00 Inc. Tax



All things considered the Sinclair IS more versatile isn't it? It would be silly really, to pay so much for a meter that didn't measure current - either AC or DC - without the inconvenience of fiddling with shunts. We are so keen on the Sinclair unit that we have decided to now reduce the price. From now on you can own this fine piece of equipment for only \$140.00 including tax. This unit is shown in our current catalogue at \$175.00 and sells well at that price.  
 SINCLAIR DM-2 MULTIMETER Cat. O-1450... \$140.00. Carrying Case Cat. O-1451... \$6.00

**THE MULTIMETER THAT MEASURES AC CURRENT \$140.00 INCLUDING TAX**



**SHOP HOURS**  
 MON - FRI: 9 to 5:30  
 SAT: 9 to 12

**POSTAL CHARGES**

ORDER VALUE	CHARGE
\$5 to \$9.99	\$1.00
\$10 to \$24.99	\$1.50
\$25 to \$49.99	\$2.50
\$50 to \$99.99	\$3.50
\$100 or more	\$5.00

BY COMET FREIGHT THE MINIMUM PACKING AND HANDLING CHARGE IS \$1.00. WE DESPATCH 'FREIGHT ON' AND YOU PAY WHEN YOU RECEIVE THE GOODS.

MINIMUM MAIL ORDER AMOUNT IS \$5

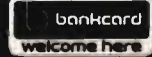



**\$39.75 MIDLAND INTERNATIONAL**

## 1 WATT HAND HELD 2 CHANNEL TRANSCEIVER

\*\*\* FULLY PMG APPROVED \*\*\*  
**FAMOUS MIDLAND 1 WATT TRANSCEIVER**  
 This is a rugged professional unit which is ideal for the boating enthusiast and sportsman. Sensitive superheterodyne receiver has tuned RF and 3 IF stages for increased reception power and sensitivity. AFC circuit reduces fading and distortion. Variable squelch cuts static and noise on standby. Has a range of up to 10 miles on land (depending on terrain) and 50 miles over water. Supplied with carrying strap, ear-phone and one set of crystals installed on 27.24 MHz or 27.88 MHz (please state preference). Has 11 transistors, 1 thermistor, 1 speech transistor and 1 diode. Effectively converted into a high level push-pull Class B system. Has 2 1/2" PM speaker and 56" telescoping antenna. Powered by 8 night light cells (has AC adaptor & battery charger connections). Has a sensitivity of 1.4 uV for 10 dB (S+N)/N.  
 Cat. D-1100..... \$39.75

**\$3.75 D-5180**

**\$8.50 D-5108 O-4621**

**BUMPER MOUNT ASSEMBLY**  
 Allows you to mount antennas directly to most bumpers without drilling holes. Features Zinc plated mount and stainless steel strap. Fully insulated design. Easy to fit.  
 Cat. D-5108..... \$8.50

**ECONOMY GUTTER MOUNT**  
 For the "roll your own" enthusiast. Allows for the design and construction of aerials for mobile use. No drilling of vehicle.  
 Cat. D-5108..... \$3.75

**DELUXE GUTTER MOUNT**  
 This deep chrome plated mount is supplied with mounting screws, 9 feet of 52 ohm coax cable and PL259 plug. The S2039 connector on mount accepts all whips with PL259 mounting. Our hi-gain antenna D-4620 is recommended or you can make or supply your own. Very easy to fit.  
 Cat. D-4621..... \$13.75

**SPECIAL FOR THIS MONTH**

**NOW ONLY \$550. NORMALLY \$585. SAVE \$35.**

**MULTI-2000A SSB/FM/CW TRANSCEIVER**

**THIS SPECIAL IS ONLY AVAILABLE ON ORDERS DATED PRIOR TO THE 31st AUGUST 1976.**



**MULTI 2000A TRANSCEIVER**  
 The ultimate in 2M equipment, operates on FM, SSB, CW. Transceives between 144.0 and 148.0 MHz in 10kHz steps. Fully synthesised repeater offset. 4 fixed channels (crystals not included) high and low power, noise blanker, wide and narrow band switch etc.  
 Sensitivity FM : 1.0uV, SSB/CW : 0.3uV. RF output : 1W and 10W (PEP). Built in power supply for 240 volt AC or ext. 12 volt DC. Cat. D-3010 ..... \$585.00

**NEW RP-10 INCREASED SENSITIVITY SIGNALIZER RECEIVER**

**SPECIFICATIONS**  
 27.28 MHz RF amplifier and attenuator  
 Gain adjustable from +15dB to -20dB.  
 No modification to existing equipment.  
 Just insert between transceiver/receiver & aerial.  
 Requires 12-14 V DC @ 35mA.  
 Automatic aerial change over built in for transmit.  
 Insertion loss negligible.  
 Use with transceiver up to 80 watts PEP.  
 Uses dual gate MOS FET for maximum performance.  
 The best investment ever for any Novice or Amateur user.  
 Cat. D-3828 ..... \$39.50



**110 SWR/PWR METER**

This Meter and Field Strength Indicator is a handy and compact device for amateur and professional use in checking the operation of a transmitter. The bridge method of comparing the power supplied to and reflected from the antenna system is utilized for SWR measurements. For RF power measurements, the average voltage from the carrier detector is measured. The calibration of the RF power meter is so adjusted to fit the 50 ohm line impedance. The 10 or 100 watt range can be easily selected by the front side switch. Continuous monitoring of the transmitter output is possible by leaving the instrument in the circuit at all times.  
 Cat. Q-1362..... \$17.50

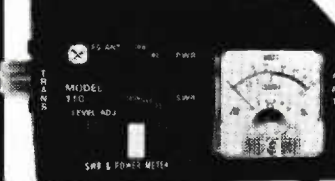

**LEARN MORSE CODE \$12.50**

Learn to read Morse Code the fast and easy way with our new double Cassette Pack. Speeds from 5 wpm to 15 wpm in graduated easy to learn steps. Imported from America EXCLUSIVELY for us.  
 Cat. D-7106 \$12.50

**Hy-Gain MODEL 14AVQ/WB for 40 thru 10 Meters**

\*Wide band performance with one setting (optimum settings for top performance furnished)

\*New Hy-Q Traps \*New 12" Double-Grip Mast Bracket  
 \*Taper Swaged Seamless Aluminum Construction

3 separate Hy-Q traps featuring large diameter coils that develop an exceptionally favorable L/C ratio and a very high Q, provide peak performance by effectively isolating sections of the antenna so that a true 1/4 wave resonance exists on all bands. Outstandingly low angle radiation pattern makes DX and other long haul contacts easy. Overall height is 18 ft.  
 Cat. Q-4300..... \$78.00

**BUY THIS MONTH & RECEIVE FREE ANTI-REPEATER CRYSTALS 1, 2, 3 and 4 VALUED AT \$32.00**

\* THIS FREE OFFER IS ONLY AVAILABLE ON ORDERS DATED PRIOR TO THE 31st AUGUST, 1976. \*

**MULTI-7 VHF 2 METER 23 CHANNEL TRANSCEIVER.** This unit is a must for all mobiles. No other unit has the features of MULTI-7 at this price. Frequency Range 146.0 to 148.0 MHz. RF power output 10W or 1W with switch. Solid state construction. Receiver Sensitivity 1.0uV @ 30 dB S/N. Cat. D-3007..... \$189.00



**AMP & TUNER My best value!**

**TUNER.** 8 transistor 13 diode AM/FM/MPX Stereo with full 88-108 MHz band width, tuning meter, AFC switch, LOC/DX switch & many other features.  
 Cat. A-1412..... \$59.00

**AMPLIFIER.** 12 transistor OTL circuit. Pre/main Stereo with mic. mixing and 4 channel speaker matrix. 10 watts RMS. Frequency response 20Hz-20kHz (1-3dB).  
 Cat. A-1264 Great Value \$69.00

**\$69. EACH BOTH FOR \$138.**



**RECEIVER PRE-AMPLIFIER**

These units are designed to be simply connected between the aerial and receiver of any 10 - 11 meter unit. You can even mount them right at the aerial if you require maximum performance. Input impedance 50-75 ohm, noise factor 5-6 dB, gain 20-30 dB, operating voltage 9-12 V DC @ 15 mA. Fully tested.  
 Cat. D-3827 ERB-27..... \$18.50



**OUT THEY GO!**

**\$24.61 TAX FREE ONLY**

**FORDS \$27.50 Inc. Tax**

**SCIENTIFIC CALCULATOR**

LAST YEAR WE WERE SELLING THIS REMARKABLE CALCULATOR FOR \$55.00 UNBEATABLE VALUE AT THIS LOW PRICE!  
 Cat. Q-3010 Tax Free \$24.61



**MY BOOK SPECIALS**

**COLOUR TELEVISION THEORY** by G.H. Hutson. 326 pages of text, diagrams & illustrations (some in colour) in this hardback edition. A MUST for students, engineers & technicians who wish to have a thorough understanding of the PAL system. Now the Standard work on this subject.  
 Cat. B-321D..... \$12.50

**SEMICONDUCTOR HANDBOOK - PART 1 - TRANSISTORS** by Van Urtner. Over 150 pages. Includes over 100,000 details of 6,750 current transistor types of European, American and Japanese manufacture. Arranged in alphabetical - numerical classification for easy reference.  
 Cat. B-2064..... \$7.50

**ELECTRONICS - IT'S EASY.** Volume 1 & 2. Widely recognised as one of the best and most clearly presented Electronics Courses ever published. Written by Peter Sydenham, M.E., Ph.D., M.Inst.M.C. and presented by Electronics Today these two volumes are a must for every student or beginner.  
 Volume 1 Cat. B-3642..... \$3.00 Volume 2 Cat. B-3643..... \$3.00

**TOP PROJECTS** prepared by Electronics Today. Every enthusiast should have this book in their library. Has 25 of the most popular and useful projects to build. This is the latest volume (Vol. 3) in the series. Just released Hot off the Press.  
 Cat. B-3645..... \$2.50

**RECORD CLEANER**

Clean your records the DECCA way. The brush has 20,000 conductive fibres which tracks across the record. The arm is metal and any static charge is earthed by the attached lead.  
 Cat. Q-7951..... \$13.95



**VIDEOLYMPIC TV GAME**

**HUNDREDS SOLD at \$99.50**

PLAY YOUR OWN TV GAMES TONIGHT AT LESS THAN HALF THE COST AS PREVIOUSLY OFFERED. **NOW ONLY \$49.50** Just plug into the aerial terminal of your TV set. Play such games as Tennis - Catch Ball - Traps Shooting - Solo.  
 Cat. X-1125..... \$49.50

Was \$99.50 **NOW \$49.50**



**AMATEUR RADIO WORLD \$3 FREE TO CLUBS**

Great Circle Map of the World produced in 3 colours on deluxe kromecote art paper. A must for every radio shack designed with Sydney at the centre but works perfectly for Brisbane, Melbourne & Adelaide. Also lists international amateur prefixes, Q code and Australian amateur frequencies. Ideal for the radio shack wall. Mount your rotator indicator through the centre & have direct read-out of bearing. Supplied FREE to Radio Clubs. Simply apply on official letterhead. Limit one only per Club.  
 Cat. B-5402 Add \$1. for packing & postage... \$3.00



**ROCKWELL CALCULATORS**

**31R \$31.27 Tax Free \$39.95 Inc. Tax**

The 31R Slide Rule Memory calculator 20 keys & a second function key that allows each key to have 2 separate uses. Has a completely independent memory which is unaffected by arithmetic or scientific operation. Value at this price.  
 Cat. Q-3625..... \$39.95

**61R \$59.95 Tax Free \$46.92 Inc. Tax**

ROCKWELL 61R REDUCED FROM \$80 An advanced slide rule for engineers and higher mathematics students. Complete with Ni-Cad and charger. Excellent value.  
 Cat. Q-3628..... \$59.95



**CAR RADIO VALUE!**

**\$79.00**

**IDEAL LONG RANGE RADIO AT AN ECONOMICAL PRICE**

This unit works on 12 volt negative earth and has 8 transistors for powerful reception. Five push buttons lets you preset 5 of your favourite stations and also you have manual tuning for all other stations. Five watts of solid power goes well with 5" x 7" oval 4 ohm speaker that is INCLUDED with the radio as a separate feature. Aerial not supplied.  
 Cat. A-5980..... \$79.00

**CAR SPEAKERS**

FIT THESE SPEAKERS AS EXTRAS TO THE ABOVE CAR RADIO. Convertible box type that can also be mounted flush. Has 4 ohm nominal impedance with 8 watts maximum power output. 130 mm Hi-compliance speaker with 90 gm magnet.  
 Cat. A-6980..... \$16.00 per Pair.



**DICK SMITH ELECTRONICS GROUP**

Head Office : Phone 439 5311. Telex AA20036. Cable 'Diksmi' Sydney.  
 Mail Orders : P.O. Box 747, Crows Nest, N.S.W., 2065.  
 N.S.W. Branches: GORE HILL - 162 Pacific Highway, 439 5311.  
 SYDNEY - 125 York St., 29 1126. BANKSTOWN - 361 Hume Hwy., 709 6600.

**SHOP HOURS** **POSTAL CHARGES**

MON - FRI : 9 to 5.30  
 SAT : 9 to 12

ORDER VALUE CHARGE  
 \$8 to \$9.99 \$1.00  
 \$10 to \$24.99 \$1.50  
 \$25 to \$49.99 \$2.50  
 \$50 to \$99.99 \$3.50  
 \$100 or more \$5.00

BY COMET FREIGHT. THE MINIMUM PACKING AND HANDLING CHARGE IS \$1.00. WE DISPATCH FREIGHT ON\* AND YOU PAY WHEN YOU RECEIVE THE GOODS.

MINIMUM MAIL ORDER AMOUNT \$5.00



# DIGITAL DISPLAY

This updated version uses bigger and more readily available seven-segment displays.

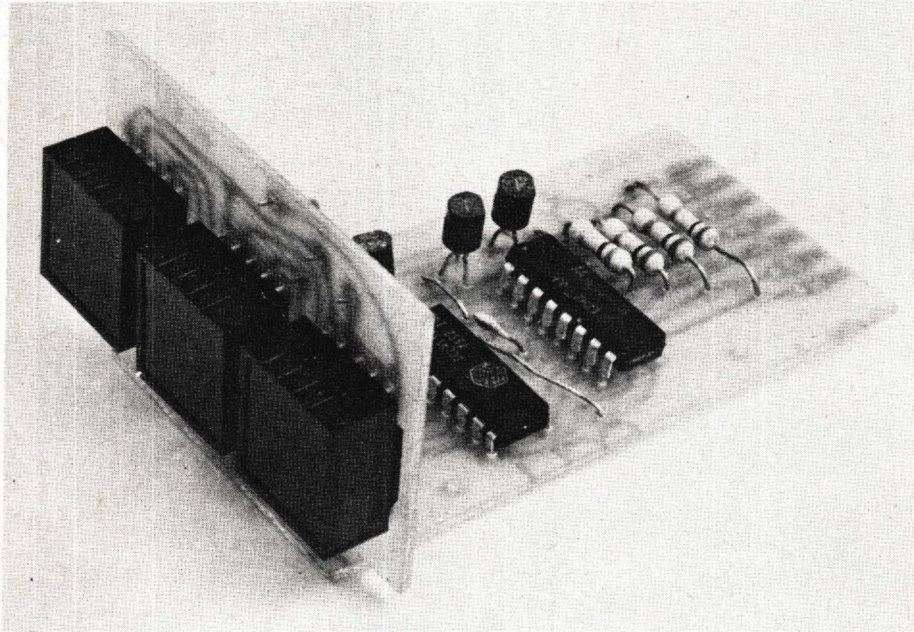

THE ETI 533 DIGITAL DISPLAY WAS originally published in the July 1975 issue of Electronics Today and has been very popular as a general purpose display module. We are republishing this project for two reasons. Firstly, many people have asked for the details of how to use a larger display. And secondly, the type of display originally specified is now quite difficult to obtain.

We therefore redesigned the display section of the module to accept the Fairchild FND 500 type of display which has 13mm high characters and is quite readily available. Of course the previous design is still quite valid and when the DL 704 and NSN74 type of displays are available they can be used as specified in the original article.

Only the small display board has been changed and it may be fitted to a previously built logic board if necessary. The new display board is, however, wider than the old board and the appropriate room must be available — especially if two modules are to be mounted side by side.

## Digital Display

All digital instruments have a common assembly in the display system. Again, almost all instruments require decade counters, stores and decoder-drivers for the display

Normal systems using TTL logic generally have a 7490, a 7475 and a 7447 to drive each 7 segment LED display digit. Hence to build a three-digit display nine ICs are required in addition to three display ICs.

However, complex logic functions are available in CMOS which allow a 3 digit display to be built using only two ICs — and such ICs are available at reasonable cost. One of the devices is a three-digit, decade-counter, store and the second is a three-digit decoder driver. Thus three digit displays can be built which have the following advantages:

1. Small size
2. Low power consumption (120 mA compared to 600 mA in TTL)
3. Wide power supply range (5-15V unregulated).
4. Cost about same as TTL but rapidly decreasing.
5. Immunity to noise is greatly improved.

### Disadvantages:

Maximum frequency about 1 MHz compared to 15 MHz for TTL.

## Construction

Construction is quite straightforward especially if the printed circuit boards

described are used. Since both ICs are CMOS devices, they can be easily damaged by static charges. Hence they should be handled as little as possible, fitted to the board after all other components and soldered using a minimum of heat.

Starting with the display board use a short length of thin insulated wire to form the link which goes between the pins of the FND500 then add the displays.

Next fix lengths of tinned copper wire to each of the four holes on the bottom of the display board. Allow approximately 10 mm of wire to extend from either end of the holes. Bend each wire so that they lie parallel and flush to the surfaces of the display board — do not solder as yet.

On the main printed-circuit board (533A) fit resistors R1,2,3,4, and R9 capacitors C1 and C2 and the three links. now mate the display board to the main board by inserting each of the previously bent wires into its corresponding pair of holes on the main board.

Apply gentle force to the display board until its bottom edge fits snugly against the main board. Solder each of the wires to both the display and main boards to make a sound electrical and mechanical support for the display.

Fit R5,6,7,8, 10, and 11 and, taking care to orientate them correctly, fit Q1, 2 and 3 and IC1 and IC2.

Lastly check that all components have been correctly fitted and all solder joints are good. If possible get someone else to check your final circuit as a final safeguard.

### PARTS LIST — ETI 533

R1, 2, 3, 4	Resistor 100 k
R5-11	Resistor see text.
C1	Capacitor 1n0 Polyester
C2	Capacitor 10 nPolyester
IC1	Integrated Circuit MC 14553 (CMOS)
IC2	Integrated Circuit 14511 or 4511 (CMOS)
Q1,2,3	Transistor BC 558 or similar
DISPLAYS	FND500 or similar. Three required.
PC boards	ETI 533A and ETI 533C



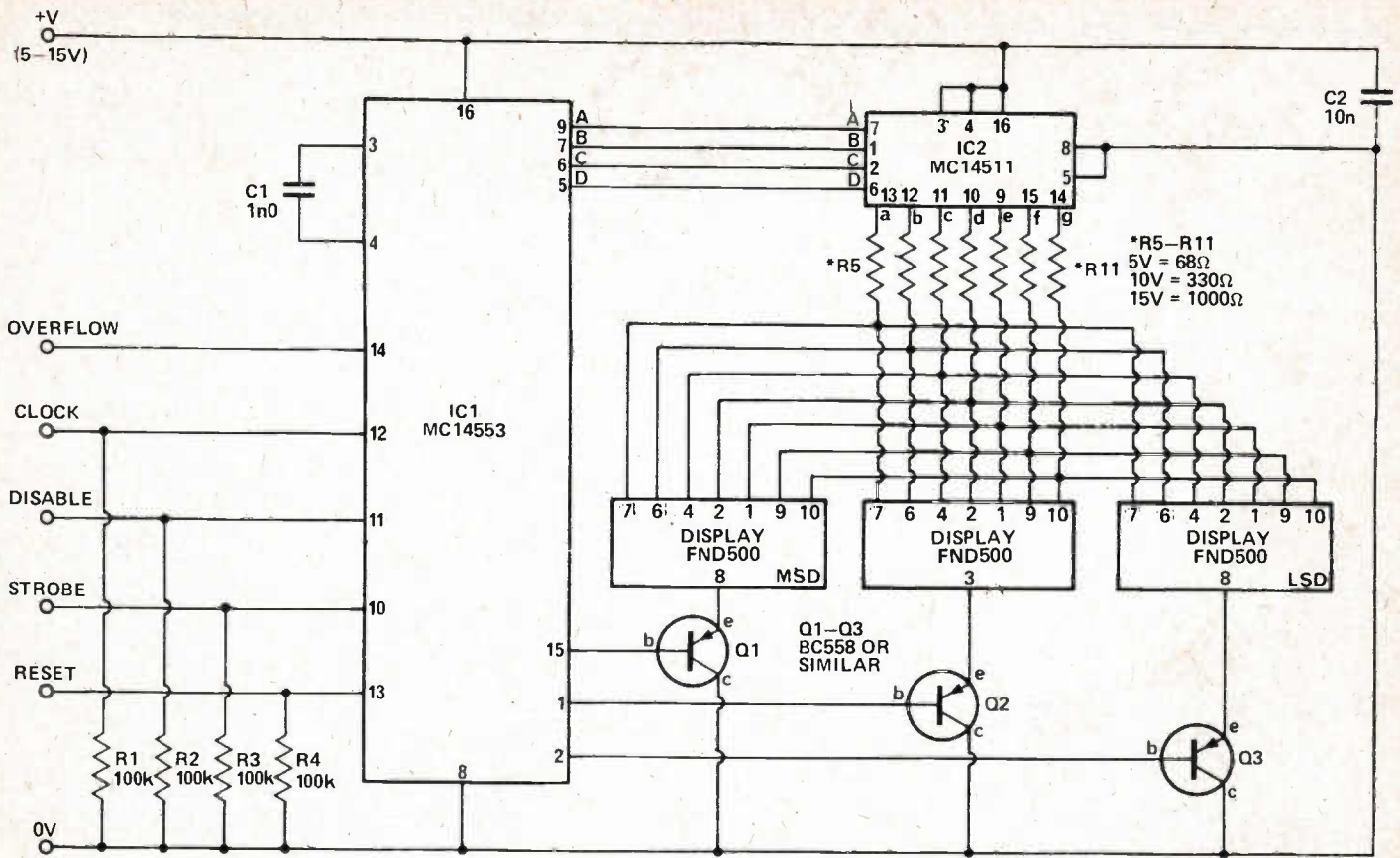

Fig. 1 Circuit diagram of the display

FOR DECIMAL PT. (RIGHT HAND)  
ON DISPLAY CONNECT  
PIN 5 TO +V VIA RESISTOR  
(OF SAME VALUE) AS ABOVE  
PIN 3 AND 8 ON DISPLAYS  
ARE INTERNALLY JOINED

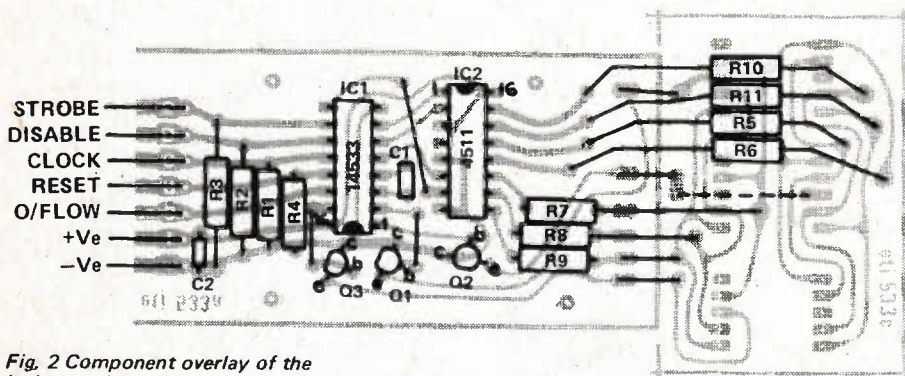

Fig. 2 Component overlay of the logic board.

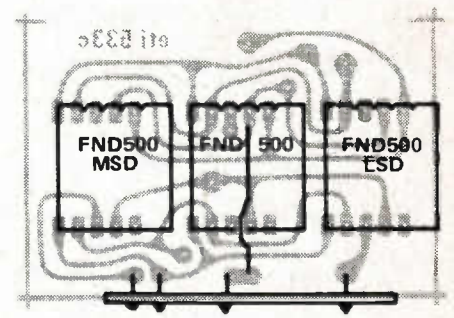

Fig. 3 Component overlay of the display board.

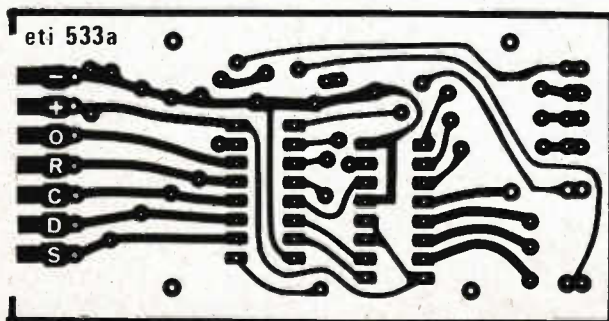

Fig. 4 Printed circuit layout of the logic board. Full size 78mm x 42mm

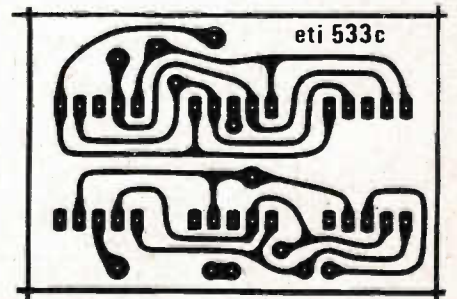

Fig. 5 Printed circuit layout of the display board. Full size 53mm x 36mm.



## How it works — ETI 533

The heart of the counter is IC1. This LSI CMOS chip contains a three-digit decade counter, three sets of latches, and a three-digit multiplexer with an internal oscillator. CI is used to set the frequency of this oscillator.

The four input lines to IC1 are used to control the operation of the counter. Since IC1 is a CMOS device R1-4 are used to protect its inputs. Pulses to be counted are fed to the clock input and on a negative transition the value in the counter is increased by one. The schmitt-trigger action of the clock input allows any value of transition time of the input pulse.

The counter operates when there is a low at the disable input (pin 11).

To ensure accurate counting the clock should be low when the disable is brought from a high to a low level. The strobe input controls the loading of the latch. When it is low, data can be accepted for display. However, the strobe input has no effect on the counter, i.e., even with the strobe input high, the counter can still be incrementing.

A high on the reset input clears the counters (to a 000 state) and stops the internal multiplexing oscillation of IC1, and so blanks the display. Returning the reset to a low allows the internal oscillator to start up and all zeros to be displayed.

All inputs are standard CMOS inputs

and require a minimum voltage change of from 30% to 70% of supply volts. However it is recommended that a swing from 0V to supply be used to give a satisfactory noise margin. Each input can be considered to be 100k shunted by 8-10 pF. Voltage swing below 0V and above supply are also to be avoided.

The one output available is the overflow (pin 14). This goes positive when the counter is 999 and the clock input is high. When the clock input goes low and advances the counter to all zeros the overflow goes low. This is a CMOS output and will swing between supply rails. It is not recommended that the overflow output be used to drive TTL directly. It can be used to drive a second 533 display to give a 6 digit readout if required.

The internal multiplexer of IC1 allows considerable saving in parts and board space. It allows a three-digit number to be transmitted over a single set of lines and it does this by leaving each digit on the output lines for a short length of time, before replacing it with the next digit. Then after presenting all the digits once, it starts over again and repeats the operation.

IC2 is a CMOS, latch, BCD to seven-segment decoder and driver, however for this application the latch is not used. It converts the 4-bit BCD code into the seven-line code necessary to drive the display segments. It also provides

sufficient current to drive the display. If it is required that the display be blanked to save power the track to pin 4 on IC2 should be cut and pin 4 switched to either +V or 0V. If 0 the display will be blanked.

Although IC2 is coupled to all three displays, only one display is lit up at any one time. Thus when it is the turn of the most significant digit to be displayed IC1 presents that number to IC2 which decodes the number and presents it to the three displays, but only Q1 is turned on, so only the left most display lights.

Note that IC1 controls which number is being presented and which transistor is turned on. This is called multiplexing. The switching between displays occurs so quickly that to our eyes the light appears continuous.

Resistors R5 to R11 limit the current to each LED display to a safe level. Three different values have been given for these resistors. Select the value appropriate to the supply voltage that you decide to use, 68 ohms for 5 V, 330 ohms for 10 V and 1k for 15 V. Transistors Q1, Q2 and Q3 also act as current amps since only a limited amount of current can be taken from IC1.

Any voltage from 5V to 15 V can be used to supply the counter, however, a supply voltage of 15 V allows the counter to operate at its highest speed.

## USING THE DISPLAY

<b>Power Supply</b>	5 to 15 Vdc (do not exceed 16 V)
<b>Clock Input</b>	Counter is advanced on the negative edge of the clock input. Speed of transition is not important.
<b>Disable Input</b>	Must be low to enable clock to advance counter.
<b>Reset Input</b>	Counter is reset to 000 if this input is high.
<b>Strobe Input</b>	If this input is taken high the display will remember the counter state at the time of going high. The counter can still be advanced, or reset without changing the display.
<b>Overflow</b>	This output is used to clock a second module to form a six-digit counter. Or to clock any CMOS circuit as an indication of overflow. The output goes high when the clock input goes high and the counter is 999. It goes low when the counter advances to 000.

**Note 1.** If long leads are used pickup may occur which causes interference with normal action of the counter.

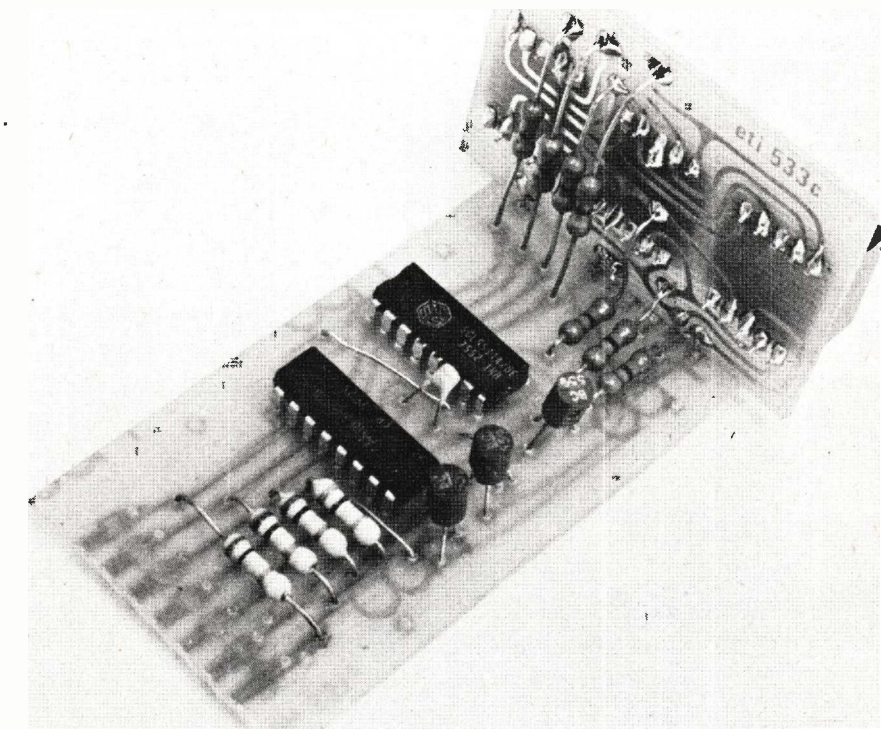

If this is suspected add a 10 nF capacitor across the inputs on the module

**Note 2.** To use the decimal points provided on the displays connect pin 5 on the displays to the positive

supply rail via a resistor which has the same value as those used for R5 to R11. A separate wafer on the range switch should be used to enable the appropriate decimal point.



# help stamp out car batteries!

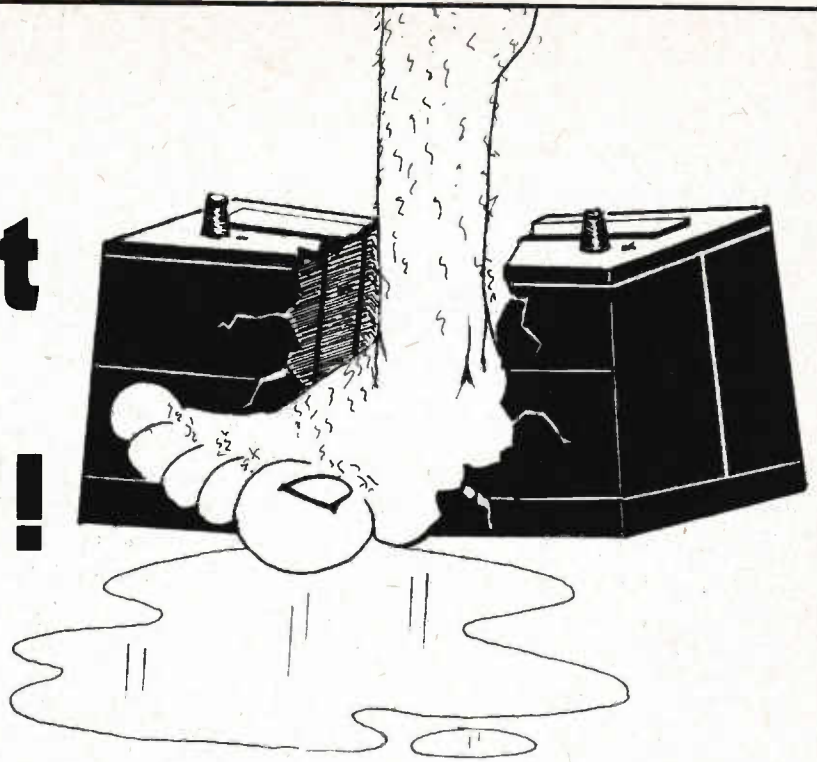

## Get a Digitronics Power Supply

Run your test bench, transistor radio, IC22A, Multi 1.7 in the shack and forget acid, leakage, fumes.

**\$44.50** + \$1.00 P&P

(in kit form). Complete with diagrams all parts including case.



### BRIEF SPECIFICATIONS

- Runs off ordinary mains.
- Output voltage 12v min. at 4 amps. Current Limited
- Output voltage 13.8v at 2.5 amps.
- Ripple 50mV max. at 3.5 amps.
- Output varies 0.5v (max) for line variation of  $\pm 10\%$ .
- Operates into short circuit for 15 minutes (min).
- Size 6 x 5½ x 3 ins. Weight 2.5 kg.

186 PARRY STREET, NEWCASTLE WEST, 2302.  
Phones: (STD 049) 69-2040 61-4991

Credit Services/Trade Accounts

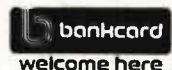



# Carbon composition resistors

Following our down-to-earth look at capacitors we now move on to resistors. And don't take them for granted . . . there's a lot more to them than you ever realised . . .

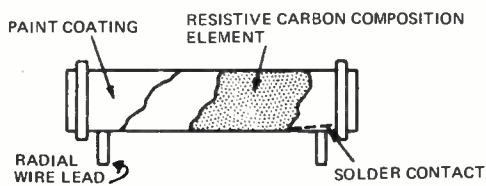

Fig. 1(a). Carbon composition resistor with the end connections made by spraying the ends with metal and the leads soldered.

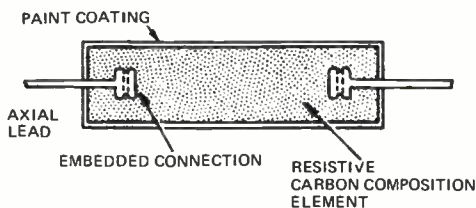

Fig. 1(b). Carbon composition resistor with the connections made by embedding leads in the element.

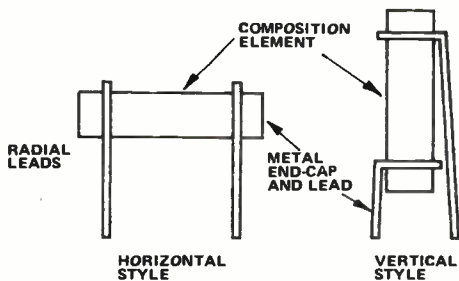

Fig. 1(c). Carbon composition resistor with pressed metal end-cap and lead connections for plugging into p.c. boards - the 'pluggable' style. The end-caps are forced over the ends of the composition rod element.

**CARBON COMPOSITION RESISTORS** have been used extensively in the manufacture of radio and television sets since the valve era but are being rapidly replaced in production by film resistors. These have superior characteristics and are becoming increasingly cost competitive.

Carbon resistors are manufactured in wattage ratings ranging from 0.1 watt to 2 watts and resistance values ranging from 10 ohms to 100 M. They are made to tolerances of  $\pm 5\%$  (E24 series,  $\pm 10\%$  (E12 series) and  $\pm 20\%$  (E6 series), although the latter is the more usual and least expensive.

There are three basic types of carbon composition resistor:

- (a) uninsulated
- (b) insulated
- (c) filament or filament-coated

**Uninsulated type:** In this type, the resistive element consists of fine carbon particles mixed with a refractory filling, which is non-conducting, bonded together by a resin binder. The proportion of carbon particles to filler determines the resistance value. The mixture is compressed into shape, usually cylindrical, and fired in a kiln. The end connection are made by any one of a variety of methods. These are illustrated in Fig. 1. In the first method, Fig. 1(a), the ends of the composition rod are sprayed with metal, and wire leads soldered on to provide radial connections. The resistor is then painted and colour coded. This method was extensively used with 1W and 2W resistors. A second method, much more widely used now, involves enlarging the ends of the connecting leads and moulding them directly into the carbon composition rod - Fig. 1(b). This

method is used extensively as it is adaptable to all wattage ratings and sizes of the resistor body. A third method is also employed. Pressed metal caps, usually having integral leads, are forced onto the ends of the carbon rod - Fig. 1(c). These caps have radial leads and are particularly suited to printed circuit board mounting as they may be plugged straight into mounting holes on the board without the necessity of preforming the leads as is required with axial lead components. These are also known as 'pluggable' types. Film resistors are also made in this style.

Uninsulated carbon composition resistors are generally smaller than the insulated types for a given wattage as their open construction permits good heat dissipation. There is the danger however, that short circuits may occur to adjacent components, and for this reason, the insulated type is preferred.

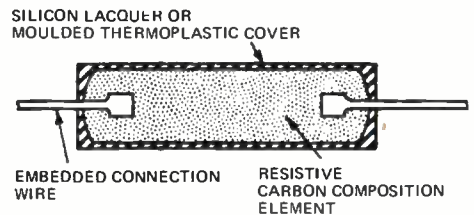

Fig. 2(a). Insulated carbon composition resistor construction.

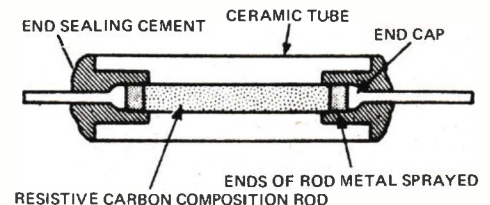

Fig. 2(b). Assembly of a ceramic tube type insulated carbon composition resistance.



**Insulated Type:** This type has the composition element made in the same manner as just described, but it is then encapsulated in either a silicon lacquer, a thermoplastic moulding or epoxied into a ceramic tube. The first two generally employ a resistance element having embedded connections, as illustrated in Fig. 1(a). The type having the element sealed in a ceramic tube generally have an element constructed as shown in Fig. 2(b). The ends of the element are sprayed with metal and an end-cap having an integral lead is force-fitted over them. This assembly is then put inside the ceramic tube and the ends sealed with an epoxy or other compound.

**Filament or Filament-coated Type:** With this type, carbon granules are dispersed, along with a filler, in a varnish which is then applied to the surface of a continuous glass or ceramic filament which is then baked. The resistance value depends on the length and mixture, the filament is cut into appropriate lengths and leads applied by one of the methods detailed above. It is usually encapsulated in an insulating compound as per the insulated style of resistor.

Carbon composition resistors have a large voltage coefficient. The value of this coefficient varies with the resistance of the component (being highest for high value resistors) and the size of the resistance element. Small resistors of a given value have less insulating filler in their composition and will have a lower voltage coefficient. The voltage coefficient for two different styles having different compositions, and for different lengths is illustrated in Fig. 3. Commonly available composition resistors have quoted voltage coefficient between 0.02 and 0.035 for values up to 1 M. Values above this have a coefficient of typically 0.05. These values may cause a maximum change in resistance of 2% when used within their ratings. The voltage coefficient of the other types of resistors is considerably smaller than for composition types — typically 0.002% or less.

A large negative temperature coefficient is one of the disadvantages of composition resistors. It is typically between 0.1% and 0.15% per °C (i.e. 1000 ppm per °C or greater), across the whole resistance range. This means that a 1 M resistor will change its value by 1 k or more for each °C change in temperature. The curve of percentage resistance change versus temperature is not linear and may be positive over one portion of the temperature range and negative over another. Figures 4 and 5 show typical temperature coefficient curves for two types of carbon com-

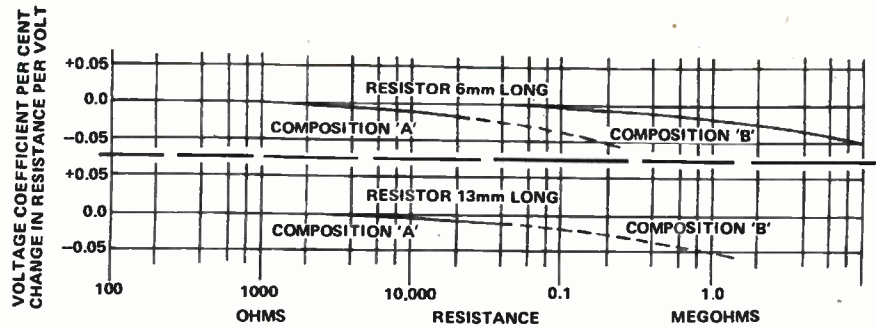

Fig. 3. Voltage characteristics of composition resistors.

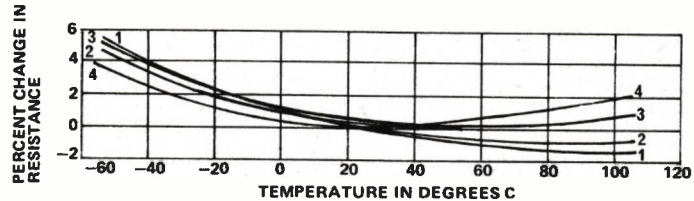

Fig. 4. Resistance-temperature characteristic, 1/2 watt, 3mm by 9.5mm, composition resistor. Curve 1, 10 megohms; curve 2, 0.27 megohm; curve 3, 10,000 ohms; curve 4, 1,000 ohms.

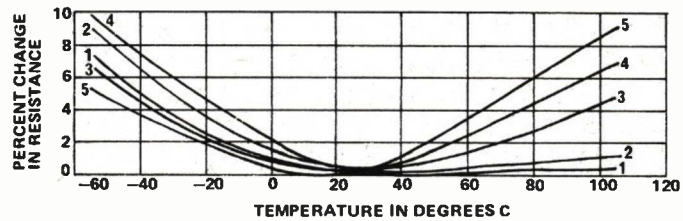

Fig. 5. Resistance-temperature characteristic, 1/2 watt, 3mm by 9.5mm, solid composition resistors. Curve 1, 1,000 ohms; curve 2, 10,000 ohms; curve 3, 0.100 megohm; curve 4, 1.00 megohm; curve 5, 10.0 megohms.

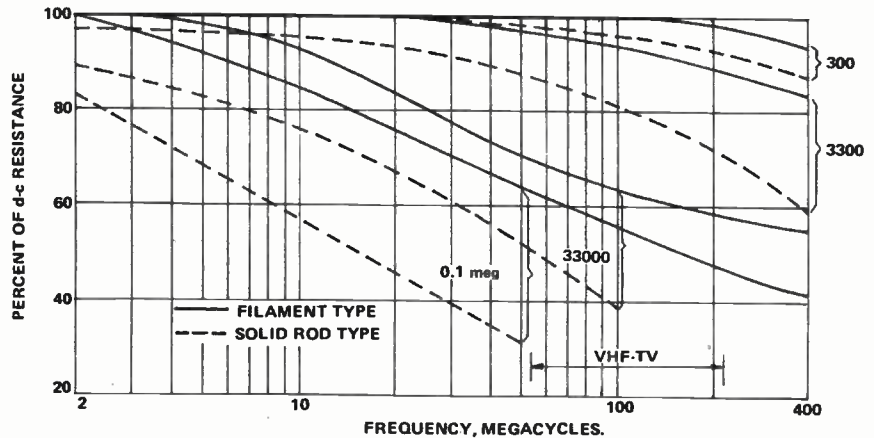

Fig. 6. Frequency characteristic of filament and solid rod types of 1/2-watt composition resistors.

position resistor for different values between 1 k and 10 W.

**Critical Resistance Value:** A resistor of specified power and voltage ratings has a critical resistance value above which the allowable voltage limits the permissible power dissipation. Below this value, the maximum permitted voltage across the

resistor is never reached at the rated power.

Carbon composition resistors show a pronounced fall-off in apparent ac resistance, compared to their dc value, with increasing frequency. The effect which is particularly bad with the higher values is known as the 'Boella' effect after its Italian discoverer. The filament-

# Carbon composition resistors

coated type is less affected than the solid rod type. Figure 6 illustrates the frequency characteristics of the two basic construction styles of composition resistor for a variety of values. The values below 200 ohms are obviously quite useful right up to UHF. Values below 100 ohms may show an increase in value with increasing frequency. Obviously at frequencies in the VHF range and above, mounting and lead length affect characteristics considerably. Absolute minimum lead length is necessary to minimise unwanted inductance. Lead lengths of 6 mm have considerable inductance at 200 MHz. Printed circuit layout can assist in minimising the problem, and mounting the resistor flat on the pc board — bending the leads as close as possible to the component body — is good. Naturally, this applies to all resistors. Radial lead components are best in this situation.

The amount of noise generated by carbon composition resistors is a function of the materials used in the composition mix. Generally, the noise generated increases with increasing voltage, increasing resistance, and decreasing size, for a given mix of materials. The noise due to current flowing through the resistor is generated by random changes in the material of the element, caused by the current flow. This noise decreases with increasing frequency and Johnson noise, which is frequency independent, becomes dominant above about 1 kHz. The current noise generated by composition resistors is a major limitation against using them at dc and low frequencies. They are not recommended for use in amplifier input stages or dc amplifiers for this reason. Microphony is also noticeable, caused by modulation of the noise voltage generated by the component. Composition resistors having

values above about 1 M Johnson noise making them unsuitable for use in high impedance amplifier inputs or other critical applications.

When subjected to overload, carbon composition resistors usually decrease in value owing to their large negative temperature coefficient. This causes the temperature to rise until the hotspot temperature is exceeded and failure occurs, usually by fracturing.

There are two basic power derating curves for carbon composition resistors. The common commercial grade types have a spot temperature of about 107°C while the more expensive types that meet more stringent specifications (usually produced to meet military specifications — MIL-spec.) have a hot spot temperature of 130°C and can be used to full ratings up to 70°C whereas the former types must be derated above 40°C. The commercial grade derating curve is given in Fig. 7 and the military grade derating in Fig. 8.

The requirements of solid state circuitry created a demand for high stability, high quality resistors. Increasing use of electronics, and the demands of evermore complex consumer and domestic electronic equipment and appliances contributed to the development and production of low cost film resistors. Carbon composition resistors are gradually being superseded, despite the excellent specifications of types available, by film resistors which are inherently superior in many respects.

... to be continued

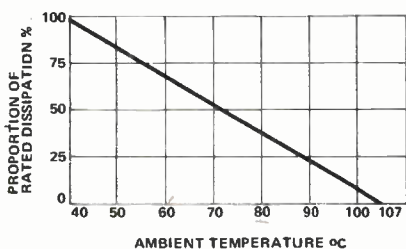

Fig. 7. Power derating curve for ordinary commercial grade carbon composition resistors.

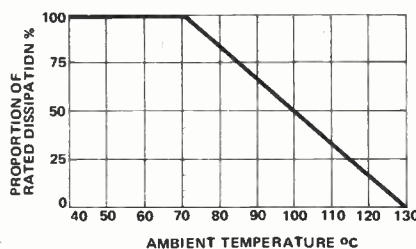

Fig. 8. Power derating curve for mil-spec or high quality commercial grade carbon composition resistors.



**EMONA**  
enterprises

21 Judge St., Randwick,  
N.S.W. 2031. Phone: 399-9061.

## EMONA E-4 ALL ELECTRONIC AM/FM STEREO DIGITAL CLOCK RADIO



\$79.95

(P&P: Interstate — \$5.50; NSW — \$3.50)

E-4 is a 24 hour dig. clock radio. It has all the features of E-2, plus: FM stereo; more output power; sliding balance, tone and volume controls; stereo headphone jack; stereo indicator; phono jack and external aerial connection.

**WARRANTY** E4, E2 & DHM-95 are fully guaranteed for 90 days. • write, phone or call in.

## EMONA E-2 ALL ELECTRONIC AM/FM DIGITAL CLOCK RADIO



\$45.95

(P&P: Interstate — \$4.00; NSW — \$2.50)

E-2 is a 24 hour Digital Clock Radio is completely electronic — no moving parts — 100% solid state. You can listen to FM or AM wake up to music or alarm, or preset the radio program. It can be used as an accurate stopwatch. And there is even an indicator that blinks whenever there has been an AC power interruption.

## CALCULATORS — Compare our prices:

- ELCON RANGE: scientific-statistic SC-6010 — \$63.00
- scientific SC-44 — \$43.00
- financial computer FN-85 — \$49
- slide rule KP-460A — \$15.50
- super memory KP-450 — \$15.50
- algebraic 8513M — \$12.00
- PANASONIC: • full scientific JE — 8410U — \$29.00
- To above add 15% S.T. if applicable (P&P inter. \$3.50 NSW \$2.00).
- All calculators guaranteed for 12 months.

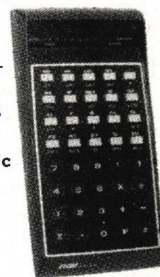

SC-6010

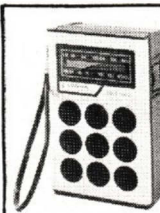

## NEW EMONA DHM-95 SOLID STATE AM/FM POCKET RADIO.

With large speaker — excellent sound. Earphones and battery included. (Note special introductory price).

\$10.50 (P&P \$1)





# Scope Cordless 60w Soldering Tool

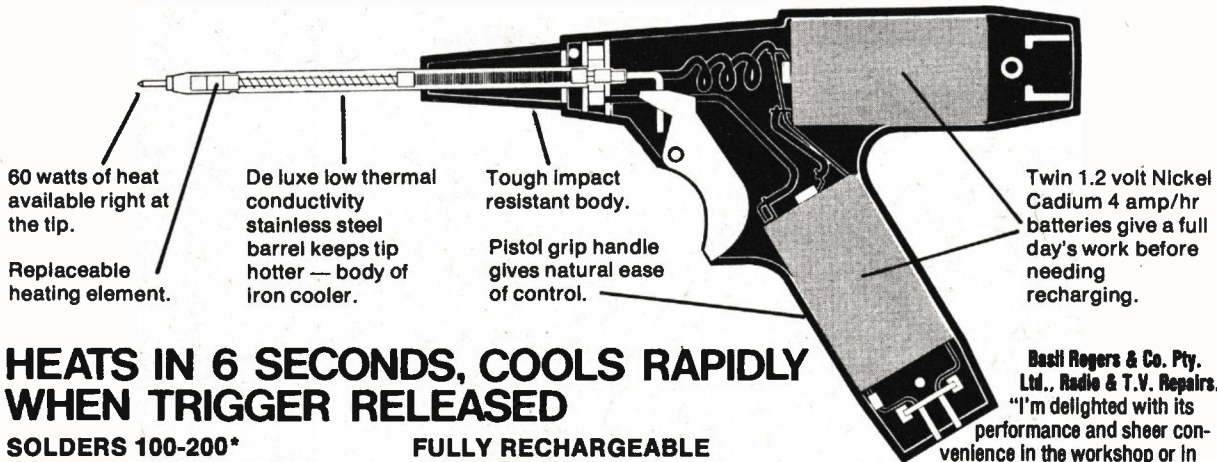

60 watts of heat available right at the tip.

Replaceable heating element.

De luxe low thermal conductivity stainless steel barrel keeps tip hotter — body of iron cooler.

Tough impact resistant body.

Pistol grip handle gives natural ease of control.

Twin 1.2 volt Nickel Cadmium 4 amp/hr batteries give a full day's work before needing recharging.

## HEATS IN 6 SECONDS, COOLS RAPIDLY WHEN TRIGGER RELEASED

### SOLDERS 100-200\* TYPICAL JOINTS BEFORE RECHARGING

\*Light electrical connections. Capacity will vary for lighter or heavier joints.

**PISTOL GRIP DESIGN** balances weight of cells for comfort and tip control:

### FULLY RECHARGEABLE OVERNIGHT, from car, power-point or Scope Transformer.

### ABSOLUTE SAFETY

No earth leakage currents. Solder anywhere with total personal and component protection.

**Basl Rogers & Co. Pty. Ltd., Radio & T.V. Repairs.**  
"I'm delighted with its performance and sheer convenience in the workshop or in the field. It's light, fits easily in your hand and you can solder even with the set on."

**Kevin Ball, T.V. Technician.**

"In my job I work mainly on circuit boards and I'm rapt with Scope Cordless. I've never reached a point where the gun can't handle a day's soldering. I like the feel of it; tremendous balance."

# SCOPE

Distributors to the Electrical Trade:

**NATRONICS PTY. LTD.** The Crescent, Kingsgrove, N.S.W. 2208

Manufactured by: **SCOPE LABORATORIES, MELBOURNE.**

# CMOS - a practical guide

Inherently rugged, CMOS logic has many advantages over other logic families — high noise immunity and uncritical power requirements are but two. This, the second article in this four part series deals primarily with quad switches.

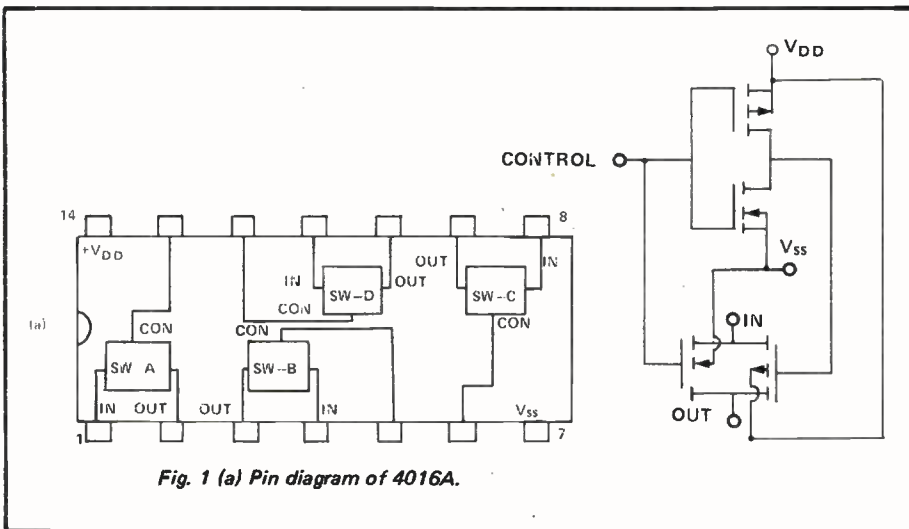

Fig. 1 (a) Pin diagram of 4016A.

THE 4016A QUAD BILATERAL switch consists of four transmission gates of the type discussed in the previous article, each with its own control input. Each switch also has a signal input and output (although these are interchangeable). When the control input is held high the input to output path behaves like a pure resistance of about  $300\Omega$  but when it is low the equivalent value is of the order of  $10^9\Omega$  at low frequency, even with fairly low supply voltages. It is impossible to give all the data which might be necessary for diverse applications — data sheets from a manufacturers may be required by the more adventurous experimenters. In any case the pin diagram in Fig. 1 should now be self explanatory.

It should be appreciated that the output impedance of the switch is fairly high and so for low signal distortion, a load greater than  $10\text{ k}\Omega$  is necessary. Using a high supply voltage (10-15 V) also helps to achieve this end. The gates will pass signals above the 10 MHz mark but as the frequency becomes higher, crosstalk between the switches (and distortion) will inevitably increase. It should be fairly clear how complicated switching systems may be realised but Fig. 2 has been included to guide constructors along the right lines.

## ANALOGUE APPLICATIONS

Many uses of this device in audio equipment have already appeared in constructional articles in this magazine and so it is to two slightly less obvious applications that we shall turn now. Figure 3 shows a sample and hold unit. When the control input is high the output tracks the input, but when it goes low the output remains frozen at the value it was at the instant of transition. The operation of the circuit

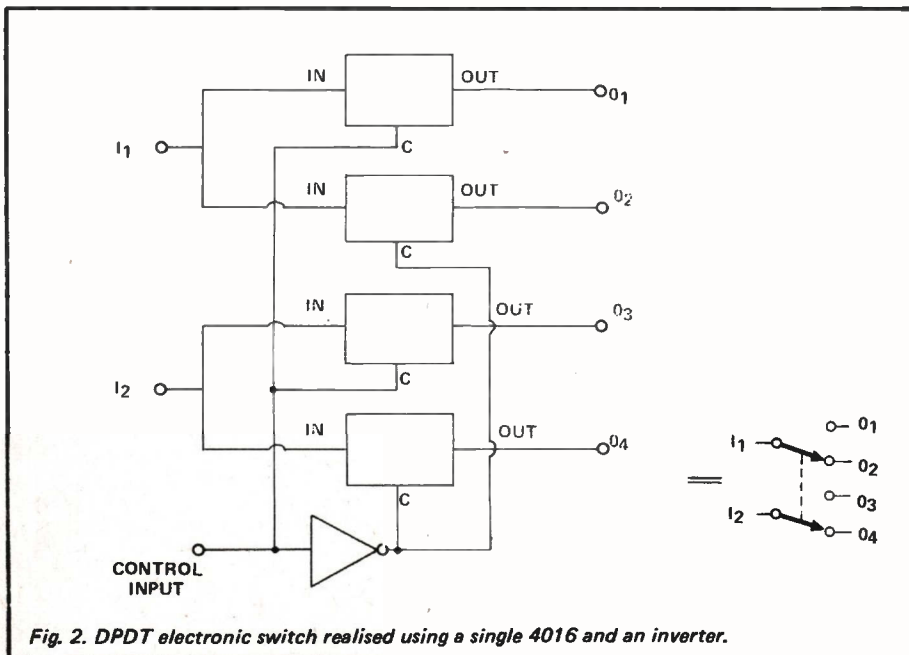

Fig. 2. DPDT electronic switch realised using a single 4016 and an inverter.



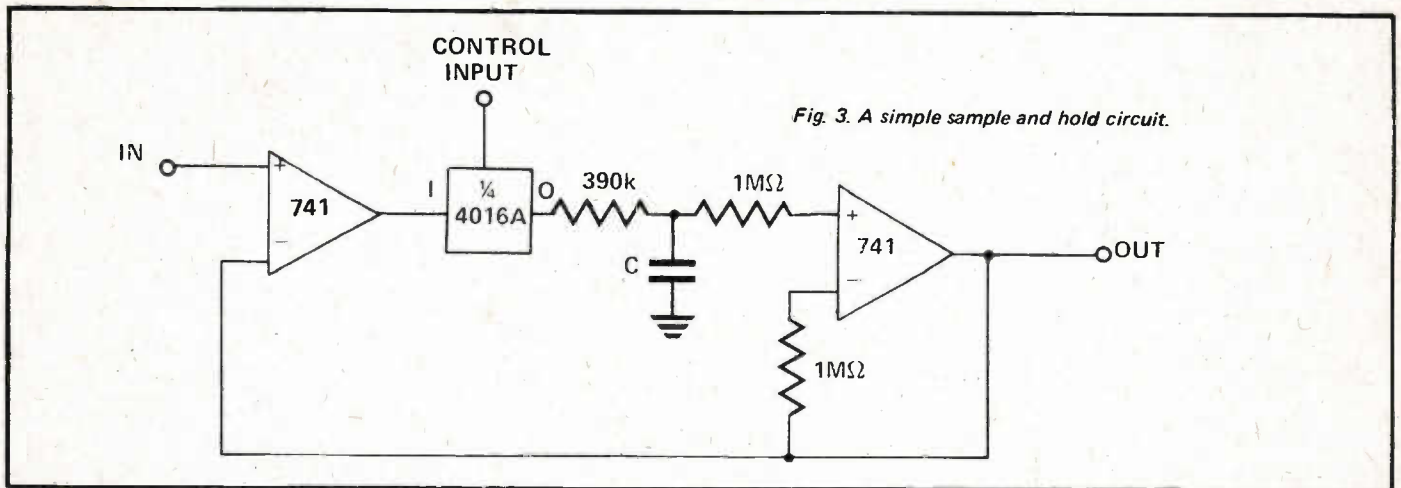

Fig. 3. A simple sample and hold circuit.

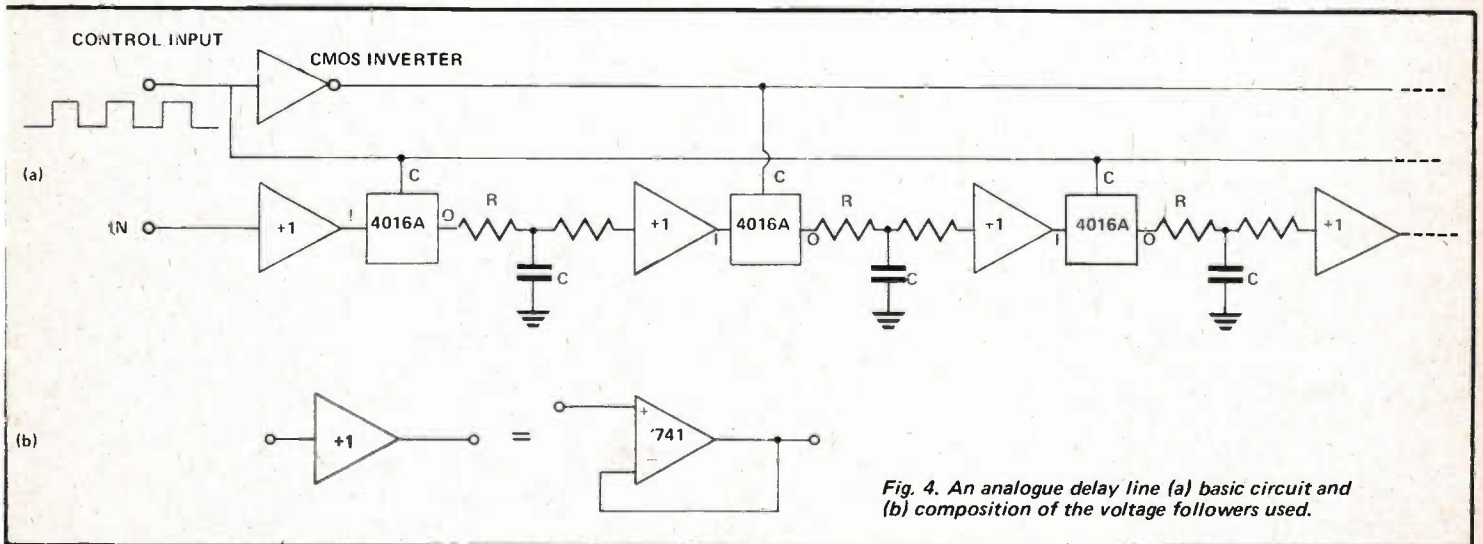

Fig. 4. An analogue delay line (a) basic circuit and (b) composition of the voltage followers used.

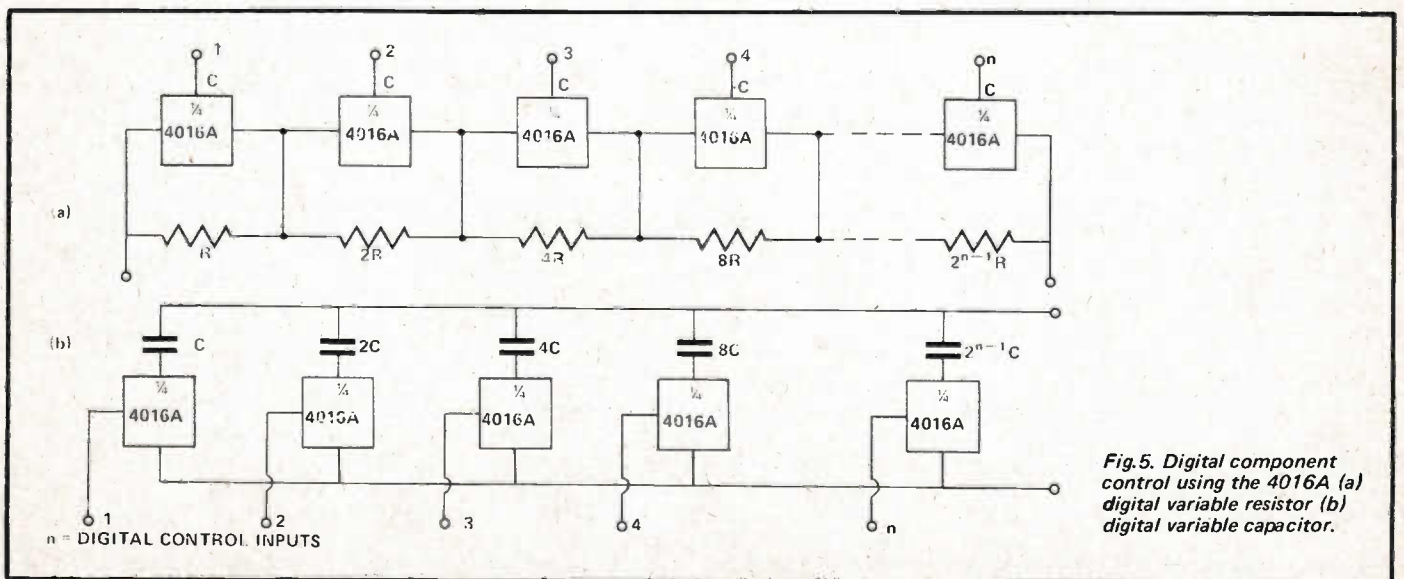

Fig. 5. Digital component control using the 4016A (a) digital variable resistor (b) digital variable capacitor.

# CMOS - a practical guide

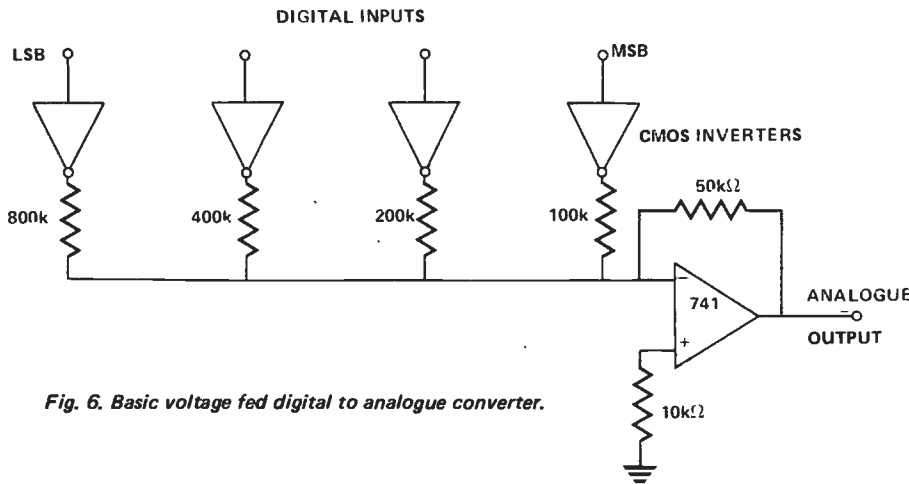

Fig. 6. Basic voltage fed digital to analogue converter.

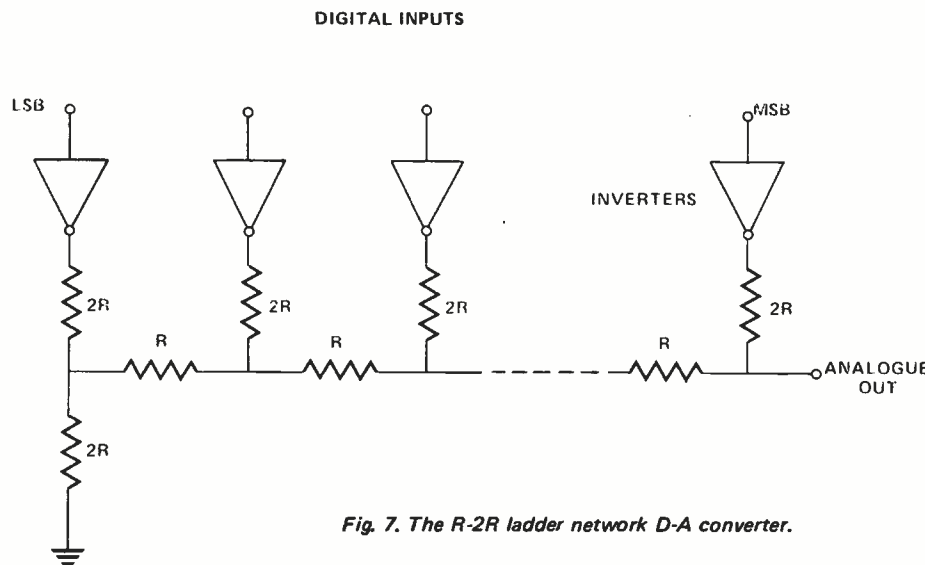

Fig. 7. The R-2R ladder network D-A converter.

will have to be optimised for specific applications, low frequencies give long delays but high distortion.

## DIGITAL COMPONENT SELECTION

There are a few fairly straight-forward uses of the 4016A in digital component selection which we will mention here because, in certain fields, they are very useful. Figure 6 shows how to produce digitally controlled resistance and capacitance networks which will vary the magnitude of the quantity in question from its basic value up to  $2^n - 1$  times that amount, where "n" is the number of gates and binary control bits. The resistor network can be used to produce a digitally gain controlled amplifier by placing it in the feedback loop of an op-amp and this can be used as a staircase generator - as well as to produce more interesting waveforms. One application of the digital capacitor is to produce a digitally controlled sweep generator by using it as the capacitor in one of the multivibrators we discussed last month.

Any type of component may be switched in and out of circuit by the 4016A. One possibility that is useful in some circumstances is to use the information on filter design in "Electronics - it's easy" to produce digital filters of different descriptions. The main thing to remember when using all these ideas is that the impedance of the component that is being switched must, at the desired frequency of operation, be large compared to the  $300\Omega$  of the 4016A gates.

## D-A AND A-D TECHNIQUES

The next use of the quad bilateral switch that we are going to consider is digital to analogue conversion, but first we are going to look at the subject of conversion on its own. Figure 6 shows a D-A converter of the type known as a weighted resistor network. The working of this circuit is easy to see and the reason it is practical in so simple a form in CMOS is that the high and low output levels from a simple gate are within a few millivolts of the supply line thus providing accurate voltage levels to the summing resistors. This simple form has disadvantages, one of which will become immediately apparent if you consider the diversity of resistor values required for an eight or nine bit version. It is for this reason that the R-2R network shown in Fig. 7 is more popular for most applications. It is difficult to explain how this configuration works without becoming

is generally self evident and it may be regarded as two voltage followers, one consisting of two op-amps with the output following the input, the other is just the second op-amp which follows the voltage stored on the capacitor. It is advisable to take care with the layout, as with all op-amp circuits, due to the huge open loop gain of these devices. The value chosen for C is a compromise between "slewing rate," that is the rate at which the circuit tracks a sudden change of input, and "holding ability" which is the length of time the circuit will hold a signal without unreasonable decay. To give some sort of guide, for a 10 kHz square wave to the control input, a  $0.01\mu\text{F}$  capacitor seems to

optimise the performance. The value of the resistors is also worth experimenting with.

An extension of the sample and hold concept is the analogue delay line which is shown in its basic form in Fig. 4. The sequence of amplifiers and gates can be extended to any desired length to achieve a longer delay, the only limitation being that in extreme cases the control lines may need to be buffered. It should be observed that alternate stages of the circuit are driven by an identical clock waveform and so the circuit works by shifting the voltage on alternate capacitors during alternate clock phases. The value of the passive components and the clock frequency



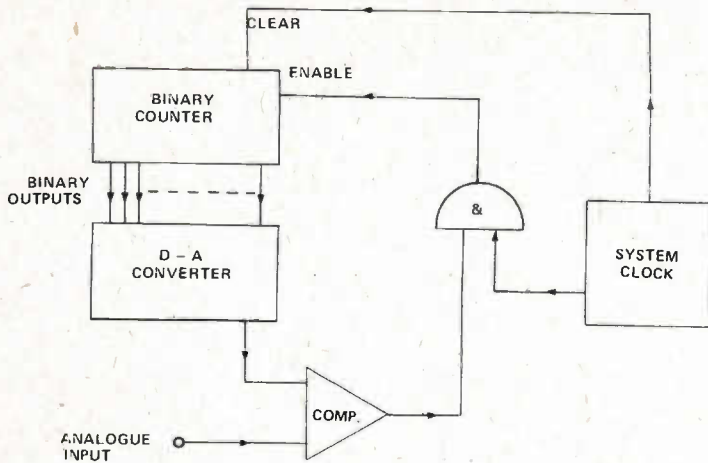

Fig. 8. Outline of A-D converter using 'Binary ramp' method. The binary counter counts up to the required value so that the output is correct during only part of the cycle.

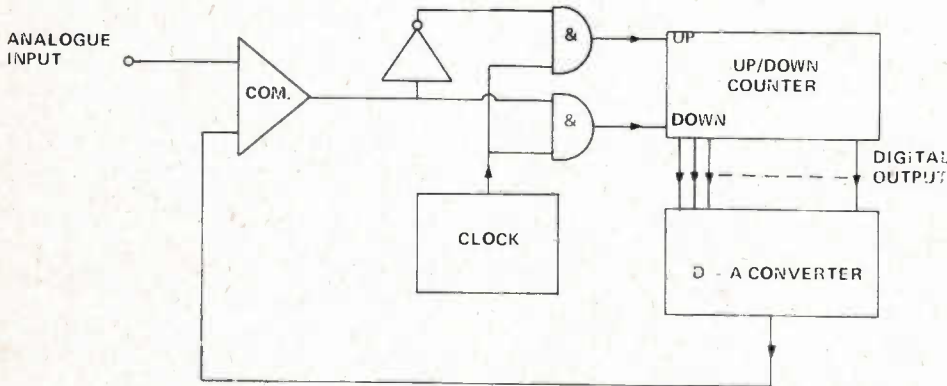

Fig. 9. A continuous counter type A-D converter. The clock just prevents the system oscillating at high frequency.

involved in mathematics but it becomes fairly clear if a three bit version is written down with the voltages in and analysed.

The basic idea for one sort of A-D converter or encoder as they are often called is shown in the block diagram of Fig. 8. This variety is called a binary ramp encoder and is similar to the ramp integration method often encountered in modified form in digital measuring equipment. The principle of operation of our binary version is that a binary counter counts up from zero until it reaches the equivalent of the analogue input. Contrast this approach with the continuous counter method outlined in Fig. 9. This provides a continuous approximation to the input and is thus generally more useful for continuously monitoring a single channel of information. It would be an advantage in many cases to have the counters working in BCD for ease of readout but this leads to complications. Finally on this subject it should be pointed out that these are circuits for experimentation and are unlikely to be directly applicable to any specific situation. They have been included because of the ease with which they may be realised in CMOS compared, say, to TTL.

#### A-D MULTIPLIER

As far as digital to analogue conversion is concerned (using the 4016A) we can take the idea a little further. What in fact we do (Fig. 10) is to use an arbitrary analogue voltage to feed the

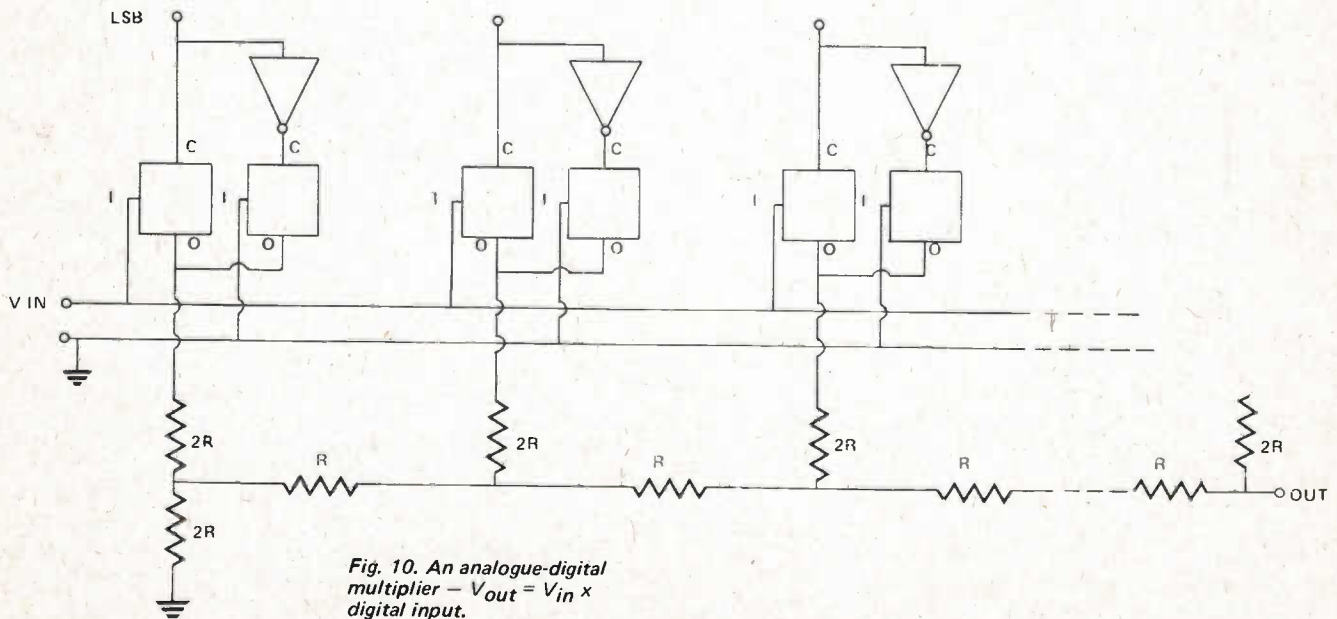

Fig. 10. An analogue-digital multiplier -  $V_{out} = V_{in} \times$  digital input.

# CMOS - a practical guide

resistor ladder and so we multiply this input by the digital input and produce an analogue result. This "hybrid multiplier" is an interesting circuit, particularly because the analogue input voltage may be ac thus producing several interesting waveforms and, on a more serious note, it may find application in hybrid computing experiments. We shall now leave the

4016A having, it is hoped, suggested some of the slightly less obvious uses of this versatile IC.

Our next subject is flip-flops — and we shall assume that the reader is familiar with the working of these devices, and so the discussion will begin with the pinout diagrams in Fig. 11. The first two are standard, dual edge — triggered devices with "D" and J-K" type data

inputs respectively. No doubt it is known that the "D" variety will divide the input frequency by two if "Q" is connected to "D" whereas the "J-K" type toggle, as this behaviour is called, when both "J" and "K" are held high. The set and reset inputs operate asynchronously (ie. independently of the clock) forcing the device into the "Q" = 1 and "Q" = 0 states respectively. These inputs operate when taken high in contrast to most TTL because TTL inputs rest high when disconnected whereas CMOS inputs must never be allowed to "float" anyway. Both the 4016A and the 4027A will operate up to about 8 MHz.

The last device in Fig 11 (the 4042A) is a quad data latch of the sort often used for temporary storage of BCD digits in applications like frequency meter displays. If the polarity input is held low then the "Q" output follows the "D" input in each latch when the clock is also low. But on the rising edge of the clock pulse the outputs are isolated and retain the data present at that moment. When the polarity input is high all this works the other way round. The clock inputs to all these devices should have rise times of 5µs or less (at V<sub>dd</sub> = 10 V).

Flip-flops on their own have uses in control circuitry and counters. If you wish to produce a counter to count through an odd sequence (a Gray code for example) it is advisable to find out about Karnaugh maps and associated techniques which aid the design process considerably. The standard form for such counters is a sequence of flip-flops whose inputs are derived from the outputs of the others by a few simple logic gates. As far as simple binary is concerned the required set-up is shown in Fig. 12 but we shall have a lot more to say on the subject of counters in general later.

The other main application of flip-flop is in shift registers. A shift register is a sequence of flip-flops so interconnected (see Fig 13) that on a clock pulse the content of each device is transferred to the next one down the line. The register so formed is referred to as a static device because, unlike some MOS devices available, data is not lost if it is not shifted for some length of time. One modification to the basic device is to provide inputs and outputs to individual flip-flops in the chain and in this form shift registers have many applications in serial-to-parallel and parallel-to-serial data conversion. This though is another subject which must wait until a little later in our discussions. ●

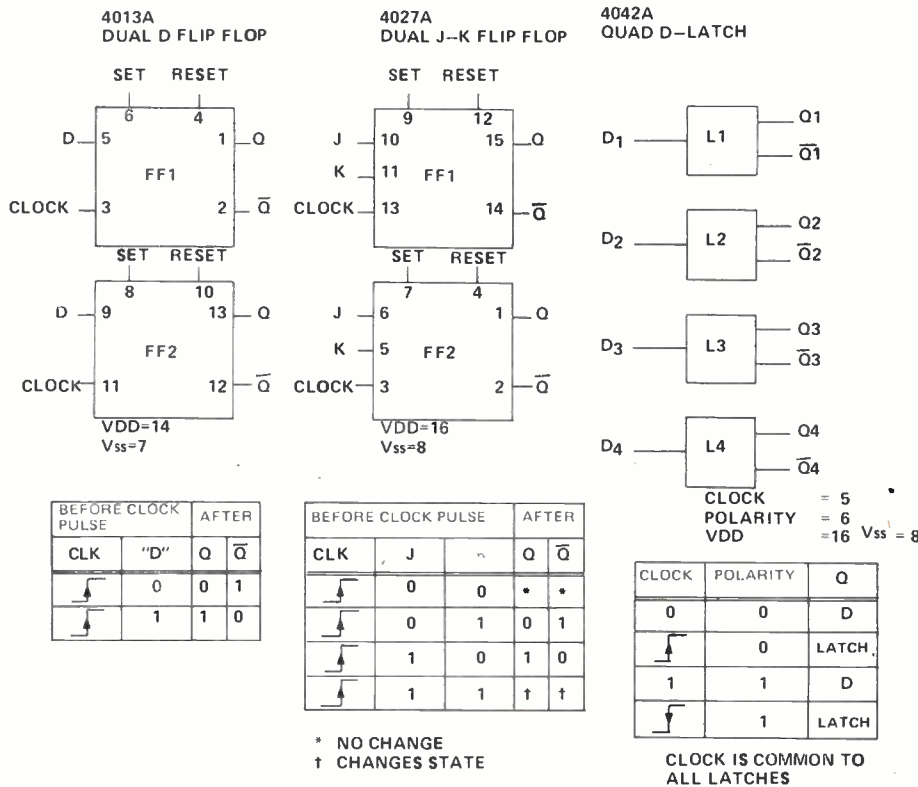

Fig.11. Three common flip-flop devices.

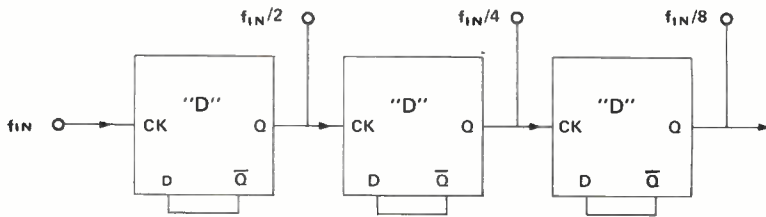

Fig.12. Basic binary counting chain used for frequency division.

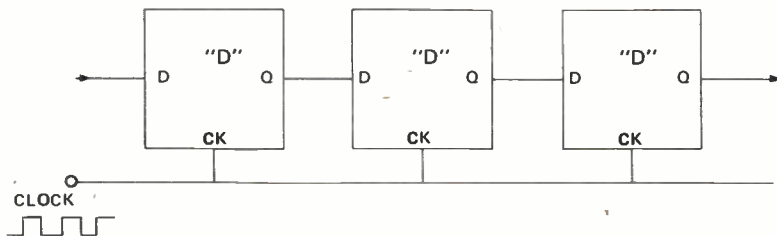

Fig. 13. Principle of shift register. The content of each "cell" is shifted one place to the right on the rising edge of the clock pulse.



# WHEN IT COMES TO ROTARY CONTROL YOU CAN'T GO PAST SOANAR FOR LOW COST QUALITY POTENTIOMETERS

A high quality range of rotary controls, widely used throughout the industry for applications in the professional, industrial and entertainment electronics field. Produced by advanced manufacturing techniques using the highest quality materials, these rotary controls conform to the Australian standard specification AS 1347 (1972)



GANGED  
SINGLE  
SWITCHED

LOG  
LIN  
24 mm & 16 mm

Technical literature available on request.

**SOANAR ELECTRONICS PTY. LTD.**

SALES OFFICES VICTORIA: 89 0661  
N.S.W.: 78 0281  
S. AUST.: 51 6981  
QUEENSLAND: 52 5421  
W. AUST.: 81 5500

30 Lexton Road, Box Hill, Vic., 3128, Australia. Telex 32286.



# Turn service problems into profits with Heathkit

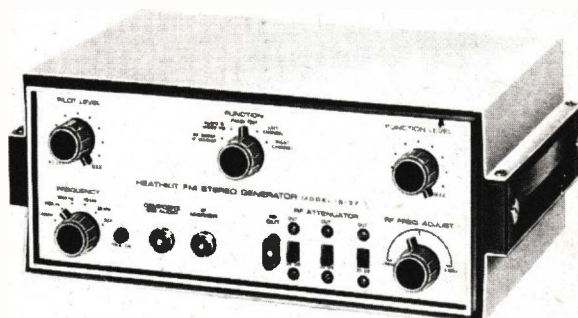

## IG-37 Heathkit Stereo Generator provides fast & accurate FM/FM stereo alignment

Provides audio or composite stereo signal for multiplex adapter adjustments ... RF carrier modulated by these signals for tuner & receiver adjustments ... phase test function for subcarrier transformer adjustment ... a variable level crystal-controlled 19 kHz pilot signal for checking receiver lock-in ranges ... plus built-in sweep and marker signals for RF and IF alignment. Other features include switch-selection of 400 Hz, 1 kHz, 5 kHz, 19 kHz, 38 kHz and one of two SCA frequencies ... test leads included.

**IG-37 SPECIFICATIONS** — RF signal frequency: 100 MHz adjustable by approx.  $\pm 2$  MHz. Pilot modulating frequency: 19 kHz  $\pm 2$  Hz. FM modulation: Left channel (stereo), right channel (stereo), Phase Test (left plus right channel in phase). Monophonic FM. Deviation: adjustable to 75 kHz. Sweep Rate: (used for RF and IF alignment) 60 Hz. Sweep Width: (used for RF and IF alignment). Adjustable to 750 kHz. RF attenuator range: 60 dB in 20 dB steps. Crystal-controlled markers: 10.7, 90.95, 96.30, 101.65 & 107 MHz. Composite signal output: Left channel (stereo); Right channel (stereo). Phase test: (left plus right channel in phase). Audio output: 400, 1000 & 5000 Hz; 10 kHz ( $\pm 2$  Hz); 38 kHz & SCA (65 or 67 kHz). Distortion: (At 400, 1000 & 5000 Hz), Less than 5%. Power requirements: 120/240 VAC, 50/60 Hz, 35 W. Dimensions: 5 1/4" H x 13 1/2" W x 9" D.



**WARBURTON FRANKI**

• ADELAIDE 356-7333 • BRISBANE 52-7255 • HOBART 23-1841  
• MELBOURNE 699-4999 • PERTH 65-7000 • SYDNEY 648-1711  
• WELLINGTON N.Z. 698-272

**WARBURTON FRANKI HEATHKIT KIT CENTRE**  
220 Park Street, Sth Melbourne, 3338  
Ph. (03) 669-4999 **IG-37**

Name .....

Address .....

..... Postcode

# You're looking at our attitude about cassette decks. The HK2000.

**harman/kardon**

We make only one cassette deck. We certainly are capable of making more. Perhaps some day we will. But it's unlikely — unless there are compelling mechanical or sonic reasons for doing so.

We have an attitude about high fidelity instruments: to give the finest expression to every function of music reproduction. And wherever we feel we have something to contribute, to do so without compromise. The HK2000 (with Dolby\*, of course) represents our attitude about cassette decks.

Its predecessor (the HK1000), was evaluated by High Fidelity Magazines as "the best so far." When our engineering explorations suggested that improvements were feasible, we replaced it. With the HK2000.

We consider that the cassette deck has a definite and honorable utility as a means of conveniently capturing, retaining and reproducing material from phonograph records, tapes or radio broadcasts.

With one major caveat. It must perform on a level equivalent to the source.

The HK2000's specifications offer measurable evidence of its quality. For example. Wow and flutter: 0.07% NAB WRMS. Frequency response: 20Hz-16kHz.

But performance specifications are only one influence on sound quality. Just as in all Harman Kardon amplifiers and receivers, the wide-band design characteristic of the HK2000 produces sound quality that transcends its impressive specifications.

It utilizes narrow gap, hard-faced, permalloy metal heads (the only heads used in professional studio tape machines) for extended frequency response and low distortion. Low frequency response is so linear that the HK2000 required the incorporation of a sub-sonic filter control that can be used to remove signals issued by warped discs.

These few factors, not individually decisive in themselves, indicate the attitude with which we conceived designed and built the HK2000.

There is, of course, a good deal more to say. Please write directly to us. We'll respond with information in full detail. Harman Kardon.

P.O. Box 6, Brookvale. 2100. Ph. 939-2922

\*Dolby is a registered trademark of Dolby Laboratories Inc.



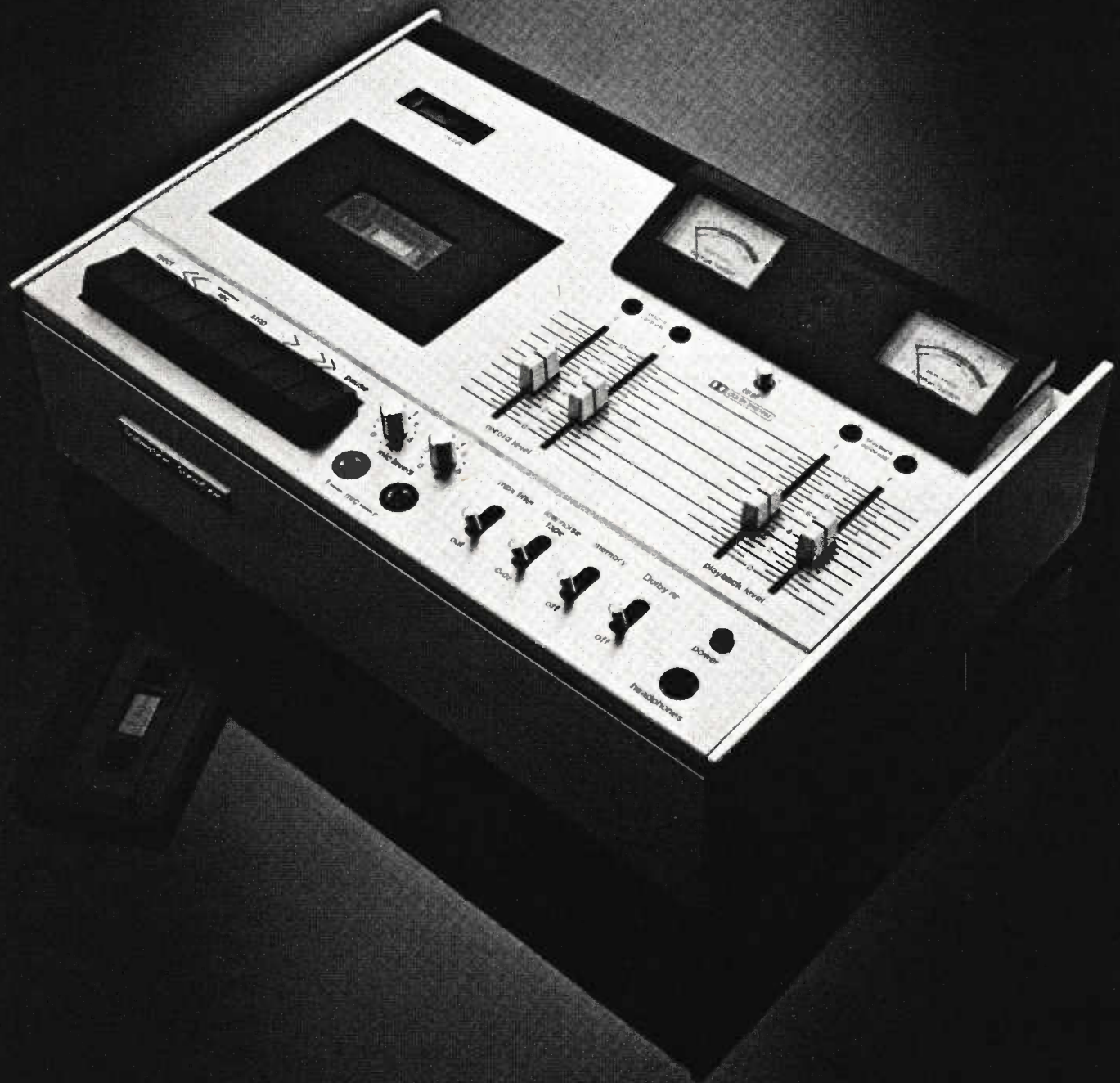

# ELECTRONICS

## -it's easy!

### OSCILLOSCOPES

OF THE MANY INSTRUMENTS required to service, test and maintain electronic systems, the cathode-ray oscilloscope must be the most versatile and useful. Other names are derivatives from the full name — the C.R.O., CRO (pronounced crow), oscilloscope and scope. Early works also refer to it as an oscillograph.

The basic workings of the oscilloscope were introduced in Part 4 where it was explained how they are used to view signal-level variations as time-versus-amplitude graphs drawn on the screen by electrons. This part provides a deeper coverage of the capabilities both simple and advanced units. We do not delve in the circuitry; although electronic system builders will always need to use an oscilloscope they will rarely need to build one.

### THE CATHODE RAY TUBE

The first cathode-ray tubes were experimental, designed to investigate the nature of beams of particles produced in thermionic-diode arrangements operating at extremely-high voltages.

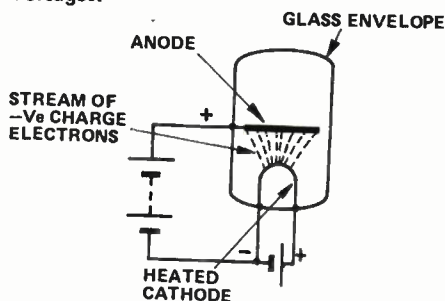
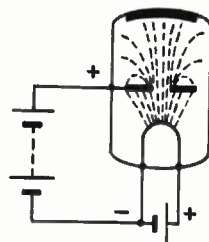

Fig. 1. The basic cathode ray tube developed through stages to provide a gun aimed at a screen.

(a) Thermionic diode in which the cathode is self-heated to cause liberation of electrons which move to the positive anode.

Figure 1 shows the three stages in developing the basic cathode ray tube. Fig. 1(a) is a thermionic diode — a valve diode. The cathode, heated by the current passing through it, emits electrons into the space around it. These, being negatively charged, are attracted to the positive anode.

The greater the voltage between the cathode and anode the greater the velocity of the electrons. If a hole is made in the anode, as in Fig. 1b, many of the electrons will pass through, forming a diverging beam on the other side of the hole. When a phosphor powder is placed on the inside of the tube the electrons reaching it cause it to glow as they give up their kinetic energy. The powder re-emits this energy as photons of visible light. Early researchers' tubes did little more than this. The nature of cathode rays was studied in the early 1900s by such famous names as Goldstein, Braun, Crookes, J. J. Thompson, Rontgen, Coolidge and Dumont. Experiments showed that the beam could be deflected by a permanent magnet and by electro-magnetic and electrostatic



(b) A hole in the anode allows some electrons to pass through to the phosphorescent screen.

fields. Prior to 1897 interest had been in physical-science investigation — not in the measurement of electronic signals. Then in 1897 K.F. Braun produced the first basic measuring device from the CR tube.

### FURTHER DEVELOPMENTS

However the CRO to become a useful, practical instrument more development was needed. From Fig. 1b it can be seen that the beam of an elementary device is badly defined and floods over the entire area of the phosphor. A tube or grid arrangement placed between the cathode and anode causes the beam to pass through the anode more cleanly, because of the negative repulsive effect of this tube assembly. The whole assembly — cathode, anode, grids and tube — is called the electron gun. Its full design is quite complex: Other elements are used to make electron-lenses (akin to optical lenses and light) to focus control and an intensity control, the former adjusts the spot shape and size on the screen, the latter the current flowing in the electron beam.

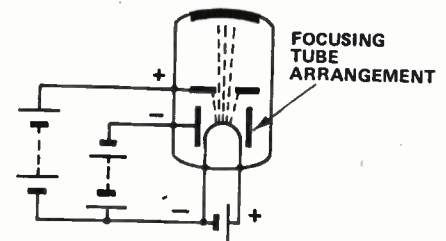

(c) A tube arrangement or grid is added to form a more concentrated and smaller size beam.

Phosphor European/ U.S. code	Fluorescence	Phosphorescence	Persistence	Burn resistance	Relative luminance	Comments
GP/P2	Bluish-green	Green	10 $\mu$ s-1 ms	Medium high	55%	Medium speed oscillography
GM/P7	Purplish-blue	Yellowish-green	100 ms-1 s	Medium	35%	Low speed oscillography.
BE/P11	Blue	Blue	10 $\mu$ s-1 ms	Medium	15%	Best photographic writing speed.
GH/P31	Green	Green	10 $\mu$ s-1 ms	High	100%	General purpose oscillography. Brightest available phosphor.
GR/P39	Green	Green	5-100 ms	High	50%	Sampling oscillography.

Fig. 2. Chart showing characteristics of oscilloscope screen phosphors.



The choice of phosphor on the screen determines the persistence (the length of time the spot glows after removal of the beam) of the display. The storage effect of various phosphors enables CROs to be made so that beam energy can be dispersed as light over time durations varying from microseconds to milliseconds. Fig. 2 is a guide to the selection of a phosphor. Manufacturers often offer a choice of screen persistence values to suit various applications. Fast moving spots, where the spot is likely to reappear on the same point in a short time, require short persistence. Long-persistence screens are suitable for slowly changing signals. (See the discussion of storage methods in the next part.)

### ELECTROSTATIC DEFLECTION

The next refinement provides a method by which the beam can be made to deflect under the control of electrical signals. Fig. 3 shows how this is done for one axis, using the electrostatic method. A voltage difference of zero between the deflection plates allows the beam to pass along the tube axis undeflected. Any voltage differential will cause the beam to be deflected towards the more positive plate. Thus we have a way to cause the beam to move in the vertical direction (called Y-axis or Y plates). A further two plates set at right angles to these (the X plates) will cause the beam to deflect in the horizontal plane when a voltage is similarly applied to them. Beam-intensity control by electrical means is defined as the Z control.

Electrostatic deflection is the easiest to deploy for voltage measurements because deflection is proportional to applied voltage. Small cathode ray tubes usually use electrostatic deflection. Large tubes, such as those used in television systems or large-screen teaching oscilloscopes, usually use magnetic deflection because electrostatic deflection would require very high deflection voltages. These do not have deflection plates set inside the tube, but make use of magnetic fields created by electromagnet coils placed around the neck of the tube. The deflection in this case is approximately proportional to the current in the coils.

Cathode ray tube design (for CROs and TV) has remained reasonably static since the late 1930s, the only obvious differences being in the linearity of beam sweeps and the shortness of tubes for a given screen size in television applications. Figure 4 is a modern oscilloscope with the cover removed to show the tube. From

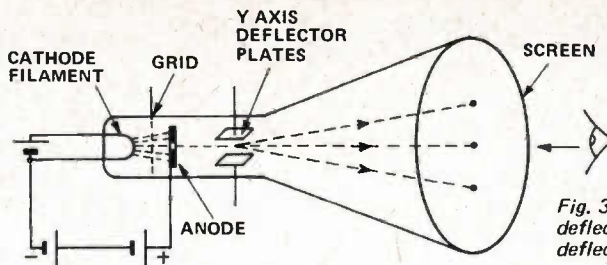

Fig. 3. The electron beam can be deflected by voltages applied to deflection plates.

the instrument viewpoint the differences have been improvements in frequency response, spot control, linearity of sweep and a wider choice of phosphors. In addition the development of tubes with more than one gun and deflection system (some dual-beam oscilloscopes, but not all, use separate beams for each channel) and storage tubes which enable the effective persistence to be varied at will have greatly improved the versatility of today's instruments.

### TURNING THE TUBE INTO A MEASURING INSTRUMENT

In the majority of cases the CR tube is used to produce a graphical display with the amplitude of a signal being expressed in the vertical (Y) direction and its variation with time being along the horizontal (X) direction. The following description is

to be read in conjunction with the schematic of Fig. 5 and the panel layout of a portable unit shown in Fig. 6.

**Time-base:** If the X plates are driven by a signal voltage that increases proportionally with time the electron beam will be deflected across the tube at a steady speed. When the signal returns to its original value the spot returns to begin the next sweep. The waveform required to produce such linear deflections is a sawtooth. (During return the beam is normally blanked out.) This provides a sweep function. The period of the sawtooth determines the time taken to cross the screen; this is expressed in the units of time per division (screens are divided into a grid of centimetre squares by means of plastic graticule or by engraving the inner face of the tube). A selector switch in the time-base section of the panel (an example is

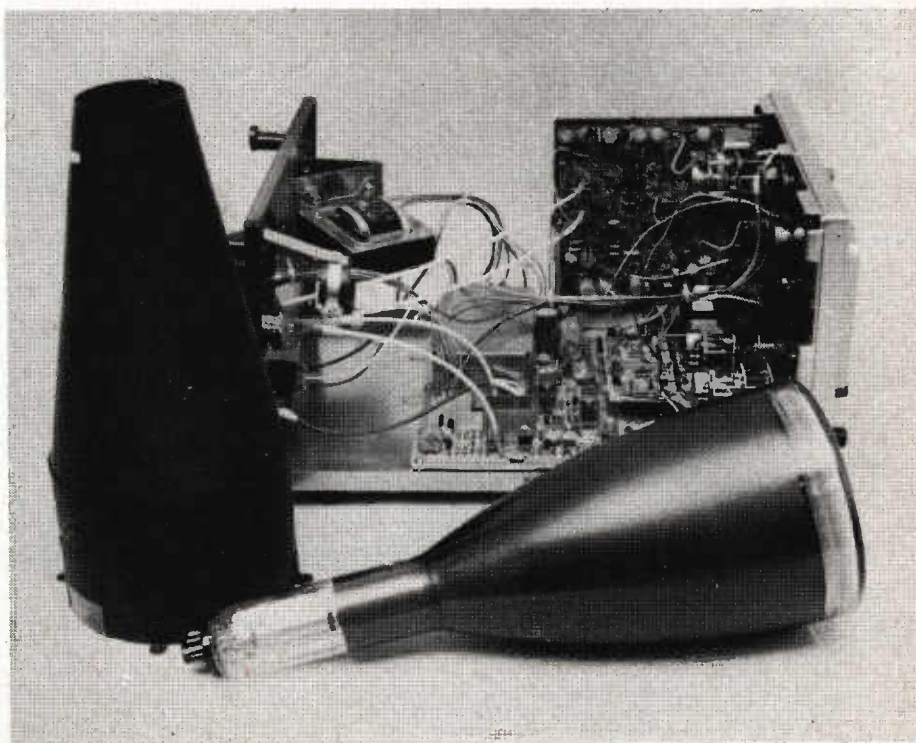

Figure 4. The insides of a modern oscilloscope — the Trio CS-1562. The cathode ray tube and its cover have been removed. Note the tube is much longer than the tubes used in TV sets (when you consider the small screen area). The cover screens the electron beam from the influences of stray magnetic and electric fields.

# ELECTRONICS—it's easy!

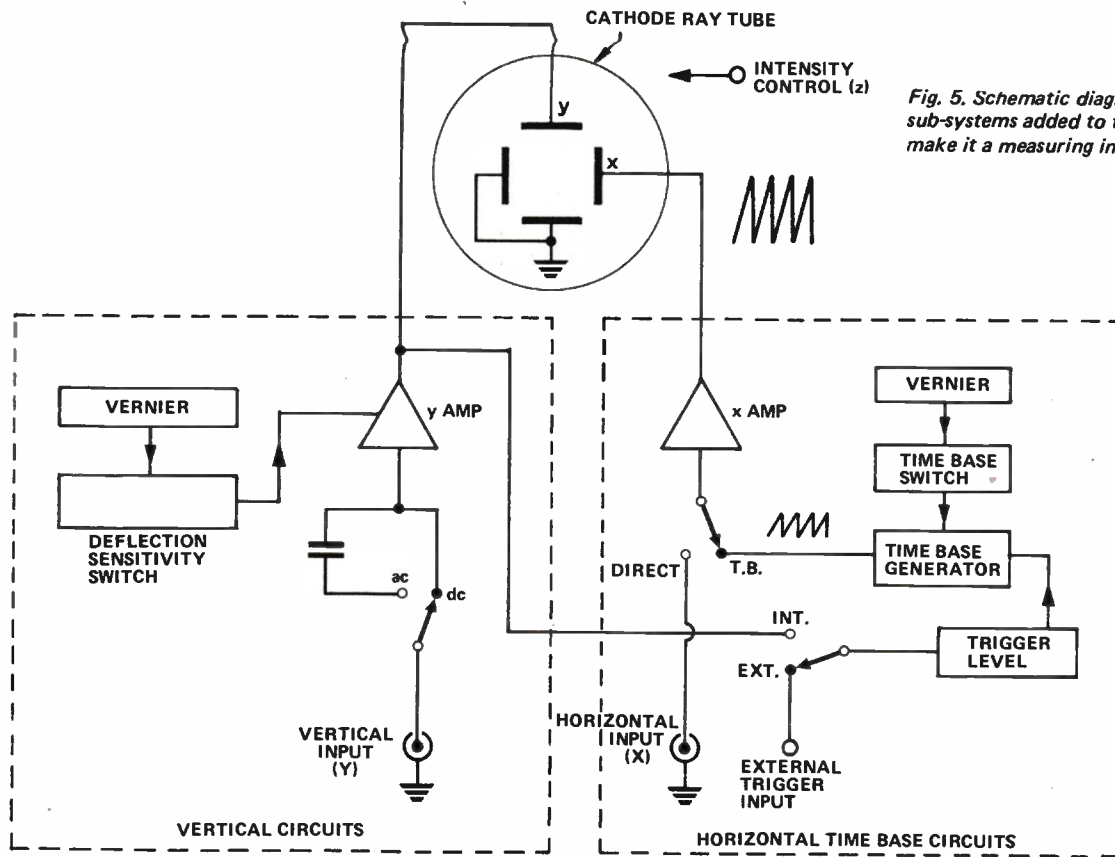
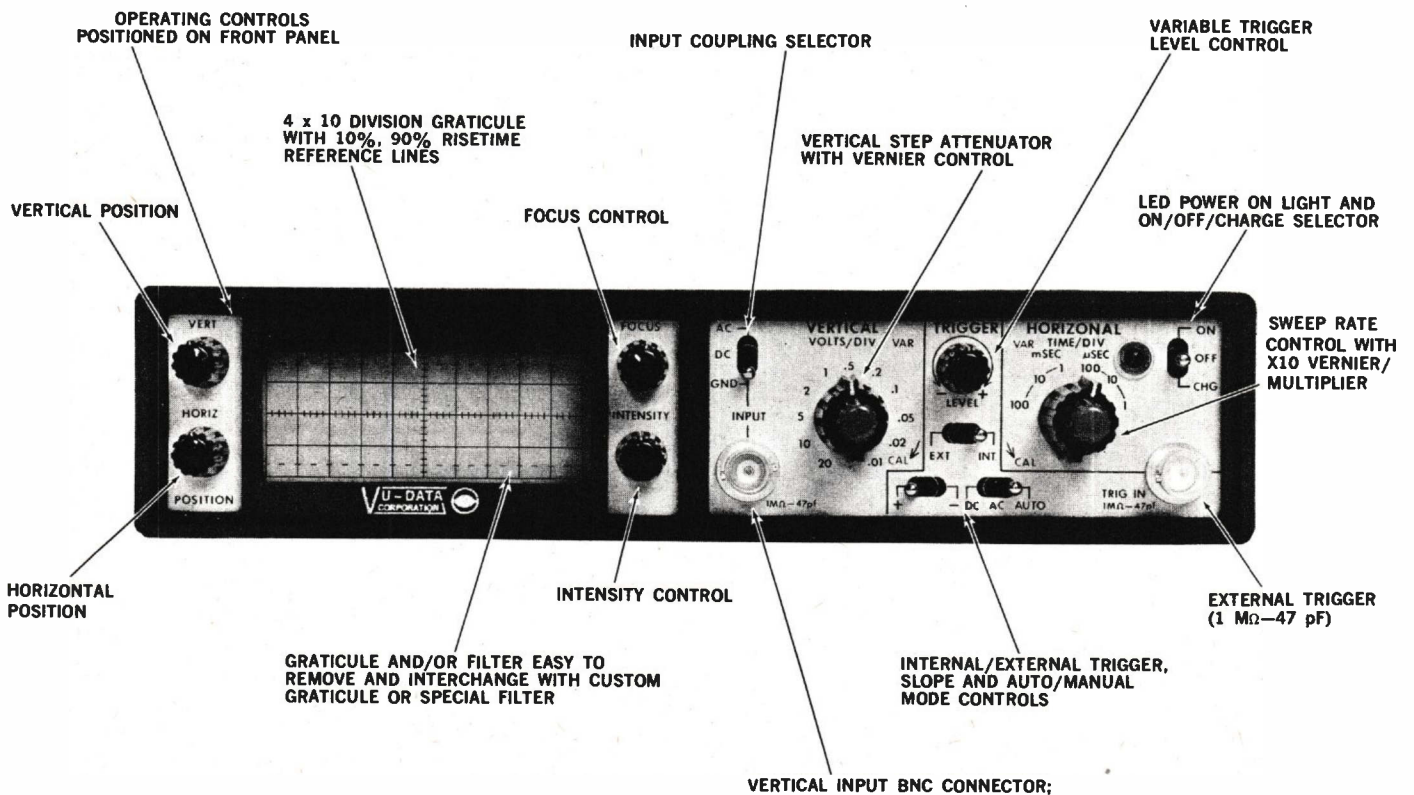

Fig. 5. Schematic diagram of essential sub-systems added to the CR tube to make it a measuring instrument.

Fig. 6. The controls of this mini-portable oscilloscope are typical of basic units. The position of controls around the screen will vary from make to make.





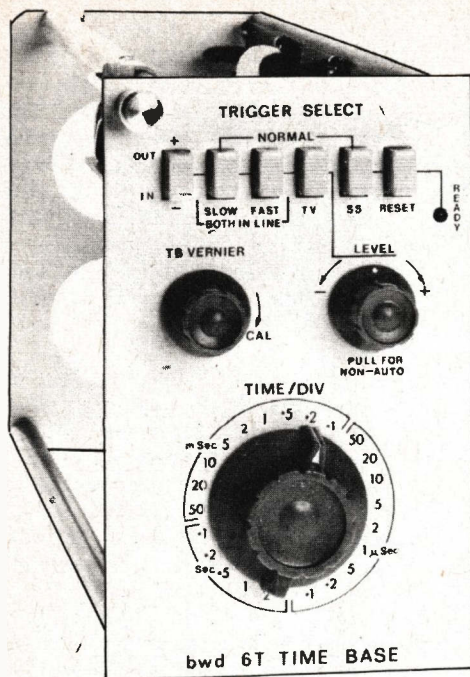

Fig. 7. Controls of a basic time-base unit include those shown on this plug-in. Terminology is generally the same for all makers but layout and controls will vary.

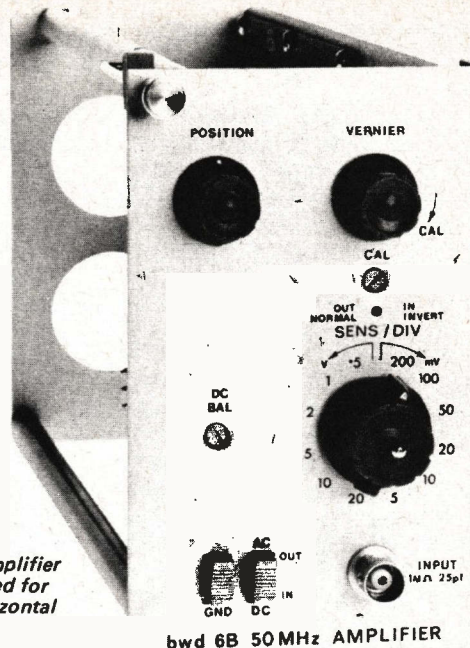

Fig. 8. Single-trace amplifier unit. These can be used for both vertical and horizontal amplification.

given in Fig. 6) enables the sweep rate to be chosen to suit the period of the signal being examined. Basic units will have time bases which range from  $0.5 \mu\text{s}$  to 0.1 seconds per centimetre; sophisticated units can go as slow as 10 seconds per division to as fast as 1ns per division. (Special "sampling" plug-ins can provide 10 ps/division.)

The time-base sawtooth generator is an integral part of all CRO measuring instruments. The accuracy of the rates are determined by circuit components — more expensive units can provide more-accurate information. A further control in the time-base section (See Fig. 7) allows the switch-selected sweep rate to be varied continuously. This is usually referred to as a vernier control. When making time measurements, such as waveform period, it is important to set the vernier control to the calibrated position.

To obtain a static display (where each cycle of a periodic signal overlays the previous one) the time-base must be synchronized with some point of the input signal. That is, the time-base is caused to begin its sweep across at the same point on the waveform being viewed. The circuit which does this is called the triggering circuit. Triggering can be taken from either an internal or an external source. When switched to 'internal' it is possible to vary the voltage level of the signal operating the trigger. Thus the sweep may be adjusted to commence at a chosen point on the waveshape. An 'auto' control position provides automatic selection of the voltage level for most reliable triggering.

**Time Base Amplifier:** The voltage required to deflect the beam over the full X (or Y) traverse is of the order of hundreds of volts. The time-base generator therefore requires an 'X' voltage amplifier between it and the plates.

In certain applications the X plates are used with signals in the same way as Y plates — that is without a time-base signal. In such cases considerable amplification may be needed. More versatile CROs offer plug-in facilities for the X input to give the user a wide choice of functions from the one unit. Simple units however, have the 'X' amplifier wired in permanently.

**Vertical Inputs:** At the same time as the time-base circuits sweep the line across the screen the 'Y'-plates are driven with a voltage proportional to the amplitude of the signal of interest. This causes the beam to be deflected in the vertical direction whilst it is swept across the screen. The result is the graphical display of signal amplitude versus time.

Again an amplifier is needed to increase the signal level so that a useful vertical deflection results. Such an amplifier must be able to amplify the incoming signal without distortion to provide vertical sensitivities up to 10 mV/centimetre (typically the most sensitive range of educational units), or maybe as high as  $10 \mu\text{V}$  per division (in sensitive oscilloscopes). The insensitive end of the range will usually be around 50 V/cm but special units (for electrical supply authority use) provide for much higher levels.

(Attenuator probes also enable high voltage signals to be investigated.)

The application needed from Y-amplifiers can, therefore, rise to 100 000 on the most sensitive range. In addition it is important that the gain be constant over the bandwidth of the signals being monitored.

Basic units provide amplifier response flat from dc to a megahertz or more. (Bandwidths are defined between points 3 dB down from maximum.) Magnetic-deflection display monitors will only reach 20 kHz whereas sophisticated high-quality instruments have bandwidths rising to 350 MHz. Sampling plug-ins provide bandwidths equivalent to dc to 1 GHz.

Vertical amplifier controls are usually grouped together on the front panel, as are time-base controls. Figure 8 shows the panel layout of a 50 MHz bandwidth amplifier. From this it may be seen that the vertical sensitivity is selected by a switch and that the y amplifier has a 'vernier' sensitivity control which must be at the 'calibrate' position when measurements of signal amplitude are being made.

The position of the trace on the screen depends upon the standing voltage applied to the plates. On both Y and X axes extra controls, (as shown in Fig. 6) enable vertical and horizontal shift of the trace position by adjustment of the bias applied. When using the CRO to probe circuits involving ac signals combined with standing dc levels — as is the case in ac amplifiers for example — the dc level

# ELECTRONICS—it's easy!

on the Y signal causes the trace of the ac signal to be displaced vertically and, perhaps, to go right off the viewing area. This difficulty is overcome if you couple the circuit signal to the Y-amplifier via a capacitor. The ac signal then centres itself on the screen at the position chosen by setting the vertical shift control. This method is acceptable provided frequencies below the cut-off of the RC filter produced are not wanted. Measurement of very-low frequency to dc signals must be dc coupled on the ac/dc selector switch provided. A further switch position enables the input to the plates to be brought to its dc zero position. This helps the operator to establish where this level is on the screen. The switch for this function is in the middle of the unit shown in Fig. 6.

**Signal Input Connections:** Oscilloscopes for use with frequencies below about 1 MHz can make use of separate plug-in/screw-down banana-plug terminals. More usually, however, the input to the Y amplifier, and perhaps to the external trigger, will use standard BNC connections. These are designed for use with coaxial cable and coax should be used for all except the shortest end connections to the circuit. The input impedance characteristics are usually quoted — 1 megohm with 20-100 pF shunting capacitance being typical values. In

some applications the CRO must be matched to reduce reflections — in such cases the input might be 50  $\Omega$  or 600  $\Omega$ . For fast rise-time studies it is necessary to ensure that the capacitive value presented does not reduce the overall bandwidth by shunting the device to which the CRO is connected. In exacting cases, needing high input impedance and small capacitance, special probes are used. These are described later.

**Calibration of the Time Base and Y-Amplifier:** The value of electronic components may drift with time, altering the sweep rate and vertical amplifier values from those indicated by the selector switch. To enable the operator to check these, more advanced oscilloscopes incorporate a special circuit that provides a fixed-frequency, fixed-amplitude square wave signal for calibration purposes. A typical signal would be 1 volt peak-to-peak. As it is derived from the mains frequency (50 Hz or 20 ms period) its time duration is also quite accurate.

## MULTIPLE TRACE OSCILLOSCOPES

Measurement situations involving oscilloscopes more often than not require display of comparative information between two points in a system — the relative input and output signals in an amplifier response test, or

the phase shift between two signals across a filter stage. Single-beam oscilloscopes are very limited because they cannot provide as much information to the user as a unit that can compare the waveforms at two points simultaneously. Three distinct alternatives are available to provide dual beam operation:

**Separate gun:** These use two, physically-separate, electron beams and deflection systems that are mounted inside the tube envelope. The beams may be generated by splitting the beam from a single gun. These are generally referred to as dual-beam units (dual-trace is a term reserved for the next method described).

Each beam has its own Y-input panel with a complete set of controls as described earlier. Dual-beam units drive both X-scans with a common set of deflection plates (as in Fig. 9) but some (rather rare) oscilloscopes enable each time-base to scan at a different rate.

In general, dual-beam units are less common because of the higher expense compared with the next method.

### Electronic switching — chopped mode:

The deflection response of an electron beam is rapid enough to allow it to be directed from one position to another at a speed exceeding the scan rates used with the signal being viewed. Fast electronic switches are used to switch the common single beam between two (or three or four) Y-inputs. Figure 10 illustrates this. Appropriate blanking (that is reduced Z intensity) is applied when needed, when the beam is chopping from one trace to the other. If the chopping rate is chosen to be at least 100 times faster than the highest frequency to be viewed the two traces appear as separate traces. Hence the name "dual-trace" for this method. In reality the traces are not continuous but are made up of dash-spaces. A hundred dashes across a screen produces a virtually continuous trace to the eye. The limit of usefulness is reached when the inbuilt chopping rate comes close to the upper frequency being viewed thus producing a dashed-line trace in which the dashes are of length equal to wanted signal features. At this point information is lost.

As far as the user is concerned there are still two groups of Y controls — just the same as for a dual-beam arrangement. The difference arises as

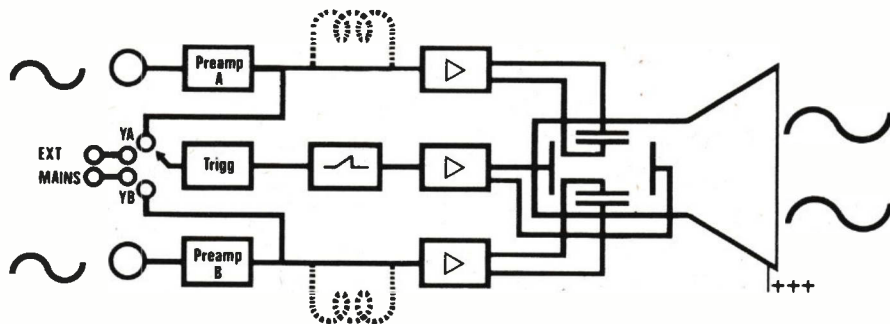

Fig. 9. Schematic of Philips 3232 dual beam oscilloscope. Common x plates provide scan for both beams, separate y plates deflect the two distinctly separate electron beams that are derived from a common gun.

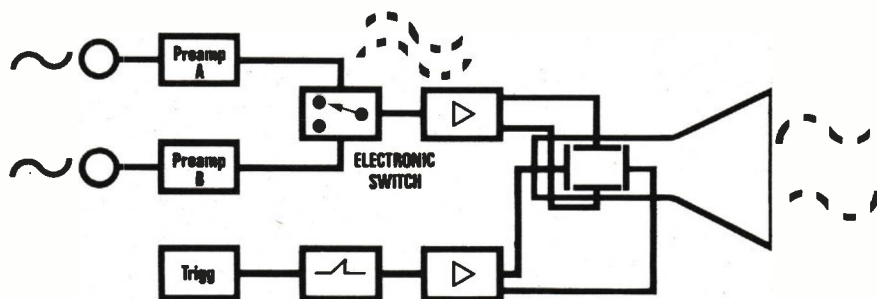

Fig. 10. Electronic-switching enables a single-beam and deflection system to provide dual-trace operation.





Fig. 11. Example of dual-trace plug-in showing the basic controls.

the position chosen on the selector switch where a 'chop' mode must be selected — see the panel of a dual-trace plug-in shown in Fig. 11.

Chopped operation ensures that the time relationship between the two signals is faithfully presented: phase measurements are also accurate (that is, providing the input amplifiers to each are identical).

Chopped operation will also display two simultaneous, non-recurrent signals, such as transients induced at various points when a complex resonant system is excited by an impulse. It is quite suitable for low-frequency signals but less convenient as the frequency rises.

### ELECTRONIC SWITCHING-ALTERNATE MODE

Switching can also be employed on a full alternate trace-by-trace basis. The first trace is a scan of channel 1, the next of channel 2 and so on. This does not suffer from the dotted defect with high-frequency viewing but it suffers from another deficiency in that the phase relationship between the two signals may not necessarily be as indicated on the screen.

The method is unusable for observation of "once-only" dual events because the second transient signal may have gone to zero by the end of the trace of the first simultaneous transient signal. The panel shown in Fig. 11 is typical of dual trace units. The selector switch enables choice of alternate, chop, channel 1, channel 2, and channel 1 plus channel 2 modes.

With two channel operation it is necessary to decide which input will synchronize the time-base scan. A switch provides the choice of appropriate internal triggering. Although only channel 2, for example, may be being viewed there are

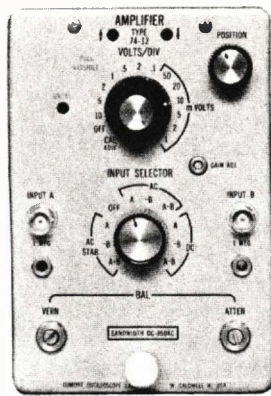

Fig. 12. Differential amplifier plug-in panel.

circumstances where it is desirable to trigger from the channel 1 signal.

The electronic-switching method enables more than two traces to be displayed— three and four-trace units are available.

### DIFFERENTIAL AMPLIFIERS

Generally the dual-trace oscilloscope is recognised by two sets of input terminals. There is, however,

another two-input unit that is for single trace operation. This is the differential input amplifier unit; it is normally provided as an optional plug-in.

Two two inputs are amplified by the high-gain differential arrangement of a dc amplifier — refer to Part II for the basic concept. These are used when common-mode noise rejection is needed and when the difference between two fully floating inputs must be studied. Figure 12 is the panel of a high-gain differential amplifier. Position and gain controls are used as for an asymmetric input Y-amplifier. The input selector provides choice of Channel A — channel B, A-B; each of these being ac or dc connected. The balance controls enable the two amplifiers to be trimmed to remove offset and gain differences.

### FINDING THE TRACE

Even experts can experience temporary difficulty when confronted with an unfamiliar oscilloscope — especially when it is complicated. Naturally it takes training to get the best from a unit. A basic difficulty is often finding the trace! These steps provide an efficient procedure that

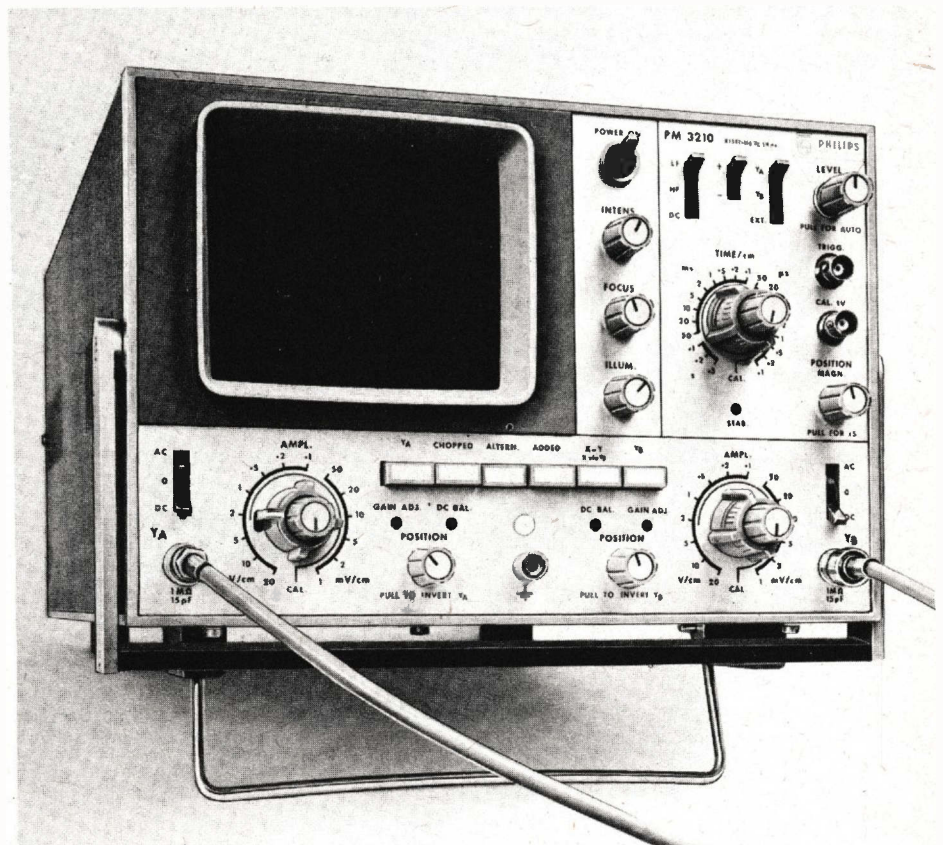

Fig. 13. Front panel of an oscilloscope that represents medium sophistication. The text contains a self test about its controls.

# ELECTRONICS—it's easy!

should be learned. Begin with the input to the Y-amplifier unconnected.

1. Ensure that the power is on. The on-off switch control is usually built in with the intensity knob, but not always.
2. Turn the intensity to 75% clockwise.
3. Switch the time-base (horizontal) to a medium speed — say 1ms/cm. This ensures that the screen displays a full line across the screen rather than a point which occurs when the scan speed is on the slow ranges.
4. Switch to auto triggering. This may be a marked position of the trigger control or a separate switch. This ensures that the trace is being triggered.
5. Switch to internal triggering. This is necessary for (4) above. Relying on an external signal to trigger the scan is unreliable — it may not be of adequate magnitude.
6. With this done slowly vary the vertical position control about its mid range point widening out to get the trace on screen.

7. The above may still not produce the trace. If not put the vertical position in its middle point and the gain at an insensitive value and begin a scan of the x-position control. This should be somewhere mid range. Too much x-shift can cause the trace to slide off screen.

Complicated oscilloscopes will invariably incorporate a variety of controls that may also need adjustment to find the trace. Space prevents a full guide to spot finding. Fortunately the more expensive units often provide a spot-finder button. Press it and the spot appears on screen enabling the controls to be adjusted accordingly to bring it back from the direction it flies too when the button is released.

When the trace is located in mid screen the intensity and focus are then adjusted by switching the scan to the slowest rate to produce a spot. These should be adjusted to produce a small round spot without halo: stationary spots on screens should be avoided as this shortens the life of the phosphor at that point.

The next part will continue the discussion on oscilloscopes providing understanding of storage kinds, the delay sweep mode, probes and special plug-ins.

## SELF TEST

If the above facilities are understood it should be a straightforward matter to master any oscilloscope with the degree of sophistication that has been introduced so far. Figure 13 is the front view of a modern unit. It is given as an exercise.

1. Locate the controls that are associated with the quality of the dot produced by the beam.
2. Does it provide two trace display, and if so by what method?
3. Which is the time-base control area?
4. Where is a Y-amplifier vernier control to be found?
5. What are the input terminating conditions?

## ALPHA MODEL DMM-1ER DIGITAL MULTIMETER KIT \$69.95\*

auto polarity, auto zero

For some time, the multimeter has been the most popular instrument in the electronics field. But until recently, there were no alternatives to complex, high-cost professional equipment. Now comes the Alpha Digital Multimeter, a full-service, low-cost instrument which will appeal to both amateur and professional alike.

Features like automatic polarity, automatic zeroing and over-range indication combine to give you a high-quality instrument you'll be proud to own. And as you test and make measurements using this versatile unit, you'll begin to "know" your equipment as never before. The Alpha Digital Multimeter — your way to greater independence in the lab or at home.

### specifications

#### AC VOLTAGE

1 millivolt to 300 volts in three ranges. Input impedance: 10 megohms. Accuracy:  $\pm 1\%$ . Frequency Response: 0 to full-scale voltage between 40 and 100 Hz; 0 to 2.4 volts between 100 and 10,000 Hz; 0 to 1.5 volts between 10 KHz and 50 KHz.

#### RESISTANCE

1 ohm to 6 megohms. Accuracy:  $\pm 0.1\%$ .

#### CURRENT

DC current: 1 microamp to 2 amps. Accuracy:  $\pm 1\%$ . AC current: 1 microamp to 300 milliamps. Accuracy:  $\pm 1\%$ . AC Frequency Response: Same as for AC voltage.

#### DC VOLTAGE

1 millivolt to 600 volts in four ranges. Input Impedance: 10 megohms. Accuracy: 0.1% to 300V,  $\pm 1\%$  to 600V.

#### RESOLUTION

1 millivolt — 1 microamp — 1 ohm.

#### GENERAL

Readout: 3½-digit LED. Power Source: four AA (penlight) size batteries (Ni-Cad, alkaline or carbon-zinc). Over-range indication: display flashes when input exceeds value of range selected. Polarity Indication: automatic (negative voltage and current indicated by display). Size: 5.1" x 3.4" x 1.5". Weight: 8 oz. Case: high-impact Cyclocac®. Color: Red.

\*TEST LEADS AND BATTERIES NOT INCLUDED



AVAILABLE EXCLUSIVELY FROM

**sabtronics**  
INTERNATIONAL

- \* Bright 3½-digit display with automatic decimal and polarity indication
- \* Measures AC / DC voltage, AC / DC current and resistance
- \* Exceptional accuracy and high resolution
- \* High-impact Cyclocac® case for durability and ruggedness
- \* Compact, light weight and battery operated for "anywhere, anytime" operation

The price as listed is in Australian dollars. Remittance must be by Bank Draft or Bank Cheque (preferably for an equivalent amount in U.S. dollars) or international postal money order in which case receipt should be sent with order.

To: Sabtronics International, P.O. Box 64683, Dallas, Texas 75206, U.S.A.

Please send via insured air mail \_\_\_\_\_ (quantity) Alpha DMM-1ER Digital Multimeter kit(s) @ \$69.95 plus \$2.95 postage and insurance for each kit ordered.

I enclose  Bank Draft  Bank Cheque or  
 International postal money order receipt

(Please Print)

Name \_\_\_\_\_

Address \_\_\_\_\_

(Postcode) \_\_\_\_\_

eti / 8A



# SCIENTIFIC KITS

Now you can build some of the most advanced digital electronic instruments with our new series of low-cost modular scientific kits. These kits will expand the range of your electronic applications enormously — and all at a surprisingly low cost.

The heart of the system is our 4-digit Decade Counter (Kit 012) which features a full 4-digit LED readout (you choose the size best suited to your application). Combine this with a 5-volt regulated power supply (Kit 030) and you have the basis of a wide range of sophisticated electronic instruments, including:

- A Digital Voltmeter (DVM) . . . . . Kit 012 + Kit 030 + Kit 017
- Frequency Counter . . . . . Kit 012 + Kit 030 + Kit 016 + Kit 014 or 031
- RPM Counter . . . . . Kit 012 + Kit 030 + Kit 020 + Kit 032

## 4-DIGIT DECADE COUNTER

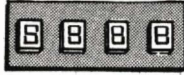

- On-chip internal oscillator for scanning speed.
- Overflow and count-extend outputs.
- Transfer, reset, count, blanking and true complement control inputs.
- Circuit board can be cascaded to 8-12-16 etc. digits.
- Kit includes all components, PCB's, and LED displays and full assembly instructions.

Kit 012A (with .25" displays) . . . . . \$23.95  
 Kit 012B (with .50" displays) . . . . . \$27.95

## 5V REG. POWER SUPPLY

- Input voltage: 25V max.
  - Output current: 1 amp max.
  - Load regulation: 50mV.
  - Output voltage: 5V
  - Line regulation: .01%
  - (Needs 8-20 volt transformer.)
- Kit 030 (excluding transformer) . . . . . \$5.95

## DIGITAL VOLTMETER

1.999V as basic, with polarity indication. 1 M ohm input impedance and accuracy to .1% if properly adjusted.

Kit 017 . . . . . \$17.95



## FREQUENCY COUNTER

Features FET input front end with trigger circuit for measuring complex waveforms. Measures from 0.1 Hz to 35 MHz when used with kit 014.

Kit 016 . . . . . \$16.50

## LINE TIME BASE

50 Hz or 60 Hz chain time base using line (main) frequency as reference. Outputs: 10 Hz - 1 Hz - 0.1 Hz. Accuracy: 0.1% - 0.05%.

Kit 015 . . . . . \$ 9.75

## R.P.M. COUNTER

Counts from 1 to 100,000 RPM.  
 Kit 020 . . . . . \$ 8.95

## 1 MHZ CRYSTAL TIME BASE

Crystal time base divider. Output 1 Mhz - 100 KHz - 10 KHz - 1 KHz - 100 Hz - 10 Hz - 1 Hz - 0.1 Hz. Accuracy better than .005% with proper adjustment.

Kit 014 . . . . . \$14.95

## MORE TO COME . . .

Watch future issues for further announcements.

# NEW! GIANT 0.8" READOUT



The latest giant size readout by Fairchild. Surpasses all other jumbo LEDs available today. Available in both, Common Anode and Common Cathode. Fits standard DIP sockets with 0.6" pin row. RH decimal. Typical forward current of only 10mA/segment. Forward voltage: 1.7V (typ.). Supplied with data.

FND 800 Common Cathode . . . . . \$4.75  
 FND 807 Common Anode . . . . . \$4.75

## LED'S

Mini red . . . . . .13  
 Mini green . . . . . .15  
 Jumbo red . . . . . .16  
 Jumbo green . . . . . .20  
 Jumbo yellow . . . . . .25

## TEXAS INSTRUMENTS 6 DIGIT DISPLAY.

Fully multiplexed, Common Cathode by Texas Instruments. Goldplated. Ideal for a mini 6-digit clock or stopwatch.



Kit 013 . . . . . \$13.00

FND 503  
 \$1.80  
 5/\$7.50



DL33  
 If you like an array of displays, we have it. Common cathode.  
 \$1.45

## DL727

One of our best readouts .5 in. high, 20mA per segment. Common anode.  
 \$3.75

## SPECIAL OFFER

HP7730  
 .33 in. high red very bright 25mA per seg. Common anode.  
 \$1.20



FND70  
 .25" High, Bright red. Common Cathode type by Fairchild.  
 85c ea.  
 5/\$3.95

## SUPER VALUES FOR ONLY \$1 EA.

- \* SPECIAL #1 - 2N2501 (house numbered 25107) NPN
- \* Brand new full lead devices by Motorola. Vcb 40; Vce 20; Hfe 100; Ft. 360mW; Ft. 350 MHz. TO 92 case. Pak of 10 for \$1.00

SPECIAL #2 - EN2222 (house numbered RD5449) NPN Leads cut for PCB insertion but still very usable. Brand new by National. Vcb 60; Vce 30; Hfe 175; Ic 800mA. TO 108 case. Pak of 20 for \$1.00

SPECIAL #3 - Same as #2 but PNP. 20 for \$1.00

- \* Special #4 - 1N4148 diodes. Leads cut and formed for PCB insertion but still very usable. Pak of 40 - \$1.00
- \* Special #5 - .01uF/100V ceramic disc caps. PCB leads. Pak of 30 - \$1.00

All prices are listed in Australian dollars. Minimum order \$A5.00. Remittance by Bank Draft or Bank Cheque, preferably for an equivalent amount in U.S. dollars. If an international postal money order is used, include receipt with order. Unless otherwise specified, goods will be shipped postpaid via airmail within three days from receipt of order.

# THE KING

## INTRODUCING

# TANYA

(60 Hz. Crystal Time Base)



## ADDITIONAL FEATURES:

- 1.) Low Power Consumption
- 2.) Directly Interfaces with King MOS Clock Chip.
- 3.) 60 Hz output with crystal time base accuracy
- 4.) Ideal for Cars, Boats, & Campers.

Kit includes All Components, P.C. Board, and Instructions for Interfacing with "THE KING" 6-Digit Alarm Clock.

\$6.95

## DELILA APPLIANCE STARTER \$9.95

(Example) Set your alarm for 7: a.m., set timer for 15 min. At exactly 7: a.m., the appliance will start; at 7:15 your clock alarm will wake you.

Kit includes all components, PC Board and instructions for Interfacing with THE KING 6-digit alarm clock. Addition Number 2

## FATIMA 4-DIGIT TEMP. KIT \$19.95

Features 4-digit temperature display; fahrenheit or centigrade; complete C-Mos application; uses 7002 4-digit counter.

Kit includes all components, PC Board and instructions for interfacing with THE KING 6-digit alarm clock. Addition Number 1



## THE KING \$23.50 6-DIGIT ALARM CLOCK

### THE KING FEATURES:

- 1) 6 digit, 12 hr. 60 cycle or 24 hr. 50 cycle alarm clock.
- 2) Time sharing capability for display of additional information
- 3) Single 12v. supply and a minimum of interface components.
- 4) AM-PM and automatic power failure indications.
- 5) 10 minute snooze
- 6) Intensity control of LEDs.



Kit No. 70250-1R (Red readouts) }  
 Kit No. 70250-1G (Green readouts) } 23.50  
 Kit No. 70250-1Y (Yellow readouts) }  
 Kit No. 70250-2R (DL727 readouts) . . . . . 27.50

Kits contain all components, PCB's, switches, alarm speaker and instructions. (Does not include 12-15 volt transformer and case).

## LSI INTEGRATION IC chips with data

MM5314	-6 digit digital clock 24 pin dip w/spec.	\$ 3.75
MM5316	-4-6 digit alarm clock 40 pin dip w/spec.	\$ 4.25
7002	-4 digit counter/latch decoder; 7 segment and BCD outputs. 28 pin dip w/spec.	\$12.50
7005	-4 digit counter/latch decoder; 7 segment output only. 24 pin dip w/spec.	\$ 9.50
7007	-4 digit counter/latch decoder with BCD output only. 16 pin dip w/spec.	\$ 7.00
MK50250	4-6 digit alarm clock multiplexed 28 pin dip w/spec.	\$5.50
MK50381	4 digit non-multiplexed radio alarm clock featuring direct drive display output. 40 pin dip w/spec.	\$7.95
PC Board for MK50250		\$4.25
PC Board for MK50381		\$3.75
7020	6 function calculator chip with direct segment drive. 8 digit	\$2.25
TDA2020	20 watt RMS audio amp. quad in-line package	\$8.95
	Data sheets only for any of the above (if IC's not purchased)	each \$0.80

## LINEARS

555 Timer Mini dip	0.59
8038 Functional generator	4.25
RCA 3043 FM If, Aud Preamp.	1.20
565 Phase Lock Loop	1.95
567V Tone Decoder	1.95
LM723 Pos. Volt. Reg.	0.59
LM309 5v. Lamp Reg	1.20
LM380 2w. Audio Amp. 8 pin dip	1.00
LM741 Operational Amp.	0.25

## TRANSISTORS-DIODES

RCA200V 115W T05 NPN	1.25
GE D40C1 NPN Darl.	0.25
2N4443SCR 400v/8A T0220	0.65
2N2222 NPN Gen Ampl.	0.20
2N3904 NPN Driver	0.15
2N3906 PNP Compl. 2N3904	0.15
2N4400 NPN Low level noise	0.20
2N5401 PNP Nixie driver	0.25
1N4004 400PIV	15 for 1.00
1N4007 100PIV	10 for 1.00
1N746 3.3 Zen.	4 for 1.00
1N4148 Switch	20 for 1.00

## CPU

8008 8 bit parallel CPU	\$22.50
2102 1K Static RAM for 8008	\$ 2.25
MM5203 2K UV erasable PROM	\$12.25

## GE TRANSISTOR ASSORTMENT

T098 cased Darling., SCRs, NPN, PNP, ect.(untested)	
50 for \$0.95	
100 for \$1.75	
300 for \$5.00	

## LED DRIVERS

75491 Quad Segment Driver	\$0.39
75492 Hex Digit Driver	\$0.49

## RCA3062

Photodetector with power amplifier. Data included.	2.25
--	------

## CERAMIC DISC CAPS

.01 MFD 50 VDC	20/\$1
68 PFD 50 VDC	20/\$1

## TANTALUM CAPS

4.7 MFD 10VDC. Axial.	10/\$1
-----------------------	--------

# sabtronics INTERNATIONAL

P.O. BOX 64683, DALLAS, TX. 75206, U.S.A. TELEPHONE (214) 369-7309.

# Which CHALLENGE will you choose ?



## NEW IMPROVED CHALLENGE SPEAKER SYSTEMS

Carefully assembled in Australia to keep prices down, these new Challenge speaker systems feature high-quality driver units imported from England and Germany. Particular attention has been given to the development of effective crossover networks to achieve even response with a minimum of coloration. Constant impedance volume controls are mounted in the back panel to adjust the output of mid-range and tweeters separately to ensure that a suitable tonal balance is possible under most listening conditions.

### TO HELP YOU CHOOSE

#### FLH-1 Mk 11

3 way system with 10" acoustic suspension woofer, 5" mid-range and ¾" dome tweeter \* crossover points: 500Hz & 5KHz \* frequency response: 30Hz-20KHz \* power handling: amplifiers up to 30 watts r.m.s. per channel \* impedance: 8ohms \* size 635mm (H) x 369mm (W) x 318mm (D).

#### FLH-2 Mk 11

3 way system with 12" acoustic suspension woofer, 5" mid-range and ¾" dome tweeter \* crossover points: 500Hz & 5KHz \* frequency response: 25Hz-20KHz \* power handling: amplifiers with output up to 40 watts r.m.s. per channel \* impedance: 8ohms \* size 740mm (H) x 440mm (W) x 300mm(D).

#### FLH-3 Mk 11

3 way speaker system with 15" acoustic suspension woofer, 5" mid-range and 1" dome tweeter \* crossover points: 500Hz & 5KHz \* frequency response: 20Hz-20KHz \* power handling: amplifier up to 50 watts r.m.s. per channel \* impedance: 8ohms \* size 800mm (H) x 480mm (W) x 350mm (D).

# Challenge

HI-FI STEREO PTY LTD

96 PIRIE ST.  
ADELAIDE  
STH. AUST. 5000  
PHONE: 223 3599



# Ideas for experimenters

These pages are intended primarily as a source of ideas. As far as reasonably possible all material has been checked for feasibility, component availability etc, but the circuits have not necessarily been built and tested in our laboratory. Because of the nature of the information in this section we cannot enter into any correspondence about any of the circuits, nor can we produce constructional details.

Electronics Today is always seeking material for these pages. All published material is paid for — generally at a rate of \$5 to \$7 per item.

## Peak detect and hold circuit

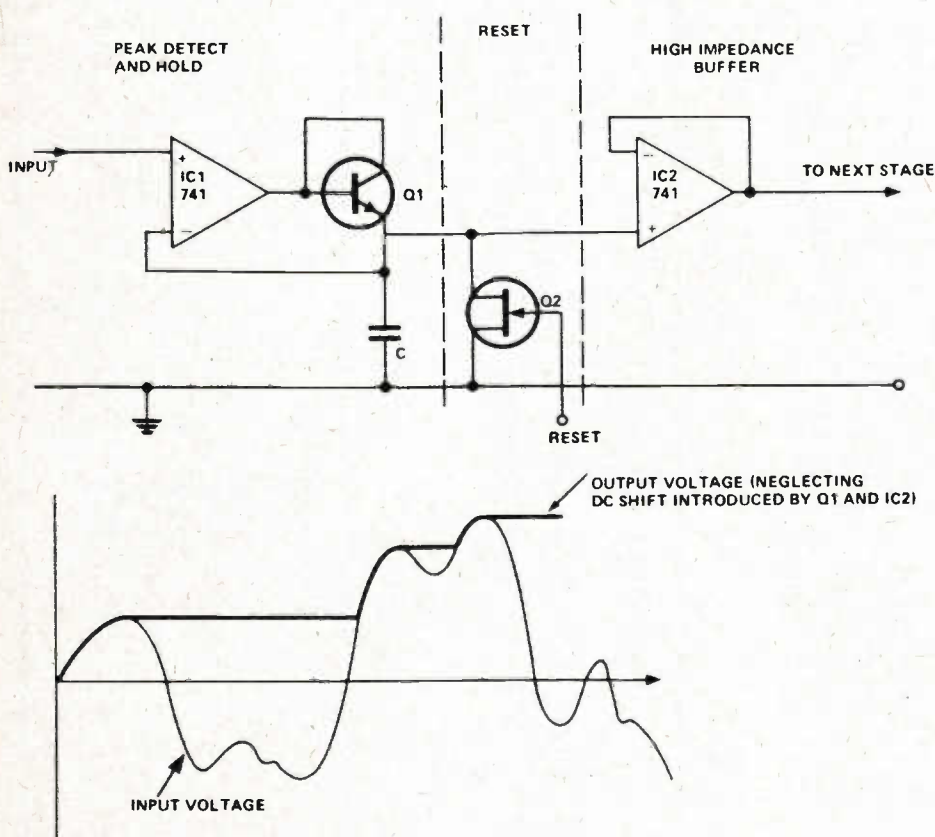

If the voltage at the input becomes bigger than the voltage on the capacitor, then the output of the 741 goes positive, the diode conducts, and the capacitor is charged up to the input voltage-forward voltage drop of diode. When the voltage at the input is less than that on the capacitor, the output of the 741 goes negative, and the diode

cuts off. To prevent the capacitor from discharging through the input resistance of the next stage, a high input impedance buffer stage (IC2) is used. The circuit can be reset by means of a FET — or similar high impedance device connected across the capacitor.

*Continued on page 95*

## LOGAN BRAE Audio Sales

HITACHI	Less than 12	12 off	36 off
C90	\$1.80 ea.	\$1.70 ea.	\$1.60 ea.
C120	\$2.35	\$2.20	\$2.10
UDC90	\$2.30	\$2.20	\$2.10
UDC120	\$3.10	\$2.90	\$2.70
UD RC60	\$2.30	\$2.20	\$2.10
UD RC90	\$2.90	\$2.75	\$2.60
BASF Cr02			
C 90SM	\$2.90	\$2.80	\$2.65
C90 SMLH	\$2.40	\$2.20	\$2.00

POSTAGE: Up to 6 — 60c or  
NSW — \$1.20 plus 10c per doz.  
VIC. S.A. QLD — \$1.75 plus 25c per doz.  
W.A. TAS. N.T. — \$1.90 plus 40c per doz.

P.O. Box 24, CARLTON.  
NSW. 2218.

Please send SAE with enquiries.  
Telephone (02) 587-3475.

## AMATEUR COMMUNICATIONS ADVANCEMENT

P.O. Box 57, Rozelle. 2039.

### RF POWER TRANSISTORS

We are proud to present these premium quality RF power transistors by C.T.C. They are rated to withstand infinite VSWR at all phase angles and are suitable for use in class AB or C circuits up to 220MHz from a 12.5V supply. The set of three is suitable for a three stage 1/2W to 40W power amplifier.

B3-12	5W out	1-4	5 up
B12-12	15W out	\$5.70	\$4.80
B40-12	40W out	\$7.70	\$7.10
		\$17.50	\$17.20
		or \$30 the set	

POST & PACKING is 20c for a single device, 40c for up to five, 60c for more.

Exchange output transistor in your IC22 for B12-12 and improve your output power. Send S.A.E. for details plus free flyer on kits and components.

### PRINTED CIRCUITS

We will shortly introduce kits etc. for making your own printed circuit boards using the RISTON process, which gives superior results. Send S.A.E. for introductory leaflet.

**PACKAGE OF TEN - DEDUCT 15%**

**PACKAGE OF ONE HUNDRED - DEDUCT 25%**

5% OFF ON ORDERS OVER \$50.00  
10% OFF ON ORDERS OVER \$100.00  
15% OFF ON ORDERS OVER \$250.00

TTL					
7400	.16	7451	.20	74153	1.14
7401	.18	7453	.20	74154	1.29
7402	.17	7454	.20	74155	1.23
7403	.16	7460	.20	74156	1.23
7404	.22	7464	.40	74157	1.14
7405	.22	7465	.40	74158	2.06
7406	.40	7470	.35	74160	1.60
7407	.40	7472	.35	74161	1.44
7408	.21	7473	.40	74162	1.71
7409	.22	7474	.40	74163	1.60
7410	.18	7475	.66	74164	1.83
7411	.29	7476	.45	74165	1.83
7413	.63	7483	.91	74166	1.71
7414	.81	7485	1.27	74170	2.65
7416	.40	7486	.46	74173	1.71
7417	.40	7489	2.48	74174	1.86
7420	.18	7490	.59	74175	1.60
7422	.30	7491	1.12	74176	1.02
7423	.33	7492	.82	74171	.97
7425	.31	7493	.69	74180	1.04
7426	.30	7494	1.08	74181	3.43
7427	.33	7495	.91	74182	.91
7430	.23	7496	.91	74184	2.29
7432	.26	74100	1.50	74185	2.29
7437	.40	74105	.51	74187	4.50
7438	.40	74107	.46	74190	1.35
7440	.20	74121	.48	74191	1.35
7441	1.13	74122	.52	74192	1.25
7442	.89	74123	.69	74193	1.19
7443	1.00	74125	.62	74194	1.25
7444	1.00	74126	.72	74195	1.02
7445	1.02	74132	1.02	74916	1.44
7446	1.07	74141	1.20	74197	1.02
7447	1.02	74145	1.20	74198	2.06
7448	1.20	74150	1.12	74199	2.86
7450	.20	74151	.91	74200	5.90
				74279	1.68

**LOW POWER**

74100	.29	74151	.33	74190	1.71
74102	.29	74155	.38	74191	1.67
74103	.29	74171	.29	74193	1.94
74104	.29	74172	.45	74195	1.94
74106	.29	74173	.56	74198	3.21
74110	.29	74174	.56	74164	3.21
74120	.38	74178	.91	74165	3.21
74130	.38	74185	1.44		
74142	1.71	74186	.79		

**LOW POWER SCHOTTKY**

74LS00	.36	74LS32	.38	74LS95	2.09
74LS02	.36	74LS40	.45	74LS107	.59
74LS04	.36	74LS42	1.40	74LS164	2.20
74LS08	.38	74LS74	.59	74LS193	2.20
74LS10	.36	74LS90	1.30	74LS197	2.20
74LS20	.36	74LS93	1.30		

**HIGH SPEED**

74H00	.25	74H22	.25	74H61	.25
74H01	.25	74H30	.25	74H62	.25
74H04	.25	74H40	.25	74H74	.39
74H08	.25	74H50	.25	74H101	.39
74H10	.25	74H52	.25	74H102	.49
74H11	.25	74H53	.25	74H103	.58
74H20	.25	74H55	.25	74H106	.58
74H21	.25	74H60	.25	74H108	.60

**SCHOTTKY**

74S00	.38	74S08	.52	74S22	.38
74S02	.45	74S10	.38	74S32	.52
74S03	.38	74S20	.38	74S74	.38
74S04	.45				

**8000 (NATIONAL)**

8091	.61	8220	1.44	8811	.65
8092	.61	8230	2.19	8812	1.02
8095	1.25	8288	1.49	8822	2.19
8121	.80	8520	1.16	8830	2.19
8123	1.43	8552	2.19	8831	2.19
8130	1.97	8563	.62	8836	.29
8200	2.33	8810	.70	8880	1.19
8214	1.49				

**8000 (SIGNETICS)**

8263	5.79	8267	2.59		
------	------	------	------	--	--

**9000**

9002	.40	9309	.79	9601	.89
9301	1.03	9312	.79	9602	.79

**6 DIGIT LED CLOCK KIT**  
INCLUDES:  
MM314 clock circuit  
6 IN7D70 LED displays (250° red 7 segment)  
All necessary transistors, resistors & capacitors  
1 double-sided PC board at commodates LED's & clock circuits  
Schematic & instructions  
Does not include 12V-100 ma transformer, switches & case \$12.95

**IC SOCKETS**  
Solder Tail - low profile

8 pin	\$.19	24 pin	.45
14 pin	.22	28 pin	.59
16 pin	.24	40 pin	.69
18 pin	.35		

**WIRE WRAP - gold plate**

14 pin	.59
--------	-----

**CMOS**

4000A	.30	4018A	1.39	4066A	1.02
4001A	.29	4020A	1.49	4068A	.51
4002A	.29	4021A	1.39	4069A	.51
4006A	1.55	4022A	1.10	4071A	.30
4007A	.30	4023A	.29	4072A	.40
4008A	1.79	4024A	1.02	4073A	.45
4009A	.66	4025A	.29	4075A	.45
4010A	.62	4027A	.68	4078A	.45
4011A	.33	4028A	1.13	4082A	.40
4012A	.29	4030A	.51	4518A	1.89
4013A	.52	4035A	1.46	4528A	1.84
4014A	1.49	4040A	1.39	4585A	2.10
4015A	1.49	4042A	1.69	4901A	.45
4016A	.56	4049A	.68		
4017A	1.19	4050A	.68		

74C00	.25	74C74	1.20	74C162	2.93
74C02	.30	74C76	1.54	74C163	3.06
74C04	.51	74C107	1.30	74C164	3.06
74C08	.78	74C151	3.00	74C173	2.61
74C10	.40	74C154	3.62	74C195	2.66
74C20	.40	74C157	2.02	80C95	1.35
74C42	1.55	74C160	2.85	80C97	1.13
74C73	1.20	74C161	2.93		

**CALCULATOR CHIPS**

CT5002	12 digit, 4 function fixed decimal - battery operation 40 pin	2.79
CT5005	12 digit, 4 function plus memory, fixed decimal 28 pin	2.99
MM5725	8 digit, 4 function, floating decimal 28 pin	1.98
MM5736	6 digit, 4 function, 9V battery operation 18 pin	3.95
MM5738	8 digit, 5 function plus memory and constant floating decimal, 9V battery operation 24 pin	4.50
MM5739	9 digit, 4 function, 9V battery operation 22 pin	5.35

**MEMORIES**

1101	256 bit RAM MOS 16 pin	1.50
1103	1024 bit RAM MOS 18 pin	1.95
1702A	2048 bit static PROM elect. prog. - UV eras. 24 pin	14.95
2102	1024 bit static RAM DTL/TTL comp. 1 ms (2602)	
2102.1	Same as 2102, except 500ns	2.95
5203	2048 bit static PROM elect. prog. - UV eras. 24 pin	10.95
5260	1024 bit dynamic RAM MOS 16 pin	1.95
5261	1024 bit dynamic RAM MOS 16 pin	2.19
5262	2048 bit dynamic RAM MOS 22 pin	2.25
7489	64 bit ROM TTL 16 pin	2.48
82523	256 bit PROM SCHOTTKY 16 pin	3.69
F93410	256 bit RAM bi-polar 16 pin	1.95
74187	1024 bit ROM TTL 16 pin	5.95
74200	256 bit RAM tri-state 16 pin	5.90

**TANALUM CAPACITORS SOLID-DIPPED +20%**

.1 mfd 35V	.25 ea.	6.8 mfd 6V	.30 ea.
.33 mfd 35V	.25 ea.	6.8 mfd 50V	.40 ea.
1 mfd 35V	.25 ea.	10 mfd 25V	.40 ea.
2.2 mfd 20V	.25 ea.	15 mfd 10V	.40 ea.
2.2 mfd 35V	.30 ea.	33 mfd 10V	.40 ea.
4.7 mfd 16V	.30 ea.	47 mfd 6V	.40 ea.

**SHIFT REGISTERS**

MM5013	1024 bit accum. dyn. 8 pin	1.75
MM5016	500/512 bit dyn. 8 pin	1.59
SLS-4025	Quad 25 bit 8 pin	1.29
2504	1024 bit multiplexed dyn 8 pin	4.95

**UNIVERSAL BREADBOARD**  
Silver plated copper circuit board 6.4 in. x 3.1 in. x .2 in. of .1" holes for DIP IC's - space for transistors, resistors & capacitors. Versatile and simple for breadboarding IC circuits \$1.50 ea.

**AUGUST SPECIALS**

NSN71L	Red common anode .27"	10/\$ 9.25	100/\$ 82
NSN74	Red common cathode .27"	10/ 9.25	100/ 82
MAN 8	Yellow common anode .27"	10/ 19.00	100/ 165
Discrete	LED Jumbo red	10/ .85	100/ 8
F93410	RAM 256 bit Bi-polar	10/ 15.00	100/ 135
LM301	Op Amp mDIP	10/ 2.38	100/ 21
LM311	Volt Comparator DIP, TO-5	10/ 8.08	100/ 71
LM340T	5V Regulator TO-220	10/ 13.50	100/ 119
75491	Quad Segment Driver DIP	10/ 6.37	100/ 56
7430	8 input gate DIP	10/ 1.78	100/ 16
74121	One Shot DIP	10/ 3.40	100/ 30
7474	Dual D flip-flop DIP	10/ 2.47	100/ 21
723	Precision voltage DIP	10/ 4.25	100/ 37

**DIODE GRAB BAG**  
400 MW. -  
SIGNAL DIODES,  
ZENER DIODES  
SWITCHING DIODES  
& RECTIFIERS

20/\$ 1.00  
125/\$ 5.00  
350/\$10.00

**MISC DEVICES**

ULN 2208	FM gain block 34dB mDIP	1.39
ULN2209	FM gain block 48dB mDIP	1.59
2513	64 x 8 x 5 character generator	11.00
CA 3046	Transistor array 14 pin DIP	.86

**METAL FILM RESISTORS - 1% 1/4 WATT**

QTY	PRICE EACH	PRICE MINIMUM 10	PRICE MINIMUM 100
0 - 10	\$.20	\$.15	
10 - 100	.20	.10	\$.09
100 - 1000		.10	.08
1000 -			

**RESISTANCE (OHMS)**

22.6	71.5	182	887	11.8K	40.2K
23.7	78.7	187	1.15K	13.0K	45.3K
25.5	84.5	191	1.5 K	15.0K	48.7K
30.9	105	205	2.49K	18.2K	54.9K
34.8	110	232	3.57K	19.1K	60.4K
40.2	115	243	4.75K	19.6K	64.9K
45.3	137	499	5.49K	22.6K	69.8K
51.1	147	604	6.04K	24.9K	84.5K
61.9	158	715	7.15K	28.0K	
64.9	178	806	8.25K	37.4K	

**Zener Diodes, Diodes & Rectifiers**

IN 486B	Diode	250V	\$.25 ea.
IN 715A	Zener	11V	.25
IN 747A	Zener	3.6V	.25
IN 754A	Zener	6.8V	.25
IN 756A	Zener	8.2V	.25
IN 904	Sw. Diode	30V	.10
IN 914	Sw. Diode	100V	.10
IN 485B	Zener	120V	.25
IN 5230A	Zener	4.7V	.25
IN 5242B	Zener	12V	.25

**DISPLAYS**

MAN1	\$1.95	ME4	\$2.29
MAN2	3.95	MV50	.15
MAN3A	.19	NSL100	.15
MAN5	2.95	NSL101	.15
MAN6	3.95	NSL102	.15
MAN7	1.49	XC209-R	.18
MAN8	2.95	MV5020	.18
MAN66	2.95	RED	.18
DL10A	2.19	GREEN	.18
		AMBER	.18
		CLEAR	.18

**MULTIPLE DISPLAYS**

NSN33	3 digit .12" red LED	1.79
HP5082-	5 digit .11 red LED	3.49
7405		
HP5082-	4 digit .11 red LED	3.25
7414		
SP-425-09	9 digit .25 gas disch.	1.79
CT7001	6 digit, 12-24 Hr, 50-60 Hz, alarm, timer and date circuits 28 pin	7.95

**FREE**

WITH \$25 ORDER

**LED KIT**  
4 JUMBO RED (5020)  
4 JUMBO GREEN  
4 JUMBO CLEAR  
4 MINI RED (NSL102)  
10 MINI CLEAR (MV50)

WITH \$50 ORDER

**RESISTOR KIT**  
180 RESISTORS, 1/2 OR 1/4 WATT + 5%  
SUPPLIED IN PLASTIC STORAGE BOX

15 ea. - 100, 470, 1K, 1.5K, 2.2K, 3.3K, 4.7K, 6.8K, 10K, 33K, 100K, 1M

WITH \$100 ORDER

**CALCULATOR KIT**  
5 FUNCTION + CONSTANT -  
MEMORY STORAGE & RECALL -  
8 DIGIT DISPLAY -  
SUPPLIED WITH ALKALINE BATTERIES

**FREE**

**LINEAR**

401	mDIP	\$.13	381	DIP	1.75
404	TO-5	.92	383	DIP	1.75
405	TO-5	.82	550	DIP	1.02
407	mDIP TO-5	.30	555	mDIP	.69
408	mDIP TO-5	1.02	556A	DIP	1.71
409K	TO-1	1.35	710	DIP	.69
410	mDIP	1.23	711	DIP	.30
411	mDIP TO-5	1.09	723	DIP	.71
420T	TO-220		731	TO-5	1.02



# Ideas for experimenters

Continued from page 93

## Basic alarm

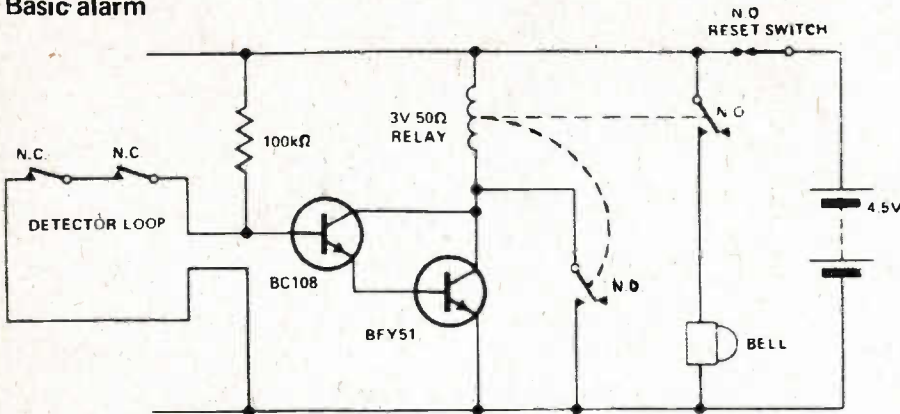

The basic alarm circuit uses the minimum of components, has a very low standing current (less than  $50 \mu\text{A}$ ) and thus may be operated from small dry batteries. The circuit has a lock-out system which prevents the alarm being

stopped, except by disconnecting the battery. Any break in the detector loop allows the current through the  $100 \text{ k}\Omega$  resistor to switch on the transistors, pulling in the lock-out relay and sounding the alarm.

## Suppressed zero voltmeter for the car

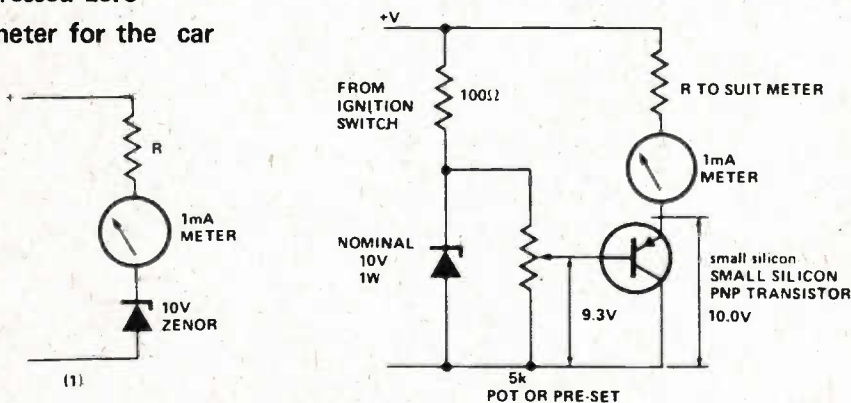

To make a meter cover the range 10 to 15 V or 10 to 20 V over its whole scale, then circuit (1) is often used.

The zener must be exactly 10.0 V and may not be available. In this case use the arrangement shown in (2).

## Measuring micro-ammeter resistance

When it is required to measure the unknown resistance of a micro-ammeter, then an ordinary multimeter on the necessary ohms range will send too much current through the meter coil, with the chance of causing damage. To avoid this, set up VR1 to give full scale deflection on the meter. Then shunt the meter with VR2 and adjust so that the meter reads exactly half scale. Remove the measure VR2, which, to a good degree of accuracy, will be equal to the meter resistance.

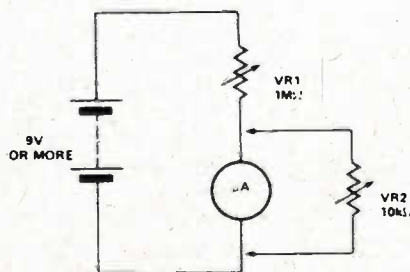

Continued on page 96

S.O.

# STAR DELTA CO.

PTY. LTD.

TRANSFORMER  
MANUFACTURERS

We can supply transformers, chokes, etc. for most of the projects featured in Electronics Today at competitive prices.

We also manufacture a range of transformers in single and three phase up to 20 KVA, all manufactured to comply with the relevant Australian Standards.

8 East St.,  
Granville, N.S.W. 2142  
P.O. Box 31, Phone 637-7870

# "COWPER"

Cabinets and chassis for all projects featured in this magazine are available from

COWPER SHEETMETAL  
& ENGINEERING  
11 Cowper Street,  
Granville, N.S.W. 2142  
Phone 637-8736  
(P.O. Box 31)

# SALOR ELECTRONICS & HI-FI

Stocking a Full Range of  
Parts for the Electronic  
Enthusiast and Hobbyist

We stock TTL, Linear, C-Mos, IC's, all clock chips, transistors, all resistors and capacitors, metal and plastic boxes. Chassis for projects, speaker kits and electronic kits. Plugs and sockets for electronic projects.

We offer a mail order service. All orders posted within 24 hours of receipt.

CONTACT US FOR THE  
HARD TO GET ITEMS.

Open 9AM - 5.30PM Mon. to Sat.

98 WATERWORKS ROAD,  
RED HILL, QLD.  
PHONE 38-5757

24 hour, 7 day service  
on phone orders.

COMPETITIVE PRICES &  
SERVICE IS OUR MOTTO.



# electronics TODAY

INTERNATIONAL

is produced by  
MODERN MAGAZINES  
(HOLDINGS) LTD.

Other MM publications include:

- Top Projects
- Electronics - Its Easy
- Colour TV Guide
- Simple Projects
- Modern Motor
- Modern Boating
- Modern Fishing
- Hi-Fi Review
- Hi-Fi Explained
- Camera & Cine
- Rugby League Week
- Australian Cricket
- Audio News

## Ideas for experimenters

Continued from page 95

### Speed control for model trains or cars

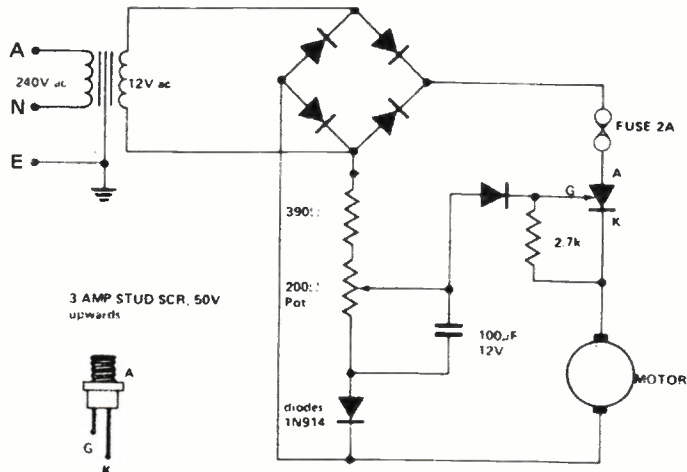

The following is a low voltage adaptation of the type of speed control popularly used to regulate power drills. It gives very good starting tor-

que and excellent speed regulation of the model. A reversing switch may be incorporated in the leads to the motor.

### Variable duty cycle oscillator

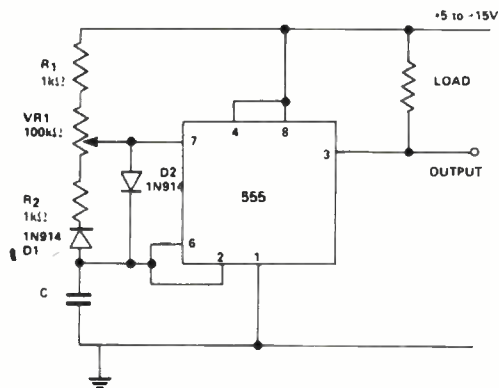

The circuit shown enables a rectangular wave output cycle which can be varied over a wide range by the setting of the potentiometer VR1.

The well known 555 integrated circuit is used as a monostable device. The capacitor C charges from the positive line through R1, part of VR1 and D2. When the voltage across this capacitor rises to two-thirds of the power supply voltage, the state of the 555 is switched so that the capacitor C discharges through D1, R2 and the other parts of VR1 into pin 7 of the 555 device. The diodes therefore enable the charging and discharging paths to be separated; the effective value of the charging and discharging resistors can therefore be set independently of one another.

When the slider of VR1 is near to

R2, the discharging time is very short and the output spends only a small fraction of its time in the low voltage state. In this case short negative pulses will be obtained at the output. Similarly short positive pulses are obtained when the slider of VR1 is near to R1.

One great advantage of this type of circuit is that the frequency is almost independent of the setting of VR1 over most of its travel. If VR1 is in the centre of its track, the duty cycle will be approximately 1:1. The frequency is almost independent of the output current up to the recommended maximum of 200 mA.

The value of C is chosen according to the frequency required. The latter can be as great as 100 kHz or very low indeed - one cycle in a few minutes.



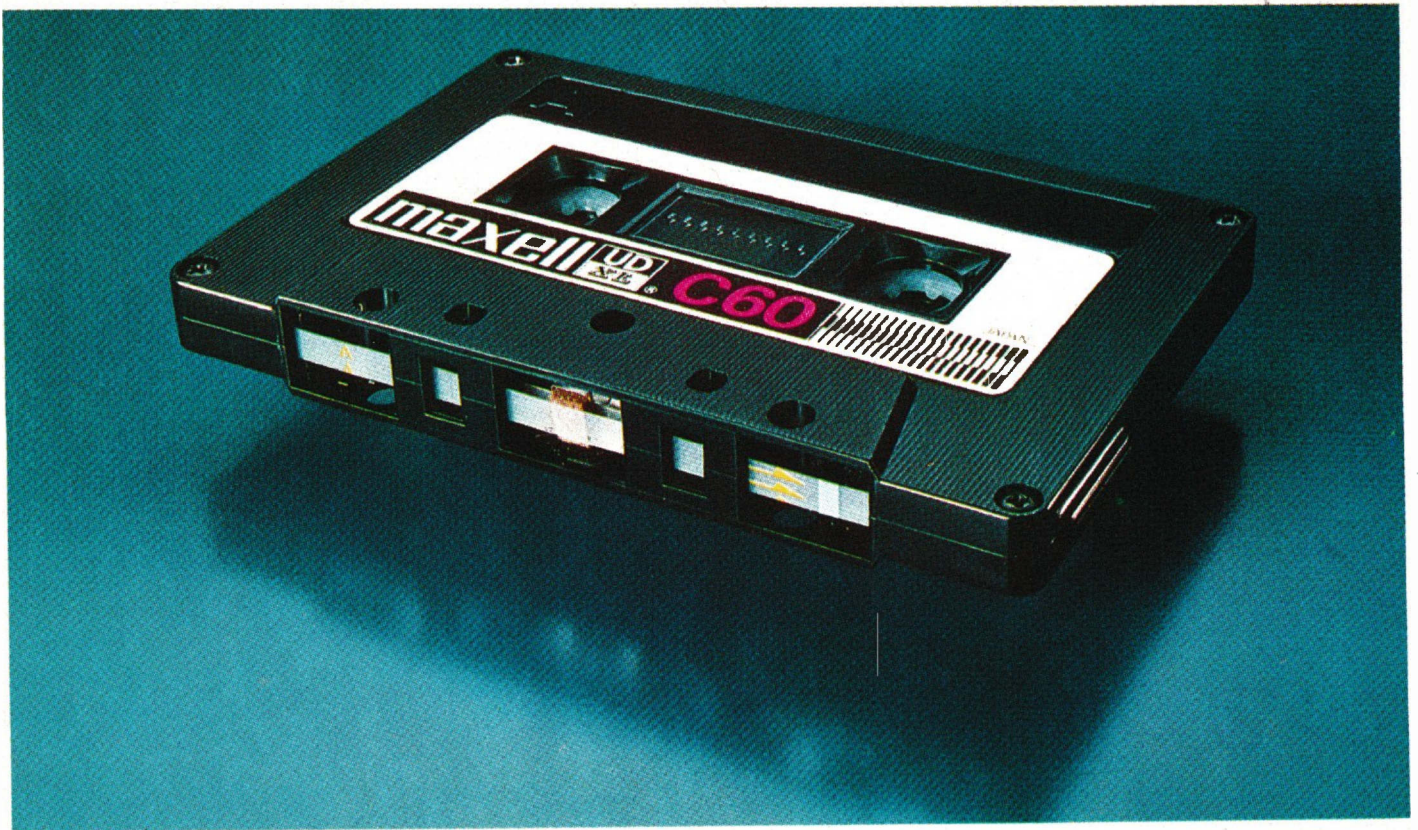

# Introducing the revolutionary UD-XL EPITAXIAL cassette



Developed by MAXELL this completely new EPITAXIAL magnetic material combines the advantages of the two materials (gamma-hematite and cobalt-ferrite): the high sensitivity and reliable output of the gamma-hematite in the low and mid-frequency ranges and the excellent performance of the cobalt-ferrite in the high-frequency range. The result is excellent high-frequency response plus wide dynamic range over the entire audio frequency spectrum.

Compared to chrome tape, sensitivity has been improved by more than 3.5dB. Because EPITAXIAL is non-abrasive, it extends to the life of the head. Consequently, the UD-XL delivers smooth, distortion-free performance during live recording with high input. When using UD-XL it is recommended that tape selector be in the NORMAL position.



Fidelity is also ensured by a precision-manufactured cassette shell with a special anti-jamming rib that provides smooth tape travel and helps eliminate wow and flutter.

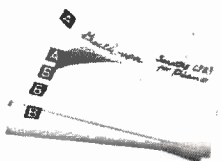

Another good idea of the UD-XL cassette is a replaceable self-index label. Simply peel off the old label and put on a new one when you change the recording contents. No more mess on the label.

Magnetic material structure

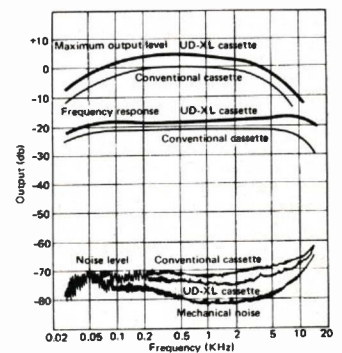
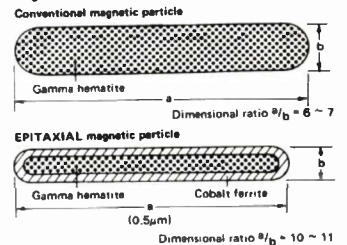

# maxell®

For further information please write to Maxell Advisory Service, P.O. Box 49, Kensington, N.S.W. 2033.

WT.GD. 76M



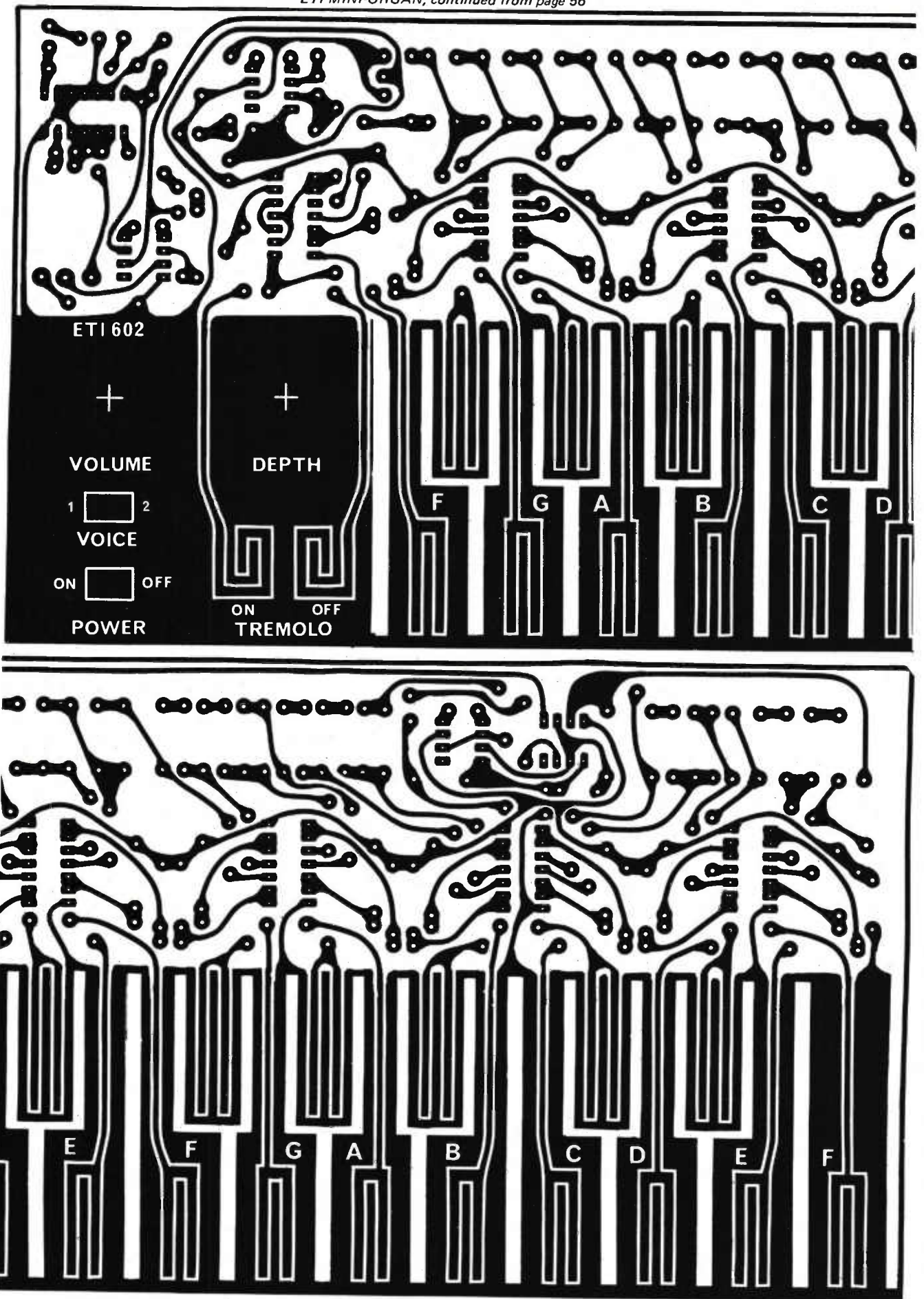

Fig 4 Printed-circuit board layout for the monophonic organ shown in two sections. Full size 345x120 mm.



# Pocket Tape Recorder

**For businessmen,  
students, teachers,  
secretaries —  
or just plain fun!**

HERE'S a recorder which is so small it slips into a coat pocket or handbag. It uses tiny 15-minute a side micro-cassettes — and weighs a mere 300 g (11 oz). Unitrex's Memocorder has a million uses! Use it to record meetings, note ideas, record interviews, report sales interviews, learn languages, take notes, exchange personal messages, rehearse speeches, tape lectures etc. etc.

## SO EASY TO USE!

You can operate the Memocorder with one hand. Two thumb-operated slide switches actuate rewind, record and replay functions. A 40 mm (1½") speaker provides good quality replay sound.

## READILY AVAILABLE MINI-CASSETTES

The Memocorder uses standard Philips micro cassettes. These cost \$4.50 each: they provide 15 minutes per side. One cassette is provided with each unit.

## INCLUDED

Earphone and jack plug; carrying case; one cassette; batteries.

## WARRANTY

Twelve months parts — 90 days labour. If the Memocorder does not work please return it to Unitrex Pty Ltd, 414 Collins St, Melbourne, 4000. Not to ETI.



**Special Introductory  
Offer \$74.45**  
(including cassette)

## UNITREX OFFER

**Electronics Today  
15 Boundary Street, Rushcutters Bay, NSW**

Please forward one Unitrex Memocorder and cassette at \$74.45 plus \$2.50 for post and packing.

Forward additional cassettes at \$4.50 each plus 50 cents post and packing.

NAME.....

ADDRESS.....

.....POST CODE.....

*Please allow at least three weeks for delivery. We regret we cannot accept company purchase orders.*

**COMPETITIVE UNITS COST NEARLY TWICE  
THIS SPECIAL INTRODUCTORY PRICE.**

# PRE-PAK electronics

SYDNEY: 718 Parramatta Road,  
CROYDON, N.S.W. 2132, P.O. Box 43,  
CROYDON, 2132. Phone: 797-6144.  
SYDNEY (CITY): 432 Kent Street,  
Sydney. Phone 29-7426  
NEWCASTLE: Shops 3-6 West End  
Arcade, 810 Hunter Street, WEST  
NEWCASTLE, 2300. Phone: 69-2103.



## ECONOMY

JETSOUND 3 way hi-fi speaker kits.  
Comprising bass driver with roll  
surround, 5 1/2" mid range, 3" tweeter  
and 3 way crossover network.

JETSOUND 12/3  
30W maximum power, \$38.50  
12" driver, 2 x 3" tweeters. P&P \$4.00

JETSOUND 10/3 \$27.50  
25W maximum power P&P \$3.00  
JETSOUND 8/3 \$18.75  
20W maximum power P&P \$2.00

## SUPER ECONOMY

JETSOUND 2 way with bass driver,  
dome tweeter and crossover capacitor.

JETSOUND 12/2  
30W maximum \$36.00 P&P \$3.00  
JETSOUND 10/2  
25W maximum \$23.95 P&P \$2.50  
JETSOUND 8/2  
20W maximum \$15.75 P&P \$1.50

CORAL 125AI Stereo Kit  
\$85.50 P&P \$7.50  
CORAL 105AI Stereo Kit  
\$61.50 P&P \$6.00  
CORAL 85 AI Stereo Kit  
\$37.50 P&P \$3.50

## JETSOUND

12" Bass	\$32.50	P&P \$3.00
10" Bass	\$19.32	P&P \$2.00
8" Bass	\$ 9.75	P&P \$1.50
5 1/2" Midrange	\$ 3.15	P&P \$1.50
3" Tweeter	\$ 1.95	P&P \$1.50
1" Dome tweeter	\$ 6.99	P&P \$1.50
8" Full range	\$10.05	P&P \$1.50
3-way crossover	\$ 6.90	P&P \$1.50

CROYDON  
STORE OPEN **7 Days a Week**

# Free Catalogue

Ring or write for your copy.  
Over 40 different test and  
measuring instruments for  
hire.

*Delivery anywhere in  
Australia*

*Bankcard Welcome*

## HOBBY HIRE

16 Coveney Street,  
BEXLEY, 2207  
Phone: (02) 50-4361

*festival*

## TECHNICIAN AUDIO ELECTRONICS

Applications are invited for the above  
position from experienced maintenance  
and installation people, preferred with  
experience in Broadcasting, Television,  
Film or related industries.

Must be capable of fault diagnosis and  
repair of modern sophisticated  
solid-state professional audio equipment.  
A knowledge of digital electronics and  
associated digital analogue conversions  
would be a distinct advantage.

*Application including telephone  
numbers should be addressed to:*

Chief Engineer -- Electronics,  
Festival Records Pty. Limited,  
P.O. Box 16,  
PYRMONT N.S.W. 2009

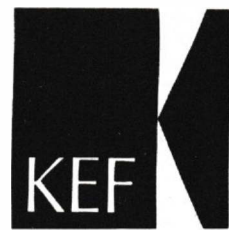

**the speaker  
engineers**

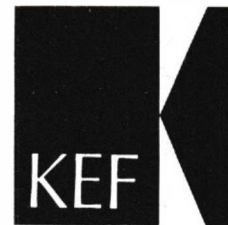

**speaker  
systems**

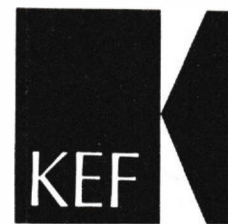

**speaker  
units**



**speaker  
kits**

Distributed by Audioson International Pty. Ltd.  
Sydney Melbourne Adelaide Perth  
938 1186 329 6066 337 7000 25 9993





# AUDIO FACTS

## NEW BIG CASSETTE

TODAY'S top-quality cassette recorders have been developed to the point where they now compete in performance with all but the very best of professional reel-to-reel recorders.

But this standard of performance has necessitated some very complex engineering much of which is required to overcome deficiencies inherent in the basic compact cassette — which was of course never intended for use in the first place.

This anomaly has long been realised and several attempts made to introduce a larger format cassette and associated hardware. BASF, for example, recently introduced their 'Unisette' cassette — a device about the size of a paper back book; several manufacturers are said to be producing hardware for the new format. But so far nothing has eventuated, for home use at least.

Now a new and potentially powerful contender has entered the field — this is the ELCASET format developed jointly by Sony, Matsushita and TEAC.

The ELCASET is about twice as big as the standard compact cassette. It uses the same tape as reel-to-reel machines ( $\frac{1}{4}$ "") and runs at  $3\frac{3}{4}$ " second, however unlike reel-to-reel machines, the left and right tracks are side by side.

Ferric, CO<sub>2</sub> and Ferri-chrome tapes will be available, but to eliminate the inconvenience of switching bias and equalisation, the new cassettes have sensing holes — position-

ed according to tape type — which automatically switch the tape decks into the correct mode. A further sensing hole is provided for automatically switching Dolby into circuit when appropriate. Photo-sensing stops the tape at the end of its travel.

Already Sony have announced two new decks specifically for the new system. The first unit — EL-7 — is a closed-loop, dual capstan, 3-motor 3-head system giving optimum tape tension and tape-to-tape contact. Wow and flutter are a very low 0.04%. A three-position bias and equalizer selector allows for changes to provide correct recording on the Type I and Type II material as well as the Type III material when it appears on the market. (These tape Type numbers follow a uniform nomenclature designated for the Elcaset format). With the Type II (Fe Cr) Tape, the frequency response extends from 25 Hz to 22 000 Hz. Direct coupling with specially shaped ferrite and ferrite heads and FETs in the pre-amplifier assures high signal-to-noise ratio, low distortion and superior sound quality.

The EL-5 has a wow and flutter of 0.06% or less. With the Type II Elcaset tape (Fe-Cr), the frequency range of the deck is 25 Hz to 20 000 Hz. It is a standard, high-performance stereo deck.

The two Elcaset tapes for use with the Elcaset deck will be placed on the market at the same time as the decks. They are the Type I (LC-60 SLH, 60 minutes, two-way) and the Type II (LC-60 DUAD, 60 minutes, two-way), which are best suited for hi-fi recording of music.

## SNAP, CRACKLE and POP

Gramophone records are particularly prone to build-up static electrical charges. These manifest themselves acoustically as annoying pops and crackles — often mistakenly assumed to be caused by dirt.

If the effect is assumed to be dirt-caused, subsequent attempts to clean the records will usually aggravate the true cause, for the static build up is usually caused by friction in the first place. Anti-static cleaners are available but many of these do more harm than good.

Arena Distributors (273 Hay St, East Perth, WA) recently sent us an anti-static gun. This device resembles a toy pistol. The trigger mechanism mechanically stresses a piezo-electric element causing a corona of ionized air to be 'emitted' from a corona discharge needle in the barrel of the unit. Positive ions are emitted when the trigger is squeezed and negative ions emitted when the trigger is released.

The unit, called the Zerostat, is pointed at the record to be treated and the trigger slowly squeezed and equally slowly

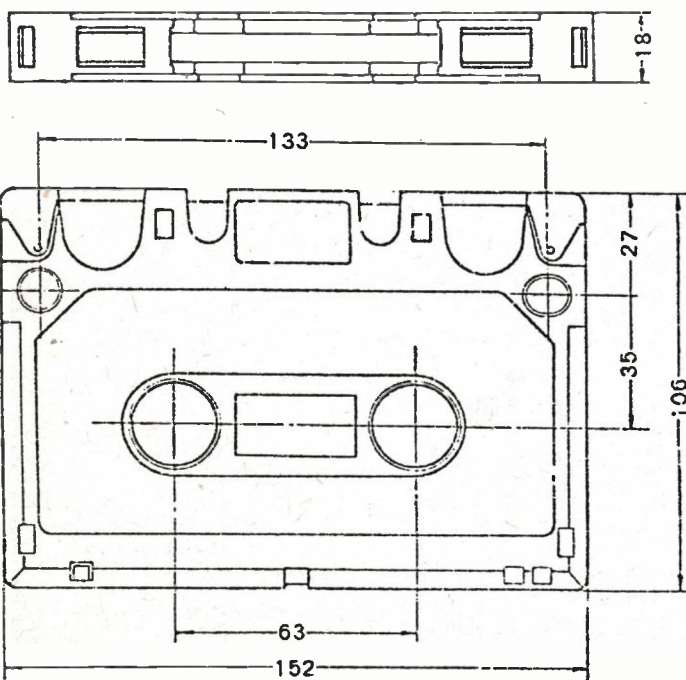

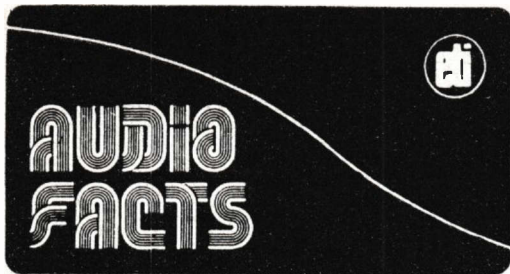

released. The effect is largely to neutralize the charge of the record.

We treated a number of records in this fashion — having first charged them by rubbing with a dry flannel (we don't recommend doing this to records that you value!) In the charged state the records were virtually unplayable. We found that the charge was effectively removed by using the Zerostat.

Several other records were checked by playing 'as is' and subsequently after using the Zerostat. In every instance there was a considerable reduction in static-caused noise.

Static build-up can be reduced by keeping your records in a humid atmosphere — but this tends to spoil the record covers. The Zerostat is a better, albeit more expensive alternative. The unit retails for around \$27.50.

### SHURE FOUR-CHANNEL CARTRIDGE

Shure Brothers Inc, has made its long-awaited entry into the four-channel sound market with a stereo/quadrophonic phono cartridge.

Designated the M24H, the new unit will not only reproduce stereo records on the same level of performance of today's finest stereo — only cartridges, but will also reproduce quadrophonic records with a fidelity that Shure claim is unsurpassed by any other stereo/quadrophonic or quadrophonic-only cartridge available.

A new hyperbolic stylus tip ensures maximum tracking of quadrophonic carrier signals in the 30 000 Hz range, while not modifying or destroying the carrier modulation that would impair subsequent plays.

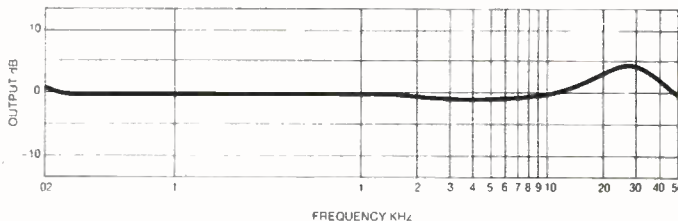

Frequency response (manufacturer's data).



## The Audio/Visual Specialists

- Full range video equipment — colour and black and white
- Colour TV monitors for off-air recording
- Continuous demonstrations
- Special Prices
- Record your favourite movie or sporting event
- New, used and demonstration equipment always in stock
- Video gives you instant playback with 'sync' sound.

2nd Floor,  
Telford Trust Building,  
79-85 Oxford Street,  
Bondi Junction.  
Phone 387-2555



# Presenting a remarkable range of products... a remarkable philosophy.

The world's reviewers agree that each of the products presented here represents true state-of-the-art, design, engineering and performance.

None is cheap, but each item is realistically priced considering the standards achieved and maintained.

And that brings us to our Remarkable Philosophy.

We feel our equipment and your interests are worthy of the finest demonstration facilities, the most expert installation and the advice of interested, knowledgeable, and honest consultants who will help you . . . not pressure you.

To this end we have appointed a small number of Hi-Fi Specialists to bring you Stanton, Fons, S.A.E., Monitor Audio and Neal state-of-the-art components.

**We invite you to audition this remarkable equipment at the selected Hi-Fi specialists listed overleaf.**







## STANTON

STANTON pickups are the almost unanimous choice of recording studios, Radio Stations and TV stations.

They are unique in that they offer spectacular performance without fragility. They also lead the field in consistency—a quality lacking in most pick-ups.

From the illustrious Calibration Standard 681 EEE through the 681 EE and 500 EE to the Broadcast 500A (so popular with radio stations) there is a Stanton pick-up to meet the most exacting need.



Stanton 681 EEE, the New Calibration Standard . . . . Stanton's finest Cartridge.



Stanton 681 EE, for application where slightly greater tracking pressure than 681 EEE is required.



Stanton 500A, the Broadcast Standard Cartridge as used by the majority of radio stations throughout Australia.

## the remarkable products...



## FONS

FONS is a new name to the world of hi-fi. Built in Scotland, the Fons CQ30 turntable has such exciting features as:—

- D.C. Servo controlled motor with gold plated commutator and silver plated brushes.
- Speeds, push button selected for 33, 45 and 78 RPM but continuously variable from 29 to 100 RPM.
- Hyper-concentric bearing typically better than  $\pm 0.000076$ mm.
- Rumble typically -79dB.
- Wow and Flutter better than  $\pm 0.03\%$ .
- Anti-feed back phase cancellation suspension system.

Fons claim that the virtual absence of wow and flutter, rumble and vibration lead to a noticeably cleaner sound, and direct comparisons with other units certainly confirm this. In fact, direct comparison with another highly regarded unit using the same Stanton 681 EEE cartridge showed a dramatic improvement.

Neal 102

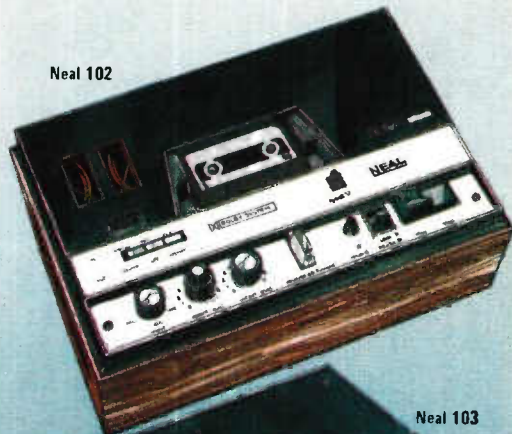

Neal 103



## NEAL

Neal is a name new to Australia but it has established a formidable reputation in the U.K. for quality, ruggedness and performance stability.

The Neal Transcription Cassette Recorder is the product of people who have many years experience in the design and manufacture of tape recording equipment.

The one word that sums up their design and their product is "integrity". You will find no miracles, no way-out designs, no change for the sake of change, just an obsession with doing everything the right way.

Separate preamplifiers are used for each of the three stereo inputs to reduce noise. This also allows three stereo (or six mono) inputs to be mixed.

Bias is readily adjustable to optimize performance from any tape, thanks to Neal's exclusive Varitape facility.

Neal are the only cassette recorder company in the world to offer the ultimate quality control check. A cassette actually recorded on the machine you buy. This is your guarantee of quality.

"Hi-Fi for Pleasure" (August 1975) consider the Neal 103 as being "the obvious choice of the serious enthusiast or semi-professional".



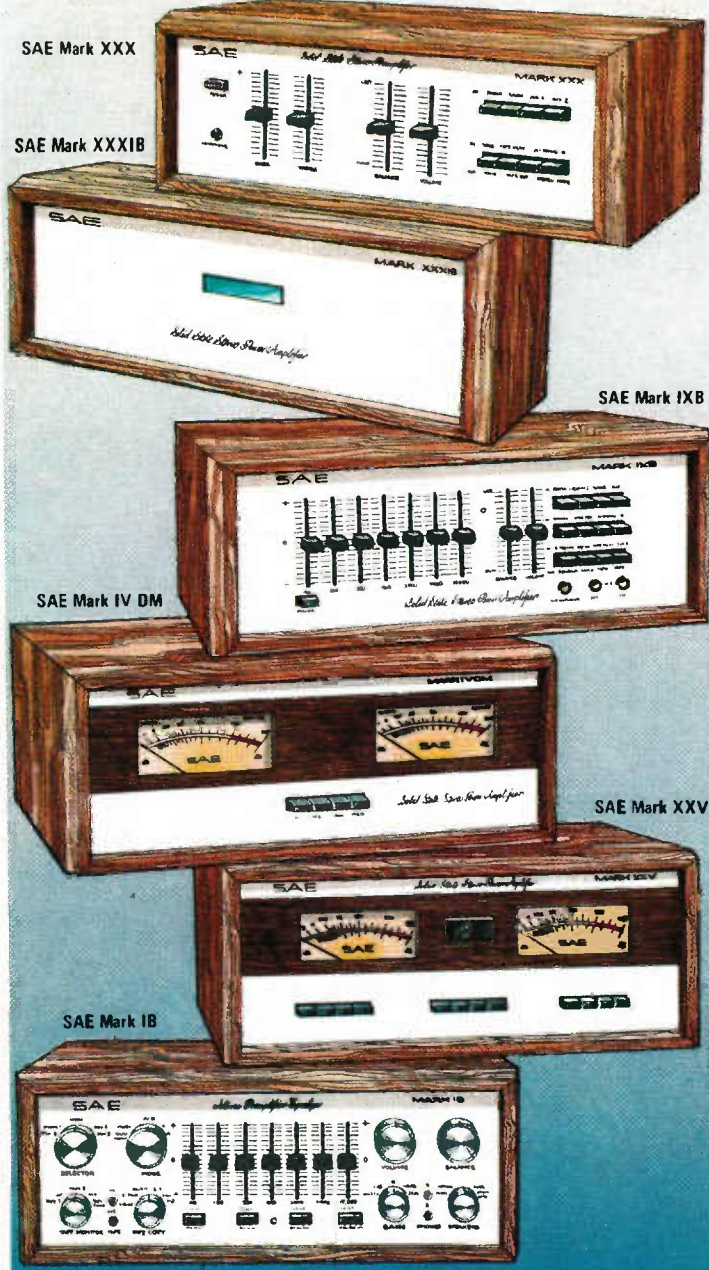

SAE Mark IXB

SAE Mark XXV

# SAE

S.A.E. Preamplifiers, Power amplifiers and Equalizers have taken the professional field by storm. The acceptance of S.A.E. into their ranks has been almost unprecedented.

Mark XXX Preamplifier with Mark XXXIB Power Amplifier brings you Connoisseur Sound at budget prices. All unnecessary items have been omitted in the pursuit of the highest possible performance to price ratio.

The S.A.E. Mark XXXIB was tested by "High Fidelity" in May 1974, at 0.031% THD 20HZ to 20KHZ at 50 watts output per channel.

Mark IXB Preamplifier with Mark IVDM Power Amplifier. This combination brings you a versatile Equalizer Pre-amplifier with a power amplifier that was described in the "Popular Electronics" May, 1975 review as "True state-of-the-art performance with distortion levels that cannot be measured with any but the most advanced laboratory instruments." "For all purposes the Mark IVDM is a distortionless amplifier". Actual measurements were 0.005% at Rated 100 watts per channel and only 0.1% at 190 watts per channel!

Mark XXV Power Amplifiers. This is surely today's ultimate amplifier. It is rated at 300 watts per channel, both channels driven, into 8 ohms, and S.A.E. ratings are almost unreasonably conservative! Built-in forced air cooling ensures long life for all components.

Mark IB Preamplifier was designed for those who have, or intend to have, very complete audio installations.

"Stereo Review" October, 1975, says "When it comes to operating and control flexibility, the S.A.E. Mark IB has few peers."

The harmonic distortion, excluding hum which "was far below 0.001% at all frequencies up to 20,000HZ."



MA1

MA3

MA5

MA7

# Monitor Audio

MONITOR AUDIO is another new company. It has leapt to prominence in only two years. In the "Practical Hi Fi Audio" October 1975, comparison of ten loudspeakers including Spendor BCI, B & W DM4, Kef Cadenza, IMF Super Compact, the Monitor Audio MA5 Series 11 was chosen as best of all. Its very low colouration, sweet-sounding treble, openness, and tight extended bass endeared it to the reviewers.

Similarly the tiny MA7 was chosen as the best of five speakers in a test conducted by "Popular Hi Fi" (June 1975) although it was the smallest and cheapest of the units tested.

At the top of the range is the mighty MA3 which retains the qualities that have established Monitor Audio at the pinnacle of loudspeaker design and manufacture, but combining these—possibly for the first time—with a power output which is awesome and a level of bass distortion which must set new standards.

"Practical Hi Fi and Audio" May 1975, measured the third harmonic distortion of the MA3 at 100 HZ at "close to 1 per cent" at 96dB sound pressure level. At the critical midrange the distortion is between 0.3% and 0.6%.

They go on to say "The first impression one gets when listening to the MA3 is one of physical presence, and this quality seems to be independent of the closeness of recording. This may be attributable to the exceptional smoothness of its midrange unit together with the use of a very analytical tweeter."

All we ask is that you give them a hearing.



# V-I-P

This is your special invitation to a full V.I.P. treatment at these selected Hi-Fi specialists throughout Australia. They guarantee you a personal hearing on our remarkable products.

**N.S.W.:** Kent Hi-Fi, 412 Kent St, Sydney.  
Hi-Tel Hi-Fi, Skiptons Arcade, 541 High St,  
West Penrith.  
Hi-Fi House, Hurstville & Wollongong.  
Newcastle Hi-Fi, 642 Hunter St, Newcastle.  
Autel Systems Pty. Ltd.  
639 Pacific Hwy., Chatswood.

**VIC.:** Sound City, 360 Lonsdale St., Melbourne.

**QLD.:** Stereo Supplies, 95 Turbot St., Brisbane.

**W.A.:** The Audio Centre, 883 Wellington St., Perth

**TAS.:** United Electronics—Hobart, Launceston and Burnie.

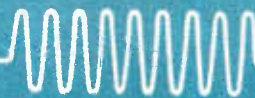

**LEROYA INDUSTRIES LTD**

Head Office: 156 Railway Pde., Leederville, Western Australia, 6007. Phone 812930.  
N.S.W. Office: 100 Walker Street, North Sydney, N.S.W. 2060. Phone 9224037.  
Victoria Office: 103 Pelham Street, Carlton, 3053. Phone 3477620.

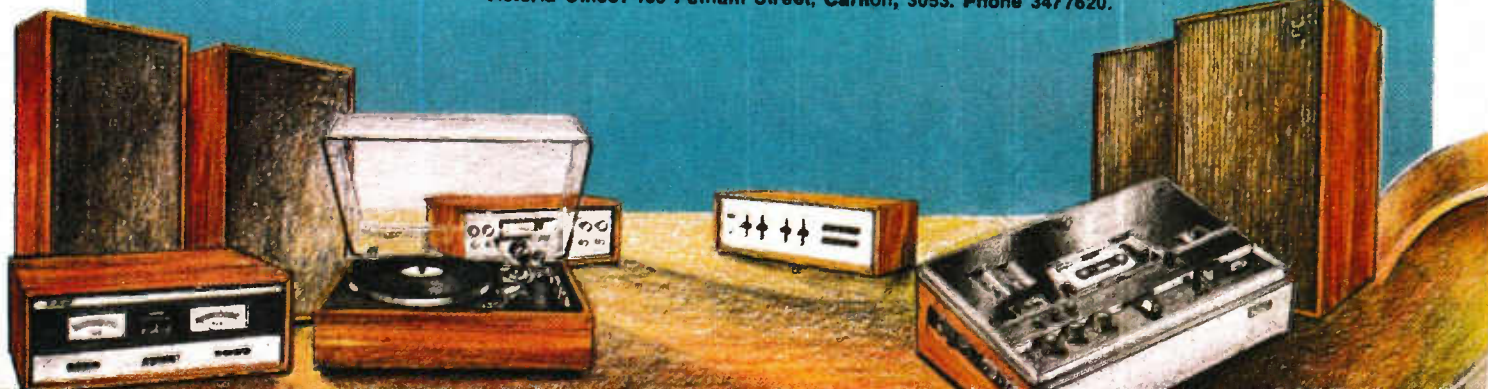



**get 'em  
off the  
ground  
with...**

**INTERNATIONAL  
ELECTRONIC  
TRADE  
OPPORTUNITIES**

IETO is exactly what the name implies — a customized international industry newsletter aimed specifically for the benefit of manufacturers, exporters, importers, representatives, agents, distributors and buyers in the electronic industry.

IETO lets everybody know who's seeking to add a line, who's expanding a distribution network, what firm is building its sales territory, who wants new products — and on and on. In short, IETO lets you know who needs what, and who needs *who* — and why, when and where.

Our newsletter is designed for anyone interested in international sales, marketing, distributing or licensing of electronic products.

That's why we're already at work for subscribers in over 50 countries!

**International Electronic Trade Opportunities**

Annual subscription rate, U.S. \$65.00.

Send for sample copies by writing to:

**Elmatex International, c/- Electronics Today International, 15-17  
Boundary Street, Rushcutters Bay, N.S.W. 2011.**

Free opportunities listing. Write for details.

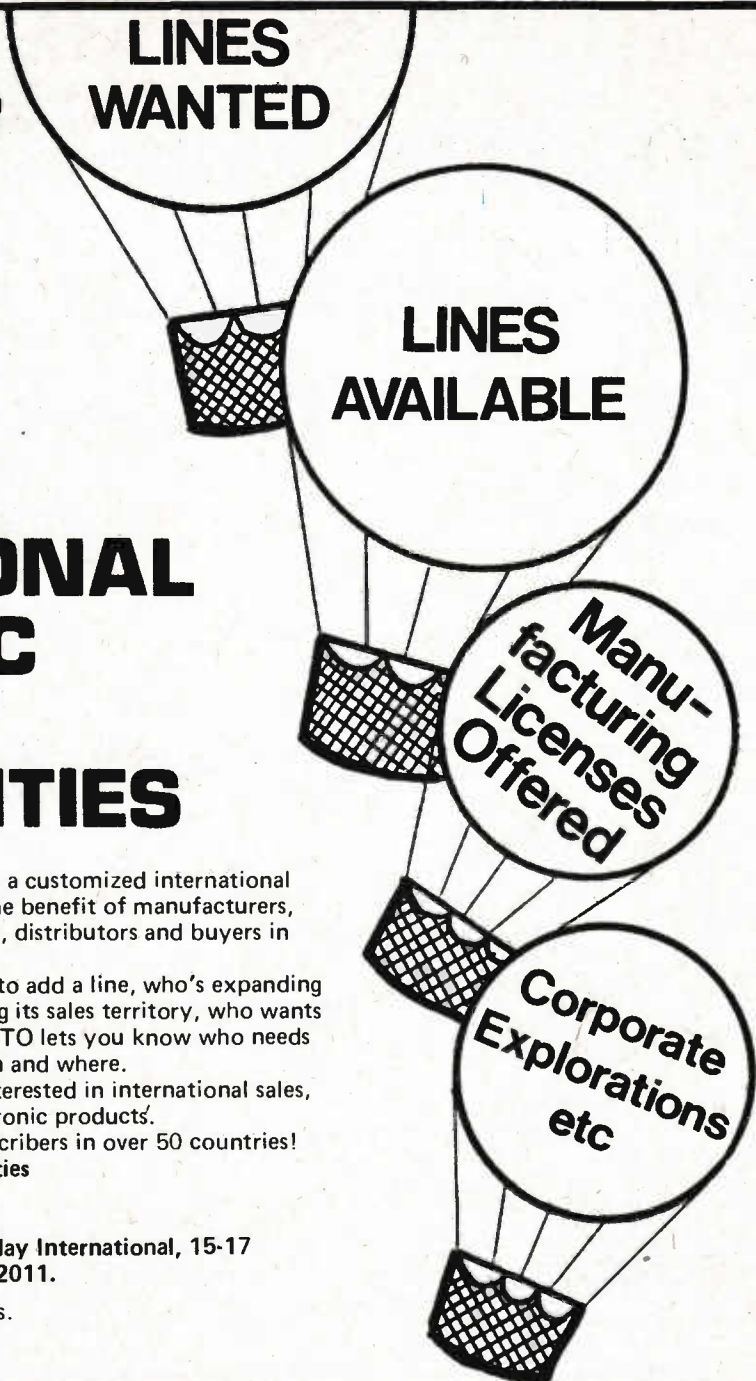

**COUPON**

Please enter my subscription to your "INTERNATIONAL ELECTRONIC TRADE OPPORTUNITIES" monthly newsletter starting with your next newsletter.

1 year US\$65  2 years US\$120  3 years US\$160   
cheque for US\$ . . . . . for the subscription is enclosed  
bill me later . . . . .

bill my company P.O. No. . . . .  
I would like to make the payment in our own currency  
in the equivalent amount of US\$ . . . . .  
Please send instructions.

Date . . . . . Sign . . . . .

NAME . . . . .

ADDRESS . . . . .

POSTCODE . . . . . AUSTRALIA . . . . .

Send to: Elmatex International, c/- Electronics Today International, 15-17 Boundary Street, Rushcutters Bay, N.S.W. 2011.

# One year from now you'll be able to read this circuit as easily as the back of a cornflakes packet.

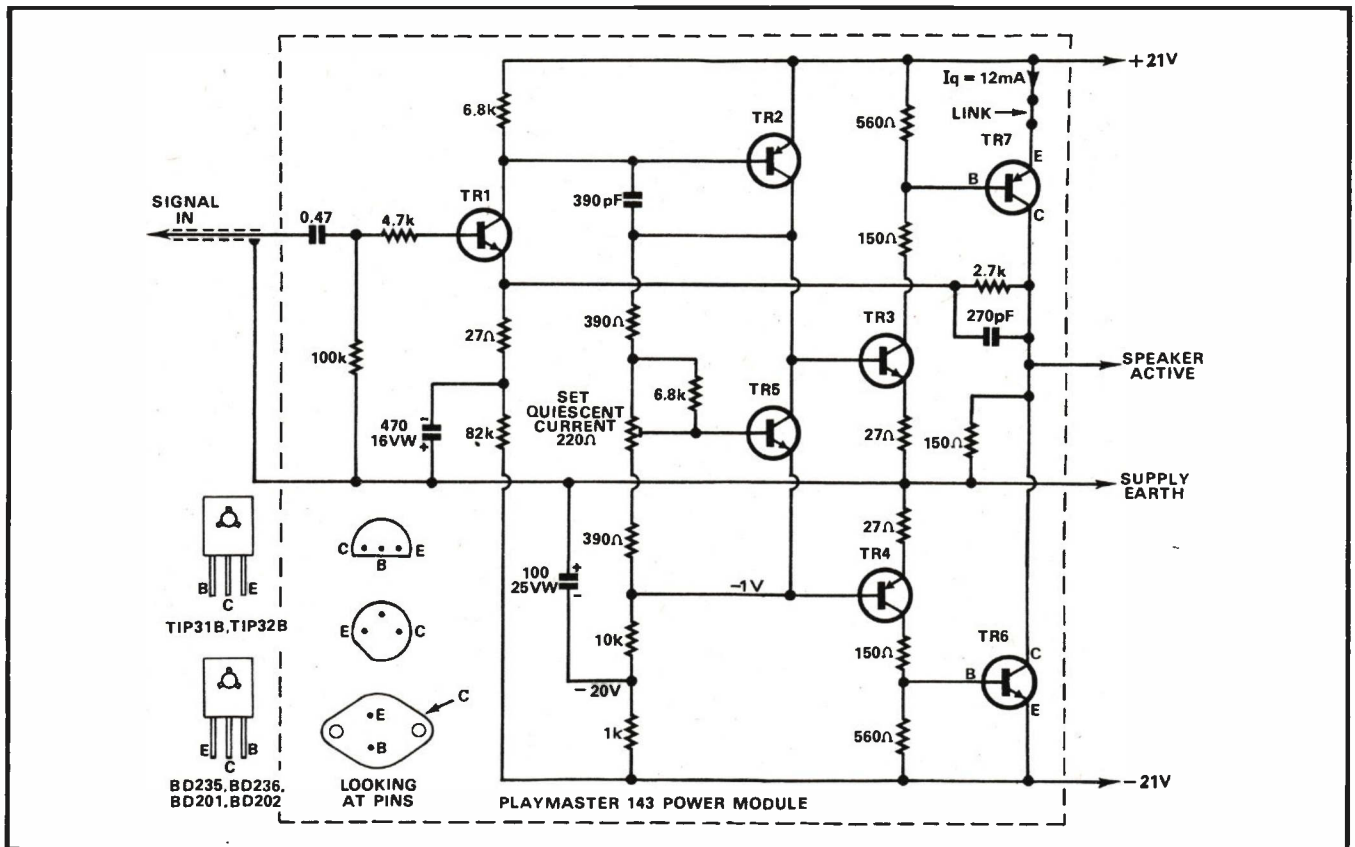

You don't need to be an Albert Einstein to learn about electronics.

All you need is youth, enthusiasm, and someone who'll give you the chance to learn at the right speed.

That's what an electronics apprenticeship in the army will give you.

A year from now you'll be able to read this circuit standing on your head. And you'll be well on the way to gaining qualifications that will make you valuable to employers everywhere.

So if you're between 15 and 17 in January and you want to get into electronics, this is probably the best opportunity you'll ever get.

Fill out the coupon and we'll send you more details. Or pick up the nearest phone and call the Army Careers Adviser in your city. (Closing date 11 August, 1976)

Townsville 71 6784, Melbourne 61 3731,  
Brisbane 31 1031, Launceston 31 1005,  
Newcastle 2 5476, Hobart 34 7077,  
Sydney 212 1011, Adelaide 223 2891,  
Wollongong 28 6492, Perth 22 4355,  
Canberra 47 6530, Darwin 89 0911.

To Army Careers Adviser  
G.P.O. Box XYZ in your  
nearest State Capital City.  
Please send me information  
about Apprenticeships in  
the Army.

Name .....

Address .....

Post Code .....

Date of Birth .....

**army**  
It's a great life



# Mini-Mart

Here's a chance to let other ETI readers know about items you have to sell — or wish to buy.

We'll print your 25 words (maximum) totally free of charge. Copy must be with us by the 18th of the month preceding the month of issue. Please, please write or preferably type your adverts clearly, using BLOCK LETTERS.

This section is available to private readers only — it is not available to commercial organisations.

If, like many of our readers, you'd prefer not to cut up your copy of ETI, just make a copy of the relevant part of this page. Please make it the same size as the original — and write your copy using BLOCK LETTERS.

PLEASE USE BLOCK LETTERS

## CONDITIONS

Name and address plus phone number (if required) must be included within the 25 words allowed.

Reasonable abbreviations, such as 25 Wrms, count as one word.

Private adverts only will be accepted. Please let us know if you find a commercial enterprise using this service.

Every effort will be made to publish all adverts received — however, no responsibility for so doing is accepted or implied.

## PUT YOUR HANDS TO WORK MAKING MONEY

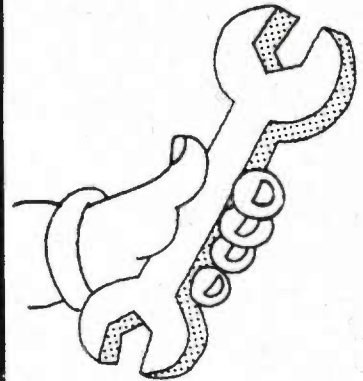

If you like working with your hands, if you appreciate the practical side of life, then you can put your hands to work to make money. Because there is a demand for skilled mechanics and technicians.

**Motor Mechanics** to service the millions of cars, trucks, tractors and other motor driven vehicles in Australia.

**Colour TV Technicians** to maintain the thousands of new colour TV sets being sold in Australia every month, and the millions of older Black and White sets.

**Electronic Technicians** to service the hundreds of thousands of computers, calculators, and all the other electronic equipment that is part of the way we live.

ICS can prepare you to gain the qualifications that are the first step in getting the best jobs in these skilled positions.

Send the coupon now, and ICS will return you a complete Career Program guide that tells you how the ICS method works, and what the training program teaches you.

You study at home, at your own pace. Almost from the first lesson, you can start putting your new knowledge to work. And your study program only asks for about an hour a day.

Would you spend an hour a day to earn more money?

**Mail the coupon — today!**

International Correspondence Schools  
400 Pacific Hwy, Crows Nest NSW 2065 Tel: 43-2121

# ICS

International  
Correspondence Schools  
400 Pacific Highway  
Crows Nest N S W 2065

Yes, I would like to put my hands to work to make money. Please send me, without cost or obligation, the Career Program guide I have ticked below.

- Motor Mechanic  
 Colour TV Technician  
 Electronics Technician

Mr /Mrs /Miss

Address

Postcode

Occupation

Age

PKB54398

## READERS' LETTERS

We make no charge for replying to readers' letters, however readers must enclose a foolscap-size stamped addressed envelope if a reply is required. Queries concerning projects can only be answered if the queries relate to the project as published. We cannot assist readers who have modified or wish to modify a project in any way, nor those who have used components other than those specified.

## TELEPHONE QUERIES

We regret that we cannot answer readers' queries by telephone.

## SUBSCRIPTIONS

Electronics Today International can be obtained directly from the publishers for \$14.00 per year (including postage) within Australia.

The cost for countries outside Australia is \$14.65 including postage (surface mail). Airmail rates will be quoted on application. Subscription orders and enquiries should be sent to the address below.

## BACK ISSUES

Our subscriptions dept can supply most back issues of ETI for the twelve months preceding the date of this current issue. Some earlier issues are also available.

The price of back copies is currently \$1.00, plus 40 cents postage and packing. Please address orders to Subscriptions Dept, Electronics Today, 15 Boundary St, Rushcutters Bay, NSW 2011.

## PHOTOSTATS

Photostats of any article ever published in ETI can be obtained from our subscription dept (address above). The price is currently 45 cents per page including postage.

## CONTRIBUTORS

Material is accepted from time to time from outside contributors. Payment is based on quality and is paid 30 days after the date of publication.

Constructional projects will be considered for publication but the standard of design must be to fully professional level. All material must be typed using double spacing and wide margins. Drawings, circuit diagrams etc need not be to professional standards as they will be redrawn by our staff. It is advisable to contact the Editor before submitting copy.

A large stamped addressed envelope must be included if unsolicited material is required to be returned.

## ADVERTISING QUERIES

Queries concerning goods advertised in ETI should be addressed directly to the advertiser — not to ourselves.

## NEWS DIGEST

News Digest items are published free of charge. Manufacturers and importers should send material at least four weeks before the date of publication.

Photographs should be of high contrast and preferably at least 100 by 150 mm. Press releases must be of a factual nature — these pages are not free advertising. The Editor reserves the right to accept or reject material at his discretion. Preference will be given to components and equipment of an essentially practical nature.

## BINDERS

Binders to hold 12 issues of ETI are available from our subscription dept (address above). Price is \$4.50 (plus 80 cents postage NSW & ACT — or \$1.50 all other States)

## COPYRIGHT

The contents of Electronics Today International and associated publications is fully protected by international copyright under the terms of the Commonwealth Copyright Act (1968).

Copyright extends to all written material, photographs, drawings, circuit diagrams and printed circuit boards reproduced in our various publications. Although any form of reproduction is technically a breach of copyright, in practice we are not concerned about private individuals constructing one or more projects for their own private use, nor by pop groups (for example) constructing one or more items for use in connection with their performances.

Commercial organisations should note however that no project or part project described in Electronics Today International or associated publications may be offered for sale, or sold, in substantially or fully assembled form, unless a licence has been specifically obtained so to do from the publishers, Modern Magazines (Holdings) Ltd or from the copyright holders.

A&R Sonar .....	81
Akai .....	34
Amateur Communications Advancement ..	93
Audio Engineers .....	4
Audioson .....	100
Auriema .....	10
Bell Tone .....	70
Challenge Hi-Fi .....	92
Cooper Tool Group .....	16
Danish Hi-Fi .....	15
Dick Smith .....	66,67
Digitronics .....	71
Director of Recruiting .....	108
Edge Electrix .....	47
Electronic Enthusiasts Emporium .....	7
Electronic Concepts P/L .....	33
Electronic Disposals .....	32
Emona .....	4
Ferguson Transformers .....	11
Festival Records .....	100
Fisher, K.D. & Co .....	40
Haco (Maxell) .....	97
Haco (Technics) .....	2
Harmon .....	82,83
Hi-Fi Hut .....	43
Hobby Hire .....	100
ICS .....	109
International Electronics Unlimited .....	94
John Carr .....	39
Leroya .....	21,103,104,105,106
Logan Brae .....	93
Maurice Chapman .....	50
Nebula .....	61
Philips .....	29
Pioneer .....	111
Pre-Pak .....	100
Sabtronics .....	90,91
Sansui Electric Co .....	112
Scope Lab .....	75
Safor Elec. & Hi-Fi .....	96
Star Delta .....	95
Trade Opportunities .....	107
Video Technics .....	102
Warburton Franki .....	81
Wireless Inst. Aust .....	13

## ADVERTISING

Sydney: Terry Marsden (Manager),  
15 Boundary St., Rushcutters Bay, 2011.  
Tel 33-4282.

Melbourne: Clarrie Levy, Suite 24,  
553 St. Kilda Rd. Melbourne. Tel 51-9836.

Brisbane: David Wood, 11-14 Buchanan  
St, West End. Brisbane. Tel 44-3485

Adelaide: Ad Media Group, 68 North Terrace,  
Kent Town, 5067. 42-4858.

Perth: Aubrey Barker,  
38 Mounts Bay Rd. Tel 22-3184.

London: Electronics Today International, 36  
Ebury St, SW1 WOLW Tel 01-730 8282.

Acoustical Consultants —  
Louis A. Challis & Associates.

Electronics Today International is published  
by Modern Magazines (Holdings) Ltd, 15  
Boundary St, Rushcutters Bay, NSW 2011. It  
is printed (in 1976) by Wilke & Co Browns  
Road, Clayton, Vic and distributed by  
Australian Consolidated Press.  
† Recommended price only. Copyright.



# At 160 watts per channel, you're in charge in the sound department.



SX-1250

Pioneer's new SX-1250 AM/FM Stereo receiver. Continuous power output is 160 watts per channel minimum RMS at 8 ohms from 20Hz to 20,000Hz with no more than 0.1% total harmonic distortion. With high performance power like this, total sound management is right at your fingertips.

Just as an example, today's advanced recording techniques capture the entire sound spectrum of a musical program. Owning the SX-1250 assures that you will receive the full acoustical value of this achievement. Enormous power is maintained by the use of a large Toroidal-core transformer and four 22,000µF electrolytic capacitors. To insure that this incredible power is delivered with the absolute minimum distortion, RIAA equalization is precise

within ±0.2dB and the phono overload level is extended to 500mV (1kHz, THD 0.1%) with input sensitivity held at 2.5mV. The step-type attenuator volume control is calibrated for direct readout of the decibel amount. And an infinite variety of tonal adjustments can be achieved with Pioneer's unique Twin Tone Control System.

Perfectly complementing the amplifier section is the outstanding performance of the FM tuner. A 5-gang variable capacitor and three dual-gate MOS FETs are combined to provide high performance spurious rejection, an effective sensitivity of 1.5µV and the S/N ratio is 74dB (stereo). Annoying drift is avoided via the sophisticated PLL (phase-locked loop) circuitry in the MPX section. Thus, switching signals are always in phase with pilot signals

and effective stereo separation is guaranteed at all times. Flexibility was a determining factor in the final design of the SX-1250. Low and high filters, a Tape Duplicate switch, anti-birdie filter, FM muting, loudness contour switch, multipath switch. Terminals for two turntables, two tape decks, three sets of speakers, a Dolby\* noise reduction unit and independent inputs for left and right channel microphones.

Pioneer's new SX-1250 stereo receiver. Power to manage your sound. Power to control it. Power to recreate the true excitement of the original performance. Power to capture the brilliance of every note that's played. The SX-1250..... power to play it any way you want

Pioneer Electronics Australia Pty. Ltd.  
178-184 Boundary Road, Braeside,  
Victoria 3195 Phone: 90-9011, Sydney  
93-0246, Brisbane 52-8231, Adelaide  
433379, Perth 76-7776

	Power Output (20-20kHz, 8 ohms, T.H.D. 0.1%)	Sensitivity (IHF)	Alternate Channel Selectivity	Input				Output		
				Phono	Tape Monitor/ Adaptor	Mic	Aux.	Speaker Pairs	Tape Rec./ Adaptor	4-ch. MPX
SX-1250	160W x 2	1.5µV	83dB	2	3	2	1	3	3	1
SX-1050	120W x 2	1.8µV	80dB	2	3	2	1	3	3	1
SX-950	85W x 2	1.8µV	80dB	2	3	1	1	3	3	1

Dolby is a trademark of Dolby Laboratories, Inc.

**PIONEER**  
leads the world in sound.





AU-11000

## The True Hi-Fi AU-11000 integrated amplifier. Involve yourself.

As the top of our line of new amplifiers, the AU-11000 really knows how to open up.

Here are some of the facts:

There is high power output to ensure the famed Sansui tonal quality. 110 watts, min. RMS, per channel, both channels driven into 8 ohms over the 20 to 20,000Hz bandwidth, with no more than 0.08% total harmonic distortion.

What this means is that you have an extra power margin that doesn't waste a fraction of the wide dynamic range and musical clarity that you'll certainly seek in an amplifier this advanced.

The AU-11000 also gives you a new toroidal power transformer and two oversized capacitors in the power supply. This assures stable power output and dynamic musical reproduction.

Finally, we've added unlimited versatility with source control convenience. A tuner switch. A tape play switch. A tape copy switch. A mode switch. Balance control. Muting switch. Level set switch. And so on. Not to mention Sansui's exclusive Triple Tone Control, which gives you an extra control for midrange sounds, in addition to bass and treble.

There are now eight new Sansui integrated amplifiers in the AU series, each with a different power rating and price tag.

If you're seeking to *involve* yourself in hi-fi, come hear us.

Sansui true hi-fi involves you at the highest levels, and lets you hear the music the way it was recorded.

It's the only product we make. It *better* be good.

### Sansui True Hi-Fi **Sansui**

EASTERN AUSTRALIA, RANK INDUSTRIES AUSTRALIA PTY. LTD. SYDNEY: 12 Barcoo Street East Roseville, N.S.W. 2069  
 Phone: 406 5666 MELBOURNE: 68 Queensbridge Street South Melbourne, Vic. 3205 Phone: 62 0031 ADELAIDE: 234  
 Currie Street Adelaide, S.A. 5000 Phone: 212 2555 BRISBANE: 14 Proe Street, Fortitude Valley Brisbane, Qld. 4006  
 Phone: 52 7333-CANBERRA: 25 Molonglo Mall, Fyshwick Canberra, A.C.T. Phone: 95 2144 / WESTERN AUSTRALIA:  
 ATKINS CARLYLE LTD. 44 Belmont Avenue, Belmont, Western Australia, 6104 Phone: 65 0511 / SANSUI ELECTRIC CO.,  
 LTD. 14-1, 2-chome, Izumi, Suginami-ku, Tokyo 168, Japan