

MAY, 1974
60c*

electronics

TODAY

INTERNATIONAL

HI-FI

Registered for posting as a periodical — Category C.

**ELEVEN GREAT
PROJECTS TO BUILD!**

**BUILD THIS
50 WATT/CHANNEL
STEREO AMPLIFIER
FOR LESS THAN \$120!**



Meet the handsome brother of the A-450.

Everybody who knows anything about cassette decks today knows about our remarkable TEAC A-450.

What makes it truly remarkable is its wow and flutter rating: 0.07%. Just like the most expensive reel-to-reel tape decks. This 0.07% figure comes from the fact that the A-450 employs an entirely new Tape Transport System which includes our own hysteresis synchronous outer-rotor motor; an extremely large,

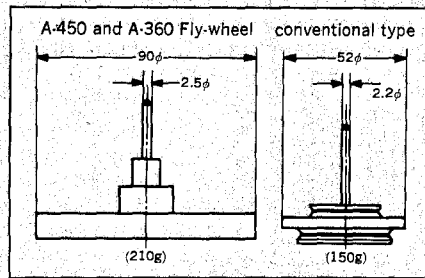

heavy fly-wheel; a flat drive-belt; and a new slipping mechanism to provide optimum reel hub tension. All finely engineered to a

tolerance of 1 micron or less.

Not to mention its built-in Dolby* Noise Reduction System, 3-stage Bias and Equalization controls, and High Density Ferrite Heads. Among its host of features.

Everyone knows something about our A-450. Including you.

So now witness its ambitious brother. The TEAC A-360. It's got the same 0.07% wow and flutter rating, Dolby system, Heads, and most of the other features as the A-450. At a lower price.

Check out the A-360 at your local stereo shop.

A-360



TEAC
The sound of perfection

AUSTRALIAN DISTRIBUTORS: Australian Musical Industries P/L., 155 Gladstone St., South Melbourne, Vic. 3205 Phone: 69-5888 — 619 Pacific H'way., St. Leonards, N.S.W. 2065. Phone: 439-6966 — Arena Distributors, 273 Hay St., East Perth. Phone: 25-9993 — Sth. Aust. Truscott Electronics Pty. Ltd., Hindmarsh Square, Adelaide. Phone: 23-3024. Miltons Department Stores Ltd., P.O. Box 146, Norfolk Island. OCEANIC DISTRIBUTORS: New Zealand: Direct Imports (N.Z.) Ltd., 590W Southampton Street, Hastings. Phone: 89-184 — Fiji: D. Jeevan & Sons, 87 Cumming Street, (G.P.O. Box 148), Suva. Phone: 22710 — New Guinea Paul Mow & Co. Box 449, Lae. Phone: 2953.

* 'DOLBY' is a trademark of Dolby Laboratories, Inc.

electronics TODAY INTERNATIONAL

MAY 1974

Vol. 4, No. 2.

main features

- THE MAGNETIC RIVER**24
Linear propulsion and levitation combined in latest scientific breakthrough.
- WINDOW WASHING — ELECTRONICALLY**42
Radio-controlled tractor cleans 15° angled Sydney Opera House roofs.
- ELECTRONIC S — IT'S EASY!**88
A new approach to basic electronics
- ELECTRONICS — IN PRACTICE**92
Transmit data using ETI's electromechanical AM/FM link.
- WIN AN EXPERIMENTER'S KIT**95
Five valuable kits to win — just complete simple electronics crossword.
- PIRATE RADIO — OUR READERS COMMENT**96
We thought that article was controversial — but
- TIME CHECK FOR RADIOCARBON DATING**118
An accurate calibration for our first 10 000 years.

special projects feature

- CONSTRUCTING ELECTRONICS PROJECTS**57
The how and why of project building.
- MONOPHONIC ORGAN**58
Miniature organ has full two-octave range — plus tremolo.
- HEE-HAW SIREN**60
Make minor changes to the organ circuit and have a hee-haw siren.
- WAILING SIREN**60
Modify that organ circuit once again to produce that classic siren sound!
- BASIC POWER SUPPLY**61
Simple regulated supply provides 4.5 — 12 volts at 400 mA maximum.
- TRANSISTOR TESTER**62
Measure and test your transistors with this easily built device.
- MULTIVIBRATOR**63
Fundamental squarewave oscillator has a thousand and one uses.
- TEMPERATURE ALARM**64
Under, or over temperature — or both — will activate this alarm.
- SIMPLE AMPLIFIER**65
Build ETI's cheap and simple 1.5 watt amplifier.
- TEMPERATURE METER**67
Solid-state meter displays temperatures — even from distant points.
- CRYSTAL RADIO**72
The classic beginners' circuit — no power supply required.
- FIFTY WATTS/CHANNEL STEREO AMPLIFIER**73
Full 50 Wrms/channel from this under \$120 stereo amplifier!

product tests

- PIONEER CT 5151 CASSETTE RECORDER**34
Moderately priced machine has performance equal to open-reel recorders.
- ACOUSTICAL RESEARCH LST LOUDSPEAKERS**48
Primarily laboratory devices. LST's are nevertheless ideal for home use.

reviews

POP TRENDS 121; CLASSICAL REVIEWS 127; BOOK REVIEWS 115.

news & information

NEWS DIGEST 13, 17, 18, 20, 21, 22; SUBSCRIPTION FORM 85; EQUIPMENT NEWS 106, 107, 108, 109; COMPONENT NEWS 110; INPUT GATE (READERS' LETTERS) 124; ADVERTISING INDEX 134.

COVER: Build Electronic Today's 50/watt per channel stereo amplifier — just one of eleven fascinating projects in this special ETI issue.

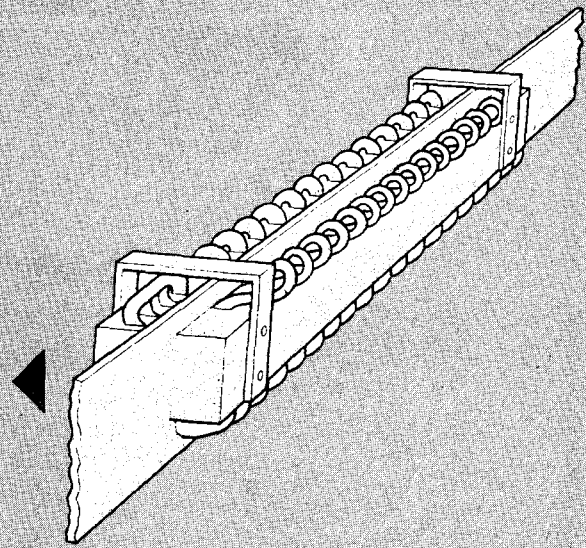

Mykit Series 50 in-1

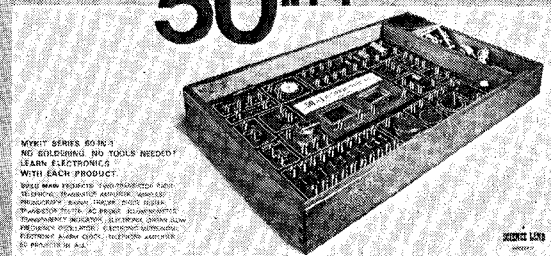

MYKIT SERIES 50 IN-1
NO SOLDERING SKILL REQUIRED!
LEARN ELECTRONICS
WITH EACH PRODUCT:
5000 WATT HIGH POWER TRANSDUCER UNIT
TELEPHONE TRANSDUCER AMPLIFIER - AMPLIFIER
PROSODYNOMETER - SOUND ANALYSIS EQUIPMENT
TEMPERATURE METER - J.C. PENNAC - AUTOMATICALLY
TEMPERATURE REGULATOR - ELECTRONIC DRIVE MOTOR
PULSE GENERATOR - ELECTRONIC AUTOMATON
ELECTRONIC AUDIO CODE - TELEPHONE ANSWERER
BY REQUEST ONLY

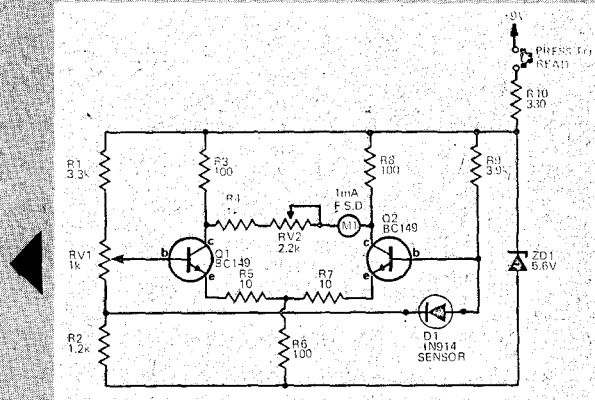

Published by MODERN MAGAZINES (HOLDINGS) LIMITED, 15 Boundary Street, Rushcutters Bay 2011. Phone: 33 4282. Cables: MODMAGS SYDNEY. Managing Director: Jules Feldman. Advertising Director: Max Press.

INTERSTATE advertising — Melbourne: Clarrie Levy, Suite 23, 553 St. Kilda Rd. (S1-9836). Adelaide: Ad Media Group of South Australia, 12-20 O'Connell Street, North Adelaide, S.A. 5006. (67-1129). Brisbane: David Wood, Anday Agency, 11-14 Buchanan St., West End (44-3485). OVERSEAS — United Kingdom: A.C.P., 107 Fleet St., London, EC4. U.S.A.: A.C.P. Room 2102, 444 Madison Avenue, New York 10022. Printed in 1974 by Conpress Printing Ltd., 65 O'Riordan St., Alexandria N.S.W. Distributors: Australian Consolidated Press. (*Recommended and maximum price only.) COPYRIGHT.

SELSOUND HI-FI PTY. LTD.

AUSTRALIA'S FIRST MAIL ORDER HI-FI SHOP
PRESENTS 35 OF THE BEST SYSTEMS IN AUSTRALIA

SALE PRICE COMPLETE SYSTEM	TURNTABLE	AMPLIFIER	SPEAKERS
\$ 499.00	Dual 1216 OR JVC Nivico SRP-87	Sansui AU-505	12' - 3 way Speaker system
\$ 475.00	Dual 1214	Sonics MR7000 Tuner Amplifier	12'' - 3 way Speaker system
\$ 575.00	Thorens TD-165 Belt Drive	Sansui AU-555A	12'' - 3 way Speaker system
\$ 825.00	Sonab 55S	Sansui AU-555A	Sonab OA5 Omni Directional
\$ 660.00	Thorens TD-165	JVC Nivico VN700	Wharfedale Melton III
\$ 750.00	JVC Nivico SRP-87	Akai AA-5500	Technics 10'' - 2 way
\$ 695.00	Sonab 55S	Yamaha CA700	Wharfedale Dovedale III
\$ 665.00	JVC Nivico SRP-87	Kenwood KA600A	Wharfedale Dovedale III
\$ 289.00	Garrard 6300	Kenwood 2000A	Sonics AS203
\$ 335.00	Garrard 6300	Sansui AU101	Sonics AS203
\$ 345.00	Silicron	Kenwood 2002A	Sonics AS203
\$ 365.00	Garrard 6300	Sansui AU101	Sonics AS250
\$ 375.00	Silicron	Kenwood 2002A	Sonics AS250
\$ 335.00	Garrard 6300	Sansui AU101	Sonics 203
\$ 375.00	Silicron	Kenwood 2002A	Sonics 250
\$ 385.00	Silicron	Technics SU3000	12'' - 3 way Speaker system
\$ 375.00	Garrard 6300	Technics SU3000	12'' - 3 way Speaker system
\$ 345.00	Silicron	Technics SU3000	Sonics 203
\$ 335.00	Garrard 6300	JVC Nivico VN300	Sonics 203
\$ 375.00	Silicron	JVC Nivico VN300	Sonics 250
\$ 365.00	Garrard 6300	JVC Nivico VN300	Sonics 250
\$ 385.00	Silicron	JVC Nivico VN300	12'' - 3 way Speaker system
\$ 375.00	Garrard 6300	JVC Nivico VN300	12'' - 3 way Speaker system
\$ 399.00	Silicron belt drive	JVC Nivico VN300	Sonics AS250
\$ 399.00	Silicron belt drive	Sonics am/fm tuner amplifier	Sonics AS250
\$ 399.00	Silicron belt drive	Monaraca SA5001	Selsound 12'' - 3 ways
\$ 875.00	Thorens 165	30 watts R.M.S. per channel	AR7
\$1000.00	Thorens 160 with Shure M9 1ED	Kenwood KA2000A	AR7
\$ 985.00	Thorens 160 with Shure V15 III	14 watts R.M.S. per channel	JVC Nivico SK-15
\$ 585.00	Silicron Belt Drive Sansui and JVC 4ch Cartridge	Akai AA5800	Sonab OA5
\$ 650.00	JVC Nivico SRP-87 4ch Cartridge	Sonab P4000	JVC Nivico SK-15
\$ 889.00	JVC Nivico SRP-87 4ch Cartridge	JVC Nivico VN900	4 Sonics AS203 8'' - 3 ways
\$1200.00	Thorens 165 4ch Cartridge	JVC Nivico MM1000	Sonics AS250 10'' - 3 ways
\$ 995.00	JVC Nivico SRP-87 4ch Cartridge	Tuner Amplifier	Sonics AS203 8'' - 3 ways
\$1325.00	Thorens 160 4ch Cartridge	JVC Nivico 4VN550	Sonics 304A 12'' - 4 ways
		12½ watts RMS p/c	Sonics 250A 10'' - 3 ways
		JVC Nivico 4VN880	Sonab OA5 Sonab VI
		25 watts RMS p/c	
		JVC Nivico 4VN880	
		25 watts RMS p/c	
		JVC Nivico 4VR5436	
		Tuner Amplifier	Sonics 304A 12'' - 4 ways
		JVC Nivico 5456	Sonics 250A 10'' - 3 ways
		Tuner Amplifier	Wharfedale Dovedale III
			Wharfedale Melton III

All the above equipment is new with manufacturers G'tees. All you have to do is forward a cheque by return mail with details of your order. We will ship the required equipment to you straight away. Ask our price on Hi-Fi components. We Guarantee Discounts up to 50%.

Please supply the following shipment.

NAME

ADDRESS

..... P/CODE.....
ETI 4-74

SELSOUND HI-FI PTY. LTD.

619-621 PRINCESS H'WAY, BLAKEHURST

Phone: 546-7462

PERSONAL CALLERS WELCOMED ALL
WEEK 9 to 6 ALSO OPEN THURSDAY
NIGHT AND ALL DAY SATURDAY.

Collyn Rivers
Editorial Director

Brian Chapman
Technical Editor

Michel Calluau
Consultant Editor

Barry Wilkinson
Engineering Manager

Glive Davis
Art Director

Bob Izzard
Production Manager

Howard Jenkins
Advertising Manager

Terry Marsden
Assistant Advertising Manager

John Bleasby
Advertising Representative
(Sydney)

Clarrie Levy
Advertising Manager
(Melbourne)

Ken Morrissey
Advertising Production

Louis A. Challis
and Associates
(Acoustical Consultants)

Electronics Today International
Ryne House
15 Boundary Street,
Rushcutters Bay 2011
Tel. 33-4282

World-Wide Service

SOLID-STATE electronic devices are generally very reliable. But they are not yet infallible.

And when they fail they need specialized service.

Yet, for an ever-increasing number of people, such service is not forthcoming.

We are receiving a continual flow of complaints from readers who have bought electronic equipment overseas and have subsequently been refused service in Australia from the agents representing the manufacturers concerned.

Most of these complaints concern pocket calculators, the majority (but by no means all) of which have been bought in Hong Kong or Singapore.

Many Australian companies *will* service all devices made by their principals — but others will service only those units actually sold by themselves.

For 1974 such an attitude is parochial in the extreme. We are still a long way from being a global village. Nevertheless people *do* move around the world. In large numbers. And when they do they tend to buy things.

Clearly this is not simply a problem for local companies to sort out themselves.

But nor is it possible to tolerate a situation in which people are being virtually blackmailed into purchasing products from local suppliers if they are to expect subsequent product service.

The products concerned are produced in vast numbers and marketed world-wide. In our view the manufacturers of these products have a responsibility to ensure that their products that are *marketed* world-wide can be *serviced* world-wide.

It may well be that there is a contrary argument that we have overlooked. If this is so we offer right now to open our editorial columns to any companies wishing to comment.

UK EDITION

Halvor Moorshead
Editor

Robert Evans
Advertising Manager

Electronics Today International
36 Ebury St., London SW1.
Telephone: 01-730-2139

FRENCH EDITION

Denis Jacob
Editeur

Christian Darteville
Directeur de la Redaction

Edouard Pastor
Directeur de la Publicite

Electronique Pour Vous
International
17, rue de Buci, Paris.
Telephone: 633-65-43

Collyn Rivers

ETI

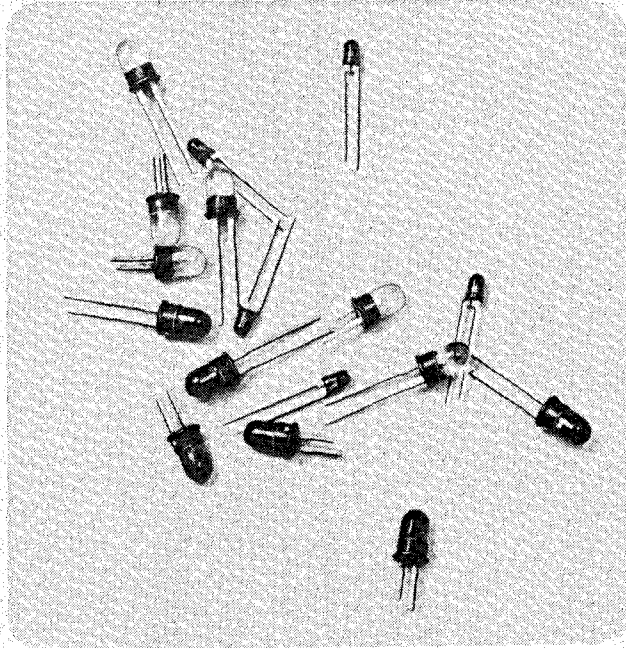

see the light?

Let HP show you their complete range of LED lamps.

Whatever your field; Electronic Engineering, Radio Technology, Instrumentation, or even in your hobby Hewlett-Packard has the range. Let us show you our bright lights, or see them at any of HP's distributors listed below. Get in touch today for the light that's right for you.

HP DISTRIBUTORS

W.A.
EVERETT AGENCY PTY LTD
17 Northwood Street
West Leederville
Western Australia, 6007
Phone 81 5500

N.S.W.
RADIO DESPATCH SERVICE
869 George Street
Sydney, 2000
Phone 211 0816

S.A.
GERARD & GOODMAN PTY LTD
192 Rundle Street
Adelaide, 5000
Phone 23 2222

QLD.
**M. O. WALTON
(ELECTRONICS) PTY LTD**
3 Moore Street
Enoggera, 4051

VIC.
RADIO PARTS GROUP
562 Spencer Street
West Melbourne, 3003
Phone 329 7888, 30 1251

HEWLETT  PACKARD

Sales and service from 172 offices in 65 countries.
Australia, 31-51 Joseph Street, Blackburn, 3130, Victoria. Telephone
89 6351. Other Offices: Adelaide, Brisbane, Canberra, Perth and
Sydney. Also Auckland and Wellington, New Zealand.

90416/30144

SONY PRESENTS THE '20' SERIES



HMP-20

Slim-style music systems that are fat value.

Just try Sony's new HMP-20 with tuner or HMW-20—their exciting new '20' Series music systems. They have just about everything you've been looking for in a home stereo system—contemporary styling, easy operation, compact enclosure, fine sound, and a modest price. There's more of Sony's advanced audio engineering in this compact unit than has ever been possible before. Integrated circuits in the sensitive and selective FM/AM tuner in the HMP-20 and power amplifier in both models ensure plenty of power over a wide frequency with low distortion. Just add

Sony's SQ4-channel decoder amplifier SQA-100 or SQA-200 and back speakers, and then you're in the superb world of SQ4-channel sound. You can record your favourite programmes off radio on the HMP-20 or off records on either model with the addition of a stereo cassette deck. The two-speed turntable has a high compliance, cartridge. Its neat dust cover is detachable. The high compliance, efficient speaker system acoustically and visually harmonises with the unit to surround you with fine stereo. The sound of these stunningly styled systems is as good as they look. Ask your Sony dealer for a demonstration.

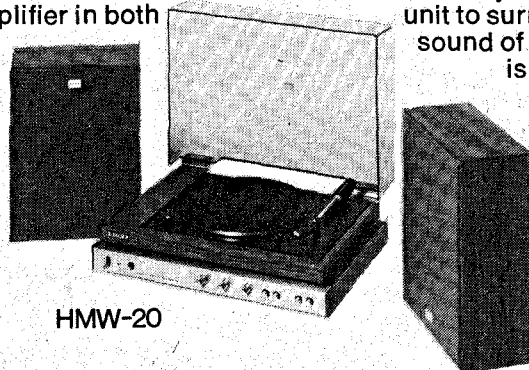

HMW-20

SK370A

SONY®

Sony Kemtron Services Pty. Ltd.

SYDNEY: 26 2651, MELBOURNE: 329 6866, ADELAIDE: 93 2338/9, BRISBANE: 44 4488, PERTH: 81 3422, LAUNCESTON: 25 322, CANBERRA: 95 2100.
Agents: NEWCASTLE: 61 4991, WOLLONGONG: 84 8022.

MSP supplies the action!

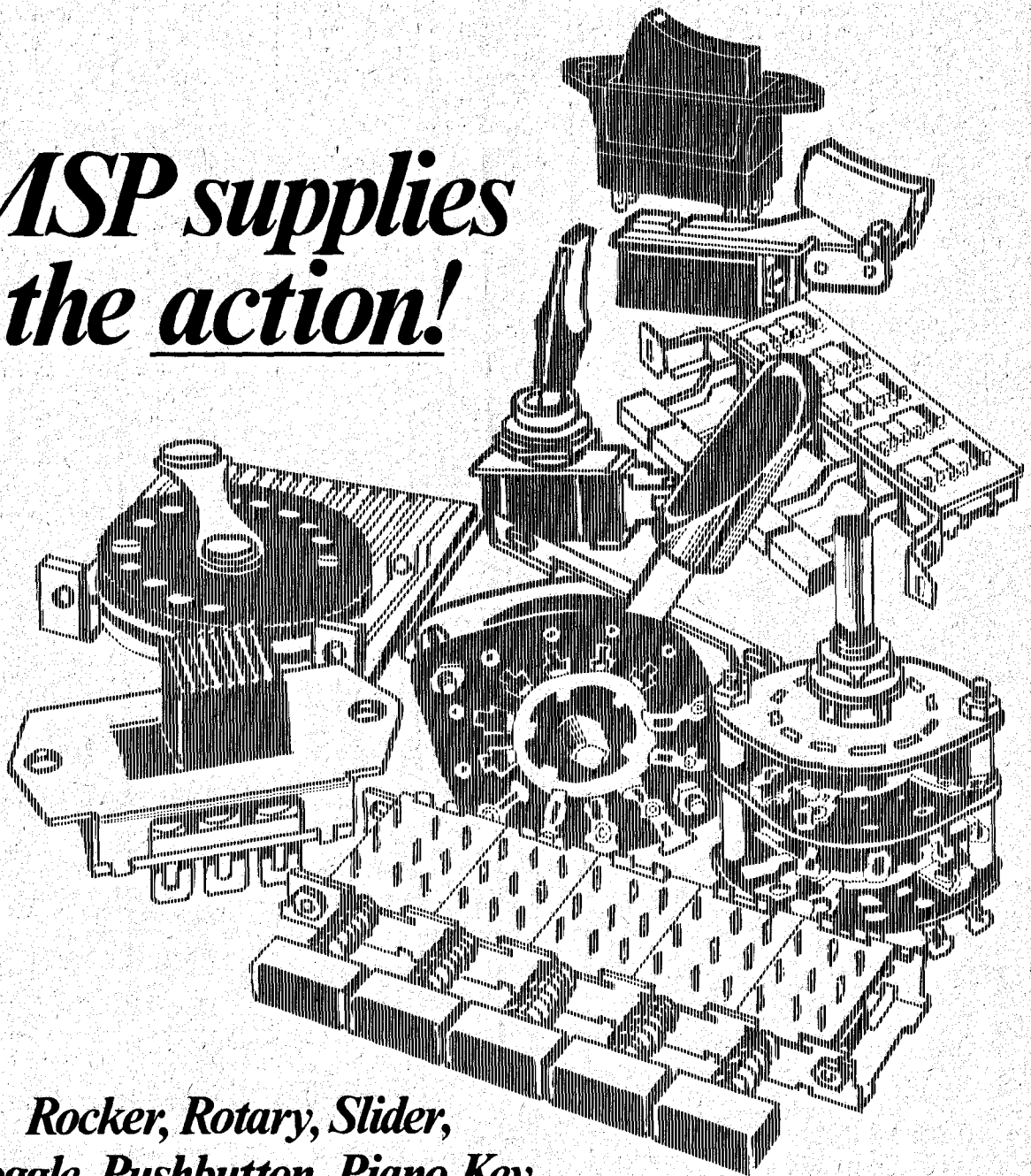

*Rocker, Rotary, Slider,
Toggle, Pushbutton, Piano-Key,
Lever, Trigger, Thumbwheel...*

Whatever your styling we can supply the action to suit —
in thousands of variations for both mains and low level switching.

Write or telephone MSP or your nearest distributor for
further information.

msp

554 PARRAMATTA ROAD, ASHFIELD, N.S.W. 2131. TELEPHONE 797 5757

A division of
Amalgamated Wireless Valve
Company Pty. Ltd.

N.S.W. George Brown & Co. Pty. Ltd. 174 Parramatta Rd., Camperdown 2050. Ph. 519 5855. VIC. Amalgamated Wireless (Australasia) Ltd. Miles St., Mulgrave 3170. Ph. 67 9161. QLD. Chandlers Pty. Ltd. Cnr. Albert & Charlotte Sts., Brisbane 4000. Ph. 31 0341. S.A. Newton McLaren Ltd. 82 Gilbert St., Adelaide 5000. Ph. 51 0111. Amalgamated Wireless (Australasia) Ltd. 48 King William Rd., Goodwood 5034. Ph. 72 2366. Gerard & Goodman Pty. Ltd. 192-196 Rundle St., Adelaide 5000. Ph. 23 2222. W.A. Amalgamated Wireless (Australasia) Ltd., 33 Railway Pde., Mt. Lawley 6050. Ph. 710 888. TAS. Amalgamated Wireless (Australasia) Ltd. 123 Murray St., Hobart 7000. Ph. 34 3836. Amalgamated Wireless (Australasia) Ltd. 42 Frederick St., Launceston 7250. Ph. 31 5466.

AD 38

IF YOU UNDERSTAND THE EXCELLENCE OF **AR** SPEAKERS YOU DESERVE TO HAVE ONE

The AR philosophy: "the design of equipment capable of reproducing music with the greatest possible accuracy, so that the work of the composer, performers and recording engineers is presented to the listener with the highest degree of precision possible."

Speakers created by Acoustic Research

Inc. range from the modestly priced to highly complex engineering achievements. And the same care and expertise is carried throughout the range: when AR develops equipment of lower cost, it embodies only such compromises as will have least effect on the accuracy with which the music is reproduced.

AR 3A

Long considered the reference standard loudspeaker the AR 3A uses a 12" woofer and two hemispherical domes for mid and high range. "Stereo Review" said of it . . . "The best speaker frequency response we have ever measured using our present test setup . . . virtually perfect dispersion at all frequencies."

Highly detailed data available.

\$839 pair*

AR 2AX

The performance standard in the design of the AR 2AX was the same as that for the 3A: natural reproduction of music without exaggeration or artificiality of sound. But where quality in the case of the AR 3A has been limited only by the state of the art and our own engineering skill, for the 2AX price was also a consideration. "American Record Guide" said "1970 brings us a better than ever 2AX and I am nuts about it".

\$469 pair*

AR 5

The AR 5 is only different to the AR 3A inasmuch as it uses a 10" woofer and a slightly different crossover. As always the standard of accuracy is the comparison to live music. At AR the best reponse curve for a speaker system, like that for a microphone or amplifier, is the one that most closely matches the input. The specifications of the AR 5 are obtained, as in all models, from production units, not prototypes.

\$599 pair*

SPECIAL OFFER:

AR Demonstration Record
"The Sound of Musical
Instruments"

Only \$5.95. Write to
W. C. Wedderspoon Pty Ltd
Box 3597 G.P.O., Sydney 2001

* Recommended Retail Price

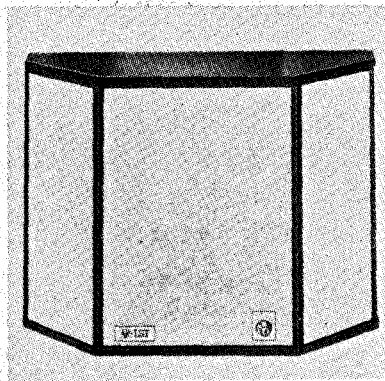

AR-LST

The "Laboratory Standard Transducer" was designed for professional applications. It offers the recording engineer a quantitative standard for the monitoring of recording and mix down operations. It is also used in scientific applications where the accuracy and repeatability of acoustical measurement is a prime requirement. It is also available for individuals who want such a precision instrument in their homes.

Highly detailed data available.

\$1795 pair*



AUSTRALIAN DISTRIBUTORS
WEDDERSPOON

W. C. WEDDERSPOON PTY LTD

3 Ford Street, Greenacre. 2190

Telephone: 642 3993 642 2595

Showroom demonstration by appointment

AR 7

This speaker is very small (248 x 400 x 150 mm) and therefore particularly suitable for 4 channel use where space is at a premium. It uses a tweeter essentially the same as that used in the renowned AR 6. The smooth and well dispersed energy output of this speaker is well balanced by a newly designed woofer which offers a standard of low distortion bass exceeding that of speakers of much greater size and cost.

\$189 pair*

AR 6

In the three years or so that the AR 6 has been available it has already become the speaker that all others are compared to in its price range. It employs the very best technology in its cone woofer and tweeter that the state of the art permits and stands comparison with the most expensive AR systems. Also available in unfinished pine.

\$289 pair*

AR 4XA

A new addition to the AR range and bringing you a third AR loudspeaker under \$300 a pair is the AR 4XA. A successor to the AR 4X the AR 4XA uses the same woofer and cabinet as its predecessor but utilises the AR 6 tweeter and a modified crossover. An audition of the AR 7, AR 4XA or AR 6 will show even the most critical listener that the differences are subtle yet obvious.

\$239 pair*

GUARANTEE:

The workmanship and performance in normal use of AR products are guaranteed from the date of purchase: 5 years for speaker systems, 3 years for turntables, 2 years for electronics.

jensen

THEY SOUND AS POWERFUL AS THEY LOOK

Looks can be deceiving. And size isn't everything. Unless you're talking about a Jensen Speaker System. When the wraps are off a Jensen (as on our Models 4, 5, or 6-left to right) you can see all the power you're looking for. With 50, 60 and 75 watts respectively, these Jensen Systems can be comfortably driven by the big new amplifiers. Yet they're so efficient they only need 10 watts to fill your room with sound.

Of course, the quality of our sound reproduction is power and efficiency

Jensen's Total Energy Response design reproduces sound accurately with low distortion of all frequencies. And we do it over a 170° angle of dispersion.

Jensen Speaker Systems have another powerful thing going for them, too. Our 46 year reputation for quality. You can't build that overnight.

And that's why Jensen gives every Speaker System a full 5 year parts and labor warranty. We know we build a quality product. And we back it up with a quality warranty.

We encourage you to compare a Jensen Speaker System with any other. The proof is in the product. And we build a better one.

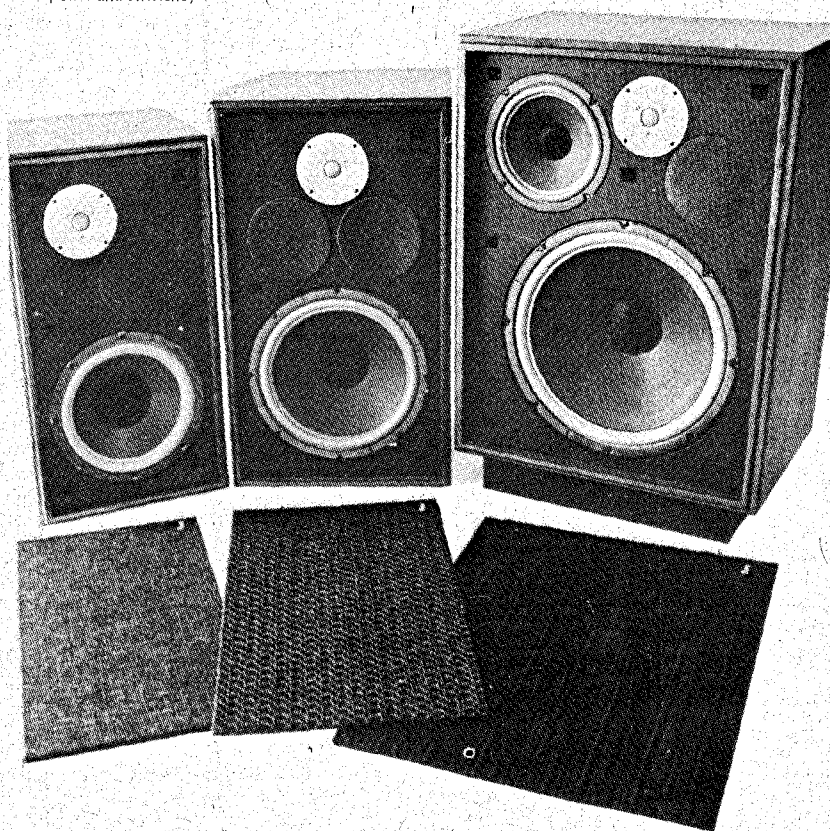

jensen

AVAILABLE FROM

QLD:

Reg. Mills Stereo —
Buranda 911089.

NSW:

Allied Music Systems —
Crow's Nest 439-1072.
Audio Gallery —
Warringah Mall
938-2205.

Dyna Stereo — St. Peters
51-7071.

Fidela Sound — Summer
Hill 799-2618.

Insound — Crow's Nest
929-2714.

Instrol — Sydney
29-4258.

Kent HiFi — Sydney
29-6973.

Magnetic Sound —
Sydney 29-3371.

Wests — Burwood
747-4444.

Dynamic Sound —
Newcastle 21-188.

Audio World —
Wollongong 295-110.

HiFi House Wollongong
286-661.

Pee Jay Sound Centre —
Broken Hill 7303.

ACT:

Plaza HiFi — Woden
821-499.

VIC:

Douglas Trading —
Melbourne 639-321.

Instrol HiFi —
Melbourne 675-831.

R & G Appliances —
Geelong 915-24.

John Lewis — Ballarat
323-615.

TAS:

Teak House — Hobart
433-249.

Audio Service — Burnie
312-390.

WA:

Leslie Leonard — Perth
224-304.

Alberts TV & HiFi —
Perth 215-004.

AUSTRALIAN DISTRIBUTORS:

BJD

Electronics Pty Ltd.

202 Pelham St., Carlton, 3053 Vic. Ph. 347-8255.

190 Willoughby Road, Crow's Nest, 2065 N.S.W. Ph. 439-4201

There's more to mid-range frequencies than meets the ear.

The graphic illustration below represents the typical frequency response expected in a good hi-fi system. A large proportion of the sound can be classified as mid-range and to hear this sound at its best a well engineered mid-range speaker is essential.

The new Plessey C6MR has been specifically designed to handle mid-range sound with excellent performance from 450 Hz to 6600 Hz and sharp roll off beyond these frequencies.

Adding the C6MR to your existing speakers and installing recommended crossover components will result in a superior 3-way speaker system. Alternatively, new 3-way speaker systems can be built based on the C6MR and any desired combination of Plessey C80, C100, C12P and 12U50 woofers and X30, C3GX and 5FX tweeters.

Plessey Crossover Inductors SOL36 and SOL42 are available to ensure extremely smooth response and minimum distortion at crossover points. With Plessey components you can

assemble high-performance multi-speaker systems that will appeal to the most discerning ear. Full application notes are available from Plessey Rola distributors or Plessey Rola direct.



**PLESSEY
Rola**

Plessey Rola Pty. Limited.
The Boulevard, Richmond.
Victoria. 3121.

Melbourne, Telephone 42 3921
Sydney, Telephone 720133
Adelaide, Telephone 223 6294

Perth, Telephone 687111
Brisbane, Telephone 70 8097

C6MR Mid-range

Frequency response
450 Hz to 6600 Hz
Voice coil impedance
8 or 15 ohms
Power Handling 20
watts RMS with
recommended cross-
over
Speaker Diameter
6-9/16"

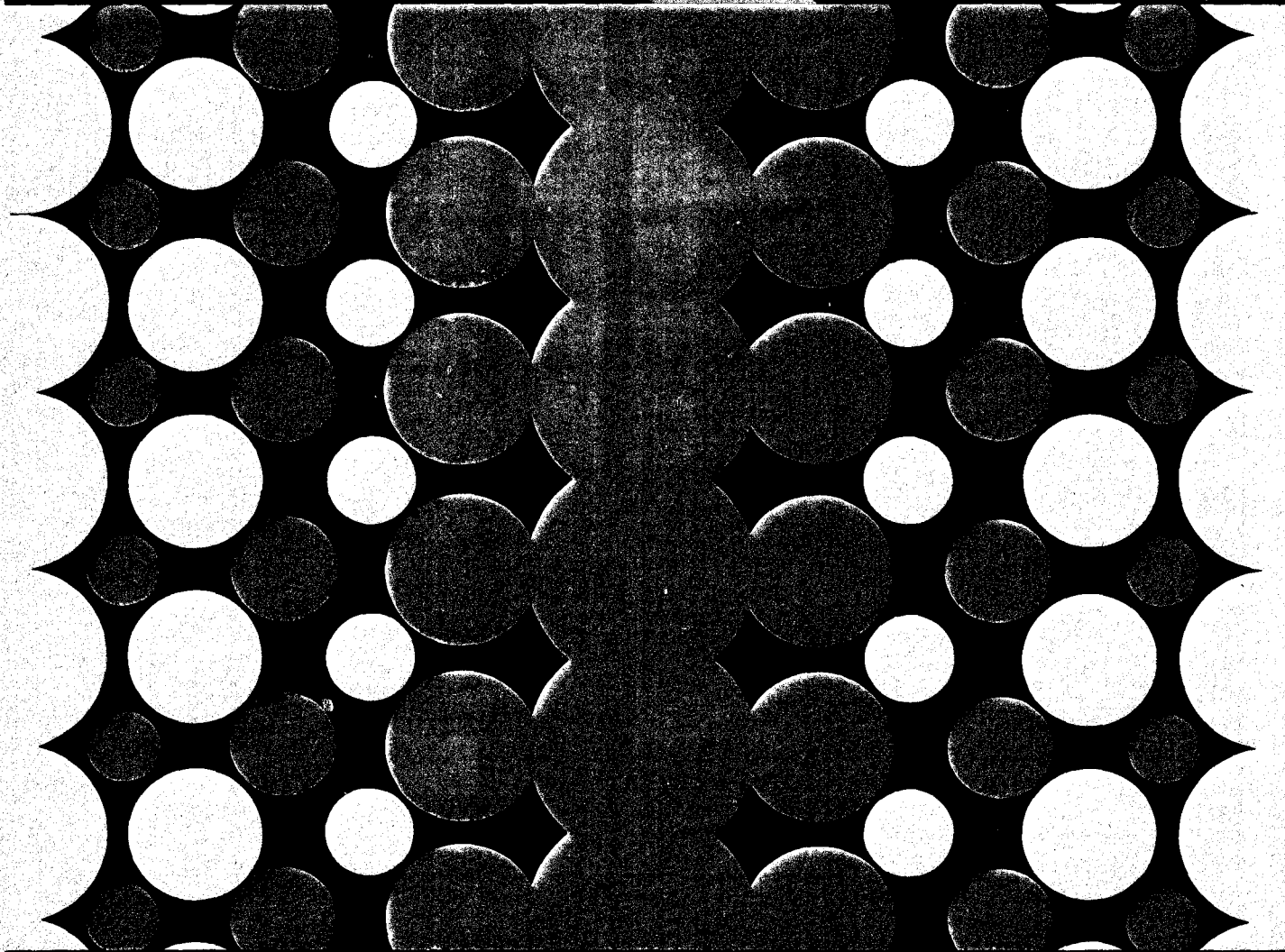
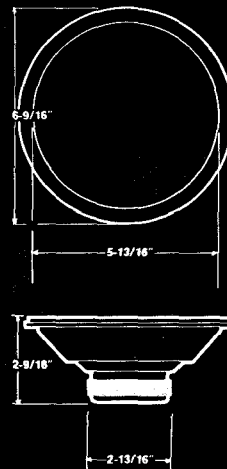

Low Frequencies

Mid-range

High Frequencies

Distributors: N.S.W.: Lawrence & Hanson Pty. Ltd., Martin De Launay Pty. Ltd. VIC.: Lawrence & Hanson Pty. Ltd., Radio Parts Pty. Ltd. QLD.: The Lawrence & Hanson Electrical Co. (Qld) Ltd. S.A.: Gerard & Goodman Pty. Ltd. W.A.: Atkins Carlyle Ltd. TAS.: W. & G. Genders Pty. Ltd. Homecrafts Tasmania. N.Z.: Plessey (N.Z.) Limited, Rata Street, Henderson, Auckland.

AR60

AUTEL SYSTEMS PTY LTD

NORTH SHORE SUPER SOUND CENTRE

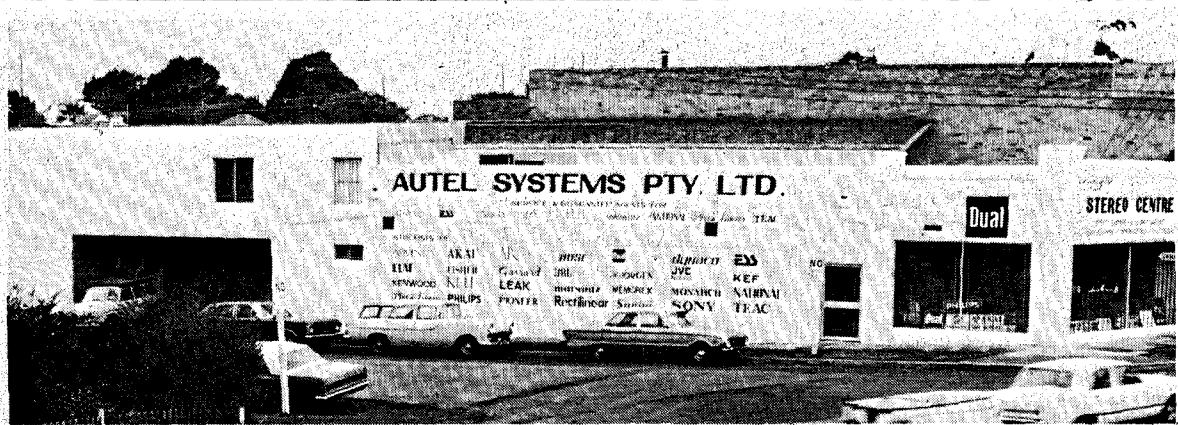

AUSTRALIA'S LARGEST MAIL ORDER SECTION

Ask for our quotation to send equipment anywhere in Australia at our competitive prices. All new equipment with full manufacturers guarantees that we can back up ourselves.

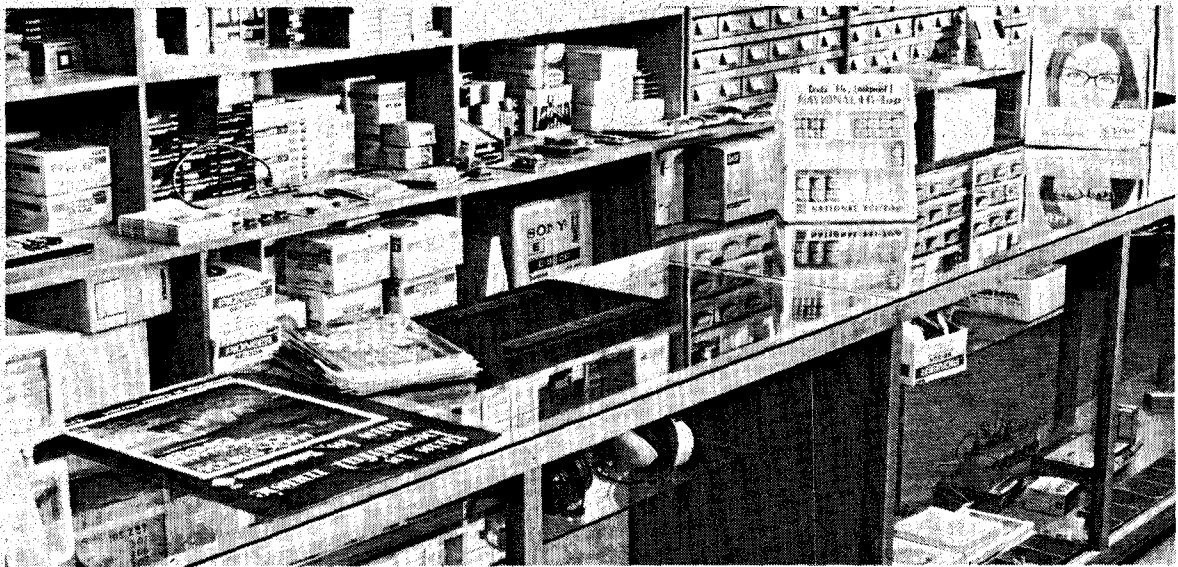

Want a lead to suit your set to match that accessory? Want any type of plug? Also, complete stocks of spare parts for National, Nivico, Teac, Jorgen, ESS, Marantz, and many others. Largest range of equivalent parts to suit those hard-to-get spare parts for rare models.

AUTEL SYSTEMS PTY LTD

639 Pacific Highway, Chatswood Phone 412 4377

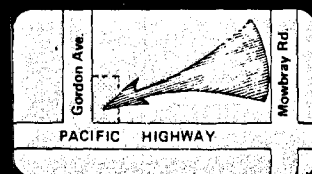

AUTEL SYSTEMS PTY LTD



No where in Australia have you the choice to buy everything you want without being forced to buy the particular brand the shop specializes in and at the best prices. Come and Compare all the brands to chose what really is the best.

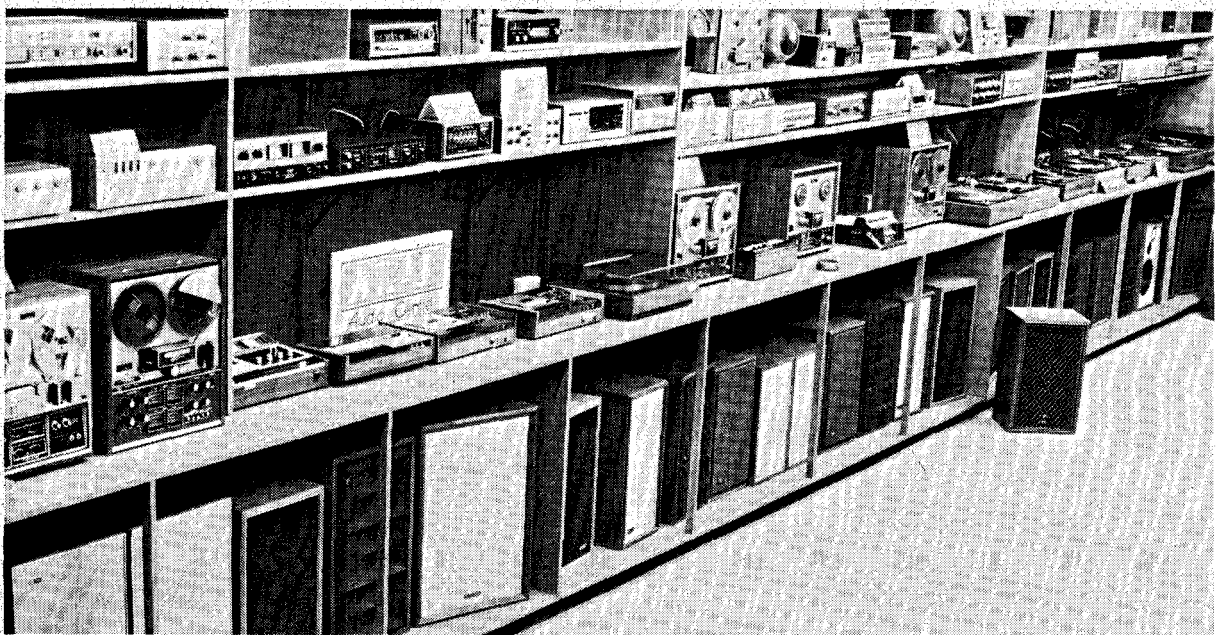

REASONS FOR BUYING FROM AUTEL

- top quality equipment at competitive prices
- free delivery and connections in Sydney metropolitan area
- Full installation for complete systems — ask for our quotation
- under guarantee service and full workshop facilities
- credit sale and terms arranged
- We are audio experts, so trust us
- We have expanded to give better service, to give you a better purchase

—PARKING IN SIDE STREET & REAR

DOUGLAS SELLS SOUND FOR LESS! LIKE THESE FABULOUS NEW AKAI 1974 MODELS

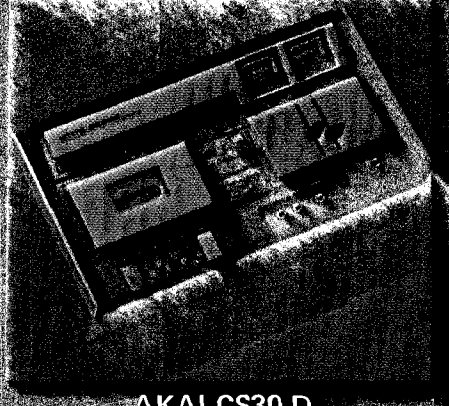

AKAI CS30 D
 Top quality deck **\$149**

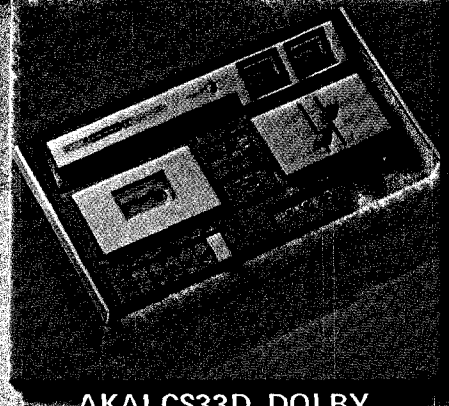

AKAI CS33D DOLBY
 for under **\$200**

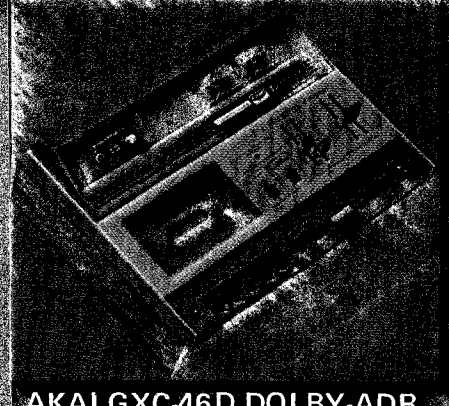

AKAI GXC-46D DOLBY-ADR
 Worlds best value, life time
 warranty heads **\$255**

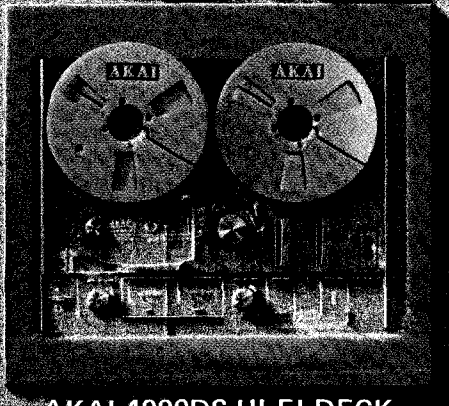

AKAI 4000DS HI FI DECK
 3 heads super value **\$219**



AKAI 201D
 3 motor deck cross field heads
\$299



AKAI 1721
 full recorder, complete **\$269**

Plus these *LINEAR DESIGN* Hi-Fi Amplifiers all with 2 YEAR warranty

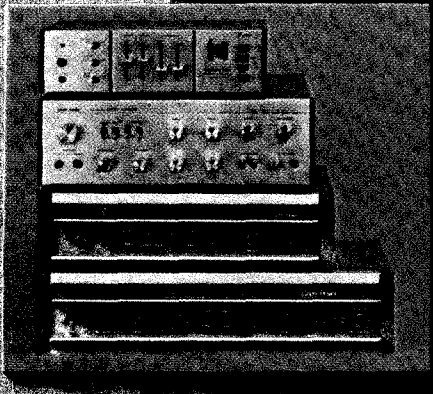

- ← A107 ————— 20 watts rms ————— **\$ 89**
- ← 8000 ————— 100 watts rms ————— **\$199**
- ← 169-B ————— 32 watts rms ————— **\$ 95**
- ← 2500 ————— 50 watts rms ————— **\$149**

**POST YOUR ENQUIRY OR ORDER TODAY!*

DOUGLAS TRADING for HI-FI SOUND

185-191 BOURKE STREET, MELBOURNE — PHONE 63 9321
 Complete range of fabulous Memorex tapes and Jensen Hi-Fi speakers

Apollo Hi-Fi Centre

283 Victoria Road, Marrickville, N.S.W.
Telephone: 560-9019

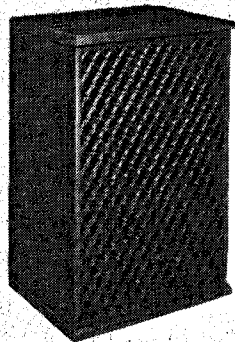

JVC SK12

40W (RMS) 6 Speaker 4-Way system

This high class speaker system is the result of JVC own intensive research programme. The SK 12 has a 12" free edge woofer, two 5" mid range speakers, two 2½" tweeters and horn super tweeter. Together these speakers give a total coverage with a flat frequency response over the whole audio range. A continuous lever control for the high frequency sounds makes the SK 12 match any room acoustics. The front grilles are removable so that the cabinet has no side edges to reflect high frequency sound. This heightens the smooth response to 25-22,000Hz.

Here is the purists delight with 70 watts (RMS) of output and specifications that are very impressive. In figures this means a frequency response of 20-50,000 Hz and a THD factor of 0.25% plus the feature of JVC's SEA tone control system that gives you ultimate control over sound at 40, 250, 1000, 5000 and 15000 Hz. This unit will connect up to two pairs of speakers, two tape recorders, turntable and three auxiliary components.

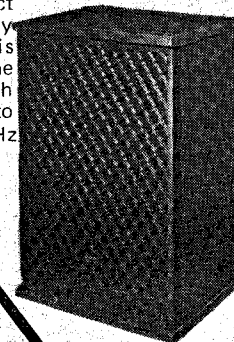

JVC SK12

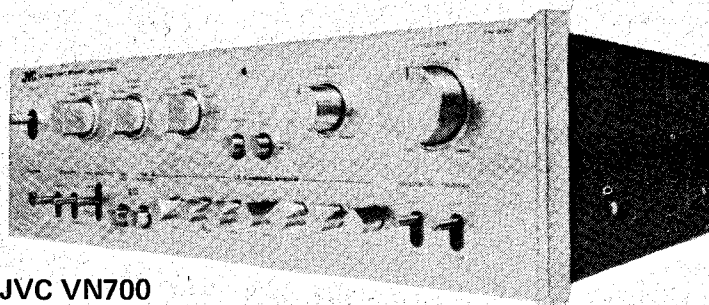

JVC VN700

"4-channel ready"

A look at this precision component will tell you its different, but a closer look will prove it. Notice how the TH universal tonearm houses a 4/2-channel compatible cartridge. And how the turntable's 4-pole synchronous motor and belt-drive system combine to give it the precision required for reproducing discrete 4-channel stereo records: wow and flutter of less than 0.1% WRMS and an S/N ratio of better than 5-dB. In addition, auto-stop-return mechanics with anti-skating device and cueing lever. In fact, all that's required to convert the SRP-87 to immediate discrete 4-channel status is JVC's 4DD-5 demodulator and stylus (4DT 10X).

JVC-SRP 87



Stereo Cassette Deck with ANRS

The professionalism of the open reel deck is combined with the convenience of the cassette in this high-performing compact, a 'must' for any serious stereo enthusiast. Built-in Automatic Noise Reduction System (ANRS) Tape Selector Switch, long life head and electrically-governed DC motor enable the unit to offer frequency response of 30 to 13,000 Hz (± 3 dB), a signal-to-noise ratio of 50 dB and low wow and flutter characteristics of 0.15% RMS. For optimum recording, the unit features a pair of large VU meters, separate sliding volume controls and convenient pushbuttons for all recording and playback functions, including one for Pause and Eject. For professional monitoring with headphones, a headphone level switch is included.

JVC 1667 V

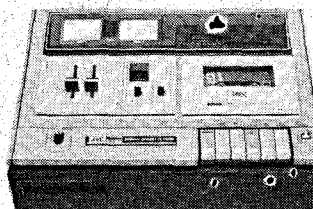

the price on this super system! See us at:—

APOLLO HI FI CENTRE

283 VICTORIA ROAD, MARRICKVILLE, N.S.W. TELEPHONE 560-9019

news digest

VEHICLE ELECTRONIC VOLTAGE REGULATOR FOR THREE-PHASE GENERATORS

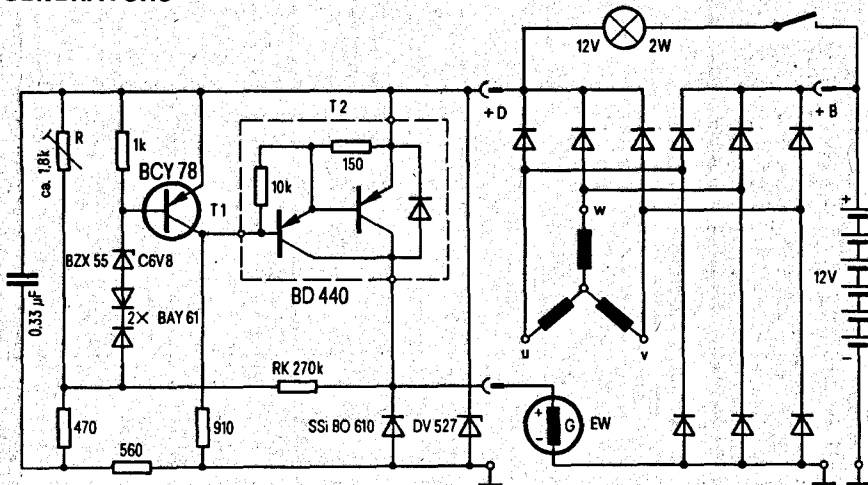

While many cars are fitted with the latest three-phase dc generators, the associated voltage regulators hark back to the days of the dc generators. They are mechanical two-step action regulators whose contacts often fatigue or burn out prematurely.

In order to gain the full benefit of the real advantages of the three-phase principle — high regulation accuracy and long life — Siemens have developed a transistor control circuit.

A dc regulator had to fulfill three functions: voltage regulator, current limitation and reverse-current cutout.

However the regulator for a three-phase generator only reacts to voltage levels, because the built-in automobile diode bridge circuit prevents reverse currents. There is no need for current limitation either, since the current curve reaches the saturation value comparatively quickly because of the constructional design of the three-phase generator. Even at very high speed this saturation value is not exceeded to any noticeable extent.

In a 12V system the new transistor regulator supplies a battery charging voltage of 14.3 V as the nominal value. During changeover from battery charging to no-load operation, control transistor T 1 becomes conductive if there is a higher voltage at the input voltage divider than at Zener diode BZX 55. At the same time the transistor Darlington circuit output stage T 2 blocks. Since the generator's

energizing coil EW lies in the collector circuit of this output stage, the energization decays with the time constant of the field. If, however, the generator's terminal voltage fails to reach the desired value, as predetermined by the Zener diode, the generator is again energized, this time more highly, because the switching condition of T 1 and T 2 is reversed.

Zener diode DV 527 protects both the regulator and the entire mobile power supply from overvoltages which could occur if, for instance, the battery cable should break and the generator energy released were suddenly superimposed on the regulated voltage. This can also be caused by defective or incorrectly detached regulator connecting cables. In each case the Zener diode does not allow the mobile power supply voltage to rise above 45 V. This value is not dangerous for the electrical parts of a 12 V system, for a short time at least.

The regulator is mounted on a ceramic substrate of 0.8 mm thickness, which supports all the elements, including the leads and resistors, the latter being glued into a corrugated injection-molded aluminium frame (60 x 30 x 14 mm). The regulator is adjusted by means of laser alignment of the input voltage divider. Unlike conventional potentiometer trimming, this adjustment remains independent of mechanical influences during operation, because the electronic voltage regulator has no moving parts.

CHALLENGE FOR ELECTRIC-VEHICLE/BATTERY MANUFACTURER

The first cost of a battery set must be eliminated from the purchase price of an electric vehicle if it is to be competitive with mass-produced, mass-merchandised, internal-combustion vehicles, Edward E. David Jr., former head of the U.S. Office of Science and Technology and now executive vice president, research and development, Gould Inc. told conferees at the Third International Electric Vehicle Symposium in Washington, D.C., last month. Dr. David also emphasized the need for new, high-energy-density batteries. He projected commercial availability of new (other than lead-acid) batteries as follows: nickel-iron, 1976; nickel-zinc, 1977; zinc-chlorine (hydrate) 1978-79; lithium-sulfur, 1980-85; and sodium-sulfur, 1980-85. Electric-vehicle penetration would be accelerated by incentives in the form of Government purchases of electric vehicles, Dr. David said.

POCKET CALCULATOR PRICE SLASHED

The NS 600 pocket calculator recently priced in the US at US\$29.95 has just been slashed to a new low of US\$24.95. Dealer price is believed to be about US\$18.

SOLDER FOR ALUMINIUM

The research battle to find a cored solder that readily and effectively solders aluminium and many aluminium alloys has been finally won.

Britain's Multicore Solders have recently perfected a cored-solder wire with four fluxes that solders aluminium and many aluminium alloys without the necessity of an external flux.

The new solder, called Alu-Sol has a melting point of 229°C and a soldering temperature range of 280°C-370°C.

An advantage of being able to solder aluminium at a low temperature is that the heat is evenly distributed and there is little loss of parent metal temper.

The techniques and equipment used for soldering aluminium with Alu-Sol are essentially similar to those used for soldering other metals with cored solder.

Alu-Sol can be fed to the joint by hand or pre-positioned so that in both cases it is melted indirectly to the heated joint components.

The flux residues according to the manufacturers are non-corrosive and non-conductive. They are completely water soluble and can be easily removed.

SOLAR-ASSISTED CAR



Just fitted — the first Lucas Solar Power Charger — on an electric vehicle owned by John Hudson (VC) Limited, commercial vehicle suppliers of Doncaster, Yorkshire, England.

The Lucas solar power unit, during daylight hours, charges a storage

battery powering the lighting ancillary systems.

This conserves maximum power from the traction batteries for drive and eliminates the tendency for lights to dim as battery power decreases.

ELLIPTICAL STYLUS FOR 78 RPM RECORDS

Shure Brothers Inc. have just released an elliptical diamond stylus specifically intended for playing 78 rpm records.

The new stylus is an optional accessory for the Shure V15 Mk. III cartridge.

Designed to track at two grammes, the VN 78-E stylus mount has a one gramme weight built in thus obviating the necessity to change the tracking weight adjustment on the tone arm when changing from a conventionally equipped V15 Mk. III to the 78 rpm version.

Although we have not yet tested the new stylus ourselves, it is reliably reported that results are very satisfactory. Surface noise is said to be very much reduced and high frequency detail is particularly outstanding.

The VN 78-E stylus is suitable for all 78's except vertically cut Pathe types or very early discs such as those made before 1914.

DGM MUSICASSETTES GO DOLBY

Deutsche Grammophon are currently releasing a new range of Dolbyized

pre-recorded musicassettes.

Surprisingly, no announcement of this seems to have been made by DGM, and the Dolbyized cassettes are identifiable only by the now well-known double-D Dolby logo on the title spine — together with a brief credit in the finely-printed music notes.

Because of the low-key introduction we have not been able to ascertain the extent to which the DGM cassette library has been produced in Dolbyized form. Releases seen however so far have included the Kempff/Leitner Beethoven First Piano Concerto and the Bohm/Berlin Philharmonic Mozart Symphonies Nos. 25, 26 and 27. Also seen have been Boston Symphony Orchestra's performances of Ozawa's Berlioz Symphonie Fantastique and the Jochum Mozart Jupiter and Schubert Unfinished symphonies.

Although these recordings do not quite compete with their disc equivalents, tape hiss is very substantially reduced.

This is the best news that cassette recorder enthusiasts have received for months — we are surprised that DGM have not made this innovation more widely known.

ELECTRONICS TODAY COMPUTER TIME SHARING COMPETITION

Winners are:—

Mr. F. Ryan, Chief Pharmacist,
The Royal Womens' Hospital,
Carlton, Vic.

Drug Distribution system in
hospitals.

Mr. W.C. Hartley, Teacher,
Carlingford High School,
Carlingford, N.S.W.

Student ranking etc.

Mr. G.H. Harris, Agricultural
Engineer, Darling Point, N.S.W.
Mass and energy flow on a
grazing property.

Mrs. T. Hillman, School of
Chemistry and Metallurgy,
Sydney Technical College,
Sydney, N.S.W.

Computerizing laboratory
techniques.

Full report next month.

NOAA —3 SATELLITE

A number of readers have asked for details of the latest NOAA —3 meteorological satellite. This device transmits local-area atmospheric data directly to ground stations in many countries.

The 409 kg spacecraft was launched from the United States Western Test Range on November 6. Its perigee and apogee is 1500 km and 1509 km respectively. Period and inclination is 116.1 minutes and 102.1°.

Tracking and telemetry is on 136.770 MHz and 137.40 MHz respectively (both at 0.25 W). Telemetry on command frequencies are 137.500, 137.620 and 1697.500 MHz (all at 5 W).

OPEN SESAME

A lock that will open only when given the correct spoken command is currently being developed by Westinghouse Research Laboratories (USA).

Westinghouse scientist in charge of the project, Dr. Reitboeck, told our reporter that 'formant patterns are just as individual as fingerprints' — the lock can thus be made to release only if the formant pattern of the command matches a recording held within the lock.

Existing devices have already been made for this and similar purposes — but at a cost hundreds of times greater than Westinghouse's projected target of US\$100 or less.

AWA CHAIRMAN OF DIRECTORS

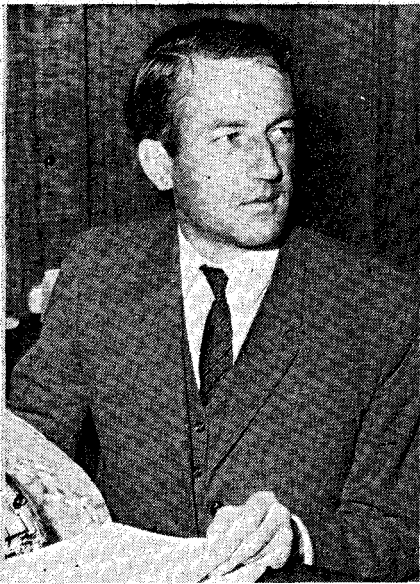

Mr. J. A. L. Hooke has been appointed Chairman of Directors and Chief Executive of Amalgamated Wireless (Australasia) Limited. He succeeds his father, Sir Lionel Hooke, who died recently.

Mr. Hooke is a graduate of Sydney University in Science and Engineering with first class honours. He was awarded the University Medal. On completion of his University studies, he spent some months on overseas investigations and then joined Amalgamated Wireless Valve Co. Pty. Ltd. at Rydalmere and, in 1960, was appointed Manager of the semiconductor division.

Subsequently, he was transferred to an executive position in the Head Office of Amalgamated Wireless (Australasia) Limited as Assistant to the Deputy General Manager. In 1966, he was appointed Assistant General Manager, Deputy General Manager in 1968, Deputy Managing Director in 1970 and Managing Director in 1971.

FOG WARNING SYSTEM FOR SOUTHERN FREEWAY

Motorists will be warned of fog by an electronic driver-aid system which is being built into the Waterfall-Bulli section of the Southern Freeway near Wollongong in N.S.W.

The 21 km tollway between Waterfall and Bulli Pass has a high incidence of fog, by Australian standards. Light fog occurs throughout the year, and severe fog averages 31 days a year.

The worst fog occurs in summer. It

is caused by warm, moist air rolling in from the sea being forced up the coastal escarpment, where it hits a cooler atmosphere and condenses into vapour.

The department will set up a weather station at Bulli to provide advance warnings.

This will be automatic in operation, sending information to the control centre (at Waterfall) on wind direction, wind speed and barometric pressure. The system will give the supervising officer data on the three conditions which in conjunction produce orographic fog.

This information will be supplemented by sight reports from radio-equipped patrol vehicles. Sensors for automatic and remote reporting of visibility will be added later.

Drivers will be warned by illuminated signs at 1½ km intervals. Each will be a matrix of small lights, spelling out short words like "slow", "stop" and "fog". The maximum driving speed will also be shown. The signs will also be able to indicate which carriageways are open and which are closed ahead of the driver. Double amber flashing lights will draw attention to the "slow" advice and double red flashers to the "stop" command.

A "stop" will not be given without warning for fear of causing pile-ups by sudden braking.

The supervisor at the Waterfall control centre will type a simple instruction into the computer, which will put a predetermined sequence of moves in train. For instance if it becomes necessary to divert traffic from a lane because of an accident — or maintenance work — the computer will set the signals at diminishing speeds for some distance back. After some seconds have elapsed the nearest signals will turn to the lane-closed symbol in the affected carriageway.

Induction coils buried in the roadway will yield information from which the computer will calculate the average speed of traffic in any section. If this is too high, additional "slow" signs will be brought into play further back to reduce the traffic-flow speed in good time.

The flashing lights will be clearly visible at distances up to 1 km and the words or symbols at 300 m. Brightness will be variable — high intensity for full sunlight and fog, and dimmed to avoid glare at night in a clear atmosphere.

Outstation equipment will be housed in small roadside cabinets near the overhead signals. The cabinets will contain the electronic drive equipment and telemetry for reporting back to the control centre that any change of signal has in fact taken place. The cabinets also will contain connections to the underground induction loops and to the handset telephones for emergency use.

LASER APPLICATION TO GAS DETECTION

A laser system for the detection of methane and other infrared absorbing gases has been developed by International Research & Development Co. Ltd., Fossway, Newcastle Upon Tyne, UK, and A.M.G. Zuurbier Ltd. of Doncaster, England, in collaboration with the Safety in Mines Research Establishment. It is for use in natural-gas safety surveying, petrochemical safety monitoring or concentration measuring, and high sensitivity gas-leakage alarm systems.

In its first application, the equipment has been installed in a patrol vehicle for the detection of small quantities of methane, e.g. 100 parts in one million, utilising the rapid detector response time of less than one second.

The operation relies on the absorption of 3.39 µm radiation by the sample gas in a cell located within a laser cavity. Gases and vapours which absorb strongly in the 3.39 µm band include butane, ethane, propane, hexane, heptane, butadiene, dimethylamine, dimethylether, ethylether, ethyl mercaptan, ethylene, ethylene oxide, propylene and many others.

The new detector has a fast response and high gas-flow rate and a wide range of sensitivities. Unlike flame-based techniques, it measures concentrations of infra-red absorbing gases in inert atmospheres and, unlike some solid-state detectors, cannot be poisoned.

NEW H-P 'SCOPE?

Hewlett Packard are believed to be about to introduce a 300 MHz portable oscilloscope to compete with Tektronix Model 485.

The H-P unit is expected to cost some \$800 or so less than its rival. A later version of the new H-P unit is believed to include a micro-processor unit.

NICKEL-HYDROGEN STORAGE BATTERY

The Societe des Accumulateurs Fixes et de Traction (SAFT) has been asked by the French Centre National d'Etudes Spatiales (CNES) to study and design a nickel-hydrogen storage battery of 55 Ah for geostationary satellites.

This type of stable, high-performance storage battery has a power-unit of mass (65 Wh/kg) twice that of nickel-cadmium generators (30 Wh/kg).

The SAFT has already designed nickel-hydrogen storage batteries, its efforts being concentrated mainly on making the hydrogen electrode more compact.

The hungry leader.

At Altec, we're not taking our leadership position for granted. We're always trying harder — challenging ourselves to develop studio monitor speakers that stay a step ahead of constant improvements in the contemporary recording process. And we can prove it. Here's the latest data on monitors installed in U.S. studios, as published in Billboard's 1973 International Directory of Recording Studios.

MANUFACTURER	NUMBER OF MONITORS USED IN U.S. STUDIOS
Altec	514
JBL	256
EV	77
KLH	35
AR	29
Tannoy	28

But we're not really satisfied — even with this impressive track record. We're still trying to better ourselves. In fact, Altec has three all-new studio monitors available right now. They're a whole new generation of speakers designed to meet the whole new range of tomorrow's dynamic recording techniques. Your studio may need them. Why not call your local Altec representative to find out? Or write us for full details.

Altec gives you the best of both worlds proven leadership, plus an unrelenting commitment to doing a better job. That's because we've really grown to enjoy being # 1 in studio monitor sales during the past three decades. And we intend to stay right there for at least the next three decades by always being our own biggest competitor — in research, in quality, in service and in satisfying the demanding needs of an ever-evolving industry. The domestic ALTEC recently introduced into Australia has already gained rapid response from the discerning Hi-Fi enthusiasts. Altec. We're the hungry leader.

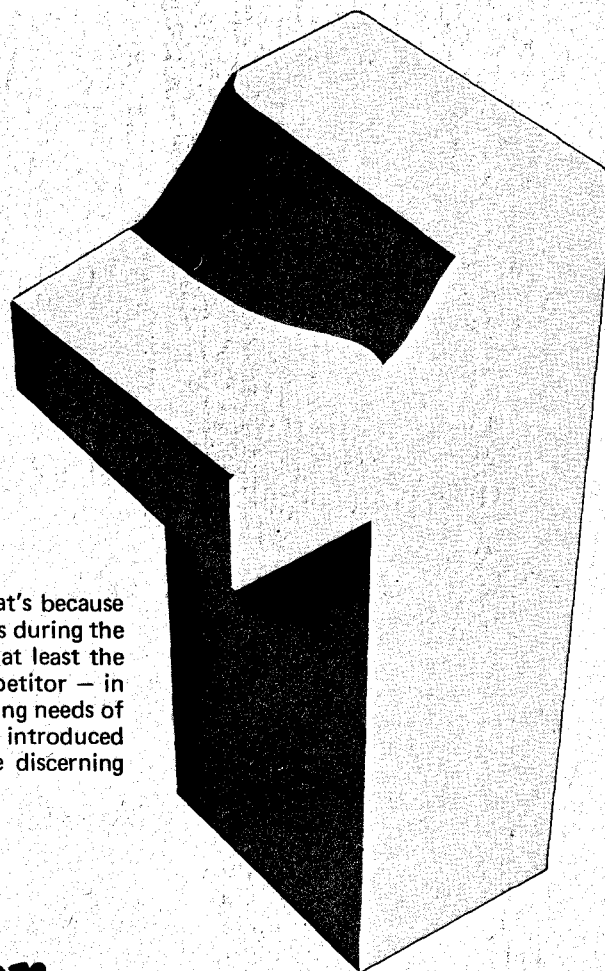

**Number one.
And have been for
nearly 3 decades.**

ALTEC
the sound of experience.

KENT HI-FI

(WHERE THE BEST EQUIPMENT COSTS LESS)

432 KENT STREET
SYDNEY
ph: 29-2743

LOW-END 4-CHANNEL CHIPS

Japanese four-channel manufacturers, Sony (SQ), Victor (CD-4) and Sansui (QS Variomatrix), have employed integrated circuit (ICs) chips in the development of new four-channel decoders, allowing the new systems to sell at a lower cost, be reduced substantially in size, and have a fuller complement of features, such as improved frequency response, tone and power output. The decoders will be on display officially for the first time at the June Consumer Electronics Show in Chicago.

Sansui has coupled with Hitachi, Ltd. to develop their QS Variomatrix chips, with sales now being transacted in the United States with American manufacturers.

Victor Company of Japan has scheduled to ship its IC demodulator circuit boards sometime this spring, with Signetics of California and Asahi Glass Co. of Japan introducing the CD-4 chips to the U.S. and Japanese markets.

Sony Corp. reports that presently domestic demand is keeping them busy with filling orders, but pinpoints May as the month when its SQ ICs will "probably be available in the U.S.," according to Heitaro Nakajima, managing director in charge of audio equipment.

Sony has been able to cut prices 60-70% because of the IC, and has recently introduced its SQD-2070 full logic decoder in the U.S., which is 1/5 to 1/6 the size of models using discrete components. The firm's four-channel ICs are packaged in three ways, one for regular matrix, two for front-rear logic and three for full logic.

Nakajima said he expected that most of Sony's stereo products and all of those in the US\$500 range "will be featuring full logic SQ decoders."

Victor Company's Toshiya Inoue, manager of the audio engineering research center, said ICs would cut CD-4 demodulators to one-quarter their previous size (discrete component models) and cut their cost by one-half.

"Less cost, less parts and less adjustments will enable more manufacturers to have systems with built-in CD-4 demodulators from low- to high-end products," he stated.

Through Hitachi, Sansui will introduce two packages of Variomatrix chips: one with two ICs at a 'popular-price' and the other with four ICs for high-end products, with the latter

package priced under US\$10.00. Size has been reduced by one-third and cost by one-fourth.

"Whereas discrete decoders required up to 16 adjustment points," states Sansui's 4-channel project manager Ryosuke Ito, "the new decoders using ICs now have only four."

NEW DISC VIDEO PLAYER

France's Thomson — CSF are expected to release details of a video record playing system within the next few months.

It is believed that the system will use a soft translucent plastic disc and a

laser readout device. Bandwidth of the encoded signal is said to be 4.5 MHz. The disc rotates at 1500 rpm and carries some 40 minutes programme material.

Thomson-CSF are currently campaigning for agreement on standards for single video disc players, such as those from Philips and Telefunken/Decca.

But preliminary information indicates that the new Thomson-CSF system would not be compatible with the Philips video player, although it could perhaps be made to cater for the Telefunken/Decca Teldec system which uses a pressure sensitive readout.

HAND-HELD LASER WELDING TOOL

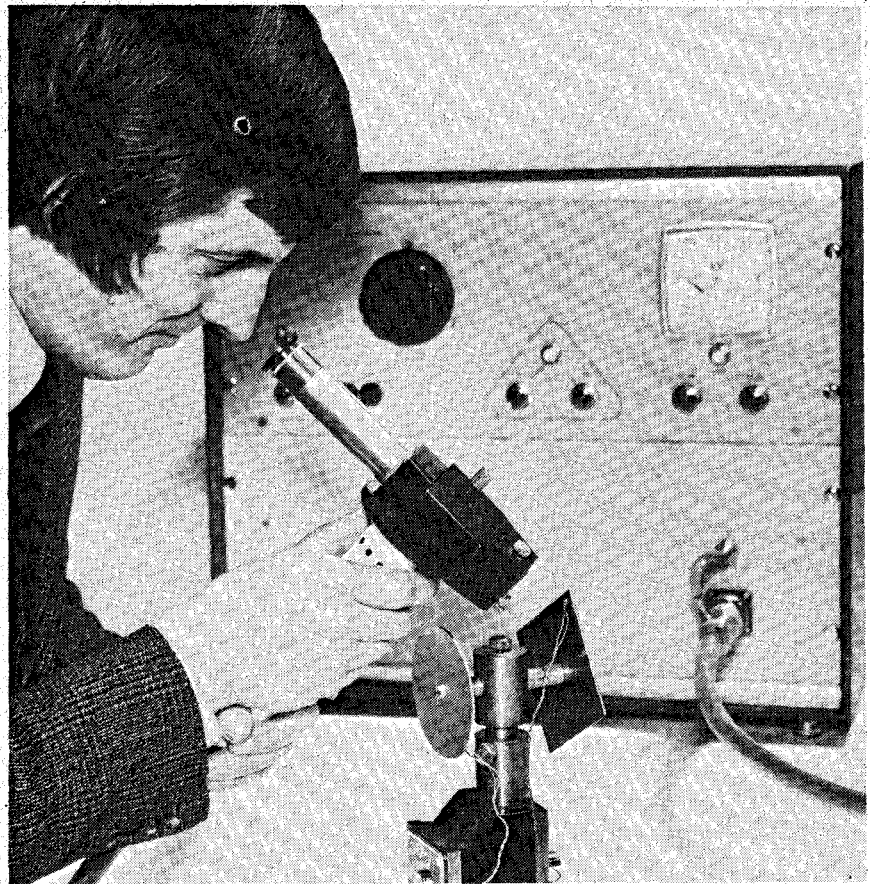

International Research and Development Co. Ltd. IRD of Newcastle in England have been involved in the design of laser micro-welders and drillers for several years. A development of their hand-held laser ophthalmoscope (used for retinal welding) is a newly released workshop model. A viewing system enables the energy of the laser (mounted in the handle) to be precisely located onto the workpiece. The power is supplied via a flexible lead from a power pack.

It welds materials of thickness up to 0.4 mm with 2 ms duration, 2 Joule pulses running at one per minute. The method has the advantages over conventional welding of ease of access in difficult spots, precision energy location, no sticking of electrodes, tolerance to dissimilar materials and minimised workpiece heating. The unit has been used to weld 0.1 mm Kovar test wires to the massive silicon iron stator of a simulated 200 MW generator.

AUSTRALIAN-SOVIET SCIENCE AGREEMENT

Three top Soviet science administrators visited Canberra last month to discuss possible co-operative technological projects involving Australia and the USSR.

The delegation consisted of Messrs. Yefremov and Kuzin of the USSR Ministry of Science and Technology; and Mr S.G. Korneev of the USSR Academy of Sciences.

Australia already has a binational agreement (since 1968) with the United States for scientific and technological co-operation with Britain in the Anglo-Australian Telescope Board. A programme is also currently being considered to establish a geostationary meteorological satellite in co-operation with Japan.

JOVIAN FINDINGS

Preliminary data retrieved from Pioneer 10 during its recent Jupiter fly-past is currently being evaluated by the Bendix Field Corporation at NASA's Ames Research Centre.

Over 3.5 thousand million bits of data have been stored.

One of the most significant findings has been the discovery of helium in the planet's atmosphere. Helium glow was measured at approximately 10 Rayleighs — hydrogen glow at about 100 Rayleighs.

Other discoveries include — proof that Jupiter's radiation belts are between 10 000 and one million times stronger than Earth's — a discovery that the planet emits more energy than it receives from the Sun (at least 2½ times as much) and has an atmosphere that is in effect a vast heat reservoir — and measurements that show that Jupiter has a strong and complex magnetic field.

MICROWAVE OVENS — NO HAZARD

Microwave ovens are not categorically a health hazard according to the just released IREEE report 'Committee on Man and Radiation'.

Whilst agreeing that a emission standard for microwave ovens was needed, the committee unexpectedly disputed the notion that a microwave appliance is inherently dangerous unless there is no detectable radiation.

The committee also refuted the widespread belief that radiation emission from microwave ovens will cause cataracts. Recent laboratory experiments have shown that the radiation levels and exposure durations are too low to cause physical damage.

US TV SETS A HAZARD

Our Washington correspondent reports that the US Consumer Product

Safety Commission is about to enforce safety standards for TV receivers.

The commission says that it has received reports of at least 16 deaths associated with fire, smoke, or electric shock attributed to TV set malfunction. It also states that it has reason to believe that potential fire, smoke or shock hazards also exist in at least 140,000 further sets currently in use.

The volume of reports and the seriousness of the injuries reported indicate that consumers may have been, and still perhaps are subject to unreasonable risks of injury associated with the use of TV receivers, the commission stated.

AIRPORT NOISE MONITOR PROBLEMS

Hewlett-Packard have agreed to refund US\$178,000 to Los Angeles International Airport because of failure of their designed airport noise monitoring system there.

The system used 15 B & K microphones within an 8 km radius for measuring take-off and landing sound levels.

Each microphone sent data via permanently leased telephone lines to an H-P minicomputer based at the airport. There a teletype machine printed out results on a 24 hour basis. The information is then analysed to see if the totalled noise level is within state prescribed levels.

Although the system, designed by Hewlett-Packard in Germany is operating apparently satisfactorily at airports in Sydney, Zurich, London and Stuttgart, it has worked 'only intermittently' at Los Angeles, says Walter Collins, Airport Noise Abatement Officer.

Airport officials who have worked for nearly two years to try to improve the system say that the failure has caused Hewlett-Packard to abandon plans to market the system elsewhere in the USA.

Hewlett-Packard's official statement says, in part — "designed to use hard-wired telephone lines which are easily obtainable in Europe and elsewhere, the system gave less than satisfactory results at Los Angeles where standard telephone lines were used." However according to Mr. Collins, analysis by Pacific Telephone and Decco Laboratories showed that the lines were not the cause.

As we close for press we have just heard that Hewlett-Packard in Palo Alto have confirmed that the system would be withdrawn from sale in the USA.

FM STEREO DEMODULATOR

National Semiconductor (Santa Clara, California) has introduced a second-generation phase-locked loop FM stereo demodulator.

To be sold at less than US\$2.10 in

100 lots, the new LM1800 takes the detected IF signal and processes it to obtain the left and right signal information from an FM stereo broadcast.

According to National, the device includes automatic stereo/mono switching and has an inbuilt stereo indicator lamp driver. Operating voltage is 10 — 24 V, channel separation is claimed to be typically 45 dB.

USA METRICATION DELAYED

America's proposed conversion to metrication has been delayed indefinitely by a political move to obtain a federal aid clause for workers and small business concerns.

Federal aid for such purposes is opposed by the Nixon Administration as well as by some members of the House Science Committee which approved the metrication plan.

LIFE — AN ELECTRICAL PHENOMENON?

Evidence that life itself may be an electrical phenomenon was presented recently at the New York Academy of Science International Conference.

Discussions at the conference focussed on the evolution, development, and application of the effects of electric currents on biological systems.

Explanation of hitherto unexplained life phenomena may be attributed to the presence of small dc currents, the delegates were told. Epithelial cells, for example, were found to regenerate faster when dc currents were applied to open wounds. In fact an adult frog limb was caused to regenerate in this way (these do not normally regenerate under any circumstances).

Cartilages in dogs were also found to regenerate in a similar fashion if dc potentials were applied.

Tumour growth was found to be altered and even retarded when placed in an electrical field.

In humans, nerves were found to heal and function faster in electric fields.

It may well be then, that stimulation, retardation, and control of all growth mechanisms may be related to electrical phenomena which in turn may be major factors in the entire life span of all living organisms.

The conference issued a warning however that caution should be exercised in early uncontrolled clinical applications of such techniques.

CASSETTES COPIES IN ONE MINUTE

Philips Industries have released an audio cassette tape copier which can automatically duplicate tapes from the original in less than one thirtieth of the cassette's normal running time.

The cassette copier manufactured by

news digest

the Telex Corporation of U.S.A. is designed for simple operation and can be used by untrained personnel.

When the original cassette is inserted the copier automatically switches itself on. A blank or used cassette is placed in the recording compartment and the rewind button pressed to ensure copying from the beginning of the tape. A track selector allows selection of track one or two, or both.

When the copy button is pushed a 30-minute cassette can be duplicated in less than one minute.

The copier automatically erases old material on selected channels, has a fully automatic rewind, end-of-tape and faulty cassette sensing and automatic shut-off when the original cassette is removed.

PATIENT WORKLOAD MONITOR DEVELOPED BY NASA

Technology derived from the Apollo and Skylab programs has been adapted by the NASA Marshall Space Flight Centre, Huntsville, Ala., to produce a new medical device called a Mobile Automatic Metabolic Analyzer (MAMA) which will be used to measure the amount of energy expended by ambulatory patients.

This instrumentation provides accurate measurements of metabolic activity of both normal and severely disabled subjects during actual working conditions. It will also be used to

gauge the progress of severely disabled persons through the several phases of their rehabilitation training programs.

In the past, most metabolic measurement has been limited primarily to oxygen-consumption studies on young, healthy males, either during stationary activity or while walking on the standard treadmill. Studies of the severely disabled during actual conditioning or retraining programs are quite rare.

MAMA utilizes a metabolic analyzer similar to the one developed for and being used by astronauts in the Skylab program. This and other instrumentation is mounted on a battery-powered cart, designed and fabricated using knowledge gained by Marshall during the development of the Lunar Rover Vehicle used in the Apollo program.

The motorized cart and instrumentation system will enable rehabilitation doctors and physical therapists to gather accurate workload information. The instrumentation consists primarily of a mass spectrometer which provides a continuous record of the amount of oxygen consumed, the carbon dioxide produced and the nitrogen and moisture exchanged. Additionally, inspiratory and expiratory volumes are recorded, as well as pulse rates and patient speed.

The cart has been designed to follow a predetermined course at a constant speed while the patient walks beside it. An optical tracker is used when the vehicle is in an automatic mode to sense the preset course. This automatic operation frees the doctor to monitor a patient's activity.

Accurate velocity data coupled with accurate physiological data will allow medical personnel to measure the

actual stress being imposed on a patient. This will aid the design of assist devices and therapeutic techniques that will minimize the stress on patients.

Most important to MAMA operation is safety. The vehicle will stop when the doctor commands it, when the sensor leaves the track, when the vehicle hits an object, when the patient falters, or when there is an electronic failure.

The unit has been presented to the Spain Rehabilitation Centre (University of Alabama Medical School, Birmingham, USA). Studies will include both semi-stationary and ambulating activities involving the use of parallel bars, crutches and other walking aids, and lower extremity prostheses or braces. Further studies will include conditions such as cardiovascular disease, cerebral haemorrhage, spinal cord injury, neurological diseases and severe pulmonary disease such as emphysema and asthma.

THICK FILM HYBRIDS IN AUSTRALIA

The thick film hybrid product line of Fairchild Australia Pty. Ltd. has been purchased by Hybrid Electronics Australia Pty. Ltd., Factory 4, 59 Malvern Street, Bayswater, 3153, Vic., and set up as an independent hybrid manufacturing operation.

Dr. Wal Berryman who was responsible for the hybrid line at Fairchild is managing director of the new company. The prime objective of the company is to provide a competitive alternative to printed circuit board component assembly.

Now in Australia

SUPEREX STEREOPHONES

From \$19.50 to the PEP-77D
Electrostatics at \$159.00



NEW from JBL

The revolutionary
Decade \$189.00 each

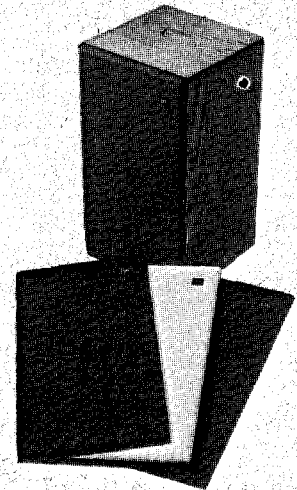

GLEN-DOR

43 THE CORSO, MANLY

Ph. 977-2709 - 977-2415

all shapes and sizes of sub miniature switches

Toggle, rocker, pushbutton, paddle, lever lock . . . every practical alternative lever action combined with maximum performance, minimum weight and size and available in one, two, three and four pole models.

Subminiature switches manufactured by C & K Components Inc. U.S.A. are readily available in just about every shape, size and configuration imaginable and they are readily adaptable to a multitude of uses where space is at a premium.

All switches feature rugged construction and simple mounting . . . long-term, trouble-free operation is ensured.

Toggle switch contacts are rated 2 amps @ 240v. AC and 5 amps @ 28v. DC resistive load. The full C & K range is now available from the Professional Components Department, Villawood, NSW or Plessey Ducon Interstate agencies.

Catalogue containing full specifications, options, information on hardware, panel layouts, mounting, etc. is available on request.

PLESSEY

Plessey Ducon Pty. Limited
Box 2, Villawood, N.S.W. 2163
Tel. 72 0133. Telex 20384

MELB.: Zephyr Products Pty. Ltd. 56 7231
ADEL.: K. D. Fisher & Co. 42 2920
PERTH: H. J. McQuillan Pty. Ltd. 68 7111
Everett Agency Pty. Ltd. 81 5500
N.Z.: Henderson (N.Z.) 6 4189

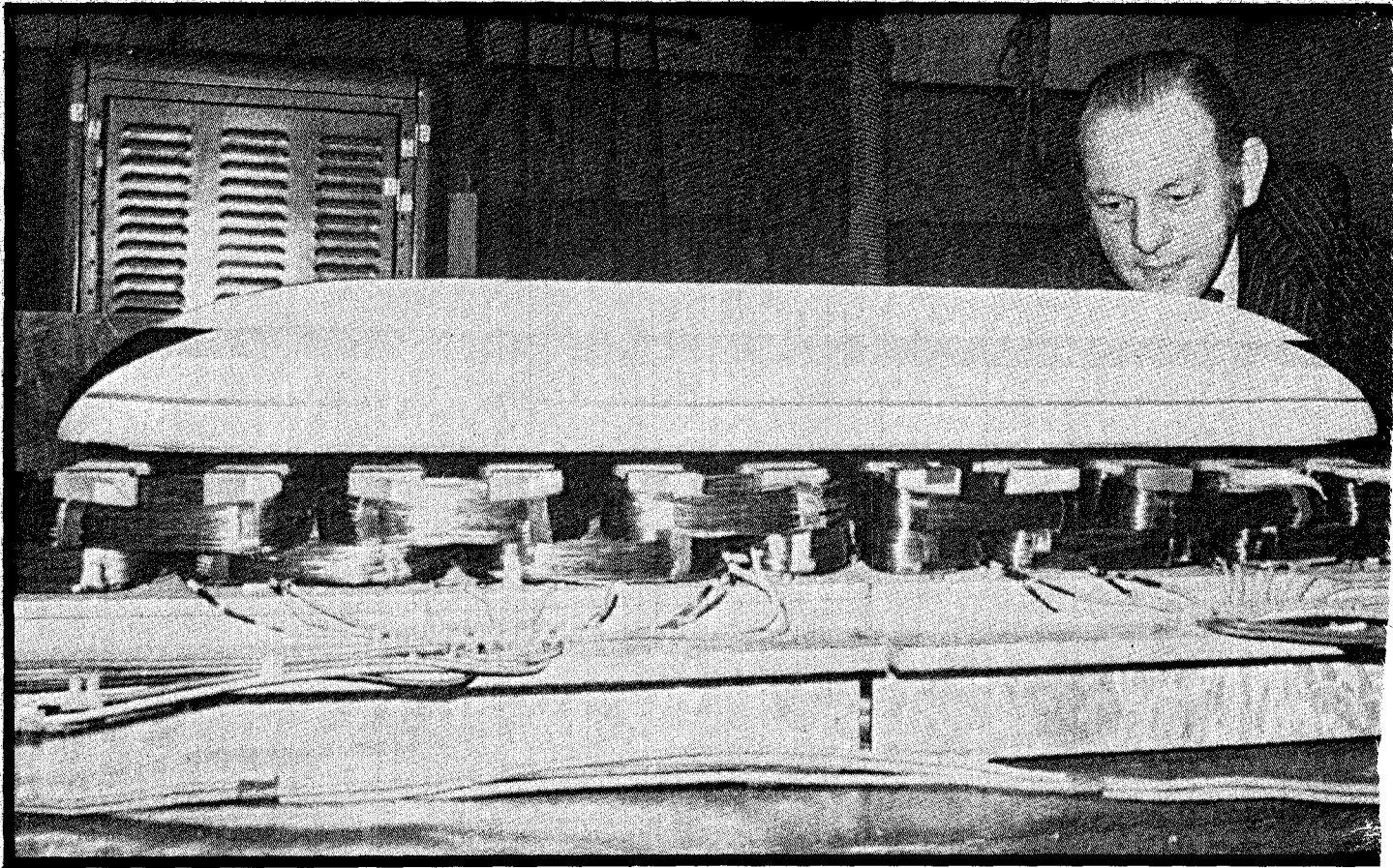

THE MAGNETIC RIVER

By Professor E.R. Laithwaite, Dept of Heavy Electrical Engineering, Imperial College of Science & Technology, London

Professor Laithwaite's article on linear motors (ETI Sept 1973) created a great deal of reader interest. Since then Professor Laithwaite's discovery and development of the 'electromagnetic river' effect has been applauded as the dramatic scientific breakthrough that it unquestionably is. Here Professor Laithwaite describes, in beautifully clear and simple terms, the sequence of events leading to his latest discovery.

SCIENCE is a process of unending discovery — a detective game in which the players, as it were, match their wits against their mental limitations.

But perhaps no attempt to define the process by analogy succeeds so well as that in which the whole is seen as a gigantic jig-saw puzzle, so large that the individual constructors are, in the main, too far apart to see each other! Thus it is a day of great joy when two science workers' efforts are seen to join up in the unique way that belongs to a jig-saw game, bringing satisfaction which perhaps only a true philosopher can know when he discovers a little more of what Sir William Bragg (President of the Royal Society, 1935-1940) described as 'The Nature of Things'.

It is even possible for one constructor to work for years on two different parts of the jig-saw and not realise how close are those two parts — how only one missing piece of the puzzle would join them together. And when that piece is finally found he feels, most of all, a sense of humility that it should have taken him so long to find it.

I hope the relevance of the foregoing remarks will be obvious when I describe how I worked for 20 years, often at great pressure, to make better and better linear motors. Spasmodically I also studied electromagnetic levitation, a highly specialised technology of little interest to most electrical engineers except as a manifestation of the 'magic' of a

4-dimensional phenomenon which we call 'electromagnetism' but will never fully understand. Our ancestors who first *designed* electric motors and generators (as opposed to copying the previous one with the odd alteration here and there) knew well the difficulties of descriptive presentation and invented analogies which would help a whole generation of young men to mass-produce those useful machines. Such analogies included the concepts of 'rotating magnetic fields', 'circle diagrams', 'phasors' and 'equivalent circuits'.

Besides helping the initiators' immediate descendants, these concepts were in fact so good as virtually to throw sand in the eyes of subsequent generations in that the latter, including myself, were taught the subject with a confidence which suggested (a) that it was all completely understood and (b) that all the research had already been done — in other words that all was known that was to be known about electrical machines.

Professor Eric Laithwaite with his most recent laboratory working-model of a high-speed vehicle on a scaled down 'magnetic river' track, photographed at Imperial College, London. The 'magnetic river' can float, guide and propel the vehicle.

The 'missing piece' of jig-saw puzzle which now links the subjects of linear motors and levitation was the study of shape — and the motivation to find it was undoubtedly high-speed transport. A linear motor primary is a highly sophisticated arrangement of coils in slots cut in laminated iron blocks, as shown at Fig. 1, the same basic structure as that which results from the imaginary process of splitting and unrolling a 'conventional' rotating electrical machine. Magnetic levitation, on the other hand, was relatively in its infancy, only a few systems beyond those in which a single coil or pair of coils supported a lump of metal ever having been tried.

The reasons for the lag in levitation research were two-fold. First, there was no great demand for it at the price that had to be paid to achieve it. Secondly, it was not a subject amenable to mathematical analysis as were the more complex but much more systematic systems of commercial motors and generators. As I see it now, the last statement can be more usefully expressed by saying that levitation is three-dimensional engineering whereas machine design has been, until recently, one-dimensional.

What I mean by this needs further explanation. In a rotating machine of the induction type, tradition has it that only machines in which the

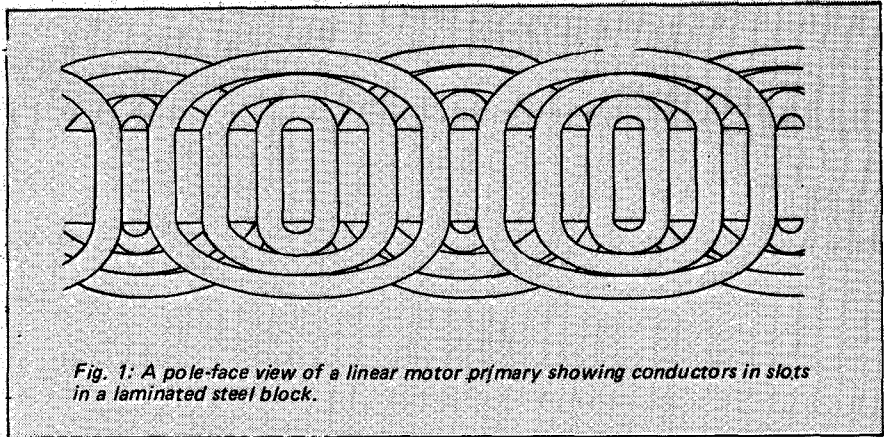

Fig. 1: A pole-face view of a linear motor primary showing conductors in slots in a laminated steel block.

clearance between rotating and stationary parts (the 'airgap' as it is called in English, although the French word *entrefer* is much more meaningful) is small are any good. Be this true or false, it is the way they are manufactured — with the result that the magnetic flux crosses the airgap radially, either 'into' or 'out from' the rotor. Then linearise this machine so that the airgap is in, say, a horizontal plane and the flux in the gap is always vertical and it can be termed one-dimensional.

Suppose, however, we examine the double sided sandwich or sheet-rotor motor shown at Fig. 2, which was thought, in the early 1960s, to be the only possible 'starter' in the high-speed transport game because it simplified the form of track member (the secondary, corresponding to the rotor of a rotary machine) to that of a simple sheet of aluminium. Some of the flux may now bend into the

horizontal plane, as shown at Fig. 3, an effect which conventionalists may regard at worst as sheer waste or, at best, as a means of limiting starting current, for they see it as 'secondary leakage flux' in terms of conventional rotary-motor engineering.

THE ACADEMIC IDEA

But suppose one is an experimentalist and an academic seeking knowledge for its own sake, who follows 'clues' out of curiosity alone. Then it is interesting to remove the top member from the machine shown at Fig. 3 and really 'let the flux bend' in the second dimension. The results of this exercise are quite amazing and instructive. Fig. 4 shows a series of them. Perhaps the first thing to be noticed is that the secondary sheet is levitated as at Fig. 5(a). Having 'seen' it one can 'explain' it simply as the result of horizontal flux lines acting on induced currents which are

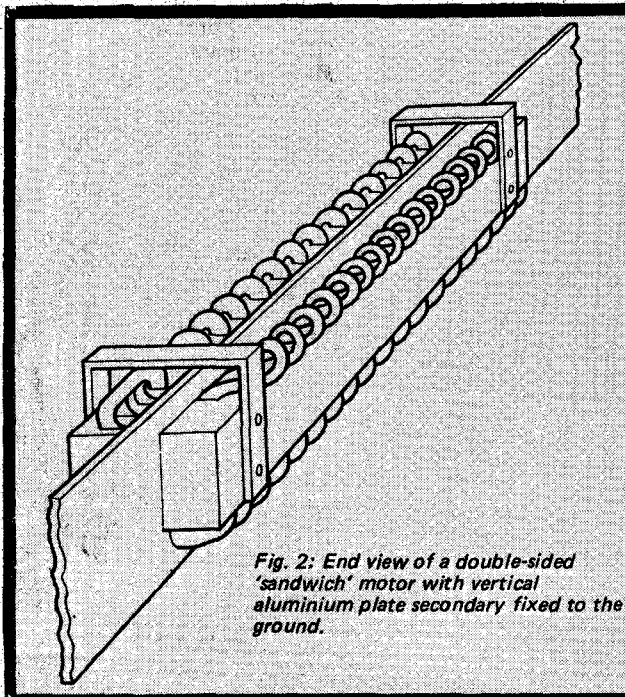

Fig. 2: End view of a double-sided 'sandwich' motor with vertical aluminium plate secondary fixed to the ground.

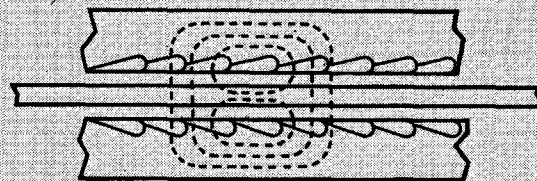

Fig. 3: Flux bending in a plane containing the direction of a motion.

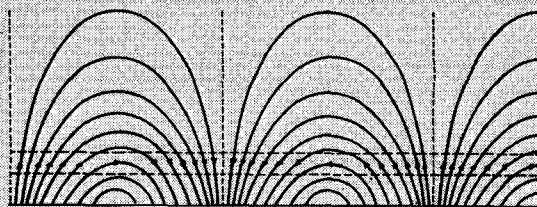

Fig. 4: Flux distribution over an open-sided linear primary.

perpendicular to the plane of the diagram, but this is a dangerous thought-path if pursued far, for those same secondary currents will be found to distort the flux enormously, until it is far from clear how the lift is generated. (Clearly, a good engineer must know how to use analogy and when to stop!) Let it suffice, at this stage, to say that the plate is lifted, but is laterally unstable.

If a conducting cylinder, which is free to rotate on its axis, is held above the open-sided motor with the secondary sheet removed (as seen at Fig. 5(b)) it rotates in the direction shown, suggesting that the magnetic flux behaves like a river of water flowing beneath and just touching the cylinder. If, however, we place the cylinder right in the 'river' so that it rests on the river bed, as at Fig. 5(c),

we might expect that because all forces on the cylinder are to the right, and the point of contact is at rest, the cylinder must roll to the right. It is inconceivable that such a cylinder would roll upstream in water.

But in the linear motor it does! So does a split washer which has no electric circuit. A wire paper-clip unwrapped and re-rolled around the pencil to form a helix will spin just

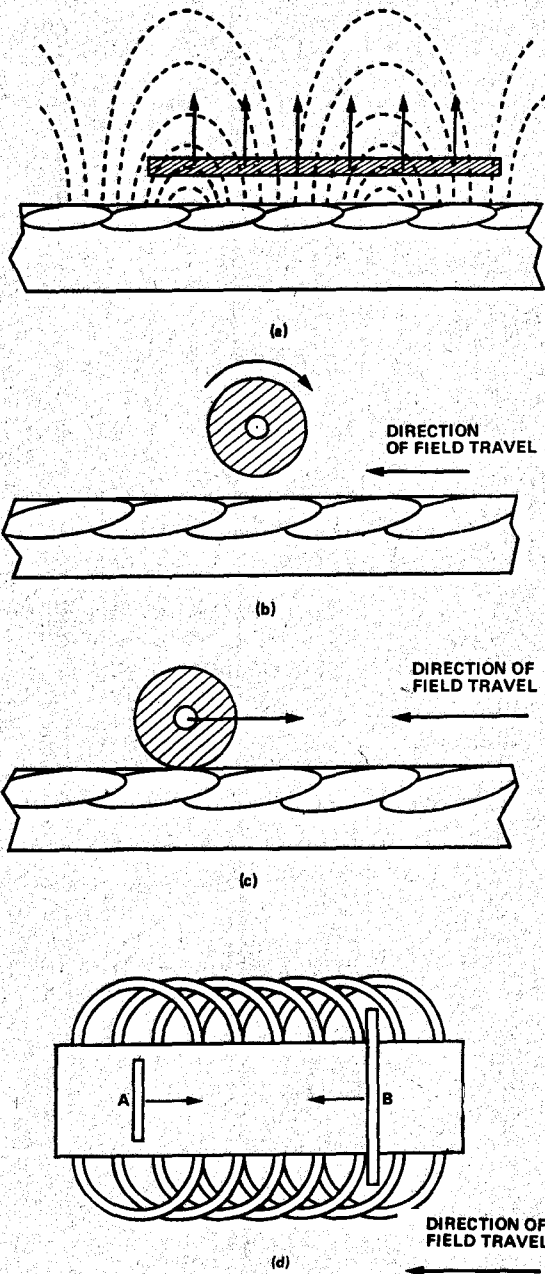

Fig. 5: Phenomena associated with the flux pattern from an open-sided motor:—
 (a) A conducting sheet experiences a lifting force in addition to one of propulsion.
 (b) A copper cylinder held and pivoted above the motor surface spins in the direction shown.
 (c) A copper cylinder in contact with the surface of the motor rolls 'upstream' in the travelling field.
 (d) Opposite rotation of a short steel rod (A) and a long steel rod (B) resting on the motor pole face.

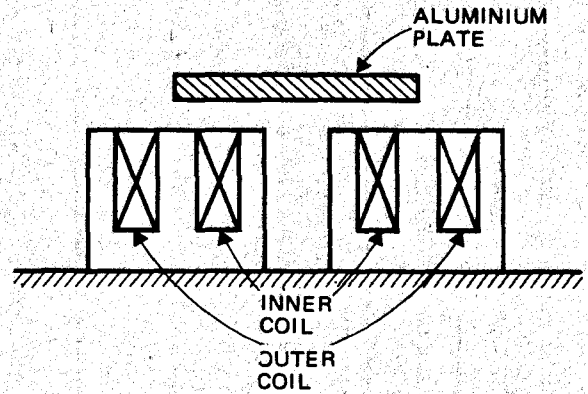

Fig. 6: Cross-section through a cylindrical levitator capable of supporting a conducting disc of the size shown.

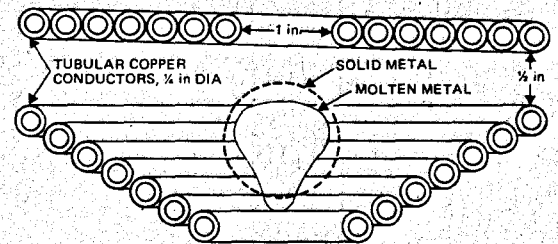

Fig. 7: Cross-section through a liquidmetal levitator using water-cooled tubes as primary windings.

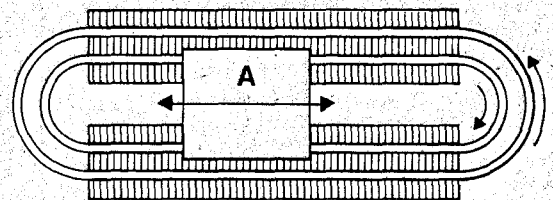

Fig. 8: Plan view of a concentric coil levitator with coils elongated to float rectangular sheets with neutral equilibrium in one horizontal axis.

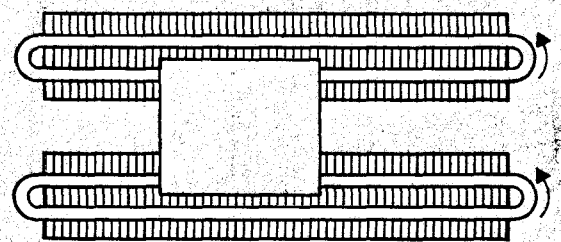

Fig. 9: Rearrangement of the coils shown in Fig. 8 produces the same basic system and the same result.

like the copper cylinder in Fig. 5(b). However, it is not the purpose of this article to 'explain' these phenomena; they were part of the evidence from experiments which led me into a three-dimensional line of thinking.

So far, we have bent the flux only in two-dimensional planes. My introduction to the third dimension came through the experiment shown at Fig. 5(d). A short steel rod rolls 'upstream' because steel is a conductor of electricity, just as is copper. But a long rod of the same diameter and material — a rod which is longer than the motor is wide — rolls very positively *downstream*! The explanation of this phenomenon took several months, until it was realised that in this instance the important flux was that which proceeded laterally and induced circumferential currents in the rod. The third dimension had made its presence felt at last.

Within a year of that explanation we were building 'transverse flux machines' (TFM) in which the whole of the working flux was conducted in lateral paths.

LEVITATION PUZZLES

Turning now to the other 'working edge' of the jig-saw puzzle — that is the levitation — the double-coil, circular plate levitator as shown in cross-section at Fig. 6, having completely cylindrical symmetry about a vertical axis, was known as far back as 1939. Levitation of liquid metals using high-frequency currents (in the order of 10-50 kHz) was also much discussed in the 1950s, a typical coil system being shown in cross-section at Fig. 7. Again the geometry was cylindrical, for man seems reluctant to abandon circles, even when an alternative is demanded! However, by 1960 the circular coil arrangement of Fig. 6 had been extended in one dimension to enable rectangular conducting sheets to be supported and (seen later to be of greater importance) to enable them to have one neutral axis along which they could be moved without any electromagnetic retardation.

Figure 8 shows a plane view of such a levitator in which the aluminium plate A is capable of unrestrained motion in the axis indicated by the arrows. It was further discovered that, unlike the circular plate devices in which the two primary coils required different numbers of ampere-turns (AT) from each other and a phase lag of approximately 30° on the inner coil current, the two coils of the system shown at Fig. 8 could each have the same AT and be connected in series with opposite sense as shown. It was then realised that for a very long primary system the ends of the coils were not detectable by the secondary

sheet and therefore from a suspension stability point of view the system is unaltered if the two coils are replaced by two narrower coils arranged non-concentrically, as shown at Fig. 9. This allows different widths of plate to be levitated on different occasions without rewinding the coils.

In 1966 the principles of the air-cushion vehicle and the linear induction motor were combined by the launching of Tracked Hovercraft Ltd. (THL) — an ill-fated marriage of electromagnetism and aerodynamics so far as Britain was concerned, as events in 1973 were to demonstrate. Earlier than 1966, Monsieur Bertin had demonstrated in France the possibility of an all-aerodynamic system using air-cushion support and lateral guidance and airscrew propulsion (later to be replaced by rocket propulsion).

When between 1960 and 1970 the world awoke to the need for a reliable high-speed ground transport system, all but M. Bertin opted for linear motor propulsion, although with a variety of lift and guidance mechanisms of which an air-cushion system was only one possible option.

A method with the obvious advantage of requiring no power for lift was to use a permanent-magnet array on the vehicle repelling a track-mounted system of similar magnets. Much was claimed for the use of new magnetic materials in such a system and it was some time before the basic properties of permanent magnets were seen to make them commercially unacceptable. First, because an arrangement of permanent magnets can never be self-stabilising, some additional stabilising equipment would be required on both vehicle and track. Secondly, anyone who designs a repulsive magnetic system invites the use of very constricted magnetic circuits, where only low effective-flux densities can be achieved without enormous quantities of permanent magnet material. Thirdly, and perhaps

worst of all, the system is not electromagnetic in that there is no current generated in track or vehicle, and is therefore not entitled to the benefit of the 'bigger-the-better' rule pertaining to electromagnetic systems, but rather the reverse. It is an irony of nature that small magnetic things work splendidly and only when you have spent your money on a big version do you find that you have wasted it!

SERIOUS PROPOSAL

A much more serious proposal, however, was to use electromagnets — whose strength could therefore exceed that of permanent magnets and yet be controlled — to attract rather than to repel, thereby employing good magnetic circuits instead of inherently poor ones.

The system is a simple piece of control technology. The track carries a pair of strips of steel, preferably on an 'under surface' (although vertical surfaces are possible, using the less-effective shearing forces rather than the attracting). The electromagnet system is fastened to the vehicle and positioned under the strips so as to attempt to lift the vehicle until the magnets make contact with the strips. Before final contact occurs, a detecting device — for example a light-beam and photoelectric cell — indicates that the magnets are within x millimetres of the strips and sends signals to an amplifier, whose output feeds the electromagnet, to control their position at a distance x from the strip. The same system can then be used for lateral guidance.

This removes two of the disadvantages of the permanent-magnet system. It is stable and has a good magnetic circuit, but cannot be scaled up indefinitely without penalty, the most probable aspect of which will be seen in the cost of track maintenance.

The maximum lifting force per unit area of poleface from a magnet is fixed

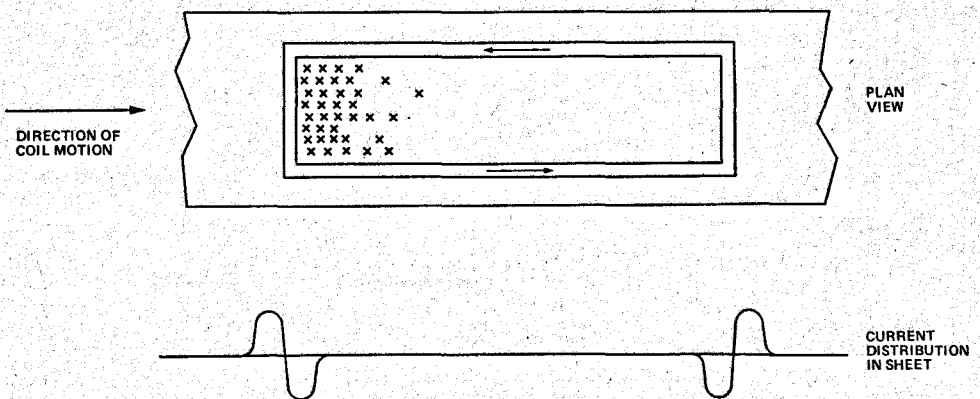

Fig. 10: Flux distribution from an induced electromotive force due to a large rectangular coil moving over a conducting sheet.

by peak flux density and therefore the total lift can only increase as the square of length. But vehicle weight tends to increase with the cube of linear dimension and therefore a vehicle scaled up by a factor of two requires eight times as much lifting force and therefore eight times the magnet pole area. Even if the mechanical clearance remains the same for the larger vehicle, the same magnetic length will be needed to produce the same flux density. The magnets will therefore be eight times as heavy but occupy twice the relative track area compared with the vehicle track coverage, in relation to the same ratio for the smaller vehicle. If, however, a greater mechanical clearance is required for the larger vehicle, magnet volume will increase more rapidly than vehicle volume, as the size increases, and this is a much more serious limitation than pole area.

Protagonists of the amplifier-fed electromagnetic suspension system, often known as 'mag-lev' (confusingly, for the same name is used for cryogenic levitation systems) claim that weight support can be obtained for such low power input as 1 watt/kg. No one can doubt this, for a crane-magnet lifting scrap-iron in a breaker's yard can lift 3 tons of metal for a total input of 80 watts (= 0.027 watts/kg). However, this figure has virtually no relation either to the size of amplifier needed or to the power it must handle. The amplifier is present in the system to correct disturbances

in supported height or in lateral displacement (a second amplifier being required for the latter axis). If the steel grip in the track is inaccurate to the extent of 1 mm of height per metre of track, a 50-ton vehicle requires 11 watts/kg to correct such a disturbance when travelling at 450 km/h (a total of over 0.5/MW of 'handled' power). The lateral guidance and roll stability may suffer even greater disturbances if a gust of wind, acting on the whole vehicle-side area, is timed by ill fortune in unison with a lateral track inaccuracy. Track maintenance will present real problems in this respect.

The alternative 'mag-lev' system uses a large air-cored superconducting magnet which has the advantage of being capable of producing flux densities in the order of 7 tesla, which cannot be matched by any other type of electromagnet. When such a magnet is draped over a conducting plate it induces currents in the latter which, being of opposite sense, repel the magnet that produced them; so lift is obtained by such an inductive system. The penalties are incurred, of course, in the costs of the cryogenic coil, of maintaining it at low temperature (a liquid helium supply), and of the aluminium track sheet. It can be argued of course that the latter is needed for linear motor propulsion anyway, but whether the same thickness will 'match' — that is suit — both requirements is a subject which so far has not advanced beyond

speculation. A simple coil-and-sheet arrangement is not laterally stable and as with feedback amplifier systems must be repeated in a second axis, so that the track is not a sheet but a 'channel' of conductor

FLUX EFFECTS

Figure 10 shows the effect of the plate currents on the flux produced by a simple rectangular cryogenic coil at speed. Flux can redistribute itself over the surface of a direct-current electromagnet of any kind without changing the line-linkages and therefore without inducing electromotive forces. The resulting plate currents are therefore virtually confined to the back edge of the magnet, and their effective 'pole-pitch' (to use induction-motor parlance) is relatively small. Small pole pitches mean low 'goodness factors', which is why the cryogenic lift system requires large thicknesses of sheet to compensate for lack of pole pitch dimension.

Flux-shifting can be avoided by the use of more elaborate coils, such as the concentric system shown at Fig. 11. But cryogenic technology has not yet reached this level of sophistication; when it does, it will enable secondary currents to be distributed in long pole pitches as shown — resulting in high 'goodness factors' and lots of lift with thin track sheets. However, there will then also be lots of drag! The system is now seen to be an induction motor in reverse, having a pole pitch and flux

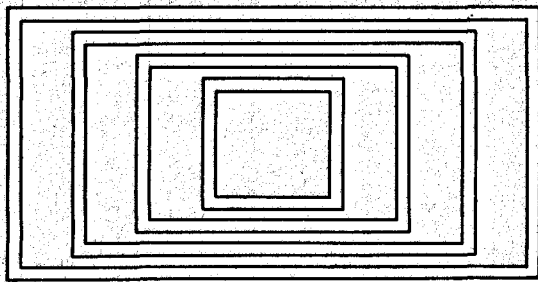

Fig. 11: A more elaborate air-cored coil intended to distribute flux and induced electromotive force more effectively.

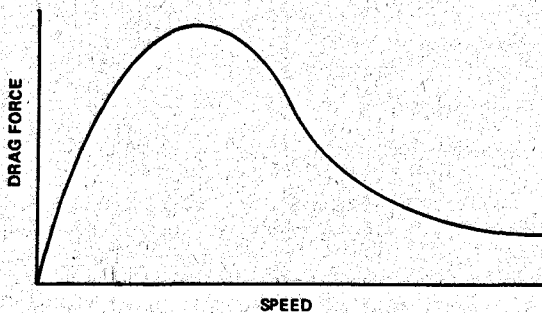

Fig. 12: Speed-drag curve of a superconducting levitating magnet.

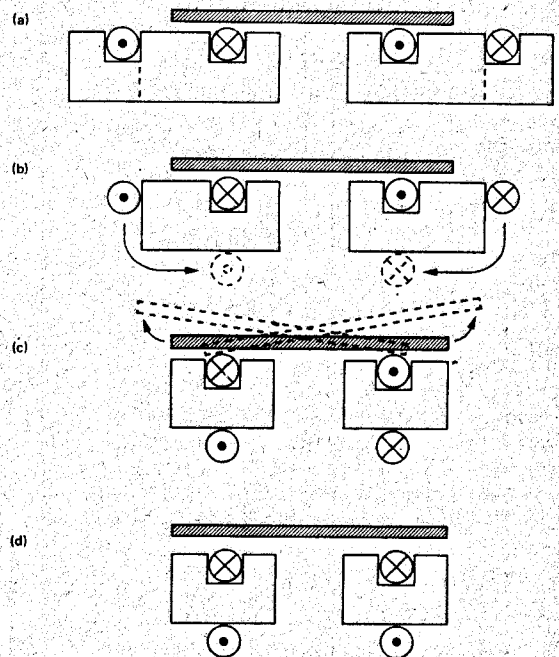

Fig. 13: Developing topology of the magnetic river: (a) Cross-section through the levitator shown at Fig. 9. (b) Removal of the outer teeth and associated core. (c) Repositioning of the return sides of the coil makes the plate unstable. (d) Reconnection of one coil restores stability.

density appropriate to a 400 km/h linear motor at rest, and its speed-drag characteristic is of the form shown at Fig. 12.

Now such a system is basically an inductive system, as is the one shown at Fig. 9. In 1972 an international exhibition ('Transpo 72') was held at Dulles, near Washington, United States of America, where THL proposed that it, along with organisations from other countries, should demonstrate a working model of a practical high-speed system. Knowing of the public's concern about noise and environmental pollution, we decided that the British exhibit should if possible be all-electromagnetic. It was realised however, that such systems were more difficult to make successfully as they were scaled down, so it was proposed to invert the linear motor propulsion system — putting the primary on the track — and to switch it on in short sections as required, allowing each section to cool for perhaps 90 percent of the running time. The levitation and guidance system already existed (Fig. 9) and it was clearly possible to put the linear motor primary between the two halves. But the width of the levitator overall was 425 cm on the 9 m run to which the exhibit was restricted, a vehicle longer than 90 cm would look ridiculous, and to scale down a practical design meant that the track width should be only 10 cm.

We doubted our ability to design a system of that size which could be run continuously, lamented the fact that no one would believe us if we ran it for only three seconds every 20 minutes or told spectators that 'all would come right when it was scaled up', and decided to attempt some new shapes which might be better.

'First of all', I agreed with my colleague Dr. J.F. Eastham, 'we know that electromagnetic levitation is all a matter of edges.' In a cross-section of the levitator of Fig. 9 (shown at Fig. 13(a)) it seemed unlikely that the edges of the outer 'tooth' could influence the plate edges (it being known that the best width of plate for lateral stability bisected the centre tooth almost exactly). Having — mentally — removed these teeth, the iron beneath the coil outer limbs could clearly go also, leaving us with the situation shown at Fig. 13(b). 'Now,' I argued, 'the primary flux links with both plate and coil (as shown), and a linkage is a linkage however it is effected, so it ought to be possible to return the lifting currents in the coil inner members beneath the steel,' as shown at Fig. 13(c). This would reduce our 425 cm wide machine to 20 cm.

Unfortunately, when we tried-out

the system it was completely unstable laterally. Then Dr Eastham remembered an earlier occasion when someone accidentally connected the machine shown at Fig. 8 with one coil reversed — which seemed to have a little effect on the lift and stability. He therefore reconnected the system of Fig. 13(c) with one coil in reverse (as in (a)) and at once obtained stability. At this point a manufacturer (Linear Motors Ltd) was consulted and this firm pointed out the difficulties of manufacturing 9 m of such primary as a continuous piece and shipping it to Washington.

'Could it not,' asked a THL employee, 'be made in sections and coupled together on site?' I pointed out that there were hundreds of strands of wire in each coil and 100-pin plugs were out of the question. But within seconds Dr Eastham said, 'Not only could you make them in sections, but in very short sections each with its own winding, and you could feed the windings from successive phases of the supply', a concept which eliminated the need for a separate driving motor. So was the vital missing piece of the jig-saw fitted into the pattern.

The magnetic river had come to light!

NEW SEQUENCE

This single notion was to trigger off a whole new sequence of thinking. It led ultimately to a system using only a single row of transverse 'C-core' electromagnets, as shown at Fig. 14(a), and the 'Transpo 72' demonstration was assured of success at only 10 cm width. But much more was to follow.

In May 1972, the date of 'Transpo 72', we were convinced that our track was no more than a scientific toy — and a very expensive toy, for it cost over 220 watts/kg lifted. All but five per cent of the input was lost in heat

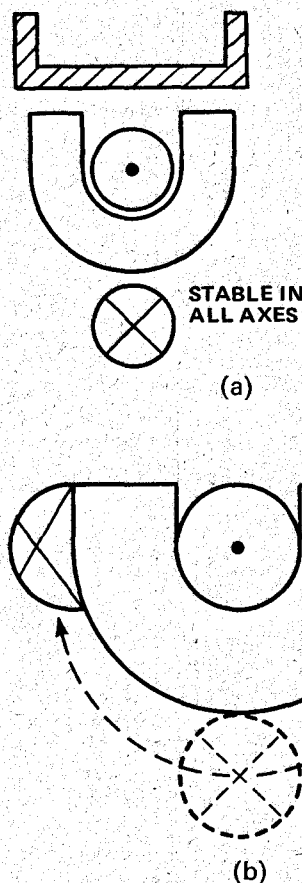

Fig. 14. Single 'C-core' magnetic river apparatus in cross-section: (a) Return current beneath the core. (b) Return currents led back up each side of poles.

in the secondary aluminium plate and the primary windings, making us realise what a poor system it was when regarded purely as a motor. But suppose we took one step back in the topological chain, to Fig. 14(b), and put 'standard' windings in what is effectively just a double row of 'teeth', as shown at Fig. 15. Now the currents induced in the plate are much better utilised than those in the crude

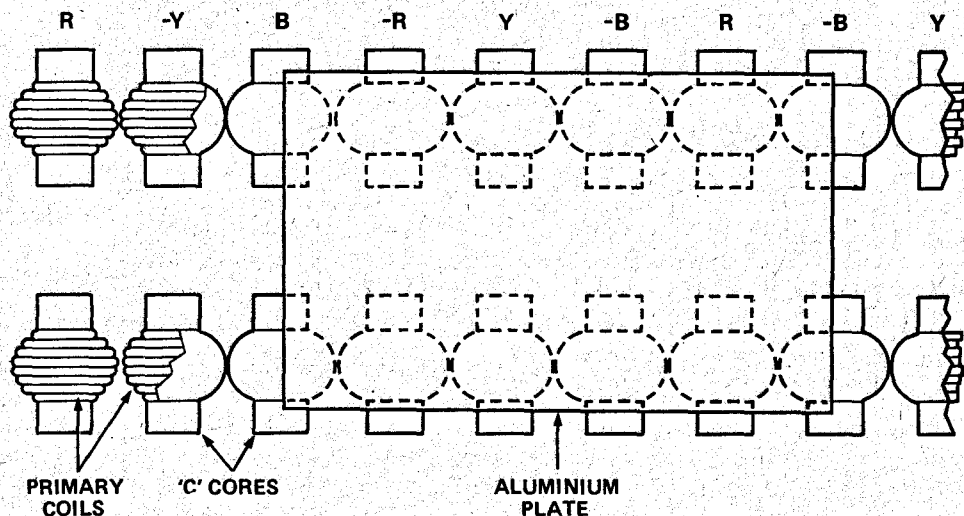

Fig. 15: The magnetic river seen (pole-face view) as simply a pair of parallel linear motors.

'Transpo 72' model — so well used, in fact, that the machine might operate at a 90 per cent efficiency (if it were made large enough). What then provided the lifting forces?

For a few days it appeared as if lift and drive could not be had simultaneously, for we already had both calculated and experimental results showing that lift force became zero at quite a high value of slip, as shown at Fig. 16. For higher speeds the lift was replaced by an attractive force which increased rapidly with increase in slip. So who was prepared to run at half speed and possibly 45 percent efficiency, just to get lift and guidance?

The final concept came quite suddenly. In a normal rotary induction motor, such as might be found in an ordinary washing machine, there are two sets of forces acting on the spinning rotor:

(1) tangential forces producing the rotation as the result of interaction between airgap flux and rotor current:

(2) radial forces arising from pure magnetic attraction between rotor and stator iron.

The forces in (2) are some 10-20 times bigger per unit area than those of induction described in (1). They are an embarrassment to the machine designer who finds that, if his rotor be only a fraction of a millimetre out of centre, the radial unbalance of these enormous forces bends the shaft. It has been the lament of engineers since Boucherot (1905) that they cannot use these magnetic forces in conjunction with continuous motion. But if *power* was associated with them *pro rata*, the washing machine motor could never exceed five per cent efficiency, and we know this not to be so. So long as there is no radial

movement, there is no mechanical power output and no inherent requirement for power input.

Linearise the machine and the fact becomes that, for no lateral or vertical motion, no power loss is necessarily incurred. It is necessary only to be sufficiently ingenious to know how to build vertical and lateral forces into the design. Then there remains only the problem of how to convert attractive force into repulsive force at high speed.

In a conventional rotating machine the rotor is subject to a radial pull which is proportional to the square of the flux density and inversely proportional to the free space permeability.

This is expressed mathematically as follows:—

$$F_{rp} = \frac{B^2}{2\mu_0} \text{ per unit area.}$$

where F_{rp} = radial pull.

B = flux density.

μ_0 = free space permeability.

Few realize that this formula is incomplete because, as primary and secondary currents flow in opposing directions, the field coil and the rotor repel each other with a force proportional to the square of the current loading per unit length of airgap times the free-space permeability.

The formula for this repulsive force may be expressed as:—

$$F_r = \frac{\mu_0 J^2}{2}$$

where F_r = radial pull.

J = current loading per unit length of airgap

μ_0 = free space permeability.

Thus the full formula for attractive force between the rotor and stator is

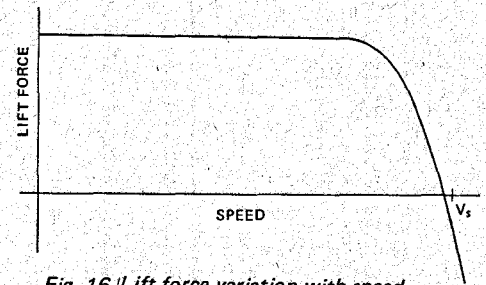

Fig. 16 Lift force variation with speed

the difference of the two forces. That

$$\text{is } - \frac{B^2}{2\mu_0} - \frac{\mu_0 J^2}{2}$$

In a commercial washing machine motor the repulsive force is only a few percent of the radial attractive force and hence is usually neglected.

But the basic rule of linear motors, where airgaps are much larger than in rotary motors, is to use wide slots and narrow teeth so that J is big and B is small. Since each term in equation (1) involves the square of the variable, little re-adjustment of B and J is necessary before the first term becomes but a fraction of the second and the equation may be written in terms of the repulsive force thus:

$$(\mu_0 J^2 / 2 - B^2 / 2\mu_0).$$

Thus by correct design, the linear motor may provide lift as well as propulsion without extra power input. While the world's electrical machine designers argue about whether feedback amplifier magnets or cryogenic coils or air-cushions are best for the suspension of high-speed vehicles, the sparkling jewel lies exposed for all to see. We can now design linear motors to give lift and guidance without additional equipment and for no additional power input.

So what are we waiting for — a miracle? ●

F.M.SOUND

FROM A.M. RADIO

The new improved Audiosound AM100 null tuner brings to you A.M. radio with a clarity & definition which is virtually limited by the original studio signal.

For an interesting demonstration contact:—



AUDIOSOUND ELECTRONIC SERVICES

148 Pitt Road, North Curl Curl. 2099 Phone 938-2068

YOU'RE LIVING IN THE HI-FI YEAR

20 A.S.

This is the Hi-Fi Year 20 A.S. *Twenty years AFTER SANSUI.* Twenty years after Sansui successfully introduced a hi-fi amplifier to the world markets. *Twenty years of Sansui achievement. Twenty years of dramatic changes on the hi-fi scene. We've seen the introduction of the stereo recording... and four channel equipment...* and Sansui has been there, pioneering research and development for the ever growing international audio market.

Today Sansui equipment leads the field, at home in Japan and overseas. Sansui's formidable reputation has been built around the performance and reliability of the Sansui product. With Japan's most dedicated electronic engineers at the drawing boards and supervising production, it's not surprising.

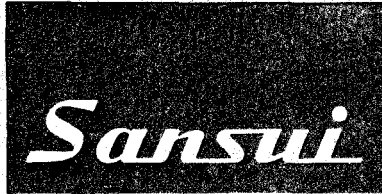

Sansui sets world wide standards for audio equipment. You're always ahead technically when you buy Sansui. And you get extraordinary value for money. See your Bleakley Gray dealer!

What's in the Sansui range in the Hi-Fi Year 20 A.S.?

- STEREO AMPLIFIERS
- FOUR CHANNEL AMPLIFIERS AND RECEIVERS
- FOUR CHANNEL "ADD ON" UNITS
- STEREO TUNER/RECEIVERS
- SPEAKER SYSTEMS
- TUNERS
- HEADPHONES
- TWO AND FOUR CHANNEL TAPE DECKS
- STEREO CASSETTE DECKS
- TURNTABLES/SOUND SOURCES
- MANY AUDIO ACCESSORIES.

Sansui equipment is distributed throughout Australia by the Bleakley Gray Corporation Pty. Limited, a Division of Rank Industries Australia Pty. Limited. Sales and service facilities are nation wide... and Sansui performance is matched only by the enthusiasm of the specialist hi-fi stores... *the men who sell Sansui.*

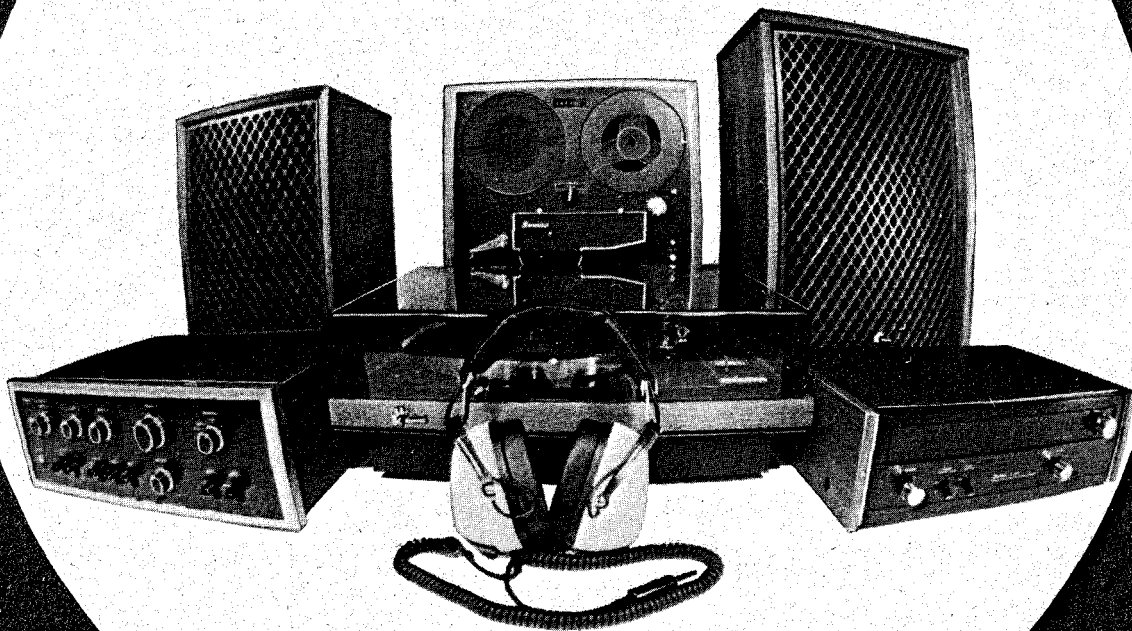

Sansui equipment is manufactured by:— Sansui Electric Co. Ltd., 14-1, 2-chome, Izumi, Suginami-Ku, Tokyo, Japan.

Sole and Exclusive Distributors: Australia, including N.Z.A.

Bleakley Gray Corporation Pty. Limited.

A MEMBER COMPANY OF

RANK INDUSTRIES AUSTRALIA

INTERNATIONAL REPRESENTATIVES: U.K. Philips Music House, Birmingham; Darwin, Pat. 3891; East & West MacFarlane Pty. Ltd., 27 Leppie Street, Queensland; Ed. 2 224

Melbourne Office: 59 Queen Street, Melbourne, Vic.
 Tel: 51 0281, Telex: 31924
 Sydney Office: 77 Pitt Street, Sydney, N.S.W.
 Canberra Office: 27 Macquarie Street, Canberra, A.C.T.
 Adelaide Office: 25 Bowden Street, Adelaide, S.A.
 Brisbane Office: 14 Prince Street, Brisbane, Qld.
 Perth Office: 27 Oxford Street, Perth, W.A.



**Instrol
System
239**

**Complete Hi-Fi Catalogue
50 cents**

**INSTROL
HI-FI**



**Instrol
System
339**

**J.B.L.
System
799**



... \$229.00 including FREE OF CHARGE the JBL belt-drive turntable, featuring the Exact tone arm MOC-202E, acoustically sprung base and hinged cover. Special System offer: \$799.00

YOUR **HI-FI** SYSTEMS

**INSTROL
HI-FI**

MELBOURNE
175 Collins St.
Phone: 55 4795

SYDNEY
175 Macleay St.
Phone: 36 4795

SPECIAL BONUS OFFER

These systems will be delivered **FREE** to any city or town in NSW or Victoria as well as Brisbane or Adelaide.

DOUBLE WARRANTY

Each system is not only covered by the manufacturer's warranty but also by INSTROL'S own full guarantee.

... have the finest personal sound system available in a quality system at such a low price. They are backed by a 5 year warranty and come in the largest range of coloured speakers in the world. The Monarch 80 amplifiers, 24 balanced turntable, combination and ADC magnetic cartridge complete this system. All for only \$429.00

**SONAB
System
429**

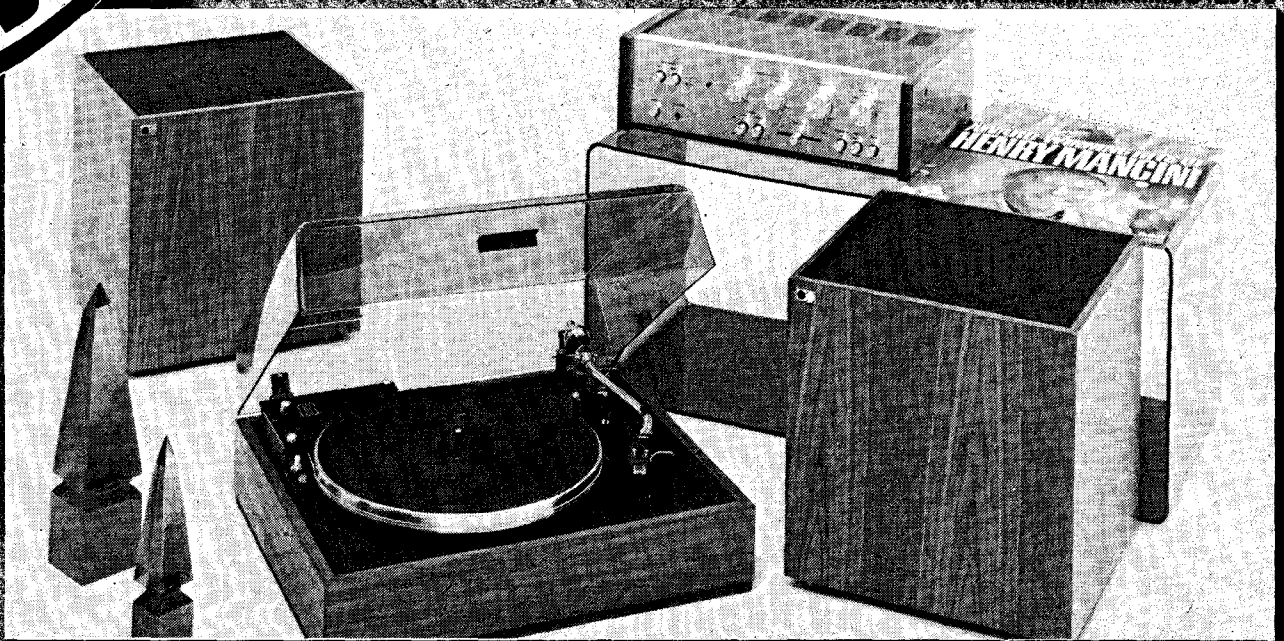

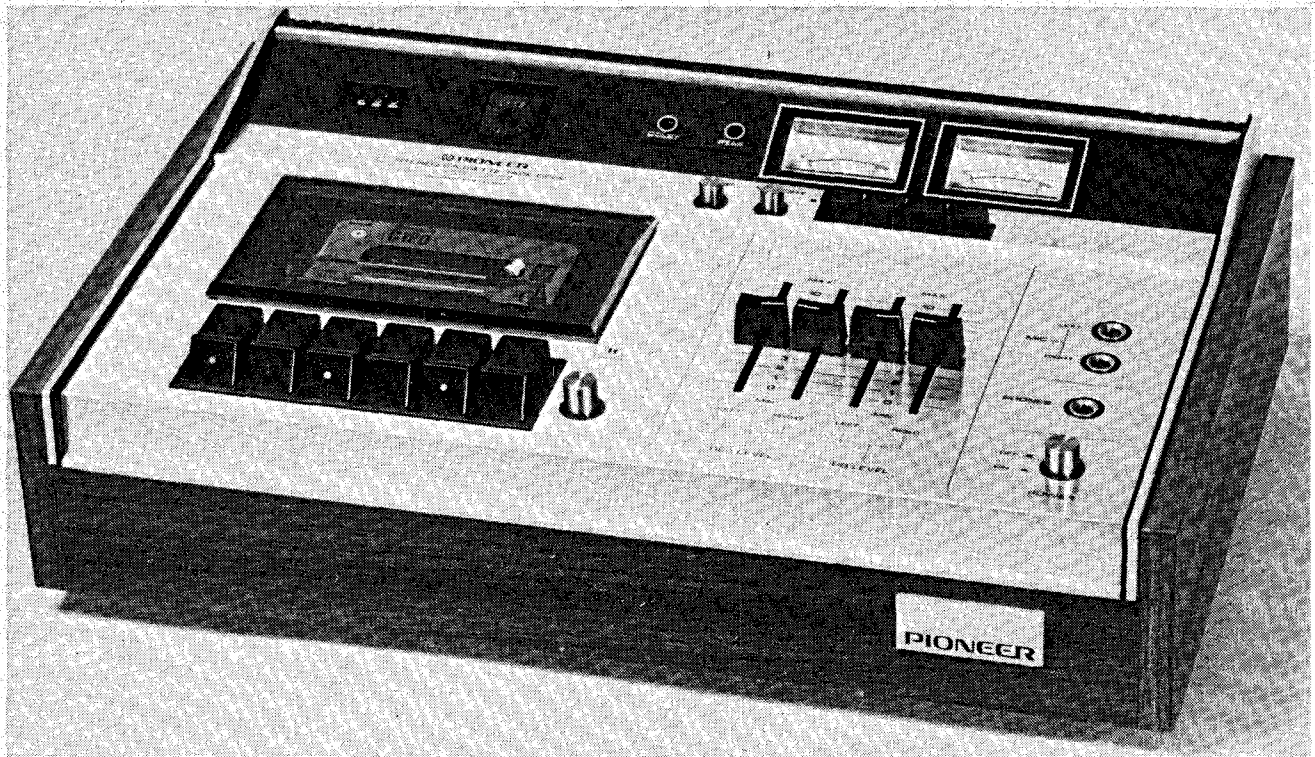

PIONEER CT 5151 Cassette Recorder

Moderately priced machine has performance equal to reel-to-reel recorders

TWO TRENDS are clearly emerging in cassette recorder development.

The first of these is for designers to produce big and expensive machines that — sometimes successfully — emulate the performance of their reel-to-reel counterparts.

The second trend is towards smaller decks — at a much lower price — which nevertheless offer the features that the great majority of people want in a cassette machine.

Pioneer's CT-5151 reviewed here is in this second category. It is in many respects very similar to the CT-4141, reviewed by Electronics Today International in February 1973 but has a number of changes that have significantly improved performance.

MECHANICAL CONSTRUCTION

The deck is divided into three main areas. At the back there is a sloping raised fascia of black plastic. This has a satin brushed aluminium inset —

fortunately finger mark resistant. This inset panel contains, from left to right, a three digit tape counter plus reset, a tape run bezel in the form of a circular rotating light, yellow during play, and illuminated with red during record, and two small bezels which respectively indicate Dolby selection and tape over-recording. To the right of these bezels are two fairly small V-U meters.

Immediately below the V-U meters are a row of push buttons of which the one on the extreme left is a skip button. This operates electronically, disconnecting the regulated motor drive to increase play speed. The skip button is only effective in the play mode and allows the tape to run at twice the normal speed with the playback head engaged. This facility makes it possible to find a passage in the middle of a tape without the inconvenience of having to stop and revert between play and fast rewind to find the exact point on the tape that

you are looking for. The facility could also be quite handy for dictation purposes.

Next to the skip control is a memory on-off switch which, on rewind, returns the tape to the 999 position indicated by the three digit counter. To the right of the memory switch are four black push buttons for Dolby noise reduction on-off, separate bias and equaliser selectors for normal or chromium dioxide tape, and at the extreme end a limiter on-off switch whose function it is to prevent overmodulation of the recorded signal.

The largest section of the recorder deck lies in front of these controls, and consists of two sections. To the left, is a large cassette well with clear plastic cover. This is one of the best that we have encountered, in that it facilitates instantaneous and positive identification of the cassette.

The pause button, unlike most others, is not a lever switch but a polished aluminium button. This

Recommended retail price — less than \$350.

facilitates identification and, in keeping with the latest trends, offers two levels of operation — pause at the intermediate level, and a lock-pause mode when fully depressed.

Slider controls are provided for record level and playback level.

Two standard tip and ring sockets are provided for high impedance microphones, together with a socket for eight-ohm headphones.

RCA-type coaxial type sockets are provided for line input and line output, and one DIN socket for record playback.

The case of the unit is a composite of veneered wood and plastic.

USING THE MACHINE

Operation of this unit is simple and straightforward. The designers have overcome many of the pitfalls of previous cassette decks through the use of a number of simple design features. The first of these is that the drive system uses a dc motor. This overcomes the need for interchangeable pulleys to cater for 50 Hz or 60 Hz line frequency operation. The second is an improvement in heads and their configuration in order to extend the frequency response beyond that of the previous CT-4141 deck. Now, the performance is so good, that, with normal gamma ferric oxide cassettes, performance is equal to that previously achieved with chromium dioxide tapes. With chromium dioxide tapes performance is almost comparable with reel to reel machines.

We tried a number of cassettes of various brands in the machine and found that, provided the controls are set as recommended in the excellent 16 page handbook, the frequency response is more than acceptable for most discerning users.

Unlike the CT-4141 where we found it necessary to optimise the performance for various tapes, the CT 5151's frequency response was quite good enough (on most brands of tape) not to require this form of optimisation.

In keeping with the CT-4141, Pioneer have again provided a limiter switch with a relatively sharp transfer characteristic which clips the signal quite effectively, at +2.5 dB. When



this limiter circuit is not used the peak overload light comes on, at +3 dB, to indicate overmodulation. The use of the limiter, as well as reducing overmodulation, significantly reduces second and third order harmonic distortion — the most unpleasant feature of overmodulation (or excessive recording levels).

It is interesting to note that the overall shape of the frequency response curve obtained with the CT-5151 is very similar in the low frequency region to that provided by the CT-4141 previously tested, but the mid-frequency linearity and high frequency response particularly with the gamma ferric oxide tapes, are

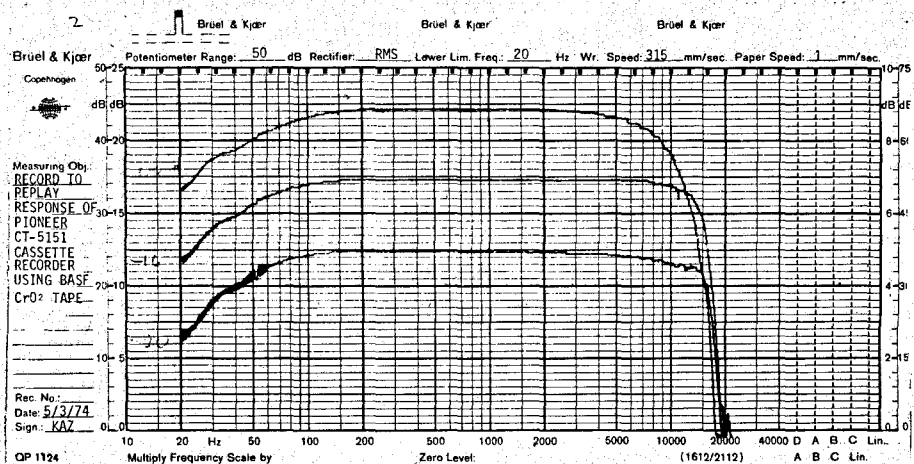
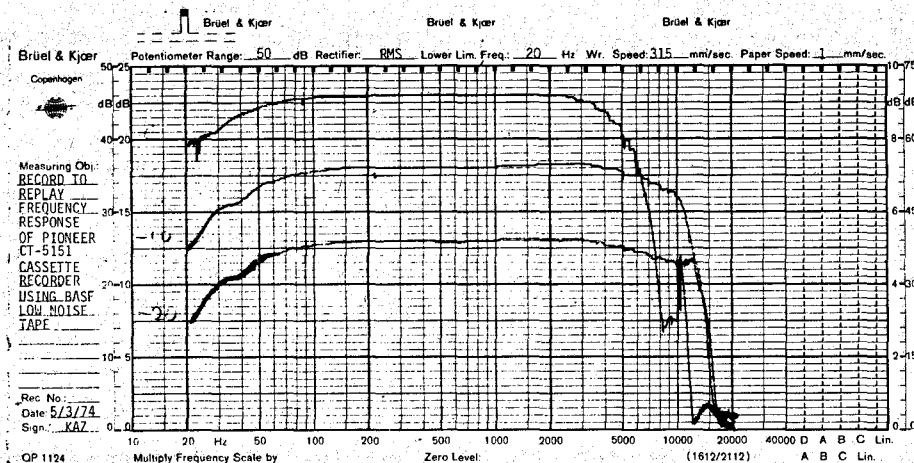

The drop out shown on the top graph (OVU) was due to a characteristic of the test tape used — not the recorder.

SUPERIOR STEREO TURNTABLES

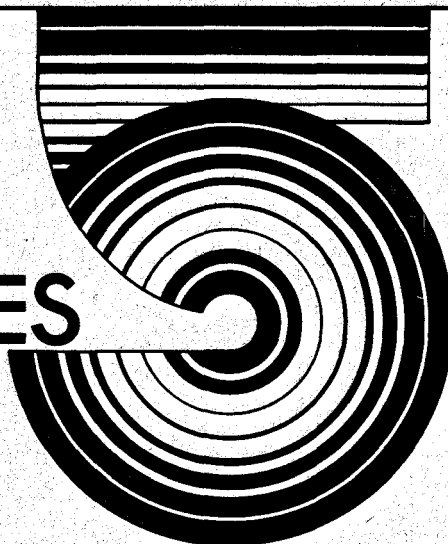

Years Guarantee

BD 2000A

A manual player of simple trouble-free design, featuring:

- 4 pole synchronous motor.
- 30 cm aluminium die cast platter weighing 1.2 kg.
- 0.1% wow and flutter or less.
- Fitted with MC 10 magnetic cartridge with 0.7 mil diamond stylus.
- Overall dimensions: 460 mm (W) x 357 mm (D) x 185 mm (H).

Price \$139

BD 6000

A manual player for the connoisseur with advanced tone arm design and extremely low rumble. Perfect for 4 channel.

- Completely isolated 4 pole synchronous motor.
- Less than .07% wow and flutter.
- Full anti skating compensation.
- Fully sprung suspension.
- Fitted with MC 20 cartridge with frequency range to 40 KHz.
- Stylus cleaner.
- Overall dimensions: 500 mm (W) x 405 mm (D) x 190 mm (H).

Price \$199

BA 600

A fully automatic design with a simplified mechanism for maximum reliability, featuring:

- Belt driven 30 cm platter weighing 1.2 kg.
- Four pole synchronous motor.
- Less than 0.1% wow and flutter.
- Static balance tone arm with anti skating compensation.
- Fully automatic and manual operation.
- Fitted with MC 8 magnetic cartridge.
- Overall dimensions: 460 mm (W) x 357 mm (D) x 185 mm (H).

Price \$169



Sole Australian Distributors & Importers **JERVIS AUSTRALIA PTY. LTD.** P.O. Box 6, Brookvale, N.S.W. 2100, Telephone 939 2922

substantially improved.

The performance achieved with chromium dioxide is remarkably flat, and a credit to the machine. This improvement is a result of the record bias, as well as the record equalisation, now being switchable for chromium dioxide and gamma ferric oxide tapes. The previous lack of this facility was our main criticism of the CT-4141. Its rectification is the single most important improvement in the CT-5151.

Wow and flutter was found to be 0.08% (weighted) at the beginning of the cassette and 0.055% in the middle. This performance is exemplary.

In most other respects the performance of the new machine is very similar to that of the CT-4141 — our measured results are tabulated in the performance chart.

The CT-5151 is a most worthy successor to the CT-4141. It has performance comparable with a number of much more expensive machines.

It is a remarkable indication of the almost breathtaking speed of cassette recorder development, that this moderately priced machine has an overall performance that equals most good reel-to-reel machines.

And that is a statement we could not have made of any cassette machines until a few months ago.

MEASURED PERFORMANCE OF PIONEER CT-5151 CASSETTE RECORDER SERIAL NO: TL 6400173

Record to Replay Frequency Response:	0 VU	60 Hz to 8 kHz	±3 dB	
(with BASF CrO ₂ cassette)	-10 VU	50 Hz to 13 kHz	±3 dB	
	-20 VU	50 Hz to 15 kHz	±3 dB	
(with BASF LH-C90 cassette)	0 VU	40 Hz to 4.5 kHz	±3 dB	
	-10 VU	50 Hz to 10 kHz	±3 dB	
	-20 VU	50 Hz to 13 kHz	±3 dB	
Total Harmonic Distortion: (at 1 kHz)		100 Hz	1k	6.3k
	0 VU	2.2%	0.9%	0.6%
	-10 VU	0.45%	0.4%	0.1%
Intermodulation Distortion: (at 1 kHz and 960 Hz)	0 VU	.085%		
	-10 VU	.08%		
Signal to Noise Ratio at 0 VU re 1 kHz: (using CrO ₂)		Linear	db(A) weighted	
	With Dolby	-47 dB	-57 dB(A)	
	Without Dolby	-46 dB	-51 dB(A)	
Erase Ratio: (1 kHz signal recorded at 0 VU)	-69 dB			
Cross Talk at 0 VU:	1 kHz	40 dB		
Wow & Flutter:	start of cassette	.08% weighted		
	middle of cassette	.055% weighted		
Line Input Sensitivity for:	0 VU	40 mV		
Line Output Sensitivity for:	0 VU	0.45 V		
Microphone Input Sensitivity for:	0 VU	0.5 mV		
Dimensions:	396 x 242 x 96 mm			
Weight:	4.7 kg			

MICROWAVE HEATING AND TESTING EQUIPMENT

We manufacture the Swedish Husqvarna microwave ovens for domestic catering and industrial processes.

Agents for Holaday Industries microwave survey and monitoring equipment for the serviceman and research worker.

FEATURES:

- (1) Easy to use and read
- (2) Rugged, virtually immune to burnout. Maximum power density 1.5 w/cm²
- (3) Measurement independent of field polarization
- (4) Utilizes two easily replaceable 9V transistor radio batteries
- (5) Replaceable probe spacer cones
- (6) Attractive carrying case

Model HI 1500 \$275.00

Model HI 1700 \$975.00

PROMPT Delivery

Microwave Heating Pilot Plant for Industrial Plant and Development Work also available.



Specifications:

- (1) Calibrated at 2450 MHz for use in the I.S.M. Band.
- (2) Three ranges provided: 0-2, 0-10, and 0-100 mw/cm², each calibrated at midpoint.
- (3) Accuracy ± 1 db
- (4) Time responses (0 to 90% of final value for a step input)
Fast — 1 second
Slow — 3 seconds
- (5) Temperature compensated
- (6) Cardinal point calibration chart provided with each meter
- (7) Estimated battery life of 1 year
- (8) Instrument package dimensions: 2½" x 3½" x 6"
- (9) Probe length: 12"

PROMPT DELIVERY

Supaspede Microwave oven Mfg. Co. Pty. Ltd.

47 Glenvale Crescent, Mulgrave 3170 Phone: 560 1468

A lot of people are going to George Brown.

On May 1 George Brown commence operations as authorised Fairchild distributors for Victoria. They join Warburton Franki in servicing this area.

From May 1 they're the people to see for prices and data on the Fairchild range. They're situated at 93 Sackville Street, Collingwood, phone 419 3986

Transistors in plastic and metal can. General purpose amps. Low noise. High speed switches. FET's. Power transistors.

Integrated circuits. In ceramic, metal can and plastic.

Linears. Operational amplifiers. Voltage regulators. Line drivers. Comparators. T.V. and audio circuits.

Digital. 7400 and 9300 TTL. DTL and Memory, MOS, ECL and Schottky.

Diodes. In DO35 microglass. Small signal. High conductance. High speed diodes and zeners.

Microwave and Opto. Light emitting diodes. Phototransistors. Displays. Optical couplers.

Nationwide Authorised Fairchild Distributors.
South Australia. Warburton Franki (Adel) Pty. Ltd., 356 7333. Gerard & Goodman Pty. Ltd., 223 2222.
N.S.W. George Brown & Co. Pty. Ltd., 519 5855
Warburton Franki Industries (Syd) Pty. Ltd., 648 1711.
Queensland. Warburton Franki (Bne) Pty. Ltd., 527 255.

A.C.T. George Brown & Co. Pty. Ltd., 950 455.
W.A. Warburton Franki, 61 8688.

Victoria. Warburton Franki (Melb) Pty. Ltd., 690 151. George Brown & Co. Pty. Ltd., 419 3986.

And in N.Z. Tee Vee Radio Limited, Auckland, 763 064, Wellington, 60 523, Christchurch, 67 748, Dunedin, 88 028.

FAIRCHILD
AUSTRALIA PTY. LTD.

Including us.

The Acid Test.

"Hey!
Watch out!
The needle's right
over into the red!"

"Relax...
I'm using a
MEMOREX
Cassette"

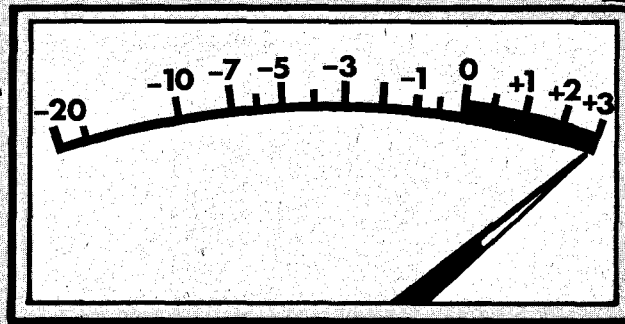

MEMOREX THE UNDISTORTER!

For the very first time you can forget about overload distortion when you record. Just use 'Memorex' the Undistorter. No hiss, no distortion, no hassle, just beautiful clean clear sound. And Memorex costs only cents more than the cheapies.

You'll never know how good your recorder is until you try 'Memorex' tape.



Leroya Industries PTY. LTD.

266 Hay Street, Subiaco, Western Australia 6008.

QLD. BRISBANE AGENCIES
Audio Centre,
72 Wickham Street,
Fortitude Valley, QLD. 4006.

N.S.W. LINEAR SOUND P/L
639 Pacific Highway,
Chatswood, N.S.W. 2067.

A.C.T. HOMECRAFTS
Petrie Street,
Canberra, A.C.T. 2600.

S.A. HILLS ELECTRONICS P/L
7 Ackland Street,
Edwardstown, S.A. 5039.

VIC. B.J.D. ELECTRONICS
202 Pelham Street,
Carlton, Vic. 3053.

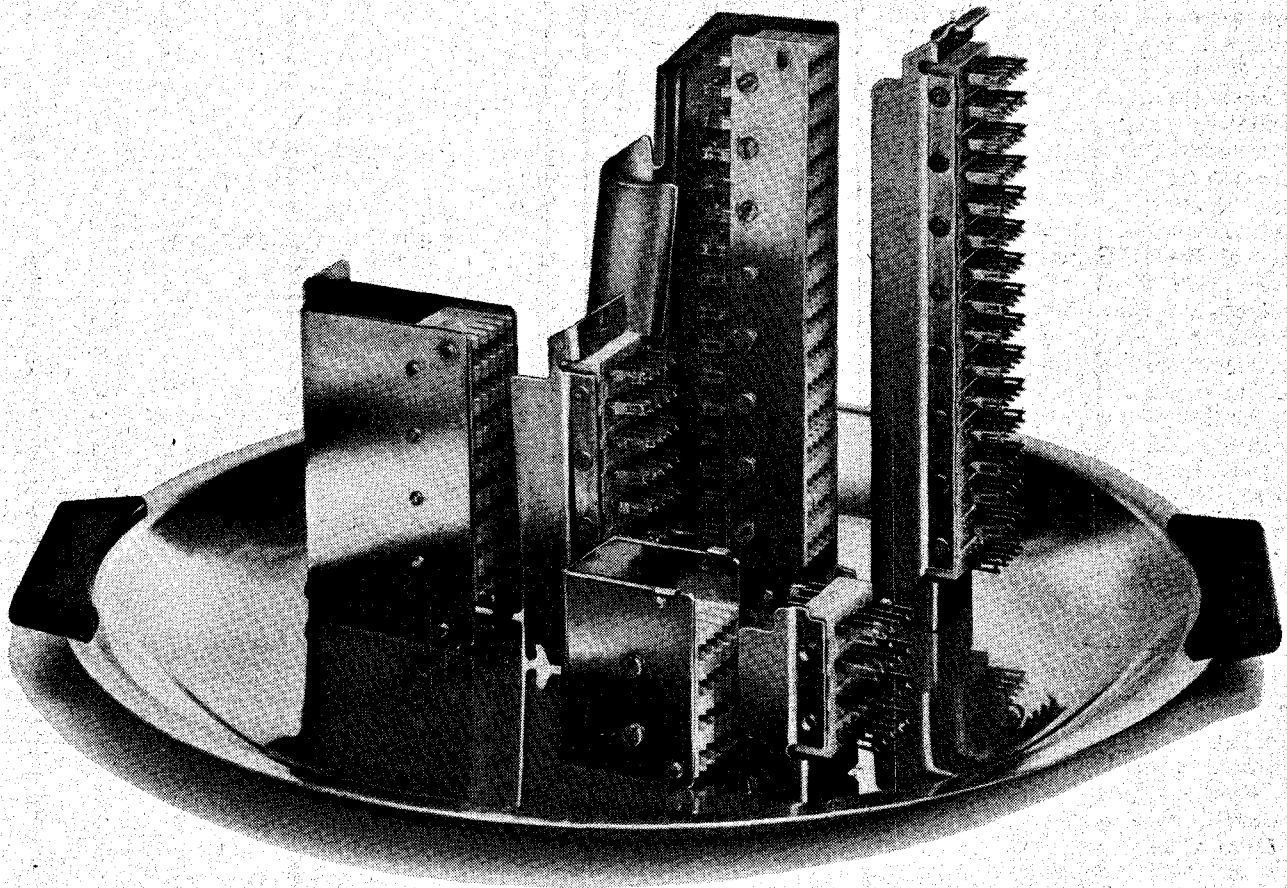

Plessey knife and fork connectors economical...rugged...versatile

Knife and fork contact units
ACTUAL SIZE

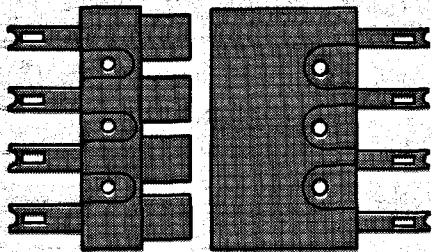

These economical multi-circuit connectors are reliability proven and of exceptionally rugged construction . . . they are available in standard 20, 40 and 80 way sizes.

Connector frames are of pressed steel finished in passivated zinc and house either 1, 2 or 4 sets of A.B.S. Green moulded modules (illustrated) each of which accommodates twenty knife or fork terminal assemblies.

The modular construction of these connectors makes them an extremely versatile means of quickly effecting multi-circuit linkage . . . Plessey offers these

modular contact units as a separate item and any number of such may be arranged and housed to suit the customer's own alternative housing design requirements.

Plessey knife and fork connectors were originally designed for use in crossbar telephone switching equipment and therefore meet the highest quality standards as demanded by Post Office specifications.

Connectors and modular contact units are available ex-stock. Comprehensive literature is available on request to the Professional Components Division.

Melb.: Zephyr Products
Pty. Ltd. 56 7231
Adel.: K. D. Fisher & Co. 223 6294
Perth: H. J. McQuillan
Pty. Ltd. 68 7111
N.Z.: Henderson (N.Z.) 6 4189

PLESSEY 

Plessey Ducon Pty. Limited
Box 2 PO Villawood NSW 2163
Telephone 72 0133 Telex 20384

PEAK

FULL FIDELITY SOUND



PEAK Speaker Systems with their matched sets of tweeters, mid range speakers and woofers, their simple but elegant cabinet design, and their crisp pure sound offer maximum performance and long lasting enjoyment from your stereo system.

Choose from the small book shelf NS-90 through the NSW250S and NSW-350 models to the superb NSW-550 deluxe with a power rating of 70 Watts and frequency unit response 25-20000 Hz.

The **PEAK BD-2000U** stereo record player is equipped with a heavy cast aluminium turntable, 30 cm dia, which is belt driven and dynamically balanced for utmost resilience and lowest wow and flutter levels. Both 45 and 33 $\frac{1}{3}$ RPM speeds are readily obtained by operating a switch on the top panel.

Normally fitted with the **PEAK MC-7** magnetic cartridge for widest frequency response and fidelity.

Available with or without the matching base/cover set illustrated.



The **PEAK KA-400** Stereo Amplifier has a full 20/20 Watt RMS power rating and frequency response 20 to 20k Hz. All wanted controls are incorporated with ultra-modern push button switching on main parameters. Spring loaded speaker switches enable quick connection of the two pairs of speakers which can be connected to this amplifier. Jet black facia with oiled walnut cabinet give this unit a most attractive appearance to complement its fine performance.

ADELAIDE
BRISBANE
HOBART
MELBOURNE
PERTH
SYDNEY

**H. ROWE
& CO PTY LTD**

A Member of the
Hecla Rowe Group

ELECTRONIC WINDOW CLEANER

How do you wash a glass roof, canted at 15°, too fragile to walk on, and several hundred square metres in area?

SYDNEY's Opera House, despite some regrettable compromises in design and execution, has been acclaimed as one of the most incredible architectural achievements of our times.

As with most major projects of this type, innumerable problems arose during construction — and some extraordinarily ingenious techniques were devised for their solutions.

Typical of such problems was this: How do you wash the glass roof — canted as it is at the curious angle of 15°, too fragile for a man to walk on, and some hundreds of square metres in area?

Initially, it was planned to use a winch-operated buggy which would run up and down the roof on rubber tyres. However final stress analysis

revealed that the glass roof was insufficiently strong to carry such a load.

Various other methods were considered before, finally, it was decided to use a small self-propelled cleaning vehicle, specifications of which were to be as follows:

All-up weight — 43 kg

Brush span — 1 metre

Propulsion — pneumatic

Speed — 10 metres/minute.

Work commenced on the first prototype in September, 1972.

Problems soon mounted. The first of these was the bulk of the trailing hoses and control cables. In order to minimise the cost and complication, as well as the weight of these cables, radio control of the vehicle was

considered. Silvertone Electronics were called in to provide a suitable radio control link, and assist in the electrical installation of all the control solenoids and switches.

Work progressed swiftly and the actual site testing commenced in March 1973. From here on, problems compounded!

The wet, slippery glass roof, canted at even a moderate 15°, caused serious traction problems. The first vehicle was fitted with four large rubber tyred wheels, which slipped and slid all over the wet glass. One of the major causes of sliding was the weight of the water and air hoses, pulling the back wheels sideways, particularly when the vehicle was out in the middle of the roof with a long length of hose trailing. The use of radio control, by eliminating the need for control cables, reduced the magnitude of this problem.

The radio link worked well, considering the number of electronic devices in use on the Opera House site. No serious cases of interference were encountered, and the advantages of the use of radio control were demonstrated time and again, particularly in the freedom of movement of the operator.

The traction problem however, became more serious with each passing week. The little tractor was modified virtually daily, and at one time, the whole floor of the workshop was covered with wheels. Wheels with rubber tyres, plastic tyres, tyres with suction caps, slick tyres, rough tyres, skinny tyres and fat tyres. All to no avail. In desperation more wheels were added and finally even more weight. Nothing seemed to work. The sight of the 40 kg tractor sliding sideways out of control, heading for the harbour became a disconcerting, and all too familiar sight!

The successful solution came from the design engineer's son who pointed out that dragging a wet chamois cloth across a wet car was hard work . . .

The tractor was modified once more, and fitted with nylon caterpillar treads clad in chamois leather. The results were startlingly effective. Traction was excellent. Successful cleaning



demonstrations resulted in an order for three tractors, (one for each roof and one spare) thus successfully completing a remarkably farsighted and difficult project. They are now under construction and will no doubt become a familiar sight to Sydney's ferry travellers when they come into use in June this year.

The crawlers are powered by compressed air motors supplied by four separate compressors built onto the Opera House equipment bays. Outlets for air and water are available on the left and right wing of each foyer. The tractor cleans to the halfway point, and is moved across to the other wing to complete the last half of the roof.

Whilst the trailing hoses are a nuisance, weight and size considerations precluded a completely self-contained vehicle, however the final results achieved were more than satisfactory, despite the trailing cables. The prototype radio control link provided by "Silvertone Electronics" is basically a model aircraft control system especially modified to relay operation, in order to mate with the solenoid-operated air valves. The first unit now under development is a five channel pulse-position modulation system, controlling the four steering solenoids and a master failsafe solenoid. The latter is de-energised upon loss of radio contact or battery power to the receiver, thus placing the crawler into a failsafe mode.

The prototype radio system operated on 26.960 MHz with 900 mW into the PA of the transmitter. No loss of control was evident, even when used on site with the 27 MHz paging system in operation.

Steering is achieved by the standard tracked vehicle method, of independent control over forward and reverse movement of each track.

The failsafe circuit simply shuts off the air supply to the main drive motors, thus preventing the vehicle from moving. The failsafe solenoid is held open by a missing pulse detector. Should the failsafe pulse disappear, or battery power be lost, the solenoid closes immediately. Forward speed is fixed at approximately 30 cm/second hence no speed control is required.

As anything up to three units may be used simultaneously, each transmitter is tuned to a different carrier frequency. A spacing of 15 kHz is adequate for safe operation, allowing up to 22 units operating simultaneously in the existing industrial control band, on any one site.

The use of P.P.M. results in a very flexible R/C link, capable of simultaneous, and independent control

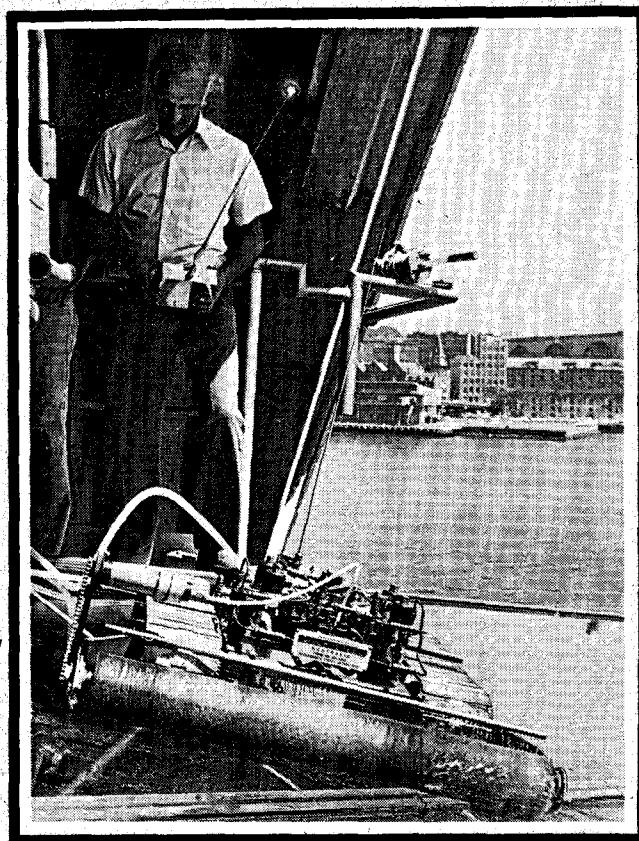

Here, the radio-controlled tractor is traversing one of the ribs used to support the massive glass sections.

of up to 50 separate command functions.

These may be either switched or proportional output type commands. The two types can also be mixed, resulting in a system, utilizing both switched and proportional output functions, however because the tractor moves very slowly, proportional control has not been used.

System resolution is better than $\pm 1/20$ for a typical closed loop feedback servo of approximately 8 kg static thrust.

Our thanks to Quick-Steel Engineering Pty. Ltd. and Silvertone Electronics for their assistance in the compilation of this article.

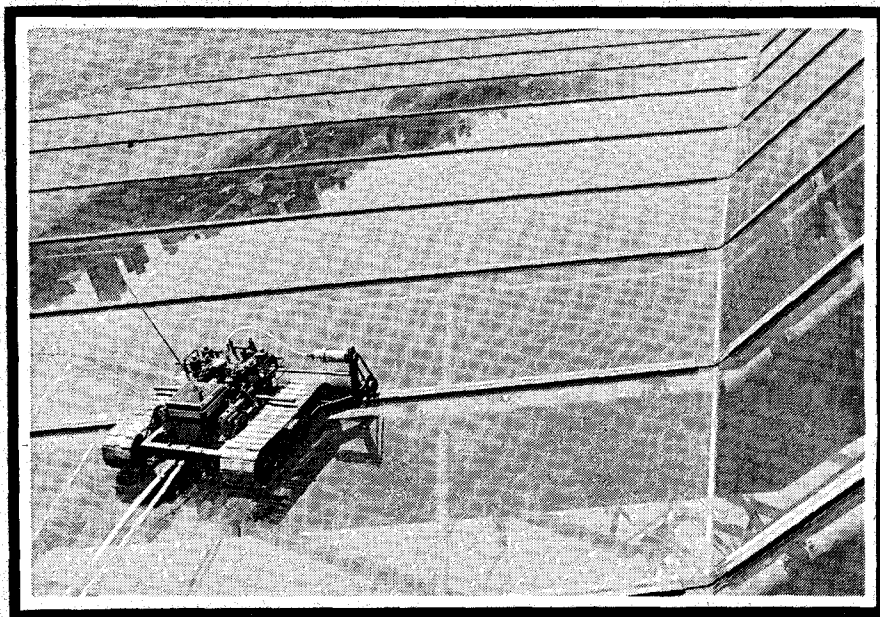

The tractor is driven by compressed air motors controlled by pneumatic air valves via the radio link. A further air motor drives the cleaning roller - mounted on the front of the device.

INTERNATIONAL ELECTRONICS UNLIMITED

DIGITAL INTEGRATED CIRCUITS

7400	\$.25	7447	\$1.45	74123	\$1.15
7401	.25	7448	1.50	74125	.69
7402	.25	7450	.29	74126	.95
7403	.25	7451	.32	74141	1.25
7404	.29	7453	.32	74145	1.25
7405	.27	7454	.45	74150	1.25
7406	.55	7455	.32	74151	1.05
7407	.53	7460	.30	74153	1.45
7408	.29	7461	.30	74154	1.75
7409	.29	7464	.45	74155	1.35
7410	.25	7465	.45	74156	1.50
7411	.35	7470	.50	74157	1.50
7413	.95	7472	.45	74161	1.65
7415	.50	7473	.55	74163	1.80
7416	.50	7474	.55	74164	2.95
7417	.50	7475	.95	74165	2.95
7420	.25	7476	.55	74166	1.95
7421	.32	7478	.89	74173	1.95
7422	.32	7483	1.25	74175	1.95
7423	.37	7485	1.20	74176	.95
7425	.39	7486	.55	74177	.95
7426	.35	7489	3.25	74180	1.15
7427	.39	7490	1.25	74181	4.25
7430	.25	7491	1.40	74182	1.10
7432	.30	7492	1.05	74190	1.65
7437	.50	7493	1.05	74192	1.65
7438	.55	7494	1.10	74193	1.65
7440	.25	7495	1.05	74194	1.65
7441	1.25	7496	1.05	74195	1.15
7442	1.15	74100	1.65	74196	1.35
7443	1.25	74105	.55	74197	1.15
7444	1.30	74107	.55	74198	2.50
7445	1.25	74121	.65	74199	2.50
7446	1.45	74122	.55		
Low Power TTL					
74L00	\$.40	74L51	\$.40	74L90	\$1.75
74L02	.40	74L55	.60	74L91	1.50
74L03	.40	74L71	.60	74L93	1.75
74L04	.40	74L72	.60	74L95	1.75
74L06	.40	74L73	.80	74L164	2.95
74L10	.40	74L74	.80	74L165	2.95
74L20	.40	74L78	.80	85L52	2.95
74L30	.40	74L85	1.25	86L75	2.95
74L42	1.75	74L86	.95		
High Speed TTL					
74H	\$.40	74H21	\$.47	74H60	\$.45
74H01	.40	74H22	.47	74H61	.45
74H02	.40	74H30	.40	74H62	.45
74H04	.45	74H40	.40	74H72	.60
74H08	.45	74H50	.45	74H74	.70
74H10	.40	74H53	.47	74H76	.70
74H20	.40	74H55	.47		
8000 Series TTL					
8504	\$.45	8200	\$2.95	8554	\$2.95
8060	.30	8210	3.95	8750	2.95
8091	.69	8214	1.95	8600	1.15
8092	.69	8219	1.95	8810	.95
8093	.69	8220	1.95	8812	1.25
8094	.69	8280	.95	8830	.69
8121	1.05	8288	1.75	8831	2.95
8122	1.05	8520	1.45	8832	2.95
8123	1.75	8551	1.95	8836	.49
8130	2.50	8552	2.95	8830	1.50
8182	1.75				

Please specify which data sheets are required with order. Add \$.50 per data sheet for items priced less than \$1.00 ea. All of above are Dual-In-Line packages.

MEMORIES

1101	256 bit RAM MOS (2501)	\$2.50 ea.
1103	1024 bit RAM MOS	7.95 ea.
5260	1024 bit RAM 16 pin	
	Low power consumption	7.95 ea.
7489	64 bit RAM TTL	3.25 ea.
8223	Programmable ROM	6.95 ea.

LED

MV108 Visible red SUPER SPECIAL	\$.25 ea.
MV500 type red emitting	.25 ea. 5/\$1.00
MV5020 type large red	.35 ea. 3/\$1.00
ME 4 Infra red TO18	.69 ea.
MAN 1 The original	3.95 ea.
MAN 3 type	1.95 ea. 3 or more 1.49 ea.
MAN 4 type	2.75 ea. 3 or more 2.50 ea.
Data-Lite 707 (MAN 1 repl)	3.25 ea.

INTRODUCTORY SPECIALS

2501 (1101) DIP	256-bit RAM MOS	\$2.00 ea.
709 MINI DIP	Operational Amplifier	.34 ea.
748 MINI DIP	Operational Amplifier	.39 ea.
75453 MINI DIP	Dual Peripheral Driver	.59 ea.
MCT II MINI DIP	Opto Isolator-Transistor	.99 ea.

Integrated Circuits for Counter Display Kit
1 ea. 7446, 7475, & 7490\$2.95 set

5312 Digital Clock Chip

28 Pin - Any Readout - 4 Digit 1 pps BCD with Data Sheet\$7.95 ea.

Transistor Grab Bag

PNP & NPN TO-18 Epoxy
Guaranteed 50% usable20 for \$1.00

CALCULATOR CHIPS

5001 LSI (40 pin) Add, subtract, multiply & divide 12 digit	
Data supplied with chip\$4.95 ea.
Data only - Refundable w/purchase1.00 ea.
5002 LSI Similar to 5001 except designed for battery power	
Data supplied with chip\$8.95 ea.
Data only - Refundable w/purchase1.00 ea.
5005 LSI (28 pin) Full four function memory, 12 digit display and calc. 7 segment multiplexed output	
Data supplied with chip\$10.95
Data only - Refundable w/purchase1.00 ea.

DIGITAL CLOCK CHIPS

MM 5311 (28 pin) Any readout 6 digit BCD with spec. sheet\$11.95 ea.
MM 5312 (24 pin) Any readout 4 digit 1pps BCD with spec. sheet8.95 ea.
MM 5313 (28 pin) Any readout 6 digit 1pps BCD with spec. sheet10.95 ea.
MM 5314 (24 pin) LED-incandescent readout 6 digit with spec. sheet10.95 ea.
MM 5316 (40 pin) Normal alarm, snooze alarm, sleep timer 12 or 24 hr. operation with spec. sheet15.95 ea.

OPTO ISOLATORS

MCA 2-30	Darlington\$.95 ea.
MCD 2	Diodes1.95 ea.
MCT 2	Transistor1.45 ea.

LINEAR INTEGRATED CIRCUITS

300 Pos V Reg (super 723)	TO-5	\$.95 ea.
301 Hi performance AMPL	MINI-DIP	.45 ea.
302 Voltage Follower	TO-5	.95 ea.
304 Negative Voltage Regulator	TO-5	1.25 ea.
305 Positive Voltage Regulator	TO-5	1.25 ea.
307 Op AMP (super 741)	MINI-DIP	.45 ea.
308 Micro Power Op Amp	MINI-DIP	1.25 ea.
309H 5 V Regulator	TO-5	1.25 ea.
309K 5 V IA Regulator	TO-3	1.95 ea.
310 Voltage Follower Op Amp	TO-5	1.25 ea.
311 Hi perf. Voltage Comparator	MINI-DIP	1.45 ea.
319 Hi Speed Dual Comparator	DIP	1.65 ea.
320 -5.2 V Negative Regulator	TO-3	1.95 ea.
320 -12 V Negative Regulator	TO-3	1.95 ea.
320 -15 V Negative Regulator	TO-3	1.95 ea.
339 Quad Comparator	DIP	1.95 ea.
340T Positive Voltage Regulator (6V, 8V, 15V or 24V)	TO-220	2.25 ea.
370 AGC/Squelch AMPL	TO-5 or DIP	1.29 ea.
372 AF-IF Strip-detector	DIP	.85 ea.
373 AM/FM/SSB Strip	DIP	3.60 ea.
376 Pos. Volt Regulator	MINI-DIP	.65 ea.
380 2 Watt Audio Regulator	DIP	1.75 ea.
382 Low Noise Dual Pre-Amp	DIP	2.25 ea.
550 Precision Voltage Regulator	DIP	.95 ea.
703 RF-IF Amp	MINI-DIP	.59 ea.
709 Operational AMPL	TO-5 or DIP	.39 ea.
711 Dual Differential Comparator	DIP	.39 ea.
723 Voltage Regulator	DIP	.75 ea.
739 Dual Hi Perf. Op AMP	DIP	1.25 ea.
741 Comp. Op AMP	MINI-DIP	.45 ea.
747 Dual 741 Op AMP	TO-5 or DIP	.95 ea.
748 Freq Adj 741	MINI-DIP	.45 ea.
1303 Stereo Pre-Amp	DIP	.95 ea.
1304 FM Multiplex Stereo Demod.	DIP	1.50 ea.
1307 FM Multiplex Stereo Demod.	DIP	.95 ea.
1458 Dual Comp. Op. Amp.	MINI-DIP	.75 ea.
2111 Dual LM211 Volt. Comp.	DIP	2.95 ea.
3065 TV-FM Sound system	DIP	.75 ea.
3075 FM Det. - LMTX and Audio Pre-Amp	DIP	.85 ea.
3900 Quad Amplifier	DIP	.75 ea.
3905 Precision Timer	MINI-DIP	.75 ea.
7524 Core Memory Sense AMPL	DIP	1.95 ea.
7525 Core Memory Sense AMPL	DIP	.95 ea.
7535 Core Memory Sense AMPL	DIP	.95 ea.
9601 Retriggerable One Shot	DIP	.95 ea.
75451 Dual Peripheral Driver	MINI-DIP	.49 ea.
75452 Dual Peripheral Driver	MINI-DIP	.49 ea.
75453 (351) Dual Peripheral Driver	MINI-DIP	.69 ea.

Please specify which data sheets are required with order. Add \$.50 per data sheet for items priced less than \$1.00 each.

PHASE LOCKED LOOPS

560 Phase locked Loop	DIP	2.95 ea.
561 Phase locked Loop	DIP	2.95 ea.
562 Phase locked Loop	DIP	2.95 ea.
565 Phase Locked Loop	DIP	2.95 ea.
566 Function Generator	MINI-DIP	2.95 ea.
567 Tone Generator	MINI-DIP	2.95 ea.

ON ORDERS OVER \$25.00 DEDUCT 10%

ALL ITEMS ARE NEW, UNUSED SURPLUS PARTS - TESTED FUNCTIONAL. SATISFACTION IS GUARANTEED. THE PRICES AS LISTED ARE IN AUSTRALIAN DOLLARS. SEND BANK CHEQUE WITH ORDER. IF INTERNATIONAL POSTAL MONEY ORDER IS USED SEND RECEIPT WITH ORDER. SHIPMENT WILL BE MADE VIA AIR MAIL - POSTAGE PAID - WITHIN THREE DAYS FROM RECEIPT. MINIMUM ORDER - \$5.00.

INTERNATIONAL ELECTRONICS UNLIMITED
P. O. Box 1708, Monterey, Calif. 93940 USA

After you don't believe the way the brand new decks sound, you won't believe the way they're priced.



CT-3131A

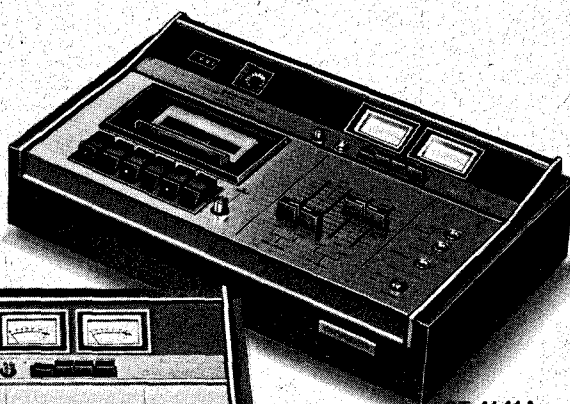

CT-4141A



CT-5151

The beauty of Pioneer's cassette decks is the way they reproduce high fidelity sound from unbelievably tiny cassettes. In fact, no others on the market with prices comparable to Pioneer's new CT-5151, CT-4141A, and CT-3131A give you so much sound for the money. Take, for instance, CT-5151, the top-notch among the three featured here. With a frequency response range from 30 to 16,000Hz, a built-in Dolby* noise reduction unit, and long-life ferrite solid tape head, you're going to want to compare CT-5151 with most of the expensive reel-to-reel decks. CT-5151 is, indeed, loaded with a lot more features like normal/chromium dioxide tape selector (bias/equalizer independently switchable), full-automatic stop mechanism, tape running pilot light, peak level indicator, over-level limiter, electronically controlled DC motor, and even a memory rewind

switch. If you've ever doubted the sound quality of cassette tape, now's the time to hear it all over again. On the CT-5151, CT-4141A, and CT-3131A, just a few of many quality high fidelity products made by Pioneer. To see and listen to them, please contact your nearest Pioneer Dealer.

Dimensions: 15 $\frac{1}{2}$ (W) \times 9 $\frac{1}{2}$ (D) \times 3 $\frac{3}{4}$ (H) inches.

Weight: CT-5151 10 lb. 9 oz.
CT-4141A 10 lb. 6 oz.
CT-3131A 9 lb. 11 oz.

Pioneer Electronics Australia Pty. Ltd.
256-8 City Road, South Melbourne Victoria 3205,
Australia Phone: 69-6605
Branches are in all states.

*"Dolby" is a trademark of Dolby Laboratories Inc.

PIONEER®

“Taking it all together — performance, features, styling — the BSR 810 moves into ranking place among the best automatics we know of. And at its price, the others may well be in for a real contest.” Hi-Fidelity Magazine, May 1972.

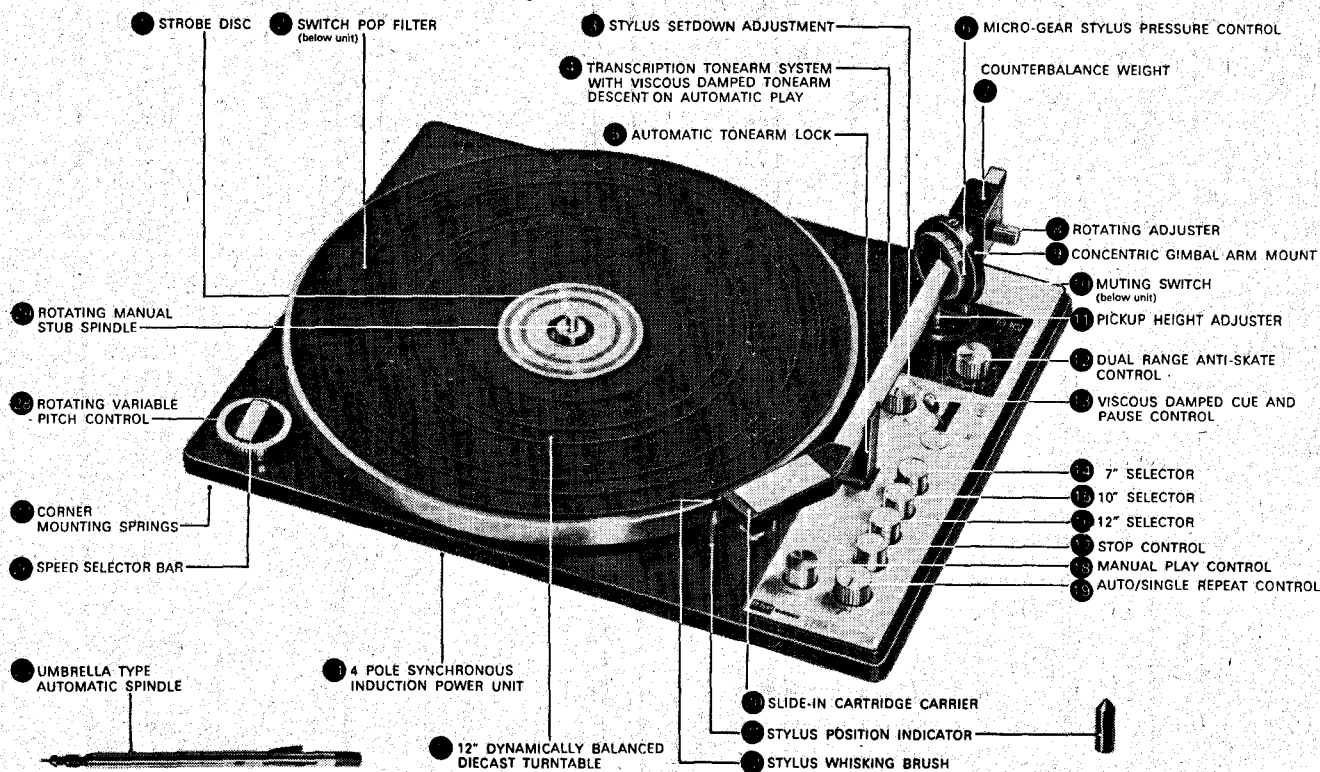

At \$149* for the kit, the brilliant BSR/810 transcription turntable is hardly cheap. But your ears will tell you it's a bargain.

* At recommended retail price.

BSR, manufacturers of most of the world's turntables, have now turned the tables on expensive units.

And here are the features that make the 810 such an attractive proposition: the unit weighs 17 lbs — the diecast turntable alone is a solid, dynamically balanced 7½ lbs. A 4-pole beautifully balanced synchronous motor automatically compensates for any fluctuation in voltage input, or for any record load. A pitch control gives absolute accuracy of speed, utilising a stroboscopic centre plate.

The low mass pick-up arm gyroscopically pivots in a concentric gimbal mount producing virtually friction free movement in both horizontal and vertical planes. It also has a slide-in cartridge carrier, decoupled one piece counterbalance for a minimum tracking pressure of ½ gramme with suitable cartridge. And the arm length is over 8½ inches to reduce tracking

error to less than 0.5° per inch.

Viscous cueing is also standard on automatic as well as manual operation, and a unique anti-skate device is also featured for elliptical and standard styli. Speeds are 33½ rpm and 45 rpm. (Which are all you need today.)

Single to automatic play conversion is achieved with the interchangeable umbrella centre spindle.

Start-stop, record size control and auto repeat and manual conversion are actuated by push button controls set in a handsome brushed aluminium panel.

Of course there is much more you'll want to know about the BSR 810. Write to BSR and we'll send you a colour brochure.

BSR (A/asia) Pty. Limited.
Anne St., St. Marys. 2760
TELEGRAMS "BSR" St. Marys. 2760
TELEX 23159. PHONE 623 0375

Goldring (N.S.W.) Pty. Ltd.,
26-28 Ricketty St., Mascot. 2020 Phone- 669 6088
Goldring (Vic.) Pty. Ltd.,
162 Pelham St., Carlton. 3053 Phone-347 5177
Goldring (Qld.) Pty. Ltd.,
35 Balaclava St., Woolloongabba. 4102
Phone-91 4972
Goldring (S.A.) Pty. Ltd.,
76-78 McLaren St., Adelaide. 5000 Phone-233 488
Goldring Sales and Service (Canberra)
Unit 5, 83-85 Wollongong St., Fyshwick. 2069
Phone-95 8248
Goldring (W.A.) Pty. Ltd.,
32 Northwood St., Leederville. 6007 Phone-84988

BSR McDONALD

810

BSR:117R2

BUY STATE OF THE ART SOLID STATE COMPONENTS— Direct from the United States!

All listed prices are in Australian dollars, International Postal Money Orders (please send PO receipt with order for immediate shipment). Banque Chasiers check (preferably in US funds) and rated company cheques (with foreign exchange stamp approval affixed) will be accepted. Due to recent Australian government restrictions we are not able to clear personal checks... All goods are new unused surplus and are fully guaranteed. Orders will be shipped within two workdays of receipt of same. All customs forms will be attached. Minimum order amount is \$5.00, do not add postage — we pay postage. Surface mail for orders under \$10.00 and Air Mail for orders over this amount.

DATA SHEETS ARE PROVIDED FOR EACH ITEM PURCHASED

7400 SERIES TTL	DIP
7400	Quad 2-input NAND gate.....\$.20
7401	Quad 2-input NAND gate..... .20
7402	Quad 2-input NOR gate..... .22
7404	Hex inverter..... .22
7405	Hex inverter*..... .20
7406	Hex inverter buffer/driver*..... .35
7408	Quad 2-input AND gate..... .22
7410	Triple 3-input NAND gate..... .20
7420	Dual 4-input NAND gate..... .20
7430	8-input NAND gate..... .20
7440	Dual 4-input NAND buffer..... .20
7441	BCD-to-decimal decoder/driver..... .80
7442	BCD-to-decimal decoder..... .80
7447	BCD-to-7 segment decoder/driver..... 1.00
7448	BCD-to-7 segment decoder/driver..... .80
7450	Expandable dual 2-wide 2-input AND-OR-invert gate..... .20
7451	Expandable dual 2-wide 2-input AND-OR-invert gate..... .20
7472	J-K master-slave flip-flop..... .30
7473	Dual J-K master-slave flip-flop..... .40
7474	Dual D-type edge-triggered flip-flop..... .40
7475	Quadruple bistable latch..... .75
7476	Dual J-K master-slave flip-flop with preset and clear..... .40
74178	Dual J-K master-slave flip-flop..... .40
7483	4-Bit binary full adder (look ahead carry)..... .80
7489	64-Bit read-write memory (RAM)..... 3.00
7490	Decade counter..... .90
7492	Divide-by-12 counter (divide by 2 and divide by 6)..... .60
7493	4-Bit binary counter..... 1.15
7495	4-Bit right-shift left-shift register..... .75
74121	Monostable multivibrator..... .60
74123	Dual retriggerable monostable multivibrators with clear..... 1.50
74193	Synchronous 4-bit binary up/down counter with preset inputs..... 1.00

*With open collector output

LINEARS	
NE540	70-Watt power driver amp.....\$1.00
NE555	Precision timer..... 1.00
NE560	Phase lock loop DIP..... 2.00
NE561	Phase lock loop DIP..... 2.00
NE565	Phase lock loop TO-5..... 2.00
NE566	Function generator TO-5..... 2.00
NE567	Tone decoder..... 2.50
NE5558	Dual 741 op amp MINI DIP..... .90
710	Voltage comparator DIP..... .60
711	Dual comparator DIP..... .25
723	Precision voltage regulator DIP..... 1.00
741	Op amp TO-5/MINI DIP..... .55
747	Dual 741 op amp DIP..... 1.00
748	Op amp TO-5..... 1.00
CA3018	2 Isolated transistors and a Darlington-connected transistor pair..... .75
CA3045	5 NPN transistor array..... .75
CA3026	Dual differential amp..... .75
LM100	Positive DC regulator TO-5..... .50
LM105	Voltage regulator..... 1.00
LM302	Op amp voltage follower TO-5..... 1.25
LM311	Comparator DIP..... 1.00
LM370	AGC amplifier..... 1.00
LM703	RF-IF amp epoxy TO-5..... .25
LM3900	Quad op amp..... 2.00
LM1595	4-Quadrant multiplier..... 1.00

8093-8094	Tri-state quad buffer DIP.....\$1.00
8850-9601	One-shot multivibrator DIP..... 1.50
8811	Quad 2-input MOS interface gate 15V open collector DIP... .30

RTL EXPERIMENTER PACKAGE

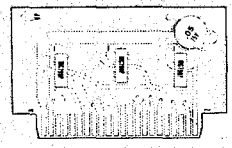

We purchased a computer using RTL logic. All the ICs are Motorola plastic DIP 700 series. Each board contains 3 or 5 ICs and a gold-plated standard 42-pin finger connector. VCC and ground are connected to all ICs, and a .05 bypass is provided. Each active pin of all ICs on the board go to a pin on the connector.

and ground are connected to all ICs, and a .05 bypass is provided. Each active pin of all ICs on the board go to a pin on the connector.

BOARDS AVAILABLE:

- #1 3 MC724P Quad 2-input gate.....\$1.25
- #2 3 MC789P Hex inverter..... 1.25
- #3 3 MC790P Dual J-K flip-flops..... 1.25
- #4 3 MC792P Triple 3-input gate..... 1.25
- #5 5 MC799P Dual buffer..... 1.25

SOCKETS FOR BOARDS:

- Bank of 5 bussed together to take 5 boards - gold-plated wire.....\$2.50
- Ten bussed together.....\$4.50

Set of 5 boards and sockets with data and applications.....\$7.95

LSI CALCULATOR ON A CHIP

This 40-pin DIP device contains a complete 12-digit calculator. Adds, subtracts, multiplies, and divides. Outputs are multiplexed 7-segment MOS levels. Input is BCD MOS levels. External clock is required. Complete data is provided with chip (includes schematic for a complete calculator).

Complete with data \$7.00
Data only \$1.00



SLA-1 OPCOA

Pin compatible with MAN-1.

Large .334" character.

Mounts on .4" centers.

Left-hand decimal point.

\$2.00 Each; 10 For \$16.00

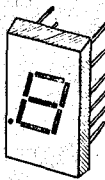

FAIRCHILD "TRIMPOTS"



Brand new 20 turn precision trimmers. These are prime parts, mostly individually packed in sealed envelopes.

FOLLOWING VALUES IN STOCK:

10 Ohm	1K	50K
20 Ohm	2K	100K
50 Ohm	5K	200K
100 Ohm	10K	250K
200 Ohm	20K	500K
500 Ohm	25K	1 Meg

Each Only 89¢

Ten for \$7.50
Please specify P or L (PCB or Wire leads).
Order NOW, these won't last!

COUNTER DISPLAY KIT—CD-2

This kit provides a highly sophisticated display section module for clocks, counter or other numerical display needs.

The RCA DR-2010 Numitron display tube supplied with this kit is an incandescent seven-segment display tube. The .6" high number can be read at a distance of thirty feet. RCA specs. provide a minimum life for this tube of 100,000 hours (about 11 years of normal use).

A 7490 decade counter IC is used to give typical count rates of up to thirty MHz. A 7475 is used to store the BCD information during the counting period to ensure a non-blinking display. Stored BCD data from the 7475 is decoded using a 7447 seven-segment decoder driver. The 7447 accomplishes blanking of leading edge zeroes, and has a lamp test input which causes all seven segments of the display tube to light.

Kit includes a two-sided (with plated through holes) fiberglass printed circuit board, three IC's, DR-2010 (with decimal point) display tube, and enough Molex socket pins for the IC's.

Circuit board is .8" wide and 4 3/8" long. A single 5-volt power source powers both the IC's and the display tube.

CD-2 Kit Complete Only \$10.95
Assembled and Tested \$13.00

Board Only \$2.50

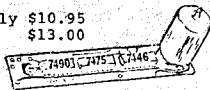

RCA DR2010 NUMITRON



RCA DR2010 Numitron digital display tube. This incandescent five-volt seven-segment device provides a .6" high numeral which can be seen at a distance of 30 feet. The tube has a standard nine-pin base (solderable) and a left-hand decimal point. Each \$4.00
SPECIAL 5 for \$17.50

COUNTER DISPLAY KIT—CD-3

This kit is similar to the CD-2 except for the following:

- Does not include the 7475 quad latch storage feature.
- Board is the same width but is 1" shorter.
- Five additional passive components are provided, which permit the user to program the count to any number from two to ten. Two kits may be interconnected to count to any number 2-99, three kits 2-999, etc.
- Complete instructions are provided to pre-set the modulus for your application.

CD-3 Board Only \$2.25
IC's, 7490, 7447 \$2.75
RCA DR2010 tube \$5.00
Complete kit includes all of the above plus 5 programming parts, instructions, and Molex pins for IC's. Only \$9.25



LM309K: 5-VOLT REGULATOR



This TO-3 device is a complete regulator on a chip. The 309 is virtually blow out proof. It is designed to shut itself off with overload of current drain or over temperature operation. Input voltage (DC) can range from 10 to 30 volts, and the output will be five volts (tolerance is worse case TTL requirement) at current of up to one ampere.

Each \$1.50 5 for \$7.00

Babylon Electronics Inc.

Post Office Box J, Carmichael, California. 95 608 U.S.A.

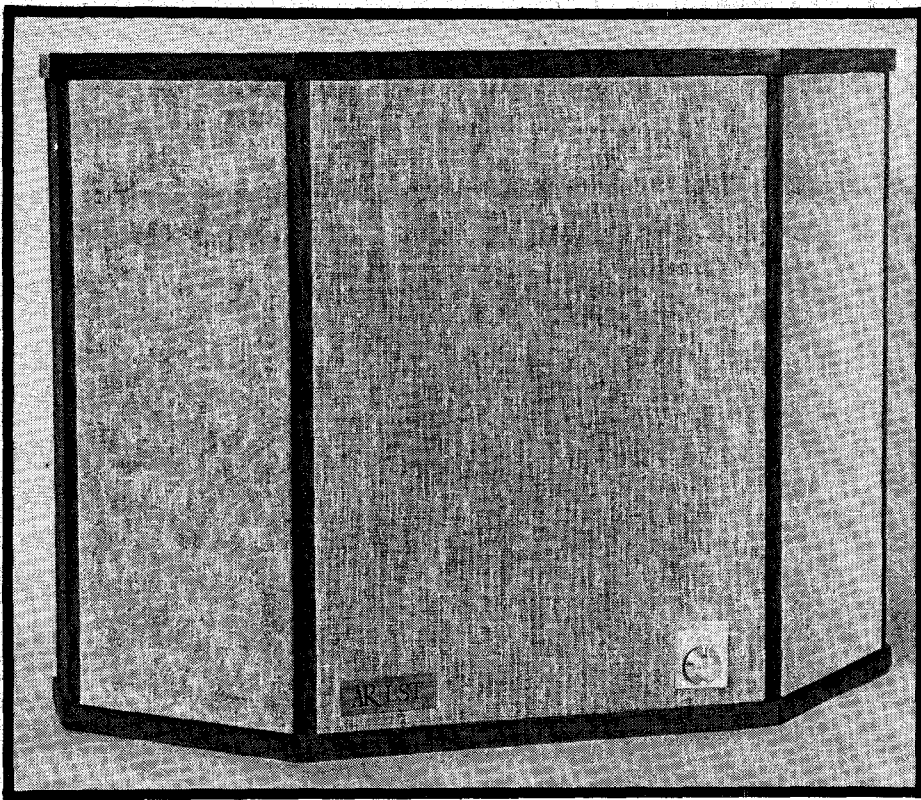

Recommended
retail price \$1795 per pair

ACOUSTIC RESEARCH LABORATORY STANDARD TRANSDUCERS

Intended primarily as a laboratory standard, AR's LST speakers are also superb for home use.

ACOUSTIC RESEARCH was founded some twenty odd years ago by Henry Kloss and Ed Villchur.

Kloss was at that time a student at M.I.T. During his spare time Kloss ran a small woodworking facility and one of his products was a range of loudspeaker enclosures designed by a Professor Baruch and an MIT student named Henry Lang.

Subsequently, Kloss met Ed Villchur, who was at that time teaching at New York University.

Villchur had just finished building an experimental speaker in which he had installed a speaker drive unit in a small totally sealed enclosure — thus using the entrapped air as a springing medium.

Henry Kloss recognized the essential

rightness of Villchur's concept, and the rest is virtually history. Together Villchur and Kloss discovered the inter-relationship between enclosure volume, speaker efficiency and low end band pass.

Much later these inter-relationships were to be elegantly systemized by Tony Hoffman (the 'H' of KLH) in an

equation known as 'Hoffman's Iron Law'.

Although Henry Kloss, together with Tony Hoffman and Malcolm Low left Acoustic Research only a few years after that company was founded, the original concepts that they introduced and established so well have remained.

Acoustic Research products are held in high esteem throughout the hi-fi world. Their latest products range from very small bookshelf units — to the laboratory standard model (LST) reviewed in this article.

A PROFESSIONAL SPEAKER

The LST model is a truly professional class speaker. It is intended for laboratory and monitoring use, although a surprisingly large number are in fact bought for private domestic use.

Surprisingly small and compact — 70 x 51 x 25 cm — the LST's nevertheless weigh a hefty 40 kg — a pointer to the extreme rigidity of the cabinet.

The LST's enclosure is built with two sloping sides on the front 'face' and is meant to be located against a wall rather than in a corner.

Finish is AR's usual impeccable oiled walnut with a beige face cloth on three faces.

A 30 cm woofer is located on the front face with two 1.9 cm hemispherical tweeters directly above.

The two side faces, at 45° to the front face, each contain two 3.8 cm mid-range hemispherical radiators and one 1.9 cm hemispherical tweeter.

UNUSUAL CROSS-OVER NETWORK

The cross-over network is unusual — perhaps unique. Unlike other loudspeakers, the LST's have a multiple-tapped autotransformer which allows the frequency response to be tailored by adjusting the gain of the woofer as well as the tweeters.

AR have also attempted to hold the overall subjective loudness at a constant level, despite response curve changes, by maintaining effectively constant drive to the mid-range drivers. The effectiveness of the above arrangement was verified during our subjective testing.

Adjustment of the auto transformer tapings is made via a six-position switch sensibly mounted on the front of the enclosure.

SUBJECTIVE IMPRESSIONS

Our initial subjective tests showed that the speakers compared extremely well with other units of this type. Fidelity was excellent throughout the audio frequency range, although a very slight peakiness was apparent on some string instruments (This non-linearity is also apparent on the measured frequency response).

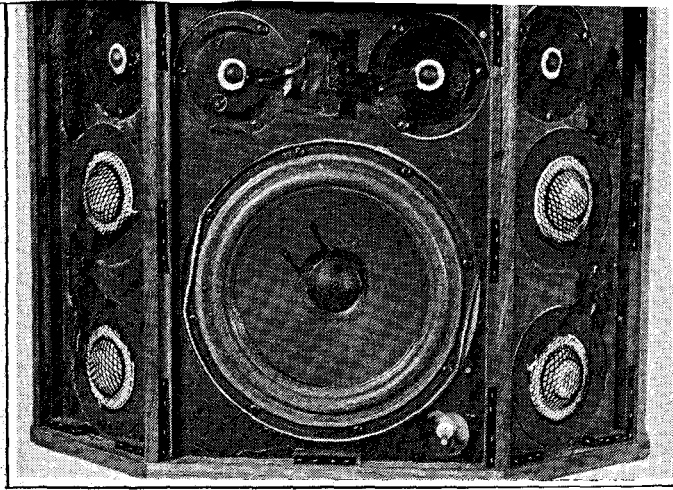

LST enclosure with front covers removed.

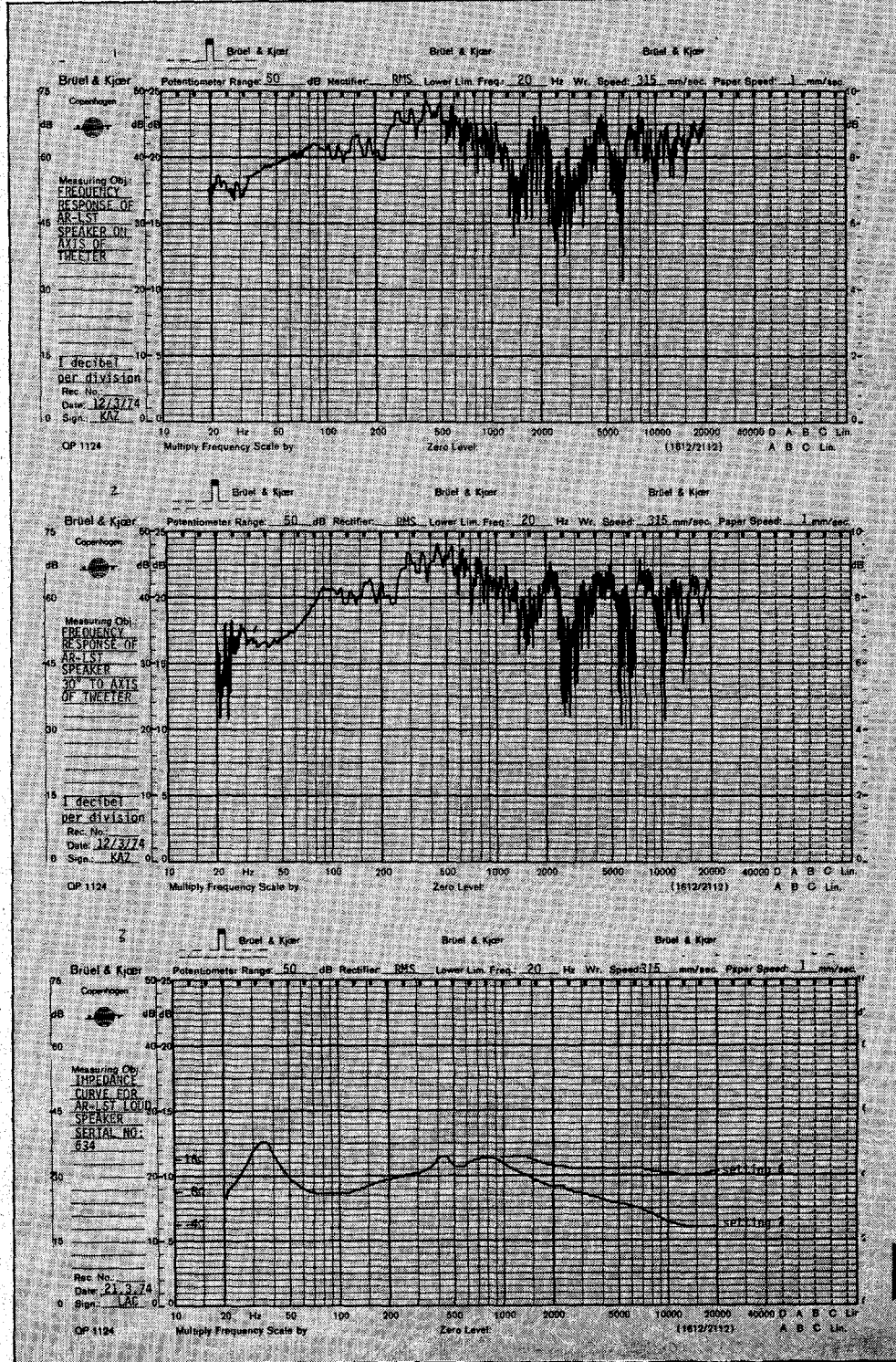



Magniamplification...

SONAB offer the P4000 as a masterpiece in amplification to comply with your own choice of components or to combine with the SONAB range of quality sound equipment that has made

them world famous. Sweden is proud of SONAB and SONAB are proud of their product, so proud in fact that they give you a 5-year guarantee. Put your money where the sound is — SONAB.

For literature on SONAB turntables, amplifiers and the rest of the SONAB range — and the name of your nearest dealer, phone or write to us:

Sonab OF SWEDEN PTY. LTD.
114 WALKER STREET, NORTH SYDNEY 2060
TELEPHONE: 929-4288, 929-4554



SON 2

ACOUSTIC RESEARCH LABORATORY STANDARD TRANSDUCERS

Especially noticeable — and appreciated — was the almost total non-directivity of the LST's. They seem to radiate energy equally in all directions, unlike many other speakers where it is necessary to remain within a narrow listening area.

MEASURED RESPONSE

Having completed our listening tests, measurements were then taken to establish the free field frequency response and distortion characteristics.

As our curves show, response is virtually identical both on and off axis. Actual response was 20 Hz to 20 kHz ± 7 dB. This is better at the low frequency end than AR's claim. On the other hand the range between 500 Hz and 7 kHz is not quite as smooth as that claimed by the manufacturer — largely due to a difference in measuring techniques. Acoustic Research, in common with many other speaker manufacturers, obtain their response curves using a long averaging time. This technique tends to mask the dips and humps that a shorter time otherwise shows.

Distortion was low, even compared with other loudspeaker enclosures designed for professional use. What little there is shows up as third

harmonic distortion which increases slightly with frequency. Nevertheless at 1 kHz and 6.3 kHz it is still a very low 0.3%.

The impedance curve varies quite widely with frequency, and is also affected by the frequency contour switch. Nevertheless the impedance variations are not sufficient to bother any modern solid-state amplifiers.

Whilst by no means challenging one of Paul Klipsch's horn loaded devices, efficiency of the LSTs is quite reasonable, just over three electrical watts producing a sound level of 90 dB at two metres on axis.

EXTENSIVE GUARANTEE

The LST is guaranteed by Acoustic Research for a period of five years from the date of purchase.

This guarantee is quite exceptional in that it not only covers parts and labour but also freight to and from the

factory or nearest service centre. The company — or their agents — will also provide, free of charge, any packing required for safe shipping.

Truly a most comprehensive guarantee which few other manufacturers (if any) can match.

Acoustic Research have excelled themselves in producing the LST speakers.

Although clearly intended for the professional market where repeatable spectral energy contours are a must, the LSTs would also prove excellent as studio monitors, where they are at least comparable to other units in this price range.

At a selling price of almost \$1800 a pair the LST's are not going to appeal to the great mass of audio enthusiasts.

But for those fortunate individuals who are able to afford them the LSTs are an almost ideal loudspeaker for home hi-fi use.

ACOUSTIC RESEARCH LST LOUDSPEAKER		
SERIAL NO: 634		
Frequency Response	± 7 dB	20 Hz — 20 kHz
Total Harmonic Distortion (for 90 dB at 2 metres on axis)		
	100 Hz	0.5%
	1 kHz	0.3%
	6.3 kHz	0.3%
Electro-Acoustic Efficiency (for 90 dB at 2 metres on axis)	3.2 watts	
Measured Impedance		
	100 Hz	8 Ω
	1 kHz	16 Ω
	6.3 kHz	6 Ω
Cross-Over Frequency	575 and 5000 Hz	
Dimensions	68.9 x 50.8 x 24.8 cms	
Weight	40.5 kg	

TUNE IN THE WORLD



DX-160 5 BAND SOLID-STATE COMMUNICATIONS RECEIVER

- RECEIVES AM-CW-SSB-HAM & SWL
- FREQUENCY COVERAGE 150KHz TO 30MHz
- A COMMUNICATION RECEIVER WITH FIELD EFFECT TRANSISTORS. FOR TRULY FINE RECEPTION
- THE "EXTRA" BAND IS A MARINE NAVIGATION BAND, IDEAL FOR SMALL BOAT OWNERS.
- (DC 12 VOLTS NEGATIVE GROUND — AC 240 VOLTS)
- COMES COMPLETE WITH "EXTERNAL SPEAKER"

\$199.95

Big, exciting, professional . . . a real brute of a receiver. The Realistic DX 160 is a five band, single conversion receiver. The appearance is neat and attractive with the main slide rule dial flanked by the band-spread dial on one side and an accurate "tuning" (S) meter on the other. The front is a solid aluminium extrusion in silver and black with controls placed below the lighted dial. Comes complete with 19 page manual. Listen to London, New York, Brussell, anywhere — tune in the world today!
20-152

TANDY ELECTRONICS

280 Victoria Road,
Rydalmere, N.S.W., 2116
Phone: 638 6953

MAIL ORDERS ACCEPTED — FREE DELIVERY

PRE-PAK electronics and agencies

HEAD OFFICE and mail order dept
718 Parramatta Rd., Croydon, N.S.W. 2132. Ph: 797-6144

OPEN 7 DAYS
MON - SUN 9.00 A.M. - 5.30 P.M.

FANTASTIPAK NO. 1
Definitely a few only — first come, first served. A fantastic Parcel of guaranteed electronic components. Including transistors, electrolytic capacitors, resistors, potentiometers, rotary switches, magnetic counter, computer boards, transformers, etc. etc. We guarantee the value of this parcel to exceed \$30.00. Available NOW at \$18.00 post free.

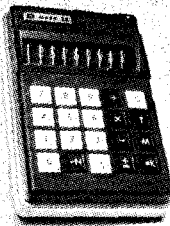

FULL PRICE ONLY
\$99.50
post \$1.50

ELECTRONIC CALCULATOR WITH MEMORY! 12 MONTHS GUARANTEE

- Rechargeable battery.
- Charger included.
- 8 digits — 16 digit recall.
- Leather Carry Case

The MARK 9 Digital Calculator has all the usual features you expect e.g. Addition, Subtraction, Multiplication, Division, Chain or Mixed Calculations, Automatic Squaring, Cubing etc., Floating Decimal Point, Constant Function, Over-range Indicator plus a few you won't find in other calculators under \$100.00. Such as: a built-in memory for storing information while doing other calculations, 8 digit capacity with 16 digit decimal point recall, negative number operations and rechargeable batteries with charger included in the price. The large green 7 segment display with 1/4" high characters is easy to read from all angles and the compact size (5 1/2" L x 3 3/4" W x 1.5/8" H) and light weight (only 13 ozs) allows you to take it anywhere. And the guarantee is for a full 12 months. We have secured only a limited number at this price — don't delay!

A full descriptive brochure is available on request.

Manufactured in USA by Radiant Energy Systems



VORTEX STEREO CASSETTE DECK

"VORTEX" Stereo Cassette Deck mechanism with tape eject facility and resettable counter. Easily operated by 5 push button (piano key) controls, and includes high quality heads. Price \$29.00. Post \$1.



Limited Quantity Avail. **\$29.00** Post \$1.00

ETI DIGITAL CLOCK KIT PROJECT 521

\$59.00
Post \$1.00

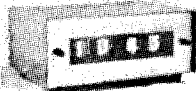

NIXIE DISPLAY

This very popular Kit uses standard TTL I.C.'s and is very easy to build, even for the novice constructor. All parts fit easily on the one P.C.B., including the neon display tubes. Two flashing red leds are synchronised to flash every second and combined with the attractive gold finished case and aluminium panel, provide a very attractive appearance.

SPECIALS

- IN914 15c
- 1000PIV 1.5A Rect 45c
- 2N2646 \$1.00
- 2N5459 90c
- AY6108 \$1.00
- AY6109 \$1.00
- BC107 27c
- BC178 30c
- NATIONAL NS600 Calculator now reduced to **\$27.50.**

CAR RADIO KIT

Features:—

- 9 Transistors
- 2 Watt Output.
- R.F. Amplifier.
- Tone Control.
- 12 volt — Ve ground.
- Push-Button or Manual Tuning.

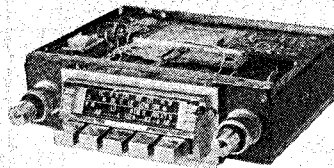

\$33.50

Exclusive to Pre-Pak Electronics!

A new 9 transistor push-button car radio kit is now available using a Philips UF415 pre-aligned and assembled tuner module. Reception is extremely good even in country districts due to RF amplifier and power output of 2 watts is more than ample. The push button or manual tuner makes for easy selection of stations and the overall appearance would complement the interior of any car. A speaker and car aerial are included. Price (complete kit) **\$37.50.**, post \$1.50. Price (complete Kit) without aerial or speaker **\$33.50.**, post \$1.50.

SUPER "SUPER-PAKS"

- PAK 28. 25 Miniature electrolytic capacitors, brand new, 3 volt to 12 volt, assorted useful values. 25 for **\$2.00.**, post 20c.
- PAK 30. 25 high grade, brand new, electrolytic capacitors in range 10 mfd to 500 mfd, from 12 VW to 80 VW. This special EXPERIMENTERS PAK includes the most common values in both pigtail and P.C. types. 25 for **\$3.50.**, post 25c.
- PAK 31. 15 high grade, brand new, electrolytic capacitors in range 500 mfd to 3,300 mfd, from 12 VW to 35 VW. Ideal for power supplies etc. Great savings and unbeatable value at **\$3.50.**, post 35c.
- PAK 39. Approx. 100 assorted polyester capacitors. 400V DC rating — all preferred and useful values, brand new and Australian made. 100 for **\$3.50** post 50c.
- PAK 40. Approx. 100 assorted polyester capacitors, 630V DC rating — same types as those above. Greatest value ever! 100 for **\$4.25**, post 50c.
- PAK 45. 10 NPN Silicon Transistors, T092 case. Suitable for small signal applications, pre-amps, driver's, general purpose. New and unmarked, intended as BC107, BC108, BC109 series. Guaranteed quality — data sheet supplied. 10 for **\$2.00** plus 20c post.

NEW SCIENTIFIC CALCULATOR

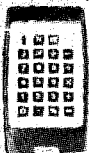

\$109

Features:—

- Memory/Constant Key
- Reciprocal Number Key.
- Square Root key
- Percentage Key.
- Automatic Squaring Key
- Floating or Fixed Decimal Point with Round-Off
- Low-Battery Indicator with auto blanking to same battery drain.
- 8 digit LED display with 16 digit recall
- Overflow and Underflow indicator
- zero suppression
- Credit Balance.

This new scientific calculator from RBM — Titan Corporation of Texas operates from rechargeable batteries and is supplied complete with recharger. Its stream lined appearance has recessed operating keys so it can be easily slipped into a shirt pocket. (Size only 5 1/2" long specially imported from USA. Limited quantity available now. Price **\$109.00.** Post \$2.00

C.D.I. KIT (OLIMS) MK. II.

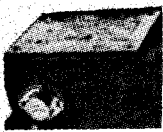

Kit **\$19.95**

Complete kit of parts to build, this superior commercially made Capacitor Discharge Ignition system. All high grade components with pre-wound transformer, P.C. board, nuts, bolts, case, instructions, etc. 12V Neg earth. Improved model now has plug and sockets for changeover to standard ignition. Post 50c.

NEW MK. III KIT, WITH ANTI-THEFT DEVICE

A great new safety feature to disable your car's ignition system while the car is unattended.

\$21.45
Post 50c

FERRIS TRANIMATE

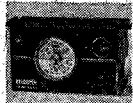

Now Only **\$8.95**

- RF Booster for transistor radios.
- Pulls in stations 100's miles away.

The fantastic new Ferris Tranimate is a 2 transistor tuned RF amplifier (patented design) for use in car or in country areas to allow portable transistor radios to pick-up distant or weak stations. Connects easily to any transistor radio, operates on 9V No. 216 battery (not included). Normally priced at **\$15.95.** SPECIAL PRICE **\$8.95.** Post 50c.

CLEARANCE SALE OF USED TEST EQUIPMENT

All in working order

- 1 only PHILIPS AM/FM Sweep and Marker Signal Generator Model GM 2889 — indispensable to TV technicians etc. **\$95.00**
 - 1 only Digital Measurements Ltd., Digital Voltmeter Type DM2001 — 5 digits, auto polarity sensing, input range. 15995 volts to 1599.5 volts in 5 ranges. A real laboratory instrument. **\$300.00**
 - 2 only SOLARTRON High voltage Regulated Power Supplies Model SRS151A. Outputs: 20 to 500 volts DC at 30mA highly regulated, 0-170V D.C., regulated bias control, 2 x 6.3V 5A A.C., with overload cutout, meter etc. **\$75.00 ea.**
 - 1 only PHILIPS GM4561 Regulated Power Supply, Outputs 145 to 315 Volts D.C. highly regulated at 100 mA, 2 x 6.3V 4A AC. Extremely reliable instrument. **\$50.00.**
 - 1 only English Grayonics Ltd., Regulated Power Supply Outputs: 1V to 400V D.C. at 200mA, 170V to 400 V D.C. at 200 mA., 170 V to 400 V bias control, all highly regulated, -300V D.C., 6.3V, 8A A.C., 6.3V 2A A.C. Very versatile general purpose supply. **\$75.00.**
 - 1 only Watson Victor Regulated Power Supply. Output variable to 500V D.C. at 50mA with current limiting. Separate voltmeter and ammeter. **\$30.00.**
- All prices plus freight.

WOLLONGONG, NSW Agent,
Hi-Tec Electronics 265
Princes Hwy, Corimal, N.S.W.
2518. Ph: 84-9034.

NEWCASTLE, NSW AGENT
Digitronics Aust. Pty. Ltd.,
12 William Street,
Maryville, NSW, 2233.
Phone 69-2040

NTH QUEENSLAND AGENT
Philtronics Cnr. Grendon
and Palmer Sts., Nth Mackay,
Qld. 4740. Ph: 78855

HUNTER VALLEY NSW N.S.W.
Hunter Valley Electronics
and Hi-Fi, 478 High St.,
Maitland, N.S.W. 2320.
Phone: 33-6664

DUBBO, NSW AGENT
A & R Olsen 34 Church St.,
Dubbo 2830. Ph: 82-2300.

WEST AUSTRALIAN AGENT
B.P. Electronics 192-196
Stirling Terr., Albany, W.A.,
6330. Ph: 41-3427

AMCRON

Crown International U.S.A.

BY CROWN INTERNATIONAL

If diamonds are the epitomy of value and quality in the realm of gems, then the Amcron IC150 control unit and D150 power amplifier is its equal in the sphere of electronics.

The superb craftsmanship required in cutting and polishing a diamond, is equal to the highest degree of craftsmanship employed at Amcron, where quality is a creed, not just a mere claim.

Unlike the price of diamonds, Amcron equipment is not sold by the carat (or watt), and the IC150/D150 amplifier combination is a reasonably priced superlative product.

You are assured of Amcron's unwavering and uncompromising dedication to excellence, when you consider the IC150/D150 combination, as the amplifier to grace your home. Your ears deserve Amcron.

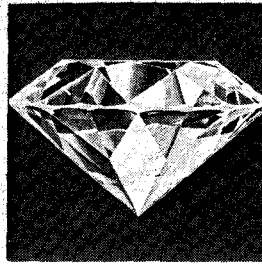

\$875

SPECIFICATIONS:

IC150

Frequency Response:— HI-LEVEL ± 0.6 db 3 Hz-100 kHz; PHONO ± 0.5 db of RIAA, calibrated. **Hum and Noise:**— HI-LEVEL 100 db below 2.5V, "A" weighted; PHONO 80 db below 10 MV input. **Distortion:**— THD essentially unmeasurable; IM .003% at rated output. **Phono Input:**— Sensitivity 1MV at 1kHz for 2.5V out; Overload 33-330 MV at 1kHz (adjustable). **Output:**— Rated at 2.5 volt, typically 10V before overload. **Volume Control:**— Over 60 db dynamic range with calibrated tracking. **Loudness:**— Excellent simulation of Fletcher Munson curves down to 60 phono, co-ordinated with volume control. **Phase Shift:**— Typically $+10^\circ$ to -12° 20Hz to 20 kHz. **Tone Controls:**— ± 15 db at 30 Hz to 15 kHz. **Filters:**— (High and low filters).

D150

Frequency Response:— ± 0.1 db 20-20 kHz at 1 watt into 8 ohm; ± 1 db 4-100 kHz. **Power Output:**— 100 watt RMS into 8 ohm, both channels operating. **Power Bandwidth:**— ± 1 db, 5-20 kHz at 75 watt RMS into 8 ohms. **Distortion:**— THD typically 0.002%. (At .01 to 75 watts) IM typically 0.005%. **Damping Factor:**— Greater than 200 from zero to 1 kHz 8 ohms. **Weight:**— 25 lbs.

THE AMCRON PHILOSOPHY

"While the plastic generations of audio equipment come and go, the steadfast performance, the unflinching quality, and the unparalleled construction of all Amcron equipment will remain."

Audio Magazine said:— "IC150 — We were all able to measure hum and noise levels of approximately — 93 db below 2.5 volts output, and phono noise of about .50 microvolts — D150 — at a typical output of 75 watts (8 ohms) IM was measured at 0.002%, by implication, THD might be expected to be approx. 0.0005% which neither Amcron nor we could measure. If you want the very best, our endorsement of the IC150/D150 is completely given without any reservations.

Stereo Review said:— IC150 "We found the frequency response to be down only 0.3 db at our lowest limit of 5 Hz and 1 db at 225 kHz. The RIAA equalization was so accurate (± 0.25 db) that we may have been checking the residual errors in our setup."
D150 — "There are not many speaker systems capable of absorbing the full output of the D150, but since its distortion at any level, can only be measured with the most advanced test equipment, one would expect it to sound first rate, and indeed it did."

AUSTRALIAN DISTRIBUTORS:

BJD

Electronics Pty Ltd. 202 Pelham St., Carlton, 3053 Vic. Ph. 347-8255
190 Willoughby Road, Crows Nest, 2065 N.S.W. Ph. 439-4201

ELECTRONICS TODAY INTERNATIONAL — MAY 1974

AVAILABLE FROM:

QLD:

Stereo Supplies —
Brisbane 213-623.
Brisbane Agencies Audio
Centre — Valley 219-139.

NSW:

Instrol — Sydney
29-4258.
Kent HiFi — Sydney
29-6973
Arrow Electronics —
Sydney 29-8580.
Miranda HiFi — Miranda
Fair 525-6745.
Audio Gallery —
Warringah Mall
938-2205.
Audico Sound Systems —
Nth. Lambton 570-501.
Audio World —
Wollongong 295-110.

ACT:

Duratone — Phillip
821-333.

VIC:

Douglas Trading —
Melbourne 639-321.
Instrol HiFi —
Melbourne 675-831.

TAS:

Quantum Electronics —
Hobart 281-337.
Audio Services — Burnie
312-390.

SA:

Sound Spectrum —
Adelaide 223-2181.

WA:

Alberts TV and HiFi —
Perth 215-004.
Perth HiFi — Perth.

What's the standard price for high quality, prestige looking stereo equipment?...



\$158 OR \$135 OR \$91?

Standard (PM-158E) solid state stereo amplifier. This compact (13 3/8" x 3 9/16" x 7 7/8") 18-transistor stereo amplifier delivers total music power of 25 watts at 8 ohms, with a continuous power of 7.5/7.5 at 8 ohms (THD 1%), and has a wide power bandwidth. Low distortion ratio. Highly selective tone control. Personal phone jack lets you enjoy stereo alone without disturbing others. Ideal for use with other units. All this, plus many other outstanding features, for just **\$91.00**.

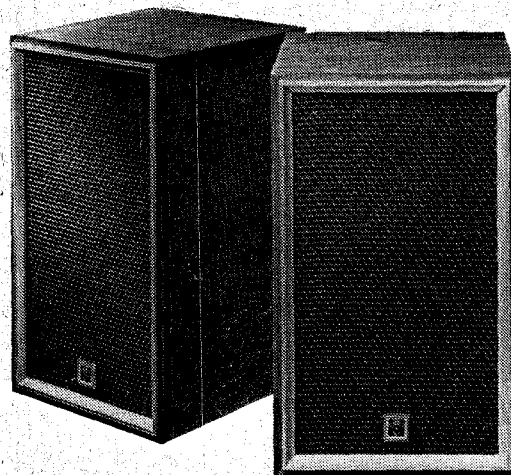

\$207 OR \$149 OR \$107?

Standard (SR-SP210K) speaker system.

Cabinet-size speakers for horizontal or vertical placement on bookshelves. Only 15 9/16" high, 9 7/16" wide, and 9 1/16" deep, these Standard speakers combine a two-way system of High Compliance Free Edge type woofer and highly efficient tweeter. Excellent reproduction with no distortion. For **only \$107** these ultra-smart, walnut-finished speakers can be yours.



\$319 OR \$219 OR \$119?

Standard (PM-403W) solid state stereo amplifier. Same size as the standard PM-158E, yet delivers an astonishing 40 watts (at 8 ohms) of total music power. The continuous power at 1 KHz is 12/12 watts at ohms. Separate bass and treble controls, volume and balance controls, speaker system selector, stereo headphones jack. Special fuses for transistors and circuit protection. Tape monitor for use with tape recorder having separate record and playback heads and preamplifiers. All this for an amazingly low **\$119.00**.

The new range of Standard stereo equipment: the perfect way to start putting together your own hi-fi system. It looks great, it sounds great, but — when it comes to price — it's not so great. Standard costs surprisingly little. Standard also manufacture a range of cassette machines and an FM/AM stereo receiver. Enquire now at your main Standard showroom:

SR STANDARD
Better than average,
cheaper than most

Allied HiFi

330 PACIFIC HIGHWAY, CROWS NEST, N.S.W. 2065. TEL: 439-1072

MCG3

CONSTRUCTIONAL projects

50 WATT STEREO AMPLIFIER * * WAILING SIREN

INEXPENSIVE AMPLIFIER * * TEMPERATURE ALARM

MONOPHONIC ORGAN * * CRYSTAL RADIO

TEMPERATURE METER * * SIGNAL TRACER

SIMPLE POWER SUPPLY * * CRYSTAL RADIO

WEE-WAH SIREN *

RUGGEDIZED

WESTON 660 SERIES Designed to Withstand Severe Conditions

GENERAL FEATURES

- Completely Drop-Proofed
- Custom ruggedized Self-Shielded Taut Band Mechanism.
- Diode Protected Meter-Movement
- Temperature Compensated
- Pluggable Circuit Board Assembly
- Quality Components Used Throughout
- Low Cost
- 5 Models Available
- From \$55.00 Plus Sales Tax.

SCHLUMBERGER INSTRUMENTATION AUSTRALIA PTY.LTD.

MELBOURNE: S.I.A., 112 High Street, Kew,
Telephone 86-9535
SYDNEY: S.I.A., 134 Willoughby Road, Crows Nest.
Telephone 439-7650
BRISBANE: L.E. Boughen, 30 Grimes Street, Tóowong
Telephone 70-8097
ADELAIDE: Associated Services, 110 Tynte Street, Nth Adelaide
Telephone 207-2246
PERTH: Dawson Instruments, 70B. Hale Road, Wembley Downs.
Telephone 41-4117

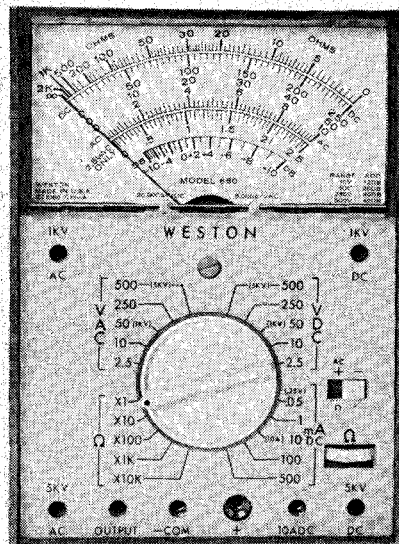

DC POWER SUPPLY MODULE

**2.5 Amp, 6-7.5-9V regulated,
pre assembled and tested!**

**All you add is your
transformer (A+R5504) and
an Instrument Case (H 43/6).**

**Ideal for Bench Testing,
Burglar Alarms, Trickle
Charging etc.,
and all Low Voltage,
high-current applications
available in our
instrument section.**

(Suggested Retail Price \$ 14.50)

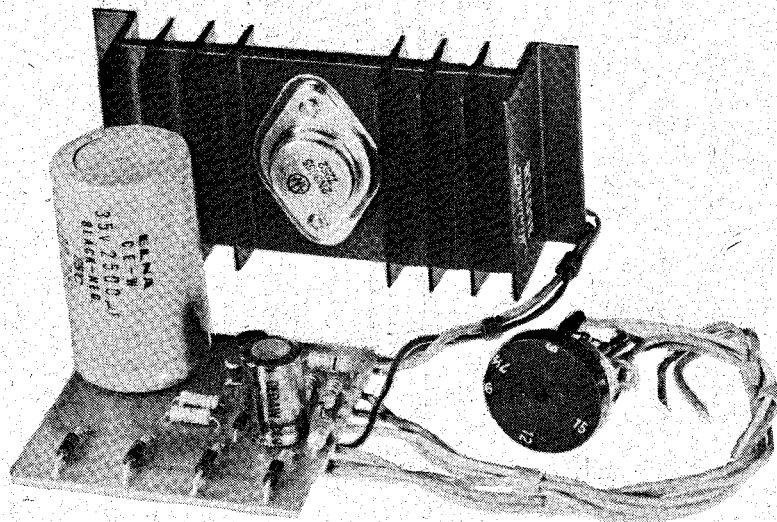

radioparts GROUP
MELBOURNE'S WHOLESALE HOUSE

562 Spencer St., West Melbourne, Vic., 3003.
Phone 329 7888. Orders 30 2224. *Telex: 32980

City Depot: 157 Elizabeth Street
Melbourne, Vic., 3000. Phone 67 2699

Southern Depot: 1103 Dandenong Road
East Malvern, Vic., 3145. Phone 211 8122

PSM ©

CONSTRUCTING ELECTRONIC PROJECTS

The how and why of project building.

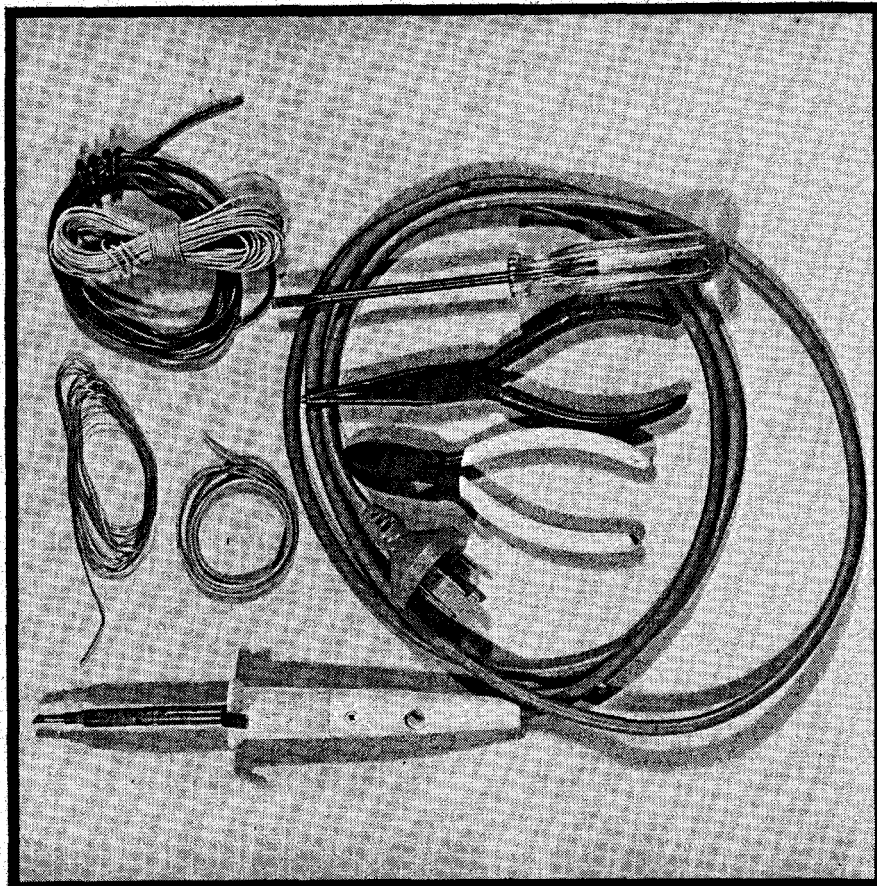

Basic tools required to commence building projects, together with solder and wire. The tools are from left to right. Adcola soldering iron, side-cutting pliers, long-nose pliers and small screwdriver.

THE fascination of electronics is largely due to the ability to build, from a relatively small selection of components, a large variety of circuitry which, are not only interesting, but are also extremely useful and fascinating.

The following selection of small

projects has been designed to illustrate the breadth and power of electronic techniques, whilst introducing the beginner to project building.

A minimum of different components has been used, and many components are common to several circuits. Additionally, many of the circuits

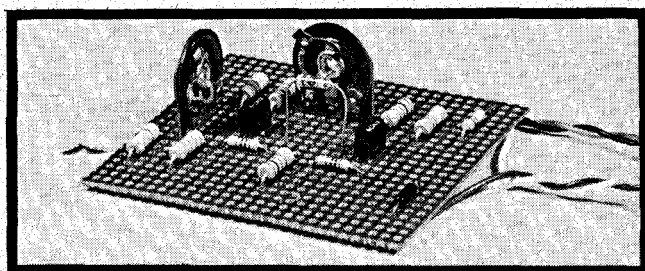

A typical matrix-board project. Note that the layout is neat and compact.

described here are basic black boxes (such as the amplifier and power supply) which may be used again and again as part of other more complex projects.

Anyone building these projects will gain much insight into general electronics, will assemble a selection of useful circuits and will be well on the way to being a competent electronic experimenter and hobbyist.

THE TOOLS

Although the serious electronic hobbyist will ultimately finish up with a very extensive tool kit, very few tools are needed to get started on project building.

The most essential thing is a good soldering iron, the one we recommend is the Adcola M70, 19 watt iron, having a 3.2 mm (1/8 inch) tip. Also required are a pair of 100 mm diagonal side cutting pliers, and a small 100 mm screwdriver with a 3.2 mm blade.

As well as the above basic tools, you will require some resin-cored solder, some 20 to 22 gauge tinned copper wire, several lengths (different colours) of PVC-covered hook-up wire (7 x .010 or 10 x .010), and a length of 1 mm spaghetti-type insulation.

Do not try to use plumber's stick solder or anything but high grade 60/40 (60 per cent tin, 40 per cent lead) 5-core resin solder. Especially do not use any acidic fluxes — otherwise your components will corrode away!

Resin-cored solder is available in a number of thicknesses, or gauges. That most commonly available is 16 SWG, but this is a little heavy for today's compact circuitry and we suggest that you obtain 18 or 20 gauge if possible.

The above tools, wire and solder are all that is required to get going on the matrix-board project, but for others you will also need a set of drills, a drill (preferably electric) and a couple of small files, one flat 150 to 200 mm and one round 150 to 200 mm. These will be required to make small heatsinks and to mount completed projects in boxes, mount switches etc.

As you progress in electronics you will find that other tools are required and a good rule to follow is:— Buy only good quality tools, and only

CONSTRUCTING ELECTRONICS PROJECTS

those that you have a definite need for.

CONSTRUCTION

There are many methods of constructing electronic circuitry, but one of the best devised so far is on a properly designed printed circuit board (such as that used for the monophonic organ project described elsewhere in this section).

Printed circuit boards are made by photographically etching the circuit pattern onto a piece of bakelite, phenolic-paper or fibre-glass board, which is coated on one side (sometimes both sides) with a thick copper surface. This process is generally beyond the hobbyist who usually purchases printed circuit boards ready made.

However printed circuit boards are only necessary where the project is intended to be used permanently, or where the expense of the board is not of great importance.

For the experimenter, there are several alternative methods of constructing circuitry. These methods are both flexible and cheap.

The most common of these methods involve veroboard or matrix board.

Both of these propriety boards are perforated at 2.5 mm intervals with small holes through which component leads may be passed. Veroboard has copper strips on the rear of the board which may be used as a means of interconnection — matrix board does not.

We have found that although veroboard *looks* the most attractive system at first sight, it is more difficult to use and once used cannot readily be recovered for use again. Hence we have specified matrix board for the simpler projects.

To use matrix board, merely pass the component's leads through the holes and route them around the rear of the board to the other component to which it is to be connected.

Where the component leads are not long enough use a short length of tinned copper as a link. Cover the bare wire with 'spaghetti'. Hook-up wire is then used to connect the power supply and input/output etc to the board. The accompanying photographs show front and rear of the temperature meter board.

When wiring the components into circuit make sure all that are polarized (such as diodes, transistors and

electrolytic capacitors) are oriented correctly. It is essential that this be checked thoroughly before switching on — otherwise components may be destroyed.

Similarly the circuitry should be thoroughly checked to make sure that no errors have been made in wiring.

A few minutes spent checking can save expensive damage and waste of time locating faulty components. ●

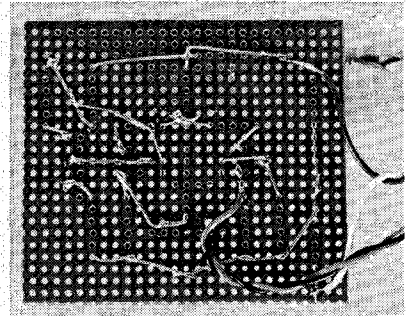

The rear of the matrix-board project showing how the component leads may be bent to make connections simply and quickly. Sleeving need only be placed over wires where they cross other wires.

ETI

PROJECT
218

MONOPHONIC ORGAN

This miniature organ has full two-octave range — plus tremolo.

The completed organ (not mounted in a case) together with its probe. We used a conventional phone jack as the probe.

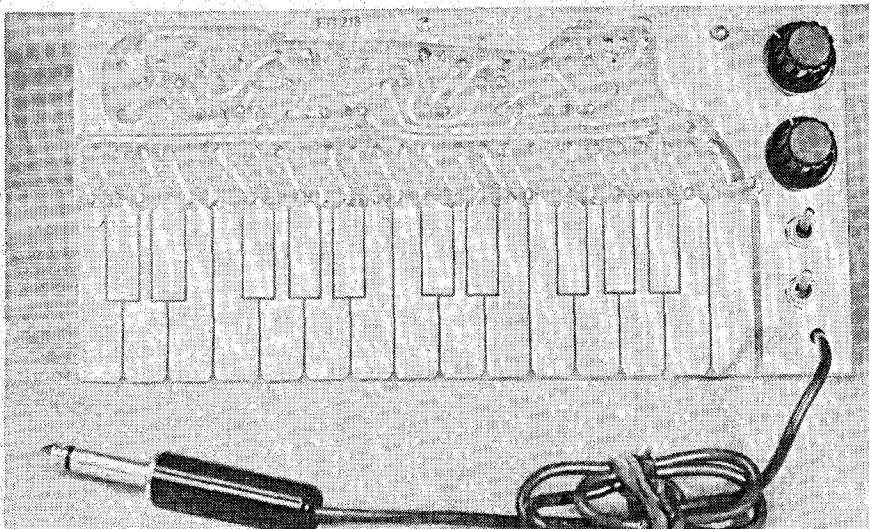

You may well have seen Rolf Harris, on his TV show, playing a small hand held organ, the notes being selected by a metal probe. Such an organ (known as a monophonic organ because only one note can be played at a time) can be very effective indeed especially when well tuned and fitted with tremolo.

The ETI organ is such an instrument, it is capable of producing a very fine sound, and should provide a great deal of musical enjoyment — as well as being electronically educational.

Because this is likely to be built as a permanent device we have designed a printed circuit board for this project. This will familiarize the builder with the advantages of using a printed circuit board (neatness, ease of

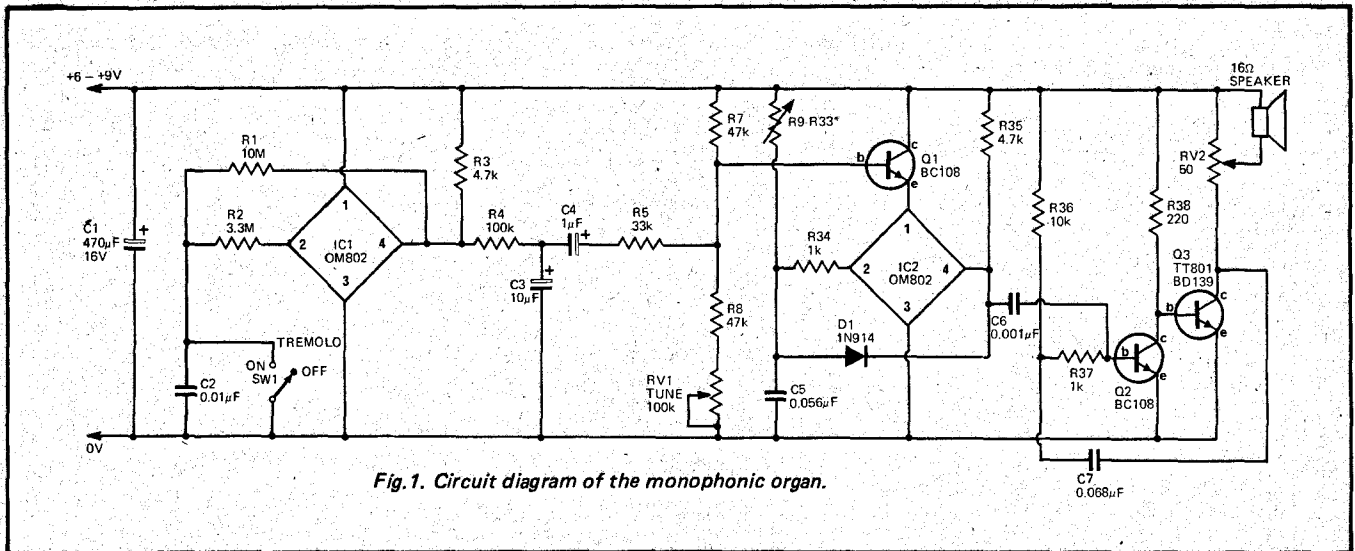

Fig.1. Circuit diagram of the monophonic organ.

construction etc). Additionally, in this case the printed circuit board offers an ideal solution to the problem of building a keyboard. The keyboard is simply etched onto the printed circuit board! As copper rapidly oxidizes when touched (resulting in high contact resistance), the board should be gold flashed or roll tinned to ensure good keyboard operation — ensure that this has been done when purchasing.

The instrument provides a full two-octave range including sharps and flats. We have selected the octaves from C (262 Hz) to C (1047 Hz) but other octaves may be obtained if required by changing the value of C5.

Fig.2. Printed circuit board layout for the monophonic organ (full size).

PARTS LIST			ORGAN ETI 218		
R38	Resistor	220Ω 1/2W 5%	RV1	Potentiometer	100 k lin rotary
R34,37	"	1 k "	RV2	"	50Ω 1W rotary
R10	"	3.3 k "	C6	Capacitor	0.001µF polyester
R11	"	3.6 k "	C2	"	0.01µF polyester
R12,13	"	3.9 k "	C5	"	0.056µF "
R14,15	"	4.3 k "	C7	"	0.068µF "
R3,16,35	"	4.7 k "	C4	"	1µF 35V electrolytic
R17	"	5.1 k "	C3	"	10µF 16V electrolytic
R18,19	"	5.6 k "	C1	"	470µF 16V electrolytic
R20,21	"	6.2 k "	IC1,2	Integrated circuit	OM802
R22	"	6.8 k "	Q1,2	Transistor	BC108 or similar
R23,24	"	7.5 k "	Q3	"	TT801, BD139 or similar
R25,26	"	8.2 k "	D1	Diode	1N914
R27,28	"	9.1 k "	16Ω	Speaker	
R36	"	10 k "	SW1	Single pole ON-OFF switch	
R29,30,31	"	11 k "	PC Board	ETI 218 gold flashed or roll tinned.	
R32	"	12 k "			
R33	"	13 k "			
R5	"	33 k "			
R7,8	"	47 k "			
R9	"	56 k "			
R4	"	100 k "			
R2	"	3.3 M "			
R1	"	10 M "			

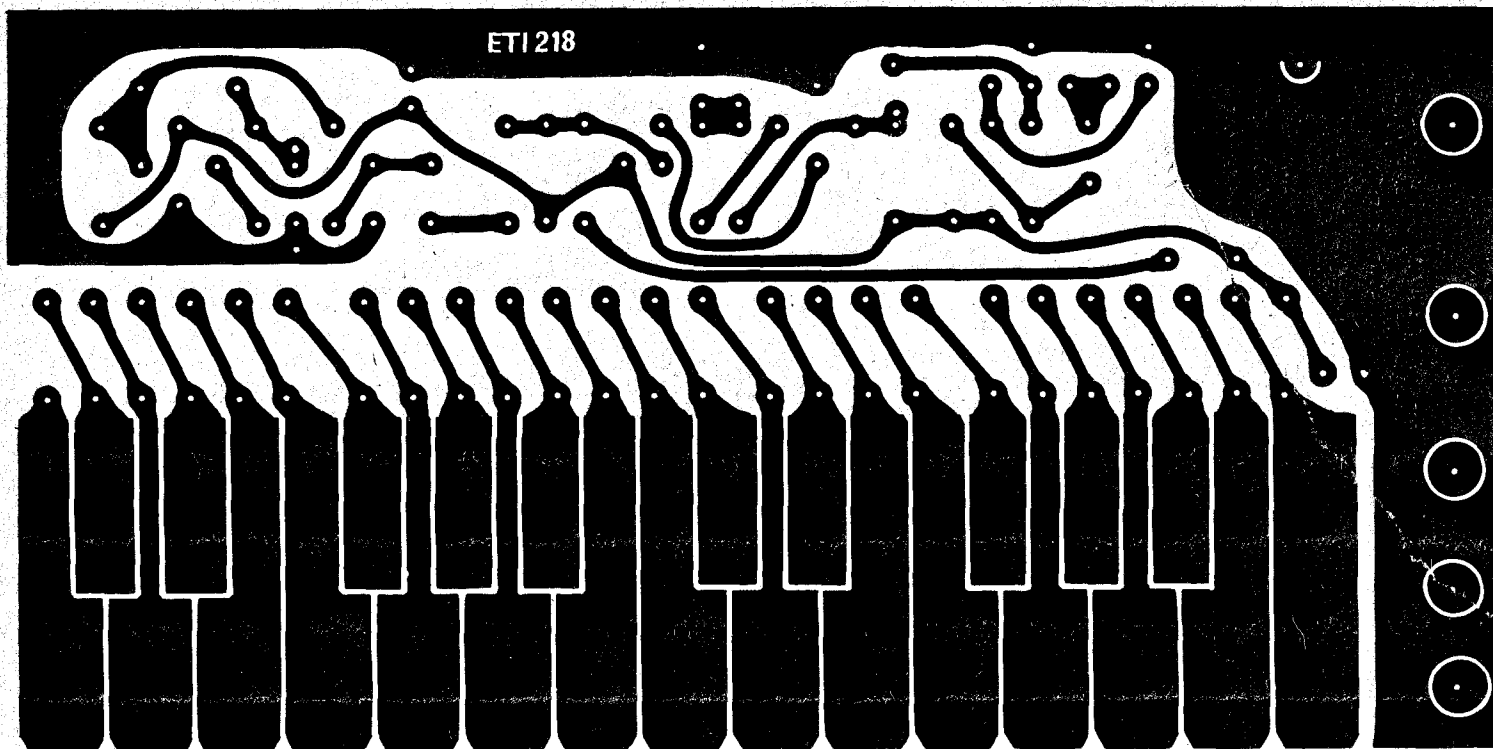

MONOPHONIC ORGAN

HOW IT WORKS MONOPHONIC ORGAN ETI 218

The heart of the organ is the integrated circuit type OM802. This is an oscillator that operates in a very similar manner to that using a unijunction transistor.

With reference to the circuit diagram, and in particular to IC1, we have the initial situation where C2 is discharged and the output voltage of the IC (at pin 4) is high at approximately 6 volts. In this condition the current into the input (pin 2) is virtually zero and hence C2 will begin to charge via R1.

When the voltage at pin 2 of the IC reaches approximately 50% of the supply voltage, both the output voltage, and the voltage at pin 2 will drop to near zero. This causes C2 to be discharged through R1 as well as through R2. When the voltage across C2 falls to less than 1 volt the output again reverts to the high state, the input current falls to zero and C2 begins to charge again.

The mark/space ratio of the cycle can be varied by changing the ratio of R1 and R2. With the values given, the mark/space ratio is 1:1 and the frequency about 10 Hz. The output is filtered by R4 and C3 to provide a waveform that is used to modulate the tone oscillator producing a pleasing variation of the basic tone. This is known as tremolo.

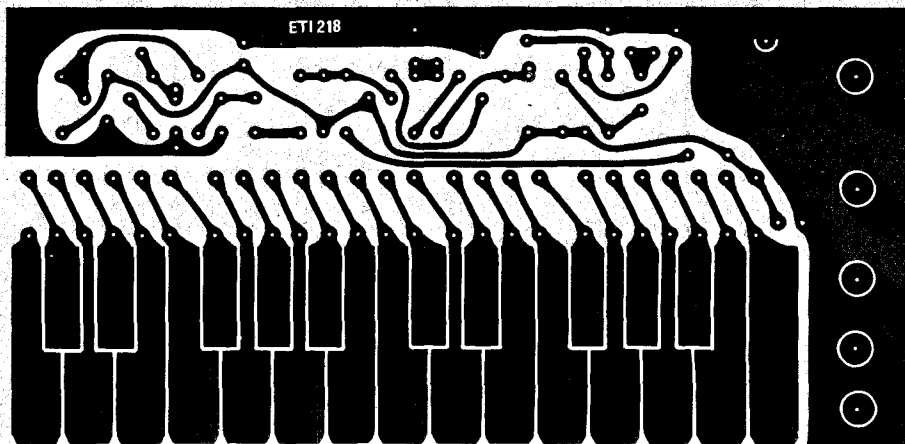

Fig. 3. Component overlay shows positions of the components on the board. Watch polarities of capacitors, transistors etc.

The tone generator (IC2), works in a similar fashion to IC1, however the supply voltage to the IC is varied through Q1 by means of the tune control (RV1) as well as by the tremolo input.

In this case C5 is the basic charging capacitor and the charging resistance (R9-R33) is selected by probing the keyboard. In the charging cycle in this instance the charging current is not removed when the threshold voltage is reached, but instead the capacitor is rapidly discharged by diode D1. Using this method, the output is low for a period of only 10 microseconds.

The resistors R9 to R33 are chosen such that the notes are a semitone apart that is, the ratio of the two

notes is $\sqrt[12]{2}:1$. Transistors Q2 and Q3 form a monostable which provides, when triggered, a pulse with a duration of 0.5 milliseconds. In the rest condition Q2 is on and Q3 off. The negative pulse from IC2 is coupled to the base of Q2 via C6 and momentarily turns Q2 off and Q3 on. Capacitor C7 couples this negative going transition into the base of Q2 holding it off for about 0.5 milliseconds whilst C7 charges up via R36. The positive pulse from IC2, which occurs 10 microseconds after the negative transition, is swamped by the much higher energy input from C7.

Potentiometer RV2 adjusts the output to the speaker from the monostable.



TWO SIREN CIRCUITS

PROJECT 219,220

Make a minor change to the preceding organ circuit – and there's a hee-haw siren.

HEE-HAW SIREN ETI219

The basic oscillator circuitry of the organ may be used to implement two commonly used siren generators. The first of these is, because of its characteristic sound, called a Hee Haw and is commonly used as a police or ambulance siren.

Operation of both sirens will be readily understood by referring to the description of operation for the integrated circuits and output stage in

the monophonic organ which uses very similar circuitry..

In the case of the Hee-Haw the frequency of IC1 is set to about 1 Hz and the mark/space ratio to 1:1. The output frequency is controlled by R6, through which C4 charges, and R4 and R5 which will either help charge C4 (higher frequency) or remove current from C4 (lower frequency). The ratio of $R6/R4+R5$ determines the difference in pitch of the two frequencies. No tune control is required and hence pin

of IC2 is connected directly to the positive rail.

WAILING SIREN ETI 220

By altering the circuit slightly the more conventional fire-brigade type siren is obtained. Here IC1 operates at a lower frequency (about 0.25 Hz) and the output of IC1 is filtered to provide the slow smooth change required.

The component values specified provide approximately one octave between the two extremes of

frequency in both cases.

These three circuits, organ, hee haw and siren dramatically illustrate how the same basic circuitry can be used to perform a variety of tasks. Note also the black-box concept, all three consist of two oscillators and an audio amplifier. A little thinking about the differences between these circuits will give the constructor much insight into electronics.

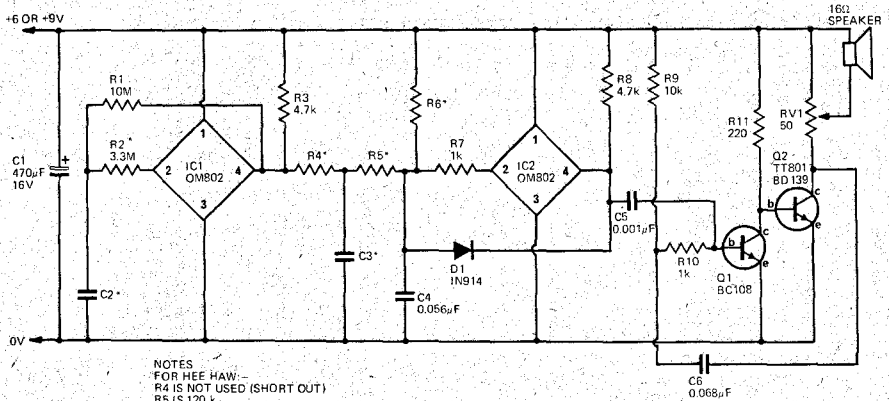

NOTES
FOR HEE HAW:-
R4 IS NOT USED (SHORT OUT)
R5 IS 120 k
R6 IS 47 k
C2 IS 0.1μF
C3 NOT USED (LEAVE OPEN)
FOR SIREN:-
R4 IS 39 k
R5 IS 18 k
R6 IS 33 k
C2 IS 0.39μF
C3 IS 100μF 16V

Circuit diagram for both sirens.

PARTS LIST HEE HAW SIREN ETI 219

R11	Resistor	220Ω	1/2W	5%
R7,10	"	1 k	"	"
R3,8	"	4.7 k	"	"
R9	"	10 k	"	"
R6	"	47 k	"	"
R5	"	120 k	"	"
R2	"	3.3 M	"	"
R1	"	10 M	"	"
C5	Capacitor	0.001μF	polyester	
C4	"	0.056μF	"	
C6	"	0.068μF	"	
C2	"	0.1μF	"	
C1	"	470μF	electrolytic	

IC1,2 Integrated circuit OM802

Q1	Transistor	BC108
Q2	"	TT801, BD139
RV1	Potentiometer	50Ω 1W
16Ω	Speaker	
D1	Diode	IN914

piece of matrix board.

PARTS LIST WAILING SIREN ETI 220

All parts as for hee haw except

R4	Resistor	39 k	1/2W	5%
R5	"	18 k	"	"
R6	"	33 k	"	"
C2	Capacitor	0.39μF	polyester	
C3	"	100μF	16V	electrolytic



BASIC POWER SUPPLY

PROJECT 221

Simple regulated supply provides 4.5-12 volts at 400 mA maximum.

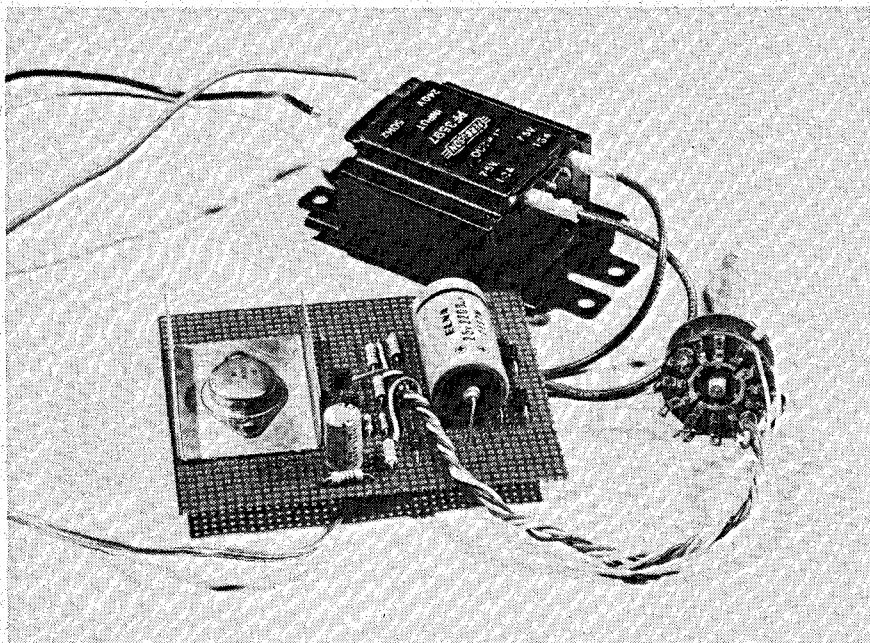

The power supply shown unmounted. Note the aluminium heat sink for the power transistor.

THIS little power supply provides a range of switch selectable output regulated voltages from 4.5 to 12 volts, selectable by a switch. The supply will provide up to 400 mA (800 mA when modified for use with the organ described elsewhere) and the output can withstand a short circuit without damage. It is therefore ideal for the experimenter or for use with high drain appliances.

PARTS LIST POWER SUPPLY ETI 221

R6	Resistor	1.5 ohms	1/2 W	5%
		(2 x 1.5 ohms in parallel for organ)		
R7	"	220	ohms	1/2 W 5%
R3	"	320	"	"
R1,8	"	1 k	"	"
R4,5	"	1.5 k	"	"
R2	"	2.7 k	"	"
Q1	Transistor	PN3643 or similar		
Q2	"	2N3055	"	"
Q3	"	PN3638	"	"
D1-D4	Diode	EM401 or similar		
ZD1	Zener diode	BZY88C13		
T1	Transformer	240V/15V @ 1A		
SW1	DPST	240V switch		
SW2	4 position	single pole switch		
		heatsink for Q2		
C1	Capacitor	220μF	25V	electrolytic
C2	"	100μF	16V	"

Piece of matrix board.

BASIC POWER SUPPLY

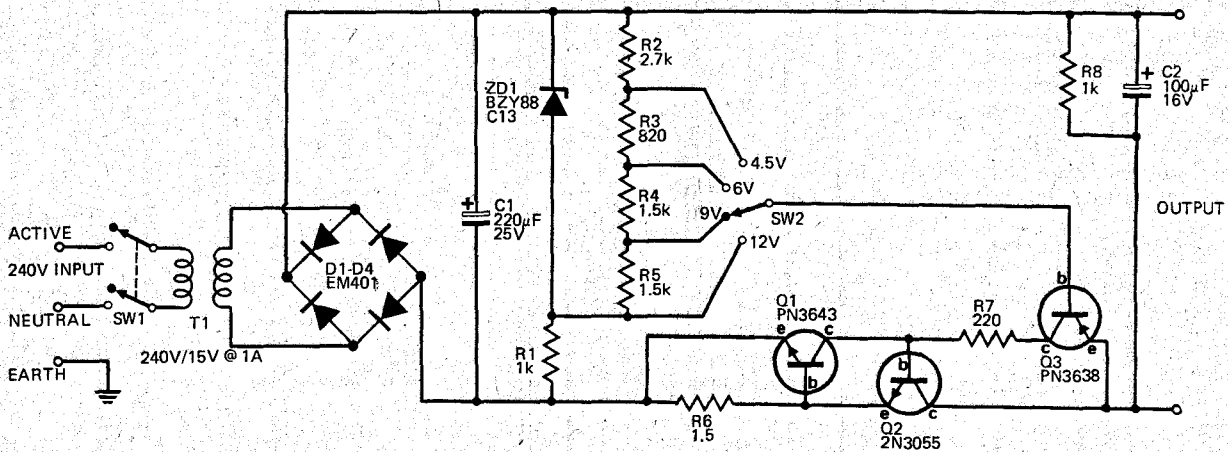

Fig. 1. Circuit diagram of the regulated power supply. Note that when used to power the monophonic organ, R6 should be 0.75 ohms (2 x 1.5 Ω in parallel). This increases the output current capability to about 600 mA.

SPECIFICATION

Nominal output voltage 12 V, 9 V, 6 V, and 4.5 V
 Output current 0 – 300 mA
 Current limit approx. 500 mA
 * except when modified for use with organ.

HOW IT WORKS

The 240 V mains voltage is reduced to 15 volts by transformer T1, and this secondary voltage is then full-wave rectified by rectifier bridge D1-D4.
 The output of the bridge rectifier is filtered by C1 to provide approximately 20 volts dc.

The series combination of Zener diode ZD1 fed by resistor R1, provides a stabilized voltage of around 13 volts which is applied across the voltage divider R2, R3, R4 and R5. Thus a series of reference voltages are generated for the regulator, where the positive rail is fixed and the negative rail is the one that is varied.

Transistor Q3 is an emitter follower where the output (emitter) is about 0.6 V higher (more positive) than the base. The base voltage is selected by SW2 from one of the tapings on the reference-voltage divider. Since Q3 cannot handle the required output current, it drives Q2, a power transistor, which can handle the required load.

When the load exceeds 400 mA (approximately), the voltage drop across R6 forward biases Q1 which turns on and shunts current away from the base of Q2. Thus the regulator loses control and the output voltage falls, limiting the current to 400 mA. As the power dissipated in Q2 under short-circuit conditions is around 10 watts, Q2 must be fitted to a heatsink. Additionally, resistor R7 limits the current supplied by Q3 to a safe value (for Q3) under short circuit conditions.

If a fully variable supply is required, a 10 k potentiometer should be used in place of the voltage divider. The wiper of the potentiometer is then fed directly to the base of Q3.

TRANSISTOR TESTER

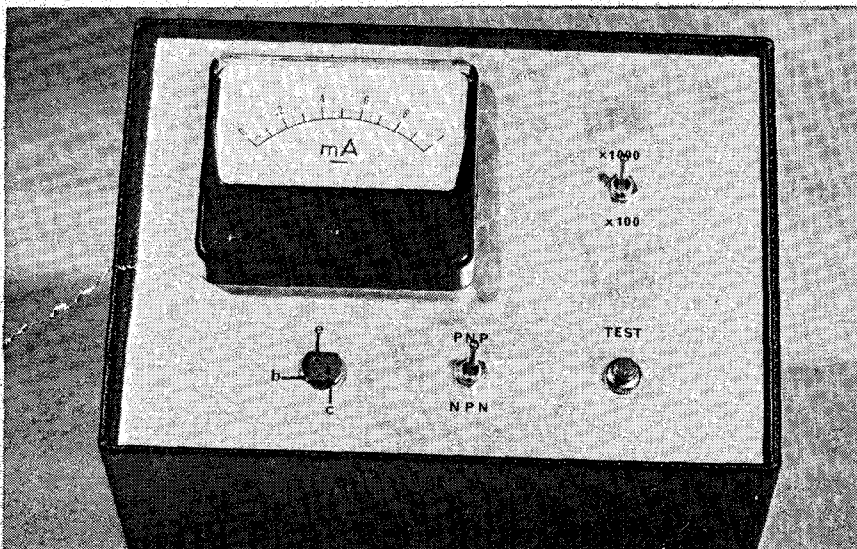

PROJECT 222

Measure and test your transistors with this easily built device.

EXPERIMENTERS will frequently use the same transistors in a whole sequence of experimental circuits, for recovering and re-using such components saves considerable outlay.

The transistor tester mounted in a metal case.

But semiconductors are easily damaged — by incorrect operating conditions — or by excessive application of heat when soldering.

Only too often a malfunctioning experimental circuit will be checked and rechecked before one realises that a transistor is dead.

A transistor tester will save hours of such frustrating and unproductive effort.

Transistors can often be bought cheaply in bulk — usually in unmarked and untested lots — or recovered from old computer boards. Here again a transistor tester will prove invaluable in eliminating the faulty bits.

The simple transistor tester described in this project not only sorts out the good from the bad but indicates also the approximate gain (β) of the transistor. This is a most useful feature for those circuits where transistors need to be matched. Two ranges of gain (beta) are provided, 0-100, and 0-1000. The tester may also be used to check transistor polarity.

PARTS LIST — Transistor Tester — ETI 222

- R3 Resistor 33 Ω 1/2 watt 5%
- R2 Resistor 270 Ω 1/2 watt 5%
- R1 Resistor 470 Ω 1/2 watt 5%
- R4 Resistor 470K 1/2 watt 5%
- D1 Diode 1N914
- ZD1 Zener diode BZY88C5V6
- SW1 Push button push-to-make
- SW2 Switch toggle DPST
- SW3 Switch toggle SPST
- 9V battery
- M1 Meter 1mA movement
- SK1 Socket T05 transistor type
- Metal case or minibox

HOW IT WORKS

Operation of the tester is very simple. The meter, M1, monitors the collector current of the transistor under test whilst R4 supplies a current of about 10 μ A into the base of the test transistor. Thus, on the 100 β range, the maximum collector current will be 1 mA and, on the 1000 β range, 10 mA. Switch SW3 therefore changes the meter sensitivity according to the beta range selected.

The meter is protected by means of D1 against damage due to test transistors being shorted. The zener diode ZD1 stabilizes the battery voltage to 5.6V.

Circuit diagram of the ETI transistor tester.

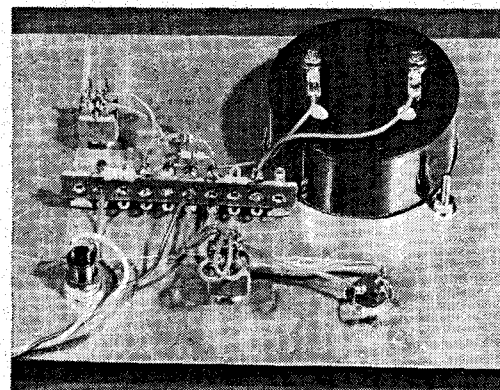
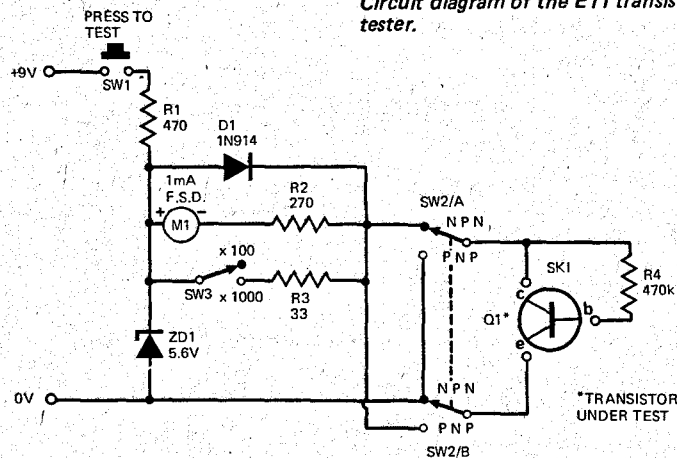

The construction method may readily be seen from this photograph of the back of the front panel.

PROJECT 223 MULTIVIBRATOR

Fundamental square wave oscillator has a thousand and one uses.

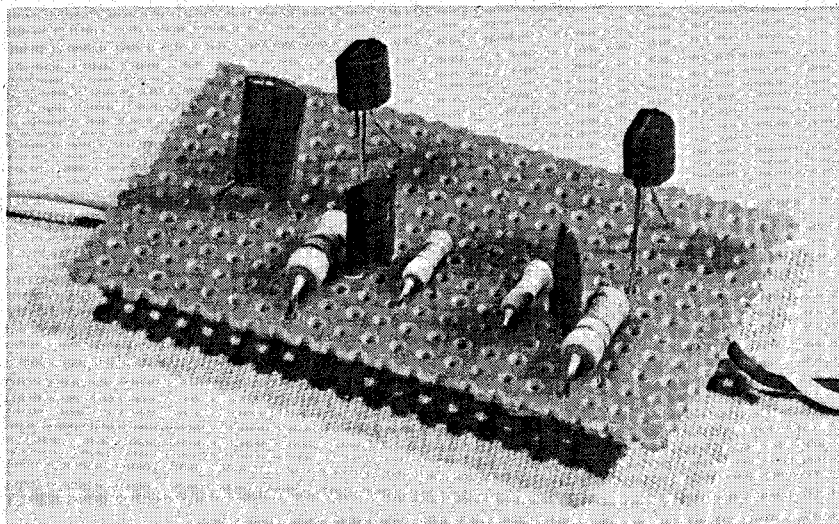

THIS simple circuit, known as a multivibrator, is in effect an oscillator which provides a rectangular output waveform. When R2 equals R3, and C1 equals C2, the output waveform will be symmetrical (i.e. it will be a square wave).

With the component values as specified in the circuit, the operating frequency will be approximately 5 kHz, but this is easily altered by changing the values of C1 and C2.

In this type of circuit, each transistor turns on and off alternately. For example when Q1 turns on, the drop in collector volts is passed via C1 to the base of Q2 turning it off. The off time of each transistor is

MULTIVIBRATOR

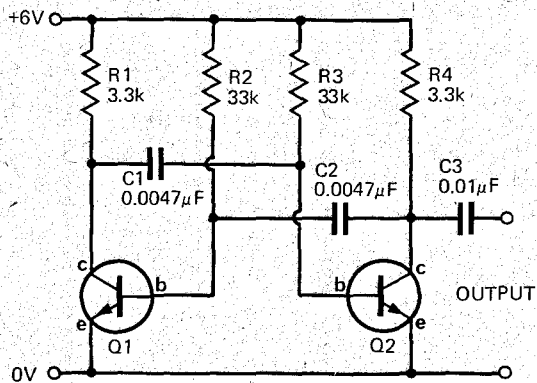

Circuit diagram of the multivibrator.

Output from the multivibrator is taken via C3, and may be used as an alarm signal, etc (via switch amplifier and speaker) or, it may be used as a signal source for tracing through amplifier and radio circuits. A square wave is rich in harmonics and, with an operating frequency in the 5-10 kHz region, the harmonics extend up into the broadcast receiver band. Thus one may locate a faulty stage in a receiver by injecting the signal into the circuit stage by stage going backwards from the output amplifier to the input stage of the receiver. When the faulty stage is reached, no output from the speaker will be obtained.

This little multivibrator has many other uses and similar circuitry will be found in many commercial and industrial electronic equipment. ●

approximately $0.7 RC$ where for Q1, R equals R2 and C equals C2.

Similarly for Q2 the time constant is determined by R3 and C1. Note that R is in ohms and C is in farads.

The two halves of the wave may be made unequal by using different values of C in the two sides. However the ratio of the two durations (called the mark/space ratio) should not exceed four to one.

The circuit is tolerant of supply voltage changes, and operating frequency will change very little over the supply range of two to seven volts. Note that with a supply above seven volts, the base/emitter breakdown voltage of the transistors will be exceeded and the frequency of operation will increase. Operation in this region is not recommended as the transistors may be damaged.

PARTS LIST	
— Multivibrator ET1 223.	
R1,4	Resistor 3.3k 1/2 watt 5%
R2,3	Resistor 33k 1/2 watt 5%
Q1,Q2	Transistor BC108 or similar
C1,C2	Capacitor 0.0047µF polyester
C3	Capacitor 0.01µF 400V polyester
6 volt battery, small piece of veroboard	

PROJECT 224

TEMPERATURE ALARM

Under or over temperature — or both — will activate this alarm.

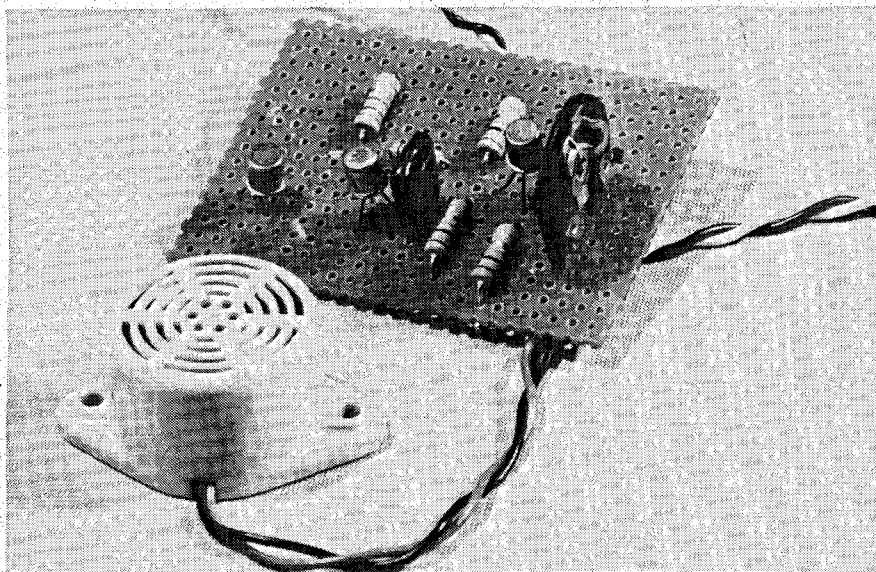

The completed temperature alarm. Note the Morganite type alarm in the foreground.

THIS circuit is designed to provide an alarm (either audible or by relay contact closure) whenever a temperature, as monitored by a thermistor, drops below, or rises above, a preset level. The thermistor sensor is a negative temperature coefficient device (NTC), that is, as temperature rises the thermistor resistance falls.

Using thermistors, the range of temperatures over which the unit will operate is from -20 to $+150^{\circ}\text{C}$. However any one single type of thermistor is only useful over a 30°C range and it is therefore necessary to select a thermistor for the desired operating point by referring to Table 1.

Select the desired temperature from column 1. The corresponding nominal value of thermistor will be found in column 2. The thermistor will have a value of resistance between 1 and 4 k at the operating temperature.

The hysteresis, or deadband, between the on and off switching points is only a few degrees centigrade and the circuit may therefore be used to switch a heater, etc, for temperature control in non-critical applications. If desired, the deadband may be widened by reducing the value of resistor R4.

TABLE 1

Operating Temperature °C	Suggested Thermistor (resistance, in ohms, at 25°C).
-20	180
0	560
+25	2200
+40	3900
+70	10 k
+100	27 k

HOW IT WORKS

The emitter of Q1 is connected to the junction of RV1 and TH1 (thermistor) which form a voltage divider. As TH1 varies with temperature the voltage at the emitter of Q1 will also vary with temperature.

Transistors Q1 and Q2 together form what is known as a Schmitt trigger. The Schmitt trigger is in fact an amplifier with positive feedback. If the temperature is below the point set by RV1, transistors Q1 and Q2 will be off, that is, not-conducting. The voltage at the base of Q1 will be set by R2, 3, 4 and 5. Since Q2 is off it does not affect the parallel arrangement of R4 plus R4 with R3. Thus with a 6 volt supply there will be 2.86 volts at the base. If the emitter voltage of Q1 falls below 2.86 - 0.6 volts, i.e. 2.26 volts, Q1 will turn on. This causes Q2 to turn on thus effectively putting R4 in parallel with R2. This causes Q1 to latch on, hence, its emitter voltage now has to exceed 3.14 - 0.6 volt

before the transistor will turn off.

Reducing the value of R4 will make the difference between these two voltages greater thus increasing the deadband.

The relay or alarm is driven by Q3 which buffers the output of Q2. The circuit may be used for over-temperature, under temperature or both types of alarm simply by using the appropriate Q3 circuitry.

NOTES:
Q3A IS USED FOR AN OVER TEMPERATURE ALARM.
Q3B IS USED FOR AN UNDER TEMPERATURE ALARM.

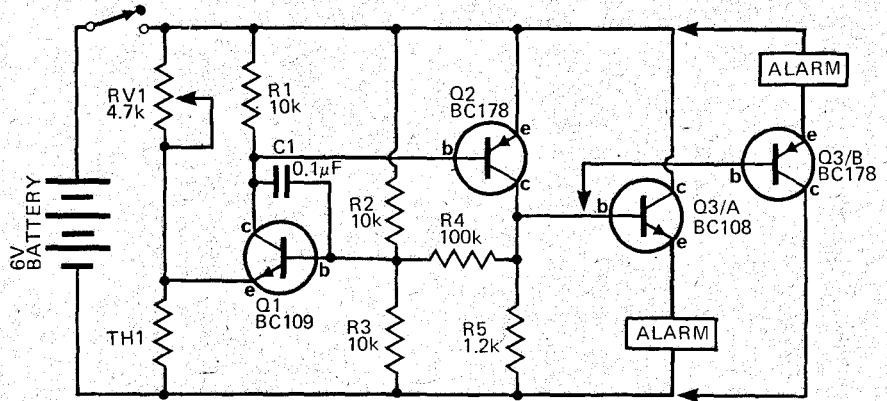

Circuit diagram of the temperature alarm.

PARTS LIST Temperature Alarm ETI 224

- R1,2,3 resistor 1.2k 1/2W 5%
- R4 " 10k " "
- R5 " 100k " "
- RV1 potentiometer 4.7k linear
- TH1 Thermistor see Table 1
- Q1 Transistor BC108 or similar
- Q2 " BC178 or similar
- Q3 " See circuit diagram
- Alarm Morganite alarm type OV, 6V relay or Sonalert etc.
- SW1 SPST toggle switch
- 6V battery
- Pieces of matrix board

ETI PROJECT 225

SIMPLE AMPLIFIER

Build ETI's cheap and simple 1.5 watt amplifier

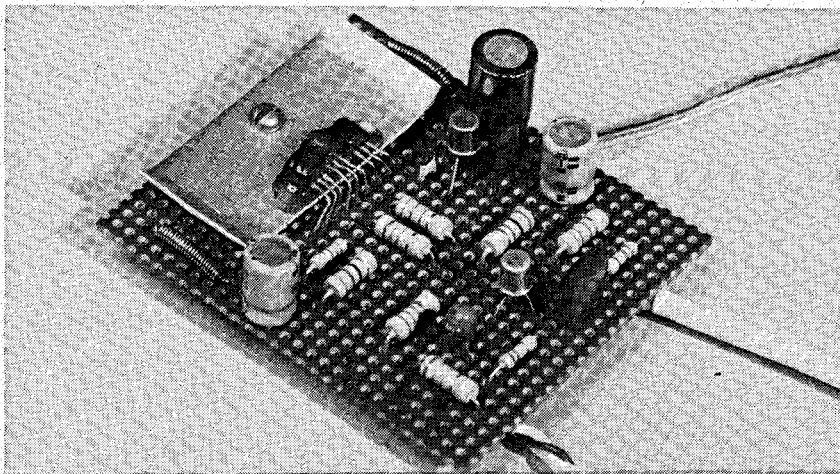

AMPLIFIER ETI 225

A SMALL AMPLIFIER is an almost indispensable aid to the experimenter. It may be used to amplify, and make audible, signals from oscillators operating in the audio range, to trace signals through another audio amplifier that is faulty, to amplify any other signal to a reasonable power level for metering or relay operation etc. etc.

There are at present on the market

The completed amplifier. Note the aluminium heatsink to which Q2, Q4 and Q5 are cemented. These transistors must be plastic TO92 types as per parts list.

SIMPLE AMPLIFIER

many integrated circuit power amplifiers providing outputs of from 1 to 3 watts but most of them require very careful layout of the circuit in order to prevent instability (an unstable amplifier may oscillate and be damaged as a result) Additionally, a discrete transistor amplifier is far more educational in that voltages can be measured in order to gain a better understanding of its operation.

Hence the ETI 225 amplifier has been designed using discrete transistors which beside being much more stable than integrated designs, is ideally suited to the needs of the experimenter.

Transistors Q2, Q4 and Q5 are glued to a piece of aluminium which acts as a heat sink (use 5 minute epoxy). These transistors must be the plastic types specified. Metal can types usually have the collector connected to the case and would be shorted by the heat sink.

We have used a short section of an electric jug element to construct the one ohm resistors in the emitters of Q4 and Q5. However, one ohm, half watt resistors will be entirely suitable.

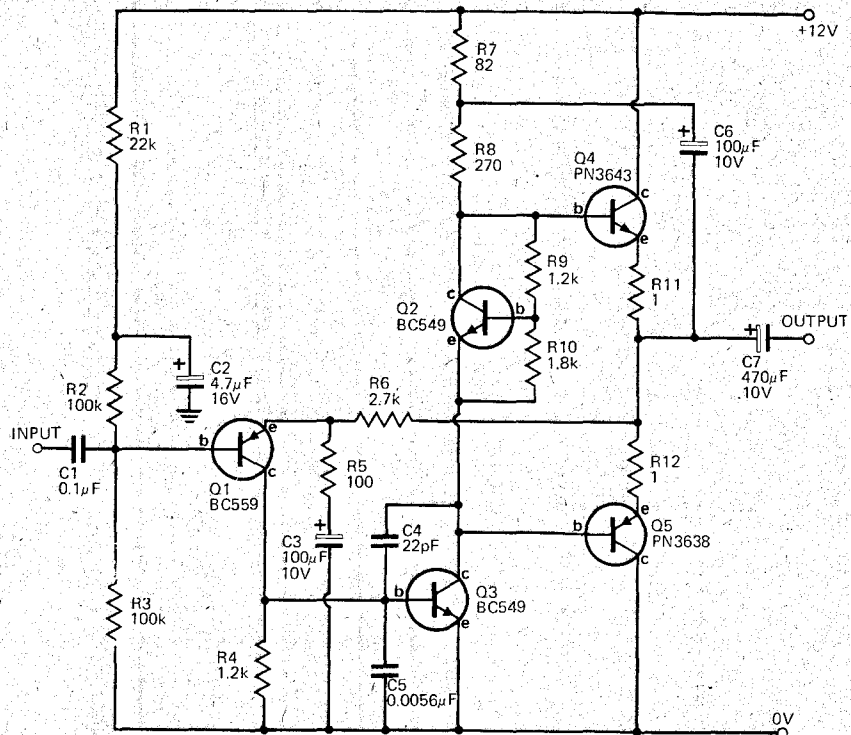

Circuit diagram of the 1.5 watt general purpose amplifier.

Transistor Q1 operates as an error amplifier which compares the input voltage and a divided down version of the output voltage. If there is any difference it provides a control voltage to Q3 in such a way that the error is corrected. The output voltage is divided down by the ratio of $(R6 + R5)/R5$ and hence the calculated gain will be 28 although the measured gain will be slightly less.

The dc bias point of the amplifier is also set by Q2 and this is unaffected by R5 and it is isolated by means of C3. To maintain an approximately constant current in Q3, capacitor C6 is used to keep the voltage across R8 (and hence the current through it) constant.

Capacitors C4 and C5 are used to provide frequency compensation.

HOW IT WORKS ETI 225

This circuit is fairly typical of a large number of audio amplifiers.

The main voltage amplifier transistor Q3 drives the complementary pair (NPN plus PNP) Q4 and Q5 which are buffers providing high current gain but less than unity voltage gain.

As the bases of Q4 and Q5 are effectively two base emitter junctions apart, Q3 is used to set the bias voltages for these transistors.

PARTS LIST AMPLIFIER ETI 225

R11,12	Resistor	1Ω	1/2W 5%
R7	"	82Ω	" "
R5	"	100Ω	" "
R8	"	270Ω	" "
R4,R9	"	1.2k	" "
R10	"	1.8k	" "
R1	"	22k	" "
R2,3	"	100k	" "
C4	Capacitor	22pF ceramic	
C5	"	0.0056µF polyester	
C1	"	0.1µF polyester	
C2	"	4.7µF 16V electrolytic	
C3,6	"	100µF 10V electrolytic	
C7	"	470µF 10V electrolytic	
Q1	Transistor	BC559 or similar	
Q2,3*	"	BC549 or similar	
Q4*	"	PN3643 or similar	
Q5*	"	PN3638 or similar	

* must be TO92 plastic types.

piece of matrix board

piece of aluminium approx. 1" x 1/2" for heatsink.

PHILIPS ONLY

BC548 BC558
BC549 BC559

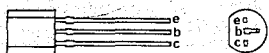

BC548 PN3638
BC549 PN3643
BC558 PN3645
BC559

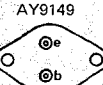
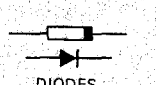
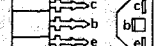
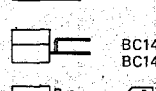
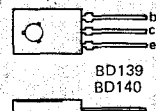
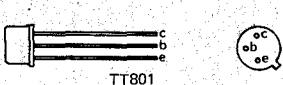
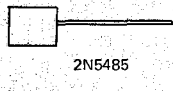
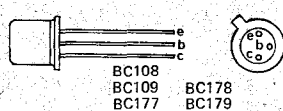
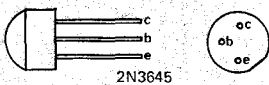

BASE CONNECTIONS

Here are the base connections for the transistors used in this project feature.

NOW AVAILABLE

KONO LEAD ACID BATTERIES

Outstanding in design and performance

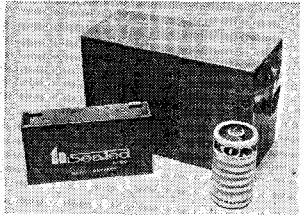

CONSTRUCTION

Fully sealed in reinforced plastic housing.

LIFE

500-1000 charge cycles or 4-5 years on float service.

DISCHARGE CURRENT

Maximum continuous discharge 200 times larger than the 20 hr discharge rate.

MIKE ELECTRIC

(AUST.) PTY. LIMITED

118 Carnarvon Street, Silverwater.
Phone 648 5400

Morganite AUSTRALIA PTY. LIMITED

INDUSTRIAL PRODUCTS DIVISION

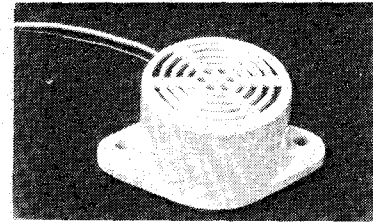

NEW, EXCLUSIVE, LOW COST MINIATURE SOLID STATE ELECTRONIC ALARM

APPLICATIONS — Portable and battery-operated equipment, alarm clocks, test apparatus, intercom sets, automotive warning indicators, timers, etc.

HIGH RELIABILITY — no moving contacts. Coil is enclosed in a magnetic pot core. No arcing, interference or RF noise.

LOW POWER CONSUMPTION — Unit consumes less power than a signal lamp. Approximately 17 mA at 12 volts. Unit can be activated directly from a transistor gate.

VOLUME — 90 decibels at 20cm. Output volume increases and decreases with voltage.

COMPACT EASY TO INSTALL — small size, weighs only 17 grams.

WIDE OPERATIONAL VOLTAGE — available in 3, 6, or 12V models

MORGANITE AUSTRALIA PTY LTD

SYDNEY: 43-4805/43-5826 ADELAIDE: 268-2244
MELBOURNE: 544-2477 BRISBANE: 52-1201
PERTH: 68-4970



SPECIALS FOR MAY



Low cost kits. Simple to construct at prices you can afford. He-Haw kit \$14.21. Siren kit \$14.70. XTAL radio complete with Ferrite rod aerial \$5.56. Organ kit \$17.67. 1W amp kit \$6.42. Temp meter \$4.05. Transistor tester \$12.65. Multivibrator sig. injector \$3.19. Power supply \$17.89.

HITACHI CASSETTES

	1 off	12 off	24 off
C 60 Low Noise	\$1.63	1.47	1.33
C 90 Low Noise	\$2.23	2.00	1.80
C120 Low Noise	\$2.88	2.50	2.25
UDC 60 Ultra Dynamic	\$2.37	2.14	1.93
UDC 90 Ultra Dynamic	\$3.15	2.84	2.56
UDC120 Ultra Dynamic	\$4.35	3.92	3.53

SONY C90 CHROME CASSETTE \$3.95

Philips Sunlamps	\$16.00
Philips 5" Squawkers	\$16.00 ea
Philips 8" Woofers	\$12.00 ea
Philips 1" Dome Tweeters	\$ 8.00

BASF DP 26 2400' 7" TAPE

1 off — \$10.00	10 off — \$ 9.00
3 off — \$ 9.50	15 off — \$ 8.50

Special limited supply

8.30 SPEAKERS 8Ω — \$12.95 each

Plessey	12U50	8Ω	15Ω	\$36.00
C12P	8Ω	15Ω	\$19.79	
C12PX	8Ω	15Ω	\$21.15	
C100	8Ω	15Ω	\$13.26	
C100X	8Ω	15Ω	\$14.68	
C8MX	8Ω	15Ω	\$ 8.95	
C6MR	8Ω	15Ω	\$ 7.90	
C60	8Ω	15Ω	\$11.09	

FULL RANGE OF:

Capacitors — Resistors — Potentiometres — Semiconductors — Tuning Condensers — Transformers — Speakers — Valves — Switches (Rotary, Slider, Toggle, etc.) — Bezels — Batteries — Stylii — Tape (B.A.S.F.) — Cassettes — Flex — Soldering Irons — Relays — Plugs — Sockets — Terminals — Tag Strips — Tagboard — Matrix Board — Copper Clad Board — Etching Material — Rectifiers — Cases — Chassis — T.V. Aerials — Cable — Fuses — Jacks and Jack Plugs and Kitsets.

EDGE ELECTRIX

34A Burwood Rd., Burwood.

Phone: 747-2931

CATALOGUE 50c. We do not have elaborate Catalogues, just a simple one everyone can understand one sole Proprietor deals with all your problems personally.

COMPLETE MAIL ORDER SERVICE

All goods available at competitive prices. Please write or ring for a quote... allow a sufficient amount to cover Freight when ordering.

AUSTRALIA'S LEADING ELECTRONIC COMPONENTS—KIT SETS AUSTRALIA



BRANCHES AT

SYDNEY

Kit-Sets Aust. (Sydney) Pty. Ltd.
400 Kent Street, Sydney
Phone 29-1005

DEE WHY

Head Office, sales centre and national mail order dept.
Kit-Sets Aust. Pty. Ltd.
1st floor, 21 Oaks Ave., Dee Why
Phone 98-7500

ADELAIDE

16A. Peel St., Adelaide
Phone 87-5505

BRISBANE

Kit-Sets Aust. (Qld.) Pty. Ltd.
293 St. Pauls Terrace,
Fortitude Valley
Phone 52-8391

MELBOURNE

Kit-Sets Aust. (Vic.) Pty. Ltd.,
271 Bridge Rd., Richmond
Phone 42-4651

PERTH

557 Wellington St., Perth
Phone 21-3047

We offer **FAST, EFFICIENT** and **COURTEOUS** Mail Order Service at guaranteed best prices.

We operate Australia's largest and most efficient Mail Order Service — our service for mail order clients is second to none. Guaranteed best prices for new components and equipment. Same day despatch.

SPECIAL 24-HOUR PHONE COD SERVICE.

This is the easy and sure way of ordering. Just phone us and state your requirements, and your order will be despatched COD within the hour. Phone 982-7500 (Area Code 02) anytime, anyday, for this service.

HERE'S HOW TO OBTAIN THE KITSET PROJECTS DESCRIBED IN THIS SPECIAL

ALL WILL BE AVAILABLE WITHIN TWO WEEKS.
LOW-LOW PRICES INCLUDE CABINETS, P.C.B.'s OR MATERIALS

Low cost 1W amplifier	\$2.95
Simple temperature meter	\$10.75
Transistor tester	\$13.90
Signal injector	\$1.25
*Simple power supply	\$14.00
Monophonic keyless organ	\$14.70
Hee-haw siren	\$12.25
Conventional siren	\$12.45
Crystal radio	\$6.15
Temperature alarm	\$6.35

Pack/post 60c per kit except * which is \$1.20.

PLAYMASTER 136

A HIGH PERFORMANCE 13 PER CHANNEL AMPLIFIER KIT \$55.00.

At still only \$55.00 (less Fairchild 13 watt RMS per channel amplifier powered hi-fi kit-set amplifier available facilities and provision for simulation provides a far better performance than over 3 times more. Fairchild transistor additional \$7.00. P/Post \$2.00.

DO-IT-YOURSELF IN ONE EVENING AND



ASSEMBLE THIS 12" TWIN CONE/1" DIA VENTED 1.6 CU FT. ENCLOSURE AND LEAVES MOST 8" AND 10" SYSTEMS FOR

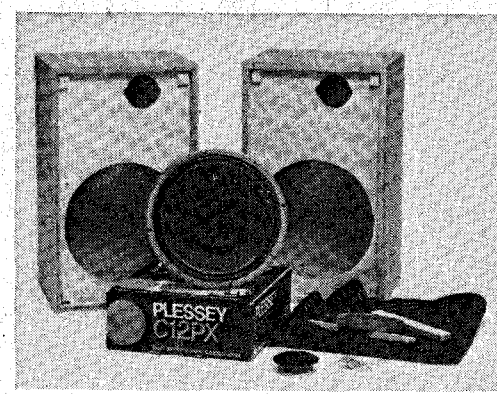

Housed in a specially designed and very remarkable system comprises the new fibre-length) C12PX 12" twin-cone, with bass and mid-range and the crystal covering the highs.

Frequency response is 30 capacity is 30 watts RMS. * OUR SPEAKER PRE-ASSEMBLED AND only a small amount of veneering to complete!

GIVES TOP PERFORMANCE AND REPRESENTS UNBEATABLE VALUE AT OUR SPECIAL LOW PRICE

ALSO AVAILABLE FULLY-ASSEMBLED PACK/FREIGHT \$5.00 EACH.

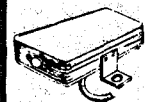

C.D.I. ELECTRONIC IGNITION KIT



With this simple easy to construct Capacitor Discharge Ignition kit you will increase —
* Fuel economy * Spark-plug life * Points life * Easier starting * much improved overall performance. Is suitable for all 12V systems, positive or negative earth. Secondary winding of transformer is pre-wound. Sturdy diecast box supplied. All parts are new and guaranteed.
A MUST FOR EVERY MOTORIST AT ONLY \$20.50! P/Post 75c.



NEW KIT-SETS ELECTRONIC MOODCOLOR THE MOODCOLOR

Specially designed, simple to construct — by anyone. 4 CHANNEL AUDIO COLOUR UNIT
CREATE LIVING COLOUR THAT MOVES WITH YOU
Designed to beat all others, this unit features variable filters driving 1kw ea. • Brilliant capability. • Only 100mV drive for full display. • black front panel and teak ends. A MUST FOR THE HOME.

COMPLETE KIT ONLY \$80.00 WIRED AND TESTED \$120.00

ONLY NEW AND GUARANTEED

CS CENTRES AND MAIL SERVICE

ITS - TEST EQUIPMENT - HI-FI

FOR THE
L ISSUE

AS APPLICABLE

AMPLIFIER KIT

WATTS RMS
FOR JUST



(resistor pack) the Playmaster 136 is definitely the best medium priced. Features full input and control and quadrasonic facilities and in commercial amplifiers costing over \$100 a pack can be supplied for an

SAVE 30%

ME TWEETER 2 WAY
TAIN A SOUND THAT
ADI!

1.6 cu.ft. enclosure, this Plessey CFL (controlled range speaker covering the ear Plessey X30 tweeter

000 Hz. Power Handling

NCLOSURE COMES
ENEREED and required
final-assembly and strip

MBLED FOR \$70 EACH

CLUSIVE

R 4



THE MOOD OF YOUR MUSIC!
es: ● 4 independent channels
t definition ● Mono or stereo
lay. ● Handsome styling with
R YOUR HI-FI SYSTEM

50 (full instructions supplied)
00 Reg. P & P \$2.00

NOW! SPEAKER SYSTEMS THAT CANNOT BE BEATEN FOR QUALITY, PERFORMANCE AND PRICE!



Steintron

THEY MUST BE SEEN AND
HEARD TO BE BELIEVED!

Kit-Sets Australia have imported a range of speaker systems direct from the manufacturers. Never before have such high quality systems been offered at such a low price. The savings have been brought about by our policy of direct importing which bring you, the customer, systems at almost half the normal retail price.

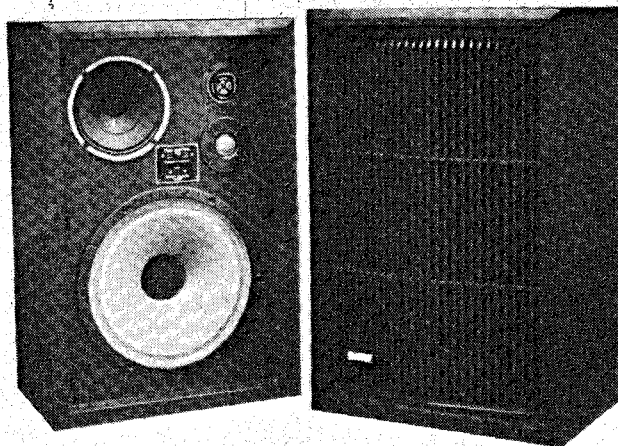

MODEL V120 12" 4-WAY SPEAKER SYSTEM

Top of the range is the Model V120 which consists of a roll surround high compliance 12 inch woofer, a 6 1/2 inch midrange (with a crispness which has to be heard to be believed) complemented by a highly efficient 1 1/2" Dome tweeter with 120° Dispersion and the most incredible 2" Super tweeter. Comes in a beautiful walnut finish, sturdy cabinet with a wood slotted grille, rather than the normal grille cloth fitted to lesser quality units. The cabinet has a cubic capacity of 2.75 cu.ft. having sides 1" thick to stop any resonances that may occur. To top all this the crossover has roll-off of 12 dB per octave and includes a tone control to allow you to tailor the response to your room. Power handling capacity 50 watts RMS frequency response 20-22000 Hz.

Our special Direct Import price is only \$198.00 per pair. Freight \$10.00 per pair for mail order.

only \$99 each

MODEL V100 10" 3-WAY SPEAKER SYSTEM

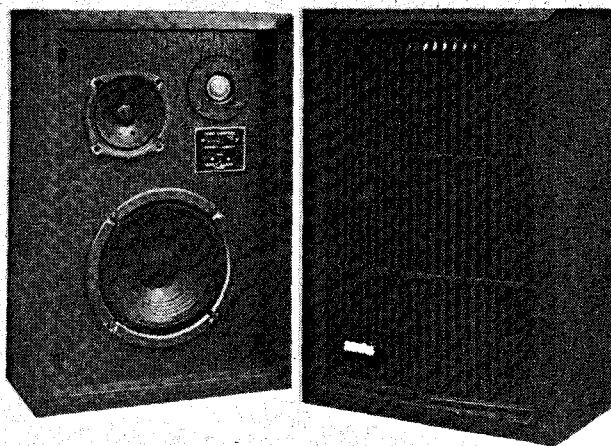

For the economy minded we have the Model V100 which has all the features of the V120 except has a 10" woofer plus 5" midrange and the same 1 1/2" Dome Tweeter in a 1.75 cu.ft. enclosure, an incredible power handling capacity of 40 watts RMS and a Frequency response of 20-20 000 Hz. \$158.00 per pair. Freight \$10.00 per pair for mail order.

only \$79 each

RTS SUPPLIED

For complete details, catalogue or order form, write to: CS CENTRES AND MAIL SERVICE, 100 Reg. P & P \$2.00

jaycar

PTY. LTD.

Telephone 211-5077
P.O. BOX K39, HAYMARKET
N.S.W. AUSTRALIA 2000
405 Sussex St., Sydney

NOW THE NEW E.T.I.
414 MASTER MIXER

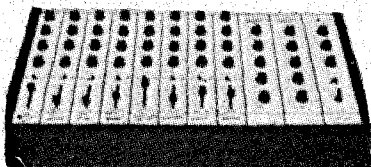

Complete kit \$198.00 P & P \$3
Mixer equaliser kit \$19.50 P & P 40c.
Preamp & tone control for 2 channels \$21.00 P & P 40c.
Power supply \$28.25 P & P 40c.
Metalwork \$15.90 P & P \$1.00.
Front panels \$2.90 ea. P & P 40c.
Timber case \$7.25 ea. P & P \$1.00.
All coils prewound.

E.T.I. 413 100 WATT GUITAR AMPLIFIER

Features • Robust and compact • Frequency response 20Hz to 150kHz \pm 3dB • Total distortion .50 at 80 watts. Complete kit of parts



ONLY \$65.00
Plus \$2.00 p&p.

ETI 420 4-CHANNEL AMPLIFIER

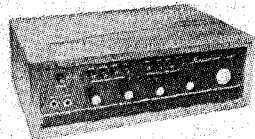

features 15watts per channel with sq decoding complete kit \$129.00

ETI 423 ADD ON DECODER AMP

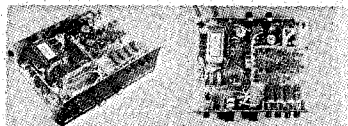

adapt your stereo to full 4 channel SQ operation for only \$59.00

SYNTHESISER

Please enquire for price details.

SPRAGUE

integrated and thin film hybrid circuits

This Guide lists Sprague integrated circuits designed specifically for the consumer entertainment market. The listing is limited to standard off-the-shelf products which fit a particular function most economically.

Tristate Electronics Pty. Ltd. recognises the need to help solve customer correlation or design problems and custom requirements, thus its application staff is readily available. For assistance of this nature, please write or call your nearest Tristate sales representative.

SPRAGUE INTEGRATED CIRCUITS REPLACE THESE TYPES:

	Fairchild	Motorola	National	R.C.A.	Signetics	T.I.
ULN-2111	—	MC1357	LM2111	CA2111	N5111	SN76643
ULN-2113	—	MC1357	LM2113	—	—	SN76642
ULN-2125	—	—	—	CA3120	—	—
ULN-2126	—	MC1339	—	—	—	—
ULN-2129	μ A3075	—	LM3075	CA3075	—	SN76675
ULN-2135	—	MFC4050	—	—	—	—
ULN-2137	μ A720	—	—	—	—	—
ULN-2165	μ A3065	MC1358	LM3065	CA3065	N5065	SN76665
ULN-2209	μ A753	—	—	—	—	—
ULN-2211	μ A704	—	—	—	—	—
ULN-2264	μ A3064	MC1364	LM3064	CA3064	—	SN76564
ULN-2276	—	—	LM378	—	—	—
ULN-2277	—	—	—	—	—	SN76177
ULN-2278	—	—	LM377	—	—	—
ULN-2280	—	—	LM380	—	—	—

For full information please write or phone:

Exclusive Australian Agents: TRISTATE ELECTRONICS PTY. LTD.

Distributed by:

GEORGE BROWN & CO. PTY. LTD. Cnr Sussex & Druitt Streets, Sydney, N.S.W. 519 5855

HIGHVIEW ELECTRICS. 8 Matthews Rd., East Bentleigh, Vic. 57 5791

FRED HOE & SONS PTY. LTD. 246 Evans Road, Sailsbury North Brisbane, Q'ld. 47 4311

CONTINUOUS MUSIC SYSTEMS & ACOUSTICS (W.A.) 8 Oswald St., Victoria Park, W.A. 61 4464.

TEMPERATURE METER

Solid-state meter displays temperatures — even from distant points

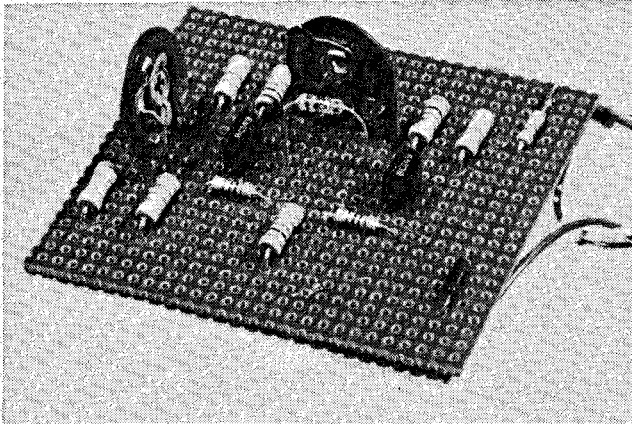

The completed temperature meter. Note that the sensing diode is shown mounted on the board. This would normally be located remotely with a pair of leads running back to the board.

AN ELECTRONIC temperature meter is an extremely useful instrument, and, is far more versatile than the mercury, or alcohol-in-glass types. For example, the temperature sensing element does not have to be located with the meter and thus, a remote sensor could be used to monitor swimming pool temperature on a meter readout located within the house. Additionally, several sensors may be used, e.g. monitoring temperatures of pool water, outside air and air inside the house. This is simply achieved by running separate sensor leads back to the meter and using a switch to select the appropriate sensor.

Many devices are capable of being used as temperature sensors. Examples of these are the thermistor, the

thermocouple and the semiconductor diode junction.

The voltage across a forward biased diode junction, whether it is part of a transistor (e.g. base emitter) or a discrete diode, has a negative temperature coefficient. This means that with an increase in temperature the voltage across the diode drops. This effect is normally detrimental to stable operation of other circuitry but may be used, as in this circuit, to measure temperature.

CALIBRATION

The meter is calibrated by adjusting the meter at two known temperatures. The temperatures of melting ice and boiling water should be used as reference points.

With the diode sensor and the thermometer immersed in melting ice,

adjust RV1 to read 0°. Then insert the sensor into boiling water and adjust RV2 for 100°. A kettle is ideal for the boiling water adjustment or some vessel that restricts the steam to some extent. Do not use an electric jug having an exposed heater element.

A known ambient temperature can be used as the low reference if desired by first adjusting RV1 such that the meter reads 0° with the sensor at ambient temperature. Then with the sensor in hot or boiling water adjust RV2 such that the meter reads the difference between the two temperatures. With the sensor back at ambient (allow time to cool) readjust RV1 to read the actual ambient temperature.

Recheck the meter at both set points for which ever method of calibration is used.

SPECIFICATION

Temperature Range	0-100°C
Sensor	silicon diode
Scaling	reasonably linear over 0-100°C

HOW IT WORKS

The negative temperature coefficient of a diode is of the order of 2 mV/°C, and in our circuit, this voltage is measured by a differential amplifier Q1 and Q2.

The diode has an offset voltage of 0.55 mV which is compensated for by RV1. A differential amplifier is used so that variations in transistors due to temperature do not affect the calibration.

As there is no instrument warm-up time, it is suggested that a push-to-read button be used to switch on power in order to extend battery life. Battery drain is about 10 mA when the meter is operational hence, if continuous readout is required, a small power supply should be used.

PARTS LIST

R5,7	Resistor	10 ohms	5% 1/2W
R3,6,8	"	100 ohms	" "
R10	"	330 ohms	" "
R4	"	1k	" "
R2	"	1.2k	" "
R1	"	3.3k	" "
R9	"	3.9k	" "
RV1	Potentiometer	1k trim	
RV2	"	2.2k	
Q1,2	Transistor	BC109 or similar	
D1	Diode	IN914	
ZD1	Zenerdiode	BZY88C5V6	
M1	1mA meter	scaled preferably 0-100	
PB1	push-to-make pushbutton		
	Small piece of matrix board		
	9V battery		

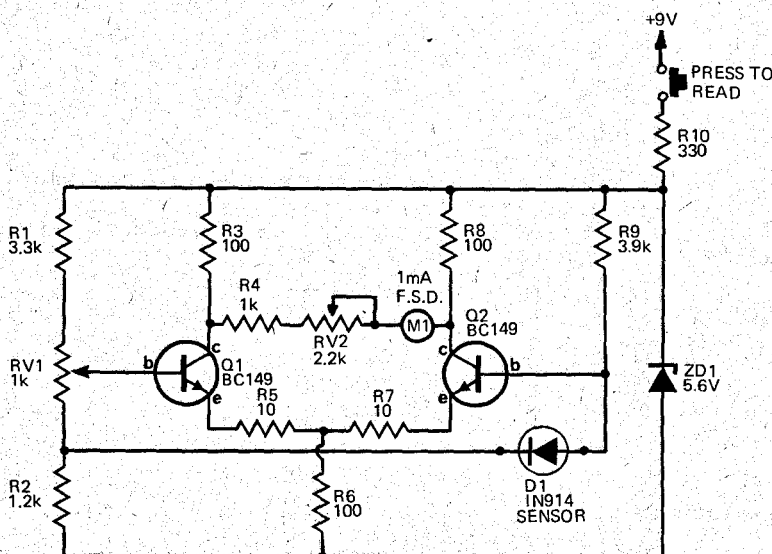

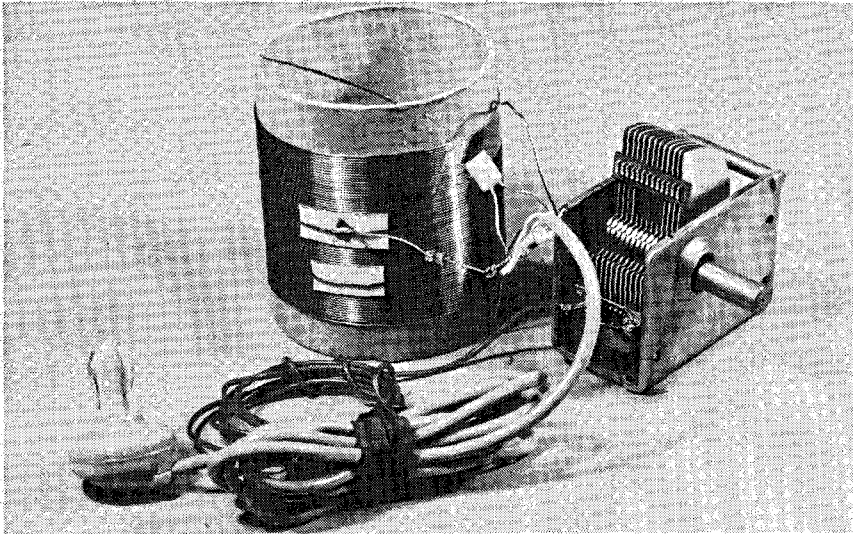

The classic beginners' circuit — no power supply is required.

ASK any of today's electronics buffs what was the first thing they ever built. Chances are it was a crystal radio set.

The crystal set is the simplest of all radios — and one of the earliest.

Its fascination is that it requires no external source of power — beyond that derived from the incoming signal itself.

A basic crystal receiver consists of an external aerial, a tuning circuit — that separates the desired signal from all other signals — a rectifying device, and a set of headphones.

In earlier days a crystal of galena was used to rectify the signal. The crystal was held in a metallic holder and a metal wire, called a

cat's-whisker, was used to touch a sensitive part of the surface of the crystal. Sometimes much fiddling had to be done to find the best operational contact.

The cat's-whisker/galena crystal arrangement is of course responsible for the name given to this type of radio but nowadays we can use a much more efficient rectifier — the semiconductor diode.

Reasonable volume can be obtained from a crystal set providing a sufficiently long aerial is used. This must be mounted as high as possible. Something of the order of 20 metres long, mounted seven or eight metres high is fine.

The headphones used should ideally

have an impedance of around 2000 ohms. Suitable types are still available from many disposal stores. If these are not obtainable, a crystal earpiece such as is supplied with most transistors will do. These generally have a very high impedance and require a high voltage drive. Hence the volume will be lower, when using such an earpiece, but it will still work.

HOW IT WORKS

An aerial receives all the electromagnetic radiation in the area. Each signal source produces voltages across the antenna and unless these signals can be separated somehow, the information we require will be hopelessly scrambled by all the other signals.

To do this, the low frequencies are rejected by C1 and the remainder are impressed across the parallel arrangement of the coil and C2. Such a parallel LC circuit has a resonant frequency, determined by the values of L and C, at which its impedance is relatively high. At all other frequencies its impedance is low. Thus only the signal which coincides with the resonant frequency of the LC arrangement will produce a signal to be rectified by diode D1. By varying C2 we may vary the resonant frequency and hence tune to different stations.

The rectified signal is then filtered by R1 and C3 to recover the original audio modulation from the selected radio station carrier.

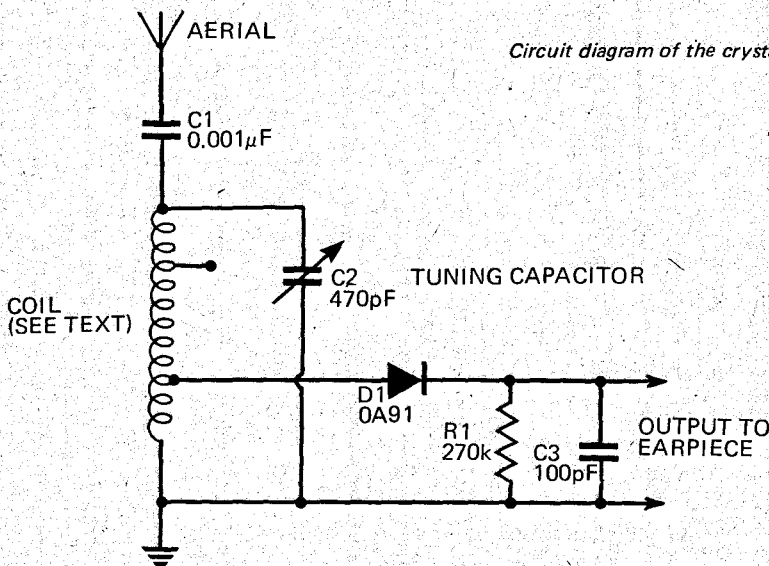

Circuit diagram of the crystal radio.

PARTS LIST — Crystal Radio ETI 227

- R1 Resistor 270 k ½ watt 5%
- C1 Capacitor 0.001µF
- C2 " 100pF
- D1 Diode OA91 or similar
- L1 Coil see Table 1.
- T.C1 Tuning gang single section 470pF Roblan or similar
- Coil former piece of cardboard tubing (see Table 1).

TABLE 1 Winding details of air-cored coil. (close wound).

COIL DIA.	NUMBER OF TURNS VERSUS WIRE GAUGE			
	22 SWG	24 SWG	26 SWG	28 SWG
1 1/8"				108
1 1/2"			96	87
1 3/4"		88	77	70
2"	82	72	67	62
2 1/4"	71	64	58	54
2 1/2"	61	56	52	49
2 3/4"	54	52		

Note 1. Tap the coil every ten turns.
 Note 2. For former sizes between those stated use an intermediate number of turns. This is not critical.
 Note 3. Select the tap for the diode by determining which one gives best volume, whilst still adequately separating the stations.

INTERNATIONAL 422 STEREO AMPLIFIER

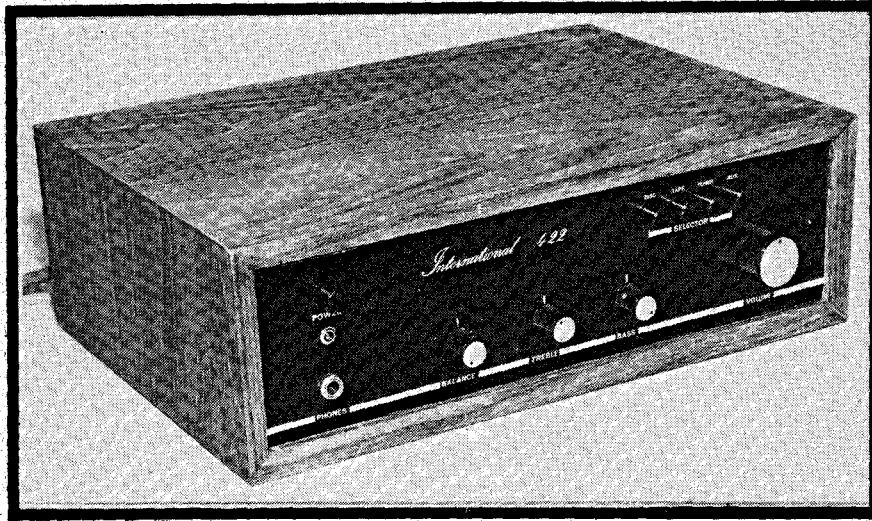

eti

PROJECT 422

This exciting new under-\$120 amplifier produces a full 50 watts (rms) per channel!

SINCE publication of our 100 watt guitar amplifier, in December 1972, several thousand have been built and a surprisingly large quantity of these have been for home stereo use. People have used two of these together with a separate preamplifier for stereo, and would you believe it, we know of a few people using four in a quadraphonic system!

This is not as way out as it sounds for many present-day speakers sacrifice efficiency to gain quality. Many high quality speakers need at least 50 watts ('rms') to drive them satisfactorily.

There is an obvious need for a high powered amplifier, and in response to many pleas, we have designed an

inexpensive amplifier that will deliver a genuine 50 watts rms per channel, both channels driven, into 8 ohms.

Since most modern speakers are 8 ohms impedance, we have not designed the amplifier for 4 ohm operation. Such an amplifier would require a much larger transformer and would be considerably more expensive, so we have decided to

MEASURED PERFORMANCE OF PROTOTYPE UNIT

POWER OUTPUT			
Both channels driven 8 Ω + 8 Ω loads	50 watts rms		
FREQUENCY RESPONSE			
20 Hz-20 kHz	± 5 dB		
CHANNEL SEPARATION			
At rated output and 1 kHz	45 dB		
HUM AND NOISE			
With respect to rated output			
Tape, Tuner and Aux. inputs	-78 dB		
Disc input (re 10 mV)	-67 dB		
INPUT SENSITIVITIES (for rated output)			
Tape, Tuner and Aux. inputs	210 mV into 47 k		
Disc at 1 kHz	2.1 mV into 47 k		
Main amplifier	500 mV into 10 k		
TOTAL HARMONIC DISTORTION			
1 watt output	100 Hz	1 kHz	6.3 kHz
5 watt output	0.14%	0.11%	0.12%
10 watt output	0.17%	0.13%	0.15%
50 watt output	0.16%	0.11%	0.13%
	0.27%	0.38%	0.60%
TONE CONTROLS			
Base	± 13 dB at 50 Hz		
Treble	± 13 dB at 10 kHz		
DAMPING FACTOR	> 70		

Internal view of the completed amplifier.

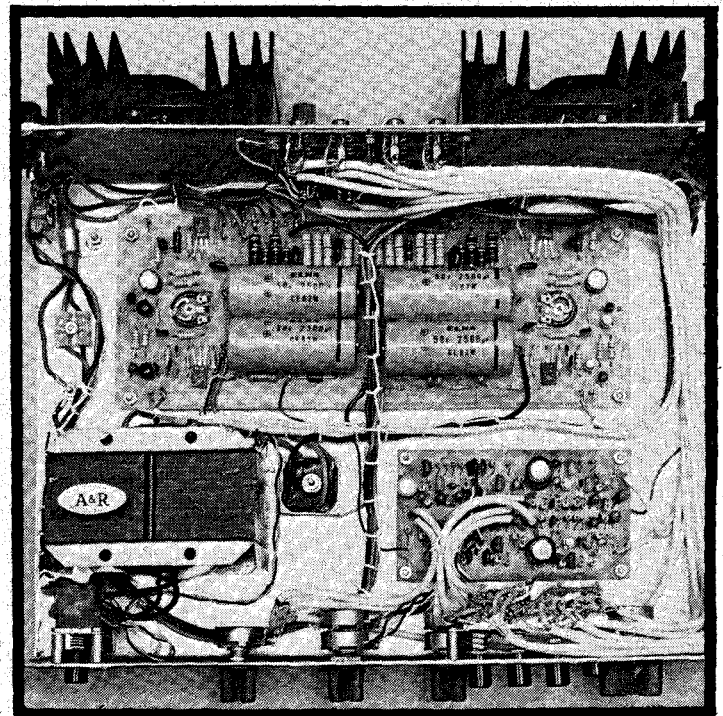

INTERNATIONAL 422 STEREO AMPLIFIER

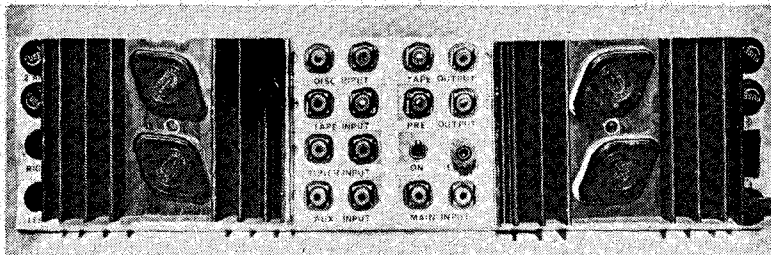

View of the rear panel of the amplifier.

Fig.1. Circuit diagram of the preamplifier (one channel only shown).

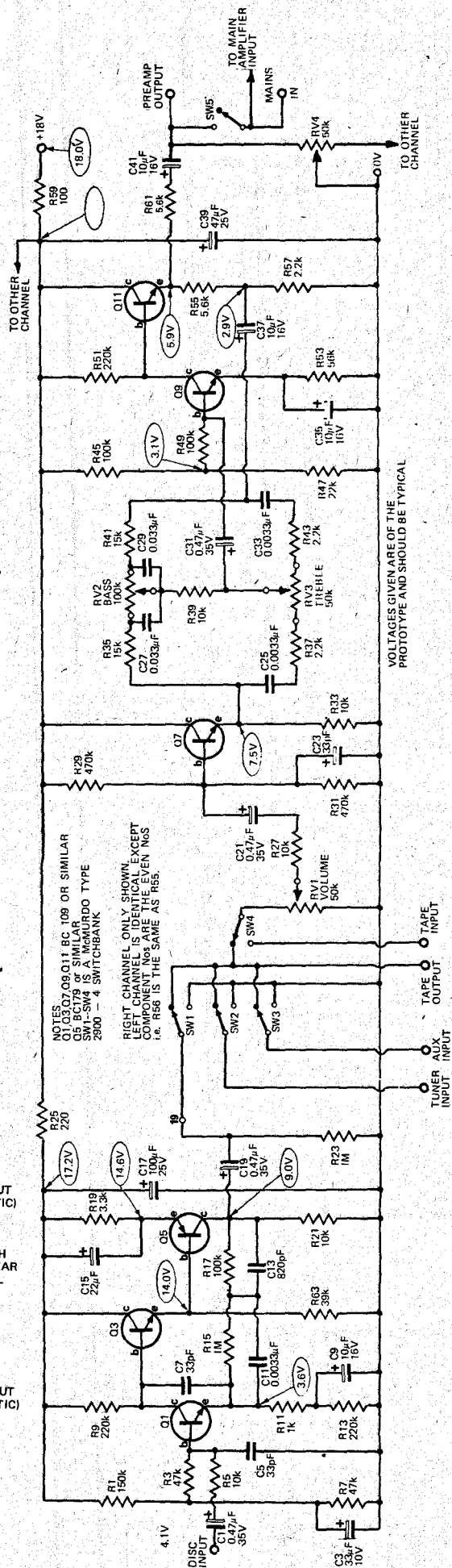

VOLTAGES GIVEN ARE OF THE PROTOTYPE AND SHOULD BE TYPICAL

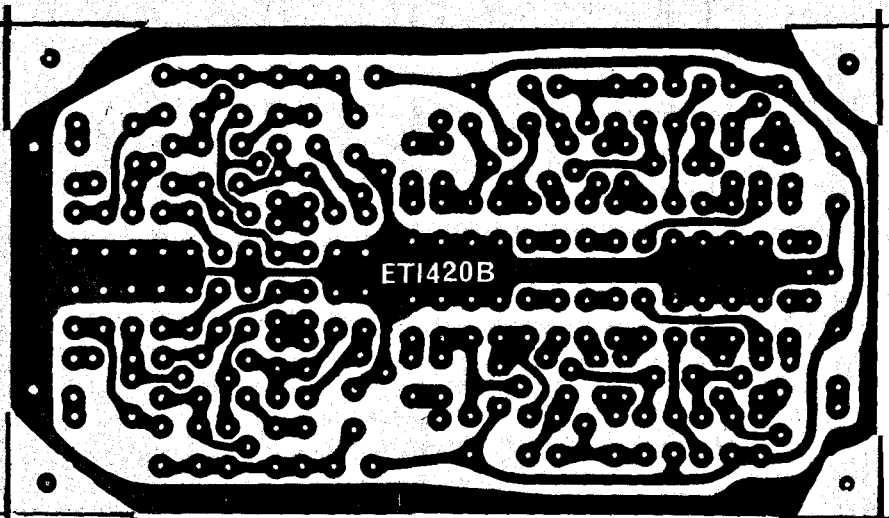
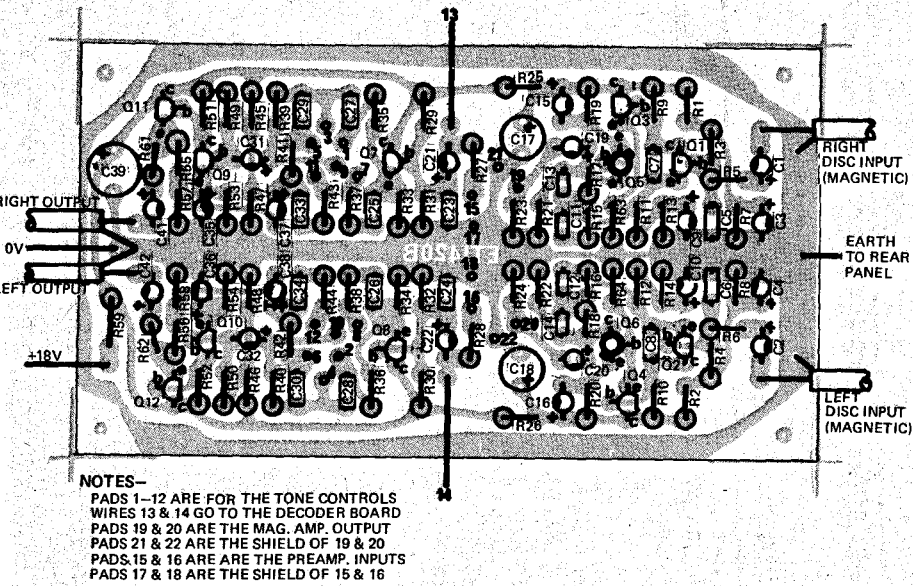

Fig.2. Printed circuit board pattern for the preamplifier.



NOTES—
PADS 1-12 ARE FOR THE TONE CONTROLS
WIRES 13 & 14 GO TO THE DECODER BOARD
PADS 19 & 20 ARE THE MAG. AMP. OUTPUT
PADS 21 & 22 ARE THE SHIELD OF 19 & 20
PADS 15 & 16 ARE THE PREAMP. INPUTS
PADS 17 & 18 ARE THE SHIELD OF 15 & 16

Fig.3. Component overlay for the preamplifier.

satisfy the many, rather than the few.

As well as being designed to provide high power at low cost, the amplifier has been kept simple from the constructional point of view. It uses the preamplifier from our ET1420 four-channel amplifier with only a few minor changes. Tape-in, tape-out and main amp in/preamp-out facilities have been provided. Tape monitoring may be achieved by pressing, simultaneously, the tape button as well as that for the desired input.

A new main amplifier board is used. This carries the components for both main amplifiers (apart from those mounted on the heatsinks) and the power supply components. All components are mounted on a simple pan-type chassis which slides into the same wooden case as was used for the four channel amplifier.

CONSTRUCTION

The construction has been kept as simple as possible so that a person

with only average electronics experience should have no problems in building the amplifier.

The printed circuit boards carry the majority of the components apart from hardware items such as switches, potentiometers and the transformer etc.

The boards should be assembled with reference to their component overlays making sure that all components are in the correct position and, that they are orientated correctly.

It is preferable that pins be used to connect all external wiring to the main amplifier board, as this will considerably facilitate wiring up the board at a later stage.

The components should be assembled onto the heatsinks with the aid of Fig. 7 and Fig. 8. Note that a mica washer should be used on both sides of the heatsink for each of the 2N3055's so that the BD139-140 transistors may also be insulated from the heatsink.

The PN3643 transistor, Q13, should be glued into the heatsink in the position shown in Fig. 7 and the wires which connect to the flying leads of the transistors should also be secured to the heatsink with glue. The new quick-dry epoxies are ideal for this application.

The chassis hardware should be assembled in the following order:—

1. Fit all the RCA sockets (tape in, tape out etc), the two-pin DIN sockets for the speaker outlets and the power outlet socket.

2. Fit the rear panel escutcheon using the fuse holders, the main-preamplifier connect toggle switch, the earth terminal and the 3-core flex and grommet, to secure it to the rear panel.

3. The heatsinks can now be fitted by passing the wiring through the rear panel holes (which should be fitted with grommets) and securing them using 12 mm long ¼" screws. The screws will screw directly into the

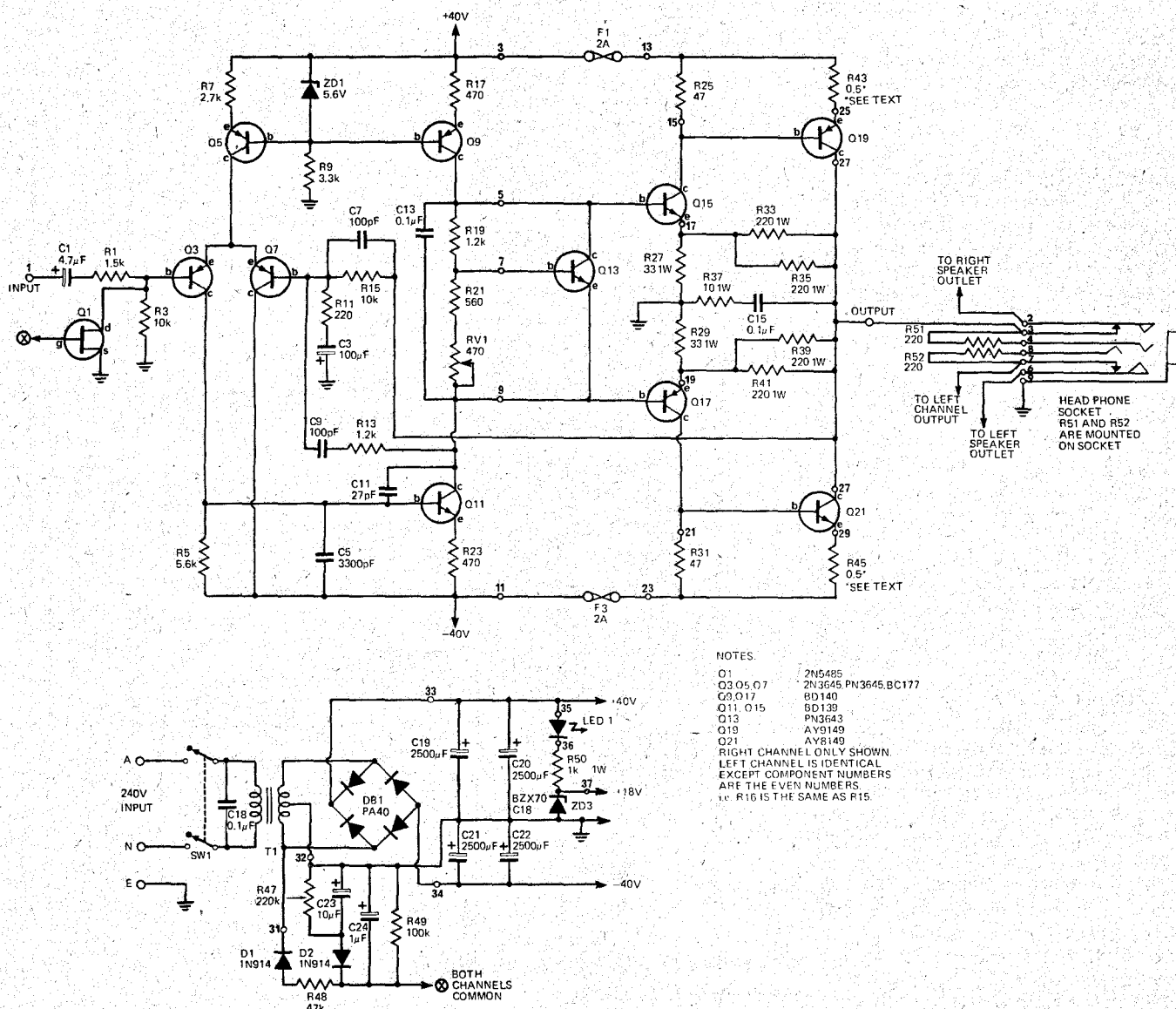

Fig. 4. Circuit diagram of the main amplifier (one channel only) and the power supply.

INTERNATIONAL 422 STEREO AMPLIFIER

heatsink-fin spacing which is designed for such a mounting technique.

4. Fit a cable clamp to the 3-core power flex and terminate the cable into a two way terminal block and a separate earth screw.

5. The power switch and the selector switch should now be mounted using 12.7 mm spacers.

6. The front panel can now be mounted. It is secured by the potentiometers, LED and the phone socket.

7. Mount the preamplifier board after connecting coax. or hookup wire where applicable. The board should be supported on 6 mm spacers.

8. Mount the power amplifier board, also on 6 mm spacers, the power transformer and the PA40 bridge rectifier.

9. The interconnection wiring should now be carried out with the aid of the schematic wiring diagrams. Note that the earth lugs of the RCA sockets for right channel PRE-OUT and MAIN-IN should be linked, and so should those for the left channel. There is no link between left and right and all other sockets have independent earths.

10. All exposed 240 volt wiring should be taped up to provide safety against personal contact. The capacitor C18 should be mounted on the power outlet socket and similarly taped up.

SETTING UP

The only setting up required is the adjustment of bias current in the output stage. For this a milliammeter having a 100 mA range is required.

Rotate trim potentiometer wipers such that they are closest to the front. This adjusts bias current to its lowest value.

Remove both fuses from the right hand channel and the top fuse of the left hand channel. Connect the milliammeter across the left channel fuseholder from which the fuse has been removed.

If a variac is available wind the ac line supply up slowly whilst monitoring the bias current. If a variac is not available the amplifier will have to be switched on, if there is any gross fault the remaining fuse will blow but no other damage should result.

The bias current should be adjusted to about 25 mA. If it is adjustable, but too high, increase the value of R21 to 820 ohms. If it is adjustable but too low, decrease the value of R21 to 330 ohms.

If it is not adjustable *at all* check for errors in the layout or wiring. In a normal amplifier the range of bias

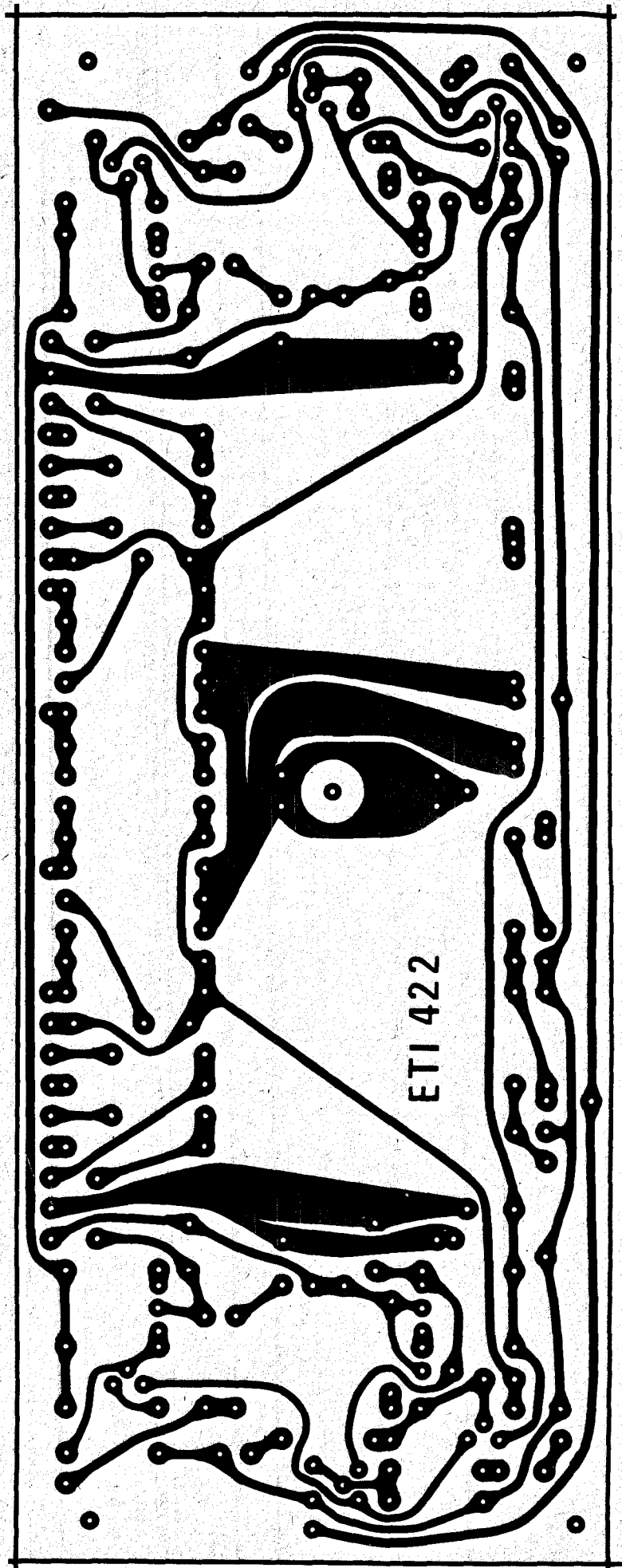

Fig. 5. Printed circuit board pattern for the main amplifier and power supply (full size).

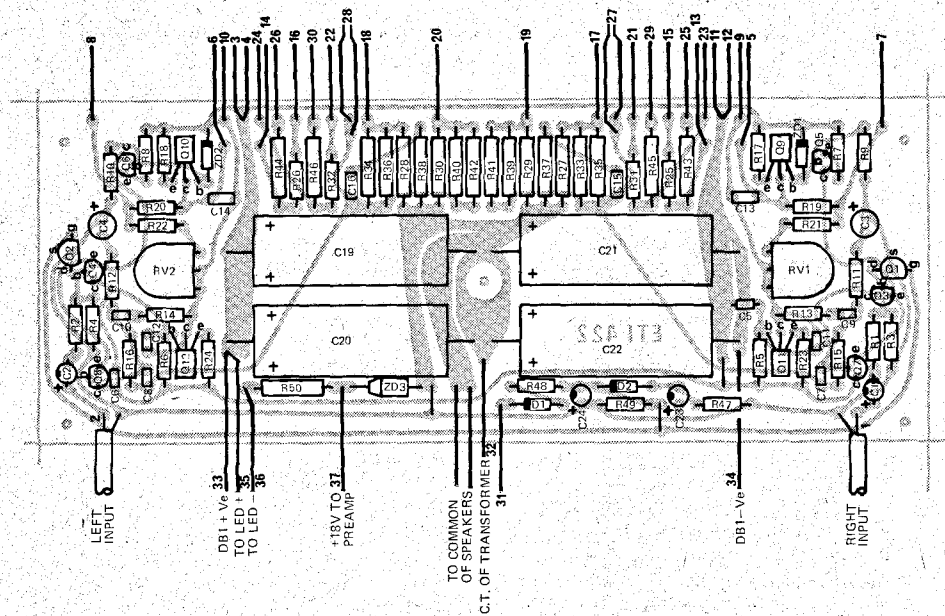

Fig. 6. Component overlay for the main amplifiers and power supply.

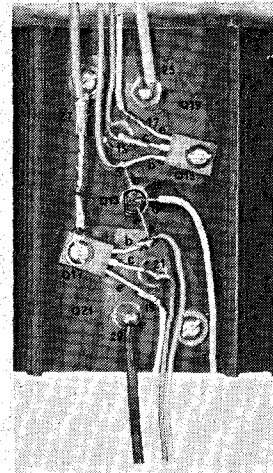

Fig. 7. Details of heatsink assembly. Note particularly the orientation of Q13.

adjustment offered by the trim potentiometer should be entirely adequate.

Switch off and replace the missing left channel fuse together with the

lower right channel fuse. Using the millimeter across the top right-channel fuse holder, adjust the right channel bias current to 20 to 25 mA as for the left channel.

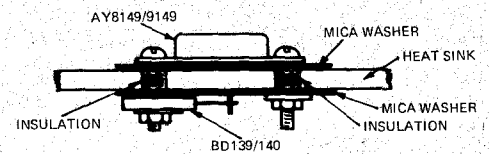

Fig. 8 Method of assembly of power and BD139-140 transistors to the heatsink.

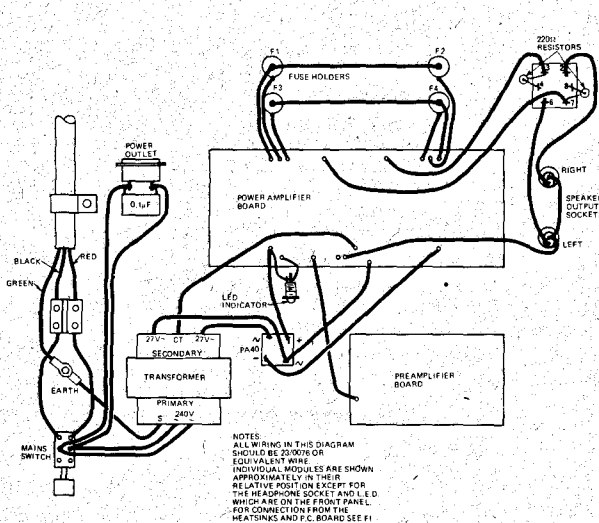

Fig. 9. Power wiring diagram of the complete amplifier.

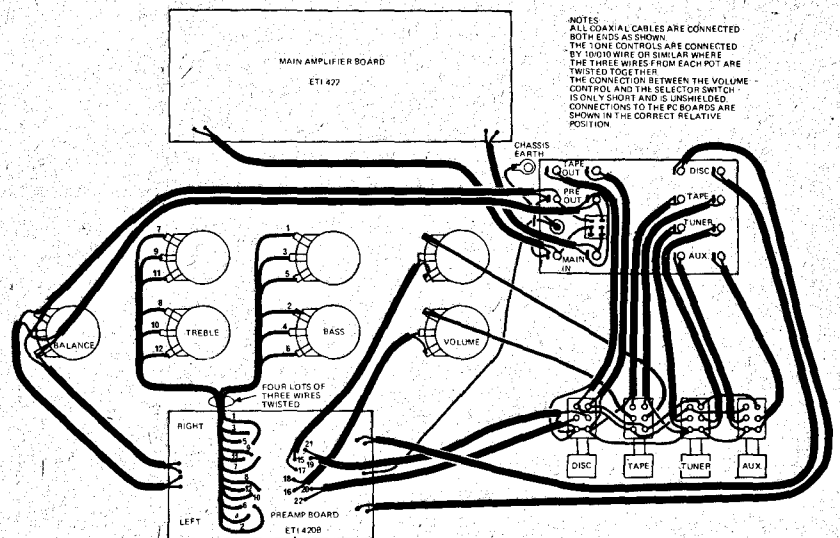

Fig. 10. Signal wiring diagram of the complete amplifier.

HOW IT WORKS — PREAMPLIFIER

The output level of a magnetic cartridge may be as low as 1 mV and this must be amplified and equalised before being applied to the tone controls.

Transistors Q1, 3 and 5 form this equalizing amplifier. The gain is controlled by R11, and the frequency response by R15, R17, C11 and C13. This complex network provides the correct RIAA

equalization, the desired signal source and appropriate network being selected by SW1, 2 and 3 and 4. The signal is then passed to Q7 which buffers the output of the volume control and drives the tone control network.

Transistor Q9 and Q11 form a high gain amplifier in which the gain is determined by the relative positions of the bass and treble controls. The gain at 1 kHz is approximately 2.

HOW IT WORKS — MAIN AMPLIFIER

The input signal is fed via C1 and R1 to the base of Q3 which, with Q7, forms a differential pair. Transistor Q5 is a constant current source where the current is $\{5.6V (ZD1) - 0.6 (Q5)\} / 2700 (R7)$ — that is about 2 mA. This current is shared by Q3 and Q7. Transistor Q9 is also a constant current source supplying about 10 mA which, if no input signal exists, flows through Q13 and Q11. The differential pair controls Q11 and thus the voltage at its collector.

INTERNATIONAL 422 STEREO AMPLIFIER

HOW IT WORKS MAIN AMPLIFIER (Cont'd)

The resistors R19 and R21, together with potentiometer RV1, control the voltage across Q13 and maintain it at about 1.9 volts. But as Q13 is mounted on the heatsink, this voltage will vary with heatsink temperature. Assuming that the voltage at points 5 and 9 is equally spaced about zero volts (ie ± 0.95 volts), the current will be set at about 12 mA through Q15 and Q17. The voltage drop across the 47 ohm resistors (R25 and R31) will be enough to bias the output transistors, Q19 and Q20, on slightly to give about 10 mA quiescent current. This quiescent current is adjustable by means of potentiometer RV1.

Local feedback is applied to the

output stage by the network R33, R35, R39 and R41, giving the output stage a voltage gain of about four. The overall feedback resistor, R15, gives the required gain control.

Protection to the amplifier, against shorted output leads, is provided by fuses in the positive and negative supply rails to both amplifiers.

Temperature stability is obtained by mounting Q13 on the heatsink. Q13 will thus automatically adjust the bias voltage. Frequency stability is ensured by C9/R13, C5, C11 and C7.

Although the power amplifier itself does not produce a thump in the loudspeaker, when switched on, the preamplifier does. This is because the preamplifier uses a single power rail and has to stabilize. To reduce this thump to an acceptable level, Q1 is

used to short the input for about 2 seconds on switch-on and immediately after switch-off.

The power supply is a conventional full-wave bridge with centre tap, providing +40 volts and -40 volts. Diode D1 is used to rectify a second negative supply which is used to control the FETs. Due to the resistance in series with the diode, the charge of C24 is slow. In addition, during the charge period, C23 is also being charged increasing the delay. On switch off, however, C23 cannot assist the voltage on C24 and the off-timing is much shorter than the on-timing.

The power supply for the preamplifier is derived by an 18 volt zener which is fed from the +40 volt rail via an LED power-on indicator and R50.

PARTS LIST — Preamplifier

R59	Resistor	100 $\frac{1}{4}$ or $\frac{1}{2}$ W	5%
R25,26	"	220	"
R11,12	"	1k	"
R37,38,43	"	2.2k	"
R44,57,58	"	2.2k	"
R19,20	"	3.3k $\frac{1}{4}$ or $\frac{1}{2}$ W	5%
R55,56,61,62	"	5.6k	"
R5,6,21,22	"	10k	"
R27,28,33,34	"	10k	"
R39,40	"	10k	"
R35,36,41,42	"	15k	"
R47,48	"	22k	"
R63,64	"	39k	"
R3,4,7,8	"	47k	"
R53,54	"	56k	"
R17,18,45	"	100k	"
R46,49,50	"	100k	"
R1,2	"	150k	"
R9,10,13	"	220k	"
R14,51,52	"	220k	"
R29,30,31,32	"	470k	"
R15,16,23,24	"	1M	"
RV1	Potentiometer	50k log dual r'tary	
RV2	"	100k lin dual r'tary	
RV3	"	50k lin dual r'tary	
RV4	"	50k lin rotary	
C5,6,7	Capacitor	33pF ceramic	
C8,23,24	"	33pF ceramic	
C13,14	"	820pF ceramic	
C11,12,25	"	0.0033 μ F polyester	
C26,33,34	"	0.0033 μ F polyester	
C27,28,29,30	"	0.033 μ F polyester	
C1,2,19,20	"	0.47 μ F 35V tag tantalum	
C21,22,31,32	"	0.47 μ F 35V tag tantalum	
C9,10,35,36	"	10 μ F 16V electrolytic *	
C37,38,41,42	"	10 μ F tag tantalum	
C15,16	Capacitor	22 μ F 16V electrolytic *	
C3,4	"	33 μ F 10V "	
C39	"	47 μ F 25V "	
C17,18	"	100 μ F 25V "	

* PC mounting or tag tantalum

Q1,2,3,4,7 Transistor BC109, BC549*
Q8,9,10,11,12 " " " " " "
C5,6 " BC179, BC559

* can be BC108,548 except for Q1,Q2

SW1-4 Switch assembly McMurdo 2900-4

PC board ETI 420 B

PARTS LIST — Main Amplifiers and Power Supply

R43,44,45,46	Resistor	0.5ohm	
R37,38	"	10	1W 5%
R27,28,29,30	"	33	1W 5%
R25,26,31,32	"	47	$\frac{1}{2}$ W "
R11,12,51,52	"	220	$\frac{1}{2}$ W "
R33,34,35,36	"	220	1W "
R39,40,41,42	"	220	1W "
R17,18,23,24	"	470	$\frac{1}{2}$ W "
R21,22	"	560	$\frac{1}{2}$ W "
R50	"	1k	1W "
R13,14,19,20	"	1.2k	$\frac{1}{2}$ W "

R1,2	Resistor	1.5k	$\frac{1}{2}$ W 5%
R7,8	"	2.7k	"
R9,10	"	3.3k	"
R5,6	"	5.6k	"
R3,4,15,16	"	10k	"
R48	"	47k	"
R49	"	100k	"
R47	"	220k	"

RV1,2 Potentiometer 470 ohm Trim type

C11,12	Capacitor	27pF ceramic	
C7,8,9,10	"	100pF "	
C5,6	"	0.0033 μ F polyester	
C13,14,15,16	"	0.1 μ F "	
C18	"	0.1 μ F 250V ac	

C24 Capacitor 1 μ F 35V electrolytic *

C1,2 " 4.7 μ F 10V "

C23 " 10 μ F 25V "

C3,4 " 100 μ F 10V "

C19,20,21,22 Capacitor 2500 μ F 50V electrolytic

* should be PC mounting type

Q1,2 Transistor 2N5485

Q3,4,5,6,7,8 " 2N3645, BC177

Q9,10,17,18 " BD 140

Q11,12,15,16 " BD 139
Q13,14 " PN 3643
Q19,20 " AY 9149, MJ2955
Q21,22 " AY 8149, 2N 3055

D1,2 diode IN 914, EM 401
ZD1 zener diode BZX70C18 **
** 20V or 16V will do if 18V unobtainable

DB1 diode bridge PA40

T1 Transformer 56V CT 1.5A A & R 9504 or Ferguson PF 3577

PC Board ETI 422
F1-F4 miniature 2 AMP Fuse and holders John Carr AH750 or equiv.

SW1 McMurdo type 2904-1

4 covers for TO3 transistors

4 insulation kits for TO3 transistors

4 extra mica washers for TO3

* If difficult to obtain, these resistors may be fabricated from a short length of electric jug element — about 90 mm is sufficient for each. Wind securely around a 1 watt resistor (100 ohms or higher) and solder into place.

mm is sufficient for each. Wind securely around a 1 watt resistor (100 ohms or higher) and solder into place.

ohms or higher) and solder into place.

PARTS LIST — General

Chassis to Fig. 15.
Front panel to Fig. 13.
Rear panel to Fig. 14.
Wooden box as per Fig. 16.
12.7 mm spacers 4 req.
6.4 mm spacers 9 req.
3 small knobs John Carr type TK196 or similar
1 large knob John Carr type TK195 or similar
1 stereo phone jack McMurdo 1291-04-02 or similar
1 LED indicator McMurdo 3240-02-02
2 heatsinks Warburton Franki WBF-003/3
Miniature DPDT toggle switch
Earth binding post
3 core flex and cable clamp
3 rubber grumets
6 $\frac{1}{4}$ " Whit $\frac{1}{2}$ " long screws
17 $\frac{1}{8}$ " Whit $\frac{3}{8}$ " long c/s screws
4 $\frac{1}{8}$ " whit $\frac{3}{8}$ " long c/s screws
17 $\frac{1}{8}$ " whit $\frac{3}{4}$ " long r/h screws
coax cable
23/0076 cable
10/0076 cable

Details of case, metalwork and front/rear panels will be published in ETI next month.

BUILD

the new HEATHKIT® Semiconductor Curve Tracer

This easy-to-build kit lets you see on your oscilloscope screen the operating parameters of virtually all types of semiconductors. Use it for sorting, inspecting, testing of bipolar transistors, diodes, SCRs, triacs, FETs, etc. The IT-1121 Semiconductor Curve Tracer can be used with any scope with horizontal sensitivity of 0.5 V/div. and vertical sensitivity of 1 V/div. All major controls are stepped in a 1, 2, 5 sequence for maximum parameter resolution. Kit includes connecting leads, extra test leads for large devices or in-circuit testing, comprehensive fully illustrated manual.

Kit IT-1121 \$105.88 inc. S/T

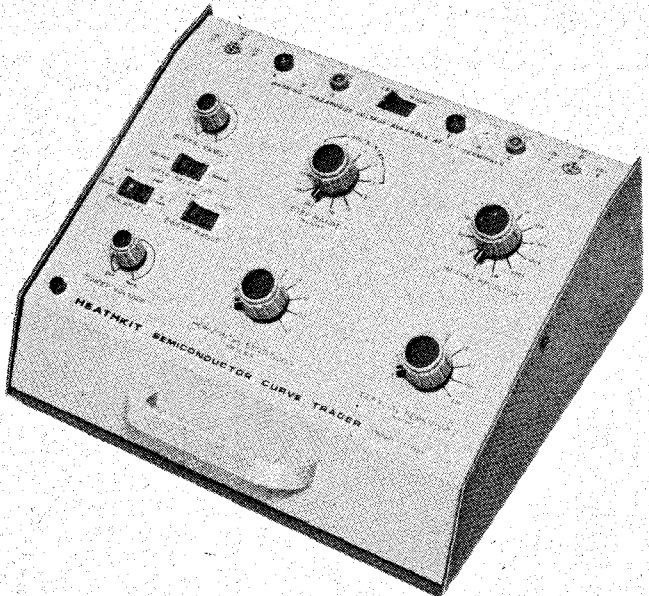

SCHLUMBERGER INSTRUMENTATION AUSTRALIA PTY. LTD.

112 High St., Kew, Victoria. and at Suite 7, 134 Willoughby Rd., Crows Nest, New South Wales

Agents:

SOUTH AUSTRALIA:

Associated Services, 110 Tynte Str., Nth Adelaide, 207-2246.

WEST AUSTRALIA:

Dawson Instrumentation, 70B Hale Rd., Wembley Downs. 41-4117.

QUEENSLAND:

L.E. Boughen & Co., 30 Grimes St, Auchenflower. 70-8097.

Distributors:

Digitronics Australia Pty Ltd., 12 William St., Maryville, N.S.W. 69-2040.

Alan Oliver (Electronics) Pty Ltd., 188 Pacific Highway, St. Leonards, N.S.W. 43-5305.

Associated Scientific Sales Pty Ltd., 29 Wollongong St., Fyshwick, ACT. 95-9138.

MAKE YOUR OWN PUSH BUTTON SWITCH PROTOTYPES

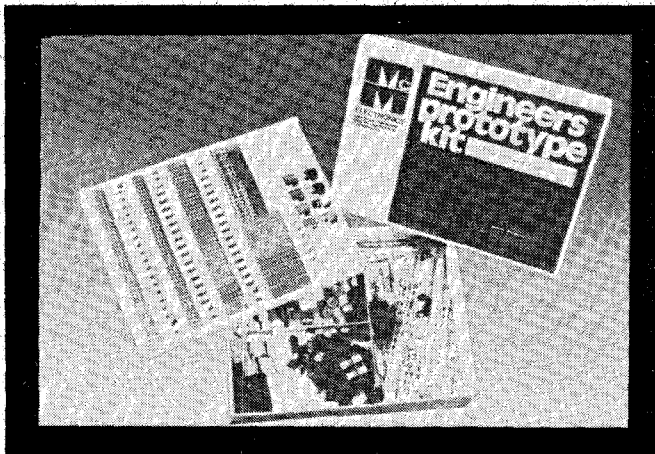

If you are involved in the design and development of electronic equipment or electrical appliances we've got a great new aid for you. You can now design and construct your own Prototype Switches from the thousands of combinations possible using our latest Engineers Prototype Kit. When you have finalized your design we will then assemble

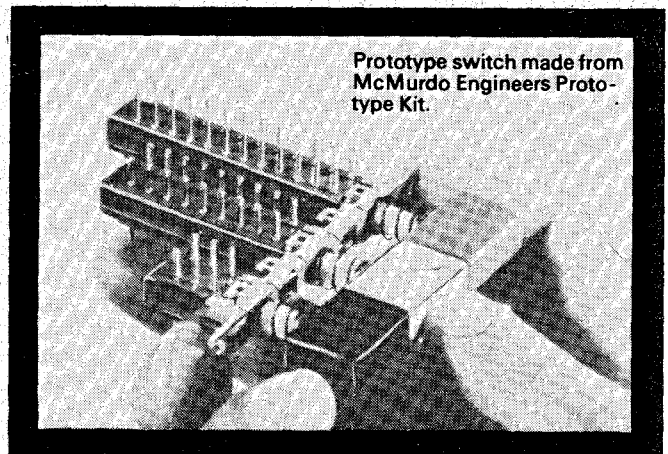

Prototype switch made from McMurdo Engineers Prototype Kit.

your production quantities (in any quantity from 10 to 10,000) at unbeatable prices! The ISOSTAT Push Button Switch Kit contains all necessary hardware, assembly instructions, parts list and a demonstration switch. Price: \$45.00 Plus Sales Tax (if applicable).



MCMURDO (AUSTRALIA) PTY. LTD.

Head Office and Factory:

17-21 Carnish Road, Clayton, Victoria: 3168. Tel. 544-3033
N.S.W. 219 Blaxland Rd., Ryde, 2112. Tel. 807-1944
S.A. 346-348 Carrington Street, Adelaide, 5000. Tel. 23-1535

AGENTS:

WESTERN AUSTRALIA: W.J. Moncrieff Pty Ltd.,

Tel 23-1194, 25-6140

A.C.T. Electronic Components Pty. Ltd., Tel 95-6811.

TASMANIA: W. & G. Genders Pty. Ltd. Tel. 31-2511, 34-4311

73/2/EKS

Dick Smith Electronics Centre

BIG PRICE CRASH

Lower duty rates and huge bulk buying have enabled us to reduce prices on some of our lines by up to 75%. So cut out this advert and stick it in your Dick Smith Catalogue over page 62A. Start saving a fortune.

All are new guaranteed National, Fairchild, STC, Texas, Motorola and other well known brands.

UP TO

75% OFF

Transistors, Brand New & Fully Guaranteed

AC107	1.9	10 up	AY8140	1.50	1.40	BD139	1.50	1.45	MJE3055	2.20	2.00	2N2926	.50	.45
AC125	.46	.40	AY9140	1.50	1.40	BD140	1.60	1.55	MPI102	.95	.90	2N3063	.80	.70
AC126	.46	.40	AY9171	1.20	1.10	BD139 / 140	3.10	3.00	MPI103(2N5457)	1.20	1.10	2N3054	1.70	1.60
AC127	.60	.56	AY9171	1.20	1.10	BDY20 Use 2N3055			MPI104(2N5458)	1.10	1.00	2N3055	1.20	1.00
AC128	.60	.56	AY149	1.40	1.20	BF167	.70	.65	MPI105(2N5459)	.95	.90	2N3056	.55	.50
AC127 / 128 Pair	1.20	1.10	BC107 (E7547)	.25	.22	BF173	.85	.80	MPI106(2N5460)	.95	.90	2N3056	.65	.60
AC132	.60	.56	BC108 (BC548)	.25	.22	BF177 (BF336)	1.50	1.40	OC26 (AD149)	1.60	1.40	2N3058	.75	.70
AC187	.70	.60	BC108B	.45	.40	BF178 (BF336)	1.50	1.40	OC28 Use ASZ15	.45	.42	2N3068	.65	.60
AC188	.70	.60	BC108C (BC549)	.45	.40	BF184	1.60	1.50	OC44	.45	.42	2N3068	.45	.40
AC187 / 188 Pair	1.40	1.30	BC109C	.45	.40	BF180	1.20	1.10	OC45	.45	.42	2N3638A	.55	.50
AD149 Use OC26			BC147	.45	.40	BF184	.65	.60	OC70	.40	.36	2N3702	.50	.45
AD161	1.40	1.30	BC148	.45	.40	BF185	.65	.60	OC71	.40	.36	2N3640	.60	.50
AD162	1.40	1.30	BC149	.45	.40	BF184	.50	.45	OC72	.45	.42	2N3641	.45	.40
AD161 / 162 Pair	2.80	2.60	BC157(BC177)	.30	.26	BF195	.50	.45	OC74	.45	.42	2N3642	.45	.42
AF114	.90	.85	BC158(BC178)	.30	.26	BF200	1.25	1.20	OC75	.45	.42	2N3643	.55	.50
AF115	.90	.85	BC159 (BC179)	.30	.26	BFW10 Use 2N5459			OC77	.40	.36	2N3644	.45	.40
AF116	.90	.85	AY149	1.20	1.10	BFN11	1.45	1.35	TF797	1.20	1.10	2N3645	.75	.65
AF117	.90	.85	BCY70	.70	.65	BFW61	1.30	1.20	TF798	1.20	1.10	2N4252	.50	.45
AF118	1.40	1.30	BCY71	.85	.80	BFY50 (2N3053)	.80	.70	TT800	1.00	.95	40250 Use 2N3054		
ASZ15 (OC28)	3.60	3.40	BCY72	.70	.65	BFY51	.80	.70	TT801	1.00	.95	40408	2.50	2.40
ASZ15 (OC29)	3.65	3.40	BD137	1.70	1.60	BFY52	.80	.70	2N301	2.80	2.60	40409	3.00	2.90
ASZ17 (OC35)	3.60	3.40	BD139	1.65	1.60	DI171 (2N8027)	1.40	1.30	2N706A	.90	.80	40410	3.00	2.90
ASZ18 (OC38)	3.65	3.45	BD137 / 138 Pair	3.40	3.20	MJE2955	3.00	2.80	2N2646	1.40	1.30			

IC'S



SN7400N	1.9	10.99	100 Mix		
SN7401N	\$0.50	\$0.52	\$0.48		
SN7402N	.60	.54	.48		
SN7403N	.60	.54	.48		
SN7404N	.60	.54	.48		
SN7405N	.60	.54	.48		
SN7408N	.60	.54	.48		
SN7408N	.60	.54	.48		
SN7410N	.60	.54	.48		
SN7413N	.80	.72	.65		
SN7420N	.60	.54	.48		
SN7430N	.60	.54	.48		
SN7437N	1.20	1.10	1.00		
SN7440N	.60	.54	.48		
SN7441AN	2.20	2.10	2.00		
SN7442N	2.00	1.90	1.80		
SN7447N	3.00	2.80	2.60		
SN7450N	.60	.54	.48		
SN7451N	.60	.54	.48		
SN7453N	.60	.54	.48		
SN7454N	.60	.54	.48		
SN7456N	.60	.54	.48		
SN7470N	1.00	.95	.90		
SN7472N	1.00	.95	.90		
SN7473N	1.20	1.10	1.00		
SN7474N	1.20	1.10	1.00		
SN7475N	1.50	1.40	1.30		
SN7476N	1.50	1.40	1.30		
SN7480N	1.80	1.75	1.70		
SN7482N	1.80	1.85	1.80		
SN7483N	2.45	2.40	2.35		
SN7486N	1.20	1.10	1.00		
SN7490N	1.20	1.20	1.15		
SN7491AN	1.60	1.55	1.50		
SN7492N	1.50	1.45	1.40		
SN7493N	1.50	1.45	1.40		
SN7495N	2.20	2.10	2.00		
SN7496N	2.20	2.10	2.00		
SN74107N	1.10	1.00	.90		
SN74121N	1.20	1.10	1.00		
SN74141N	3.20	3.10	3.00		
SN74192N	4.00	3.80	3.70		
SN74193N	4.00	3.80	3.70		

D PACKS ALL \$1.50 EACH

D1	20 Red Spot Transistors PNP
D2	16 White spot R.F. transistors PNP
D3	6 OC 72 transistors
D4	4 AC 128 transistors PNP high gain
D5	4 AC 126 transistors PNP
D6	7 OC 71 type transistors
D7	2 AC 127 / 128 Complementary pairs PNP / NPN
D8	2 AF 117 type transistors
D9	3 OC 171 H.F. type transistors
D10	7 2N2926 Sil. Epoxy transistors mixed colours
D11	4 OC 44 Germanium transistors A.F.
D12	4 AC 127 NPN Germanium transistors
D13	20 NKT transistors A.F. R.F. coded
D14	10 OA 202 Silicon Diodes Sub-Min.
D15	15 IN914 Silicon Diodes 75Piv 75mA
D16	2 10A 600 PIV SILICON rectifiers 16A25R
D17	7 Silicon switch trans. 2N706 NPN
D18	8 Silicon switch trans. 2N708 NPN
D19	7 Silicon NPN trans. 2N2369, 500MHz (Code P397)
D20	3 2N3053 NPN Silicon transistors
D21	7 BC 107 NPN transistors
D22	7 NPN transistors 4 x BC108, 3 x BC109
D23	8 NPN high gain trans. 3 x BC167, 3 x BC168
D24	4 BCY70 PNP transistors TO-18
D25	4NPN transistors 2 x BFY51, 2 x BFY52

New Low Price TRIACS

G.E. Brand - Plastic Pack	
SC141D 6 amp	1.9 - 10 up
400V	2.00 1.90
SC146D 10 amp	
400V	2.25 2.00

Bargain Diacs - for use with Triacs

BR100	1.9	10 up
ST4	.80	.75
	.98	.50

Low Cost D.I.L. I.C. Sockets

8 pin	1.9	10 up
14 pin	.40	.36
16 pin	.45	.40
	.50	.45



New Lower Prices ZENER DIODES

400 MW (BZY88-BZX79 series)	1.9	10 up
1.5 / 2.5 Watt (BZX70 series)	.35	.32
10 Watt (5 Watt BZY93 type)	1.60	1.20



SIGNAL DIODES

Top quality Philips, S.T.C., Texas etc.			
'AA119	1.9	10.99	100 up
BA100	.25	.22	.20
BA102	.45	.42	.40
BA114	.40	.35	.30
OA90	.25	.20	.15
OA91	.25	.20	.15
OA95	.25	.20	.15
OA200	.30	.25	.20
OA202	.30	.25	.20
IN4148 (IN914A)	.15	.13	.10

POWER TRANSISTOR BONANZA!

Coded GP100 brand new TO3 metal case germanium P.N.P.	
Possible replace OC25, OC28, OC29, OC30, OC35, OC36, ASZ15, ASZ16, ASZ17, ASZ18 and majority of germanium power transistors in OC, AD and NKT range.	
V _{ceo} - 50V V _{ceo} - 80V I.C. - 10 amps	
Plot - 30W life = 30-170	



EXPERIMENTERS

Buy some of our best low-cost Germanium transistors!		
OC 44	1.9	10 up
OC 45	.45	.42
OC 70	.45	.42
OC 72	.45	.42
OC 74	.45	.42
OC 75	.45	.42

Yes - identical to those that normally sell at \$1.80 each.

ND120 NIXIE DRIVER TRANSISTOR

Suitable replacement for 65X21 C437 2N1893 etc V _{ceo} - 120V	
1.9	ONLY 60c

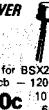

SILICON RECTIFIERS - Fabulux Value

1 Amp (Plastic)	1.9	10.99	100
EM4005 / IN4001 50 Volt	.15	.14	.13
EM401 / IN4002 100 Volt	.20	.19	.18
EM404 / IN4004 400 Volt	.22	.21	.20
EM410 / IN4007 1000 Volt	.36	.34	.30

10 Amp (Stud 8010 Case) - A Bargain
MR110 100 P.I.V. .90 .85 .80
MR410 400 P.I.V. 1.20 1.10 1.00

ENORMOUSLY RUGGED SCRS

Ideal for S.C.R. Ignition etc. - TO48 Case.	
C1640 400 Volts at 16 Amps	1.2 2.75 2.50
C1680 800 Volts at 16 Amps	4.50 4.25



LIGHT EMITTING DIODES

Cheapest in Sydney - Litronic, Texas, Fairchild.		
Miniature red	1.9	10 up
Lge with Mrg, red	.30	.26
Medium green	.90	.80



SILICON CONTROLLED RECTIFIERS

Bargain prices - all plastic pack G.E. 1.9 10 up		
BRV99	1.60	1.50
CI038 200 Volts at 8A	1.78	1.58
CI08Y1 30 Volts at 4A	1.00	0.95
CI08D1 400 Volts at 4A	1.50	1.30
CI22D 400 Volts at 8A	2.20	2.00
CI22E 500 Volts at 8A	2.70	2.50



2N3055

115 Watt Silicon NPN Power - FULLY IMPORTED - best in Australia

\$1.20 each

2N414

10 transistor radio IC from Ferranti. Operates from 1.5V. Power Gain 72 db consumes only 300uA. Frequency range from 150KHz to 3MHz. See Elementary Electronics E.A. May

ONLY \$3.95

BABANI AND BERNARDS BOOKS

BP1	First Book of Transistor Equivalents and Substitutes	\$1.00
BP2	Handbook of Radio, TV and Ind Tube and Valve Equivalents	1.00
BP3	Handbook of Tested Transistor Circuits	1.00
BP4	International Handbook of the World's Short Wave, Medium and Long Wave Radio Stations & FM & TV Listings	50
BP6	Engineers and Mechanists Reference Tables	80
BP9	38 Practical Tested Diode Circuits for the Home Constructor	1.00
BP11	Practical Transistor Novelty Circuits	2.20
BP14	Second Book of Transistor Equivalents and Substitutes	25
129	Universal Gram-Motor Speed Indicator	.75
161	Radio, TV and Electronics Data Book	.40
196	AP-RF Reactance-Frequency Chart for Constructors	2.00
202	Handbook of Integrated Circuits (IC) Equiv. and Substitutes	25
RCC	Resistor Colour Code Calculator.	

Silicon Bridge Rectifiers

High quality assemblies giving maximum ratings and reliability at minimum cost.

Type	Current	P.I.V.	1-9	10 up
MB1	1.8A	100	1.40	1.20
MB4	1.8A	400	1.80	1.60
MB8	1.8A	800	3.20	3.00
MB10	1.8A	1000	4.20	4.00
PA40	8A	400	6.00	5.75
PA60	8A	600	6.75	6.50
PA80	25A	400	7.20	7.00

Solid State LED Displays

DL707	0.3" high	3.90	3.50
DL62	0.6" high	8.90	8.25
FND70	0.3" high	3.70	3.50

Special RF Transistors

2N5569	7 Watt	1.9	8.00
2N5580	15 Watt	7.75	7.45
2N559			

Dick Smith Electronics Centre

PROJECT 250 HIGH QUALITY 25 WATT STEREO AMPLIFIER FROM

ONLY \$14.95

- * HUGE BREAKTHROUGH IN COST
- * GUARANTEED NO PARTS MISSING
- * AS USED BY LEADING MANUFACTURER
- * ALL PARTS READILY AVAILABLE, NO SPECIALISED ICs ETC.
- * PHILIPS CAPACITORS AND RESISTORS, MOTOROLA TRANSISTORS
- * FOR 8 OHM SPEAKERS

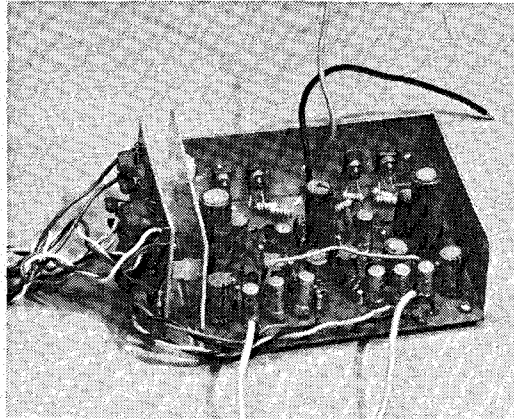

- * HEATSINK AND FULLY TINNED PCB INCLUDED
- * 10 TRANSISTORS, 4 DIODES, LOW DISTORTION OTL DESIGN
- * PREAMP/TONE CONTROL NETWORK BUILT-IN
- * COMPONENTS ALONE WORTH MORE THAN COST OF THIS FULLY ASSEMBLED AMPLIFIER.
- * FULL PROVISION FOR VOLUME, TREBLE, BASS AND BALANCE CONTROLS
- * 25 WATT PEAK TOTAL POWER (12.5W TOTAL RMS)

Are you sick and tired of buying kits that aren't complete? Are you fed up with waiting for back orders? Well we know how frustrating it can be for you and until now there has been little we can do to help. It's been extremely difficult to locate parts while this shortage goes on. But once in a while we can do something to make you happy and our life a little bit easier. So here's the good news -

We have made special arrangements to import a large number of high quality pre-assembled amplifier modules. YES THEY ARE ABSOLUTELY COMPLETE. WE GUARANTEE NOT A SINGLE PART MISSING. All you have to do is wire in the four controls, connect a power supply and you have a fully working amplifier. The same job is in fact being used by a leading manufacturer in equipment that sells at \$150.

There are no special parts, ICs etc in this amplifier. It is entirely conventional using OTL (output transformerless) design. Transistors are epoxy types from Motorola, Caps and resistors are Philips. 10 transistors and 4 diodes. Need we say more?

Ready to take ceramic pickup direct or magnetic via a pre-amp. Give it a go. Whether you're an advanced constructor or a beginner you'll get this going in no time. We supply full instructions, circuit etc. You simply have to connect controls and power supply. We can supply the amp in various forms as described below.

Money back if not satisfied. Yes!! The usual Dick Smith guarantee applies to this kit. Inspect for 7 days and return if not satisfied, untouched, and we will refund your money less P&P. **HAVE YOU EVER SEEN AN OFFER LIKE THAT ON A KIT?**

Twice the power of it's nearest competitor. Prebuilt, Tested, Available Ex-Stock. No hard to get ICs ... all this at 20% less than its nearest rival. It's ridiculous eh?

So call in and see one working. We are so confident of the performance of this amplifier that we have one set up in our Hi Fi room alongside some of the top gear in Australia. We're using it with a ceramic pick up and two 6" speakers (all available from us). Make the comparison, amaze yourself!!!

Use this order form **GUARANTEED IN STOCK FOR INSTANT DESPATCH**

Tick boxes as required and send your remittance for immediate delivery.

PROJECT 250A KIT includes fully built and tested amplifier, full circuit and suggested power supply circuit. Simply add your four pots - 3 x 50k dual log and 1 x 50k single linear - various wires and a power supply. Approx. 24-30V @ 1A. **AMAZINGLY LOW PRICE ONLY \$14.95 (P&P \$1.00).**

PROJECT 250B KIT exactly as 250A above but also includes four rotary pots. All you need to add is a power supply and some wire links. **\$19.95 (P&P \$1.50).**

PROJECT 250C KIT Includes amp and controls as 250B above. Plus a full power supply kit. It will take under an hour and some wire links to complete the amplifier. Here is a **COMPLETE** kit for a 25W amplifier for **\$29.95 (P&P \$2.00).**

Name

Address

.....Postcode

I enclose cheque/Money Order/Postal Order to value \$

Other suggested accessories in stock at time of going to press but not guaranteed to be in stock, possible delays of upto 3 weeks depending on demand.

Metalwork kit \$8.00 (P&P \$1.00) intended for the popular Playmaster 136 but easily adapted. Finished in light grey hammertone.

Front panel \$3.00 (P&P 50cents) from the Playmaster 136 satin finish looks quite posh. Easily adapted.

6" speakers (as used in our demo) C6LX (or similar) \$8.75 each (P&P \$1.00).

BSR Turntable G11.204 Fully automatic \$39.00 (P&P \$2.00)

SPEAKER BOX SPECIAL

We have obtained a limited quantity of fully built speaker boxes. **NOT A KIT.** Takes 6" speaker. 15" x 10" x 7" realistic teak finish with expensive looking Colan speaker cloth. Normally \$15.75 so hurry while they last as only **\$9.50 (P & P \$2.50).**

DICK SMITH WHOLESALE PTY LTD

160-162 Pacific Highway, Gore Hill NSW 2065.
Tel 439 5311

HAM RADIO SUPPLIES

MAIL ORDER SPECIALISTS

67-7329

323 Elizabeth Street, Melbourne (2 doors from Little Lonsdale Street)

67-4286

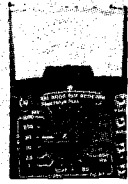

MODEL OL-64D/P MULTIMETER

20,000 ohms per volt. DC volts: 0.025, 1, 10, 50, 250, 500, 1000 (at 20K o.p.v.), 5000 (at 10K o.p.v.). AV volts: 0-10, 50, 250, 1000 (at 8K o.p.v.). DC current: 50uA, 1mA, 50 mA, 500 mA, 10 amps. Resistance: 0-4K.

400K, 4M, 40 megohms. DB scale - 20 to plus 36 dB. Capacitance: 250pF to 0.02uF. Inductance: 0-5000 H. Size: 5/8" x 4-1/8" x 1 3/4" in. Price \$19.75 p.p. 50c.

CT-500/1. \$16.75

Popular, medium-size, mirror scale. Overload-Protected.

AC/V: 10V, 50V, 250V, 500V, 1000V, (10,000Ω/V)
DC/V: 2.5V, 10V, 50V, 250V, 500V, 5000V (20,000Ω/V)
DC/A: 50uA, 5mA, 50mA, 500mA.
OHM: 12KΩ, 120KΩ, 1.2MΩ, 12MΩ, db: -20db to +62db.
Approx. size: 5 1/2" x 3-5/8" x 1 3/4". p.p. 50c.



RF SIGNAL GENERATOR Model TE-20D

SPECIFICATIONS

Dial has 7 separate band TE-20D covers 120 kHz - 500 MHz (6 Fundamental Bands & 1 Harmonic Band). Freq. Accuracy: + or -2%. Audio Output: to 8 volt. Internal Modulate: 400 Hz approx. Tube: 12BH7A, 6AR5. Power Source: 105-125V, 220-240V AC 50/60 Hz. 12 watts TE-20D employs a Xtal socket and can be used as below. a. - Self-Calibration. b. - Marker Generator. Small size-Space Saving. Printed Circuit for a uniform characteristic. Dimensions 140 x 215 x 170 mm. Weight: 2.8 kg. Price \$47.00. P&P \$2.00

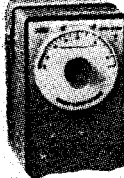

H10K1 MODEL L-55 FET MULTITESTER

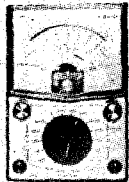

This amazing instrument features a 20 Meg ohm input impedance, 36 ranges from 300 mV full scale to 1200 volts and can measure as low as .2 ohm! Comes complete with probes and carry case. \$42.95 p.p. 75c.

MODEL C1000 \$6.95 p.p. 50c.

Is the ideal low cost pocket meter.

AC volts: 10V, 50V, 250V, 1000V (1000Ω/V).
DC volts: 10V, 50V, 250V, 1000V, (1000Ω/V)
DC current: 1mA, 100mA
OHMS: 150KΩ
Decibels: -10db to +22dB.
Dimensions: 4 3/4" x 3-1/8" x 1-1/8" 4 3/4" x 3-1/8" x 1-1/8"



200-H. \$13.50 p.p. 75c.

90° quadrant meter. Pocket size. AC/V: 10V, 50V, 100V, 500V, 1000V, 10000V (10,000Ω/V).
DC/V: 5V, 25V, 50V, 250V, 500V, 2500V (20,000Ω/V).

DC/A: 50uA, 2.5mA, 250mA
OHM: 60KΩ, 6MΩ
Capacitance: 100pF to .01uF, .001uF to .1uF.
db: -20db to +22dB.
Audio Output: 10V, 50V, 120V, 1000V Ac.
Approx. size: 4 1/2" x 3 3/4" x 1-1/8"

ELECTRONIC KITS FOR BEGINNERS



Mykit Series 150 in 1



Mykit Series 10 in 1

Popular imported electronic kits, no soldering, easy to assemble, battery operated, safe, suit all ages - children and adults, board type construction with easy to follow instructions that make them ideal gifts.

CRYSTAL RADIO KIT No. 28207, tunes AM broadcast band, simple 1 hour construction, no batteries, ideal for beginner. \$4.95 p.p. 30c.

AM TUNER AMPLIFIER KIT No. 28241, build your own 3 transistor tuner and amplifier, all parts transistors, tuning gang, transformers, speaker etc. \$13.50 p.p. 75c.

10 PROJECT ELECTRONIC KIT, No. 28202, 10 working projects, SOLAR BATTERY, builds radios, oscillators, signal generators, all solid state. \$8.95 p.p. 75c.

15 PROJECT ELECTRONIC KIT No. 1544, learn electronics with each project. Build these, morse code oscillator, radios, alarms, sirens etc. \$11.25 p.p. 50c.

IC-20 20 PROJECT ELECTRONIC KIT, learn about integrated circuits with this educational kit, 20 working projects including integrated circuit. \$13.25 p.p. 75c.

50 PROJECT KIT No. 28201 DELUXE MODEL, 50 working projects, educational entertaining, all solid state, includes everything, nothing to buy, constructed in hardwood case, panel meter, radios, amplifiers, burglar alarms, tachometer, test equipment, good value - \$21.50 p.p. \$1.00

DELUXE 150 ELECTRONIC PROJECT KIT using integrated circuits. Contains all parts for 150 different working projects including I.C. diode and transistor radio, electronic switches, relays, alarms, test equipment, etc. etc. Very good value. Prices \$34.95 p.p. \$2.00

80/ Project kit build 80 different and sophisticated circuits. Includes mike, speaker etc. \$24.50 p.p. \$2.00.

SOLID STATE 19 TRANSISTOR MULTI-BAND RADIO - 9 RANGES

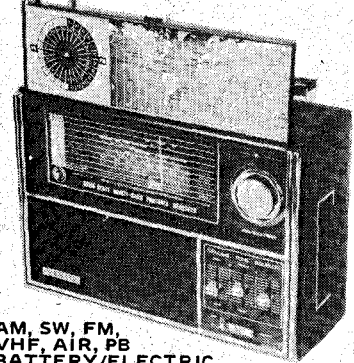

AM, SW, FM, VHF, AIR, PB BATTERY/ELECTRIC COLOUR CODED 9 BAND DIAL

1. AM 535 to 1600 kHz, 2. Marine 1-5 to 4 MHz, 3 & 4. combined SW 4 to 12 MHz, 5. 30 to 50 MHz, 6. 88 to 108 MHz, 7, 8 & 9 combined VHF Aircraft 145 MHz-174 MHz incorporating weather band. Slider controls, Dial light, Fine tuning control, Flip-up Time Zone map, Telescope antennas complete with batteries and AC cord. \$79

AM/FM/AIR-PB-WB SOLID STATE RADIO

VHF MONITOR

battery electric

\$35

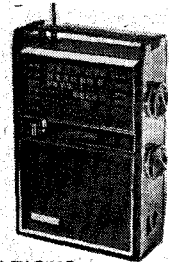

SPECIFICATIONS

Transistor: 12 Transistor, & 8 Diode; Frequency: FM 88-108 MHz, AM 540-1600 kHz, AIR-PB108-174 MHz; Power Output: Maximum 500 mW; Undistorted 280 mW; Speaker: 3" 8 ohms; Earphone: Magnetic 8 ohms; Power Source: DC 6V UM-2 x 4 pcs. or AC 230 Volt; Antenna: Ferrite bar for AM, Rod antenna for FM/AIR-PB-WB; Controls: Volume (w/on-off switch); Selector (AM/FM/AIR-PB-WB); Accessories: Earphone & batteries; Dimensions: 3 3/8" x 6 1/4" x 9 3/4"; Weight: Approx. 3 lb.

MODEL NC-310 DE LUXE 1 WATT 3 CHANNEL C.B. TRANSCEIVER

• WITH CALL SYSTEM
• EXTERNAL AERIAL CONNECTION

SPECIFICATIONS, NC-310

Transistors: 13
Channel Number: 3, 27.24 OMHz
Citiz. Band
Transmitter Frequency Tolerance: ±0.005%
RF Input Power: 1 Watt
Tone Call Frequency: 2000 Hz
Receiver type: Superheterodyne
Receiver Sensitivity: 0.7uV at 10 dB S/N
Selectivity: 45 dB at ±10 kHz
IF Frequency: 455 kHz
Audio Output: 500 mW to External Speaker Jack
Power Supply: 8 UM-3 (penlite battery)
Current Drain: Transmitter: 120-220mA
Receiver: 20-130mA.
Price \$49.50 per unit or \$99.00 pair

SCOOP PURCHASE!

BSR 123 STEREO RECORD CHARGER

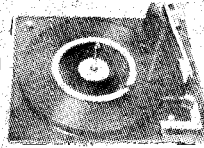

4-speed low mass tubular aluminium arm cueing device (lifter). Complete with spindles ceramic cartridge C1, replacement stylus S88 takes all size records 240V, special reduced price: \$22.95 p. & p. \$2 extra.

NEW REDUCED PRICE TRIO COMM. RECEIVER

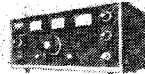

Trio Model 9R59DE, four bands covering 540 kHz to 30 MHz., two mechanical filters for maximum selectivity, product detector for SSB reception, large tuning and bandspread dials for accurate tuning, automatic noise limiter, calibrated electrical bandspread. S meter and BFO, 2 microvolts sensitivity for 10 dB. S-N ratio.

AT NEW REDUCED PRICES **\$145**
TRADE-IN ACCEPTED

SCOPE

SOLDERING IRONS

Buy a SCOPE and join the club of satisfied users—you need not keep it a secret, others don't. That's why SCOPE is known at all the best places—in the tool kit, on the bench, in the boot, on the kitchen table, in the garage, on the service truck, in the engine room, even on the roof . . . Wherever SCOPE goes it gives you the best service—and a host of satisfied users will agree *it is the FASTEST, the EASIEST, the SAFEST . . . THE BEST.*

ECONOMICAL

Consumes current only whilst in use. Scope performs all the functions of other irons from 40 to 150 Watts. (Miniscope—up to 75 Watts).

FAST

Fast heating due to the unique replaceable carbon element. Only 5 to 6 seconds' initial heating up time from cold, then practically instantaneous.

VERSATILE

Copes with all soldering jobs—from miniature components to large solder lugs. Temperature control at your finger tips. Heat only when, where and as much as needed.

SAFE

Low voltage operation. Scope irons operate from 2.5V to 6V.

For your complete protection and the satisfactory operation of your Scope iron, demand and use THE **natronics** TRANSFORMER which incorporates a specially designed ELECTROSTATIC SHIELD. It is the only transformer approved by SCOPE Laboratories.

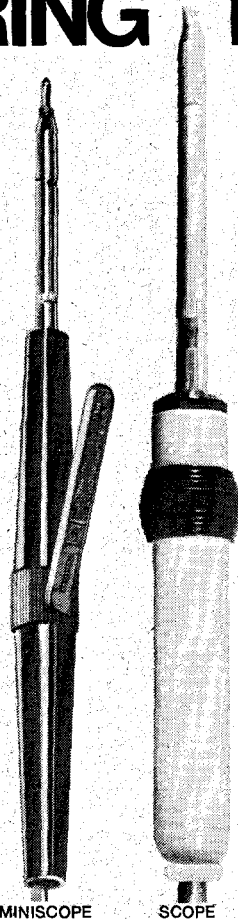

MINISCOPE

SCOPE

SPARE PARTS

No expensive resistance wire heating elements to replace. Maintenance without special tools. Spare tips, carbon elements and other parts readily available from your Scope Distributor.

Scope products are available from all major electrical wholesalers and Hardware Stores throughout Australia and from H. W. Clarke, Wellington and Auckland, New Zealand.

The Scope is yours to have and to maintain easily. It's an Australian made.

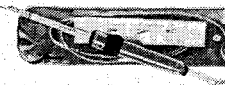

CONVENIENT

Ideal for those almost inaccessible spots. No burning of adjacent insulation.

LIGHT WEIGHT

Scope weighs only 3½ oz. Miniscope 1¾ oz.

All irons are supplied complete with a spare tip and two elements.

Modern two-tone styling, together with a strong stainless steel barrel is a feature of the De-Luxe Iron, which comes in a handy re-usable plastic pouch. The Standard economy version, with black handle and mild steel barrel, is supplied in a cardboard fibre pack.

natronics transformer

*Approved by electricity authorities
APP. No. N/360/6894-5

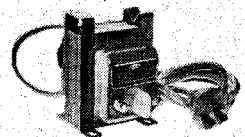

ETCHING TOOL

Prevent theft,
etch your name or symbol
on personal possessions

Distinct, permanent identification can be made in moments with the **VIBROSCOPE** on any metal, ferrous or non ferrous, hardened or annealed, dull or polished.

Not just a surface marker, the etching action of the Vibroscope produces good penetration with lasting results. Simply attach to a 4V accumulator, or 6V car battery, or Scope iron mains transformer and the Vibroscope electric etching tool is ready for action. Anyone who can write can use Vibroscope—make "your" mark for security.

Maintenance is ridiculously simple. When the long wearing tungsten tip or core of the vibrating steel plunger wears out, it is very easily replaced and spares are readily available from all suppliers of Scope products.

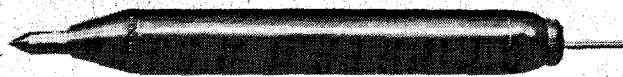

VIBROSCOPE

NATRONICS PTY. LIMITED
IRH COMPONENTS DIVISION

THE CRESCENT, KINGSGROVE, N.S.W. 2208. PHONE: 50-0111
74 RAGLAN ST., PRESTON, VIC. 3072. PHONE: 44-5021

Interstate Agents
HOB. TAS. 34 2811
LAUN. TAS. 31 5545
PERTH W.A. 81 4155
ADEL. S.A. 23 1971
BRIS. QLD. 21 1933
New Zealand
H. W. CLARKE
(N.Z.) LTD.



Please Post free SCOPE literature



NAME

ADDRESS

CITY

POSTCODE

Dollar Stretcher Sale!

INTRODUCTORY SPECIALS

84. **Invisible Auto Tape Antenna** — a revolutionary invisible tape antenna which may be fitted around front windscreen or rear window — self adhesive. Gives clear reception on all stations. \$2.25 ea.
85. **Rola 2 1/4", 25 Ohm Speaker** — for transistor radios, tape-recorders, amplifiers, hobbyists etc. Type 225A. Normally priced at \$2.30. Sale Price \$1.00 ea.
86. **Ferrite Aerial Rods** — 3/8" diameter rod by 5 1/2" long. Ideal for radio servicemen etc. 3 for \$1.20.
87. **Ferrite Aerial Rods** — 3/8" diameter x 8" long. A useful size which fits most radios. 2 for \$1.00.
88. **Ferrite Aerial Rods** — a flat ferrite rod 0.75" x 0.2" x 5 1/2" long. Suits many Japanese Radios including National. 2 for \$1.00.
89. **Ferrite Aerials with coils** — 1/2" diameter x 8" long. A large ferrite rod for mantel radios and larger type portables: complete with 2 section coil. Individually packed in styrox foam No. 7124. \$1.00.

Satisfaction Guaranteed or your money cheerfully refunded!

90. **Ferrite Aerial with coils** — a 3/8" diameter x 6 1/8" long rod with 2 separate coils for increased versatility. Would suit most radio sets, No. 7126. \$1.00.
91. **Ferrite Aerial with coils** — a 3/8" diameter x 6 1/8" long rod with standard 2 section coil — a very popular type. No. 7122. \$1.00 ea.
92. **Ferrite Aerial with coils** — a 3/8" diameter x 8" long rod with standard 2 section coil — suits most popular radios. No. 7118. \$1.00.
93. **Ferrite Aerial with Coil** — small flat ferrite rod 0.65" x 0.15" x 2.2" long with standard 2 section coil. \$1.00.
94. **Ferrite Aerial with Coil** — a large flat ferrite rod 0.65" x 0.15" x 5.2" long with standard 2 section coil. \$1.00.
95. **Radio Knob Asstd** — a selection of 15 useful plastic and metal knobs suit car radios, mantels, portables, transistors etc., 15 for \$1.00.
96. **Miniature 5 kohm volume controls** — for transistor radios. Universal type used by most manufacturers. Ideal for building pocket radios and for repairs. 4 supplied with plastic knobs for only \$1.00.
97. **Radio Tuning Condenser** — a 3 gang 4.5pf compact size tuning gang, standard 1/4" shaft — ideal for building, experimenting with or repairing radios, tuners etc. Brand new, cheapest in Australia! \$1.95.
98. **3 Bank Push-Button Switch** — from McMurdo — a modern, miniature Isostat switch bank for P.C. or lead wiring. Features 3 non-interlocking or independent DPDT switches mounted in one row with attractive black rectangular knobs. Would enhance the appearance of any amplifier or front panel. \$1.45.
99. **Transistor Tuning Gang No. 2.** 3/4" x 3/4". A standard replacement type as used in most radios. 200pf per gang with inbuilt trimmers. \$1.00, 10 for \$8.00, 100 for \$65.00.
100. **3 — SPST Rotary Wafer Switches** — standard OAK Type, 3/8" mounting hole, 1/2" long shaft. \$1.00.
101. **2 — 3 PDT Rotary Wafer Switches** — standard OAK Type, as above. \$1.00.
102. **Rotary Wafer Switch** — 3 position 9 hole triple wafer OAK switch, latest type, 3/8" diameter mounting hole, 3/4" long shaft. \$1.00.
103. **2 — Rotary Wafer Switches** — 3 position plus mains on/off, 3 pole, 3/8" diameter mounting hole, 1/2" long knurled shaft. \$1.00.
104. **2 — Rotary wafer switches** — 6 pole 3 position, dual wafer, OAK 'H' type, 3/8" diameter mounting hole, 1/2" long shaft. \$1.00.

electronic agencies

THE MAIL ORDER DISCOUNT HOUSE,
P.O. BOX E5,
CONCORD EAST. NSW 2137.

NOTE: Add postage, rated 5% of order value. Minimum order value = \$2.00. C.O.D.'s send \$2.00. prepayment. Guaranteed 24 hrs despatch or money refunded. Please use this easy order form.

Smile and be happy while you drive!

Listen to your favourite music with one or two of these super

SPEAKERS FOR CARS

- CS1 5" Speaker, 15 ohms, with black plastic grille. \$5.00.
- CS2 9" x 6" Speaker with bronze coloured metal grille, available 3.5, 8 or 15 ohms. \$5.50.
- CS3 Car Radio Console with built-in 7" x 5" Speaker, available 3.5, 8 or 15 ohms. Sloping front, with cut-outs for car radio. Suit floor mounting cars, trucks etc. \$8.50.
- CS4 Car Radio Speaker housing — mounts under any type radio, sloping front with mounting brackets, matt black finish. Supplied with 6" x 4" speaker, 3.5 or 15 ohms. \$4.99
- CS59 Car Stereo Speakers — 5" heavy duty 4-5 Watt Speakers mounted in a handsome black plastic sloping front cabinet for rear shelf mounting, 8 ohms impedance. Stock No. SK709. \$6.25 ea. or \$11.80 pair.
- CS60 Car Stereo Speakers — flush mounting with long-life chromed grille. Incorporates 5 inch speaker, 4-5 watts, 8 ohms impedance. Stock No. GK705, \$6.25 ea. or \$11.80 pair.
- CS62 Car Radio/Stereo Speakers — a deluxe charcoal finished cast-metal cabinet houses a hi-fi quality twin-cone speaker, (7" x 5", 7 watt, 8 or 15 ohms impedance). For rear-shelf or under-dash mounting. Unbelievable hi-fi quality! \$8.50 ea. or \$15.90 pair.

CAR TACHO



- * Suit 4, 6, 8 cyl
- * 0-8,000 RPM
- * 6 or 12 volt
- * Pos or Neg Grd.
- * Large 3" scale

Latest 3" impulse Tacho features a sporty-looking matt black housing designed to mount on top of the dash and an illuminated scale for night-driving. Complete with leads, fitting instructions and 90 day warranty. \$12.99

FREE FLYER!

- Send S.A.E. (size about 10" x 6") with two 15 cent postage stamps for our fantastic Summer Catalogue of stock lines, specials and bargain priced components. You won't be sorry!

BEGINNERS TOOL KIT



- 10 piece asst.
 - Chrome vanadium steel.
- All the tools you need: 1 pr. 5in. side-cutters, 1 pr. 5in. long-nosed pliers (both quality English manufacture), 3 Philips — head and 2 standard screwdrivers (best German brand), small neon-testing screwdriver and 2 aligning tools.

Package deal offer \$6.99.

MINIATURE 24 VOLT CRADLE RELAYS

Suitable for all electronic projects, switching applications, burglar alarms etc.

Specifications: Coil resistance — 700 Ohms. Min-Max Volts — 11V-33V. Contact Material — Silver. Contact Ratings — 1 Amp, 30 Watts.

TYPE RE1

Two changeover — size 7/8" x 5/8" x 1 3/8" high. \$1.50.

TYPE RE2

Four changeover — size 1 1/8" x 5/8" x 1 3/8" high. \$1.75.

PERMEABILITY RADIO TUNERS

JUST IN!

We have just received a limited quantity of manual and push-button car radio tuners, some complete with dial, pointer and escutcheon. First come-first served!

MODEL PRT5 — Manual type, 3 coils — aerial R.F. amp and oscillator. Compact size 2", 1 3/4" x 3/4" with 2" shaft. Complete with knob and connection diagrams. \$1.95.

MODEL PRT6 — Manual type, 3 coils — aerial, R.F. amp and oscillator. Compact size only 2 1/2" x 1 1/4" x 1 1/4" with 1 3/4" shaft. Made by MSP, comes complete with knob and connection diagrams. \$1.95.

MODEL PRT9 — Manual type 4 coils. Same as push-button type but with tuning spindle and dial pointer. With connection diagrams. Stock No. 044-043. \$1.50.

As above, with chromed metal dial photo and all states dial. \$2.25.

MODEL PRT10 — Manual type 3 coils. Same as push-button but with tuning spindle and dial pointer, connection diagrams. Stock No. 037. \$1.50.

As above, but with chromed metal dial plate and all states dial. \$2.25.

MODEL PRT15 — Push-button/manual type, 4 coils. A high-grade tuner with long-life mechanism and resettable push-buttons. Comes complete with dial pointer, push-knobs, tuning spindle and knob and connection diagrams. Stock No. 029-047-052. \$2.90.

As above but with chromed metal dial plate and all states dial. \$3.90.

5 inch T.V. TUBE



Brand new, sealed in manufacturer's carton

SPECIAL PRICE \$11.95.

Ideal for servicemen, amateurs and experimenters. Specifications:— Electromagnetic deflection, 70 deg. angle, filament 12 Volt 70mA, Anode voltage 8kV at 50µA, 2nd grid voltage 300V, 1st grid cut-off voltage —25V, electrostatic focusing, size 5 1/2" x 4" x 7" long.

Price \$11.95. (plus \$1.00 registered post)

A limited quantity of yokes is available to suit above T.V. tube.

Price \$7.50

NEW FANTASTIC



ULTRASONIC

\$5.95.

Use as transmitter or receiver at 30-40 kHz for ultrasonic experiments. As featured in E.A. English P.W. and American magazines. Size 1" diameter x 1 1/4" long with lead and RCA type plug.

NIXIE TUBE SALE

\$2.50 ea. 4 for \$9.00



Mullard ZM1080.

0 to 9, characters 13mm high, 170V operation, 2mA anode current, includes red filter, fitted with 14 pin base, vertical mounting.

Mullard ZM1000

0 to 9, characters 14mm, 170V operation, 2.5mA anode current, decimal point left side, fitted with 14 long wire leads, vertical mounting.

\$3.25 4 for \$12.00

Mullard ZM1174

0 to 9, characters 15.5mm, 170V operation, 2.5mA anode current, includes red filter and decimal point, fitted with 14 pin base, vertical mounting.

Price \$3.25 4 for \$12.00

Whether your needs run to one hundred high stability TCXO's, or one thousand monolithic crystal filters, or you just want ten thousand crystals in a hurry at the right price, Hy-Q Electronics are as close as your telex or telephone.

We've built a reputation for being up front. When quality, price and delivery are being considered, you don't have to accept eight week delays when you've thousands of dollars worth of equipment just waiting for crystals. Call Hy-Q . . . for faster delivery!

**You name it.
We've got it!**

**and lots
and lots of
others, too.**

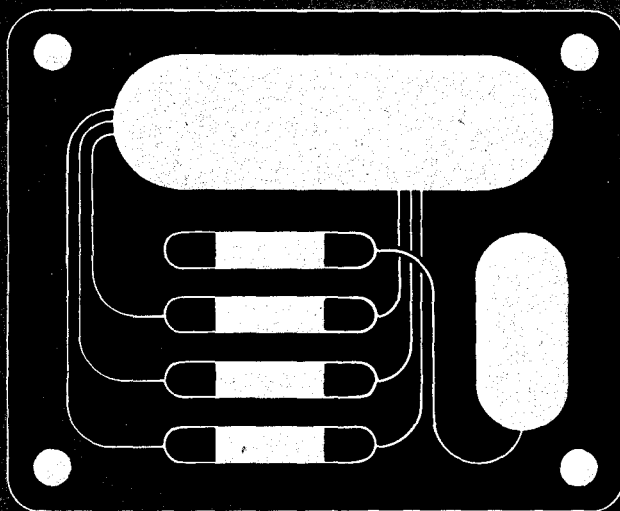

P.O. Box 256
Frankston
Victoria, 3199
Australia.
Phone: 783 9611
Telex: 31630
Cables: HYQUE
Melbourne

P.O. Box 29,
Pasir Panjang
Singapore, 5
Cables: HYQUESING
Telex: RS21427

Hy-Q
Electronics



Slowly but surely, sales of Electronic Today International are increasing.

Of course we are delighted — but an ever more serious world shortage of paper means that we must reduce wastage as much as possible.

In some areas, the magazine is already in short supply, and the situation may become worse.

There are two ways to ensure that you receive a regular copy: place a regular order with your newsagent, or take out a subscription which will cost you a bit more for postage, but will guarantee you your copy.



Subscription Dept.,
 Electronics Today International
 15-19 Boundary St.,
 Rushcutter's Bay, NSW.

Here is my cheque/postal order for \$8.50 (including postage) for my annual subscription to ETI starting with next available issue.

Name:

Address:

..... Post Code

T

Timbre

breaks the sound barrier...

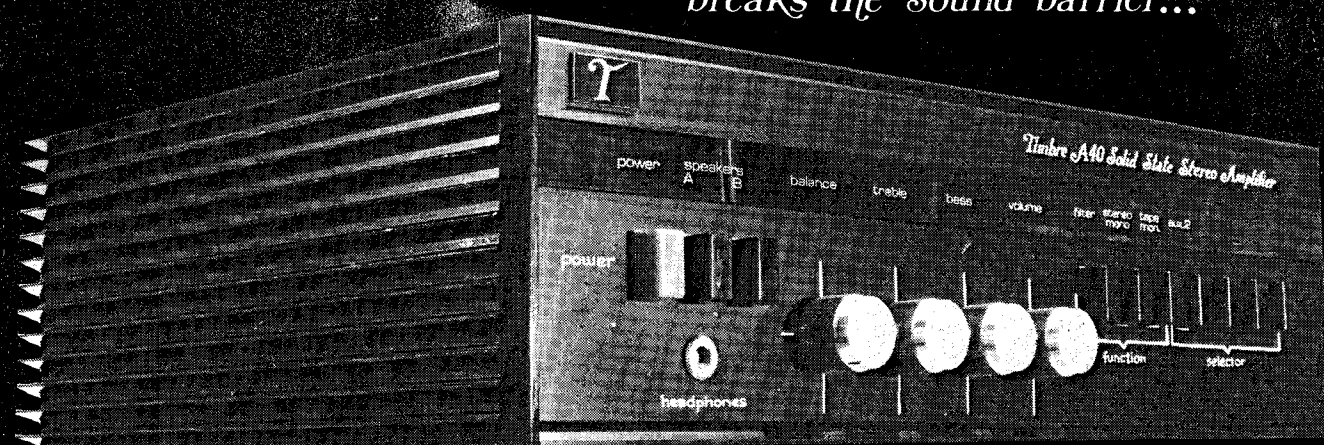

P. O. Box 91, St. Leonards. Phone 922 3405

Specifications

The Timbre A40 amplifier has been designed using discrete operational amplifiers to give low distortion, flat frequency response and easily controlled gain.

The tone controls are of the Baxandall type with the frequency determining elements in the feed back loop.

The power amplifier is a fully complementary output design using current drive to all stages after the basic two transistor gain section. This is achieved by use of a current source load for the class A driver transistor and boot strapped load into this class A driver. The class B output transistors run without standing current giving very good thermal stability.

Attention has been paid to stability into reactive loads and, together with the very low distortion figures obtained gives a sound quality of exceptional standard.

Power Output: R.M.S.	40 watts per channel into an 8 ohm load both channels driven.
Frequency Response:	20 Hz to 20 kHz ± 1 dB.
Total Harmonic Distortion:—	Better than .1% (20 Hz to 20 kHz)
Intermodulation Distortion:—	Better than .1%
Hum & Noise:—	Phono 65 dB. Tape 65 dB. Tuner 80 dB. Aux 80 dB.
Sensitivity:—	Phono 3mV. Tuner 200mV. Aux 1 200mV. Aux 2 500mV.
Scratch Filter:—	6 dB. at 12 kHz. 12 dB. at 20 kHz.
Tone Controls:—	Treble ± 15 dB at 10 kHz. Bass ± 15 dB. at 100 Hz.

ELECTRONICS -it's easy!

Capacitance and inductance — the basic concepts

SO FAR we have concentrated on circuits which are composed of pure resistance only.

The relationship between current, voltage and resistance in such circuits follows Ohm's Law $E = IR$.

Ohm's Law is a linear relationship, that is, if we graph current against voltage for a particular value of resistance we obtain a straight line.

In practical circuits however we find that, when the current is varying with time, Ohm's Law does not adequately explain all the things that happen. This is because resistance is not the only basic property that an electronic circuit has, and the response of a circuit to a varying signal may be far from linear.

All electronic circuits have two further basic properties (other than resistance) which are evident only

whilst current and voltage are changing. These two properties are known as **INDUCTANCE** and **CAPACITANCE**. They are of extreme importance in electronics.

Both of these phenomena enable energy to be stored in a circuit. An inductance stores energy in a magnetic field. Capacitance stores energy in an electrostatic field.

In this part of the course we will study the nature of capacitance and inductance, how components having given quantities of these properties are constructed, and additionally how all three basic components behave when subjected to transient signals.

THE TRANSIENT

The word transient describes comparatively short-lived conditions that may exist in a circuit

when some form of electrical disturbance is applied — a sudden voltage change for instance.

The transient behaviour of the resistors, capacitors and inductors is fundamental to numerous electronic techniques — as we shall see.

Basically the way a transient signal is modified by a component depends on the energy storage capability of that component. Previously we have seen how a switch may be used to turn a source of power on and off causing a current to flow in the load — e.g. a bell or lamp. If however we were to examine how the current in the circuit changes with time for the bell and lamp, we would find that the current does not, in fact, change from zero to maximum instantly, but changes in the manner shown in Fig. 2a and 2b (respectively). The initial part of these

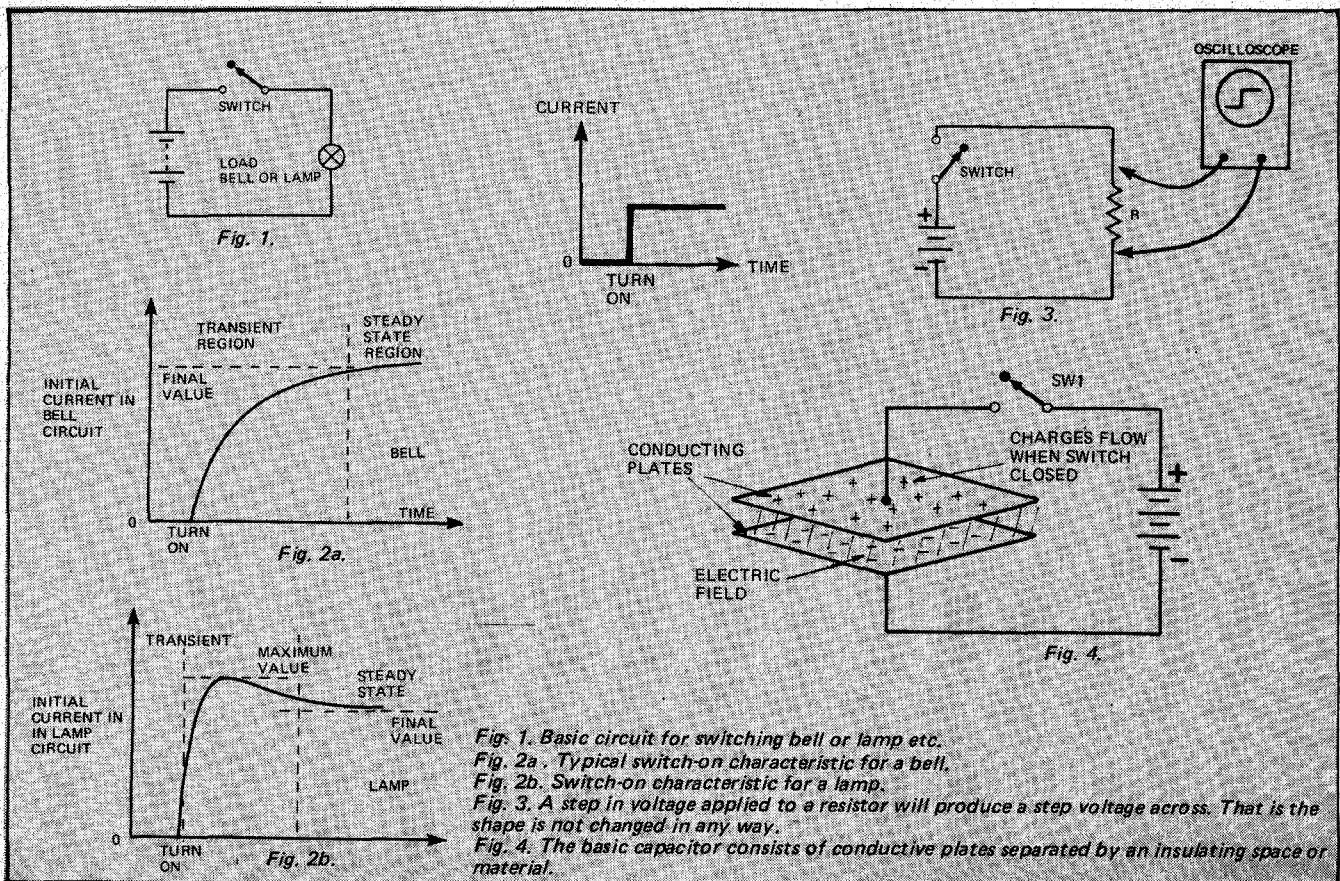

two curves is the transient region. Once the signal has *stabilized* to a constant value it is said to be in the steady state condition.

In the case of the bell the current rise is slowed by the electromagnetic effect of the coil (used to attract the metal armature). The coil of the bell is in fact — an inductor, and energy is stored in the electromagnetic field set up by current flow in the coil.

Current in the lamp, when first switched on, varies for a different reason. In this case the current immediately rises to a maximum value that is determined by the cold resistance of the filament. But as the lamp filament heats up, its resistance increases, causing the current to decrease to a steady-state value which is less than the initial value. Again it is the storage of energy — in heat form in this instance, that produces the initial transient response.

RESISTORS AND TRANSIENTS

We know that pure resistors cannot store electrical energy — they can only dissipate it in the form of heat. Consequently, a properly designed resistor, for use in electronic circuits, will not modify the time behaviour of an electronic signal. A square-wave applied via a switch, as mentioned above, will still remain a square wave.

This is illustrated in Fig. 3 which shows the waveform developed across a pure resistor in response to a step-change input. Such a test is called a step-response test.

Any kind of waveform when applied to a resistor (sinewave, sawtooth, pulse etc) will be handled without change of shape in the time dimension.

However although waveshape will not be affected, the amplitude will be, the output value will depend upon the voltage drops occurring in the resistive circuit and is easily calculated using Ohm's Law.

In ordinary electronic circuitry practical resistors behave like pure resistors and hence we need not worry about transient conditions.

But, as the operating frequency of a circuit is raised, to around 50 MHz or beyond, the resistor may have inductance and capacitance as well as its designed resistance value. For such work, special component design techniques must be used to minimize these undesirable (in this case) side-effects.

CAPACITANCE

Every electronic circuit will have current carrying conductors or components running next to other conductors or components. Where adjacent parts of the circuit are operating at different potentials, there will be an electric field between the

two parts. This is a basic physical principle.

It takes energy to set up a field and it has been found that the amount of energy stored in an electric field for a given voltage difference is proportional to the area of the adjacent surfaces, and inversely proportional to the distance between them. That is, the capacity to store energy is inherent in the physical arrangement — the larger the conducting surfaces and the smaller the distance between them — the higher the energy storage capacity. Little wonder then that this characteristic of a circuit is known as CAPACITANCE.

In practical circuits the inherent capacitance between components and leads is very small and, unless the circuit is operating at very high frequencies, of little importance. However capacitance is useful, and we can put it to work by building

components which have definite known values of capacitance.

The basic construction of such a component is illustrated in Fig. 4. There we can see that a capacitor may be constructed from electrically conductive plates separated by an insulating material. The electrical insulator, known as the DIELECTRIC may be air, oil, insulating paper, plastic film, ceramic layers or special fluids, depending on the properties required.

Assuming the capacitor in Fig. 4 has no initial charge, the voltage source causes charges to flow, the moment the supply switch is closed, creating a charge imbalance between the two plates (negative charges on one side and positive on the other). The charge imbalance will create an electric field in the dielectric between the plates and a voltage across the plates which opposes the source. Thus charges

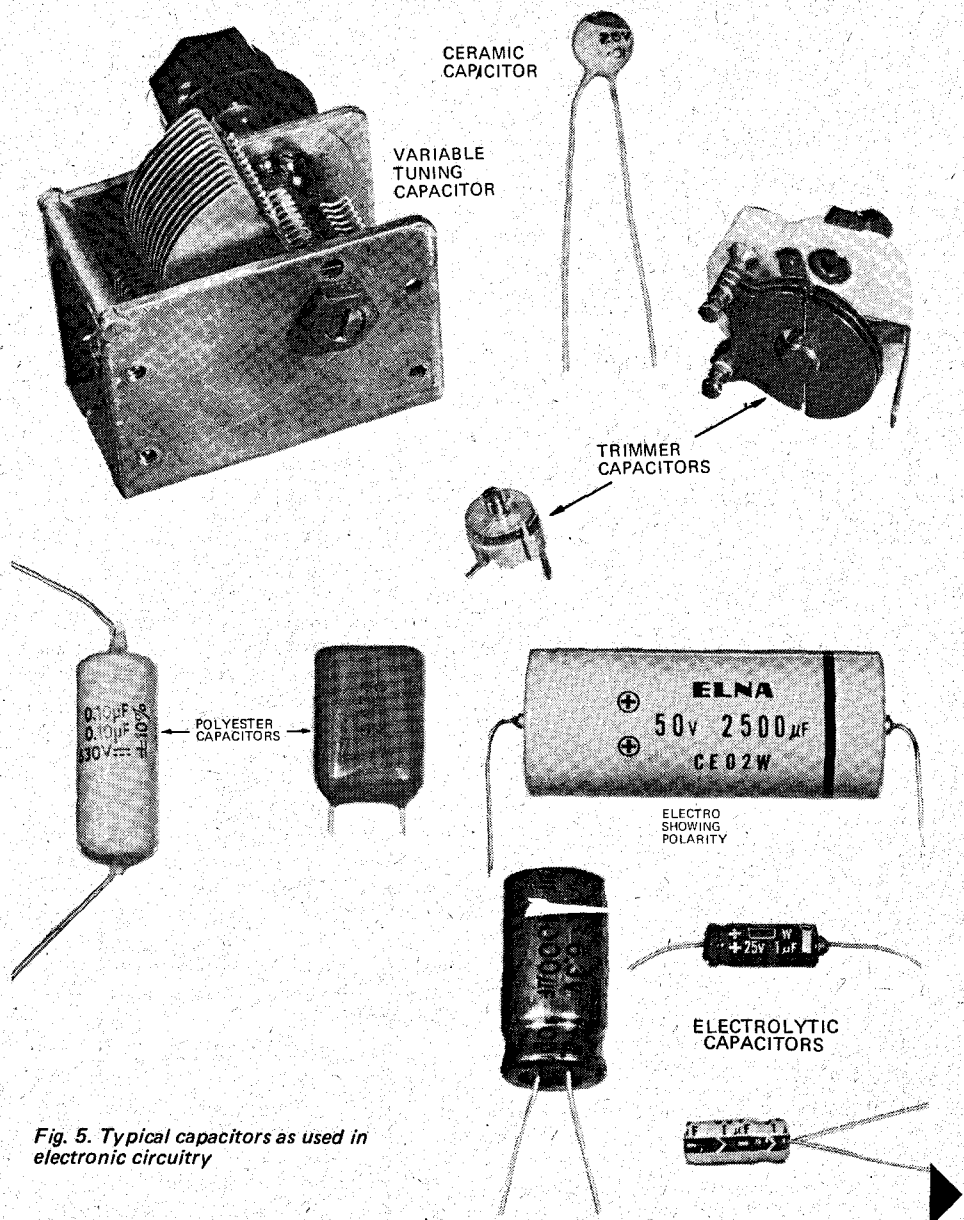

Fig. 5. Typical capacitors as used in electronic circuitry

ELECTRONICS-it's easy!

continue to flow until the voltage across the capacitor and that from the source are equal.

If the supply switch is opened, the charge remains, together with a voltage across the capacitor that depends on the quantity of charge stored. In this condition the capacitor is said to be charged.

Any resistance connected across the plates will provide a path for the charges to flow towards neutrality. Practical dielectric materials and mounting insulators are unable to provide an infinite insulation resistance and hence all capacitors have a finite value of resistance. The charge storage time, therefore, depends upon this resistance which is known as the LEAKAGE RESISTANCE. Quality capacitors have very high leakage resistance and are able to hold charge for many days, but their extra cost is not always warranted.

As mentioned earlier, physical principles tell us that the storage capability of the capacitor is given by:-

$$C = k \frac{A}{d}$$

where k equals dielectric constant
A equals area of plates
d equals distance between plates

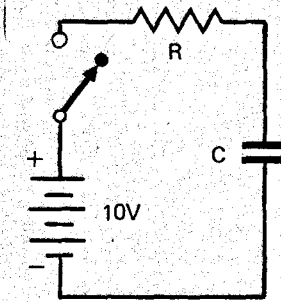

Fig. 6a. Circuit of an RC network.

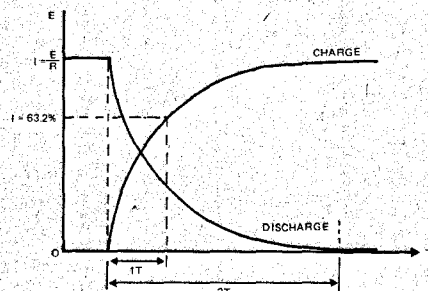

Fig. 6b. The transient behaviour of the RC network of Fig. 6a.

The dielectric constant ('k' in the equation above) is a number dependant upon the material used.

For example air is the standard dielectric having a constant of 1. Barium titanate has a dielectric constant of 1143, therefore a capacitor with barium titanate as a dielectric would have 1143 times the capacitance of an air dielectric capacitor with the same plate spacing.

The unit of capacitance is the FARAD and is the value of capacitance by which an applied voltage change of one volt per second produces a current flow of one ampere.

In practice the FARAD is a far larger value than is normally encountered. Instead the smaller sub-units microfarad ($\mu F = 10^{-6} F$), nanofarad ($nF = 10^{-9} F$) and picofarad ($pF = 10^{-12} F$) are most commonly employed.

Physical size limitations prevent the flat plate capacitor, described above, from providing any more than a few picofarads of capacitance.

In order to make components having larger values of capacitance, different construction methods must be employed which utilize as much plate area as possible, have the smallest possible gap and use high dielectric-constant materials as insulation. However, small gaps imply low insulation resistance and large values are only obtained at the expense of increased physical size, and/or, reduced safe working voltage levels.

In the so called solid-dielectric types several manufacturing methods are used - rolls of aluminium foil interleaved with plastic film, layers of deposited materials etc. Knowledge of the actual construction is of little importance to an understanding of electronics however, so we will leave these aspects to the designer. What does concern us is that by using this method of construction, reasonable working voltages are obtainable, but for values of $100\mu F$ or more physical size becomes a considerable problem.

A second major class of capacitor, known as electrolytic, provides an answer to the size problem, although they have other disadvantages which prevent them from being a universal replacement.

In the electrolytic capacitor the dielectric layer is produced by electrolytic action (by means of a chemical solution or paste) on the surface of the aluminium foil. By this means very large values are obtainable in reasonable sizes. They suffer

however from the fact that they are polarized (meaning that one connection lead must always remain positive with respect to the other). Electrolytic capacitors can be recognized, usually, by the leads being marked with polarity. If the polarity is reversed the capacitor will be damaged - it may even explode!

Electrolytic capacitors must not be used for ac signals unless the signal is biased with a dc level so that polarity of the capacitor is never reversed. (This is not as great a disadvantage as it may seem). Further, the insulation resistance of electrolytics is usually relatively low. However, not withstanding the above disadvantages,

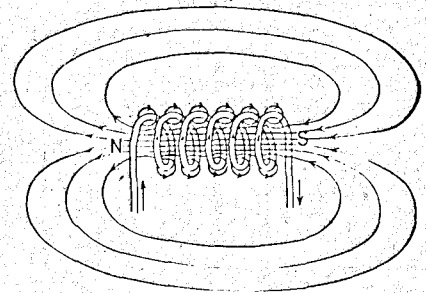
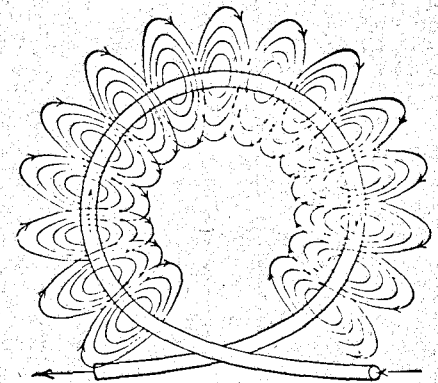
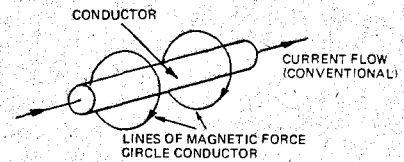

Fig. 7a. The basic inductor is merely a wire with current flowing through it.
Fig. 7b. The magnetic field about a single loop of wire carrying a current.
Fig. 7c. The magnetic field about a loosely wound coil of wire carrying a current.

electrolytics are used extensively because of their large capacitance per given volume of component.

An assortment of capacitors is shown in Fig. 5 and more illustrations may be seen in the trade catalogues mentioned in the previous article in this series.

As with resistors, capacitors are made in a wide range of values and may be fixed or variable types. In the variable types, those that have a wide capacitance range and have a shaft suitable for mounting a knob are known as *tuning* capacitors; those having a screw driver adjustment are known as *trimming* capacitors.

Fixed capacitors are sometimes colour coded and this code is given in Fig. 5. Usually however the value is marked on the capacitor together with its tolerance and working voltage e.g., 100 $\mu\text{F} \pm 10\%$, 50 V working.

CAPACITORS AND TRANSIENTS

We previously explained that charges will continue to flow into a capacitor until the voltage across the capacitor equals that of the source.

The important thing to realize about this is that charge flow constitutes a current flow *even though there is no direct electrical path!* Further, current flows only whilst the capacitor is charging or discharging. A little thought will show that if a changing voltage is applied to the capacitor a corresponding change in charge current will occur. Thus if dc is applied, the capacitor, after an initial charge period, will block any further dc current, but *an ac signal will pass through the capacitor.* The great usefulness of a capacitor is therefore in separating various sections of a circuit, as far as dc signals are concerned, but coupling them for ac signals.

The amplitude-time relationship for the charging (and discharging) of capacitors obeys an exponential law (stated simply, an exponential change is one which doubles, or halves, for each unit interval of time) and the shape of the charging function is always the same, (see Fig. 6), the only variation being in the scales used. The actual time taken for a capacitor to become fully charged (or discharged) depends on the size of the capacitor (i.e. amount of energy to be stored or released) and upon the amount of series resistance in the charging circuit. Fig. 6a shows a basic charging circuit.

As the charging curve obeys a well defined mathematical law we are able to characterize all charging and discharging operations by what is called the **TIME CONSTANT** (symbol T or τ).

The **TIME CONSTANT** is by definition the time taken to charge to 63.2% of the final value, or discharge to 36.8% of the final value. These

values are chosen because the time constant is then simply equal to the product of the resistance and capacitance values. That is:—

$$T = CR$$

where T = time in seconds
 C = capacitance in Farads
 R = resistance in Ohms

For example a 1 μF capacitor, charged through a 1 kohm resistor, will reach 63.2% of its final voltage in one millisecond. Note that the actual value of the applied voltage does not alter the relative amount of charge stored in a given time.

A handy rule to remember is that the capacitor is virtually fully charged (an exponential charge never reaches the final value — it merely halves the charge remaining each additional time unit) after a time of $3T$.

Similarly when a resistor is placed in parallel with a capacitor that is already charged it will discharge to 36.8% of the final value in accordance with the $T = CR$ rule. As all capacitors have some internal leakage resistance effectively in parallel, they will all become discharged eventually.

The concept of time constant is important when capacitors are used as a means of storing voltages or for smoothing variations on a dc voltage, but more about this later.

INDUCTANCE

Previously, we have briefly mentioned that, when a current flows through a conductor, there is always an associated magnetic field around it, as shown in Fig. 7a.

We can show that the field exists by observing the movements of the needle of a compass when held near it. Again, this is a physical principle for which we have no real explanation — we merely know that it is *there* and have learnt how to make use of it. Thus, as with a capacitor, energy is stored in a field. This time, however, it is a *magnetic* field, not an electrostatic field as with capacitance.

The magnetic field around a simple loop of wire is shown in Fig. 7b. The field is represented by lines of circular form around the wire carrying the current. These lines are called lines of magnetic flux and constitute the magnetic field. The closer the lines are together — the stronger the field.

One way of reinforcing the field is to wind the wire into a coil, as in Fig. 7c. The effect is to concentrate the lines of force through the centre of the coil and thus produce a denser field. The field may be still further concentrated by winding the coil around a soft iron core and by winding several layers of wire. By such means we can produce powerful electromagnets which have many uses (such as in the relay used in an earlier experiment).

If we try to vary the current through the coil we find that the change is resisted, i.e., the coil tries to maintain the current at a constant level. This is because the coil generates a voltage, called the back emf, which always opposes the supply voltage change. This effect is known as **INDUCTANCE** (symbol L) and is only evident when the current tries to change.

The unit of inductance is the **HENRY** and is defined as that value of

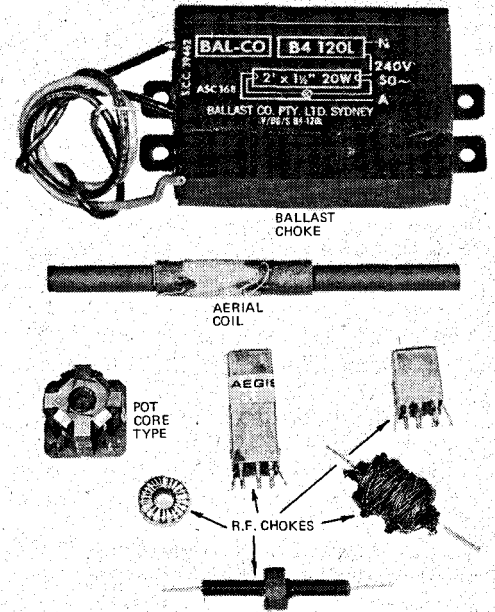

Fig. 8. Typical inductors as used in electronics.

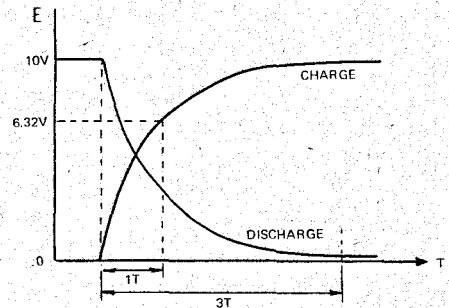
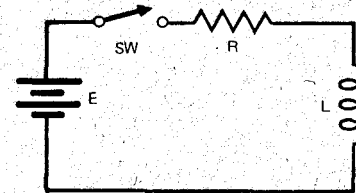

Fig. 9a. The basic resistor and series inductor circuit.

Fig. 9b. The transient characteristics of the series LR circuit.

ELECTRONICS-it's easy!

inductance which will produce an emf of 1 volt across it when the current is changing at 1 ampere per second.

$$\text{Thus } e = L \frac{di}{dt}$$

where e = instantaneous voltage across coil

L = inductance in Henries

$\frac{di}{dt}$ = rate of change of current in amperes/second

A single piece of conductor has only a minute amount of associated inductance. It is so small that it may be neglected in circuits operating at low frequencies. However, as with capacitance, inductance is useful, and components may be specially constructed having values of inductance from a few microhenries to tens of Henries, with millihenry and microhenry values being the most commonly used.

The inductance value depends upon the number of turns, and (if used) the iron core. It does not depend on the resistance of the wire. Unfortunately large inductance values, of small physical size, can only be made by using thousands of turns of very fine wire, and hence, the resistance is high.

Thus an inductor which is required to carry a large dc current will be bulky and heavy.

Practical inductors, therefore, come in many shapes and sizes and may range from a single piece of wire to a million-turn coil, or a many kilogram-weight unit as used in radio transmitters. Fig. 8. shows a range of units commonly encountered in low power electronics. Variable inductors are also required in some circuits and these may be produced by arranging for, a variable air gap in the iron circuit or, a small slug of ferrite (a type of ferromagnetic material) which can be screwed in or out of the coil, or by using a sliding contact to 'tap off' various parts of the coil.

INDUCTORS AND TRANSIENTS

As said earlier, an inductor will resist any attempt to change the steady-state field conditions. In other words energy being put into, or taken out of, the field experiences a retarding force. This means that the inductor is quite happy to pass a dc current but will oppose any changes in that current. Hence an inductor is useful where it is desired to pass a dc current but block any ac component. This is the reverse of the effect of a capacitor which passes ac and blocks dc.

In a similar fashion to the capacitor, we find that the inductor has a characteristic time constant, in response to a step function input, and the current versus time curve also follows an exponential law.

The time constant for an inductor-resistor circuit is given by:-

$$T = \frac{L}{R}$$

where T = time in seconds

L = inductance in Henries

R = resistance in Ohms

The circuit of an LR network is given in Fig. 9a together with the current versus time behaviour when the switch is first closed. At the instant the switch is closed the value of current is zero but the rate of change of current is very high. Thus the current increases rapidly at first, and then more slowly as it approaches the Ohm's Law value ($\frac{E}{R}$). When the current reaches a steady state value the inductive effect disappears.

Thus we see that in any circuit containing inductance or capacitance *Ohm's Law only applies during direct current (that is steady state) conditions.* Next month we will show you how the effects of inductance and capacitance on an ac signal may be calculated. We will also examine a special kind of inductor known as a transformer.

ELECTRONICS -in practice

Continuing the signal transmission project

THE PREVIOUS ARTICLE in this series described how to build a low-frequency mechanical form of signal generator that could be used to examine waveforms and signal transmission.

We now expand this project so that it may be used as the sending end of, firstly, an amplitude modulated (AM) and secondly a frequency modulated (FM) telemetry link. (A telemetry link is one that carries information).

AM DEMODULATION

The generator is connected to the transmission line over which signals are

to be sent. The line can be of any practical length providing the resistance of the cable is kept low. Bell wire or twin lighting flex is ideal.

Using the AM control, the received signal will be as shown in Fig. 10. This signal must be processed (demodulated) to regain the original signal - which in this case was the angle of the AM potentiometer input shaft.

Demodulating an AM signal is very easy. All we need to do is just average out the pulses using a smoothing circuit in which the values of the

resistor and capacitor have a time-constant chosen to smooth out the 1 Hz carrier frequency but not the lower signal frequencies. The circuit shown in Fig. 10 does just that.

The needle of a multimeter, connected as shown, will rise and fall in sympathy with rotation of the AM potentiometer shaft. If the AM control is left set you should find that a frequency change - induced with the FM control potentiometer - will not alter the output level, showing that the AM link is not affected by changes in frequency.

FM DEMODULATION

This is not as easy to achieve. The requirement is that the demodulating circuit provides energy to the output meter that is proportional to the frequency of the signal received, not to its amplitude - as was the case with AM.

It is accomplished here using several stages each having a specific purpose - see Fig. 11.

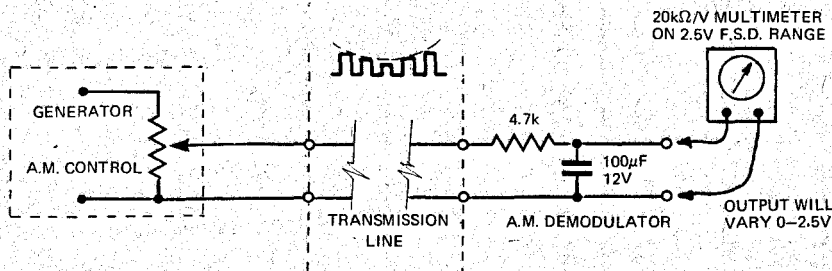

Fig. 10. AM demodulator circuit.

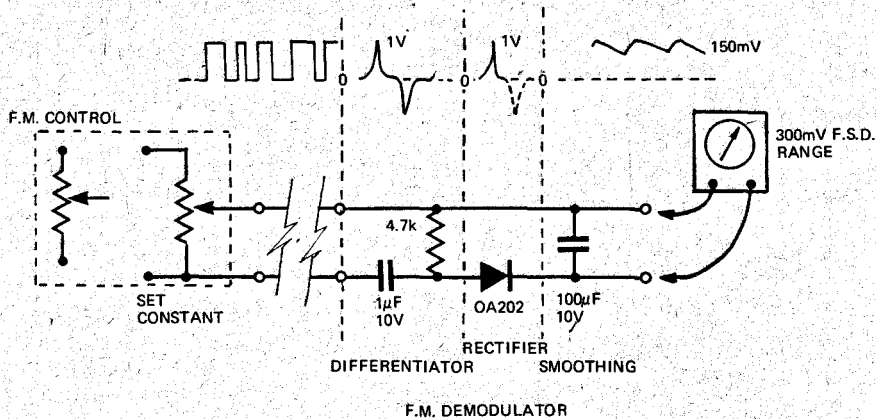

Fig. 11. FM demodulator circuit.

The first stage accepts the square waves as received and produces a pulse of constant width and height (and, therefore, constant energy) at each transition of the square wave.

The circuit used is called a differentiating circuit for it produces the differential of the input signal. This means that changes in the signal produce an output signal — but steady-state levels do not. In our circuit, the capacitor is used to let charge through when the signal is varying but not when it is steady.

The choice of time-constant decides the size of the pulses produced.

The second stage has the task of removing the negative-going pulses from the preceding differentiator which produces both positive and negative pulses and, unless one or the other is removed, the negative and positive going pulses will effectively cancel out — resulting in zero output.

The pulse-removing stage consists of a half-wave rectifier that lets through positive pulses only.

A more efficient circuit would be a full-wave rectifier as it would let both polarities through, giving twice the energy.

The original signal has now been converted to a train of constant size pulses that occur at a rate depending on the positions of the FM control input shaft. All that remains now is to average these pulses with our, now familiar, capacitor-resistor smoothing circuit.

This circuit is not particularly efficient and only fractional volts are produced at the output. It does, however, incorporate the basic concepts used in many circuits without needing the addition of amplifiers.

The waveforms at each position are given in Fig. 11. If you have an oscilloscope available you will be able to observe them.

This circuit will send shaft position information using FM techniques and the output signal is not affected for reasonable variation in AM control.

AC COUPLING

We know that capacitors will pass ac signals, but not steady dc levels. This is easily demonstrated by adding two (electrolytic) capacitors in series with one line as shown in Fig. 12. Provided the values are around those shown, the AM and FM links will work just the same. It is quite satisfactory to increase the size as this improves the coupling but a reduction in size will attenuate the signal.

MULTIPLEXING

So far we have not actually sent more than one signal along the wire at a time. If several generators were available, each operating at a different frequency, it would be quite possible to build a multi-channel link.

A simpler way to demonstrate this instead is to use a dc circuit through the wires as shown in Fig. 13. Operation of the light does not affect the AM or the FM link also working over the same two wires.

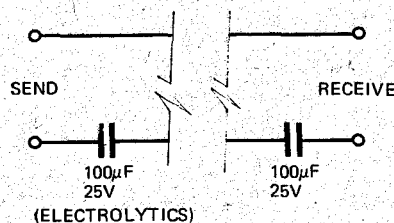

Fig. 12. The addition of capacitors does not stop the transmission of ac signals along the line.

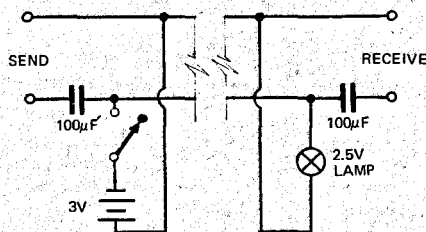

Fig. 13. A dc lamp circuit will operate on the line at the same time as a modulated signal channel thus demonstrating multiplexing.

UNITED TRADE SALES

280 LONSDALE ST. MELBOURNE, 3000

PHONE 663-3815 (Opposite Myers)

SOLID STATE A/C. D/C 3 BAND AM/FM/AIR/PB/WB. PORTABLE TRANSISTOR RADIOS. Frequency Range AM 530-1640 kHz-FM 88-108 MHz. Air/PB/WB. 108-175 MHz. Weight approx. 1.2 Kilos. Excellent reception on Aircraft Band and P/B and AM. These sets are available only from us. Fully Guaranteed., \$50 ea. P/P \$2.50.

POWER SUPPLIES, EX COMPUTER. FULLY TRANSISTOR REGULATED.

These units are as new and are in perfect working order. Original cost was in excess of \$300 each. Two Models available: 240V A.C. Primary, 12V D.C. Secondary at 5 Amps, and 240V. Primary 30V D.C. Secondary at 5 Amps. \$30 each. Freight Forward. Weight approx. 12 kilos.

COMPUTER TAPE 1/2" diameter on 12" reels in plastic boxes. Good condition \$1.00 ea. P/P \$1.00.

COMPUTER BOARDS. Approx. 10 Transistors plus 30 Diodes and Resistors on each board. All components have long leads \$1.00 ea. P/P 40 cents. Special offer, 6 Boards for \$5.00 plus P/P \$1.50.

COMPUTER RELAYS SILVER WIRE TYPE. 4 sets changeover contacts. Size 2 1/2" x 1" x 1/2" complete with socket, 20V coils with latching coil assembly. 75 cents ea. P/P 20 cents.

SILICON DIODES. 100 P.I.V. 145 Amps. \$3.00 ea. P/P 30 cents.

CASSETTE TAPE HEADS. Mono, Transistor, \$1.50 ea. P/P 15 cents.

TRANSISTORS — OC470, OC203, OC45, 2N1308, 35 cents ea. AC126, 2N1306, 45 cents ea. 2N1308/2N1309 Matched Pairs, \$1.50 P/P 10 cents.

PIANO KEY SWITCHES. Six keys, 5 sections with 6 changeovers, \$1.00 ea. P/P 30 cents.

CRYSTAL FILTERS. 10.7 MHz to 10 kHz. Bandwidth \$5.00 ea. P/P 30 cents.

TELEPHONES. Black — complete with handset. \$3 each P/P \$1.50.

LARGEST STOCKS OF SURPLUS HAM RADIO PARTS AVAILABLE

Wanted to buy — Test Equipment, Transmitters or Receivers

Wanted to buy — Test Equipment, Transmitters or Receivers

Wanted to buy — Test Equipment, Transmitters or Receivers

Wanted to buy — Test Equipment, Transmitters or Receivers

Wanted to buy — Test Equipment, Transmitters or Receivers

Wanted to buy — Test Equipment, Transmitters or Receivers

Wanted to buy — Test Equipment, Transmitters or Receivers

Wanted to buy — Test Equipment, Transmitters or Receivers

Wanted to buy — Test Equipment, Transmitters or Receivers

Wanted to buy — Test Equipment, Transmitters or Receivers

Wanted to buy — Test Equipment, Transmitters or Receivers

Wanted to buy — Test Equipment, Transmitters or Receivers

Wanted to buy — Test Equipment, Transmitters or Receivers

Wanted to buy — Test Equipment, Transmitters or Receivers

Wanted to buy — Test Equipment, Transmitters or Receivers

Wanted to buy — Test Equipment, Transmitters or Receivers

Wanted to buy — Test Equipment, Transmitters or Receivers

Wanted to buy — Test Equipment, Transmitters or Receivers

Wanted to buy — Test Equipment, Transmitters or Receivers

Wanted to buy — Test Equipment, Transmitters or Receivers

Wanted to buy — Test Equipment, Transmitters or Receivers

Wanted to buy — Test Equipment, Transmitters or Receivers

Wanted to buy — Test Equipment, Transmitters or Receivers

Wanted to buy — Test Equipment, Transmitters or Receivers

Wanted to buy — Test Equipment, Transmitters or Receivers

Wanted to buy — Test Equipment, Transmitters or Receivers

Wanted to buy — Test Equipment, Transmitters or Receivers

Wanted to buy — Test Equipment, Transmitters or Receivers

Wanted to buy — Test Equipment, Transmitters or Receivers

Wanted to buy — Test Equipment, Transmitters or Receivers

Wanted to buy — Test Equipment, Transmitters or Receivers

Wanted to buy — Test Equipment, Transmitters or Receivers

Wanted to buy — Test Equipment, Transmitters or Receivers

Wanted to buy — Test Equipment, Transmitters or Receivers

Wanted to buy — Test Equipment, Transmitters or Receivers

Wanted to buy — Test Equipment, Transmitters or Receivers

Wanted to buy — Test Equipment, Transmitters or Receivers

Wanted to buy — Test Equipment, Transmitters or Receivers

Wanted to buy — Test Equipment, Transmitters or Receivers

Wanted to buy — Test Equipment, Transmitters or Receivers

Wanted to buy — Test Equipment, Transmitters or Receivers

Wanted to buy — Test Equipment, Transmitters or Receivers

Truly the worlds finest..... **SONICS** SPEAKER SYSTEM and AUDIO COMPONENTS

THE NEW STEREO RECEIVER

Guaranteed High Fidelity Plus.

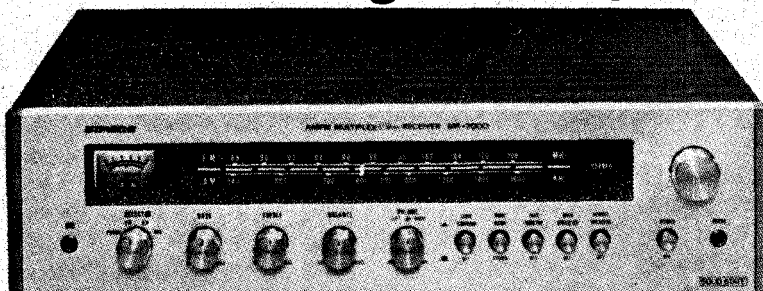

SOLID-STATE AM/FM MPX STEREO RECEIVER

Model MR-7000

- SEMICONDUCTORS
FET 1. Transistor 21
Diodes 13. IC 2.
- AMPLIFIER SECTION
Music Power Out Put (1HF): 70W (4Ω) 50W (8Ω)
Speakers: 4 to 16ohms, Two pairs of output
Speaker Terminals
- FM TUNER SECTION
Frequency Range: 88~108MHz
Usable Sensitivity (1HF): 3.0uV
Capture Ratio: 2.0db

- AM TUNER SECTION
Frequency Range: 535KHz to 1620Hz
Usable Sensitivity (1HF): 15μV
- MISCELLANEOUS
Power Voltage: AC117V/230V, 50/60Hz
Dimensions (Overall): 455m/m(W)17-7/8",
130m/m(H)5-1/8",
330m/m(D)13"

Australian Agents

SEVENSEAS ELECTRONICS PTY LTD

166 Parramatta Rd., Ashfield, NSW 2131 Phone: 799-2555

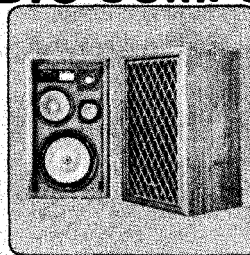

70W 3-WAY 4-SPEAKER
Model AS-227A
Speakers: 10" Woofer,
6-1/2" mid-range,
3" cone type tweeter,
Dome type tweeter
Power Capacity: 70 watts
Impedance: 8 Ohms
Frequency Response:
27~22,000 Hz.
Enclosure Dimensions:
13-5/16" (W) 338 mm
x22-3/4" (H) 578 mm
x11-5/8" (D) 295 mm
Enclosure Finish:
Walnut open pore
Weight: 16.5 kg (36.3 lbs)

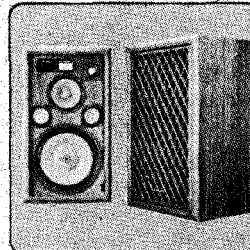

100W 4-WAY 5-SPEAKER
Model AS-337A
Speakers: 12" Woofer,
6-1/2" mid-range,
3" cone type tweeterx2,
Dome type UHF tweeter
Power Capacity: 100 watts
Impedance: 8 ohms
Frequency Response:
25~22,000 Hz.
Enclosure Dimension:
15" (W) 380 mm
x25-5/8" (H) 650 mm
x11-5/8" (D) 295 mm
Enclosure Finish:
Walnut open pore
Weight: 21 kg (46.2 lbs)

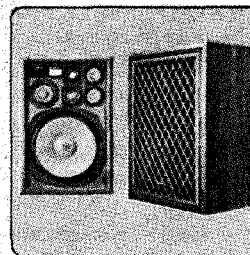

120W 5-WAY 6-SPEAKER
Model AS-447A
Speakers: 16" Woofer,
5-1/4" cone type low mid-range,
Dome type high mid-range,
3" cone type tweeterx2,
Dome type UHF tweeter
Power Capacity: 120 watts
Impedance: 8 ohms
Frequency Response:
22~22,000 Hz.
Enclosure Dimensions:
17-9/16" (W) 446 mm
x25-5/8" (H) 650 mm
x11-5/8" (D) 295 mm
Enclosure Finish:
Walnut open pore
Weight: 27.5 kg (60.5 lbs)

TDK philosophy EXTRA-DYNAMIC ... THE AUDIOPHILE TAPE

NEW ASTOUNDING MATERIAL ... PURE BLACK "MAGNETITE"
TDK research has brought magnetite to cassettes for the first time. TDK Electronics Co. Ltd. is a pioneer in the field of electromagnetics, and has now achieved the stabilisation of Magnetite material for recording tapes for the first time.

THE CASSETTE DESIGNED EXPRESSLY FOR PURE SOUND
Performance data show ED superiority, but Your Ears also tell the difference of ED Cassettes. There is linearity of frequency response from low to high frequency range. No need for Cro selector to correct for excessive high response and low frequency drop off. Any good recorder can now give balanced high fidelity recordings.

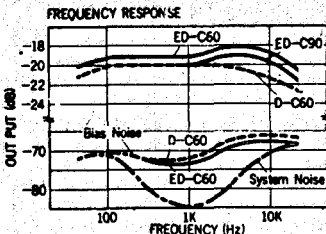

THE IDEAL CASSETTE FOR NORMAL BIAS
The bias required is normal, that is the target for any magnetic tape. ED is the dynamic tape which suits almost every cassette recorder. No necessity for special bias settings. The superior performance of ED is achieved by the highest and even the lowest priced recorders.

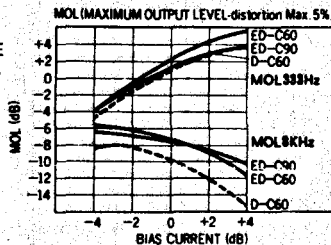

Convoy Imports Division of Convoy International Pty. Ltd.,
84-86 Nicholson Street, Woolloomooloo, 2011, Sydney (02) 357-2444

ELECTRONICS -it's easy CONTEST No.3

**FIRST FIVE
CORRECT
ENTRIES
WIN THESE
EXPERIMENTER
KITS**

Mykit Series 50 in-1

gakken

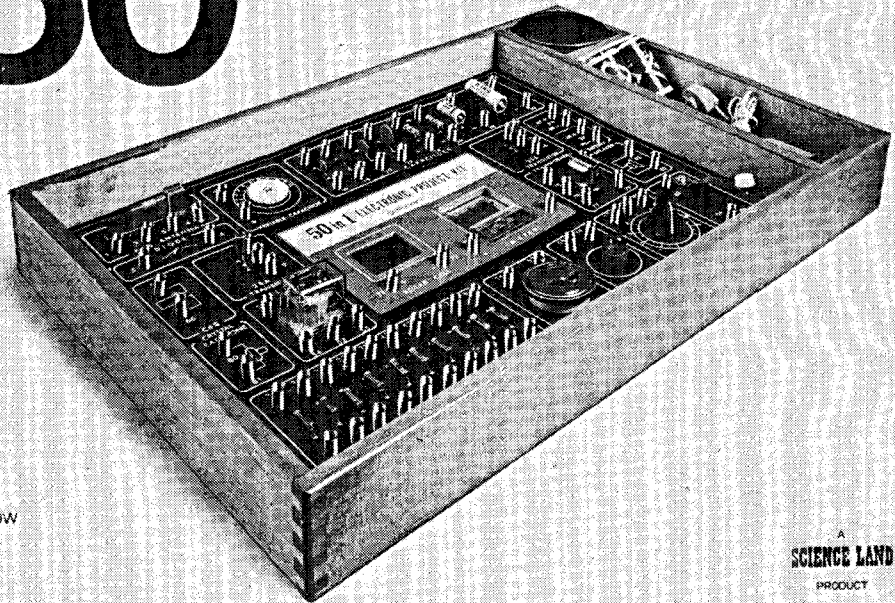

**MYKIT SERIES 50-IN-1
NO SOLDERING. NO TOOLS NEEDED!
LEARN ELECTRONICS
WITH EACH PRODUCT.**

**BUILD MAIN PROJECTS: TWO-TRANSISTOR RADIO
TELEPHONE. TRANSISTOR AMPLIFIER. WIRELESS
PHONOGRAPH. SIGNAL TRACER. DIODE TESTER.
TRANSISTOR TESTER. AC BRIDGE. ILLUMINOMETER.
TRANSPARENCY INDICATOR. ELECTRONIC ORGAN (LOW
FREQUENCY OSCILLATOR). ELECTRONIC METRONOME.
ELECTRONIC ALARM CLOCK. TELEPHONE AMPLIFIER.
50 PROJECTS IN ALL.**

A
SCIENCE LAND
PRODUCT

ELECTRONICS TODAY CROSSWORD - ACROSS

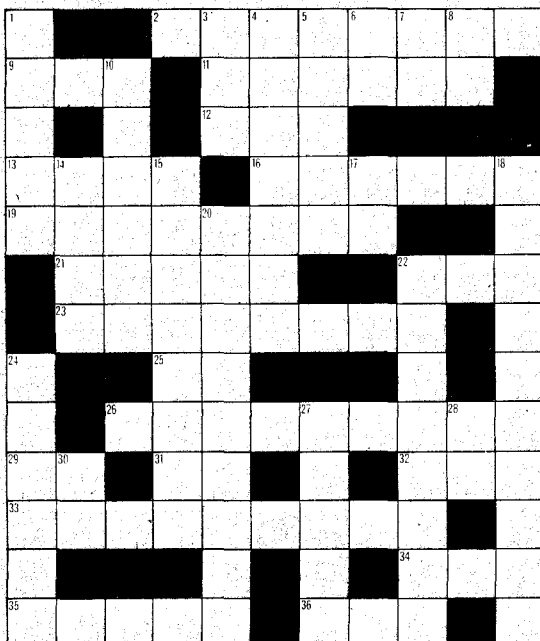

2. Negatively charged particle
9. Currently an insurance company
11. 1011 in decimal
12. Diode Emitter Logic?
13. Bombs and power
16. Time-pulse generators
19. Demodulator
21. Moving part of a motor
22. Dual-in-Line IC package
23. Not digital
25. Welsh slide-rule scale
26. Motors, house wiring and such
29. Household power
31. A cold integrated circuit?
32. A piece of digital information
33. Resistance that consumes no power
34. The lamp is - - - - -
35. Once they thought radio waves travelled in anaesthetic?
36. Help! in Morse code

6. The box
7. Regarding
8. Not off
10. Positively charged particle
14. A million million of them are fearful
15. Most conductors are - - - - -
17. A basic digital gate
18. Frozen semiconductor physics?
20. Bipolar transistor connection
22. Not ten bells
24. On account of the Light Brigade
27. Discrete audio frequencies
28. A backward integrated circuit
30. Collector to emitter subscript

Entries must be addressed to:—
Electronics Today International, 15-17
Boundary St., Rushcutters Bay, NSW
2011.

CLOSING DATE: May 24th 1974
(entries post marked May 24th will be
accepted).

DOWN

1. Unit of capacitance
3. Light Emitting Diode is not a leader
4. Electrolytic capacitor
5. Musical instrument

**The five 50:1 Electronic Experimenter's
kits to be awarded as prizes in this
contest have been donated by Dick
Smith Electronics Centre. Thanks Dick!**

PIRATE RADIO

THE Pirate Radio article, featured in our January issue created an extraordinary amount of interest. In fact we received more readers' letters and 'phone calls about that article than any we had published before in the history of the magazine.

One slightly unexpected finding was that quite a lot of amateur radio people are sympathetic to the *concept* of CB'ing — just so long as it doesn't happen in an existing amateur band!

Another was the fact that many pirate operators have little knowledge of the amateur radio movement. Clearly some PR is urgently needed.

In their letters most pirates emphasized that they were upright responsible citizens — often performing a public service — but it is hard to reconcile this self-image with letters such as the one published here where the writer describes the manner in which he evaded PMG inspectors — even wrecking his car in one attempt.

The letters published in this follow-up article are a representative selection of those received.

Some of the letters were far too long for publication in their entirety. These we have cropped, but in such a way that the overall meaning remains unchanged — we hope!

Others contained unsubstantiated allegations against named people and organisations, and these we naturally cannot publish.



HOBBY-CLASS LICENCE

I would like to formally congratulate you for your provocative and in-depth article on pirate radio in the January issue of Electronics Today International.

I am gratified, that at long last, one of my many submissions to the Postmaster General (i.e. the letter reproduced on page 36-37 of the January issue) has received the right kind of publicity.

Pirating undermines the aims, objects, functions and traditions of amateur radio — their fraternity jealously guards their hard won radio space. It is that particular point which leads me to believe that my proposed Hobby Class Licence would not be at all acceptable to the W.I.A. if the frequency allocation was mooted for placement in or adjacent to the two metre amateur band.

Let's face it — the Limited Licencee's attitude would "What's the good of sitting for the AOCP if you have to share the band with appliance operators". Could you blame him?

The only answer, as I see it, is to grant a Hobby Class licence for narrow band FM operation in the area around 440 MHz as you have suggested.

Relatively few amateurs use UHF, primarily due to the different nature of the gear, both in construction and propagation.

Preferably the allocation should be immediately adjacent to the amateur UHF allocation, however I am told from the

PMG that the space is not available, therefore some of the amateur allocation should be made exclusively available for hobbyists. This would be a tremendous thing for amateur radio in the long run.

Regretably I cannot see cordial relations between amateurs and "appliance operators" sharing the same channels.

As an aside I am of the opinion that the new Novice License will not provide for the beginners or the "appliance" types as the theory examination will have to be fairly rigid to allow the novices the use of 30 watts PEP sideband on HF Bands — obviously we need another license classification.

I do realise that UHF gear is expensive, however there will be used commercial rigs on the market within a year or so and more practically I am sure that Australian UK distributors of Japanese equipment would be able to give us some very attractive prices for suitable equipment if we were to put a proposition. Eventually our own industries would tool up for the occasion and produce low cost gear.

For that matter the "serious" pirate expends as much on his station as the average amateur — the raw recruit somewhat less of course.

(This letter was sent to us by the author of the letter reproduced on page 36-37 of the January issue. The writer wishes to remain anonymous for reasons that we fully understand and respect. — Ed.)

- our readers comment

For some years, it has been possible to obtain licenses to operate approved hand phone equipment and use these in accordance with fairly rigid requirements as set down by the P.M.G.

Unfortunately it has also been possible to purchase non-approved equipment which does not conform with specifications i.e. higher power, multi-channel facilities etc. Surely if these non-approved units are available to the public, the onus must be on the P.M.G. to educate and advise people on what is permitted. This is not being done at present! The P.M.G. have plenty of information available and are usually most helpful when approached, but they do not disseminate this information through the media very often (not at all in our experience - Ed). Usually it is only referred to briefly in a local newspaper, indicating that "Joe Bloggs" was fined \$100 for operating an illegal transmitter.

Now to Mr Harrison's views, some of which I agree with and others I disagree with entirely. I would first disagree with the writer's belief that "problems would almost inevitably increase if the 27 MHz Citizens Band was legalised. It seems that Mr Harrison has a preconceived idea that everybody who operates 27 MHz equipment illegally wants to operate high power units. In the Page 34 letter I see no reference to the writer's wishing to do so. Certainly it is possible to gain almost as much efficiency from a 1 watt hand held unit, as a 5 watt mobile if the equipment is used properly. Mr. Harrison, should take a trip to New Zealand and hear mobiles operating 1 watt sets into external antennas from vehicles or operating the same units from a base location.

Mr. Harrison makes the point that many people are interested in communicating rather than technology, yet goes on to suggest that these same people should be given a portion of the 2 metre or 70 cm. spectrum to operate in. Are these non-technical people expected to build this equipment, or purchase same.

Cheapest 2 metre transceiver available commercially at

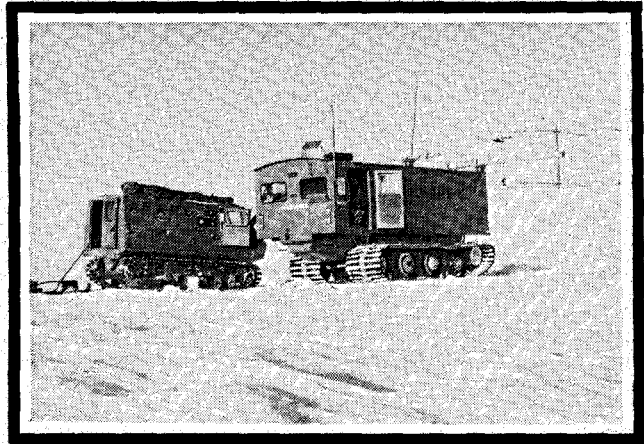

Several of our 'pirate correspondents' queried Roger Harrison's knowledge or experience of mobile radio - one suggesting that he should see it in operation in New Zealand.

In fact Roger's experience in this field is extensive - it includes a spell in the Antarctic - where reliable mobile radio communication is literally a life or death business.

Roger's caption to this photograph, which he took a couple of years ago, reads 'CB Mobile 1 lends a hand to CB Mobile 3 at the roadside following a Mayday call'.

present sells for around \$150 and V.H.F. equipment is not readily available for amateur use!

Finally I agree with Mr. Harrison on one point which I consider important. If the system is to remain as is at present, then legislation must be introduced to prohibit the sale of unsuitable equipment; or at least it be made mandatory for all wholesalers or retailers to make the public aware of the P.M.G. requirements.

(Name and address supplied, but withheld by request).

THE PMG'S OFFICIAL POSITION

STATEMENT CONCERNING "CITIZENS RADIO SERVICES"
(From the Postmaster General)

Representations are received from time to time asking that the licensing of radio services under the Australian Wireless Telegraphy Act and Regulations should be extended to permit the establishment and operation of what are known in the United States of America and certain other countries, including Canada, New Zealand and Japan, as "Citizens Radio Services".

The rules relating to the operation of "Citizen Radio Services" differ in each of the countries where they have been authorised. In general, however, they provide for private short-distance radio-communication for the business or personal activities of the licensees. The transceiver units employed are of relatively low power and the radio frequencies used, which are shared among licensees, are selected from a number set aside for the purpose. Various categories of this type of service are authorised in the United States of America. Those which employ frequencies in the 27 megacycles band are comprised of mobile stations with a power limitation of 5 watts but which may be used at fixed locations as required. Distances over which communication may take place extends up to 150 miles. The stations must not be used, however, "for engaging in radiocommunication as a hobby or diversion, that is, operating the station as an activity in and of itself", nor for international communications. Certain other restrictions apply in regard to the nature of the messages which may be passed, the stations with which communication may be

established and the area in which operation may take place.

As the outcome of many applications for approval to employ imported low-powered transceiver equipment manufactured for use in "Citizens Radio Services", the (Australian) Post Office decided in 1961 that licences should be granted for the operation of approved classes of hand-held transceivers with a transmitting power not exceeding one watt, when required for emergency services, to facilitate sporting or other group events, and for such other useful purposes as are considered to warrant the grant of licences. An additional licensing condition is that the only antenna which may be used with the unit is the one supplied as an integral part of the equipment. This antenna must not be detached or extended in any way.

As at 30th June, 1972, some 16 000 units of the type in question had been licensed for use in what are known here as "Handphone Mobile Services" and which are employed for many of the purposes for which "Citizen Radio Services" are used in other countries. For example, numerous stations of this type are used by Police, Fire Brigades, Forestry Departments, Civil Defence Authorities and other public bodies, and also by private individuals and organisations in connection with construction jobs, surveying, property management, boating and other sporting and group activities.

The attachment of the conditions, mentioned in paragraph (3) above, to licences authorising the operation of these low-powered units has ensured that in this country

PIRATE RADIO — our readers comment

THE PMG'S OFFICIAL POSITION

they are employed only for useful purposes and that the few frequency channels in the 27 megacycles band which can be made available for their operation are not occupied with unessential conversations to the detriment of more important messages including those relating to emergencies.

Other types of low-powered services for which Australian licensing rules provide and for which approved types of equipment operating in the 27 megacycles band are suitable, include those which may be established within the confines of specified premises, such as manufacturing plants, services required for maritime in-shore safety by boating clubs and rescue groups and one-way paging services for use in hospitals and other similar situations. In these types of services five watt base stations are permitted.

Australian licensing policy has for many years provided for the authorisation of a wide variety of other types of radio-communication services. These include land and harbour mobile radio-telephone services operating in the very high frequency bands, that is, bands above 30 megacycles, which permit communication between base stations and mobile stations in vehicles and also with personal mobile units where required. These services are employed extensively by essential public services, such as Police, Fire Brigade, Civil Defence and Ambulance Authorities and also by motoring servicing organisations, repair and maintenance businesses of all types, taxi and

transport fleets and many other service industries. Licences may be obtained, of course, for the establishment and operation of stations used in the pursuit of hobbies, such as the control of model aircraft, for gliding and for the conduct of Amateur radio stations.

Apart from the fact, as explained above, that radio services may be authorised in this country to meet all legitimate demands, the extension of licensing policy to provide for the use of common radio frequencies, for the conduct of all kinds of business and personal conversations would lead, as it has done elsewhere, to a state bordering on chaos in the frequency bands concerned to the detriment of services designed to meet real public and private needs. It would also readily facilitate contravention of long-standing Government policy in Australia that the public telephone and telegraph systems which have been provided at considerable public expense, should be the normal means of communication between individuals residing in areas where these services are available.

In view of the circumstances outlined above it has been decided that the public interest would not be served by amending the licensing provisions for low-powered radio services in Australia in the manner proposed.

(It is fascinating — and perhaps instructive — to note, that, in February, 1973, the PMG Dept. were still using the term 'megacycles' — Ed.)

NOT AS A HOBBY

I have been lobbying for a Citizens Radio Service in Australia for four years now. I have written to the Postmaster General on numerous occasions, and to many members of Parliament. Although many have agreed that we should have such a service, as yet nothing further has been done about it.

A Citizens Radio Service exists in the USA, Canada, New Zealand, Japan, Sweden and Italy, and I can see no reason why our government does not introduce such a system here. There are already PMG approved transceivers available, and on present figures given to me by the Department in Melbourne it is estimated that over a quarter of a million CB sets are being used illegally, and are selling at the rate of over 100 per week. There is no restriction on the sale of this equipment, therefore the Department cannot restrict the use.

A Citizens Radio Service must never be allowed to be used as a hobby. If a person wishes to have radio as a hobby he has only to study and pass his Amateur Radio Certificate

At present, the PMG has a special team of inspectors attempting to clean up the so-called illegal Citizens Band, but they are finding it an almost impossible task.

The only way now to bring any sense into the general chaos would be to grant a Citizens Radio Service. Issue licences from the Post Office as is done in New Zealand, and stop all this cloak and dagger carry-on by our Radio Inspectors. They are very busy men, and I am sure their time and efforts could be better spent. They must be costing the country a fortune.

As far back as 1961 the Australian electronics industry was prepared for a CB Service and the Managing Director of Commonwealth Electronics was quoted as saying "As far as we can see there is no reason why a Citizens Radio Service should not be provided in Australia right now."

It is now 1974 and we have still not been granted this service.

As well as normal communications between licences, this service would also give our country a great safety network. The vast areas of our mountain and desert regions would hold no fear for a person who may become lost or injured

in such a place. He would only have to call for help on his transceiver and help would be available.

I was instrumental in saving the lives of a woman and her son adrift in a boat off Cairns in Queensland. I received on my equipment a Mayday call from these people, due to freak radio conditions, and passed the message on to the Morwell Police.

Other major rescues include:

"Two sailors rescued when their boat overturned at Mann's beach."

"Two sailors caught in a bad storm near the 90-mile beach at Wilson's Promontory."

"A scout and scoutmaster lost on Mt. Erica."

"Assisted the police in rescue operations when the late Geoff Watt was lost on Mt. Erica."

"Reported many accidents along the Princes Highway through having CB sets installed in our vehicles."

"I was saved by a CB set when I became hopelessly bogged in my car in the mountains north of my home."

I have been using 27 MHz now for seven years and have found its services are excellent.

I am well aware that arguments can be advanced against the concept of a Citizens Radio Service, though not all of them stand close examination.

It would call for a good deal of administration — though this could be paid for by licence fees. Frequency space would be required — though an enormous amount of traffic can be concentrated in a narrow band. 27 MHz does not have to be used for this service. Abuses of privilege may occur, but this kind of service is "self-levelling" to a considerable degree.

A friend of mine went into a Melbourne retailer and enquired about purchasing two transceivers. He also asked about licences, and was told by the salesman that he was covered by his normal Radio & TV licence!

All this equipment can be purchased at any electrical retail outlet in Australia.

It is surely unreasonable to convict people for using this equipment whilst such unrestricted sales are allowed to continue.

*Brian W Thomas,
Morwell, Victoria.*

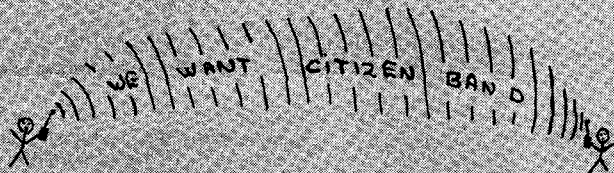

PAMPHLET CURRENTLY CIRCULATED BY A PIRATE RADIO GROUP

WE WANT CITIZEN BAND

This circular has been devised to urge all persons interested in personal communication, via the media of two-way radio, to encourage the necessary legislation to amend the Wireless Telegraphy Act for the establishment of a Citizens' Radio Operators' Licence in Australia.

In simple terms this licence would make lawful the exchange of personal radio messages between base and mobile stations using low powered equipment.

Of all facilities available to modern man, telecommunication is perhaps the most important and oft used; however, in this country it is RESTRICTED FOR USE IN SELECTED COMMERCIAL AREAS AND AMATEUR RADIO.

Do you know that all "walkie-talkies" in Australia must be approved types and licensed in pairs at a cost of \$12.00 per annum; that these licences will not permit you to communicate with any person other than the operator of

your counterpart radio; that the penalties for breaching these laws are astronomical (see Wireless Telegraphy Act).

In 1958, American Congress passed a Bill to establish a Citizen Band Radio scheme; today there are almost 3½ million such "C.B." licences in the U.S.A. An American citizen can establish his own radio station for the exchange of personal messages with his family or any other station without the need of any great technical knowledge.

This vast number of private operators has brought about social clubs and valuable general emergency groups in the U.S.A.

New Zealand, our nearest neighbour in the South Pacific, has Citizen Radio Services.

Why then haven't we similar licensing in Australia? We are so far behind the USA, Canada and New Zealand in this field that a group of people have decided to do something to bring about the changes.

The previous Government has denied us the right to use and enjoy low powered two-way radio for personal communication.

If you are convinced that these ideas are right, then please do something about them!

Finally, can you help by contacting your local Member of Parliament, write to the Wireless Institute of Australia, engage in radio talk-back programmes, write to the newspapers and radio magazines and speak with influential people who can further this movement.

It's time to act now if you want a Citizens' Radio Service in Australia.

Australian Citizen's Radio
Movement,
(Gippsland Branch ACRM.)

A BALANCED VIEW

May I offer a few points for discussion on the impending discussion on CB type operation.

In support of a case for a legal and controlled "Public access communications service" some unemotional justification of this view is required. Your contributor has rightly referred to the radio spectrum as a natural resource and therefore to be conserved, with such conservation implying that necessary safeguards must be introduced to enable intelligent use being made of the spectrum.

Providing these criteria are met, there is nothing intrinsically wrong with using a limited amount of spectrum for hobby, pleasure, instruction, or just plain idle chatter. Our other more tangible natural resources — lakes, rivers, national parks are available for public use under controlled conditions. There appears no valid reason why public interest could not be similarly served by limited availability of frequencies.

To get authorities to agree to this point of view is, of course, another thing; who is willing and on what grounds is anyone to judge the relative merits of any intended or current use of parts of the spectrum for hobby or pleasure? — amateur radio and R/C model aircraft are within this category.

Procrastination by the legislators in making a positive decision in legalising the CB activity is only going to compound the present chaos with the present unsavoury impressions — in any event, the money spent on catching offenders could be better applied in administering a properly constituted system.

Having thus tried to justify CB'ers on their own merits, I would take issue with the unwarranted comparisons made between the amateur service and CB operators. If I have read the signs correctly, the CB'ers attitude in the main, puts technical considerations as a relatively minor part of their activities — at best a rather superficial parameter. No doubt there is some justification for the claim that some

amateur channels are "chatter frequencies", but it is an established fact, that in passing an examination, his motivation for becoming an amateur was different in the first place: i.e. his natural enthusiasm for the hobby and his self motivation in improving both operating skills and technical capabilities.

The present 27 MHz operators *may* become interested in the DX potential and technical aspects of amateur radio as a result of their activities, but it is contrary to everyone's interests to justify Citizens Band operation legally or otherwise on the premise that it is a proving ground for future amateur radio recruits.

It is equally erroneous to suggest that the proposed novice license should replace the CB'ers — each activity has a differing purpose in life, with a right to exist and pursue their interests as they see fit, providing of course, *proper control and responsibility is exercised.*

The WIA has no need to have a policy on CB operation, except to disassociate itself from the present rationale being applied to the situation. It must however strenuously oppose any attempts to have amateur frequencies used for any private communications service — give CB'ers VHF channels by all means, but leave the amateurs to sort out their salvation from, and with, other priority services contending for space.

In conclusion it must be made clear that for the short and long term development of private access channels, those interested should form a responsible and active national body to work towards the acceptance by authorities of the concept. Having done this, such a body must be able to control its members and by the self-policing attitude so effective with the amateur service, show that their activities are in the continued interest and convenience of the public.

Whilst not agreeing with radio piracy — amateur or bootleg CB, I have sympathy with their cause. There is however a right and a wrong way to go about it.

I hope your journal, without irrelevancies, can assist the case.

Peter Williams, VK3IZ

If you're not a South Australian reader, you're almost certain to find this announcement of no interest whatsoever.



Ron Robson.



Spiro Hanoumis.

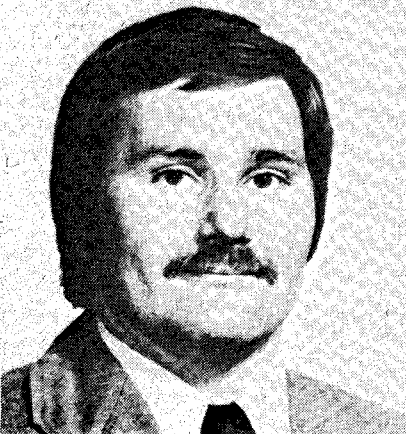

Robin Davidson.

If you are from S.A. however, this is important. On March 18th, Warburton Franki commenced operation as authorised Fairchild distributors in South Australia. They joined Gerard & Goodman in servicing that area.

Warburton Franki Pty. Ltd. address in South Australia is 322 Grange Road, Kidman Park, S.A. 5035, telephone 3567333.

The Warburton Franki Fairchild team is Ron Robson, Manager Electronics; Spiro Hanoumis, Outside Sales; Robin Davidson, Inside Sales. Backing them up is Sales Supervisor Len Bannister, Jeff Mousley, Gary Francou, with Mike Rogers at Whyalla, and Ian Gard at Mt. Gambier.

Ron, Spiro and Robin are the people to contact for prices and data on the Fairchild range.

Transistors in plastic and metal can. General purpose amps. Low noise. High speed switches. FET's. Power transistors.

Integrated circuits. In ceramic, metal can and plastic.

Linears. Operational amplifiers. Voltage regulators. Line drivers. Comparators. T.V. and audio circuits.

Digital. 7400 and 9300 TTL. DTL and memory. MOS, ECL and Schottky.

Diodes. In D035 microglass. Small signal. High conductance. High speed diodes and zeners.

Microwave and Opto. Light emitting diodes. Phototransistors. Displays. Optical couplers.

Nationwide Authorised Fairchild Distributors.
South Australia. Warburton Franki Pty. Ltd., 3567333. Gerard & Goodman Pty. Ltd., 2232222.

N.S.W. George Brown & Co. Pty. Ltd., (at their new address) 174 Parramatta Rd., Camperdown, 5195855. Warburton Franki Industries (Syd) Pty. Ltd., 6481711.

Queensland. Warburton Franki (Bris) Pty. Ltd., 527255.

A.C.T. George Brown & Co. Pty. Ltd., 950455.

W.A. Warburton Franki Pty. Ltd., 618688.

Victoria. Warburton Franki (Melb) Pty. Ltd., 690151.

And in N.Z. Tee Vee Radio Limited, Auckland, 763064, Wellington, 60523, Christchurch, 67748, Dunedin, 88028.

FAIRCHILD
AUSTRALIA PTY. LTD.

PIRATE RADIO - our readers comment

RESPONSIBLE PIRATES?

I am a pirate operator of some experience. My friends were first encountered through this medium, as was the highly satisfying and well-paid job I have now. My boss has the AOC, as has one of my fellow workers.

In 1966 I was a reasonably avid short-wave listener. I was at the peak of interest in this and ready to get my AOC when I put my right hand into a handsaw. So much for Morse Code, writing, and everything else for awhile, by which time my interest in AOC's had fallen.

Coming on air in April I called myself The Batman and pursued my activities as keenly as I had done in my SWL days.

My first day of activity yielded a large number of contacts and six Eyeball QSO's, to wit, Baron, Whistler, Alpha 1, TL Mobile, Southern Cross and Chuck. (Saturday 8th April 1972, 1 p.m. onwards) One of these, TL, had a CBT72G in his car, and since I'd never seen one I was immediately impressed. I purchased one from a man using the call sign of Bunyip for \$100 on Wednesday 24th May 1972.

Shortly thereafter, at 9 p.m. on Wednesday 31st May 1972, Bushranger was raided. This was my first experience of the "Dreaded R.I.'s" (PMG Radio Branch inspectors) as they became known. Naturally enough since I was on the air every night, it wasn't long before the R.I.'s knocked on my door. I had warned my family as to what they should expect and do, so escaped.

Snagglepuss was not so lucky. He lost six rigs. One week later the same R.I.'s ambushed me in Bryant Street Rockdale, to see me drive off in a manner against which the French Hell Drivers would've seemed like slot-car players. Another mate of years' standing, A.T.J., was not so lucky.

At this stage of my pirate career I had left my job and decided that I would bludge for a few months, so my main interest became pirating. With it I could have companionship when I desired it yet switch it off when I didn't. R.I.'s came and went, Alpha 1 was raided (I was there) but I survived.

Then on Thursday 15th February 1973 on the corner of Gibbes and Bryant Streets, Rockdale, the R.I.'s caught me.

That was a blow, but good pirates never die (they just run out of money). On Monday 25th June 1973 I purchased another CBT72G and installed it in my car, not the original car but another.

On Monday 29th August at 119 Philip Street court I was fined \$40, with \$5 legal fees and \$4 court costs plus having my rig confiscated.

On Wednesday 29th August 1973 at 7.20 p.m. I was lured to an "eyeball QSO" on the corner of Princes Highway and

King George's Road, Blakehurst. I pulled in; an R.I.'s car pulled in ahead of me. I drove off, as did they in pursuit, and the results leave me to wonder why they weren't more serious than they were. I crashed, My rig and I survived, but my car did not.

Since then I have seen other keen pirates go; my wife some time ago wished to avoid premature grey hair so coerced me into enrolling with the WIA for my amateur course. Once she had done so I realised the underlying desire for it since 1966, and now wish to obtain it for my own sake as well as for her peace of mind.

I know many good people as a result of my pirate activities, and would not know them otherwise. Several are in electronics, one is a doctor, a couple are factory workers, some at school, one a businessman of considerable repute, one a policeman, and so on. Are they to be scorned? Ridiculed? Prosecuted?

The frequency band extends from, say, 0-1 MHz to approximately 100 MHz and contains Lord knows how many available communications channels. May I quote Roger Harrison? "It has to be remembered that, in one sense, the radio spectrum is a national resource." He wrote more, including points referring to policing this asset, but he has missed one point.

Australia is not a nation. It is people like you and I, who make a nation what it is. They - we - decide its government, a government who allegedly represents us. Does it? Out of nearly 100 000 000 cycles of useable spectrum space, is 0.03% asking much? Is a bandwidth of 300 kHz an excessive amount to give to Australia's people? So what if we ruin it? Cause chaos on it? Elsewhere the bands are policed. Why not leave us our 300 kHz. Your cover photo depicting a bold, swashbuckling, rig-clutching pirate is not in keeping with the true scene.

(The next section of our correspondent's letter contains allegations that (named) members of the WIA are or have been radio pirates. This section is absolutely defamatory and has been deleted - Ed).

Julius Antony Kentwell,

Although this letter is not typical of all those received from 'pirates', we have received several others that are similar.

The writer's description of the manner in which he escaped from PMG inspectors - on one occasion crashing and writing-off his car - does not lend much credence to the 'pirate radio' movement's self-image of themselves as 'responsible citizens' - Ed.

SEARCH AND RESCUE

I just read the article on pirate radio. Being a pirate myself but for a different reason, I must make some comments about this excellent article.

Being a member of a search and rescue unit we have to pirate on 27 MHz as most equipment is too expensive (i.e. the equipment that the PMG wish such groups to use).

Anyway to get to the point it looks like most people miss the main object of CB radio in the USA, and why we should have CB radio in Australia.

CB radio was meant to be a cheap form of communication for small business and as a safety link between base and mobiles such as cars, trucks, four-wheel drive, boats, trail-walkers, fishermen, shooters and as a back-up service in case of disaster when normal land lines are unusable. But people started to abuse privilege granted to them. The FCC did not enforce the regulations from the start. For years it ignored warnings from responsible people. Firms that make CB equipment found that more money could be made from linear amplifiers suitable for CB radio.

Now the FCC cannot or will not do anything to clean up the mess it let happen but just makes a lot of noise. Shifting CB to a different frequency allocation will not ease the problem as the CB manufacturers will soon produce linear amplifiers for this band as well.

I come now to what I believe is a valid reason for introducing CB into Australia.

The first and strongest case would be the floods in NSW and Queensland. How many people were in great danger, stranded and isolated without any form of communications for several days?

During floods and bushfires the land lines of the PMG really take a pounding from the elements. Even with the hardest of work by their hard working linesmen it sometimes takes weeks to restore the vital links. During these times of flood and fire, medical assistance, food supply, information on the whereabouts and safety of people, general assessment of the disaster are of the utmost importance. How can you inform a central co-ordinating force of your troubles when land lines are unserviceable. Try smoke signals in a flood?

METAL GLAZE RESISTORS DON'T CRACK UP UNDER STRESS AND STRAIN

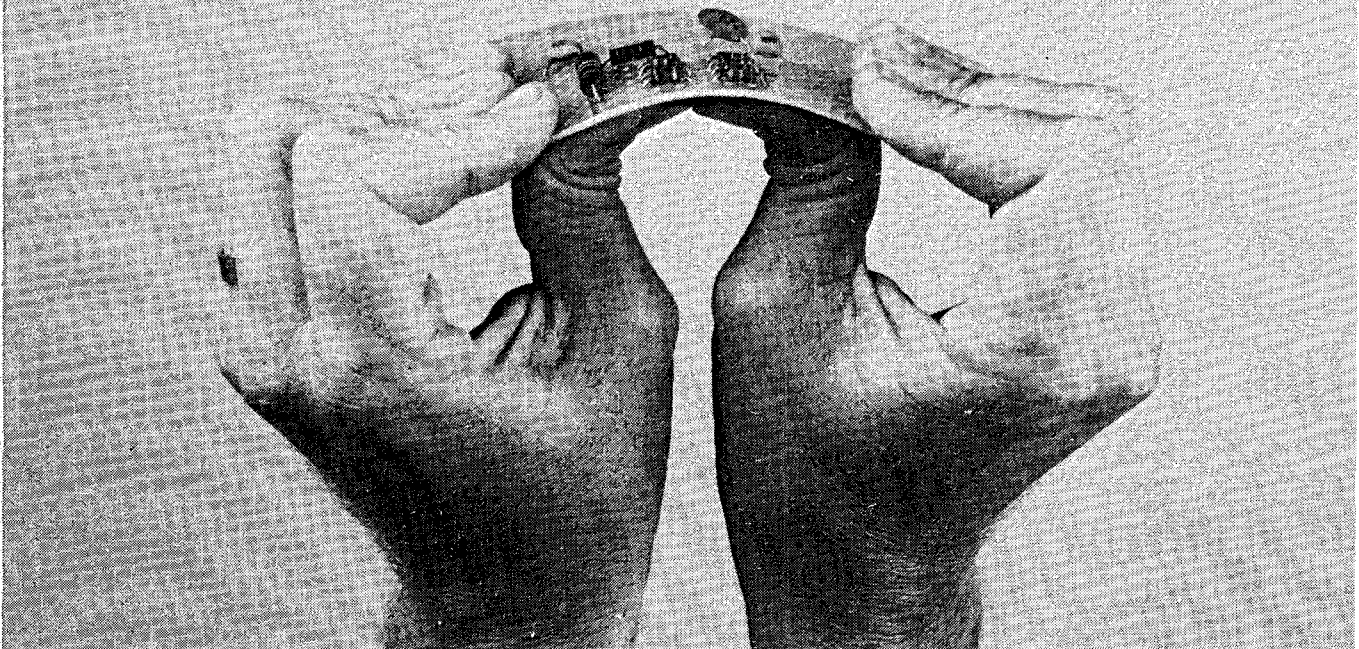

Metal Glaze™ resistors are made to take stresses and strains that crack up so many other types. Physically and electrically, they're tough customers.

Metal Glaze resistors can take PC card flexing, exposure to solvents, automatic machine insertion, potting—and general knocking around. The glass-hard Metal Glaze film is permanently fused to a solid ceramic core. Lead wires are soldered to the core in a patented process. This makes the resistive element and the terminations one continuous component which, even in its sub-assembly form, is mechanically stronger than many finished resistors. Moulded in a tough, environmentally protective envelope, Metal Glaze resistors are practically indestructible. Metal Glaze resistors can take their share of electrical jolts, too. For power handling they're conservatively rated, and often can be operated at twice rated power without degradation. Short-time overload and high temperature characteristics are excellent.

Competitively-priced Metal Glaze resistors are available in a range of power ratings, temperature coefficients and tolerances. For further information complete the coupon and post today.

Manufactured in Australia by:

NATRONICS PTY. LIMITED

IRH COMPONENTS DIVISION

The Crescent, Kingsgrove, N.S.W. 2208

Please send me information on Metal Glaze Resistors.

NATRONICS PTY. LTD.
IRH COMPONENTS DIVISION
P.O. BOX 71, KINGSGROVE, N.S.W. 2208

Name.....

Company.....

Address.....

Postcode.....

MG174

PIRATE RADIO - our readers comment

With today's compact electronic equipment run on small dry cell batteries, a hand-held five watt CB transceiver can maintain contact over 15 to 30 miles.

Bushfires are a thing we have to live with in this country. Communication with a fire spotting tower would help the Forestry Commission with information from people near the scene of the fire. Also people that are trapped by a fire can call for help.

Road accidents, especially in the country, motorists can call for help by informing the police, ambulance and sometimes fire brigades, that their services are required. All this without leaving the scene of the accident. This is very important on roads where low volume traffic passes. The person who finds the smash must stay with the victims and not leave to drive many miles to find a working phone.

Now for volunteer search and rescue groups. Most groups receive no money from either State or Federal governments so they must find their own funds. Each party of searchers

must have a transceiver to maintain contact with base and adjacent searchers. I took part on a search when, two years ago, a child was missing (he has not been found). His pullover was found by a party of searchers but base could not be informed because of a lack of portable equipment. It was three hours before a person could get back to base to inform search co-ordinators. By this time it was getting dark. Other searchers could not be re-directed into the area where the pullover was found. During this search (it lasted 14 days) a lot of illegal 27 MHz equipment was used. I found out later the PMG radio inspectors were sitting on a nearby mountain listening - in the hope of identifying some of the users for later prosecution. I was told this by a radio inspector and I will swear this before a court anytime. I hope you will find space to print this long letter.

(Name and address supplied, but withheld by request)

NO WELL-ARGUED CASE

Your article stated that nobody has presented a well argued case for CB. For five years I have followed CB as a licensed operator and may I add a pirate, as pirating is almost unavoidable due to our restricted licensing system.

In his article Roger Harrison seemed to be trying to convert CB'ers to amateurs - the hobbyist interest - or make it appear that we "pirates" only want to become amateurs.

Personally I have this interest but most people I have met through CB are only interested in it for the benefits of personal communication and the hope that one day they might be able to help someone in distress which is the prime purpose of CB (? - Ed.).

With so many people on CB it is the only media where help can be readily obtained in an emergency.

Several years ago a close friend of mine was instrumental in the saving of two lives. These people were adrift off the coast of Queensland with only walkie talkies and he received the distress call while talking to a friend, this was in Victoria! Those two lives were saved because he believed like myself, that we must have a band that the ordinary person can use and monitor in case the above situation arises again.

In the above case VHF and UHF would have been completely useless!

In the USA a survey taken by the FCC shows that approximately 300 000 people (1/3 of the licensed population) used their CB sets for emergency use over a one year period. An average of 17 calls per person licensed. Twenty per cent of these calls were for natural disasters, 80 per cent for auto trouble and accident, of this 51 per cent were in assistance to police and fire officials, and 21 per cent concerned illness or injury.

In Australia no figures are available but to my knowledge the CB'ers in Australia, which according to the PMG number approximately 250 000 (? - Ed.) assist in many road accidents and emergency situations. (The PMG number licensed hand-phone services at approximately 17 000). This alone is another good case for CB.

I hope this letter will be printed and read by people with the same views as myself who will, I hope, help us by writing letters to members of Parliament, newspapers and other influential people to further this cause.

David E. Helyut,
Australian Citizens Radio Movement,
ACRM Vic.

ONE OUT - TWO IN!

CB as it's called is for those who use it constructively - a means of personal communication with their families, etc.

The PMG states there is adequate land line facilities, so CB won't be legislated into being legal. The only trouble is that a person on the out-back roads with a broken leg will have to crawl 30 miles to the nearest phone to get help.

The printed article in ETI didn't cover the safety angle and the CB'ers who use their spare time to monitor the 27 MHz Band in the hope of saving someone before it's too late.

The PMG can't stop the usage now, for every pirate they catch, another two come on.

Your article states that if it were legalised there would be too much interference and the whole thing wouldn't be worthwhile, the only trouble is the air waves are currently being monitored and any person using bad language, etc, is immediately told off, if that doesn't stop him, we track him down . . . that usually stops him.

It's a public service and that's the way we CB'ers are going to keep it.

The one worthwhile comment on the article was on the bottom of pages 36-37, a very interesting letter and one which deserves some credit.

It's the second time that the topic has been joked about nationally and I think that any future material published on the topic should be that of how much the CB'ers have done.

DXing..

is **EASIER**

With an "S" Meter

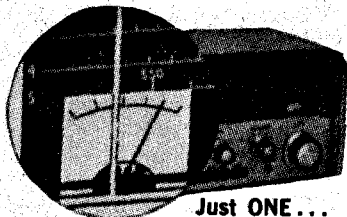

Just ONE...

of MANY FEATURES

Built into the **Eddystone**

EC10 Mk II

COMMUNICATIONS RECEIVER

- * Transistorized — Battery or AC Operation.
- * Fine Tuning Control.
- * Audio Filter for CW.
- * Easy-to-read Dial — 110 to 1 Ratio — 9" wide.
- * Continuous Coverage from 550kHz to 30MHz.

World-Wide DX Reception

Write for **FREE** leaflet **NOW!**

EDDYSTONE
Edometer MkII



GRID DIP OSCILLATOR



Ex-stock from Wholesalers
or Australian Agents

R.H. Cunningham
PTY. LTD.

VIC: 493-499 Victoria St., West
Melbourne. Phone: 329-9633.
N.S.W.: Sydney. Phone: 929-8066.
S.A.: Adelaide, Arthur Hall Pty. Ltd.,
1-3 The Parade West, Kent Town
5067. Phone: 42-4506.
W.A.: Perth. Phone: 49-4919.
QLD.: L. E. BOUGHEN & CO.,
Auchenflower. Phone: 70-8097.

TELEX: Melb. 31447, Sydney 21707

EDDYSTONE EC 10 Mk II E.T. 5/74

Name

Address

MAIL THIS COUPON TODAY

PIRATE RADIO - our readers comment

ROGER HARRISON SUMS UP

ILLEGAL activity on 27 MHz appears to be split into two basic kinds.

(a) Hobby/casual interest ("Amateur"-type).

(b) Unlicensed "public service"/commercial use.

The first obviously predominates, particularly in city/suburban areas. These people are the ones our January article was discussing. Listening on the air will confirm this anytime.

My original remarks still stand. I'm not labouring under *any* preconceived ideas or misconceptions. Sure, I'm interested in converting those pirates who wish to continue their hobby interest and expand their activities.

They can only *gain* by becoming amateurs. There are many amateurs willing to assist. My concern is making the path easier, and more accessible to these people. My suggestions in the January article were toward this end.

From the many letters received it is clearly obvious that many pirates have turned to 27 MHz as an outlet for their hobby interest because they are unaware, to a greater or lesser degree, of the amateur licence requirements, and how, when or even where to obtain information or assistance. The WIA has an inherent *responsibility* to disseminate and publicise this information. It has not only *failed* *dismally* to do this, but has been *totally* *negative* about the whole matter.

What little PR *is* disseminated is oriented towards seven-year-olds or the cogniscenti. The WIA attitude, by design or by default, is that of an exclusive, elitist club. It is far easier to become a Mason than a radio amateur and WIA member.

Little wonder that barely more than 50% of Australia's amateurs belong to the WIA. Many non-members know little about it apart from that it exists! This lack of PR is, in my considered opinion, one of the major contributions to the 27 MHz pirate problem. The WIA is cutting not only its own throat but the Australian amateurs' as a whole as well.

The second class of activity is becoming more and more prevalent as supposedly "legitimate" claimants to 27 MHz licences are, somehow or another, denied the appropriate

licence. According to document RB191 of the PMG Radio Branch, sporting clubs, search and rescue groups, scout groups etc, can be permitted licences for hand-held radio telephones. The tardiness of some Radio Branches/Radio Inspectors is to blame here for the illegal use of 27 MHz equipment by such groups.

The PMG needs to revise its thinking and/or policies if there is to be any solution to the problem or any sensible licensing scheme.

The functions, regulations and licensing scheme for 27 MHz is quite OK as it stands, but the administrative procedures and issuing of licences according to the principles set out in RB191 should be overhauled.

For some reason, the right people — legitimate claimants — seem to be unable to get licences. (No matter which way you look at it — wanting contact with your wife, from the family car, is not a valid reason; just selfish). Apart from this problem, the PMG has failed adequately to publicise the fact that licences are necessary to use 27 MHz transceivers (or indeed *any* transmitter/transceiver).

I can only stress again, that legislation is *necessary*, to restrict the *purchase* of transceivers to those who provide proof of having a licence.

To suggest that we *must* have citizen's radio as a *safety* service is rather overstating the case. Civil Defence and Search and Rescue groups, as well as organisations such as the NRMA, RACV, etc, *should* be able to provide this adequately — given appropriate encouragement and assistance by the public, the government and the PMG.

Those interested in communications as a hobby should be allowed a somewhat smoother and easier access to amateur radio activities — they also have a legitimate claim — and another class of licence, along the lines that have been suggested, is necessary as soon as possible.

I do not claim my suggestions to be a panacea to the problems of 27 MHz pirating, but it would go a long way towards solving the problem, whilst assisting those people interested in finding an outlet for their interests. ●

This correspondence is now closed. — Ed.

Why we decided not to advertise S.A.E.

Every amplifier manufacturer and his agent claims all sorts of perfection for his amplifier so what good is one more claim? Even though the claims are true this time?

With all the exclusive break-throughs in circuitry, even the worst amplifiers must sound better than the real thing by now.

And we thought "S.A.E. never seem to advertise in the U.S.A., and yet they're accepted as America's best amplifiers and loudspeakers. All the pro's rave about them. So why should we advertise them? Anyway, with its performance, looks, price and warranty, S.A.E. gear should just walk off the dealers shelves.

Anyway our problem is not to sell S.A.E., but to get it. Our next two shipments are just about sold out, so what's the point in advertising? It'll only make the supply position worse."

That's why we decided not to advertise S.A.E.

Still, we ought to use the photos they sent us.

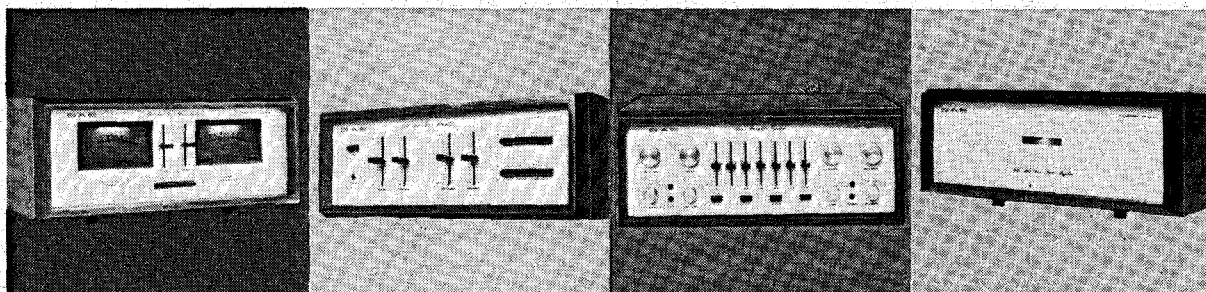

MARK IVCM, 2 x 100 Watts RMS

MARK XXX, Preamplifier

MARK IB, Preamplifier Equalizer

MARK XXXI, 2 x 50 watts RMS

Sole Australian Distributors

Leroya Industries PTY. LTD.
266 Hay St., Subiaco, Western Australia 6008.

QLD. BRISBANE AGENCIES
Audio Centre,
72 Wickham Street,
Fortitude Valley, QLD. 4006.

N.S.W. LINEAR SOUND P/L
639 Pacific Highway,
Chatswood, N.S.W. 2067.

A.C.T. HOMECRAFTS
Petrie Street,
Canberra, A.C.T. 2600

S.A. HILLS ELECTRONICS P/L
7 Ackland Street,
Edwardstown, S.A. 5039

VIC. B.J.D. ELECTRONICS
202 Pelham Street,
Carlton, Vic. 3053

LER 053

SUPER-COUNTER

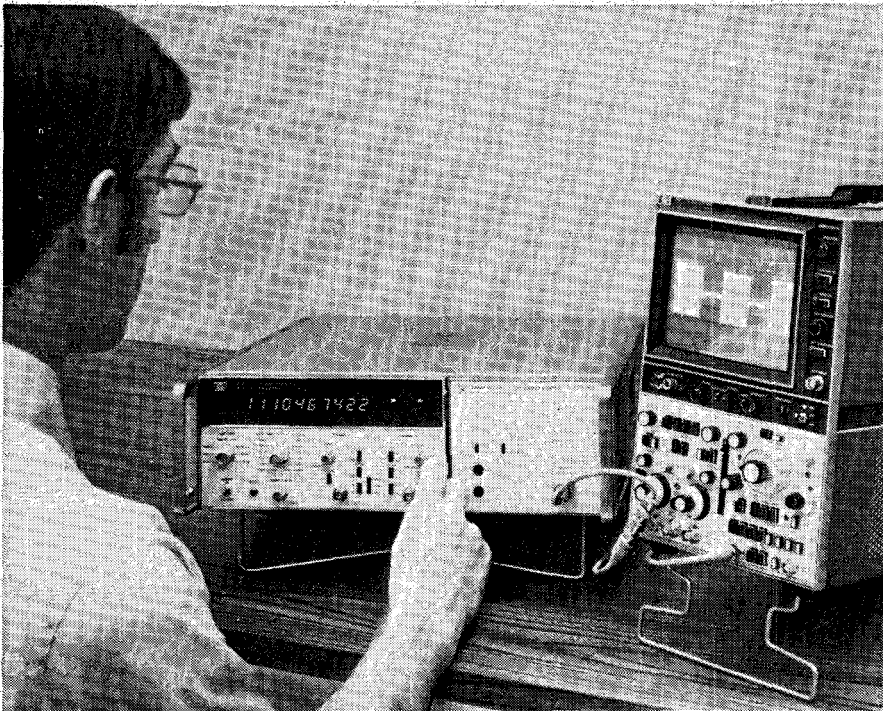

A radically-new plug-in electronic counter, Model 5345A from Hewlett-Packard, in one second can measure any frequency from 1 Hz to 500 MHz with 9-digit resolution. It resolves one-shot time intervals to 2 nanoseconds, and measures the frequency of RF pulses as brief as 50 nanoseconds. With improved time interval averaging it can resolve repetitive time interval measurements to 1 picosecond. With frequency averaging, a technique new with the 5345A, never-before-achieved precision is possible in measuring the frequency of pulsed microwave signals. The counter is available with full digital output, input programming capability, calculator interface, and accessories to 18 GHz.

Because it uses the industry's first commercial 500 MHz clock and automatically calculates frequency as the reciprocal of the period measured, the 5345A at any gate setting measures all frequencies up to 500 MHz with constant and extremely high resolution. (In the usual counter, resolution drops with input frequency. All earlier reciprocal-taking counters used clocks of 10 MHz or over.) Similarly, it is the 2 ns period of the 500 MHz clock that makes possible 2 ns resolution of one-shot time interval measurements.

The new counter has two channels rather than the usual one. Each has 10 mV sensitivity from dc to 500 MHz, is

dc-coupled, and has switchable high impedance (1 megohm, 30 pF) or 50 ohm input. Thus the 5345A is the first high-frequency counter that uses standard oscilloscope probes, either the 10:1 compensatable high-impedance types or the 500-ohm terminating probes.

These and other new abilities are the result of applying an entire new family of 500 MHz monolithic integrated circuits featuring sub-nanosecond switching, designed and fabricated by Hewlett-Packard.

While a new family of high-performance plug-ins is under design, to exploit the instrument's new capabilities, all existing plug-ins for its predecessor, the widely-used HP Model 5245L, function in the 5345A, with greater speed and resolution. One of the new plug-ins is the first heterodyne converter that can lock automatically to measure pulsed microwave frequencies as well as CW. CW measurements may be made accurately, even in the presence of very large amounts of FM. A second new plug-in adds a third 10 mV, 500 MHz input channel, especially useful in analyzing data communications circuits.

Further details from Hewlett-Packard Australia Pty. Ltd, 31-51 Joseph St., Blackburn, Vic. 3130.

WAVETEK SHORT FORM CATALOGUE

Kenelec Systems Pty. Ltd. now have available the latest short form catalogue on Wavetek products. These include function generators, oscillators, programmable generators, phase meters, generator modules, sweep/signal generators etc.

The instrument range covers frequencies as low as 100 uHz, up to 1.4 GHz. Over 30 different instruments are listed with illustrations and brief descriptions. Two new instruments are included: a high frequency sweep generator with digital readout, 0.005 Hz to 10 MHz; and a transmission line test set covering 50 Hz to 15 kHz.

Copies are available from Kenelec Systems Pty. Ltd., 142 Highbury Road, Burwood, Vic. 3125.

SKIN PACK HOLDS COMPONENTS DURING SOLDERING

When components are loaded onto a printed circuit board, the problem arises of holding them into position when the board is inverted for hand soldering, or of preventing dislodgement during wave or dip soldering.

Skin packaging solves this problem by vacuum forming a plastic film over the entire component side of the board. This 'skin' locks components in position, and also provides protection during subsequent handling.

Royston Electronics now have a range of vacuum forming machines suitable for this type of work.

Machines range from large semi-automatics to small manuals such as the SA1014A - a table top model which forms an area of 23 x 33 cm with a depth of draw up to 75 mm.

Further details from: Royston Electronics Pty. Ltd., 22 Firth Street, Doncaster, Vic. 3108.

TRANSIENT TIME CONVERTER

The Riken Denshi Model TCB-1000 transient time converter is suited to research and experimentation in physics and electrical engineering, as a means of handling fast single-occurrence events or repetitive events which the ordinary recorder or oscillograph are unable to follow. Information is stored in a semiconductor memory for reproduction under a slower time base. The same information can be reproduced at a fast rate of display on an oscilloscope.

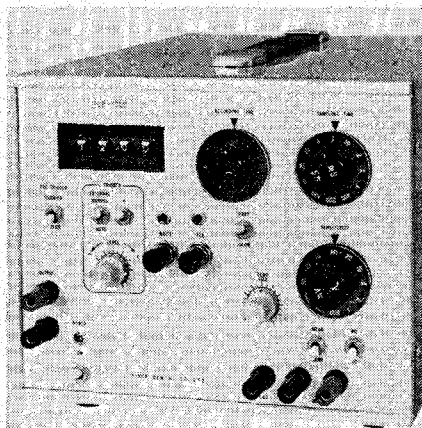

Since the sampling time can be selected, the converter can be used for a wide range of frequencies, from very slow waves to the kilohertz region. Applications are found in the study of vibration impact, creep, rupture, sounds and reverberations, response to laser stimulation, acceleration etc.

Full-scale transient voltage can be recorded as one word within 2μ sec. sampling time, more or less without relation to the analogue quantity. There is no delay to rise times. Maximum sensitivity is ± 50 mV F.S. Input impedance exceeds 2 megohms (fixed for all ranges).

Full scale in X- and voltage axes is represented by ten-bit binaries (1024 bits for full spans).

The zero point can be set to a positive or negative voltage or to voltages in positive or negative zones only, to expand the scale.

Automatic triggering is included in addition to manual triggering.

These converters do away with the troublesome procedure of photographing memory scope displays. Converter output is used to drive a recorder directly. Accuracy is better than 1%.

Further details from: John Morris Pty. Ltd., P.O. Box 80, Chatswood, N.S.W. 2067.

DUAL-RANGE LABORATORY/INDUSTRIAL DIGITAL THERMOMETER



A new platinum resistance digital thermometer has two ranges, from -200 to $+600^{\circ}\text{C}$ with a resolution of 0.1°C and from -100°C to $+200^{\circ}\text{C}$ with a resolution of 0.01°C . Accuracy over both ranges is $\pm 0.5^{\circ}\text{C} \pm 0.25\%$ of reading. A linear analogue output, standard on this Hewlett-Packard Model 2802A, simplifies its use with any standard chart recorder.

A snap-in battery module is available for portable operation. Buffered BCD output is also available as an option.

Probes with standard or armoured cable can be used and are available

with cables up to 200 feet long. A simple, one-point calibration procedure takes only a few moments.

The Model 2802A operates within its rated accuracies over ambient conditions from 0 to 55°C and relative humidity to 95% at 40°C . Its housing is cast aluminium, and this combined with all solid-state circuitry and an all solid-state display makes the instrument rugged enough for field use.

Further details from: Hewlett-Packard Australia Pty Ltd, 31-51 Joseph St., Blackburn, Vic. 3130.

ELECTRONICS TODAY INTERNATIONAL — MAY 1974

Semiconductors Sale

FANTASTIC SEMICONDUCTORS SALE at MICRONICS for THIS MONTH ONLY!! Never to be repeated. Stock up NOW and take advantage of these INCREDIBLY LOW PRICES. LOOK!!! BC109 — 10 for \$2.50, BC179, BC157, 2N3638A, AC126 — 10 for \$4.50, AC127 — 10 for \$5, AD161/162 Mchd Pr — \$2.20, AS205 (BC107) — 10 for \$2.50, 2N216 (CA1) — 10 for \$3, 2N1637 (F116N) — 10 for \$3, 2N1638 (F17N) — 10 for \$3, OC602 (AC125N) — 10 for \$4, AS2 P.N.P. switch — 10 for \$2, AS44 P.N.P. switch — 10 for \$2, 25B411(40440), 2N3730, DG14 (40442) — \$2 ea., 2N1639, 2N218, 2N412, 2N591, 2N641, 2N642, 2N2613 — 10 for \$3.50. SILICON Power Diodes — 1N3194 (400v, 75A) — 10 for \$2, 1N3196 (800v, 75A) — 10 for \$2.50. TRIACS — AC06BR — 50c, 40485 — 80c. ZENER DIODES — 400mw, 4.7 volt — 10 for \$2.50. AUDIO AMP Integrated Circuits incl. circuit digist — PA234 1w R.M.S. — 2 for \$3.50, 5102AY 3w R.M.S. — 2 for \$6, TAA621 4w R.M.S. — 2 for \$8. ELECTROLYTICS — Top Quality Pigtails 10μ 25v — 10 for \$3, 64uf/10v, 68uf/16v, 10uf 25v — 10 for \$1.47uf/10v — 10 for 10c. POLYESTER CAPS — Top Brand 10%, 160v — .001, .012, .015, .018, .033, .039, .056, .68 — 10 for \$0c, .2, .15, .13, .22 — 10 for 70c, .27, .39, .56, .68, .82 — 10 for \$1. CERAMICS — .001u, .0027uf (500v), 22pf — 20 for 30c. COPPER CLAD BOARDS — (6" x 4 1/2") — 10 for \$2. FERRIC CHLORIDE ETCHANT (Solid) 100 gm bag — 40c. TUNING CONDENSERS (Miniature) as used in small transistor radios — 31ea. Bank of 2 PB switches Push on/off — 50c, Toggle switches 250v 3A D.P.S.T. — 40c, Slide switch (18 pin) — 40c, Microswitches 250v 10A — 80c ea. SUPER BARGAIN PACKS at incredible prices — RESISTORS (Mixed), 5%, 10%, 1/2w, 1w, ideal for servicing, V.H.F. or hobbyist — 100 for \$1. (Top Quality) POLYESTER CAPS, Top Quality 160v, 270v, 400v, 10% Tol. in a range of values — 100 for \$3.50. POTS — Dual, single, switch and Tap pots (No Rubbish) — 20 for \$4. CERAMIC DISC CAPS, mixed — 50 for \$1. (Miniature) ELECTROLYTIC CAPS mixed — 25 for \$2. STYROSEAL CAPS — 25 ass'd for \$1. TANTALUM CAPS — All miniature, mixed — 20 for \$2 (No junk). ZENER DIODES — Mixed 1w types — 10 for \$5. Mixed 10w types — 10 for \$3. SWITCHES — Including Rotary, Toggle and Push Button switches — 10 for \$5. (value at least \$12). TAG STRIPS — Mixed — 50 for \$2. TRIMMERS (12-120pf) — 10 for \$1. COILS — Miniature R.F. osc. IF coils — 10 for \$1.50. NOTE — These reduced prices are on until next issue is out so HURRY for your BARGAINS. Post and Pack 20c or extra for heavy parcels. MICRONICS, P.O. Box 175A, Randwick, N.S.W. 2031.



IF YOU HAVE A PROBLEM GIVE US A CALL

SILVERTONE ELECTRONICS

UNIT 6, No. 2 SCHOFIELD ST. RIVERWOOD, NSW. 2210

Phone 533 3517

Free price list 9 x 4 SAE please (12c)

CITIZEN BAND CRYSTALS

U.S. Channels 1-23 N.Z. Channel 4. 455 kHz conversion (suit Sharp, Pony, Midland, Lafayette and Zodiac) 4.225 MHz conversion, (suit Sharp models CBT72, CBT55, CBT81) commercial crystals 27 MHz also available \$6 per pair including postage.

SHARP CORPORATION OF AUSTRALIA PTY LTD
CRYSTAL DIVISION
22 Burrows Rd., St. Peters, 2044.
Tel: 519-5522

FERGUSON

Manufacturers of: Electrical/electronic equipment, wound components and lighting control equipment.

BRANCHES IN ALL STATES

FERGUSON TRANSFORMERS
PTY. LTD.
HEAD OFFICE:
331 High St., Chatswood, 2067.

Phone: 02-407-0261

DISPOSAL SALE

Of Surplus and Ex Government
Electronic Gear

**STOCK MUST BE CLEARED
NO REASONABLE OFFER REFUSED**

**OPEN 9.30 AM - 5 PM Monday to Friday
9 AM - 12 noon Saturday**

AVO Model 7 & 8 Multimeters. As new condition from \$35.00

No. 19 & No. 62 Transceivers. Plenty of part wrecked units any reasonable offer will buy.

A.W.A. RC Audio Oscillator, 20Hz to 200kHz in 4 bands. HIZ & 600 ohm 240 Volt AC \$65.00

COAX CABLE 58 ohm Ascand 15 P1/24. Brand new 1/8" outside diameter. 12c per yard, \$10 per 100 yard reel.

LARGE QUANTITIES of hard to get valves, transformers, semi-conductors & components, dural tubing, cables multicore & coaxial, connecting leads Cannon type plugs multipin, relays PMG types & miniature, telephone parts, teleprinter units, all types of panel meters new & used, test equipment, multimeters, signal generators, oscilloscopes, power supplies, standard racks and thousands of component parts, potentiometers, capacitors oil filled & electrolytic, high & low wattage resistors, transistor circuit boards, crystals.

SPECIAL THIS MONTH ONLY
Standard P.M.G. Black Telephones Dial Type tested with Ericson Plug \$7.95 few only!

Ericaphon Plastic Telephone dial in base - latest type \$19.75 As new few only!

Ericson 800 Series Telephones dial type as new \$17.50 few only!

PMG Type Telephone Plugs, white plastic standard type Ericson 95c a pair.

4 Digit Counters. Post Office Type 40 Volt 50c each.

HAM RADIO DISPOSALS

104 Highett Street, Richmond, Vic., 3121
(Near Lennox Street) Phone 42-8136.

EQUIPMENT NEWS

MINI 'SCOPES FROM PHILIPS

Two new mini oscilloscopes, which can be placed on the palm of the hand, but which are normally used hung around the neck, have just been introduced by Philips Industries Ltd.

Both instruments have a 5 MHz bandwidth, dimensions of 86 x 135 x 190 mm and weigh a mere 1.8 kg, including the optional, re-chargeable battery pack. Sensitivity of the single-trace mode, designated the PM 3000 is 10 mV, while that of the dual-trace PM 3010 is 30 mV.

These new instruments have been developed to meet the need for a professional-standard oscilloscope that is light and small enough to be used virtually anywhere.

A multimeter is nowadays inadequate for testing complex electronic circuitry which often use digital techniques, but conventional service oscilloscopes weighing 10 to 15 kg are inconvenient for regular service calls. Hence the need for an oscilloscope having the equivalent dimensions and weight of a multimeter.

The new Philips mini 'scopes meet this requirement, and when the carrying case is used they also permit hands-free operation for difficult to reach situations. Moreover there is no need for a mains supply, since the

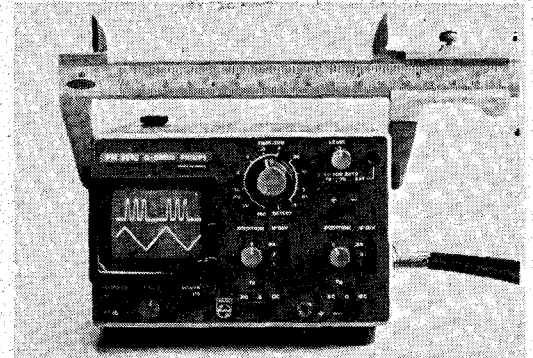

optional battery pack gives up to five hours operation and can be recharged overnight in eight hours.

Advanced components are naturally used in order to achieve these size and weight reductions, combined with a specially developed c.r.t. that uses a 1.5 kV accelerating voltage. Together with the extremely small spot size and internal graticule, this ensures a high resolution bright display.

The display is on a 4 x 6 division screen (one division equalling 4.5 mm) which can be magnified approximately 1.3 times using the removable lens.

Both oscilloscopes are marketed and serviced by the Test & Measuring Instrument Department of Philips Scientific & Industrial Equipment, 200 Goulburn Street, Sydney.

MICROWAVE SPECTRUM ANALYSER

A new Microwave Spectrum Analyser available from Ronald J.T. Payne features wideband dispersions to 1 GHz, 60 dB display dynamic range and one-control phase to lock for optimum display stability at high resolution.

The tuning range of 10 MHz to 6.5 GHz suits the PSA-532A Microwave Spectrum Analyser to a wide range of applications, including pulsed and CW signal analysis; AM, FM and PM spectral studies; RFI monitoring; wideband spectrum surveillance and harmonic or distortion analysis. Frequency resolution is programmed to dispersion for ease of operation but may be uncoupled and separately adjusted in the range 1 to 200 kHz.

The analyser is available in plug-in form to suit Hewlett-Packard 140/141 series and Tektronix 530/550/580 series mainframes or complete with the Nelson Ross MF-9 mainframe and

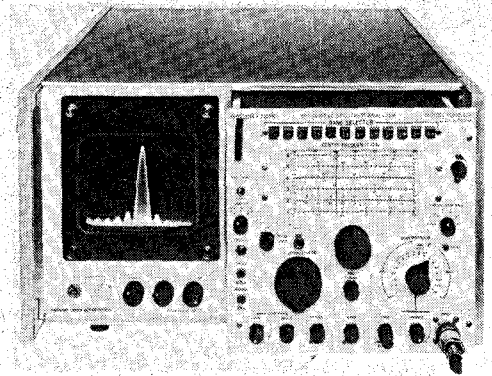

calibrated CRT display 60 dB/linear/13 dB square law.

This plug-in is the latest in the Nelson Ross range, and is compatible with existing models covering RD, SSB, sonic and audio applications down to 0.5 Hz.

Further details from: Ronald J. T. Payne Pty Ltd, 385-387 Bridge Rd., Richmond, Vic. 3121.

COLOUR TV PATTERN GENERATOR

The Arlunya PG11 is an extremely versatile portable battery operated solid state test pattern generator specifically designed for carrying out dynamic and static convergence, grey scale tracking and purity alignment in PAL colour receivers.

Its low cost, small size with rugged construction make it suitable for service organisations to use for their outside service personnel for installing new receivers, clarifying nuisance calls, and general house call service.

The PG11 provides five basic

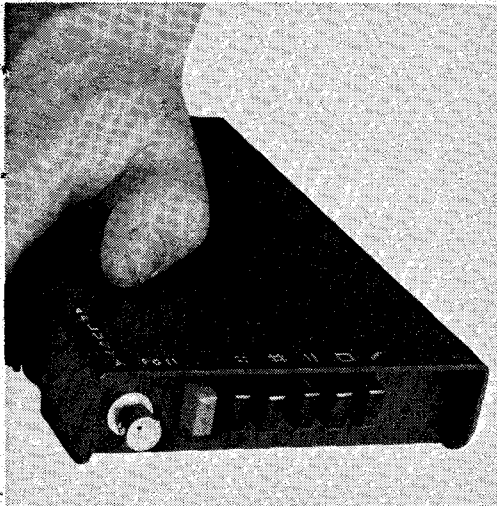

patterns: crosshatch, dots, staircase, white raster and vertical bars.

Designed and manufactured in Australia in accordance with best international instrument practice it meets the relevant CCIR standard and the requirements of the Australian Broadcasting Control Board Specifications.

Comprehensive data and demonstrations are available on request from the manufacturers.

Further details from: Arlunya Pty Ltd., P.O. Box 113, Balwyn, Vic. 3103.

ETI's equipment and component news sections are editorial - not advertising.

All copy is published free of charge. Manufacturers or their agents should forward material for possible publication to the Editor, Electronics Today International, 15 Boundary St., Rushcutters Bay, NSW.

BRIGHT ◆ STAR ◆ CRYSTALS

ESTABLISHED FOR THE PAST 35 YEARS FOR ALL YOUR REQUIREMENTS

STILL ON TOP

Bright Star Crystals are preferred by leading Manufacturers throughout the country for

**ACCURACY - STABILITY
ACTIVITY - OUTPUT**

Consult us for Crystals for any Mobile Radio. All types available.

DISCOUNT FOR QUANTITY ORDERS

AMATEUR AIRCRAFT and
ULTRASONIC also available.

Our modern factory equipment allows us to offer you PROMPT DELIVERY for all CRYSTAL requirements.

DEVOTED EXCLUSIVELY TO
THE MANUFACTURE OF
**PIEZO ELECTRIC
CRYSTALS**

Contractors to Federal & State
Government Departments.

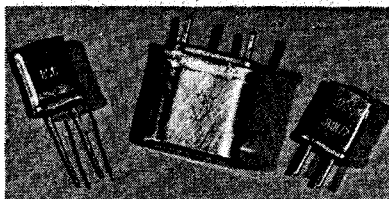

"All Types of Mountings"

REPRESENTATIVES -

Australia and New Zealand
Messrs. Carrel & Carrel,
Box 2102, Auckland.

Rogers Electronics
P.O. Box 3,
Modbury North, S.A.
Phone: 264-3296

Paris Radio Electronics,
7A Burton Street,
Darlinghurst, N.S.W.
Phone: 31-3273

Fred Hoe & Sons Pty. Ltd.,
246 Evans Road,
Salisbury North, Brisbane.
Phone: 47-4311.

W.J. Moncrieff Pty. Ltd.,
176 Wittenoom Street,
East Perth, 6000.
Phone: 25-5722.

Write for a free comprehensive
price list or quote for your
requirements.

BRIGHT STAR CRYSTALS P/L.
35, EILEEN ROAD, CLAYTON,
VICTORIA, 546-5076

Goodmans

LOUDSPEAKERS CONSTRUCTOR RANGE

DT2 - Dome tweeter, Freq - 2000 - 22,000 Hz. Axent 100 - Dome tweeter with built-in crossover. 3 3/8 inch mid-range speaker freq - 800 - 5000 Hz. 15 watts. 6 1/2 inch DIN Bass - mid-range speaker freq - 35 - 5000 Hz. 20 watts. 8 inch Din Bass speaker freq - 30 - 5000 Hz. Twinaxion 8 wide range freq - 40 - 18,000 Hz. 15 watts. Twinaxion 10 wide range freq - 40 - 18,000 Hz. 15 watts. Audiom 100 12 inch bass speaker, freq - 35 - 3000 Hz. 30 watts. Axiom 401 12 inch wide range freq - 30 - 11,000 Hz. Power handling 40 watts.

AVAILABLE AT LEADING
HI-FI RETAILERS

Send for free
illustrated brochure.

Distributed by:

THORN SALES



123 Bamfield Rd,
West Heidelberg.
Victoria 3081,
Tel. 459-1688.

Division of AWA-Thorn
consumer products
Branches all states

COMPONENT NEWS

CIRCUIT TEMPLATES

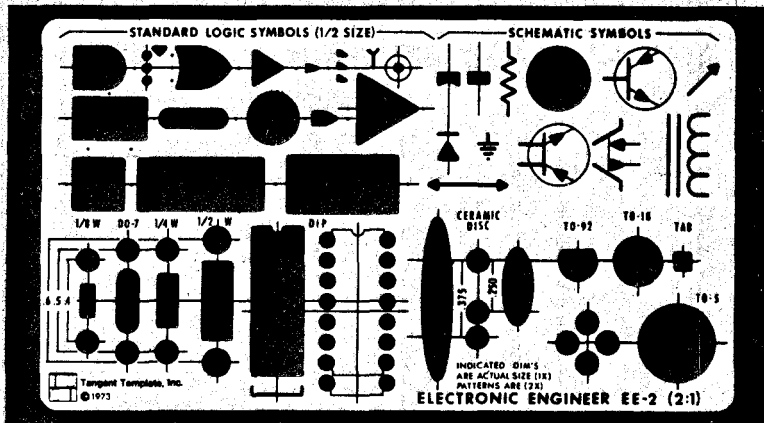

Draughtsmen and electronic design and layout staff will be interested in a range of logic, schematic and component layout templates manufactured by Tangent Template Inc. of San Diego, California.

Each template features a complete set of standard logic symbols meeting ANSI Y32.14 requirements. Additionally, the most useful schematic symbols for creating usable schematic and logic diagrams are included. Completing the template are

the basic component layout patterns required for laying out and detailing electronic assemblies. Featured are basic resistors, capacitors, and semiconductors used in most electronic equipment.

The templates are made from .030 green tinted plastic.

Further details from: W.H.K. Electronic & Scientific Instrumentation, P.O. Box 147, St. Albans, Vic., 3021.

DATA MODULE SYSTEM FOR COMPLEX PROGRAMME CONTROL

A data input system which simplifies programming numerically controlled systems such as machine tools has been developed by a Swiss company.

The system, developed by Ghielmetti, is now available in Australia through McMurdo (Australia) Pty. Ltd.

Switching modules each containing four normally open contacts or four changeover contacts and diodes mounted on a special printed circuit board matrix are selectively actuated by inserting special programming plugs.

The programming plugs have lengthwise ribs each with 16 possible code combinations. The code ribs operate some or all of the four contacts in the switch body corresponding to the selected character and code of the plug which is inserted.

The switching modules are mounted on a special double layer circuit board called a data matrix.

Four coded channel circuits per switch column are provided on the upper side of the data matrix to carry the output signal. The input signal is carried by bus bars on the under side of the data matrix, running at right angles to the coded channels.

In switching applications, the single bus bars of the switch body rows are triggered by an electronic or mechanical pulser with impulses of indeterminate length. The binary information of the four bits of each switch body is formed by the vertical ribs of the programming plugs through the operated contacts and presented at the data outputs. At the next step the information of the next row is available at the data outputs.

Programming matrixes containing up to 10 000 modules have been made; 30 x 26 modules can be mounted on a standard matrix.

Instead of singly inserting the programming plugs the use of a programming template allows complete programmes to be stored and changed over in seconds.

Typical applications include traffic light programming, numerical control of machine tools, chemical and furnace process control, serial data input into automatic typewriters, and parallel input of fixed addresses into computers.

Further details from: McMurdo (Australia) Pty. Ltd., 19 Carninish Road, Calyton Vic. 3168.

NEW CONDUCTIVE PLASTIC TRACK QUADRANT FADERS

Two recent additions to Plessey's extensive range of Faders are the designated Types EM4C and EM5C respectively, designed principally as low cost instruments for lighting control in studio applications.

The Type EM4C includes among its facilities a cue switch and a choice of three lamp positions for scale illumination; termination is by an eight-way printed circuit board edge connector. Range of values of rated resistance: 1 k to 100 k. Limiting element voltage: 500 Vac. Peak 350 Vdc.

The Type EM5C is an identical unit which features board terminations at an angle of 40° to the vertical, thus achieving a reduction of the required clearance in desk depth.

Commercial enquiries should be addressed to Professional Components, Plessey Ducon Pty Ltd, Christina Road, Villawood, NSW, 2163.

TO5 TRANSISTOR SOCKET

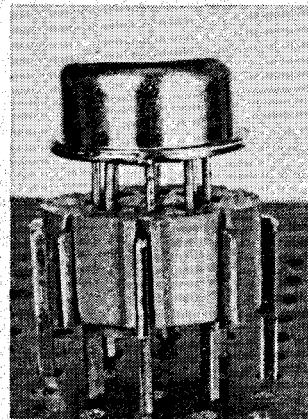

A socket for an eight-lead TO5 transistor which fits directly into a 0.1" pitch printed circuit board has been added to the Jermyn range of products from McMurdo (Australia) Pty. Ltd.

The socket accepts the device without bending the leads.

The problems of layout and drilling of boards to fit eight-lead TO5 devices is minimized by the new socket.

Because the socket pins are on the outside of the socket body, testing from above the board can be done. It also provides more space for soldering.

The gold plated bronze contacts are rated at 1 amp. To make insertion of the device easier, the 'lead-ins' are funnel shaped.

The socket body is moulded from glass-filled nylon. Insulation resistance

Continued on page 112.

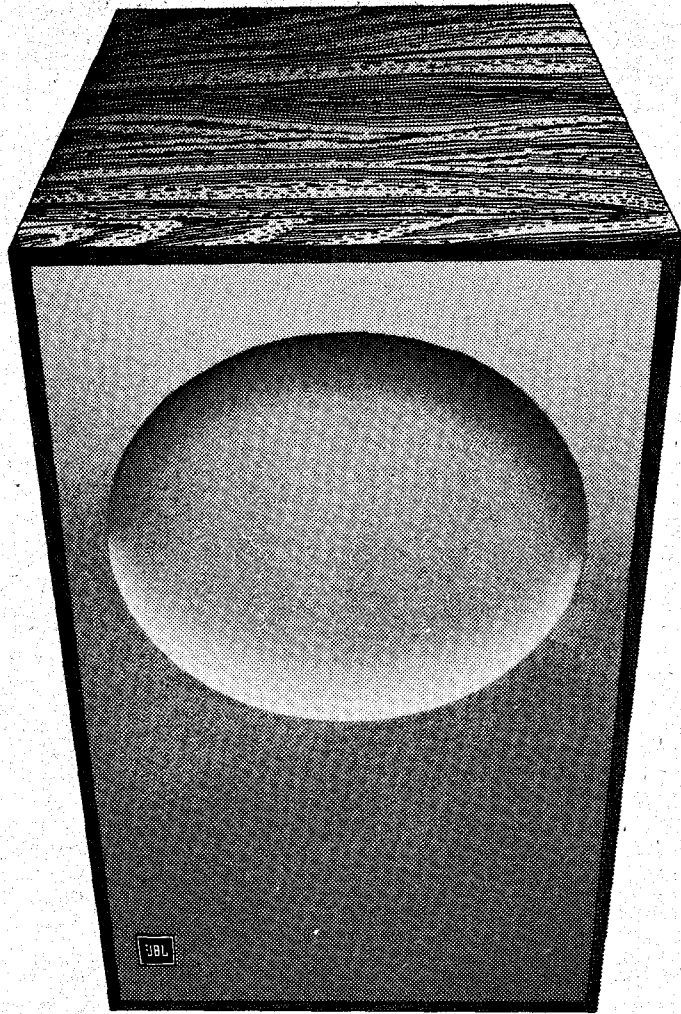

JBL's 88 Plus.

(It's more than simply a great bookshelf speaker.
We made it especially for those of you who can't —
or won't — leave well enough alone.)

JBL's 88 Plus has the largest low frequency speaker we put into any bookshelf system — 12 inches. It has an extremely efficient high frequency unit that stays calm and clear even when the going gets loud.

Turn up the sound. Way up. Listen to a bass guitar, a bass drum, an organ, a cello. You can tell them apart on an 88 Plus. (With a lesser speaker, bass sounds lose their individuality — grumbling together in sullen anonymity.)

Come listen to JBL's 88 Plus. It's yours for \$295.00, and it's a superb two-way system. It's not a three-way system, but you can't have everything, can you?

— From \$189.00 to \$4000.00.

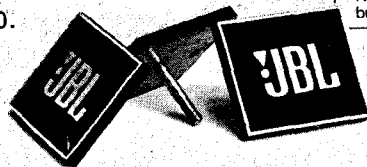

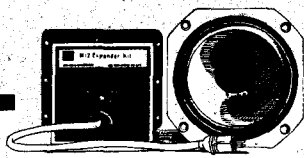
Plus. 

You can change the 88 Plus into a three-way system and get more presence, more power handling capability. (As a matter of fact, you'll end up with the acoustical twin of a JBL professional studio monitor.)

We've designed a M12 Expander Kit that has a 5" mid-range transducer, a dividing network and a presence control.

All you need is fifteen minutes, ninety-seven bucks and a screwdriver.

Now, if that isn't enough to make you happy, you'll just have to build your own.

James B. Lansing Sound, Inc./3249 Casitas Avenue, Los Angeles 90039/High fidelity loudspeakers from \$189 to \$4000.
DISTRIBUTED IN AUSTRALIA BY JERVIS AUSTRALIA PTY LTD, PO BOX 6 BROOKVALE, NSW 939-2922.

between pins is in excess of 10^{10} ohms at 500 Vdc.

Further details from: McMurdo (Australia) Pty. Ltd., 19 Carinish Road, Clayton, Vic. 3168.

HEATHKIT DISTRIBUTION IN NSW

Schlumberger Instrumentation Australia (Pty) Ltd have announced the appointment of distributors in N.S.W. for the Heath range of equipment. Schlumberger Instrumentation Australia have made this decision owing to the heavy demand on Heathkit and the wide marketing area involved in the N.S.W. division.

The appointments have been made on basis of technological support from the distributors in assisting purchasers in any problems encountered.

Schlumberger Instrumentation Australia have indicated that distributors would carry full stocks of kits suitable to the Australian market.

Distributors: Sydney - Alan Oliver (Electronics) Pty. Ltd., 188 Pacific Highway, St. Leonards, N.S.W. Telephone 43-5305. Newcastle - Digitronics Australia Pty Ltd., 12 William Street, Maryville, N.S.W. Telephone (049) 69-2040. Canberra - Associated Scientific Sales Pty. Ltd., 29 Wollongong Street, Fyshwick, A.C.T. Telephone (062) 95-9138.

MINIATURE MATRIX PROGRAMME BOARDS

A miniature matrix programme board system has been introduced by McMurdo (Aust.) Pty. Ltd., to meet the growing trend to miniaturisation.

The programme boards have a grating of 3 mm to provide four times as many holes in the 75 x 75 mm front plate surface as the widely used conventional boards, with 4.5 mm grating.

Large matrix boards with up to 100 x 100 holes can be manufactured.

The standard board with a 12 mm fixing border allows an uninterrupted matrix area of 22 x 22 holes. A narrow board is available with 20 x 20 holes. The connections are made with two grids of bus bars. The first grid is directly under the front plate which runs horizontally and the second deck vertically. Made of hardened beryllium copper, the bus bars are coated with 0.25 u gold plating and insulated with polycarbonate.

Terminals are provided as two side groupings designed for soldered contacts. Terminals for wrapping up to three connections, or for direct mounting onto a printed circuit board are also made.

The diode, short circuit and cable plugs to match the system have brass contact pins with 0.25 u gold plating. Miniature plugs for programming the

board include short circuit and diode plugs and two-way short circuit cable plugs. Special plugs with two to 15 pins permit programming diagonally across the board.

The matrix boards are inscribed by engraving or silk screen printing covered by a transparent scratchproof melamine layer.

Programming templates and adaptor plates are available to store and change programs which may be required at a later date or frequently repeat themselves.

Further details from: McMurdo (Australia) Pty. Ltd., 19 Carinish Road, Clayton, Vic. 3168.

MULTI-PURPOSE IC

A most-versatile new IC has just been announced by RCA.

The device (CA 3097E) consists of five independent and completely isolated elements on one chip.

Elements consist of an npn transistor, a sensitive-gate SCR, a programmable UJT, pnp/npn transistor pair and a zener diode.

Applications include, timers, light dimmer/motor controls, oscillators, one-shot multivibrators, voltage regulators, comparators, Schmitt triggers, constant current sources, amplifiers, logic circuits, SCR triggering, pulse circuitry etc.

Further details: AWA Pty Ltd., 554 Parramatta Rd., Ashfield, NSW 2131.

VARIABLE POWER SUPPLIES

BY SCIENTIFIC ELECTRONICS

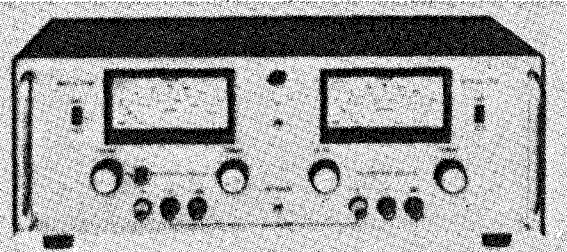

- Single and Dual Outputs
- Output Voltages to 60 Volts
- Output Current to 6 Amps
- Excellent Line and Load Regulation
- 0° to 60°C Operating Temperature
- Ten Turn Controls
- Constant Voltage/Current Limit
- Constant Voltage/Constant Current

Distributed by

ELECTRO TECHNICS PTY. LTD.,
36 Park Street, South Melbourne, Vic. 3205.
Phone: 699 2716
Sydney 25 3955 Brisbane 47 4311



The Best Connections— Belling & Lee RF Connectors.

straight or right angle

Belling & Lee have today's widest range of RF Connectors—and they're generally available from stock. Shielded or insulated plugs; conductors for soldering, crimping or solderless; straight or the new right angle model L2156.

- Special collet clamps for efficient braid connections and anchorage in cable mounting members.
- Impedance 60-70 ohms.
- Mating conforms to BS3041 and IEC169-2.

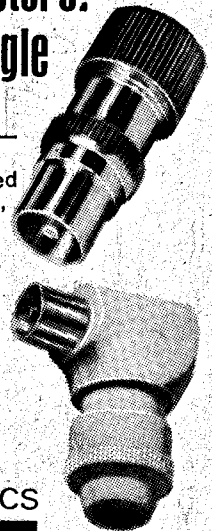

TECNICO ELECTRONICS

Premier Street, Marrickville, NSW, 2204 Tel 55-0411
2 High Street, Northcote, Vic. 3070 Tel 489-9322
Adelaide 23-2222 • 267-2246 Brisbane 52-7255
Perth 8-4137

MO8786/1273

ONE OF THE WORLD'S OLDEST PRINCIPLES OF PHYSICS IS THE NEWEST BREAKTHROUGH IN HI FI.

This is going to sound incredible to you, but here goes:

EPI has found a way to produce a big, deep bass sound in a loudspeaker that requires only 4 to 5 watts RMS per channel and costs less than \$100.

You're shaking your head. "How could they possibly . . . ?"

We did it by eliminating the most expensive part of a speaker: the woofer. And replacing it with a patented process, a remarkable technique for producing tight, accurate bass response down to below 50Hz: the "Organ Pipe Principle".

Revolutionary is not too strong a word for EPI's new MicroTower.

Instead of the usual configuration of tweeters and woofers, this deceptively simple new kind of speaker uses two full-range 4½" drivers to produce high and mid-range frequencies.

Now, here's where the Organ Pipe Principle come in:

When an organ pipe is excited by a small flow of air, it radiates sound in all directions.

In much the same way, EPI's MicroTower takes the small vibrations that are produced by low frequency bass notes in the two drivers, and amplifies those

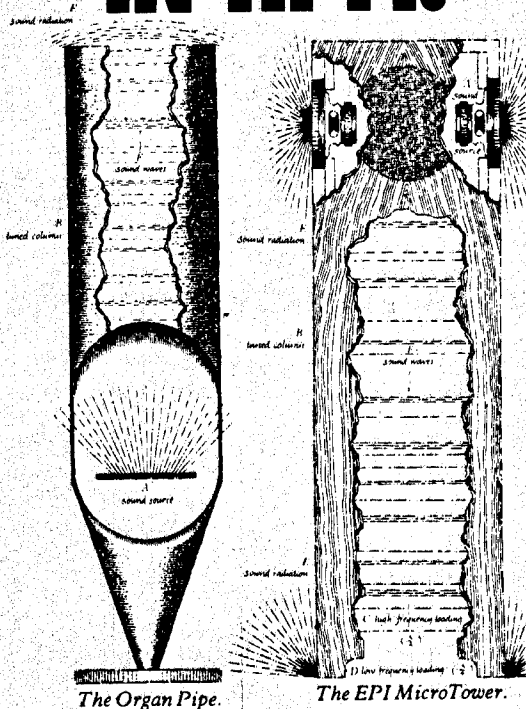

The Organ Pipe.

The EPI MicroTower.

vibrations to the proper level, over three octaves of bass response, within the speaker cabinet itself!

What this remarkable breakthrough means to the quality of the sound is something remarkable, too:

EPI's MicroTower produces truly omnidirectional sound, or what we prefer to call "Spherical Sound". This means that the MicroTower radiates sound almost equally in all directions, at all frequencies, and with virtually no distortion. (Until now, the only speakers capable of this were EPI's Tower at \$2000 per pair and MiniTower at \$1000 per pair.)

At under \$100 for EPI's MicroTower, just about anybody can afford it. And with its ability to deliver on only 4 to 5 watts RMS per channel, anybody with even the most inexpensive kind of amplifier can now hear bass notes he never heard before.

Within a matter of years, we predict that most component speakers will embody some form of what is now being offered in EPI's MicroTower. But for now, at least there's only one place it's coming from: Epicure Products Inc., One Charles Street, Newburyport, Massachusetts 01950.

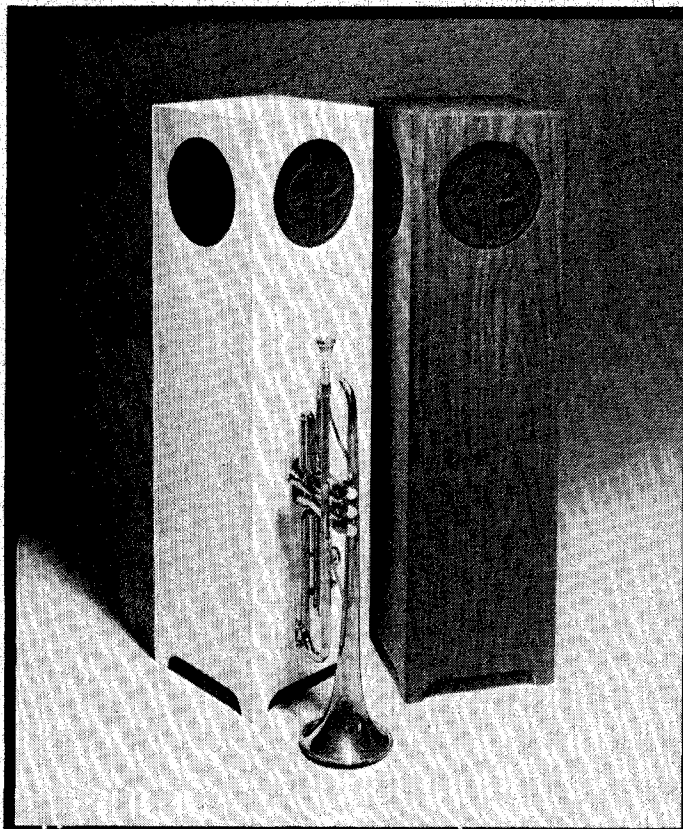

Sensational New loudspeaker system from the USA

EPI MICROTOWER I's

Yes, the impact is sensational. Superb performance complemented by really beautiful styling, at a price you can afford. Under \$100 each.

What is more the MicroTower I's are suitable for amplifiers rated from only 5 watts per channel, right up to 50 watts per channel.

They're available in both white and walnut finish to look great in your room. It all adds up to outstanding value, so hear them soon, see them soon, and you'll buy them soon. From your EPI Dealer.

For brochure & dealer list write:

AURIEMA (AUSTRALASIA) PTY LTD
P.O. BOX 604, BROOKVALE, NSW 2100

CONVOY FOR RELIABLE SERVICE ON QUALITY HI-FI EQUIPMENT

TAPE AND CASSETTE RECORDERS A SPECIALITY

The white building facing the end of Plunkett Street, Woolloomooloo.
Open all day Saturday and late Thursday. Ample parking.

Convoy Technocentre
Tel 357 2444

A.C.E. ELECTRONICS **RADIO** **PHONE 51-3845 51-7008**
136 VICTORIA ROAD, MARRICKVILLE, N.S.W. 2204



SONATA

All Silicon Solid State Hi-Fi Stereo Amplifier Model — 4000. Specifications: Power output 25 watt RMS per channel — 8 ohms. Harmonic distortion less than 2%. Freq. response 25-40,000 \pm 2dB. Input sensitivity magnetic 3mV ceramic 400mV Tuner 150mV Aux 150mV. Equalizer RIAA. S/N ratio more than 50 dB. Cross-talk more than 45 dB. Output Imp. 4-8-16 ohms. Tape output 50mV at R47K ohms. Tone controls: Bass 100 Hz \pm 10dB. Treble 10,000 Hz \pm 10 dB. Power 240V AC 50 Hz. Size 350w-200-110H m/m. Weight. 4.05kg. Features stereo headphone output. Rumble filter control. Loudness control. Slide balance and tone controls. Provision for extension speakers. Walnut/Teak cabinet, operating instruction booklet with circuit. \$99.00 pack and post \$2.00.

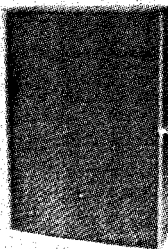

NEW MAGNAVOX 8.30 SPEAKER SYSTEM

16 c.ft. 8 ohms and
15 ohms. Oiled Teak
Veneer.

Complete, ready for use \$60.00
8-30 Speaker Only \$16.50 ea
3TC Tweeter Only \$3.40 ea
Fully Built Cabinet \$32.00 ea
Cabinet Kit \$22.00 ea

VARIE — ACK

Toroidal wound auto-transformers 240V
AC 50 Hz input continuously variable
0-260V AC
1 amp — \$23.75; 2 amp —
— \$25.95; 5 amp —
\$38.90; 10 amp —
\$61.00; 20 amp —
\$149.50



Standard
Stereo
Headphones
\$4.70

BATTERY CHARGER

12volt — 4 amp
Approved by elect authority. Mains

operated — complete with battery leads
and clips — unbreakable plastic case,
weight 3.8lbs automatic charging
foolproof fuse, double insulated. \$2.95 P
& P \$1.25.

GOODMANS

World Famous Bass Speaker, Model
Audlom 18-P, 18" Dia 8 ohm V-C 100
watts nominal \$98.00.

AMERICAN CTS 15" SPEAKERS

100 watts RMS voice coil 8 ohms, Bass
Guitar Model V.C. Dia 2" freq. range
30-4000 Hz Resonance 30-50Hz Sen.
100 dB. Lead Guitar — Elect. Organ
Model. Freq. 80-8000 Hz Reson. 70-90
Hz Sen. 107 dB \$76.00 P & P \$2.00.

STROBE TORCH

200 to 6000 flashes per minute. Ideal for
stop motion and slow motion study
\$140.00 P & P \$2.00.

STEREO TURNTABLES

Dual 1229	\$260.00
Dual 1218	\$183.00
Dual 1216	\$135.00
Dual 1214	\$112.00
Garrard Zero 100	\$171.00
Garrard Zero 1005B	\$171.00
Garrard SP25 KK 4	\$62.60
Garrard 5300 auto changer	\$44.60
BSR C142 auto changer	\$46.50

Above prices do not include cartridge.
Magnetic cartridge with diamond stylus
to suit all models \$12.50 extra.

PHILIPS AD0160

1" Dome tweeter. 8 ohms \$8.95 P & P
50c.

SENNHEISER HD-414

Stereo headphones \$25.00 P & P 65c.

BOOK REVIEWS

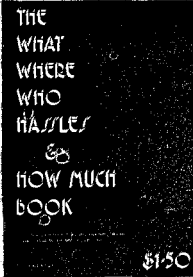

The W.W.W.H. & H.M. Book, edited by Roger and Valrie Harrison, published by 'Amateur Communications Advancements' 47 Ballast Point Rd., Birchgrove, NSW 2041. Price \$1.75 (including postage).

The What Where Who Hassles & How Much Book — otherwise to be known as the 'Amateur's Pink Pages; despite its black on yellow format — must be one of the most genuinely useful publications that we have seen for a very long time.

Basically it is a comprehensive listing of where to buy what and from whom in the electronics industry.

These are several *existing* directories of the Australian electronics industry, but these cater primarily for the large-scale equipment manufacturer and commercial organisations in general. They are of little use to the home constructor or one-man businesses.

Roger & Val Harrison, on the other hand, have set out to produce a component and equipment directory specifically intended for amateurs and small business concerns.

The directory covers everything from aardvarks to wound components, including a section entitled 'The Category of Certain Things' — a miscellany of miscellaneous companies.

Included in many sections are some extraordinarily accurate, succinct and amusing comments — George B... 's entry for example states 'have damn nearly everything', service slow — take sandwiches!

Everyone involved in hobby electronics *needs* this book — at \$1.50 it has to be good value — it's worth that just for the jokes!

Buy it. — C.R.

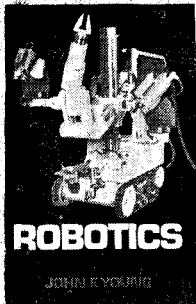

ROBOTICS by John F. Young. Published by Butterworths 1973. Hard covers, 303 pages 135 x 215 mm.

Most books on robots tend to be written in a popular vein with little technological descriptive content. This book is not in that category. It is written by a most experienced research and development worker and prolific writer in the practising world of robot deployment in the real world. It is an excellent review of the hardware and philosophy of automation techniques.

In Young's terms a robot is far more than a humanoid machine having human form. Here his terms of reference encompass all devices that make use of feedback and

cybernetic concepts. Included subjects, therefore, run to such topics as mechanical handling; artificial limb (prosthesis) design; pattern, speech and sound recognition; domestic aids; automated transportation and reliability of systems. This text is a must for any designer or user of automatic control hardware. It is a book that provides the practical know-how missing in most works covering control theory.

Subject material is grouped according to the various characteristics of animal physiology, thus relating to the design needs of a wide range of robot devices. Chapters include discussions of sensing, muscles, actuators, power supplies, mobility, limbs, vision, character recognition, perception, hearing, speech and reliability. There is, however, no mention of the vital survival mechanisms needed in the fully workable robot. Each chapter is tied to the original material with an average of some fifty learned papers: references run right up to the year of publication making this an invaluable source book.

The level of explanation is suited to all technically trained persons, the emphasis being on hardware more than on academic theory. The author has included many accounts of his experience; these, along with numerous quantitative descriptions of robots, help to convey the reader into a realistic world where robots live amongst us. It is a pity that the publishers chose a format without half-tone illustrations for line diagrams do not convey as much practice as a well chosen photograph. There are no plates and relatively few line diagrams.

This book, and its earlier companion volumes by the same writer... 'Cybernetics' and 'Cybernetic Engineering', give an efficient introduction into what robotry can do and to the current state-of-the-art in this expanding discipline. The book shows that we are still along way from the stage where robots could take over the world! — P.S.



NORTRONICS
AUDIO RECORD/PLAY HEADS
DIGITAL AND MINI DIGITAL HEADS
 Replacements for almost every recorder.
 Mounting Kits and Guide Posts.



The finest Replacement Heads available for CASSETTE 8 TRACK CARTRIDGE and REEL TO REEL RECORDERS and PLAYERS. Prices range from \$12.00. Alignment Tapes and Cleaners for Cassette, Cartridge and Reel to Reel.



Regular maintenance ensures continued optimum performance.
AUSTRALIAN MANUFACTURING LICENCEES
E.I. EMAC INDUSTRIES Pty. Ltd.
 23 Edinburgh Street, Huntingdale, Vic.
 Phone 544-5157

**The sound
quality of
reel to reel...**

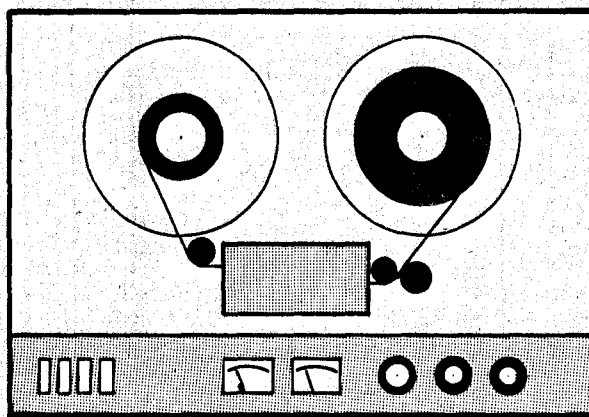

**with the fuss-free ease of
CASSETTE recording***



* KX-700 is the lowest-priced high-quality solid state Cassette Deck with the DOLBY unit that lowers tape hiss or background noise to that of much larger open reel decks. It's the ultimate in compact hi-fi recording.

It's in with the **CLICK** Clique

Just click a cassette into a Kenwood KX-700 Cassette Deck for the ultimate in *compact* hi-fi. Sound as real as reel to reel is yours because KX-700 incorporates the DOLBY unit that cuts tape hiss to an inaudible low . . . whether you listen on headphones or pipe the great sound through your stereo hi-fi system. There's no toying with tapes . . . cassettes click in—pop out—and your hands are free for better things. Get long-play, fuss-free real sound enjoyment . . . Kenwood KX-700 stereo Cassette Deck.

FEATURES • Dolby Unit • Super Ferrite Heads • 25-16,000 Hz. frequency response • Wow/Flutter less than 0.13% • 3-tape selector • Auto shut-off • Sliding switches • VU meters • Microphone and headphone jacks.

NEW KX-700 by
KENWOOD

Distributed by:

JACOBY
MITCHELL

• Sydney 630 7400 • Newcastle 61 4991 • Wollongong 84 8022 • Brisbane 52 8266 • Melbourne 41 7551 • Hobart 34 2666 • Adelaide 93 6117 • Perth 81 4144

SENSORS ON

Observations about science and technology — by Talus

On the stupidity of man (or travelling in cars).

PSYCHOLOGISTS have a theory that the human animal is bent on his own destruction. There is plenty of evidence to support this theme!

Have you ever driven a car in thick fog? I remember a time when visibility was down to a few metres ... wet mist, fog and at night ... My safe speed seemed to be around 30 kph and I was wondering all of the time when a car would loom out of the gloom ahead, on my side of the road. To my amazement a car appeared behind me and overtook at quite a speed. As its tail lights were very visible I decided to follow at his pace but at a respectable distance behind. I couldn't keep up! The car reached 90 kph before I decided he was courting disaster and, therefore, so was I. I opted out — leaving it to fade away ahead.

There must be something about fog, for the motorways in Europe, where it occurs commonly (it is not all pollution, but usually natural mist), are the frequent scene of great pile-ups. In March the British M1 road saw 160 vehicles involved in just 40 minutes; there have been many similar incidents before.

Solutions are ever being tried. For instance, these motorways have warning lights that state the safe speed to observe. But few drivers follow the rules, as was demonstrated by a big accident a year or so ago.

The French have suggested a more positive solution. Firstly, all cars would be fitted with closed circuit radio so that they are all in potential communication over a small area. When a car is involved in a reasonably bad accident its accelerometer triggers the car's transmitter sending out a warning signal to cars within about 1 km. These cars, in turn, send out a repeated signal to those behind.

It sounds a great scheme for it provides the police with a means to communicate with the moving driver for this and other purposes. Personally I very much doubt if the drivers would

all take heed of the warning signal (an audible one is suggested in preference to a visible one). A more positive device is needed to provoke the driver to obey or, even better, completely overrule his ability to control the car's speed. There would be problems in this last idea and I leave that to our designers.

Costwise the experts say this scheme is not comparable with the cost of accidents. It works out that the accident rate due to this cause is equivalent to only a few dollars spent on each new car. How you can really assess the cost of the lives lost is another matter though. Personally, an anti-collision device or system that cost me about \$30 seems money well spent: I value life at a great deal more than that.

Other schemes have been proposed and several are under serious consideration at this time. Radar devices are the most favoured but still a few years away from the market place. It is a matter of price.

Who can really say what will develop. Cars may go right out of fashion before anti-collision devices are brought down in cost. Looking back a mere few years we have seen what can happen in the semiconductor and circuitry market. Radios that are cheap enough to throw away rather than repair, calculators that threaten to replace the learning of tables and arithmetic in everyday life and computers that rule the design of systems because of their cheapness and tremendous versatility.

As interesting as human behaviour in fog is human tolerance to dangers. We know alcohol and driving fatalities are highly correlated, we know alcohol and driving fatalities are highly correlated, we know that driver skill is so variable that the roads carry drivers of woeful ability in demanding situations, we know that our road systems have deficiencies that provide accident situations where there is no

alternative but collision .. the situation becomes totally beyond the drivers' control. Yet for all of this we continue to tolerate the shortcomings of the road transport system.

In sharp contrast are the very stringent safety measures demanded for air travel (the recent DC10 disaster raises doubts when one hears that the procedure for closing the fatal cargo door was probably not understood because the man who closed it could not read the notices!). Even though the safety of air travel, per mile covered, is far better than for the domestic car, there must be few of us who do not feel a slight amount of apprehension when we travel by plane.

The fact is that humans are so variable and so fickle that they have the inbuilt and often unconscious power to totally overrule a fact they do not wish to hear. At least machines do not suffer from this gross defect. ●

FM Radio is coming!

But did you know
that many
programmes will be
broadcast in
stereo?

Next month's ETI
explains how it works

ELECTRONICS TODAY
INTERNATIONAL

June issue — on sale — end of May

TIME CHECK FOR RADIOCARBON DATING

Bedevilled with the problems of establishing the true age of prehistoric remains, archaeology has been revolutionised in the past 20 years by the introduction of scientific methods of dating where previously there was mainly inspired guesswork. For organic remains such as wood and bone, the chief of these methods is radiocarbon dating. But this technique has been shown not always to give accurate results . . .

BEDEVILLED with the problems of establishing the true age of prehistoric remains, archaeology has been revolutionised in the past 20 years by the introduction of scientific methods of dating where previously there was mainly inspired guesswork. For organic remains such as wood and bone, the chief of these methods is radiocarbon dating. But this technique has been shown not always to give accurate results . . .

The principle of radiocarbon dating is that a fraction of the carbon dioxide in the atmosphere contains radioactive carbon-14 which is absorbed by plants during photosynthesis and by animals feeding on plants. When the plant or animal dies, the input of carbon stops and the carbon-14 gradually reverts to

the common non-radioactive form, carbon-12. So the ratio of carbon-12 to carbon-14 in a dead plant or animal is a record of the time lapse since it died.

Radiocarbon dating is not accepted without reservations however. Where written records are occasionally available, as in Egyptology, the method is sometimes shown to be wrong by several hundred years. Probably the proportion of carbon-14 in the atmosphere in those times differed from today's value so that dates calculated using the present level have a built-in error. Therefore, the radiocarbon method itself needs checking.

A way of doing this has now been devised by Professor Colin Renfrew, an archaeologist at the University of Southampton, Southern England, and a statistician from the northern English University of Sheffield, R. M. Clark. They report that the radiocarbon method can be corrected to make it safely applicable to finds dating back to 5000 BC.

COMPARISON AVAILABLE

Clark and Renfrew looked at two geographical regions where alternative methods of dating happen to be available for comparison with the radiocarbon clock.

American scientists have found that high up in the White Mountains of

California a tree, the Bristlecone Pine, survives to an incredible age — some are 4500 years old, making them the oldest living things — and the dry climate allows the preservation of still older dead trees. By counting the annual growth-rings the wood in the trees can be dated to within two or three years. That is a ready-made check on the radiocarbon method which shows that dates obtained by it are fairly accurate — back to 1500 BC, although they become seriously wrong for earlier times. For example, pine formed in 2500 BC gives a radiocarbon date of only 2100 BC, and wood known to have been formed about 5000 BC is given a date almost a thousand years younger.

But because of the uncertainty engendered by the imprecision of the radiocarbon clock, archaeologists are loth to rely on the Bristlecone Pine calibration. One fear is that the concentration of carbon-14 at the high altitudes where the pine grows might have been in some way unusual, making the radioactive basis in California not strictly comparable with that in Europe and the Middle East.

So, for a second check, Clark and Renfrew went back to the written records of ancient Egypt. From 1800 to 3000 BC these can be dated accurately by reference to the astronomical events they mention. Thus when-ever organic material is found in conjunction with written records a further check on the radiocarbon method is possible.

However, neither method can be used on its own as a calibration for the radiocarbon method — in the first case because the carbon-14 content of the trees may be in some way anomalous, and in the other because the Egyptian finds dated by the radiocarbon method may somehow have got mixed up with written material from an earlier or later time. So Clark and Renfrew used statistical techniques to compare the two methods of calibration. This is necessary to check whether any discrepancies that do occur are sufficiently small to have happened by chance, or whether they are serious enough to cast doubt on the validity of either scale.



Carbon dating is throwing new light on the Megalithic structures of Western Europe, such as Stonehenge which is set on Salisbury Plain in the south of England.

It turns out that the two scales are compatible, and as the chance of each scale being in error by exactly the same amount is extremely small, the conclusion is that either can be used. But as the pine tree calibration is more detailed and covers a greater span of time it is used in preference to the Egyptian data.

SIGNIFICANCE OF RESULT

This result has great significance for archaeology. Our knowledge of European prehistory is being radically changed by radiocarbon dating so the greater confidence which should follow from Clark and Renfrew's work will be widely appreciated in scientific circles. Perhaps the most notable advance is that archaeologists are questioning the view that European culture originated in the ancient civilisations of the Near East, gradually fanned out through Europe and eventually reached the western coasts. This 'diffusion theory' arose long before scientific dating of individual finds became possible, and is founded on factors such as supposed similarities of style between tombs in western Europe and the Near East.

Carbon dating is causing a startling revision of these views. Megalithic structures in western Europe — for example, that remarkable and huge stone circle, Stonehenge, in southern England — are found to be older than structures in the Aegean which are supposed to have influenced them. By showing how the carbon-14 clock can be corrected, Clark and Renfrew make these relationships much more distinct. On the 'diffusion' theory, megalithic tombs in western Europe are based on tombs built in Crete about 2500 BC which can be dated from Egyptian artifacts found with them. Yet the carbon-14 dates for the western tombs are 3000 to 3500 BC. In Britain, Stonehenge was attributed to Aegean influences arriving in Britain around 1500 BC, but it now seems to have been built 500 years earlier.

Perhaps even more important, Clark and Renfrew greatly extend the potential of radiocarbon dating. Although strictly speaking their work applies only from 1800 to 3000 BC, it strongly suggests that the corrected method can be used to the limit of the Bristlecone pine tree data, 5000 BC approximately, with the possibility of going back a few thousand years earlier as even older pieces of wood turn up in California.

In principle the carbon-14 method, can date material as old as 50 000 years, but although an accurate calibration for the first 10 000 years is now within reach, there is still no way of knowing whether the method is accurate for the earlier period. ●

Coilmaster

**DELUXE
ACCURATE
COIL
WINDER
\$17.95**

Post & Pack \$1

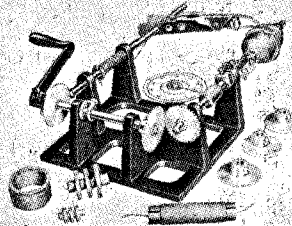

This Easy-to-use machine winds honeycomb, spiderweb and solenoid coils of various widths and diameters — equal in appearance to a factory job. Also suitable for winding chokes, transformers and filter inductors. Indicator counts number of turns on coil. The COILMASTER is suitable for both experimental and practical work. Supplied with accessories including wood spools, metal pegholders and extension for making long solenoid coils. Instructions included.

SEND REMITTANCE WITH ORDER FOR IMMEDIATE DELIVERY ANYWHERE TO THE SOLE AUSTRALIAN AGENTS.

LAFAYETTE ELECTRONICS 94 HIGH ST., ST KILDA, VIC 3182. Phone 94-6036

PROTECT YOUR MAGAZINES



BINDERS

HOLDS 12 COPIES OF

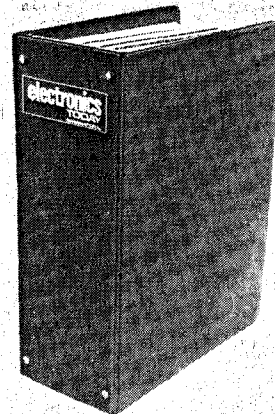

**electronics
TODAY
INTERNATIONAL**

ONLY \$3.50

INCLUDING SALES
TAX & POSTAGE

**CONTACT:
SUBSCRIPTION DEPARTMENT**

**MODERN MAGAZINES (HOLDINGS) LTD.,
15 BOUNDARY ST., RUSHCUTTERS BAY, 2011**

The Convoy Technocentre now represents the complete range of **BANG AND OLUFSEN** audio equipment in Sydney. A special Bang and Olufsen centre has been created within the Technocentre where you can relax, listen, and look at the advanced styling that is a feature of all Bang and Olufsen equipment. The Convoy Technocentre, the white building facing the end of Plunkett Street, Woolloomooloo, phone 357 2444. Ample parking.



BEOSYSTEM 1200. This is a complete stereo system designed so that each unit perfectly complements the others. The Beosystem 1200 is a break with tradition offering many fine features and placement possibilities.



Bang & Olufsen

Convoy Technocentre

A
L
A
N

OLIVER ELECTRONICS

188-192 PACIFIC HIGHWAY ST LEONARDS

PHONE 43-5305 PO BOX 4, NSW. 2065.

P
T
Y
L
T
D

VORTEX CASSETTE DECK

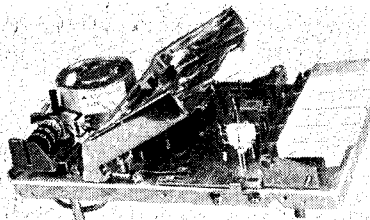

Stereo Cassette mechanism with cassette eject, resettable counter and piano key controls... Price \$29.00 P&P \$1.00.

STEREO RECORD & REPLAY PREAMPLIFIER KIT. Fits directly on to Vortex deck and matches up to piano key controls. Circuit includes Erase & Bias Oscillator, Gain and Bias Controls, etc.

BASIC KIT... comprises P.C. Board, Function switch, Equalisation Inductors, Bias Trim pot, circuit details etc. . . . Price \$8.00 P&P 50c.

COMPLETE KIT... comprises all components necessary to build the full Preamplifier . . . Price \$21.00 P&P 50c. Mains Kit to supply pre-amp. \$7.50 P&P 50c.



THE BIGGEST NAME IN KITS

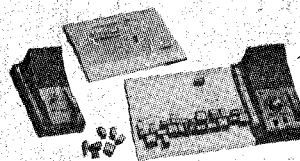

HI DAD
"For the junior engineer"
THE ELECTRONIC WORKSHOP "36"
36 Interesting Projects
Introduction to Electronics
\$29.42 P & P \$1.00

SINE SQUARE WAVE GENERATOR
1 Hz to 100 kHz sine wave & 5 Hz to 100 kHz square wave.
Both outputs floating.

Kit IG-18, \$103.82
P & P \$1.00

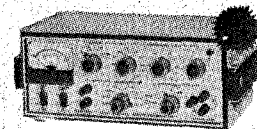

SOLID STATE VOM
The Heathkit IM-16 combines the precision of a vacuum tube voltmeter and the portability of a voltohmmeter. A front panel switch permits operation from the power line or the internal battery.
Kit IM-16, \$77.43 P & P \$1.00

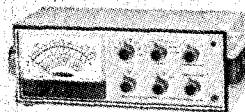

YOUR LOCAL



Catalogue 30c P&P

DISTRIBUTOR

RECORDINGS POP

REVIEWER: Mike Delaney

"For Everyman" — Jackson Browne.
W.E.A./Asylum. Stereo. SD.5067.

"Grievous Angel" — Gram Parsons.
W.E.A./Reprise. Stereo. MS.2171;

"Laid Back" — Gregg Allman.
W.E.A./Capricorn. Stereo. CP. 0116;

"Valley Hi" — Ian Matthews.
W.E.A./Elektra. Stereo. EKS.75061;

"Song For Juli" — Jesse Colin Young.
W.E.A./Warner Bros. Stereo. BS.2734;



"Well I've been out walkin'
I don't do too much talkin'
These days.

These days —
I seem to think a lot
About the things that I forgot
to do.

And all the times I've had the
chance to . . ."

"These Days" — Jackson Browne.

Songs of Innocence and Experience,
Songs of Love and Loneliness, Songs
of Pain — Music for the Spirit: heart
food for the times your soul needs (at
least) to feel free.

. . . And if you think it will help I
can bring my guitar and sing you a
song."

Gram Parsons, Ian Matthews, Jesse
Colin Young, Jackson Browne, Gregg
Allman — poets, weavers of melody
and emotion, dealing openly and
intelligently with their existence,
illuminating golden our capacity to
love. For finding a way to love, as the

grievous angel himself would always
say.

Ten more years down Dylan's
speechless, seeking trail — the Spirit
which silently loops the ties that bind,
reconciling everything;
Renewal-through-loss/Truth-through-
pain; Hope sad-eyed and Faith
sometimes laughing. Joni Mitchell said
it best: "And you could complete me
— I'd complete you."

All this pathos must surely signal
something?

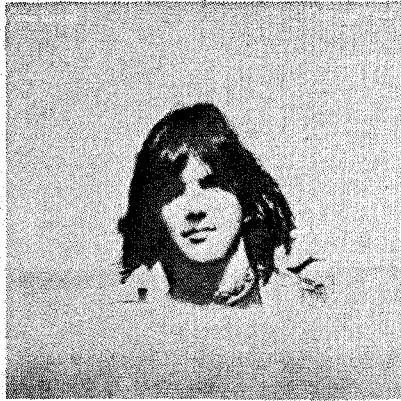

"It's a hard way to find out
that trouble is real.
In a far-a-way city
with a far away feel.

But it makes me feel better
Each time it begins —
Callin' me home —
Hickory Wind."

*"Hickory Wind" —
Gram Parsons/Bob Buchanan*

"Grievous Angel" is the second and
last solo set from the late Gram
Parsons, hurt child-whore with the
heart of gold, unrecognized motivator
behind much of the best in
contemporary country/American
Roots music through his work in the
Byrds, the Flying Burrito Brothers and
his close personal influence over the
Jagger-Richard team i.e. "Dead
Flowers", "Wild Horses", "Angie"
outstanding. A few high reelers, some
hard picking barrel-house roll, one or
two road songs and a host of archingly
beautiful love ballads all set down with
honesty, simplicity, tenderness and
charm; a curious blend of White
Gospel/country blues tradition, Grand
Ol' Opry sentiment and Nashville
funk, mellowed out in the warmth of
Parsons' Southern sensibility and
strength in Spirit — troubled, ever
restless, yet somehow centred firmly

Far superior to the excellent though
erratic "G.P." release of some twelve
months ago, "Grievous Angel" is the
legacy of a young master, soul
inspired, soul weary, seeking
fulfillment | truth-through-pain
(whatever happens, regardless, just
don't be denied). A beautiful album
laid heavy with harvest: Boudleaux
Bryant's "Love Hurts", Tom T. Hall's
rollicking "I Can't Dance", a remake
of the Byrds' classic "Hickory Wind"
and a batch of Parsons newbies —
"Brass Buttons", "Las Vegas", \$1000

Wedding" and "In My Hour Of
Darkness".

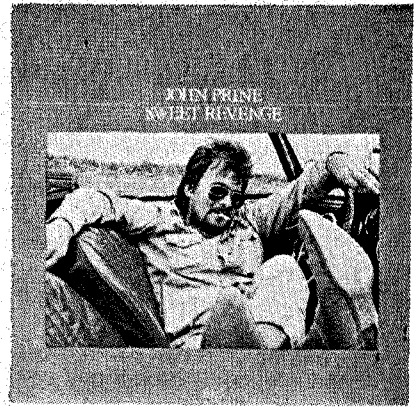

In a vein not unrelated to Gram
Parsons, Jesse Winchester's intimately
lyrical "Third Down — 110 To Go"
(W.E.A./Stereo. BR.2102) and John
Prine's devastating, thoroughly
inspired debut set simply titled "John
Prine" (W.E.A./Stereo. SD.8296) mark
further definitives in contemporary
country, and, as such, cannot be
recommended too highly. Also, Prine's
latest, "Sweet Revenge"
(W.E.A./Stereo. SD.7274) and Loudon
Wainwright's current "111"
(C.B.S./SBP. 234238) shouldn't be
overlooked.

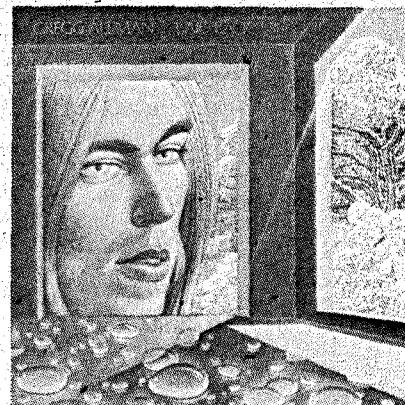

Gregg Allman's superb "Laid Back",
his first solo effort outside the Allman
Brothers Band, draws a wide, lucidly
convertible birth in styles, juxtaposing
Chicago and Delta blues, Atlantic soul,
country, orchestrated jazz/rock forms
and heavily emphasized Gospel in any
and all combinations, relying largely
on accentuated brass/guitar/multi-
keyboard interlays, cascading rhythms,
deliberate and pronounced tempo. A
vividly lyrical, majestic set, each song
sent soaring with Allman's keen sense
of Spiritual purpose, directive presence
and sheer generosity, richness in
sound: "Midnight Rider", "Queen of
Hearts", Jackson Browne's classic
"These Days", "All My Friends" and
the traditional "Will The Circle Be
Unbroken" do it best — with urgency,
drama, poetic depth. An album to
cherish down through the years: file it
alongside Gene Clark's "White Light"
(Festival/Stereo. SAML.934353) and
you'll have a pair.



"There's a Spirit in the wind today.
Keep on —
Keep on sailing.
You can't make it on your own."

*'Keeping On Sailing' —
Ian Matthews*

For years the most articulate, consistently moving writer/performer involved with English folk styles through his work in Fairport Convention, Matthews' Southern Comfort, Plainsong and as a solo artist, Ian Matthews has finally gone California country with a vengeance, a move he's been edging towards and threatening for years (particularly in view of his most recent Plainsong adventure — "In Search Of Amelia Earhart" (W.E.A./Stereo EKS.75044). Splicing the order and clarity of the former with the economy, colour and poignancy of American Roots music, "Valley Hi" bears the fruit of both traditions, naturally, joyfully, expertly: Richard Thompson's "Shady Lies", the Scotch reeling "Old Man At The Mill", songs from Jackson Browne, Randy Newman, Steve Young, Michael Nesmith and Don Gibson, plus Matthews' own "Keep On Sailing", "Leaving Alone" ring pure with sincerity, conviction, much and subtle grace in Spirit. A gorgeous, absorbing album to rock gently and warm your heart.

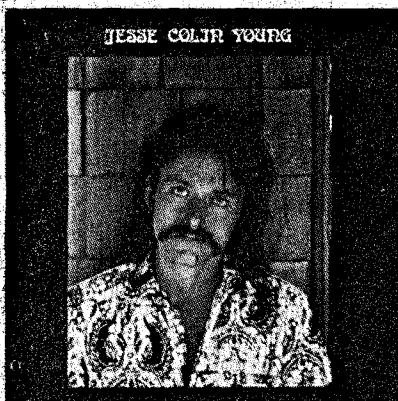

"When the mornin' sun has come shining darkness from my eyes —
And I wake up in the tree tops.
Darlin' —
Got you by my side.
There's a sweet smile on your face

And your hair is all undone.
Yeah, and I feel that we are one
When the mornin' sun has come."
'Morning Sun' — Jesse Colin Young

"Song For Juli", Jesse Colin Young's first solo since the Youngbloods suffocated themselves, is definitive Sunshine music — light, effervescent, billowing free like clouds in the breeze; weaving joyously acoustic folk, country, Dixie blues, Rag-time jazz, Swing, Scat, massive amounts of New Orleans panache — everything lilting high with humour, enthusiasm, taste and subtlety. Songs of Praise and Affirmation, glowing love songs — refreshing, invigorating like a cold stream mountain fall bathed in sunlight, warmed by those peaceful, easy feelings from an open heart. Real Ozone music gliding free-flight — a glorious, wholly elevating sound, guaranteed to return you safely to your door at journey's end: "Morning Sun", the lyrical "Ridgetop"/"Evenin'" suite, T. Bone Walker's funky "T. Bone Shuffle", the delicate, floating "Song For Juli" and a pacy "Lafayette Waltz"/"Jambalaya (On The Bayou)" medley are the picks.

With Gregg Allman, Ian Matthews, particularly Jesse Colin Young and Jackson Browne, it's a music of Renewal; of clear light and fulfillment through Hope, Faith, much love — everything as it should be: positive, triumphant, dancing with optimism, a rich and resonant love of life, of wide and open space, of the free elemental Spirit — equal parts earth and wind, fire and water. Sunshine music!

If the shoe fits, and Sunshine music does come in every size, why not check out the following releases, some new, all definitive: Grateful Dead's enervating "Wake Of The Flood" (W.E.A./Stereo. GD.01) and the latest "Best Of — Skeletons From The Closet" (W.E.A./Stereo.W.2674); "The Captain & Me" (W.E.A./Stereo.BS.2694) and the just issued "What Were Once Vices Are Now Habits" (W.E.A./Stereo.W.2750) by the ever-ebullient Doobie Brothers; David Crosby's brilliant first solo "If I Could Only Remember My Name" (W.E.A./Stereo.SD.7203); anything by Jonathan Edwards, especially "Honky-Tonk Stardust Cowboy" (W.E.A./Stereo.SD.7015); Bob Dylan's "Planet Waves" (W.E.A./Stereo.7E.1003) by far his best in years; "Last Train To Hicksville" (Festival/Stereo.L.34960) the final set from the enigmatic masters of pre-rock Hoke, Dan Hicks & His Hot Licks; "Holland" (W.E.A./Stereo.MS.2118), "Surf's Up" (E.M.I./Stereo.SOSL.10313) and the current "In Concert" (W.E.A./Stereo.2RS.6484) — all three by the staggeringly fine Beach Boys; Steely Dan's eloquent "Can't Buy A Thrill" (E.M.I./Stereo.SPBA.3057); everything by the excellent Loggins & Messina, particularly their latest "Full Sail" (C.B.S./Stereo.SBP.234438); the gentle, evocative "Hat Trick"

(W.E.A./Stereo.BS.2728) by America; the Byrds' double master work "Untitled" (C.B.S./Stereo.S2BP.220065). Take your pick.

"Now if I seem to be afraid
to live the life that I have made
In song —
Well it's just that I've been losing
for so damned long.

Please don't confront me with my failures
I have not forgotten them."

'These Days' — Jackson Browne

Quite simply, Jackson Browne is one of the most sensitive, poetic and meaningful writers in contemporary music — many of his songs already well known through Judy Collins, The Byrds, Jackson Five, Bonnie Raitt, The Eagles, Gregg Allman, Linda Ronstadt and so many others: "For Everyman", along with his debut set ("Jackson Browne" — E.M.I./Stereo.SYL.9002) is one of those rare, great occasions when it all seems worth it, like when the Vision would rise upon William Blake's "weary eyes, Even in this Dungeon & This Iron Mill". A troubadour, acoustic in style, his songs reflect an uncanny, wholly riveting insight and compassion, Soul light by surrounding sorrow, for the seeker searching fulfillment — both Spiritual and emotional. An intensely introspective poet, ever hopeful with all faith placed in love; an artist with the sublime knowledge that everything's going to turn out fine regardless, so there's little point in despair.

"For Everyman" is a work of permanence — definitive heart balm. Again, Songs of Praise and Affirmation, Love songs so explicitly beautiful, so completely real, so thoroughly moving. "Our Lady Of The Well", "I Thought I Was A Child", the gently forceful "Take It Easy", "These Days" and the intimate "Times You've Come" feature and highlight one of this year's best albums:

Honestly, you can't afford not to hear Jackson Browne — both albums, with what they have to say, mean a great deal to you.

THE HEAVIEST OF METALLOIDS AND THE BEST IN ROCK'S ART- DECO.

"Burn" (E.M.I./Stereo.TPSA.3505) from the much renovated Deep Purple riff machine; "Iceberg" (Festival/Stereo.L.35001) by ex-Man guitarist, Deke Leonard; Grand Funk's excellent "Shinin' On" (E.M.I./Stereo.SMAE.11278) — further proof of Todd Rundgren's genius in production; "Stranded" (Festival/Stereo.ILPS.9252) — the third and finest from England's amazing Roxy Music; the Who's "Quadrophenia" (Phonogram/Stereo.2644.001) — a dredging back and dangling of England's mid-sixties. ●

D.C. TO 15MHz

5mV/cm

506

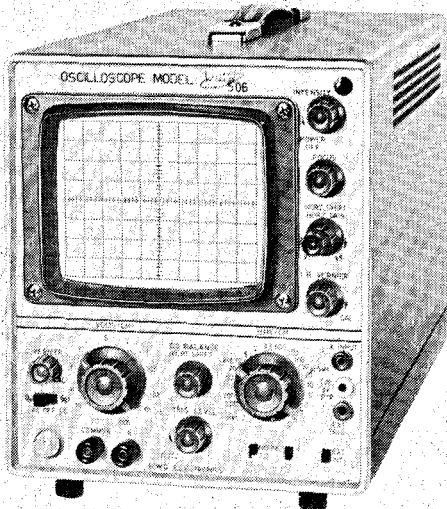

A superb single beam oscilloscope providing wide band width with high sensitivity, extremely stable TV triggering and an isolated ground for those difficult to obtain 'in circuit' measurements.

Bandwidth: DC to 15MHz - 3db
Sensitivity: 5mV to 50V/cm with vernier
Time Base: 200n Sec - 10 Sec/cm with vernier
Magnification: x1 to x5 calibrated
Triggering: 5Hz - 15MHz 1 cm deflection or 1V p-p ext.
Trig. Facilities: AUTO. Level select Int, Ext and TV
Horz. Amplifier: DC to 1MHz - 3db
Sensitivity: .6V to 6V/cm
Z Modulation: 20V neg. to blank trace at normal, intensity, input T.C. 5mSec (DC coupled option available)

PRICE: \$304 F.I.S. Capital Cities plus tax applicable

D.C. TO 7MHz

10mV/cm

509B

The finest value low cost 100% solid state oscilloscope available today. Thousands in use around the world serving education, colour T.V. servicing and industry.

Bandwidth: DC to 7MHz - 3db
Sensitivity: 10mV to 50V/cm
Time Base: 1 μ Sec to \geq 1 Sec/cm with vernier
Magnification: x1 to x5 calibrated
Triggering: 2Hz to 10MHz 1 cm deflection or 1V p-p ext.
Trig. Facilities: AUTO, Level select, Int and Ext.
Horz. Amplifier: DC to 1MHz
Sensitivity: .6V to 6V/cm
Z Modulation: 20V pos. blanks trace at norm inten.

PRICE: \$209.00 F.I.S. Capital Cities plus tax if applicable.

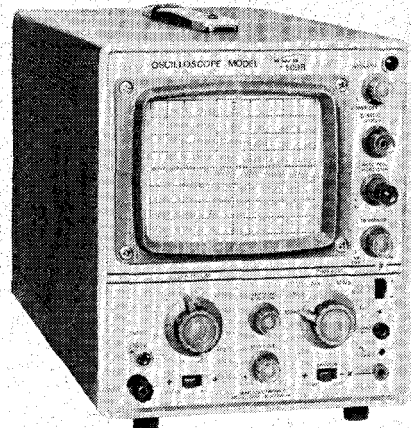

**WINNER OF AWARD
FOR OUTSTANDING
EXPORT ACHIEVEMENT**

B.W.D. ELECTRONICS PTY. LTD.

Designers and Manufacturers of the finest electronics instrumentation.

329-333 Burke Road, Gardiner, Vic. 3146 PH: 25 4425 (3 lines)

127 Blues Point Road, North Sydney N.S.W. 2060 PH: 929 7452 92 6756

• S.A. A. J. Ferguson Pty. Ltd. PH: 51 6895

• W.A. Cairns Instrument Services PH: 25 3130

• Q.L.D. Warburton Franki (Brisbane) Pty. Ltd. PH: 52 7255

• A.C.T. Associated Scientific Sales Pty. Ltd. PH: 95 9138

DUMMY HEAD RECORDING

In E.T.I. March '74 you have a reference to Sennheiser dummy head stereo recording.

The following is extracted from an editorial by John W. Campbell, out of Analog S.F. dated November 1962, and may be of interest to you.

"The sine-wave theory of speech and hearing seems to be one of those false postulates like phlogiston. It's mathematically handy, because maths can handle sines and cosines so readily — but that doesn't make it valid. Plane geometry is much easier than spherical, but that doesn't mean you can navigate around the earth using plane geometry.

Dr. Wayne Batteau, of United Research Corporation, has developed a new approach: he has a gadget that encodes human speech into a pure binary pulse code — pure on/off — that a computer can accept directly.

He can transmit his coded pulses with a two-hundred Hz channel, and decode it to clear intelligible speech. His encoder gadget costs I should guesstimate, about \$5 to make, and the decoder perhaps \$50.

It discards completely the theory of sine wave frequency distributions, amplitudes, et cetera, and approaches the problem from a quite different aspect — a pure time analysis concept.

Dr Batteau has, also, developed a system of three-dimensional sound recording that makes any stereo effort seem exceedingly clumsy — also based on a time-analysis theory of sound. (stereo is designed to allow you to determine the left-right direction of sound: Batteau's system allows you to determine that a source is up-to-the-left or down-in-the-centre. It's three dimensional, not two. With it, you can hear a girl shaking the maracas over, under, and around behind your head — which is a quite, ghostly effect indeed!)

Batteau's encoder eliminates frequency, amplitude, and phase, as such. There are plenty of clues around that these are unimportant — the four year old treble and the basso profundo use neither the same frequency, frequency spectrum, nor amplitude. Whispering and shouting both transmit the same message — and don't show similar frequency or amplitude distributions.

The Artificial Larynx, originally developed by Bell Labs during their sound research, allows a man to talk,

yet he can control neither frequency nor amplitude. It has even been shown that a man in a very noisy environment can 'talk' understandably without making a sound himself! Merely moving his lips, jaws, and tongue produces a shaping of the ambient sound which can be heard as speech.

One item that Batteau did — a crucial one — was his discovery of the true function of the pinnae — the external ears. The Biophysics communication group, at MIT, when I asked them some questions concerning the external ears, were quite sure that they had no real significance in hearing research — that experiments with microphones in silicone rubber mouldings made from human ears were quite pointless and rather silly.

According to the Official Orthodox Theory of how we hear, the external ears are quite unimportant — more decorative attachments like a moustache, than useful or necessary functional parts of the hearing mechanism. So the Biophysics Communication people necessarily held that research into that aspect of hearing wasn't a worth-while project.

They happen to be wrong.

Most animals have mobile, dirigible trumpet ears — the horse for instance. The primates are unusual in having the peculiar convoluted, immobile ears they do... and the primates are also unusual in having an immensely developed and convoluted brain attached to those ears.

Another class of animal having complexly convoluted, and rather immobile ears, are the bats however.

And bats just happen to be world's top sound-system experts.

There's a simple experiment you can make that's quite astonishing. There are two steps; 1. Have a sit down, eyes closed, facing B, who's equipped with some keys to jingle. B jingles the keys, high-left, low-centre, high-right, et cetera, while A locates the source of the sound, points, and then open his eyes to check. The usual score, with normal hearing, will run ninety per cent accurate both in altitude and azimuth. Step two changes one factor: 2. A holds the upper part of his ears downwards with his fingers, locates the sound, points and open his eyes. Normal hearing gives about ninety per cent score on azimuth — but the altitude angle is wildly inaccurate.

Conclusion: One minute spent experimenting indicates most strongly

that the external ear is no mere decoration! It is, somehow, an astonishingly effective device for determining the vertical angle of a sound source. (Not important to a plains animal of a large size — like a horse — but *quite* important to an arboreal monkey).

Incidentally, you'll find that you can do almost as well with a single clink of the keys, as with continued clinking. The sound-locating system works perfectly on a single transient. It had to; predators don't ordinarily make continued crackling noises in the underbrush.

Batteau found, with his moulded ears, and tiny microphones where the eardrums would be, that the external ear constitutes a dual acoustic delay line network — a highly asymmetrical delay-line that imposes about a two-microsecond delay on sound waves arriving from different vertical angles, and a different form of delay on sound waves arriving from the rear.

The Official Authorised physicists today love to talk about "highly sophisticated techniques"; one of these days those highly sophisticated physicists are going to catch up with the highly sophisticated technique of sound-locating that grandly ignored 'mere decoration' of the external ear actually is. But only at the expense of sacrificing his Orthodox Theory; since it is known that human ears can't hear above about 15,000 cycles per second, it's obviously impossible for them to distinguish a two-microsecond phenomenon.

So there they sit, with their ears hanging out, and not listening to what they're hearing."

John E.V. Ellis
Wongan Hills 6603

The above may not represent MIT's Official Orthodox Theory now. During his recent visit to Australia I had dinner one evening with Dr. Bose (who, apart from making some very fine speakers is Professor of Electrical Engineering at MIT). Dr. Bose expressed views very similar to those contained in the above letter — in particular, the part that the pinnae play in the location of a sound source — Ed.

CHINESE SEISMOGRAPHS

Seems as if there was more to that Chinese seismograph (ETI, March, April 1974) than was at first apparent.

(Continued on page 130)



no gimmicky sales talk. just the facts.

- * High-precision, polished uniform thickness POLYURETHANE BELT provides smooth revolution with minimized wow-flutter (less than 0.175) and high s/n ratio (better than 48dB).
- * DIE-CAST ALUMINIUM ALLOY DOUBLE RIM PLATTER, driven by belt drive system assures precise and constant speed through optimum flywheel action.
- * 4 POLE SYNCHRONOUS MOTOR assures smooth, and stable revolution.
- * STATIC BALANCE TYPE S-SHAPED TONEARM with REVOLVING TYPE COUNTERWEIGHT eliminates lateral balancing weight and assures easy and stable operation.
- * New ANTI-SKATING DEVICE, with self compensating CANCEL FORCE according to stylus pressures, eliminates the distortion caused by inside-force and protects stylus and record.
- * REVOLVING type counter weight and PLUG-IN TYPE. New SLIM LINE and non-resonance HEAD SHELL made of special light aluminium alloy accepts cartridges of 4 to 9 grams.
- * DIRECT READING SCALE RING coupled with counter weight permits easy and accurate adjustment of the stylus pressure from 0 to 3 grams.
- * OIL DAMPED ARM LIFTER provides the up and down arm movement by feather-touch lever.
- * "FEATHER-TOUCH" SPEED SELECTOR allows easy selection of 33.1/3 or 45 r.p.m: speed with BELT PROTECTION MECHANISM.
- * CARTRIDGE, designed after severe hearing test, reproduces fresh dynamic sound realistically with fine tracing ability.
- * SEMI-AUTO and MANUAL models also available.

RALMAR
agencies pty. ltd.

71 Chandos St., St. Leonards 2065 Tel.: 439 4352

AGENTS:

QLD: Tallerman & Co. Pty. Ltd., Robertson St., Valley, Brisbane
VIC: K.J. Kaires & Co. Pty. Ltd., 4 Hill Court, Macleod
S.A.: K.D. Fisher & Co., 72-74 McLaren St., Adelaide
N.Z.: Avalon Radio Corp. Ltd., 131-139 Hobson St., Auckland

STATE DISTRIBUTORS:

W.A.: G.K. Cameron & Co. Pty. Ltd., 246 Churchill Ave., Subiaco
A.C.T.: Sonny Cohen & Son, 20 Isa St., Fyshwick
TAS: W. & G. Genders Pty. Ltd., Launceston, Burnie, Hobart
N.T.: N.T. Musical & Electrical Wholesale Pty. Ltd., 54 Cavenagh St., Darwin



NEW ERA III BEGINS



Now after seven years of extensive laboratory research and development, the remarkable Shure V-15 Type III Phono Cartridge is ready for the connoisseur's high fidelity system. It clearly defines the outer limits of the state of the art of phono cartridge design. It is indeed the worthy successor to the world-acclaimed V-15 Type II Improved!

Among its brilliant innovations is an all-new laminated magnetic core structure, and an exquisitely designed stylus assembly with 25% reduction of effective stylus mass.

Result: (1) Higher-than-ever trackability at the ultra-light tracking forces of the 1970's; (2) an astonishingly flat frequency response with no noticeable emphasis or de-emphasis at any frequency; (3) an extended dynamic range even beyond that of our V-15 Type II Improved; and (4) all this without a reduction in output level.

We call the Type III the Synergistic Cartridge. It maintains all performance factors in perfect equilibrium to produce a total audio effect greater than the sum of its individual improvements.

All in all, the V-15 Type III offers an extraordinary listening experience.

NEW REDUCED PRICES

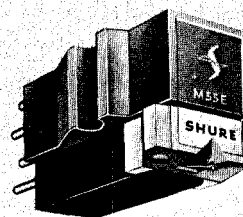
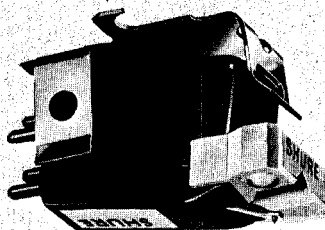
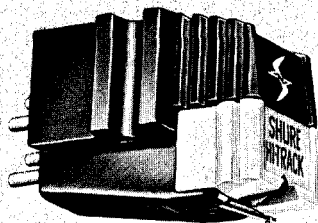

CARTRIDGES WITH ELIPTICAL STYLII

- \$87.00** V15 Type III $\frac{3}{4}$ to $1\frac{1}{4}$ grams tracking.
- \$38.00** M91ED $\frac{3}{4}$ to $1\frac{1}{2}$ grams tracking.
- \$26.00** M93E-EP $1\frac{1}{2}$ to 3 grams tracking.
- \$19.00** M55E-EP $\frac{3}{4}$ to 2 grams tracking.
- \$17.00** M44E-EP $1\frac{3}{4}$ to 4 grams tracking.

CARTRIDGES WITH SPHERICAL STYLII

- \$80.00** V15 Type III-G $\frac{3}{4}$ to $1\frac{1}{4}$ tracking.
- \$17.00** M75-6S-EP $1\frac{1}{2}$ to 3 grams tracking.
- \$16.00** M75-CS-EP 3 to 5 grams tracking.
- \$16.00** M44-7-EP $1\frac{1}{2}$ to 3 grams tracking.
- \$16.00** M44-C-EP 3 to 5 grams tracking.
- \$16.00** M44-G-EP $\frac{3}{4}$ to $1\frac{1}{2}$ grams tracking.

The above are current recommended resale prices

Australian National Distributors

AUDIO ENGINEERS PTY LTD

342 KENT STREET, SYDNEY 2000

Queensland:
RON JONES PTY. LTD
57 Castlemaine St.
Milton 4064.

Victoria:
AUDIO ENGINEERS (VIC)
2A Hill St.,
Thornbury 3071

— TELEPHONE: 29-6731

Western Australia:
ATHOL M. HILL P/L.,
1000 Hay St.,
Perth 6000



PERGOLESI: Stabat Mater. Mirella Freni (soprano), Teresa Berganza (alto); Solisti dell'Orchestra Scarlatti, Napoli/Ettore Gracis. Archiv 2533-114 (\$6.20).

I must say I have never been able to understand quite what the popularity of this work is — perhaps it is the story of the 26-year-old Pergolesi feverishly dictating it on his premature deathbed that makes people so fond of it. But it seems such a pity to favour it to the neglect of the 'Salve Regina' for solo soprano, which really is one of the masterpieces of the eighteenth century. The beauty of both works is in the tension and resolution of the harmonies which the masters of the Late Baroque did to angelic perfection. The actual qualities of the instruments which perform the music are less important, and this is unfortunately where the present performances goes wrong. I have no complaints whatever about the quality of the string-playing, and both Freni and Berganza obviously have a good understanding of what they are singing, but the interpretation is far more suited to a Romantic work than this piece. Freni and Berganza are both operatic voices — the piece was written for castrati, and thus their full, rich voices are quite unsuited in a work intended for pure, clear and almost sexless tones, and which ideally should not really even be associated with a human production. The characteristic poignancy in Pergolesi's and other late Baroque composers' works comes from this next-worldly feeling, created not only in the instrument qualities but from the supremely delicate point-counterpoint, a series of heart-rending suspensions resolved just in the nick of time and almost by divine intervention. To impose further pathos, interpretation, emotion — what you will — from outside, in performance is entirely unnecessary and sounds just plain wrong — even sentimental. A classic case of More is Less.

However, you may like it that way, and the execution on this record is quite faultless (the voices are perhaps a little too prominent though). For some reason, Archiv seems never to have heard of anti-static, for their records almost always seem to collect massive amounts of dust in a very short time and merely crackle at you if you try to clean them. Otherwise, their production is typically conscientious, with lengthy notes and the text of the work (in Latin) given with translations into German, English and French, and none of which seems to bear much relationship to any of the others.

There was once, however, a record released about 15 years ago and now disastrously deleted, which had the 'Stabat Mater' on one side and the magnificent 'Salve Regina' on the other.

Gracis takes the first duet and a couple of other brackets extremely slowly, and thus it takes 42' 27", (spread meanly over two sides). The older record (with Bruna Rizzoli (sop.), Claudia Carbi (alto), the Chamber Orchestra and Womens' Choir of the Teatro Comunale di Firenze under Milinari-Pradelli) was in the Philips Monumenta Italicæ Musicae series (A 0044 6L), and the performance was every bit as monumental as the music. I hadn't heard of any of the artists but the conductor before, and it makes one wonder how many wonderful performances never see a record groove. If you ever see the record around, snap it up: but I would like to put in a plea here for someone to re-release it, and the sooner the better. — T.R.B.

FLUTE CONCERTI — MOZART: Concerto No.1 in G, K.313; Concerto No.2 in D, K.314; Andante in C, K.315; Concerto for Flute and Harp* in C, K.299. **HAYDN:** Concerto in D, Hob.VIII. **GLUCK:** 'Reigen seliger Geister' ballet music from 'Orfeus and Euridice'. Aurele Nicolet (flute), Rose Stein* (harp). Munich Bach Orchestra/Karl Richter. Telefunken TK11508/1-2 (2-record set with notes), \$10.40.

A curious, if not very imaginative, collection. Mozart's works here (his complete concerto output for flute) were all commissioned and written for an instrument he disliked intensely; Haydn's concerto (again, his complete concerto output for flute) isn't Haydn's, and Gluck's music is not even a concerto but excerpted from an opera.

Gluck's music from Act III of Orfeus (to begin at the end) is a piece of astonishing beauty and pathos. He did in fact write a proper flute concerto of considerable quality, but it is very rarely heard; the present excerpt is

much better known. On these records it follows the Haydn concerto, on side 4, and shows up almost painfully the latter's lack of quality. This so-attributed Haydn concerto is baldly plonky to start with and at the end has only improved to the prettily conventional. I have mentioned in a recent review (of the Haydn cello and oboe concerti) that the lack of a trace of genius is not enough in itself to deny its authorship by Haydn or any other master; but lack of any inspiration at all is quite another matter. This concerto hasn't any, and it needs no history book to tell us that it isn't Haydn's work. Instead it seems to have been the work of one Leopold Hoffmann, a contemporary Viennese composer and conductor of once considerable reputation — though Haydn didn't think so. Humour has it that Haydn offered this opinion when he heard Hoffmann's flute concerto.

Mozart's concerti are of course another matter. Considering the fact that Mozart heartily disliked the flute, the care and beauty he lavished on them is amazing. It seems that the second concerto is a transcription of an earlier oboe concerto, but the 'true' flute concerto is hardly of lesser quality. The Andante K.315 is an alternative slow movement for the one in K.313, supplied for Dechamps (a Dutch merchant who commissioned the concerti), who didn't know what to do with the original one. As for the concerto for flute and harp, it seems that Mozart didn't like the harp either. Nor for that matter did he like trumpets (which made him ill), or kettledrums. There is a story, no doubt apocryphal, that I read once and have never been able to find since, that sometime in his early twenties Mozart was stricken with a general irritable depression and feeling of inadequacy; and in a fit of masochism he wrote a number of equali for something like five flutes, four trumpets and kettledrums (or some equally ghastly combination). Einstein (more realistically) suggests they were written for the Salzburg Riding School.

At any rate, the present concerto was commissioned by the Duke of Guines for himself and his daughter, and Mozart certainly made as good a job of it as his dislike of the instruments permits (there are in the final coda a couple of bars quite unplayable for the harpist, which Tovey claims was quite intentional and probably quite malicious). In the notes included in this set, the German text states that the concerto was brought into existence for a new (special) occasion, which in the English version is 'an "occasional" work'. Though an inadvertently misleading translation it has some truth, because the concerto to me is only tolerable in infrequent

Bookworms Corner

Chew your way through some of these (most are in paperback form so are excellent value).



P & P 50 cents unless stated.

Our book section is rapidly becoming the best place in Sydney for the electronics man, whether professional or hobbyist. New titles are arriving almost every day and we are finding it a little difficult to keep up with tremendous demand. The following titles, selected at random, will give an indication of our selection. We suggest you call in and browse or write with details of your interest for suggested titles.

Foundations of Wireless and Electronics by Scroggie. Now in its 8th edition, this book comes from that well known contributor to *Wireless World*. 520 pages cover the basics in great depth before delving into transmission lines, amplification, waveform generation etc. \$6.10

Building Hi-Fi Speaker Systems is just one of the many Philips Applications Books and fills a gap that we've had many enquiries about. 140 pages crammed with design information, dimensions etc. Latest revised edition includes quadraphonic systems and 24 complete designs. \$4.20.

Motorola IC Data Book covers data on MECL series wity complete specs, selector guides etc. Over 400 pages. \$3.75.

Integrated Circuits. A Basic Course by Hibberd of Texas Instruments. A McGraw Hill publication taking you into the technology of MOS, LSI etc. The course consists of 10 'lessons' covering the impact of ICs through to digital logic and solid state technology. \$10.25

How to Listen to the World from the publishers to *World Radio TV Handbook* and produced in association with the BBC. Helps to improve listening to overseas programmes and reception. A must for all SWLs and DX listeners. 168 pages. \$4.95

Semiconductor junctions and devices. 340 pages by Dr Burford III of McDonnell Aircraft Corp is a survey of devices, properties and applications. Goes from simple conductivity to two junction transistor synthesis. Simplified approach to Fermi, Esaki and Black box concepts. \$12.75

Microelectronic Circuits and Applications by Carroll. Full of facts, figures and design procedures based on 78 articles from 'Electronics' grouped in 16 Chapters. Active and Passive circuits, optoelectronics, cyogenics, FETs, PIN diodes etc. etc. A must for anyone connected with microelectronics. Large format 360 pages. \$13.00 P&P \$1.00.

Electronic Circuits Manual by Markus. A phenomenal book in 99 chapters gives 3,100 circuits with values of all parts for every imaginable application, 990 pages. Think of any application and you'll find a circuit to kick your design ideas off. Every lab should have one for browsing. Each circuit has full design reference so the book acts as an index to save time searching in other publications. Large format and the best value at \$22.00 P&P \$1.50.

UK	
Everyday Electronics	40c
Practical Electronics	50c
Practical Wireless	50c
Television	50c
Wireless World	70c

US	
Scientific American	\$1.00
73 Magazine	\$1.00
CQ Radio Journal	\$1.10
Popular Electronics	50c

Dick Smith Electronics
160-162 Pacific Highway,
Gore Hill, 2065 439-5311.

doses. Apart from the celeste, what more tinkly instruments can one think of than the flute and harp? — even Mozart couldn't prevent himself from writing a frilly concerto.

The recordings were made in 1960 and 1962, and though they have fine sound for those times they sound a bit brittle nowadays (but not overly so). The Gluck and 'Haydn' are delightfully played; similarly the Mozart, though if you want the flute concerti (and Andante) as the main attraction I would recommend the Schaffer performance with the Philharmonia Orchestra under Efreim Kurtz (HMV Concert Classics SXLP30150, \$4.50) as having the edge on Nicolet's version. These are 1958 performances but the sound is astoundingly good (this identical performance is also available on Seraphim, \$3.50, but I haven't heard it and can't comment on its sound quality). The very recent Turnabout version, also \$3.50, with Schwegler and the Wuertemberg C.O. / Faerber, does not really compare with either the Nicolet or Schaffer versions. The notes in this set should be taken with a few grains of salt though, both for historical inaccuracy and for subjective opinion misused for historical opinion: "Even though the opinion circulates in musicological circles that Mozart could not stand the flute, and a slightly dubious passage in a letter is quoted as evidence of this," — there is more evidence than one letter — "... this view is refuted by the two glorious flute concertos... and the intimate Andante...". What drivell. — T.R.B.

SCHUBERT: Eight Symphonies (plus Rosmunde music). Berlin Philharmonic Orchestra/Karl Boehm. DGG Anniversary Edition (5-record set with notes) 2720 062-10 (\$23.55).

It is probably true to say that Schubert hardly wrote a note of Schubert in his symphonies.

He wrote very good everyone else instead.

But the symphony was never Schubert's medium, as the Lied and piano music were, and probably not the least because he had not a single lesson in orchestration in his life. The third movement of the First Symphony, for example, if played somewhat faster than it is here, could be Haydn; large sections of the Ninth, and elsewhere, could be Mendelssohn; the first movement of the Fifth (known to anyone who watched the recent serial 'Little Women' on ABC-TV as the signature music) is pure Mozart, as genuine as Mozart could ever have written; and throughout all of the symphonies is the strong influence of Beethoven, demonstrating Schubert's veneration for him. Only in the Fourth and Eighth did he really hint at himself,

and in both it is the lyric quality which characterizes his piano music and *Leider* which appears — but still those strange, migratory modulations are largely missing.

In the interests of historical accuracy, I should mention that Schubert wrote ten symphonies, not eight. The first six are straightforwardly numbered; the eighth is the 'Unfinished', but the 'Great' C major commonly numbered 9 (or 7), here (7), is actually number 10. Number 7 in E major is now extant in the 1821 partial score and a 1934 reconstruction by Felix Weingartner (available non-locally on a 1952 Vanguard record, VRS-427, Vienna State Opera Orchestra / Littschauer), and is not a very interesting work despite the excellent reconstruction. The genuine No.9 is the lost Gmunden-Gastein Symphony of 1825. Josef Joachim supplied an orchestration of the 'Grand Duo' Sonata for piano, four hands, which he probably erroneously supposed to be the sketches for the symphony, no doubt because of its extraordinary scope and quality. I have not heard it but have seen it described as "rather dull and Schumannesque" — it is available for the curious, however, on Vanguard VRS-417, Vienna State Opera Orchestra / Prohaska.

As for the present performances, I was not as impressed with this set as I was with the BPO/Boehm set of Mozart Symphonies in the same series, in general. Isolated movements are marvellous such as the last of No.2, but generally I found them rather lacking in intensity, though of course careful and loving performances. The sound quality here and there left something to be desired as well. All but the 3rd, 4th, 6th Symphonies and Rosamunde are repressings from as early as 1964, and some of them unfortunately show their age in a rather harsh sound. It would also be worthwhile to check Side 9 (the 'Unfinished' Symphony) before buying this set — mine was probably an isolated faulty pressing but the quality was so bad that the side was virtually unplayable. It is quite easy to see the peculiar surface, without even playing it.

Though there are probably better single versions of some of these symphonies, as a collection it is a very worthwhile set. The reduced price is an added attraction, as almost all the earlier symphonies in particular are on full-price records. The enclosed notes are very interesting and detailed (even with movement timings); the booklet cover is a reproduction of a portrait of Schubert, the back cover a photograph of the BPO in concert, and even the back of the box has a large photograph of Boehm on it. — T.R.B.

Dub from tape reel to tape cassette- or vice versa! Sony's TC-330 is only \$299*

She wants to play a cassette, he has his favourite reel. No problem! Sony's exciting new TC-330 plays both—in stereo. Here is the perfect stereo control centre, with all-silicon transistor integrated stereo amplifier. There's easy dubbing from reel to cassette or vice versa. Rich tone comes from 5W RMS per channel. Two lid-integrated high compliance speakers. Separate treble and bass controls. Noise suppressor to cut out tape hiss. Public address facility, too. Stereo headphone jacks. Superb tape recorder has three speeds, 7" reel capacity, two meters, 4 digit tape counter and auto shut off. Cassette recorder features easy push button operation, simple loading 3 digit tape counter, and tape end indication lamp (when used with SONY compact tape cassette). Merely connect a turntable like Sony's PS-5100 to the TC-330 and you have the complete sound system.

SONY[®]
Sony Kentron Services Pty.Ltd.

SYDNEY: 26 2651, MELBOURNE: 874 8222,
ADELAIDE: 93 2338/9, BRISBANE: 44 4488,
PERTH: 81 3422, LAUNCESTON: 25 322,
CANBERRA: 95 2100. Agents: NEWCASTLE:
81 4991, WOLLONGONG: 84 8022.

*Recommended retail price



SPECIFICATIONS

System: 4-track stereo recording and playback
Power requirements: AC 100, 110, 117, 125, 220, 240V, 50/60Hz
Power consumption: 45 W
Tape speed: Open reel, 7½ ips (19 cm/s), 3¾ ips (9.5 cm/s),
1½ ips (4.8 cm/s)
Cassette, 1½ ips (4.8 cm/s)
Reel capacity: 7" (18 cm) or smaller
Cassette: SONY Compact Cassette C-60 (60 minutes),
C-90 (90 minutes), C-120 (120 minutes) or
equivalents
Frequency response: Open reel, 30 - 18,000 Hz at 7½ ips (19 cm/s)
30 - 13,000 Hz at 3¾ ips (9.5 cm/s)
Cassette, 50 - 10,000 Hz at 1½ ips (4.8 cm/s)
Signal-to-noise ratio: Open reel, better than 50 dB
Cassette, better than 45 dB
Flutter and wow: Open reel, 0.12% at 7½ ips (19 cm/s)
0.15% at 3¾ ips (9.5 cm/s)
0.2% at 1½ ips (4.8 cm/s)
Cassette, 0.2% at 1½ ips (4.8 cm/s)
Harmonic distortion: 2.5%
Level indication: Two level meters
Power output: 5W x 2 (15W, total dynamic power)
Recording time: Open reel, stereo 6 hours at 1½ ips (4.8 cm/s)
Cassette, stereo 1.5 hours at 1½ ips (4.8 cm/s)
with compact tape cassette C-90

Fast forward and rewind time: Open reel, within 2 min., 30 sec.
Cassette, within 1 min., 30 sec. with C-60
Inputs: Microphone, sensitivity -72 dB (0.19 mV),
impedance 600 ohms
Auxiliary, sensitivity -22 dB (0.06 V),
impedance 100k ohms
Phono, sensitivity -57 dB (1.1 mV),
impedance 65k ohms
Outputs: Line, output level -5 dB (0.44 V),
impedance 100k ohms
External speaker, impedance 8 ohms
Headphone, impedance 8 ohms
Dimensions: 21¼" (W) x 11¼" (H) x 13¼" (D) (538 x 300 x
352 mm)
Weight: 43 lb (19.5 kg)
Accessories: Microphone F-25
SONY demonstration tape
SONY compact tape cassette C-30
SONY reel R-7A
Connecting cord RK-74
AC power cord
Head cleaning ribbon
Recommended optional
accessories: Stereo headphone DR-4A, DR-5A
Microphone mixer MX-600M
Rec/PB cord RC-2
Telephone pick-up TP-4S

INPUT GATE

LETTERS FROM OUR READERS

(Continued from page 124)

We are indebted to Mr. J. R. F. Alonso of South Yarra for the following information.

"In its original form, the device was a combination water storage urn cum ornamental fountain. The jets of water issuing forth from the dragon's mouths kept the balls (very respectable sized balls, by the way) dancing inside the mouth.

The frogs are one of two types of common receiver vessels, the frogs exemplifying the stand-up variety to receive from a vertical or parabolic jet, the other, looking sort of like the pyramid's Sphinx to receive water from land pipe lines.

An illustration of the latter type is in Needham plate CLX in volume 4 page 132ff, figure 425.

The fountain reservoirs of this type were described by "Hsiao Hsun, along with tiger robots, dragons spouting perfumed mist and several dragon headed boats full of mechanical figures" (Needham). Page 133 of volume 4 shows a very comprehensive description of similar "Scientific Devices", scientific in the sense of being early attempts at applying scientific principles to the production of semi-utilitarian decorative figurines (if you can call a figurine a three or four tonne bronze casting with a tonne and a half of liquid inside. Some of the devices, perhaps this one, had several compartments for different liquids (water and wines) and a hidden slave in the roof opening and closing the valves as required.

The device was also used, suitably modified, as a seismograph to detect the existence and general direction of earthquakes. A long rod buried in the ground at the bottom of the heavy urn was connected by linkages to a device that dropped the ball opposite to the direction from which the quake came. The ball fell in the frog and perusal every few hours would indicate, albeit crudely, the direction from which the earth pressure pulse came. The device is described in Needham volume three, section 24, on early Chinese seismology, and a description and picture of it also appears in M. Loewe, *Everyday Life In Early Imperial China*, published by Batsford. The approximate date for the seismographic adaptation of the heavy urns is 210 BC."

J. R. F. Alonso
South Yarra Vic.

(The reference work to which Mr Alonso refers is — *Joseph Needham, FRS., Science and Civilization in China, Cambridge University Press, 1965 — four volumes so far — in particular Volume 4, Physics and Physical Technology*).

SOUND SYSTEMS WANTED

Our company here in Malaysia are interested in expanding into the PA, intercom, and hotel sound systems field, and would like to contact Australian manufacturers of this equipment. We were originally, medium voltage switchboard manufacturers and have already imported A\$200,000 worth of contactors, timers, meters, switches etc, from Europe, in the past six months. Also we are involved with fire-alarm and security systems.

We would very much appreciate it if you would print this letter.

Dr. Wong Chin Teng

Anyone interested should contact the company directly. Their address is Douglas Electric Controls SDN. BHD. No. 37 Road 20/14 Paramount Garden, Petaling Jaya, Selangor, Malaysia.

SIMPLE NUMBERS

Congratulations on a very informative, interesting magazine. May I suggest though that measurements, such as on p. 28, column 3, half-way down: "Spending on high-energy lasers now runs to $\$90 \times 10^6$ p.a. ..." could be phrased better as "\$90 million ..." The present method seems extraordinarily cumbersome.

W.K. Tranter
Putney 2112

That one slipped past! In future we will express measurements more simply wherever possible.

GODDESS' MILK

Your luna analysis is the strangest casein here for many years.

Who's this JF who doesn't know the fat content of goddess' milk?

We test *all* milk and find goddess' milk as deficient in nutrition as is that of human kindness. Neither will make cheese, but testing them makes bread. — Jim Kelly, Managing Director, Foss Electric (Aust.) Pty Ltd., Balgowlah, NSW 2093.

(Foss Electric (Australia) Pty. Ltd., market equipment for determining the butterfat and protein content of milk).

complete range of turntables at

see the



SYDNEY HI-FI

83-87 york st., sydney 29-1082
29-2377



AUST. DIST:

MAGNACORD INTERNATIONAL

276 CASTLEREAGH ST. SYDNEY
PHONE 61-9881

MORE POWER FOR YOUR DOLLAR

DOMINION STEREO AMPLIFIERS



MODEL KTX-2000V
Size: 13.8" x 7.9" x 4.3"

SPECIFICATIONS:

POWER SUPPLY
240 volts AC.
FREQUENCY RANGE:
25 - 30,000 Hz \pm 2dB
OUTPUT IMPEDANCE:
4 - 16 ohms
Output Power:
15W x 15W RMS 8 ohms
40W x 40W music power

DISTORTION (TOTAL HARMONIC)
1 watt = 0.14%
14 watts = 0.16%
16 watts = 0.18%

Other Dominion Stereo Amplifiers
Model KTX 4000V, 25W x 25W RMS
Model KT 1200V, 6W x 6W RMS Price: *\$85.45
Agents: **HI-FI STEREO CENTRE**

Mezzanine floor, 157 Elizabeth St., Melbourne. Trade enquiries: Phone 329 7888.

ZEPHYR RECOMMENDS THESE ELECTRET CONDENSOR MICROPHONES

- * ATTRACTIVE APPEARANCE * OUTSTANDING PERFORMANCE
- * EXCELLENT SIGNAL-TO-NOISE RATIO

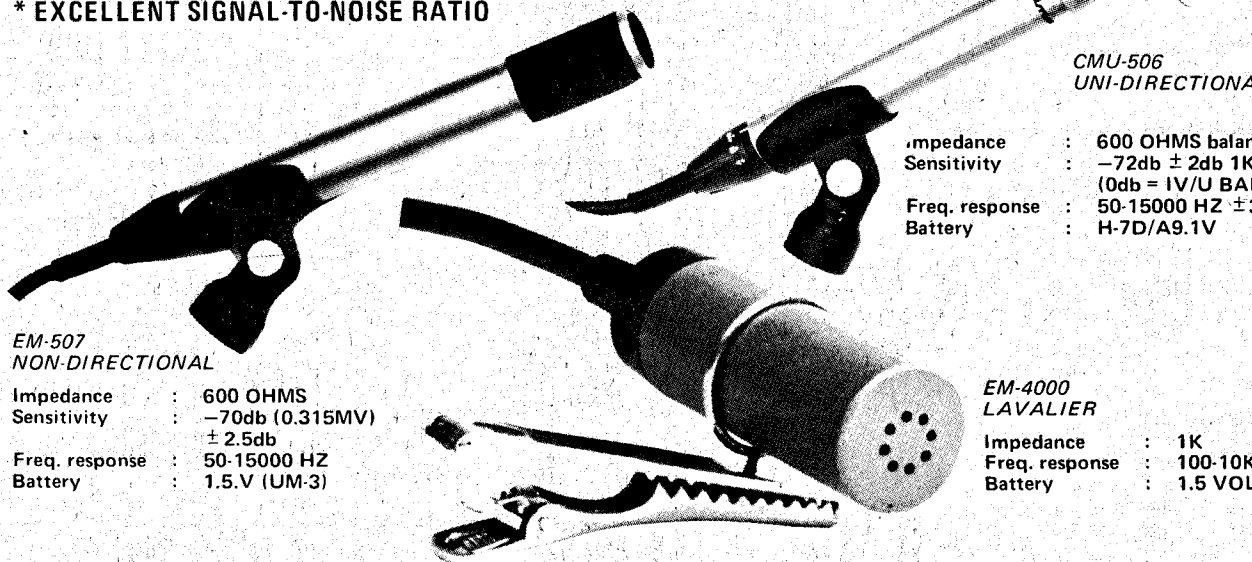

**EM-507
NON-DIRECTIONAL**

Impedance : 600 OHMS
Sensitivity : -70db (0.315MV)
 \pm 2.5db
Freq. response : 50-15000 HZ
Battery : 1.5V (UM-3)

**CMU-506
UNI-DIRECTIONAL**

Impedance : 600 OHMS balanced
Sensitivity : -72db \pm 2db 1K HZ
(0db = 1V/U BAR)
Freq. response : 50-15000 HZ \pm 3db
Battery : H-7D/A9.1V

**EM-4000
LAVALIER**

Impedance : 1K
Freq. response : 100-10K HZ
Battery : 1.5 VOLTS

MARKETED IN AUSTRALIA BY

ZEPHYR PRODUCTS PTY LTD

70 BATESFORD ROAD, CHADSTONE 3148, VICTORIA - PHONE: 56-7231

for superb 4 channel reproduction

go for **GRACE**

* Stereo Elliptical * Matrix 4 channel * 4 channel discrete

After producing superb cartridges for 20 years, Grace, in conjunction with NHK (Government sponsored Broadcasting Institute of Japan) continued its search for an even better cartridge. This resulted in the F8L, then the Broadcast Standard Sigma 709 was developed from the commercial broadcasting field. From this came the F8C for critical hi-fi enthusiasts, and now comes the F8F, Shibata 4 channel.

The GRACE range includes:

- F8C** Employs the well-proven Luminal Trace stylus, and tapered magnets ensure a flat response throughout the entire scale. Frequency range 15 — 25,000 Hz ± 2 dB -1 dB
- F8L** Flat response, distortion-free performance, lifelike tonal reproduction, ideally suited to laboratory testing of audio equipment or records. Luminal Trace stylus, frequency 20 — 20,000 Hz ± 2 dB.

NEW! G707 'QUADMASTER' 4 CHANNEL TONEARM

Ultra light weight, semi-integrated. When used with 4-channel stereo or high compliance cartridge, gives the superb reproduction available only from an integrated pickup. The fixed Lowmass head shell allows undistorted mid-frequencies tracking. Micro pivot Gimbal bearings reduce friction resistance to less than 20 milligrams.

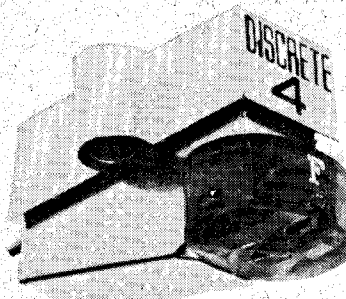
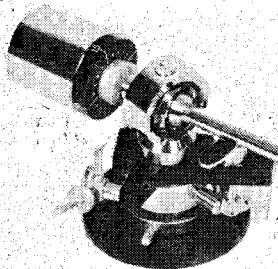

CANADIAN STEREO GUIDE said about Grace: "all in all, a very fine cartridge that deserves a place among the top performers".

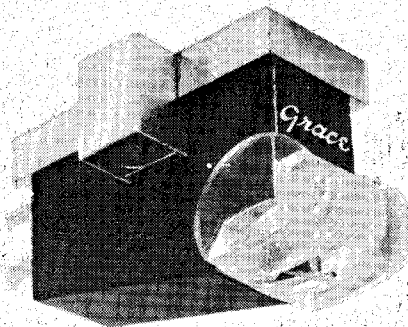

F8F MATRICAL FLUX 4 CHANNEL CARTRIDGE

Specially developed for reproducing Discrete 4 channel records. A wide range cartridge with Shibata stylus. Lightweight materials reduce cantilever mass to about half of other cartridges for improved frequency response, reduced mechanical impedance, high compliance. Minimal wear on stylus and record. Frequency 10 — 50 kHz. Also available as F8E for Matrix 4 channel and regular 2 channel stereo with luminal trace elliptical stylus.

STATE AGENTS:

- N.S.W.** M & G Hoskins Pty. Ltd., 37 Castle St., Blakehurst, 2221. Telephone: 546 1464
- Q'LD** Stereo Supplies, 100 Turbot St., Brisbane 4000. Telephone: 21 3623
- S.A.** Challenge Hi-Fi Stereo, 6 Gays Arcade, Adelaide 5000. Telephone: 223 3599
- TAS.** Audio Services, 72 Wilson St., Burnie 7320. Telephone: 31 2300
- VIC.** Encel Electronics Pty. Ltd., 431 Bridge Rd., Richmond 3121. Telephone: 42 3762
- W.A.** Albert TV & Hi-Fi, 282 Hay St., Perth 6000.

Sole Australian Agents:

INTERDYN

**International Dynamics
(Agencies) Pty. Ltd.,
P O Box 205, Cheltenham, Vic.**

*Need we
say more?*

Proof indeed of the quality of the Luxman SQ 700X comes from F. C. Judd, writing in the authoritative British "Audio Magazine" March 1973:

“ *The makers tend to under-rate the performance of this amplifier. Rated twenty watts (sine wave) power per channel, the tested amplifier yielded over 25 watts per channel BOTH DRIVEN. I estimate the SQ 700XG to be a top performance amplifier. (Complete review on request.)* **”**

Briefly: 27 transistors, 2 silicone varistors, 4 silicone diodes. Frequency response 10-50,000 Hz \pm 1dB. Distortion less than 0.1%. Other "ultimate fidelity" amplifiers built by Lux, the world's most experienced amplifier manufacturers: SQ 505X, SQ 507X, SQ 202.



LUX

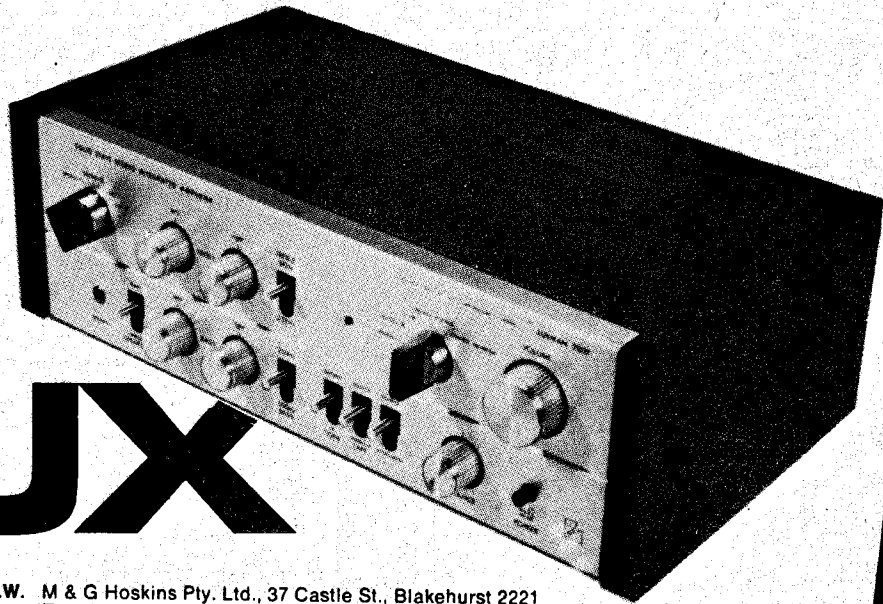

Available from:

- N.S.W.** M & G Hoskins Pty. Ltd., 37 Castle St., Blakehurst 2221
Telephone: 546-1464
- Q'LD** Stereo Supplies, 95 Turbot St., Brisbane 4000
Telephone: 21 3623
- S.A.** Challenge Hi-Fi Stereo, 96 Pirie St., Adelaide 5000
Telephone: 23 3599
- TAS** Audio Services, 44 Wilson St., Burnie 7320
Telephone: 31 2390
- VIC** Encel Electronics Pty. Ltd., 431 Bridge Rd., Richmond 3121
Telephone: 42 3762
- W.A.** Albert TV & Hi-Fi, 282 Hay St., Perth 6000
Telephone: 21 5004

Sole Australian distributors:

INTERDYN

INTERNATIONAL DYNAMICS (AGENCIES) PTY. LTD.,
P.O. BOX 205, CHELTENHAM, VIC. 3192

READER INFORMATION SERVICE AND ADVERTISERS' INDEX

For further information on Advertisers listed below complete the coupon/s stating information required including company and position held (if relevant). Cut out the coupon and post to:-

**ELECTRONICS TODAY INTERNATIONAL, RYRIE HOUSE, 15 BOUNDARY STREET,
RUSHCUTTERS BAY, SYDNEY, 2011.**

ADVERTISERS' INDEX

	Page No.
Ace Radio	114
Apollo Hi-Fi	15
Audio Engineers	126
Audio Sound Elect. Service	30
Auriema	113
Aust. Musical Ind.	2
Autel Systems	12-13
Babylon Electronics	47
B.J.D.	10,53
Bright Star Crystals	109
B.S.R.	46
BWD	123
Carr, John	70
Convoy	94,114,120
Cunningham, R.H.	104
Douglas Trading	14
Edge Electrix	67
Electronic Agencies	83
Emac Industries	115
Fairchild	38,100
Ferguson Transformers	108
Glendor	22
Ham Radio	82,108
Hewlett Packard	6
Hy Q	86
Instrol	32-33,136
International Dynamics	132-133
International Electronics Unlimited	44
I.R.H.	84,102
Jacoby Kenwood	116
Jervis	36,111
Kent Hi-Fi	19
Kitsets	68-69
Lafayette	120
Leroya	39,105
McMurdo	79
Micronics	107
Mike Electric	67
Morganite	67
M.S.P.	8
Oliver Electronics	120
Pioneer Electronics	45
Plessey Ducon	23,40
Plessey Rola	11
Pre-Pak	52
Radio Parts	56,131
Ralmar	125
Rank Industries	31
Rowe, H	41
Schlumberger	56,79
Scientific Electronics	112
Selound Hi-Fi	4
Seven Seas Electronics	94
Sharp	108
Silverstone Electronics	107
Smith, Dick	80-81,128
Sonab	50
Sony Kemtron	7,129
Supaspede	37
Tandy Electronics	51
Tecnico	112
Thorn Sales	109
Timbre	87
Tristate Electronics	70
United Trade Sales	93
Wedderspoon, W.C.	9,135
Zephyr Products	131

Send to: **ELECTRONICS TODAY INTERNATIONAL,
Ryrie House, 15 Boundary Street, Rushcutters Bay,
Sydney, 2011.**

ADVERTISER.....
PRODUCT.....
NAME.....
ADDRESS.....
.....POSTCODE.....
COMPANY.....
POSITION..... 5:74

Send to: **ELECTRONICS TODAY INTERNATIONAL,
Ryrie House, 15 Boundary Street, Rushcutters Bay,
Sydney, 2011.**

ADVERTISER.....
PRODUCT.....
NAME.....
ADDRESS.....
.....POSTCODE.....
COMPANY.....
POSITION..... 5:74

Send to: **ELECTRONICS TODAY INTERNATIONAL,
Ryrie House, 15 Boundary Street, Rushcutters Bay,
Sydney, 2011.**

ADVERTISER.....
PRODUCT.....
NAME.....
ADDRESS.....
.....POSTCODE.....
COMPANY.....
POSITION..... 5:74

Send to: **ELECTRONICS TODAY INTERNATIONAL,
Ryrie House, 15 Boundary Street, Rushcutters Bay,
Sydney, 2011.**

ADVERTISER.....
PRODUCT.....
NAME.....
ADDRESS.....
.....POSTCODE.....
COMPANY.....
POSITION..... 5:74

Four reply coupons are provided here for your convenience. Please list only ONE advertiser and ONE product on each coupon. If you require information on more than four individual products, make as many copies of the coupons as you like (preferably typed) - again using one coupon form for each product.

The compliment we like best about the new Monarch Series 8:

"It's no surprise!"

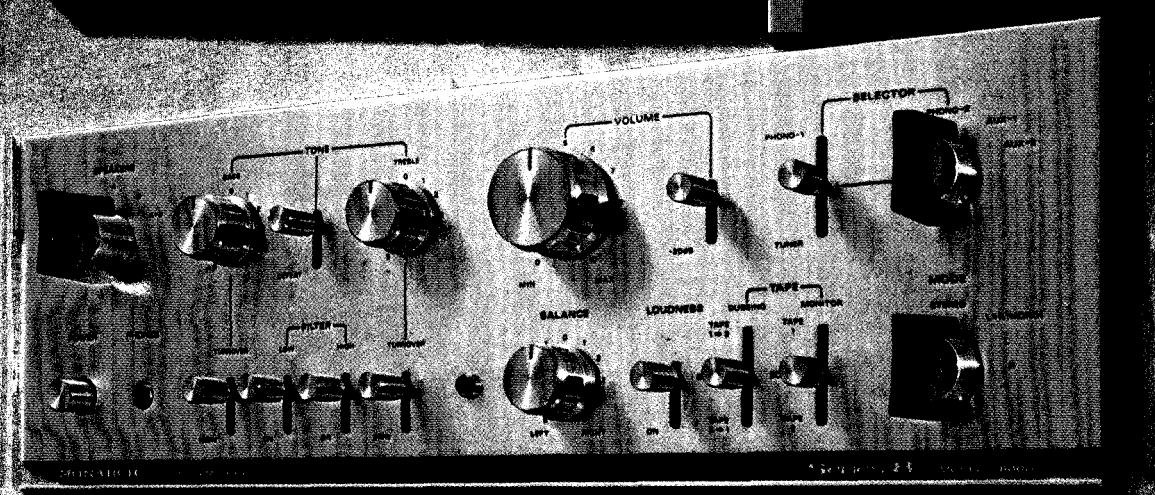

When people already think of one name as the best value for money, they naturally expect every new model to maintain the same high standards — or improve on them. So, Monarch's brilliant new Series 8 amplifiers will come as no great surprise.

No surprise — even though we've created a superb new amplifier, top-of-the-range Monarch 8000 to bring you continuous RMS power of 55 watts per channel at 8 ohms, with distortion of less than 0.1%; even though we've included tape dubbing and turnover controls; even though we've produced a frequency response of 10 Hz to 60,000 Hz; even though we're presenting three other new Monarch amplifiers — the 80, 88 and 800, which feature dramatic improvements in power and efficiency. It's no great surprise — because you expect Monarch to be the best... And it is, so all

Monarch amplifiers remain "kings" on a power-to-performance-to-cost rating.

Try any of them. The prices are as undistorted as the sounds. All with the same beauty of design you expect of top performers. And all have the Monarch two-year guarantee on parts and labour. You know you're getting Monarch quality. Without paying more.

Monarch 8000	—	110 watts RMS
Monarch 800	—	80 watts RMS
Monarch 88	—	48 watts RMS
Monarch 80	—	24 watts RMS



AUSTRALIAN DISTRIBUTORS

WEDDERSPOON

W. C. WEDDERSPOON PTY LTD

3 Ford Street, Greenacre. 2190

Telephone: 642 3993 642 2595

Showroom demonstration by appointment

AVAILABLE FROM REPUTABLE DEALERS EVERYWHERE

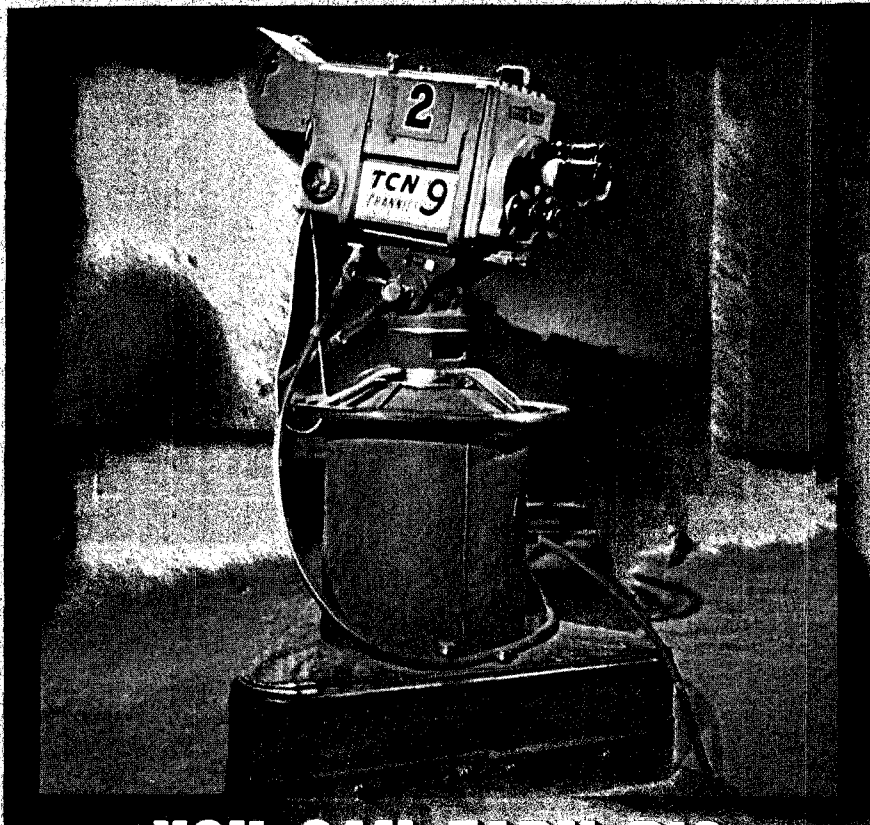

YOU CAN EARN BIG MONEY IN RADIO—TELEVISION ELECTRONICS

ASK YOURSELF THESE 3 QUESTIONS!

1. Am I in a dead-end job? 2. Could I earn more by learning more? 3. Could I use my spare time to get ahead?
- If the answer is yes, there is room for you in radio/television/electronics.

NOW IS THE TIME TO TRAIN!

Does your job offer good prospects—real security? Does it hold your interest? If not, now is the time to do something about it. Electronics is expanding daily. It's the most exciting subject you can study. The sky's the limit for the trained electronic technician . . . but only the trained man. Radio and television tech-

nicians are in huge demand. Train for success now, in Australia's fastest-growing industry! Join the ranks of skilled men . . . the Australian Radio and Television College can train you for a bright future with unlimited prospects. Send for the free booklet, "Careers in Radio, TV and Electronics" and find out how A.R.T.C. can bring you success—in your own business or as well-paid technical staff.

A.R.T.C. CAN TRAIN YOU AS IT HAS THOUSANDS OF OTHERS

For nearly 40 years A.R.T.C. has successfully trained thousands of progressive Australians who realised how much the training could mean to them. Now they're making big money in radio and television. Training can bring you success, too.

FOR A FEW CENTS PER DAY YOU CAN STUDY THE A.R.T.C. WAY

. . . in your spare time, you can equip yourself for a rewarding career in electronics. The future belongs to the trained. A.R.T.C. teaches you from the ground up . . . step by step . . . at your own pace. Remember, opportunity is always knocking for the trained man!

PRACTICAL UP-TO-DATE LESSONS

At the work benches and lecture halls of A.R.T.C.—or in your own home by correspondence—you can learn every necessary aspect of radio, television and electronics. The Course gives you both basic and advanced instruction.



No previous experience or high educational standard required . . . only enthusiasm and normal intelligence. A.R.T.C. will give you all the instruction you need. Each lesson is made easy to understand by numerous illustrations and diagrams. The Course adapts itself to your requirements, your speed. It's up to you! Instruction is individual and intensely practical.

THOUSANDS OF SUCCESSFUL STUDENTS HAVE PROVED THIS

Make your spare time earn money for you while training at home.

Many students make extra money after only a few weeks' tuition. Train at the modern A.R.T.C. workshops, if more convenient.

GET INTO ONE OF THESE PROFITABLE CAREERS IN RADIO/TELEVISION ELECTRONICS

There is a career for you in one of the many branches of electronics, including manufacture, servicing, research, sales, executive positions, armed forces, audio, etc., etc.

A.R.T.C. can help you gain one of these sought-after careers. Remember, it's the trained man who wins, every time!

MAIL COUPON NOW!

Safeguard your future! You are invited to send in the coupon below. A.R.T.C. will mail you by return their big free and post-free booklet, "Careers in Radio, TV and Electronics". This exciting book shows you definite steps you can take towards a big future—how you can succeed in life and find satisfaction in doing a worthwhile job well.

AUSTRALIAN RADIO AND TELEVISION COLLEGE

PTY. LTD.
A.N.Z. BANK BUILDING

Cnr. Broadway and City Road, Sydney.
(Opp. Grace Bros.) Phone 211-4244 (3 lines.)



AUSTRALIAN RADIO & TELEVISION COLLEGE PTY. LTD.

206 Broadway, Sydney, N.S.W.

Dear Sir,

Please send me, without obligation, your free booklet, "Careers in Radio, TV and Electronics".

NAME

ADDRESS