

OCTOBER 1973  
50c

# electronics

## TODAY

INTERNATIONAL

HI-FI

*Jansen*  
FULL-SCALE MUSIC  
SYNTHESIZER TO BUILD



**\$10,000 COMPUTER CONTEST!**  
**DIGITAL STOPWATCH PROJECT**  
**HOW TO REPAIR CALCULATORS**

REGISTERED FOR POSTING AS A PERIODICAL - CATEGORY C

**You wouldn't buy  
the wrong pair  
of shoes  
for your feet.**

So why buy the wrong tape deck for your home?

It can happen. There are so many to choose from. Each has its own way of enticing you.

Yet the TEAC A-3300 stereo tape deck stands out. It has everything a serious amateur would want, plus many features that even the professionals love.

It accepts the big 10½ inch reels. So when you give your next party, you'll have uninterrupted music for up to six hours. Instead of having to change tapes all the time.

Your own recording technique will improve also. Because the A-3300 has TEAC's unique



Edi-Q, an electronic record pause control. It eliminates the clicks and snaps that can occur when you pause and then restart. The professionals use it. Now you can also.

You'll especially appreciate the front panel bias switch for the proper selection of bias current and recording equalization. It's an important feature; it gives you the most enjoyment from the new low noise/high output tapes, as well as regular tapes.

Attach TEAC's A-180 to the deck.

It's our Dolby\* Noise Reduction Unit. You'll enjoy sound perfection because the Dolby eliminates unwanted tape hiss and other noise. Music never sounded so good. We invite you to take the step and bring this TEAC package of sound into your home.

Notice how well it fits.



**TEAC**  
The sound of perfection

AUSTRALIAN DISTRIBUTORS: Australian Musical Industries P/L., 155 Gladstone St., Sth. Melbourne, Vic., 3205. Phone: 69 5888 — 619 Pacific Hwy., St. Leonards, N.S.W., 2065. Phone: 439 6966 — Arena Distributors, 273 Hay St., East Perth. Phone: 25 9993 — Sth. Aust. Truscott Electronics Pty. Ltd., Hindmarsh Square, Adelaide. Phone: 23 3024. OCEANIC DISTRIBUTORS: New Zealand: Direct Imports (N.Z.) Ltd., 590W Southampton Street, Hastings. Phone: 89 184 — Fiji: D. Jeevan & Sons, 87 Cumming Street, (G.P.O. Box 148), Suva. Phone: 22710 — New Guinea: Paul Mow & Co., Box 449, Lae. Phone: 2953.

# electronics TODAY INTERNATIONAL

OCTOBER 1973

Vo. 3. No. 7

## main features

- \$10,000 COMPUTER CONTEST** .....34  
*Four computer terminals plus free time are prizes in exciting new contest.*
- MOTOR SPEED CONTROL** .....44  
*Photo-tachometer provides speed reference in feedback control circuit*
- COOKING BY MICROWAVES** .....56  
*How microwave ovens work, and why they are used — Peter Sydenham reports.*
- CREATIVE AUDIO — PART TWO** .....64  
*A practical guide to creating and producing your own sound*
- MOTIONAL FEEDBACK** .....75  
*New technique from Phillips uses motional feedback to improve bass response*
- HOW TO REPAIR ELECTRONIC CALCULATORS** ....78  
*A down-to-earth practical guide to calculator fault finding.*
- EXPERIMENTAL SPEAKER** .....92  
*Using bass reflex enclosures for low resonance speaker drive units.*
- SENSORS ON** .....106  
*Observations about science and technology — by Talus*
- SIXTY MILLION VOLTS!** .....114  
*Latest Van de Graaf generator uses segmented belt for high current output*

## product tests

- NAKAMICHI 1000 CASSETTE RECORDER** .....48  
*This cassette machine can genuinely compete with reel-to-reel recorders*
- MICRO MONITOR HEADPHONES TYPE MX-1** .....86  
*Electrostatic headphones use battery-derived polarising voltage*

## projects

- INTERNATIONAL MUSIC SYNTHESIZER** .....24  
*Here is the project that our competitors said was 'impossible'!*
- DIGITAL STOPWATCH** .....96  
*Measure elapsed time electronically with this inexpensive digital system*

## reviews

RECORDINGS, CLASSICAL 135; POP TRENDS, 129; BOOK REVIEWS, 126.

## news & information

NEWS DIGEST, 16, 17, 18, 19, 20, 22; AUDIO NEWS, 109; COMPONENT NEWS, 124; EQUIPMENT NEWS, 118; INPUT GATE (READERS' LETTERS), 132.

*COVER: Featured this month is Electronic Today International's Model 4600 MUSIC SYNTHESIZER. (Full details describing the construction of this unit commence on page 24 — this issue).*

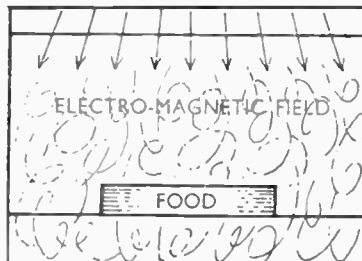

Published by MODERN MAGAZINES (HOLDINGS) LIMITED, 15 Boundary Street, Rushcutters Bay 2011. Phone: 33 4282. Cables: MODMAGS SYDNEY. Managing Director: Jules Feldman. Advertising Director: Max Press. INTERSTATE advertising — Melbourne: Clarrie Levy, Suite 23, 553 St. Kilda Rd. (51-9836). Adelaide: Ad Media Group of South Australia, 12-20 O'Connell Street, North Adelaide S.A. 5006. (67-1129). Brisbane: David Wood, Anday Agency, 11-14 Buchanan St., West End (44-3485) OVERSEAS — United Kingdom: A.C.P., 107 Fleet St., London, EC4. U.S.A.: A.C.P., Room 401, 1501 Broadway New York. Printed in 1973 by Compress Printing Ltd., 65 O'Riordan St., Alexandria N.S.W. Distributors: Australian Consolidated Press. (\*Recommended and maximum price only.) COPYRIGHT.

# Give your present stereo system a \$500 sound for around \$20

For a modest expenditure you can now significantly improve your \*8 ohm speaker system to give the exciting experience and 'presence' of a frequency response to beyond 20,000 Hz.

The Philips dome tweeter is a professional unit designed to ensure natural reproduction over its wide frequency range and thus enhance any speaker system, whether 2 watts or 40 watts. The dome construction avoids the annoying 'beam effect' of conventional tweeters with its characteristic 180° polar radiation pattern of sound dispersion at all frequencies up to 20 KHz.

Excellent transient response and low distortion are achieved by employing a high efficiency low mass diaphragm with a high flux density Ferroxdure 300R magnet system.

Convert in minutes – each kit complete – 2 Philips dome tweeters, cross-over capacitors and full instructions.

\*Suitable also for other impedances with appropriate cross-over values.

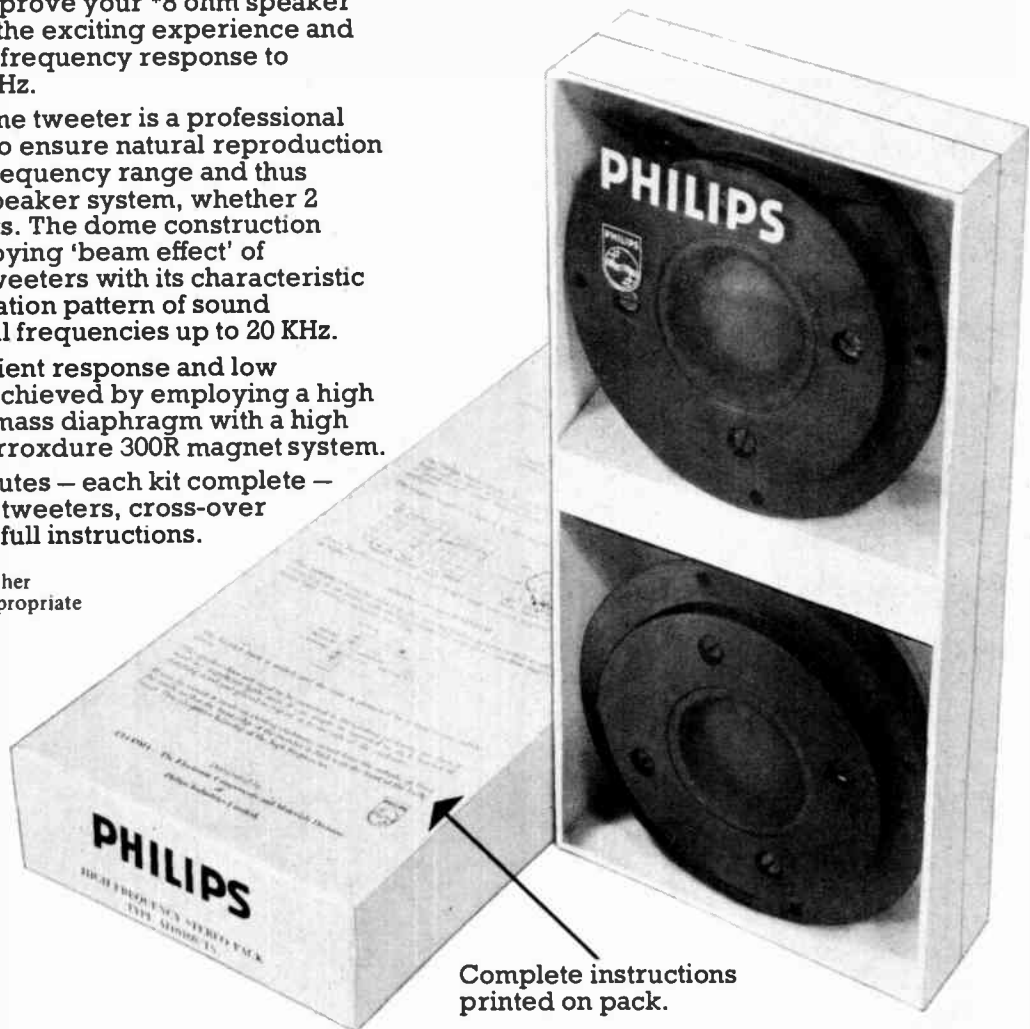

Complete instructions printed on pack.

## PHILIPS

## ELCOMA

ELECTRONIC COMPONENTS AND MATERIALS  
Sydney, Melbourne, Brisbane, Adelaide, Perth

153.24

*Collyn Rivers*  
Editorial Director

*Brian Chapman*  
Technical Editor

*Michel Callaud*  
Consultant Editor

*Barry Wilkinson*  
Engineering Manager

*Clive Davis*  
Art Director

*Bob Izzard*  
Production Manager

*Howard Jenkins*  
Advertising Manager

*Terry Marsden*  
Advertising Manager (Sydney)

*Clarrie Levy*  
Advertising Manager  
(Melbourne)

*Louis A. Challis*  
and Associates  
(Acoustical Consultants)

*Electronics Today International*  
Ryrie House  
15 Boundary Street,  
Rushcutters Bay 2011  
Tel: 33-4282

#### UK EDITION

*Halvor Moorshead*  
Editor

*Alex Mellon*  
Advertisement Manager

*Electronics Today International*  
Australian Consolidated Press,  
107 Fleet St., London, E.C. 4.  
Telephone: 01-353-1040

#### FRENCH EDITION

*Denis Jacob*  
Editeur

*Christian Darteville*  
Directeur de la Redaction

*Edouard Pastor*  
Directeur de la Publicite

*Electronique Pour Vous*  
International  
17, rue de Buci, Paris.  
Telephone: 633-65-43

# Compromised FM

IMPLICIT in the arguments, both for and against Australia's adoption of the UHF frequency band for FM broadcasting, is the assumption that the listener will be able to enjoy programme material reproduced with true fidelity.

But if overseas experience is any guide to what will happen here, this assumption is not valid, for, no matter what the theoretical capabilities of FM broadcasting may be, the system has been hopelessly compromised by the truly appalling design of nearly all mass-produced FM receivers.

Certainly, manufacturers of hi-fi FM turners and tuner/amplifiers have produced some magnificent products capable of really excellent reproduction — but for every one of these units there are a hundred nasty little 'transistor' radios that are basically the old AM units with rudimentary FM front ends. The resultant sound from these devices is hardly distinguishable from their AM counterparts and makes a mockery of FM broadcasting.

It would be interesting to learn from the many companies currently planning to produce FM radios in Australia, whether the sound quality of their products will be in any way superior to the overseas products. And if so — why?

*Collyn Rivers*



**JVC**  
**NIVICO**

A FULL RANGE OF  
JVC 4 CHANNEL SYSTEMS  
AVAILABLE AT SELSOUND HI-FI  
FROM \$450.00

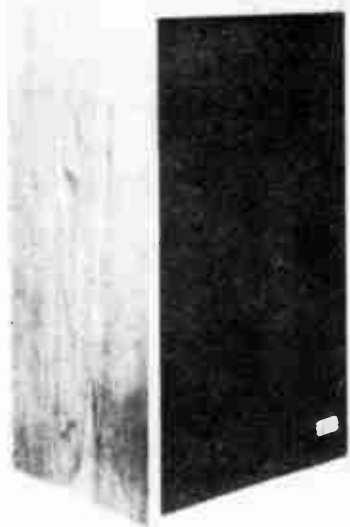

**JVC**  
**NIVICO**

MODEL No.  
V5-5396

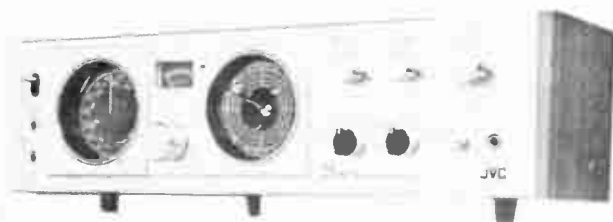
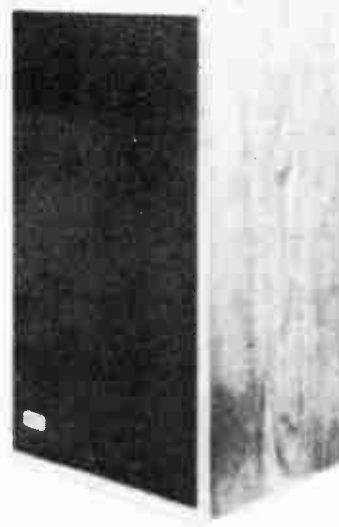

**JVC**  
**NIVICO**

MODEL No.  
4MM-1000



**JVC**  
**NIVICO**

NIVICO  
MODEL NO. SRP473

*The specialists in stereo and four-channel hi-fi systems. For discriminating and budget minded buyers.*

**SELSOUND HI-FI**

619-621 PRINCES HIGHWAY, BLAKEHURST  
Phone 546-7462 After Hours 522-6747

# SELSOUND HI-FI

*The specialists in stereo and four-channel hi-fi systems. For discriminating and budget minded buyers.*

619-621 Princes Highway, Blakehurst  
Phone 546-7462 After Hours 522-6747



We stock — Akai, AR, Apart, Advant Dual, DEITRON, Elac, Garrard, JBL, JVC, NIVICO, Kenwood, Leak, Monarch, Marantz, National, PIONEER, Sansui, SONAB, Sony, SONICS, Teac, Thorens, Wharfedale, YAMAHA

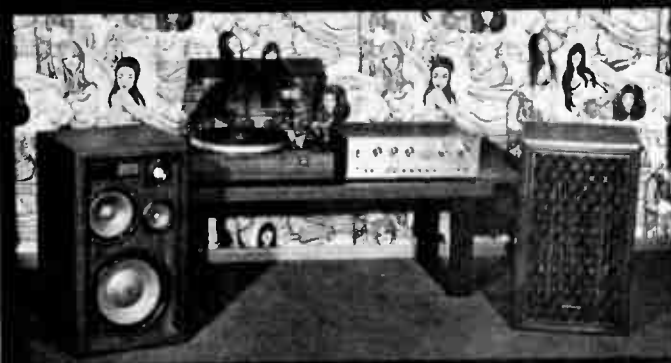

Dual 1214 or belt drive turntable fitted with magnetic cartridge

J.V.C. Nivico VN300 amplifier 15 watts R.M.S. per channel or Yamaha CA500 Amplifier 22 watt R.M.S. per channel

Sonics three-way speaker system — 8", 5½", 3¼"

**Complete System: \$345**

Four-channel belt drive turntable.

J.V.C. Nivico 100 watt four-channel amp. or J.V.C. Nivico 60 watt 4ch. Tuner Amp.

Three-way four speaker system 10", 6½", 2 x 3¼"

Three-way three speaker system fitted with 8", 5½", 3¼"

**Four channel complete system: \$585**



# ULTRALINEAR IS HERE

*THE MOST TALKED ABOUT SPEAKERS AT THE SYDNEY AND MELBOURNE HI FI SHOWS. AT INCREDIBLE PRICES.*

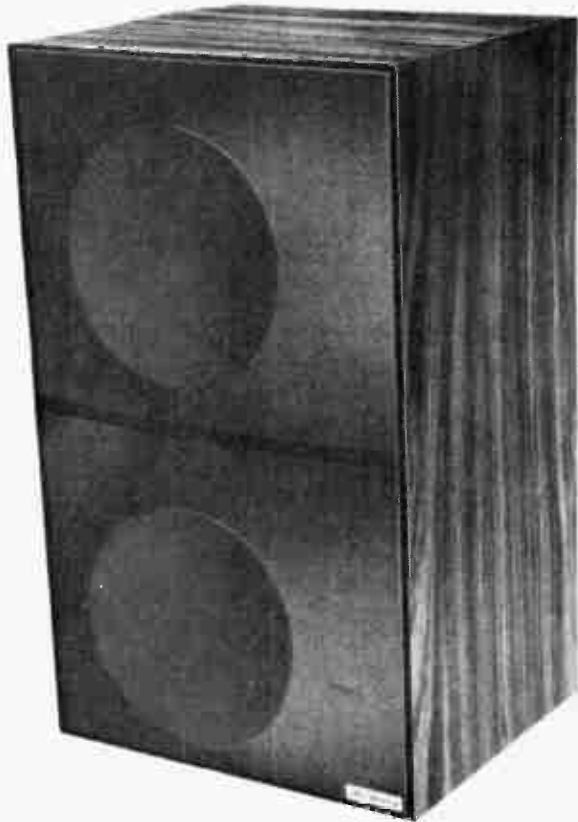

## MODEL 150

DRIVERS 12" Air Suspension Woofer.  
2½" Super Tweeter.  
FREQUENCY RESPONSE 32 Hz to 20,000 Hz  
CROSSOVER FREQUENCIES 2500 Hz  
MINIMUM POWER REQUIREMENT 5 Watts RMS  
MAXIMUM POWER HANDLING 40 Watts RMS  
NOMINAL IMPEDANCE 8 Ohms  
COLORS AVAILABLE: ORANGE, CHARCOAL  
TIMBER WALNUT FINISH  
SIZE: 24 3/8" H x 14½" W x 12" D

**PRICE \$119 EACH**

### AVAILABLE FROM

SYDNEY: Autel Systems Pty. Ltd., 412-4377; Dyna Stero, 51-7071; S.G.Everets, 602-7859; Appollo T.V. 560-9019.

NEWCASTLE: Hi-Fi; Taree Photographics; CANBERRA: Pacific Stereo. MELBOURNE: Radio Parts; S.A. Sound Spectrum; TAS: Belcanto Audio; W.A. Arener Distributors; BRISBANE: Tel Air.

## MODEL 200

DRIVERS 12" Air Suspension Woofer.  
5" Sealed Midrange.  
2½" Super Tweeter.  
FREQUENCY RESPONSE 28Hz to 20,000 Hz  
CROSSOVER FREQUENCIES 1500 Hz and 4000 Hz  
MINIMUM POWER REQUIREMENT 10 watts RMS.  
MAXIMUM POWER HANDLING 60 watts RMS  
NOMINAL IMPEDANCE 8 Ohms  
COLORS AVAILABLE: RED, BLUE, BLACK, BROWN,  
TIMBER WALNUT FINISH  
SIZE: 24 3/8" H x 14½" W x 12" D

**PRICE \$139 EACH**

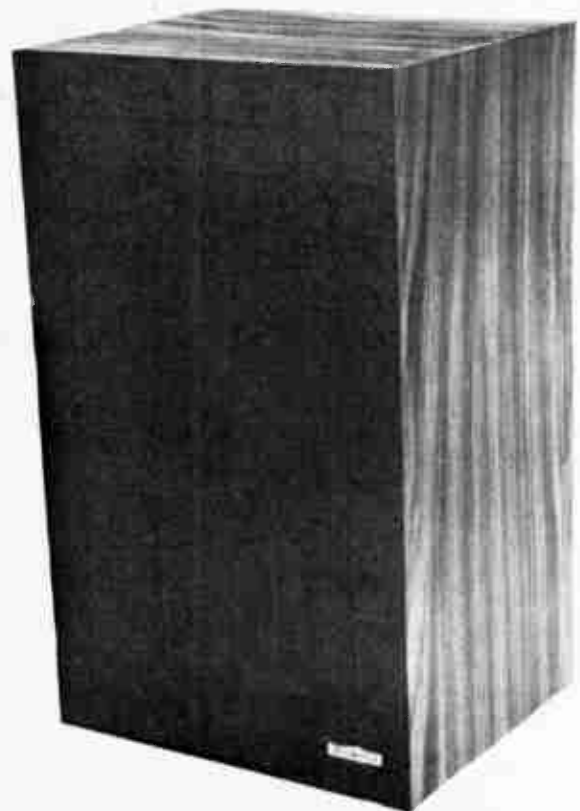



# ULTRALINEAR IS HERE

- *DESIGNED FOR THE FUTURE*
- *5 YEARS PARTS AND LABOUR WARRANTY*
- *AUTOMATIC CIRCUIT OVERLOAD BREAKER.*

## MODEL 100

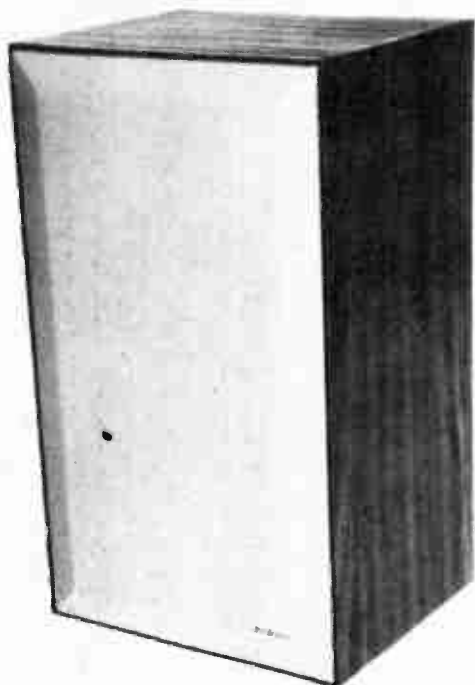

DRIVERS 12" Twin Cone Woofer.  
2½" Super Tweeter.

FREQUENCY RESPONSE 37 Hz to 20,000 Hz.

CROSSOVER FREQUENCIES 2500 Hz

MINIMUM POWER REQUIREMENT 5 Watts RMS

MAXIMUM POWER HANDLING 30 Watts RMS

NOMINAL IMPEDANCE 8 Ohms

COLORS AVAILABLE: RED, BLUE, BLACK, BROWN.

TIMBER WALNUT FINISH

SIZE 24 3/8" H x 14½" W x 12" D

**PRICE \$94 EACH**

## LINEAR SOUND 82

\* 1 year parts and labour warranty

\* As reviewed in Aust. Hi-Fi Speaker Guide Vol II

DRIVERS 8" Acoustic Suspension Woofer

1½" Pressure Dome Tweeter

FREQUENCY RESPONSE 37 Hz 20,000 Hz

CROSSOVER FREQUENCIES 2300 Hz

MINIMUM POWER REQUIREMENT 3 Watts RMS

MAXIMUM POWER HANDLING 25 Watts RMS

NOMINAL IMPEDANCE 8 Ohms

COLORS AVAILABLE: BROWN

TIMBER WALNUT FINISH

SIZE 21½" H x 13" W x 9¾" D

**PRICE \$69 EACH**

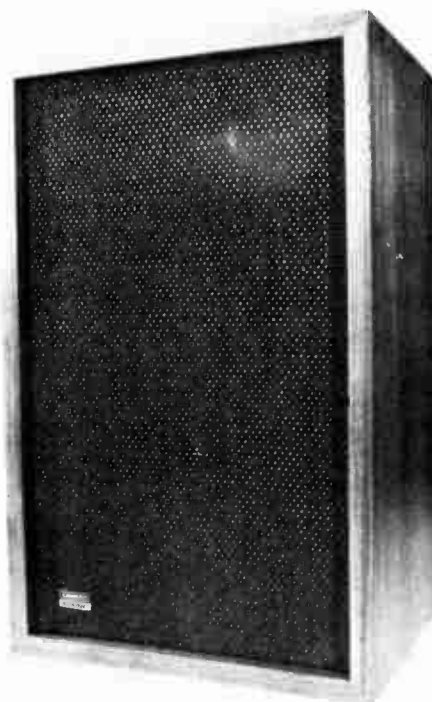

SOLE AUSTRALIAN AGENTS

## LINEAR SOUND PTY. LTD.

639 PACIFIC HIGHWAY CHATSWOOD Phone: 412-4352.

# Everything you've ever wanted to know about 'Eveready' rechargeable batteries but were afraid to ask.\*

\*Our unabashed coupon will reveal all.

Please send me all the details on  
Eveready nickel cadmium rechargeable power cells.

Name \_\_\_\_\_

Address \_\_\_\_\_  
\_\_\_\_\_

Postcode \_\_\_\_\_

085.P.339.01

You are almost certainly aware that 'Eveready' make a prodigious range of nickel cadmium rechargeable power cells.

Each one is completely sealed, utterly reliable and exhaustively tested. They come in just about every possible shape and size and voltage.

Along with our magnificent charging units which are compact, ruggedly constructed and modestly priced.

But rather than go on and on bending your ear about them in the narrow confines of this advertisement, we've prepared a brochure bursting with details. And it's yours, absolutely free, in return for the coupon above.

We'll forward it to you promptly under plain wrapper together with the answers to any thorny problems you may have with regard to nicad cells or anything else concerning portable power that just may be keeping you awake nights.

No charge.

**Union Carbide Australia Limited.**

Sydney Consumer Products Division, 157 Liverpool St. 20656. Brisbane 243-253 Edward St. 311391.  
Melbourne 505 St. Kilda Rd. 261241, 262332. Adelaide 41-49 Currie St. 516099. Perth 901 Hay St. 212926

**EVEREADY**

BATTERIES Products of

**UNION  
CARBIDE**

'Eveready' & 'Union Carbide' are registered Trade Marks.



# Linear Design

BRINGS  
ON  
THE  
NEW



MODEL GST1 TURNTABLE

R.P. \$139.00 COMPLETE

## "ENTFERNEN SIE DEN DONNER VON DER MUSIK!!"

That's German, and translated it means:- "Remove the Thunder from your music" and that's exactly what you get with the GST-1 Turntable:- No RUMBLE!!

Never have your records sounded so quiet between tracks.

What DO you get? Well, some nice things like:

1. A high torque synchronous motor
2. A neoprene belt drive system
3. A finely balanced 4lb. platter
4. A unique floating suspension to reduce acoustic feedback.
5. A superb transcription tone-arm (see specifications)
6. A Shure M55/E cartridge
7. Magnetic anti-skate adjustment
8. A smooth hydraulic lifting device
9. A handcrafted walnut plinth and lid
10. A two year guarantee.

All this for \$139.00. Can it be any good? You bet yall.

See the Linear Design Turntable at your nearest HI-FI dealer NOW!!



## SPECIFICATIONS

Turntable: Aluminium alloy cast 4lb platter.  
Drive: Hysteresis synchronous motor via neoprene belt

Wow & Flutter:  $\pm 0.05\%$ .

Rumble: Better than 56db.

Speed Deviation: Less than 0.9%

Tone Arm: Static-balance type with lateral balancer, overhang and height adjustment levers. Heavy elements are close to the fulcrum and provides low inertia.

Tracking error: Less than 1 degree.

Stylus Pressure:  $1\frac{1}{4}$  grams (with Shure M55/E).

Arm Lifter: Smooth hydraulic type lift.

Antiskate: Magnetic repulsion of direct reading type.

Weight range: 0-3 grams.

Plinth finish: Oiled walnut only.

DISTRIBUTORS:

**BJD**

Electronics Pty. Ltd.

202 Pelham St., Carlton, 3053 Vic. Ph. 347-8255.

190 Willoughby Road, Crows Nest, 2065 N.S.W. Ph. 439-4201

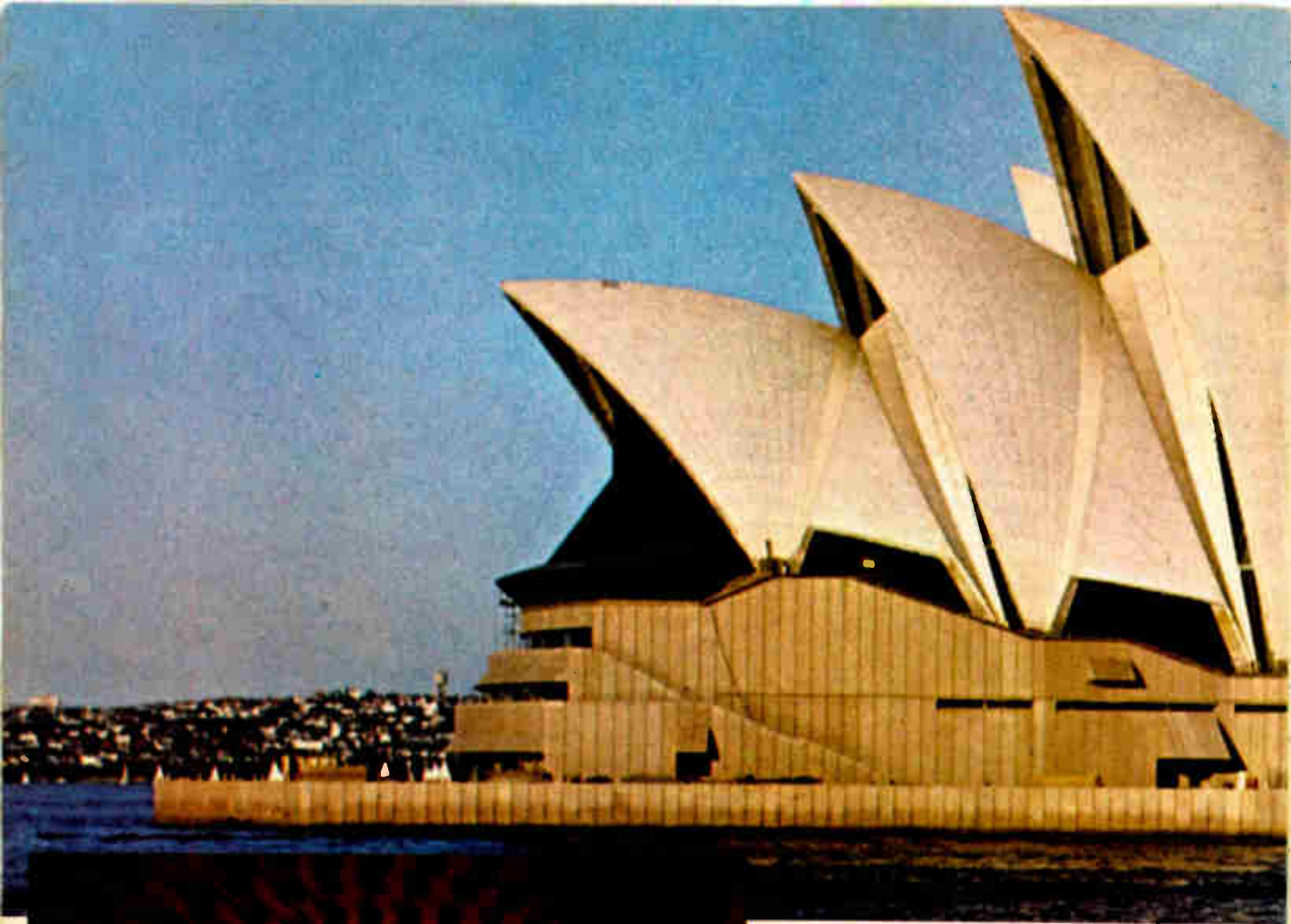

# Beautiful superb

Kenwood gives you  
both

Great to look at and admire while you're enjoying the good sound . . . whether it be orchestral, ballet or pop concert – that's Kenwood. The hi-fi equipment that is engineered for spectacular effects in sound . . . like the Opera House. Meticulous Kenwood research assures you of true high fidelity in the inspired engineering of circuits and components. Kenwood experts in aesthetics and ergonomics assure you of standards of control and cabinet design that compliment your taste. The scratchproof panels and rich timber grains mate perfectly with other furnishings.

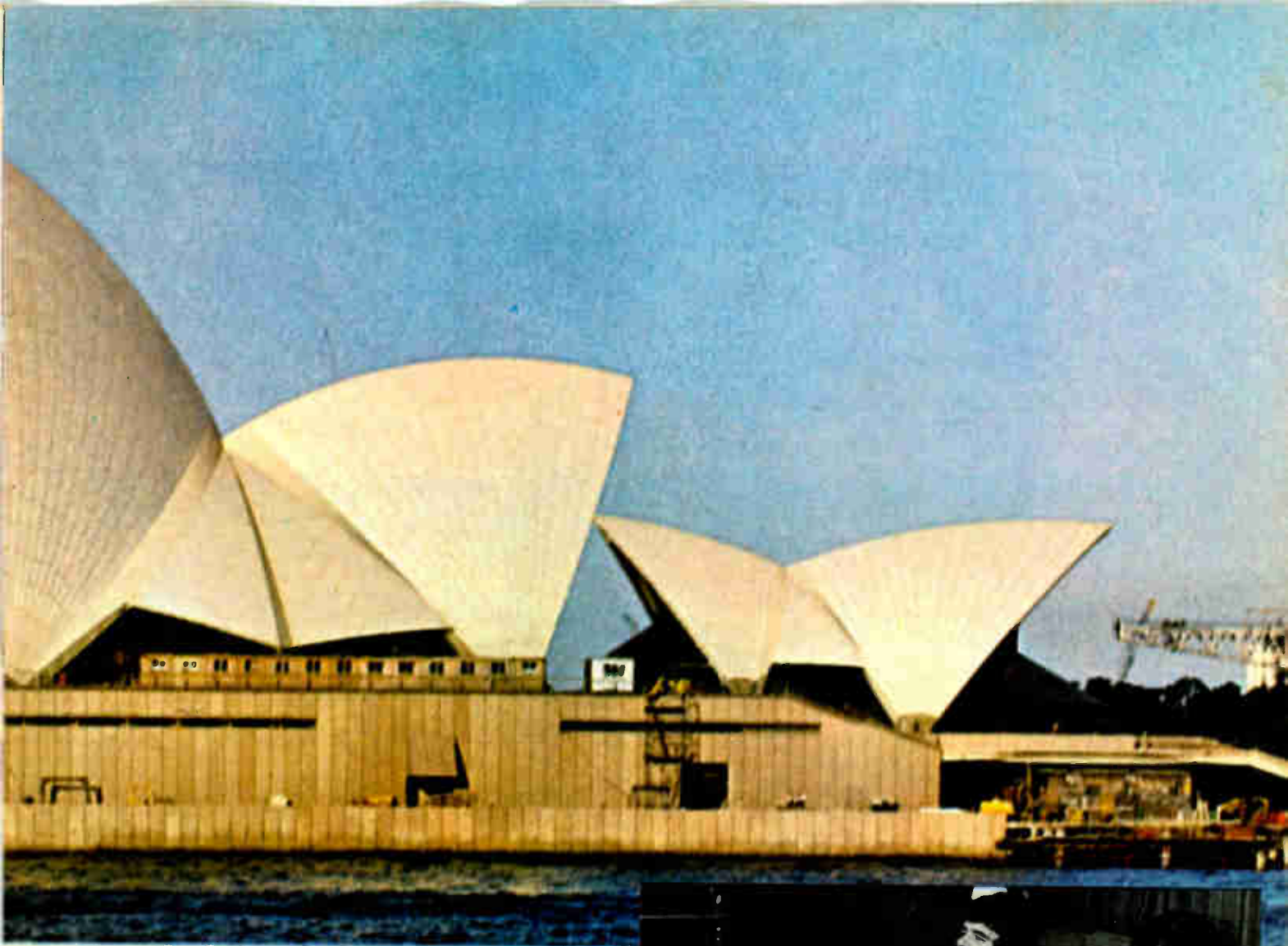

# exterior.. acoustic fidelity

What does Kenwood offer? Turntables, cassette decks, amplifiers, tuners and speakers for 2-channel or 4-channel listeners of unusual discernment.



*Kenwood high-fidelity system illustrated comprises KP-3021 auto. turntable, the KX-700 Dolby cassette deck, the KR-3200 13.5 watt per channel amplifier driving two KL-7090 6-speaker enclosures.*



*the sound approach to quality*



## KENWOOD

N.S.W.: 215 North Rocks Rd., North Rocks 2151.  
Tel.: 630 7400. A.C.T.: Assoc. Scientific Sales Pty. Ltd., 29 W'gong St., Fyshwick 2600.  
Tel.: 95 9138. VIC.: 30 Kerr St., Fitzroy 3065.

Distributed by:  
**JACOBY  
MITCHELL**

Tel.: 41 7551. S.A.: 652 South Rd., Glandore 5037.  
Tel.: 93 6117. QLD.: 41 Skinner St., West End 4101. Tel.: 44 4674.  
W.A.: 10-12 Southport St., Leederville 6007  
Tel.: 81 4144

TAS.: Lawrence & Hanson Pty. Ltd., 34 Brisbane St., Hobart 7000.  
Wills & Co. Pty. Ltd., 7 The Quadrant, Launceston 7250.

JMK/28-73

**DOUGLAS**  
SELLS SOUND FOR LESS!



## **AKAI GXC 46-D** Hi-Fi cassette stereo tape deck

Styled right, performs superbly. With the inclusion of the famous GX Head focused-field recording system and two other top systems, Dolby Noise Reduction and Akai Automatic Distortion Reduction systems, the sound of this brand new cassette machine belies the notion that natural clear sound reproduction can only be achieved with an open reel unit. Check the features and then listen. Amazing Hi-Fi response: 30-18,000Hz at 58dB S/N (with Dolby). You'll be glad you did.

New Tariff Reduction Brings  
New Lower Price  
NOW ONLY

**\$255**

*\*POST YOUR CHEQUE OR ORDER TODAY!*

**DOUGLAS TRADING for HI-FI SOUND**

185-191 BOURKE STREET, MELBOURNE — PHONE 63 9321

Complete range of fabulous Memorex tapes and Jensen Hi-Fi speakers

# FLUKE

The Company that revolutionised

the DIGITAL MULTIMETER World now introduces

four new DIGITAL COUNTERS (with more to come)

## Check the Performance and the Prices !

### Frequency Measurement 1952A Counter Timer



- D.C. to 80 MHz  
Expandable to 515 MHz.
- Frequency Ratio, Single Period, Multiple Period Averaging Time Interval Measurement, Totalize
- Matched Input Channels
- Coupling, Slope & Attenuation Controls
- 7 Digit LED Display Expandable to 9 Digits
- Continuous Trigger Modes
- 50 mV sensitivity
- Trigger Level Control with Status Lamps
- Self Check
- Units Annunciation, Overflow, Gate Lamp
- Optional Interface Package
- Optional TCX0

**\*\$625**

### Frequency Measurement 1950A Digital Counter

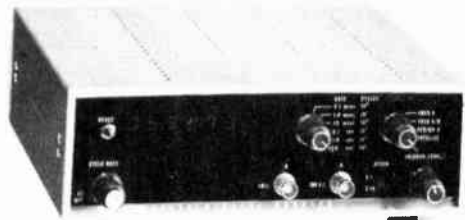

- 5 Hz to 50 MHz
- Frequency, Single Period, Multiple Period Averages, Ratio and Totalize
- 6 Digit LED Display with Automatic Annunciation
- Trigger Level Control with Status Lamps
- 240V ac or 12 V dc operation

**\*\$395**

### Frequency Measurement 1941A Digital Counter

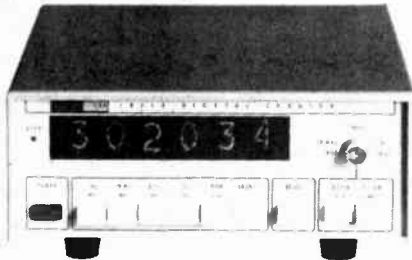

- 10 Hz to 40 MHz
- Frequency, Totalize and R.P.M. Indicator
- Trigger Level Control
- Variable Cycle Rate

**\*\$265**

### 1980A VHF, UHF Telecommunications Frequency Counter



- 5 HZ to 515 MHz
- Snap-On Battery Pack (Optional)
- to 6 Digit LED Display
- TCX0's to  $2 \times 10^8$
- Units Annunciation
- 35 mV increasing to 50 mV Sensitivity over the entire range
- $-20^{\circ}$  C to  $+60^{\circ}$  C Operating Range (Optional)

**\*\$695**

\*Duty and Sales Tax excluded.

## REQUEST LITERATURE OR A DEMONSTRATION NOW

### ELMEASCO INSTRUMENTS PTY. LTD.

P.O. Box 334, Brookvale, N.S.W. 2100. 939-7944

Adelaide 64-3296

Brisbane 71-3366

Melbourne 26-6658

Perth 25-3130





## AMATEUR RADIO AT SCOUT JAMBOREE

The South Australian Scout amateur radio station VK5BP will be taking part of the 10th Australian Scout Jamboree to be held 28th December-6 January next.

The station will commence transmission at 0230 GMT on Sunday, December 30th and will operate 24 hours a day until 1030 GMT on Saturday, 5th January, 1974.

The station will be equipped with three S.S.B. transmitters covering all bands, two transmitters will be operating simultaneously on separate bands while the third will be in a 'filaments on' condition in case of failure of either of the operating equipments. Each transmitter will operate for 16 hours on air, and eight hours on standby to give equal usage of all equipment. The basic operating frequencies will be:—

160 metres	1.819 MHz*
80 metres	3.625 MHz*
40 metres	7.050 MHz*
20 metres	14.190 MHz*
15 metres	21.190 MHz*
10 metres	28.190 MHz*

\*Dependant on frequency being clear of use.

Propagation conditions from day to day will determine the two bands in operation.

Three Aerial Systems will be in use:—

- 1) A Rotatable Quad for 20, 15, 10 metres.
- 2) Dipoles at 90° for 80, 40, 20 metres.
- 3) Long wire for 160 through 10 metres.

It is hoped that many stations around the world will take part, thus ensuring that the operation of the Jamboree Station will be a success.

## NATIONAL SEMICONDUCTOR INTO CALCULATORS

In the USA, National Semiconductors are unofficially reported to be preparing to release a pocket-sized electric calculator. Selling price is believed to be US\$39.50.

It is virtually certain that the National unit will use that company's MOS chips and LED displays.

## LASER BEAM TO TREAT GLAUCOMA

The successful use of a laser beam to treat glaucoma is reported by a Soviet scientist. Dr. Michael M. Krasnov, professor of ophthalmology at the Second Moscow Medical Institute, says glaucoma was brought under control in 88 of 94 patients. The therapy eliminated the need for surgery, but it

had to be repeated about every six months. However, Dr. Krasnov says the procedure takes only ten minutes and can be done in the doctor's office. Ophthalmologists in the US have been working on similar treatment for glaucoma patients but so far have had inconclusive results. A spokesman for the National Eye Institute in Bethesda, Md., believes the laser used by Dr. Krasnov may direct thermal energy faster and more efficiently than those that are used in glaucoma research in the US.

## NSW POLICE TO GET INSTANT INFORMATION

Stolen motor vehicle . . . hit-run driver . . . abandoned car . . . multi-car accident . . . these are just four fairly common reasons why the police may wish to obtain details of particular motor vehicle registrations as quickly as possible.

In NSW at present all such police enquiries have to be made by telephone calls to the NSW Department of Motor Transport, Rosebery. There, the information is manually recorded, and then passed on to the police requiring the information.

By the end of this year, or early next year, the NSW Police Department will be hooked up to the Department of Motor Transport's computer, enabling the Police Communications Centre to obtain both visual display of information or hard copy printouts in a matter of seconds.

The terminal units which will shortly be installed in the Stolen Motor Vehicles Index (SMVI) and the Radio Centre will be linked to the computer partly by copper-covered steel-core coaxial cable.

Once the terminal units are installed — the SMVI will have two VDUs (Visual Display Units) and one hard copy printout and the Radio Centre one VDU and one printout — all Sydney metropolitan police telephone enquiries will be handled by the SMVI and all metropolitan radio queries (from mobile patrols) by the Radio Centre.

Country enquiries will come in either by telephone or by telex. The police telex network is being greatly extended and will soon link all country 'Inspector stations' with Sydney.

Initially, the information available will relate only to vehicle registration. This information has already been computerised by Department of Motor Transport data processing staff.

The next two phases of conversion to computer systems will take in all details of drivers' licences and, later, traffic conviction records.

The Department of Motor Transport's IBM Model 370/145 Computer

## REMEMBER



FOR PERSONAL ATTENTION  
AND HONEST ADVICE  
PLUS THE BEST PRICE

## MIRANDA HI-FI

SHOP 67, TOP LEVEL,  
MIRANDA FAIR, N.S.W.

WE STOCK ALL BRANDS  
525 6745

has 14 disc drives at the moment and this will shortly be increased to 18, providing a total capacity of 1800 million information characters.

The entire Master Vehicle File of the NSW Department of Motor Transport — covering some 2 350 000 vehicles and listing such details as plate number, make, model, body weight, horsepower, insurance classification, etc. has now been computerised.

The computerised form of this mass of information is just four computer disc packs, each of which is kept continually 'on line' for instant access to details.

## INORGANIC/LITHIUM BATTERY

An experimental inorganic/lithium battery has been developed by General Telephone & Electronics at its research centre in Waltham, Mass. An outgrowth of research sponsored by the US Office of Naval Research on electroluminescence of inorganic liquids, the battery functions by electrochemical decomposition of inorganic solvent material (containing an inorganic salt) at a carbon electrode, and oxidation of lithium electrode material, during discharge of the cell.

## FIBRE OPTICS IN AIRCRAFT

Britain's Marconi-Elliott Avionics organisation has received a grant from that country's Ministry of Defence to see whether fibre optic links can be used to transmit digital data in the normally adverse electromagnetic environment in aircraft.

The experimental system uses standard gallium arsenide emitters. Silicon photodiodes are used as receivers. A bundle of 100 fibres is used to ensure reliability in the event of some fibres breaking.

Clock rate of the system is five megabits/sec and pulse widths of a few tenths of nanoseconds are used.

## TO AND FROM METRIC

An interesting new IC shortly to be marketed by MOS Technology (Valley Forge, Pa, USA) is an array for pocket calculators.

The IC incorporates 36 conversions from metric to the current US system. These conversions include length, area, volume, temperature and liquid units, apart from the normal four functions plus percentage and memory. Chip number is MPS 2521A-005.

## LOGARITHMIC RESPONSE

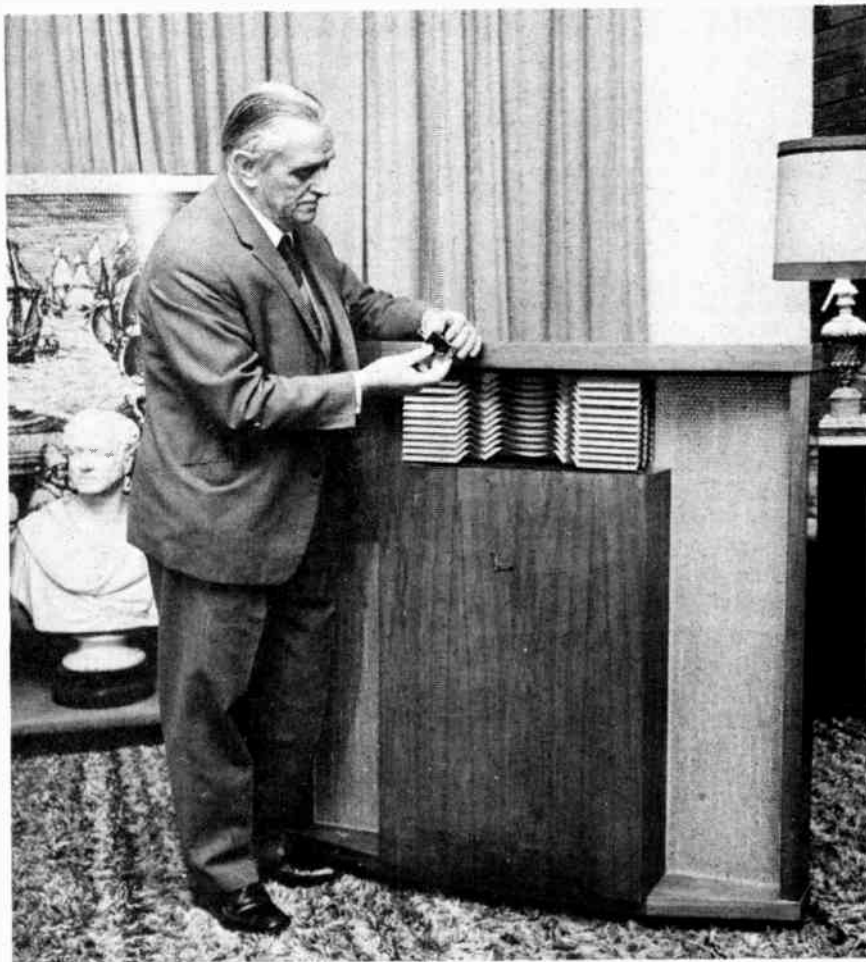

A dramatic illustration that the ear's response to sound levels is logarithmic, not linear (i.e. power level must be increased by ten times to double apparent sound level) was given recently by Phil Harrison of the Convoy Technocentre in Sydney.

Phil used a tiny Sony transistor radio — it can just be seen in Phil's right hand — to drive a JBL Hartsfield hornloaded speaker enclosure.

Despite the radio's output being only a few milliwatts, the sound level from

the speaker surprised people who were not aware of the logarithmic nature of the ear's response.

Admittedly, the JBL speaker used for the demonstration was a particularly efficient design — probably 5 to 10% — but the demonstration primarily proved that to increase sound levels to any really marked extent, quite mammoth increases in amplifier power are required. Hence the emergence of power amplifiers rated at 100+ watts.

## NEW STANDARD FOR ELECTROTECHNOLOGY SYMBOLS

A new Australian standard for graphical symbols used in electrotechnology, covering signal transmission symbols, has been published by the Standards Association. It is issued as Australian Standard 1102, Part 10.

It specifies standard graphical symbols for use in various types of diagram to illustrate different forms of signal transmission. The method adopted involves establishment of various basic symbols together with

qualifying symbols indicating a special function or property.

The symbols may be combined to produce more complex or more descriptive symbols, the principles covering the combining of the symbols having been demonstrated in examples given in the standard. The examples are not intended to be exhaustive but it is considered that it will be possible to construct any symbol required from those given in this part of the standard and from other parts defining basic symbols.

The standard is identical with the recommendations of the International Electrotechnical Commission (IEC).

Copies of AS 1102, Part 10 may be obtained from the various offices of the Standards Association for \$1.60 each (Postage extra).

### PACEMAKER HAS RECHARGEABLE BATTERY

A pacemaker with rechargeable battery has been developed by scientists at Johns Hopkins Applied Physics Laboratory. The \$1800 pacemaker is powered by a space-satellite-type cadmium battery. A patient can handle the required weekly recharging at home in a few hours using household current. A special vest produces an alternating magnetic field, energizing the battery through the skin but not harming the wearer. Developers expect the pacemaker, which has been installed in 50 patients so far, to last about 20 years, doing away with the periodic operations for battery replacement.

### HITACHI PICKS PHILIPS VCR SYSTEM

Hitachi Electronics of Japan have signed an agreement with N.V. Philips of Eindhoven, Holland, for the manufacture of video cassette recorders to the Philips format.

This follows Philips' submission to the Electronic Industries Association of Japan for standardisation to the Philips VCR format.

Hitachi joins a list of more than a dozen European and American electronics companies that have accepted the Philips video cassette concept.

Similar world acceptance was made some years ago when Philips pioneered the audio "compact cassette".

### SUPER TAPE?

Philips have recently released details of a new magnetic tape that — on paper at least — totally outperforms all other tapes currently on the market.

Output is stated to be no less than 7.5 dB higher (high frequency) signal to noise than chromium dioxide tapes and 12 dB higher than iron oxide.

The tape is manufactured from finely separated metallic iron, instead of the conventional iron oxide, as the magnetic medium.

Nine dB more bias current is required than for current ferric tapes — or 6 dB more than chromium dioxide. This implies that, if the tape is commercially developed — and this by no means certain — tape decks will need yet another bias switch position!

# now available.. for all audio systems

sanken hybrid audio power amplifiers



Series S1-1000A Sanken Audio Amplifiers are high power hybrid amplifiers for Hi-Fi, stereo, musical instruments, public address systems and other audio applications. Two power ranges of 25 and 50 watts rms output are provided. The amplifiers are completely self-contained, requiring only an output coupling capacitor, parasitic oscillation suppressors and a power supply. • Single-ended push-pull output. • Withstand a 5 second output short-circuit • Less than 1/2% distortion at 25 and 50 watts. • 1/2 dB response from 20 to 100,000 Hz.



Model S1-1010Y Sanken Audio Amplifiers are medium power hybrid amplifiers for Hi-Fi, stereo, musical instruments, public address systems and other audio applications. The amplifiers do not require a heat sink for operation at 25°C ambient or less. • Single-ended push-pull output. • Withstand a 5 second output short-circuit

Sanken Hybrid Voltage Regulator S1-3554M (5v, 3A). • High power hybrid voltage regulator of monolithic circuitry and a power transistor chip. • Power supply for TTL and DTL IC's in control and measuring equipment. • Few external components and no further adjustment required. • Built-in circuit protection against continuous overload and short circuit.

For full information please write or 'phone:

**Tristate Electronics** 2 Sarah St., Mascot, N.S.W. 669 2657

**Highview Electrics** 8 Matthews Rd., East Bentleigh, Vic. 57 5791

**K. D. Fisher & Co.** 34 Capper St., Kent Town, S.A. 42 2920

**Continuous Music Systems & Acoustics (W.A.)** 8 Oswald St., Victoria Park, W.A. 61 4464

# the OLD stereo

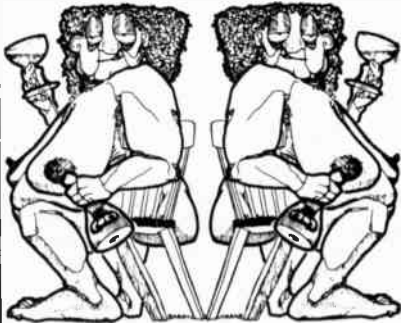

# NOW THE NEW INTERNATIONAL



Available in a JAYCAR kit

Kit of parts for preamp inc. switch assembly \$50.60 + \$1.00 p.&p.

Kit if parts for power amp inc. transformers \$68.00 + \$1.00 p.&p. Complete kit wired and tested \$164 + \$2.00 p.&p.

Complete kit of parts \$144.00 + \$2.00 p. + p.

plus **FREE!**

With every complete 416 kit purchased, one super-duper-fantastic-whopper pack which includes:

- 1 scope deluxe soldering iron
- 1 'Bib' wirestripper
- 1 pack 16c. 'Ersin' solder
- 20 yards 1mm spaghetti
- 5 rolls p.v.c. tape AND 1 electronic nut

## JAYCAR

211-5077 211-5077

405 Sussex St. Haymarket N.S.W.  
Australia 2000  
P.O. Box K39 Haymarket

# news digest

## HOME MOVIES OF THE FUTURE?



A stamp sized electronic device invented at the General Electric Research and Development Centre may someday result in a television camera no larger than a pack of cigarettes.

The tiny GE device, a solid-state imager, performs the same function as the large video vacuum tube currently used in television cameras. It converts an optical image into an electrical video signal.

With a solid state camera, a small video tape recorder, and a home television set, a family could make home "movies" for instant replay. In other applications, cameras built around the imager would be invaluable in military and security installations and in color imaging systems for commercial television cameras.

The GE imager is a photosensitive silicon semiconductor chip — one-eighth of an inch square — that utilizes a technique called "charge

injection" to create an electrical video signal from an optical image.

The chip is studded with 32 rows of metal-oxide-silicon (MOS) capacitors, and every row contains 32 pairs of MOS capacitors. Each pair of capacitors functions as an individual light-sensing device. As light strikes the chip, each pair of capacitors collects an electrical charge proportionate to the intensity of light striking it.

To process the electrical charges stored by the capacitors into a television image, the rows are scanned electronically by integrated circuits built into the chip's perimeter. Upon a signal from the scanning circuits, each pair of capacitors individually releases its charge, "injecting" it into the silicon base of the chip.

The strength of the charge is measured, and the measurement is used to produce an area of appropriate shading on a television screen.

**if you know  
nothing  
or everything  
about HI-FI  
here's what  
Convoy  
Technocentre  
offers**



**\* HI-FIDELITY MUSIC SYSTEMS**

Quadraphonic — Stereo — Mono — from record, tape, cassette, radio or microphone

**\* TAPE RECORDING SYSTEMS**

Quadraphonic, Stereo or Mono — Portable or Mains operated, or both; remote control; concealed; timed recordings; both professional and semi-professional equipment.

**\* QUADROPHONIC**

Upgrade your existing system with selected — record players, amplifiers, tape decks and adaptors.

**\* SPECIAL ELECTRONICS SERVICE**

For everything described here, plus Dictating Machines, Intercoms, Electric Eye Systems, etc.

**\* CONSULTATION SERVICE**

Every electronic sound problem solved at our showroom or by appointment — Home, factory, shops, clubs, etc.

**A UNIQUE INVITATION TO ENJOY SOUND SATISFACTION**

The professional consultants at the Convoy Technocentre of Sound have created the most unique group of listening studios ever! Carefully selected Hi-Fi Systems are grouped together logically so that confusion vanishes. You are invited to select your particular system or component in a pleasant and relaxed atmosphere comparable to your own home. Prices to suit every budget.

**YOU SAVE AT CONVOY TECHNOCENTRE**

If your budget is \$300 or \$5,000 the Convoy Technocentre has tested and selected the exact system you require and will guarantee selected systems with on-the-premises service for 15 months. When you come to upgrade your system you will see just how much extra you save because of big trade-in values. As specialist importers Convoy keeps prices down; value and service are way up. Terms to suit your budget also.

**SPECIAL SERVICE FOR HI-FI GEAR.**

**Convoy Technocentre**

Corner Plunkett & Maclean Street, Woolloomooloo  
Open Thurs. nights and Saturdays. Phone 357-2444

**FREE PARKING AT DOOR.**

# news digest

GE's solid-state imager marks the first time that a charge-injected device (CID) has been used to create a video signal from an optical image. With this CID technology, the imager has a high tolerance to defects.

At its present stage of development, the picture produced by the GE imager lacks the detail of a conventional television camera. However, its resolution is sufficient to permit identification of individual people.

Development of an imager with nine times the resolution of the present device — a silicon chip containing 100 rows of 100 pairs of capacitors — is nearing completion at the GE Research and Development Centre in Schenectady, N.Y.

The developers of the imager, GE project engineers Gerald J. Michon and Hubert K. Burke, expect broad applications for this invention, and predict that it could ultimately lead to the development of a television camera one-tenth the size and weight of the smallest TV cameras now available. An experimental camera no larger than a small home movie camera already has been built around the imager at the GE Research and Development Centre.

Since the imager can be produced with current solid-state electronic manufacturing techniques, a TV camera based on the imager probably could be manufactured for a fraction of the cost of a conventional camera. Because of its solid-state construction, such a camera would have a longer operating life than conventional cameras and would require less electrical power when in use.

## VIDEOPHONE HAS MULTIPLE USES



In Germany, Siemens have a new video-telephone design, Videaset 101, ready for series production.

This device is a further development of the first European video-telephone for dial operation, which was presented by Siemens in 1967 and has been in use since 1971 for a trial service between the Deutsche Bundespost in Darmstadt and the manufacturers in Munich. The new video-telephone is characterized by a larger screen, improved picture quality and simplified operation. It uses the internationally proposed standard video bandwidth of 1 MHz.

Consistent use of the 1 MHz bandwidth led to a noticeable improvement of the service features. The screen, for instance, has been enlarged to 12.8 x 14.1 cm (height x width) and a 267 line scan, provides good resolution. For transmission of written texts, for example, a capacity of about 500 characters can be used.

The picture unit is rotatable, and its camera section can be tilted by  $\pm 6^\circ$ . A mechanical scissor aperture permits the use of plumbicon and silicon-vidicon type camera tubes, as well as the conventional vidicon. With all these types of tubes the automatic aperture control ( $F = 2.8$  to 22), together with the gain control (factor 16), makes it possible to control a brightness range of approximately 50 to 50 000 lux with good depth of vision at all stages.

The camera may be switched to focal distances of 32 cm, 80 cm, or 3 m<sup>8</sup>). In normal service the two larger distances are intended for recording a single person or a group of persons. For transmission of graphics a mirror is swung in front of the lens, and by adjusting the focal length it is possible to choose three different image areas in the proportion 4:2:1, allowing good adaptation to the picture content.

Apart from the audio-visual link between persons and the transmission of graphics, the new equipment is suitable for calling down pictorial information from central microfilm stores, and data from EDP systems. Information services with moving pictures and accompanying sound are an additional possibility. The following examples are intended to give an idea of the wide range of applications of the video-telephone as a data receiving terminal: information on rail and air timetables; news service; address and telephone enquiries; merchandise information with buying by telephone; bank and postal orders with identity check; access to education programs and other services (stock on hand, component data, information on literature, reference documents, management data).

# Sonab

## Dealer of the Month

*Talk to the experts at Instrol Hi-Fi Centre now at two exciting locations.*

### INSTROL HI-FI CENTRE

91a YORK STREET SYDNEY  
(between Market and King Sts)  
(opposite Rank Xerox)  
Phone 29-4258.

375 LONSOALE ST, MELBOURNE  
(rear Elizabeth St.)  
(opposite Cobb Co. Car Park)  
Phone 67-5831.

**When second  
best is not quite  
good enough....**



**think of Sweden...and Sonab**

SONAB of Sweden Pty. Ltd., 114 Walker Street, North Sydney, N.S.W. 2060. Ph 929 4288/4554.

# INTERNATIONAL MUSIC SYNTHESIZERS

— designed and developed by Barry Wilkinson and Trevor Marshall

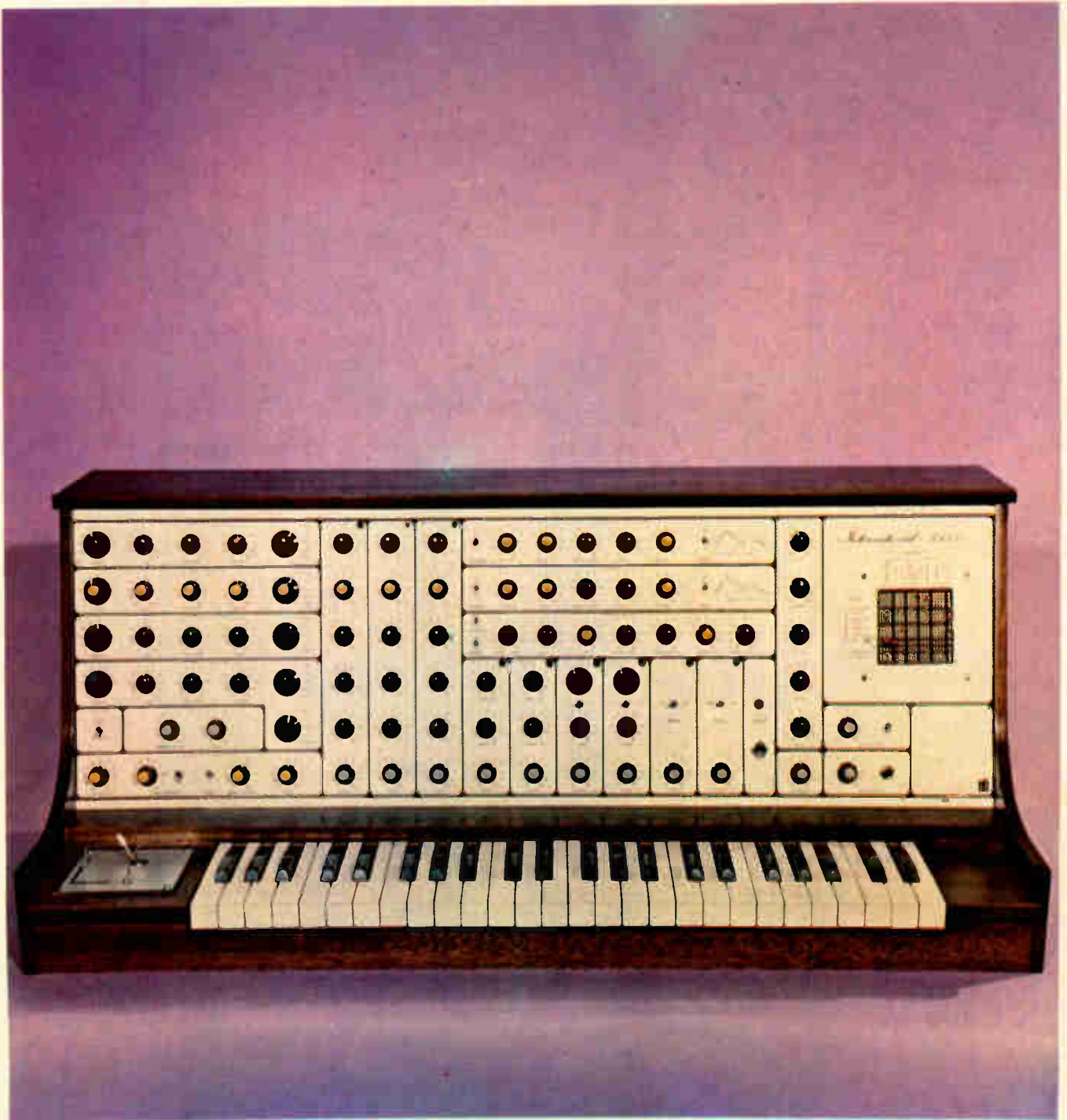



This article is the first of a series that will describe the construction of two music synthesizers — the International 3600 and the International 4600.

The 3600 is a relatively inexpensive model that is basically designed as a portable, limited capability instrument for stage work. It does however offer a performance superior to most small synthesizers at present on the market.

The larger 4600 is a full scale unit. It uses the same electronics but has more modules, a programming patchboard and many additional features which make it more suitable for studio use.

The flexibility of both units, in particular the larger, allows individual constructors to tailor an instrument to their own requirements.

**EXPERIMENTATION** in electronic music has been carried out since the earliest days of vacuum tube technology. One of the earliest pioneers in the field was B.F. Meisner who published the article "Design Considerations for a Versatile and simple Electronic Musical Instrument" in 1935. By the late 40's the electric piano and organ had become well established, but very few real advances were made. Even in the early 60's, the electronic-music studio consisted simply of a variety of tape recorders, filters and other devices which were used to modify the sounds of conventional instruments.

The first real breakthrough came in 1965 with the introduction of the first commercial Voltage Controlled Electronic Music Synthesizer designed by Robert Moog. Since then development has been rapid indeed, and in just eight years synthesizers have become one of the most versatile and flexible of electronic musical

instruments. Today they are used extensively by both popular and classical musicians to create new and exciting sounds.

Very soon after Moogs' revolutionary voltage-control concepts were introduced, the use of a digital computer was proposed as a means of extending the basic system and providing real time control of synthesizer operation. During recent years much work has been pioneered on digitally generated "computer music". This concept however, despite its incredible potential, is still in its infancy, and dependent for advancement on further technological developments.

The basic genius of voltage control is its conceptual simplicity, and although the method of implementation has changed much since 1965, the concept itself has not. Moog proposed that the basic sound sources, such as electronic oscillators and random noise generators, be electronically generated and that these sources be modified in amplitude and frequency by other electronic devices. The resultant signals would then be processed conventionally with reverberation and multi-track tape techniques. This in itself was not revolutionary but Moog proposed that all these generation and modification functions be **VOLTAGE CONTROLLED**. He then designed such circuitry — and the Voltage Controlled Music era had begun.

Voltage control implies that the oscillator frequencies (and/or harmonic structure), the gains of mixer/amplifiers and the cut-off frequencies of timbral-determining filters could all be changed by a control voltage. It need not be a constant voltage, indeed one oscillator could control another's frequency which in turn could control another, and so on. The complexity of sounds thus generated defy classical description, some of them are subjectively very pleasant, some are not, but they *all* are creative. Conventional sounds that can be specified in terms of amplitude, frequency and timbre can now be artificially produced and, if desirable, the specifications can be changed to "improve" the basic effect.

It was indeed fortunate that much research had been previously conducted into the structure of conventional instrumental sounds and consequently musicians such as Walter Carlos (responsible for the recording "Switched on Bach") were able to speedily demonstrate the versatility of the voltage controlled synthesizer and thus ensure its widespread acceptance.

### DESIGN PHILOSOPHY

The International Voltage Controlled Synthesizer has been developed as a

The Commonwealth Copyright Act (1968) vests in the 'maker of a work' the exclusive right to reproduce, publish and adapt that work for a specified period of time, (generally the life of the 'maker' plus fifty years).

Commercial manufacturing organisations should clearly understand that such copyright extends to all plans, drawings, circuit diagrams, photographs etc. published by this magazine.

The act of manufacturing for sale or lease, any apparatus or device based on material published in this magazine is a breach of such copyright — unless prior arrangements have been made with the Editor to manufacture under an assignment or licence of copyright.

Such an arrangement is currently being negotiated to enable assembled and tested International Music Synthesizers to be commercially available.

Full details of these completed units will be published as soon as full details are to hand.

Commercial organisations are also asked to note that certain aspects of this design are the subject of provisional patents. These are:—

Provisional Patent 3650, — method of generating sawtooth waveforms.

Provisional Patent 3651, — method of switching resistors in voltage controlled filters.

# INTERNATIONAL MUSIC SYNTHESIZERS

"state of the art" system. Extensive use has been made of digital techniques and CMOS has been used as the primary logic family.

No compromises have been made that would hinder expansion of the system to keep pace with the ingenuity or finances of its owner. The basic modules have been selected so that the unit will be just as suited to studio use as it is for a live "on-stage environment."

In the larger unit, a 484 point patchboard system is used to facilitate the rapid selection of various equipment configurations.

Separate headphone and main output level controls and switches are provided to ease on-stage cueing of the device.

All control voltages and generated waveforms have the same limits (zero and +5 volts), so that control and signal voltages are directly interchangeable.

The unit requires only a 240 volt ac supply (the synthesizer is not critically dependent on either the voltage or frequency of this supply), and an external power amplifier and speaker for normal operation. The headphone output will supply in excess of one watt. This is adequate to drive a small monitor speaker if an external amplifier is not available. Any dc offset voltages inherent in the circuitry are nulled in the initial construction. The keyboard intervals are also tuned during initial construction *and will not require readjustment* unless the unit is unusually roughly handled.

## VOLTAGE CONTROLLED OSCILLATORS (VCO)

Four VCO's are provided in the 4600 unit, three in the 3600 unit. Each VCO is switchable to the output waveforms listed below:—

Sine, Triangular, Sawtooth, Reverse sawtooth, Pulse wave (including square-wave with variable mark-space ratio).

The fourth oscillator (provided in the larger unit) can provide two simultaneous outputs. In all oscillators, great care has been taken in the design to ensure purity of waveform.

Each oscillator covers the frequency spectrum 0.1 Hz to 10 kHz in eight ranges. There are LO, 32ft, 16ft, 8ft, 4ft, 2ft, 1ft and ½ft. The seven top ranges are tuned exactly one octave apart and the "LO" range is provided to generate sub-audio frequencies for special effects.

The oscillators are completely linear over the upper 10 octaves of their

range and several fed from the one control voltage will "track" accurately over the entire keyboard.

## CONTROLLER

The model 4600 has a Controller unit which provides an adjustable dc voltage and an ac coupled modulation level control.

In the model 3600 this facility is replaced by a Modulation unit which has the outputs of Oscillator 3, the transient generator and the noise generator available as modulation sources. Each function has a separate level control.

## THE KEYBOARD CONTROLLER

The keyboard is fully digital. Forty-eight separate voltages are generated as a four octave x 12 semitone matrix. These are normally adjusted to produce an equal tempered scale. The output voltages (and hence oscillator pitch) have negligible temperature dependence nor will they change significantly as the unit ages.

This method used for voltage generation is completely different from, and its performance superior to, all other keyboard controllers details of which have been previously published. Most other keyboard controllers generate a linear pattern of voltages which are then converted to the required semitone values in an exponential converter, or by using an exponentially controlled oscillator. These exponential converters usually rely upon the characteristics of a transistor emitter base junction in which the temperature drift is substantial, resulting in the semitone interval having to be retuned every time the unit is played.

On the larger unit only, a fully variable "glide" (or "portamento") facility is provided, with a companion on/off switch. An "Absolute Pitch" control allows continuous transposition over several semitones.

The keyboard also generates a trigger output which goes from -7 to +7 volts whenever a key is pressed and returns to -7 volts when the key is released. A sample and hold circuit acts as a "memory" to maintain the control output voltage at the value of the last key pressed. (This enables the oscillators to maintain the last pitch selected until another key is pressed).

## VOLTAGE CONTROLLED FILTERS

Two VCFs are provided in the large unit and one in the smaller unit. They provide three separate filter characteristics: lowpass, bandpass and highpass. The cut-off slopes in all

modes are 40 dB decade, using easily reproduced two-pole active filters. The cutoff frequencies are a linear function of control voltage over a minimum range of 50 Hz to 5 kHz. Thus a filter and an oscillator fed from the keyboard (or, of course, any other control source) will track each other automatically. This also, is a feature not usually available in commercial equipment.

The filter characteristics do not change with a change in control voltage, that is, the Q factor is independent of frequency.

## NOISE SOURCE

This generator produces an almost purely Gaussian white noise. A digital shift register with feedback is used to generate a pseudo-random binary sequence  $2^{18}$  bits long (262 144 random points). Every second, about 30 000 are generated and these are integrated (filtered) to provide a random noise signal.

The spectral purity of this white noise is much better than those methods which use a Zener diode or noisy transistor as the source. In addition no component selection or tuning procedure is required.

## THE ENVELOPE GENERATOR

This module modifies the amplitude-time characteristic of a continuous input tone to give it "attack" and "decay" characteristics. A unique envelope is generated as shown in Fig. 1A.

All slopes are variable over a minimum range of five milliseconds to five seconds and the delay is adjustable from "off" — in which mode slope 3 is initiated only when the keyboard trigger goes to zero — to a maximum of approximately three seconds. This unique feature allows simulation of very fast attack-decay instruments (vibraphones, for example). The envelope generator contains a voltage controlled amplifier that is switchable to either linear or square-law control characteristics. Provision is also made for an external trigger (other than that from the keyboard) to initiate the envelope.

Fig. 1A. Characteristics of envelope generator.

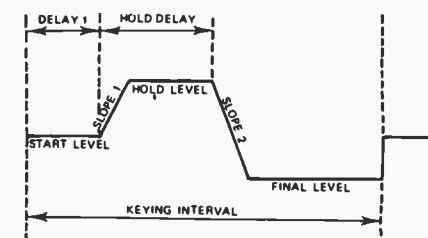

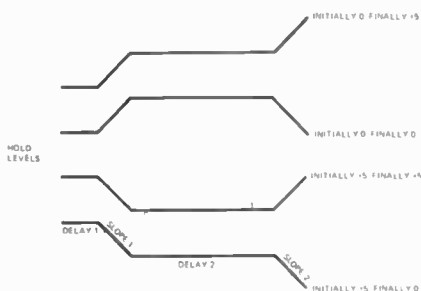

Fig. 2A.

## THE TRANSIENT GENERATOR

Two types of transient generator are used, type A and type B. Type A is primarily used to modulate the keyboard output voltage, such that transients can be generated on oscillator and filter outputs during the formation of a single note. The International 3600 has only one transient generator which is of type A. The 4600 has two generators, one type A known as TRANSIENT 2, and one type B known as TRANSIENT 1.

The type B generator is basically similar to the envelope controller but does not include a voltage controlled amplifier. Hence its output is a dc waveform and not a modulated envelope as in the envelope generator. This unit may be used as an envelope control if required in conjunction with one of the ring modulators.

The type A transient generator is a unique feature, as an infinite variety of output functions are available.

When a trigger is received, nothing happens until a preset delay (delay) has elapsed. Slope is then initiated until the hold level is reached. Delay 2 is initiated on the completion of delay 1 after which Slope 2 begins and continues until the final preset level is reached.

For example if the following settings are made:—

START LEVEL	0
DELAY 1	2
SLOPE 1	2
HOLD LEVEL	+5
HOLD DELAY	2
SLOPE 2	2
FINAL LEVEL	-2

then the keyboard output voltage when a key is pressed would be modified as shown in Fig. 2A.

Such an output would, when applied to an oscillator, cause it to commence the note in tune, raise it say one octave higher and then drop one octave lower. This frequency

modulation of the oscillator can create some very interesting and pleasing sounds. The number of semitones or octaves shifted up or down is uniform over the entire keyboard range, the design range plus or minus two octaves. Usually however this signal would be used to control a VCF (in the bandpass mode) being fed from a complex waveform (considerable harmonic content). Upon pressing a key the above waveform would cause the filter to commence at the timbre as selected by the VCF "tune" control, sweep up to the higher overtones and finish on the lower components.

Although this diagram may be typical, the start hold and final levels may be varied as required.

This timbral change allows the simulation of instruments such as the piano as well as the generation of new sounds which are quite different to those from basic instruments.

## AMPLIFIERS 1 AND 2

These units are fitted to the International 4600 only and are in effect voltage controlled amplifiers which serve a dual function as selected by a mode switch.

When the "Ring modulator" mode is selected the unit effectively multiplies the two input functions. Thus if either is zero, the output is zero. If one input is a dc control voltage varying between zero and +5 volts then the output will consist of the other input function with an amplitude linearly controlled by the dc control voltage.

The other mode merely ac couples the input and in this mode the unit may be used as a general purpose amplifier.

## MIXERS

Five mixers are used in the 4600, all are direct coupled and hence may be used for control voltages or signals.

Mixers 1 to 3 are used solely for mixing the outputs of oscillators 1 to 4 and there is no access to their inputs. Mixers 4 and 5 have two inputs each, their outputs however may be paralleled to provide one four-input mixer.

A special mixing arrangement is provided in the 3600. This will be described in detail in a later article.

## JOYSTICK CONTROL

A joystick is fitted to the model 4600. It is accessible via the patch board and may be used to control, for example, two oscillators simultaneously, but differentially.

## OUTPUT EQUALIZER AND VOLUME CONTROL

The output section is identical in the 3600 and 4600 with the exception that inputs are via the patchboard in the 4600 but are hardwired in the 3600.

All signals are passed through a five section equalizer. This signal is then mixed with the same signal after passing through a spring reverberation unit. The reverberation control acts like a crossfader allowing the proportions of direct signal and reverberation to be controlled. The combined signal is then passed to an output amplifier and to a headphone amplifier each of which has an independent level control. A switch is provided to switch off output if required.

## NEXT MONTH

This series will continue next month when we will describe the construction of the keyboard, the oscillators, and the power supply. ●

## BIBLIOGRAPHY

1. Robert Moog "Voltage Controlled Electronic Music Modules" J. Audio Eng. Soc. 13, 200 (1965).
2. B. F. Meisner "Design Considerations for a Simple & Versatile Electronic Musical Instrument" J. Acous. Soc. Am. 6, 181 (1935).
3. D. W. Martin "Decay Rates of Piano Tones" J. Acous. Soc. Am. 19, 535 (1947).
4. Harold Bode "A New Tool for the Exploration of Unknown Electronic Musical Instrument Performances" J. Audio. Eng. Soc. 9, 264 (1961).
5. Gordon Mumma "An Electronic Music Studio for the Independent Composer" J. Audio Eng. Soc. 12, 240 (1964).
6. J. Gabura & G. Ciamaga. J. Audio Eng. Soc. 15, 49 (1968). Computer Control of Sound Apparatus for Electronic Music".
7. M.D. Freedman "A Digital Computer for the Electronic Music Studio" J. Audio. Eng. Soc. 15, 43 (1967).
8. Walter Carlos "Switched on Bach".

## SPECIFICATION INTERNATIONAL 3600 SYNTHESIZER

### KEYBOARD

No of Keys 48 (F to E monophonic)  
 Controls:  
 Tuning  $\pm 2$  semitones  
 Glide adjustable rate 0 to 10 seconds  
 Sweep allows manual sweep, up or down, from the keyed note over any selected span.

### MODULATION

Provides source of modulation for oscillators other than from the keyboard.

Controls:  
 Oscillator 3 selects Osc. 3 as source  
 Transient selects transient generator as source.

Noise Selects output of internal white noise generator as source.

### OSCILLATORS

Number 3  
 Controls:  
 Input selects keyboard or modulation

### Range

Tune  
 Free Run

### Shape

Waveform

Output Switch

Output Level  
 LEVEL

Provides control of noise and external input signals to input of the filter mixer.

Controls:  
 External

unit as source of control off position provided. provides 7 ranges from  $\frac{1}{2}$ ' to  $32'$  plus low frequency (0.01 Hz) special effects source. tuning range of  $\pm \frac{1}{2}$  octave internal voltage source which manually adjusts oscillator over full range. varies mark/space ratio of square wave output. selects sine, triangular, sawtooth, inverted sawtooth or square wave as output. routes signal to filter envelope or direct to output stage. adjusts output level

varies level of external signal from 50 mV to 2 V

Noise

### FILTER

Type  
 Inputs

Cut off Rate  
 Control Range  
 Controls:  
 Control Source

Free Run

Tune  
 High/Low  
 Mode switch

### ENVELOPE

(see specification of model 4600)

Input  
 Output

**EQUALIZER, REVERBERATION, OUTPUT and PHONES** same as model 4600.

controls level of noise to filter.

active, voltage controlled. mixed signals from oscillators and level unit. 24 dB/octave greater than 2 decades

Keyboard, modulation or off (manual) by front panel switch provides manual control of filter cutoff tunes filter to control source selects tuning range. selects high pass, band pass or low pass filter characteristic.

direct from keyboard to modulation level control

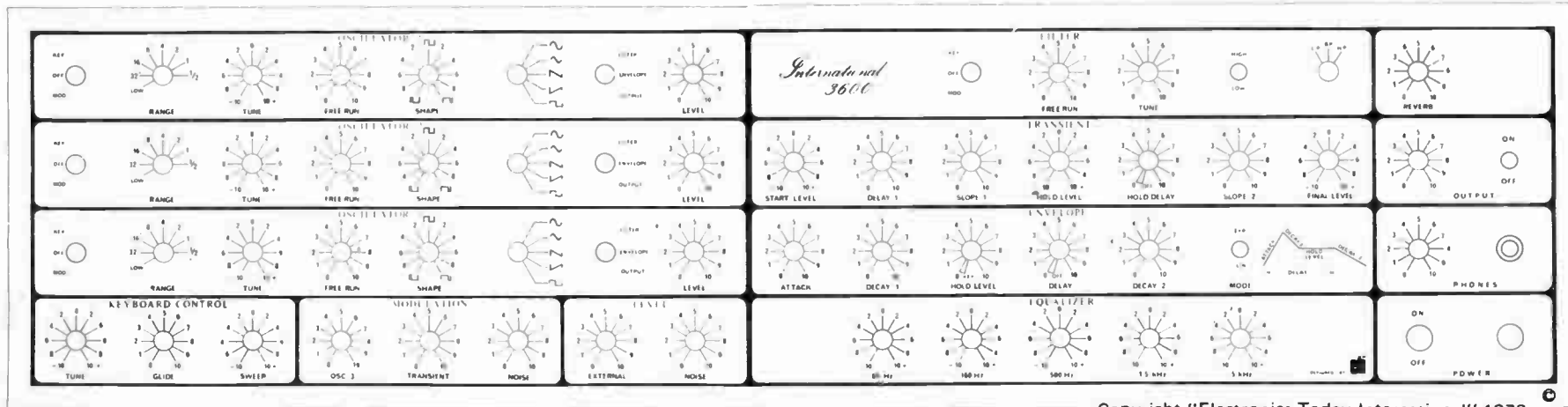

Copyright "Electronics Today International" 1973

## SPECIFICATION INTERNATIONAL 4600 SYNTHESIZER

### KEYBOARD

Number of Keys 48 (F to E monophonic)  
 Outputs to Patchboard  
 Trigger -7 V to +7 transition at each key press. Trigger is inhibited if more than one key is pressed. 0 to +5 volt transient generator No 2 patchboard.

Analogue (direct)  
 Analogue (modulated)  
 Inputs

Controls:  
 Sweep allows manual sweep, up or down from the keyed note over any selected span.

Glide adjustable rate 0-10 seconds switchable.

MIXERS 1, 2 and 3  
 Inputs

Level control

Overload  
 Output

MIXERS 4 and 5

Inputs  
 Input levels  
 Output level  
 Output

5 (one from each oscillator output) each with independent level controls. adjusts output level from each mixer. Indicated by LED lamp. to patchboard.

two each from patchboard individually adjustable adjustable with overload indication to patchboard.

### TRANSIENT 1

Basically similar to Envelope Generator but voltage controlled amplifier is omitted. Hold level may be adjusted to match keyboard output.

### TRANSIENT 2

Trigger Input  
 Levels

Delay 1  
 Slopes 1 & 2  
 Hold Delay

Outputs

from keyboard or patchboard start hold and final adjustable 0 to +5 volts. adjustable 5 msec to 5 sec adjustable 5 msec to 5 sec adjustable 5 msec to 5 sec or for duration of key contact closure. to patchboard and to keyboard control.

Transient	selects direct modulation of keyboard by transient generator No. 2.
Modulation	allows patchboard input to modulate keyboard to maximum of $\pm 2$ octaves.
Tune	tunes keyboard $\pm 2$ semitones.
<b>OSCILLATORS</b>	
Number	4 (oscillator 4 has dual output)
Controls:	
Range	provides seven ranges from $\frac{1}{2}$ ' to 32' plus low frequency (0.01 Hz) special effects source.
Tune	tuning range of $\pm \frac{1}{2}$ octave
Free Run	internal voltage source manually adjusts oscillator over full range.
Shape	varies mark/space ratio of square wave output.
Waveform	selects sine, triangular sawtooth, inverted sawtooth or square wave as output
	second output of oscillator 4 provides noise or controller output.
<b>NOISE</b>	
	provides pink or white noise direct to the patchboard. Noise is also selectable by oscillator 4, second output.
<b>CONTROLLER</b>	
Input	from patchboard
Output	to patchboard and output switch of oscillator 4.
Controls:	
Level	sets dc level, that is, centre frequency of controlled oscillator.
Modulation	controls level of modulation source selected via patchboard.

<b>FILTERS 1 and 2</b>	
Type	active, voltage controlled
Inputs	0-5 volt signal from patchboard 0-5 volt control from patchboard
Controls:	
Mode	selects high pass, bandpass or lowpass filter characteristics
High/low	selects tuning range
Tune	tunes filter to control source.
Level	controls output level with overload indication.
Cutoff Rate	24 dB/octave
Control Range	2 decades
<b>AMPLIFIERS 1 and 2</b>	
Type	voltage controlled, ac or dc coupled
Input Signal	via patchboard (0 to + 5 volts)
Input Control	via patchboard (0 to + 5 volts)
Mode	
Mod	dc coupled functions as voltage controlled amp
Amp	ac coupled function as ring modulator
Output	to patchboard level controlled and with overload indication.
<b>ENVELOPE</b>	
Input Trigger	from patchboard or keyboard direct.
Attack Decay 1 and Decay 2.	all adjustable from 5 msec to 5 sec.
Hold Level	adjustable 0-5 volts.
Delay	adjustable 5 msec to 5 sec, or duration of key contact closure as selected.
Control Mode	linear or exponential voltage controlled amplifier with a range of 60 dB.
Output	to patchboard.

<b>EXPONENTIAL CONVERTER</b>	
Input	0 to + 5 volt from patchboard.
Output	0 to + 5 volt to patchboard.
	converts linear input to exponential output.
<b>JOY STICK</b>	
	2-axis control of any two functions linear or exponential output as required 0 to + 5 V.
<b>EXTERNAL SIGNALS</b>	
Number of Inputs	2 signals 50 mV to 2 V
Input Impedance	10 kohms.
<b>OUTPUT EQUALIZER</b>	
Number of Stages	5
Centre Frequencies	60 Hz, 160 Hz, 500 Hz, 1.5 kHz.
Type	Active filter
Range of Adjustment	> $\pm 10$ dB.
<b>REVERBERATION UNIT</b>	
Type	multi-spring adjustable mix-fader
Output	from full reverb. to original sound without reverb.
<b>PHONE OUTPUT</b>	
Power Output	1K $\Omega$ 1 watt
Load Impedance	8 ohms
Output Level	control provided.
<b>SIGNAL OUTPUT</b>	
Level	0 to 1 volt RMS
Load Impedance	1 k ohm
Level control	level control provided together with on/off switch.

# INTERNATIONAL MUSIC SYNTHESIZERS

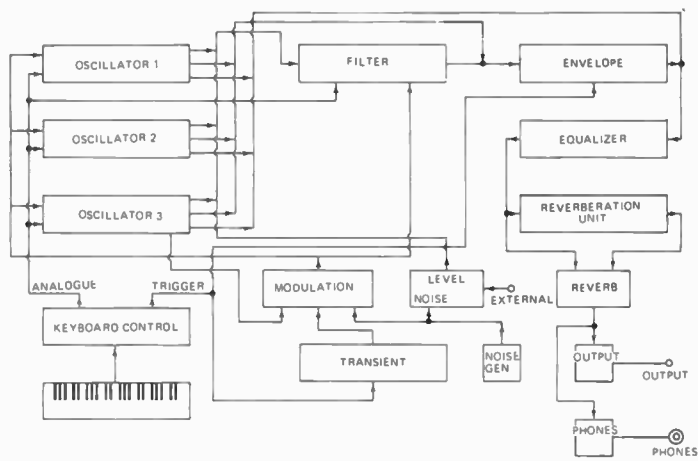

Block schematic of 3600 unit.

Copyright "Electronics Today International" 1973 ©

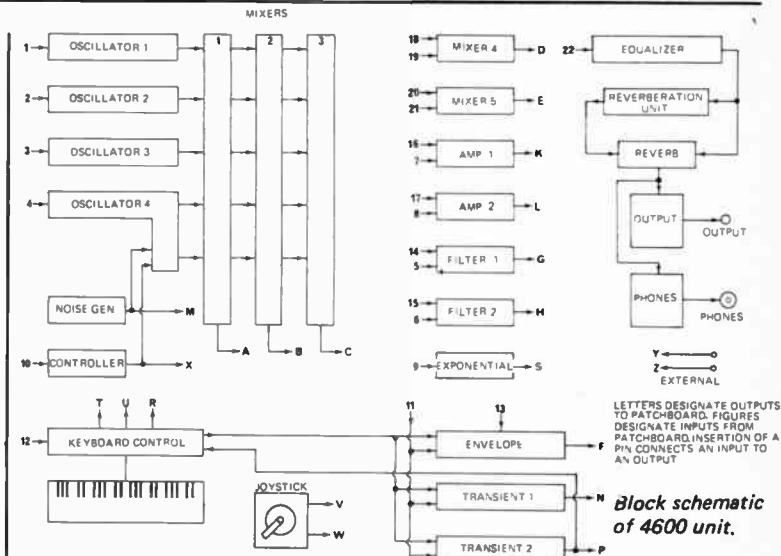

LETTERS DESIGNATE OUTPUTS TO PATCHBOARD. FIGURES DESIGNATE INPUTS FROM PATCHBOARD. INSERTION OF A PIN CONNECTS AN INPUT TO AN OUTPUT.

Block schematic of 4600 unit.

Copyright "Electronics Today International" 1973 ©

## THE PERCEPTION OF SOUND

### Loudness

The most basic characteristic of a sound is its loudness. The apparent loudness of a sound is a function of its intensity, or level, but there are three main factors which affect our perception of that intensity.

The first factor is that of the response characteristics of the ear. Our hearing can accommodate a huge range of sound intensity, but our perception of that intensity is not linear but logarithmic. To double the apparent loudness of a source, its intensity must be increased at least eight times. This is the reason for the use of exponential converters in the synthesizer, they are there to change a *linear* signal change to a *subjectively linear* (logarithmic) signal change.

The second factor is the *frequency - dependent sensitivity* of our hearing mechanism. This is expressed graphically in the well-known Fletcher-Munson equal loudness level contours (Fig. 1).

These show that as the intensity of a sound is reduced there is a considerable reduction in hearing sensitivity in the bass region relative to that in the midrange.

This phenomenon accounts for the difference in apparent loudness between (say) a 200 Hz sine wave and a 200 Hz sawtooth wave. The sawtooth wave contains high harmonic content and although its

overtone are not the same intensity as the fundamental, our hearing is more sensitive to them. As the effective loudness of a complex sound is dependent on the algebraic sum of the loudnesses of each component of that sound, we hear the sawtooth as being much "louder" than the sine wave, although their amplitudes may be identical.

The third factor affecting perceived loudness is the *duration* of the sound. It takes a finite time for our hearing to react to the presence of a sound and to analyze its characteristics.

Sounds which are very short in duration (.01 seconds, or 10 milliseconds) are perceived as being of lower loudness than they actually are (in addition very little pitch information is gathered from such a short burst of sound). Further, when the ears have become conditioned to the presence of a sound there is a gradual drop in apparent loudness.

When we synthesize very short attack transients we must allow for this lack of sensitivity and this means a much larger overshoot is required than would otherwise seem necessary.

**Absolute Pitch** Although perception of pitch is not precisely logarithmic, an exponential characteristic comes fairly close to producing equal subjective pitch change from a linear input. (Fig. 3.)

**Musical Pitch** Two tones whose frequencies differ by a factor of 2 are said to be *one octave apart*. This octave is usually divided into twelve increments, known as semitones which differ from each other by

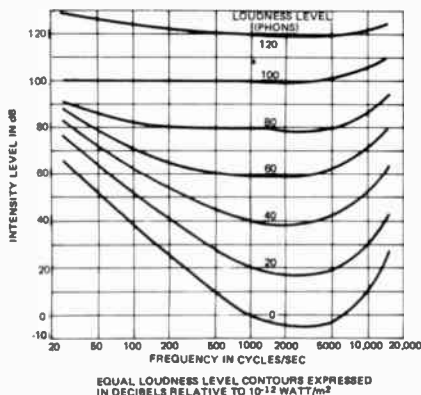

Fig. 1. Equal loudness contours (Fletcher-Munson)

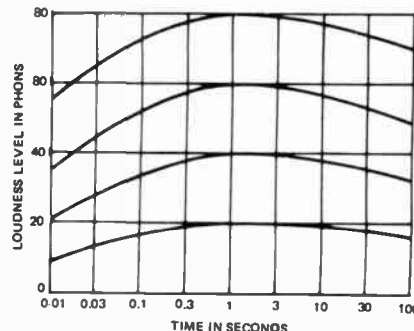

Fig. 2. Relation between loudness level and duration time.

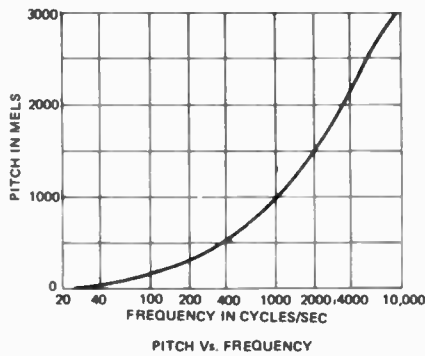

Fig. 3.

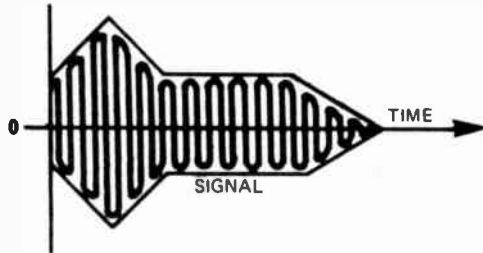

Fig. 4 The 'envelope' of a sound is the variation of its intensity with time.

a factor of the twelfth root of 2 ( $12\sqrt{\approx 1.059463}$ ).

Such a musical scale is termed "equal-tempered" and is used for all keyboard instruments. There are also several so called "just" or "true" scales that are based on harmonic structure. A musical textbook should be consulted if further information on these scales is required.

All previous voltage controlled synthesizer designs have been able to obtain "equal tempered" intervals only. The digital keyboard incorporates in both the

synthesizers described in this series *can* be adjusted to these "just" scales, this should only be considered by a competent musician and is generally unnecessary. Frequencies of the fundamental tones of each semitone in the effective musical scale are shown in Table 1.

**Envelope** The envelope of a sound is the variation of its intensity with time as shown in Fig. 4. The rate of variation of the envelope is very slow compared with the time variation of the sound itself (sine wave shown in Fig. 4 is the base sound.) Although the envelope is symmetrical about zero it is usually referred to in terms of the modulus.

**Timbre** The timbre of a musical sound is the characteristic that makes it possible to distinguish between two tones having the same intensity and fundamental frequency, but different waveforms. It expresses our ability to recognize the sound of a violin as different from that of a trumpet, even though the two instruments may be playing with the same pitch and loudness.

To describe analytically the timbre of a sound we must specify the frequencies of all the constituent components (termed "Partials") of that sound and their respective envelopes. (This group of envelopes is referred to as the 'Complex Envelope' of a sound).

The partials may not necessarily be harmonic, indeed many natural sounds have partials which are inharmonic. For example, the frequency of the fifteenth overtone of middle C on a piano, is greater than sixteen times the fundamental frequency (middle C).

With an electronically generated waveform, however, the overtones are direct multiples of the fundamental, and so a miscellany of different oscillators must often be used when attempting to simulate the sound of a "natural instrument". ●

TABLE 1 THE TEMPERED SCALE

	OCT 1	OCT 2	OCT 3	OCT 4	OCT 5	OCT 6	OCT 7	OCT 8	OCT 9	OCT 10
F	21.8	43.7	87.3	174.6	349.2	698.5	1396.9	2793.8	5587.7	11175.3
F#	23.1	46.2	92.5	185	370	740	1480	2960	5920	11839.8
G	24.5	49	98	196	392	784	1568	3136	6272	12543.9
G#	26.0	51.9	103.8	207.7	415.3	830.6	1661.2	3322.4	6645	13289.8
A	27.5	55	110	220	440	880	1760	3520	7040	14080
A#	29.1	58.3	116.5	233.1	466.2	932.3	1864.7	3729.3	7458.6	14917.2
B	30.9	61.7	123.5	246.9	493.9	987.8	1975.5	3951.1	7902.1	15604.3
C	32.7	65.4	130.8	261.6	523.3	1046.5	2093	4186	8372	16744
C#	34.6	69.3	138.6	277.2	554.4	1108.7	2217.5	4435	8889.8	17739.7
D	36.7	73.4	146.8	293.7	587.3	1174.7	2349.3	4698.6	9397.3	18794.5
D#	38.9	77.8	155.6	311.1	622.3	1244.5	2489.7	4978	9956.1	19912.1
E	41.2	82.4	164.8	329.6	659.3	1318.5	2637	5274	10548.1	21096.2

32 <sup>1</sup>	[Bar]										Half tone factor is 12th root of 2 approximately 1.05946309 scale is based on A - 440 Hz
16 <sup>1</sup>	[Bar]										
8 <sup>1</sup>	[Bar]										
4 <sup>1</sup>	[Bar]										
2 <sup>1</sup>	[Bar]										
1 <sup>1</sup>	[Bar]										
1/2 <sup>1</sup>	[Bar]										
KEYBOARD COVERAGE OF SYNTHESIZER											

# INSTROL

# NEW LOWER A.D.C. PRICES

## ADC STEREO CARTRIDGES — AMERICA'S QUALITY CARTRIDGE

### ADC 220X ... \$15.00

ADC 220X. Type: Induced Magnet; Output: 6 mV at 5.5 cms/sec. recorded velocity; Tracking Force: 1 to 2½ grams; Frequency Response: 10 Hz to 18 kHz ± 3dB; Channel Separation: 20dB from 50 Hz to 10 kHz; Compliance: 20 x 10<sup>-6</sup> cms/dyne; Spherical Stylus Tip Radius: .0007" Vertical Tracking Angle: 15°



### ADC 10E mk4 ... \$45.00

Type: Induced Magnet\*  
Output: 4 mV at 5.5 cms/sec. recorded velocity  
Tracking Force: .7 gram  
Frequency Response: 10 Hz to 20 kHz ± 2 dB  
Channel Separation: 30 dB from 50 Hz to 12kHz  
Compliance: 35 x 10<sup>-6</sup> cms/dyne  
Elliptical Stylus Tip: Contact radius: .0003"; lateral radius: .0007"  
IM Distortion: Less than ½% — 400 & 4000 Hz at 14.3 cms/sec. recorded velocity  
Vertical Tracking Angle: 15 degrees  
Recommended Load Impedance: 47000 ohms nominal

### ADC 220XE ... \$18.00

ADC 220XE. Type: Induced Magnet; Output: 6 mV at 5.5 cms/sec. recorded velocity; Tracking Force: 1 to 2½ grams; Frequency Response: 10 Hz to 18 kHz ± 3 dB; Channel Separation: 20 dB from 50 Hz to 10kHz; Compliance: 20 x 10<sup>-6</sup> cms/dyne; Elliptical Stylus Tip Radii: Contact radius .0003"; Lateral radius .0007"; Vertical Tracking Angle: 15°

### ADC 500XE ... \$27.00

ADC 500XE. Type: Induced Magnet; Output: 5 mV at 5.5 cms/sec. recorded velocity; Tracking Force: ¾ to 2 grams; Frequency Response: 10 Hz to 20 kHz ± 2 dB; Channel Separation: 20 dB from 50 Hz to 12 kHz; Compliance: 35 x 10<sup>-6</sup> cms/dyne; Elliptical Stylus Tip Radii: Contact radius .0003"; Lateral radius .0007"; Vertical Tracking Angle: 15°



OTHER MODELS: ADC 25 — \$110.00; ADC 26 — \$75.00; ADC XLM — \$70.00; ADC VLM — \$56.00

### J.H. Turntable (complete) ... Save \$\$\$\$

This outstanding turntable value consists of:—



ALL THE ABOVE FOR ONLY

#### (A) J.H. TURNTABLE

Belt drive, synchronous motor, unmeasurably small rumble, wow and flutter of better than 0.04%, negligible hum radiation, with 12" diameter of platten.

#### (B) EXCEL ES 801 ARM

Oil-damped cueing device; fully calibrated stylus pressure adjustments; adjustable bias compensation; universal headshell.

#### (C) A.D.C. 220X

Magnetic cartridge. Tracking force 1½ to 3 grams, extremely linear and smooth frequency response.

#### (D) INSTROL 44 STAND PLUS HINGED 'PERSPEX' COVER

This acoustically sprung player stand is available in either oiled teak or walnut, complete with moulded perspex cover and "stay-up" hinges.

**\$105.00**

(fully assembled & packaged)

### COMPLETE FULL-COLOUR HI-FI CATALOGUE AND PRICE LIST ... ONLY 50c

Contains full specifications, gloss colour illustrations and special Instrol discount pricing on the following items—:

Turntables, cartridges and styli, Amplifiers, Amplifier kits and Dynakits, Speaker system, Speaker kits, Speaker enclosures, Tuners, Four channel equipment, Tape decks and recorders, Dolby cassette decks, Record Storage cabinets and kits, Equipment Cabinets (Built and Kits) for hi-fi, Hi-Fi accessories, Guitar amplifiers and guitar speaker systems (Built and kits), Instrol products, etc.

Please send me your complete hi-fi catalogue and price list. I enclose herewith postage stamps or money order to the value of 50c. I understand that the 50c will be refunded on my first purchase.

NAME .....

ADDRESS .....

..... P.C.....

T310



# INSTROL

# RECORD STORAGE CABINETS

## Now available in pre-cut kits

The Instrol range of record storage cabinets has the warmth and fashion appeal you expect of something which is to be part of your home. All veneered timbered panels are of the very best quality, both with the built and polished cabinets or with the pre-cut kits. Kits are absolutely complete in every detail, including detailed instructions.

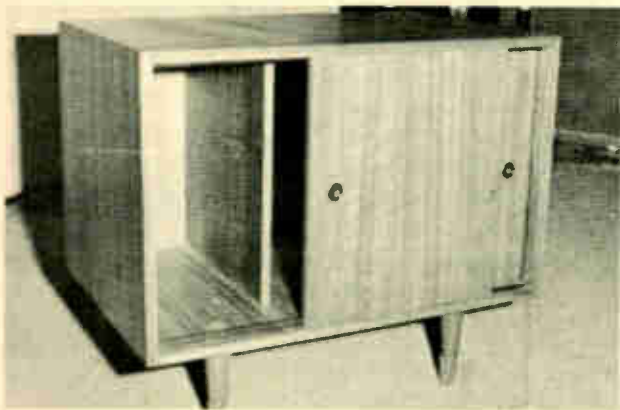

**MODEL RS No. 1**

A neat general purpose unit, designed to carry between 80 and 100 records, it measures 23 $\frac{3}{4}$ " x 14" (high) x 14 $\frac{1}{2}$ " (deep). Kit price is \$29.50 (teak or walnut veneer). Normally comes with base, but 4 $\frac{1}{2}$ " legs optional.

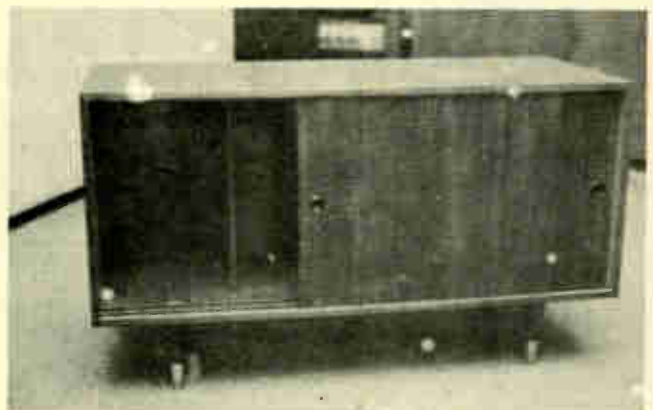

**MODEL RS No. 2**

A larger unit measuring 35 $\frac{1}{2}$ " x 14" (high) x 15 $\frac{3}{4}$ " (deep), the kit is priced at \$45.00 (teak or walnut veneer). Normally comes with base, but 4 $\frac{1}{2}$ " legs optional.

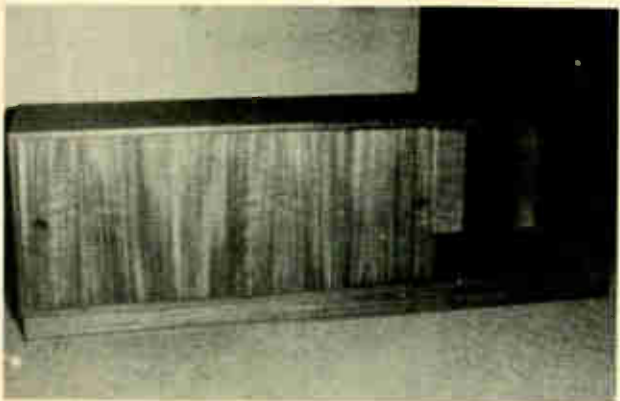

**MODEL RS No. 3**

This model measures 51 $\frac{1}{4}$ " x 14" (high) x 15 $\frac{3}{4}$ " (deep) and is priced at \$49.50 (teak or walnut kits). Normally comes with base, but 4 $\frac{1}{2}$ " legs optional.



**MODEL RS No. 4**

This attractive model is aesthetically styled with full height opening doors and recessed handles cut from solid teak. With two record storage shelves, one on top of the other, and ample vertical dividers, the unit measures 35 $\frac{1}{4}$ " x 31 $\frac{1}{2}$ " (high) x 16" (deep). Kit price is \$65.00 (teak or walnut veneer).

## INSTROL HI-FI

TWO GREAT LOCATIONS

SYDNEY — 91a York Street, Sydney. Phone 29 4258

MELBOURNE — 375 Lonsdale Street, Melbourne.

Phone 67 5831

ALL MAIL ORDER — 91a York Street, Sydney.

Please send me the following record cabinets or turntable system. These will be sent by road transport or passenger rail, freight payable on receipt of goods. (Cartridges will be sent freight free).

..... at \$ .....

..... at \$ .....

..... at \$ .....

I enclose my money order/cheque for \$ .....

NAME .....

ADDRESS .....

..... P.C. ....

T310



# \$10,000 COMPUTER CONTEST

If you were given a computer terminal, plus generous free computer time — for three months — what would you do with it?

- FORECAST WEATHER?
- MAKE COMPUTER PICTURES?
- STUDY INFLATION TRENDS?
- ANALYSE SOCIAL PROBLEMS?
- DESIGN MAPS?
- INVESTIGATE EINSTEIN'S THEORIES?

THIS is a competition with a difference. All you need to compete is a logical mind and a little ingenuity.

Entrants are asked to suggest original uses for computer time-sharing, keeping in mind the practical feasibility of the project and the overall value it would have to the community.

No previous experience with computers is necessary to present a winning suggestion.

## TIME-SHARING BASICS

A computer cannot do anything more than you can do using simple arithmetic, log tables, a slide rule, or a calculator — as far as computation is concerned.

But what it can do that you can't is to perform calculations, a thousand — or even a million times faster than you can. A typical computer can for example multiply 250 000 16-digit numbers in less than one second!

The system may be used to perform identical calculations on a whole set of input data, analyse the results, organize the answers into tabular form, and then print out the resultant table and/or use it to plot a graph.

It will do all this virtually as quickly as you can feed in the data.

As an example, imagine the time required to sort 10 000 names and addresses into alphabetical order and then type them out in that order. A computer will do this almost instantly — at the

rate of 30 characters a second.

In essence, a computer is a tool that increases your capacity to do intelligent work. It enables you to work out problems more quickly, with less drudgery, and with greater accuracy.

It extends mankind's brainpower as an engine extends his muscle power — resulting in a new capacity to discover, create, build, solve and think.

Computer power such as this is enormously expensive — if the computer is owned by the user. Computer time-sharing systems resolve this problem by locating a massive computer in a central location and then providing access to this main computer from a multiplicity of time-sharing terminals in users' premises.

Thus massive computational power is available to the system's users at a tiny fraction of the cost of owning a computer.



**ACCOUNTANTS**

prepare inflation-adjusted accounts

**ELECTRONIC DESIGN ENGINEERS**

calculate circuit characteristics

**FINANCIERS**

evaluate risk-alternatives

**HISTORIANS**

trace authorship of old tracts by syntactical analysis of the texts.

**INVENTORY CONTROLLERS**

calculate economic ordering quantities

**MATHEMATICIANS**

solve up to 24 simultaneous differential equations.

**NUTRITIONISTS**

calculate optimum combination of available ingredients to meet nutritional requirements.

**PHYSICISTS**

correlate respiratory conditions with pollution

**PRODUCTION ENGINEERS**

prepare 'make-or-buy' analyses

**PROJECT PLANNERS**

schedule critical path method networks with multiple activities

**QUALITY CONTROL ENGINEERS**

determine process tolerances

**STATISTICIANS**

perform multiple regressions with multiple independent variables

**TEACHERS**

co-ordinate school activities

# COMPUTER TIME-SHARING

## ~ its many uses

THE first computer was developed as an aid to scientists trying to overcome the speed limitations imposed by mechanical calculations. They sought to utilise the vast speed inherent in electrical impulses and to replace mechanical components with electronic components of higher reliability. Having succeeded in

building such a machine it is not surprising that the first use made of it was for research, and as is often true with new technologies, the research had profound military significance. The first machine was used by scientists to assist with the enormous mathematical computations involved in the development of nuclear weapons.

Since that time, computer speeds have increased to such an extent that a modern high-power machine could accomplish the equivalent amount of computation that was done in the entire atom bomb project — which spanned several years — in less than one hour!

### The Super Slide-Rule

One traditional branch of technology, engineering, has always worked with quantitative measurements and parameters and has long applied mathematical methods to the solution of problems. Hence it comes as no surprise that engineers followed quickly in the footsteps of the scientists in using computers to solve design problems. Being used to dealing with numbers and with mathematical concepts and notation, engineers had little difficulty in making the necessary transition to computer-based techniques. Moreover, this decision whether or not to use computer techniques could be reasonably clear-cut. Could the computer perform the necessary analysis and calculations more economically than other methods? Unfortunately, decisions to use

computers are rarely that simple — many of the benefits that accrue are far less tangible and cannot always be expressed in monetary terms. Often the job in question is not feasible by any other means, hence no cost comparisons are possible.

The main areas in which engineers use computers are design, analysis, computation and engineering management. Typical computational applications include survey calculations, cost estimating and cut and fill computations related to earthworks and highway construction. In the analysis area, the ability to study electronic circuitry, structures and hydraulic networks has been vastly enhanced. The speed with which the computer can re-analyse the effects of changes in the system under study is of particular value and hence engineering design has been almost revolutionised. In many design areas, the end result can be approached from several angles and the engineer often has a wide choice of design methods open to him.

Radically new design methods have been developed which rely completely on the speed and techniques of the computer — methods which have no possible manual parallel. Several new design techniques in electronics and structures could never have been developed and used without the computer's aid.

A less traditional but rapidly growing series of applications is in the area of engineering management. The use of critical path methods for project planning and control, feasibility studies using discounted cash flow techniques, cost estimating, simulation



# \$10,000 COMPUTER CONTEST

studies and resource allocation models are accounting for a larger and larger slice of the engineers' computer budget.

## Electronic Brains?

The power of the computer to handle vast computational loads is well known, but its role in scientific research and engineering touch few of our personal lives. It is in the area of business data processing that we see most evidence of the computer in our daily activities. The membership renewal form that looks suspiciously like a punched card, the bills that arrive from the gas, electricity and 'phone people, the funny looking numbers on the bottom of our cheques, the inevitable "computer made a mistake" excuse we get when we ring to complain about errors in our bills, the feeling of uneasiness we get when we hear that the taxation department is turning loose its computer on our tax returns — if you stop and think, it seems that computers are everywhere.

Unfortunately, the computer is probably the most maligned and least understood of all modern machines. Despite its vast computational resources, its ability to process and manipulate all forms of data at incredible speeds and its tremendously complex electronics, it has none of the magical properties often ascribed to it. The term "electronic brain" could not be further from the truth. It is *only a machine*, and as such can do nothing without being told — and told in such a precise and unambiguous way that the instructions must cover every possible eventuality otherwise the computer will be unable to follow them.

The things that give the computer its apparent magical powers are not transistors and integrated circuits, but *people*. No computer can solve any problem or perform any task that people, given enough time, could not do. The path to the solution must be known first — the computer, given the method, merely covers the distance along that path a lot quicker than we could.

## The Super-Bookkeeper

The computer has the ability to input, sort, search, store, transfer, manipulate, convert, transcribe, communicate and output massive amounts of information at almost unbelievable speeds. This makes it very useful for processing business data. Routine repetitive tasks that would require an army of clerks can be processed rapidly, accurately, economically and efficiently by a computer. It has been said that if it were not for the computer, the banking industry in the U.S. would need to employ the entire female work-force of that country. Contrary to some people's belief, computers rarely make people redundant. It is true they perform many tasks previously done by people, but the very use of computers creates many new job opportunities. Forms have to be coded, cards have to be punched, the computer has to be programmed, operated and maintained. Moreover, computers have in many ways given us the room to expand and progress. To take away the computer now would cause complete economic chaos. Like most of the machines of modern technology, it has contributed substantially to the standard of living we all enjoy.

*Continued on page 39*

*Part of the main computer to which the time-sharing terminals are connected.*



There are practically countless uses for computer time-sharing, here are just a few:—

### Applied Mathematics & Theoretical Calculations

- regression analysis
- statistical analysis
- curve fitting and plotting
- numerical analysis
- reliability calculations
- experimental calculations

### Business Forecasting and Planning

- marketing and economic forecasting
- evaluation of risk alternatives
- project planning
- simulation and modeling
- pricing
- probabilistic models

### Education

- marketing planning and analysis
- engineering and scientific determination
- mathematical calculations
- research compilation and analysis
- teaching computer technique
- programmed learning

### Engineering

- electrical network analysis
- chemical processes
- structural analysis and design
- hydraulic analysis
- machine design
- surveying and co-ordinate geometry

### Financial Analysis

- product cost
- general analysis
- depreciation and amortization
- investment analysis
- budgeting
- credit and collections
- accounts transactions and reports
- cash flow
- portfolio analysis
- cost accounting.

### Management

#### Decision-Making

- make-lease-buy decisions
- alternative courses of action
- evaluation of new product plans
- capital investment analysis
- transportation and distribution models

#### Manufacturing Planning, Production, and Quality Control

- machine loading
- production and cost estimating and analysis
- numerical control programming
- work and facility scheduling
- quality control evaluation
- inventory control

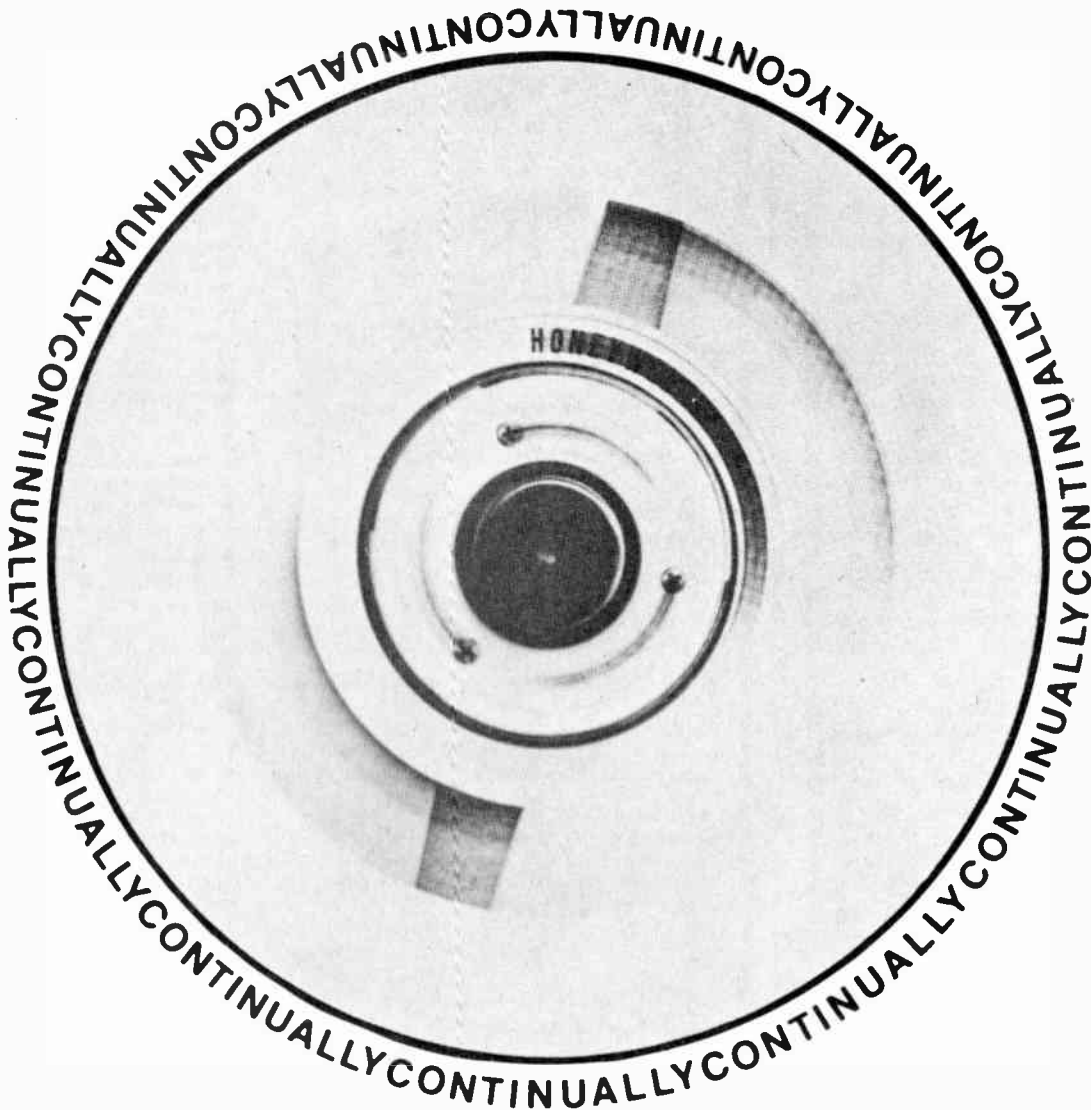

**OFFERING TIME SHARING SERVICES  
IN SYDNEY AND MELBOURNE**

Only \$100 a month for a \$1 million computer.

Available on one month's contract.

Only 2 days' training required.

Honeywell first in Australia, first in the world with Computer Time Sharing Service.

Already hundreds of users in Australia.

Communicate with the computer by P.M.G. telephone.

The Sydney and Melbourne time sharing systems fully compatible.

Over 300 programmes immediately available on line.

Programme in Basic-Fortran-Algol-Edit.

The world's leader in time sharing

# Honeywell

Information Systems Division

SYDNEY 69 0355

MELBOURNE 67 8221

BRISBANE 21 6683

ADELAIDE 51 6203

CANBERRA 49 7966

MBA6/2/32

HIS.P8

## BUILD THIS LOW COST 8" REFLECTOR TELESCOPE



Write for informative  
FREE catalogue  
or  
send \$1.90 for our 35  
page illustrated  
instruction manual

### AMATEUR ASTRONOMERS SUPPLY CO.

11B Clarke Street,  
Crows Nest, Sydney 2055  
Phone 43 4360

## UNITED TRADE SALES

280 LONSDALE ST. MELBOURNE, 3000  
PHONE 633-3815 (Opposite Myers)

SOLID STATE A/C.D/C.S BAND  
AM/FM/AIR/PB/WB. PORTABLE  
TRANSISTOR RADIOS Frequency Range  
AM 530-1640 Khz.FM 88-108 Mhz.  
Air/PB/WB. 108-175 Mhz Weight approx.  
1.2 Kilos. Excellent reception on Aircraft  
Band and P/B and AM. These sets are  
available only from us. Fully Guaranteed,  
\$85.00 ea. P/P \$2.50.

POWER SUPPLIES. EX COMPUTER.  
FULLY TRANSISTOR REGULATED.  
These units are as new and are in perfect  
working order. Original cost was in excess of  
\$300 each. Two Models available.  
240V.AC.Primary, 12V. DC. Secondary at 5  
Amps, and 240V. Primary 30V.DC.  
Secondary at 5 Amps. \$35.00 each. Freight  
Forward. Weight approx. 12 kilos.

COMPUTER TAPE. 1/2" diameter on 12"  
reels in plastic boxes. Good condition \$3.00  
ea. P/P 50 cents.

COMPUTER BOARDS. Approx. 10  
Transistors plus 30 Diodes and Resistors on  
each board. All components have long leads  
\$1.25 ea. P/P 40 cents. Special offer. 6  
Boards for \$6.00 plus P/P \$1.00.

COMPUTER RELAYS SILVER WIRE  
TYPE. 4 sets changeover contacts. Size 2 1/2"  
x 1" x 1/2" complete with socket. 20V coils.  
75 cents ea. P/P 20 cents.

AS ABOVE but with latching coil assembly.  
\$1.00 ea. P/P 20 cents.

SILICON DIODES. 100 P.I.V. 145 Amps.  
\$3.00 ea. P/P 30 cents. Terminal Assemblies  
for above. 50 cents ea. P/P 15 cents.

CASSETTE TAPE HEADS. Mono,  
Transistor. \$1.50 ea. P/P 15 cents.

WIDMAIER PUSH BUTTON SWITCHES.  
Latching with 2 sets changeover contacts.  
\$1.50 ea. P/P 20 cents.

PIANO KEY SWITCHES. Six keys, 5  
sections with 6 changeovers. \$1.00 ea. P/P  
30 cents.

CRYSTAL FILTERS. 10.7 Mhz. 10 Khz.  
Bandwidth. \$5.00 ea. P/P 30 cents.

LARGE STOCKS OF SURPLUS  
HAM RADIO PARTS AVAILABLE

Wanted to buy -

Test Equipment. Transmitters & Receivers

# \$10,000 COMPUTER CONTEST

## WHAT THE WINNERS WILL RECEIVE

Each winner will receive the following:-

- \* One STC time-sharing computer terminal installed, in the place of his choice, free of charge.
- \* Up to \$1500 of G265 Time-Sharing computer time.
- \* Free instruction in computer time-sharing.
- \* Free telephone service throughout Australia whilst the computer terminal is connected to the main computer.

The following conditions are applicable to all winners.

- a) Only the Honeywell G265 systems may be used.
- b) There will normally be a time limit of three months duration - commencing from the date of terminal installation.
- c) The organizers are prepared to extend the time limit and dollar value of any prize if, in their absolute discretion, they consider that further computer

- d) time would benefit the prize winning project, the project is of outstanding value, and that work so far completed on the project is sufficiently meritorious to warrant an extension.
- d) Instruction in the use of computer time-sharing will be carried out at Honeywell's educational centres in Sydney and Melbourne. In the event that a prizewinner is prevented from attending such training courses, Honeywell will allot him (or her) 12 hours of terminal time for use with its Computer Assisted Instruction course of programs - which may be undertaken from the prizewinner's terminal.

This multi-thousand dollar competition is sponsored by:- Electronics Today International & Honeywell Pty Ltd. Standard Telephones & Cables & Australian Post Office.

The concept, possibilities, and limitations of computer time-sharing are explained in this - and in the next two issues of Electronics Today International.

Following the study of this material, readers are invited to propose specific applications.

These applications will be judged on the basis of:-

- \* Practical feasibility
- \* Originality
- \* Ingenuity
- \* Overall value to the community

The competition is open to all Electronics Today readers resident in Australia except employees of Honeywell Pty Ltd and Modern Magazines Ltd.

To ensure that all readers have a fair go, entries will be judged in four classifications. These are:-

- 1/ Primary and Secondary Schools.
- 2/ Universities, Tertiary Educational Institutions, State and Commonwealth Departments and Instrumentalities.
- 3/ Industrial and Professional - this includes Private and Public Companies, Partnerships and employees of same - where the entry is either sponsored by, or in the name of a company or partnership, and/or where the nature of the entry is closely associated with the entrant's

occupation and sphere of business or professional activity.

4/ Private - this classification covers private individuals not included in classifications 1-3 above, e.g. people at school or university submitting entries independently of their school or university, private experimenters, housewives, etc. etc.

The judges reserve the right to reclassify entries and to withdraw awards from any category if no entry in that category is judged to be of a sufficiently high standard to merit an award - in such case, the award will be re-allocated to another entrant classification if the number and/or standard of entries warrant.

The entry must consist of a summary of the idea or project, its benefits in terms of its social or commercial value - this should be outlined in not more than 500 words. An outline of the intended approach and methods to be used must also be included - but not necessarily within the 500 word description.

Each entry must be accompanied by our official entry coupon - this is printed below, and will also be included in our November issue.

Entrants may submit any number of entries - providing that a separate entry form is included with each entry.

Final closing date for entries is December 12, 1973.

### OFFICIAL ENTRY FORM

Honeywell/Electronics Today International  
Time Sharing Computer Competition

Herewith my entry to your Time Sharing competition. I have read the contest rules and conditions and agree to abide by the decision of the judges.

SIGNED ..... DATE.....

NAME (block letters) .....

ADDRESS .....

A separate entry coupon must accompany each entry.

Closing date for this competition is December 12, 1973.

Send all entries to:-  
Electronics Today  
International, 3rd Floor,  
15 Boundary St,  
Rushcutters Bay, 2011,  
NSW.

### Data Processing

Typical data processing tasks include company payrolls, invoicing, sales analysis, stock control, costing, processing banking transactions and other bookkeeping-type functions. As a by-product from many of these activities, comes vital information necessary to management to control business operations. These types of applications differ markedly from research and engineering uses. The main areas of variance are in computational loads and input/output volumes. Most business applications of this type require comparatively little computation and what there is tends to be very simple, although highly repetitive. The amount of data going in and coming out however tends to be voluminous and the other information necessary to process the input data, usually stored for reference by the computer on magnetic tape or disc, can also be substantial. Scientific and engineering applications in general are quite the reverse and are characterised by heavy computation, low

input/output and few, if any, reference files.

It is only recently that time-sharing systems have had the capability to tackle business applications of this nature. The limiting factor was the comparatively low speed of the input/output device, the keyboard terminal. The development of the "remote job entry" terminal, usually a card reader/line printer device, capable of speeds up to 40 times faster than keyboard terminals plus the availability of wider band width telephone communication lines now gives users the ability to process high input/output jobs using a time-sharing computer system. Even without such terminals, the user can still control the computer's operations from his keyboard terminal and direct output to the high speed devices at the computer centre for later delivery by courier.

The great advantage of using a time-sharing system for work of this nature is that all a user's data is available on a single system, to which

he always has instantaneous access. Much of this data can be used for other purposes through the keyboard terminal. Also, the problems involved in having an on-site computer, (and there are a few), are avoided. Costs can be lower, more certain and better controlled.

There is still a vast range of application areas not yet mentioned — Manufacturing, Production, Financial Analysis and Planning, Business Forecasting, Operations Research and Management Decision-Making to name a few. So far we have only looked at the more familiar applications where the computational power and data processing ability of the computer is used directly.

It is probably true to say that the really worthwhile benefits of using a computer only start to be felt when the computer is applied to these other areas. A computer is a very powerful business tool and is most effective when applied to the more complex and critical business and management problems. ●



### EXTRA AND BACK ISSUES

The first article in this contest was published in September 1973.

Back copies of this issue are still obtainable from our subscription department. Cost is 80 cents including postage — or 70 cents if collected from our premises. The address is "Subscription Dept.", Electronics Today International, 15 Boundary St, Rushcutters Bay, 2011, NSW.

Further supplies of the *current* issue are obtainable from the same department — price is 50 cents if collected or 60 cents post free.

**KEYSTONE** the  
**ROCK and ROLL**  
**LOUDSPEAKER**

available from BURNETT AUDIO,  
64 Palmer Street, Cammeray, N.S.W., 2062. Phone 922-1347

# kitsets aust.



AUSTRALIA'S LEADING ELECTRONIC  
KIT COMPONENT AND HI-FI SPECIALISTS

*have now opened in*

## PERTH

Our latest electronic and Hi-Fi centre  
is centrally located opposite the new bus depot

**557 Wellington street**

**Perth Phone 213047**

# VISIT US TODAY

## FOR

- ★ Australia's largest range of new and guaranteed electronic kits, components, test equipment and hi-fi for the enthusiast.
- ★ Guaranteed lowest prices in Australia – KITSETS GUARANTEE TO MATCH OR BETTER ANY GENUINE PRICE OFFERED ELSEWHERE IN AUSTRALIA.
- ★ Convenient walk-around self-service showroom centrally located, right in the heart of Perth.

*West Australian Manager: Alan Paton*

Please note: All mail orders are still to be sent direct to our national mail order dept., P.O. Box 176, Dee Why, NSW 2099.

*(See advertisement, page 122 this issue)*



# Here's a superb stereo sound source you'll still be proud to own ten years from now.

And it will still be up to date. Of course, you do need to be discriminating, and realise where long term value lies in terms of precision engineering and its relationship to performance. We suggest you invest wisely in:—



## THE NEW SWISS MADE THORENS MODEL TD 160 TRANSCRIPTION TURNTABLE.

Incorporating the radical new Thorens TP 16 tone arm — the arm overseas reviewers have enthused over — the Thorens TD 160 offers unrivalled engineering at a most attractive price. A 16-pole two-phase synchronous motor and belt drive combined with a dual chassis suspension system provide a wow and flutter figure of 0.06% according to DIN 45507, weighted. This is a remarkable figure in anybody's language.

The platter of the TD 160 is of non-magnetic zinc alloy, 12" in diameter and weighing 7 lbs. Two speeds are standard — 33's and 45 rpm. Stray magnetic flux has been minimised so that even the most sensitive cartridges may be used with the TD 160 without incurring problems with hum induction.

Bearing friction of the revolutionary Thorens TP 16 tone arm has been reduced to less than 20 milligrams in both planes measured at the stylus tip.

Your Bleakley Gray dealer will be pleased to demonstrate the all-new Thorens TD 160 transcription turntable. No doubt he'll also show you the superb Thorens TD 125 Mk. II electronic transcription turntable, a three-speed model which is undoubtedly the most sophisticated turntable manufactured in the world today. The TD 125 Mk. II has many superior features and naturally costs more than the TD 160. Both Swiss made Thorens turntables offer long term reliability and an extraordinary standard of performance.



## SELECT AN ORTOFON STEREO CARTRIDGE.

From Denmark comes the new Ortofon M15 Super Stereo cartridge, recognised as the lowest distortion cartridge in the world. The magnet design of the M15 Super is quite unique. Signal currents are generated on the most linear portion of the magnetic transfer curve. There are no moving magnets, nor conventional magnetic gaps.

This Ortofon cartridge is available with an elliptical or conical diamond stylus. Both styli are replaceable.

Frequency response of the M15 Super is 20 Hz to 20 kHz, this figure varying only 1 dB up to 10 kHz. The same figure applies to the M15 Super with the conical stylus. Channel separation is 25 dB and recommended tracking force is 1 gram.

Ortofon's new extralinear magnetic circuit employed in the M15 Super Series reduces tracking and tracing distortion, frequency and phase distortion as well as harmonic and intermodulation distortion to the lowest level ever available in a magnetic stereo cartridge. The result is extraordinary fidelity and musical clarity.



## USE WATTS EQUIPMENT TO KEEP YOUR RECORDS CLEAN.

Few music lovers realise the damage that airborne dust and dirt can do to a valuable record collection. Not only do these factors contribute greatly to reproduced noise and interference — the actual wear on the record can be considerable. Watts record maintenance equipment solves most of the problems. We recommend:

### THE WATTS "MANUAL PARASTAT" Mk. IIA.

This is a dual-purpose record cleaner designed to maintain new records in new condition and to restore fidelity to older discs. Use immediately prior to playing.

### THE WATTS "DISC PREENER".

Designed expressly for records which have not had previous anti-static treatment. The "Disc Preener" keeps new records like new.

### THE WATTS "DUST BUG". (Illustrated.)

This effective device cleans the record, removing dust and static charges as the record actually plays. Surface noise can be reduced considerably with the "Dust Bug". This item should be used every time you play a record, for the sake of both records and stylus.

**\*See your nearest Bleakley Gray dealer. He'll help you create a stereo sound source you'll still be proud to own ten years from now!**



Australian National Distributors:  
**Bleakley Gray Corporation  
 Pty. Limited.**

A division of Rank Industries Australia Pty. Limited.

Melbourne Office: 28 Elizabeth St., Melbourne. Vic. Tel. 33 8101. Telex 31904  
 Sydney Office: 177 Salisbury Rd., Camperdown, N.S.W. Tel. 519 5555  
 Canberra Office: 25 Molonglo Mail, Fyshwick, A.C.T. Tel. 95 2144  
 Adelaide Office: 3 Bowen St., Kensington, Tel. 32 4288  
 Brisbane Office: 3 Prospect St., Bowen Hills, Qld. Tel. 52 7333  
 Perth Office: 27 Oxford St., Leederville, W.A. Tel. 81 4988  
 INTERSTATE REPRESENTATIVES: N.T. Pfitzer's Music House, Smith  
 Street, Darwin. Tel. 3999. Tel. 3 W. McCulloch Pty. Ltd., 57 George  
 Street, Launceston, Tas. 3352

Bleakley Gray Corporation Pty. Limited,  
 28 Elizabeth Street, Melbourne, 3000.  
 Please send me all the facts about the Thorens TD-125  
 Mk. II/Thorens TD-160/Ortofon cartridges/Watts equip-  
 ment. (Delete items not required.)

NAME \_\_\_\_\_ (BLOCK LETTERS PLEASE.)  
 ADDRESS \_\_\_\_\_  
 POSTCODE \_\_\_\_\_

BG-TOW-673

# PLESSEY PROFESSIONAL CONTROLS

Plessey provides the widest selection of Professional class carbon and wire-wound resistive controls of both commercial and DEF Qualification standard.

The range offers miniature potentiometers rated upwards from 50mW to power rheostats of 500W, together with a choice of resistances, tapers, shafts, mounting arrangements, ganged and dual types and specials to suit customers' specifications. Ganged potentiometers with track matching to within 1.6db. are available for stereophonic equipment, test instruments and other applications.

Potentiometers employ a hot moulded carbon track construction giving extremely low electrical noise throughout a long, trouble-free life. Life expectancy is in the order of 9 million cycles of rotation with a resistance change of no greater than 1%.

Plessey potentiometer tracks consist of a phenolic moulding loaded with carefully controlled proportions of conducting carbon filler providing superior power dissipation and temperature coefficient characteristics compared to carbon film types.

A standardised range is available ex stock. Literature is available on request to the Professional Components Division.

**PLESSEY** 

Plessey Ducon Pty. Limited  
Box 2, Villawood, N.S.W. 2163  
Tel. 720133. Telex 20384

MELB.: Zephyr Products Pty. Ltd. 56 7231  
ADEL.: K. D. Fisher & Co. 42 2920  
BRIS.: Douglas Electronics Pty. Ltd. 62 1899  
PERTH.: H. J. McQuillan Pty. Ltd. 68 7111  
Everett Agency Pty. Ltd. 8 4137  
N.Z.: Henderson (N.Z.) 6 4189

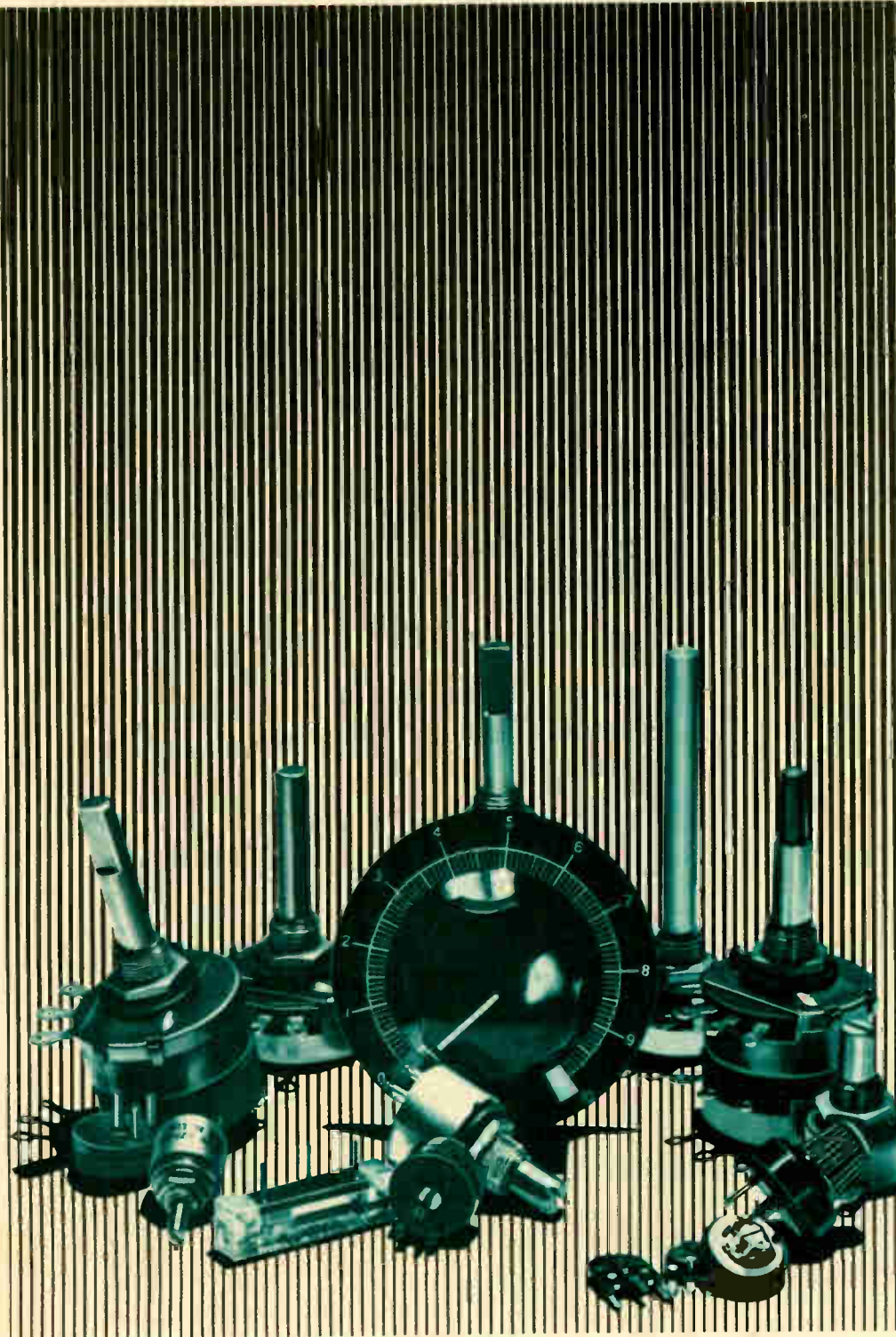

# JENSEN'S TOTAL ENERGY RESPONSE

At Jensen Sound Laboratories, we have a reputation for building great speaker systems.

Our newest design, for the new line of Jensen Speaker Systems, gives an even fuller, richer sound than ever before.

We call it Total Energy Response. That's what you hear when our woofers, tweeters and purring mid-ranges start to sound off.

Our Total Energy Response makes a difference you can hear

when you compare our systems to any others. Because in every price range, they give the best performance per dollar on the market today.

Consider these three new systems from Jensen. With more features, matched components and the best 5 year warranty in the business.



*Model 4* A three way system introducing the first purr in speakers Jensen's purring mid-ranges. There's a 10" woofer, 5" direct radiating mid-range and Sonodome® ultra-tweeter. \$365 Pr.

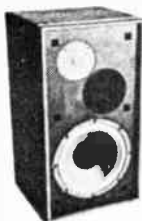

*Model 5.* What a cast of characters. A three way system with a 12" woofer, two purring 5" direct radiating mid-ranges, Sonodome ultra-tweeter. \$440 Pr.



*Model 6.* A fabulous four way, four speaker system, including a huge 15" woofer, 8" purring direct radiating mid-range, 5" direct radiating tweeter, and Sonodome ultra-tweeter. \$520 Pr.



## AUSTRALIAN DISTRIBUTORS:

**B.J.D. Electronics Pty. Ltd., 190 Willoughby Road, Crows Nest, 2065 N.S.W. Ph. 439-4201  
202 Pelham St., Carlton, 3053 Vic. Ph. 347-8255**

# MOTOR SPEED CONTROL

Photo-tachometer provides speed reference in this feedback motor control circuit.

IN MOST dc motor speed control circuits, a voltage proportional to actual motor speed is compared with a voltage proportional to the desired speed and an error, or correction, signal is obtained. The error signal is amplified and used to adjust the speed of the motor in such a way as to reduce the error signal to a near-zero value. Provided that the circuit has been properly designed, the motor will run at a speed close to that desired.

The voltage supplied to the motor will determine the output power or torque, as well as the speed, so that at low speeds very little torque is produced. The normal method of overcoming this problem is to supply the motor with constant voltage pulses with a duty cycle proportional to the error voltage so that the full torque is produced at low speeds.

There are a number of ways that can be used to derive a voltage proportional to motor speed. One method which has been favoured in the past, involves measuring the back emf of the motor. This can lead to problems, as both the input and the output are obtained from the same point, namely the motor.

It is possible to obtain a voltage proportional to motor speed using an opto-electronic tachometer system. A circuit employing this technique is shown in Fig. 1.

The motor armature, or output shaft, is pointed with twenty stripes, ten black and ten white. A fibre optics Y-guide is focused on to the pattern and one branch is used to provide illumination from a small d.c. driven lamp. The other branch of the Y-guide feeds light reflected from the pattern to a photo-transistor,  $Q_1$ . The output of  $Q_1$  will be a signal with a frequency proportional to motor speed as ten pulses will be produced for each complete rotation of the armature.

The transistor  $Q_2$  is a pulse shaper which feeds a tachometer circuit giving an output directly proportional to input frequency and therefore motor speed.

The FET,  $Q_4$ , acts as a buffer to minimise the loading on the tachometer circuit and provide a fairly low output impedance, which is appropriate to the differential comparator which follows it. In addition,  $Q_4$  acts as a level shifter to ensure that there is sufficient output

to bias the comparator when the tachometer output is zero. The diode,  $D_3$ , provides a measure of temperature compensation.

The comparator compares the tachometer output with the voltage at the wiper of the speed adjustment potentiometer  $R_{13}$  and produces an error signal if a difference exists. The capacitor,  $C_3$ , prevents motor speed overshoot if the setting of  $R_{13}$  is changed rapidly.

The network  $R_{15}$ ,  $R_{16}$ ,  $C_4$  and  $D_4$  forms a voltage-stabilising supply circuit for these circuits.

If an error signal exists because the potential at the wiper of  $R_{13}$  is higher than the output of the tachometer, it means that the motor is rotating too slowly. The pulse width modulator formed by a Schmitt trigger circuit will trip and full power will be supplied to the motor. As the motor speed increases the error signal will fall until it is almost zero. At this point the Schmitt trigger will remove power from the motor. The process is continuous and the motor is supplied with a train of pulses, the width of which will be proportional to the error in the motor speed, or the load on the motor.

Fig. 1. Circuit diagram of complete motor speed controller.

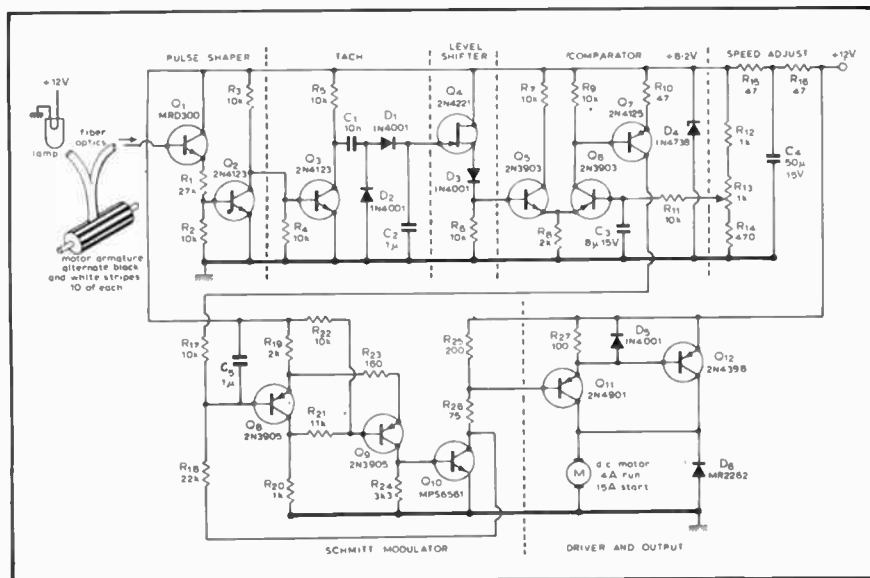

Feedback for the circuit is obtained by directly measuring the motor speed, and results in accurate speed control over a wide range of output powers, as can be seen in Fig. 2. This drawing also shows the effect of power supply voltage variations. Fig. 3 indicates the effect of temperature variations.

Temperature compensation may be improved by removing diode  $D_2$  and connecting one or more diodes in series with  $R_9$ .

Applications Laboratory Semiconductor Products Division Motorola Inc.

**SPECIAL**

A 'BONANZA' PURCHASE AGAIN FROM M.S.C.!!!

**THORN-ATLAS  
2 TRACK & 4 TRACK TAPE DECKS  
SUITABLE FOR 5" REELS**

*ALL NEW, CARTONED & GUARANTEED*

Complete with Moulded front Panel, Push-button Controls, 240 volt A.C. 50 cycle Motor with Fan, 1-7/8" or 3-3/4" I.P.S. Speed Control, MONO or STEREO Record/Replay & Erase Heads.

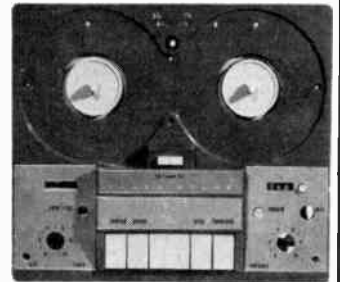

*ONLY LIMITED QUANTITIES AVAILABLE. RUSH YOUR ORDER NOW!*

**FANTASTIC VALUE FOR THE DISCRIMINATING HOBBYIST**

**2 TRACK TAPE DECK \$25.50**

**4 TRACK TAPE DECK \$32.50**

Postage Rates: N.S.W. 75c Vic. & QLD. \$1.15  
N.T. & TAS. \$1.65 New Zealand \$4.25



95-97 Regent Street, Redfern, N.S.W. 2016. Tel: 69-5922  
188-192 Pacific Highway, Gore Hill, N.S.W. 2065. Tel: 42-5305.  
Head Office & M.O. Dept. P.O. Box 156, Redfern, 2016.

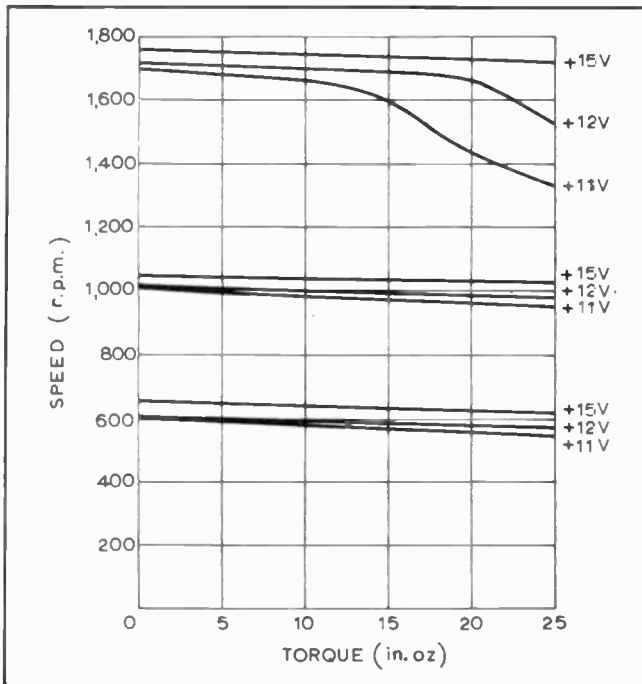

Fig. 2. How motor speed varies with changes in load and supply voltage for circuit described.

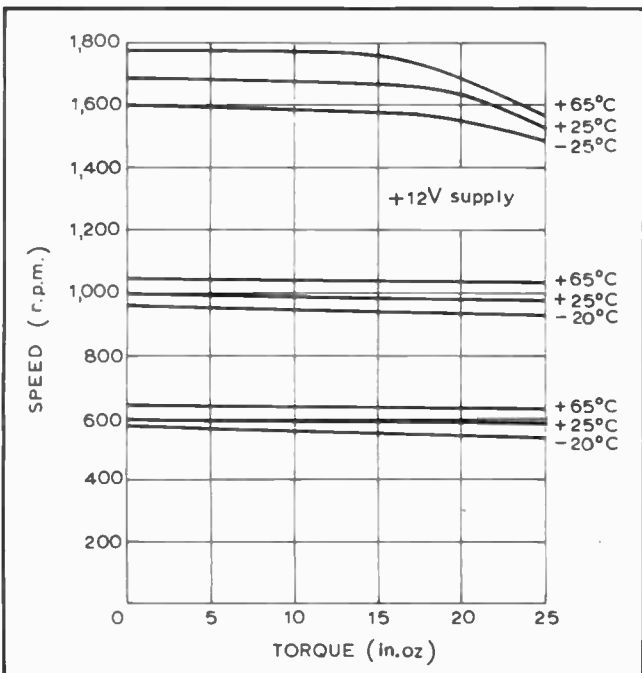
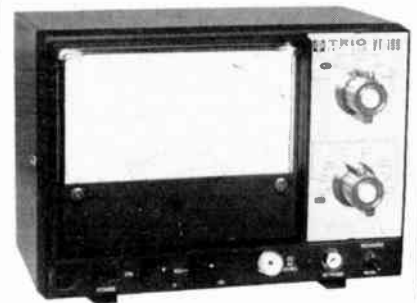

Fig. 3. How temperature affects motor speed using the circuit described.

**ELECTRONIC FET VOLT-OHM METER**



MODEL VT 108



**PRICE:**  
**\$68.00**

Plus  
Sales Tax 15%

**SPECIAL FEATURES:**

1. Eight voltage ranges, 0.5 to 1500 V DC, 1.5 to 1500 V AC.
2. Seven resistance ranges, 0.1 ohm to 1000 Mohm.
3. Input impedance, 11 Mohm DCV, 1 Mohm ACV.
4. Frequency response, 15 Hz to 5 MHz.
5. Memory function. Holds reading for more than 30 seconds.
6. Easily read, large scale.
7. Battery operated - AC power option available.
8. Weight - 2 Kg.

**PARAMETERS**  
PTY. LTD.

SYDNEY 43 6577 • MELBOURNE 90 7444  
ADELAIDE 51 6718 • PERTH 81 2866  
BRISBANE 78 5422 • NEWCASTLE 61 4321  
WOLLONGONG 74 0278 • CANBERRA 97 3579

Advertisement only

# Dual presents the 701.



## A significantly different kind of turntable.

The Dual 701 is the quietest turntable ever made. Not only in our judgment, but in that of the first independent test laboratory to evaluate its performance. This had been accomplished by an entirely different kind of motor, designed expressly for the 701, and by a very innovative approach to the problem of resonance.

Instead of the familiar, high-speed AC motor, the 701 has an all-electronic, low-speed, DC motor, with feedback-controlled speed precision. Because this motor rotates at the record speed, 33-1/3 or 45 rpm, the need for speed-reduction systems such as friction-idler or rim-belt is eliminated. Instead, the platter is rotated directly by the motor, and the record spindle is the top of the motor shaft.

The 701 motor is so quiet and free from

vibration that it does not require any isolation mounting, but is mounted directly to the chassis. Dual's exclusive design of overlapping coils, a unique feature of the motor, eliminates the successive pulses common to every other existing motor, including other electronic types, high speed or low speed.

Another dual innovation serves to prevent interference from reaching and affecting the stylus. Two separate anti-resonance filters, each tuned to a specific resonance range, are located within the counterbalance housing. One filter is tuned to the resonant range of the tonearm/cartridge system; the other, to the resonant range of the chassis. Each filter serves to cancel out the resonant energy that would otherwise impart spurious signals to the stylus.

Other features of the 701 — the gimbal

tonearm suspension, anti-skating and pitch-control — are shown and described on the facing page. Still others include direct-dial tracking pressure, with 0.10 gram calibrations from 0 to 1.5 grams. And, a cue-control, silicone-damped in both directions. Unlike other Dual turntables, the 701 is designed for only single-play. But like other Duals, it can be operated either fully automatically, or as a manual turntable.

Because of the unique motor and anti-resonance filters, the 701 is slightly quieter than the 1229. But if you now own a 1229, or any other current Dual, you will detect only a minor difference. And we don't suggest that you trade in your present Dual for the 701.

Rather, as an expression of the state of the art, the 701 is recommended for the listener who demands the quietest turntable ever made.

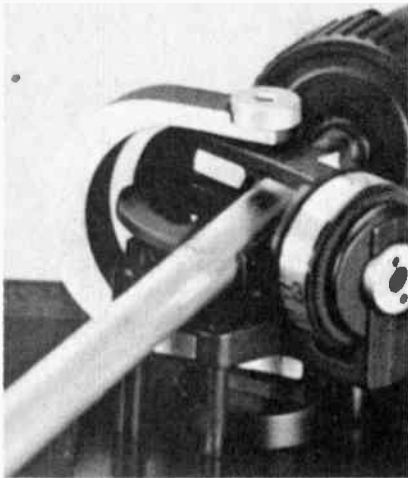

**Tonearm mounted in four-point low friction gimbal suspension.**

The 701 tonearm pivots on identical sets of low-friction needle-point bearings, set in a special designed double gimbal. Each gimbal is hand-assembled, and gauges designed by Dual assure that bearing friction will conform to stringent specifications.



**Separate anti-skating for conical and elliptical styli.**

Balanced tracking pressure on groove sidewalls is assured by separate calibrations for conical and elliptical styli. This provision is required in such low-friction tonearms which are highly responsive to the difference in frictional pull of each stylus shape.



**8% pitch-control range for each speed, and built-in illuminated strobe.**

An electronic pitch-control, variable over an 8% range, is provided for each of the 701's two speeds (33-1/3 and 45 rpm.) Thus, either speed can be varied without affecting the other setting. Each pitch-control is provided with a reference setting for standardization. For viewing convenience, the illuminated strobe window has an adjustable angle, from directly overhead to approximately 20 degrees forward.

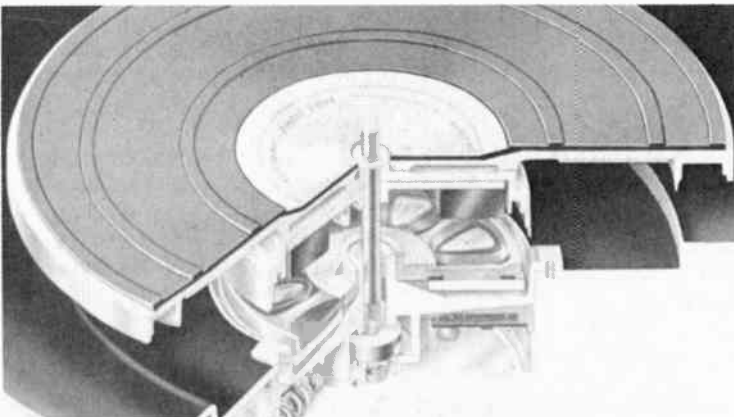

**The motor of the Dual 701**

The EDS-1000 motor developed by Dual for the 701 is an all-electronic, low-speed, brushless, DC motor with Hall-effect feedback control, and energized by a regulated power supply.

Unlike conventional DC motors, commutation (electrical switching) is not done by brushes and commutator ring. The 701 motor has electronic switching, commutation and speed regulation. Two Hall-effect generators drive four switching transistors which produce a rotating magnetic field in the motor's field coils. Depending on the position of the rotor, the magnetic field causes the four magnetic pairs on the rotor to be pushed and pulled continuously.

The field coil design is unique and exclusive with two stacked coil layers, each consisting of eight bifilarwound (coreless) coils, offset by 22.5°, achieving a gapless rotating magnetic field that eliminates the successive pulses of magnetic flux typical of all other motor designs.

Dual. Two stacked coil layers, each consisting of eight bifilarwound (coreless) coils, offset by 22.5°, achieving a gapless rotating magnetic field that eliminates the successive pulses of magnetic flux typical of all other motor designs.

Note: The absence of magnetic springback or other rotation irregularities can be demonstrated by turning the rotor manually, no resistance will be sensed. Also, because of the coreless field coils the motor is free of hysteresis of eddy-current losses and the disturbances of pole frequencies.

The rotational speed of the 701 motor is controlled electronically. A voltage which is a function of motor speed is fed to an electronic regulating circuit, and is compared to a constant standard voltage derived from a regulated power supply. Any difference in these two voltages causes an immediate change in the motor current, hence the motor speed.

The rotor is a barium ferrite ring magnet, magnetized in eight segments (poles) on its lower front surface. A steel plate serves as a magnetic return circuit. The regulated power supply makes the speed independent of variations in power-line independent of variations in power-line voltage or frequency. Speed can be set directly to either 33-1/3 or 45 rpm. Thus the platter is driven directly by the rotor, without need for any speed-reducing linkage such as friction-idler or rim-belt.

Further, in contrast to the high speed (1800 rpm) vibrations of the conventional AC motor, the 701 motor is so free from vibration that it is mounted directly to the chassis without introducing any rumble.

In summary, the 701 electronic direct-drive system, with its over-lapping gapless design, rotating magnetic return circuit and coreless field windings, is the most advanced drive system available for record playback today.



**FRED A. FALK (SALES) PTY LTD**

28 KING STREET, ROCKDALE, N.S.W. 2218. Phone: 599-3722

# NAKAMICHI 1000 CASSETTE RECORDER



The first cassette machine that can genuinely compete with reel-to-reel recorders . . .

Price — approximately \$1000

TEN years ago, when Philips of Eindhoven developed the compact cassette, the sceptics agreed that it was just a passing fad.

Five years later, when other firms started to take up licencing rights, the sages agreed, that, whilst perhaps here to stay, the cassette system was really just a toy suitable for dictation, but would never be adequate for music reproduction — and as for hi-fi . . .

In the meantime the development of cassette machines had moved from Holland to Japan, and by 1971 Japanese had developed a number of top quality cassette machines that could provide a genuine 12 kHz bandwidth — using the best low noise tapes, and up to 15 kHz with the (then) new chromium dioxide tapes.

By this time the sceptics were looking a little less blase but could still argue that erase ratio was poor — “to say nothing about the awful wow, flutter and distortion.”

Needless to say it then took a mere metaphorical twinkling of a Japanese

eye before a whole new range of cassette machines were released that not only provided adjustable bias — to suit all types of tape — but also included the operational facilities that for so long been lacking in reel-to-reel machines.

But still the sceptics persisted — they admitted that the best cassette machines were now a listenable proposition — “but of course they can never match the best reel-to-reel machines — they never will.”

Well they're wrong.

A cassette machine has now been produced that is equal in every respect to top quality reel-to-reel recorders.

This machine is the Nakamichi 1000 recorder.

Although virtually unknown to the general public, Nakamichi are in fact one of Japan's largest manufacturers of cassette recorder components. For some years they have been working on the design of a cassette system, the performance of which would match

that of high quality reel-to-reel machines.

The successful result is largely due to a series of feasibility studies aimed at determining which design parameters needed to be improved to provide the desired performance.

### THREE HEAD DESIGN

Nakamichi found that one of the major problems was that of providing suitable heads. For good reproduction it is necessary to use very narrow playback head gaps — the smaller the effective gap, the wider the frequency response obtainable. In conventional cassette machines, this narrow head gap cannot be exploited because the functions of the playback head and the record head are combined in one unit.

The Nakamichi machine overcomes this difficulty by using three separate heads.

The record head is fabricated from a particularly hard high-permeability ferrite. It has a five micron gap — this is necessary to achieve the good bias and signal flux penetration essential for extended response.

The playback head is made from 50 micron thick super permalloy laminated foil. This head is located in the normal position but incorporates a gap of only 0.7 micron.

Erase is performed by a third head; fitted in place of the normal tape guide, and adjacent to the left hand capstan and pinch roller.

Core material for these heads is a new niobium alloy that has wear resistance claimed to be ten times better than obtained from normal permalloy.

Nakamichi's engineers have found that even small errors in head alignment seriously degrade high frequency performance (Fig 1), and that such errors are the rule rather than the exception in cassette recorders.

To ensure that such errors do not occur in their own product, Nakamichi have mounted all three heads so that each may be independently adjusted for optimum azimuth alignment.



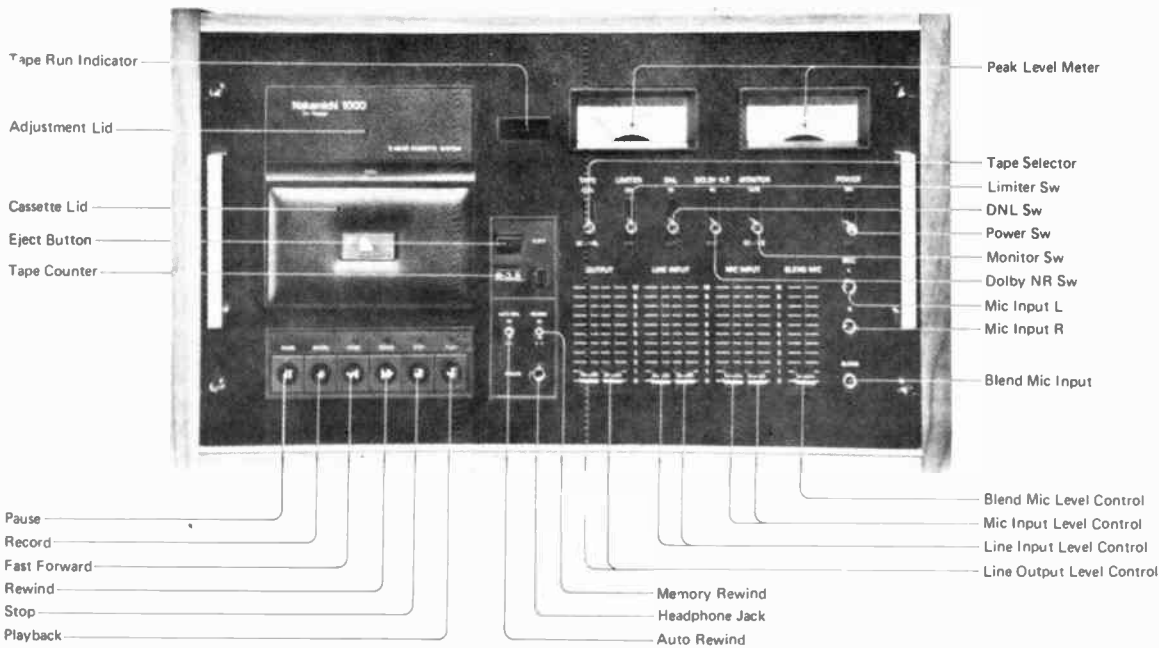

The heads are mounted on a bracket supported from the top of the head housing. When the unit is in use, the complete head assembly is lowered onto the cassette by a solenoid.

Azimuth alignment adjustment is very simply performed. The machine incorporates circuitry in which digital electronics detect phase differences, between record and playback heads, of an internally generated test tone. (This tone is also used for calibrating the inbuilt Dolby noise reduction system). A knurled screw is then adjusted until a correct indication is given by a pair of light emitting diodes.

After one has become familiar with the procedure, the whole operation takes about six seconds to perform.

### THE MACHINE AS A WHOLE

As our main picture shows, the Nakamichi 1000 is a large unit — far bigger than any other cassette recorder on the market. Dimensions are 52.5 cm wide by 30 cm high by 22 cm deep and it weighs a hefty 18 kg.

Normally the unit is housed within a walnut veneered case. However for studio use this case is removable, and the unit may then be fitted into a standard 19" rack. The front panel has been designed to match standard studio panels, using white engraving on a black background to provide a very professional appearance.

The machine's controls are grouped in three sections.

On the left hand side of the front panel is the cassette holder. This flips down when an 'eject' button is pressed. Above this holder is a separate hinged panel that covers the heads and the alignment controls, together with a fine speed control (for varying pitch).

The major function controls of Pause, Record, Fast Forward, Rewind,

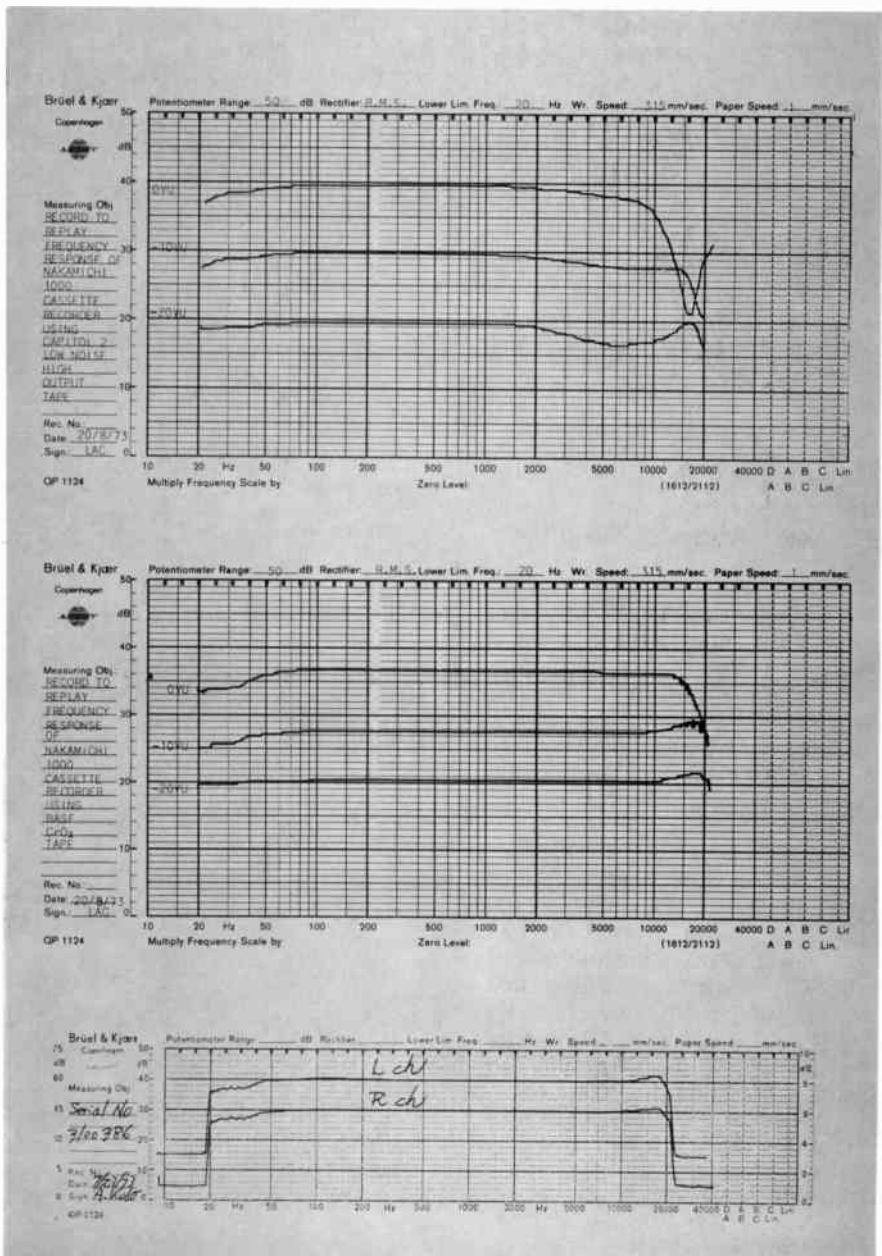

Compare the lowest graph (supplied with the machine by Nakamichi), with the -20VU curve on the graph in the middle (taken on our own Bruel & Kjoer equipment). As will be seen, the two curves are virtually identical.

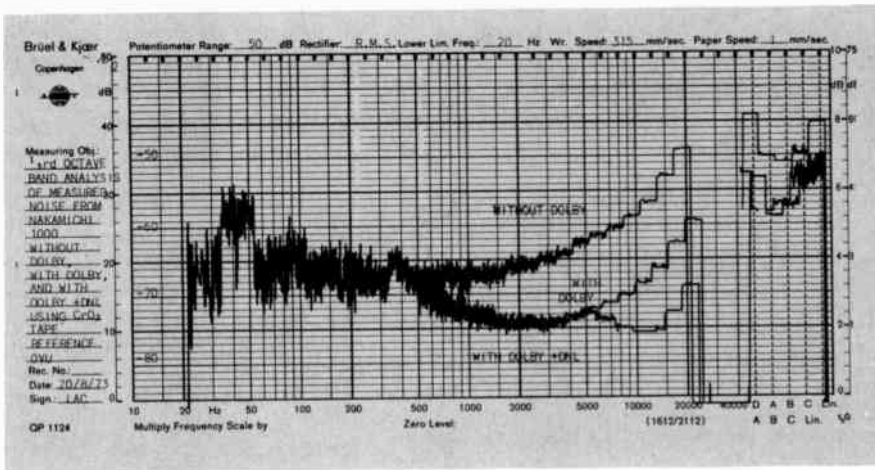

Stop and Play, in the form of touch buttons (which should not be confused with their distant cousins the piano key switches) are mounted immediately below the cassette holder. These controls are simple, yet delightful to use, and the best ergonomic design that we have yet experienced. The control logic for these switches has been very carefully thought out to provide click-free operation of the highest professional standard

A tape-run indicator is mounted in the top centre of the deck. Below this is an eject button, a three-digit counter and reset button, an auto-rewind button, memory rewind button and headphone jack.

The memory rewind switch enables the user to set the tape counter to zero (by using the reset button) at any point on a tape – then, when the memory control is switched to 'on' – activating the rewind button will cause the tape to rewind and stop at the desired point.

The auto-rewind control will cause the machine to sense the end of a tape, and switch the machine to rewind the tape back to the start.

A tape-run indicator is mounted in the top centre of the deck; below this is an eject button, a three digit counter

and reset button, auto-rewind button, memory rewind and headphone jack. The memory rewind switch is very useful. It enables the user to set the tape counter to zero by using the reset button, before recording new material, then by switching on the memory ON control, the activation of the rewind button will automatically rewind to that point. The auto rewind control will play a tape right through to the end and rewind back to the start again.

On the right-hand side of the deck are three levels of controls. At the top are two peak reading VU meters. Whilst clearly labelled, these meters are not as well calibrated as we would have expected on an otherwise so well constructed piece of equipment.

Below the VU meters, in a line from left to right, are toggle levers for selecting the correct bias and erase levels for chromium dioxide or low noise high output tapes. (It should be clearly noted that that this deck is not intended, nor is even suitable, for recording with low grade tapes). Next to the tape selector toggles is a limit switch that clamps signals above +3 VU peak, back to a +4 VU limit.

Next control along is a switch that brings a dynamic noise limiter circuit into operation. This DNL system, developed by Philips, operates only

during the replay process and limits high frequency noise in the spectrum above 5 kHz.

Apart from the DNL system, the machine also incorporates the Dolby noise reduction system. This is intended to be used with all cassettes recorded on the machine – and of course for replaying Dolby-processed cassettes. The control for the Dolby circuit is next in line to the DNL switch.

The last two switches in this line-up are the monitor selector, which switches the VU meters to either programme input or replay head; and the mains on/off switch.

Below this row of switches, from left to right, are the slider controls for the two output channels, two line input channels, two microphone input channels and one blend microphone channel (whose output is fed to both of the other channels). The microphone sockets are wired so as to be short circuited except when a jack is inserted. The three standard microphone tip and sleeve jack sockets are located in a line below the power on/off switch. These sockets are designed for microphones with a nominal impedance of 600 ohms.

The rear panel contains two DIN sockets for microphones and line input/output; two pairs of RCA type coaxial sockets for line input and output, a switch for FM multiplex decoding, a screwdriver trim potentiometer for tone calibration level for Dolby system control and four trim potentiometers for 'normal' and chromium dioxide record/calibrate level control adjustment.

With the machine comes a well illustrated 12 page instruction book. This is written in excellent English but contains no circuit diagram. The book contains a troubleshooting chart but a notice on the back of the machine states that no service parts are available to users, and recommends that, in the event of trouble, the machine be taken to a properly

### Azimuth adjustments

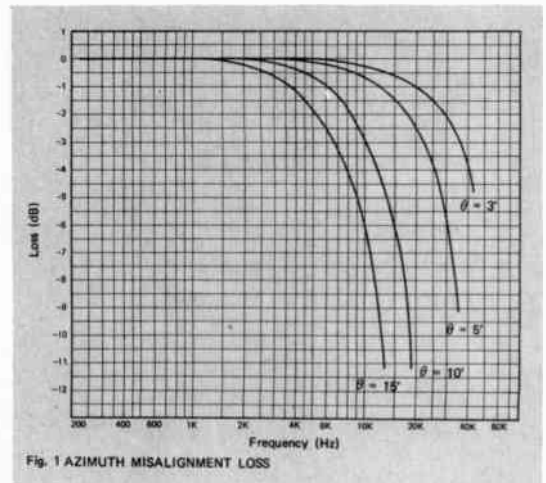

Fig. 1 AZIMUTH MISALIGNMENT LOSS

equipped service organisation.

The machine is supplied complete with a beautifully finished box containing an unrecorded chromium dioxide C60 cassette; an alignment cassette, with a 400 Hz reference signal recorded at 200 pico/webers/mm; a mirror cassette for inspecting the heads for cleanliness, and a box of cleaning stubs. Also included is another special cleaning stick for head cleaning — and the inevitable cleaning rag.

### INTERNAL CONSTRUCTION

Internally, the construction has to be seen to be believed. The electronics are unbelievably complex for a cassette recorder and incorporate no less than 138 transistors, eight integrated circuits and 59 diodes. The location of these components is not defined as no circuit data is provided.

The heart of the machine is the tape transport mechanism. This uses a double capstan system with two capstan shafts connected to two fly wheels driven by a belt. The double capstan system creates a constant, stable, tension between the two capstans. The condition of the tape between the two capstans is not affected by external conditions such as irregular take up, supply torque, or uneven winding of the tape. The two fly wheels are physically large and the overall performance is further enhanced by a pneumatic damper which controls the pinch roller to remove the oscillatory motion and clicks that are so often a feature in cassette recorders.

### OBJECTIVE TESTING

Our first objective tests — a series of record to replay recordings made at 0 VU, -10 VU and -20 VU, were very disappointing — in fact the results were no better than those we had obtained the previous day from two other machines costing half the price. Subsequently we found that these poor results were due to the machine's head adjustments having been misaligned before the machine came to us for review.

Once the azimuth alignment had been set — a task that took about 15 seconds to learn and six seconds to do — the results were dramatically different!

For the first time ever, we had a machine with a genuine 20 Hz to 20 kHz capability (using chromium dioxide tape at -10 VU).

It is necessary to stress that this performance is only obtainable using a top quality chromium dioxide tape cassette. With conventional tapes — at recording levels exceeding -10 VU — the performance is not substantially better than can be obtained from

much cheaper machines, in fact with such tapes the full 20 Hz — 20 kHz performance can only be achieved at -20 VU. (Unfortunately a calibrated bias control has not been included in the specification — as this machine is obviously intended for semi-professional use this omission is rather surprising).

A data sheet and level recordings were provided with the machine. We were pleased to find that all figures quoted by the manufacturers were in accordance with our findings — the level recordings (reproduced within this review) were virtually identical.

A dramatic demonstration of just how good the Nakamichi machine really is, was shown when we made comparative recordings — using the same programme content — on the Nakamichi, our standard Nagra recorder (at 15"/sec) and our standard laboratory recorder (at 7½"/sec). Almost incredibly, we could not detect any difference between the Nakamichi and the Nagra — and the

laboratory machine was slightly *inferior* in terms of signal to noise. The value of the Dolby system plus dynamic noise limiting was proven.

The Nakamichi 1000 is the first cassette machine that can truly claim to be a contender in the field previously dominated by reel-to-reel machines. Whilst this machine is nearly the ultimate in terms of what was aimed for by the designers, they have not, as they admit, solved *all* the problems. In particular the performance with standard gamma ferric oxide based tapes still falls short of the performance realisable on reel-to-reel recorders. Research at Nakamichi is continuing to overcome this problem.

Accepting the limitation that it may only be used satisfactorily with premium grade chromium dioxide tapes, the Nakamichi 1000 can otherwise compete on its own terms in the field previously dominated by reel-to-reel recorders. ●

#### NAKAMICHI TT1000 CASSETTE DECK SERIAL NO. 3100386

##### Record to Replay Frequency Response:

(with BASF CrO <sub>2</sub> tape)	0 VU	20 Hz to 17 kHz	±3 dB
	-10 VU	20 Hz to 20 kHz	±3 dB
	-20 VU	20 Hz to 20 kHz	±3 dB
(with Capitol 2-C60 tape)	0 VU	20 Hz to 9 kHz	±3 dB
	-10 VU	20 Hz to 16 kHz	±3 dB
	-20 VU	20 Hz to 20 kHz	±3 dB

##### Total Harmonic Distortion

(at 1 kHz)	0 VU	1.4%
	-10 VU	0.4%

##### Intermodulation Distortion

(at 1 kHz and 960 Hz)	0 VU	1.2%
	-10 VU	0.3%

##### Signal to Noise Ratio at 0 VU re 1 kHz

(Using CrO <sub>2</sub> , DNL, + Dolby)	57 dB (A)
	52 dB (Lin)

##### Erase Ratio

(1 kHz signal recorded at 0 VU)	-62 dB
---------------------------------	--------

##### Cross Talk at 0 VU:

100 Hz	38 dB
1 kHz	42 dB

##### Wow & Flutter —

Peak	0.2%
Weighted	0.08%

##### Line Input Sensitivity for

0 VU	100 mV
------	--------

##### Microphone Input Sensitivity for

0 VU	0.44 mV
------	---------

##### Line Output Sensitivity for

0 VU	1.05 V
------	--------



# NAKAMICHI

# Professional TRI-TRACER 3 HEAD CASSETTE DECKS



**MODEL 1000**

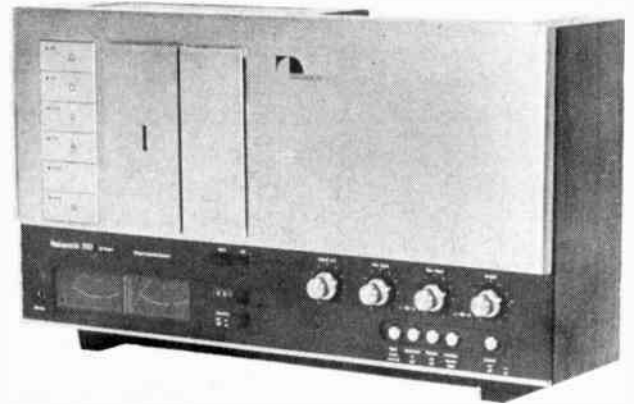

**MODEL 700**

The Nakamichi Tri-Tracer's are the world's finest cassette units. In quality and performance they will equal the highest standards previously found only in reel to reel decks.

### THREE HEAD CONFIGURATION

Separate Record, Playback and Erase Heads permit instantaneous tape monitoring and ensures a frequency response of up to 20 kHz. by using a 5 micron, head gap, record head and a 0.7 micron, replay head.

### INBUILT AZIMUTH ALIGNMENT SYSTEM

A unique and simple system which enables perfect head alignment thus eliminating poor high end response and phase shift created by the change in tape running condition due to the dimensional differences in various brands of cassette enclosures. One of the great failures of conventional cassette decks is improper head alignment.

### IC LOGIC ELECTRONIC CONTROL

All tape motion controls are solenoid operated with light finger touch buttons. I.C. Control Logic circuit produces a sequence control of complicated timing which eliminates clicks and pops.

### TAPE DRIVE SYSTEM

Closed loop double capstan, staggered large flywheels maintain perfect tape tension across the 3 heads with ultra low wow and flutter. Phonic-wheel type D.C. servomotor maintains absolute correct speed for record and play — a separate motor is used for fast forward and rewind.

### DOUBLE NOISE REDUCTION SYSTEM

The Nakamichi 1000 is unique in having both Dolby NR System and Dynamic Noise Limiter (DNL). By the use of the two systems in series, the noise level can be suppressed by more than 13 dB. Both systems can be used independently.

### PITCH CONTROL

Any speed within the range of  $\pm 6\%$  can be selected. This

can be used for correction of information previously recorded off speed or for playback altering the pitch of music etc.

### PEAK LIMITER AND DB PEAK LEVEL METERS

Eliminates the risk of over recording.

### NAKAMICHI General Specifications | MODEL 1000

FREQUENCY RESPONSE:	35-18,000 Hz $\pm 3$ dB. (Dolby in — Low Noise Tape) 35-20,000 Hz $\pm 3$ dB. (Dolby in CRO <sub>2</sub> Tape)
SIGNAL TO NOISE RATIO:	Better than 60 dB.
WOW & FLUTTER:	Less than 0.10% DIN 45507 Weighted Peak.
TOTAL HARMONIC DIST.	Less than 2% (at 1kHz, 0 dB).
CHANNEL SEPARATION:	Better than 35 dB (at 1 kHz, 0 dB)
ERASURE:	Better than 60 dB (at 1 kHz, sat. level).
CROSS TALK:	Better than 60 dB (at 1 kHz, 0 dB).
BIAS FREQUENCY:	105 kHz.
INPUTS:	MIC INPUT: 600 ohm 0.5mV BLEND MIC. INPUT: 600 ohm 0.5mV DIN MIC. INPUT: 600 ohm 0.5mV LINE: 100K ohm 100mV
OUTPUT:	LINE: 1.2v (max.) Variable. DIN LINE: 1.2v (max.) Variable. PHONES: 3mW 0 dB.
DIMENSIONS:	20.7" wide x 11.7"H. 8.6" D.
WEIGHT:	39 lbs.

AUST. AGENT:  
MAGNA TECHTRONICS AUST. P/L.,  
P.O. Box 150, Crows Nest.  
Phone 439 1651 or 439 3013

NSW DISTRIBUTORS:  
JACK STEIN AUDIO,  
275 Clarence St.,  
ALLIED MUSIC SYSTEMS,  
330 Pacific Highway, Crows Nest

VIC. DISTRIBUTORS:  
DOUGLAS TRADING,  
185-191 Bourke St., Melbourne.

# We've got style!

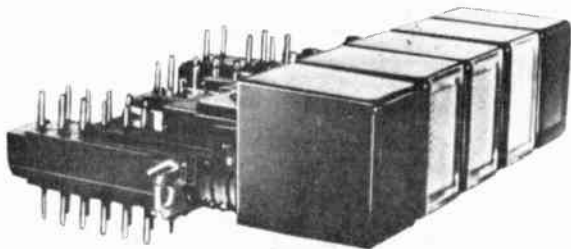

Style 2  
Button with snap-in lens 15 m.m. pitch.

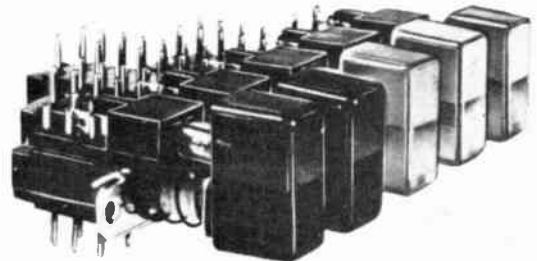

Style 3  
Integral button frosted for maximum light dispersion 10 m.m. pitch.

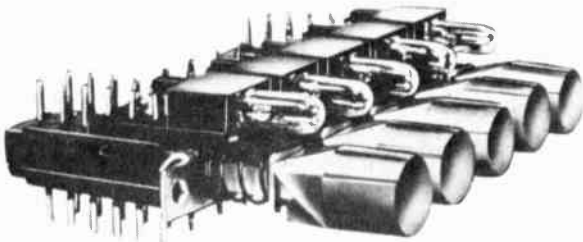

Style 4  
Round button with rear prism for maximum light transmission 12.5 m.m. pitch.

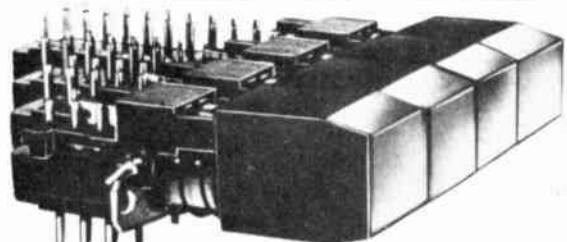

Style 5  
Button with three sided snap-in lens 15 m.m. pitch.

Yes, we now have four NEW styles of Illuminated Push Buttons to suit the well known Isostat push button switch range.

You can make your choice of the exact style of illuminated buttons to complement your equipment styling.

Now, check all these features of Isostat Illuminated Push Button switches.

## ILLUMINATION

By proven vibration-proof incandescent wedge-base lamps.

6, 12, 24 and 30 volt (30 mA or 1 watt).

## VERSATILITY

1 to 10 buttons; 2, 4, 6 or 8 change-overs (also 2 Amp A.C. Module).

Illuminated button pitch spacings; 10 m.m., 12.5 m.m. and 15 m.m.

Push on-Push off and Interlock ( $\frac{1}{2}$  Million operations). Momentary (1 Million operations).

Lockout and Solenoid operations available.

Can be mounted on Printed Circuit Boards or hand soldered.

## QUALITY

Silver *Laminate* contacts, self wiping. Low contact resistance — low capacitance. Sealed contacts impervious to solder, flux or dust.

Replacement contact shaft with new contacts can be quickly inserted from the front.

## RATINGS

A.C. Modules; 2 Amps at 250 volts A.C.

Standard Modules; 1 Amp at 250 volts A.C.

Accepted by the S.E.C.V. for mains connection.



**McMURDO (AUSTRALIA) PTY. LTD.**

Head Office and Factory  
17-21 Carinish Road, Clayton, Victoria 3168 Tel 544 3033  
N S W 242 Blaxland Road, Ryde 2112 Tel 807 1944  
S A 346-348 Carrington Street, Adelaide 5000 Tel 23 535

## AGENTS

QUEENSLAND Douglas Electronics Pty Ltd  
Tel 97 8222 97 8655 Watton Electronics Tel  
385275 WESTERN AUSTRALIA W J Mon-  
crieff Pty Ltd Tel 231194 256140 A.C.T.  
Electronic Components Pty Ltd Tel 956811  
TASMANIA W & G Genders Pty Ltd Tel  
312511 344311

73/1/SW

# Never before has this little noise accompanied this much music.

If you're sophisticated enough to be reading this magazine, you're probably familiar with the two main characteristics of cassette decks: hiss and nonlinear frequency response.

Which should make you thoroughly unfamiliar with the performance capabilities of our new HK-1000. As the charts indicate, it behaves more like reel-to-reel than a cassette deck:

Signal-to-noise (unweighted) is  $-58$  dB with Dolby and  $-70$  dB in the audible hiss level above 4,000 Hz. The frequency response curve is essentially flat from less than 30 to beyond 15 kHz,  $\pm 1.5$  dB, with CrO<sub>2</sub> tape. (This curve is due largely to the way we drive our heads. Instead of the conventional constant *voltage* drive to the head, the HK-1000 is designed for constant *current* drive. Many studio model reel-to-reel decks are designed the same way.)

Because of a new low in noise and a new wide in frequency, the HK-1000 brings you a new clarity in music.

Ours is the first cassette deck designed for maximum phase linearity. Square wave response is better than every other cassette deck and even some expensive reel-to-reel decks. And the better the square waves, the cleaner and more transparent the music.

Discriminating audiophiles will also appreciate the wide selection of controls to take control of. There are two "peak-reading" VU meters; automatic shut-off in all transport modes; separate controls for recording playback and microphone levels; a "memory" rewind feature that lets you key a selection to the exact start location; a Dolby test oscillator; both record and Dolby playback calibration adjustments on the top panel; and so on.

The HK-1000 is also designed so you can use it often

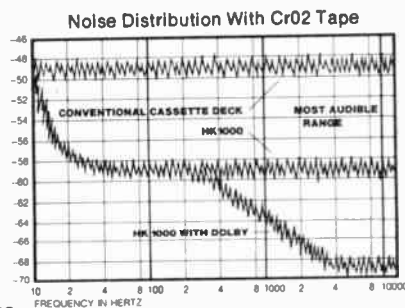

## Noise.

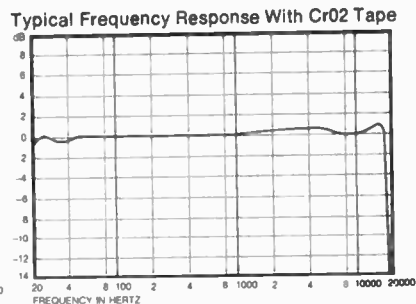

## Music.

closing the doors of expensive hand-built cars. For complete details and specs, write



Sole Australian Distributors & Importers,  
**JERVIS AUSTRALIA PTY. LTD.**  
P.O. Box 6, BROOKVALE. 939-2922.

**harman / kardon**  
*the music company*



# Select Sansui stereo amplifiers for...

Superior design  
Superb engineering  
Sparkling performance



AU-505

When you're considering the purchase of a complete new stereo system, the control amplifier is the key to the whole program. So it's worthy of detailed analysis.

There are six audibly superior control amplifiers in the Sansui range . . . from 30 watts RMS to 100 watts RMS. All feature *all-silicon* transistor design — and distortion is considerably *less* with Sansui control amplifiers, as output stages are semi-complementary Darlington designs without *input or output* transformers. Transformers have always caused some distortion problems in amplifier design — but not with Sansui!

The startling difference you will notice with any Sansui stereo amplifier is the *tonal*

*quality* and the obvious *dynamic range*. In every price bracket your new Sansui amplifier sounds like a much more expensive unit. These are not idle words. In the review of the least expensive Sansui amplifier, the AU-101, a leading Australian journal said . . . "*... few amplifiers, regardless of price, give an overall test result as good as this*". Another review said . . . "*... better than most other amplifiers at twice the price*".

With those comments made about the AU-101 (recommended price \$149) can you imagine how effective the other models in the Sansui range are? With more power and, let's face it, higher price tags?

*Let's look at the complete Sansui stereo amplifier range:*



AU-555A

MODEL	POWER RATING at 8 ohms.	FREQUENCY RESPONSE	REC. PRICE
AU-101	30 watts RMS	20-60,000 Hz. $\pm$ 2 dB.	\$149
AU-505	50 watts RMS	20-60,000 Hz. $\pm$ 2 dB.	\$199
AU-555A	50 watts RMS	20-40,000 Hz. $\pm$ 1 dB.	\$237
AU-666	70 watts RMS	10-40,000 Hz. $\pm$ 1 dB.	\$325
AU-888	90 watts RMS	10-70,000 Hz. $\pm$ 1 dB.	\$403
AU-999	100 watts RMS	5-100,000 Hz. $\pm$ 1 dB.	\$460

**IMPORTANT:** All prices are recommended prices only. The actual cost can well be less — as trade-in valuations can make a world of difference. See your Bleakley Gray franchised dealer!

Bleakley Gray Corporation Pty. Limited,  
28 Elizabeth Street, Melbourne, 3000.  
Please send me complete details about the Sansui amplifier Model .....  
and the name of my nearest Bleakley Gray dealer.

NAME .....

ADDRESS .....

POSTCODE .....

*Sansui*

Sansui Distributors: Australia, excluding W.A.:

## Bleakley Gray Corporation Pty. Limited.

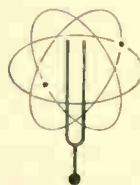

A division of Rank Industries Australia Pty. Limited.

Melbourne Office: 28 Elizabeth St., Melbourne, Vic. Tel: 63 8101\* Telex 31004  
Sydney Office: 177 Salisbury Rd., Camperdown, N.S.W. Tel: 519 5555\*  
Canberra Office: 25 Molonglo Mall, Fyshwick, A.C.T. Tel: 95 2144\*  
Adelaide Office: 3 Bowen St., Kensington, Tel: 32 4288  
Brisbane Office: 3 Prospect St., Bowen Hills, Old Tel: 52 7333  
Perth Office: 27 Oxford St., Leederville, W.A. Tel: 81 4988

INTERSTATE REPRESENTATIVES: N.Y. Pitman's Music House, Smith Street, Darwin, Tel: 3001, Fax: K.W. McCulloch Pty. Ltd., 57 George Street, Launceston, Tel: 2 5322

**W.A. DISTRIBUTORS:**

Atkins Carlyle Limited, 1-9 Milligan St., Perth, 6000. Tel. 22 0191.

Sansui equipment is manufactured by:— Sansui Electric Co. Ltd., 14-1, 2-chome, Izumi, Suginami-Ku, Tokyo, Japan.



Speed is the main, but by no means the only, advantage of the microwave oven.

In this article, Dr. Sydenham describes this relatively recent addition to our ways of cooking food.

# COOKING BY MICROWAVES

WE COOK our food for a variety of reasons. It becomes easier to chew, easier to digest, more palatable and often it is made freer from food infection. Knowledge of cooking is said to have helped the evolution of man.

It seems man has always known of the need to cook food: Peking man (500 000 years before present) had roasts before he could communicate. Palaeolithic man left very clear evidence of having cooking skills — many roasting devices have been dated to that period (200 000 — 30 000 years B.P.). Indeed it is asserted by some that the resultant easier chewing led to a reduction in jaw muscle structure enabling brain-power to develop instead. It has also been suggested that the developing delicate jawbone structure enabled more articulate speech to emerge.

Palaeolithic ovens were crude, but effective. Line a suitable hollow with stones and set a good fire. When hot, remove the burning wood and place in the food wrapped in leaves. Cover the earth and wait until done. Some primitive tribes still use this hot-stone cookery. It is not hard to understand why "haute cuisine" did not flourish in civilisations cooking by this means.

The finer aspects, or the art, of cooking arose with the Tigris based

middle-eastern civilisations — the Assyrians, Persians and the Egyptians — but the earliest known cook-book is accredited to one Marcius Gravius Apicus (No, he did not invent gravy!) of 1st century A.D. Rome.

Sophistication of the culinary art implies that cooking technology exists, for most recipes demand precise control of cooking heat and duration. From the 17th century onward, cooking in closed ranges become more and more accepted; the open spits being reserved for large roasts. These early ranges were the forerunners of the modern relatively portable production-line produced ovens. Gas ovens were invented as early as 1830 but they were not generally accepted until the late 19th century. It was then that our modern concept of an oven was born.

Eating out became fashionable in the 19th century — many of the famous chefs lived at that time; Escoffier, Careme and Soyer come to mind. Here began commercial catering where people's livelihoods (and customers lives!) depend upon the chef's ability to produce cooked dishes as and when patrons demand them.

The oven developed as an enclosure wherein heat is trapped in order to provide a well-defined and predictable cooking environment. In a kitchen,

heat lost can become uncomfortable and it is also expensive. Insulation was added to reduce heat loss.

Gas ovens were the first to have thermostats fitted so that the temperature was controlled — electric controls followed later. In the main, most ovens are either electric or gas, but hot air, steam and wood are used occasionally. Regardless of how they are heated, the conventional oven cooks by the provision of hot air that heats through the food via thermal

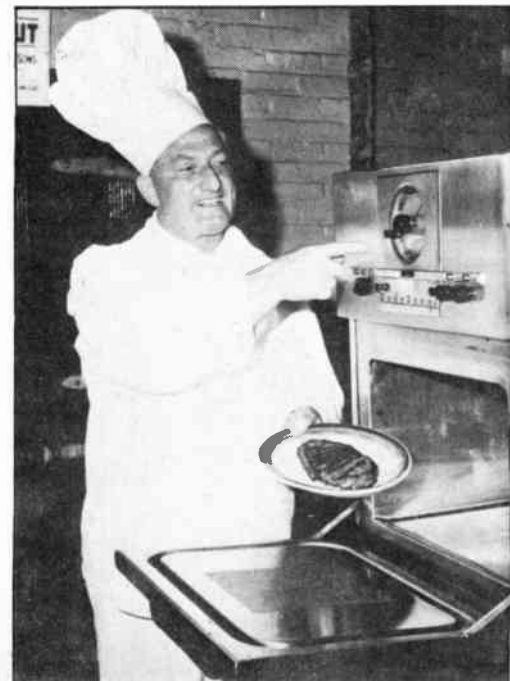



conduction. As most foods are poor conductors of heat, the cooking time and temperature must be chosen so that the inside is just cooked without burning the outside. This considerably restricts the speed at which food can be cooked.

### COOKING WITH RADIATION

Faster cooking is possible if the penetrating property of electromagnetic radiation is used to put heat directly into the food molecules, instead relying upon thermal conductivity. As a general rule the longer the wavelength the deeper the direct penetration effect of a radiation. This fact combined with the energy absorbing properties of food (especially those containing water) leads to other ways to cook than by placing the food in a heated oven.

Infra-red heating would be the first to consider as a means for cooking with radiation. Special infrared heating elements and lamps, providing most of their radiated power in the 1-6  $\mu\text{m}$  wavelength region (see Fig. 1) can penetrate to depths of a few millimetres. They can, therefore, cook food a little faster and more uniformly. Infrared chicken roasters are a common sight in the instant food store.

The construction of an infrared oven is simple, and the principle of operation easily comprehended, for the only difference between it and a conventional electric oven is that the heating elements must radiate onto the food and be of different design.

If radiation with a longer wavelength is employed, the heating effect penetrates deeper giving more uniform heating with a subsequent reduction in cooking time. Moving across the Fig. 1. chart we see that the next useable longer wavelength radiation is centimetre or microwave energy. (There is a technological gap between

the far infrared and microwaves — no high-power, inexpensive, generators exist). At this wavelength, 12 cm is commonly used (2450 MHz), penetration averages out at around 3 cm, so most foods are heated truly from within. Penetration depends upon the food being cooked — in sponge it will penetrate 8 cm whereas in steak only 3 cm.

The technology needed to build a microwave oven is more in the realm of a radio engineer than the handyman, for the generation and control of UHF radiation requires a special electronic oscillator (called a magnetron) and knowledge of waveguide techniques.

### PRINCIPLES OF MICROWAVE HEATING

In order to understand microwave heating let us first consider heating of a dielectric material (food is such) using radio frequency ac current.

Plates formed on each side of the material form a capacitor, as shown in

Fig. 2, with a dielectric in the gap. The quantity of power dissipated in the dielectric when energised by the source is related to the square of the applied voltage, the frequency of the source, the dielectric constant and the loss angle of the material. Loss angle is the slight phase-angle difference existing between the actual phase angle (which is close to  $90^\circ$  but not exactly so) and  $90^\circ$  — its value reflects the energy dissipated in the non-perfect dielectric.

The important feature of dielectric heating is that the power absorbed by the dielectric materials depends on the dielectric constant of the material and this is usually high when the thermal conductivity is low. Hence this method will uniformly heat materials that will not respond well to conductive heating.

Basic relationships show that more power is dissipated as the frequency rises, and this logically leads to the use of the highest frequency possible that has a wavelength consistent with the

Fig. 1. The electro-magnetic radiation spectrum.

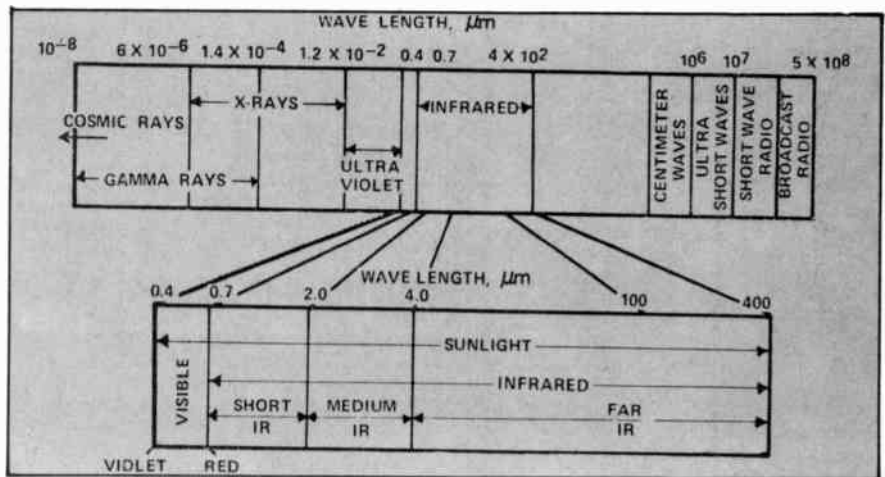

Microwaves are reflected by metal items.

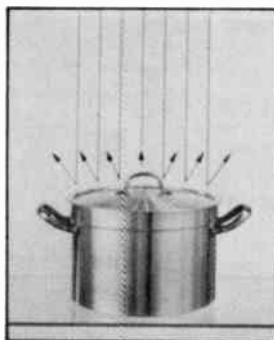

Microwaves pass through such items as glass, china, high density plastics and paper wrappings — without creating heat in them.

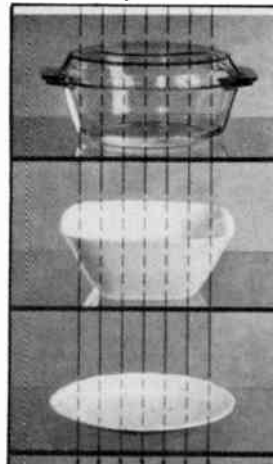

Microwaves are absorbed by most types of food to varying degrees dependent on the cellular structure of the food.

If we place food on a cool china plate and place it in a microwave oven the food becomes hot whilst the plate remains cool enough to be removed using a cloth.

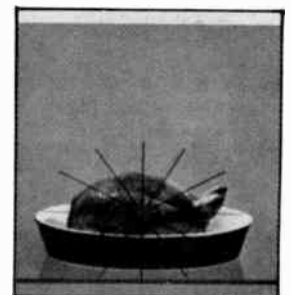

# HAM RADIO SUPPLIERS

MAIL ORDER SPECIALISTS  
323 Elizabeth Street Melbourne  
(2 doors from Little Lonsdale Street)



**200-H. \$12.50**  
90° quadrant meter.  
Pocket size.  
AC/V: 10V, 50V, 100V, 500V, 1000V (10,000Ω/V)  
DC/V: 5V, 25V, 50V, 250V, 500V, 2500V (20,000Ω/V)  
DC/A: 50μA, 2.5mA, 250mA  
OHMS: 60kΩ, 5MΩ  
Capacitance: 100pF to .01μF, .001μF to 1μF  
dB: -20db to +22db  
Audio Output: 10V, 50V, 120V, 1000V AC  
Approx. size: 4½"x3¼"x1½"

**AS-100D/P. \$34.50**  
High 100,000 Ω/Volt sensitivity on D.C.  
Mirror scale. Protected movement.  
AC/V: 6V, 30V, 120V, 300V, 600V, 1200V (10,000Ω/V)  
DC/V: 3V, 12V, 60V, 120V, 300V, 600V, 1200V (100,000Ω/V)  
DC/A: 12μA, 6mA, 60mA, 300mA, 12A  
OHMS: 2kΩ, 200kΩ, 20MΩ, 200MΩ  
dB: -20 to +63db  
Audio Output: 6V, 30V, 120V, 300V, 600V, 1200V AC  
Battery internal  
Approx. size: 7½"x5½"x2¾"



**MODEL OL-64D/P MULTIMETER**  
20,000 ohms per volt. DC volts: 0.025, 1, 10, 50, 250, 500, 1000 (at 20K o.p.v.), 5000 (at 10K o.p.v.). AC volts: 0-10, 50, 250, 1000 (at 8K o.p.v.). DC current: 50μA, 1mA, 50mA, 500mA, 10 amps. Resistance: 0-4K, 400K, 4M, 40 megohms. DB scale -20 to plus 36 dB. Capacitance: 250pF to 0.02μF. Inductance: 0-5000 H. Size: 5¼ x 4¼ x 1¾ in.  
**Price \$19.75**  
Postage 30c.

**MODEL C1000 \$6.95**  
is the ideal low cost pocket meter.  
AC volts: 10V, 50V, 250V, 1000V (1000Ω/V)  
DC volts: 10V, 50V, 250V, 1000V, (1000Ω/V)  
DC current: 1mA, 100mA  
OHMS: 150kΩ  
Decibels: -10db to +22db  
Dimensions: 4¾"x3¼"x1½"  
4¾"x3¼"x1½"



**CT-500/P. \$16.75**  
Popular, medium-size, mirror scale. Overload Protected.  
AC/V: 10V, 50V, 250V, 500V, 1000V (10,000Ω/V)  
DC/V: 2.5V, 10V, 50V, 250V, 500V, 5000V (20,000Ω/V)  
DC/A: 50μA, 5mA, 50mA, 500mA  
OHMS: 12kΩ, 120kΩ, 1.2MΩ, 12MΩ  
dB: -20db to +62db  
Approx. size: 5½"x3¾"x1¾"



**A-10/P \$55.00**  
Giant 6½" Meter. Inbuilt signal injector. Overload Protected.  
AC/V: 2.5V, 10V, 50V, 250V, 500V, 1000V, (10,000Ω/V)  
DC/V: 0.5V, 2.5V, 10V, 50V, 250V, 500V, 1000V at 30,000Ω/V  
5000V (10,000Ω/V)  
DC/A: 50μA, 1mA, 50mA, 250mA, 1A, 10A  
AC/A: 1A, 10A  
OHMS: 10kΩ, 100kΩ, 1MΩ, 100MΩ  
dB: -20 to +62db  
Signal Injector: Blocking oscillator circuit with a 2SA102 transistor  
Approx. size: 6¾"x7¾"x3¾"

**Our Lowest Priced 1-Watt 2-Channel Transceiver**  
**MODEL 13-700**  
• 2 channels - Call Signal® alert tone  
• High level modulation  
• Jacks for battery charger and AC adaptor  
Model 13-700 Specifications  
**GENERAL**  
Circuitry: 11 transistors, 1 thermistor, 1 squelch transistor, 1 diode. Accessories included: Carrying strap, earphone.  
Channels: 2, Channel 11 crystals installed.  
Controls: On/off volume, squelch, Call signal channel selector, push-to-talk.  
Jacks and Connections: AC adaptor, battery charger, earphone.  
Power Sources: 8 penlight cells, 12-volt.  
Unit Size: 7 1/16" h. x 2 5/8" w. x 2 1/8" d.  
**RECEIVER**  
Receiving System: Crystal controlled superheterodyne tuned RF.  
Sensitivity: 1.4 uv for 19 dB (S+N)/N.  
**TRANSMITTER**  
Modulation: High-level Class B push-pull type.  
RF Input Power: 1 watt.

# SCOPE

## soldering irons

Buy a SCOPE and join the club of satisfied **USERS**—you need not keep it a secret, others don't. That's why **SCOPE IS KNOWN AT ALL THE BEST PLACES**—in the tool kit, on the bench, in the boot, on the kitchen table, in the garage, on the service truck, in the engine room, even on the roof... Wherever **SCOPE** goes it gives you the best service—and a host of satisfied users will agree it is the **QUICKEST**, the **EASIEST**, the **SAFEST**... **THE BEST OF ALL SOLDERING IRONS.**

**ECONOMICAL**  
Consumes current only whilst in use. Scope performs all the functions of other irons from 40 to 150 Watts. (Miniscope—up to 75 Watts).

**FAST**  
Fast heating due to the unique replaceable carbon element. Only 5 to 6 seconds' initial heating up time from cold, then practically instantaneous.

**VERSATILE**  
Copes with all soldering jobs—from miniature components to large solder lugs. Temperature control at your finger tips. Heat only when, where and as much as needed.

**SAFE**  
Low voltage operation. Scope irons operate from 2.5V to 6V.

For your complete protection and the satisfactory operation of your Scope iron, demand and use **THE APPROVED SCOPE natronic TRANSFORMER** which incorporates a specially designed **ELECTRO-STATIC SHIELD.**



\*Approved by electricity authorities APP. No. N/360/6894-5

**CONVENIENT**  
Ideal for those almost inaccessible spots. No burning of adjacent insulation.

**LIGHT WEIGHT**  
Scope De Luxe weighs only 3½ ozs. Miniscope 1¾ ozs.



All irons are supplied complete with a spare tip and two elements and suitably packed for presentation as a gift.

**SPARE PARTS**  
No expensive resistance wire heating elements to replace. Maintenance without special tools. Spare tips, carbon elements and other parts readily available from your Scope Distributor.

Scope products are available from all major electrical wholesalers and Hardware Stores throughout Australia and from H. W. Clarke, Wellington and Auckland, New Zealand.

## SCOPE MEANS A LIFETIME OF SATISFACTION

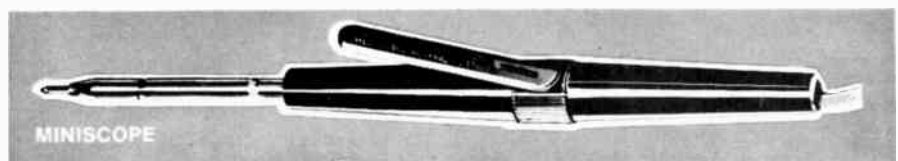

# IRH Components Pty. Limited

THE CRESCENT, KINGSGROVE, N.S.W. 2208. PHONE: 50-0111  
74 RAGLAN ST., PRESTON, VIC. 3072. PHONE: 44-5021

**Interstate Agents**  
**HOB. TAS. 34 2811**  
**LAUN. TAS. 2 2844**  
**PERTH W.A. 8 2271**  
**ADEL. S.A. 23 1971**  
**BRIS. QLD. 21 1933**  
**New Zealand**  
**H. W. CLARKE (N.Z.) LTD.**

Please Post free SCOPE literature

NAME .....

ADDRESS .....

CITY ..... POSTCODE .....

**IRH** THE COMPONENT DIVISION OF IRH INDUSTRIES LIMITED

# COOKING BY MICROWAVES

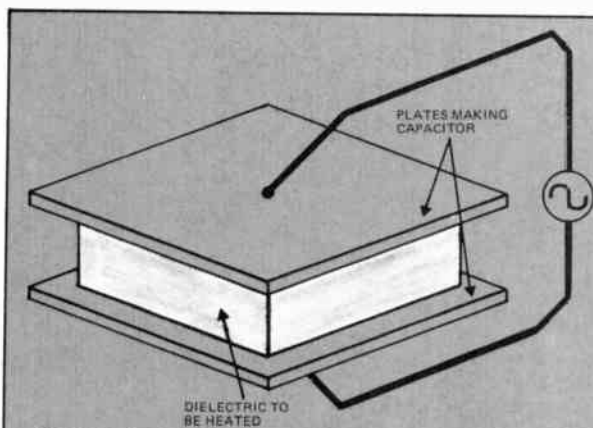

Fig. 2. In R.F. dielectric heating, metal plates plus the dielectric material form a capacitor.

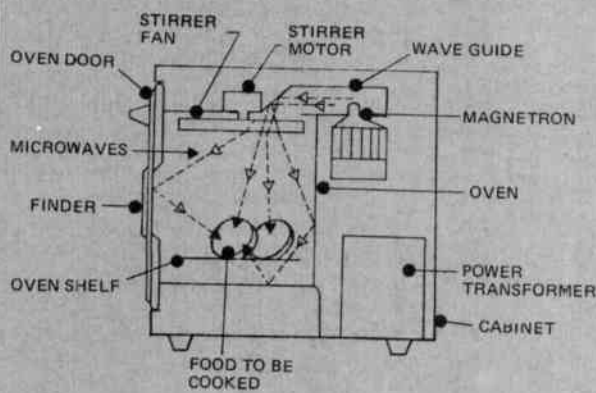

Fig. 3. Cross-section of a typical microwave cooking oven.

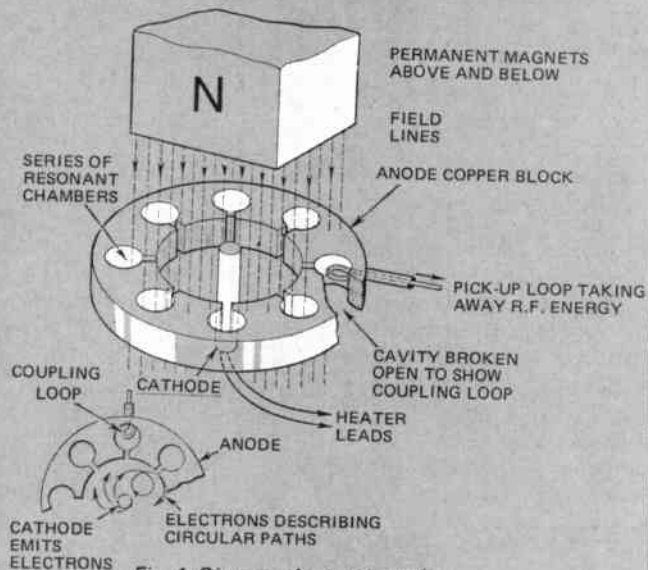

Fig. 4. Diagrammatic representation of the magnetron structure.

size of the food. Microwaves. At radio frequencies the food size is much smaller than the wavelength, so the source can be coupled merely with the metal plates but this is neither convenient nor the most efficient for cooking. When the wavelength is comparable with object dimensions it is necessary to use waveguide techniques to couple to the food. This requirement slightly complicates the design of a microwave oven, for it is necessary to design the cooking cavity as part of the waveguide system.

The design of the cavity of a microwave oven is reasonably critical but a simple and economic enclosure can be made using a metal-lined rectangular box of approximate dimensions. This forms a resonant cavity into which the food is placed. The output of the microwave oscillator could be coupled directly into this but it is more usual to employ a short length of rectangular waveguide so that the oscillator valve can be placed behind the oven.

In telecommunication transmission, waveguides and cavities must be carefully designed to ensure that they

operate only in specific modes. In an oven, however, it is, in fact, advantageous to have multi-mode operation for this liberates more power. The oven cavity, being many times larger than the wavelength, supports many modes providing numerous paths for the radiation to enter the food.

The walls and floor are made of metal in order to reflect the radiation. This is further aided by a metal fan that rotates in the roof of the oven, in front of the waveguide output. This creates a rotating microwave reflector that bounces the radiation around. Usually the fan, called a mode stirrer, is covered by a plastic cover and cannot be seen.

These requirements lead to an arrangement as shown in Fig. 3. The magnetron — its operation is described later — feeds the cavity via the cross-over waveguide.

Bearing the basic fundamentals in mind, we see that cooking in a microwave oven requires a different approach to that used in a normal oven. Firstly, any metal food container would upset the resonance

of the cavity, detuning the system dramatically. Because of this, food is cooked in paper, glass or plastic dishes. The lower the dielectric constant of the container, the colder it stays. For example, air has a dielectric constant of 1, paper 2 to 3 and glass to 5 to 10. Water has a particularly high constant of 80, so it gets much hotter than the container it rests in (until conduction transfer takes effect). This is the reason why food heats so readily — it is mainly composed of water.

As nothing gets hotter than the food, materials used for constructing the oven need only be able to withstand a temperature a little hotter than the boiling point of water. Construction can, therefore, be very light, if desired, even being made entirely of plastic with a thin metal lining. For more detail of the use of microwave ovens refer to the books listed at the end of this article.

Let us now look at the magnetron valve in more details.

## THE MAGNETRON OSCILLATOR

Until the late 1940's there was no device available that could generate

# COOKING BY MICROWAVES

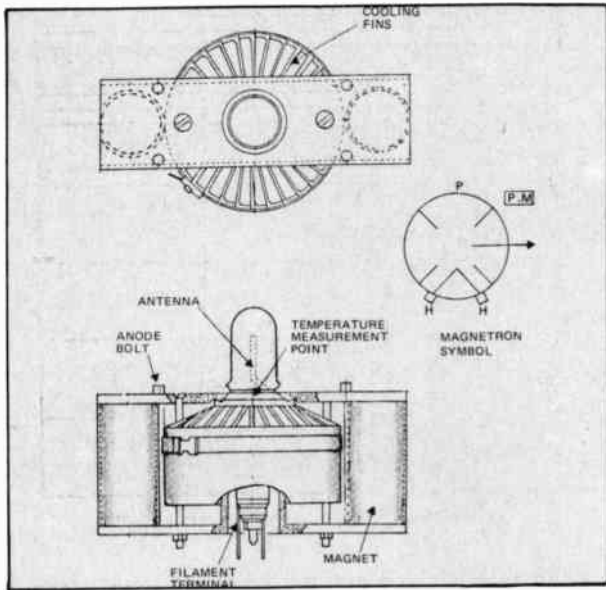

Fig. 5. 2M90 magnetron used in 1300W Sharp oven.

large-power microwave signals in the kilowatt region. Radar, which relies on the transmission of high power pulses was responsible for the development of a cheap oscillator just before 1945. As the valve combines the operation of electrons in a magnetic field it was called a magnetron. By 1945 the Raytheon Corporation of the United States had developed the first microwave oven.

The action of the magnetron is most easily understood by first considering the physical structure which is shown in Fig. 4. A copper anode, having circular cavities surrounds a central cathode which encloses a robust heater. Permanent magnets provide a magnetic field that passes through the anode and reaction space, running parallel to the cathode. One cavity has a pick-up loop to take out the microwave oscillations. The whole unit is evacuated.

In the absence of the magnetic field, electrons emitted from the heated cathode pass across to the anode because of the high anode voltage: this is the operation of a normal vacuum-tube diode. With the field applied, however, the electrons are forced to move in small, tight, circular paths on the way to the anode and, in doing so, set up microwave oscillations in each of the circular cavities. In essence, each cavity is a tuned L,C circuit, the inductance being a single turn of copper and the gap the capacitance. It is not necessary to collect power from all cavities as they operate together. In the practical device cooling fins are added to aid the dissipation of losses in the anode.

There are many shapes and sizes of magnetron but those used in ovens are similar to that outlined in Fig. 5. Air is

forced up through the fins to further aid cooling.

The efficiency of magnetrons varies from 30 to 70 percent. It depends very much on the field strength, anode to cathode voltage and the impedance presented to it by the load. The unit shown in Fig. 5. can deliver 1750 W into a matched load, but in oven applications where optimum matching is not always obtained, its output power drops to 1300 W. The anode voltage is 1750 Vdc, anode current 675 mA and the cathode is heated by a 40 A, 4 V heater. Maximum dissipation is 2 kW hence the need for an efficient cooling system when the magnetron is loaded.

Other sizes in use include a smaller 600 W unit and a larger 2200 W. Oven efficiencies overall are typically 50 percent. That is, the figures quoted above need to be doubled to arrive at the approximate electrical consumption. This apparent inefficiency can be misleading for, compared with a conventional oven, they, in fact, use less power for a given cooking task as the cooking time is much less and there is less waste of heat in the oven itself.

## THE PRACTICAL MICROWAVE OVEN

The layout of the microwave oven is largely dictated by the magnetron and the cooking cavity. Other bulky components needed are the high voltage transformer and rectifier bridge, the filament transformer, a blower to cool the magnetron and a timing switch.

A number of safeguards and protective devices are required to obtain safe reliable operation. In all, the complete internal wiring adds up

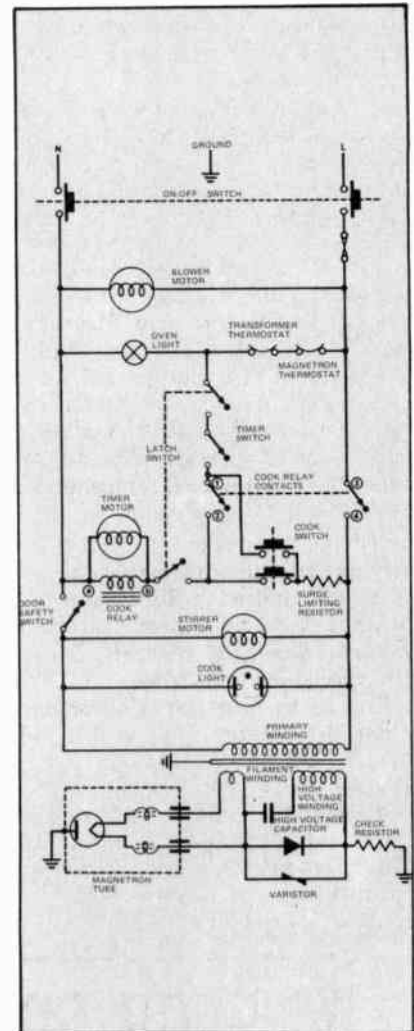

Fig. 6. Simplified schematic wiring diagram of a Sharp oven.

to be a small system. The schematic of a Sharp Model R-6500 600 W oven is given in Fig. 6.

Upon closure of the door, a whole series of switches and relays go into action to ensure that the door is closed, that the magnetron heater is up to temperature and that the blower and mode stirrer are going — before full high-tension is applied to the anode of the magnetron. The timer then runs, automatically cutting off the system in correct sequence after the required duration.

Both the magnetron and the main transformer are thermostated to cut them off if their temperature rises above preset limits: the magnetron temperature must not exceed 110°C. A door switch is important for two reasons. Firstly, because an open door detunes the system and, secondly, because close proximity to the microwaves can be dangerous.

When handling the microwave oven the manufacturer recommends that it is not knocked as this might reduce the magnetic field of the magnetron, resulting in lowered output. It is wise

to keep a glass of water in the oven to act as a load in the event of it being turned on when empty, a condition that can damage the magnetron due to reflected energy arriving back in the output antenna.

When not actually cooking, most ovens can be left on standby — this is useful for commercial catering where seconds count, but it can be expensive, for the standby consumption is about 300 W.

Due to the relatively complex operation and possibly variable performance of the magnetron a simple test has been devised to test the power output. The method specifies that two litres of water be placed in the oven in a glass or plastic container. After two minutes of operation a 600 W oven should produce a temperature rise of about 8°C in the water.

For all this complexity it must not be assumed that the microwave device is unreliable. Indeed a life of several hard years is to be expected at the very least. Servicing, however, does require specialised knowledge.

To have or to have not is a leading question. In America it is estimated that 60 percent of ovens are microwave — this type is bought first. Sales there ran to around  $3 \times 10^6$  units a year in recent years. Prices go as low as US\$190. Understandably in countries where they are not as fashionable, a higher price is demanded.

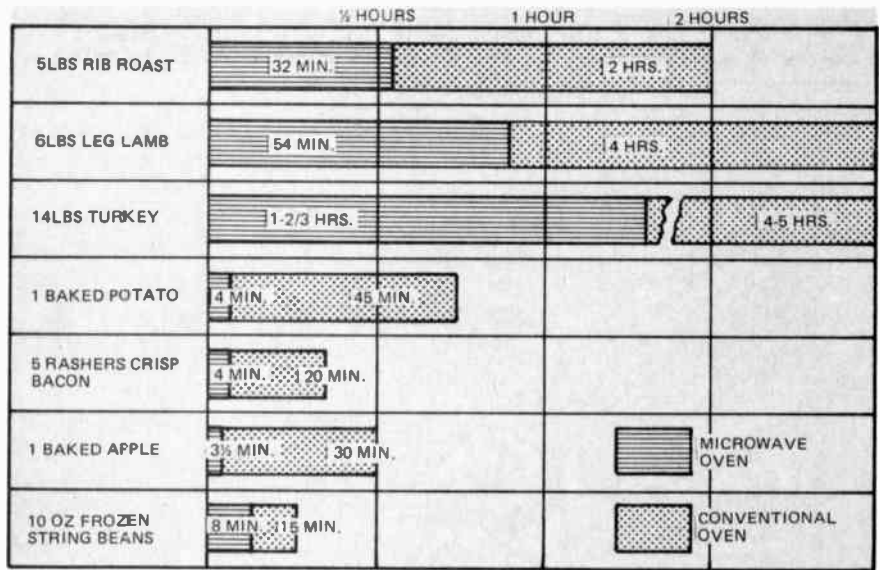

Fig. 7. Comparative cooking times of 600W microwave and conventional oven.

It is not entirely correct to compare them with normal ovens, for the cooking time is so much faster (see Fig. 7) that a commercial situation may well warrant their cost.

Finally, it can be seen that microwave heating is not confined to cooking food. It has been used to vulcanise rubber, dry adhesive coatings on rubber and plastic strips, and to dry glue on the spines of books — 15 seconds compared with several hours for air-dried binders. In essence, microwave heating is applicable

whenever the material has poor thermal conductivity.

#### SUGGESTED READING:

"A Guide to Microwave Catering" — L. Napleton, Northwood Publications, London, 1971.

Continuing issues of "Microwave News", Philips Electrical Industries.

"Microwave Heating" — State Electricity Commission of Victoria Industrial Information Sheet No. 3. October, 1971.

## PA & PB BRIDGE RECTIFIERS — EX STOCK

### 8,12 AND 25 AMPERE AVERAGE CURRENT

#### FEATURES

- 400 VOLTS TO 1000 VOLTS PIV
- UNIVERSAL, 3-WAY TERMINALS — SNAP ON, WRAP AROUND, OR SOLDER
- INSULATED METALLIC CASE FOR MAXIMUM THERMAL CONDUCTIVITY
- DIFFUSED SILICON JUNCTIONS WITH AVALANCHE CHARACTERISTICS
- SMALL SIZE — SIMPLE INSTALLATION



The MINIBRIDGE, manufactured by E.D.I., USA, was designed to replace larger bridges or four studs in power supplies, converters, inverters, motor control circuits and DC motor starters. The unique beam lead sandwich construction is used instead of discrete axial lead plastic encapsulated rectifiers allowing better heat transfer from junction to case and lower operating junction temperatures.

TYPE	PA40	PA60	PA80	PA100
	PB40	PB60	PB80	PB100
PIV/leg	400V	600V	800V	1000V

Matching AMP "250" Series FASTON connector available

#### AUSTRALIAN GENERAL ELECTRIC LIMITED DISTRIBUTORS:

86-90 BAY STREET, ULTIMO. 2007  
TELEPHONE: 212-3711

Fairchild Australia Pty. Ltd., Sydney 439-4355, Melbourne 723-4131.  
PB Components, Melbourne 53-2766.  
GEC-Elliott Automation Pty. Ltd., Adelaide 71-7971, Melbourne 387-2811,  
Sydney 439-1922, Brisbane 32-0441.  
Watkin Wynne Pty. Ltd., 32 Falcon St., Crows Nest. 43-2107.  
H. Rowe & Co. Pty. Ltd., Perth 28-5444.  
The National Electrical & Engineering Co. Ltd., Wellington 553-709,  
Auckland 599-089.

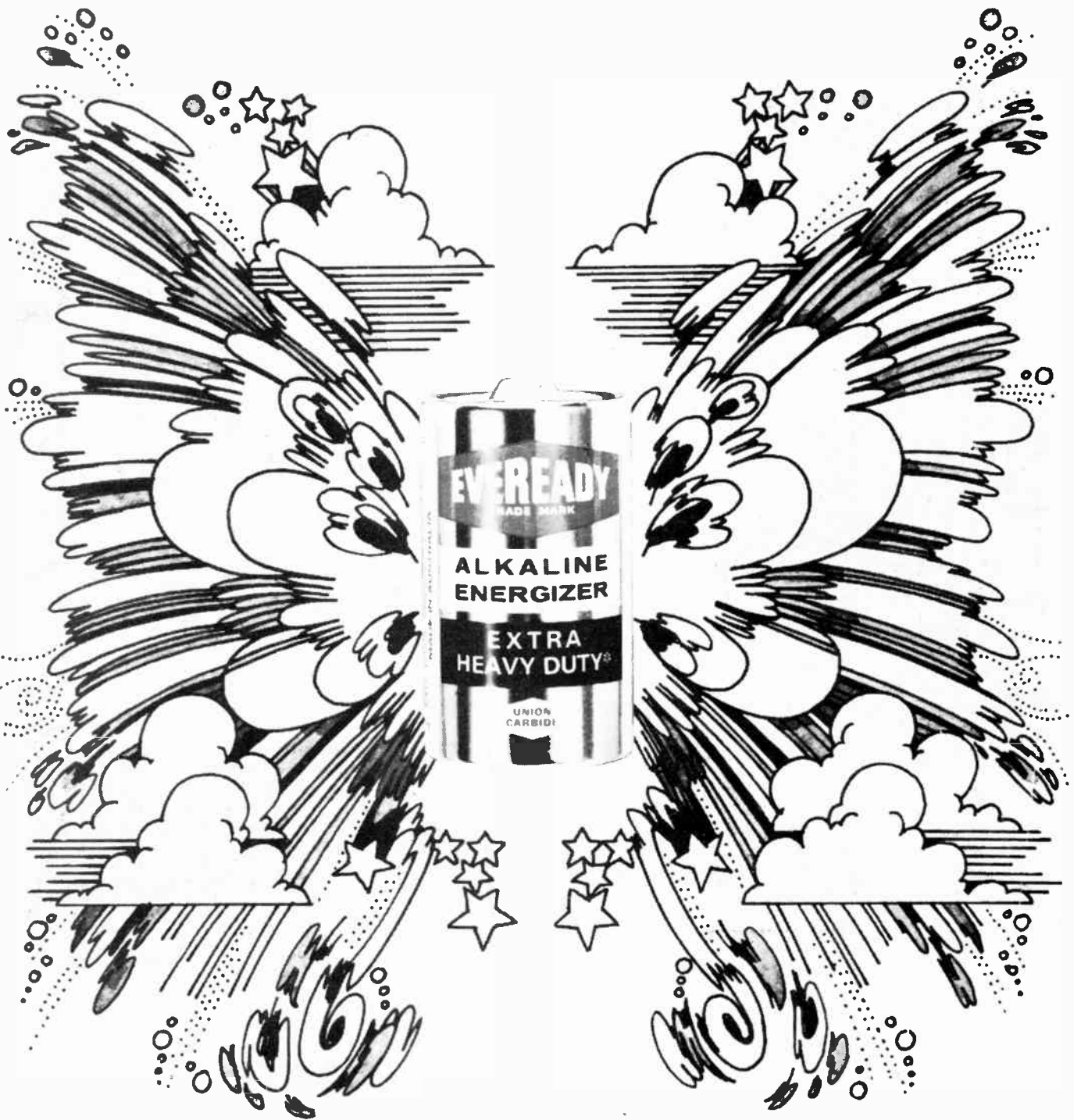

## To Dream the Impossible Battery.

*Why impossible?*

*Well, a battery which outperforms all others, with continuous use in high drain equipment; a battery to operate over a wide range*

*of temperatures; remain utterly sealed; deliver a more consistent voltage at all times; give low impedance and resultant fidelity improvement in sound equipment.*

*Whew. But, we built it. 'Eveready' Gold Alkaline Energizer. Against all odds. Spread the word. The impossible can happen.*

**EVEREADY** BATTERIES Products of **UNION CARBIDE**

'Eveready' & 'Union Carbide' are registered Trade Marks.



# 539A

## DUAL TRACE OSCILLOSCOPE

### NOW!

DC TO 12MHz -3db

### AND

FLAT WITHIN 5%  
OVER THE ENTIRE  
VIDEO BAND WIDTH

\*Instant selection of line or frame trigger from any video signal even when it's buried in noise or varying in amplitude.

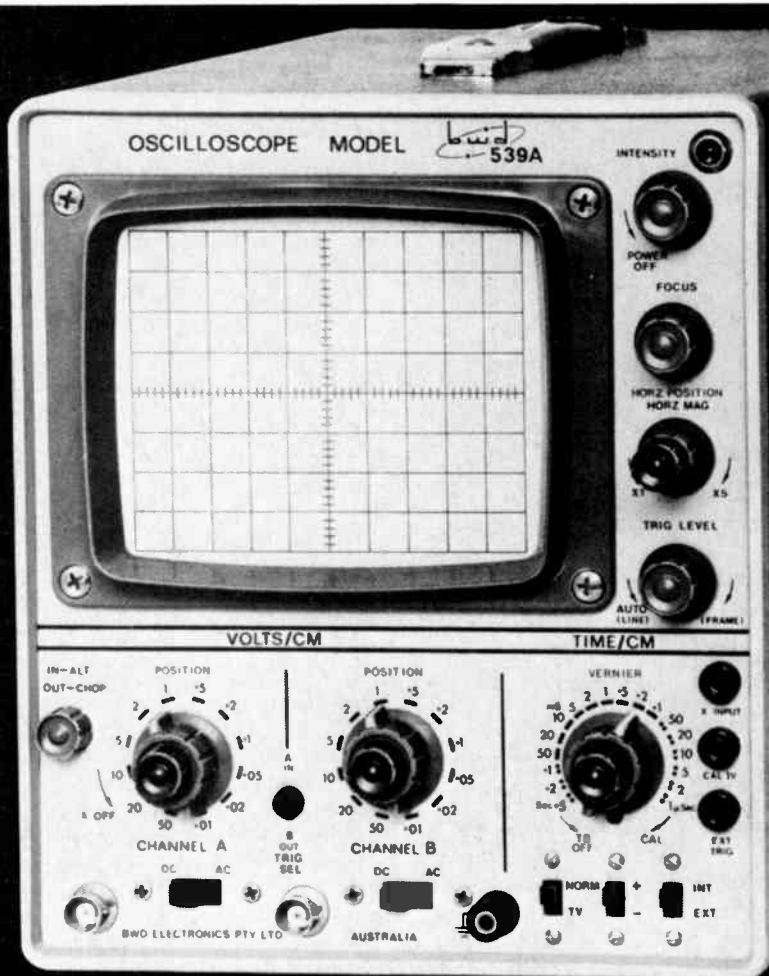

CHECK THE SPECIFICATIONS AND SEE WHY  
IN INDUSTRY EDUCATION AND SERVICE  
THE bwd539A IS SO WIDELY ACCLAIMED.

#### VERT. AMPLIFIERS

DC-12MHz-3db  
10mV-50V/cm Both Channels  
Ampl. usable to >20MHz

#### DISPLAY

Chan. A & B or  
Chan. B only

#### TIME BASE

200n Sec. to 2.5 Sec./cm  
Including X5 magnification  
and 5-1 Vernier

#### TRIGGER

Chan. A or B or EXT.  
+ or - Norm. or TV  
Auto. or Level Select

#### TRIGGER RANGE

5Hz to >15MHz 1 cm defl.  
2 cm composite video

#### GENERAL

8 x 10 cm CRT, 3KV EHT  
Z Mod. 20V P-P, 1MΩ input  
Horz. Input DC-1MHz, 0.6-6V/cm

#### PRICE

For this  
Superbly Stable 100% Solid State  
Oscilloscope

## \$375

(12 months' warranty)  
Plus tax if applicable  
FIS Australian Capital Cities

b.w.d. 539A.  
Federal Stock No.  
6625-66-046-6608.  
AN AUSTRALIAN  
OSCILLOSCOPE  
IN SERVICE  
AROUND THE WORLD.



WINNER OF AWARD FOR OUTSTANDING EXPORT ACHIEVEMENT



**B.W.D. ELECTRONICS PTY. LTD.** Designers and Manufacturers of the Finest Electronic Instrumentation  
329-333 Burke Road, Gardiner, Vic. 3146. Ph. 25 4425. 127 Blues Point Road, North Sydney, N.S.W. 2060. Ph. 929 7452.  
**S.A.:** A. J. Ferguson Pty. Ltd. Ph. 51 6895. **W.A.:** Cairns Instrument Services. Ph. 23 3871.  
**QLD.:** Warburton Franki (Brisbane) Pty. Ltd. Ph. 52 7255 **A.C.T.:** Associated Scientific Sales Pty. Ltd. Ph. 95 9138.  
**N.T.:** J. C. Electronics. Ph. 3605 and from B.W.D. Agents around the world.

GL&C1257BW

# CREATIVE AUDIO



Fig. 1 Using a Defluxer to degauss the record head of a Ferrograph tape recorder.

## PART TWO

A practical guide to creating and producing your own sound by Terry Mendoza, B.Sc. (Hons).

COMMON to all forms of creative recording is the making of taped copies from original 'master' tapes. This process is known as 'dubbing'. Although apparently straightforward, it is in fact impossible to render an *exact* tape copy from an original.

There are a number of reasons why this should be:

The transients on a master tape may inadvertently have been allowed to enter overload conditions momentarily, thus introducing a typical 3% distortion (a VU meter may not even indicate this incursion into distortion); because of this many broadcasting engineers prefer the 'Peak Programme Meter (or PPM) which traces programme transients. If this overload level occurs over short periods the resultant distortion may be acceptable, but if such a tape is *copied* to an equal flux level, so that 0 dB on the copy tape corresponds to 0 dB on the master tape, the transient periods will again have been subjected to 3% distortion, thus on the copy all peaks will be marred by a now unacceptable 6% distortion.

If the record gain control is reduced to combat distortion so that the peaks alone provide 100% modulation of the tape, the soft passages will now be recorded to a much lower level than before, and tape hiss and thermal noise originating in the electronics will become obtrusive.

Tape copying has also to contend

with various forms of external breakthrough that may be present, radio pick-up, induced mains hum (or its harmonics) and 'impulse' interference (experienced when for example, a refrigerator thermostat switches on or off).

Radio breakthrough is more common when the recording equipment is used in the vicinity of a strong radio signal, close to a transmitter for instance. It happens when the input of the equipment functions, albeit poorly, as a detector circuit and aerial. Transistorised input stages often resemble a junction diode detector circuit and unscreened, or inefficiently screened, connecting leads provide the necessary signal input facility with the result that AM and even FM signals are detected and passed into the system where they undergo further amplification.

The first line of attack against external interference, is the use of good quality, tightly-braided screened lead for equipment interconnections. Suitable cable should have a nominal impedance of about 50 ohms and a core/screen capacitance of not more than 100 pF/metre.

Mains transformers and fluorescent lighting inductors are both sources of powerful magnetic fields and for obvious reasons signal carrying cables should not be allowed to trail close to them. (Tapes should also be guarded against the hazard of powerful magnetic fields — failure to take precautions results in partial erasure, high noise levels and massive print-through of signals from adjacent tape windings).

Radio breakthrough can be alleviated by tying the base of the troublesome first stage transistor to its emitter with a low value capacitance (47 to 100 pF). Audio signals will pass through normally whereas any HF radio signals will 'see' a short circuit and not pass into the system.

Tape heads should be adequately protected from stray magnetic fields — if it is evident that the screening is insufficient, mumetal shields can be constructed. A special foil for this application is manufactured by Telcon, but care must be taken to avoid sharp angles when working the material or its efficiency will be impaired.

The well-documented "hum-loop" is a further cause of high level of mains interference due to incorrect equipment earthing methods.

Care should be exercised in the construction of audio equipment; it is

better to run individual wires from the 'earthy' side of relevant components to a single earth potential point on the chassis rather than festoon an earthing wire from component to component around the apparatus.

It is evident that a tape copy walks a tightrope between hiss and miscellaneous interference on quiet passages, and distortion on louder transients.

Considering the foregoing in terms of programme compilation one should always try to preserve, as clearly as possible, the character of the original material. Thus this covers the retification of deficiencies on the master during the copying process; this may entail filtering or boosting selected frequency bands, expanding or compressing the dynamic range of the recording, or adding reverberation or echo onto a 'dry' master. The adjustment of characteristics, often in a very drastic form, is the major tool in impressionistic recording as utilised in modern plays, music concrete, and electronic music.

## HISS AND NOISE

Thermal amplifier noise and tape noise are the two principal causes of hiss which, except by using expensive Dolby A Noise Reduction equipment, is impossible to eliminate completely. Furthermore, when carrying out multitrack recordings (to be dealt with in a later article), these imperfections become cumulative and, in conjunction with peaking distortion, limit the number of re-recordings that it is feasible to make.

In order to extend these limiting boundaries, it is logical to restrict the number of amplifying (and resistive) stages between the replay head of the master machine and the record head of the recording machine. The use of a hi-fi preamplifier interposed between replay head and record head is therefore deprecated if it is going to raise the hiss level to any appreciable degree.

For the same reason it is usual to tap the output of a tape recorder between the preamplifier and main amplifier stages; this feed is variously termed 'line out', 'cathode follower', 'low level' or 'monitor' output. The output is connected to the 'line in' or 'radio' input of the recording machine having taken account of the stated input impedance (this figure gives the limit of load that may be applied to the input without fear of degradation of



recording quality due to excessive load impedance).

If there is a control governing the output level of the replay machine, this should be set to between half and three-quarters of maximum gain. This setting ensures the replay amplifier will not be overloaded but nevertheless supplies plenty of signal to the recording machine.

Should the recording machine 'see' an inadequate signal level, the sensitivity of its recording amplifier has to be set near maximum with resulting amplifier noise increase. Conversely the replayed signal should not exceed five times the sensitivity of the recording machine.

## CHOICE OF MAGNETIC TAPE

It is common to find the operator's manual supplied with tape machines specifying particular brands of tape as 'suited' to the recorder. The reason for the recommendation is that all tapes possess different characteristics (measurable differences may even occur between subsequent batches of the *same* brand of tape) that require different ac bias settings for optimum recording quality.

Thickness of the magnetic oxide on the tape largely governs the tape maximum output level. Finer magnetic powders incorporated in the paint that is applied to the plastic base may impart the finished tape with low noise, or low noise/high output properties, but again bias changes may be necessary for the best results. It has been shown that an increase in the high frequency bias modulating the audio signal, results in the high treble bias-modulated signals registering *within* the tape oxide, away from its head-contact surface. This means that on replay the oxide registering the treble frequencies is not intimately contacting the tape head, and a muffled treble-end results. On the other hand, a reduction in the bias value limits the maximum signal possible at low audio frequencies.

This explanation largely oversimplifies the situation as it ignores modulation noise, tape noise, distortion and related problems. However it does reveal the quandary confronting the recorder manufacturer; to enable the lay user to achieve good results with the recorder, the manufacturer must set the bias and record pre-emphasis to suit a particular tape brand, hence the recommendation in the operator's manual.

Considering a three-head recorder, it is not an unduly difficult task for an enthusiast to set the bias on his machine for a particular type of tape.

Basically the method involves

metering the output from the replay head whilst feeding a steady tone to the line input. Many recording studios use a 1 kHz sine-wave tone although one authority recommends a 10 kHz signal for line-up purposes. The bias level control is cut back, the tape set in motion and the bias gradually increased. The meter at first registers the increasing bias with corresponding increase in signal gain — indicated on the meter. A plateau is reached which is then followed by increasing bias leading to decreasing signal output. The correct bias setting is achieved when the signal output drops by 2 dB to 5 dB.

One advantage resulting from bias adjustment is that it allows specialized tapes, not normally considered for domestic use, such as BASF LR56 and LGR, to be brought into service. Tapes of this nature can be recorded at a higher signal level than normal so that the signal to tape noise ratio is more advantageous, thus requiring less amplification with an attendant reduction in replay amplifier noise. In addition, correct bias 'tweaking' gives a wide flat frequency response combined with minimum distortion.

(The reader should study this subject more deeply before attempting to re-align his own equipment — alternatively some service departments can do it for him).

The rationale dictating maximum tape area per second has already been covered in the first article in this series. The condition of the tape heads themselves is also a major quality-determining factor and hence warrants regular attention. Regular use of a defluxer (degausser) prevents a gradual build-up of head magnetization which otherwise causes an increase in background hiss levels, even affecting *later* replay of master tapes by the magnetized heads. In use, the defluxing device is placed against each head in turn (see Fig. 1) and the current switched off when the defluxer has been safely removed from the vicinity of the tape machine. This avoids the possibility of the switching transient inducing further residual fields in the heads.

The tape copying process itself can be considered from the two separate aspects, dynamic range and tonal modification possibilities.

## DYNAMIC RANGE

Programme material is compounded of a continuously varying pattern of different loudnesses and to produce taped copy of the dynamic range of sound reaching the microphone, the recording gain controls *could* be set to an average loudness value and then left alone.

This however is unsatisfactory as

tape hiss becomes clearly audible when the programme level falls, and conversely, during louder periods the recording will be distorted. To keep the signal in the useable band, the simplest way is continuously to monitor the input level, smoothly adjusting the record gain control accordingly. Gradual operation of the control is essential, as even if rapid operation is not revealed on the recorded programme material itself, it will make itself evident by the abrupt pulsation of the background sound level.

With an orchestral work, or other known programme material, the gain should be gradually decreased a few seconds before an expected peak so that when the crescendo actually occurs, the large dynamic change will be registered without incurring distortion. If skillfully carried out, even a tutored ear will remain blissfully ignorant of the operation.

Although this simple manual control may be used to produce quite technically adequate recordings with single or two channel recorders — it becomes impracticable with multi-channel machines.

Professional recording studios, for example, may use several banks, each of as many as 24 microphones, connected to individual mixer/amplifiers and thence to separate tape tracks.

It is obviously impractical manually to adjust the levels of 24 amplifiers in an attempt to maintain optimum signal-to-noise ratio on each tape track, and because of this, automatic devices are used to this end.

## COMPRESSORS

These devices effect a continual gain reduction, so that instead of the output level following the input in a 1:1 ratio, it becomes 2:1, 3:1 or, in some cases, even tighter slopes. The nearer the slope approximates a 1:1 condition, the greater will be the resemblance of the output dynamics to the original signal (see Fig. 2).

## LIMITERS

Acting similarly to compressors, these too alter the relationship between input and output levels. However they operate only at the 'loud' end, to limit transients exceeding a preset peak volume. Tighter compression ratios are used, usually greater than 10:1 and these are combined with a fast 'release' characteristic, so the heavy compression ceases simultaneously with the transient leaving the softer programme material that follows unaffected.

The 'release' time is often manually variable so that it can be suited to the

# CREATIVE AUDIO

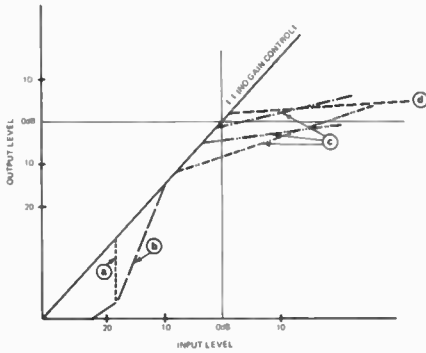

Fig. 2. Gain characteristics of various control devices: (a) noise gate – switching in as input passes – 18 dB; (b) low level signal expander; (c) compressors and compressor/limiters; (d) limiter.

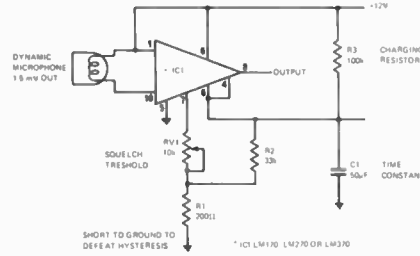

Fig. 3. Squelch preamplifier (with hysteresis) – from National Semiconductor Linear Application Notes, AN-51, Sept. 1971.

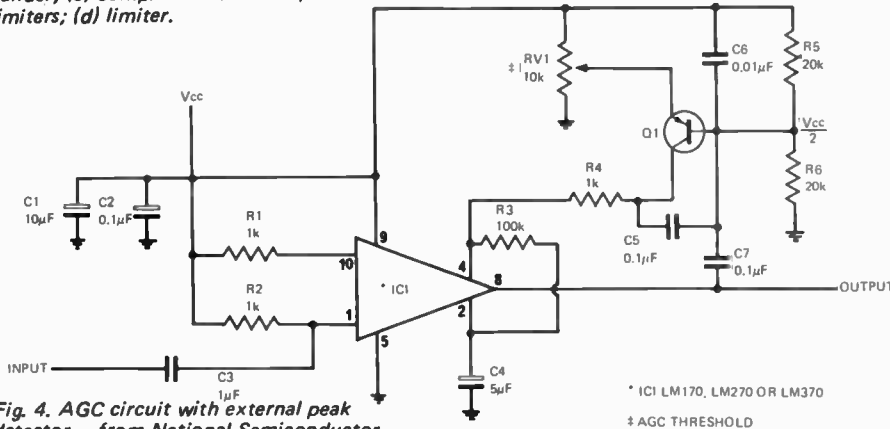

Fig. 4. AGC circuit with external peak detector – from National Semiconductor Linear Application Notes, AN-51, Sept. 1971.

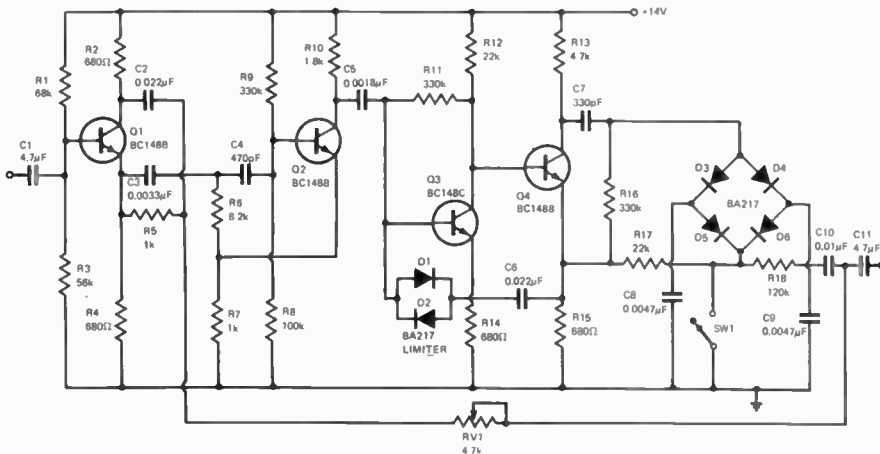

Fig. 5. Complete circuit of Philips dynamic noise reducer. Capacitors  $C_1$ ,  $C_2$  and  $C_3$  form part of the high-pass filter. Diodes  $D_1$  and  $D_2$  and capacitors  $C_4$  and  $C_5$  form a peak detector providing a control potential to attenuator diodes  $D_3$  and  $D_4$ .

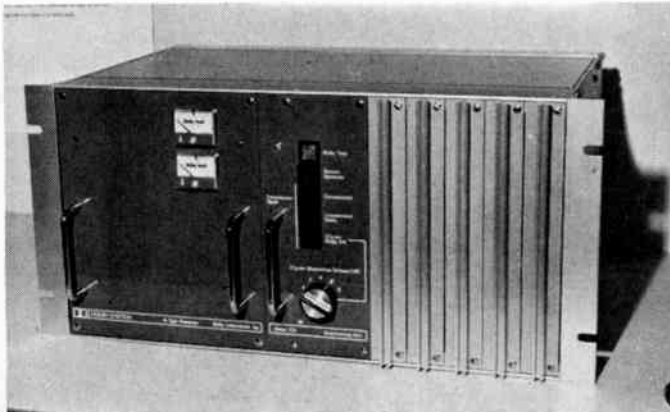

Fig. 6a. Dolby A Professional Noise Reduction System.

type of programme material; if the release time is set too long it gives rise to a 'hole' immediately following the limited transient. Often, it is only by trial and error that the right release characteristic can be chosen for the material being recorded.

The threshold above which the limiting action takes effect, can also be altered and, for the most natural effect, this is set into operation just prior to the point of maximum tape modulation. The dynamic range up to this point is thus unaffected and, although distortion will occur on very loud peaks, it will be of a much lower severity than would be the case without the limiter in circuit.

## EXPANDERS

Dealing with the quiet sounds, at the other extreme of the dynamic range, expanders increase signal output level at a more rapid rate than the signal input increases. These units drag soft signals rapidly out of the danger zone – where they would have to compete with tape and amplifier hiss – swelling the signal with something like a 3:1 ratio.

Noise gates act in the same region, but rather more drastically, with ratios of around 100:1; they perform as automatically switched attenuators, operating at a preset low level threshold.

These units have for a long time been much used in communications applications where their operation is descriptively termed a 'squelch' facility.

National Semiconductors have developed a very interesting integrated circuit designed specifically for automatic gain control and squelch applications. Figures 3 and 4 show circuits, using this IC, that may serve as a starting point for the experimenter in this field.



Fig. 6b. Bank of 24 Dolby A noise reduction units for use with 24-track tape machine.

## NOISE LIMITERS

Philips have designed a 'dynamic noise limiter' intended primarily for cassette tape replay (See Fig. 5). This circuit is based on the premise that the louder a musical instrument is played, the greater will be the number of high frequency harmonics produced (when played quietly, few instruments emit fundamentals above 500 Hz). A detector circuit identifies material lacking in upper harmonics and when such material occurs, the detector introduces a steep low-pass filter, thus blocking the high frequency, (hopefully) without altering the actual (lower frequency) programme content.

A final classification covers complementary processor and deprocessor units, the Dolby system being a prime example. They reduce noise emanating from the parts of the signal chain between the input to the processing stage and the eventual output from the deprocessing unit — such noise includes tape noise, print-through effects and amplifier noise.

In units such as these, the upper end of the dynamic range is passed through completely untreated, as loud sounds mask the much lower level background noise. The low-level signals at the input are expanded during the processing stage so they are recorded well above the inherent system noise, but still left at a slightly lower level than the untreated 'loud' band.

When the processed signal passes through the deprocessor the differential volumes will be sensed and the lower-level signals subjected to compression, this restoring the former dynamic range.

System noise in these passages will also undergo the same compression, effectively giving the same signal to noise ratios in the soft passages as in the loud ones.

The domestic Dolby B system concentrates on progressive hiss reduction in a band stretching upwards

from 600 Hz, and achieving 10 dB noise reduction above 3000 Hz.

The Dolby A system, nowadays almost universally used in recording studios, works on the same principles, but use four separate frequency bands each with its own processor/deprocessor for smooth operation throughout the frequency spectrum. (See Fig 6a and 6b).

## EXPERIMENTAL CIRCUITS

The reader may find the photo-electric limiter — compressor circuit shown in Fig. 7 useful for a variety of applications — adjustment of the threshold dictates whether limiting or compression occurs. To set up, VR2 is set to maximum resistance and VR3 adjusted so that the bulb just glows in the darkness. If metering is used VR5 is set to full scale deflection with no signal present.

For optimum performance, the bulb should be in contact with the cadmium sulphide cell.

Different release times are obtained by employing switched capacitances between 1  $\mu$ F and 10  $\mu$ F in place of C2.

One advantage of this circuit is that there are no active noise-generating components in the actual programme chain.

A more elegant circuit, based on the use of a FET as a voltage dependent resistor in one arm of a potential divider across the input to an amplifier can be found in the July 1972 issue of the UK magazine Studio Sound (L. Stickells pp. 71, 73, 75).

The compressor circuit shown in Fig. 8 works in a similar fashion, the MOSFET deriving its power from the audio signal itself. When -3V is applied to the MOSFET, its resistance is 10k, dropping to 300 $\mu$  (maximum compression) with -10V.

The transformer turns ratio should be at least 20:1.

Varying the base bias of transistors in push-pull configuration is one sensitive

means of varying the amplifier gain. The 'electrical level control' illustrated in Fig. 9 must initially have the output balance adjusted to minimize the dc shift at the output with applied control voltage. After this the gain balance is trimmed to give minimal second harmonic (at the output) due to the input signal — using a sine wave input rather greater than normal, the gain balance is moved to provide the most symmetrical output waveform.

A general purpose expander-compressor is shown in Fig. 9a, this utilizes the electrical level control combined with a logarithmic rectifier.

Simultaneous compression before, and expansion after, a noisy device is possible using a complementary electrical level control configuration; dynamic range is not affected whilst the deleterious effects of the noisy device are much reduced or eliminated (Fig. 9b).

When any stereo signal is to be limited or compressed, the attenuation must be carried out synchronously to both channels using a 'tandem' system of dc control voltage. Altering the gain of one channel only results in the stereo panorama surging to and fro in a false and obvious manner.

Despite its many advantages, it must be emphasised that limiting is not the complete panacea for all recording level problems, as, especially with classical music, limiting can be extremely obvious and unpleasant — particularly to the musically trained ear.

## SIGNAL MODIFICATION DURING DUBBING

A second aspect of the copying process is the manual modification of the frequency characteristics of the signal before it enters the second recorder. The term 'manual' has been used here to differentiate from such automatic modifying devices as dynamic noise limiters.

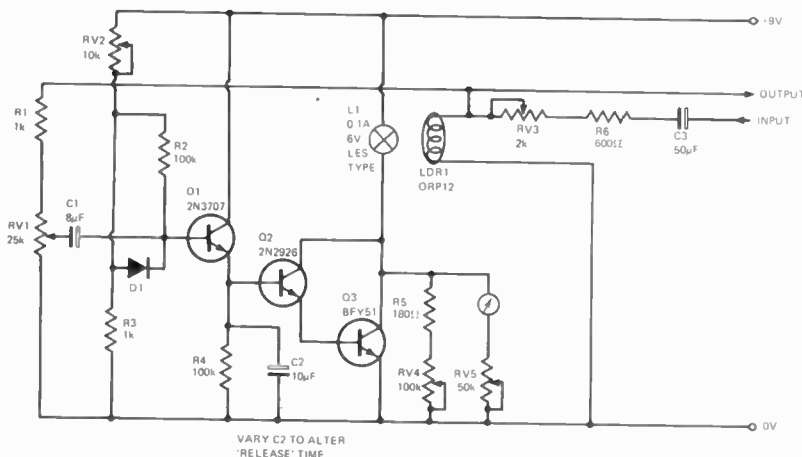
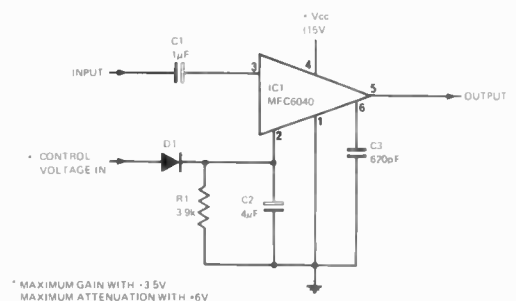

Fig. 7. Photo-electric limiter-compressor.

*Voltage controlled amplifier/attenuator, this circuit, intended primarily for experimenters, has a maximum gain of 13 dB and maximum attenuation of approximately 77 dB (relative to 500 mV rms signal input).*



# MARANTZ

## answers the 4-Channel Question

Marantz alone presents products that will change with the advances in 4-Channel design. Our refusal to build in the three current 4-Channel decoding systems is based on one very good reason. We have no desire to produce and market a product that may become antiquated before the end of the year, thus destroying the credibility of Marantz in the eyes of our dealers and particularly our customers.

Providing all three systems (SQ, QS, CD-4) in one package at a competitive price requires sacrifices in other areas of that product, such as power and features. This would be an acceptable compromise if all three 4-Channel systems will be used by our customers but in fact, in a short time you will be using only one of the three systems. And, the system you will be using will be made obsolete by advances in technology. Marantz does not want to say "Buy a Marantz and pay for three 4-Channel systems, but you will only use one of them. And, the one you use will soon be made obsolete by advances in product design, such as SQ full-logic."

What Marantz does say is, "Buy A Marantz and pay for a system that you can use today and tomorrow; A system that does not waste money on features that will become obsolete and/or never be used." We can make this statement because Marantz built a number of unique features into their 4-Channel equipment.

### A PLUG-IN, PLUG-OUT POCKET:

You can up-date any Marantz unit when and if you wish by purchasing an inexpensive Decoder module. An example of the use of the pocket would be the new, full-logic SQ IC chips soon to be available, which Marantz is producing. With a Marantz unit you need only plug in our module. On the other hand, the consumer that purchases a unit with everything built in will not be able to take advantage of this new technology without going to great expense, and paying for items such as the cosmetics of an accessory chassis, power supply circuits, etc. In fact, he is stuck with an obsolete receiver or amplifier.

### VARI-MATRIX:

A Marantz-designed matrix circuit that synthesizes 4-Channel

sound from stereo sources and does an adequate job of decoding SQ and QS program material. Since the Vari-Matrix is a synthesizer, and will provide a 4-Channel effect from any program source, it will always be useful.

### BRIDGING:

Marantz provides a bridging circuit on all of their 4-Channel products that will convert the four amplifiers into a stereo amplifier. A nice feature if you want stereo now and 4-Channel later, or if you want more power from your total system by bridging the front channels, and adding an additional 2-Channel amplifier for the rear channels.

### DOLBY:

The Marantz philosophy of non-obsolescence is also evident in the design approach used to build Dolby into a number of the 4200 series receivers. Because Dolby is a fully-developed process and is accepted as the industry's standard for noise reduction, the Dolby system can be used today and to-morrow with any type of tape machine. And, will even process Dolby records when they become available. Building the Dolby system into our receivers creates many advantages. Among these advantages are:

**COST REDUCTION:** Since the Dolby circuit is built into the receiver's chassis, additional costs for separate power supplies and chassis are not accrued.

**VERSATILITY:** The Marantz Dolby system can be used with any type of tape or recorder. Complete calibration controls assure maximum flexibility of the unit.

Marantz continues to lead the industry with high-quality, innovative product design. Our products offer the flexibility and features that assure our customers an absolute value and quality that is offered by no other company. This is why Marantz has chosen the approach to the industry's 4-Channel dilemma that the new products solve today, without being obsolete tomorrow.

# CREATIVE AUDIO

This includes various filtering processes which are used to attain, or alter the flat frequency response characteristic, to compensate for deficiencies in the recording environment, to enhance or increase the definition of an instrumental sound.

When treble boost is desired, it is advantageous to apply it before the material gets onto the master tape, because boosting at the copying stage also boosts tape hiss.

Subject to noise limitations imposed by the amplifier, treble or bass boost/cut may economically be applied to a signal by passing it through a domestic hi-fi amplifier (retrieving the signal at the 'tape-out' or 'low-level out'). Alternatively, for treble and bass modification, it may be worthwhile utilising the simple active tone control circuit shown in Fig. 10.

Tonal modification is due to the frequency dependant feedback network between the collector and base of the transistor. The input is 40 kΩ at 1 kHz with the controls flat, and the output a usefully low 180Ω. (This circuit was developed by Mullard Ltd).

Many signals demand more specialised treatment than is provided by circuits which just tweak the two ends of the frequency spectrum.

An octave filter bank is the answer in such cases. Unfortunately such devices are usually priced well out of the range of the amateur enthusiast.

However the equaliser described as part of the ETI Master Mixer may be used to perform at least some of the functions of a full octave equaliser (ETI, March 1973).

## MAKING THE COPY

The equipment should be given five to ten minutes to warm up before actually making any tape copies,

especially if the equipment has been kept in a cold room. To assist the warming-up process, recorders can be placed in the fast-wind mode.

Opening and closing input level controls a few times clears any possible 'noisy' patches on the fader tracks.

During the warm-up process, the duration of the piece to be copied may be timed, noting any extra-loud or soft passages to be negotiated.

The recording and replay tapes can now be threaded up on their relevant machines and the initial recording levels set by a trial recording.

Copying 'proper' should take place after both machines have reached full speed; to give adequate run-up time, the replay tape should be set back a little way before the required passage. The recording machine is started before starting the replay machine, any unwanted gap being edited out of the copy later. A neat result can be gained by editing leader tape up to the start of the wanted material on the playing tape. Similarly, having noted the initial levels required, it is preferable to start the recording machine with the inputs closed, then rapidly fade up to the previously noted levels.

Commencing copying, the sequence of events will thus entail: (1) Start record machine with controls fully closed; (2) Start replay machine; (3) Rapidly fade up recording gain controls to the predetermined levels in time to catch the commencement of the required passage.

If a slow fade-in is warranted, adjustment of the control is initiated as the leader on the replaying master is seen to finish.

Material compilation will be covered later in this series, but an important rule relating to 'fades' is that they should be conducted as near to the end of the programme chain as possible, preferably when dubbing

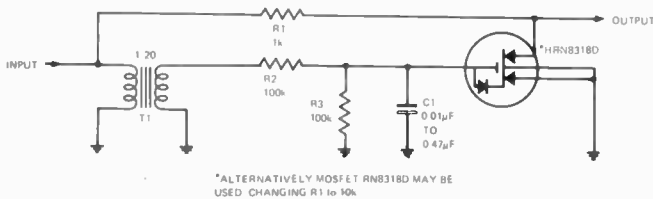

Fig. 8. MOSFET Volume compressor (requires no power supply).

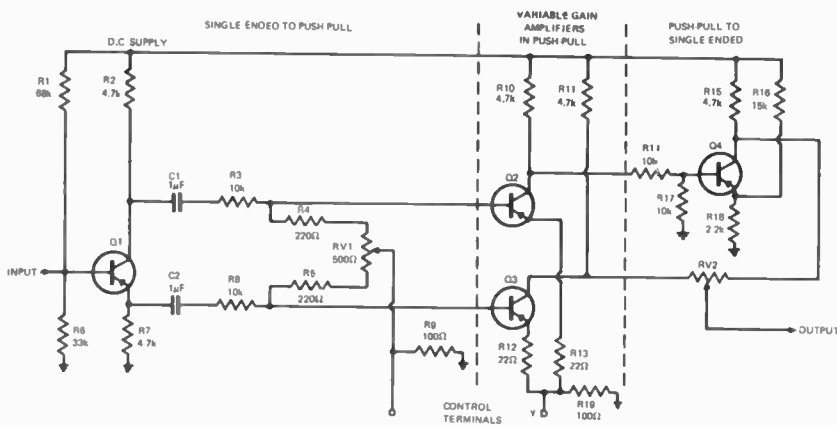

Fig. 9. Electronic level control.

Logarithmic rectifier (shown schematically in Fig. 9a). ▼

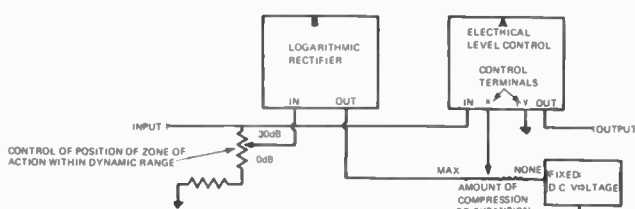
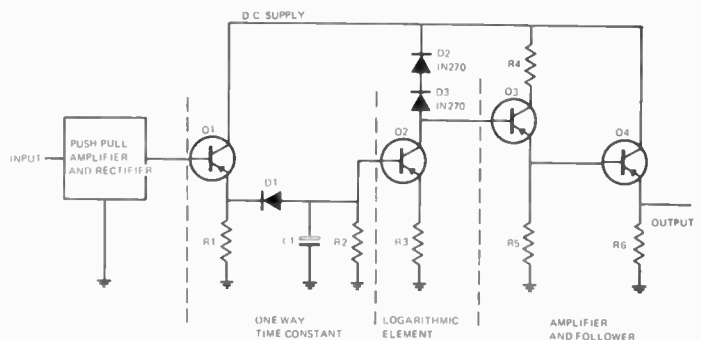

Fig. 9a. General purpose expander-compressor (the circuit of the logarithmic rectifier, indicated as 'B' is shown inset).



# CREATIVE AUDIO

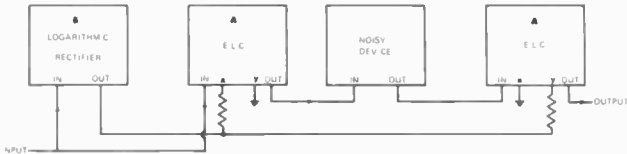

Fig. 9b. Simultaneous compression before and after a noisy device.

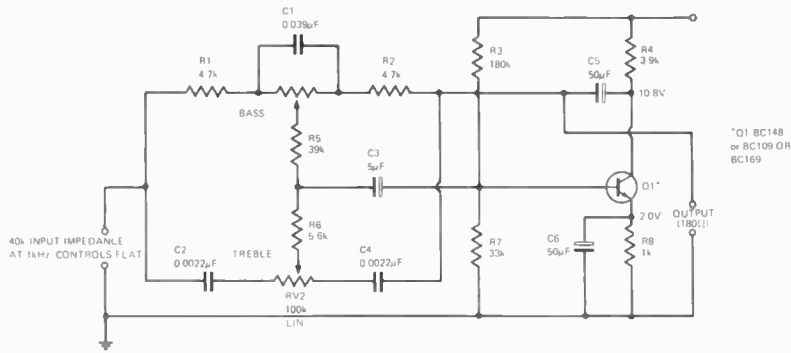

Fig. 10. Active tone control circuit.

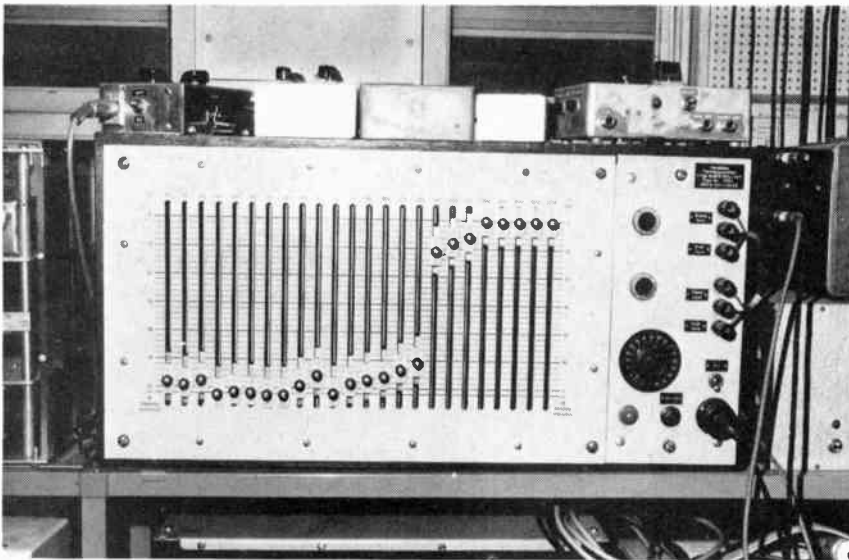

Fig. 11a. Specialised one third-octave band equalizer used in the production of electronic music. Rotary control on right enables progressive insertion or removal of the filter.

onto the final 'finished' programme ape. This retains maximum signal-to-noise ratio at the fade.

When copying other than multiple generation (copies of copies) dubbing, it is beneficial to record extreme peaks 2 dB lower than on the original. Carefully riding the gain control in quiet passages will give the impression of a dynamic range equivalent to the original.

Finally, when a number of recordings are to be sequentially copied onto a tape, or only selected passages are to be re-recorded (sometimes called "electronic editing") the following procedure will reduce unwanted clicks and produce a polished result: At the finish of the copying of each selected passage, the recording machine should be placed in the 'pause' position. The recording tape is manually rewound just an amount sufficient to cover the effects due to the tape being halted and the next selected piece dubbed, released the 'pause' at the right moment as the master tape plays.

## Integrated Circuits

SN7490	.....	\$1.80 ea.
SN7441AN	.....	\$2.50 ea.
SN7475N	.....	\$1.80 ea.
SN7400N	.....	75c ea.
SN7410N	.....	75c ea.
SN7430N	.....	75c ea.
SN7440N	.....	75c ea.
SN7472N	.....	\$1.75 ea.
SN7473N	.....	\$2.00 ea.
SN7447N	.....	\$2.60 ea.
LM709 OP AMP	.....	\$2.60 ea.
LM709 OP AMP	.....	\$2.60 ea.
LM305 Pos Reg	.....	\$3.80 ea.
LM304 Neg Reg	.....	\$4.90 ea.
TIL 209 L.E.D.	.....	80c ea.

Postage on I/C's 10c ea.

## Transistors

2N3055	.....	\$1.60 ea.
BC109	.....	60c ea.
BC108	.....	50c ea.
BC107	.....	50c ea.
2N3568	.....	75c ea.
2N3866	.....	\$1.50 ea.
2N3819 Fet	.....	85c ea.
LM380 2 Watt Audio IC. 8 volt to 22 volt Rail. 50K ohm input Impedance, short circuit & overload protection.	.....	\$2.85 ea. p/p 10c.

Electrolytics 40,000 uf 10 volt \$2 ea. P/P 35c.  
New Cracked Carbon Resistors, 1/4W & 1/2W 5%. Full range. 5c each.

## Peak Panel Meters KR65 Series

Size 3 1/4 x 2-5/16 x 2-1/8. Rectangular 2 screw mounting.		
0-1 MA	.....	\$5.25
0-1 AMP	.....	\$5.70
0-5 AMP	.....	\$5.70
0-10 AMP	.....	\$5.70
0-20 AMP	.....	\$5.70
0-10 AMP AC	.....	\$5.00
0-20 Volts DC	.....	\$5.45
0-40 Volts DC	.....	\$5.45

Packing & Postage on Meters 50c

WAYNE COMMUNICATIONS  
757 Glenferrie Rd.,  
Hawthorn 3122. PH: 81-2818

# INTERESTED IN MUSIC AND HI-FI?

then buy yourself a copy of

# EAR FOR MUSIC

Australia's great new musical monthly.

48 BIG glossy pages of records and hi-fi stereo reviews PLUS exclusive interviews and stories on pop, classical, rock and jazz.

EAR FOR MUSIC IS ON YOUR NEWS STAND NOW! ONLY 60c.

# PRE-PAK electronics and agencies

HEAD OFFICE and mail order dept  
718 Parramatta Rd., Croydon, N.S.W. 2132. Ph: 797-6144

WOLLONGONG, NSW Agent, Hi-Tec Electronics 265 Princes H'way, Corimal, N.S.W. 2518. PH: 84-9034.

NEWCASTLE, NSW AGENT  
New agency to be advertised next month.

SOUTH AUSTRALIAN AGENT  
Revolver Electronics (mail order only) 20 Essex St., Goodwood S.A. 5034.

NTH QUEENSLAND AGENT  
Philtronics Cnr. Grendon and Palmer Sts., Nth Mackay, Qld. 4740. Ph: 78855  
DUBBO, NSW AGENT  
A & R Olsen 34 Church St., Dubbo 2830. Ph: 82-2300.  
WEST AUSTRALIAN AGENT  
B.P. Electronics, 192-196

Stirling Terr., Albany, W.A. 6330. Ph: 41-3427  
VICTORIAN AGENT  
Geo Hawthorn Electronics, 966-968 High St., Armidale, Vic. 3142. Ph: 509-0374.  
QUEENSLAND AGENT  
Proportional Systems Aust. 4 Gaythorne Rd., Gaythorne, Brisbane, Qld. 4053.

## NEW TELE-FIX CALCULATOR

Save dollars on T.V. repairs. This easy-to-use diagnostic calculator is a valuable aid in determining faulty valves in all makes of T.V. sets, and experts agree that 90% of T.V. problems are valve faults. Using the Tele-Fix Calculator you can now identify and replace these valves at an average cost of less than \$2 to \$3 each. Comes complete with operating instructions and reference chart. Price only \$2.00 including postage.



## MAY WE REMIND YOU . . .

Our Head Office at Croydon (N.S.W.) is open

# 7 DAYS A WEEK

from 9.00 AM to 5.30 PM

Our modern store on Parramatta Road (Sydney's main western distributor) has recently been renovated to provide fast efficient self-service displays and off-street parking facilities are available.

## The "NO BULL" catalogue Part III.

means just that; no frills, no fancies, no extravagant promises . . . just plain facts . . . In a clear, concise, easy-to-read form. All products carry a technical description and illustrations where possible and this makes for good reading and easy selection of your requirements.

Part I (8 pages) appeared in the centrefold of the June Issue of ETI and Part II (4 pages) appeared in the centrefold of the July Issue of ETI. Now we present Part III. If you missed out on Parts I and II, just drop us a line (or mention it in your next order) and we'll mail them to you immediately, free-of-charge. Watch out for the next four pages which we propose to insert in the December Issue — don't miss out! It's a special pre-Christmas issue.

OUR CONDITIONS OF SALE (Numbers 1 to 20) THE CUSTOMER MUST BE SATISFIED!

**NEXT  
3  
PAGES**

## New TESLA Record Player . . .

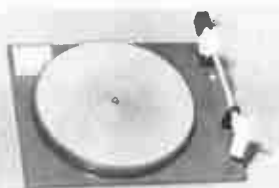

only  
**\$32.50**

**1/3 OFF**

Now including 4 pole induction motor (a MUST for magnetic cartridges) and large diameter turntable, this Continental player combines ease of operation with attractive appearance to produce a Hi-Fi quality unit at modest cost. Incorporating features normally found available in only the more expensive record players, this superb reproducer is only available from PRE-PAK and because of our keen buying power, we are able to offer these at 1/3 off normal price. You pay only \$32.50 plus \$1.00 freight. Included in this low price is a high quality ceramic cartridge and accessory pack. Operates on 240V A.C. 50 Hz and is fully guaranteed for 3 months from date of purchase. Remember, the all-up price is \$32.50, plus \$1.00 freight. A base and cover is available (pre-cut and ready to install) at a cost of \$17.00. (Freight \$1.50).

COSTS LESS  
AT PRE-PAK

## Introducing the Hi-Fi Mics —



**ELECTRET CONDENSER MICROPHONES**  
Frequency response 40 — 18 kHz.

**Omni-Directional Microphones.**  
Model EM82 — (600 Ohms impedance) and Model EM82H — (50K Ohms impedance).

**Specification:**  
Sensitivity: — 65db ± 3 dB (EM82)  
— 45 dB ± 3 dB (EM82H)  
Operating Voltage: 1.1 to 1.5 Volts DC.  
Current Consumption: 160µA.  
Continuous Hours: 10,000 hours.  
Cable: 16.5 ft. with phone plug.  
Dimensions: 0.87 diam x 6.38 ins.  
Weight: 6.8 ounces.  
Accessories: Built-in ON-OFF Switch, Mic Holder, Lavalier, Wind Screen and Battery (1.5V penlight cell).

Model EM82 **PRICE \$20.70 post 50c**

Model EM82H **PRICE \$22.50 post 50c**

**Uni-Directional Microphone**  
Model EM83H (50K Ohms impedance).

**Specifications:**  
As above, excepting sensitivity — 50 dB ± 3 dB.  
Accessories: as above.

**PRICE: \$25.90 post 50c.**

## FERGUSON

### LOW HEIGHT POWER TRANSFORMERS

This new range of transformers is constructed similar to a flourballast for compact size (height 1 1/2", width 2-3/8", length 4-5/16") and economy. Two identical secondary windings are available for series or parallel operation.



TYPE	NOMINAL RATING
PF3596	6V @ 10VA
	6V @ 10VA
PF3597	7.5V @ 10VA
	7.5V @ 10VA
PF3598	9V @ 10VA
	9V @ 10VA
PF3599	12V @ 10VA
	12V @ 10VA
PF3600	15V @ 10VA
	15V @ 10VA
PF3601	20V @ 10VA
	20V @ 10VA
PF3602	25V @ 10VA
	25V @ 10VA

**PRICE \$4.95, plus post 30c.**

# SOUNDS OF

Create your own custom-built stereo sound-system with famous **Garrard** turntables.



## ZERO. 100

Advanced Automatic Transcription Turntable — with ZERO Tracking Error Pick-Up Arm!

The Garrard Zero 100 offers the greatest combination of advanced features available in any automatic turntable today.

- A two speed automatic or manual turntable of exceptional quality.
- Will play up to 6 records automatically.
- Ingenious pick-up arm that virtually eliminates tracking error.
- Magnetic bias compensator calculated for spherical or elliptical styli.
- Neon illuminated stroboscope and fine speed control.
- Adjustable stylus force 0-3 grammes in ¼ gram steps.
- Adjustable cartridge carrier for optimum vertical tracking angle.

Specifications: 2 speeds 33.1/3 and 45 rpm. Wow and Flutter: better than 0.1% rms. Rumble: better than 51 dB.

PRICE: \$215 (without cartridge).

ZERO 100S — same as above but designed to play single records only.

PRICE: \$199 (without cartridge). Base and Cover \$22.00, (teak/walnut).

**NEW** unique Garrard design pivots pick-up head to keep stylus tangential to groove as arm tracks record.

### MODEL SL72B

This transcription unit features a weight counter-balanced pick-up arm with gimbal type pivots, a slide-in cartridge carrier, integral calibrated stylus force adjustment and bias compensator. Changes records automatically, has 3 speeds, a synchronous motor and auto/manual operation.

PRICE: \$119 (without cartridge).  
Base and Cover \$22.00 (teak/walnut).

PPE Special \$119

### MODEL 40B

One of the most popular of the Garrard range, it has 3 speeds, cue and pause facilities, repeat operation and manual/auto facility. It changes records automatically, has 2 pole induction motor, low mass arm, and plug-in head-shell. Like all Garrard turntables, it carries a full manufacturer's warranty.

PRICE: \$58 (without cartridge).  
Base and Cover \$19.00 (teak/walnut).

PPE Special \$58

### MODEL SP25 MK III

This famous record player combines all the facilities and refinements required by the hi-fi enthusiast. Plays single records with automatic or manual operation, has 3 speeds, 4 pole induction motor, counter-balanced arm, plug-in headsheel, cue and pause control, stylus force calibration and bias compensator.

PRICE: \$69 (without cartridge).  
Base and Cover \$19.00 (teak/walnut).

PPE Special \$69

### MODEL 2025TC

This attractive 4 speed record changer is for the budget-conscious hi-fi buff. It has a cue and pause control, low-mass tubular pick-up arm, and large diameter turntable. The appearance is predominantly black with matt silver-finish trim. Carries a full manufacturer's warranty.

PRICE: \$45.95. (without cartridge).  
Base and Cover \$19.00 (teak/walnut).

PPE Special \$45-95

## PACKAGE DEALS

B2. Garrard SL72B as package deal B1, but with Excel ES70S Magnetic Cartridge.  
PRICE: \$142.00, plus freight.

A1. Garrard Zero 100 with power and audio leads and base/cover (hinged), with Shure M91 ED Magnetic Cartridge.  
PRICE: \$259.00, plus freight.

C1. Garrard 40B with power and audio leads and base/cover (hinged), with Sonotone Ceramic Cartridge.  
PRICE: \$79.50, plus freight.

A2. Garrard Zero 100, as package deal A1, but with Shure M55E or Excel ES70E Elliptical Cartridge.  
PRICE: \$249.00, plus freight.

D1. Garrard SP25 MK.III with power and audio leads and base/cover (hinged), with Excel ES70S Magnetic Cartridge.  
PRICE: \$91.00, plus freight.

B1. Garrard SL72B, with power and audio leads and base/cover (hinged) with Shure M55E or Excel ES70E Elliptical Cartridge.  
PRICE: \$154.00, plus freight.

E1. Garrard 2025TC with power and audio leads and base/cover (hinged), with Sonotone ceramic cartridge.  
PRICE: \$66.00, plus freight.

### AR-11

### BELT-DRIVE TURNTABLE.

A hi-fi semi-automatic belt-drive turntable from one of Japan's largest manufacturers. A magnificent turntable, it has a 4 pole synchronous motor, 3 bearing main shaft and double float suspension system. The gravity centre static balance tone arm features auto return and shut off and a magnetic cartridge is included free of charge. Comes complete in base and cover with audio and power leads and is ready for immediate use.

Special limited offer!  
PRICE: \$115.00, plus freight. PPE Special \$115

### SILCRON

### Mk. III TURNTABLE

A high-quality belt-drive turntable with 12 pole synchronous motor, 2 speeds 33.1/3 and 45 rpm, and dynamically balanced cast aluminium turntable platter. Wow and flutter is less than 0.04% and rumble is almost unmeasurable.

PRICE: \$44.00, plus \$1.00 freight. \$44

### DUAL

### AUTO RECORD CHANGERS.

1214 — An auto/manual reproducer with de-luxe features incl. hydraulic lift, pitch control, counterbalanced arm, 4 pole motor.  
PRICE: \$105.00, (without cartridge), plus freight.

1216 — Precision Dual engineering makes this turntable one of the finest-looking available today. All features and facilities are provided on this unit.  
PRICE: \$125.00, (without cartridge), plus freight.

1218 — Suitable for the audio engineer and the serious listener to whom quality is MOST important. It is a delight to own and operate.  
PRICE: \$159.00, (without cartridge), plus freight.

1299 — One of the best record changers available in the world today. It offers the highest calibre of performance, extreme operating ease, and a number of new technological advances.  
PRICE: \$224.00, (without cartridge), plus freight.

# PRE-PAK ...for the electronics in your life



# CREATION



CREATE YOUR OWN CUSTOM-BUILT STEREO SOUND SYSTEM WITH A PRE-FAB HI-FI SPEAKER KIT ...

## 2 MORE

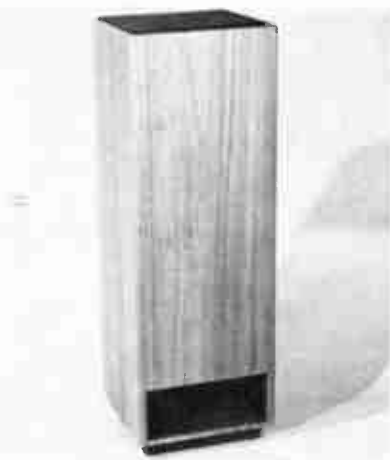

SPEAKER KITS EXCLUSIVE  
TO PRE-FAB HI-FI PRODUCTS.

### System 601

## OMNI-DIRECTIONAL SPEAKER ENCLOSURE KIT.

A true omni-directional speaker system ... at a price you CAN afford. Unlike conventional speakers, the sound is radiated from the top of the enclosure and a well defined stereo image is created wherever you may be in the room.

This easy-to-build design was offered as a project in the June '73 issue of Electronics Australia, (Page 58) and has proved a popular choice of Hi-Fi enthusiasts for its ease of construction and quality sound.

Available exclusively from PRE-PAK ELECTRONICS, the price of each Kit, together with Plessey C-80 Woofer, X-30 Dome Tweeter and professional 2-way Crossover, is just \$49.00 (Post \$3.00).

Specifications: Size 13" x 12" x 30" High. Finish: Teak or Walnut veneer, matt black metal grille top. Frequency Range: 30 Hz to 20 kHz. Power Rating: 20W. We will be pleased to forward further information on request.

**PRICE \$ 49 EA**

## SYSTEM 701

## KEF CONCERTO-STYLE ENCLOSURE KIT

THE SPEAKER WITH WORLD-WIDE ACCLAIM

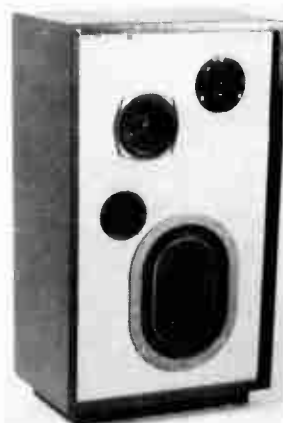

This KEF 3 way, 3 speaker system using the components specified in the original KEF Concerto cabinet, offers exceptional tonal quality, low colouration and controlled bass response down to 30 Hz.

The speaker complement comprises a 13" x 9½" long throw bass unit Model B130, a 5" mid-range unit Model B110 and a 1 inch Dome Tweeter Model T27, together with the professional DN-12 Crossover Network.

The 2.8 cu.ft. cabinet kit comprises pre-cut sides, top and bottom, ready to assemble; front baffle with speaker cut-outs, grille cloth and frame, back panel with terminal mounting plate, floor stand and internal lining. A vent tube and mid-range speaker separation tube are also supplied together with screws, nails, glue etc. The veneer is available in teak, maple or walnut and assembly instructions are included. Cabinet size — 30" high x 18" wide x 12" deep.

We will be pleased to demonstrate to you these remarkable speaker systems at PRE-PAK ELECTRONICS, Head Office (open 7 days a week).

SYSTEM 701: full price including speakers and components as described — \$145.00, each Kit, plus freight.

PRE-FAB HI-FI PRODUCTS, (a Division of PRE-PAK ELECTRONICS)  
(new factory), 31 BYRON ST., CROYDON N.S.W., 2132. Address all mail to  
P.O. BOX 43, CROYDON N.S.W. 2132 — Phone 797-6144.

**PRICE \$ 145 EA**

**If you want a job done properly,  
do it yourself.**

**PRE-PAK ...for the electronics in your life**

# PRE-PAK electronics and agencies

## TEST EQUIPMENT

### GRID DIP OSCILLATOR

Model TE15 (Transistorised). A versatile GDO with 6 overlapping ranges, 440 kHz-280 MHz for use as Signal Generator, Absorption Wave meter, Oscillator, Modulation Monitor, Regenerative Detector etc. Ideal for all hams!  
**Price: \$33.25, Post 75c.**



### MINI-SWR METER

Model SE-406. In-line monitor meter for measuring standing wave ratios in transmission aerials; suits 50 ohm or 72 ohm line, frequency range 1.9 MHz-180 MHz.  
**PRICE: \$8.75, post 40c.**



### SIGNAL INJECTOR

Model SE-260. A very useful instrument for fault-finding in AF and RF sections of radios, amplifiers etc. It has a high output at 3 kHz which is rich in harmonics — a MUST for every serviceman.  
**PRICE: \$6.95, post 30c.**

### SIGNAL TRACER

Model Se 500. A useful companion to the Signal Injector to quickly trace signals in AF and RF circuits. Uses diode detector and crystal earpiece.  
**PRICE: \$4.75, post 25c.**

### AUDIO SIGNAL GENERATOR

Model TE-22D. This popular high quality low distortion audio oscillator covers frequency range 20 Hz to 200 kHz on sine wave, 20 Hz-25 kHz on square wave with an output of 7V peak. Includes 4 range attenuator and has an accuracy of ± 3%. Operates on 240V A.C.  
**PRICE: \$39.50, post \$1.50.**

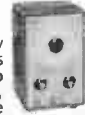

### MODEL ITI-2 MULTIMETER

A handy multimeter for the beginner or service engineer — guaranteed 20K ohms/volt, DC 10K ohms/volt AC. DC V — 5, 25, 50, 250, 500, 2500. AC V — 10, 50, 100, 500, 1000. DC Current 50uA, 2.5mA, 250mA. Ohms 0-6K, 0-600K. Decibels — 20 to +22 dB. Capacitance — 500pf to .1mfd.  
**PRICE: \$11.95, post 50c.**

### TMK MODEL TP5SN MULTIMETER

20K ohms/volt DC, 8K ohms/volt AC. A rugged (metal-back) high quality instrument with mirror scale. DC V — 0.5, 5, 50, 250, 500, 1000. AC V — 10, 50, 250, 500, 1000. DC Current — 50uA, 5mA, 50mA, 500mA. Ohms — 0-2K, 0-20K, 0-200K, 1-2Meg. Decibels — -20 to +36 dB. Capacitance: 50pf to .1mfd. Instruction book and circuit diagram included — guaranteed.  
**PRICE: \$19.00, post 50c.**



### TMK MODEL 117 FET MULTIMETER

11 Megohm input DC, 1 Megohm input AC. TMK reliability and superior engineering make this FET Multimeter the best on the market today! Features 4" easy-to-read mirror-back scale, battery test facility, stable and drift-free operation and strong impact-resistance plastic case. DC V — 0.3, 1.2, 12, 30, 120, 300, 1200. AC V — 3, 30, 120, 300 RMS. DC Current — 120uA, 1.2mA, 12mA. Ohms — 0-20K, 0-200K, 0-20Meg, 0-2000Meg. Decibels — 20 to +51 dB. Includes instruction book and circuit diagram — guaranteed.  
**PRICE: \$49.50, post \$1.50.**

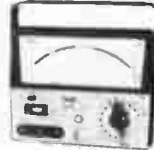

### TMK MODEL 5025 MULTIMETER

50K ohms/volt DC, 5 ohms/volt AC. A superior laboratory multimeter with 5" easy-to-read scale, 2% DC accuracy, 3% AC and 57 ranges. DC V — 0.25, 2.5, 10, 50, 250, 1000. AC V — 3, 10, 50, 250, 1000. DC Current — 50uA, 5mA, 50mA, 500mA, 10 Amp. Ohms — 0-10K, 0-100K, 0-1Meg, 0-10Meg. Decibels — 20 to +81.5 dB in 5 ranges. NOTE: Features ± 2 switch to double the number of ranges available, polarity reversal switch, output jack, in-built meter protection. Includes instruction manual and circuit diagram.  
**PRICE: \$39.50, post \$1.50.**



### TMK MODEL TW-50K MULTIMETER

50k ohms/volt DC, 5K ohms/volt AC. A deluxe instrument in unbreakable plastic case with 50 ranges and mirror scale. DC V — 0.25, 2.5, 10, 50, 250, 1000. AC V — 3, 10, 50, 250, 1000. DC Current — 50uA, 5mA, 50mA, 500mA, 10 Amps. Ohms — 0-10K, 0-100K, 0-1Meg, 0-10Meg. Decibels — 20 to +81.5 dB in 5 ranges. NOTE: Features ± 2 switch to double the number of ranges available. Includes instruction book and circuit diagram — guaranteed.  
**PRICE: \$27.50, post \$1.00.**



### R.F. SIGNAL GENERATOR

Model TE-20D. A high grade RF signal generator with 7 overlapping ranges 120 kHz-500 MHz of ± 2% accuracy. It has internal modulation (400 Hz) but will also operate with ext. mod. or Xtal for increased versatility. It includes fine and coarse RF attenuator plus adjustable audio output at 400 Hz to 8V peak. Operates on 240V A.C.  
**PRICE: \$46.90, post \$1.50.**

## SPECIAL PURCHASE OF HIGH POWERED GUITAR SPEAKERS



### 100 WATT, 15 INCH, BASS SPEAKER

We have made a fantastic purchase of these super-heavy duty 100W Speakers. Intended primarily for use with guitar amplifiers, they are also suitable for organs and high-power audio applications. If you are interested, DON'T MISS OUT. Order yours today.

Australian made; available in 8 or 15 ohms. Weight of magnet: 13 lbs. Total weight: 19½ lbs. Flux density 11,500 gauss; 260,000 maxwells. Bass resonance: 25 Hz. Power rating — 100W r.m.s. continuous. Voice coil diameter 3" on aluminium former bonded with high temperature epoxy. Very heavy duty cast aluminium frame. Price: \$125, plus Freight. 50W, 15 inch bass speaker, MODEL 15BH Similar in style and purpose to above. Specifications Australian made; available in 8 or 15 ohms. Weight of magnet: 7½ lbs. Total weight: 10½ lbs. Flux density 15,000 gauss; 180,000 maxwells. Bass resonance: 50 Hz. Power rating — 50W r.m.s. continuous. Voice coil diameter 2" on aluminium former bonded with high temperature epoxy. Heavy duty steel frame. Price: \$55, plus freight.

### ETONE HI-FI BASS SPEAKER

Model 12W8, 12" Woofer. A sensitive 12" neoprene rubber surround high-powered bass speaker for high quality HI-FI Systems. Power Handling, 35W RMS. Voice Coil Diameter: 2 inches. Bass Resonance: 22 Hz. Frequency Response: 22 Hz-2.5 kHz. Flux Density: 10,000 gauss, 130,000 maxwells.  
**PRICE: \$35.000, plus freight.**

### ETONE HORN MID-RANGE

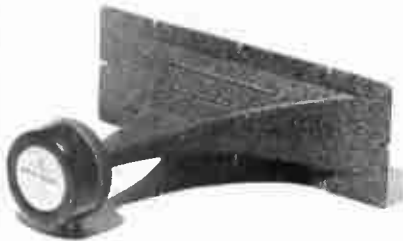

It must be seen to be appreciated. It features a solid heavy-duty driver unit and a cast aluminium horn with front opening: 18" x 10". Overall length: 20". Power handling: 50W RMS. Frequency Response: 1 kHz to 10 kHz.  
**PRICE: \$125.00, plus freight.**

### ETONE GUITAR PA SPEAKERS



These trade-line speakers are now available for sale direct to the public! Suitable for high powered guitar and public address amplifier systems, these heavy-duty speakers feature cast housings, large diameter voice coils and powerful magnets for maximum efficiency. Fully recommended and guaranteed.

Model PH. 12 inch Woofer. Suitable for PA, lead or rhythm guitars. Power handling, 35W RMS. Voice Coil Diameter: 2 inches. Available in 8 or 15 ohms.  
**PRICE: \$27.00, plus freight.**  
 Model HX. 12 inch Bass Unit. Suitable for PA, bass guitar etc. Power handling, 50W RMS. Voice Coil Diameter: 2½ inches. Available in 8 or 15 ohms.  
**PRICE: \$35.00, plus freight.**

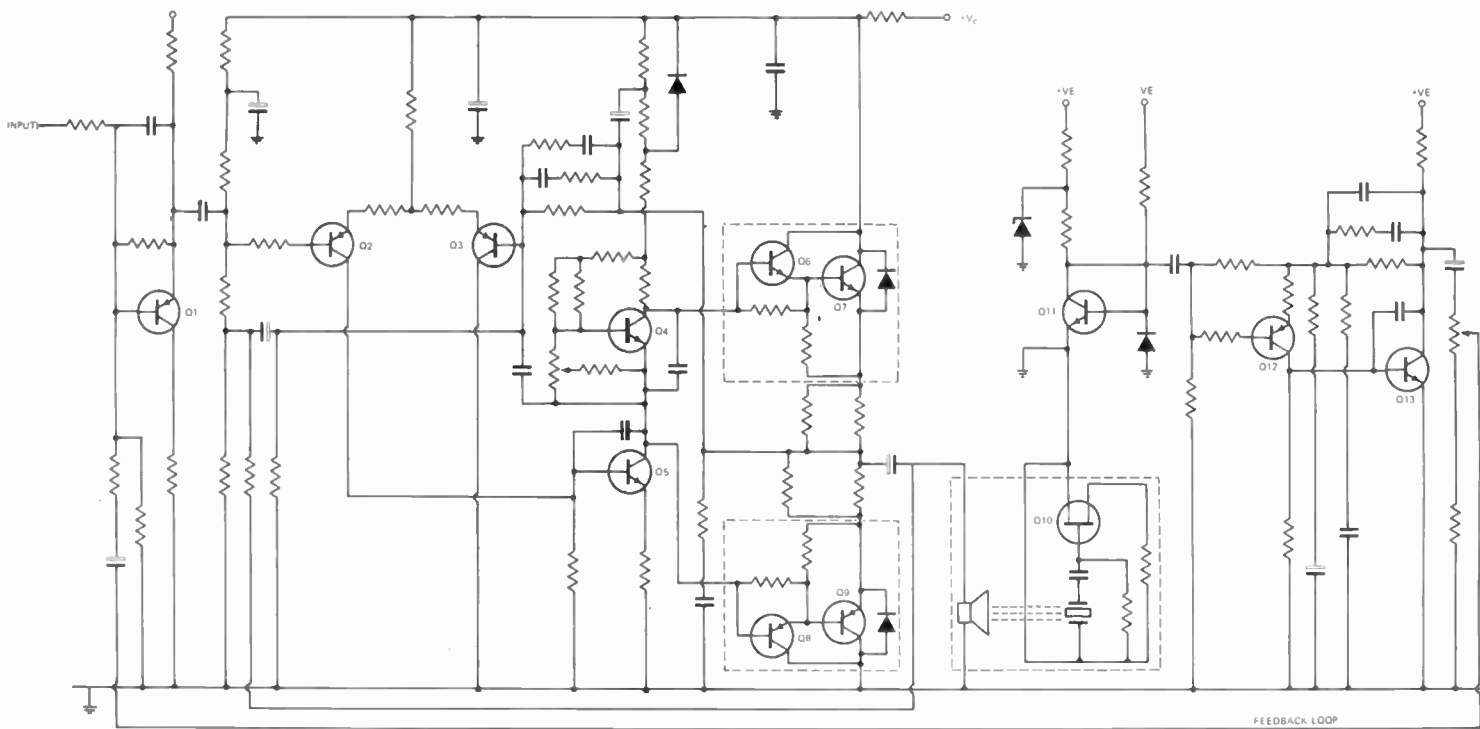

# MOTIONAL FEEDBACK

New technique from Philips uses motional feedback to improve bass response.

DESCRIBED briefly in our News Digest pages last month, Philips have developed a technique for applying motional feedback to a loudspeaker/amplifier system with the aim of producing better bass response from small speaker enclosures.

In this technique, an electrical signal, proportionate to the movement of the loudspeaker cone, is compared with the input signal to the amplifier. If there are any discrepancies, a corrective signal is generated that forces the cone to move in the correct fashion.

The basic principle is by no means new, in fact a number of commercial systems using motional feedback have been marketed in the past two decades.

Common to all these systems is the requirement to obtain an electrical signal proportional to speaker cone movement. This may be done by sensing the voltage across the voice coil, by using a second (signal) winding on the voice coil, or, as Philips have done it, by using an acceleration

transducer clamped to the cone itself.

The transducer used by Philips is a ceramic device that produces a voltage proportional to acceleration. In principle it is not unlike a ceramic pick-up cartridge.

The loudspeaker enclosure used by Philips is very small (38 x 28.5 x 22cm). This enclosure houses crossover networks, feedback circuitry, and the power amplifiers used for the bass, the mid-range and treble drive units.

The motional feedback circuit is used only for the 20cm (8") bass driver and its associated 40 watt amplifier. The circuit of this section of the amplifier/speaker combination is shown in Fig. 1.

The feedback signal from the ceramic transducer is fed to an adder, together with the original input signal, the combined signal is then taken to a comparator where it is compared with the current that flows through the loudspeaker voice coil. If there is any difference between the two signals,

this difference is then amplified and used to correct the discrepancy.

To protect the bass driver from damage caused by the feedback control loop attempting to force the speaker cone to generate long excursion, very low frequency movements, the band of frequencies fed to the bass driver is limited to 35 Hz - 500 Hz. This is achieved by a 12 dB/octave low pass filter and an 18 dB/octave high pass filter in the input circuitry.

Further circuitry is used to in effect 'tailor' the feedback response to the characteristics of the drive unit used.

In practice the Philips motional feedback system works well - the bass response is comparable to that formally obtainable from much larger enclosures.

Reference:-

Klaassen, J.A. and de Koning, S.H. "Motional feedback with loudspeakers". Philips Technical Review, Vol 29, pp. 148 - 157. ●

# ROTEL® goes 1 better!

Since Rotel introduced its RA 210, RA 310, RA 610 to the Australian market, the acceptance has been remarkable and the praise lavish from those who really know a topline amplifier when they use one. Now Rotel launches its new range of even more sophisticated models, easily identified by simply adding a "1" to the numbers above! Read all about this fantastic new Rotel range with second to none value, more quality, lower distortion!

## RA211

Frequency response 20-75,000 Hz. 12 watts RMS per channel. 50 watts total music power (IHF). All solid state electronics, all silicon output transistors. Pushbutton controls for power, speaker system 1, speaker system 2, loudness and tape monitor. Headphone jack, facilities for magnetic and ceramic cartridges, tuner, tape recorder, auxiliary equipment. In handsome timber cabinet.

## RA311

A solid state integrated amplifier that lets you enjoy a new world of genuine high fidelity sound! Advanced solid state electronics, low-noise silicon output transistors, 22 watts RMS per channel at 8 ohms, 90 watts total music power (IHF). Frequency response, 15-90,000 Hz distortion 0.1% at 1 kHz. Facilities for magnetic and ceramic cartridges, radio tuner, two tape recorders, and auxiliary input. Tape dubbing from tape 1 to tape 2, 4-channel matrix speaker switch for simulated 4-channel surround effect. High and low filter, loudness, and 1 and 2 speaker system switches. Housed in handsome timber cabinet.

## RA611

140 watts total music power (IHF), 35 watts at 8 ohms, RMS. Frequency response 5-100,000 Hz, distortion 0.1%. Generates an amazingly transparent sound. Professional tape dubbing facilities from tape 1 to tape 2 or reverse, facilities for two turntables (magnetic), tuner, two tape recorders, and two auxiliary inputs. Three AC outlets, tone control defeat, muting, high and low filter switches. Individual bass and treble controls for each channel. Slider controls for balance, bass and treble.

See also the potent RA 1210, 160 watt RMS (4 ohm) amplifier with twin power.



## HEAR THE NEW ROTEL "1 BETTER" RANGE AT

**N.S.W.** M & G Hoskins Pty. Ltd., 37 Castle St., Blakehurst 2221  
Telephone: 546-1464  
**Q'LD** Stereo Supplies, 95 Turbot St., Brisbane 4000  
Telephone: 21 3623  
**S.A.** Challenge Hi-Fi Stereo, 96 Pirie St., Adelaide 5000 100  
Telephone: 23 3599  
**TAS** Audio Services, 44 Wilson St., Burnie 7320  
Telephone: 31 2390  
**VIC** Encel Electronics Pty. Ltd., 431 Bridge Rd., Richmond 3121  
Telephone: 42 3762  
**W.A.** Albert TV & Hi-Fi, 282 Hay St., Perth 6000  
Telephone: 21 5004

Sole Australian distributors:  
**INTERNATIONAL DYNAMICS**  
(AGENCIES) PTY. LTD.,  
P.O. BOX 205, CHELTENHAM, VIC. 3192

**INTERDYN**

# MICRO

the  
magnificent!



In June, 1972, Australian Hi-Fi Magazine said:  
*"There is no doubt that the Micro MR 611 is a fine turntable, and after a long period of usage, we are unable to fault it" . . . "This is a transcription turntable made to professional standards" . . . "It appeals to people who demand only the best that money can buy."*

In the Micro range, you'll find a turntable that gives good performance at a reasonable price, or like the MR 611, ultimate performance regardless of price. The Micro range includes: MR 611, MR 111, MR 211, MR 311 turntable/base/cover. MB 300, MB 600, MB 800S turntables only. Micro cartridges M2100/6, M2100/E, VF 3100/7, VF 3100/E, broadcast-station-standard VF 3200/E, and MC 4100/E moving coil. Also MA 101 Mk11 4-channel arm, and Micro Electrostatic Headphones.

Available from:

- N.S.W. M & G Hoskins Pty Ltd., 37 Castle St., Blakehurst 2221  
Telephone: 546-1464  
Q'LD Stereo Supplies, 95 Turbot St., Brisbane 4000  
Telephone: 21 3623  
S.A. Challenge Hi-Fi Stereo 96 Pirie St., Adelaide 5000  
Telephone: 23 3599  
TAS Audio Services, 44 Wilson St., Burnie 7320  
Telephone: 31 2300  
VIC Ence! Electronics Pty. Ltd., 431 Bridge Rd., Richmond 3121  
Telephone: 42 3762  
W.A. Albert TV & Hi-Fi, 282 Hay St., Perth 6000  
Telephone: 21 5004

Sole Australian distributors:

**INTERNATIONAL DYNAMICS**  
(AGENCIES) PTY. LTD.,  
P.O. BOX 205, CHELTENHAM, VIC. 3192

**INTERDYN**

Despite their apparent complexity, electronic calculators are relatively easy to repair. This article shows you how.

by Patrick N. Godding.  
Micro Instruments & Telemetry Systems Inc. Albuquerque, New Mexico.

# ELECTRONIC CALCULATORS -how to repair them

SMALL electronic calculators require more sophisticated trouble-shooting techniques than those used to service many other kinds of electronic equipment. In addition to the basic procedures used in discrete transistor circuits, calculator servicing requires some understanding of integrated circuits and logic.

To service a defective calculator you will need a pencil-type soldering iron (30 to 40 watts at about 700° F), small screwdrivers, solder remover, sharp knife, diagonal cutters, and needle-nose pliers. A multimeter and oscilloscope are the only mandatory pieces of test equipment, but a frequency counter can come in handy at times. Some problems can be solved with no test equipment at all or possibly a multimeter alone.

## BASIC REPAIRS

A few general procedures will save lots of time and reduce the prospects of inadvertently damaging additional components in an already defective machine.

First, give the machine a careful visual inspection. Burned or bubbly resistors, blown electrolytic capacitors, solder bridges, and other obvious malfunctions can usually be quickly found and corrected. If the problem involves a destroyed component, never install a replacement part until the cause of the problem is found and corrected. Never use a replacement

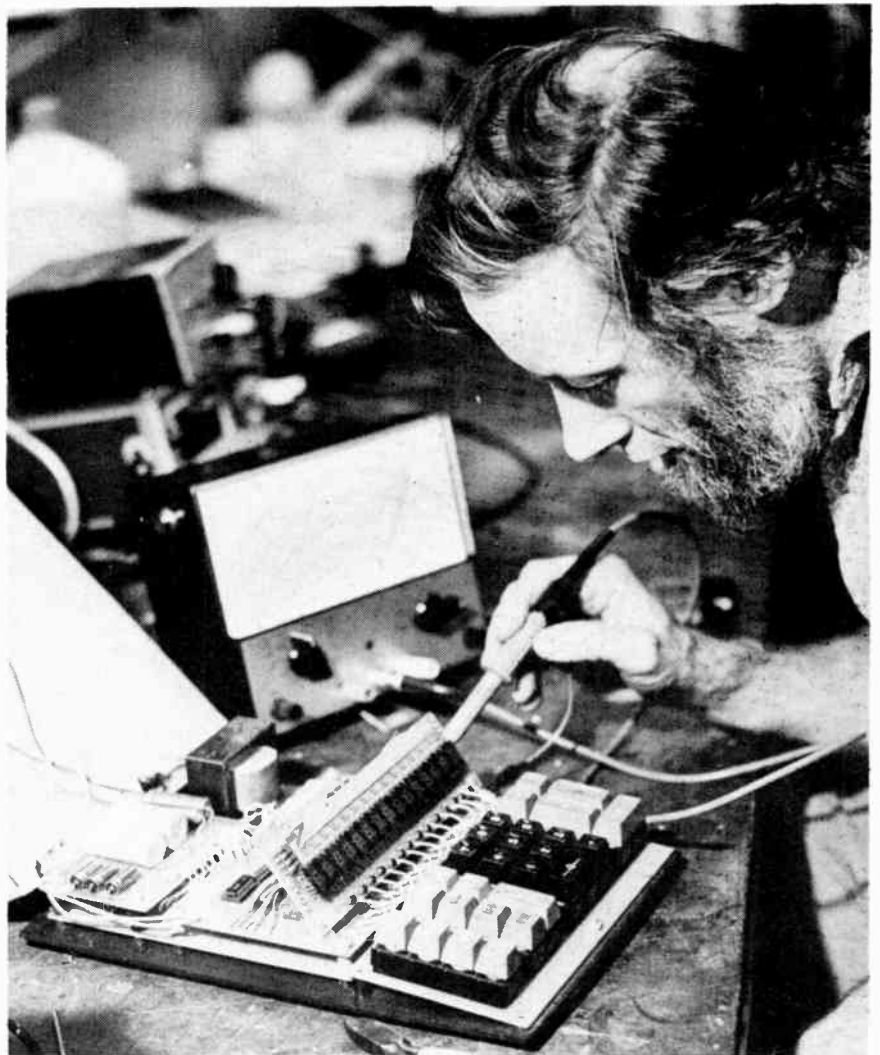

## CHART OF COMMON FAULTS

SYMPTOM	TROUBLESHOOTING PROCEDURE
No display or entry	Check: Power Supply Clear Circuit Clock Circuit
Overflow works but no display	Check: Power Supply LSI Chips (output)
Display always on or off	Check: Display Digit Driver Soldering LSI Chips (output)
Segment always on or off	Check: Segment Drivers Soldering LSI Chips (output)
More than one segment or display device on	Check: Soldering
Keyboard Switch failure	Check: Keyboard LSI Chips (input)
All digits on or off	Check: Power Supply
Random segments on	Check: LSI Chips (output) Segment Drivers
Function key failure	Check: LSI Chips (arithmetic)
Entries not possible (display normal)	Check: Keyboard LSI Chips
Constant function always on	Check: Constant Circuit and Switch LSI Chip (input)
Display flickers	Check: Power Supply
Error indicator on and no entries possible	Check: Power Supply

component of poorer quality than the original one.

Next time it may be necessary to turn on a calculator to find the symptoms of a problem, never leave a malfunctioning machine on longer than necessary.

A good example is the overflow indicator. If the readout devices don't light, multiply two numbers whose answer will give an overflow indication. If the "Error" signal is displayed, the problem is not in the input, control, or arithmetic sections of the machine. In this manner possible causes of the trouble can be quickly identified.

Finally, if a thorough visual inspection fails to reveal the problem, begin troubleshooting at the point of the improper indication and work backwards, checking each associated component. If more than one problem exists, begin with the simplest, since it frequently leads to the major trouble spot. Here's a typical example:

In Fig. 1, the "C" segment in the display fails to light. Follow these steps to isolate the trouble:

(1) Check continuity from the "C" segment to Q5's emitter.

(2) Check Q5's base for proper incoming signal.

(3) Check Q5

(4) Check R15

(5) Check R14

To cover as many troubleshooting procedures as possible, the remainder of this article is divided into subsections describing the problems and symptoms common to the various calculators. The accompanying troubleshooting chart summarizes this material and helps pinpoint many trouble sources.

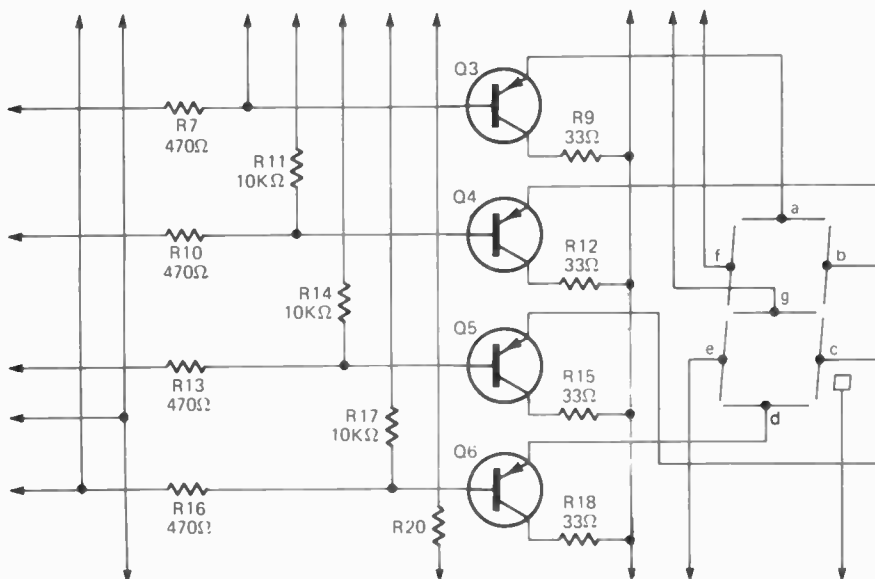

Fig. 1 Partial schematic of driver circuit for a seven-segment digital readout device. In the problem discussed in the text, the "C" segment of the readout does not light.

## KEYBOARD

The keyboard consists of an array of switches either connected directly to the input LSI chip or connected to a matrix which is scanned by the input chip. The latter technique is usually used in multi-chip calculators.

In the direct input technique such as the one shown in Fig. 2, the 0-9 digit keys are connected to a diode matrix which provides a BCD (Binary Coded Decimal) output. An open or shorted diode will cause incorrect segments on the display readouts to light. A shorted keyboard switch, either digit or function, can cause a great variety of symptoms.

After eliminating other possible causes of the problem, disconnect the keyboard and make entries manually. If this cures the problem, check each switch in the keyboard for continuity. If only one key fails to work properly, the problem is in the switch itself, an open line to the input section, or the

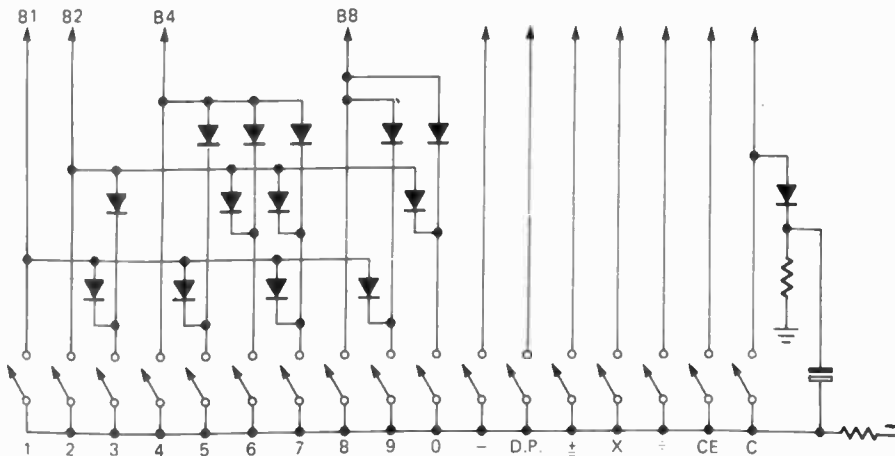
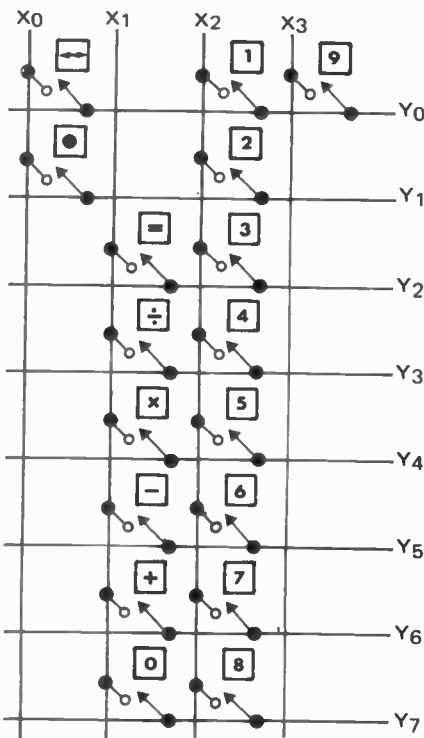

Fig. 2 — Direct-input keyboard with the 0 to 9 keys connected through a diode matrix that provides a BCD output. An open or shorted diode causes errors in readout indication.



ALL SWITCHES  
NORMALLY OPEN

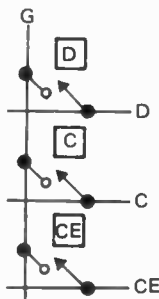

Fig. 3. Matrix-type keyboard. Closing a key places pulses on the associated 'Y' line.

input LSI chip. Another possible cause of trouble is input lines from the keyboard shorted to one another. This problem can be identified by using a multimeter to check for shorts.

In most multi-chip calculators, the input chip scans a keyboard matrix to detect entries. In Fig. 3 (the keyboard matrix for a MITS 816 desk calculator) the "X" lines are pulsed by the input chip and the "Y" lines are at a negative voltage. When a key is depressed there will be pulses on both lines common to the closed switch.

The pulses can be seen on an oscilloscope, and, if not present, the problem is either in the keyboard or the input chip. If pulses are seen on a "Y" line with no keyboard entry, that particular line is shorted to one of the "X" lines at the keyboard, the input chip, or one of the interconnection lines. When no pulses appear on the "Y" line with a correct entry, the entry switch is open. An "X" line with no pulses means the input chip is not functioning or the line is shorted (probably to ground).

A non-functioning chip is caused by an internal defect, lack of clock pulses, or insufficient voltage. If any key clears the machine, it is shorted to the CLEAR key. And when the CLEAR ENTRY key is shorted the normal display will be on, but the machine will not accept entries.

#### POWER SUPPLY

Usually consisting of a transformer and one or more bridge rectifiers, some of which are regulated by either a transistor or Zener diode, the power supply is the major source of trouble in most electronic equipment. A close visual inspection is important when a malfunction points to the power supply. A shorted supply line, for example, is indicated by a burned or bubbly series resistor and is usually

caused by a shorted regulator, shorted filter capacitor, or possibly a short in the LSI circuitry.

LSI chips generally require two regulated voltages,  $V_{GG}$  and  $V_{DD}$ .  $V_{GG}$  is a higher voltage and if open or shorted, no entries are possible and an error indication is sometimes seen. With a missing  $V_{DD}$ , there is no display and no entries can be made.

If the regulated driver voltage is shorted or open, the condition of the driver circuitry determines whether the display readouts are all on or off. But one of these malfunctions will be present.

Both gas discharge and electro-fluorescent readout devices require a large anode voltage with the latter also requiring a filament voltage. The entire display is off when either of these voltages is open or shorted.

Fig. 4 shows a typical power supply for a calculator using electro-fluorescent readout devices. The +45V is anode voltage and the -2.4V is for the filaments. The -26V and -14V are  $V_{GG}$  and  $V_{DD}$  respectively, and the -5V is the segment and digit drive bias voltage. If a bridge rectifier diode shorts, the output voltage is reduced. If an input filter capacitor opens, the readout tubes receive unfiltered voltage and appear to flicker on and off. If a capacitor shorts, its voltage line is at zero potential and one or more bridge rectifier diodes may short.

Three of the lines shown in Fig. 4 use Zener diodes for regulation. If the output is open, the total current in the line goes through the Zener diode, sometimes causing it to short and the series resistor to bubble. The voltage line reads higher than normal if the Zener opens. This may or may not cause a problem, and if the difference between the peak voltage and the Zener's rated voltage is only a few volts the machine should operate normally.

#### CLOCK

LSI calculators, just like full-scale digital computers, require a time base to synchronize all operations. The timing pulse generator is called the clock, and it usually consists of an astable or free-running multivibrator or series of gates in a TTL chip. The former approach is used mainly in LSI calculators that require a two-phase clock. These are usually one or two-chip machines. If the timing pulses are missing at the output of the clock IC, the problem is either in the chip or its associated components, or the chip's supply voltage is open or shorted.

A representative TTL clock is shown in Fig. 5. The clock pulses are fed through a buffer for interfacing with



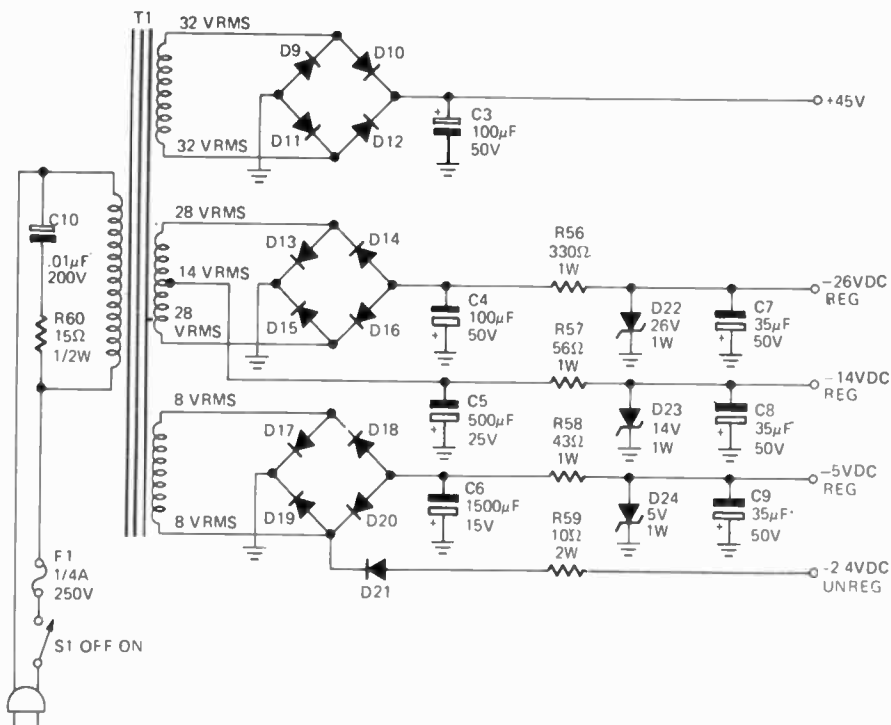

Fig. 4 A typical power supply for a desk-type electronic calculator. The one shown is for the MITS model 816 and uses Zener diodes to deliver regulated voltages.

configuration for added current gain. At any one time, a driver transistor is either on or off. Driver circuits are required for the various digits and the segments within a digit. Both are described below.

### DIGIT DRIVERS

The digit drivers are fed from the output LSI chip, and their output goes to the anode of the display device. Fig. 6 shows a typical Darlington configuration used in most drivers. Initially the base of Q15 is positive with respect to its emitter and is driven into saturation. This turns Q16's base negative, turning off Q16 and the digit. When the proper command is received, the digit line output goes negative. This turns Q15 off, which forces Q16 into saturation, and the digit turns on.

A digit which is constantly on can be caused by a faulty output LSI chip, open interconnect leads from the chip to driver, Q15 open, Q16 shorted, or the readout anode shorted to +V. Conversely, a digit that never turns on is caused by the opposite of any of the above problems.

### SEGMENTS DRIVERS

The same basic circuit shown in Fig. 6 is used to drive the segments of the readout devices, but a separate driver is required for each segment. The information coming from the output chip is fed through a BCD to seven-segment converter and then is sent to the segment drivers.

In some driver circuits, such as the one shown in Fig. 7, a shorted transistor can cause the gate in the converter feeding it, to short. This is a good example of why a good IC should never be randomly substituted for a defective one. If at all possible, test it in another calculator or in an IC

the LSI chips, and the absence of pulses can frequently be traced to the buffer transistor. Check for proper voltage at both the transistor and the chip. If voltages are correct, check the clock chip in an IC tester or try it in another calculator. **CAUTION: To avoid possible damage to the IC, never substitute a good chip for a bad one until the problem is discovered and eliminated.**

### DISPLAY DRIVERS

The driver system for a display consists of switching transistors which are sometimes arranged in a Darlington

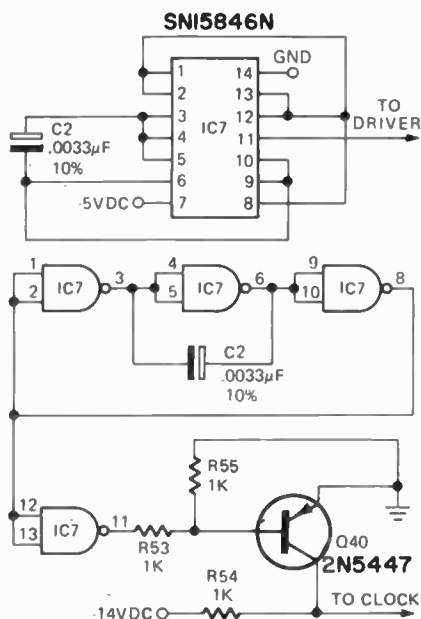

NOTES  
NOMINAL OUTPUT FREQUENCY 130KHz  
ALL RESISTORS IN OHMS  
ALL RESISTORS 1/2W, 5%

Fig. 5. Timing pulse generator is known as a "clock" in calculator terminology.

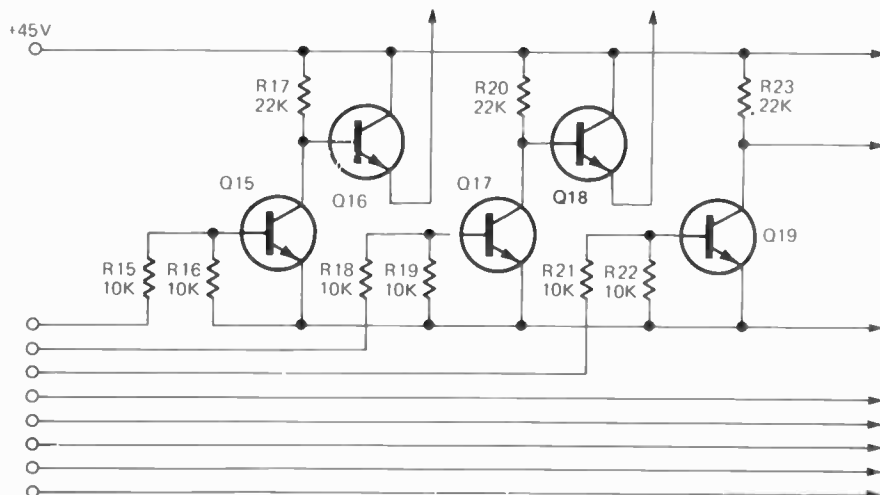

Fig. 6. The Darlington configuration used here is typical of the amplifiers used in the digit drivers in calculators. A similar arrangement is used in some segment drivers.

# Its every word is crystal clear.



You won't miss a word with this fully solid state Acitron SSB025 transceiver. The crystal stability combined with the special 'noise blanker' ensures maximum clarity at all times.

It operates in the frequency range of 2-12 MHz and is ideal for long range communications. Operation is simplicity itself.

The transceiver is particularly compact and light but it's tough too. Takes any amount of handling whether in mobile, portable or fixed station use.

The Acitron SSB025 is designed and made by ACI Electronics in Australia to RB209 and fully backed by service. Like to know more? Then mail this coupon for a technical brochure.

ACI Electronics  
310-324 Ferntree Gully Road,  
Clayton North, Victoria, 3168.

Please send me technical details of your  
Acitron SSB025 transceiver.

Name: .....

Company position: .....

Company name: .....

Address: .....

..... Postcode .....

**ACI** A.C.I. Electronics

ACE2780FP/R.

# ELECTRONIC CALCULATORS

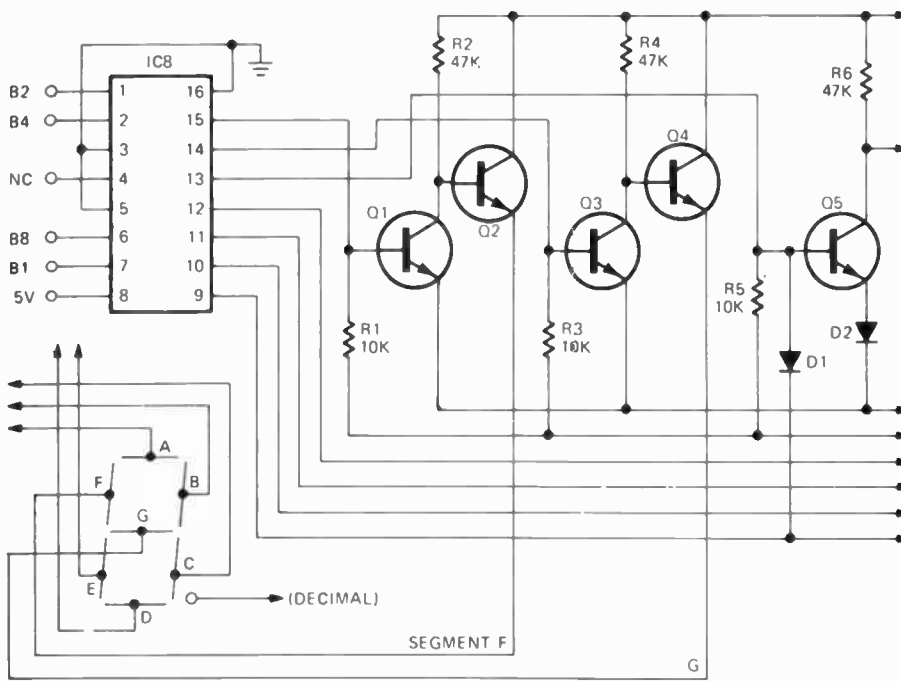

Fig. 7. BCD to 7-segment decoder. BCD input to IC8 (on pins 1, 2, 6 and 7) is converted to 7-segment data on pins 9-15. Transistor-pair drivers for segments F and G are shown.

tester. If it's bad, find the cause of the problem before trying a new chip.

Operation of the driver in Fig. 7 is as follows: With no segments illuminated, the output BCD lines are at -5V and the converter outputs are at 0V. If a 2, for example, is entered on the keyboard, it will appear on the four BCD lines as: B1 = -5V; B2 = 0V; B3 = -5V; and B4 = -5V. This code at the input of the BCD converter forces the A, B, C, D, E, and G outputs to go to -5V and the remaining segments stay at 0V. The -5V signal at Q1's base cuts off Q1, turns Q2 on, and causes the appropriate segment to be illuminated. This circuit is virtually identical to the digit driver discussed earlier, and the same service procedures apply.

## DISPLAY DEVICES

Most electronic calculators employ light emitting diodes, gas discharge, or electro-fluorescent display devices. The LED readout has characteristics similar to those of a conventional diode. A typical seven segment LED readout has eleven connection pins — one per segment, one for the decimal point, and three for the anodes, LED readouts usually employ a series string of at least two diodes per segment to give dots which merge into a line pattern.

If all the diodes in a particular segment are not illuminated, the readout is defective and should be replaced. When two segments in an LED readout are shorted together

internally, isolating the bad readout from others in the display may prove difficult. One way to find the bad readout is to measure the resistance between the two segments on each readout with a high-sensitivity ohm-meter such as a bridge comparator. A second method is to remove each LED readout from the display and test it individually until the defective unit is located, a messy procedure if the readouts are soldered in place. If a segment fails to light in only one readout, either the device or the solder joints at one or more of its pins are defective.

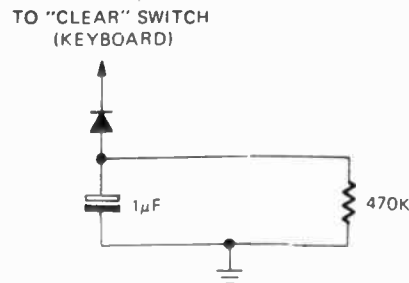

Fig. 8. Typical automatic clearing circuit. Clear line is earthed momentarily when power is first applied to the calculator.

## AUTOMATIC CLEAR

When initially turned on, most calculators automatically reset to zero without the need for a command from the CLEAR key. A typical automatic clear circuit is shown in Fig. 8. In operation, the circuit grounds the clear line momentarily after power is applied to the machine. If the indication is no display and no entries are possible. A shorted diode won't affect the circuit each time the power is activated, but occasionally the machine will not automatically clear. An open capacitor or diode will disable the circuit, but the machine can be manually reset via the CLEAR key.

## SIGN AND ERROR

The first readout on a display is generally used as a status indicator and receives only a few commands. The minus sign indication and overflow signal come directly from an LSI chip through buffer stages. As shown in Fig. 9, there are four active components involved with these functions in a typical circuit. Troubleshooting procedures previously described also apply here.

## CIRCUIT BOARD AND SOLDERING

Very small calculators frequently use double-sided printed circuit boards with plated-through holes. When a component is being removed from a plated-through hole, careful de-soldering procedures must be followed. Too much heat can cause the metal land to become detached, while insufficient heat can result in the plating coming out with the component's lead. Experience is the only way to determine the amount of heat required for the component and the size of the land around the lead hole.

When removing a component, always cut the component leads and then remove one lead at a time. Once the leads are removed it's a simple task to remove any remaining solder with a solder puller. Component replacement is a simple matter, but be sure the replacement part is at least equivalent in value and tolerance.

On tightly packed boards be careful to avoid solder bridges. To reduce this possibility use a small wattage soldering pencil iron and 24-gauge or smaller solder. Heat sinks are usually not necessary if solder time is limited to a few second and if you apply solder just after heat is applied. Metal lands that run very close together along the board are particularly susceptible to shorts caused by small slivers of metal.

[(Continued on page 84)]



**EVERYONE**

Can have the **BEST**

in **STEREO**

Listening Equipment

**SENNHEISER**

**HD414**

**Stereo Headphones**

- **LIGHTWEIGHT**, very easy on the ears.
- **REMOVABLE** sponge **EAR PADS** fit gently against the ears — not round them no "boxed-in" feeling.
- Can be used with any **Tape Recorder or Amplifier**.
- **OUTSTANDING** frequency response, 20-20,000 Hz.

Available ex-stock from  
Wholesalers or  
Australian Agents

**R.H. Cunningham**  
PTY. LTD.

VIC.: 439-499 Victoria St., West  
Melbourne. Phone: 329-9633.  
N.S.W.: Sydney. Phone: 929-8066.  
W.A.: Perth. Phone: 49-4919.  
QLD.: L. E. BOUGHEN & CO.,  
Auchenflower. Phone: 70-8097.

TELEX: Melb. 31447, Sydney 21707

SENNHEISER HD 414 E.T. 10/73

Name \_\_\_\_\_

Address \_\_\_\_\_

\_\_\_\_\_

MAIL THIS COUPON TODAY

## ELECTRONIC CALCULATORS

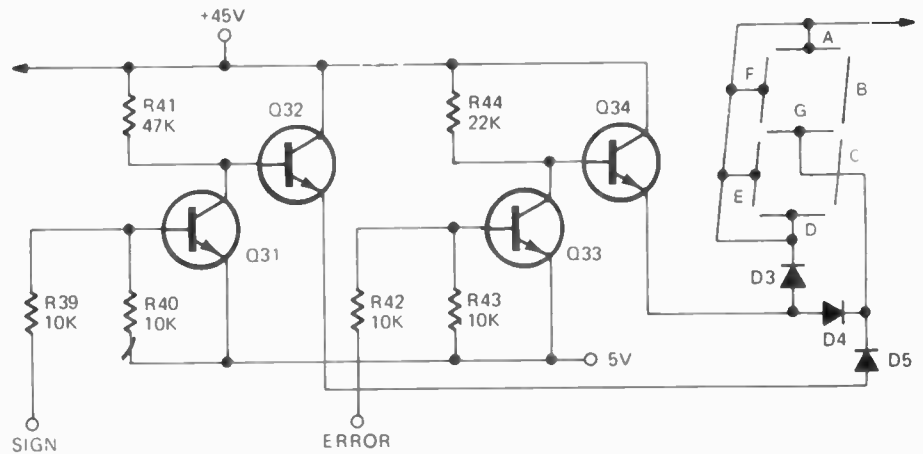

Fig. 9. Minus sign is produced by forward-biasing diode D5, thus lighting indicator segment G. When an error occurs, diodes D3 and D4 are turned on, forming on "E" by lighting segments A, D, E, F and G.

### MOS LSI HANDLING PRECAUTIONS

So long as they are in the circuit, MOS (Metal Oxide Silicon) LSI (Large Scale Integration) IC's are practically trouble-free. When the chips are improperly handled, however they become susceptible to damage from static electricity and mechanical pressure.

When removing a chip from a socket, ground the fingers on the calculator ground line (making sure the machine is not on) and pry up each side of the IC package with a screwdriver, using a gentle rocking motion until the IC comes loose. When the IC comes free of the socket, pick it up without touching the pins and place it on a piece of Styrofoam covered with aluminium foil.

When installing a chip in a socket, ground yourself and then carefully line up all the pins with the socket receptacles. Apply gentle pressure at first one end and then the other until the IC is secure in the socket. **CAUTION:** If the MOS LSI IC's are soldered in place **DO NOT** attempt removal unless the proper equipment and experience is available.

Troubleshooting the LSI portion of a calculator is extremely difficult if a block diagram showing inputs and outputs for each chip is not available. If the diagram is available, it can be used to work from the output chip, or section of a chip, backward to the input of the input of the preceding chip. The procedure is more difficult in multi-chip calculators since some chips invariably receive feedback input information from other chips.

### CASE HISTORY

The MITS 1440 is a multi-function desk calculator with square and square root capability. The machine can also store a 14 digit word in memory. The unit uses fourteen readouts in its display and six LSI chips. A machine came in for service in which the overflow indicator worked but the display failed to operate. The power supply voltages and the pulses on the digit lines and BCD lines from the output chip to the display buffer were all good. From here on let's quote from the servicing technician's report:

"Having no other place to go I began looking at the input and output signals around the output chip. I started at the outputs of the circuit (pins 4 and 10 of IC11), found they were not present, and began working backwards until finding correct input pulse at pins 8 and 9 of gate 30a. There was no output at pin 10 of the IC socket. I then checked pin 10 at the IC lead and determined that it was operating properly. A continuity check showed an open between pin 10 of the socket and the IC. Resoldering the pin failed to correct the problem. I removed the socket and found that pin 10 had been broken internally. The socket was replaced and when the chip was reinstalled the machine operated properly."

There are numerous examples of this kind of troubleshooting procedure. The best way to learn the technique is to service some actual calculators. ●

Reprinted by permission  
from Radio Electronics, Aug. 1973  
published by Gernsback Publications Inc.



## The incomparable Ferrograph now an incredible

# \$660

Recommended Retail... Model 704.

When the novelty wears off, and you've pushed all the buttons and seen all the flashing lights and chrome.

When you're tired of hiss and hum and distortion. When you realize that performance, dependability and long life are what really matter.

Then you'll know why Ferrograph stand alone in the world of sound.

Then you'll know how Ferrograph can guarantee every part of all their products for 3 years.

If you want facts and figures, we'll send them to you, but what we can't send you are the indefinables.

The satisfaction of using precision instruments.

The security of knowing that when you flip a switch you'll get results. The pleasure of hearing sound that not only "looks good on paper" but is good—as good as you can get. No hiss, hum or distortion. The

knowledge that your Ferrograph will still be in top condition when the toys are long discarded.

These are the reasons people buy Ferrograph.

They're the same reasons you don't see used Ferrograph equipment in the For Sale ads.

If you've tired of toys, join the big boys— use **FERROGRAPH**. you can afford to now!

SOLE AUSTRALIAN DISTRIBUTORS

## *Leroya Industries PTY. LTD.*

266 Hay Street, Subiaco, Western Australia. 6008

**N.S.W.:**  
Autel Systems P/L.  
Telephone 412 4377

**VIC.:**  
Douglas Trading Co.  
Telephone 639 321

**QLD.:**  
Brisbane Agencies  
Phone 21 9139

**S.A.:**  
Sound Spectrum P/L.  
Telephone 23 2181

**A.C.T.:**  
Pacific Stereo P/L.  
Telephone 95 0695

LER 045

# MICRO MONITOR HEADPHONES TYPE MX-1



**electronics**  
TODAY  
INTERNATIONAL  
**product test**

Electrostatic headphones  
use battery-derived  
polarising voltage.

SOME fifty years ago, my father, as a mere lad, built his first crystal set. Over a period of years this set was progressively modified, becoming a one valve, then a two valve, and finally a three valve radio.

My father was very proud of this radio, and by the time that he had reached three valves, he had as many as four-sets of headphones working in parallel so that the family could gain the maximum pleasure from this wonderful new medium, then called 'wireless'.

The headphones that my father and his family used were early electro-dynamic types. These were bulky, uncomfortable, and had a

frequency response of a mere thousand or two hertz, nevertheless they were greatly appreciated for the sense of intimacy that they offered with this new medium.

The Second World War provided a new impetus in the development of headphones, and, for the first time, standards for both testing and excellence were created — where Rafferty's rules had previously applied.

The most important aspects of such standardisation came as part of the need for testing headphones used in the field of audiometry, and standards similar to those developed by the American National Bureau of Standards, Artificial Ear Type 9A, and others were created.

The past ten years have seen new types of headphones gain a place of prominence and unquestioned value in the field of hi-fi. Not the least reason for this is the need for people to listen in peace and privacy — yet at sound levels of their own choosing.

Whilst these requirements are generally met, even in the cheapest of headphones, many headphones are lacking in fidelity, balance of frequency response, or the 'richness' of sound which, by and large, only loudspeakers are able to provide. Some manufacturers have tackled these problems in a number of ways, including the use of multiple drivers, but, as a generalisation, only very few headphones can match good loudspeakers in true fidelity.

In fact we have tested more than fifty sets of headphones during the past few years, and of these, only three had outstanding fidelity. The Micro Monitors type MX-1 reviewed here is one of these.

The Micro Monitors, with their MP1 power source, have a number of unusual features.

The first of these is that the electrostatic polarising voltage is derived from a miniature nine-volt battery and inverter, rather than being derived from the mains, as is the customary practice. Whilst we doubt if there is *any* inherent danger in the

normal technique, some potential users of electrostatic headphones dislike having mains-derived voltages a few millimetres from their ears!

A second feature of these headphones is that they are both light (100 grams) and comfortable. There is little attenuation of external sounds, thus the Micro Monitors provide a 'free' feeling somehow in tune with the environment. They are fitted with comfortable earpads with neat adjustable plastic covered chrome strips that swivel out on either side for comfortable wearing. The connecting cord is a sensible 2½ metres long and has a tie pin clip at the point at which the two separate cords join into a single cable for connection back to the power source via a single four-pin plug.



### MEASURED PERFORMANCE

Frequency response was evaluated by using our Bruel and Kjaer artificial ear type 4153. This contains a ½" diameter capacitor pressure microphone type 4134 having a particularly flat frequency response to beyond 20 kHz. The measured response was unusually good at ±6 dB from 20 Hz to 19 kHz (excluding a 500 Hz drop-out between 12 kHz and 13 kHz — which was virtually inaudible on normal programme content).

Our automated total harmonic distortion curve was obtained at a signal level equivalent to 100 dB at 1 kHz. The result was very good, for whilst the range from 20 Hz to 40 Hz had a drooping distortion curve (4% to 1%), the distortion was generally less than 1% over the remainder of the audible range. The distortion peak of 3% at approximately 760 Hz is for real, but surprisingly occurs only at a very narrow band of frequencies. The levels of distortion measured are inaudible — even to the purist.

Our subjective (listening) tests showed that the sound is 'transparent' and totally free of colouration. All members of our staff agreed that they could detect programme content that they had not previously noticed when listening to the same demonstration records reproduced through any of our various studio monitor loudspeakers.

All our listening tests showed that the affinity of the listener to the music was enhanced, and that the feeling of envelopment by the music was complete.

The Micro Monitor headphones are good. Very good. If you try them the chances are that you'll decide that without them — or some very much like them — your hi-fi system is incomplete.

At under \$70 a pair they are excellent value for money. ●

### MICRO-MONITOR HEADPHONES TYPE MX-1 FREQUENCY RESPONSE (Using Bruel Kjaer Artificial Ear type 4153)

20 Hz to 19 kHz	±6 dB (excluding 500 Hz notch at 12 kHz)
Distortion level at 100 dB S.P.L.	100 Hz 1 kHz 6.3 kHz
	0.6% 0.6% 0.5%
Weight	Headphones 0.1 kg
	Power Supply 1.1 kg
Battery requirement	1 miniature 9V type 216

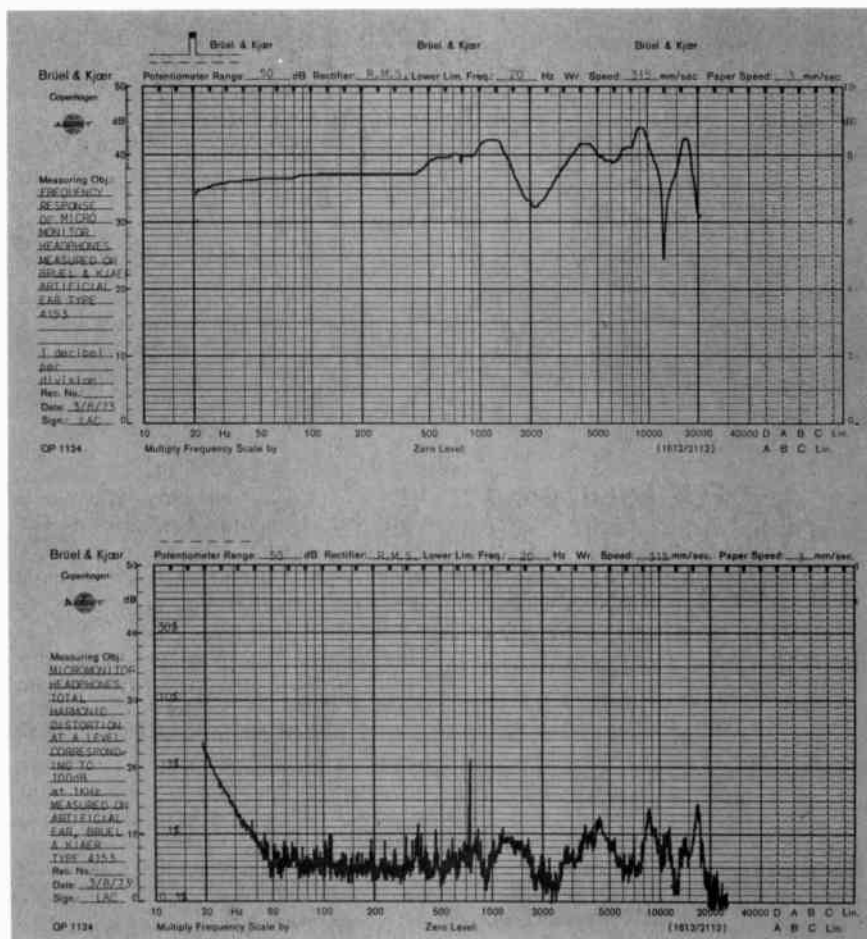

# First we made them easy to use. Now we've made them easy to get.

**Yes, we now have distributors.** The best there are in Australia. These distributors have in stock our complete line of LED displays and LED lamps.

**Easy to use.** All these products are solid-state and directly DTL-TTL compatible. And they are all designed for ease of application.

**A complete LED lamp family.** Our LED lamp family offers a complete selection of lens, lead and light output combinations. Our new T-1 Mini-LED is just 0.125" in diameter. This device offers high brightness over a wide viewing angle. And you have a choice of lenses; red diffused, clear or clear diffused. This little gem, known as the 5082-4480, costs just 45c in 100 quantities. The T-1 3/4 long lead wire wrappable 5082-4880 lamps start at 45c each in 100 quantities; the short or bent lead 5082-4440 LEDs start at 45c in 100 quantities. Higher volume prices on all these devices are even more attractive.



**A new low-cost isolator.** At 5 MHz bandwidth, it's 25 times faster than any other isolator on the market. It has a high DC isolation voltage of 2500 volts, and a high common mode rejection of 10 volts at 2 MHz, making the 5082-4350 ideal for eliminating ground loops in digital or analog line receivers, floating power supply and feedback networks. Prices start at \$2.66 each in 100 quantities.

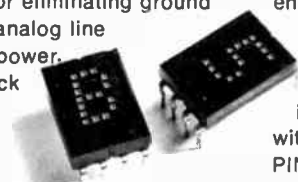

**A low-cost LED display.** Our numeric and hexadecimal displays have simplified your designs with on-board electronics, standard package configuration, and categorized light outputs. Best of all, the 5082-7300 numeric has a new low price of \$10.80 in 100 quantities.

**A new 1.5" LED numeric.** This new LED display, visible from 60 feet, has on-board electronics, wide viewing angle, and is designed for edge mounting in a standard

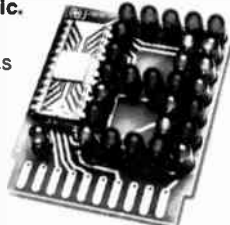

PC board socket. Solid-state reliability makes the 5082-7500 ideal where dependability is important. The price is \$23.40 each in 100 quantities.

**Small character LED displays.** The 5082-7405 is a 5 digit end stackable display. It minimizes power consumption and offers ease of implementation with a standard 14 PIN DIP package. At only 7 mW per digit, this display is ideal for calculators, portable instruments and anywhere that low power and high brightness are important. The 5082-7405 is priced at \$2.97 per digit in 100 quantities.



**Easy to get.** Call the distributor nearest you for immediate delivery. Or write us for more information.  
HEWLETT-PACKARD AUSTRALIA PTY. LTD., 22-26 Weir Street, GLEN IRIS, 3146, Victoria. Telephone: 20 1371 (6 lines). Other offices in Adelaide, Brisbane, Canberra, Perth and Sydney. Also Auckland and Wellington, New Zealand.

## The Light Source



HEWLETT  PACKARD

COMPONENTS

DISTRIBUTORS:—

**VIC.**  
**RADIO PARTS GROUP,**  
562 Spencer Street,  
West Melbourne, 3003.  
Phone: 329 7888, 30 1251.

**N.S.W.**  
**RADIO DESPATCH SERVICE,**  
869 George Street,  
Sydney, 2000.  
Phone: 211 0816.

**S.A.**  
**GERARD & GOODMAN PTY. LTD.,**  
192 Rundle Street,  
Adelaide, 5000.  
Phone: 23 2222.

90331/30037



# the jamproof cassette

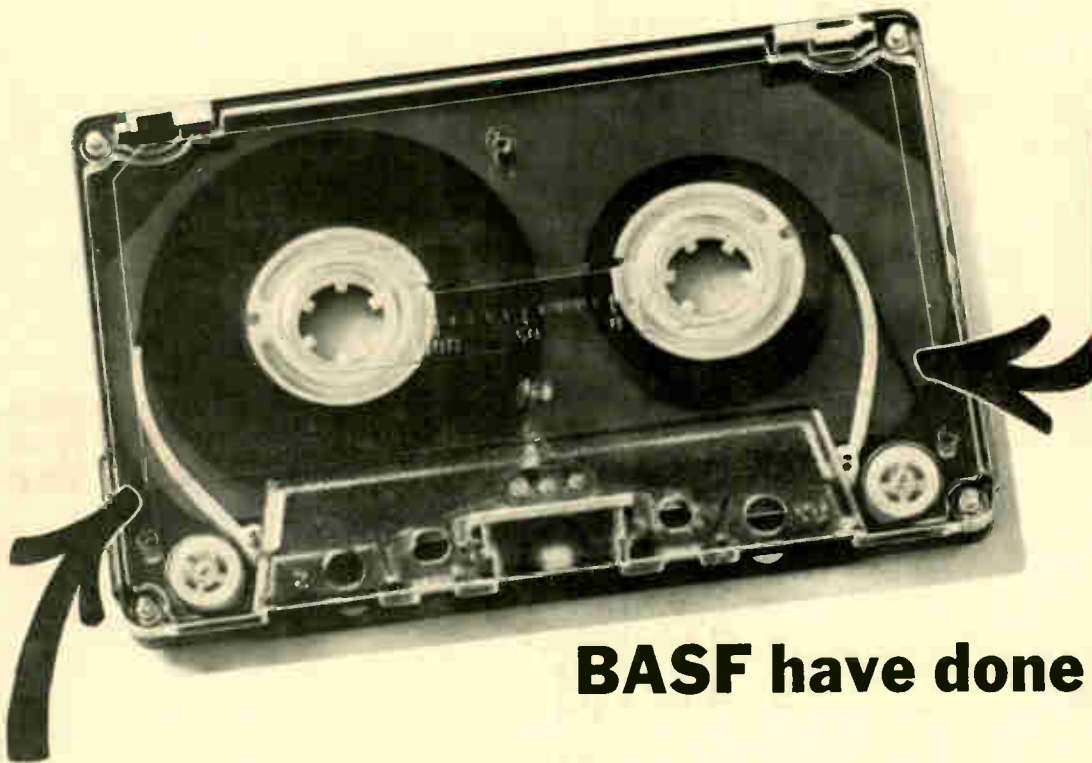

Special  
Mechanics  
**SM**  
Spezial  
Mechanik

## BASF have done it!

We've eliminated the biggest source of cassette customer complaints you have to unravel (sometimes literally). BASF made the world's very first recording tape. Now we've patented a brilliantly simple, foolproof improvement for the innards of cassettes. It's called Special Mechanics and it consists of two plastic "tusks" that guide the tape accurately on and off the hubs. So it stays neatly wound instead of looking like a ball of string, and jamming in the cassette.

As well as the worst kind of jam ups, Special Mechanics virtually eliminates the wow and flutter that happens with anything less than perfectly smooth running. Special Mechanics is *guaranteed* to give your customer smoother, trouble-free recording and playback. Or we'll give them a . . . **FREE REPLACEMENT CASSETTE**. And once you've solved your customer's jamming problems, he'll be able to enjoy 2 other BASF firsts. LH

tare—Low noise and High output, both together in the one tape. Or Chromium Dioxide tape for dramatically improved dynamic range and frequency response at 1½ i.p.s. BASF's **BIGGEST EVER NATIONAL ADVERTISING CAMPAIGN** will be telling your customers all about SM, LH and CrO<sub>2</sub>. So they'll be looking for the BASF bullseye in your store. Make it easy to find, and make yourself some jam!



**Distributors:** Sydney (Head Office): Maurice Chapman & Co. Pty. Ltd., 276 Castlereagh St. 2000. Newcastle: W. L. Redman Agencies, 11 Hall St., N.S.W. 2300. Canberra: Sonny Cohen & Sons, 20 Isa St., A.C.T. 2600. Melbourne: Maurice Chapman & Co. Pty. Ltd., 146-150 Burwood Rd., Hawthorn, Vic. 3122. Brisbane: Chandlers Pty. Ltd., 399 Montague Rd., West End, Qld. 4101. Adelaide: Neil Muller Pty. Ltd., 8 Arthur St., Unley, S.A. 5061. Perth: Anderson-Tedco, 11-13B Belmont Ave., Belmont, W.A. 6104. Launceston: P. & M. Distributors, 87A Brisbane St., Tas. 7250. Darwin: Pitzners Music House, Smith St., N.T. 5790.



BA2753

# GOLDRING

## SHIELDED AUDIO CONNECTING CABLES



G3- 900 5 Pin Din Plug to 2 3.5mm Plug 2m.



G3- 901 5 Pin Din Plug to 5 Pin Din Plug 2m.



G3- 902 5 Pin Din Plug to 5 Pin Din Connector 2m.



G3- 903 5 Pin Din Plug to 4 RCA Plugs 2m.



G3- 904 5 Pin Din Plug to 4 3.5mm Plugs 2m.



G3- 905 5 Pin Din Plug to 6.5mm Stereo Line Connector 2m.



G3- 906 3 Pin Din Plug to 3 Pin Din Plug 2m.



G3- 908 5 Pin Din Plug to 1 3.5mm Plug 2m.



G3- 907 5 Pin Din Plug to 2 Alligator Clips 2m.



G3- 909 2 RCA Plugs to 6.5mm Stereo Line Connector 2m.



G3- 910 4 RCA Plugs to 4 RCA Plugs 2m.



G3- 911 RCA Plug to RCA Plug 2m.



G3- 912 RCA Plug to RCA Connector 2m.



G3- 913 RCA Plug to Stripped End 3m.



G3- 914 RCA Plug to 3.5mm Plug 2m.



G3- 915 3.5mm Plug to 3.5mm Plug 2m.



G3- 916 3.5mm Plug to 2 Alligator Clips 2m.

*This is only a selection of the Goldring Connecting cables — see the full range at your local dealer.*

**GOLDRING ENGINEERING  
(A/ASIA) PTY. LTD.**

NSW 26-28 RICKETTY STREET, MASCOT. 2020. PHONE 669 6088  
VIC 162 PELHAM STREET, CARLTON. 3053. PHONE 347 5177  
QLD 35 BALACLAVA STREET, WOLLONGABBA. 4102. PHONE 91 4972  
SA 76-78 McLAREN STREET, ADELAIDE. 5000. PHONE 23 3488  
ACT UNIT 5, 83 WOLLONGONG ST., FYSHWICK. 2609. PHONE 95 8248  
WA 32 NORTHWOOD STREET, LEEDERVILLE. 6007. PHONE 8 4988



## The Best Connections— Belling & Lee RF Connectors.

### straight or right angle

Belling & Lee have today's widest range of RF Connectors—and they're generally available from stock. Shielded or insulated plugs; conductors for soldering, crimping or solderless; straight or the new right angle model L2156.

- Special collet clamps for efficient braid connections and anchorage in cable mounting members.
- Impedance 60-70 ohms.
- Mating conforms to BS3041 and IEC169-2.



TECNICO ELECTRONICS



Premier Street, Marrickville, NSW 2204 55-0411  
2 High Street, Northcote, Vic 3070 489-9322  
Adelaide 23-2222 Brisbane 62-1899 Perth 8-4137

TE848D/773

# NEW!

## AM TUNER MODULE

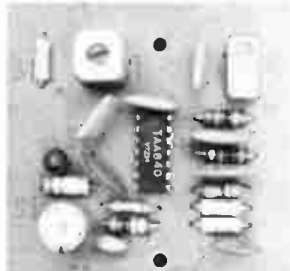

A neat little tuner module on a 2 11/16" x 2 1/2" printed circuit board. It is packaged in a transparent plastic bag with instructions ready for display. The module is already aligned and can be used with an A.W.A. 39260 gang and ferrite rod aerial, the aerial also available from T.V.T. if needed.

**Brief specifications:**  
Tuning range 510-1625 KHz. Output 750 mV into 100 K. Power supply 7 to 9V DC, 20 mA from battery etc.

## MAG PRE-AMP

A complete magnetic pre-amp on a 13/16" x 2 1/2" printed circuit board, packaged in a transparent plastic bag with instruction sheet. The circuit contains 2 high gain transistors per channel to provide the excellent performance that potential users will want. **Brief specifications:**  
Frequency response within 1dB of RIAA curve from 30 Hz to 20 KHz. Sensitivity is 2mV for 150mV output at 1 KHz. Input impedance is a nominal 50 K. Noise is typically -68dB. Distortion figure; less than .04% THD at 250mV and 1KHz output.

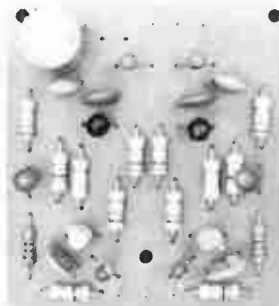

Available from most Wholesalers



**T.V. TUNER SERVICE P/L.**  
469 St. Georges Road, Thornbury, Victoria. 3071  
Telephone 44-6179

*Truly the worlds finest.....*

# SONICS SPEAKER SYSTEM

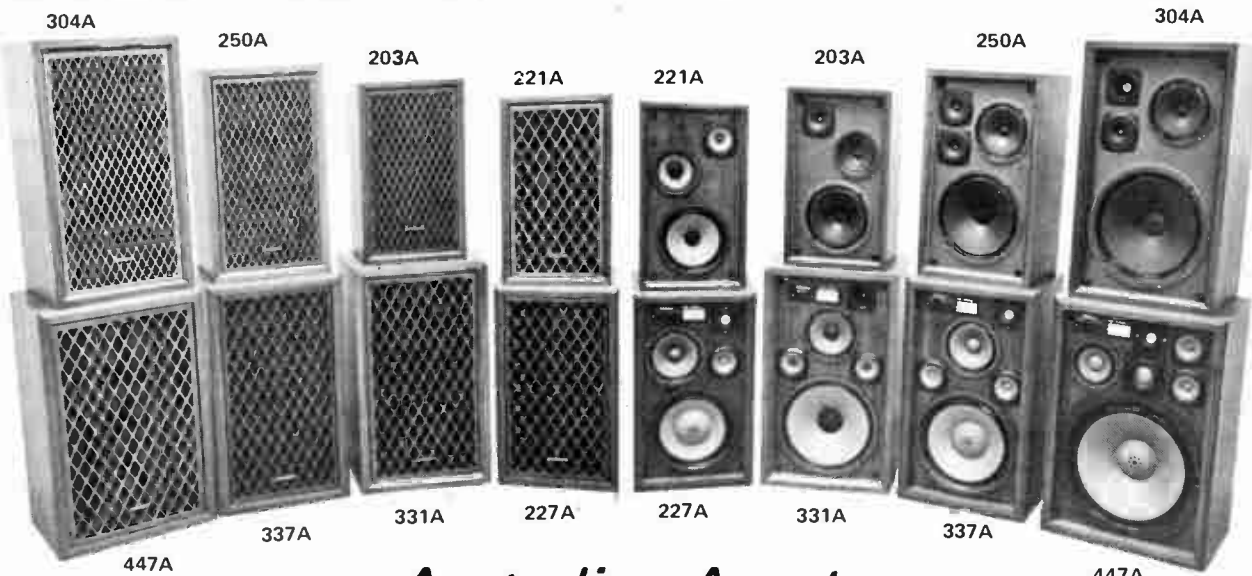

*Australian Agents*

## SEVENSEAS ELECTRONICS PTY LTD

166 Parramatta Rd., Ashfield, NSW 2131 Phone: 799-2555

# EXPERIMENTAL SPEAKER

Using bass reflex enclosures for low resonance speakers — by Nelson Pass,  
Design Engineer, Electrostatic Sound Systems Inc., Sacramento, California.

A FEW years ago, bass speakers commonly had free air resonances around or above 40 Hz, and they were often used in bass-reflex enclosures, where the output of the port helped to compensate for the speaker's decreased output below the resonant frequency. Today however, speakers having a subsonic resonance of 15 Hz are not unusual, and it is generally regarded that a bass-reflex enclosure is impractical or unusable for two reasons.

Firstly the so-called "optimum volume" for such a speaker is calculated to be of the order of ten cubic feet using standard bass reflex design. Secondly, for an enclosure of more convenient dimensions, it would require a long and narrow duct to tune the enclosure to such low frequencies. Such a duct would cause the enclosure to behave more as a closed box and would serve no useful purpose.

These conditions arise from the

premise that tuning the enclosure to match the free air resonance of the speaker will result in optimum response. This is true of speakers having resonances above 30 Hz, but it becomes impractical and unnecessary for speakers resonant below 25 Hz.

When a bass-reflex enclosure is tuned to the resonant frequency of the speaker, the back wave of the speaker passes through a low-pass filter (the enclosure volume in conjunction with the inertia of the air in the duct) and emerges through the duct to join the radiation off the front of the speaker. The enclosure allows low frequencies through but blocks higher frequencies (Fig. 1). At the same time, this acoustic circuit shifts the phase of the back wave, so that at frequencies above resonance, the out-of-phase back wave is shifted into phase with the front wave by the time it emerges from the duct. This, being in phase, this wave increases the amount of bass

energy radiated from the system. At the resonant frequency of the enclosure, the wave from the duct begins to lose its phase shift, and below resonance it becomes detrimental to the output. (Fig. 2).

The bass-reflex design lowers the cutoff frequency a few Hz and just as important, increases the load on the speaker at resonance, dampening the resonance. This results in lower cone excursion and greatly reduced harmonic distortion.

It is possible to make use of the bass-reflex design to lower the amount of harmonic distortion in a speaker with subsonic resonance, not by tuning the enclosure to the resonance of the speaker, but by tuning above that frequency.

As the frequency goes down, the excursion of the speaker must go up to provide the same power output (Fig. 3). For a 12 inch woofer, that can mean that it must travel 3 inches to

Fig. 1. Typical acoustic output of duct versus frequency.

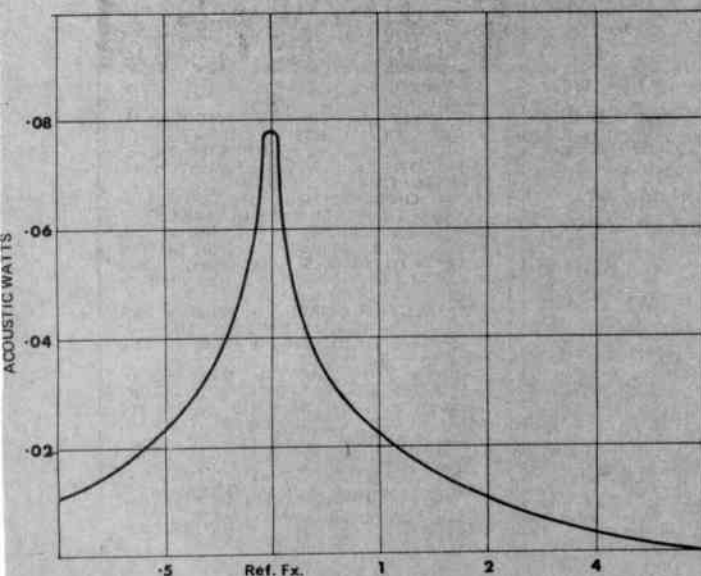
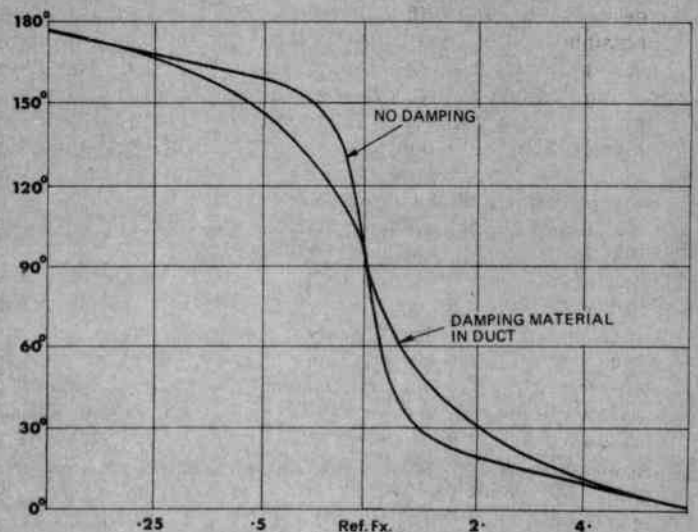

Fig. 2. Typical phase difference between speaker and port output as a function of frequency.



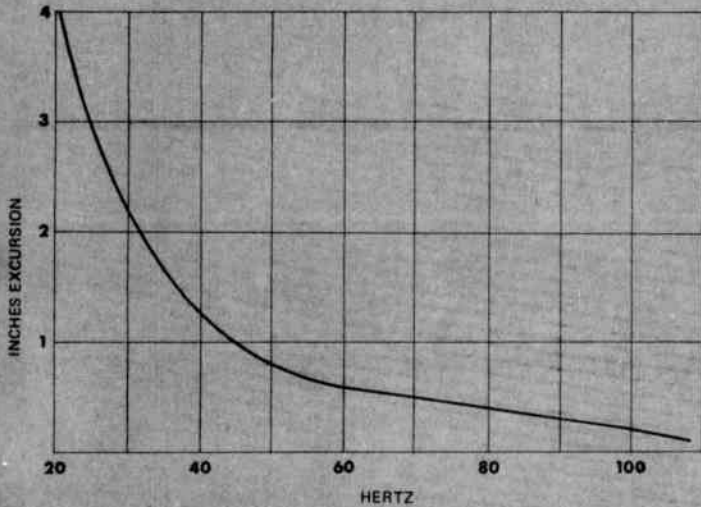

Fig. 3. Peak to peak excursion for 25cm (12") speaker versus duct length.

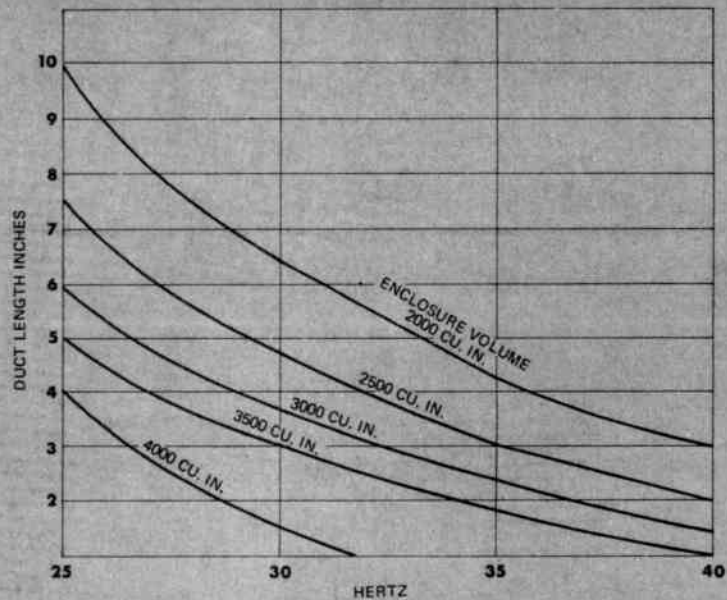

Fig. 4. Resonant frequency versus duct length.

generate one acoustic watt at 30 Hz. Even very good speakers will distort long before that. But if we could make efficient use of the power radiated off the rear of the cone, we could reduce this excursion to almost half, greatly reducing distortion.

I have found that by tuning the enclosure as high as 35 Hz, with a speaker of 15 Hertz resonance, the frequency response of the speaker is virtually unchanged, but the amount of distortion in its low frequency sinusoidal output can be varied radically depending on the duct. If the enclosure is tuned too high, for example 40 Hz, the waveform may look like a staircase instead of a sine wave at several watt power levels. If it is tuned below 30 Hz, it may exhibit notching at the peaks due to high excursion.

There is another advantage to this acoustic circuit. The very low resonant frequency of the speaker leaves the designer free to make as much use as possible of the high damping factors now available in solid state amplifiers. A high damping factor will damp out much of a speaker's output at resonance. This is detrimental to the frequency response of the speaker whose resonance occurs between 40 and 100 Hertz and where the acoustic circuit is often designed to take advantage of that resonance. But it is not detrimental to the output of a speaker with subsonic resonance — just the opposite. A high damping factor will lower the subsonic excursion and reduce the harmonic distortion. It will also smooth out the smaller resonant peaks and dips caused by the speaker and by standing waves in the enclosure. The greatest benefit will be

due to improved transient response from the increased control the amplifier will have over the speaker. To make use of the high damping factor, the crossover network and connecting cables must be designed to have as little resistance as possible.

The optimal enclosure volume for a given speaker should be determined experimentally, but for those without the inclination or finances to perform such experiments, I would recommend approximately 45 cubic inches volume for every square inch of cone area (about 3,000 cu. in. for a 12 inch speaker, 2,600 for a 10 inch, and 1,900 for an 8 inch speaker). Note that these values are for the enclosure volume before the speaker has been mounted in place.

Since the enclosure resonance is not as low as the speaker's, there is no difficulty in using a duct with a two inch diameter. A smaller diameter would render the duct ineffective and is not recommended. The resonant frequencies for two-inch ducts of various lengths is given in Fig. 4. If you wish to use a duct of a different diameter, the resonant frequency of the enclosure is given by the formula:

$$Fr = 2155 \frac{Ad}{(Ve - Vd)(ld + .96\sqrt{Ad})}$$

- Fr = enclosure resonant frequency
- Ad = cross-sectional area of duct inches<sup>2</sup>
- Ve = volume of enclosure inches<sup>3</sup>
- Vd = volume of duct
- ld = length of duct

The enclosure should be as solid as possible and filled lightly with fibreglass or dacron to dampen standing waves. Tuning the enclosure

is an involved task and will require the use of a microphone whose output can be viewed on an oscilloscope. The speaker should be tested out of doors by applying a few watts of sine wave (30-50 Hz) and viewing the output of the speakers on the oscilloscope while varying the duct length until a length is found that results in the least distortion. The worst distortion will occur at 30Hz, so that the best duct length for 30 Hz will probably also be the best for the higher frequencies.

As mentioned before, the duct changes appear to produce very little difference in actual frequency response, but it is possible with experimentation to produce as little as 1 percent harmonic distortion at a 10 watt power level at 50 Hz, a value that few other speakers can match. ●

## BARGAIN SALE

### SPECIALS OF THIS MONTH!!

CERAMIC DISC CAPS:- .001/500v — 20 for 50c.  
 POLYESTER CAPS:- 0022/400v — 20 for 60c. ELECTROLYTICS:- 47uf/10v — 10 for 40c. COPPER CLAD BOARDS 6"x3" — 10 for \$1.50. TAG STRIPS, 10 lug — 10 for 60c.  
 SEMICONDUCTORS:- BC108-10 for \$2.90, BC109C-10 for \$4, EM402-10 for \$1.85, PA234, 1w R.M.S. Audio Amp IC only \$1.95 incl. data. SUPER BARGAIN PACKS:- Resistors, mixed 1/2w, 1w, 5%, 10%, ideal for VHF or servicing — 100 for \$1.  
 POLYESTER CAPS:- Top Quality 10% Tol. 160v, 270v, 400v — 100 for \$3.50. ELECTROLYTICS:- Top Quality — 25 for \$2.  
 CERAMIC DISC CAPS:- Mixed, 50 for \$1. POTENTIOMETERS:- Incl. Dual, Single, switch, Tap Pots — 10 for \$2.50. Post and Pack 20c or extra for heavy parcels.

MICRONICS, P.O. Box 175A  
 Randwick, N.S.W. 2031.



1. Power Rheostats.

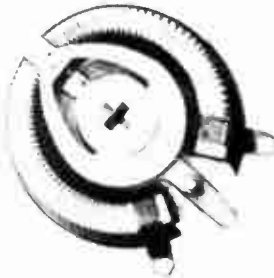

2. Carbon composition, Metalglaze precision film and wirewound resistors.



3. Single and multi-turn Trimming Potentiometers.

4. Capacitors.



5. Rotary and Slider Potentiometers. Single and Stereo.

# Quality Components and Service

## Only the best from IRHC



6. Ceramic Resonators and Filters.

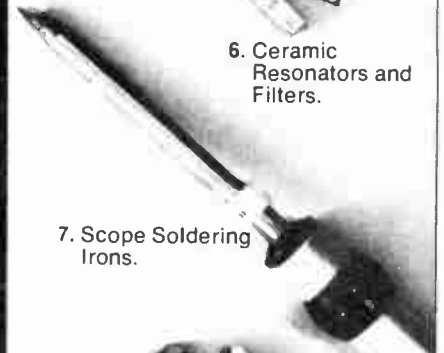

7. Scope Soldering Irons.



8. A switch for every application.



15. Reed Relays.



14. Oil Tight Switches.

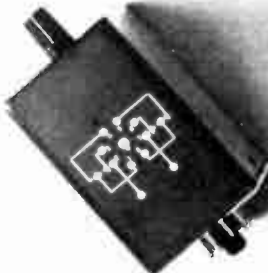

13. Solid State Time Delay Relays.

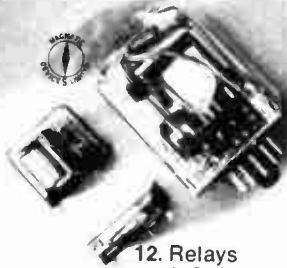

12. Relays A.C. & D.C.



11. Magnetic Reed Switches.



10. Solenoids.



9. Neon Indicator Lamps.

# IRH Components Pty. Limited



THE CRESCENT, KINGSGROVE, N.S.W. 2208. PHONE: 50-0111 74 RAGLAN ST., PRESTON, VIC. 3072. PHONE: 44-5021

### REPRESENTATIVES

Agents and distributors in all states

Please send me catalogues on the products indicated.

1  2  3  4  5  6  7  8  9  10  11  12  13  14  15

NAME: .....

COMPANY: .....

ADDRESS: ..... Postcode: .....

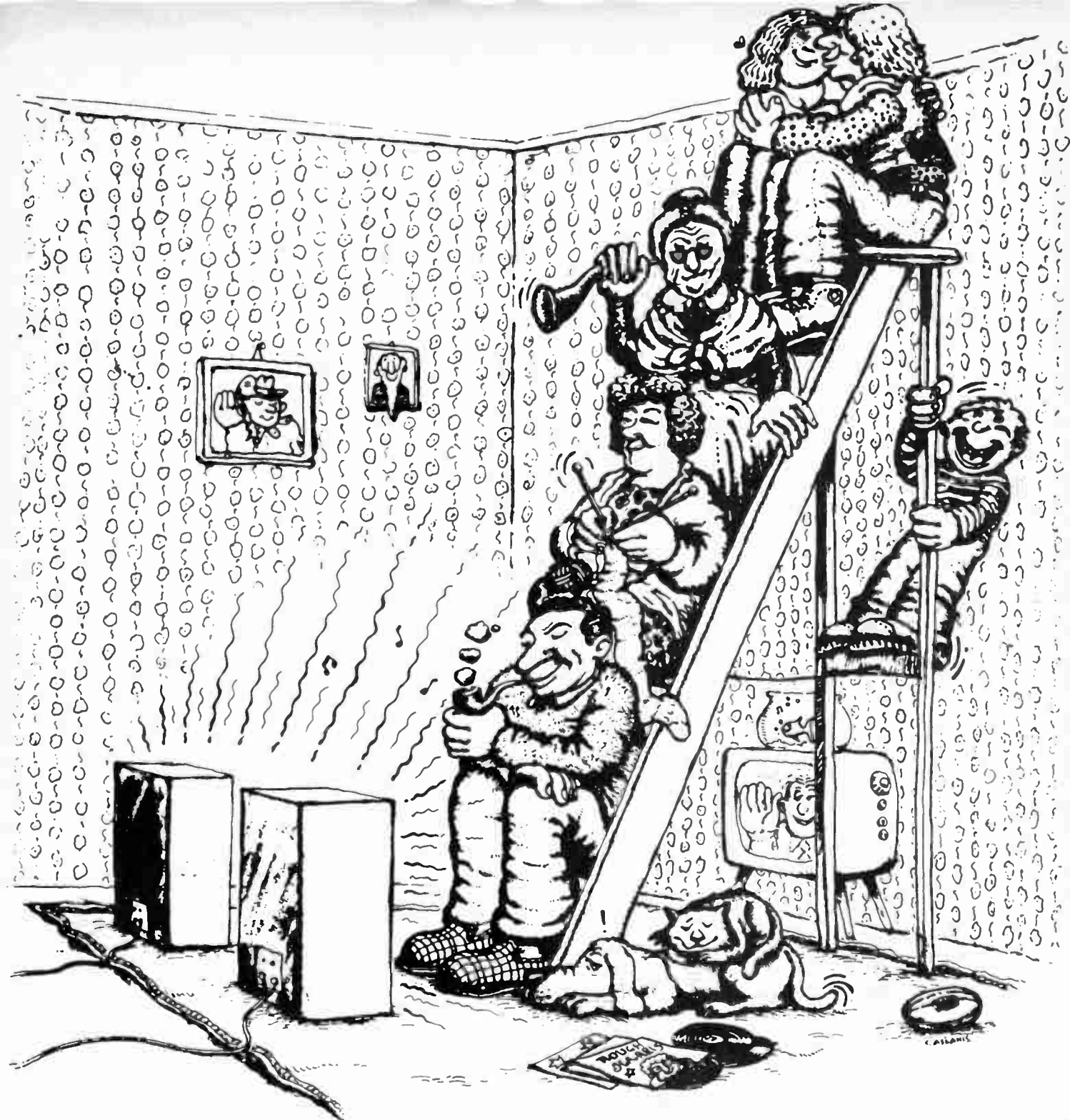

## THE NEW CORAL STAGE 7 SPEAKERS OFFER A WIDER RANGE OF SEATING POSITIONS.

Sharing stereo can be a problem. That old familiar hangup of a triangular arrangement for listener and speakers doesn't leave much room for family appreciation, far less showing it off to a crowd.

Unless you're a solitary, you should hear what the Coral Stage Series can do to improve matters.

The Coral Stage Series has something you don't find on other speakers. A metal whirllig which is a wide-focus acoustic lens. It spreads the sound from the mid-range, the tweeter and the super

tweeter speakers, so that you hear the same quality of reproduction in all parts of the room.

This means that you can hear the full stereophonic or quadrophonic effect wherever you choose to sit. Consequently entertaining is that much easier.

Instead of designing your room round the speaker system,



you can now fit the system into your room. So long as there are no obstacles to absorb the sound, you should hear everything perfectly.

Everything from the largest of the Coral Stage Series, the Stage 7, is 25-20,000 Hz. The 12" woofer uses a hollow-formed cone of Coral's special chemical fibre pulp. It is

mounted in a beautifully finished polished walnut baffle, flat on both sides to eliminate acoustic bounce. Above it, the mid-range and tweeters stand proud of a toning fabric-covered panel.

You'd think you meant those speakers to be seen, the care we've taken with the construction. And indeed, we have given you the opportunity to display them. The speaker grille lifts off very simply.

Unlike some speakers we could mention, Coral have nothing to hide.

Sole Australian Distributors: General Accessories, 153 Sturt St., South Melbourne, Vic. 443 Concord Rd., Rhodes, N.S.W. 81-97 Flinders St., Adelaide, S.A. 50-54 Lt. Edward St., Brisbane, Q'ld. 46 Milligan St., Perth, W.A. Cnr. Ingham Rd. & Echlin St., Townsville, Q'ld. Homecrafts, 199 Collins St., Hobart, Tas.



**ETI PROJECT 520**

# DIGITAL STOP WATCH

Measure elapsed time electronically with this inexpensive digital system.

ALTHOUGH entirely adequate in many situations, conventional stopwatches have a number of limitations which preclude their use — or at least their accuracy of timing — in many applications.

This is particularly true of sporting applications, where the start line may be in a different geographical location from the stop line, and where timing accuracy to within hundredths of a second may be required.

Another serious drawback of many conventional stopwatches is that the display consists of multiple hands and/or dials, the readings of which must be added together to give elapsed time. At best this arrangement is clumsy — at worst it may be misread.

Apart from the form of display, another serious limitation of conventional watches is that human reflex time may cause errors in the measured time by a (variable) amount. Delays of 0.1 to 0.5 seconds are typical. Clearly this last limitation makes readings to anything better than 1/10th second virtually impossible —

even though some watches are capable of this degree of resolution.

For these reasons, international sporting bodies are turning to digital timers that are started and stopped by electronic means, such as light beams (horse and motor racing), or touch plates (swimming).

Whilst extremely effective and reliable, commercially built systems of this sort are generally very costly and well beyond the means of the average car, motorcycle or athletic club.

The ETI Digital Stop Watch has been designed specifically to fill this low-cost need, whilst still providing the required accuracy and flexibility of operation. With suitable inputs, the standard instrument will provide a resolution of one hundredth of a second. Accuracy is one two hundredth of a second ( $\pm \frac{1}{2}$  digit).

A unique overflow arrangement allows the four digit display to read times up to 3999.9 seconds in tenths of a second, or 399.9 seconds in hundredths of a second.

It is also possible to modify the unit

to read to one millionth of a second for short time interval measurements (such as are occasionally required in science and industry). The necessary changes for this are detailed in Table II.

Three different modes of operation are provided to cater for practically any application. These are:—

## MODE 1

**STOPWATCH** — In this mode a single push-button (either internal or external) provides the functions, Press to start, Press to stop, Press to reset — just as with a conventional watch.

## MODE 2

**REMOTE START/STOP** — In this mode three push-buttons may be used at separate locations to Start, Stop, and Reset the timer. This mode would be very useful for timing events such as 50-metre swimming, motor car standing start quarter miles etc.

## MODE 3

**LAP TIMER** — Here a single push-button is used to provide separate lap times. The counter



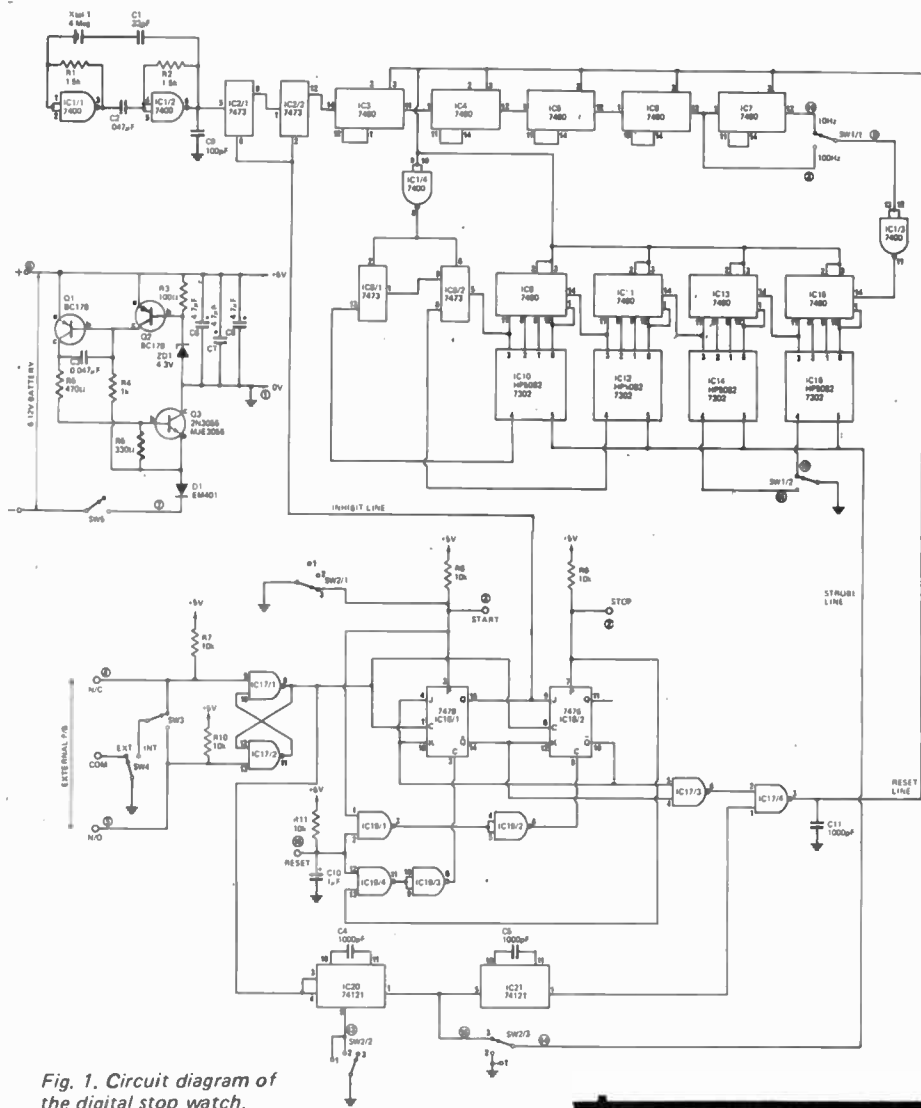
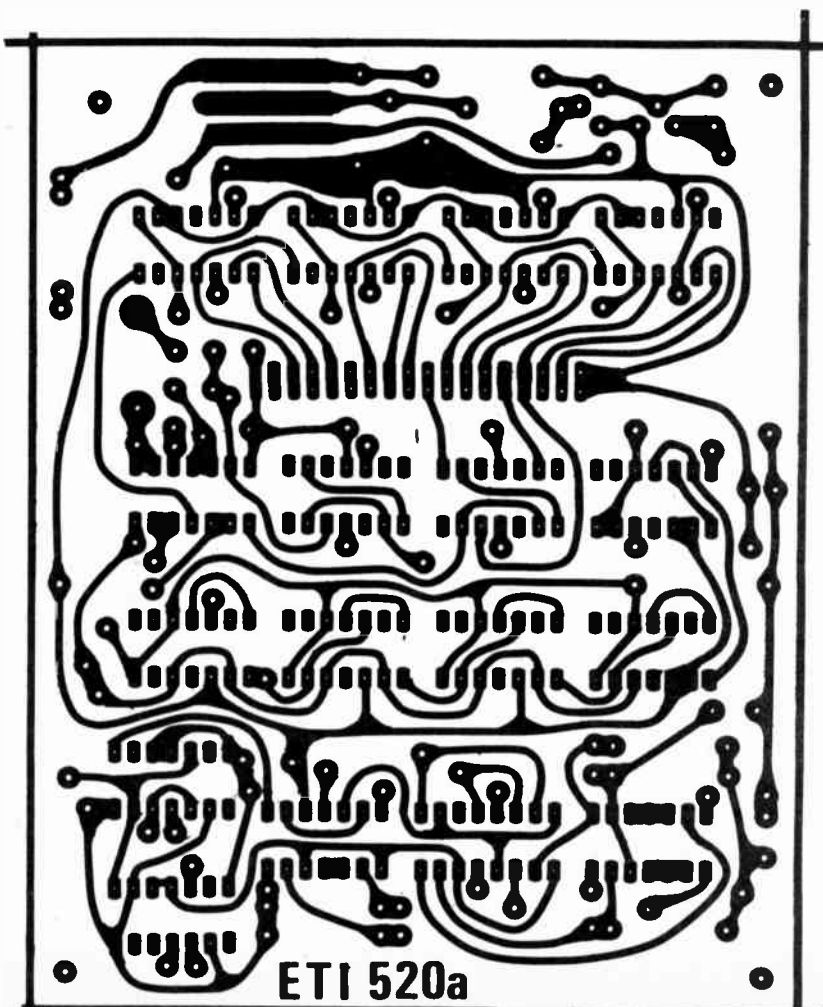

Fig. 1. Circuit diagram of the digital stop watch.

Fig. 2. Main PC board layout for the stopwatch.



displays the time elapsed between successive presses of the button, hence there is no timing error due to time lost whilst taking readings.

The whole unit operates from a single five volt supply, hence an inbuilt regulator is provided enabling the unit to be run from any six to 16 volt battery – or any other source capable of providing 700 mA – without the need for switching. A series diode is included in the power circuit to prevent damage in the event of inadvertent reversed battery polarity.

### CONSTRUCTION

This is not really intended as a suitable project for absolute beginners, nevertheless if the recommended printed circuit board is used, construction should not present any major difficulty.

Firstly mount all integrated circuits onto the main board paying particular attention to orientating the spot or notch on the IC as shown in the component overlay.

Fit resistors capacitors, transistors and the crystal, again paying attention to polarities and orientation – where applicable.

If an MJE3055 flat-pack transistor is used for Q3 it may be mounted as shown in Figures 4 and 3. Make sure that the transistor is insulated from the chassis.

If the 2N3055 is used, it must be

### SPECIFICATION

RESOLUTION (selectable by slide switch) (if modified)	0.1 or 0.01 sec 1.0μ sec
DISPLAY (overflow indication to 39999)	4 digits
ACCURACY (crystal controlled timebase)	±1/2 digit
CONTROL	internal or external push buttons, or external electronics at TTL levels
POWER REQUIREMENTS (external battery)	6-16 volts 700 milliamps
OPERATING MODES	
Mode 1	normal stop watch
Mode 2	remote stop/start
Mode 3	lap timer

ETI 520a

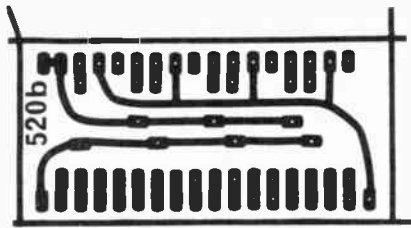

Fig. 3. The display chips are mounted on this small sub PC board.

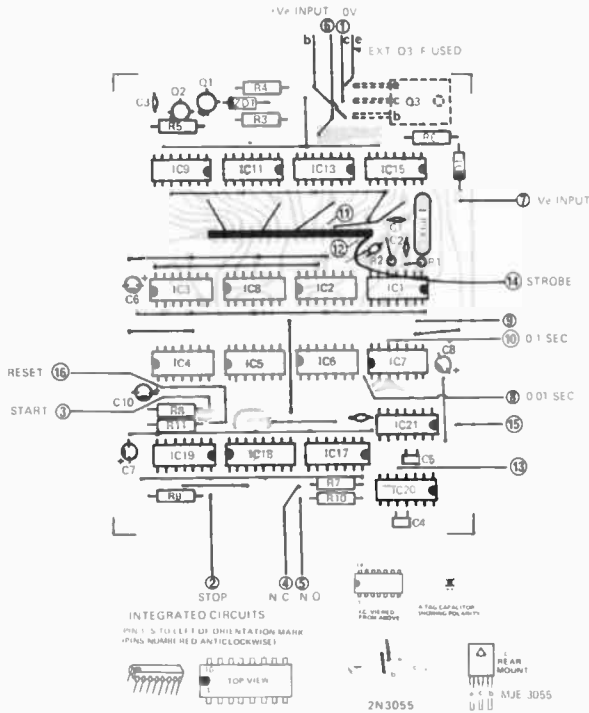

Fig. 4. Component overlay for main board.

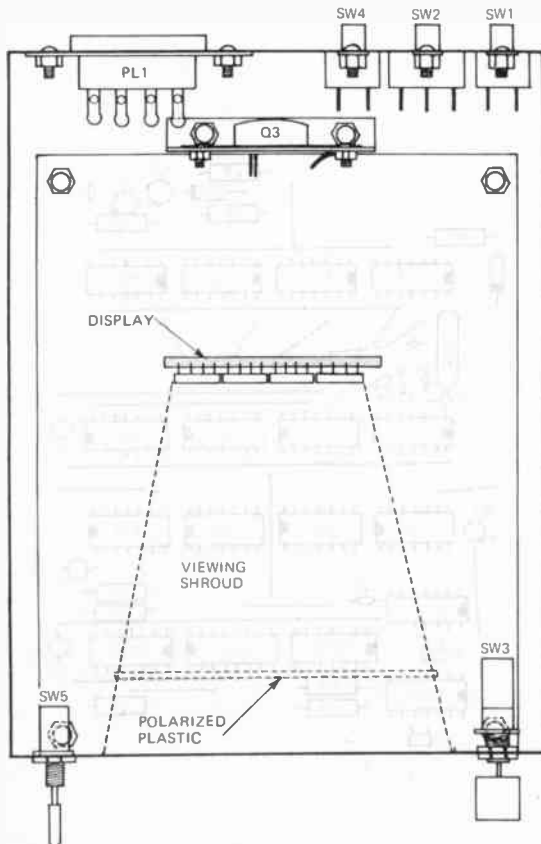

Fig. 5. Positioning of major components on the chassis.

## HOW IT WORKS

Basic timing is generated by a 4 MHz crystal, in conjunction with IC1/1 and IC1/2 which are digital gates operated in a linear mode. The output of IC1/2 is divided by four in IC2/1 and IC2/2 to provide 1 MHz. This further divided to 10 Hz by IC3 - IC7. The 10 Hz or the 100 Hz output from IC6 is selected by SW1/1 as the basic 0.1 second or 0.01 second timing.

The selected clock frequency is inverted by IC1/3 and counted by ICs 15, 13, 11 and 9. Inverter IC1/3 is used to give the clock an initial  $\frac{1}{2}$  digit lead in order that the accuracy should be  $\pm \frac{1}{2}$  digit rather than the usual  $+0 - 1$  digit in conventional digital instruments.

The display ICs provide a visual indication of the counter's contents. These ICs contain a store as well as decoders and drivers for the display. A four bit binary code is used where digits 10 to 15 are not used, and a control line or strobe is used to gate counter data into the store. If this line is low (less than 0.8 V) the information at the four inputs will be decoded and displayed. If the line is high (greater than 2.4 V), the store will still register the last input, and the counter state may change without affecting the display.

Only four display chips are used but by using the two most-left-hand decimal points as overload indicators, the full range is extended to 39 999 rather than 9999. There is no indication of overflow beyond 39 999 but the timer will continue to recycle and multiples of 40 000 can be added to obtain the correct time.

Three control lines are used for the counters. These are:-

1. The Reset Line: This line is used to stop the counters, reset and hold the counter to zero whenever it is in the high state (greater than 2.4 V).

2. Inhibit Line: This line stops the clock divider whenever it is in the low state (less than 0.8 V). Thus it stops the counting and freezes the display without resetting it.

3. Strobe Line: This line controls the store as previously described. In modes 1 and 2 SW2/3 applies a permanent zero to the line hence the store is only used in mode 3.

In modes 1 and 2 the state of the reset and inhibit lines is determined by IC18. The output states of IC18 for reset, start and stop conditions are given in Table 1. In mode 1 these states are set up by directly setting the preset (pins 3 and 8) and clear (pins 2 and 7) inputs whereas in mode 2 the IC's are toggled from one state to the other.

Either an external push-button or the internal one, SW3, may be used to toggle IC18 through its three states. Switch contact bounce is eliminated by RS flip-flop IC17.

In mode 3, IC18 is locked into "start" by SW2/1. IC20 and IC21 are monostables that provide, when triggered, a single, one-microsecond-wide, pulse which goes from 'high' to 'low' and back to 'high'. As the two monostables are in series, IC21 provides its pulse at the end of that from IC20. The first pulse controls the display stores, and the second pulse resets the counters to zero. Thus when the button is pressed, IC20 provides a strobe pulse that transfers the contents of the counter to the store. The store then closes and the second pulse from IC21 resets the counters to zero; the contents of the store, however, are retained and displayed until the next time the button is pressed. In modes 1 and 2 IC20 is inhibited by an earth on pin 5 from SW2/2.

The power supply is a series pass regulator type and will accept input voltages within the range six to 16 volts whilst providing the correct output of five volts. Correct operation will be maintained on batteries down to about five volts but display brilliance drops off. Diode D1 is used to prevent damage from reversed input polarities.

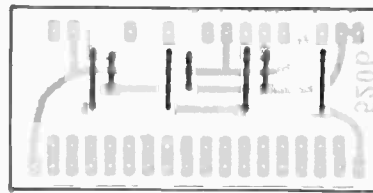
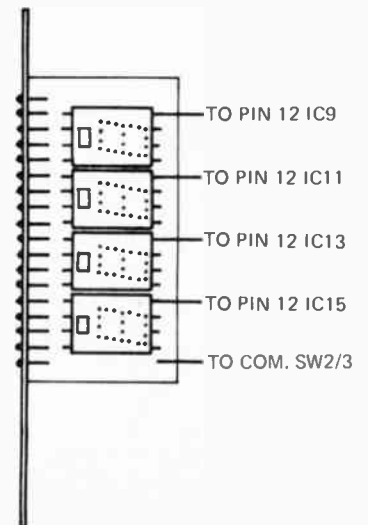

Fig. 6a. Links must be inserted as shown on component side of board before displays are fitted (26 gauge tinned copper). 6b. The displays are mounted as shown with the chip towards bottom of board.



mounted on a separate aluminium bracket as per Fig. 14. It too must be insulated from the bracket by a mica washer and insulation bushes. Connection to the collector of the 2N3055 is made by fitting a solder tag under one of mounting bolts. The three connections to the 2N3055 are made by flying leads to the board as per the overlay Fig. 4.

Next fit tinned copper links and then the display ICs to the small display board as per Fig. 6. When the display chip is viewed at a particular angle, the approximately 3mm square IC chip can be seen through the red plastic front lens. This should be positioned towards the bottom of the display board to obtain correct orientation.

The display board is attached to the main board by tinned copper wire links (26 SWG). The easiest method of linking is to begin with a separation of about 12mm between the boards and sew the two boards together with a length of tinned copper wire. Then

pull the display board down onto the main board making sure the display board is vertical. Solder the wires in place and snip off the excess wire.

Now mount the switches, power socket, PC board assembly and 2N3055 and bracket (if used) to the chassis and interconnect as per Figures 4, 5, and 7. The displays are mounted well back in the body of the timer to allow good visibility in daylight.

A viewing duct should be constructed from light cardboard (manilla folder) as per Fig. 11. The inner surface should be painted matt black and a piece of polarized plastic (as per Fig 12) inserted in the duct where indicated by the slot markings.

### USING THE TIMER

The timer draws around 700 mA and therefore, should be operated from a

car battery (or similar) supplying a minimum of 6 volts and a maximum of 16 volts.

Although the timer operates extremely well as a hand operated stop watch, the major advantages of the unit are only realized in lap timing (which does not require further explanation) and in the remote start/stop mode. In this latter mode the full accuracy of the unit is realized by using light-beam (or other electronics) start/stop control.

A typical light beam set-up is illustrated in Fig. 15, and a suitable transistor detector/amplifier in Fig. 16. A certain amount of mechanical work is required, as the light output of the globe must be focused into a parallel beam by a lens. A lens in the receiver must also be used to focus the

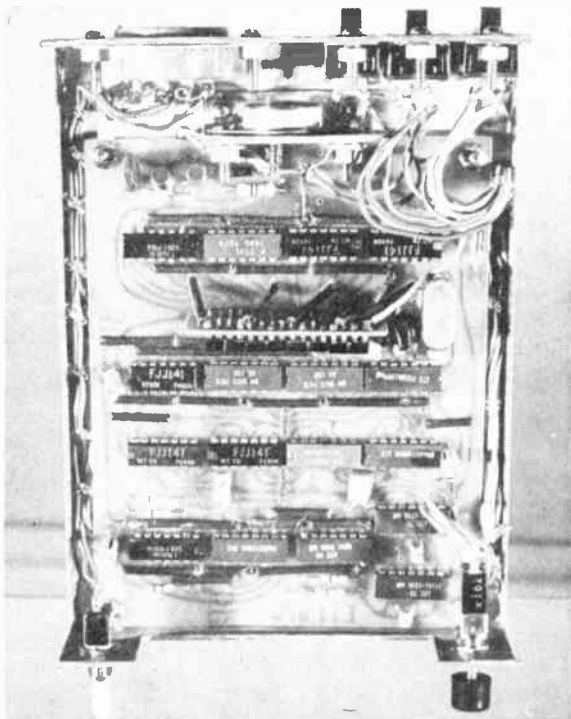

Internal view of the stop watch.

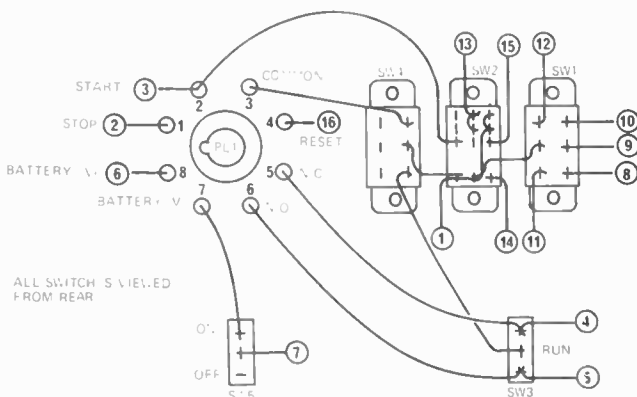

Fig. 7. Wiring to switches and power/control socket.

**HEWLETT PACKARD**  
 22-26 Weir St., Glen Iris, Vic. 3146. Tel. 20 1371

Special offer — 4 Only 5082-7302 LED displays as used in ET1 520 Digital Stop Watch \$44.16 tax paid. Offer expires 3rd January 1974.

Send this coupon to Hewlett Packard

Name .....

Address .....

.....

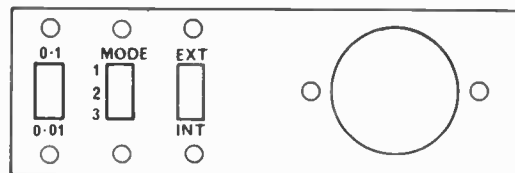

Fig. 8. Rear panel layout.

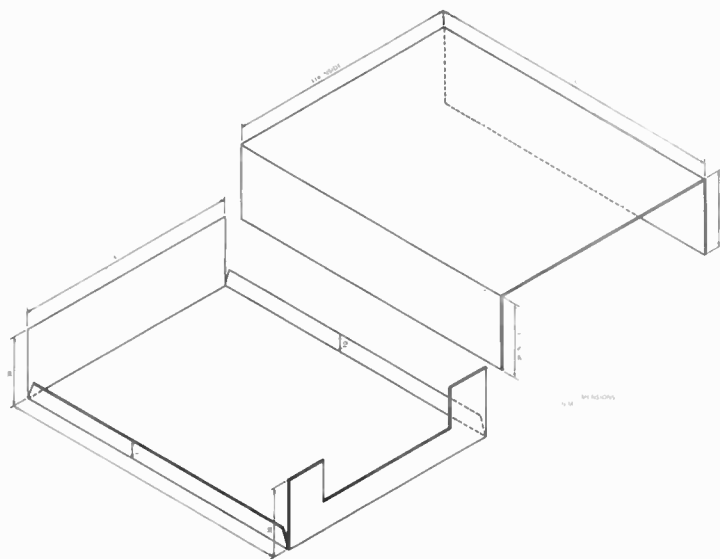

Fig. 9. Case dimensions.

**Wouldn't it be nice if you could get one of National's new LM 321 pre amps plus one of their famous LM 308 op amps to use with it, plus data sheets and application notes all in one swell Designers Kit for 1/3 off—only \$4.95?**

**Guess what?**

<b>1/3 off</b>	<b>1/3 off</b>
<p>To get your Designers Kit for only \$4.95 with data sheets and application notes, call or take this coupon to your nearest franchised National Semiconductor distributor (listed below). Do not mail to N. S. Electronics Pty. Ltd.</p>	
Name _____	Title _____
Company _____	
Street _____	

**NATIONAL**

**Swell  
Designers Kits  
Here**

Victoria — Radio Parts Pty. Ltd.  
N.S.W. — Pre-Pak Electronics  
Electrobit  
Professional Electronic  
Queensland — N. S. Electronics

30 1251  
797 6144  
667 4611  
28 6287  
70 8097

Tasmania — Medhurst  
S.A. — Gerard & Goodman  
W.A. — Moncrief

34 5511  
23 2222  
25 5722

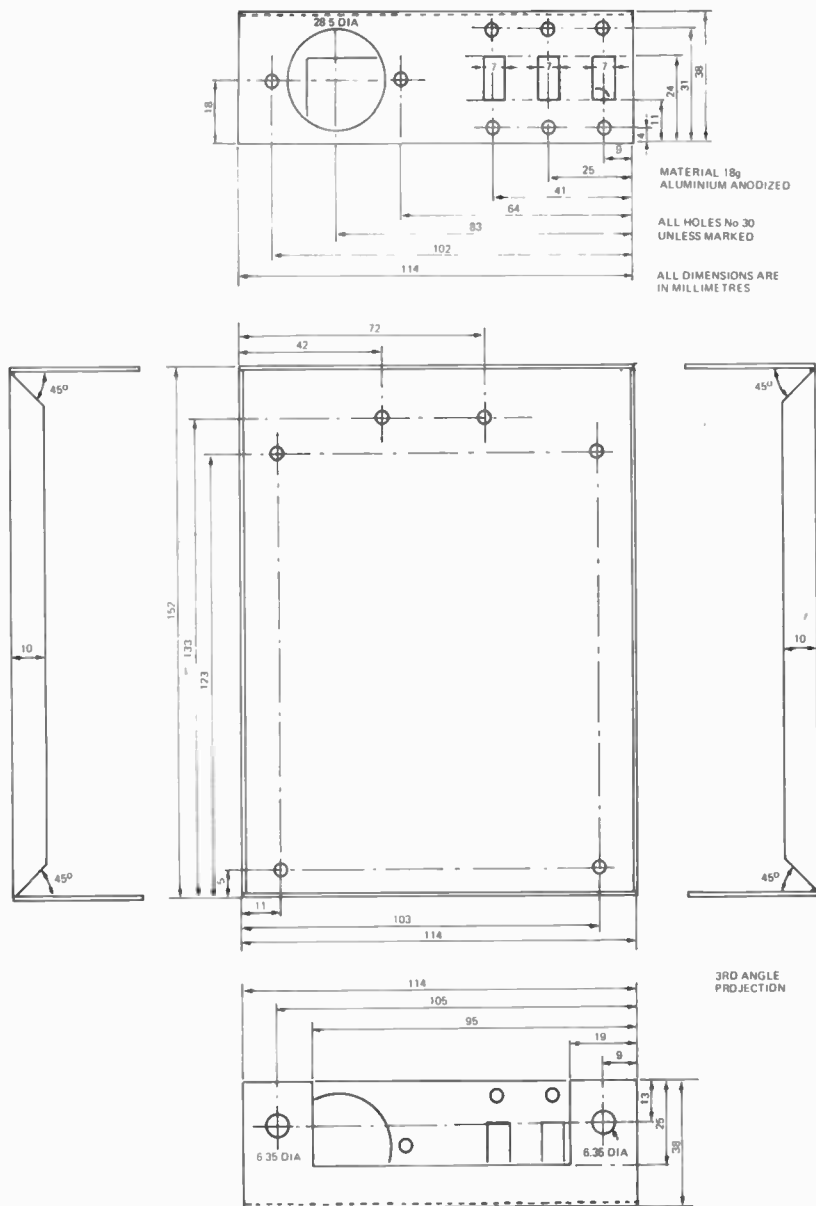
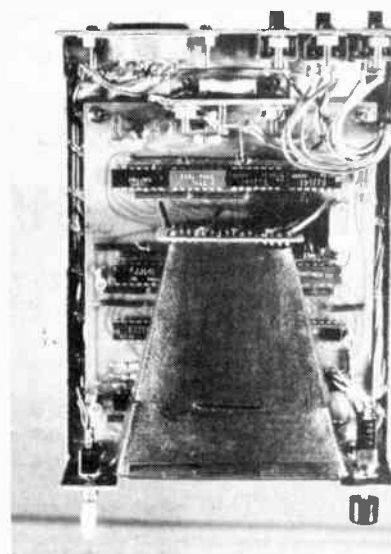

Fig. 10 Drilling details of chassis.

light onto the "active spot" of the photo-transistor. A light shield should extend in front of the receiver lens to prevent operation of the detector due to sunlight etc.

After the transmitter and receiver are mechanically aligned the 100 k potentiometer should be adjusted to provide about 1.5 volts across the photo-transistor. When the beam is broken the voltage across the photo-transistor should rise to four volts or more. Almost any available NPN photo-transistor may be used.

(Continued on page 102)



The viewing tunnel in position.

Fig. 11. Viewing tunnel is made from cardboard. Inner surface should be painted matt black to avoid reflections

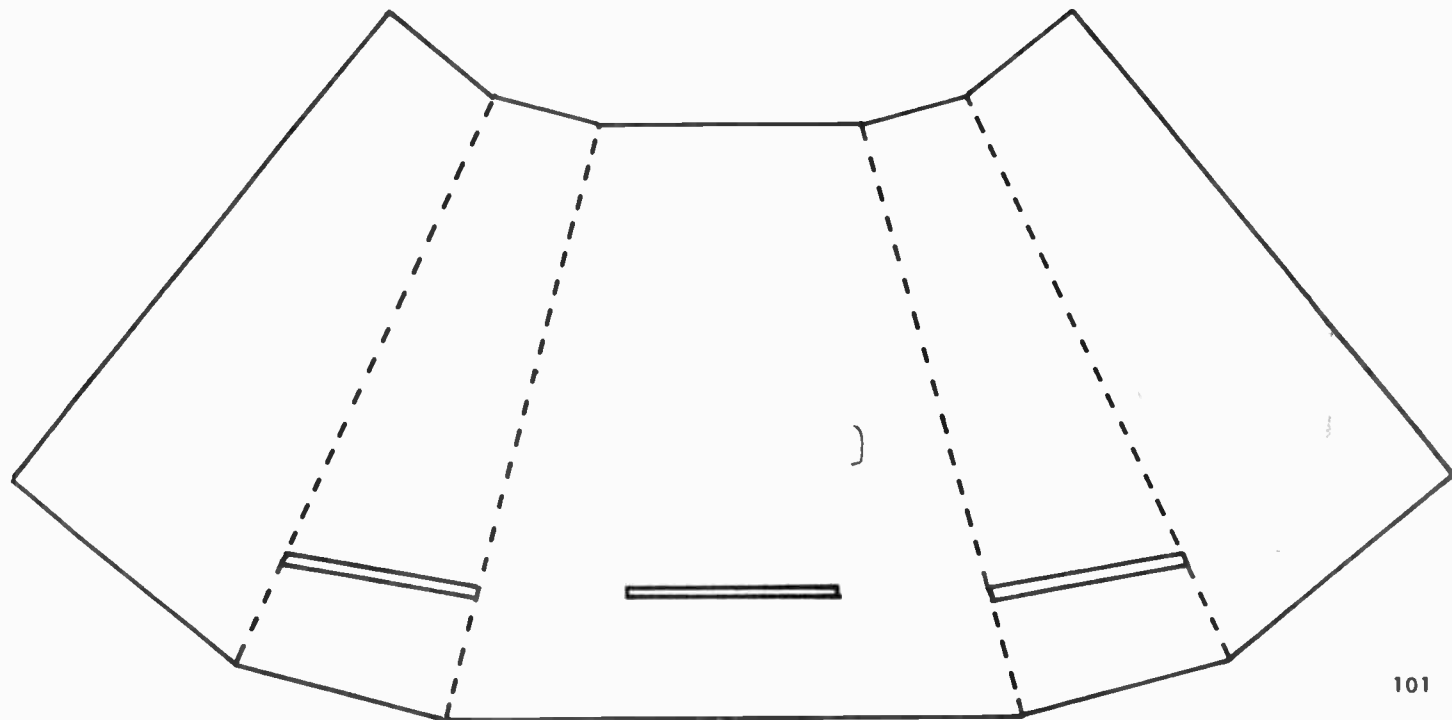

**PARTS LIST**

R1, R2 resistor 1.5 k 1/2W 5%  
 R3, resistor 100 ohm 1/2W 5%  
 R4, resistor 1 k 1/2W 5%  
 R5 resistor 470 ohm 1/2W 5%  
 R6 resistor 330 ohm 1/2W 5%  
 R7-R11 resistor 10 k 1/2W 5%  
 C1 capacitor 33 pF ceramic  
 C2, C3 capacitor 0.047pF polyester  
 C4, C5, C11 capacitor 0.001uf polyester  
 C6, C7, C8 capacitor 4.7pF 10V tag electrolytic.  
 C9 capacitor 100 pF ceramic  
 C10 capacitor 1pF 10V tag electrolytic.  
 Q1, Q2 transistor BC178 or similar  
 Q3 transistor 2N3055 or MJE3055  
 D1 diode EM401  
 ZD1 zener diode BZY88C4V3  
 IC1, IC17, IC19 integrated circuit 7400  
 IC2, IC8 integrated circuit 7473  
 IC3, 4, 5, 6, 7 integrated circuit 7473  
 IC9, 11, 13, 15 integrated circuit 7490  
 IC10, 12, 14, 16 integrated circuit HP5082-7302  
 (see coupon)  
 IC18 integrated circuit 7476  
 IC20, 21 integrated circuit 74121.  
 Note that the prefix of 74 series ICs depends on manufacturer.  
 XTAL 1 Crystal 4 MHz 30pF capacitance  
 PC boards ET1 520A and ET1 520B.  
 SW1 switch DP DT slide  
 SW 2 switch 3P3T slide  
 SW3 switch SPDT push button  
 SW4 switch SPDT slide  
 SW5 switch SPDT toggle  
 Metal box to Fig. 10. Heatsink to Fig. 14 (if required) 8 pin octal valve base, piece of polarized plastic (preferably circular polarization) as per Fig 12.  
 4 1/4" long spacers for PC board (3 only if MJE 3055 is used).

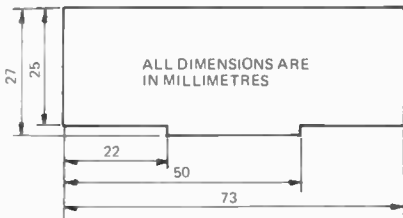

Fig. 12. Dimensions of polarized plastic window (fitted in slots of viewing tunnel).

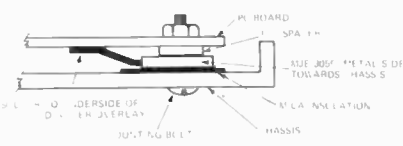
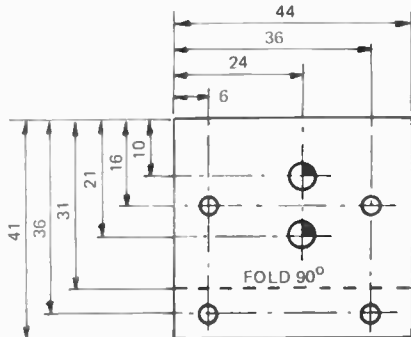

Fig. 13. Mounting details of MJE 3055.



ALL DIMENSIONS ARE IN MILLIMETRES  
 ○ 4 HOLES No 30  
 ● 2 HOLES 5 mm DIA

Fig. 14. Heat sink (if required) for 2N 3055

**TABLE I**

**STATES OF IC18**

	PIN 10	PIN 11	PIN 14	PIN 15
RESET	1	0	1	0
START	1	0	0	1
STOP	0	1	1	0

note that 1 means > 2.8 V, 0 means < 0.8 V

**TABLE II CONNECTIONS FOR DIFFERENT RESOLUTIONS**

RESOLUTION (SECS)	MAXIMUM & INDICATED TIME	CONNECT TIME BASE OUTPUT (SW 1/1) TO	CONNECT DECIMAL POINT TO
* 0.1	3999.9 secs	PIN 12 of IC7	PIN 4 of IC16
* 0.01	399.99 secs	PIN 12 of IC6	PIN 4 of IC14
0.001	39999 msecs	PIN 12 of IC5	NO CONNECTION
0.0001	3999.9 msecs	PIN 12 of IC 4	PIN 4 of IC16
0.00001	399.99 msecs	PIN 12 of IC 3	PIN 4 of IC14
0.000001	39999 μsecs	PIN 12 of IC2	NO CONNECTION

\* Standard on stop watch as published. All ranges may be included by using a rotary switch in place of SW1.

Note: An additional error of ±1/2 digit occurs on 1 μsec range. In laptime mode 3, IC20 and IC21 contribute a 2 μsec delay. Mechanical switches are not suitable for very short resolutions, electronic means must be used.

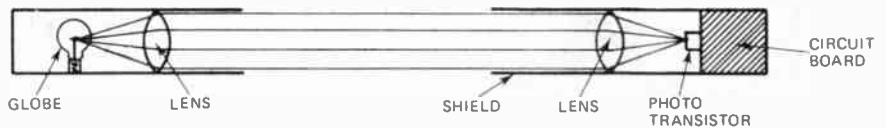

Fig. 15. Arrangement of light beam transmitter and receiver.

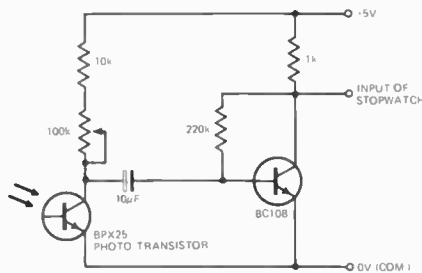

Fig. 16. Circuit of a suitable light-beam detector for electronically controlled stop watch.

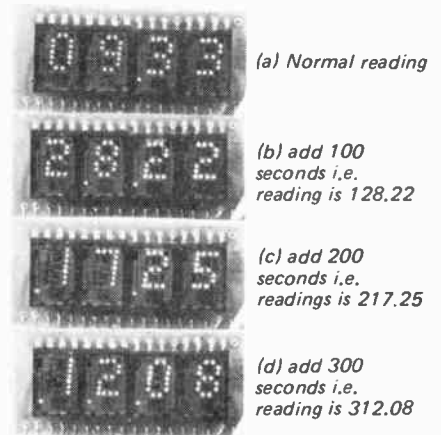

Fig. 17. Method of extending timing range.

**TABLE III**

1ST POINT	2ND POINT	READING	
OFF	OFF	as indicated	(a)
OFF	ON	add 100 seconds	(b)
ON	OFF	add 200 seconds	(c)
ON	ON	add 300 seconds	(d)

The four-digit display is capable of reading to 99.99 seconds (0.01 sec resolution) after which it recycles to zero and commences a new cycle. The maximum reading however is extended to 399.99 by using the two leftmost decimal points to count display cycles.

The count cycle is given in Table III and Fig. 17 where the decimal points are numbered from left to right.

When on 0.1 second resolution the maximum displayed time is 999.9 seconds and thus 1000, 2000 or 3000 seconds must be added as appropriate.

# There's more to mid-range frequencies than meets the ear.

The graphic illustration below represents the typical frequency response expected in a good hi-fi system. A large proportion of the sound can be classified as mid-range and to hear this sound at its best a well engineered mid-range speaker is essential.

The new Plessey C6MR has been specifically designed to handle mid-range sound with excellent performance from 450 Hz to 6600 Hz and sharp roll off beyond these frequencies.

Adding the C6MR to your existing speakers and installing recommended crossover components will result in a superior 3-way speaker system. Alternatively, new 3-way speaker systems can be built based on the C6MR and any desired combination of Plessey C80, C100, C12P and 12U50 woofers and X30, C3GX and 5FX tweeters.

Plessey Crossover Inductors SOL36 and SOL42 are available to ensure extremely smooth response and minimum distortion at crossover points. With Plessey components you can

assemble high-performance multi-speaker systems that will appeal to the most discerning ear. Full application notes are available from Plessey Rola distributors or Plessey Rola direct.



## PLESSEY Rola

Plessey Rola Pty. Limited.  
The Boulevard, Richmond,  
Victoria. 3121.

Melbourne, Telephone 423921  
Sydney, Telephone 720133  
Adelaide, Telephone 422920

Perth, Telephone 687111  
Brisbane, Telephone 700097

### C6MR Mid-range

Frequency response  
450 Hz to 6600 Hz  
Voice coil impedance  
8 or 15 ohms  
Power Handling 20  
watts RMS with  
recommended cross-  
over  
Speaker Diameter  
6-9/16"

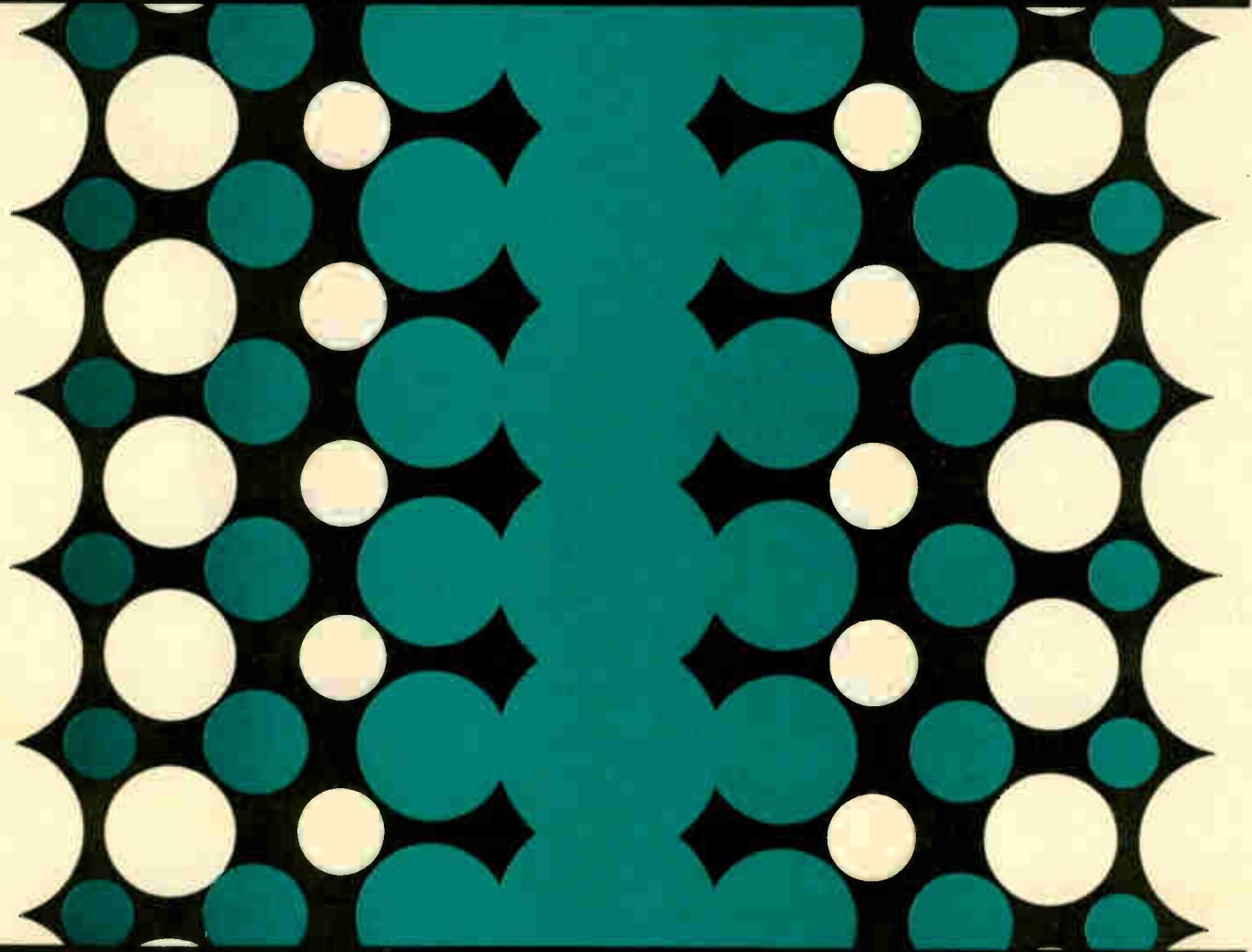
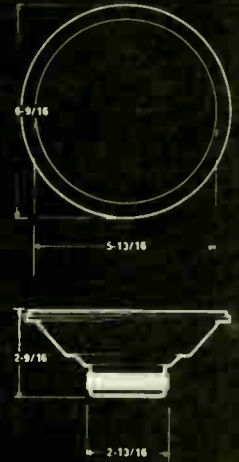

Low Frequencies

Mid-range

High Frequencies

Distributors: N.S.W. General Accessories, Lawrence & Hanson Pty. Ltd. VIC. General Accessories, Lawrence & Hanson Pty. Ltd. Radio Parts Pty. Ltd. QLD. General Accessories, The Lawrence & Hanson Electrical Co. (Old) Ltd. S.A. General Accessories, Gerard & Goodman Pty. Ltd. W.A. General Accessories, Atkins Carlyle Ltd. TAS. W & G Genders Pty. Ltd. Homecrafts Tasmania. N.Z. Plessey (N.Z.) Limited, Rata St. Henderson, Auckland.

AR54

# You don't need another lecture on Dolby just facts

The freedom from noise gained with the 'Dolby' system has meaning only if each and every part of the machine is designed and built to the highest standards of mechanical and electronic excellence, as all four Technics 'Dolby' cassette decks are.

To complement the Dolby system, RS279US, RS276US, and RS271US incorporate the exclusive H.P.F. \*\* head, which ensures superb high frequency reproduction. (10 year guarantee). The RS279US boasts of being the world's first 3 head cassette deck.

Additionally RS279US and RS276US have two motors, one of them a Direct Drive brushless low speed motor.

No belts, idlers or clutches so the deck is free from unevenness and vibrations. Wow and flutter is a low 0.10% WRMS.

Naturally all four Technics 'Dolby' cassette decks have CR02/Normal tape selector, automatic stop, memory rewind, lockable pause control and all the other advanced features that contribute to outstanding sound reproduction.

The fact is at least one Technics 'Dolby' cassette deck will fill your needs.

RS 276 US



RS 279 US



RS 263 US

RS 271 US



## Technics



DOLBY SYSTEM



Guaranteed and serviced across Australia by HACO

\* Under licence from Dolby Laboratories Inc. \*\*Trademark

WTGD13N



# A NEW low cost CRO for colour TV servicing



**\$430**  
DUTY PAID

## 10 MHz ADVANCE OS250TV Dual Trace Oscilloscope

### BRIEF SPECIFICATIONS

**Display:** 5 in flat faced CRT giving 10cm x 8cm display EHT — 3.6 kV overall. Phosphor — P31. Long persistence (P7) available as an option.

**Vertical Deflection:** Two identical input channels. Y1 and Y2. Bandwidth (—3dB) DC—10MHz. Sensitivity 5mV/cm to 20V/cm in 1-2-5 sequence. Input Impedance 1 M $\Omega$  / approx. 28 pF. Input coupling DC—GND—AC.

**Display Modes:** Single Trace Y1 and Y2. Dual Trace chopped or alternate modes, automatically selected on timebase switch. Chop rate approx. 250kHz. X-Y mode with Y1 input giving X deflection and Y2 input giving Y deflection. Bandwidth DC to 500kHz  $\pm$  3 $\circ$  phase shift at 20kHz.

**Horizontal Deflection: Timebase** — 1 s/cm to 0.5s/cm in 18 ranges (1-2-5) sequences. X Expansion —X10 pull switch gives fastest speed of 100 ns/cm. Variable control gives 2.5:1 reduction in sweep speed.

**Trigger:** Variable level control with option of bright line in absence of signal. Source Internal Y1 + or —  
Y2 + or —  
External + or —

**Coupling AC, AC fast TV Frame. Sensitivity Internal 2mm approx. 40Hz-2MHz. External 1V approx. 40Hz-2MHz. Internal 1cm approx. 8Hz-10MHz. External 5V approx. 8Hz-10MHz.**

**Additional Facilities:** Calibrator 1V  $\pm$  2% square wave at supply frequency. Dimensions .18cm(7") x 29cm(11 $\frac{1}{2}$ ") x 42cm(16 $\frac{1}{2}$ "). Approx. 7 kg.(15 lb).

**Optional Accessories:** Probe Kit PN 32824. A passive probe kit with X1 and X10 attenuations. With X10 attenuation input impedance is 10M $\Omega$  /13.5pF. Viewing Hood PN A1/32264.

The Advance OS250 Oscilloscope is a 10MHz Dual Trace instrument with a 10cm x 8cm display. It is designed for use in general purpose laboratory work, educational use and TV and servicing applications.

It features two identical input channels with a maximum sensitivity of 5mV/cm and a bandwidth of DC to 10MHz. The two channels may be viewed separately, alternately at fast timebase speeds, or chopped at a 250kHz rate at low timebase speeds.

Particular attention has been paid to trigger performance, and the system used includes a variable control with bright line operation in the absence of a signal, or when the trigger level is outside the range of the input signal.

Distributed by:

**JACOBY**   
**MITCHELL**

215 North Rocks Rd., North Rocks, N.S.W. 2151. Phone: 630 7400  
• Melbourne — 41 7551 • Adelaide — 93 6117 • Brisbane — 52 8266  
• Perth — 81 4144 • Canberra — 95 9138

# SENSORS ON

Observations about science and technology — by Talus.

THE world is reality. Our actions exist, our knowledge is related to *physical* existence — that is what endeavour is about. Yet we are continually bombarded with the feeling that academia is best, hand-skills and actually doing-things rate second best. After all, salaries reflect this. But we must not lose sight that practice is essential to progress as is guidance and theorising. Do we have the right mix of practice and theory?

Looking back into history we find that practitioners have periodically passed into and out of public favour whilst academicians have enjoyed reasonably steady acceptance. Even in

Mayan times the priest astronomers had grades of hands-on acceptance. The 'observer-in-chief' was forbidden to be physically concerned with the dangerous instruments of the then crude science. The ancient Greeks did build many devices of engineering science but historians regard them generally as regarding all things explainable using native-born brain-power — the brain needed little observation to assist. The Romans were little better, their instrumentation was devised to fulfil everyday needs of building, in the main.

It was not until the time of Bacon (in the 17th century) that experimental philosophy became respectable. He suggested that nature needed to be discovered by physical contact as well as by studious pondering.

Practice continued to be part and parcel of scientific research — in the latter days of the 17th century famous scientists worked hand-in-hand with the craftsmen of the time. Today the same relationship exists to some degree but there is still a professional versus trades attitude. There are too many higher echelon people who regarded instrumentation as a lowly job suited only to tradesmen and technicians — it appears they feel there are no real taxing problems there that need a longer trained person. But to solve many instrumentation problems we need a combined effort of both.

Coming back to the need for practice it is interesting to consider the number of significant advances that have resulted as the result of chance situations occurring during practical endeavour. The dull-emitter used in high efficiency thermionic valves was discovered by experiment — it is said we still do not know why such emitters are better than other substances.

The economic production of cheap steel was the result of a chance observation made by Bessemer during his experimental trials on pig-iron. Men of the time knew that controlled carbon content was the answer but no-one could device a cheap way to

control it until Bessemer hit upon the concept of blowing air through it — by chance.

During a class demonstration of electric discharges (about 1880) Elihu Thomson accidentally welded the leads together. His prior practical experience immediately yielded the realisation that electric welding was possible. No doubt many others had experienced this but no-one had pursued its possibilities.

I think everyone has heard of how Rontgen accidentally discovered X-rays; and Madame Curie, radio-activity. Other examples of accidental discovery are silver iodide photography developed by mercury vapour, penicillin noticed as contaminated moulds.

This element of chance still exists today. New forms of linear motor (the oscillating kind and the new 'magnetic-river' combining suspension with propulsion), electrostatic-cooling, the Wiegand effect; all these have emerged as chance discoveries of the past two decades.

Those who feel practice is beneath them, or not necessary to progress, should ponder on these discoveries. They were each born as the combination of an alert pre-trained mind being practically applied, at depth to problems. They did not emerge as the result of purely studious paper studies. The continued occurrence of such discoveries suggests there are many more to find. Perhaps someone will hit upon an anti-gravity device, discover what magnetic field-lines really are, or how to convert solar energy into electricity at low cost. Such discoveries could revolutionize our ideas and engineering practice.

The main lesson to remember is to follow-up those seeds of ideas we practitioners are always uncovering. Remember, no matter how small they appear to be, they may lead to a significant discovery. Have you neglected to take some of these ideas further in order to see what results — or did you give up when the others laughed? ●

## RADIO CONTROL



**HELICOPTERS AIRCRAFT  
CARS BOATS**  
COMPLETE RANGE OF:  
**MOTORS, ACCESSORIES,  
KITS, BALSA**

Manufactured of SILVERTONE digital proportional radio control equipment. Light industrial radio control applications also catered for.

**SILVERTONE  
ELECTRONICS**

UNIT 6, No. 2 SCHOFIELD ST.  
RIVERWOOD, NSW. 2210  
Phone 533 3517  
Price list available. S.A.E. 9 x 4  
(12 cents).

# ILLUMINATED FIBRE PRODUCTS

You can now build your own changing color glass fibre optic lamp

**SAVE UP TO \$100**

We can supply the Hobbyist with the Glass Fibre Sprays, Transformers, Quartz Halogen lamps, Electric motor with a reduction box, color wheels, Electric blowers, Lamp holders etc. with instructions on assembly, ready to be mounted into your own box

Suggested Retail \$75 for complete set.

All parts available from KIMBERLEY PLASTICS PTY. LTD. Melbourne or the distributors listed below.

**ILLUMINATED FIBRE PRODUCTS** have now released 2 new models, that change color automatically so ask for them at your nearest distributor.

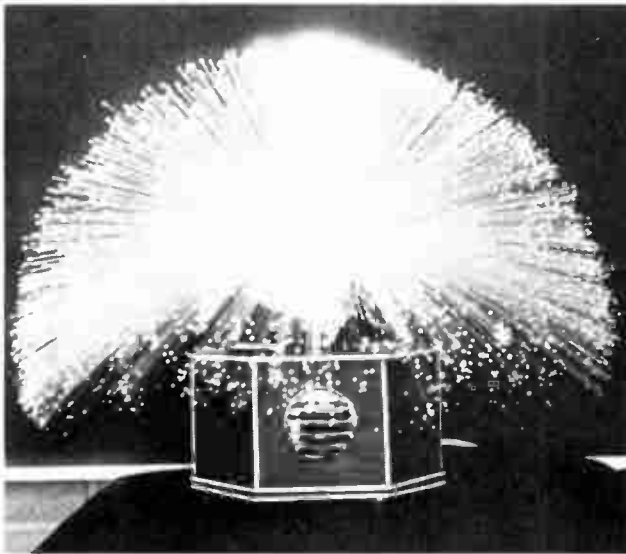

**KIFP/4 CORALITE** a brilliantly strong automatically changing 7 color display lamp that has a 15 m/m fibre glass spray, quartz halogen lamp, electric cooling fan and mounted in an attractive wood-grained hexagonal sided base. Fitted with a special safety thermal overload switch.  
Suggested Retail \$125.

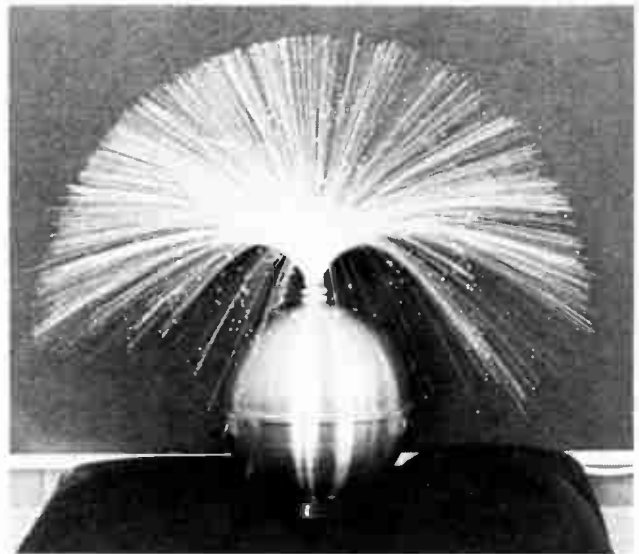

**KIFP/3. STARDUST** a beautiful delicate auto changing color lamp — with a 9 m/m glass fibre spray on a 6½" diameter sphere anodised base, red, gold or blue.  
Suggested Retail \$70.



#### *Distributors*

**NEW GUINEA** Hagen Electrics Pty Ltd, P.O. Box 100 Mount Hagen New Guinea, Phone: 521 562.

**NEW SOUTH WALES** Remfrey Bros. 1/97 Cremorne Rd, Cremorne N.S.W. 2090. Phone: 90 6716.

**VICTORIA** Radio Parts Group, 562 Spencer St, West Melb. Vic. 3003. Phone: 30 1251.

**Dorward Enterprises Pty. Ltd.** 56 Levenswell Rd, Moorabbin Vic. 3189. Phone: 95 4633.

**QUEENSLAND** Ace Plastics (Aust) Pty Ltd, 29 Hayward St. Stafford, Queensland 4053. Phone: 56 3041

**WEST AUSTRALIA** Cox Distributors, 509 Charles St, North Perth Phone: 21 6510.

**KIMBERLEY PLASTICS PTY. LTD.**

CNR. SOUTH ROAD & ALEX AVENUE, MOORABBIN, VICTORIA 3189

CABLES: KIMPLAS MELB.

# Announcing the second Cassette Revolution

# TDK

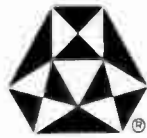

## The audio tape with **MAGNETITE\***

\* **mag-net-ite** (mag'nə-tit) *n.* A massive, granular, isometric, black iron oxide,  $Fe_3O_4$ ; lodestone; an important ore of iron. [**<MAGNET + -ITE!**] — **mag-net-ite's** (-tīt'ik) *adj.*

The Collins dictionary

Magnetite is the first magnetic substance recorded in history — Lodestone. Because TDK was founded in 1935 by a group of engineers who developed a new iron oxide compound ferrite, TDK research has now been able to develop an entirely new recording material from Magnetite which produces the best recorded signal on tape possible today. TDK have named this new tape Extra Dynamic as it is manufactured specifically for the Audiophile who requires reel-to-reel performance from a cassette recorder.

ED is capable of reproducing satisfactory signals from 20 to 23,000Hz; The noise level and harmonic distortion is so low, and the level of recording possible without distortion is so high, that hiss reduction systems involving boosting and filtering are not necessary.

*Sole Australian Agents*

## CONVOY IMPORTS

Division of Convoy International Pty. Ltd.,  
84 Nicholson Street, Woolloomooloo, Sydney;  
Phone: 357-2444

In spite of its high performance it requires only normal types of bias and erase. Its frequency response is virtually flat from the lowest to highest frequency. It will make even low priced recorders sound greater than they do with TDK SD. Available in C40 — \$3.80, C60 — \$4.80 and C90 recommended list.

TDK also manufacture the famous SD (Super Dynamic) tape in both reels and cassettes and TDK low noise tape in reels and cassettes, regarded as the best value for money of any tape manufactured in the world. TDK tape also available in SD and low noise cassettes, reel tapes and endless cassettes.



### DISTRIBUTORS:

**N.S.W.** Convoy International Pty. Ltd.,  
Cnr. Plunkett & Maclean Streets,  
Woolloomooloo. 2011.  
Phone 357 2444

**VIC.** K.J. Kaires & Co. Pty. Ltd.,  
4 Hill Court,  
Macleod. Vic. 3085  
Phone 459 2344  
Australian Musical Industries Pty. Ltd.,  
155 Gladstone Street,  
South Melbourne. Vic. 3205.  
Phone 69 7281  
Ralec Wholesalers Ltd.,  
404 George Street,  
Fitzroy. Vic. 3065  
Phone 560 8377

**QLD** C.A. Pearce & Co. Pty. Ltd.,  
74-76 Bowen Street,  
Brisbane, Qld. 4000.  
Phone 21 4944

**WA** Arena Distributors (Australasia) Pty. Ltd.,  
Romney Building,  
273 Hay Street East,  
Perth. WA. 6000.  
Phone 25 9993

**SA** Truscott Electronics Pty. Ltd.,  
62-64 Hindmarsh Square,  
Adelaide, SA, 5000.  
Phone 23 3024, 23 3275

**TAS.** W. & G. Genders Pty. Ltd.,  
(Head Office)  
53 Cameron Street,  
Launceston. 7250.  
Phone 31 2511

69 Liverpool Street,  
Hobart. 7000.  
Phone 34 4311

Speed Street,  
Coee. 7320.  
Phone 31 2344

3 Edward Street,  
Devonport. 7310.  
Phone 2 1921

## SHAPE OF THINGS TO COME?



The Concept 4X Allegro from the USA's Zenith Radio Corporation reproduces four-channel discrete discs, 8-track tape and FM radio broadcasts. This prototype modular music centre of the future uses touch electronic controls that light up as they are turned on, and Allegro speakers activated from across the room, by signals from infrared devices. The unit reproduces sound twelve ways. View shows stereo and four-channel instruments under flip-top thermoplastic lid.

## DISCRETE/MATRIX SENSOR

As Electronics Today International forecast nearly a year and a half ago, a device has now been developed that automatically distinguishes between discrete and matrixed records and switches the correct decoding circuit into use.

The new device, developed by Japan's Onkyo Corporation, is also said to be capable of detecting the difference between SQ and RM matrices.

Other Japanese manufacturers are believed to be working along similar lines and reports indicate that such systems will be incorporated in their 1974 model range.

## FOUR-CHANNEL CASSETTE RECORDER

An eight-track, four-channel cassette deck has recently been developed by JVC. It was shown publicly for the first time at the recent Consumer Electronics Show in Chicago.

The new unit is based around the 'Cronios'

head. This has been engineered with sufficient precision to record and replay signals from each of eight separate tracks on 0.15" wide cassette tape.

According to Karl Kohda, tape recording engineer of JVC's parent company – the Victor Corporation, the new unit is compatible with standard two-channel and even mono cassettes.

The special cassettes required for the new unit – the 4CD-1680 – will be made by the Victor Company, and will be completely compatible with existing two channel recorders.

Karl Khoda told our reporter that the new unit will be on sale early in 1974 and will retail for under \$500.

## SONY USE CARBON FIBRES

Japan's Sony Corporation has developed a new range of audio components in which carbon fibre material replaces aluminium in highly stressed areas and for those components where lightness is essential.

Components so far developed include tone arms, cartridges and speaker cones.

It is understood that the new designs are at present, experimental and that no date has been set for incorporating them in commercial production.

## FOUR-CHANNEL RECORD PROBLEMS

Reports from the USA indicate that RCA are regretting their decision to market all their discs in the four-channel Quadradisc format.

As RCA's Quadradisc CD4 records are totally compatible with mono and stereo record players – as well as the discrete systems for which they were designed – it seemed to be a logical step to market one record type for all systems.

Unfortunately it just hasn't worked. Record dealers all over the States have placed the RCA discs in that part of their display reserved for four-channel records – but have not placed duplicate copies in their standard stock racks! The effects on sales can be imagined.

Apart from that, many prospective purchasers could not be persuaded that records carrying a four-channel label really could be played on two-channel equipment.

Already the Warner group has decided to cut its losses and to produce stereo as well as four-channel versions of its new recordings – and to charge a premium price for the four-channel version, RCA is expected to follow suit very soon.

**As we close for press RCA have just announced that all future releases will be in separate stereo and four-channel forms.**

*Continued on page 110*

## NEW STYLUS SHAPE REDUCES WEAR

A new stylus tip shape developed by Toshiba is claimed to provide a wider frequency response than spherical styli yet avoids the shorter playing (and record) life of elliptical styli.

The new shape is stated to reduce styli wear by some 10 times – and record wear by 40 times compared with elliptical styli.

The Toshiba organisation intend to give manufacturing licences to interested cartridge manufacturers – with the proviso that the name 'Extend' is marked on the product.



# AUDIO NEWS

## HMV FOUR CHANNEL SOUND



His Master's Voice have recently launched their Series 4-40 Quadraphonic Sound System. Incorporating an SQ decoder the new system has been designed and manufactured in Australia. The system is capable of playing all mono, stereo and matrix records.

## SPEED LISTENING

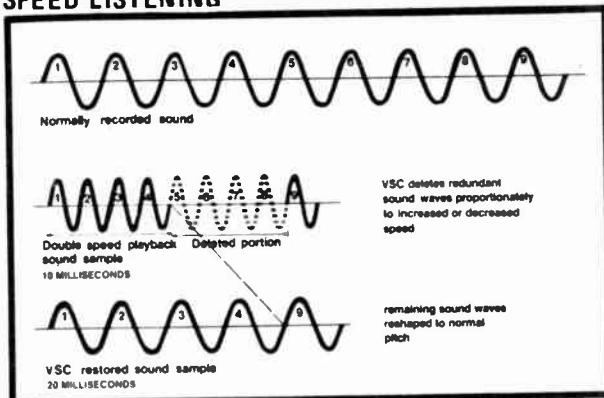

A new low cost tape playback system that compresses speech up to 2½ times normal speed with no change in pitch or tone has been incorporated into the Copycorder family of portable cassette recorder/player/copiers, developed by Magnetic Video Corporation of Farmington, Michigan, USA.

Equipped with variable speech control, Magnetic Video's new model CC-103 Copycorder can slash listening time by more than half, says Andre A. Blay, President of the company, enabling people to acquire information and communicate with each other better, faster and easier.

To date, explained Blay, people, especially educators, have been frustrated in their desire to use compressed speech. They have had to send their originals away to have a compressed version made which was costly and time consuming. Or they have had to

buy expensive compressed speech playback-only machines, which usually meant the listener was tied to the machine, at the machine's convenience. With Copycorder, the teacher can give a student a compressed tape cassette copy which the student can then play on any regular cassette tape player.

In compressing speech, the VSC unit samples systematically. It is not selective to pauses and long vowel sounds only. Just as a reader learns to speed read at 400-600 words per minute, with training, people can "speed listen", at three to four times normal speed.

Tests have shown that the listener retains more of the material delivered at compressed speed than if he heard it at normal speed, because listening to compressed speech forces him to pay closer attention.

# CEMA C-MOS

We know C-MOS is hard to get your hands on, that is why we  
advertise 50% of the items of the 400 series and  
75% of the 500 series EX-STOCK

*We are distributors and stockists of:*

- MOS AND BI-POLAR MEMORIES • DISPLAY AND DISCRETE LEADS
- DIGITAL-ANALOG CONVERTERS

**If you want goods in the American Market Place Get With The Strength**

21 CHANDOS STREET,  
CROWS NEST N.S.W.  
Ph. 439-4655  
Telex 22846

543 KINGS STREET,  
MELBOURNE VIC. 3001  
Ph. 3297144  
Telex 32295

2 WATSON AVE.,  
ROSE PARK S.A. 5067  
Ph. 324311

# ACTIVE FILTERS

FREQUENCY - 0.01 Hz to 20 kHz  
 ZERO INSERTION LOSS \* LOW NOISE  
 HIGH STABILITY - 250 PPM/C° \* SMALL SIZE

AUDIO - CUSTOM BUILT - TUNABLE  
 TELECOMMUNICATIONS Tx/Rx  
 STANDARD CC ITT CHANNELS AVAILABLE

TELECOM RECEIVER CURVES

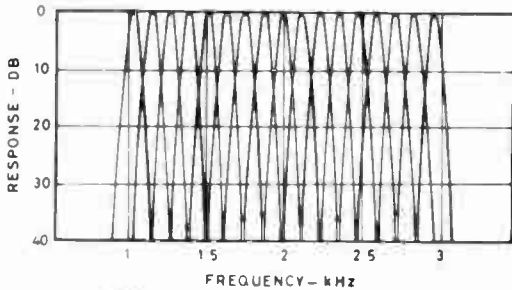

**TEKNIS** PTY. LIMITED  
 AUSTRALIA

SYDNEY: P.O. Box 635, Crows Nest, N.S.W. 2065.  
 Ph: 439-1599.  
 MELBOURNE: P.O. Box 121, Carlton South, VIC. 3053  
 Ph: 347-7039.  
 ADELAIDE: P.O. Box 45, Kingswood, S.A. 5062.  
 (Head Office) Ph: 72-2355

# VARIABLE POWER SUPPLIES

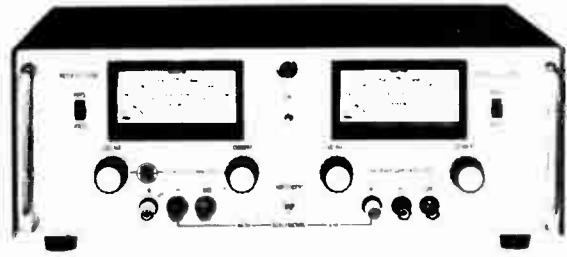

- Single and Dual Outputs
- Output Voltages to 60 Volts
- Output Current to 2 Amps
- Excellent Line and Load Regulation
- 0° to 60°C Operating Temperature
- Ten Turn Controls
- Constant Voltage/Current Limit
- Constant Voltage/Constant Current

SCIENTIFIC ELECTRONICS PTY. LIMITED

42 Barry Street, Bayswater,  
 Vic. 3153. Phone:  
 Melbourne 729-3170; Brisbane 47-4311;  
 Sydney 25-3955

# BUY DIRECT BY MAIL & SAVE \$5.69

AUSTRALIA'S LEADING MAIL ORDER TAPE & ACCESSORY SPECIALISTS



**SPECIAL  
 POST FREE  
 OFFER**

- 9 BRAND 5 PREMIUM QUALITY TAPES
  - CASSETTE CARRY CASE
  - FREE HEAD CLEANER
- Regular Value \$17.64

ALL FOR ONLY

**\$11.95**

**SEND THIS COUPON TODAY!**

**DIRECT TAPE DISTRIBUTORS**

Box 3040 G.P.O. SYDNEY, 2001, N.S.W.

I enclose cheque for \$11.95

NAME .....

ADDRESS .....

# Tandberg didn't rush out and build just another tape cassette deck



## TANDBERG TCD 300 stereo — the definitive high fidelity cassette deck

The Tandberg Series TCD 300 Stereo is an entirely new cassette tape deck which meets the specifications set forth in DIN standard 45500 for high fidelity equipment to full satisfaction. Designed and manufactured at the Tandbergs Radiofabrikk in Norway, Series TCD 300 meets the stringent quality requirements imposed on all Tandberg tape machines.

### DUAL CAPSTAN CLOSED LOOP TAPE DRIVE

This special tape handling system provides two capstan/pinch-roller systems that determine the position and orientation of the tape relative to the sound heads. This system ensures absolutely stable tape handling as well as minimum wow and flutter. Best possible results are obtained even with worn cassettes.

### THREE MOTORS

The Tandberg Series TCD 300 has three motors (one hysteresis synchronous motor and two DC reel motors). The 2 separate

winding motors make it possible to reduce the full-length winding time for a C 60 cassette to about 40 seconds.

The tape handling mechanism feature rugged design and construction to assure excellent stability and reliability. Motors turn off automatically at end of tape for both recording/playback and fast forward/rewind, and the pinch rollers disengage tape. This eliminates risk that the tape will remain under pressure or in tension while the tape deck is not in use, and thereby ruin the cassette.

### SOUND HEADS

Because the sound heads used in Series TCD 300 are made of hot-pressed ferrite, they can be guaranteed against wear throughout the service life of the tape deck.

### DOLBY SYSTEM

The Tandberg TCD 300 Stereo features a built-in Dolby noise reduction system. This system reduces tape noise by about 10 dB relative to conventional systems

and enables the Series TCD 300 to satisfy the signal/noise ratio requirements set forth in DIN standard 45500. The Dolby system is of special importance in a cassette tape machine for four reasons: tape noise is high, tapes are narrow, magnetic coatings are thin and tape speed is low. The Dolby system can be switched on and off.

### PEAK READING METERS

Series TCD 300 is provided with peak reading meters that show peak recording levels. Levels are regulated with a linear motion potentiometer. These meters also show the level of the playback signal.

### "SPEC. TAPE" SWITCH

The Tandberg Series TCD 300 is compatible with the most modern types of tape. This two-position selector switch can be set either for low noise, high output (LH) tape and for chromium dioxide (CrO<sub>2</sub>) tape.

CrO<sub>2</sub> switch position makes all four adjustments necessary for optimum recording with this kind of tape: record

equalization, record bias, play equalization and erase current.

- Complies with high fidelity specifications set forth in DIN standard 45500.
- Hot pressed ferrite heads.
- Dolby noise reduction system.\*
- 3 motors provide fast forward/rewind and precise record/playback.
- Hysteresis synchronous drive motor.
- Dual capstan closed loop ensures ideal tape handling and maximum stability.
- Two illuminated peak reading equalized recording and playback indicators.
- Minimum wow and flutter.
- Low Noise/CrO<sub>2</sub> Tape Switch.
- Electronic Controls.
- Microphone preamplifiers.
- Linear motion potentiometers for input levels.
- Automatic endstop.
- Wall mountable.
- Horizontal or vertical use.

— quality that can last a lifetime — all inquiries write or call into . . .

# KENT HI-FI

(WHERE THE BEST EQUIPMENT COSTS LESS)

432 KENT STREET  
SYDNEY

ph: 29-2743



# SURUGA CASSETTE RECORDER STEREO AMPLIFIER SYSTEM

WITH AM RADIO AND BUILT-IN DIGITAL CLOCK WITH TIMER

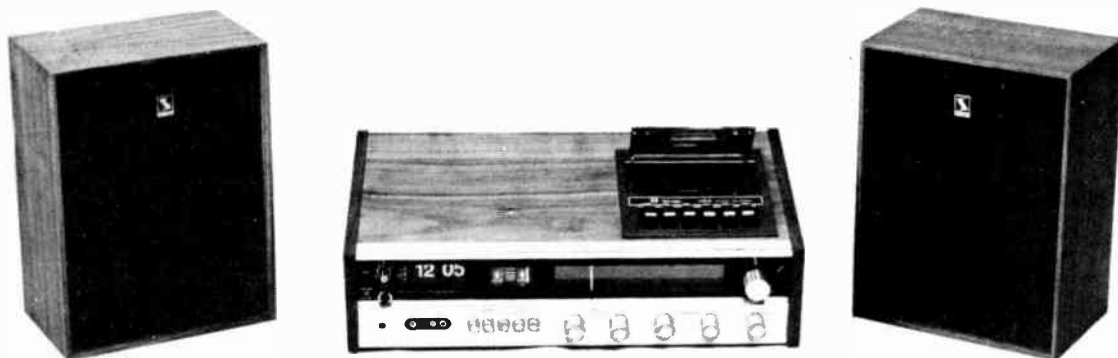

Model SE4308

The system is a combination high quality deluxe AM receiver; a Stereo amplifier for record reproduction, a precision stereo cassette recorder with a digital clock and a timer, and a matched pair of dynamic microphones. It is designed for optimum re-production of program material from Radio Broadcasts, Cassette Phonographs and any other Audio Source. Full facilities are provided for recording directly from radio receiver, live program from microphones, external equipments such as record players, 8 track cartridge players, etc. For your added pleasures and conveniences, AUTOMATIC RECORDINGS, WAKE UP and GOOD NIGHT SLEEP services can be made.

- Total Power Output: 15W(1HF) 10W (RMS @ 8 ohm .8% distortion)
- Frequency Range Tuner: AM 535-1605 Hz
- Frequency Response: 20-20,000 Hz at -3dB or less
- Stereo Separation: 30 dB
- Stereo Cassette Deck: 4 Track 2 Channel
- Clock and Timer. Clock: Made by Copal, Auto. off/on w/Sleep Switch.
- Time: Up to 3 hour time set.
- Auto Recording: Up to 1 hour with C120 Cassette
- Voltage: AC 240V, 50 Hz
- Dimensions: Main Unit: 17" (W) x 4-3/8" (H) x 9-7/8" (D)
- Speaker Enclosures: 8-1/8" (W) x 9-7/8" (H) x 5 3/4" (D) (with 6 1/2" speakers)

1. **SURUGA MODEL SE4308**

*with speaker system*  
*less speaker system*

*\$252-45 tax included*  
*\$239-70 tax included*

2. **SURUGA MODEL SE4308A/MAG CT**

*with pre-amp for magnetic gramo cartridge*

*with speaker system*  
*less speaker system*

*\$265-20 tax included*  
*\$252-20 tax included*

Sole Australian Agents:

**radioparts** GROUP

Telex 32980

562 Spencer St., West Melbourne, Vic 3003  
Phone 329-7888. Orders 30-2224  
OPEN SATURDAY MORNINGS

City Depot: 157 Elizabeth Street,  
Melbourne, Vic. 3000 Phone 67-2699  
Southern Depot: 1103 Dandenong Road,  
East Malvern, Vic. 3145. Phone 211-8122

# SIXTY MILLION VOLTS!

Latest Van de Graaf generator uses segmented belt to obtain high current output.

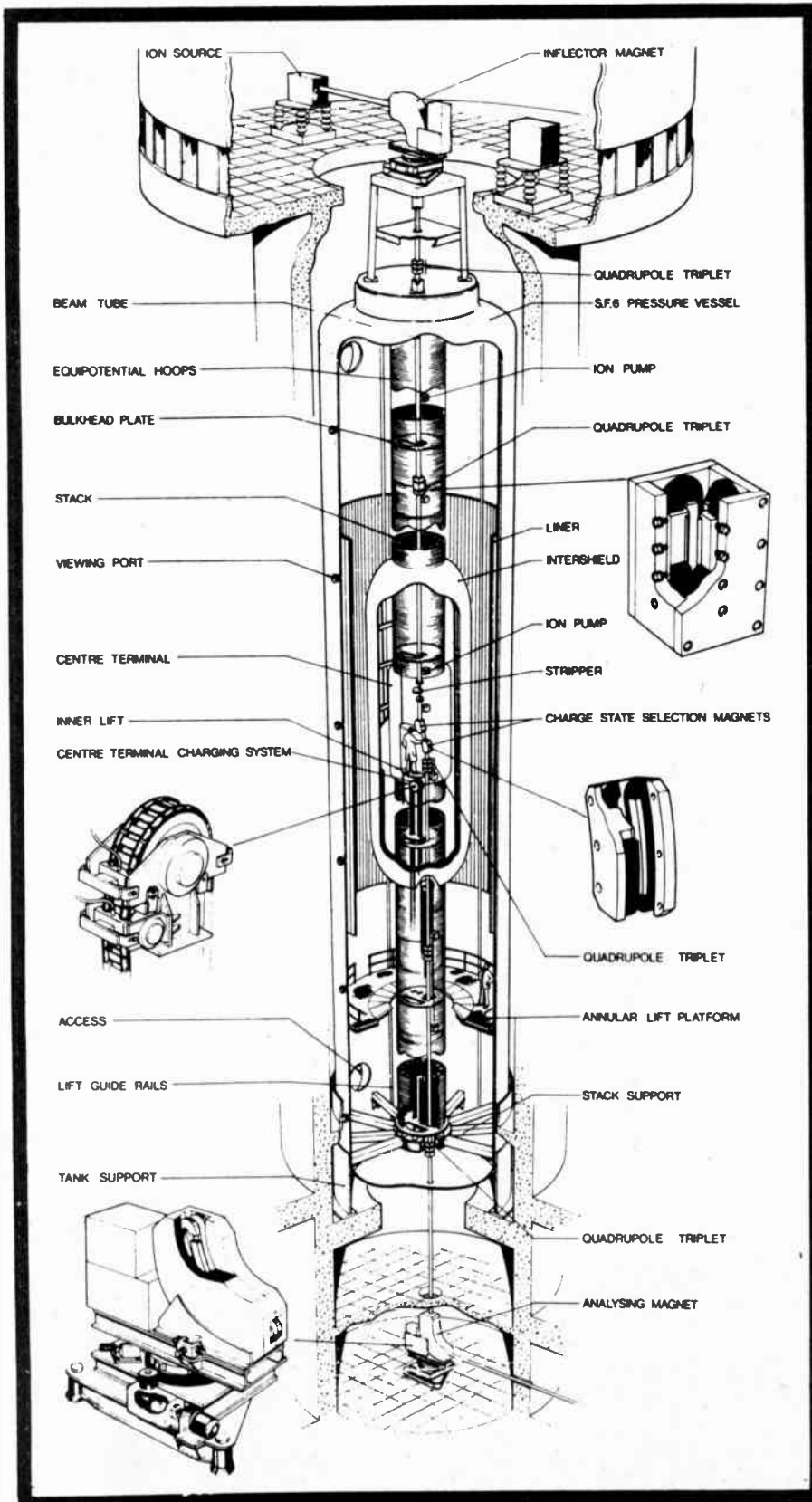

Diagram of large Van de Graaf generator proposed for Daresbury.

ELECTROSTATIC generators of the Van de Graaf type are widely used in research establishments, in universities, in schools and in hospitals to provide a source of small direct current of relatively high voltage. School machines, for example, can attain between a quarter and a half a million volts, while the largest machines can reach 20 or so million volts. This type of facility can be used in teaching, in physical research to accelerate or produce fundamental particles, or in medical research to investigate the use in therapy of high energy beams of particles for irradiating tumours and lesions.

The normal rubber-based flexible belt, which carries the electric charge up to the high voltage collector, runs in the vertical plane round two insulated pulleys, separated by up to 50 feet, and has an electric charge sprayed on to its surface by a corona discharge between a metal comb and the belt itself. The charge, which may be either positive or negative (that is, a deficiency or a surplus of electrons), is carried up and collected at the upper terminal by a similar metal comb. The charge collects on the dome-shaped cover on the upper terminal until the rate of arrival is balanced by the rate loss through corona discharge, when the voltage of the upper terminal becomes steady.

By suppressing the corona discharge from the dome by enclosing the machine in a chamber filled with a high-dielectric-strength gas such as sulphur hexafluoride ( $SF_6$ ), the voltage can be increased substantially.

Rubber-based belts of the normal type can carry charging currents of up to one milliampere, and this is their main advantage. But they do have a number of basic disadvantages: for example, inhomogeneities in the insulator material lead to fluctuations in the terminal voltage and the belts have a very limited life because they can easily be torn to pieces by violent high voltage discharges. They also create a great deal of dust — anathema to the maintenance engineer — and the method of charging can lead to the production of unpleasant gaseous breakdown products in machines working in a high pressure  $SF_6$  atmosphere.

## BEST OF BOTH WORLDS

The most acceptable alternative is a system in which the electrical charge is induced in a series of individual conductors which can be joined together to form a flexible belt by suitably shaped insulators. A number of belts of this kind have been made and tried and they have all proved successful in terms of durability and in providing stable operating conditions. But they have all suffered from a low maximum current-carrying capacity, somewhere about 100 micro-amperes, less than a tenth the capacity of the original flexible belt.

A new belt, jointly developed by engineers and scientists at the Science Research Council's Daresbury Laboratory and the Physics Department of Reading University, overcomes the disadvantage of limited current but retains the good features of earlier designs.

One of these belts, called a Laddertron, has been tried with new driving mechanisms and charging arrangements on the one-million-volt Van de Graaf machine at Reading University. Working in an SF<sub>6</sub> atmosphere at 100 pounds/inch<sup>2</sup> (gauge), a charging current of 550 micro-amperes was achieved by a belt 12.7 cm wide running 15 metres per second — more than five times the charging current of any other metallic belt and more than half the currents achieved with rubber belts. Larger Van de Graaf machines will require wider belts and it is expected that these will achieve even higher currents than the rubber belts on the largest machines.

The new type of belt will be used in the 60-million-volt machine designed to take the place of the Daresbury electron synchrotron NINA when it is

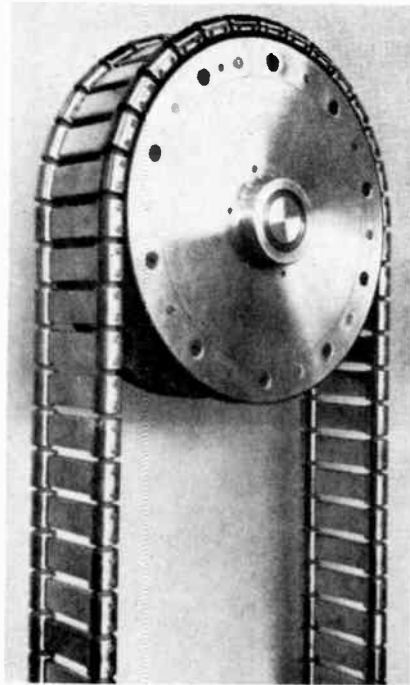

*The Laddertron belt going over the pulley where the charge is removed as it passes through a mirror image of the induction process.*

phased out in 1978. It will be a Van de Graaf working in the tandem generator mode and designed to produce initially 20 million volts at the centre terminal; it will be updated eventually to 30 million volts at the centre terminal mainly through improvements in design and by developments in the technology of manufacture of the flight tubes.

## STABILITY PLATEAU

For a tandem generator, two flight tubes are provided, one above and one below a central high voltage terminal charged to 20 million volts. If the centre terminal were charged positively, and if negatively charged hydrogen ions (protons carrying two

electrons) were introduced at the top of the upper and highly evacuated flight tube, they would be accelerated towards the centre terminal and arrive with an energy of 20 000 000 ev (20 Mev). If both electrons were stripped off, leaving positively charged protons, these would be repelled by the centre terminal and accelerated down the lower flight tube to arrive at the target at ground potential but at 40 Mev.

In its fully developed state the machine will supply 50 Mev protons for investigating aspects of nuclear structure. It will also be used for producing high energy heavy metal ions — for example, highly charged atoms like barium or lanthanum with atomic numbers around 50, 60, or 70 with a surplus or deficiency of electrons. Such ions, with energies of around 500 Mev or higher, can be used to bombard targets of similar atoms in order to stick atoms together and so synthesise new, trans-uranium elements. One atom of atomic number 50 added to another of 60 could produce a new atom of atomic number 110.

One point of great interest will be to investigate the so-called stability plateau said to exist at atomic numbers near 120. Previously most of the known transuranic elements were valued for their radioactive properties, which make them suitable for a variety of jobs ranging from tracers to alpha-particle sources and materials to power nuclear batteries.

But if interest lies in these elements metallurgical properties they will need to be stable (non-radioactive). The new Van de Graaf machines should not only help to create the high number atoms but also provide a means of studying them. ●

Now in Australia

## SUPEREX STEREOPHONES

From \$26.50 to the PEP-77D  
Electrostatics at \$159.00



## NEW from JBL

The revolutionary  
Decade \$189.00 each



## GLEN-DOR

43 THE CORSO, MANLY

Ph. 977-2709 — 977-2415

# Capitol 2.<sup>®</sup> the tape that doesn't tax your head

Introducing the perfected iron-oxide tape . . .

## Capitol 2.

The one that reduces friction between your tape and the tape head.

The world's finest iron oxide tape (20-20,000 Hz) — a lot more stable and a lot less expensive than most.

Comes in singles and stakpaks . . .  
tape lengths C 60, C 90, C 120.

High output low noise cassette tapes with exclusive Cushion-Aire<sup>®</sup> backcoating. Great results on all cassette recorders.

**Capitol 2 . . . the iron-oxide tape.**



Distributed by EMI (Australia) Ltd.,  
International Leaders in Electronics,  
Records and Entertainment.



### SONATA

#### All silicone solid-state Hi Fi Stereo Amplifier Model NS-1600D

10 watts R.M.S. per channel. Each channel has separate bass/Treble controls.

Inputs for magnetic or ceramic cartridge, crystal mic., radio, tape — tapeout stereo headphones. 8-16 ohms. Instruction booklet, circuit supplied. Timber cabinet. Dimensions: 14½" x 8" x 4". Price \$67.50. Pack & Post \$1.50. Interstate \$2.50.



### NEW MAGNAVOX 8-30 SPEAKER SYSTEM

1.6 c.ft. 8 ohms and 15 ohms. Oiled Teak Veneer.

Complete, ready for use ..... \$59.00  
8-30 Speaker Only ..... \$16.50 ea  
3TC Tweeter Only ..... \$3.40 ea  
Philips 1" Dome Tweeter  
per pair ..... \$20.00  
Fully Built Cabinet ..... \$32.00 ea  
Cabinet Kit ..... \$22.00 ea

The 1.6 cu.ft. Cabinet can be supplied with a Baffle Board pre-cut to suit your Speakers. Some of the other combinations available are 12" + 6" + Tweeter — 10" + Mid + Tweeter — 2 x 6" Tweeter, etc.

### STEREO RECORD CHANGER

C141 — C142 — C142-A3

Current models, 4 speeds, automatic or manual operation.

Deluxe model with 12in turntable. Cueing device, Ceramic cartridge, Diamond Stylus ..... \$40.00  
Deluxe model as above with — adjustable counter balance, 2-spindles, calibrated stylus pressure control added .. \$46.50  
Deluxe model as above with 12in. Diecast Heavyweight Turntable, 4-pole Shielded motor. Suitable for magnetic cartridge ..... \$56.50.

Pre-cut oiled teak mounting platform and fully moulded tinted perspex cover, \$20.50 p/p \$1.50



Model C142 and C142-A3 can be supplied with Magnetic Cartridge and Diamond Stylus at \$10.00 extra.

### PANEL METERS



Type	MRA-38	MRA-45	MRA-52	MRA-70	MRA-85
Size	1¾" sq.	2" sq.	2½" sq.	3¼" sq.	4¼" sq.
Barrel Dia.	1½"	1¾"	2"	2¾"	2¾"
50uA	\$5.75	\$6.40	\$7.00	\$8.15	\$10.25
100uA	5.45	5.80	6.40	7.65	9.60
500uA	4.60	4.85	5.50	6.65	8.50
1mA	3.95	4.45	5.00	6.40	8.00
10mA	3.65	4.25	4.85	5.80	7.65
50mA	3.65	4.25	4.85	5.80	7.65
100mA	3.65	4.25	4.85	5.80	7.65
500mA	3.65	4.25	4.85	5.80	7.65
1mA'S'	4.25	4.65	5.25	6.40	8.50
V.U.	4.50	5.25	5.60	6.65	9.50
15V DC	4.40	4.85	5.35	6.40	8.50
500V DC	4.40	4.85	5.35	6.40	8.50
300VAC	4.75	5.25	5.80	6.65	9.00
1 Amp. DC	4.40	4.85	5.35	6.40	8.50
10 Amp. DC	4.40	4.85	5.35	6.40	8.50
30 Amp. DC					9.00

### MAGNAVOX WIDE RANGE FREQUENCY RESPONSE TWIN CONE SPEAKERS, 8 or 16 ohms.

30 — 16000 Hz.

6WR Mk.V 12 watts RMS \$ 9.90  
8WR Mk.V 16 watts RMS \$10.75  
10WR Mk. IV 16 watts RMS \$11.50  
12WR Mk. IV 16 watts RMS \$12.50  
Pack & Post 65c. Send S.A.E. for Data Sheet.

### STEREO HEADPHONES

Fully padded, 9ft curl cable with plug. 25-18,000 Hz. 8 ohms deluxe — slide vol. control. \$11.35. Rotary Vol. control \$10.95. P/P 65c.



Standard Stereo Headphones \$4.70

Sennheiser HD-414 stereo headphones \$25.00 P & P 65c.

### GARRARD

#### STEREO TURNTABLES

Zero 100 ..... \$177.80 less cartridge  
SL 72B ..... \$97.00 less cartridge  
SP 25 MK III ..... \$55.80 less cartridge  
Base and Cover for all the  
SL 65B ceramic cart ..... \$82.80  
above units ..... \$23.80  
Send S.A.E. for technical specification

### ROLA SPEAKERS

12U50. 50 watts 25-11kHz \$35.00  
12U x 50. 50w. 40-13kHz \$40.00  
C100. 20w. 40-11kHz \$14.90  
Send S.A.E. for data sheet.

C100X ..... \$14.00  
C8MX ..... \$8.35  
C100 ..... \$12.75

### CAR RADIO SPEAKERS

Ferrite magnet, Lantor cloth cover for cone protection. All available with 3-8- or 15 ohm voice coil.

Size	6" x 4"	7" x 5"	8" x 4"	9" x 6"
Freq-Hz	115-8500	85-8500	85-7500	85-8500
Watts	6	7	7	8
Price	\$5.25	\$6.55	\$6.90	\$7.25

P & P 50c.

### CAR SPEAKERS

Top quality — black sloping front cabinet. 8 ohms 5" \$12.50 per pair.

### Hi Fi Speaker System

Bookshelf style 14" x 8½" x 8¾". 6½" quality speaker 8 ohms. 8 watts Timber Cabinet walnut. \$20.80 each P & P 95c \$40.00 pair.



### STEREO RECORD PLAYER

240V Ac operation. Chromed tubular metal 9" tone arm with adjustable counter balance and rest — ceramic cartridge, sapphire stylus. 4 speed motor and 6¾" metal turntable with mat. \$7.90 — post 50c.

### PHILIPS AD0160

1" Dome tweeter. 8 ohms \$8.95 P & P 50c.

### 12VOLT TACHOMETER

4 on 6 cylinder 0-6000 rpm. 2¼" Dia. \$9.00

## PRECISION L, C, R AND LOSS MEASUREMENTS

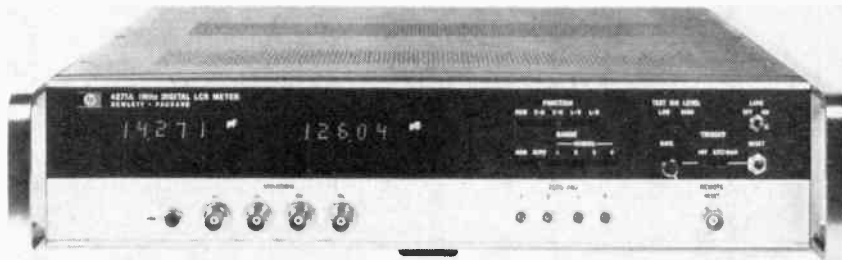

Using a four-pair measurement technique to reduce errors due to stray capacity and residual inductance, this new Hewlett-Packard Model 4271A 1 MHz LCR Meter makes as many as ten readings per second with accuracies to 0.1%. Readout is a 4-digit LED display with 90% overrange.

Capacitance measurements are made in four ranges to 19.999 nanofarads. The lowest range is 10.00 picofarads full scale.

Inductance measurements are made to 1999.9 microhenries in four ranges. Lowest range is 1000 nanohenries full scale.

Capacitance loss components are measured as parallel conductance (100.00 micromhos to 100 millimhos in four ranges) or dissipation factor (to 1.000).

Inductance loss components are measured as series resistance (10.00 ohms to 10.000 kilohms) or dissipation factors (to 1.000). Selectable functions with loss components simultaneously displayed are C-D, C-G, L-R or L-D.

Capacitance test voltages are 20 mV and 500 mV rms. Inductance test currents are 5 mA to 2  $\mu$ A. Offset adjust for both capacitance and inductance measurements is used to cancel stray capacitance and conductance, or residual inductance and resistance due to test leads.

Further details from:— Hewlett-Packard Australia Pty. Ltd., 22-26 Weir Street, Glen Iris, Vic. 3146.

## BATTERY OPERATED "MEGGER"



The well known range of "Megger" Testers by Evershed and Vignoles has been expanded by the addition of the BM8 battery operated Multi-Voltage Insulation Tester. This instrument is intended for use where high values of insulation resistance may be met, such as in high voltage cables and where tests can be of long duration.

There are four testing voltages (100, 250, 500 and 1000 V), selected by a rotary switch.

The maximum resistance range is 10 000

megohms and infinity at 1000 volts, and an indicator continuously monitors the condition of the internal dry batteries.

Complete with test leads and test and carry case.

Further details from:— H. Rowe & Co. Pty. Ltd 185 Hoddle St., Richmond, Vic. 3121

## NEW MACHINE AUTOMATICALLY WINDS SINGLE OR SECTIONAL BOBBINS

A new high production precision spin winder, designated as Model ACW-10A Type SW, will automatically wind multi-section bobbins with controlled turns count in each section as well as single bobbins. Fully automatic operations include step-over from one section to the next through the bobbin notch; tie down of the finish lead; and cutting of the start and finish leads. Up to six individual windings can be automatically placed on the same bobbin or a single winding can have as many as five taps, all numerically programmed on the switch control panel. The operator only removes the finished bobbin and installs an empty bobbin as the turntable indexes. Production rates for a 1000 turn coil range from 250 per hour with a single table, to 1200 per hour with optional multiple tables on the same machine.

Further details from:— NS Electronics Pty. Ltd., cnr. Stud Road & Mountain Highway, Bayswater, 3153.

## VERSATILE SINGLE-SENSOR HYGROMETER

A hygrometer covering the full humidity range with a single sensor can detect the difference between zero, ½ vpm and one vpm (volume parts per million) yet it can be immersed in water or washed in a solvent.

The sensor has been designed by its British manufacturer (Moisture Control and Measurement Ltd) to respond specifically to the presence of water vapour. Neither calibration nor stability is affected by most industrial gases — including hydrogen, carbon dioxide, carbon monoxide and methane.

Unlike the more usual electrolytic sensing devices, the new instrument has an output unaffected by gas flow rates and operates equally well in static atmospheres and in high gas flows.

As a result, the makers state that the Series 2000 hygrometer can be employed for almost every type of moisture analysis in a vast range of industrial and research applications. Potential users include the electronics industry (checking the dewpoint in glove boxes, controlling relative humidity in Standards laboratories); the gas industry (checking instrument air, town gas, natural gas); the electricity industry (leak detection in nuclear reactors, monitoring alternator and contact-breaker purge gases); plastics processings; the food industry; medical applications and biological research; and engineering (checking the dewpoint of furnace gases, measuring the efficiency of gas dryers, controlling the drying of sand moulds and the humidity of metal stores).

The sensor is sufficiently robust to withstand severe knocks without damage or loss of calibration. It is a moisture-sensitive capacitor consisting of an aluminium rod, anodised to produce a porous aluminium oxide surface, with very fine insulated wire wound helically around it. Rod and wire form the two electrodes of the capacitor while the aluminium oxide is the dielectric. Besides being more robust than gold or other porous metals generally used, the fine wire does not create a conductivity problem which may cause non-linearity in some aluminium oxide sensors.

Range of the instrument is 0 to 100 per cent relative humidity, or 0 vpm to saturation, or minus 80°C to plus 100°C dewpoint. With a high gain setting, ten complete scale lengths can be obtained over these ranges or, with a reduced gain, the full humidity range can be covered on a single scale. Accuracy is plus or minus three per cent of full scale.

The sensor responds to changes of water-vapour pressure at any level from vacuum up to 2 000 lbf/in<sup>2</sup> (140 kgf/cm<sup>2</sup>). Response for increasing or decreasing humidity levels is instantaneous.

Further details:— Richard Foot (Australia) Pty. Ltd., 613 Hume Street, Crows Nest, N.S.W. 2065.

# MIRANDA HI-FI

stockists of the world's leading sound brands

SHOP 67, TOP LEVEL, MIRANDA FAIR, N.S.W.

PHONE 525-6745 OR 525-7800

N.S.W. AGENTS, SALES & SERVICE FOR JORGEN - ELECTRA - SINUS

## Now! Get more sound quality for less than you expected to pay!

Let Miranda Hi-Fi and Jorgen show you how to enjoy quality hi-fidelity and still afford to add to your record collection. A.M.I. Jorgen systems are without equal in their price areas. You can enjoy superb Jorgen sound quality for as little as \$199.

 **JØRGEN**

Hi Fi Excellence

COMPLETE SYSTEMS FROM . . .

**\$199 to \$499**

(2 channel)

(4 channel)



**JORGEN 'CENTAURUS' —  
WOW! WHAT A BUY  
FOR ONLY \$399**

Way ahead of any stereo system in the price range. Big, powerful amplifier delivers 20 watts to each speaker enclosure. Has tape monitoring facility and input for two changers when editing. Amplifier is equipped with low filter, high filter and mute switch.

**DON'T TRY TO COMPARE THE JORGEN 'CENTAURUS' WITH ANY OTHER \$399 HI-FI SYSTEM . . . YOU CAN'T. CHECK THESE FEATURES**

● Amplifier — .555 Jorgen 40 watts RMS ● Changer — Dual 1214 Manual/Auto ● Cartridge — Magnetic Goldring ● Styli — Diamond ● Speakers — 10" 3 way, tuned vent encls.

**MIRANDA  
HI-FI**

The sound is best when there's no crowd around . . . Thursday to Saturday is busy and noisy, so call Monday, Tuesday or Wednesday — relax! listen! save!

# COSTLESS imports

These Package Systems offer the best Quality and value in Australia. Look listen and compare. There are packages from \$159.99 to \$1,200.00. Here are some examples:—

- \$199.99** Dietron 75 Watt I.C. Amp. Garrard Turntable with Cue device Realistic Mini II 8" 2 way speakers.
- \$249.99** Dietron 75 Watt I.C. Amp Garrard 40B Turntable with Mag. Cart. Realistic Midi 8" 2 way speakers.
- \$299.99** Rambler 80 Watt I.C. Amp Garrard 40B Turntable with Mag. Cart. Realistic Midi 8" 2-way Speakers.
- \$399.99** Expo 80 Watt Amp with S.E.A. System Garrard SL72B Turntable with MAG. Cart. Realistic MAXI 10" 3-way Speakers.
- \$399.99** As above but with Nivico 60 Watt Amp.
- \$459.99** As above but with Pioneer 100 Watt Amp.
- \$599.99** Nivico 550 4 Channel Amp. Garrard Syncrolab Turntable with Mag. Cart. 4 Realistic Midi 8" 2-way Speakers.
- \$659.99** Leak Delta 70 Amp. Garrard Zero 100 Turntable with Shure M75 Cart. Realistic Mini Ultimate 12" 4 way speakers.

These combinations may be altered to suit your requirements.. Available at Cost Less stores refer page 130

## EQUIPMENT NEWS

### NEW APPROACH TO INDUSTRIAL pH MEASUREMENT

Traditionally, only the pH electrode and its holder — the electrode system — were exposed to the harsh conditions at the sampling point in the process plant. The amplifier, indicator and control systems needed relatively safe surroundings — typically at a remote control panel. This arrangement always resulted in long, high-impedance cable runs, with several junction points and hence several potential trouble spots. Set-up, too, was made difficult by the distance between the measuring point and the amplifier.

The introduction of two new pH transmitters by Electronic Instruments Limited, the analytical instrumentation company in the George Kent Group, has made possible a new approach. These two new transmitters, the Models 2836 and 6320, can be located right at the point of measurement thereby eliminating the high-impedance cabling problem, and giving all the advantages of locally mounted impedance converters without the cost penalty of such units. An important feature of the two new E.I.L. instruments are their built-in meters. Local indication of pH value makes setting-up a simple and rapid routine operation with no need for communications between the point of measurement and a control panel. Both of these instruments provide a high-level current output signal proportional to pH value that can be transmitted to remotely mounted recorders, indicators, data loggers and/or process controllers.

Both of the new instruments incorporate all solid-state circuitry which ensures drift-free operation over a wide temperature range to provide the stability essential for on-plant operation. Both are housed in moulded cases in P.P.O. fitted with transparent polycarbonate covers that are weatherproof and corrosion resistant.



#### Model 2836 pH Transmitter

Accessibility, accuracy and resolution are features of the E.I.L. Model 2836 expanded-scale pH transmitter. It can be used to measure any 2-, 5- or 10- pH units in the range of 0 to 14 pH. It also offers a

choice of 0 to 10 mA, 2 to 10 mA or 4 to 20 mA fully isolated current outputs.

The instrument includes automatic temperature compensation in the range 0 to 100°C by means of a temperature compensator mounted in the associated electrode system. A variable isopotential control is built into the instrument to allow compensation for the temperature coefficient of the measured solution.

As an optional extra the Model 2836 can be fitted with a two set-point high/low alarm or control circuit fully adjustable over the complete range of the instrument.

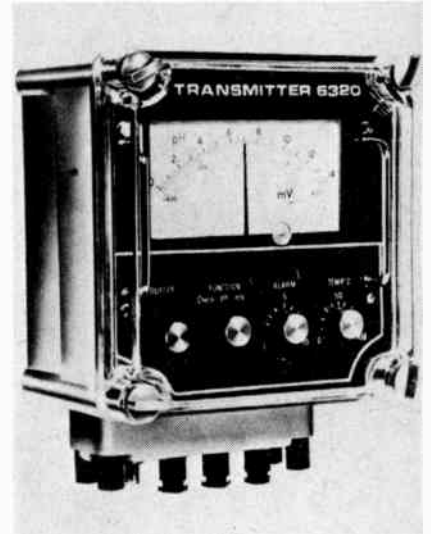

#### Model 6320 pH & Redox Transmitter

Particularly suitable for industrial effluent monitoring, the E.I.L. Model 6320 is a solid-state instrument of high accuracy and good stability. When used for pH measurement the instrument is available with a 0 to 14 pH range and provides a 0 to 1.0 mA current output signal into a maximum load of 5 k ohms. Manual temperature compensation for process temperature variations is provided. For Redox potential measurements an instrument with a range of 0 to 800 mV is provided.

A single set-point alarm or control contact is a standard feature of this instrument.

These instruments are available from Kent Instruments (Australia) Pty. Limited, which is also a member of the George Kent Group.

Further details from:— Kent Industries (Australia) Pty Limited, 70-78 Box Road, Caringbah, N.S.W. 2229.

#### TRUE RMS POWER OVER WIDE RANGE

A new portable wattmeter — the Green 2601 — is now available from Racal Electronics Pty Ltd. It is claimed to be ideal for all types of power measurement from dc to UHF within a wide power range of 0.01 to 300 watts. The internal load is liquid cooled and has a large over-range capacity. Impedance is 50 ohms with an optional 100 W transformer for 75 ohm operation.

Power readings are taken from a linear scale giving true rms readings. The VSWR is better than 1.3:1 at 1 GHz.

A frequency range from dc to 500 MHz covers dc, line power, studio, ultrasonic,



# Amcron AURALINEAR SPEAKER SYSTEMS



Model ES26 \$990 per pair \*



Model 212 \$1670 per pair \*  
\* recommended retail price

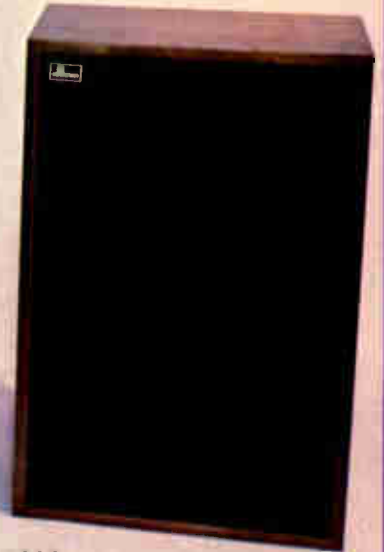

Model ES14  
\$720 per pair \*

As a serious audiophile, you no doubt recognize that the weakest link in the sound reproduction system has long been the speaker. You would not tolerate an amplifier with 4-5% distortion or with response as poor as  $\pm 4$ db or with a bandwidth of only 100-10,000 Hz. And yet, only a very few loudspeakers on the market today are even that GOOD! So no matter how fine the rest of the system, the sound has always been limited by the speakers.

Sensing this weakness, many music lovers have been begging for a line of

Amcron speakers that would live up to the Amcron reputation for innovative excellence, earned by its professional tape recorders, power amplifiers and preamplifier. Amcron engineers have been working for many years to develop such a speaker design. But they felt that they would rather design none at all, than to ruin their reputation with a mediocre product that was "JUST ANOTHER SPEAKER".

At last, recent breakthroughs in electrostatic speaker design have made possible genuinely accurate sound

reproduction. Now Amcron can offer you a line of three "Auralinear" Speaker Systems, which unite wideband electrostatic radiators with special long-throw woofers, each model worthy of the Amcron name in every respect. They are the first and only speakers to radiate "ABSOLUTELY FLAT AND HONEST SOUND".

Amcron is eager to make the "LIVE SOUND EXPERIENCE" yours. Who knows, you may already have live sound in your amplifier system just waiting to be expressed through Amcron Auralinear Speakers.

## What makes Amcron speakers unique?

1. Radically new wideband electrostatic radiators have thinner membranes for greater efficiency and greater acoustic output. Special long-throw low distortion acoustic suspension woofers exhibit absolute flat response over the entire range. This means comfortable distortion-free listening at full realistic sound levels, even at low frequencies. Reliable electrostatic elements need no pampering.
2. Model ES212 has bi-directional radiators emanating sound through front, back and sides of upper enclosure.
3. Multi-element arrays of electrostatic radiators are set at precise angles to form a powerful "ACOUSTIC LENS".
4. All speakers are two-way with SEAMLESS electrostatic response.
5. The Electrostatic and woofer sections of each model, are protected from overload by solid state circuit boards (separate circuits for each section), coupled with a resettable circuit breaker.

# BJD

Write for full literature and description of the Auralinear Speakers.

## ELECTRONICS PTY. LTD.

190 Willoughby Road, CROWS NEST 2065 439-4201  
202 Pelham Street, CARLTON. 3055 347-8255.

# KIT-SETS

# AUSTRALIA

## AUSTRALIA'S LEADING ELECTRONIC SPECIALISTS

**DEE WHY**  
21 Oaks Ave.,  
Dee Why  
Ph: 982-7500

**SYDNEY**  
400 Kent St.,  
Sydney  
Ph: 25-1005

**BRISBANE**  
293 St. Paul's Ter.,  
Fortitude Valley  
Ph: 52-6291

**MELBOURNE**  
271 Bridge Rd.,  
Richmond  
Ph: 42-4651

**ADELAIDE**  
50 Grenfell St.,  
Adelaide  
Ph: 87-5505

**PERTH**  
527 Wellington St.,  
Perth  
Ph: 21-3047

### DIGITIME



The latest design from E.T.I. of a digital solid state clock which includes L.E.D. decimal point, and accuracy of 4 seconds a year, 12 or 24 hour operation. We have modified the P.C. Board to accommodate a different nixie as stated. Complete kit including cabinet and label.  
Only \$66.50. \$2.00 pack/post.

**SPECIAL ANNOUNCEMENT!!**

### SYNTHESIZER

We are pleased to announce that Kit-Sets Aust. will be supplying kits for the new Music Synthesizer being featured in this and forthcoming issues of Electronics Today.

As the parts list for this project will not be available until completion of the article, prices have not been finalised. But we assure customers that the final price will be lower than the price of the individual components.

Customers calling at our Centres are advised that terms are available. We foresee a large demand for this project and therefore urge customers interested, to forward a deposit to avoid disappointment.

### ETI 419

#### Guitar/Mixer Preamp

At last for all owners of the ETI 413 100W power amps and other comparable amps!

The latest high quality Preamp — specially designed for general use.

This kit as described in Electronics Today September, 1973, allows for 2 high and 2 low inputs, includes input sockets, P.C. Board but no case or power supply.

Price for Module Kit \$9.80 + 50c Post/pack

Price for Mains Adaptor Kit containing transformer and four diodes \$4.55 + 50v Post/Pack



### BATTERY CHARGER

— the Ultimate



This very sophisticated battery charger from "Electronics Today" will do everything but stand on its head. It is short circuit proof, reverse polarity proof, and features automatic charge reduction as the battery becomes charged. Kit includes metal box, and all other parts required to build this essential piece of workshop equipment. Refer "Electronics Today" August 1973. Price \$34.50. Pack/Post \$1.50.

### INTERNATIONAL 416



International 416 25watt R.M.S. Stereo Amp. Undoubtedly the most sophisticated stereo amplifier so far offered in kit form in Australia. FEATURES: ● A genuine 25 watt R.M.S. per channel performance. ● Less than 0.5% Distortion. ● Piano key push button selectors for high and low filters, A-B speaker switching and selector switches. ● Slider volume and tonal controls. ● Up to the minute styling. ● Simple construction. This project is a must for the home constructor looking for a powerful amplifier for use with high quality equipment. \$140.00 plus \$2.00 pack/post.

**SPECIAL OFFER**

### FOR THE BUDGET CONSCIOUS — PLESSEY WIDE-RANGE TWIN CONE LOUDSPEAKERS

These superb twin cone, wide range speakers provide excellent sound reproduction over a wide frequency range and can be easily added to at a later stage, if required.

	Size	Freq. Response	Power Handling	Price
C6LX	6	54-20000	6	\$ 6.40
C8MX	8	35-20000	7	\$ 9.50
C80X	8	35-20000	20	\$14.90
C100X	10	40-20000	20	\$15.50
C12PX	12	35-13000	30	\$21.00
12UX50	12	40-13500	50	\$47.00

### IF YOU CAN'T VISIT YOUR NEAREST CENTRE

For simple convenient, same day mail order service — Send your order and cheque to: — KIT SETS (AUST.) PTY. LIMITED, P.O. BOX 178, DEE WHY 2098 — or phone (Area Code 02) 982-7500 (24 hr. service) for same day PMG/COD Service.

## EQUIPMENT NEWS

VLF, LF to UHF measurements. Calibration is therefore possible at dc or line frequencies. Accuracy is stated to be 5%. The thermocouple used is fast acting, and readings are insensitive to modulation peaks, instability and spuria. A peak reading diode operated range is included and can be calibrated for any range in use at 3 watts - 300 watts using a sensitivity control. This enables PEP and modulation measurements

to be made. A demodulated output is provided for oscilloscope or distortion meter modulation analysis.

The Green 2601 is portable, measures 320mm x 215mm x 88mm, and weighs 5kg. (11 lbs). The price includes an integral absorption load unit.

Further details from:— Instrumentation Division, Racal Engineering Pty. Ltd., 47 Talavera Road, North Ryde, 2113. ●

## HIGH PERFORMANCE, LOW COST DUAL TRACE OSCILLOSCOPE

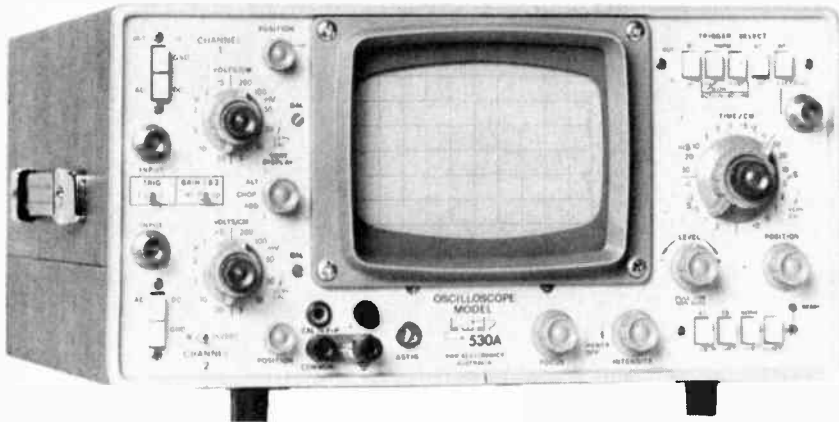

The latest portable oscilloscope from B.W.D. Electronics Pty. Ltd. provides a combination of features previously restricted to the higher priced bench instruments. Perhaps the most significant of these is a vertical amplifier performance of dc to 20 MHz with a sensitivity of 1 mV/20 V/cm on both channels and a dc to 40 MHz triggering capacity.

Identified as the Model 530A, the unit also provides a time base range of 40 nsec to 10 sec/cm, including X5 magnifier and vernier; identical X-Y operation; and ac or battery

power options.

Completely portable, the 530A weighs 8.5 kg (ac version). The dimensions are H 16 cm, W 31 cm, D 42 cm. Despite this absence of bulk, the instrument boasts a large 6 x 10 cm CRT with internal parallax-free graticule. As with previous instruments, the 530A is entirely designed and manufactured in Australia, and carries the normal B.W.D. 12 month warranty.

Further details from:— B.W.D. Electronics Pty. Ltd. 331-333 Burke Road, Gardiner, Vic. 3146. ●

## POCKET SIZE 'LOGIC PROBE'



A new shirt-pocket-size logic (square wave) generator for trouble shooting, testing and inspecting digital circuitry has been

developed by Kurz-Kasch, Inc. U.S.A.

Power is provided by the system under test, thus allowing the probes to be used in the field or laboratory.

The probe may be used for such applications as setting flip-flops, running counters, and performing clock functions.

A simple readout system indicates 'true', 'zero', or 'pulse' readings on two colour-coded visual electronic readouts in the probe tip. Absence of logic levels is indicated by all readouts remaining off. Logic levels can be quickly and accurately tested in virtually any IC system including desk calculators, business machines, NC machines, computers or telephone systems, the manufacturers claims.

A simple selector switch provides 100 Hz, 1 kHz, 10 kHz, 100 kHz and 1 MHz signals. The logic probes are available in five models for testing 4.75 Vdc to 15 Vdc.

Further details from:— DC Electronics Pty. Ltd., 32 Smith Street, Collingwood, Vic. 3066. ●

## BATTERY SAVER

### REGULATED

## BATTERY ELIMINATOR

Multi Voltage 4.5, 6, 7.5, 9 V

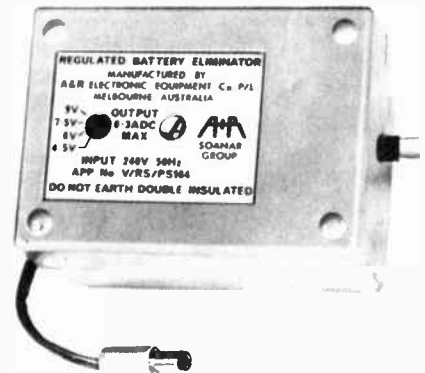

### TYPE PS164

- Unlimited operation of Battery-operated. Transistor Equipment from 240 Volt AC Mains at negligible power cost.
- Output regulated to prevent speed variation in Tape Recorders motors. Constant Voltage to radios, etc., gives more undistorted power at high volume.
- Approved by Electric Supply Authorities.
- Double Insulated for extra safety.
- Ideal for 4.5, 6, 7.5, or 9V Transistor Radios, Tape Recorders, Small Transistorised Amplifiers and Test Equipment, etc.
- Filtered to ensure hum-free operation.
- Output selected by rotary switch, recessed to prevent accidental alteration

### Technical Specifications:

Input 220/240V 50Hz.  
Output 4.5, 6, 7.5 or 9V DC Regulated,  
Maximum Current 0.3 Amps.  
Regulation — less than 10%.  
Ripple — less than 0.25% RMS.  
Dimensions 3½ ins. x 2½ ins. x 2 ins.  
(90 x 65 x 50mm.).



## A & R-SOANAR GROUP

### SALES OFFICES

VIC: 30-32 Lexton Rd., Box Hill.  
89 0238.

NSW: 4 Close St., Canterbury.  
78 0281.

SA: 470 Morphett St., Adelaide.  
51 6981.

### INTERSTATE AGENTS

QLD: R. A. Venn Pty. Ltd., Valley.  
51 5421.

WA: Everett Agency Pty. Ltd.,  
West Leederville. 8 4137.

# COMPONENT NEWS

## NEW LED DRIVERS

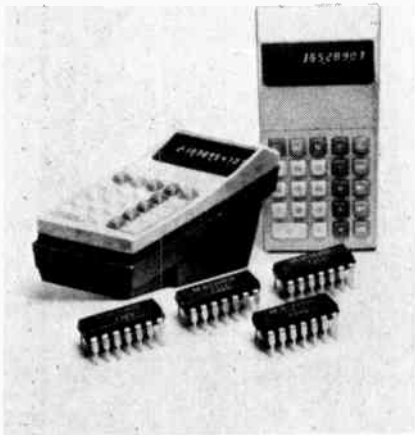

Two new LED drivers from Motorola are available for immediate delivery. Ideal for driving displays in electronic calculators, these devices provide the necessary interface circuitry between the MOS calculator chip and the diode arrays. The MC75491 is a quad-segment driver and the MC75492 is a hex-driver.

Further details from: Motorola Semiconductor Products, Suite 204, Regent House, 37-43 Alexander Street, Crows Nest 2065.

## 10-AMPERE PROGRAMMABLE 2 to 35-VOLT SERIES VOLTAGE REGULATOR

A 100-watt hybrid silicon voltage regulator capable of line regulation of 0.10 percent and load regulation of 0.15 percent has been introduced by Motorola.

The new device designated MPC1000 is a 10-ampere positive or negative series voltage regulator capable of operating with input voltages as high as 60-volts. Output-voltage can be adjusted from two to 35-volts to permit this single device to serve a wide range of output voltage requirements.

Output currents of 10-amperes are easily obtained from the MPC1000 without external transistors, claim Motorola; however, circuits using external pass transistors can expand the capability of the regulator to handle currents in excess of 50-amperes. Current limiting protection also has been built-in to protect the regulator from excessive surge currents.

Rated for operation over the full military temperature range from -55C to +200C, the MPC1000 is housed in a hermetically sealed metal TO-3 package with a 9-pin base.

Further details from: Motorola Semiconductor Products, Suite 204, Regent House, 37-43 Alexander Street, Crows Nest 2065.

## 0.3-INCH HIGH, SEVEN-SEGMENT LED INDICATORS

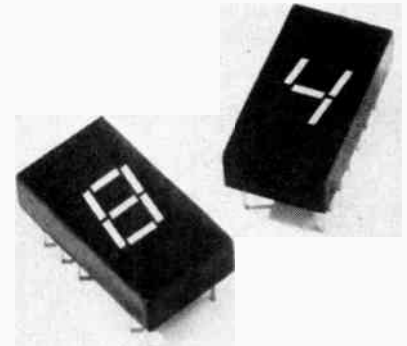

Now at prices equal to, or less than comparable gas-discharge display tubes and many LED displays, this new series of Hewlett-Packard solid-state numeric indicators is especially suited for commercial applications. With uniformly lit, diffused segments, these characters appear sharp and clean, and thus are pleasing to the eye. Calculators, television receivers, radios and digital clocks are among many uses to which they can be put.

Two 0.3-inch high, single-digit units are announced. The Hewlett-Packard Model 5082-7730 contains a left-hand decimal point; the Model 5082-7731 has a right-hand decimal point. Both have the same pin configuration and same package outline as the MAN-1, Data-Lit 10, and similar LED displays, although the character height is larger. The use of the standard DIP package allows for socket or printed circuit board mounting. Individual digits can be close packed on 0.400-inch centres, but the larger character height allows other spacings where desired.

Electrically, these displays are IC compatible. Forward voltage per segment or decimal point is 1.6 volts. Luminous intensity is 250 microcandelas per segment typically. Operating current is typically 10 mA per segment when strobed.

Both displays, built on rugged lead frames, are arrays of eight discrete diodes optically "stretched" to a uniformly lighted diffused bar. Only one LED per segment is required because of a unique funnel-shaped "light pipe" that lights a bar five times the length of the LED chip. Nonetheless, a wide viewing angle is maintained.

Character encoding on either device is performed externally by commercially available BCD to 7-segment decoder/driver circuits. Using strobing techniques, only one decoder/driver is needed to drive a display of up to 15 digits.

To improve contrast, the entire front surface of the display, except for the emitting areas, is finished in a uniform flat black. An additional filter may be used to further lower ambient reflections and improve contrast.

Further details from: Hewlett-Packard Australia Pty Ltd, MARCOM Department, 22-26 Weir Street, Glen Iris, Vic. 3146.

## ALL NEW PHOTODIODE NEEDS IS STARLIGHT

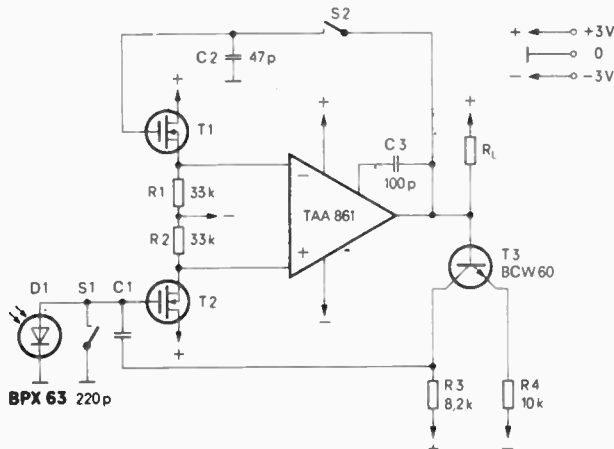

Even the light of the stars on a moonless night is claimed to be sufficient for the new Siemens photodiode BPX 63 to operate as an optoelectronic receiver, for example, for photographic exposure meters. The photosensitivity of the diode is 10 na/1a. At an illuminance of  $10^{-2}$  lx ( $10^{-3}$  lx behind the matching filter), the components supplies an output voltage exceeding 0.5 mV without thermally generated charge carriers excessively interfering with the useful current. A circuit for a photographic exposure meter designed in the Siemens Applications Laboratories also ensures that the aperture setting can only be affected by the useful signals and not by the noise signals.

Photoconductive cells have hitherto been used as light detectors for exposure meters.

Low illuminances however produced such high time constants that a temporary light burst led to forced interruptions lasting several minutes. At  $10^{-2}$  lx, which is approximately the light intensity on a moonless night, the employment of photoconductive cells becomes problematical. On the other hand, in the Siemens photodiode BPX 63, the number of charge carriers thermally generated per unit of time and decisive for the time constants of the element is very low, as is the saturation current. The diode current does not reach 1 pA until the diode voltage exceeds 0.5 mV.

Further details from: Siemens Industries Limited, 544 Church Street, Richmond, Vic. 3121.

## MINI MOTOR FOR CLOCK MECHANISMS

Philips miniature permanent magnet synchronous timing motors of the 110 09-series have been specially designed for clock mechanisms where low power consumption, silence and small dimensions are required.

The new mini motor is claimed to be an important development for rate-change clocks in electricity meters, central heating control clocks, miniature time switches, elapsed time indicators, and quartz crystal clocks as used in cars.

Designed to operate at 375 rev/min from 50 Hz ac, the motor can be matched to differing load requirements by varying the supply voltage between 12 V and 24 V. at 12 V, torque of 0.2 gcm is claimed for only 50 mW input power; at 24 V, torque is 0.8 gcm for 2000 mW input power. Connected in series with a low-wattage resistor or a capacitor, the motor can also be used with higher supply voltages. Two nylon pegs are provided for twist-lock mounting.

Philips miniature motors are marketed by Elcoma, Mars Road, Lane Cove, NSW.

## VARIABLE ELECTRONIC FILTER

Ithaco, Inc. has developed the Model 4251 Variable Electronic Filter, designed for state-of-the-art accuracy of all parameters.

Operating either as a high-pass or low-pass filter, the corner frequency may be set with three digit resolution and 1% accuracy from .01 Hz to 111 kHz. Phase and amplitude accuracy are claimed to be  $2^{\circ}$  and 1% respectively. Attenuation slope is 24 dB/octave. Total hum and noise is 50  $\mu$ volts or less.

Used as a low-pass filter, response can be set to be maximally flat (Butterworth) or linear phase (Bessel).

Available options include a built-in dc amplifier, a rechargeable battery, and provision for operation with external preamplifiers. Two 4251's are operable as a 24 dB/octave bandpass, a band-reject filter; or alternatively, as a 48 dB/octave high - or low-pass filter.

The precise characteristics of these filters make them uniquely suited for specialised applications including anti-aliasing, installations with two or more matched channels, pulse data acquisition, and noise analysis.

Used with Ithaco low noise preamplifiers, the Model 4251 is particularly suited for use in such areas as acoustics, geophysics, and biomedical research.

Further details from: - Elmeasco Instruments Pty. Ltd., 7 Chard Street, Brookvale, NSW, 2100.

## NEWMARKET TO CONTINUE GERMANIUM TRANSISTORS

In a recent trade letter, Newmarket Transistor Co. announced their intention to continue production of germanium transistors "for the foreseeable future". At a time when many other semi-conductor manufacturers are quitting the field, this comes as welcome news to manufacturers and service organisations who are dependent on obtaining germanium transistors. Newmarket manufacture commercial, CV and BS9000 types. Full details of the Newmarket range may be obtained from the Australian Agents, Tecnico Electronics, Premier Street, Marrickville N.S.W. 2204 or Tecnico Electronics, 2 High Street, Northcote, Vic. 3070.

## SERVICE

CONVOY INTERNATIONAL  
OFFERS SERVICE ON ALL  
HI-FI EQUIPMENT AT  
SYONEY'S LOWEST PRICES

FREE PARKING

Special tape recorder adjustment, our technicians can adjust your tape recorder so that it gives super performance on the brand of tape you use. You will be amazed at the improvement in performance for such a small charge.

**Convoy** PTY/LTD

Cnr. Plunkett & MacLean Sts,  
Woolloomooloo - 357 2444  
Open Thurs Nights & Saturday.

## CLEARANCE SALE

### ELECTRONIC EQUIPMENT AND COMPONENTS

Receivers, transceivers ex-Army & Citizens Band transmitters, test equipment, oscilloscopes, sig. generators, multimeters, chassis racks, panels, computer parts & boards, power transformers up to 6.6KV, valves, transistors, potentiometers, etc., speakers, amplifiers, cables - hook/up & coaxial 50 & 70 ohm, multicore up to 50 core. Panel meters, AVO meters, valve testers and all types of electronic components.

7,000 sq. ft. of electronic gear, plenty of parking come and inspect. Open 10-5 p.m. weekdays, 9.30-12 Saturday. Wanted to buy receivers, transceivers, electronic equipment & components. Top prices paid.

SPECIAL THIS MONTH

No. 62 transceivers Army type 1.6 to 10M/C 12 Volt operation price \$39.50. 50 ohm coaxial cable 1/2" diam. new price 45c yd.

**HAM RADIO** (DISPOSAL BRANCH)

104 Hightt Street, Richmond, Vic.  
3121. PHONE: 42-8136.

# Coilmaster

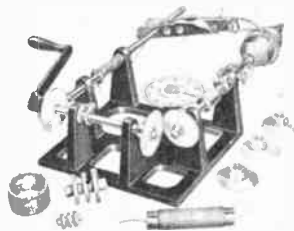

**DELUXE  
ACCURATE  
COIL  
WINDER  
\$15.95**  
Post Paid

This Easy-to-use machine winds honeycomb, spiderweb and solenoid coils of various widths and diameters - equal in appearance to a factory job. Also suitable for winding chokes, transformers and filter inductors. Indicator counts number of turns on coil. The COILMASTER is suitable for both experimental and practical work. Supplied with accessories including wood spools, metal pegholders and extension for making long solenoid coils. Instructions included.

SEND REMITTANCE WITH ORDER FOR IMMEDIATE DELIVERY ANYWHERE TO THE SOLE AUSTRALIAN AGENTS.

**LAFAYETTE** ELECTRONICS 94 HIGH ST., ST KILDA, VIC 3182. Phone 94-6036

## NOW OFFERED FOR THE FIRST TIME

# RANG mini 80 ELECTRONIC CALCULATOR

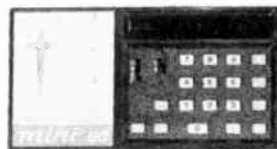

### SPECIFICATIONS

Here at last! the "MINI 80" - a midget electronic calculator that performs like a giant. Now complicated computations are reduced to press-button simplicity anywhere you need it... in the office, in the plane or at a luncheon meeting. Incredibly accurate answers in a flash, silently, easily. To achieve this marvelous miniaturisation in size and weight we put in an ingenious electronic brain measuring no larger than one-eighth inch square! Yet this tiny chip of metal oxide silicon (MOS) performs the functions of thousands of complex transistors. Known as the 'Large Scale Integration' (LSI) and similar to one that helped land man on the moon, this minute brain puts the 'mini 80' way ahead in electronic technology.

Capability: Addition, subtraction, multiplication, division, mixed calculation, constant calculation and round off. Method: Addition and subtraction, chain multiplication and division. Operation digits: Entry: 8 digits. Addition/subtraction  $8 \pm 8 = 8$  digits. Multiplication:  $8 \times 8 = 8$  digits. Division:  $8 \div 8 = 8$  digits. Decimal Point System: Manual preset and floating (Selector: Floating, 2, 4 & 6). Logic Element: MOS/LSI. Operating Temperature:  $0^{\circ}\text{C} - 40^{\circ}\text{C}$ . Power Source: 5 penlight super or alkaline manganese batteries. Battery Life: Approximately 10 hours of normal use - with alkaline manganese or heavy duty batteries. Dimensions: 140 x 75 x 23 mm ( $5\frac{1}{2} \times 3 \times 7/8$  in.) Weight: Without battery 160 grams (6 ozs).

ONLY  
\$89.95  
P & P 50c.

From the sole Australian distributors and stockists

**M.S. COMPONENTS**

95-97, Regent Street, Redfern, N.S.W. 2016  
188-192, Pacific H'way, Gore Hill, N.S.W. 2065.

# BOOK REVIEWS

REVIEWERS: Collyn Rivers, Brian Chapman

## RCA SOLID STATE SERVICING.

Published by RCA Distributor Products  
1973. Soft covers, 352 pages  
205 x 135 mm. Review copy supplied by  
Technical Book Co. Pty. Ltd,  
Melbourne. Australian price \$4.65.  
Available from Modern Books &  
Plans Sydney.

Nowadays there is very little electronic equipment in use, domestic or professional, that is not solid state. Hence, to the serviceman, knowledge of solid state servicing techniques is not only desirable but essential.

The book under review was prepared by RCA Corporation to provide basic knowledge of solid state techniques and servicing procedures. It is a wide ranging text covering information on AM and FM radio, amplifiers, tape recorders and control equipment for high-fidelity equipment, as well as black-and-white and colour television.

Fully two thirds of the book is devoted to the theory of common solid-state devices and circuitry. The treatment is of necessity limited to basic descriptions only, but would be to a level entirely adequate for the serviceman as it is essentially of a practical nature.

The last third of the book commences with a section on how to find and replace defective components in solid state circuitry. This is followed by individual chapters on AM and FM Receiver servicing, Servicing Black and White TV Receivers and Servicing Colour Receivers.

There are many useful hints and tips throughout the book which would be of great assistance to anyone involved in solid-state servicing and at the more than reasonable price, the book will find ready acceptance. — B.C.



**HI-FI IN THE HOME** By John Crabbe,  
Third edition, published by Blandford  
Press Ltd. 1972. Hard covers, 328 pages  
203 x 140 mm. Review copy  
supplied by publisher. Australian  
distributor Glenville Publishing Co.  
Pty. Ltd., Price \$6.80.

In recent years the Hi-Fi industry has seen a tremendous boom. Everybody seems to have audio equipment of one form or another and to be demanding ever higher standards when purchasing new or replacement equipment.

Many people however are at a loss technically. They don't understand the jargon of the industry and only know that they want something that sounds better. But how does such a person cope with the 'erudite' salesman who quotes 'IHF music power' and other such (incomprehensible to the layman) terms? They are virtually at the salesman's mercy, and whilst most salesman try to fit the customer with equipment appropriate to his budget, there are some who are simply interested in selling the equipment etc, which has the best profit margin.

How does the buyer protect himself from such tactics? Firstly by educating himself in the terminology and techniques of high-fidelity audio equipment.

The book under review is probably the best available for the above purpose. It commences with an exposition on the nature of musical sounds and the ear's response to them, followed by a description of the technical requirements for recording and reproduction as a result of certain features of these sounds.

Each individual component of the Hi-Fi system is discussed thoroughly and this is followed by a discussion of the factors affecting reproduction in average rooms. Practical guidance is given as to how equipment should be chosen and set up and how to make the best of room acoustics.

Choice and care of records, notes on planning and giving recorded concerts, and various psychological and aesthetic values of music reproduction in the home are discussed. Finally a glossary of audio terms and abbreviations, a bibliography and an extensive index are all provided at the end of the book.

Treatment of the subject is down to earth and the uncomplicated text should be readily followed by those without previous related knowledge.

In all this is an excellent book for those who like music and want to know how to buy and use audio equipment to best advantage. A recommended purchase for every serious audio fan. — B.C.

**THE SOVEREIGN STATE: The secret history of ITT** by Anthony Sampson, published by Hodder & Stoughton; 288 pages.  
Not yet available in Australia.

ITT is the eleventh largest of the world's multi-national conglomerates. If only one eleventh of what is said about ITT in this book is true, it would be well in the lead as the world's unloveliest.

In the 1930's, ITT founder Sosthenes Behn bought a 28% interest for ITT in Focke-Wulf. That company's bombers then pounded Britain — where ITT owned Standard Telephones and Cables.

Whilst ITT-owned telephone lines were passing information to Nazi Germany's submarines, ITT direction-finders were saving other ships from those submarines' torpedoes.

As recently as the past three years, ITT is reported to have made three major attempts to manipulate the Nixon administration.

One attempt, a US\$400 000 sweetener, was offered to the Republican National Convention last year. Another, perhaps linked with the \$400 000, was an attempt to persuade the US Justice Department to drop the biggest anti-trust suit in its history: this involved the acquisition by ITT of the Hartford Insurance Company.

The third, Machiavellian in its sinister implication, was ITT's efforts to use the CIA to prevent the election of Chilean President Dr. Allende. When that plot failed, they tried to have him deposed. ITT's interest in Chile? They ran the phone service there!

These incidents, and many others, are all documented in Anthony Sampson's book "The Sovereign State: a secret history of ITT".

The book describes in detail the days when ITT was founded (in 1920) by Sosthenes Behn, a man whose ethics (if such a word may be used in this context) was to make money by every and any method that worked.

In the 53 years since its formation, ITT has moved into countries all over the world. In some it makes telephones — and all the bits that make telephone systems possible — in others it runs industries as diverse as car rental agencies, bakeries, canteen vending machines and secretarial schools.

But despite ITT's enormous size, its history, as Sampson tells it, is one of failure rather than success.

Until the September (1973) coup, Dr. Allende's government survived, ITT did not obtain the anti-trust settlement in the USA — and, as Sampson emphasises, the financial world has found out that ITT's apparent growth in earnings is due largely to the sales of the assets of the companies it acquires.

It is all a very long way away from the capitalist ethic.

Karl Marx would have laughed, and laughed and laughed. — C.R.

## 3 1/2 Digit Multimeter

- DC Volts & Current AC Volts Resistance
- 0.2% DC accuracy 0.3% AC
- Automatic Polarity

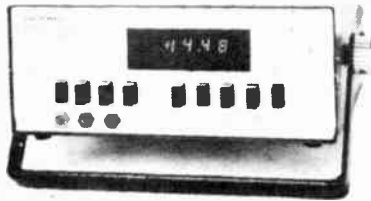

## 10 MHz Automatic Counter

- Read-out automatically displays four most significant digits of measured frequency
- Manual over-range gives 1Hz resolution on all signals, making the 201A equivalent to an 8-digit counter



**HALTRONICS** pty.ltd.

57 Sinclair St Crows Nest NSW 2065 Ph 920845

New Zealand agent: W & K McLean Ltd  
103 Felton Mathew Ave  
Glen Innes Auckland

**\$135!**

**\$160!**

*Realistically speaking...*

**REALISTIC** with SEPARATE SPEAKER

a Realistic performer

a Realistic value...

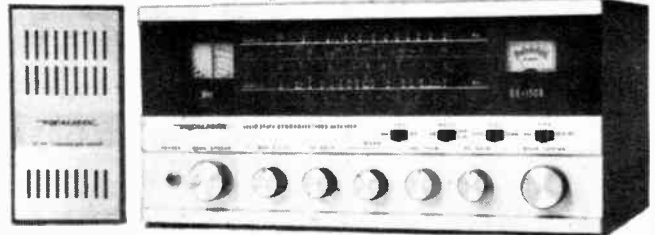

SW/CW SSB/AM  
4 BANDS 535 to 30 MHz (includes Broadcast)  
TRANSISTORISED all solid state  
240V AC or 12V DC operation

The popular REALISTIC DX150B which has gone from strength to strength with amateurs, shortwave and broadcast listeners alike now has a further improvement. A SEPARATE MATCHING SPEAKER included. The DX150B gives long-range world-wide realistic reception on 4 bands, including Broadcast. Fully transistorised - all solid state - no warm-up delays. The DX150B will run on dry cells if current fails or is not available, will operate from a car's cigarette lighter or any 12V DC source. A 240V AC power supply is also built in. Over 30 semi-conductors - product detector for SSB/CW, plus fast and slow AVC - variable pitch BFO - illuminated electrical band-spread - fully calibrated for amateur bands - cascade RF stage - AM, for RF and AF-tuner stabilised - OTL audio-illuminated 'S' meter.

SUGGESTED RETAIL PRICE **\$234.20** ... that's realistic too!

**W**eston electronics company

(A division of Jacoby Mitchell Ltd.)

Weston Electronics Company  
376 Eastern Valley Way, Roseville, 2609.  
Cables and Telegraphic Address: 'WESTELEC', Sydney. Phone: 407 1212

Please forward free illustrated literature and specifications on Realistic.

NAME .....

ADDRESS .....

WE/69

# THE REAL TEST IS IN LISTENING...



EMPIRE'S VARIABLE RELUCTANCE CARTRIDGE is different from other cartridges. The diamond stylus floats free of its magnets, imposing much less weight on the record surface. Every Empire long-playing cartridge is fully shielded. Four poles, four coils, three magnets (more than any other cartridge) produce better balance and better hum rejection. Magnetically balanced to perfection, it has a signal to noise ratio of 80 dB,

featuring a moving magnet element and diamond stylus lever system .001 inch thick. The entire cartridge weighs only 7 grams — the ideal cartridge weight for modern compliance requirements.

# EMPIRE

Sole Australian Distributors  
**JERVIS AUST. PTY. LTD.**  
P.O. BOX 6  
BROOKVALE, N.S.W. 2100  
TELEPHONE: 939 2922



# VALUE VALUE VALUE VALUE VALUE VALUE VALUE VALUE VALUE VALUE VALUE **VALUE**

## AT UNDER 150 DOLLARS

Unquestionably, the SU3000 from Technics is one of the most eyebrow-raising amplifiers on the market today.

Elegant in design. Generous in rich sound. Virtually free of noise and distortion. And what's more you won't find better value anywhere.

The SU3000 houses all the latest advances in audio amplification and has a full 28 watt (R.M.S.) output. Advanced direct coupled OCL circuitry allows this unit to boast of a frequency response of 10 – 50,000 Hz – 3dB.

The front panel boasts a complete set of controls. Bass, treble, balance, and high/low filters controls are just some. A special feature is the level control that allows you to fade in or out the microphone with that professional touch. Also featured is a two tape monitor circuit that permits simultaneous recording on two tape decks or dubbing from one tape onto the other.

The rear panel has a complete range of inputs and outputs.

So if you're still unconvinced what value this amplifier really is then just try one at your nearest Technics dealer.

There, allow your ears and pocket to do the testing.



 **Technics**



Guaranteed and serviced across Australia by **HACO**

WTGD9N



**RECORDINGS  
POP**

---

REVIEWER: Mike Delaney

**"ROGER McGUINN"** – Roger McGuinn. C.B.S. Stereo, SBP.234331. I'm So Restless – My New Woman – Lost My Drivin' Wheel – Draggin' – Time Cube – Bag Full Of Money – Hanoi Hannah – Stone – Heave Away – M'Linda – The Water Is Wide.

Roger McGuinn was there at the beginning, the most complex and fascinating Byrd: 'before hippies, riots, love-ins, freakouts, DMT, STP, Moog, Dolby, Hair, Haight and psychedelic bubble-gum'. He was the task-master for that vital, magical, sweet-sounding, absolutely beautiful, ageless/timeless Byrds-type music.

McGuinn kept it all together. In the end, he could have claimed that he was the Byrds – he never did, not ever, but he could have just the same. He watched the sixties come and grow and self-destruct all around through countless Byrd deaths/transfigurations/resurrections. He was there *still* as the circle kept turn-turn-turning nine years later, through the original Clark-Clarke-Crosby-Hillman-McGuinn Byrds reunion album; *still* playing and *playing* still that flowing, hopeful, gorgeous American rock music – 'truly American, absurdly Californian, almost painfully Southern Californian'.

McGuinn opened the floodgates by sandwiching Dylan with the Beatles; Coltrane and Shankar and Woody Guthrie with Dylan and the Beatles; the first, first, first – it doesn't matter so much that he was the first, but he was the first – the first to realize this, well, potential inherent by juxtaposing forms: "There's an international music coming out; it's kind of like halvah, you know, it has all these ingredients: Latin and blues and jazz flavours, Anglo-Saxon church music, Negro church music. It has a lot of different forms".

Simply, through McGuinn and those indefinite Byrds permutations, an entire generation was inspired – constantly and thoroughly: "Our records, and for that matter, all art, acts as a sort of balancing thing for the world. Byrds' albums are electronic magazines (cartoons, features and editorials). In this way, they are eclectic. They're sort of bi-annual audio magazines, dating from the time the Byrds first started recording. I think of myself as the editor of the magazine. Even "Sweetheart Of The

Rodeo" fits. You don't think doing an all-country music is, in itself, an editorial? Well, it was... a feature on country music, a close up, a special issue – Gram Parsons was, ummmm, sub-editing..."

And McGuinn kept it together – after Gene Clark; after David Crosby; after Gram Parsons and Chris Hillman and so on and so forth. He kept the Byrds perfect on that highly complex, imperceptible level. Nothing made obvious, nothing allowed to protrude: everything here, now, current, with no sense of actual immediacy and no knowledge of the definite – "Like, even now, in my interpretation of 'Tambourine Man', whether Dylan meant it or not, the tambourine man was Allah, the eternal life force, and 'take me for a trip upon your magic swirling ship' was just like 'let my soul go where you want it to and I promise to go under it'".

And the feeling – younger than yesterday/younger than that now. McGuinn carried the tradition: that wondrous, affirmative, joyful *feeling* – that soliptical poignancy opening to sadness; that *feeling* of anticipation, of newness and *deja vu* spliced as one – no matter how many times you've played "Mr. Tambourine Man" or "Turn Turn Turn" or "Eight Miles High" or "Fifth Dimension" or "My Back Pages" or "The Bells of Rhymney" or "Chestnut Mare" or "Mr. Spaceman" – it was the first time since the first time; a rediscovery, a surprise – a source of constant renewal. And the fact that it IS the first time since the last time makes it continually joyous, continually different.

Briefly, McGuinn realized all this – the basis of relationship, the reason the Byrds always had that intimacy and depth and animation: the reason I'm sitting here writing about McGuinn's first solo album and *talking* about the Byrds – it's just inevitable. Derek Taylor said it precisely: "The Byrds are still here because within us and without us they are invincible". Heavy? You betcha.

So Roger eventually disbanded the last Byrds for the first and the circle was complete, their motion compounded – no loose ends, everything just SO; the way it had to be. Approximately perfect. And, after all, after everything that went down, he flew the coop.

McGuinn went solo, not because he needed to or wanted to so much, but because he'd realized the Byrds full circle, and any further statement (if any) with any other line-up would have been invalid, certainly pointless.

Some might find it unhealthy to dwell so much on the past, but with the Byrds and

McGuinn's part in the Byrds, simply it's him and his – The Byrds were a great many things and, towards the very end, McGuinn was *the* thread, *the* sustaining consciousness, the one constant strength. And the Byrds are still here because McGuinn is still here. Like I said before, he kept it all together and we owe him his dues.

Anyway, "Roger McGuinn" is solo album number one. Naturally, there *are* differences (particularly in view of the reunion set), but after ten years as aviary master, they really don't hold much ground – only relatively. This could be the Byrds seventeenth album (just like David Crosby's first solo essentialized his role on the first five) – the voice, the arrangements, the movement, that same economy of gesture, expression and words. *That* guitar. That disarming, thorough majesty in form and order. Yes, and one more thing, that same *feeling*: the capacity to touch a human spirit, leaving that touch to work and activate what it may.

"You don't have much part in what you're doing. You're like a trolley car – shooting down the tracks – and you get the electricity from the wire above you and the tracks below you. Creation is like being in a trance. It's... entrancing".

What McGuinn shows with his own set more than anything, is that ability to make almost any transition at any given time – just like hearing, say, the Byrds' "Turn, Turn, Turn" in between "I'm A Clown" by David Cassidy and Roxy Music's "Pyjamarama", which I did – last night. Sort of open recognition that an obvious environment is immediately insignificant. Such subtlety: halvahisms. Only the Stones and Dylan and the Beatles really understood the Byrds' impact. And, of course, McGuinn. Especially McGuinn.

Musically, the album bears diagonally across his entire career, defining and re-evaluating his general style, placing in some form of temporal perspective its components: from acoustic folk right the way through to light, billowing jazz – all stops in between. And there are MANY: each song, each genre, each evolved development taken each step and realized with the Byrds as its medium: everything re-affirmed here, on the solo.

"I'm So Restless", McGuinn's first folk solo since "It's Alright Ma (I'm Only Bleeding)" from the "Easyrider" soundtrack, again defies you to compare him with Dylan – like a parody, but more of an approximate parallel: "Dylan? He don't give a shit anymore." The difference is in the impact is in the irony is in the consistency – McGuinn *still does*: The Byrds never doubted that they were the Byrds, but who the Byrds are may still be a mystery. Roger clarifies – "I'm So Restless".

Lillian Roxon said it first: "The Byrds were the first *thinking* musicians. And they were articulate (at least Crosby and McGuinn were) at a time when all the Beatles could do was whip off a string of funny-but-not-so-deep one liners. The Byrds were the first acid rockers, the first head rockers, the first message rockers, the first space rockers – not only musical, but political and mystical..."

"Time Cube" is another variation on the "Space Odyssey"/"The Notorious Byrd Brothers" theme – "...an ethereal trip



# Realistic®



Speaker systems, ahead in technology, leaders in value, attractively styled in customized wood or selected colour combinations. The only speakers in Australia to be guaranteed electrically for 5 years.

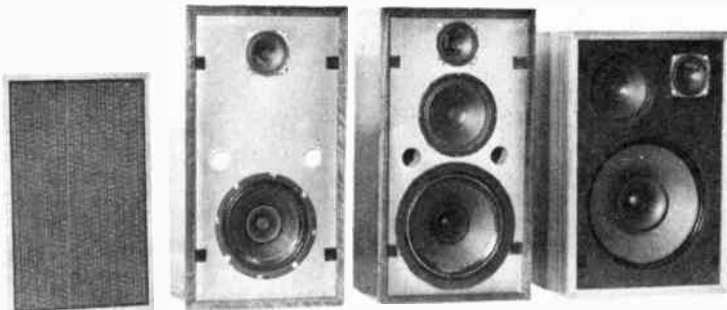

Mini II  
8" 3 cone  
2-way

Midi  
8" 3 cone  
2-way

Maxi  
10" 4 cone  
3-way

2001  
12" 4 cone  
3-way

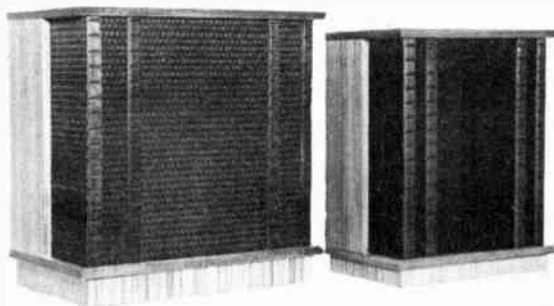

Maxi Ultimate  
15" 5 way  
50 watts R.M.S.

Mini Ultimate  
12" 4-way  
45 watts R.M.S.

**OMNI-DIRECTIONAL SYSTEMS, AVAILABLE  
WALNUT & SELECTED COLOR COMBINATIONS**

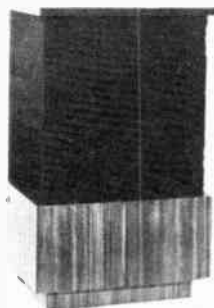

Series II  
10" 6-way Omni  
Series II  
12" 6-way Omni



Mini III omni  
10" 3-way

See the complete range of Realistic products at

## COSTLESS imports

- N.S.W.: Basement, 89 Castlereagh Street, Sydney N.S.W.  
Shop 7, 239 Oxford Street, Bondi Junction. N.S.W.  
306-310 New South Head Road, Double Bay. N.S.W.
- VIC.: 118-124 Toorak Road, South Yarra. VIC.
- QLD.: Shop 42, The Pavilion, Queen Street, Brisbane. Q'LD.
- S.A.: Centrepont, 162 Rundle Street, Adelaide. S.A.  
opening soon at Gosford, Eastwood, Canberra.

## POP

into metaphysics, into the mesh Einstein theorized about. He proved, theoretically... and I choose to believe it... that there's an ethereal mesh in the universe and probably the reason for the speed of light being what it is, is because of the friction going through that mesh."

McGuinn's jazz things, "My New Woman" and the harsher, Brian Wilson/Beach Boys affected "Draggin'", continue in the vein introduced back in the "Fifth Dimension"/"I See You" period - both melodies catch up, jump ahead, eventually subside, but with no sense of peak, forcing you to play them over and over again with the curious feeling you've missed something. Neither resolves, spiralling out (everything really happens off the record) and onward, up, down, here, there. He's an artist/he don't look back just around.

"Stone", David Whiffen's superlative "Lost My Drivin' Wheel" and the two traditionals, "Heave Away" and "The Water Is Wide", showcase McGuinn's keenly satisfying, perceptual sense of arrangement; also, his ability to switch gears effortlessly from purist folk to country to a country-folk-rock amalgam realizing that inherent relationship between the three, and the consequences of having them continually juxtapose still retaining their intrinsic characters as separate styles. No mean feat, I can assure you.

So, briefly, once again, it's the McGuinn recipe for musical halvah. Each is fully executed, furthering all the majesty, warmth and heroic stature of his Byrds-type rewirings a la "He Was A Friend Of Mine", "Wild Mountain Thyme", "Satisfied Mind", "The Bells Of Rhymney" and the latter (Byrds phase two: McGuinn-Battin-Parsons-White) "Old Blue" and "Farther Along".

Perhaps the most endearing quality about "Roger McGuinn" is in the way each song, each delivery, each nuance somehow seems to reflect a re-affirming of past designs: "Bag Full Of Money" draws its substance from the schmuck-spoofed "Drug Store Truck Drivin' Man" ("Dr. Byrds & Mr. Hyde" album), sans humour and avec message prophetic; "Stone" harks right back to McGuinn's vocal stance on the pleading "I Trust"; "Hanoi Hannah", an acoustic blues 12-string/12-bar, and the gorgeous calypso "M'Linda" follow on in the idolatry femme cameo a la "Candy", "Precious Kate", "Kathleen's Song" and "Antique Sandy".

That, in a nutshell, is Roger McGuinn's first post Byrds album - consummate musicianship, much variety, much dexterity and much emotion: another slice of slowly melting innocence; a solo vestal vigil above the rumbling thunder and black storm clouds which have always threatened, yet never succeeded, in putting out the best lit fire, the brightest flame of all. Sadder-but-wiser; happier-but-not-so-smart (I'm younger than that now.)

"I can remember when nowhere in the Western Hemisphere had men, as men, musicians, and media manifestations, loomed as large and promising as OUR Byrds".

"Aahh, but I was so much older then..."  
A beautiful album.

# Ludwig . .

(he would have approved)



**Van Beethoven** a creative genius of music.

LANCODIE only reproduces this genius. It can be enjoyed by you, by following an easily understood, and informative assembly leaflet with a readily accessible kit of parts and components arranged in their natural working order. Don't show LUDWIG the discourtesy by expecting his best from anything less than equipment of the finest of quality ■ ■ ■



POWER OUTPUT: 35 Watts R.M.S. per channel at 8 ohms (both channels driven)

DISTORTION: Less than 0.05% total harmonic  
Less than 0.05% I.M.

FREQUENCY RESPONSE: 20 Hz to 20 KHz  $\pm$  0.1 db

Stable and ring free output into reactive loads up to 0.5  $\mu$ f.

■ ■ TA 350 the finest of quality.

# \$ 150

quality coupled with simplicity—

## LANCODIE

Send MAIL ORDER to:- LANCODIE P.O. Box 91, St. Leonards N.S.W. 2065.  
The price of \$150 includes package & post C.O.D 70<sup>¢</sup> extra.

LANCODIE products are available at ELECTRONIC KITS & ACCESSORIES

24 Darcy St., St. Marys, N.S.W. 2150. Tel. 635 9415 ● 186 Queen St., St. Marys, N.S.W. 2760. Tel. 623 0346.

# INPUT GATE

LETTERS  
FROM  
OUR READERS

## DO CHROMIUM TAPES WEAR RECORDER HEADS?

I would like to use chromium dioxide tape in my recently purchased Harmon Kardon HK 1000 cassette recorder, but some of my friends tell me that this type of tape causes excessive head wear. An audio dealer confirmed this view.

This rather bothers me as the manufacturers of the recorder do not provide any warning that this may happen.

Have you any views on this — or have you performed any tests to see just how much extra wear is caused by this type of tape?

Incidentally is there anything to be gained by using these tapes on low quality machines. — LG. Bordwell Park NSW.

*\*We know of no evidence that indicates that chromium dioxide tape currently on the market wears recorder heads to a greater extent than iron oxide based tapes.*

*Certainly this problem existed during the development period but was solved before any chromium dioxide tapes were offered for general sale.*

*We have not carried out any comparative test ourselves because such an experiment would contain so many independent (and only partially controllable) variables that the result would not be very reliable.*

## KLIPSCH EFFICIENCY

In your review of the Klipschorn (ETI, August 1973) I believe that you

have created a difference of opinion, about the efficiency, that should not exist.

You stated the efficiency in the octave 345-690 Hz was 3% and also that if the directivity of the relevant speaker (mid-range) is taken into account, the apparent efficiency in the listening area is approximately 50%, i.e. the efficiency of an omnidirectional speaker producing the same sound intensity for the same input power would be 50%. This is where I believe a misunderstanding has arisen. In all the papers of Paul Klipsch that I have seen he makes no claims about the efficiency of this mid-range speaker. He claims an efficiency of 50% for his bass horn which being omnidirectional would agree with the efficiency of 3% for the mid-range speaker to produce a level frequency response in the desired listening area.

I would appreciate your opinion since if it turns out the efficiency of the bass horn is not what is claimed then many of the texts and papers on the subject in the past appear to be wrong. — J.A. Christies Beach, S.A. 5165.

*\*From a purely pragmatic point of view, the choice of frequency in determining efficiency should not matter at all as efficiency in the medium and low frequency regions should be independent of frequency, and the method of measurement of this parameter should also be independent of frequency.*

*When we state that the directivity of*

*the mid-range speaker would provide an apparent efficiency in the listening area of approximately 50 percent, this is not the crux of the matter but rather that the measured efficiency at the low frequency driver is not 50 percent. Klipsch and Associates now accept that this claim was rather optimistic and that the measurement techniques utilised originally left something to be desired.*

*Mr. D'Arcy's final comment is, I think, very important in that there is good reason to believe that many of the tests and papers produced in the past were inaccurate, as is becoming increasingly evident when modern measurement techniques are applied.*  
— Louis A. Challis.

## DIGGING DELANEY

As a regular reader of Electronics Today International allow me to congratulate you on a particularly good magazine.

Your equipment reviews are great, and the reviews of popular music, especially Michael Delaney's are a consistently reliable buyer's guide.

Delaney seems to be one of the few reviewers who really listens to the albums he reviews and he is one of the few actually prepared to criticise a genuinely rotten album.

Full marks to him and you for a mighty fine evening's reading every month. May your circulation double, and Delaney find lots more good records to review. — Terry Landon, Bondi Rd., Bondi, NSW. ●

## ELAC PUZZLE COMPETITION

Prize — an ELAC STS.244-12 Cartridge.  
Awarded to the first correct entry opened on  
publishing date of next issue of Electronics Today International

### Answer to Competition No. 5

The minimum number of moves works out to be 18, 446, 746, 311, 387, 512, 998.

Working at the rate of 1 move per 2 seconds, the total time necessary to complete the task would be 1, 169, 084, 781, 566 years 322 days, 59 minutes and 56 secs.

*This entry was sent in by  
Mr. Russell Maddock, AHQ Survey Regiment  
Fortuna, Bendigo, Vic.*

*A little side light is that a remote group of Tibetan monks in successive generations are supposed to be working at this task. On the day of the last move, the world will end. When they started is not known but we can safely assume they have one heck of a lot of moves still in front of them.*

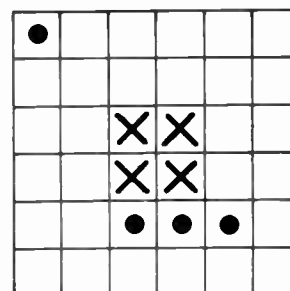

### Now Puzzle No. 7

Cut the square into four parts, each one exactly the same size and shape. You must cut along the lines and each part must contain a dot and an X.

POST ENTRIES TO:

ELAC PUZZLE COMPETITION No. 7  
P.O. Box 150, Crows Nest, N.S.W. 2065

Permit No T/C 4108



## It's all yours. From \$1,375 for 52 unbelievable days.

Now for \$25 less than it used to cost you to fly to London and back, Pan Am can take you to 12 cities in eight countries, give you accommodation, all meals on the continent and bring you back for just \$1,375.

And that's just one of six world holidays in the Pan Am New Horizons World Holidays series.

Here's a summary of the six holidays. For more complete information, see Pan Am or your Pan Am travel agent, or send in the coupon.

### The Adventurer.

52 Days from \$1,375 ex Australia and New Zealand visiting Los Angeles, London, Koblenz, Nuremberg, Salzburg, Vienna, Klagenfurt, Venice, Rome, Switzerland and Paris.

### The Connoisseur.

45 Days from \$1,967 visiting San Francisco, New York, Paris, London, Copenhagen, Lisbon, Rome, Istanbul, Hong Kong.

### The Executive.

39 Days from \$1,588 visiting Honolulu, San Francisco, New Orleans, New York, London, Frankfurt, Zurich, Rome, Hong Kong.

### The European Special.

38 Days from \$1,469 visiting Hong Kong, Tel Aviv, Rome, Paris, London, Frankfurt, Milan, Athens.

### The European U-Drive Holiday.

53 Days from \$1,396 flying to and driving thru so many places in France, Italy, and Great Britain we haven't the space to list them all.

### Round The World Free Wheeler.

60 Days from \$2,085. Another Drive Yourself holiday. Sixty days travelling leisurely thru Europe, Great Britain, and the Californian seaboard of the United States.

### The Pan Am Do It Yourself Club.

Or you can plan your own holiday. Visiting as many or as few places as you want. And use Pan Am's World-Rent-A-Car Plan wherever you want.

# FOR SALE

Please send me the World.  
I'm interested in the:

- Adventurer  Connoisseur  
 Executive  European Special  
 European U-Drive

Round World  
 Free Wheeler  
*(tick the ones you want brochures for)*



- I want to travel with a group  
 I don't want to travel with a group  
*(tick applicable)*

Name \_\_\_\_\_

Address \_\_\_\_\_

Postcode \_\_\_\_\_

My Travel Agent is \_\_\_\_\_

Sydney: Pan Am Cnr., Elizabeth St., at Martin Place, 25-7111. Melbourne: 233 Collins St., and Southern Cross Hotel, Exhibition St., 654-4788. 065.P.461B

Fares ex Sydney

## Pan Am New Horizons World Holidays.

Sydney: Pan Am Corner, Elizabeth St., at Martin Place, 25-7111. Melbourne: 233 Collins St., and Southern Cross Hotel, Exhibition St., 654-4788. Brisbane: 191 Elizabeth St., 21-7477. Canberra: 28-36 Ainslie Avenue, 48-9184. Adelaide: Aston House, 13 Leigh St., 51-2821. Perth: Terrace Arcade, 104 St. Georges Terrace, 21-2719.

# The complete range of Optoelectronic devices

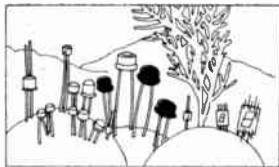
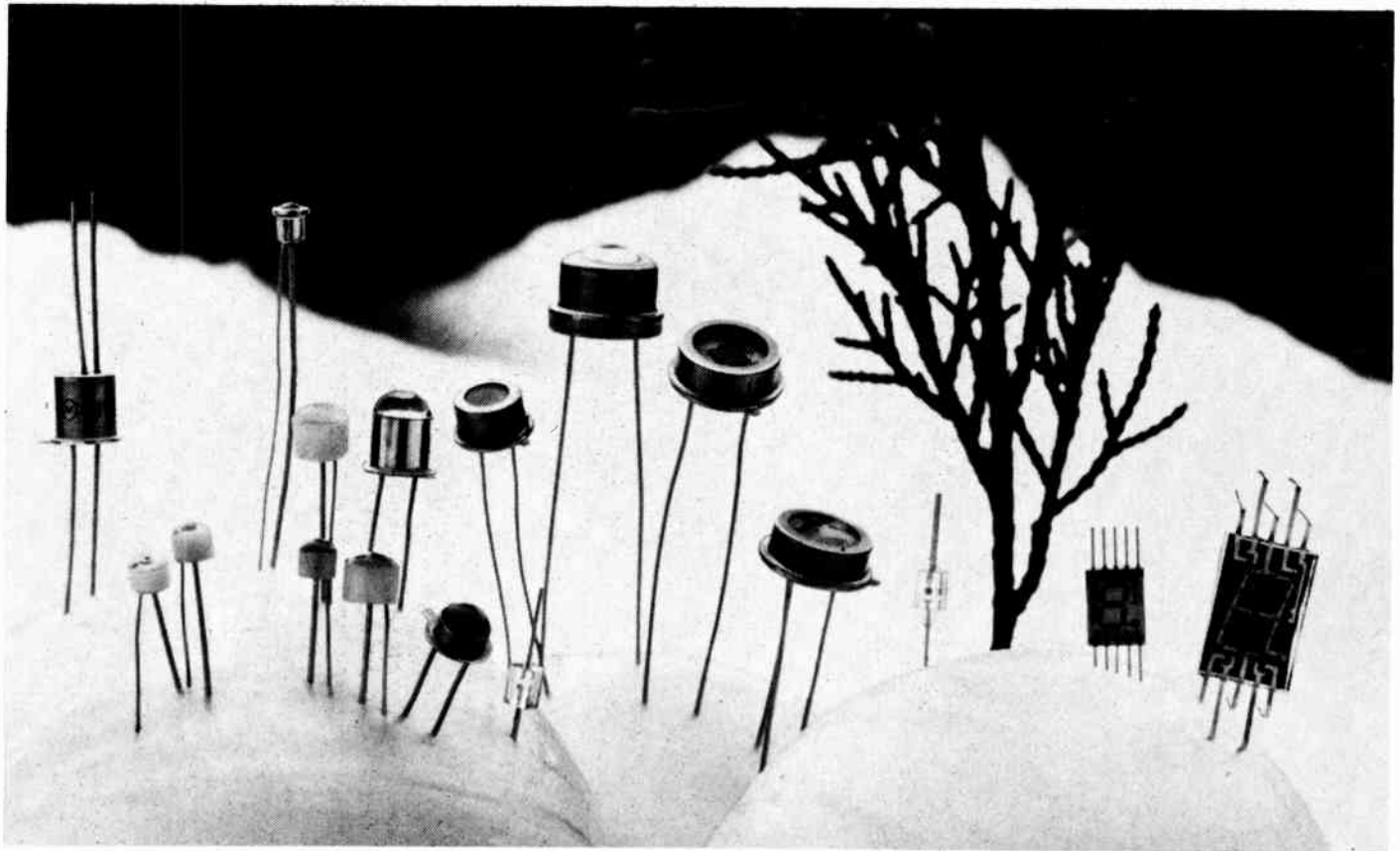

## Photodiodes

DKI photodiodes are of diffused planar silicon construction, feature high performance and reliability and are suitable for application in computer peripheral equipment, process control, industrial control, photo-meters or any other design requiring light sensitivity.

A 9-bit silicon photodiode array is available which finds application in punched paper tape readers of input machines for computer and NC equipment.



## Phototransistors

DKI phototransistors are of planar silicon construction and are highly sensitive devices. They are particularly suitable for use in optical measuring equipment, control devices and other electronic applications.



## Solid-state Numeric and Alphanumeric Displays

DKI numeric displays are of GaAsP monolithic or hybrid, 7-segment composition. They are suitable for application in a wide variety of display apparatus. Features include high brightness with small current, numerals 0-9 and decimal point and rugged, vibration-resistant construction.

Typical applications include computer terminals, electronic desk and portable calculators, cameras, electronic wrist watches and various digital measuring instruments.

The alphanumeric display (not illustrated) is a 5 x 7 dot matrix of 36 GaAsP red L.E.D.s.

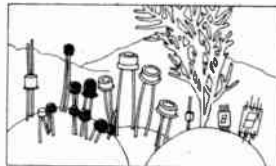

## Light Emitting Diodes

DKI L.E.D.s are available in INFRARED, RED or GREEN versions.

A wide range of body styles is available to suit a multitude of applications including solid-state indicators and displays, photochoppers, photocouplers, photo-switches . . . e.g. punch tape readers, conveyor control, rotation counters, automatic weighing machines, position control and opto-isolators.



## Photocouplers

The DKI photocoupler employs GaAs L.E.D.s and Si phototransistors. Its light source and sensor are optically coupled with no electrical connection. Typical applications include pulse transformers, photoswitches, photorelays, power separation circuits (for analog and digital) and level converting circuits (for potential and impedance).

## \*Optical Mark Sensor

(\*not illustrated)

DKI manufacture an optical mark sensor which senses by the reflection method, 12-unit signal marks and a timing mark recorded on the paper for DCR use and converts the data into electrical signals.

It is composed of GaAsP L.E.D.s as the light source, planar silicon photodiodes as the sensor and IC preamplifier.

# PLESSEY

Plessey Ducon Pty. Limited  
Box 2, Villawood, N.S.W. 2163  
Tel. 72 0133. Telex 20384  
Melbourne: Zephyr Products Pty. Ltd.  
56 7231. Adelaide: K. D. Fisher & Co.  
42 2920. Perth: H. J. McQuillan  
Pty. Ltd. 68 7111.  
Everett Agency Pty. Ltd. 8 4137.  
New Zealand: Henderson (N.Z.) 6 4189.

AC79



**AUSTRALIAN MUSIC FOR HARPSICHORD AND CLAVICHORD: Froberger, Poglietti, Fux, Mozart, Haydn, Beethoven. Igor Kipnis. CBS Odyssey 2004 (\$2.75). Distributed by Avan-Guard Music.**

Anyone who has heard Halm's transcription of Beethoven's "Grosse Fuge" string quartet for orchestra will realize the arrogance of arrangers who think they know better than the composer how he should have written his music. Surely there is sufficient music for non-piano keyboard available as to make it unnecessary for Kipnis to transcribe three of the seven pieces he performs on this record? Einstein has claimed that the only pieces Mozart could have written for harpsichord are the three concerti (arrangements) K.107 and the four concerti (also arrangements) K.37, 39, 40 and 41, and even these last four are regarded as the first four of the 27 piano concerti. Nevertheless, here we have the Early Pieces K.1-5, played even more extremely on the clavichord, and the variations K.265 on "Ah, vous dirai-je, Maman" played on the harpsichord. These variations are far too characteristic of the piano to succeed this way, but more so can it be said of the six Beethoven Variations on "Nel cor piu non mi sento", Wo070, which also appear. It is by no means disastrous, but some of it is very mannered, in particular variation IV - I'm afraid I find Beethoven played on an 18th-century-style harpsichord in the style of Paderewski just a little incongruous. And while griping about transcriptions, Kipnis has elsewhere recorded Mozart's Piano Concerto No. 9 with a harpsichord - I am now eagerly awaiting his edition of Rachmaninov's Harpsichord Concerto No. 2 in C minor, Op. 18, and Beethoven's Clavichord Concerto No. 5 in E flat (the 'Emperor').

But to be more positive, the genuine cembalo works here - Poglietti's Canzona and Caprice on the Cackle of the Hen and the Crow of the Rooster, Fux's Chaconna in D, Froberger's Suite No. 26, and Haydn's Sonata No. 13 Hob.XVI/6 - are in imaginative choice and they are excellently played, barring a surplus mannerism or two. Using two different instruments is a definite improvement on the usual tedium imposed by two sides of just one or the other, and the technical quality is particularly good. It

is very easy to over-compensate for the very low volume (and quality) level of the clavichord, thus producing an entirely unnatural sound, but much to the technicians' praise it has been avoided this time. It is also heartening to see the small pieces of six-years-old Mozart's K.1-5, which are quite delightful - far from mere juvenilia with only curiosity value to their name. The timing is more than usually generous, especially for this label (58½ minutes), and (if one forgets about the acceptability of transcriptions) this is an excellent record all round, no pun intended, especially at its price. - T.R.B.

**PURCELL - Complete Funeral Music. Te Deum. Jubilate Deo. Choir of St. John's College (Cambridge), English Chamber Orch., Symphonie Sacre, George Guest (cond.) ARGO ZRG-724.**

A new and complete recording of the Funeral Music on one disc is a very desirable thing. This performance includes: (1) the Funeral Sentences comprising "Man that is born of Woman" (1682) and the early "In the midst of Life"; (2) the five-part anthem "Remember not Lord our Offences"; (3) March; (4) Canzona, and (5) "Thou knowest Lord"; the five-part anthem dating from about 1682 and often associated with the Funeral Sentences, while the last three numbers were specifically intended for the funeral of Queen Mary II in 1695. None of these pieces are new to records. Several of the anthems have been available on various discs at one time or another. There was, as well, the memorable recording by the Geraint Jones Singers of "Man that is born of Woman" and nos. 3-5 and now available only as an import on SERAPHIM 60001. I have not been able to hear the recording by American DECCA (DL-710114) but, in any case, this record limits itself to the numbers known to have been performed for Queen Mary's funeral. To my knowledge then, this is the first time all of Purcell's Funeral Music has been recorded together.

Unfortunately, however, completeness is just about the only recommendation one can give for this particular recording. It is good to hear this music performed by an all male choir but the performance itself completely lacks verve as to be at times unbearable. There is little sense of attack or rhythm and the phrasing adopted here seems oblivious of the accents so important in this music. One has only to compare the recording here of the anthem "Remember not, Lord, our offences" with the Willcocks-directed reading on TELEFUNKEN SAWT-9558 to realize that the music here need not sound as insipid as it does. The instrumental March and Canzona are performed by sackbuts and tympani from the Symphonie Sacrae but the articulation here is amateurish, timing is clumsy and there is again little sense of accent so that the famous March especially belies any feeling of strong nobility. The renditions of the "Te Deum" and "Jubilate Deo" on the reverse are much better but one still feels a need for stronger drive and attack to give the music a better sense of weight. The solo singing here by countertenors James Bowman and Charles Brett are wonderful to hear but the efforts of everyone are vitiated by the remarkable lapses in pitch by bass Forbes Robinson. I am in fact astonished how the engineers

could have passed the section of the "Jubilate Deo" beginning "For the Lord is gracious". Recording is clear and spacious, while the surfaces of my copy reveal the usual clicks and extra noise one has become quite accustomed to receive from DECCA records these days. - J.A.A.

**PUCCINI-TOSCA - Price, di Stefano, Taddei, Corena. Vienna Philharmonic, Herbert von Karajan (cond.) DECCA 5BB 123/4.**

The finest performance of *Tosca* on records is still, to my mind, the old Callas-di Stefano-Gobbi recently re-released in England by HMV (SLS-825) and will presumably make its way here later in the year. In the meantime, this *Tosca*, once available as part of RCA's Soria series, has been reissued in this country for DECCA at a special subscription price. If you have not as yet acquired the Callas set and only one recording of *Tosca* can meet your economic standards, then I would suggest waiting a bit. The sound on that set may well be old by today's standards but the performance presents three very fine singers at their best and is excitingly conducted by Vittorio de Sabata.

If, however, you must have fine sound or are willing to invest on a second set then the present recording will undoubtedly meet the highest expectations. There is, in fact, no other *Tosca* which comes so close to the standards achieved by the older set and there are certain aspects which are realised here better. My reference to fine sound is hardly ironic: *Tosca* is along with *Turandot* the most sonically extravagant of Puccini's operas. One must have the dynamic range of recording to cope with, for instance, the end of Act I and the offstage chorus in Act 2. In this respect, not even the recent technical refurbishing of HMV of the Callas set helps to meet the extreme dynamic ranges of this score. This recording, produced by John Culshaw of "Ring" fame, is even after almost seven years still magnificent in sound. The cannon shots, those bells at the beginning of Act 3, the sound and effects contribute a great deal to the fineness and excitement of this recording. The most sonically complex portions of this score, the Tel Deum of Act I and the cantata in Act 2 present every strand of the sound with clarity and seemingly without any effort on the part of the engineers to hold things back.

The second undoubtedly strong asset of this recording is the conducting of Herbert von Karajan. de Sabata's conducting is certainly one of the finest tributes we have to his career and perhaps this is a case of comparing one magnificent interpretation with another, but I do feel that perhaps Karajan does have the edge over de Sabata. Karajan has at his disposal a finer orchestra, the Vienna Philharmonic and at least under this conductor the tone of the Viennese strings and especially the brass seem very appropriate to this score. Karajan is also more flamboyant in this very flamboyant music. There is little hesitation on Karajan's part to extract every ounce of melodrama from the score; the orchestra plays often with pointed and, if I may add, appropriate emphasis and even exaggeration. The rubatos are at times dizzily applied but the overall result is to achieve a grand sense

# TECH. BOOKS

## MAIL ORDERS BY RETURN POST

A.R.R.L. Antenna Book \$4.35.  
 Amateur Radio Techniques (RSGR) \$6.05.  
 Basic Electricity \$12.90. 5 vols. combined.  
 Basic Electronics \$4.55. U.S. Navy text book for beginners.  
 Basic Electronic \$15.20. 6 vols. combined.  
 Basic Electronics Circuit \$7.30. 2 vols. combined.  
 Basic Ind. Electricity \$7.30. 2 vols. combined.  
 Beginners Guide to Transistors \$3.55.  
 Breakthrough Book \$11.00. About life after death contact experiments.  
 Basic Electronic Problems Solved \$6.15.  
 Colour Receiver Techniques \$6.50. By Towers.  
 Colour T.V. Pal Secam and Others Systems \$13.50.  
 Colour Television Pal System \$9.25. By Patchett.  
 Colour T.V. Principles and Practice \$16.10. Vol. 1.  
 Colour Television Theory \$10.80. By Hutson.  
 Colour T.V. Servicing \$14.85. By King.  
 Designing with T.T.L. Integrated Circuits \$20.50.  
 Dictionary of Telecommunications \$7.50.  
 Digital Principles and Applications \$11.05. By Malvino.  
 Electronics Data Handbook \$3.55. Formulae and tables.  
 Electronics Eng. Reference Book \$24.00. By Hughes and Holland.  
 Electric Guitar Amplifier Handbook \$5.45.  
 Elements of Transistor Pulse Circuits \$6.30. By Towers.  
 Future Shock \$6.90. By Alvin Toffler.  
 Hi-Fi Tape Recorder Handbook \$6.80.  
 How to fix Transistor Radios and Printed Circuits \$5.15.  
 How to Listen to the World \$4.40. New 7th edition.  
 Learn Electronics through Troubleshooting \$12.75.  
 Local Design of Electrical Circuits \$8.30.  
 Mazda Book of Pal Receiver Servicing \$11.90.  
 Modern Relay Techniques \$7.50.  
 104 Transistor Projects \$4.40.  
 110 Semiconductor Projects for Home Constructions \$6.10.  
 Operational Amplifiers \$15.00.  
 101 Ways to use your Colour T.V. Test Equipment \$4.05.  
 Practical Thinking \$5.95. By Ed. De Bono.  
 Principles of Pal Colour T.V. and Related Systems \$3.80.  
 Pulse Digital and Switching Waveforms \$11.15.  
 Radio and Electronic Handbook \$4.25.  
 A.R.R.L. Radio Handbook 1973 \$6.95.  
 Reference Data for Radio Engineers \$25.00  
 Semiconductor Devices and Circuits \$8.50.  
 Semiconductor Diode Lasers \$6.45.  
 Tape Recording for the Hobbyist \$4.40.  
 Technical Manual Sylvania. Receiving tubes/picture tubes and semiconductors \$5.15.  
 Transistor Audio Amplifiers \$19.00.  
 Transistor Circuit Design \$9.90. Solution to basic problems.  
 Transistor Equivalents \$3.00. European American Japanese.  
 20 Solid State Projects for Car and Garage \$4.25.  
 20 Solid State Projects for the Home \$6.10.  
 Understanding Solid State Circuits \$6.15.

Add 60c N.S.W., 80c ACT & other States to above prices for postage & packaging.

**MODERN BOOKS AND PLANS**  
 280 PITT ST. SYDNEY 2000 NSW

# CLASSICAL

of drama all too rare in performances of opera such as this. You might say de Sabata is more to the point than Karajan but in fact de Sabata is as flamboyant in his own way. I rather prefer Karajan's way with this music.

With regard to the singing on this set, there can be no doubt that the older set is superior. But when I say this I must confess that even when the present recording was first issued on RCA, my first reaction on listening to it was a rather curious feeling that the principals here very much had the older set in mind. Di Stefano was of course the Cavaradossi in the HMV set as well. His voice was in better state then, and there is less of a tendency to over-emphasis as in the newer set, but then as more recently the tessitura of his music made severe demands on his voice. Having said this, however, it still remains true that his Cavaradossi is superior in dramatic sense to any other on records. Giuseppe Taddei is no Gobbi but he sings very well and once again I think his articulation and delivery here is based on Gobbi's own, which is not to say that Taddei is just reminiscent of Gobbi's singing. Even after several years I find it hard to approach the singing on this set without being reminded of the style on the older recording. The Angelotti here (Carlo Cava), even the Sacristan (Fernando Corena) reminds one of F. Calabrese and M. Luise.

Finally, when one considers Leontyne Price's *Tosca* one is almost convinced that the cast on the present set evidently had the virtues of the older recording in mind. There is no doubting the superior vocal quality of Price's voice to Callas'. It is more a flexible and naturally more opulent voice. But here delivery, *portamento*, even the occasionally harsh articulation of top notes, the *mezza voce* these are very reminiscent of Callas' own performance. Callas' sensitive enunciation of text, her moulding of a phrase is finer and perhaps one can say that whereas Price presents an excellent *Tosca*, Callas' identification with *Tosca* is simply complete.

But we are, once again comparing one magnificent performance with another. There are moments when Callas' interpretation is unforgettable: the end of the second Act, and how natural her "Mario! Ah! Morto!" in the third Act. Perhaps if I had to choose one set I would have the Callas but I would rather not be in such a position. — J.A.A.

**MUSIC AT NOTRE DAME IN 1200** — Deller Consort, instrumentalists. BASF 25 29318-1.

This splendid record is, to my knowledge, the only recording available to contain both organa quadrupla, the Graduals "Viderunt omnes" and "Sederunt principes" attributed by the English theorist known to scholars as Anonymous IV to the 12th-13th century Parisian master, Perotin.

By the same master we also receive his "Alleluia nativitas" and the remarkable anonymous organum "Alleluia Christus resurgens" with clausula "Mors"; finally, there are two anonymous conductus, the "Pater noster commiserans" and "Dic Christi veritas". Side B of this record including "Sederunt principes" and the two

anonymous conductus are also available in the same performance with the Deller Consort's superb performance of the Machaut *Notre Dame Mass* on BASF. Coupled here with more contemporaneous material, this record can serve as a fine survey of the music of this period. Further, none of the pieces here duplicate any of the items available on TELEFUNKEN's fine two disc survey of the *Ars Antiqua*.

Performances of this music vary a great deal as even a cursory comparison between this recording and the above TELEFUNKEN set will show. Konrad Ruhland and the Capella Antiqua (Munich) on TELEFUNKEN are generally much more refined and details are often very clear. What is needed in that performance is less of the temptation to gloss over the always strong rhythmic patterns in the music and a greater sense of strength and drive. Deller's forces here are certainly strong rhythmically: for once the end of "Sederunt principes" sounds like a real dance and an ecstatic one at that. The drive in this performance makes it very hard for one not to respond to those hypnotic triple rhythms, and it is also easier after this record to sympathize with those medieval ecclesiastics who took great exception to this music. Unlike the TELEFUNKEN recording, there is also a more marked effort here to contrast parts and the many instances of dissonance (to our ears) and clash of parts come off with splendid effect.

Perhaps my only serious objection to the performance here is the nasal enunciation of the plainsong portions of this music. I rather feel that a less tense delivery would make better contrast for the polyphonic sections. Others, however, would no doubt disagree with me as to the delivery of the plainsong sections; in any case, this is small matter compared to the general excellence of the performances here. Thoroughly recommended — and not just to the specialist. — J.A.A.

# SERVICE

To all quality audio equipment . . .

re-coning of hi-fi speakers . . .

re-winding of transformers . . .

60 Hz sine inverters —  
 Hammond organs . . .

Ring 922-1347  
**BURNETT AUDIO**  
 64 Palmer Street, Cammeray, N.S.W.



**"... (The Dynaco A-25)  
has established a  
new standard of performance  
in uncolored, natural sound."**

THE HI-FI NEWSLETTER (P.O. Box 539, Hialeah, Fla. 33011)

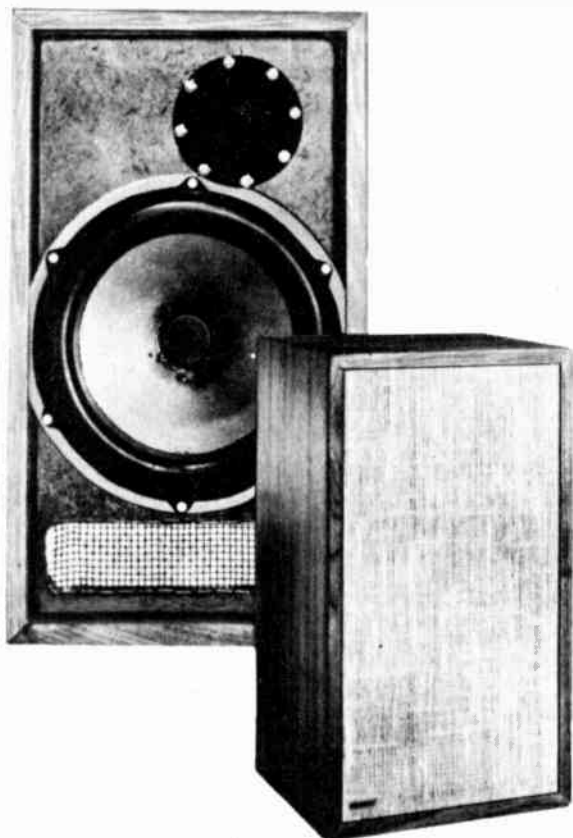

**"...you'll have a  
hard time buying  
more musical  
naturalness  
at any price."**

THE STEREOPHILE (Box 49, Elwyn, Pa. 19063)

The critiques from these hobbyist magazines have unusual merit as these publications accept no advertising. Their comparative evaluations are funded solely by the subscriptions of ardent audiophiles.

The A-25's sound quality is a direct consequence of its smooth frequency response, outstanding transient characteristics, and very low distortion. Its aperiodic design (virtually constant impedance over its range) provides an ideal load so any amplifier can deliver more undistorted power (and thus higher sound levels) for a given speaker efficiency.

Uniformity of impedance also makes the A-25 the best choice for adding two new speakers to an existing stereo setup using the Dynaco system\* for four-dimensional reproduction. In this way, true "concert hall sound" can be enjoyed with a standard stereo amplifier.

See and hear two additional Dynaco models, the A10 and A35 with markedly similar sonics and closely matched characteristics at your Dynaco dealer now. Together with the A25, these models represent the finest value available today.

*FOR YOUR NEAREST DYNACO DEALER. WRITE OR PHONE*



JERVIS AUSTRALIA PTY. LTD.  
P.O. Box 6, Brookvale. N.S.W. 2100  
Phone: 939 2922

# SUTHERLAND

# SOUND

## ***LARGEST HI-FI COMPLEX SOUTH OF SYDNEY***

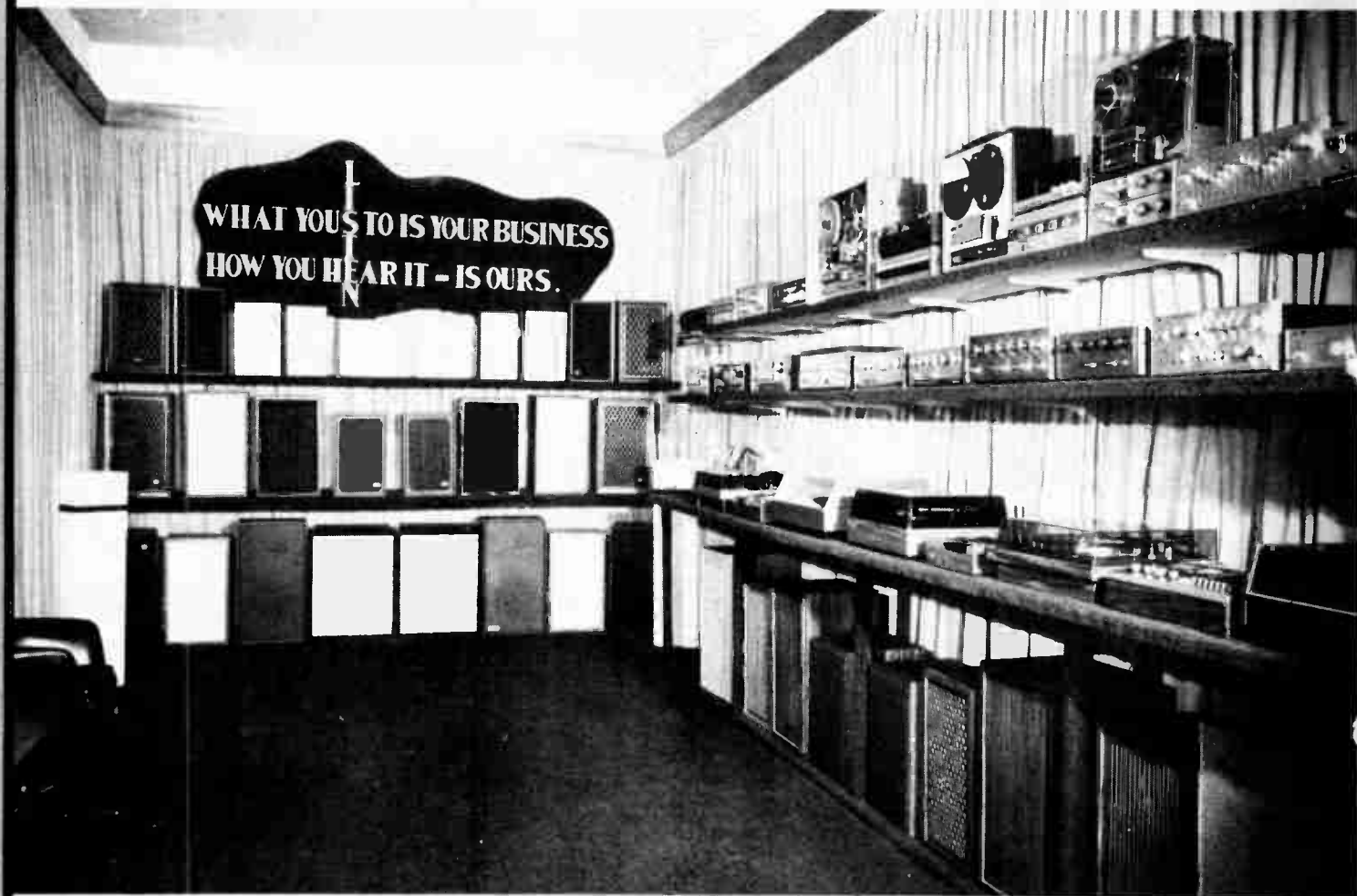

Sound Fidelity designed a sound lounge representing the average size lounge room — fully air conditioned, acoustically tested — where you can sit down — relax and hear hi-fi demonstrated at its best, thus giving you that 'at home feeling'. All equipment is connected to a specially designed comparator allowing you that instant freedom of choice in selecting your hi-fi system.

Sound Fidelity are not partial to any particular brand. WE ARE STOCKISTS FOR ALL QUALITY HI-FI BRANDS and sell at the best prices available. With FREE home delivery and installation.

Sound Fidelity design manufacturer quality stereo wall units — cabinets — speaking boxes — turntable bases and covers — record units and coffee tables. OBLIGATION FREE QUOTES.

**OUR MOTTO "What you listen to is your business"**

**5 BOYLE STREET; SUTHERLAND**

# FIDELITY CENTRE

## SOUND FIDELITY



Easy access — ample parking facilities at all hours — modern decor.

## CAR STEREO



Largest car stereo display in Sydney with over 20 working units to choose from to suit your car needs — installation and service with 6 month's parts and labour guarantee.

## SPARE PARTS



Stereo Test Records — record cleaners — leads — plugs — cartridges — cassettes — styli tape — microphones etc. You name it. IF NOT IN STOCK — WILL HAVE.

## SERVICE CENTRE



Stereo Grams — hi-fi systems — car stereo musical instruments serviced by 17 years hi-fi technical experience. On the spot after sales service a speciality.

NOTE: CAR STEREO — SPARE PARTS & SERVICE OPEN ALL-DAY SATURDAY. AFTER HOURS HI-FI DEMONSTRATIONS AVAILABLE.

— HOW you hear it is ours.

SALES 521-6926 • SERVICE 521-6092

**NOW AVAILABLE**

'D' SIZE LEAK PROOF.  
**KONO**  
LEAD ACID BATTERY.

**A new concept in design and performance**



**CONSTRUCTION**  
Fully sealed in reinforced plastic housing.

**LIFE**  
500-1000 charge cycles or 4-5 years on float service.

**DISCHARGE CURRENT**  
Maximum continuous discharge 200 times larger than the 20 hr discharge rate.

**ECONOMY**  
Value of 200 'D' type dry batteries.

For further information contact:—

**MIKE ELECTRIC**

(AUST.) PTY. LIMITED

12 Norman Street, Peakhurst, N.S.W. 2210

Phone: 533-3288

# THE rustrak PRIVATE EYE

Rustrak Miniature Recorders chart voltage, current, power, temperature, pressure, strain, events; or virtually any parameter that can be converted into an electrical signal. Inkless, drywriting, rectilinear recording with wide range of sensitivities, writing and chart speeds. Quick, easy chart review and re-wind. Sliding access window. Rugged die-cast aluminium case in epoxy suede-like charcoal grey finish.

63" chart roll — one month's supply at 1" per hour. Portable or for panel mounting as a system component. Accuracy  $\pm 2\%$  of full scale. Only 5 $\frac{3}{8}$ " high, 3 $\frac{3}{8}$ " wide, 4 $\frac{1}{4}$ " deep. Weighs 3 $\frac{1}{2}$  lbs. Combine any two functions on one chart in our new Dual 300 Series.

Model 288



TECNICO ELECTRONICS



Premier Street, Marrickville, N.S.W. 2204. Tel. 55 0411  
2 High Street, Northcote, Vic. 3070. Tel. 489 9322  
Adelaide: 67 2246. Perth: 25 5722.

T8241/373

## ZEPHYR RECOMMENDS THESE ELECTRET CONDENSOR MICROPHONES

- \* ATTRACTIVE APPEARANCE \* OUTSTANDING PERFORMANCE
- \* EXCELLENT SIGNAL-TO-NOISE RATIO

EM-507  
NON-DIRECTIONAL

Impedance : 600 OHMS  
Sensitivity : -70db (0.315MV)  
                  :  $\pm 2.5$ db  
Freq. response : 50-15000 HZ  
Battery : 1.5.V (UM-3)

CMU-506  
UNI-DIRECTIONAL

Impedance : 600 OHMS balanced  
Sensitivity : -72db  $\pm 2$ db 1K HZ  
                  (0db = 1V/U BAR)  
Freq. response : 50-15000 HZ  $\pm 3$ db  
Battery : H-7D/A9.1V

EM-4000  
LAVALIER

Impedance : 1K  
Freq. response : 100-10K HZ  
Battery : 1.5 VOLTS

MARKETED IN AUSTRALIA BY

**ZEPHYR PRODUCTS PTY LTD**

70 BATESFORD ROAD, CHADSTONE 3148, VICTORIA — PHONE: 56-7231

**ELECTRONICS TODAY**

**INTERNATIONAL**

**ELECTRONICS  
-it's easy!**

**NEXT MONTH**



**EDGE ELECTRIX**  
 25A Burwood Rd, Burwood 2134  
 Phone: 747-2931  
*Specialists in Electronic Components and spare parts.*

**SPECIALS FOR SEPTEMBER**

**BASF CASSETTES**

C120 transparent pack	.....	\$2.30
C90 transparent pack	.....	\$1.59
C120 Library box (low noise)	..	\$2.65
C90 Library box (low noise)	..	\$2.10
C60 Library box (low noise)	..	\$1.59
G120 Library box Chromium Dioxide	.....	\$4.32
C90 Library box Chromium Dioxide	.....	\$3.68
C60 Library box Chromium Dioxide	.....	\$2.93

**ADD 25c POSTING FEE**

**PLESSEY - ROLA SPEAKER**

C6MR/8Ω/15Ω	.....	\$7.90
C60/8Ω/15Ω	.....	\$11.09
C80/8Ω/15Ω	.....	\$12.43
C100/8Ω/15Ω	.....	\$13.26
C3GX/8Ω/15Ω	.....	\$4.67
X30/8Ω/15Ω	.....	\$8.50
C6LX/8Ω/15Ω	.....	\$6.37
C60X/8Ω/15Ω	.....	\$12.62
C8MX deluxe/8Ω/15Ω	.....	\$8.95
C80X/8Ω/15Ω	.....	\$8.95
C100X/8Ω/15Ω	.....	\$14.68

**ADD 50c POSTING FEE**

12U50/8Ω/15Ω	.....	\$36.00
--------------	-------	---------

**ADD \$1.50 POSTING FEE**

**CATALOGUE AVAILABLE AT  
70c INCLUDING POST**

**The Slider \$14.98.**



To operate most testers you need two hands. For the controls of the Jemtester TH-12 you need one. Instead of turning the changeover switch, you slide it with your thumb. Instead of turning the zero adjustment, you roll it with your finger.

Other attractive features of this tester include printed circuits to eliminate troubles such as disconnected wiring; overload and anti-shock protection is built-in; and meter readings are made simple by virtue of a large scale printed in red and black on a white ground.

Naturally, it's guaranteed unconditionally for 12 months. You can own this multimeter for \$14.98, instead of paying the \$18.72 which is the recommended retail price, by filling in the coupon below and sending it to General Accessories, now. Be quick about it, though; supplies are limited.

**SPECIFICATIONS, 20,000 ohms/volt. RANGES,**  
 DC VOLTAGES: 0~0.25/2.5/10/50/250/10000V (20KΩ/V)  
 AC VOLTAGES: 0~10/50/250/10000V (5KΩ/V)  
 DC CURRENTS: 0~50μA/0~25/250mA (250mV drop)

**To: General Accessories,**  
 153 Sturt St., South Melbourne, Victoria, 3205.

Please send me the Jemtester TH-12, for which I enclose my cheque for \$14.98.  
 Please send further literature on the complete Jemco tester range. (Cross out where non-applicable.)

Name .....

Address .....

# READER INFORMATION SERVICE AND ADVERTISERS' INDEX

For further information on Advertisers listed below complete the coupon/s stating information required including company and position held (if relevant). Cut out the coupon and post to:—

**ELECTRONICS TODAY INTERNATIONAL, RYRIE HOUSE, 15 BOUNDARY STREET,  
RUSHCUTTERS BAY, SYDNEY, 2011.**

## ADVERTISERS' INDEX

A & R Soanar Group	123
Ace Radio	117
Amateur Astronomer	38
Auriema	68
Australian Consolidated Industries	82
Australian General Electric	61
Australian Musical Industries	2
Autel	8-9
B.J.D. Electronics	11,43,121
Bleakley Gray	41,55
Burnett Audio	136
BWD Electronics	63
Cema Distributors	110
Convoy Pty Ltd	125
Cost Less Imports	120,130
Cunningham, R.H.	84
Convoy Technocentre	21
Convoy TDK	108
Direct Tape Disposals	111
Douglas Trading	14
Ear for Music	70
Edge Electric	141
Elmeasco	15
EMI	116
Fred Falk	46-47
General Accessories	95,141
Goldring Engineering	90
Glen-Dor Audio	
Haco	104,128
Haltronics	127
Ham Radio	58,125
Hewlett Packard	88
Honeywell	36
IRH	58,94
Instrol	32-33,144
International Dynamics	76-77
Jacoby Mitchell	12-13,105
Jervis	54,127,137
John Carr	20
Kent Hi-Fi	112
Kimberley Plastics	107
Kit-Sets	40,122
Lafayette	125
Leroy	85
McMurdo	53
Magna Techtronics	52,132
Maurice Chapman	89
Micronics	93
Mike Electric	140
Miranda Hi-Fi	17,119
Modern Books & Plans	136
M.S. Components	45,125
N.S. Electronics	100
Pan-Am	133
Parameters	45
Philips Industries	4
Plessey Duncan	42,134
Plessey Rola	103
Pre-Pak	71-74
Radio Parts	113
Scientific Electronics	111
Selsound	6-7
Seven Seas Electronics	91
Silverstone Electronics	106
Sonab of Sweden	22,23
Sound Fidelity	138-9
Tecnico	91,140
Teknis	111
Timbre	131
Tri-State	19
TV Tuner	91
Union Carbide	10,62
United Trade Sales	38
W.C. Wedderspoon	143
Wayne Communications	70
Weston Electronics	127
Zephyr Products	140

Send to: **ELECTRONICS TODAY INTERNATIONAL,  
Ryrie House, 15 Boundary Street, Rushcutters  
Bay, Sydney, 2011.**

ADVERTISER

PRODUCT

NAME

ADDRESS

POSTCODE

COMPANY

POSITION

10:73

Send to: **ELECTRONICS TODAY INTERNATIONAL,  
Ryrie House, 15 Boundary Street, Rushcutters  
Bay, Sydney, 2011.**

ADVERTISER

PRODUCT

NAME

ADDRESS

POSTCODE

COMPANY

POSITION

10:73

Send to: **ELECTRONICS TODAY INTERNATIONAL,  
Ryrie House, 15 Boundary Street, Rushcutters  
Bay, Sydney, 2011.**

ADVERTISER

PRODUCT

NAME

ADDRESS

POSTCODE

COMPANY

POSITION

10:73

Send to: **ELECTRONICS TODAY INTERNATIONAL,  
Ryrie House, 15 Boundary Street, Rushcutters  
Bay, Sydney, 2011.**

ADVERTISER

PRODUCT

NAME

ADDRESS

POSTCODE

COMPANY

POSITION

10:73

Four reply coupons are provided here for your convenience. Please list only ONE advertiser and ONE product on each coupon. If you require information on more than four individual products, make as many copies of the coupons as you like (preferably typed)—again using one coupon form for each product.

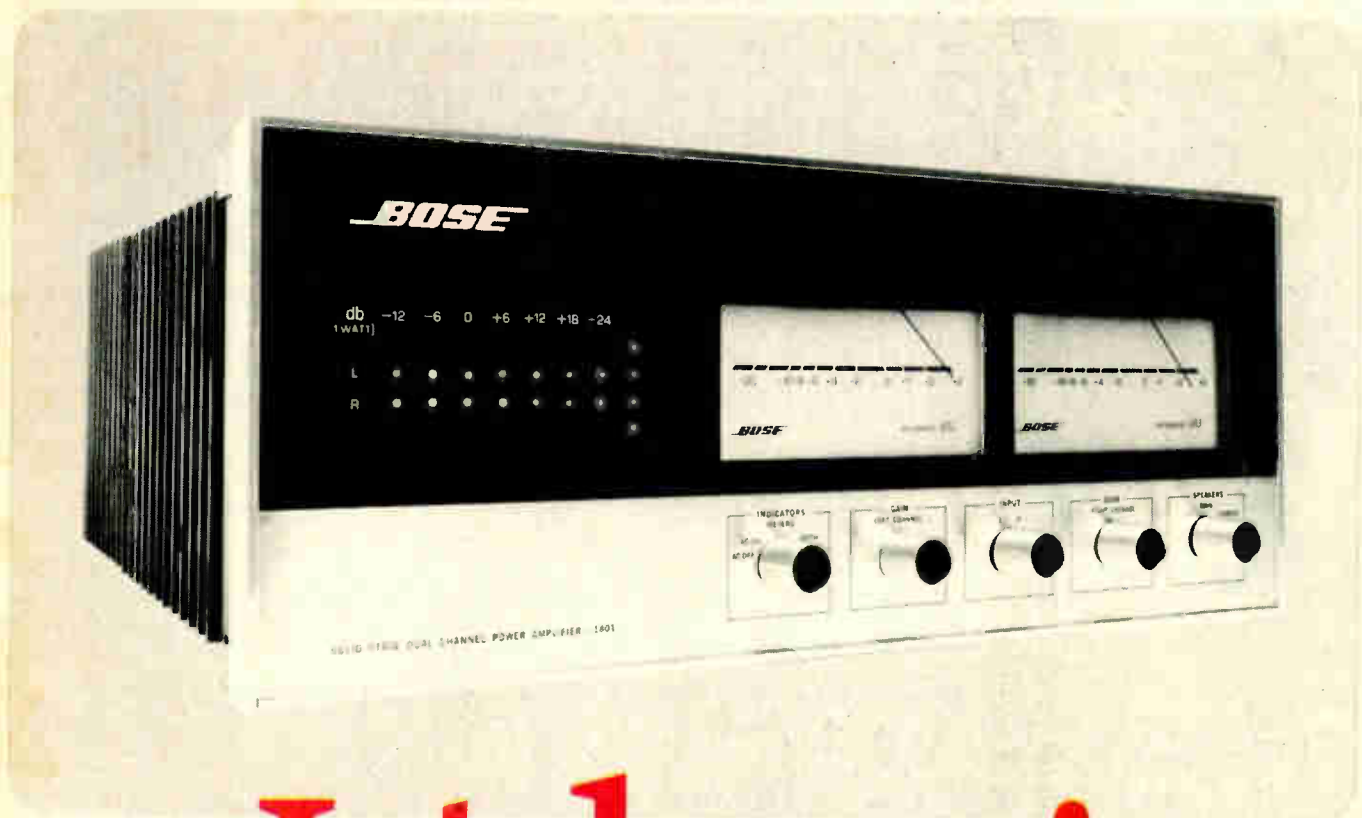

# It's here!

## BOSE 1801-

the power amplifier all the world has waited for.

500 watts RMS at 8 ohms

If you already have a good low-power amplifier and if you are satisfied with playing music at moderate listening levels that do not overload your amplifier, then you are wise to keep your present equipment. Spending more on the Bose 1801 will bring no audible benefit at your present listening levels. (It is often said that a high-power amplifier will do a much better job at low volume levels than will a low-power

amplifier because the former is almost idling . . . but this is just folklore.)

However, if you want to take full advantage of the ever increasing dynamic range on records and tapes, and if you want to enjoy the full impact of the fortissimos and grand crescendos at volume levels comparable to those of the live performance, we believe that the Bose 1801 is by far the best amplifier to meet your needs.

Australian Distributors

### WEDDERSPOON

W. C. WEDDERSPOON PTY LTD  
193 Clarence Street, Sydney.

## BOSE®



# 40,000 TECHNICIANS CAN'T BE WRONG!

- More than 40,000 ambitious men have benefited from A.R.T.C. training.
- Join this large number of successful men!
- Attain job security and financial reward.
- These can only be yours from:

AUSTRALIA'S

## ESTABLISHED ELECTRONICS COLLEGE

THE AUSTRALIAN RADIO & TELEVISION COLLEGE PTY. LTD.

- ESTABLISHED OVER 40 YEARS
  - OVER 15 FULL TIME STAFF TO ASSIST YOU
  - FULL NIGHT-CLASS PRACTICAL LESSONS
- OR
- EXTENSIVE CORRESPONDENCE TRAINING WITH SPECIAL PRACTICAL HOME-TRAINING KITS

**Mail Coupon NOW** • You are invited to mail the coupon below which can be your first step towards securing a job or business of your own with good prospects, security and big money. A.R.T.C. will mail to you by return, at no obligation to you the big free booklet: "Careers in Radio and Television". This booklet will show you definite steps you can take for a better job, how you can succeed in life. Post the coupon, phone or call NOW.

**AUSTRALIAN RADIO  
AND TELEVISION  
COLLEGE**

**PTY. LTD.  
E.S.&A. BANK BUILDING,**

Cnr. Broadway and City Road, Sydney.  
(Opp. Grace Bros). Phone 211-4244 (3 lines)



RADIO, T.V. & ELECTRONICS

**AUSTRALIAN RADIO & TELEVISION  
COLLEGE PTY. LTD.**

206 Broadway, Sydney, N.S.W.

Dear Sir,  
Please send me, without obligation, your free booklet, "Careers in Radio, TV and Electronics".

NAME .....

ADDRESS .....

T310