

NEWS, AUDIO, COMMUNICATIONS AND COMPUTERS

electronics today

OCTOBER 1978

INTERNATIONAL

\$1.25*

NZ \$1.50



TV TANK GAME

LCD Stopwatch

Two-transistor SW Radio

Getting into Shortwave

The competition don't like the sound of this at all.

For quite some time, other manufacturers have been trying to produce tape with the qualities of the Maxell UD-XL. At the same time, Maxell have been quietly perfecting an even better series.

The UD-XL I and UD-XL II tapes are designed to attain maximum performance at the ferric and chrome position on your tape deck. Whichever tape position you choose, Maxell can give you a better performance.

UD-XL I TAPE, FOR FERRIC (norm.) POSITION (120us)

UD-XL I offers an excellent sensitivity of 1 dB higher than even UD-XL. MOL performance is also 1 dB higher over the entire audio frequency spectrum. The result is a new standard in ferric tape, with wider dynamic range and less distortion than ever before.

How does the UD-XL I compare then, with ordinary low-noise tapes?

Sensitivity is higher by 2.5 dB, and MOL performance by as much as 6 dB.

Yet, for all this UD-XL I requires no special bias or equalization. Simply set your tape selector as you normally would at the ferric position – but there the comparison ends.

UD-XL II TAPE, FOR THE CHROME POSITION (70us)

UD-XL II tape is such a dramatic improvement on most other tape that can be used in this position, that comparison is really unfair.

For example, if you're familiar with conventional chromium-dioxide tape, you'll know of the associated problems of poor output uniformity – plus low maximum output level and rather high distortion.

UD-XL II tape offers you excellent MOL, sensitivity, and an output improvement of more than 2 dB over the entire frequency range.

Maxell's unique 'Epitaxial' process gives you absolute sensitivity and stability, and no drop-out problems. What's more, the shells are moulded in diamond cut dies, and made to tolerances 5 times greater than the Philips standard. And, like all Maxell tapes, UD-XL II has the 5-second cleaning leader.

In short, if you're recording in the chrome position, you can now achieve all the advantages – with none of the drawbacks.

A prospect we think you'll find very exciting – even if the competition don't.



electronics today

INTERNATIONAL

Editorial: Les Bell
 Managing Editor: Collyn Rivers

PROJECTS

718: SW Radio42
Two transistor design

553: Tape/Slide Synchronizer59
For recorded lectures, or good memories

811: TV Tank Game66
Hours of TV fun

590: LCD Stopwatch74
Large, easy to read display



Cover: All the fun (?) of tank warfare can be yours with our TV Tank Game which is described on page 66. Pic courtesy of Wheels magazine.

FEATURES

It Goes and GEOS14
They're not twin satellites

Quality Recordings21
Direct to disc music

VCT34
How to build one

Getting into Short Wave Radio.50
How to listen, etc....

Print Out85
Z-80 VDU Driver

Fourier Transforms90
What they are, what they do

Digital Electronics By Experiment96
Part 8 of this series

Communications Section102
For Hams, SWL's, CB'ers

NEWS & INFORMATION

News Digest4 Mini Mart.111

Sound Briefs.29 PCB's for ETI Projects112

Print Out News.83 Propagation Predictions ...118

CB News102 Ideas for Experimenters ...123

Amateur News104 Reader Services.130

SWL News105 Index to Advertisers.130



A Modern Magazines Publication
 * Recommended retail price only.

Registered for posting as a publication –
 Category B

News Digest

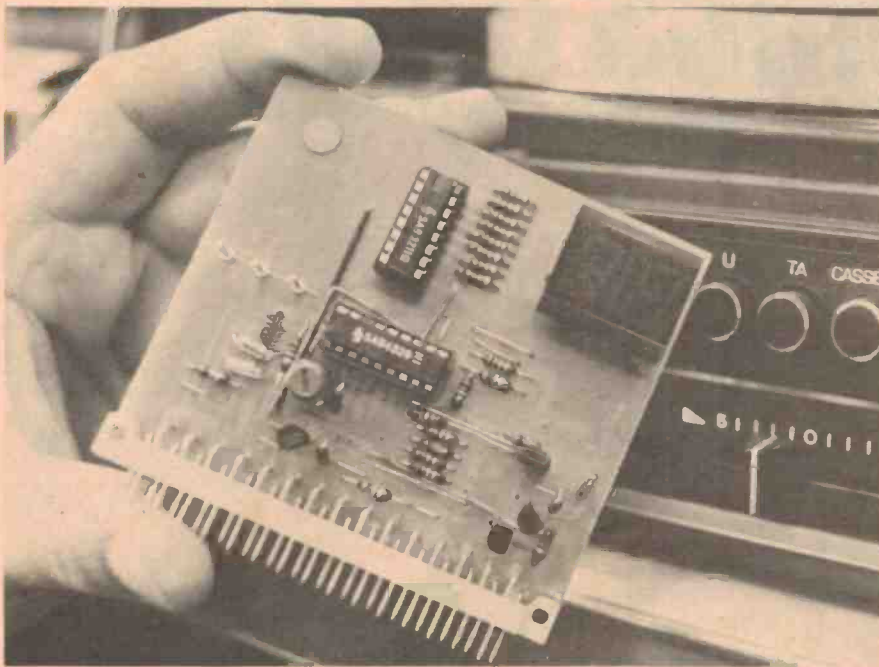

New Tasks for IR Light

A new receiver circuit from Siemens now supplements the range of functions of wireless remote control with infrared light: the SAB 4209 offers a fourth analog function of continuous regulation.

The new circuit should be extremely popular with hi-fi addicts. Where it was previously possible to change only three functions such as volume, treble and bass (or colour, brightness and volume)

from the depths of an armchair, the balance can now be adjusted without stirring. In other respects, the SAB 4209 circuit is nearly identical with the SAB 3209. A further 30 instructions are however available at the (serial) interface bus. This provision is made for the future requirements of, for example teletext machines.

For further information please contact *Siemens Industries Limited* in Melbourne, Sydney, Brisbane or Perth.

Roof Power

A roof overhead plus the electricity bill paid into the bargain — that's the deal General Electric Co. hopes to offer consumers!. GE are attempting to combine specially developed roof shingles with photovoltaic solar cells. During testing, a hexagonally shaped array of 19 silicon cells supplied by Solarex Corp., bonded to 52 shingles, generated a maximum average of 98 watts per square metre.

Bonded to each rectangular synthetic rubber shingle is a hexagon made of strong, heat-tempered clear glass containing 19 solar cell disks, each with a diameter of 53 mm. An embossed glass cover plate is bonded to the top. The upper half of the hexagons' underside is then bonded to the shingle. The life of the roof is expected to be about 15 years.

Phone Line TV

The Visicom Corp. of PO Box 2058, Cairns, Qld., have been appointed agents for Robot Phone Line TV transmitters and receivers. This system, which uses standard CCTV cameras, monitors and accessories, provides visual and voice communications over any voice grade circuit or radio link. The units are Telecom approved for connection to the phone network and private lines throughout Australia as well as many overseas countries.

Applications for the system include remote surveillance, data exchange, rural education, fast picture transmission and many other uses.

Video information is transmitted in 128 by 128 picture elements, each element coded into one of 16 grey shades, and stored in a 64Kbit memory.

New Radio Terminal from Motorola

The latest in imagination-stretching technology from Motorola is a hand-held microprocessor-based computer terminal which incorporates a radio link with the host computer. The 53-key terminal contains a 2 W FM transceiver which operates in the US's UHF business band. At the other end of the radio link is an RDX1100 control unit which communicates with an IBM mainframe through a conventional data communications link. The hand-held terminal includes a 480-character memory and a 16-character LED display.

Car Antiskids Appearing

After several years' delay, two German car makers are preparing to introduce antiskid systems on their cars. Daimler-Benz AG will offer it as an option on their top-of-the-line 6.9, and next year BMW will use it. Both companies will use a system developed in cooperation with Robert Bosch GmbH which applies antiskid to all four wheels, not just two as in previous systems.

Analogue Digital Watch

Texas Instruments have done it again. This time the digital watch breakthrough consists of making an LCD display which uses 120 elements arranged in two circular patterns to simulate a conventional 'analogue' watch face. Not only that, but they've designed a multiplexing technique to drive it, and a special I²L watch chip to work the whole set-up. The use of I²L allows the top-of-the-line TI watch to feature a clearer display, and a voltage regulator which provides automatic temperature compensation to match the temperature coefficient of the display. The watch is expected to sell for between \$275 and \$325 in the US, but expect prices to fall sharply as the technology becomes available.

Watch Out HP, TI!

Sharp Electronics has developed what is claimed to be the world's first hand-held scientific computer. The programming language used is tiny FORTRAN, and the machine, which is at the prototype stage, has alphanumeric capabilities. Sharp has no plans to market the unit at present.



Hand-Held DMM

True RMS, autoranging, 0.01% resolution and current range up to 10A are standard features of a new full four digit multimeter from Philips Test and Measuring Instruments. The PM 2517 is available with LED or liquid crystal displays and is fully protected against overloading on all ranges.

As well as measuring voltage, current and resistance, the PM 2517 can measure

temperature from -60° to $+200^{\circ}\text{C}$ with an optional low cost probe. Other options include data hold which allows the display to be frozen by a switch on the probe.

Careful circuit design with customised LSI circuits for both digital and analogue parts of the multimeter has enabled Philips to produce a high performance instrument in a compact form. Overall dimensions are 172 x 118 x 58mm and weight is only 0.8kg.

MC6803

Latest word from Austin, Texas, home of Motorola Semiconductors, is of another processor in the 6800 family — the 6803. The 6803 is object code compatible with the 6800, but also includes some new 16-bit instructions — amongst them 8 x 8 bit multiply.

Two versions are available; the MC6803 has an internal clock which divides a 3.58 MHz crystal by 4 for cheapness, while the MC6803E uses an external clock. Otherwise the two chips are identical, with 128 bytes of RAM on-chip, a UART, up to 13 bits of parallel I/O, a 16-bit timer and multiplexed address/data bus. Since there is no ROM on the chip, it would be a good choice for small systems which will be produced in small volume, as well as for hobbyist use.

Data Disco Vision

Hopes that the video disk may prove to be a cheap bulk storage device for computers are nearing fruition. In about six months, we should see the introduction of Draw (Direct Read After Write), a variation on the MCA Disco Vision optical video disk. Around thirty prototypes are now in field trials.

Electronic Popcorn

After electronic yoghurt (ND last month), the latest food to be electrified is popcorn. The US company Amana Radarange has developed a cone-shaped Microwave Popcorn Popper which focusses the field at the bottom of the cone to pop the corn in $3\frac{1}{2}$ mins without oil. Can this be the electronics breakthrough of the decade?

Super-dense memory

In the search for ever-larger, ever-cheaper memory systems for large computers, IBM has come up with a new scheme based on the use of tunable-dye laser to induce chemical changes in selected molecules of a storage material. The photo-reactive material is cooled to just a few degrees above absolute zero, and the laser is used to 'burn holes' in the material, each hole representing one bit of data. Storage density can be extremely high, as chemical changes only occur in a very few molecules.

More Bionics

Martin Marietta Corp has developed a new remotely controlled, or 'telechiric' arm for the Marshall Space Flight Center. The arm, which has six degrees of freedom, is controlled by a computer, and follows through pre-programmed sequences of movements.

The design of the control man-machine interface is the really new part of the design — this is handled by a CRT which displays just what the arm is doing and what activity is being conducted, as well as prompting the operator to key in the next movement.

Hi-fi Power Transistors

A range of six new power transistors which are specifically designed for hi-fi output stages and drivers is being marketed in Japan by Matsushita. The 'Super Linear Power Transistors' feature an fT up to 100 MHz and a wide SOAR.

Polish Video Disk

Western engineers usually don't think of Soviet countries as being advanced in consumer technology, but in fact, since this represents valuable export technology, the Polish company Fonica have developed a capacitive-pickup video disk player. However, the player will probably not go to market until the 30-min playing time is doubled according to a spokesman.

Tone Control IC

Motorola is now sampling a single-chip tone control which uses dc control levels, thus replacing expensive dual-gang pots. The IC is mainly intended for car radios, but a version intended for hi fi use will follow.

DON'T MISS THIS HANDHELD DIGITAL MULTIMETER THE ME-522



Specifications

- Display: Liquid Crystal Display
- Maximum indication: 1999 or -1999
- Polarity: Automatic, negative polarity indication.
- Zero adjustment: Automatic
- Overrange indication: (1) or (-1) is displayed, in the first digit position.
- Sampling time: 300 mSec
- Battery voltage indication:
- Operating temperature: 0 to 40°C (32° to 104°F) less than 80% RH
- Accuracy temperature: 23° + 10°C (73.4° + 50°F) less than 75% RH
- Power source: Single 9V transistor battery (NEDA 1904 or s -006p)
- Power consumption: Approx 15mW
- Battery Life: Zinc Carbon 150 to 200 hours.
- Insulation voltage: Between the case and the input terminal and external input power jack; AC 1500V for one minute.
- Size: 95mm (W) x 155mm (D) x 45mm (H); 3.74in.(W) x 6.10in.(D) x 1.77in.(H)
- Weight: 300g (10.56oz) (excluding batteries)
- Accessories: Test lead (red) 1 pc
 Test lead (black) 1 pc
 Operator's manual 1 copy
 Battery 1 set
 Spare fuse (Located battery compartment) 1 pc

Electrical Specifications

DC Current Measurement

Range	Accuracy	Resolution	Input R	Voltage drop (in F.S.)	Circuit protection
200µA	±(0.8% of rdg + 1dgt)	0.1µA	1KΩ	200mV	20mA for 1 minute
2mA		1µA	100Ω		60mA for 1 minute
20mA		10µA	10Ω		100mA for 1 minute
200mA		100µA	1Ω		1A Fuse
1A	±(1% of rdg + 1dgt)	1mA	0.12Ω	120mV	

AC Current Measurement

Range	Accuracy	Resolution	Input R	Voltage drop (in F.S.)	Circuit protection
200µA	±(1% of rdg + 0.3% of F.S + 1dgt)	0.1µA	1KΩ	200mV	20mA for 1 minute
2mA		1µA	100Ω		60mA for 1 minute
20mA		10µA	10Ω		100mA for 1 minute
200mA		100µA	1Ω		1A Fuse
1A	±(1.25% of rdg + 1.3% F.S + 1dgt)	1mA	0.12Ω	120mV	

Frequency response 40Hz ~ 1KHz

Resistance Measurement

Range	Accuracy	Resolution	Test current	Test power	Circuit protection
200Ω	±(0.25% of rdg + 1dgt) + 0.2°C	0.1Ω	1mA	Lo	DC ± 30mA
2KΩ		1Ω	1mA	Hi	AC 30mA for 1 minute
20KΩ	±(0.25% of rdg + 1dgt)	10Ω	100µA		DC ± 100V
200KΩ		100Ω	1µA	Lo	AC 100V rms for 1 minute
20MΩ		10KΩ	0.1µA	Hi	

AC Voltage Measurement

Range	Accuracy	Resolution	Input R	Circuit protection
200mV	±(0.5% of rdg + 0.3% of F.S + 1dgt)	100µV	10MΩ	AC 350V rms for 1 minute
2V		1mV		
20V		10mV		
200V		100mV		650V rms for 1 minute
600V		1V		

Frequency response 40Hz ~ 1KHz

DC Voltage Measurement

Range	Accuracy	Resolution	Input R	Circuit protection
200mV	±(0.25% of rdg + 1dgt)	100µV	10MΩ	DC ± 500V or AC 350V rms for 1 minute
2V		1mV		
20V		10mV		
200V		100mV		DC ± 1100V or AC 650V rms for 1 minute
1000V		1V		

AVAILABLE FROM

AMPEC ENGINEERING CO. PTY LTD

1 Wellington St, Rozelle, NSW 2039 Telephone: (02) 818 1166

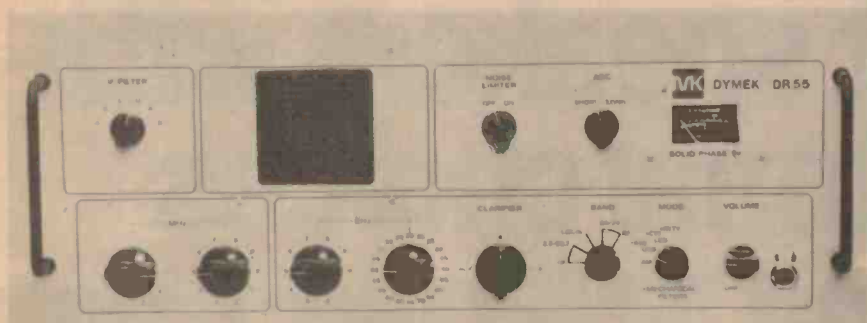

McKay Dymek DR55

The McKay Dymek DR55 is claimed to be the first fully synthesized receiver of its kind available for only US\$800.00 in the States.

High level RF front end design and digital phase lock loop tuning make the DR 55 easy to operate and allow frequency changes in a fraction of the time required with conventional mechanically tuned receivers. (It's not so hot for tuning up and down a band,

though!) The DRR 55 has many applications in the commercial, governmental and marine areas including WWV monitors for time and frequency calibration, back up service for main receivers and point to point communications.

Ceramic filters are supplied as the standard final selectivity element with optional Collins mechanical filters available for Upper and Lower SSB, CW and RTTY. For more details write *McKay Dymek Company, P.O. Box 2100, Pomona, California 91766.*

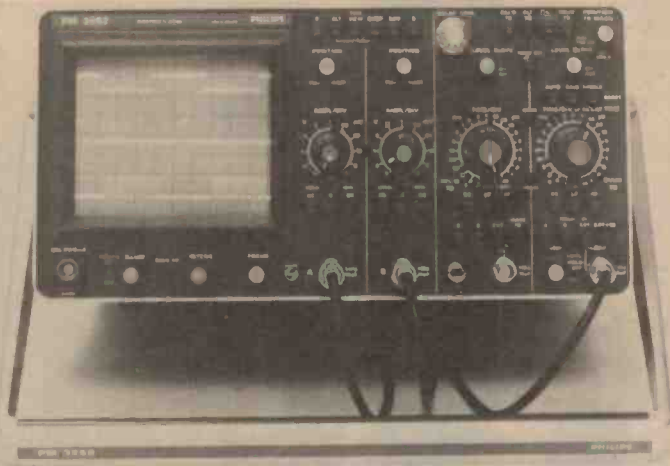

New Philips Scope

A compact dual-channel 100 MHz oscilloscope has been introduced by Philips Test & Measuring Instruments. The PM3262 is unique in providing both trigger-view and alternative timebase operating modes. In addition, the new 'scope features a 5mV sensitivity over the full bandwidth, with a high 2mV sensitivity up to 35 MHz.

Triggering to over 200 MHz and the provision of two external trigger sensitivity settings — "standard" and "double by ten" — enables this oscilloscope to meet the majority of ECL, TTL and other logic measurement

needs. Other triggering features include a composite mode for the main timebase.

The trigger-view channel allows exact triggering conditions to be displayed and so allows direct comparisons between trigger and signal. This is particularly useful for such applications as computer or other digital equipment servicing where triggering depends on a clock pulse and relationships between clock and information are important.

Dimensions of the oscilloscope is a compact 316 x 154 x 410 mm (12.45 x 6.06 x 16.21 ins) and it weighs just 9.6 kg (21 lbs).

Operation is possible from a wide range of ac and dc supplies and an optional battery pack is available for field applications. Power consumption is only 45 W and running time from the battery pack is available for field applications. Power consumption is only 45 W and running time from the battery is 3 hours.

Synergistic Beer Drinking

At ETI we're great believers in the concepts of feedback, both positive and negative, and we like to try to apply them to the production of the magazine whenever possible. For example, we use questionnaires to obtain information about the interests of our readers, so that we can try to cater for them in the .mag.

But possibly the best form of feedback available to us is simply talking to you, the readers, directly. This way we soon find out if you've got any complaints, and we also get some good ideas from you about what you'd like to see in ETI.

To try to improve our feedback system even further, and have some fun into the bargain, we reckon it would be very productive for us all to get together for a few beers occasionally and so we are introducing a custom which has been called Synergistic Beer Drinking by *Dr. Dobb's Journal of Computer Calisthenics and Orthodontia*. On the first Wednesday of every month, we (that is, the ETI staff) will be found in the evening having a few beers in the *Bayswater Hotel*, in *Bayswater Road, Rushcutters Bay*. If you want to pop in for a chat about what you're doing, or what we're doing, or about what you'd like us to do, then we'd be delighted to talk to you. So, let's see you there for a few beers and a bit of a chat.

IC Recording Heads

Remember Exxon Enterprises, the oil giant which initially funded Zilog? Well, they're getting into advanced electronic technology again, this time with a company called Magnex Corp. Magnex are developing a new generation of magnetic recording heads based on semiconductor deposition techniques, in hopes of increasing storage density ten-fold on computer mag disks. Present technology permits densities of 3 Mbits/in², but Magnex hope to improve this to over 100 Mbits/in².

Now. Two 3-way 40 watt speakers with nine tonal choices

Save about \$50 per hour while you assemble them

Even if you didn't know them by number, you probably heard about the Philips AD12K12 MK11 Speaker Kits.

Because they are now a no.1 best-seller.

And here is the compact AD8K30, 8" 3-way compact system, with fine electronic and acoustic components (1" domed tweeters, 5" mid-range, super 8" bass drivers). Brilliant clean sound, with a frequency response closely following the ideal Bruel & Kjaer curve for hi-fi equipment measured in an actual listening room, using the "Third Octave Pink Noise Method".

Plus 9 combination tonal choices to adjust to the acoustics of your own listening-room.

You can assemble the AD8K30's in about two hours. You will get a professional result and save about \$100 per pair over a comparable system. Phone or send coupon now for full details of this and all our kits.

PHILIPS ELECTRONIC COMPONENTS AND MATERIALS

Sydney 427 0888 • Melbourne 699 0300 • Brisbane 277 3332
• Adelaide 45 0211 • Perth 65 4199



ELCOMA

Philips Electronic Components and Materials
P.O. Box 50, Lane Cove, NSW 2066

Please send me full details and brochures on your loudspeaker kits and a list of retailers who stock them.

NAME _____

ADDRESS _____

STATE _____ P/CODE _____

ETA



**Electronic
Components
and Materials**

PHILIPS

BA.EL.3



SAW Filters on Lithium Niobate

For some years work has been in progress on integrated filter devices requiring no coils or capacitors. Surface-wave filters are produced in the form of comb-like conductors on the surface of piezoelectric substrates. Siemens has now succeeded in building surface-wave filters on substrates made of lithium niobate. The new device is already being used in picture IF stages in television sets.

In contrast to conventional LC filters, surface-wave filters exhibit a fixed filter characteristic. No alignment is required. As the volume of these filters is so low, compact intermediate-frequency boards can be designed with a greatly reduced number of components. Since the properties of the filters remain unaltered for many years, the highest possible operational reliability is guaranteed. Dependence on the ambient temperature inside a TV set can be ignored. It was originally intended to use a ceramic material with piezoelectric properties as the substrate for the comb-like filter structures. However, the high cost of manufacture and low constancy of this material was not in keeping with the low price level demanded for television sets. LiNbO_3 single crystals, in contrast, open the way to economical batch production with optimum filter characteristics and the highest possible frequency accuracy.

The three structure elements of a surface-wave filter — input converter, coupler and output converter — are etched out of an aluminium layer with the aid of a photolithographic process.

When electrical signals are applied to the converter, it emits surface waves in the same cadence in various directions. The coupler picks up a portion of these waves and passes them on to the output converter, which transforms them back into electrical signals. The coupler prevents unwanted waves of differing propagation speeds from reaching the output converter. Further technological measures are required to damp reflected, and thus delayed, waves. The low transfer loss of the filter is the result of the high piezoelectric coupling factor of lithium niobate.

Siemens has a number of the new surface-wave filters in its sales programme. These filters conform with the CCIR Standards B/G and I and the English Standard. The filter OFW 369 is available for antenna converters. Special surface-wave filters are envisaged for the French and U.S. markets. All versions come in a 19 x 16 x 5 mm package with five terminals brought out on one side.

For further information please contact *Siemens Industries Limited* in Melbourne, Sydney, Brisbane or Perth.

ETI/Unitrex Calculator Contest

The August contest must really have stumped a lot of you, as we received what must be an all-time record low number of entries. However, you didn't let us down, and we do have a winner — D. W. Hawke, of Elizabeth South, 5112. He employed the standard method of making up a huge truth table to obtain the solution, which is, of course, that the King cannot unite his kingdom.

Thanks to Mr. I. S. Brown, of Glen Forest, 6071, we have a simpler problem this month. An absent minded teller switched the dollars and cents when he cashed a cheque for Mr. Brown, giving him dollars instead of cents and cents instead of dollars. After buying a five-cent newspaper, Mr. Brown discovered that he had exactly half as much as his original cheque. What was the amount of that cheque?

Seal an empty envelope, write your answer on the back of it, and send it to: Unitrex Calculator Contest (Oct), ETI Magazine, 15 Boundary Street, Rushcutters Bay, NSW 2011. The closing date is Friday, 17th November.

Talking Programmable Calculator

The company who seem to be coming up with a lot of advances in calculators these days is not, as you would expect, TI or HP, but Sharp. Their latest programmable calculator verbally prompts the user, and can be used by untrained staff. The first application programs for the machine are aimed at US auto dealers and will calculate sales, leasing and other financial operations involved in car sales. The machine will even remind the salesman if he forgets something. The conversational calculator weighs just over 20 kg and looks just like a large conventional calculator.

Erratum

An error was made last month in the circuits of the SCR output version of the vari-wiper. As shown, a wire is connected from the supply line to the self parking contacts on the motor. This wire is *not* used for wound field coil motors and should be left out of the circuit.

ETI Staff Vacancy

We are looking for someone to work on ETI's project development staff. Applicants must be capable of, firstly, designing and breadboarding prototype circuits, and secondly, converting the proven circuits into well-built finished projects of the high standard necessary for publication.

Skills required include a good standard of workmanship, both electronically and mechanically. Ability to design pc boards would be an advantage, though limited experience in this area should not deter candidates from applying. A strong background in digital electronics is essential.

The majority of work is design and construction, but it will be necessary to liaise with other editorial staff in the presentation of the magazine project article.

The job is in our project development lab at Rushcutters Bay. Salary will depend upon experience and ability, but will be in the region of \$12 000.

For further information phone Phil Wait on (02) 33 4282, or write, enclosing a complete resume, to *Staff Vacancy, Electronics Today International, 15 Boundary Street, Rushcutters Bay, NSW 2011.*

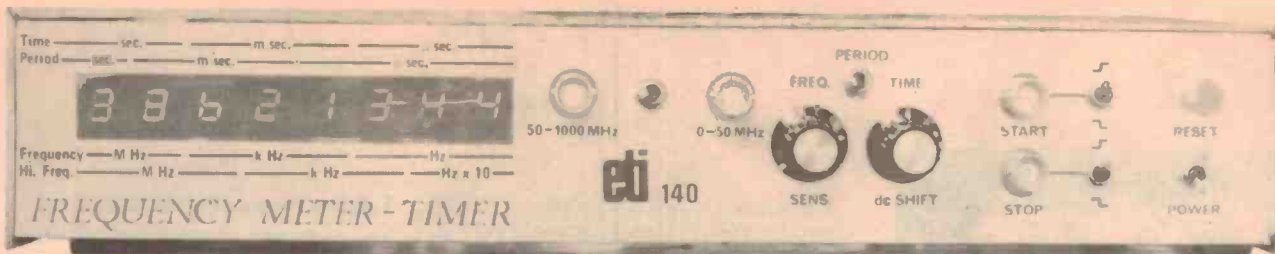

ETI DIGITAL FREQUENCY METERS

COMPLETE KITS:

1 GHz **\$171.00** (\$195.90 inc. tax)
 50 MHz **\$151.00** (172.90 inc. tax)

Pre-punched chassis and front panel. Top-grade crystal and oven components supplied. All components are supplied, and all are high quality and guaranteed.

ASSEMBLED UNITS:

1 GHz **\$260.00** (\$299.00 inc. tax)
 50 MHz **\$240.00** (\$276.00 inc. tax)

Units are fully assembled, tested and calibrated. Guaranteed against faults in parts or workmanship for 6 months.

Registered post is free in Australia. Service back-up is available. Air or road freight is payable by customer (deduct \$4 from purchase price). NZ and PNG customers: Tax free prices plus \$2 for surface mail or \$10 for airmail (both insured). Money-back Guarantee: If not satisfied return within 7 days (in perfect condition and in original packing, kits unassembled) for refund less postage.

Fairchild Digital Alarm Clock Module — \$16.95

Certified post and packing \$1.50

- Built-in alarm.
- Large (16mm) LED readouts.
- Snooze function — 9 minutes approx.
- Compact size — 87mm W x 38mm H x 85mm D.
- AM/PM indicator.
- Alarm set indicator.
- Seconds display on command.
- Power failure indication.
- Wide viewing angle.
- Data sheet included.

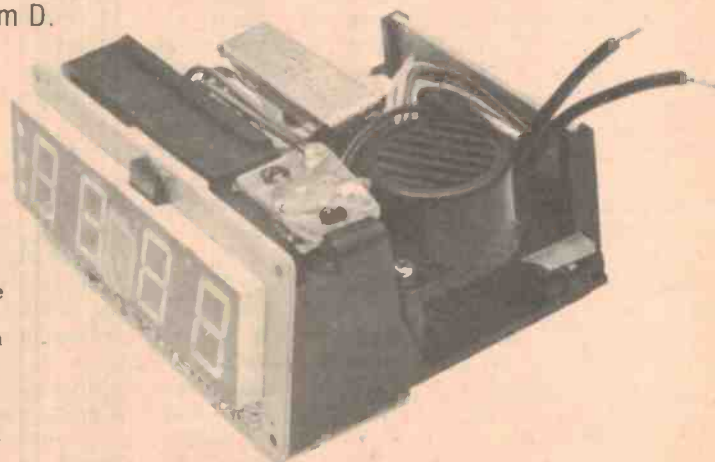

Assembled and tested, including power supply and switches — just add a power cord and case for a complete alarm clock. May be converted to switch a radio, in which case the 59 minute sleep function may be used — one extra switch required. Second count may be held, or reset to zero and held. Unaffected by momentary power cuts. Longer power cuts are indicated by flashing LED and alarm sounding. COD \$1.50 extra. Money-back Guarantee: If not satisfied return within 7 days (in perfect condition and in original packing) for refund less postage.

J. R. COMPONENTS

P.O. Box 128, EASTWOOD, NSW. 2122.
 Phone (02) 85-3976.

SEALED, RECHARGEABLE, MAINTENANCE-FREE BATTERIES...



Internationally accepted YUASA BRAND batteries have such features as —

- no maintenance, never need topping up
- unspillable, may be charged/discharged in any position
- wide range of capacities.



SEALED NICKEL CADMIUM BUTTON CELLS

- Various types available for —
Standard rate discharge
High rate discharge
Trickle charge
- Large range, 1.25 cells available in
single or multi cell stacks from
10 MAH to 500 MAH
- May be charged and discharged
over a wide temperature range



SEALED NICKEL CADMIUM SINTERED PLATE CELLS

- Various types available for —
High temperature operation,
Rapid recharging,
High rate discharge
- Self resealing gas release safety
venting system
- Large range 1.25 volt cells from
140 MAH to 3500 MAH
- 'AA', 'C' and 'D' sizes available



SEALED LEAD CALCIUM BATTERIES

- Long life, 1200 cycles or 5 years float
service life possible
- Self resealing gas release safety
venting system
- May be continuously cycled or float
charged
- May be charged and discharged
over a wide temperature range
- Long shelf life, capable of prolonged
open circuit standing
- Large range —
6 volts from 1.2 A.H. to 10 A.H.
12 volts from 1.9 A.H. to 20 A.H.

ADDRESS ALL ENQUIRIES TO:

New South Wales: I.E.I. Pty. Ltd. 109 Alexander Street Crows Nest, 2065 Phone: 438 2722, 438 2932

Victoria: I.E.I. Pty. Ltd. 29 Stafford Street Huntingdale, 3166 Phone: 544 8411

Queensland: Bob McKnight (Trading) Unit 32, 125 Abbotsford Road Mayne, 4000 Phone: 52 7600

Western Australia: R.F. Datodi & Associates 16 Prowse Street West Perth, 6005 Phone: 321 4429

South Australia: Aquavia Controls Pty. Ltd. 61A Baden Terrace O'Sullivan's Beach, 5166 Phone: 384 1444

Tasmania: George Harvey Electric Pty. Ltd. 76 York Street Launceston, 7250 Phone: 31 6533, 162-164 Argyle Street Hobart, 7000 Phone: 34 2233

IMPORTED BY **CHLORIDE** Chloride Batteries Australia Limited
now the most complete range available in Australia

TASMAN ELECTRONICS

FOR MAIL ORDER ELECTRONICS SUPPLIES

74LS -	
74LS00	.22
74LS01	.28
74LS02	.22
74LS03	.22
74LS04	.25
74LS05	.25
74LS08	.23
74LS09	.28
74LS10	.22
74LS11	.28
74LS12	.28
74LS14	1.10
74LS20	.28
74LS21	.28
74LS27	.28
74LS28	.32
74LS30	.28
74LS32	.28
74LS37	.32
74LS38	.32
74LS40	.32
74LS42	.90
74LS73	.46
74LS74	.46
74LS75	.48
74LS78	.52
74LS85	1.10
74LS86	.48
74LS90	.64
74LS92	1.00
74LS93	.70
74LS95	.90
74LS109	.45
74LS113	.46
74LS114	.45
74LS125	.65
74LS133	.28
74LS138	1.30
74LS151	1.15
74LS157	.70
74LS160	.85
74LS163	1.10
74LS164	1.55
74LS169	1.45
74LS174	.65
74LS175	.80
74LS190	1.20
74LS191	1.20
74LS192	1.10
74LS193	1.00
74LS194	1.95
74LS195	.95
74LS196	1.30
74LS197	1.30
74LS221	1.15
74LS251	.75
74LS253	.75
74LS257	.65
74LS259	3.10
74LS279	.50
74LS290	1.10
74LS365	.65
74LS366	.65
74LS367	.65
74LS368	.60

CMOS -	
4001	.25
4002	.30
4007	.30
4008	1.20
4011	.25
4012	.25
4013	.50
4014	1.30
4015	1.45
4016	.55
4017	1.20
4018	1.10
4020	1.35
4021	1.20
4022	1.20
4023	.30
4024	.90
4025	.30
4027	.60
4028	.90
4040	1.30
4042	1.00
4043	.90
4044	.90
4046	1.50
4049	.55
4050	.50
4051	1.20
4052	1.20
4053	1.20
4066	.70
4068	.30
4069	.30
4070	.30
4071	.30
4072	.30
4076	1.70
4077	.30
4078	.30
4081	.30
4082	.30
4510	1.40
4511	1.40
4518	1.40
4520	1.40
4528	1.20
4553	6.50
4555	1.00
4584	.70
74C00	.35
74C02	.35
74C04	.40
74C08	.40
74C10	.40
74C14	1.50
74C20	.40
74C48	2.40
74C73	1.10
74C76	1.10
74C90	1.40
74C93	1.40
74C175	1.75
74C192	1.75
74C193	1.75

VOLT. REGS -	
7805	1.20
7812	1.20
7815	1.20
7818	1.20
7824	1.20
78CB	2.20
78L05-12-15-18-24	All 40c
7905	1.50
9712	1.50
7915	1.50
7918	1.50
9724	1.50
79L05 to 24	All 80c
309	2.00
317	2.90
723	.50

DIODES -	
OA90	.15
OA91	.15
IN4002	.8
IN4004	.8
IN4007	.16
IN5404	.35
IN4148	.6
W02 BRIDGE	.88

LINEAR -	
741	.35
747	1.10
3900	.99
301	.45
307	.86
311	.85
324	1.00
555	.35
TL071	.70
TL080	1.15
1418	.96

TTL -	
7408	.30
7421	.30
7432	.40
7490	.35
7493	.35
74121	.55

FND357	1.40
LED-RED	.20
8 P.I.C. SOCKET	.25
16 P.I.C. SOCKET	.33
TO3. SOCKETS	.23
1/2 W RESISTORS E 24	.3
1 W RESISTORS E 12	.7
5 W W/W	.22

TASMAN ELECTRONICS

12 Victoria St, COBURG. 3058. Ph (03) 354-5062

PERSONAL SHOPPING? CERTAINLY

PHONE

PROFESSIONAL AUDIO EQUIPMENT

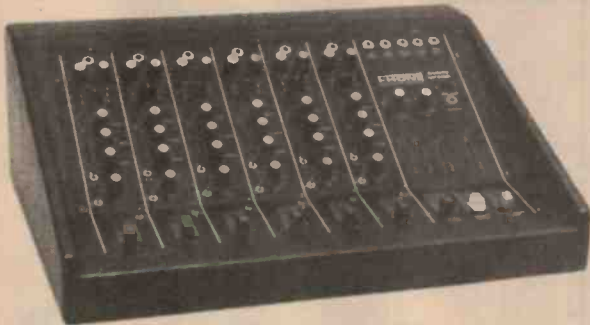

PHONE 6 CHANNEL AUDIO MIXER

A fully professional audio mixer, available in mono or stereo, with internal power amplifier (mono 200W RMS at 8ohm, stereo 2 x 100 RMS at 4ohm) short circuit protected. 240V power input and speaker outputs (cannon sockets).

- Balanced microphone inputs. ● Microphone phasing switch with channel off position. ● Input attenuation controls. ● Slide level controls. ● Equalizer, bass, mid-range and treble (±18dB). ● Pan slider with centre stop. ● Separate monitor and effect sends. ● LED VU display with pre and post level selection switches. ● A-B headphone cue selection switches. ● LED VU display on mixer outputs. ● Headphone cue selector A-B, left and right mixer output, monitor output, effect return. ● Headphone amplifier 2 x 4W RMS. ● DIN Aux. input/output socket. ● Mixer cabinet finished in heavy duty black vinyl.

(Mixers also available in 12, 18 or 24 channels)

PHONE MONO/STEREO GRAPHIC EQUALIZER

The new 'Phone' 20 element 4 octave equalizer (25Hz to 19.2KHz) is a sophisticated electronic unit, developed after intensive research into today's professional requirements, designed to play an integral part in recording studios, sound reinforcement and Hi-Fi equipment.

- Balanced and/or unbalanced input/outputs.
- 14dB cut and boost (±1dB).
- Convenient centre stop slide controls.
- Signal to noise better than -80dBa.
- Output level +18dBm.
- Optical LED VU display.
- 19" rack mount.
- Optional wood grain cabinet for Hi-Fi use.
- Choice of silver or black brushed face finish.

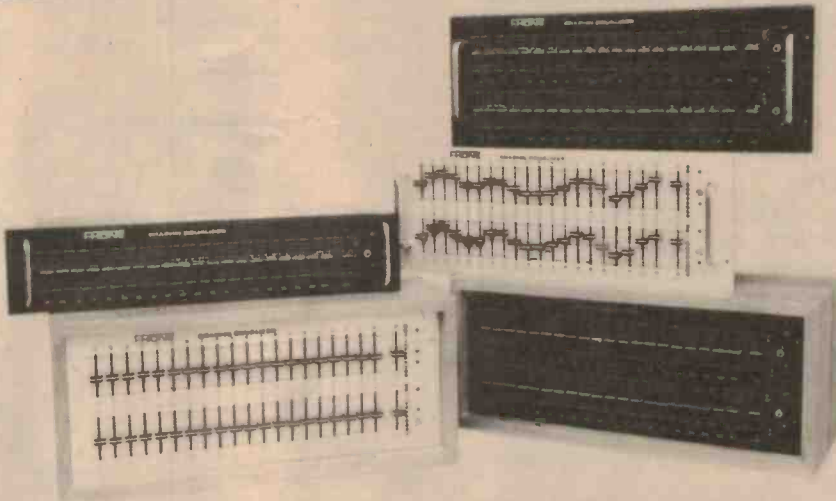

PHONE DELUXE DISCO

Designed for reliability, appearance and gutsy performance, with unique acoustic feedback eliminating characteristics.

- 250W RMS power amplifier.
- 2 x 3 Way extended 45/60 vertical or horizontal speaker units, each containing 1 x 15" RCF speaker,
- 1 x 100W 90° horn, 2 x high frequency radiators.
- 3 Way internal music modulated light show.
- Outlets for external light show (600W per channel).
- Rap around console.
- 3 Channel audio mixer - channel A, channel B, microphone.
- LED VU display on mixer output.
- Headphone cue provisions.
- 2 x 4W RMS headphone cue amplifier.
- Cross fade slide control.
- Cross fade bypass switches.
- Fitted with Shure M55E magnetic cartridges.
- Heavy duty black vinyl desk top.

(4 Way electronically crossed units available)



FOR FURTHER INFORMATION CONTACT :

PHONE AUDIO Pty. Ltd.

20 MAIN ST. UPWEY Vic. 3158
03 754 2572 03 754 6268

AGENT :

ZEPHYRA PRODUCTS

70 BATESFORD Rd. CHADSTONE
Vic. 3148
03 568 2922

It Goes and GEOS

Two satellites, despite their similar names, fulfil vastly different functions, says Brian Dance.

THERE ARE NOW so many satellites in geosynchronous orbits about the equator that even their names are leading to much confusion. This is particularly true of the GEOS satellites developed by the European Space Agency to measure the electric and magnetic fields in the earth's magnetosphere and the GOES craft (Geostationary Environmental Satellites) which have been developed by the Americans to monitor the weather systems over the western hemisphere.

GEOS Craft

The first GEOS satellite was launched on April 20th, 1977, but unfortunately the American Delta 2914 launching vehicle developed a malfunction during the separation of the second and third stages. It was therefore not possible to place GEOS 1 in its intended geosynchronous orbit, but as much information as possible is nevertheless being gained from the seven experiments on board this craft.

The incorrect orbit of GEOS 1 has resulted in an exposure to radiation of a higher intensity than had been intended and this has degraded the performance of the solar cells on board this craft. In addition, it orbits the earth with a 12 hour period instead of remaining stationary about a point on the earth's surface, but nevertheless it is in radio contact with the ground station in Germany for some eight hours per day.

Shortly after noon on July 14th 1978 a second satellite known as GEOS 2 was successfully launched from the Kennedy Space Centre and attained its correct geosynchronous orbit some 35 000 km above the equator. It was launched just in time to measure the effect of a massive solar flare lasting some 15 minutes. The intensity of this flare was so great that the observatory at Boulder, Colorado advised the USSR that it was felt that there was a considerable risk for the safety of the two Russian astronauts in Salyut 6.

One of the special features of the GEOS craft is their exceptionally high rate of scientific data transmission of some 100 kb/s. This feature, when considered with the fact that continuous communication is obtained between the

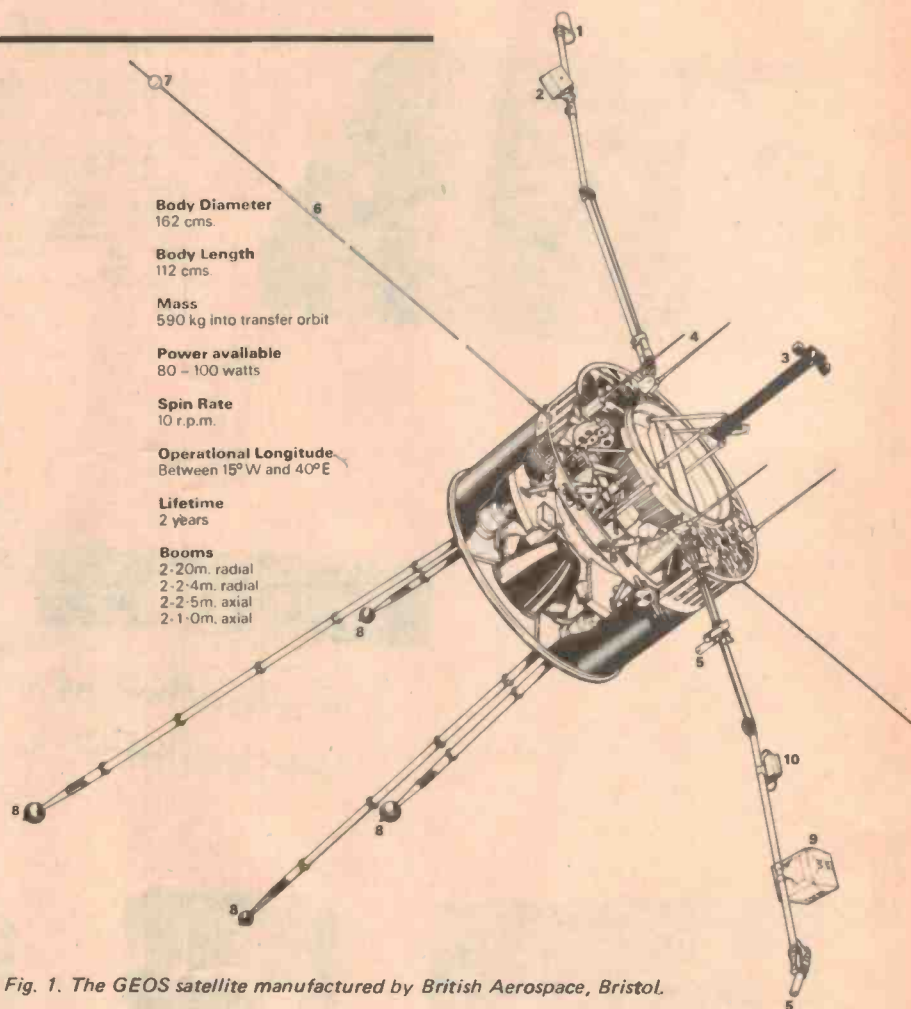

Body Diameter
162 cms.

Body Length
112 cms.

Mass
590 kg into transfer orbit

Power available
80 - 100 watts

Spin Rate
10 r.p.m.

Operational Longitude
Between 15°W and 40°E

Lifetime
2 years

Booms
2-2.0m, radial
2-2-4m, radial
2-2-5m, axial
2-1-0m, axial

Fig. 1. The GEOS satellite manufactured by British Aerospace, Bristol.

satellite and the ground station owing to the use of a geosynchronous orbit, means that GEOS 2 will transmit about one hundred times as much data as any European scientific satellite yet launched.

GOES Craft

NASA has just awarded a US \$38.8 million contract for three new Geostationary Environmental Satellites (GOES D, E and F) to Hughes Aircraft Company. These new spacecraft will eventually replace the GOES craft already in orbit. GOES D is scheduled for launch in mid-1980 as the first meteorological satellite to be placed in a geosynchronous orbit from the Space Shuttle; it will be positioned 36 000 km over the equator at 75°W longitude directly South of the East coast of the USA. GOES E and F will be launched later in the 1980's.

Each of the GOES satellites will weigh about 820 kg at liftoff and will be 2.16 m in diameter and 4.45 m in length. They will be the US link in a five satellite project, part of the Global Atmospheric Research Programme (GARP) which is scheduled to become fully operational by December 1978 using the GOES satellites which are already in orbit. The GARP project includes the Japanese GMS satellite (also developed by Hughes Aircraft Company), the Meteosat European satellite and the Russian vehicle GOMS which has not yet been launched.

The GARP project has the two primary objectives of improving weather forecasting and gathering data on climatic changes on the surface of the earth. The most important piece of scientific equipment to be carried on board the three new GOES satellites will be a visible and infra-red sensor designed

and built at the Santa Barbara Research Centre, California. This sensor will be known as VAS (Visible/Infra-red Spin-Scan Radiometer Atmospheric Sounder) and has been designed to improve the accuracy of short term weather forecasts.

The versatile VAS instrument produces two dimensional images of cloud systems present in various parts of the atmosphere and provides information on their speed and their direction of movement. The VAS equipment also develops temperature and humidity profiles of clear air from the surface of the earth up to an altitude of some 15 km.

The GOES satellites will also contain a Space Environmental Monitoring System consisting of three sensors which monitor solar emission activities to help the planning of aircraft flights and scheduling of communications transmissions.

A Data Collection System on board the GOES spacecraft will be able to receive and relay environmental data sensed by widely dispersed surface platforms (such as river and rain gauges, seismometers, tide gauges, buoys, ships and automatic weather stations). Such platforms transmit data to the satellites at regular intervals when they receive an interrogation signal transmitted by a particular satellite; however, if any platform sensor receives information that exceeds a certain predetermined level, it will immediately transmit the information to a satellite as an emergency measure.

Fig.2. The GEOS satellite which is also a spin craft. Note the S band high gain antenna on the left and the helical UHF antenna on the right, both of which are on the de-spun platform, together with the S band omnidirectional antenna projecting upwards along the axis of the craft.

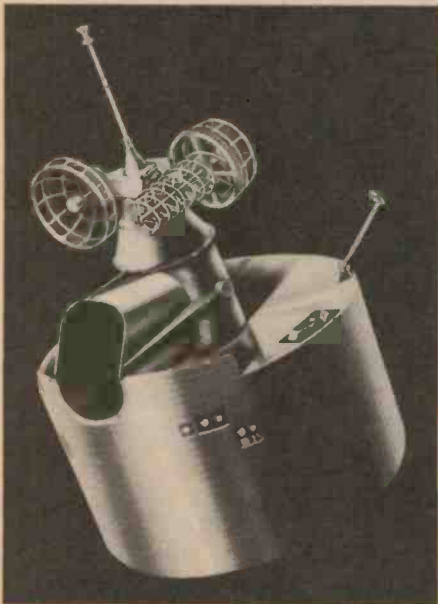

COMING!

SIMPLE PROJECTS

Volume 2

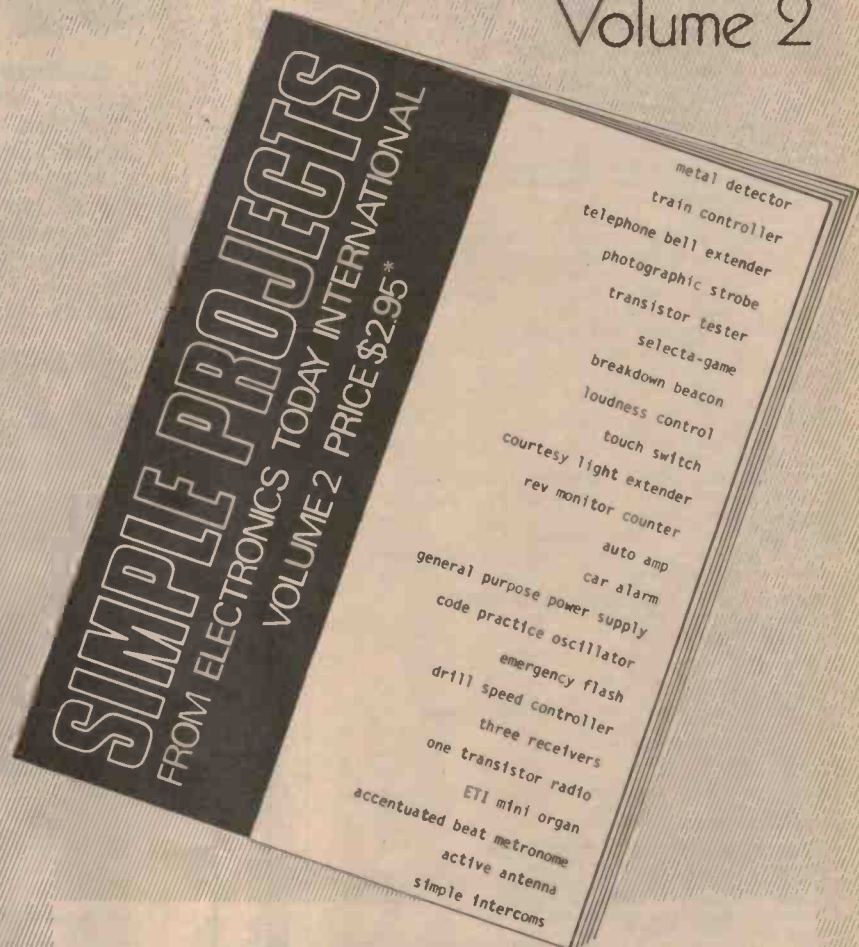

Our latest project book. Simple Projects Vol 2 is a collection of the most popular of our simpler projects together in one convenient book. Contents include:— Induction balance metal detector, Train controller, Telephone bell extender, Photographic strobe, Transistor tester, Selecta-game, Touch switch, Code practice oscillator, Car alarm, Auto amp, Breakdown beacon, ETI mini-organ, Accentuated beat metronome, FM antenna. Look for Simple Projects Vol 2 — at your newsagents next month. Recommended retail price is \$2.95 or you can order directly from Electronics Today, 15 Boundary Street, Rushcutters Bay. 2021. (Add 45 cents for post and packing).

BOOKS

Just some of the books from the biggest range of radio and electronics books in Australia. If the book you require is not listed below, it can be ordered from us.

NEW - NEW - NEW Latest editions of some of the most popular books on the subject:

Just In — New A.R.R.L. Handbook 1978 Edition.....	\$12.95
Just In — World Radio TV Handbook 1978.....	\$12.95
R.S.G.B. Handbook (New Edition) Volume 1.....	\$21.85
R.S.G.B. Handbook (New Edition) Volume 2.....	\$18.90
Reference Data for Radio Engineers (New Edition) I.T.T.....	\$40.50
Radio Handbook (William Orr) 20th Edition.....	\$26.50
How to Build Proximity Detectors and Metal Locators (John Potter Shields).....	\$6.35
An Introduction to Microcomputers — Volume 1 — Basic Concepts (Adam Osborne).....	\$12.55
An Introduction to Microcomputers — Volume 2 — (New Enlarged Edition) — Some Real Products (Adam Osborne).....	\$21.55
6800 programming for Logic Design (Adam Osborne).....	\$12.55
8080 Programming for Logic Design (Adam Osborne).....	\$12.55
Weather Satellite Handbook.....	\$7.80
VHF Antenna Handbook.....	\$7.80
The 73 Test Equipment Library — Volume 1 — Component Testers.....	\$7.80
The 73 Test Equipment Library — Volume 2 — Audio Frequency Testers.....	\$7.80
The 73 Test Equipment Library — Volume 3 — Radio Frequency Testers.....	\$7.80
The 73 Test Equipment Library — Volume 4 — IC Test Equipment.....	\$7.80
111 Digital and Linear IC Projects (Don Tuttle).....	\$8.50
Unique IC OP-AMP Applications (Walter C. Jung).....	\$7.00
IC OP-AMP Cookbook (Walter C. Jung).....	\$17.80
TTL Cookbook (Lancaster).....	\$12.25
TV Typewriter Cookbook (Lancaster).....	\$13.50
RTL Cookbook (Lancaster).....	\$6.60
CMOS Cookbook (Lancaster) 1st Edition 1977.....	\$13.50
Active Filter Cookbook (Lancaster).....	\$20.25
IC Timer Cookbook (Jung).....	\$13.50
Transistor Specifications Manual — 8th Edition.....	\$9.50
Transistor Substitution Handbook — New Edition.....	\$6.75
International Transistor Selector (T. D. Towers).....	\$6.95
Master Tube Substitution Handbook (Tab Books).....	\$7.00
Australian Electrical Wiring Theory and Practice (Pathebridge & Williams).....	\$11.45
Electronic Components and Materials (Phillips).....	\$3.75

American Radio Relay League Publications:

Hints and Kinks for the Radio Amateur.....	\$7.20
The Radio Amateur's VHF Manual.....	\$7.20
A.R.R.L. Antenna Handbook.....	\$8.80
Understanding Amateur Radio.....	\$8.80
The Radio Amateur's License Manual.....	\$6.20
A Course in Radio Fundamentals.....	\$7.20
Specialized Communications Techniques for the Radio Amateur.....	\$7.20
FM & Repeater for the Radio Amateur.....	\$7.20
Single Sideband for the Radio Amateur.....	\$7.20
Ham Radio Operating Guide.....	\$7.20
Electronics Data Book.....	\$7.20
Solid State Design for the Radio Amateur.....	\$12.80
Learning to Work with Integrated Circuits.....	\$4.00
Getting to Know Oscar from the Ground Up.....	\$6.20

Microcomputers/Microprocessors Books:

Programming Microprocessors (M. W. McMurrin).....	\$9.75
Microprocessors: Technology, Architecture and Applications (Daniel R. McGlynn).....	\$18.80
Microprocessors (Electronics Book Series) Hardcover.....	\$17.65
Microcomputers/Microprocessing: Hardware, Software and Application (Milburn & Julich).....	\$26.50
Minicomputer Systems: Structure, Implementation and Application (G. Weitzman).....	\$29.55
Microcomputer Primer (Waite & Pardee).....	\$10.75
Minicomputers for Engineers and Scientists (G. Korn).....	\$33.15
How to Buy and Use Minicomputers and Microcomputers (W. Barden, Jr.).....	\$13.50
Microprocessing/Microprogramming Handbook (B. Ward).....	\$9.75

Howard W. Sams Publications:

TV Servicing Guide — Arranged by Trouble Symptoms (Leslie D. Deane & Calvin C. Young, Jr.).....	\$6.50
Electric Guitar Amplifier Handbook (Jack Darr).....	\$10.20
Transistor Fundamentals — A Programmed Learning Course Volume 1 — Basic Semiconductor and Circuit Principles (Robert J. Britte).....	\$7.25
Transistor Fundamentals — A Programmed Learning Course Volume 2 — Basic Transistor Circuits (Charles A. Pike).....	\$7.25
Transistor Fundamentals — A Programmed Learning Course Volume 3 — Electronic Equipment Circuits (Martin Gersten).....	\$7.25
Transistor Fundamentals — A Programmed Learning Course Volume 4 — Digital and Special Circuits (Louis Schweitzer & Reginald H. Peniston).....	\$7.25

Other Titles:

Colour Television Theory (Hutson).....	\$10.00
The Oscilloscope (G. Zwick).....	\$8.50
Radio, Valve and Semiconductor Data 10th Edition (Compiled By A. Ball).....	\$4.25
MOS Digital IC's (G. Flynn).....	\$8.60
Wind/Solar Energy — For Radio Communications and Low Power Electronic/Electric Applications (E. Noll).....	\$10.75
Sound System Engineering (Don & Carolyn Davis).....	\$26.95
Servicing with the Oscilloscope — 2nd Edition (Gordon J. King).....	\$11.20
Slow Scan Television Handbook (Miller & Taggart).....	\$7.90
73 Dipole and Long-Wire Antennas (Edward M. Noll).....	\$6.75

For Mail Orders please add: \$1.10 Local \$1.75 Interstate
McGILL'S AUTHORISED NEWSAGENCY PTY. LTD.
 187 Elizabeth Street, Melbourne. Phone: 60-1475-6-7
 Prices Subject to Alteration

BUILD MUSIC AND SOUND

Expand your talent with the SH1 synthesizer; let it take you into areas previously reserved for musicians. Roland, the world's largest maker of electronic musical equipment, now provides you with a comprehensive operator's manual which will show you how to enjoy and understand the never-ending creative possibilities.

Simply hook up the SH1 with your hi-fi system and play your favourite electronic, pop or orchestral sounds — or sound effects like surf, rain, wind, etc.

\$750 gets you into the exciting world of electronics and sound
*recommended retail



SH-1

- KEYBOARD (32 keys, 2-1/2 octaves)
- VCO (voltage controlled oscillator)
- Modulator
- Autobend Depth
- Autobend Time (8-360 msec)
- VCO Range (32', 16', 8', 4', 2')
- Waveform (sine, square, triangle)
- Pulsewidth Modulation (Min-50%)
- PWM Mode Switch (Env-1/Manual/LFO)
- Sub-oscillator
- 1 oct Down / 2 oct Down
- AUDIO MIXER
- VCO
- Sub-oscillator
- Noise Generator
- Ext Sig
- Overload Indicator
- NOISE GENERATOR
- White/Pink Selector
- HIGH PASS FILTER
- Cutoff Frequency Control (25Hz-5KHz)
- VCF (Voltage Controlled Filter)
- Cutoff Frequency Control (5 Hz-20KHz)
- Resonance (Min-Self Oscillator)
- ENV-1 Control Depth
- Modulator
- KYBD Control
- Envelope Follower Control
- VCA (Voltage Controlled Amplifier)
- Hold Control
- Envelope Switch (ENV-1/ENV-2)
- ENVELOPE GENERATOR 1
- Attack Time Control (1.5 msec-2.5 sec)
- Decay Time Control (1.5 msec-8 sec)
- Sustain Level (0-100%)
- Release Time (1.5 msec-8 sec)
- Gate Trigger Selector Switch (Gate + Trg/Gate/LFO)
- ENVELOPE GENERATOR 2
- Attack Time Control (1.5 msec-3 sec)
- Release Time (1.5 msec-8 sec)
- Gate Selector Switch (Gate/LFO)
- Modulator
- Mode Switch (Random / r / n / v)
- Rate Control (0.2 Hz-25Hz)
- Delay Time Control (0-3 sec)
- Rate Indicator
- Controller
- KYBD Ext CV GATE Selector Switch
- Total Tuning (+700 cents or over)
- Portamento Time Control (0-2.5 sec)
- Total Volume
- Transpose Switch (L/M/H)
- Bender Level
- Bender Sensitivity (VCO, VCF)
- CONNECTION JACKS
- Output Jack
- Output Level Switch (L/M/H)
- Phones Jack (8 ohm stereo)
- Phones Output Level Switch (L/M/H)
- External Input Jack
- External Signal Input Level Switch (L/M/H)
- External Control Voltage Input Jack (1 V/1 Oct)
- External Gate Voltage Input Jack (ON with +7.5 V or over)
- Keyboard Control Voltage Output Jack (1 V/1 Oct)
- Keyboard Gate Output Jack (OFF-0 V, ON-14 V)
- POWER CONSUMPTION: 10W
- DIMENSIONS: 610(W) x 370(D) x 135(H)mm
- WEIGHT: 8.4 kg, 14 lbs
- ACCESSORY: 2.5m Connection Cord

Super Fat Sound from a New 24dB/oct Filter

*Specifications are subject to change without notice.

Write or call for more information.
Roland Corporation (Australia) Pty. Ltd.
 13 Chard Road, Brookvale, N.S.W. 2100.
 Telephone (02) 938 3911.



INTRODUCING THE AR9. FOUR-ON-THE-FLOOR PLUS "ELECTRO-AUTOMATIC TRANSMISSION."



Bookshelf and mid-size speakers have been AR's act for 25 years.

Nobody builds them better, tests them more thoroughly or backs them with a stronger warranty.

But the flagship of most speaker lines is a big, floor-standing job. A heavy hitter that will blow your socks off. And our flagship has just come in.

The AR9 is a four-way, floor-standing speaker, 52 1/4 inches tall, with 5 drivers and the ability to handle amplifiers capable of delivering up to 400 watts (gasp!) continuous power per channel. (With amplifier being driven to clipping 10% of the time on normal music source material.)

The price: approximately \$1250 a copy.

But the AR9 is a lot more than big and expensive.

The thing sounds simply fantastic.

Flat as a pancake all across the sound spectrum and virtually unaffected by room placement.

Each speaker contains two 12-pound, 12" diameter woofers. The two of them

AR are linked by a kind of electronic automatic transmission." Deep in the low end where volume falls off as frequency goes down, the "automatic transmission" cranks up the woofers to maintain volume without the usual break-up and distortion.

Crossover points have been rearranged so that the 8" low mid-range driver handles the critical range of human voice—a design refinement that contributes to the startling clarity of the AR9 sound.

There is a new semi-horn on one high-frequency driver.

Improved liquid cooling.

A tweeter voice coil made with new high-temperature materials.

Refinements of proved AR engineering concepts abound throughout the system.

And the results are absolutely startling.

Our ears tell us, and our test instruments confirm, that the new AR9 is nothing less than the most perfect speaker system possible today.

To get a more complete write-up, contact your AR Dealer or us.

But better yet, listen to the AR9.

Then tell us it's not the fantastic speaker system you've ever heard.

ANOTHER TRIUMPH FOR TRUTH IN LISTENING.

Acoustic Research Australia
P.O. Box 21 — 7 Ford St.,
Greenacre, NSW, 2190
Phone: 642-3458

If you want the condenser microphone sound on stage, Electro-Voice gives you that option.

The PL76 and PL77 condenser cardioid microphones are fast becoming the number one choices of vocalists who want to make the "studio-condenser" sound a part of their act. Both mikes give you condenser performance in a package that competes with dynamic microphone durability. Their gutsy, bass-boosting proximity effect adds presence to any voice. The PL76 is powered by a 4.5 volt battery. The PL77 is similar except that it is also phantom powerable. The "77's" output is 4 dB down from the "76's" to allow for more flexibility at the mixing board, and it has a recessed on/off switch that many sound men prefer.

For those desiring the more traditional dynamic sound, the PL91 and PL95 fit the bill perfectly. The PL91, with its mild bass-boost and clear highs is a joy to work with. The PL95, the "pro's choice" in a dynamic cardioid, offers the best gain-before-feedback of any



dynamic mike in the business – a test we invite you to make.

Electro-Voice also offers four superb instrument microphones. The PL5 dynamic omni is the mike to use when high sound pressure levels are encountered, as you would find when miking bass drums or amplified guitars, basses or synthesizers.

The PL6, with its patented Variable-D¹ construction gives you cardioid (directional) performance without up-close bass boost – perfect for miking brass, reeds, percussion or piano. The PL11, even though it's a directional mike, maintains its response curve off axis. "Leaked" sound from off-axis instruments are faithfully reproduced – not colored in any way.

E-V's PL9 dynamic omni has one of the flattest frequency response curves in the business – from 40 to 18,000 Hz. And its small size lets you mike instruments you couldn't get near with other mikes offering this performance.

All E-V Pro-Line microphones come with super-tough Memraflex grille screens that resist denting. Designed to

keep your mikes looking like new for a long time. All have a non-reflecting gray finish that won't compete for attention under bright stage lights.

When the time comes to update your current mike setup, we invite you to A-B Electro-Voice Pro-Line mikes against any others, for any application. If you try them, you'll want them in your act.



174 Taren Point Road, Taren Point, NSW, 2229.
Tel: 525-8588, Telex: AA26793.

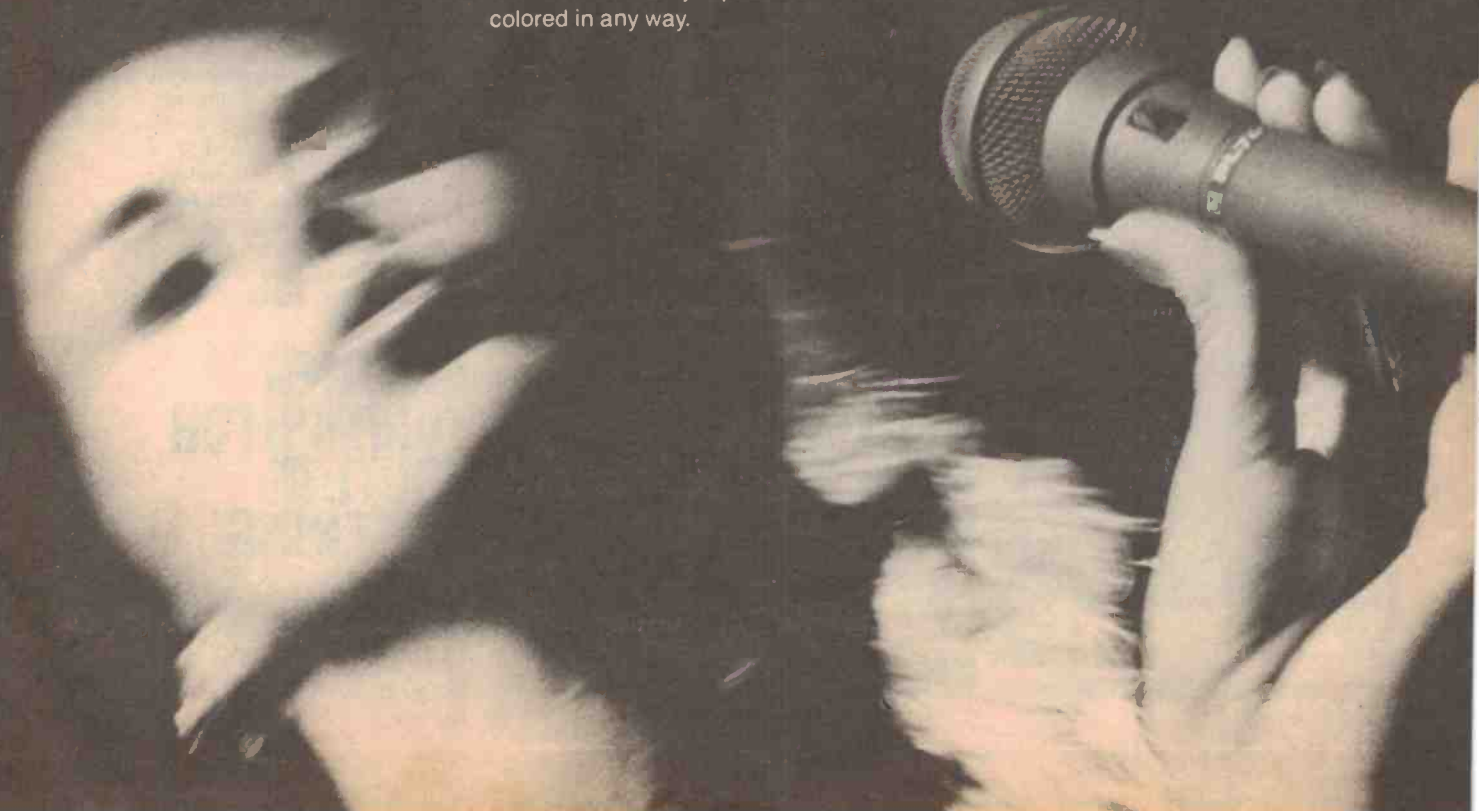

How we beat the pony express



ACTIVE

Silicon Valley carries large stocks of ACTIVE COMPONENTS with off the shelf availability of the latest current issue products.

Silicon Valley's stock of MPU products comes from industry leaders such as Motorola, Texas Instruments, AMI, National Semi-Conductors, Signetics and Synertek; displays from Motorola, Burroughs and Elcoma.

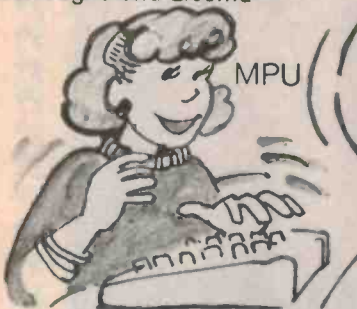

MPU



Components such as ROMs, PROMs, EROMs, RAMs, UARTs, Registers, Multiplacers, OP Amps, LEDS, CMOS, S/TTLs and LS/TTLs. All this complemented by supporting software and in-store programming.



PASSIVE

Silicon Valley has recently added over 2,000 passive components to its already extensive range. If you need electronic components with off the shelf availability visit the electronic supermarket of Silicon Valley.

Silicon Valley has more than 7,000 active and passive components with off the shelf availability.



WE'RE EVERYWHERE

silicon valley

Silicon Valley Stores

SYDNEY:
23 Chandos Street, St. Leonards
Tel: (02) 439 2965

Shop 4, PO Arcade, Joyce Street, Pendle Hill
Tel: (02) 636 6566

BRISBANE:
22 Ross Street, Newstead
Tel: (07) 52 1339

MELBOURNE:
380 Bridge Road, Richmond
Tel: (03) 429 4780

ADELAIDE:
170 Sturt Street, Adelaide
Tel: (08) 51 4080

NEW ZEALAND:
AUCKLAND
7-9 Kirk Street, Grey Lynn, Tel: 76 1169

Authorised Distributors

N.S.W.
Pre-Pok Electronics
718 Parramatta Road, Croydon
Tel: (02) 797 6144

In-Electronics
84 Ramsey Street, Haberfield
Tel: (02) 799 3331

Kit-Sets
657 Pitwater Road, Dee Why
Tel: (02) 982 7500

Applied Technology
109-111 Hunter Street, Hornsby
Tel: (02) 476 4758

Martin De Launay
270 Kiera Street, Wollongong
Tel: (042) 28 6020

Serve-U Appliance Centre
107 George Street, Bathurst
Tel: (063) 31 1356

Rendell Research
Ringwood Road, Exeter

A.C.T.
Diacom
29 Calbee Court, Philip
Tel: (062) 82 3581

QLD
Kit Sets
293 St. Pauls Terrace, Fortitude Valley
Tel: (07) 52 8391

Hunts Electronics
P.O. Box 546, Toowoomba
Tel: (076) 32 9677

VIC
Rod Irving Electronics
499 High Street, Northcote
Tel: (03) 489 8131

Stewart Electronics
240b Huntingdale Road, Huntingdale
Tel: (03) 543 3910

South West Electronics
119 Hopkins Street, Footscray
Tel: (03) 689 3819

S.A.
Ktronics
260 Wright Street, Adelaide
Tel: (08) 212 5505

W.A.
Atkins Corlyle
1-9 Milligan Street, Perth
Tel: (09) 321 0101

Fill in coupon for the following Silicon Valley Customer Services

- Tick
- | | |
|--|---|
| <input type="checkbox"/> Active Components Price List | <input type="checkbox"/> Literature/Data Price List |
| <input type="checkbox"/> Passive Components Price List | <input type="checkbox"/> Mail Order Information |
| <input type="checkbox"/> M.P.U. Price List | <input type="checkbox"/> Complete List of Stockists |

Name

Address

State Post Code

Post to Silicon Valley, P.O. Box 898, Crows Nest, N.S.W. 2065.

Introducing the new range of EMI Cassettes.



Sound Quality.

These new cassettes from EMI are designed to meet and exceed the exacting specifications in all performance areas, with special attention given to ensure smooth and trouble-free mechanical operation.

The new EMI Cassettes produce excellent results over the whole range of available equipment. All are available in 60, 90 and 120 minute playing time.

Whatever your equipment, whether they are recording speech or music, the EMI Cassette range will precisely match your needs.

1. Measured using the EMI recommended 2.5dB overbias at 6.3kHz, derived from the reference batch C521V (the value of bias internationally used by the majority of domestic recorder manufacturers).
Tape speed 4.76cm/s (1 7/8 in/s)
Track width 0.6 mm
Record head gap length 2µm
Replay head gap length 2µm
Replay amplifier characteristics: 120µsec and 3180µsec
(In accordance with IEC Publication 94 Edition 3, BS1568 Part 1 and DIN 45513)
2. The Frequency Response is obtained when the record amplifier characteristic has been adjusted to give a flat frequency response (25Hz - 15Hz) from the reference tape batch C521V of -30dB (Ref. 1*).

*Ref 1. Relative to an RMS Flux of 250mWb/m Tape Width (25mMx1mm) at a frequency of 315Hz (in accordance with IEC Publication 94 Part 2).

TYPICAL FREQUENCY RESPONSE OF EMI CASSETTES

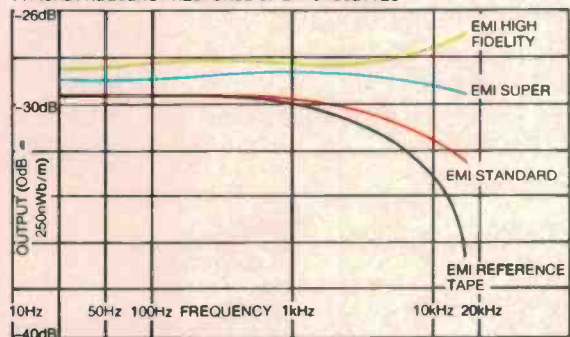

RANK AUSTRALIA
PROFESSIONAL SERVICES GROUP

12 Barcoo Street, East Roseville, Sydney 2069. Telephone: 406 5666
60 Rosebank Avenue, Clayton South 3169. Telephone: 543 4122
50-52 Vulture Street, West End, Brisbane 4101. Telephone: 44 2851
101-105 Mooringe Avenue, Camden Park 5038. Telephone: 294 6555
430 Newcastle Street, Perth 6000. Telephone: 328 3933
120 Parry Street, Newcastle 2309. Telephone: 26 2466

High Quality Recordings

IN THESE DAYS of splice perfect studio tape recordings, the actual experience of being recorded for posterity is still a sobering trial for even the well conditioned and hardened professional musician.

The renewed interest in the direct cut process highlights the musician's ability to overcome psychological barriers concerning interpretation, techniques and spontaneity. Professionals are reputation conscious and those who commit their art to the direct disc display a sense of adventure and a deep interest in reproducing sound as accurately as possible.

The adventure of direct disc recording is not new. Correspondence from such legendary pianists as Busoni and Paderewski relate their worries concerning condensed interpretation for accommodation onto time-limited playing side. This squeezing of music into exact time lengths and the necessary five or ten seconds rill between each item surely puts a strain on any musician.

For this reason it could appear that even the last province of the jazz musician — improvisation — needs to be fully written before the event. This encroaches into the realm of classical type music where every second is accounted for and a 10% leeway is the maximum. Apparent spontaneity is the life force of any music performance and a reference disc that is continuously replayable without boredom is to be treasured.

It is not surprising that top flight 'real-time' jazz improvisors have never been recorded on direct disc with freedom to improvise. A few wayward thoughts and the whole recording could be overlong or overmodulated.

Strict Improvisation

Perhaps the most audacious, yet strictly disciplined, music improvisation comes from Ali Akbar Khan, the Indian musician, who lives at his college in southern California. This style of music is ideal for direct cut discs as it embraces music of emotional intensity and rhythms on stringed and percussive instruments. In addition, the master Indian musician can present strict improvisations from a few minutes to hours.

Until a few recent issues, the direct cut disc had generally been used as a quality demonstration medium but rarely provided continually enjoyable music. The patchwork quilt of the usual tape-spliced, normally processed disc continues to present the more accurate musical performance.

Direct cut processes do give very fast rise times which, however, may still be limited according to the mixing console used and the sometimes necessary controls in the cutting chain.

Charlie Byrd, CCS8002, (45rpm)

This collection of five pieces for guitar-based quintet is superbly recorded. The musical miscellany contains indigenous rhythms, modern riffs and drum styles.

In particular, Byrd's own composition Old Hymn contains some very fine, indeed fantastic, guitar playing. Passing reference to Villa Lobos' guitar studies is, of course, unavoidable. Watch the levels in this piece as the drum passages can blow unfused speakers.

Virgil Fox — The Fox Touch, Volumes 1 and 2, CCS7001/2

Without doubt, the most exciting and exhilarating of all direct cut discs. Virgil Fox is an old hand at presenting organ music in a colourful manner as many readers will remember from his Heavy Organ Bach recitals for Americas youth. These famous performances were accompanied by blazing clouds of coloured smoke.

This extrovert master musician provides two remarkable programmes of organ music including the famous Bach compositions 'Tocatta and Fugue in D Minor', and the 'Tocatta, Adagio and Fugue'. Both are on the first disc. Other staggeringly well presented items are blockbusters of Widor, Franck, Dupre, Gigout, Alain and Jongen.

Producer Wodenjak (ex *Sound Advice* publisher) chose well in *Audio's* Bert Whyte, and console circuit designer John Curl (whose initials grace the Mark Levinson JC-1 pre-amplifier). Don't miss these discs. The bass, middle and treble ranges are very powerfully engraved onto normally excellent surfaces.

The organ chosen is a mighty beast whose specifications are unfortunately not included with the discs. This musically inventive pair of discs will test all aspects of the audio system while providing inspiring music.



MXR Digital Delay

Expanding the Boundaries of Creativity

The MXR Digital Delay is a self-contained audio delay line which utilizes sophisticated technology to achieve a new standard of professional quality performance. The culmination of an intensive design program, the MXR Digital Delay is unparalleled in versatility, ease of operation, and creative application.

Although the MXR Digital Delay is capable of a wide variety of effects, the basic function of the unit is quite straightforward. The input signal is processed through circuitry which delays the signal by a specific amount of time. It is then mixed back with the 'dry' or undelayed signal at the output of the delay. The effect produced will depend upon the amount of delay time chosen. The basic effects that can be obtained by using appropriate portions of the wide delay range provided by the MXR Digital Delay include discrete echoes, vocal doubling, and hard reverberation. In addition to these basic effects, the MXR Digital Delay contains associated circuitry which allows such unique effects as flanging, pitch alterations (vibrato, pitch bending), frequency modulation and infinite (non-deteriorating) repeat-hold.

The MXR Digital Delay employs digital random access memory to produce a time-delayed signal. This technique, derived from computer technology, represents a departure from previous shift register methods. The analog input signal is converted to digital form, stored in the memory circuitry and removed at some designated later time. It is then converted back to analog form and fed to the output.

This method provides the user with the advantages of a wider usable delay range, more precise control of delay time, and preservation of signal quality. The MXR Digital Delay makes available delay times ranging from 0.08msec. to 320msec. (1 second = 1000msec.), fully variable, without excessive noise or mechanical reliability problems. This delay range is expandable to 1280msec., in increments of 320msec., by means of up to three additional plug-in memory boards. These boards are available from MXR and are easily installed by the user.

The MXR Digital Delay is designed for a wide variety of applications including recording, P.A., and amplified musical instruments. The unit is rack-mountable for studio installation, and an optional road case is available for onstage use by the traveling musician.

For more information see your MXR dealer.
The Music Distillery, 503 Pittwater Road,
Brookvale, NSW. 2100 (02) 938-2372, 938-4095.

MXR Professional
Products Group



High Quality Recordings

San Francisco Limited, CCS5004, (45rpm)

Apart from the easy gospel style of Terry Garthwaite and her vocal harmonist Willow Wray, this is an enjoyable, real flavour, night-club style disc.

Drum and wind soloists are top notch musicians with more flexibility than normal in the direct cut medium.

Cal Tjader, Huracan, CCS8003, (45rpm)

This apparently distant-miked disc still retains the essence of close-miking with silky treble and throbbing bass. The end of side two has delicate continuous brushing strokes on cymbals; don't mistake this for surface noise or tape hiss.

The composition 'Huracan' has some good low notes.

Peter Appleyard Presents, Salisbury Laboratories

SALS020001

This Canadian direct cut disc follows modern close miking techniques.

The enormous line-up of percussion instruments is the basis of Appleyard's internationally successful arrangements.

There is something for everyone on this disc. From 'Mambo' to the 'Swinging Shepherd Blues', to the very up-tempo, big band sounds of 'Open the Gates of Love' and 'Night Journey', both by Doc Severinson. These last two are very exciting, driving, full-band expositions with up-front recording styles.

The disc features very tight and controlled acoustics with wide spread but occasional engineering of fades. Most of the music presented has great tension and, considering the instrumental line-up, the results are very smooth even when the rhythmic tension is building towards large climaxes.

World Orchestra of Young Musicians, conductor Pierre Hetu, Musicus MS2-45101, (2 disc set, 45rpm)

Moussorgsky/Ravel: Pictures at an Exhibition.

Richard Strauss: Til Eulenspiegel.

Dvorak: 8th Slavonic Dance.

This auspicious recording of a very young group of musicians has received engineering that varies from excellent to passable. The strings are very well focussed and full-bodied, the brass is natural in timbre.

Slight surface noise intruded during the 'Catacombs', and the strings sound engineered during the 'Great Gate of Kiev'.

This orchestra has received excellent tuition under such inspired personalities as Jean Martinon, Karel Ancerl, Bernstein, Rowicki and Mehta.

Diahann Carroll, Duke Ellington's Orchestra directed by Mercer Ellington, DRC400 (Orinda)

This tribute to Ethel Waters is mentioned as being a digital recording but the cover does not carry information other than a few claims to exceptional technical achievements. The disc was processed at the JVC cutting studio which indicates it was cut at half speed with the resultant trade mark of super clean treble.

The bass sections in Saint Louis Blues do not seem to be as deep as some direct discs but the fullness and cleanliness is well controlled. The vocalist appears suspended in exact focus between the speakers.

In general, a good representation of night club music excellently recorded.

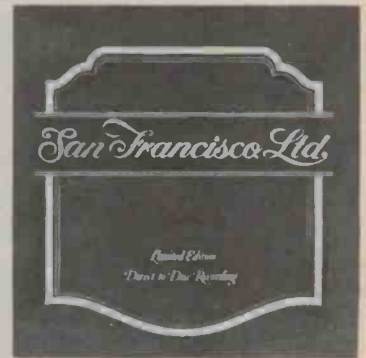



De-soldering problems?

The new Weller power vacuum desoldering station for printed circuit board repair. Famous Weller closed loop temperature control protects sensitive components while soldering or desoldering. See-through solder collector is easy to clean or replace. Non-burnable cord sets afford safety and longer life. Low voltage tool inputs give added safety margins. High impact resistant tool handles and stainless steel barrels mean longer tool usage.

Also there's now cordless soldering from Weller - (see right). Soldering was never easier than with the Weller cordless kit, consisting of iron charger, solder, 4 different tips and a handy screwdriver. Other products from The Cooper Group include Crescent, top quality electronic pliers; Lufkin, measuring equipment; Nicholson, precision files; Xcelite, professional hand tools and Wiss shears and scissors. Whatever your requirements, you can choose Cooper products with confidence.



The Cooper Group

CRESCENT · LUFKIN · NICHOLSON · WELLER · WISS · XCELITE

The Cooper Tool Group Limited,

P.O. Box 366, Nurigong Street, Albury NSW 2640, Australia. Telephone: 215511 Telex: 56995



ULTIMATE.

Philips High Fidelity Laboratories.

In any range of equipment there is a leader. One which sets the standard by which the others are measured.

With Philips Hi-Fi Stereo, the Hi-Fi Laboratories range stands at the very top.

These state-of-the-art Hi-Fi components, which were developed in America, offer precision craftsmanship, technical perfection and outstanding performance.

High-Fidelity Pre-Amplifier

The AH 572 High-Fidelity Stereo Pre-Amplifier is an ultra-low distortion (0.008%) two-channel unit featuring high-accuracy step detent controls,

illuminated function readouts and touch switches with LED indicators for smooth, silent, sophisticated programming. It also includes adjustable phono input levels and a tape selector that provides five separate tape modes.

High-Fidelity Stereo AM/FM Tuner

The AH 673 High-Fidelity Stereo AM/FM Tuner incorporates touch switches with LED indicators and illuminated function readouts. Other features include ASNC (Automatic Stereo Noise Cancelling). Separate level controls for AM and FM. An FM interstation disturbance mute. And an exclusive AM centre-tuned meter for wide-band full fidelity AM reproduction.

High-Fidelity Stereo Power Amplifier

The 210 watts RMS per channel high-performance AH 578 High-Fidelity Stereo Power Amplifier completes the Philips Hi-Fi Laboratories range. It comprises high-accuracy step detent controls, touch switches with LED indicators and illuminated power meters and protection indicators. Also incorporated in the AH 578 are a sub-sonic filter, thermal and overload protection, and provision for connecting two pairs of loudspeaker systems.

**Philips Hi-Fi
Laboratories Range.
A step closer
to sound perfection.**



PHILIPS

We want you
to have the best



High Quality Recordings

Organ Sounds from Mount Olivet, ARK1094-S

Careful playing by Diana Lee Metzker underlines the deep bass notes available to high fidelity enthusiasts on this recording. Perhaps the best system test for bass is the Karg-Elert selection which presents notes guaranteed to resonate pickup arms and music systems.

The recording was made by US loudspeaker manufacturer Bob Fulton.



Arthur Fiedler and the Boston Pops, CCS7003

Tchaikovsky and Rimsky Korsakov; Capriccios Italien and Espagnol

Another high quality combination of personality conductor, really top class orchestra and well known music. The dynamic range is wide, the sound is full bodied with some very deep bass notes. A typical direct cut disc, smoothness with good perspectives.

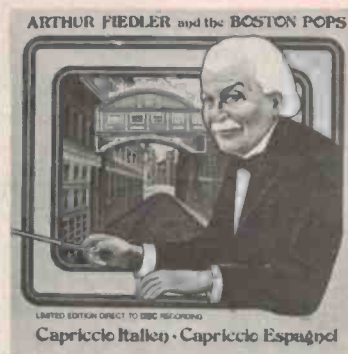

LadyBird, Audio Lab ALJ 1054

Night-club type presentation of well-known items in easy-to-listen-to arrangements.

Very wide spread and separation is a feature of this disc, and piano perspective is slightly removed for once. The double bass is impressively natural and well balanced with the piano, and the electric guitar and drumkit are also recorded with natural acoustic.



Eternal Father, Volume 2, Richardson Records RRS-6

Contains a number of well known hymns and credos sung by the choir of US Naval Academy midshipmen with two organ solos by the resident chapel organist.

The reverberant acoustic occasionally heightens choral effects, giving a pleasing perspective, and the men's voices are very clearly recorded with a slight echo sometimes being returned to the microphone position.

The Langlais organ solo bass notes modulate the treble output.



Wagner and Prokofieff Excerpts, Sheffield Lab 7 and Lab 8

The beautifully produced covers and booklets pre-empt the musicality and realism that is missing from these latest Sheffield discs. Perhaps the subtleties and shadings received in concert halls and opera theatres on normally processed taped performances could not be fully attempted in the direct cut process of Sheffield.

This lack of musical continuity highlights the 'hi fi-ness' of the performances. Acoustic balance is at odds with instrumental sections as each seems to overlay the other; almost as if they are occupying the same seats.

Low frequencies and midrange are powerfully engraved with telling effect. The treble register is often unrealistic and harsh; upper massed strings are thin in tone, especially in their harmonic structure.

As a feat of direct cut engineering these latest Sheffield discs must be recommended for their sonic performances below about 5 kHz, above which feedback control of the cutter head is reduced and where some high frequency limiting is generally applied in tape to disc recordings.



Great British Sound Achievements

The BRITISH company Goldring has an enviable reputation for world famous stereo magnetic cartridges and replacement styli

G820



- Exceptional performer for standard equipment
- Reliable and rigorous in service
- Frequency range 20 Hz to 20 kHz
- Playing weight range 1.5 to 4.0 gm

G 820 DJ

- Designed for disc jockeys and broadcasting studios ● Retains performance of proven G820
- Rugged, high performer ● "Nude" diamond mounted in steel sleeve
- Stylus assembly anchored to stylus block
- Tracking range 1.5 to 5.0 gm

Picked as "Best Buy" by "Hi-Fi for Pleasure" ●
Brings out original sound in quality equipment ●
Top performer at half price ●
Frequency range 10 Hz to 23 kHz ●
Playing weight range 0.75 to 2.0 gm ●



G820E



G820SE

- A British design aimed at perfection
- Excellent stereo reproduction
- Pedigreed performer
- Frequency range 10 Hz to 25 kHz
- Playing weight range 0.6 to 1.75 gm

Budget priced quality cartridge ●
Performance comparable to other good quality models ●
Constructed on same basis as G820 series ●
Playing weight range 2.5 to 4.0 gm ●

G850



G900SE



AND THE FAMOUS BRITISH-MADE GOLDRING

- Offer outstanding performance through exceptional low mass
- Performance comparable to best moving coils
- Offers interesting contrast with some "Prestigious" models
- Performance comparable to other cartridges costing two and three times as much.
- Frequency range: 10 Hz to 28 kHz
- Playing weight range: 0.75 to 1.5 gm

**FOR TECHNICAL EXCELLENCE IN HI-FI PICK-UP
CARTRIDGES AND REPLACEMENT STYLI LOOK FOR**

BRITISH
MADE

Goldring
ENGLAND

AUSTRALIAN DISTRIBUTORS FOR
GOLDRING PRODUCTS LTD - ENGLAND

SOUNDRING DISTRIBUTORS

Write for further details
Trade Enquiries Welcome

1/514 MILLER ST,
CAMMERAY, 2062
P.O. BOX 154, CAMMERAY, 2062
TEL (02) 92-1990

Perfection... from Nakamichi

If you believe that perfection is a thing of the past, take a good look at the Nakamichi 410 Preamplifier, 420 Power Amplifier and 430 FM Tuner — the most elegantly compact, best performing trio of components on the market today.

Timelessly styled, they adapt to the most limited spaces (each measures less than 9" x 16" x 3¼") and can be arranged in an endless variety of ways. Altogether, they occupy less space than most receivers, yet, since each is a separate component, the three easily adapt to unusual space requirements. Installed "bare", they are a handsome addition to any interior; attractive walnut finish enclosures are available at small additional cost.

Each, of course, embodies world-famous no-compromise Nakamichi engineering and quality construction ... with the distinctive "feel" of meticulous manufacture. So, if you're limited by space or budget, but unwilling to compromise on quality or performance, nothing could be more perfect.



410

420

430



For your nearest dealer, brochures and information contact
CONVOY INTERNATIONAL PTY. LTD.
4 Dowling Street, Woolloomooloo, N.S.W.
2011. Tel (02) 358 2088

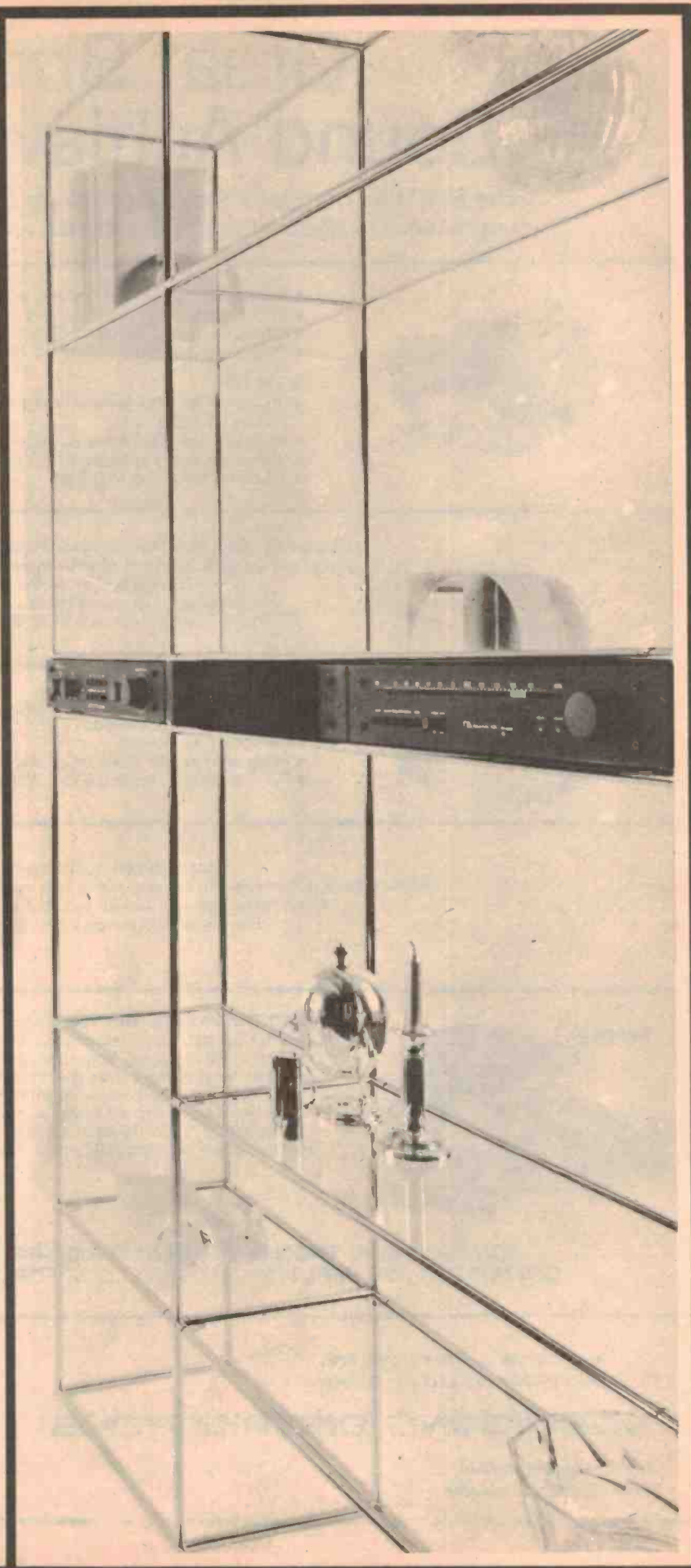

High Quality Recordings

The Spirit of Christmas Braced, The Annapolis Brass Quintet, Richardson Records RRS-5

Containing thirteen carols, noels and hymns, this record will interest every brass player. The perspective is a fraction flat and occasionally the brass may seem sharp but the transcriptions are very good and excellently played.



Distributors:

Sailisbury Direct Cut — Concept Audio.
Sheffield Direct Cut — Megasound.
Crystal Clear Direct Cut — Luxor.
Orinda Direct Cut and Normal — Luxor.

Normal Process Discs:

Audio Lab — MR Acoustics.
Ark — MR Acoustics.
Musicus
Richardson

SOUND BRIEFS

Two-speed cassette deck

BIC is marketing a cassette deck operable at either 1 7/8 inches/second or 3 3/4 inches/second. In effect doubling tape speed improves the high frequency response by a factor of two. As the whole of this improved response is not required, BIC say that they have 'exchanged the excess portion for significant improvements in signal/noise ratio, distortion, dynamic range etc, whilst still providing superior frequency response'.

Such claims cannot be dismissed as advertising hyperbole — BIC are guaranteeing a frequency response of 25 Hz — 22 kHz \pm 3 dB at the higher speed.

(BIC's claim to a 'world first' caused tantrums at ETI — our design engineer modified a cassette recorder to run at 3 3/4"/second way back in 1972 as part of a 'fifth wheel' for recording automobile performance data!)

Astrocom/Marlux also attempted to build a two-speed machine some years ago — we're not quite sure what happened to it but the rumour is that Philips would not support the concept. We understand however that BIC's machine has Philip's tacit approval.

Printed Cartridges Soon?

JVC has developed a technique for 'printing' the inductors required for a moving coil cartridge directly onto a tiny wafer substrate which in turn is fixed to the stylus cantilever very close to the stylus tip.

We understand that JVC have no definite marketing plans but a few pre-production devices are said to be around.

Fuji To Compete With 3M's Metafine Tape

Japan's Fuji Photo Film has formally announced that it is about to start manufacturing a metal particle tape the performance of which appears to be similar to 3M's recently announced 'Metafine' product.

Fuji are claiming 7 dB — 12 dB increase in maximum output level (MOL) over chrome tapes, and a 3 — 9 dB improvement over their own FX-II material.

The company says that the new tapes and cassettes will be available as soon as machines are available to use them. This should be almost immediately as Tandberg have just released details of their TD20A open-reel recorder and TCD 340A cassette deck — both of which are fully capable of recording, erasing and playing back the new metal particle tapes (full report this section ETI last month).

Remington and Decca Reissues

Selected recordings from old Remington and Decca catalogues are currently being reissued by a company in California. Anyone interested should contact them directly — Varese International, P.O. Box 148, Glendale, California 91209, USA — mention you heard about it in ETI.

**SAVE
\$ \$ \$ \$ \$**

HARMONIX

SPEAKER KITS *Simply a better sound.*

PLESSEY/FOSTER COMPONENTS

**Loudspeakers
to satisfy
the most
demanding
enthusiast.**

Here they are — from the small HX8-2 way to the big HX15-3 way loudspeaker system. If you've ever heard from them, you'll know you've listened to the result of superb craftsmanship in the science of sound.

Model	Power	Frequency Range	Price Per Pair Kitform	Price Per Pair Assembled	Do-It-Yourself You Save Per Pair
HX8-2W	20W RMS	20 Hz-15 kHz	\$155.00	\$195.00	\$40.00
HX10-3W	20W RMS	20 Hz-20 kHz	\$210.00	\$275.00	\$65.00
HX12-3W	35W RMS	20 Hz-22 kHz	\$255.00	\$345.00	\$90.00
HX12-3WA	45W RMS	20 Hz-21 kHz	\$235.00	\$345.00	\$110.00
HX15-3W	70W RMS	18 Hz-40 kHz	\$365.00	\$465.00	\$100.00

MAIL ORDER: NSW Country & Interstate — Freight extra.

For further technical information and your nearest dealer contact **Harmonix Acoustix** on (02) 519-5127 or write to 29 Vincent St, Marrickville. 2204.



DEALERS — the list grows.

- **HARMONIX** speaker kits now available from:
 - **HI-FI CITY**, 269 Elizabeth St, Sydney. 235-8401
 - **IN ELECTRONICS**, Haberfield. 79-9331
 - **HI-FI JUNCTION**, Bondi Junction. 389-4000
 - **TERRY'S SOUND LOUNGE**, Bowral.





EMONA
enterprises

Room 208/661 George Street, Sydney Phone: 212-4815

P.O. Box 188, COOGEE. NSW. 2034.

**FOR PROMPT MAIL
ORDER SERVICE!**

CHRISTMAS ALREADY? NOT YET, BUT SOON!

ORDER FROM EMONA NOW AND SAVE YOURSELF FROM CHRISTMAS RUSH

FROM **UT** UNIK TIME

SOLAR! CHRONOGRAPH Electronic LCD Digital Watch

6-digit 11 function chronograph
Hour/Minute/Second/Month/Date/Day
/Stop Watch (hour/minute/second/
1/100 sec.)

- Gold case & band — \$70
- Silver case & band — \$65

ALSO AVAILABLE:

- 6F. LCD Digital-ALARM watch (not solar), case similar to above.
- Gold case & band — \$70
- Silver case & band — \$65
- 5F. LCD Digital — LADIES watches
- Round gold case & leather band — \$40
- Round silver case & leather band — \$35
- Rectangular gold case & leather band — \$45
- Rectangular silver case & leather band — \$40



the world's thinnest DIGITAL TIMEPIECE

Featuring:

- 5 function, 4-digit quartz crystal accuracy Hour, minute, second, month, date
- Super thin styling (6 mm) with 4 elegantly styled faces
- Removable battery hatch for easy customer battery replacement
- Gold or silver toned case with lizard or mesh band options
- High contrast, easy to read liquid crystal display with command backlight
- Full year warranty with worldwide service



SUPER SLIM:

- Gold case & band — \$70
- Gold case & leather band — \$60
- Silver case & band — \$65
- Silver case & leather band — \$55

12 MONTHS WARRANTY on all watches.
P & P (all watches) NSW \$2, Interstate \$3. OTHER
MODELS ARE AVAILABLE.

LED DIGITAL ALARM CLOCK \$20.⁵⁰

(P & P
\$2.00)

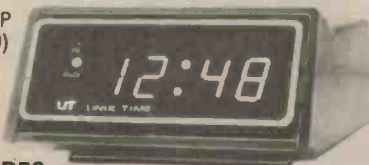

FEATURES:

- Stylish design ● Large bright LED display
- Colours: white, yellow, black, red ● Tilted front panel for easy viewing ● Alarm ● 9 minute snooze time ● Seconds display
- Bright-dim control.

TRADE ENQUIRIES WELCOME

CALCULATORS

from TEXAS INSTRUMENTS



**PC100A
with
TI-58/59**

	Excl. S. Tax	Incl. S. Tax
T.I.-25.....	\$32.00	\$35.00
T.I.-30.....	19.00	20.50
T.I.-30 Student Pack.....	23.00	25.00
S.R.-40.....	28.00	32.00
T.I.-55.....	53.00	59.00
T.I.-57.....	74.00	85.10
T.I.-58.....	109.00	120.50
T.I.-59.....	247.00	275.00
T.I.-5050M.....	81.00	90.00
T.I.-BA Business Analyst.....	33.00	37.95
Little Professor.....	16.00	17.90
Data Man.....	23.00	25.00
T.I.-MBA.....	75.00	87.40
T. I. Programmer.....	53.00	59.00
T.I.-MM Money Manager.....	21.00	23.50
PC-100A Printer.....	213.00	236.00
Library Modules for T.I.-58/59.....	31.00	35.00
Blank Mag. Cards for T.I.-59.....	14.00	16.10
Programming Forms — Pads.....	2.20	2.80
TP-30250 (3 rolls of paper, PC100A)	10.00	11.50

The new SINCLAIR Enterprise — Programmable!

- Real computing power.
 - A comprehensive program library: General, Finance, Statistics, Mathematics, Physics, Engineering and Electronics.
- (For more details see Sept. '78 ETI)

Excl. S/Tax **\$69** Incl. S/Tax **\$79.35**



THE ULTRASLIM NS 108 by National Semiconductor. For details see Sept. '78 ETI.

Excl. S/Tax **\$44** Incl. S/Tax **\$50**

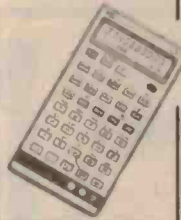

BMC

LCD-8W, Billfold Pocket Calculator with clock/stopwatch & alarm. (See May '78 ETI)

Excl. S. Tax **\$41.74.** Incl. S. Tax **\$48**

LCD-8M, Billfold Pocket Calculator

Excl. S. Tax **\$16.95.** Incl. S. Tax **\$19.50**

1212PD, 12 digit Display Printer

Excl. S. Tax **\$108.70** Incl. S. Tax **\$125**

NOTE: For all calculators and digital multimeters; P&P, Int. \$3, NSW \$2 (up to \$50 value) Int. \$4, NSW \$3 (up to \$100 value). Goods valued over \$100 delivered by courier — freight paid by receiver.

NEW! NEW! NEW!

Sinclair Digital Multimeters DM235



Only \$130 (plus 15 percent sales tax)

**Exclusive Sinclair
12 months guarantee!**

FEATURES:

- 3½ digit resolution ● Large, bright, wide angle LED display reading to ± 1999 ● Automatic polarity selection ● Industry standard 10M ohms input impedance ● 0.5 percent of reading basic accuracy ● Full multimeter facilities including AC current ● Resistance measurement up to 20M ohms. ● Direct reading of semi-conductor forward voltages at 5 different currents ● Simple, unambiguous controls with readings always in volts, mA or k ohms. ● Selection of all functions from a single input terminal pair ● Automatic overrange indication ● Automatic decimal point placement ● Operation from disposable or rechargeable cells, or from AC adaptor/charger ● Facility for battery condition test.

Six functions in 26 ranges

- DC Volts — 1mV to 1000V; AC Volts — 1mV to 750V; DC Current — 1 uA to 1A; AC Current — 1 uA to 1A; Resistance — 1 ohm to 20 M ohms; Diode test — 0.1 uA to 1mA; 10M ohms input impedance.

Reading rate: 2½ per second

Temperature coefficient: less than 0.05 degrees C of applicable accuracy specification

Dimensions: 10" x 5.8" x 1.6" (225 x 148 x 40mm)

Weight: Less than 1½ lbs (640 gms)

Sockets: Standard 4mm for resilient plugs, ¼" (19mm) spacing
Power Requirements: Four 'C' or R14 size disposable cells, or approved AC adaptor or Sinclair rechargeable cell pack

Supplied Complete with test leads and prods, and operator's instruction manual
Options A/C adaptor/charger units for 117V; 220V or 240V; Rechargeable battery pack; Eveready carrying case with neck strap and lead stowage compartment; 30kV High voltage probe.

PDM35

Only \$65
(plus 15 percent S/T.)

**Now everyone can
afford to own a
digital multimeter**



A digital multimeter used to mean an expensive, bulky piece of equipment. The Sinclair PDM35 changes that. It's got all the functions and features you want in a digital multimeter, yet they're neatly packaged in a rugged but light pocket-sized case, ready to go anywhere. Features: 3½ digit resolution reading to plus/minus 1999. Automatic polarity selection. 10M ohm input impedance. Full multimeter facilities. Resolution of 1mV and 0.1nA. Semiconductor junction test facility. 1 percent of reading accuracy. Genuine pocket format. Ranges: DC volts: 1mV to 1000V. AC volts: 1V to 500V. DC current: 1nA to 200mA. Resistance: 1 ohm to 20M ohms. Contents: PDM35; test leads with probes; owner's operating manual — protective carrying pouch. Power Requirements: 9 volt transistor radio battery or 9 volt approved AC adaptor.

**Exclusive Sinclair
12 month guarantee!**

David Reid Electronics Pty Ltd.

104 KING ST NEWTOWN 2042 P.O. BOX 317 NEWTOWN PH. 519-6361



Boy here's the catalogue that will solve all your component buying problems. Write now for our finest catalogue yet published. Around 4,000 items, many illustrated. Bargain list sent free, post coupon to David Reid Electronics, Box 317 Newtown and 60 cents to cover P & P.

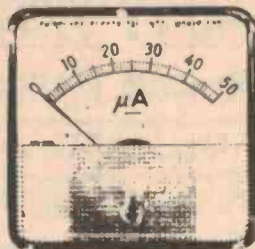

PANEL METERS

	1-9	10 up
MR 38P	\$8.25	7.75
MR 52P	9.75	9.25
MR 65P	11.25	10.50

HI MIKE MICROPHONE STAND TYPE MS 30

LOOK AT THIS \$19.50

SUPER LED SPECIALS

LH IS Style Red	\$1.00	Green	\$1.25
TIL 209 small red	25c		
TIL 211 small green	45c		
TIL 220 Std red	25c		
TIL 222 Std green	40c		
TIL 22X Std yellow	40c		
Red plus green in one package	\$2.00		



Electrokit 48

30 Watt Sanken Power Module and Component Electrokit

1. This kitset includes a 30 Watt Sanken Hybrid Amplifier SI-1030G and its ancillary components.
2. Supplied with Power Module, silk screened printed circuit board, fuse and components to complete the module.
3. Input of 520 millivolts
 - A. Suggested Transformer Davred D1350/2
 - B. Suggested Power Supply Electrokit 47



4. Output impedance 8 ohms.
5. Supply voltage 54 VDC.
6. Frequency Range 20 Hz - 100 KHz.
7. Comprehensive circuit and assembly instructions included.

- C. Suggested Stereo Pre-amplifier Electrokit 18
- D. Suggested Amplifier Cabinet Electrokit 50

\$21.95

SEEING IS BELIEVING A 3½ LCD MULTI METER

LOOK ONLY

\$99.95

PLUS TAX

Prices subject to alteration E+OE

DEL SOUND - PTY LTD - BRISBANE

1 Wickham Tce, (cnr. Wharf St.) 229-6155 (Park at rear)
35 Logan Rd, Woolloongabba. 391-7048.

**IF WE CAN'T BEAT THE OPPOSITION PRICE,
WE WILL TRY TO MATCH IT . . . IF WE DON'T STOCK IT,
WE WILL TRY TO GET IT FOR YOU**

Guess who's now
a Dick Smith dealer?

● SPECIALS IN ● TOP QUALITY COMPONENTS

Motorola 2N3055	75c
Motorola MJ2955	90c
Philips 555 8 P.I.C.	50c
Philips 741 8 P.I.C.	45c
Resistors 1/3 W.	4c
10 Way Rainbow Cable.	.65c metre
16 Way Rainbow Cable.	\$1.00 metre
6-Piece Jewelers Screwdriver Kit.	\$.25

Sound Hire - DJ and party for all occasions.

Old distributor for:
RCA Semiconductors and Swan Electronic Components.

complete electronic supplies

Wholesale, trade and mail orders welcome. Add 10%
post and pack. Stocks and prices valid at 16.6.'78.

Make way for ADULT TV GAMES

Programmable Microprocessor; Blackjack, Baccarat, Poker, Showdown, 5 Card Stud, 7 Card Stud, Draw, Backgammon and 18 other games.

WAREHOUSE SALE. All items new and guaranteed. Same day delivery on Bankcard, Money Order and Bank Cheques, Personal Cheques once cleared. Trade welcome.

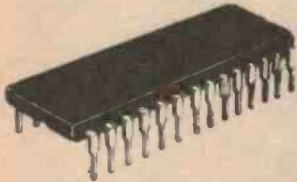

TV GAME IC
AY-3-8500 \$1.20 incl post

PLL CB IC
NECuPD 861C \$1.20 incl post

LCD 6-function WATCH

MADE IN JAPAN

Hour/Minute/Second
Day/Date/Backlight.
Normally \$61.50



\$29 plus \$2 postage.
Gold only.

LCD WATCH-PEN

from internationally famous
BEST SEMI-CONDUCTOR LTD
It's a 6-digit silver-styled Ball Pen and Chronograph 13cm long (patents pending)



- Stop Watch (up to 60 minute)
- Lap Time function
- Hour, minute, seconds continuous readout.
- Month, day and date.
- Back light for night reading.
- Medium point ball pen (standard refills) for effortless writing.
- Strong pocket clip.

Normally \$65.50 \$32 plus \$2 postage. Silver only.

LCD CALCULATOR + WATCH

with AUDIBLE ALARM. Usually \$59

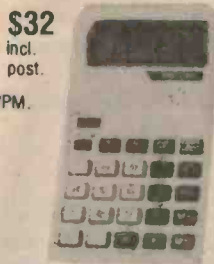

\$32 incl. post.

- Memory calculator.
- Digital CLOCK, day/date/AM/PM.
- Digital clock.
- Alarm pips.
- Alarm reminder.
- Accurate stop watch
- Stop watch and lap timer.
- 10th seconds indicated.
- Lap timer.

4 ONLY Video Recorders
Second-hand, good order, B&W. **\$199.**

NEW!

THE ADS-381 FROM MONO-SOUND TO STEREO-SOUND

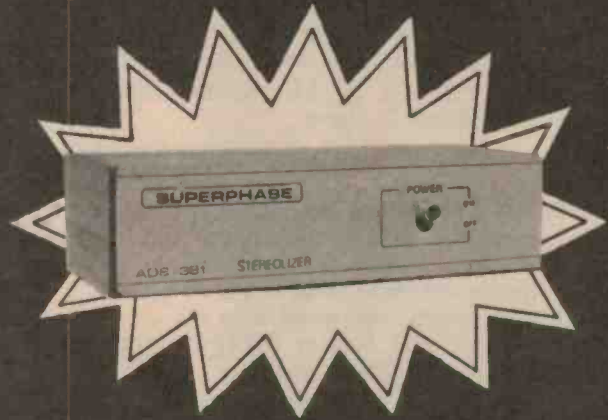

THE SUPERPHASE ADS-381 STEREOLIZER — MAKES YOUR TV STEREO-SONIC

- The ADS-381 Stereolizer is a new audio product specially engineered to create stereophonic sound from mono music source.
- It brings your TV and AM radio from Mono to Stereo Effect.
- It adds new enjoyment.

\$29 BULK BUYING MEANS LOWER PRICES
incl postage 9V battery not included
TRADE ENQUIRIES WELCOME



Import Agents

XENON WORLD IMPORTS

Box 33, WARRADALE,
SOUTH AUST. 5046.
PHONE 296-1033.

PLEASE PRINT ORDERS HERE

Quantity	Model Type	Description	Price	P&P	Amount

TOTAL SUM

NAME (please print)

ADDRESS P/CODE

I enclose \$ (Cheque, Money Order) CARDHOLDERS SIGNATURE

Charge my Bankcard
Bankcard No:

<input type="text"/>	<input type="text"/>	<input type="text"/>	<input type="text"/>	<input type="text"/>	<input type="text"/>	<input type="text"/>	<input type="text"/>	<input type="text"/>	<input type="text"/>
----------------------	----------------------	----------------------	----------------------	----------------------	----------------------	----------------------	----------------------	----------------------	----------------------

Exp. Date

VCT

Two prior articles on the VCT have appeared in ETI. The first of these was written by Ron Harris who reviewed the history of the VCT and briefly covered potential circuit applications. In the second, by the present author, the internal functioning of the VCT was examined. The purpose of this article is to describe the concept, design and performance of a "discrete" form of VCT which readers may build themselves. By J.E. Morris, Department of Physics, Victoria University of Wellington, New Zealand.

THE CIRCUIT SYMBOL of the voltage-current transactor (VCT) is shown in Fig. 1 with both voltage input and current output terminals floating. In the future it is expected that single chip VCTs (Ron Harris, ETI January 1977) will challenge the familiar op-amp as the universal linear circuit building block. At present, however, these have yet to emerge. In the meantime considerable familiarity with the VCT concept and with its circuit applications may be achieved by building a PCB version using readily available IC transistor arrays.

A single-ended VCT (C.A. Holt, "Electronic Circuits: Digital and Analog" p. 788) is shown in Fig. 2. The floating output version of Fig. 3 corresponds to the circuit discussed before (J.E. Morris, ETI August 1977). In both figures the unfamiliar symbols (boxes) are intended to represent current mirrors. Ideally, the output from the high impedance current source(s) exactly equals the input current into the low impedance terminal (arrow-head). VCT operation is based upon these current mirrors.

No attempt will be made here to duplicate the earlier explanation of circuit operation which is expected to be reasonable clear from the diagrams (Figs. 2 and 3) anyway). The essential point is that the differential input voltage $V_1 - V_2$ leads to an imbalance in the currents flowing in the two halves of the symmetrical circuit and that this imbalance is translated into a load current I_L . The load is driven by constant I_L current sources (high impedance) and the input impedance is high to minimise input signal loading. With the system of Fig. 3, load current is given by

$$I_L = \frac{2}{3} (V_1 - V_2) / R_{EXT}$$

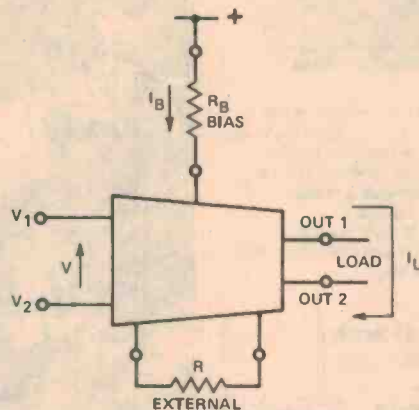

Fig. 1. VCT symbol and external connections.

up to the point where the bias current is exhausted, i.e. for $I_L < \frac{2}{3} I_B$.

Transistor arrays

The original intention of the project described here was to build the current mirrors using perfectly matched transistor arrays in miniature flat IC packages. These were to be mounted on an alumina substrate with printed thick

film interconnections in the circuit described in the earlier articles. As is often the case with electronics, however, the realities of the situation dictated a very different course.

In the first place both miniature package arrays and arrays of matched transistors were neither readily available nor acceptably priced! After some searching of the data books, we settled for the RCA arrays CA3084 and CA3086 on the basis of price and availability. (The pin diagrams for these are reproduced in Fig.4). Not all of the components in these packages are used; in particular, the Darlington transistor D in the CA3084 is not employed in the VCT circuit.

The first point to be determined was the effectiveness of these transistor arrays in current mirror circuits. No claim is made for transistor matching in the CA3086 other than the obvious one of thermal matching. In the CA3084, Q_3 and Q_4 are obviously organized as current mirror outputs and Q_1 , Q_2 are described as a matched pair. The specifications on Q_1 , Q_2 look

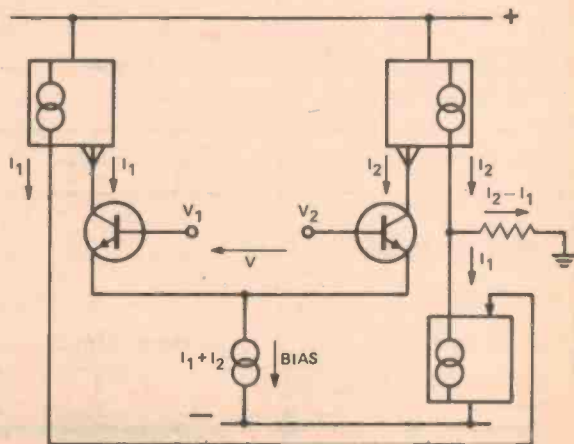

Fig. 2. Single-ended VCT (e.g. CA3080 operational trans-conductance amplifier).

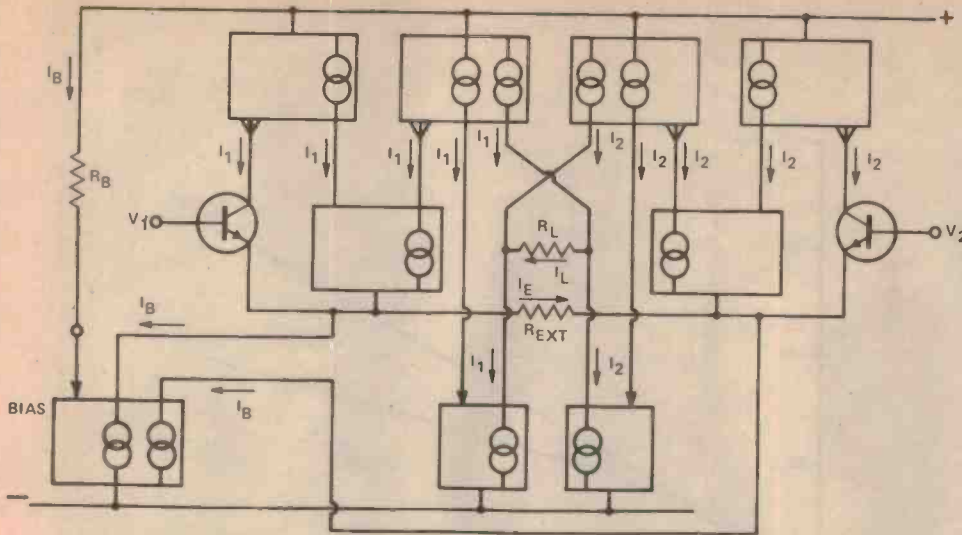

Fig. 3. VCT with floating input.

$$I_L = I_1 - I_2$$

$$I_E = 3I_1 - I_B$$

$$I_E = (V_1 - V_2)/R_{EXT}$$

$$I_E = I_B - 3I_2$$

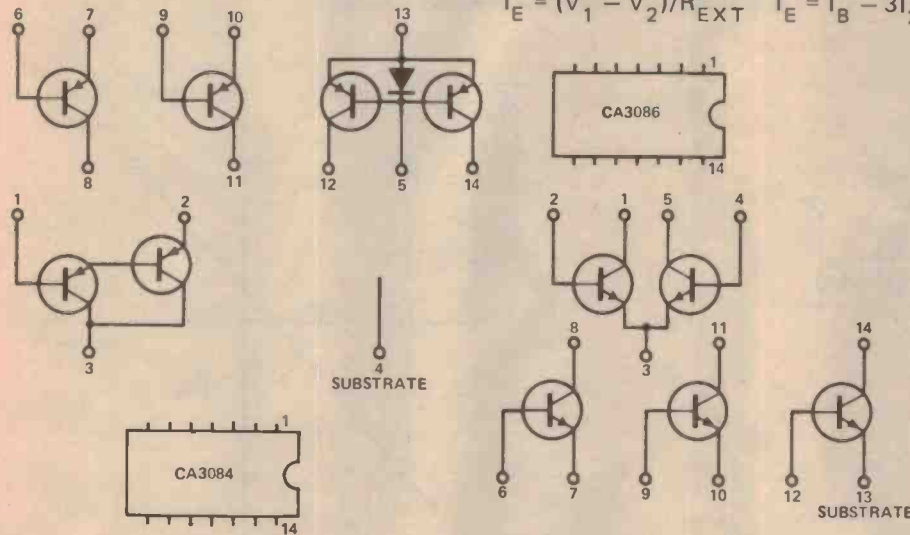

$$I_{12}, I_{14} = I_{13} \pm 15\%$$

$$I_{12} = I_{14} \pm 10\%$$

$$Q_1, Q_2: \text{ for } I_7 = I_{10}, V_{BE1} = V_{BE2} \pm 6 \text{ mV}$$

(all specs at $I_C = 100 \mu\text{A}$).

Fig. 4. IC transistor arrays - pin connections and CA3084 specifications. (S - substrate connection to most negative point).

impressive and those of Q_3, Q_4 seem rather inadequate (Fig. 4) but in fact for current mirror applications the reverse is true in both cases. To put these specifications into perspective, consider two similar base-emitter junctions where $I_{E1} = I_{S1} \exp(e V_{EB1}/kT)$ and $I_{E2} = I_{S2} \exp(e V_{EB2}/kT)$. Suppose these two junctions may be regarded as extremely well matched e.g. to $\pm 1 \text{ mV}$ in V_{BE} carrying identical currents I_E . Substitution above leads to

$$I_E = I_{S1} \exp(eV_{EB}/kT)$$

$$= I_{S2} \exp(eV_{EB}/kT) \exp(e^{-3}/kT)$$

and if equal V_{EB} 's are now specified for the current mirror application

$$I_{E2} = I_{S2} \exp(eV_{EB}/kT)$$

$$= I_{S1} \exp(-e \cdot 10^{-3}/kT)$$

$$\exp(eV_{EB}/kT)$$

$$= I_{E1} \exp(-e \cdot 10^{-3}/kT)$$

At room temperature, $kT = 1/40 \text{ eV}$ and $I_{E2} = 0.96 I_{E1}$. So a $\pm 1 \text{ mV}$ matching in V_{BE} leads to a 4-5% error in a current mirror application. In this light, $Q_3 - Q_4$ seem to be reasonably matched for the purpose and $Q_1 - Q_2$ less so.

Clearly, the point is best resolved by direct measurement of current mirror performance using the arrays themselves.

Current mirrors

As a first step, the transistors were checked for matching. For the CA3086, all transistors (except possibly the substrate transistor Q_5 whose measure-

ments were later deemed to be suspect) were matched to within a 12 mV spread for a given current up to 500 μA . This figure reduces to a low 1 mV range at 1 mA and increases again with increasing current to about 9 mV at 10 mA. (All measurements at $V_{CE} = 3 \text{ V}$.) It is only possible to measure terminal characteristics of Q_1 and Q_2 in the CA3084 and from 10 μA to 10 mA, V_{BE} values were matched to within 1 mV.

The performance of the CA3084 current mirror is shown in Fig. 5 and that of a more complex system in Fig. 6. Clearly, the extra components of the more complicated circuit (which are all subject to variations from the nominal device parameters), lead to increased discrepancies in the output current. On the other hand, the simple circuit, (as found within the CA3084 chip, for example,) provides output matching within specification although the absolute level is lower than expected.

With the CA3086 a slightly different measurement technique was employed (Figs. 7 and 8) where transistor gain

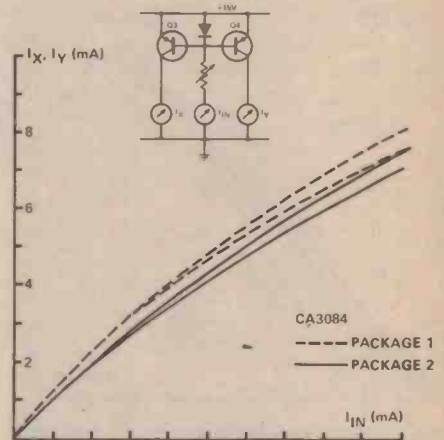

Fig. 5. Elementary current mirror - output matching test.

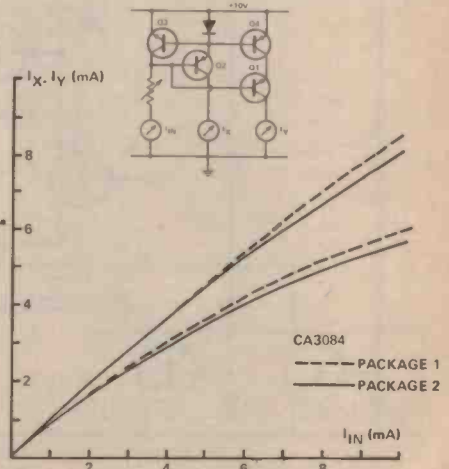

Fig. 6. Complex current mirror - output matching test.

VCT

was permitted to vary with V_{CE} . This accounts for the curvatures of the output characteristics in Fig. 7. In Fig. 8, the performance of the more complex system is seen to be clearly inadequate. (The transistors in these two diagrams with base and collector shorted together function as diodes, as does Q_4 in Fig. 6).

The results of this section led immediately to the decision to use only the basic type of current mirror. Both types were examined in the earlier article (ETI August, 1977) and the more complicated form is used in the prototype single chip VCT. The advantage of the complex circuit is that it performs better with low gain transistors but the typical h_{FE} figures of 100 and 40 (for the CA3086 and CA3084 respectively) are expected to be adequate. The problem with the system being developed here is that of poor matching and an

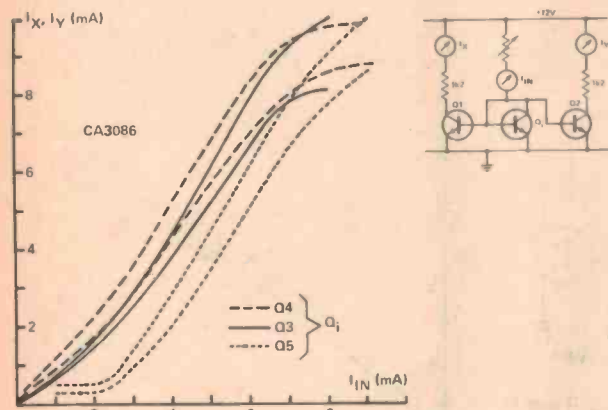

Fig. 7. Elementary current mirror - transistor matching.

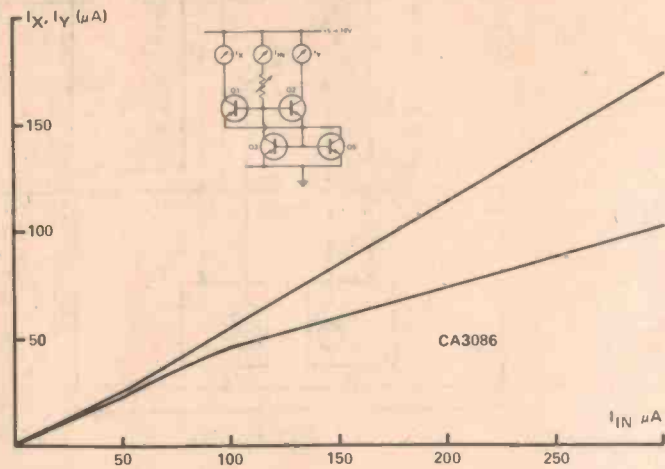

Fig. 8. Complex current mirror - output matching.

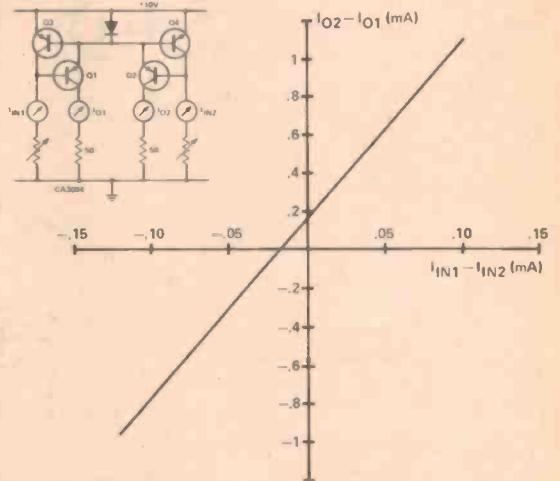

Fig. 10. Effect of linking current mirrors within the VCT.

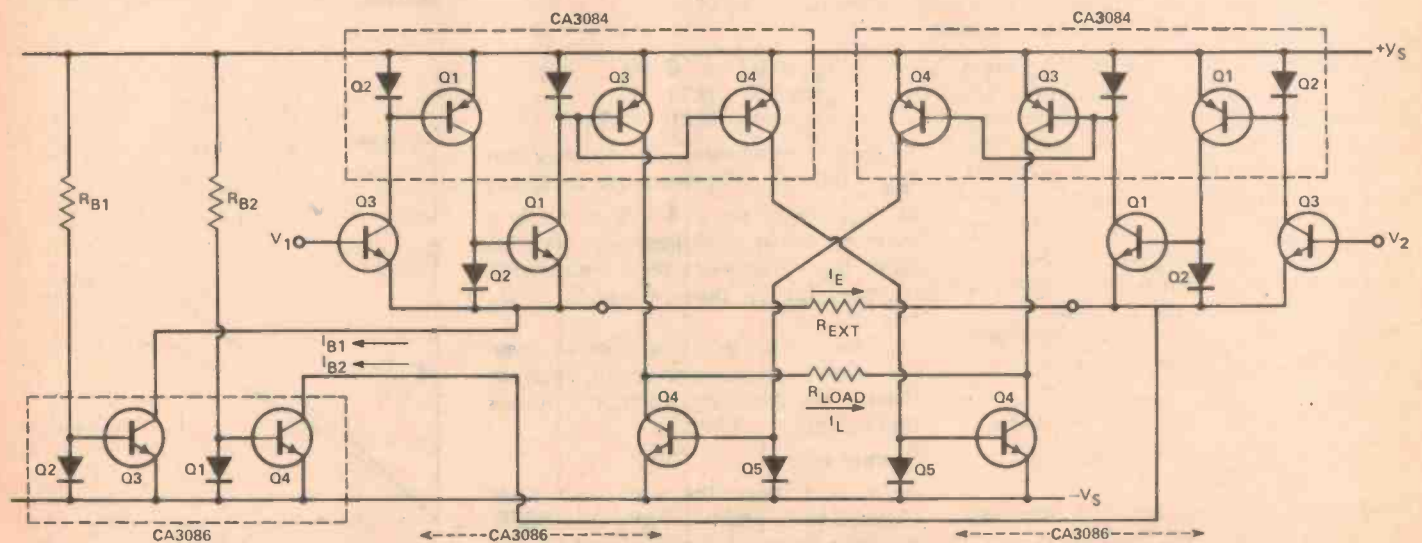

Fig. 9. Simplified VCT design employing IC transistor arrays.

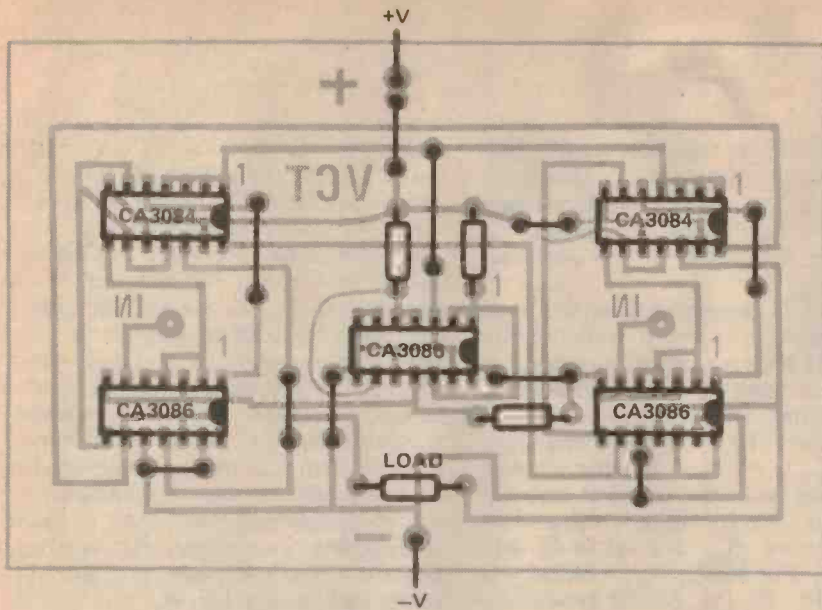

Fig. 11. PCB layout, showing external components, wire links, etc. - view from component side.

elementary worst case analysis demonstrates the superiority of a minimal component count.

Discrete VCT

The actual circuit employed is shown in Fig. 9 and differs markedly from the one discussed in the earlier articles. In the first place, the simple current mirror has been used throughout for reasons given above. Second, there is obviously no opportunity to provide current gain by utilising multiple emitter transistors since these are not provided in the arrays. (This is no disadvantage for the purpose of a familiarisation exercise.) The third discrepancy is apparent by comparison of Fig. 9 with Fig. 3. In recognition of device parameter variations and the asymmetry which these will necessarily cause, the bias circuit has been split into two independent sources. In effect, this provides both bias and offset capabilities. Usually one would employ Darlington's as the input transistors. This step would require an extra CA3086 and has been omitted.

A fifth difference lies with the elimination of any link between the input circuit current mirrors of the two sides. The circuit described in previous articles uses the complex current mirror with diodes shared between the two sides of the VCT. This set-up has been simulated (Fig. 10) and found to be ineffective as a means of compensating for bias imbalance between the two sides. If I_{IN2} is increased,

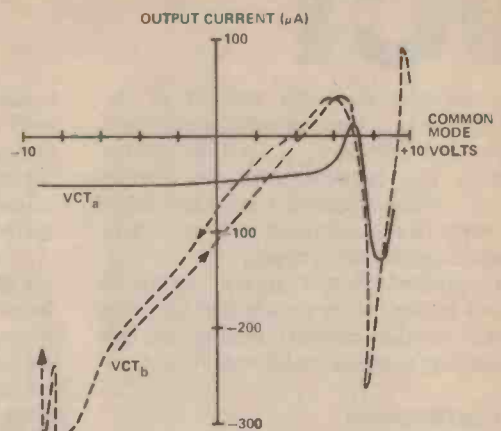

$R_{EXT} = 1k$
 VCTa: $R_{B1} = 4k, R_{B2} = 5k2$
 VCTb: $R_{B1} = 4k, R_{B2} = 5k5$

Fig. 12. Common mode signal transfer ($V1 = V2$).

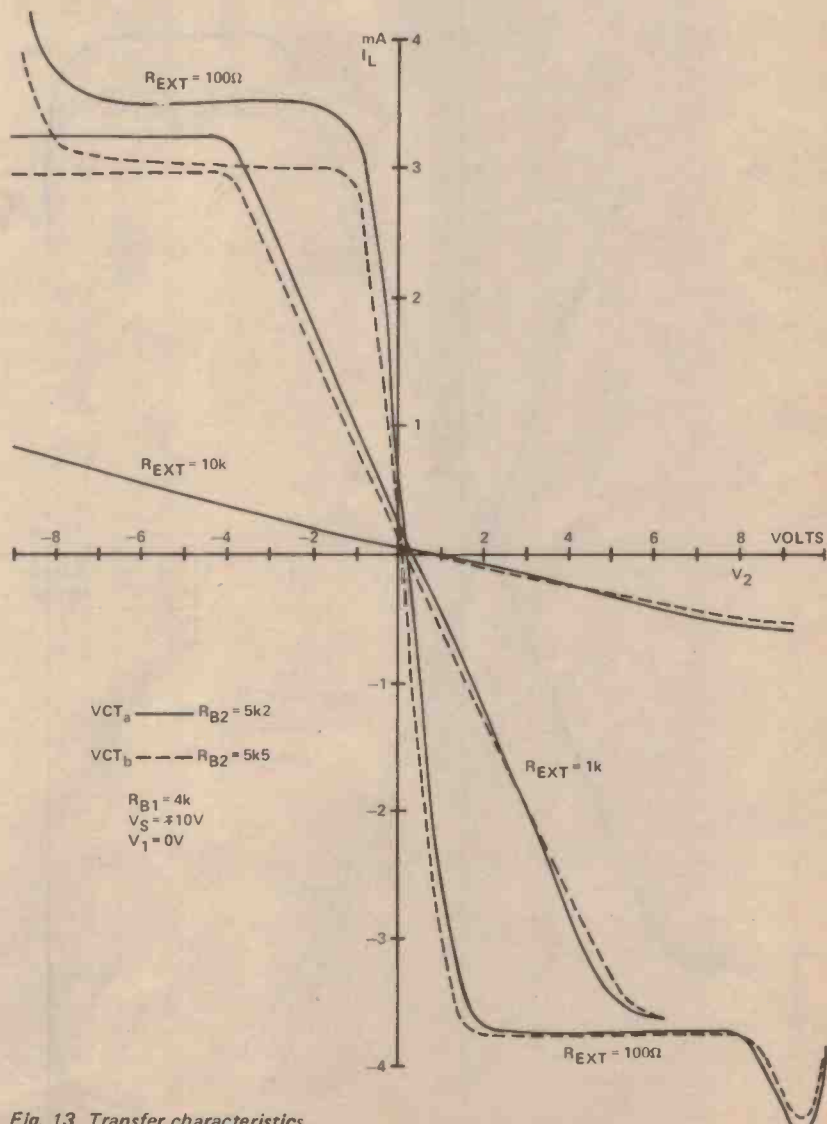

VCT_a — $R_{B2} = 5k2$
 VCT_b - - - $R_{B2} = 5k5$
 $R_{B1} = 4k$
 $V_S = \pm 10V$
 $V_1 = 0V$

Fig. 13. Transfer characteristics.

VCT

for example, the base current of Q_2 and hence I_{O2} increase with a compensating decrease in I_{O1} . A link of this type is not possible with the simple mirror system adopted here, but would not have been employed with the more complicated circuit anyway.

A printed circuit board layout is shown in Fig. 11. No claim is made with regard to the optimal quality of this layout but it seems satisfactory.

VCT performance

It is not the function of this article to present an exhaustive survey of the circuit's performance in varied applications. Many of these have been proposed elsewhere (ETI, January 1977) and the

reader is left to try these individually with his own discrete VCT. There are, however a few pitfalls which warrant further discussion. Most of these may be classed as limitations of the non-ideal system.

Two VCTs were constructed and these are identified as 'a' and 'b' from here on. In general, they performed similarly, but there were some significant differences. Unless stated otherwise, below, supply voltages of ± 10 volts were employed with $R_{EXT} = 1k$ and only current monitoring as loads. The first test was to establish bias current levels to achieve a null output. R_{B1} was set to $4k$ with each unit. For VCTa, $R_{B2} = 5k212$ and for VCTb, $R_{B2} = 5k552$ established

zero output currents for $V_1 = V_2 = 0V$. Drifts (of the order of $1 \mu A$ for VCTa and $40 \mu A$ for VCTb) were noted over the next few minutes and R_{B2} was finally set to $5k2$ for VCTa and $5k6$ for VCTb. In the test for common mode rejection (Fig. 12) the residual offset and the magnitude of short term drift effects are apparent; (output levels must significantly exceed these drifts). As the supply voltages are approached, transistors begin to cut off and this may in turn lead to unpredictable effects depending on the relative parameters of the various devices. The lesson to avoid approaching the supply rails is clear. While the common-mode rejection ratio seems satisfactory for VCTa (Fig. 12), the curve for VCTb clearly indicates an asymmetry in the circuit, i.e. there is at least one transistor mismatched to its counterpart on the other side; (this mismatch is most likely in a variation of gain with VCE).

Fig. 13 shows the standard transfer characteristics. The slight variations in slope are due to R_{EXT} tolerances and the measured values (VCTa: $1mA/12V$ and $6ma/7.75V$ for $R_{EXT} = 10K, 1K$) exceed expectation slightly (c.f. $1mA/15V, 6ma/9V$) due to a small current gain caused by transistor mismatching. This effect also leads to small discrepancies from the expected current limit levels (e.g. $\frac{2}{3} \times 20V/4K$ and $\frac{2}{3} \times 20V/5K2$).

The results described in the preceding paragraph were obtained with one input grounded as a matter of convenience. There is a dramatic shift in the offset current when one end of the load is also grounded (Fig. 14) and when both these fixed points are switched to the other side of the VCT. It would seem that the concept of 'floating' input and output require re-examination.

It must be noted that while one might expect the two ends of the floating load to sit at approximately zero volts, it does not take a great deal of device variation to produce extreme deviations from this. In both the circuits built here, two output transistors (Q_4, Q_5 of CA3086, see Fig. 9) were saturated at null output. (With different selection of devices, saturation of CA3084 Q_3 and Q_4 is equally likely). This creates

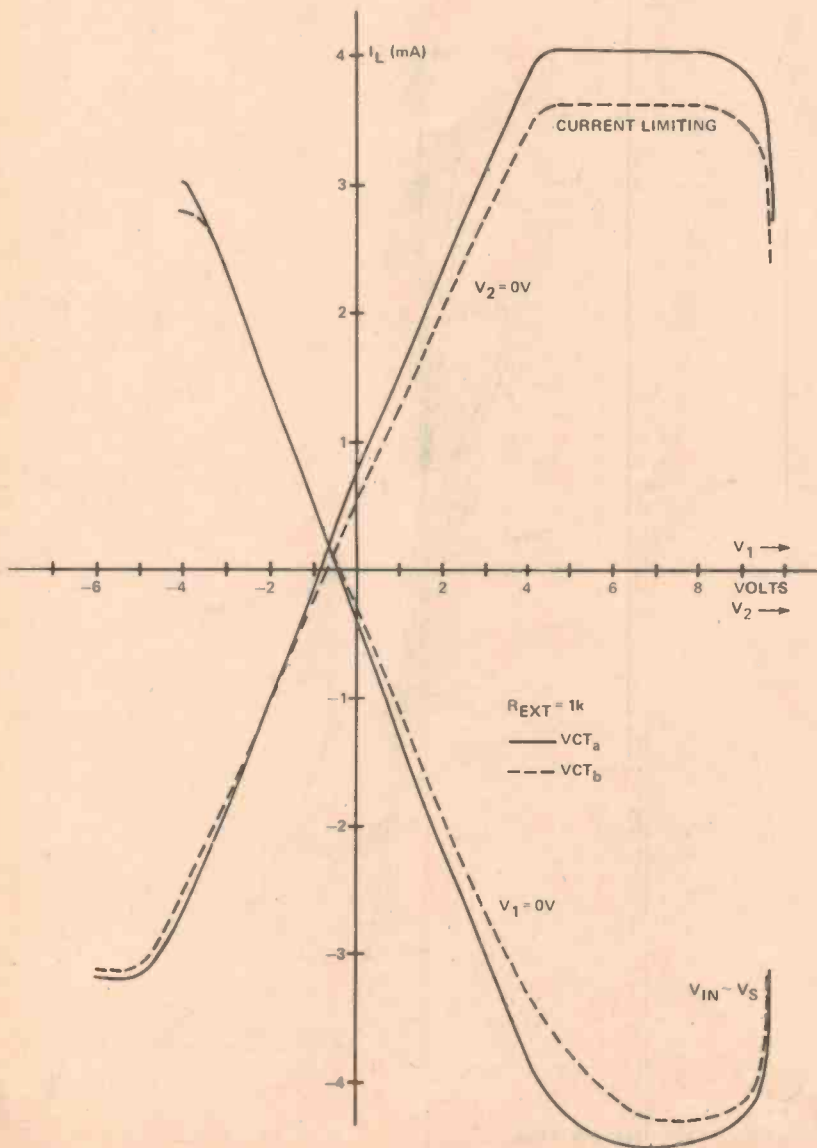

Fig. 14. Transfer characteristics with one end of the load grounded and with corresponding input grounded.

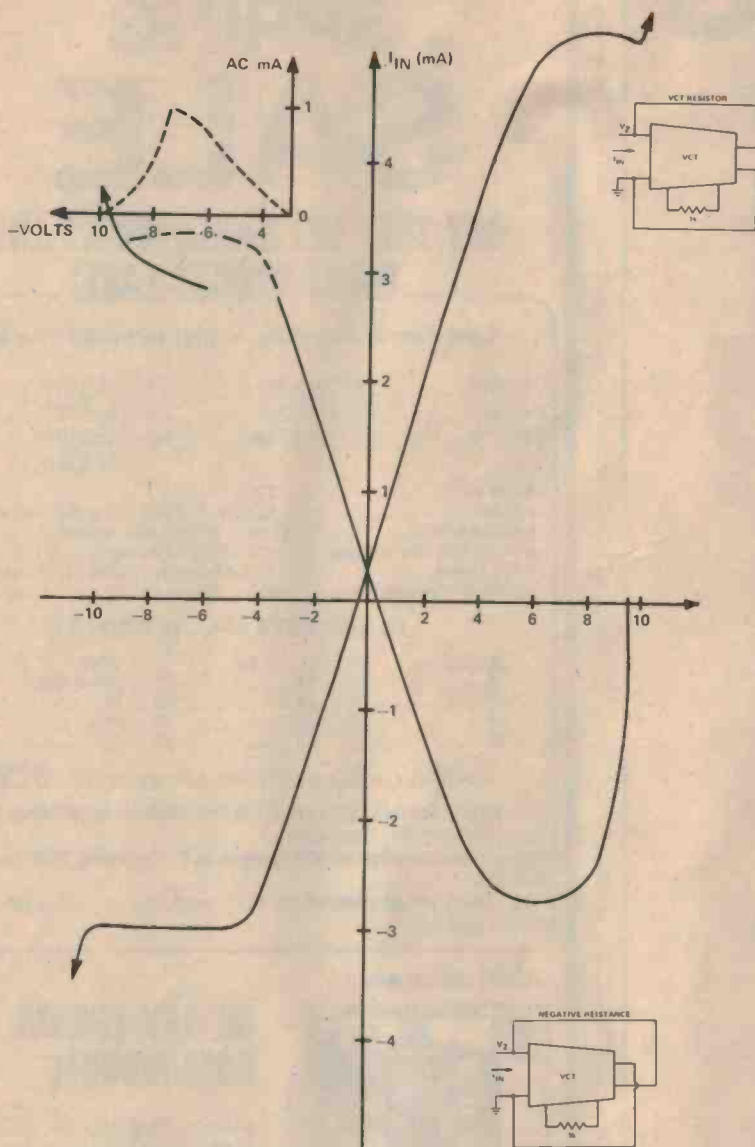

Fig. 16. VCT 'resistors' - positive and negative.

no problems for the floating load unit high frequency or switching applications where performance will be down-graded by transistor saturation. It does, however, mean that the output must be rezeroed if either end of the load is to be tied to a fixed potential as in Fig. 14.

The four constant current sources which comprise the output circuitry lead inevitably to saturation as soon as there is an imbalance between them. In many cases zeroing the output current aggravates the problem. If device selec-

tion is contemplated, these are the transistors to consider first.

Variation of load current with load impedance (Fig. 15) suggests that the output impedance is about 40K, substantially below the 60-100 K Ω range expected from the transistor specifications because of saturation. The differential small signal input resistance has been measured at about 35K which is approximately $h_{FE} R_{EXT}$. This figure would be increased by the use of Darlington input transistors.

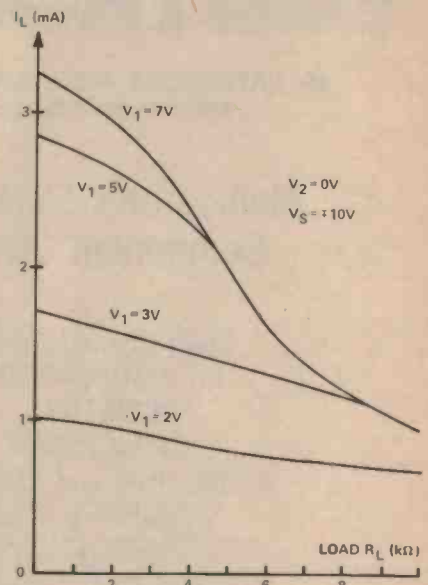

Fig. 15. Effect of output load resistance.

Up until this stage, none of the more exotic circuit applications has been discussed. A few remarks should be made, however, in closing. Ideally the output is a constant current and can be used to linearly charge a capacitor, e.g. to provide integration. The constant current sourcing is not perfect however and integrating applications will be limited to frequencies greater than $(2\pi R_{OUT}C)^{-1}$. A similar limitation will exist for gyrator performance.

A gyrator was built with the two VCTs but oscillated. The oscillation is believed to originate, however, with the use of inadequate power supplies - another point to note in investigating these circuits - rather than with that circuit itself. Gyrators operate on a negative impedance conversion principle so it is instructive to consider the resistance applications of the VCT in Fig. 16 where the terminal resistances are expected to be $\pm \frac{3}{2} R_{EXT}$. In the negative resistance case an oscillation region was identified (see inset). If the negative resistance circuit is examined, it clearly provides positive feedback if the driving source (V_2) impedance is not zero.

In closing I wish to acknowledge the assistance of Jock Howie and others with this project.

ELLISTRONICS

289 LATROBE ST, MELBOURNE, 3000
PHONE (03) 602-3282

Melbourne's Electronic
Component Centre

- SEMI-CONDUCTORS
- POTENTIOMETERS
- RESISTORS
- CAPACITORS
- ALUMINIUM and PLASTIC
- PROJECT BOXES
- INSTRUMENT CASES
- PROJECT KIT BOARDS
- TEST EQUIPMENT
- VERO BOARD
- BLOB BOARD
- TRANSFORMERS
- KNOBS, WIRE and CABLES
- STICKERS
- TURNTABLES
- RADIO/TV ANTENNAE
- CB RADIO
- HAM RADIO and ACCESSORIES
- BATTERIES
- EZ HOOKS
- HEAT SINKS
- SWITCHES (C&K etc.)
- TECHNICAL BOOKS
- CANNON PLUGS & SOCKETS
- EDGE CONNECTORS

In fact just about everything electronic. All by leading manufacturers and fully guaranteed. We will not be undersold by any retailer on components stocked in our store. The next time you are in town be sure to visit our store and check our low, low prices.

Short form catalogue now available —
send 30c stamp

ELLISTRONICS

FOR THE BEST VALUE IN
ELECTRONIC COMPONENTS

SEMCON MICROCOMPUTERS
PTY. LTD.

SPRING SALE

**OUT THEY GO! RIDICULOUSLY LOW!
WHILE STOCKS LAST!**

Low Power Schottky — just to mention a few.

74LS02	25	74LS20	27	74LS161	87
74LS04	27	74LS30	27	74LS163	87
74LS10	27	74LS160	87	74LS190	99
				74LS368	63

- Z80 4MHz\$29
- 8080A\$10
- 6820/6520-PIA\$7.50
- 11C90-650 MHz prescaler\$10
- 555 Timers25c
- CRT5027 Controller Chip\$30
- CG5004L-1 Character Gen with on chip shift register.....\$19
- Edge Connectors to fit D2 Evaluation Boards; 43 x 2 way \$7, 25 x 2 way\$3.50

IC SOCKETS — LOW PROFILE

SOLDER	DIL — TIN		WIRE
8	22	32	WRAP GOLD
14	25	40	24
18	25	45	14
18	30	40	16
			65

ONE ONLY — Motorola D2 Kit, built and tested **\$250**

AND MORE! For information call (02) 848-0800 or visit our showroom at No. 1 Chivers Rd, Thornleigh.

For your convenience we will be open on Sat. morning, 14th and 21st October.

Mail Orders will be accepted for our Spring Sale — money refunded if stocks sold out.

ALSO AVAILABLE:

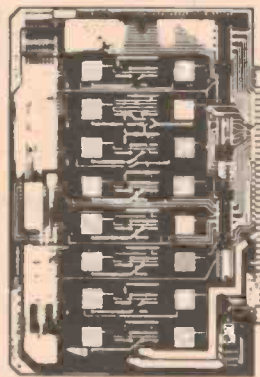

8K-16K EPROM ROM MODULE

- Accepts up to 16 2708's
- -5V generated on card
- Motorola Bus

\$135

(This is a built board, however it does not include EPROMS. 2708's; 1-8 \$14.50, 9-16 \$13.50).

- 4K x 4 Static RAMS 250 nS, \$12.50.
- 7205 Intersil CMOS Stopwatch Timer Chip (just add 7 seg. LEDS, crystal & a few switches for a digital stopwatch) \$15.00.
- 7107 Intersil DVM Chip, \$15.00.
- 8K Byte Static Memory Card, \$275 assembled, \$219 kit, \$298 assembled with Parity, \$110 for kit without RAMS.
- Card Cage/Backplane, \$74 — with 8 edge connectors, \$133.

Please add 15 percent S/T to all prices.

SHOWROOM: 1 Chivers Rd, Thornleigh, NSW. 2120.

MAIL ORDER: PO Box 61, Pennant Hills, NSW. 2120.

PHONE: 848-0800. Add 15 percent S/T. P&P \$1.50. Goods valued over \$100 will be sent by courier, standard charges for freight and insurance; Syd. metro — \$2.50, NSW country & interstate — \$7.00.

LISTEN HERE . . .

THE NEW YAESU FRG-7000 RECEIVER IS DESIGNED WITH THE REAL SWL IN MIND!

When you're through playing games with those 'toy' receivers, try the Yaesu FRG-7000. It's got the lot - full HF band coverage (0.25 - 29.9MHz) with provision for SSB, AM and CW reception. The world-renowned 'Wadley Loop' circuitry holds the receiver rock-steady. Virtually no drift - what every SWL needs to copy those hard-to-get stations. We could go on and on about the magnificent FRG-7000: but have a look for yourself. Call in today - and dream a little!

Terms available to approved applicants

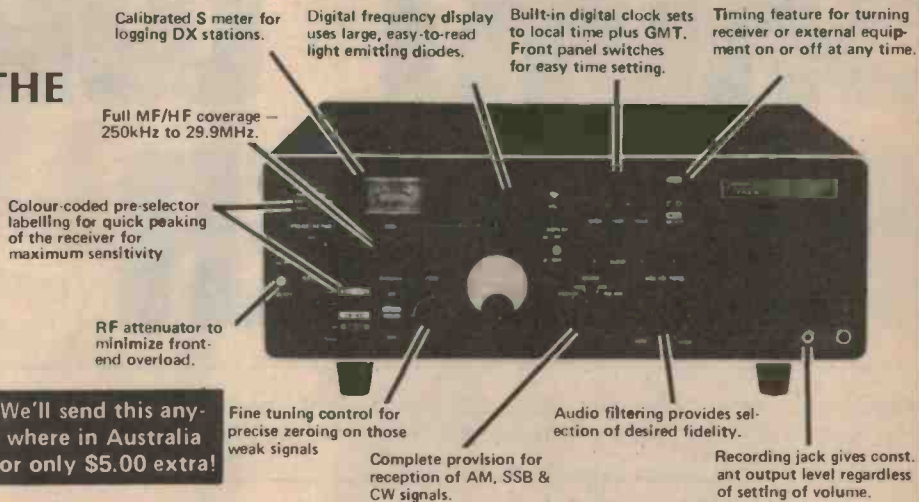

COUNTRY CUSTOMERS: Take advantage of our special 7-day inspection offer. If you're not completely happy with the FRG-7000, return it within 7 days in original condition and packaging and we'll refund the purchase price. What could be fairer than that?

\$695⁰⁰
Cat D-2848

Test-drive the FRG-7000 SOON!

CHAMPAGNE TASTES & BEER WAGES?



TRY THE YAESU FRG-7

\$395⁰⁰

Cat D-2850

If you still want outstanding performance, but you are not ready for the FRG-7000, try the little brother - the FRG-7. Same up-to-the-minute Wadley Loop circuitry, same incredible performance, but without the 'frills' such as the digital frequency display, digital clock, timer, tone control . . . but it is still delightful to use. The Yaesu FRG-7 - a REAL receiver!

TERMS AVAILABLE (to approved applicants - personal shoppers only).

EXCLUSIVE!

With every FRG-7 from Dick Smith or dealers, you receive this exclusive 6 page guide to short wave listening - written by Arthur Cushen, MBE - world famous short-wave correspondent and broadcaster.

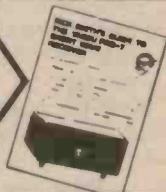

Take advantage of our special 'Comet Freight' offer: We'll send either receiver anywhere in Australia for only \$5.00 extra! (Normally costs much more!)

NOW An economy SWL's antenna system

Designed specifically for Dick by a short-wave expert, this antenna kit needs no soldering, is complete and ready to assemble and has full instructions. Get the most out of your receiver with a good antenna.

**NO
SOLDERING!**

IDEAL FOR USE
WITH EITHER
THE FRG-7000
OR THE FRG-7!

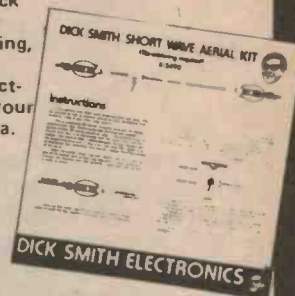

\$9⁵⁰

Cat K-3490

STOP PRESS: Announcing the winner of our 'Win a Trip for Two to Tokyo' contest:

Mr Ray Jessup, of Turramurra NSW.

DICK SMITH ELECTRONICS

SYDNEY 125 York Street, SYDNEY. Ph. 29 1126
147 Hume Hwy, CHULLORA. Ph. 642-8922
162 Pacific Hwy, GORE HILL. Ph. 439-5311
30 Grose Street, PARRAMATTA. Ph. 683-1133

MELBOURNE 399 Lonsdale Street, MELBOURNE. Ph. 67 9834
656 Bridge Road, RICHMOND. Ph. 42 1614
BRISBANE 166 Logan Road, BURANDA. Ph. 391 6233
ADELAIDE 203 Wright Street, ADELAIDE. Ph. 212 1962



SHOPS OPEN 9AM to 5:30PM
(Saturday 9AM - 12 noon)
BRISBANE 12 Hour service

ANY TERMS OFFERED ARE TO APPROVED APPLICANTS ONLY

Many lines available from the Dick Smith Electronics Centres at

GRACE BROS

Broadway - Bunnings - Chatswood - Liverpool - Newcastle - Mt Druitt - Parramatta - Roselands and Warringah Mall



MAIL ORDERS P.O. Box 747, Crows Nest, N.S.W. 2065. Post and packing extra

Dealers across Australia.

SHORT WAVE RECEIVER

Maybe you can't afford a super-radio like some of those mentioned in our other SW Radio article this month, but we've got the answer. . .

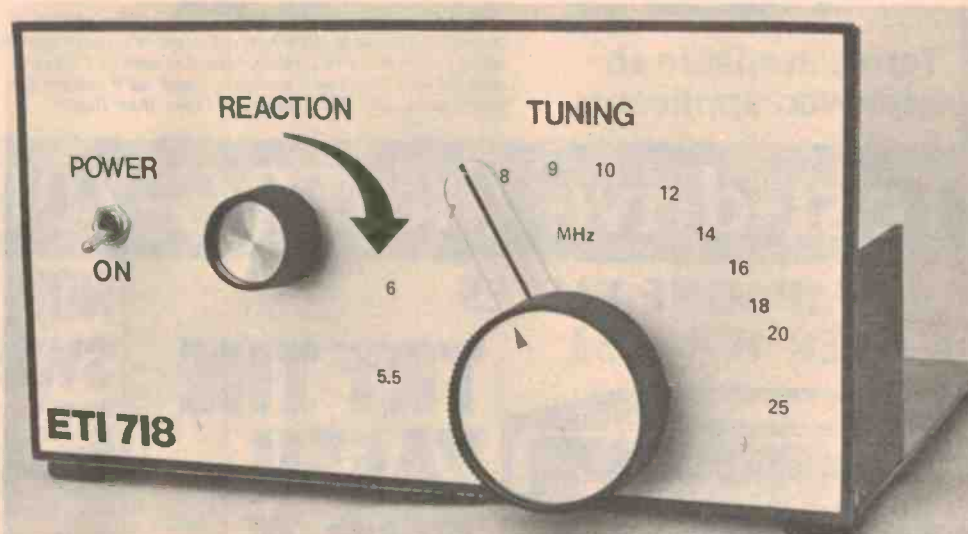

APART FROM THE very early sets, which were based upon coherers and other devices you never hear of today, the first radios were very straightforward designs totally unlike today's sophisticated superhets. The early Tuned Radio Frequency (TRF) sets were simply a tuning circuit with some gain and a detector circuit, but later designs used positive feedback, in the form of reaction, to increase the performance. It is still possible to get a lot of fun from sets of this type.

By using modern solid state components a very simple reaction set can be built which offers surprisingly good performance at low cost. The Field Effect Transistor has almost identical performance to the earlier valve and is the basis of this design.

The circuit of fig. 1 uses an MPF 131 dual gate MOSFET as a regenerative detector, followed by a BC548 audio amplifier stage which is capable of

driving a crystal ear piece, high impedance head phones, or being fed to the input of an amplifier. The frequency coverage is approximately 5.5 to 25 MHz, or 54 to 12 meters.

This coverage includes many interesting features such as the international broadcast bands at 49, 31, 25, 19, 16, and 13 metres, as well as amateur bands at 40, 20, and 15 metres.

Operation

Satisfactory operation depends on the proper use of regeneration, which unless operated correctly will result in poor performance and interference to neighbouring sets.

Initially, set C1 about half closed and increase the regeneration until a point can be found where signals are heard when tuning. Increasing the regeneration will increase the volume, until a point is reached where a whistle is heard when

tuning across a station. The most sensitive point is where this whistle just fails to arise.

Regeneration has to be adjusted in conjunction with the tuning, because the setting of RV1 will change as the set is tuned across the band. The tapping position of the coil also influences regeneration, and may have to be lowered to obtain correct operation on some frequencies. The tapping point found to give the best results will also depend on the length of antenna used. As a starting point, try the middle tap and then move the tapping point up or down the coil to give the strongest signals, while still able to achieve regeneration.

Reception of CW signals is possible by using the regeneration control so the set is just oscillating, while the tuning gang is set so that a beat note is heard. This can also be done for SSB signals but the tuning will be very critical.

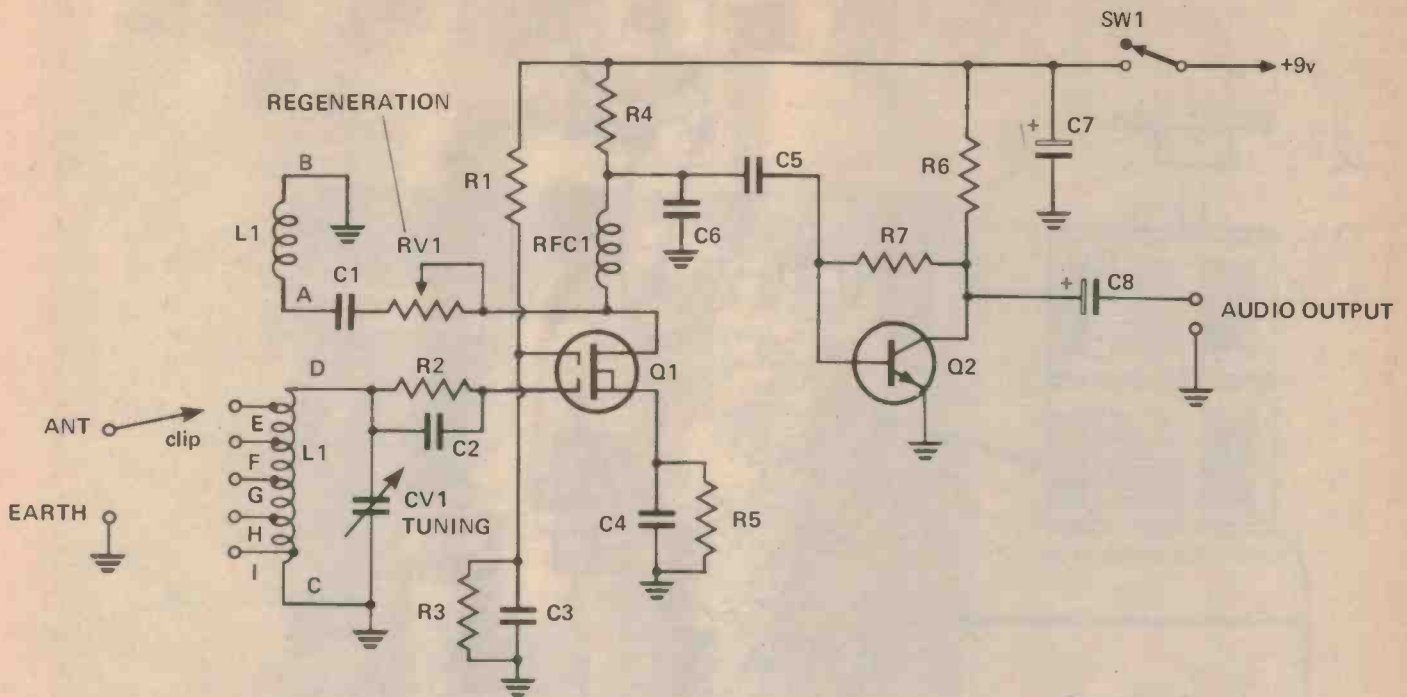

Fig. 1. Circuit diagram of the receiver.

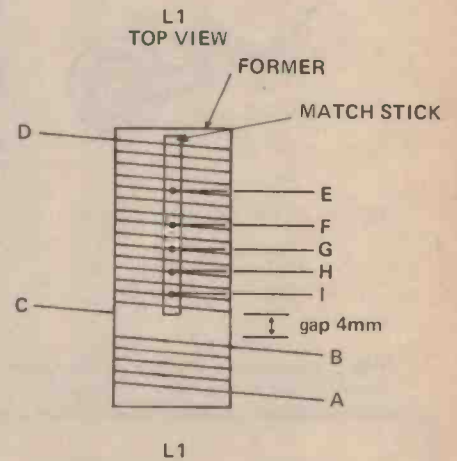
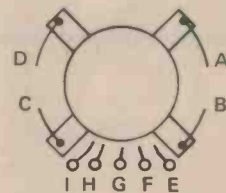

Table 1 - Coil Winding Details

Reaction coil: 4 turns of 24 B & S enamelled wire, closewound at the base of the former in a clockwise direction.

Tuning coil: 15 turns of 24 B & S enamelled wire, closewound, starting 4 mm above the top of the reaction winding in a clockwise direction. Taps at 2,4,6,8 and 11 turns from the bottom of the winding. Turns which are tapped are raised over a matchstick.

HOW IT WORKS - ETI 718

Signals from the antenna are coupled into the tuned circuit (L1, CV1) via the clip lead and the coil taps. The tapping point is varied to give the best match from the antenna to the circuit, yielding the best performance.

The tuned circuit acts as a filter, only letting the desired frequency through to the FET (Q1), since the tuned circuit resonates at a frequency set by the position of the variable capacitor, (CV1). As the value of the capacitor is varied, so the resonant frequency of the tuned circuit, and the frequency of reception, is varied.

The radio frequency signal at the desired frequency is then fed to the FET (Q1), where it is amplified and appears at the drain. Because the radio frequency choke (RFC1) presents a high impedance (or near open circuit) to radio frequencies the signal passes through C1 and RV1 to the regeneration coil wound on L1. Some of this signal, the amount determined by the setting of RV1, is coupled back to the tuned circuit.

For regeneration to occur, the signal fed back to the input must be the same polarity or 'phase' as the incoming signal.

A phase reversal occurs in the FET, so a second phase reversal is necessary. This is achieved by connecting the feedback to the reaction coil upside down (i.e. to the bottom of the winding, and the earth to the top). In this condition of positive feedback the circuit can be made to oscillate.

The feedback signal now passes through the tuned circuit again to the FET, although this time it is 'detected' before it is amplified once more. Detection recovers the audio information from the signal before audio amplification. The radio frequency choke looks like a short circuit to the low frequency audio signal which passes through it. It cannot however pass through resistor R4, but is coupled to the audio amplifier (Q2) via C5, where it is amplified before being fed to the output. Any unwanted RF signal which happens to get through the RF choke is shorted to earth by a small value capacitor (C6).

Maximum circuit gain, and therefore maximum audio output, occurs when the regeneration control is advanced so that the circuit is just not oscillating. This point also yields the best 'selectivity', or the ability to distinguish between close stations.

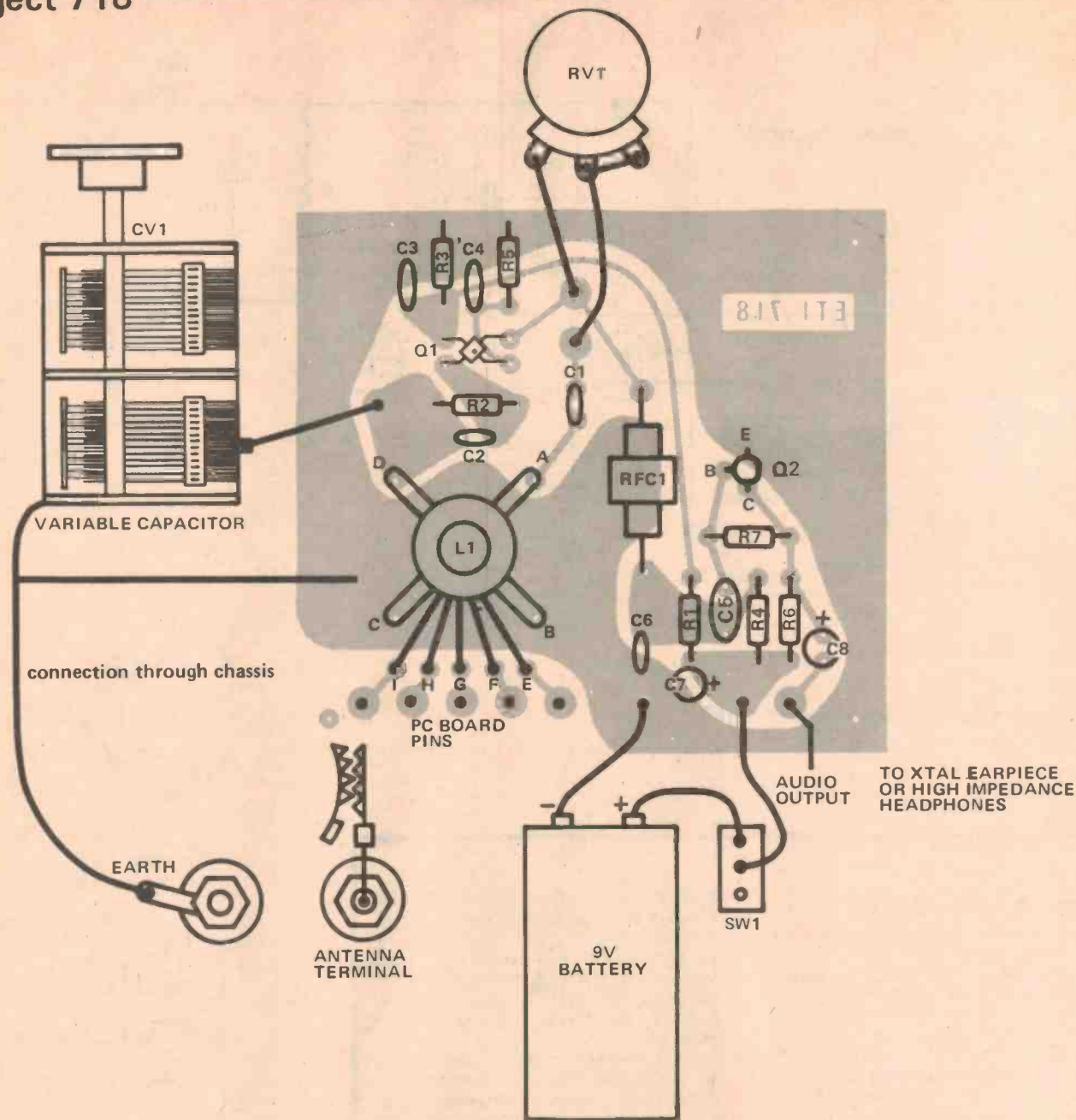

Fig. 2. Component overlay, as seen from the component side of the board. Note carefully the connections to the coil.

PARTS LIST – ETI 718

Resistors all 1/4 W, 5%

R1	4k7
R2	1M2
R3	10k
R4	2k2
R5	1k
R6	10k
R7	4M7

Potentiometer

RV1	2k lin pot
-----	------------

Capacitors

C1	10n ceramic
C2	270p ceramic
C3,4	100n ceramic
C5	100n greencap
C6	1n ceramic or greencap
C7	10µ tantalum 16VW
C8	4µ7electro 16VW

Variable Capacitor

CV1	415ptuning capacitor or similar (see text)
-----	--

Semiconductors

Q1	MPF131 dual gate MOSFET
Q2	BC548 or similar

Miscellaneous

pc board	ETI 718
pc board pins	
coil former	12 x 30 mm air cored Dick Smith Cat. No. L-1110
RFC1	2.5 mH RF choke Dick Smith Cat. No. L-1824
box to suit	(see text)
SPST on/off switch	
planetary drive, 5 to 1 reduction	
length of 24 B&S enamelled wire	
9 V battery and battery clip	
knobs, rubber feet, crystal earpiece or high impedance headphones, headphone socket	

Construction

All the components except the tuning capacitor are mounted on a printed circuit board, (see fig. 2). Other types of construction such as vero board can be used but may not offer the same repeatability of results. The coil (L1) is wound separately as in Table 1 and later mounted on the PC board. If the type of former in the parts list is used, the solder lugs on the former will line up with holes in the PC board and the former can then be held down onto the board by its connections. Short lengths of wire are used between the coil taps and the PC board. Printed circuit pins are then soldered into the tapping points and the tap changed by means of the alligator clip from the antenna terminal.

In our receiver we used one section of a second hand dual tuning gang. Most gangs from an old radio will do as long as only one section is used, the lowest frequency of operation depending on the value of capacitance.

The chassis is 175 by 90 mm and 140 mm deep, and is constructed entirely from single sided PC board (copper side inward). This method is both cheap and easy, the front panel being soldered onto the base plate. Squares of PC board are soldered into the ends for rigidity of the front panel.

A planetary drive mechanism is used with the tuning capacitor and is attached to the front panel with two nuts and bolts. A plastic cursor can be cut from a sheet of thin perspex and attached to the outside of the drive mechanism with Araldite to provide a dial pointer.

The regeneration potentiometer and the ON/OFF switch are also mounted on the front panel, with the antenna, earth and output connections mounted on a small piece of PC board at the rear. All wiring should be kept as short as possible, especially to the

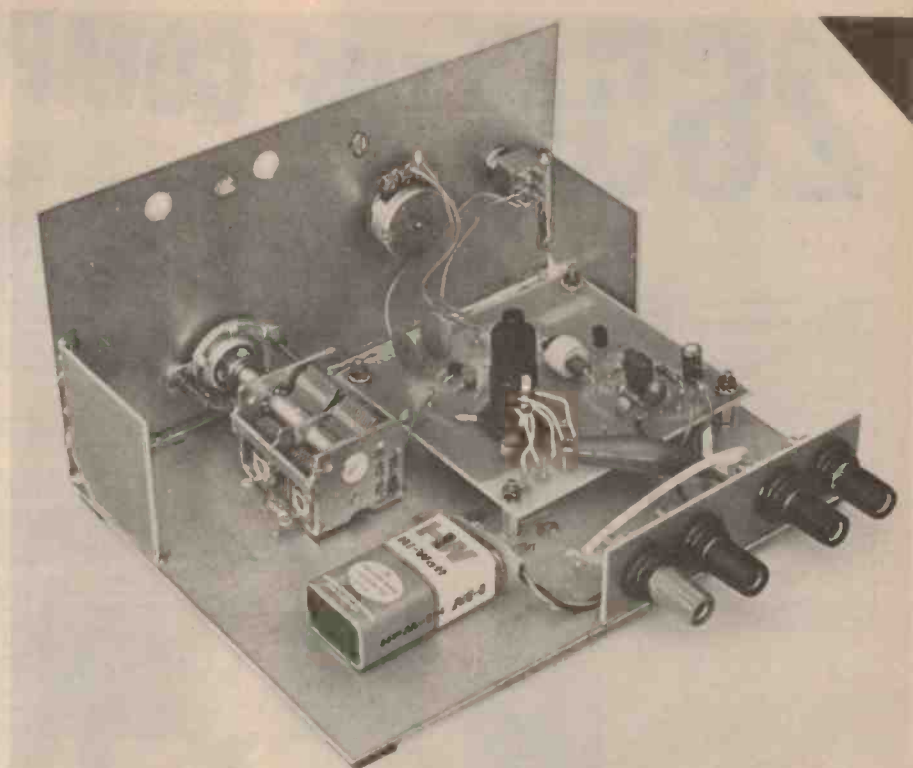

Rear view of the completed unit. We used one section of a dual gang tuning capacitor. The terminals from left to right are: Antenna, Earth, and the two output connections.

regeneration control and the tuning capacitor.

Antenna and Earth

Although some signals can be heard with a small indoor antenna, an outdoor antenna is much better. The antenna should be as long and as high as practicable, running perhaps from the house to a tall tree or other building. Figure 3 shows a typical antenna installation which will give good results. The lead-in from the antenna should be kept as short as possible, so a good position for the set would be close to a window.

An earth is not essential but is generally worthwhile, since it can help

to avoid the effects of hand capacity by grounding the metal chassis. The set can be earthed to a water pipe or run to a metal spike driven into the ground.

Performance

The number of short wave signals that can be heard depends upon the time of day, early morning, late afternoon and night being the best. After a few periods of listening at various times you will know what to expect. Using an indoor antenna we were able to receive strong signals throughout the day and the number of stations heard rapidly increased towards dark.

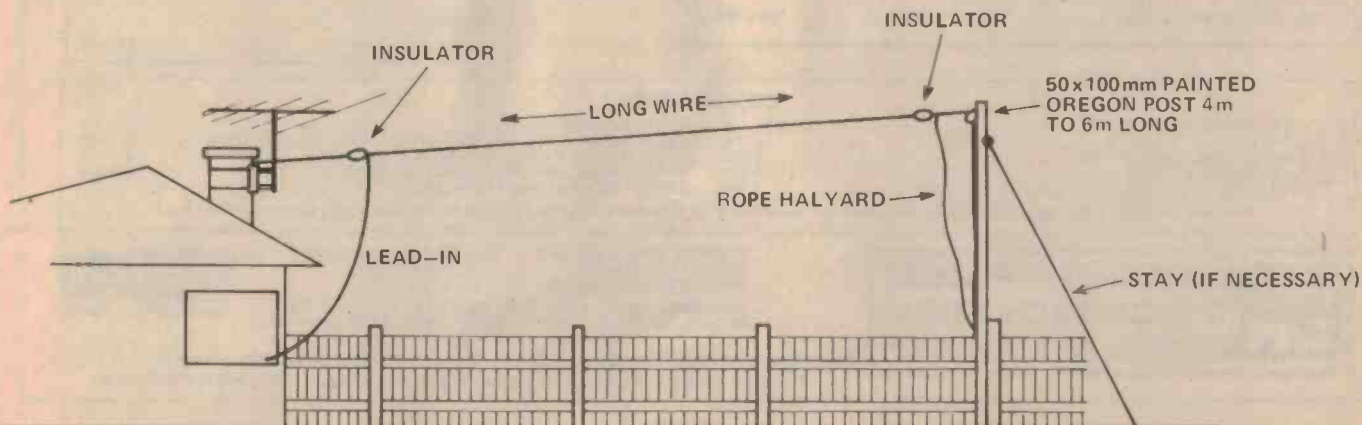

Fig. 3. A typical Long Wire antenna. The Lead-in should be as short as possible

2650 THE COMPLETE SYSTEM

EPS 100 POWER SUPPLY

This economy power supply kit can provide plenty of power for your system with plenty left over for the future expansion. The kit comprises of P.C.B. all components, heatsink and heavy duty transformer. It provides the user with three regulated voltages +5v at 10AMPS—12 volts and +12 volts at 1AMP, unregulated voltages may be tapped of the transformer should these be required.

EPS 100 POWER SUPPLY

Tax Paid \$55.00

CASSETTE INTERFACE

For the storage of programmes onto tape we provide a Simple Cassette Interface based on the Kansas City Format.

The S.E.C.I. Kit comprises of P.C.B. and components including test tape for easy alignment.

SECI CASSETTE INTERFACE

Tax Paid \$24.50

DG.640

Designed by David Griffiths this superb software controlled V.D.U. kit composes of all components including crystal, IC sockets and top quality plated through hole PCB. Our exclusive 54 page assembly/trouble shooting and software manual is also included. The display format is 16 lines by 64 characters to give upper and lower case letters, reversed video characters (black on white), flashing characters and a graphics resolution of 64 x 128 dot matrix. The unit conforms to the ever increasing popular hobby computer standard S100 bus.

Tax Paid \$149.50

KT9500

Signetic Corporation of America recently announced a 50% price reduction on the KT9500 2650 microcomputer kit. This is great news and now allows the hobbyist to own for a mere \$115.00 an 8 bit microcomputer that becomes the centre of his home computer that now costs only \$500 for the complete system.

The KT9500 kit comes with all necessary ICs, resistors capacitors and other hardware components. The kit consists of the 2650 microprocessor chip 1K bytes or ROM that contains PIPBUG (a loader, editor and debug programme), 512 bytes of RAM, both serial and parallel input/output ports and an on board clock housed on a plated through hole P.C.B., edge connector and our exclusive assembly manual, sample programmes and is covered by our technical warranty and service policy.

A 24 Pin Wire Wrap Socket has been included.

This is to replace the ordinary socket used for PIPBUG and will allow the user to easily wire wrap on a 2708 EPROM (e.g. BINBUG) with the instructions provided.

KT 9500

Tax Paid ... \$115.00

2650 RAMSTICK MOTHERBOARD/ RAMSTICKS

To assist the hobbyist in the easy expansion of memory, Applied Technology designed Ramsticks, these are a 1K bytes memory module that plug into each other to progressively build up the users memory as expansion is required. (A 2K version using the new 2114 memory chip will soon be available). The ramsticks are housed on a motherboard that allows very easy connection to the KT9500 and decodes up to 16K bytes of memory. The kit consists of a P.C.B. and all components including facilities for a crystal clock if required. (CRYSTAL \$7.95 extra). For future memory expansion a second motherboard can be added allowing another 16K bytes of memory to be added.

Ramstick Motherboard

Tax Paid \$35.00

Ramstick

Tax Paid \$25.50

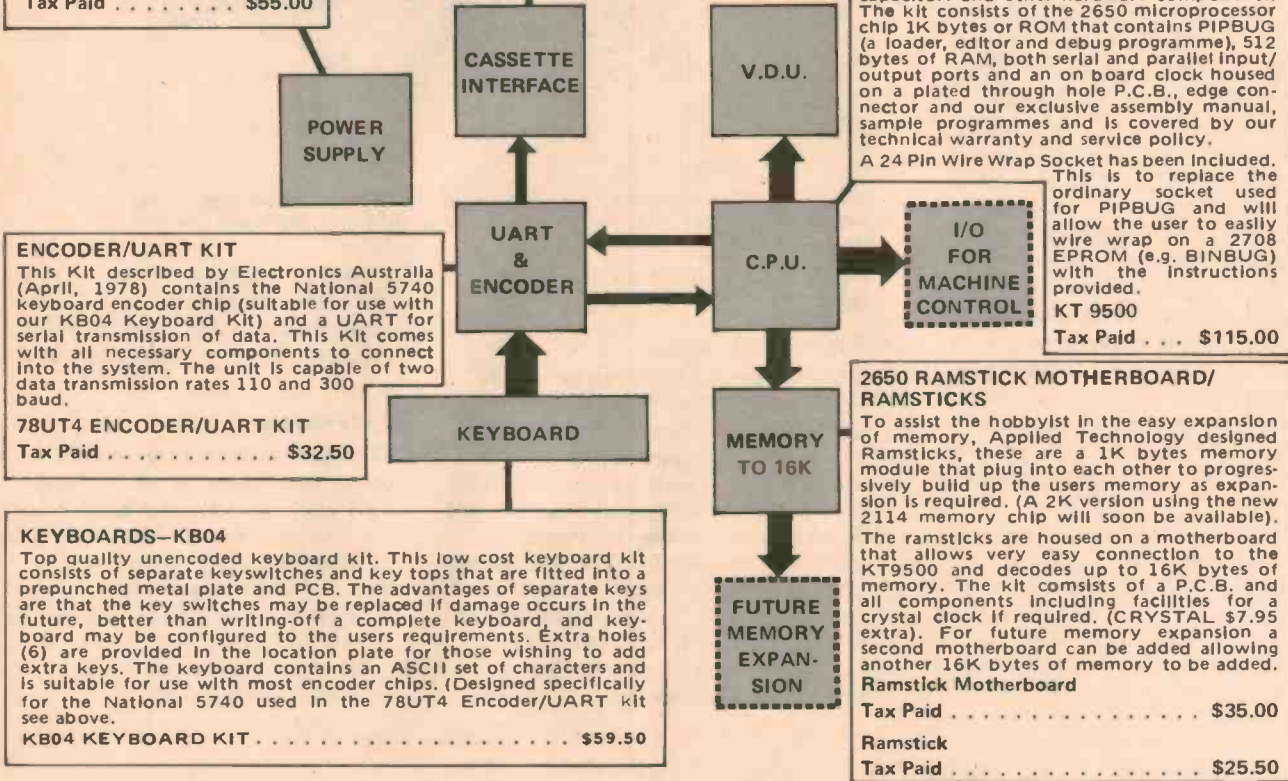

ENCODER/UART KIT

This Kit described by Electronics Australia (April, 1978) contains the National 5740 keyboard encoder chip (suitable for use with our KB04 Keyboard Kit) and a UART for serial transmission of data. This Kit comes with all necessary components to connect into the system. The unit is capable of two data transmission rates 110 and 300 baud.

78UT4 ENCODER/UART KIT

Tax Paid \$32.50

KEYBOARDS—KB04

Top quality unencoded keyboard kit. This low cost keyboard kit consists of separate keyswitches and key tops that are fitted into a prepunched metal plate and PCB. The advantages of separate keys are that the key switches may be replaced if damage occurs in the future, better than writing-off a complete keyboard, and keyboard may be configured to the users requirements. Extra holes (6) are provided in the location plate for those wishing to add extra keys. The keyboard contains an ASCII set of characters and is suitable for use with most encoder chips. (Designed specifically for the National 5740 used in the 78UT4 Encoder/UART kit see above).

KB04 KEYBOARD KIT \$59.50

ODDS & ENDS

2650 GAMES TAPE 1	12.75	2650 GAMES TAPE 2	12.75
2650 UTILITY TAPE 3	12.75	2650 BINBUG (FOR USE WITH 640 VDU) PROM	25.00
2650 BINBUG CASSETTE	5.00	2650 HOME PROGRAMMING COURSE	12.50
2650 USERS GROUP	40.00	2650 BASIC (4K MEDIUM) TAPE & LISTING	29.50
CRYSTALS 1, 2, 4, 5, 10, 12, 18 & 20 MHZ	7.95	2650 TECHNICAL MANUAL	8.50

For any further information ring or write to David Brown (Telephone Hours 10.00 a.m.—2.00 p.m., Monday—Friday)



**APPLIED
TECHNOLOGY
PTY. LTD.**

POST & PACKAGING \$2.00 all orders
CERTIFIED MAIL 0.50 extra
REGISTERED MAIL 2.00 extra

POSTAL ADDRESS—P.O. Box 311, Hornsby 2077
HEAD OFFICE/SHOWROOM—109/111 Hunter St.,
Hornsby (9.00—5.00, MON. to SAT.)

PHONE: (02) 476 4758 General Enquiries — (02) 476 3759 (Technical Information)
PRICES & SPECIFICATIONS SUBJECT TO CHANGE WITHOUT NOTICE

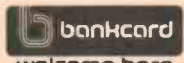

What the world is coming through!

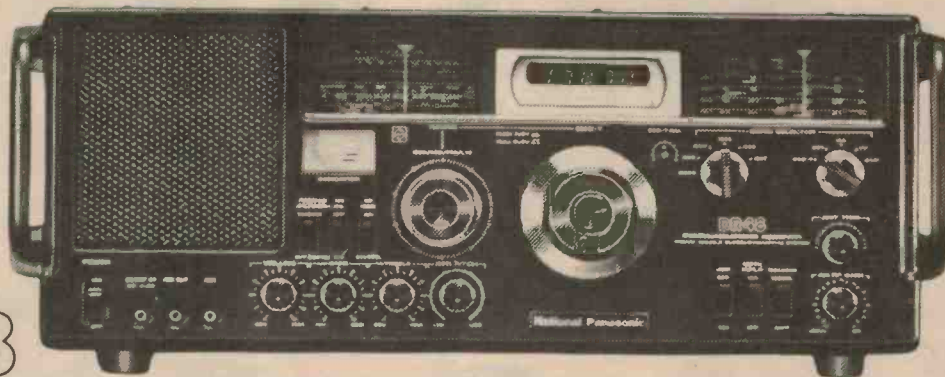

RF 4800

DR48

10-Band AC/DC Communications Receiver with Direct Readout Digital Frequency Display on SW₂~SW₈

This full-feature AC/DC communications receiver is a shortwave listener's dream. With eight SW bands plus FM and MW broadcast coverage is complete. Shortwave extends all the way from 1.6 to 31.0 MHz, and all frequencies, from SW₂ to SW₈ are digitally displayed with an accuracy of 1 kHz. It has a full complement of front panel controls and facilities, too.



DR22

**RF-2200
8-Band AC/DC Portable Radio
with Direct Readout Mechanism**

Here is a professionally equipped radio with six SW bands plus FM and MW. It features a frequency-linear dial and a sophisticated all-gear drive tuning mechanism. You also get a band spread dial divided into 10 kHz intervals with eight marker points for accurate use with the unit's 125kHz/500kHz crystal marker switches. There's also a BFO switch and a wide/narrow bandwidth selector for crystal clear reception.

DR28

RF-2800

**6-Band AC/DC Portable Radio
with Direct Readout Digital Display on All Bands**

A superb radio loaded with sophisticated circuitry and features. It gives you electronic digital frequency display on all bands. Shortwave coverage from 1.6 to 30 MHz. FM and MW reception. Precision two-speed tuning with an all-gear-drive system. BFO pitch control. A wide/narrow bandwidth selector. Separate bass and treble controls. And more.

For further information please write to
National Panasonic (Australia) Pty. Limited
P.O. Box 278, Kensington, N.S.W. 2033

National DRseries

Uncompromising Performance from Auditec

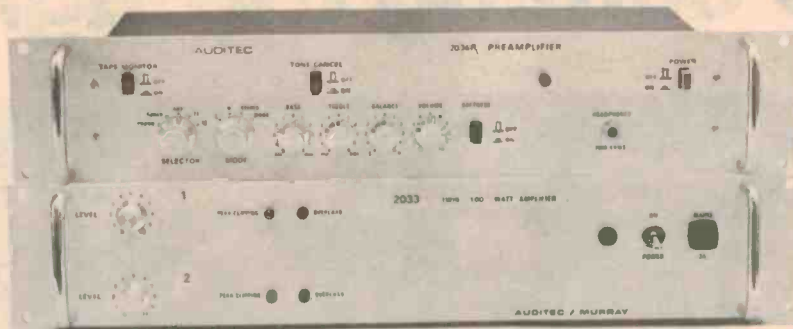

Possibly the world's best preamplifier and power amplifier in terms of sheer audio performance — the Auditec 2036R and 2033.

For descriptive leaflets call, phone or write to:

AUDITEC AUSTRALIA PTY. LTD.

10 Waitara Avenue, Waitara. NSW. 2077. Phone (02) 48-4116. (Pacific Highway side of Waitara Station)

AGENTS:

Melbourne: Zephyr Products, phone 568-2922
Brisbane: Delsound Pty Ltd, phone 229-6155.
Adelaide: Neil Muller Pty Ltd, phone 272-8011
Perth: Willis Trading Co., Phone 321-7609
Canberra: Musique Boutique, phone 82-2553.
Bundaberg: Bundaberg Hi-Fi, phone 71-3176.
Darwin: Darwin Communications Systems, phone 85-3184.
Alice Springs: Farmer & Davies Electronics, phone 52-2967.

Albury: Ray Walsh Sound Systems, phone 21-1502.

Tamworth: Hi-Fi Gallery, phone 66-2525.
Surfers Paradise: Beno's Musical Supplies, phone 38-1568.

NSW: President Sound, Wentworthville, phone 631-6689; WMR Electronics, Glenfield, phone 605-1203; Dawes Sound Systems Blaxland, phone 39-4421.

PORTABLE DIGITAL MULTIMETERS

Volkmeters with excellent readability in direct sunlight

FEATURES

- Automatic polarity, decimal and overload indication.
- Weight, 9.2 ounces.
- No zero adjustment and no full scale ohms adjustment.
- Large LCD readout for easy reading without interpolation.
- Size, 1.9" H x 2.7" W x 4.0" D.
- Parts and labour guaranteed for one year.
- Operating temperature range, 0 to 45 deg. C.
- Input voltage protection in the ohms and current modes.

LM-300

3 Digits
1 percent accuracy
with LCD readout.



Measures DC volts, AC volts, Ohms and current.

&

LM-350

3½ Digits
0.5 percent accuracy
with LCD readout.

RMS-350

3½ Digits
0.5 percent accuracy
with LCD readout.



Measures VDC, DCMA, Ohms and true RMS, VAC & ACMA



Trade enquiries welcome

NON LINEAR SYSTEMS (AUST) PTY LTD

61 Lothian St, W. Melbourne, Vic. 3015.
Phone (03) 329-9951, (03) 329-9377.

DISTRIBUTED BY:

Vic. Radio Parts, 329-7888.

NSW. Radio Despatch, 211-0816.

SA. Protronics, 51-4713.

QLD. Electronic Components, 371-5677

Switch on the World!



Available Approximately November 30th, 1978

Realistic's General Coverage Receiver.

The many voices of the modern world. Informative and exciting. From Moscow to Memphis, the air-waves are bristling with international broadcasts. Here is your chance to listen in to your world with 30 bands.

With the new Realistic DX300 General Coverage Receiver you can listen in to global news broadcasts, fascinating two-way radio messages. All you have to do is turn it on and tune it in.

The DX-300 has the famous Wadley Loop tuning system plus digital frequency readout replacing less accurate mechanical dials with electronic precision.

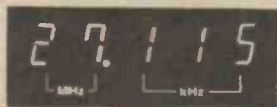

With the built-in 6 element ceramic filter and a manual audio bandwidth, adjacent channel interference is sharply reduced. In other words, a clearer, stronger signal from the selected channel.

Operates on either AC, 8 "C" batteries (not included) or 12 VDC external power.



The three step RF attenuator prevents strong signals from overloading the receiver and allows instant return to full sensitivity.

Plus the DX-300 is equipped with a product detector and ± 1 kHz clarifier for the best SSB and CW demodulation.

You can tune into,
 - foreign broadcasts
 - marine SSB
 - standard AM
 - longwave and WWV,
 - all HF Ham bands/CB

All from 10 kHz to 30 MHz continuous over 30 bands.

Its another Tandy Electronics first. An LED Digital Readout General Coverage Receiver at a price you can afford. With the Realistic DX-300, the world is just a flick of the dial away.

399⁹⁵ REALISTIC

Specifications

Sensitivity for 10 dB Signal-to-Noise Ratio: AM, 1 μ V at 900 kHz and 0.5 μ V at 7.1 MHz; SSB, 0.5 μ V at 900 kHz and 0.3 μ V at 7.1 MHz. Selectivity: ± 3 kHz. -6 dB: ± 10 kHz, -70 dB. RF: Triple conversion, quartz controlled. IF: 1st, 54.5-55.5 MHz; 2nd, 3-2 MHz; 3rd 455 kHz. Antenna Inputs: 50 ohm coax, balanced open line or single wire. Size: 15.2x36.8x24.7cm. Power Requirement: 240 VAC. 50 Hz. 12VDC neg. gnd.

TANDY
ELECTRONICS

Independent Tandy Electronics dealers may not be participating in this promotion.

Getting into Short Wave Radio

Your ticket to the world of short wave radio is your receiver, and the way you understand its operation. Here Bob Padula of the Australian Radio DX Club, explains what to look for when buying or operating a radio.

DURING THE PAST two or three years, interest in shortwave radio as a hobby has been marked by a dramatic increase in the numbers of people joining the many DX Clubs around the world. This emergence of shortwave radio as an alternative spare time activity has been associated with the rapid advances in communications receiver design and mass production manufacturing techniques originating in the Asian electronics industry. Contrary to the situation some ten years ago, purchase of a modern, high-quality, multi-band shortwave radio is now well within the reach of most aspiring hobbyists.

The past few years has also been marked by a certain amount of categorization amongst the ranks of shortwave listeners throughout the world, introduced by leading DX groups in Australia and elsewhere, so that the Clubs could more readily determine how they could best serve their memberships. As a result, it is generally accepted that there exists two main categories of shortwave enthusiasts, which, in broad terms, may be defined as:

*Those listeners who wish merely to listen in to foreign broadcasts, in much the same way and for the same reasons that they would tune in to their local broadcasting station. This listener group is generally interested in foreign radio mainly for entertainment, news, music, and perhaps for keeping in touch with the home country. The term "Short-wave Listener", commonly abbreviated to "SWL" is the accepted way of referring to this category of listener.

*Those hobbyists having a more technical involvement in foreign broadcast listening, and who are interested in the study of propagation patterns, frequency usage, scheduling, technical monitoring, and possibly in the compiling of notes for inclusion in reception reports subsequently sent to the stations for verification (QSL) purposes. For this

large group of listeners, program content is not of prime importance, as these hobbyists are more concerned with advancing long-distance (DX) reception techniques, and the stations tuned in will consist of a very broad spectrum of those on the air, including those broadcasting in languages other than English. These listeners are generally known as "DXers".

DXers will tend to study the reception of stations operating in all frequency bands, often specializing in DXing the Tropical Bands, such as are used for regional broadcasting in Africa, Asia, and Latin America. The reception of weak signals is important to the DXer, as a challenge to his skill and hobby expertise, whereas the SWL will normally confine his listening to higher powered transmitters beaming programs to his own reception area.

Different Needs

These two listening groups should be kept in mind when discussing how to choose a suitable receiver; whilst some common features will emerge for receivers for both hobbyist groups, the needs of the serious DXer will often be somewhat different to those of the SWL. The situation can be further complicated by the different needs of listeners who may require fully portable equipment, as compared with hobbyists preferring receivers intended for fixed use in the home, and running off a mains supply.

It is of course impossible to recommend a particular receiver, or receivers, that will serve each and every hobbyist satisfactorily; one particular set may have certain shortcomings for a given reception application — the same receiver may be well ahead of others in its class for another style of listening. Overall, the listener must look at his own requirements, and should certainly not rush out and buy the set that looks the nicest, has the most colored dials, and perhaps costs the

world! The new listener should pay attention to these main factors:

*Whether he wishes to explore serious DXing, or merely pursue general program listening, or possibly some combination of both;

*what he is prepared to spend;

*whether he wants to listen away from home, perhaps whilst on holidays at the beach or in the hills, or from a permanent location back home;

*the fidelity of audio reproduction desired;

*the ease of tuning, controls, and frequency readout that is desired.

Unfortunately, reviews of receiving equipment far too often fail to take into account the somewhat differing needs of the DXer, as compared with the SWL. Most reputable DX Clubs these days publish from time to time realistic reviews of new receivers, written around the general needs of SWLers and DXers. For the new listener, who may not be a member of a DX Club, access to this sort of material is often unavailable, and he may not be aware of what membership of a DX Club can provide. It should be kept in mind that membership of DX Clubs is not confined only to advanced, technically trained and highly skilled listeners, but rather that the Clubs essentially consist of a wide spectrum of listeners, with assorted hobby interests, ranging from the novice SWL through to the advanced, semi-professional DXer. Most hobbyists fall somewhere in between these extremes. However, there is of course a slant towards the encouragement and development of DXing skills and technical expertise, for those who have the capability, motivation, and dedication, but this should not deter the new listener from joining one, or more of the larger DX Clubs.

For some time, the Australian Radio, DX Club has recognized the unique problems faced by newcomers to SW listening, and has introduced a special service, for both members and non-

members, known as the "Receiver Review Package". This contains a wide variety of brochures, technical specification sheets, and literature made available by receiver manufacturers and distributors, as well as copies of previously published reviews of selected communications sets, originally appearing in the Club's bulletin. Information on availability and cost of this special Package, plus general Club information, is available on request from the ARDXC, Hon. Secretary, PO Box 67, Highett, Victoria 3190, for return postage. New members of ARDXC receive a comprehensive "New Member Kit", including the "Guide to DXing for Beginners", which expands on the information given in this introduction.

Basic Requirements of Receivers

Frequency Coverage

For general DX work, a set offering continuous coverage from 2 MHz through to 30 MHz is essential. Some sets have limited coverage and tune only the major international SW bands — other sets cover only some of the major bands. Such equipment is suitable only for the SWL, and the serious DXer wishing to explore the territory between bands, will need access to frequencies not normally required by the SWL. With the possibility of extensive rearrangements of international frequency allocations for the various radio services emerging from the 1979 World Administrative Radio Conference and new or additional bands being created, many existing sets will be quite inadequate, if designed around the bands as they now exist. With increased sunspot activity,

Sony's top-line CRF-330K has a digital dial and incorporates a cassette recorder.



A good example of the use of a separate bandspread dial is the Trio Kenwood R300.

due to the ascent into the new cycle, use of the high frequency 13 and 11 metre bands will be stepped up over the next two or three years, and sets for general SWL work should have coverage of those bands.

Sensitivity

For DX work, good sensitivity is essential. In olden days, before the advent of semiconductors, valve type sets showed a serious drop off in performance above about 17 MHz, and required all sorts of outboard preselectors and preamplifiers to boost the top-end performance. Modern, well engineered sets do not generally exhibit this sort of deficiency, and operate well up to their design limit, which is often around 31 MHz. Good sensitivity refers of course to the ability of the set to detect and respond to weak signals, and is usually specified in terms of microvolts (μV) of input signal to give a standard output. Published data usually gives two sets of figures — one for normal double sideband AM, the other for SSB/CW. Sensitivity of between one and two microvolts will provide adequate performance for the DXer. It is of interest to note that some professional quality receivers have sensitivity figures of $0.25 \mu\text{V}$ (SSB) and $0.5 \mu\text{V}$ (double sideband AM), for 30% modulation, and for a 10 dB signal to noise ratio.

The ability of the set to receive a small signal above the noise level is important, and not how well the set can amplify the signal. For the general SWL, superior sensitivity is not so important, as this style of listening usually revolves around stronger signals, and not the weak input levels sought after by the

serious DXer. If portability of the set is desired, this means that good sensitivity is mandatory for both the SWLing and DXing applications. Many hobbyists maintain listening whilst travelling, from holiday locations not only in Australia but overseas and perhaps on board ship — an insensitive set coupled to a small antenna under such circumstances is only so much excess baggage!

Careful study should be made of published sensitivity specifications — if the figures show sensitivity figures worse than 4 or $5 \mu\text{V}$ for 10 dB signal/noise, then the set would have only limited application for the serious DXer.

Selectivity

Most of the current general coverage communications receivers, and the advanced design multi-band portables (and semi-portables) have been engineered around a performance capability of benefit generally only to the SWL. Clearly, manufacturers are looking at the mass market for their dollar return on R & D investment, and it is the SWL group that is of course the largest user of SW radios at the present time. It is for the SWL that modern production and manufacturing methods have been directed in recent years, but it is interesting to note that at least one major Japanese manufacturer has shown a willingness to respond to the requirements of the serious DXer, for future development. Surveys are currently being conducted amongst the large DXing groups within North America on those features thought to be most desirable on equipment designed es-

Getting into Short Wave Radio



pecially for the DXer market, and the rapid upsurge of interest in DXing, as opposed to SWling, in Japan, is also considered to be a key factor in the probable introduction of a relatively inexpensive set designed specifically for the serious DXer.

As a result of this present situation, the selectivity characteristics of many modern, general coverage receivers have been found to be somewhat inadequate for serious work, due to the relatively broad skirt of the overall response curve. The shape factor of the IF response is important when serious DX work is pursued in the crowded bands of today, and many currently available sets are designed to give good audio quality, at the expense of adjacent channel separation. If a set cannot separate stations operating on carrier frequencies 5 kHz apart, the DXer is at a serious disadvantage, as many of the weak signals he will want to listen to lie immediately adjacent to strong international broadcasters. Even strong international stations may not always be heard clearly, if there is another strong station on an adjacent channel, beaming hundreds of kilowatts into the listener's area.

Selectivity figures are usually given as

the total bandwidth at the -6 dB point and the -60 dB point. For normal double-sideband (AM) reception, a total bandwidth of about 3 kHz is ideal at the -6 dB point, broadening out to around 10 kHz at the -60 dB point. The selectivity characteristic of this type of design is perfectly satisfactory for most DXing applications, which offers a good overall audio reproduction capability, and with adequate adjacent channel separation of stations 5 kHz apart. A set exhibiting such features was the very popular Trio 9R59 valve type receiver, now superseded, and which has been rated by many serious DXers as one of the best general purpose communications sets ever built in its particular price range.

Many current sets have much broader response characteristics — typically, at the -6 dB point, total bandwidth might be 6 kHz, widening out to about 14 kHz at the -60 dB point. For true communications purposes, bandwidths such as these are too broad for adequate separation of stations on adjacent channels, and whilst satisfactory for general SWling, are often made the subject of receiver modifications after purchase, by fitting narrower bandwidth filters for specific requirements.

When studying selectivity data as published by manufacturers, care should be taken in properly interpreting it — there is a tendency nowadays to quote merely the bandwidth for SSB reception at the -6 dB point; this will be half the total bandwidth required for satisfactory double sideband AM reception.

More sophisticated receivers, costing upwards of \$2000 have superior selectivity features, such as selectable upper or lower sideband, and variable selectivity, to cater for a wide variety of listening requirements. There are many sets, originally manufactured during World War 2, still in regular use, whose selectivity features are superior to those of a lot of the current receivers. For example, the Marconi CR100 series (described by some DXers as the best set ever made) has an inbuilt crystal filter and variable selectivity, ranging from total bandwidths of 6 kHz down to 300 Hz. The well know Hammarlund HQ180 featured variable selectivity and selectable upper or lower sidebands, and there are many other similar sets still in use with this type of useful selectivity characteristic. The Drake SPR-4 is a currently available set featuring switchable variable selectivity; the famous RCA AR88D has five selectivity

modes, ranging from 500 Hz to 13.5 kHz at the -6 dB point.

Unfortunately, for the new listener on a limited budget, there is not much he can do about the selectivity characteristics, unless he has some technical training and is able to carry out a modification to improve this aspect of the set's performance. The currently available Yaesu-Msaun FRG7 has proven to be a very popular set for general SWL and DX work, but many users have indicated that its marginally inferior selectivity features have caused them to look elsewhere for a set suitable for serious DXing. In fact, many DXers have added a modification to the FRG7 to sharpen up the selectivity, and at least one receiver distributor in the USA has marketed this mod as an option on purchase.

It is encouraging to note that the latest products emerging from Japan, and in particular the National DR48 and its little brother, the DR28, exhibit selectivity features approaching what is considered to be optimum for the serious DXer. Using ceramic filters, quoted selectivity data for the DR48 and DR28 indicates a bandwidth of 3.4 kHz at the -6 dB point, and 12 kHz at the -60 dB point, which is adequate for most reception applications for the serious DXer, and excellent for the SWL.

Stability

By this is meant the ability of the set to stay tuned to a given frequency after a nominated warm-up period (generally about 15 minutes). In older equipment, drift was often caused by physical shock which meant that the better class set was built like "tanks", making them suitable only for fixed station use. Ageing of valves also required recalibration periodically, and adequate ventilation, coupled with voltage regulators, had to be provided to minimise the effects of temperature change on local oscillator frequencies. Elaborate and expensive compensating networks and the use of negative coefficient components in the local oscillator circuits of valve sets was typical, in order to minimise the effects of frequency change by external conditions.

Modern solid state equipment exhibits far fewer stability shortcomings than the older valve type gear. Drift for modern receivers may generally be less than 100 Hz during any 30 minutes after warmup, and less than 100 Hz for a 10% change in line voltage. Advanced circuitry, such as the synthesized drift cancelling system, is now being used extensively in many modern designs, including

several relatively inexpensive receivers.

For reception of SSB signals, stability is very important, to avoid having to have one hand continuously on the controls for the entire listening period! Nothing is worse than to have to continually retune the set in attempting to follow a SSB signal, due to shortcomings in the receiver design, where the signal is constantly dropping out of resolution. Many cheaper multi-band portable SW sets are sadly deficient in this characteristic; though performing well in the general areas of selectivity and sensitivity — their short term drift performance is very poor. This undesirable effect will not normally apply to sets intended for general SWLing, or for general DX work on double-sideband AM signals. It should be noted that some international SW stations are now experimenting with SSB transmissions as part of their normal schedule, and for this reason new purchasers should obtain sets with a capability for this mode of reception, if serious DX work is desired. The very expensive professional quality receivers have exceptionally good long-term drift features, but this type of gear will normally be out of reach for the average SWL or DXer.

Spurious Signal Rejection

The most expensive and elaborate set in the world, having superior sensitivity, selectivity, and stability features will be totally useless if the received signal cannot be separated from a babble of whistles, birdies, and other spurious products. For sets with an IF of 455 kHz, "double spotting" at twice the IF

Sony's ICF-5900W is a very high performance portable.



The FRG-7 is one of the most popular receivers in the world today.



The Standard C6500 is a recent Wadley-loop design.

(910 kHz) away from the desired signal is a very real problem, especially at frequencies above about 15 MHz. The effect is due to inadequate selectivity in the RF stages, and causes signals 910 kHz above the wanted frequency to be heard as "double spots", alternatively known as "images". The wanted signal can be tuned in at two spots on the dial, separated by 910 kHz. Additional RF stages were often designed into some equipment used for armed services work, and sets having two RF stages are not uncommon, such as the Marconi CR100 and RCA AR88D. Image-rejection capability is always worse at the high frequency end, and only by very careful attention to design can the rejection ratio be reduced to tolerable levels. On some modern sets, with only one RF stage, the problem can be reduced simply by insertion of an antenna tuning unit in the input to the set from the external antenna. Alternatively, the use of an outboard preselector can often eliminate most of the troublesome double spotting effect on inexpensive receivers. Double-conversion designs have been developed where the first IF is set at a relatively high figure, sometimes around 10 MHz, to provide for good image rejection ratios, followed by a second IF of perhaps 100 kHz for increased selectivity. Some designs have featured triple conversion in an attempt to optimise the conflicting requirements of selectivity and image rejection.

Spurious signals generated within the set have become more common nowadays due to the widespread use of

Getting into Short Wave Radio



The R-820 is Trio Kenwood's general coverage flagship.

solid state devices in the RF stages. In some valve type sets, strong signals could break through and cause overloading due to improper alignment or tuning, or by inadequate attention to design in the RF circuitry. The cross-modulation effects caused in this way appear as unwanted signals superimposed on the desired signal, and can be reduced by attenuating the input signal level, ideally by the use of the receiver's manual gain control, if fitted. Many modern solid state sets exhibit this shortcoming, and often suffer from severe cross modulation problems generated in the RF stages that use bipolar transistors. Close proximity medium-wave stations frequently show up at various points in the SW tuning range, particularly on simpler receivers, and even on some more expensive sets, it is virtually impossible to eliminate this major deficiency, beyond moving one's residence out into the hills! Reduction of the problem when using solid state gear can sometimes be achieved by using properly designed and adjusted filters in the antenna input to the receiver. Very severe cases can sometimes be overcome by fitting an attenuator, and many of the modern sets have such a device already built into the design. Contrary to what might be expected, the use of extra-long outdoor antennas is not recommended for general DX work where local MW transmitters are sited within a few km from the receiver — attempts to use long antennas generally only create even more spurious signal and cross modulation products when solid state gear is operated. Some of the very cheap multi-band portable SW radios are atrocious in their ability to reject strong signals, both SW and from MW stations — often, SW stations can be heard over the MW dial, due to

inadequate design attention in the RF and mixer stages. Beware of such equipment, which has no real application for the serious DXer or SWL. If an intended receiver purchase exhibits all sorts of whistles and birdies when used with an antenna of reasonable length (say, about 10 metres long), it would be wise to look elsewhere. Whilst some of these sets may look pretty, with elaborate dials and colored knobs, their overall performance is appalling, and their only value is of a cosmetic nature.

Tuning, Dials, Calibration, Readout

During the early 1940's, the trend was for receivers to have two separate tuning gangs, coupled to separate dials, and electrically in parallel. One was called the "main tuning", the other "bandspread". When used with switched band changing, and by suitable selection of circuit constants, bandspread tuning was available for any desired portion of the spectrum covered by the main tuning. This tuning arrangement is still used in many current designs, and many recently superseded sets are in widespread use

with this dial configuration. It is seen in the popular Lafayette series (both valve and solid state) — HE30, HA230, HA600, HA800, the Trio 9R series (9R59DE, -DE, -DS), the Realistic DX160, and many others. It offers electrical bandspread, sufficient for general DX or SWL work, relatively cheaply and easily, without the introduction of expensive design features. Sets of this type generally have the bandspread dial calibrated for either the major SW bands, or the amateur bands, together with a 0-100 logging scale, and readout to 5 or 10 kHz is achievable, when operated carefully and sensibly. For this to occur, the main tuning dial has to be accurately set to a predetermined frequency, so that the bandspread dial can be read off directly. This is done either by using stations whose frequencies are known, or by internally generated "marker" signals, which are switched from the front panel, perhaps at 5, 10, 50, or 100 kHz intervals. Sets of this nature continue to give reliable service in DX shacks around the world, not only for general DX and SWL work, but also for amateur and utility listening. However, some skill needs to be developed in making sure that the band-edge frequencies are correctly set up before using the bandspread dial, and some familiarity with the SW bands is necessary to establish the starting and end points.

Some sets incorporate mechanical bandspread arrangements, often by using concentric tuning dials, one with a fast tuning rate, the other for slow tun-

The FRG-7000 is the successor to the popular FRG-7.



ing. The famous Eddystone series of communications receivers uses a dial which has a superb gear reduction and movement, allowing direct readout to 5 kHz by use of the inbuilt logging scale.

The serious DXer often uses auxiliary equipment for tuning accuracy, such as the very popular but somewhat archaic Number 10 Crystal Calibrator, which may still be available from disposals sources for around \$20 or so. The well known BC221 Frequency Meter is used extensively by serious DXers, but is not so favoured by the general SWL, due to the technical requirement for its proper setting up and use. New BC221's are currently available here in Australia, and represent good value for the money.

The use of solid state frequency counters, connected across the local oscillator output of the set, arranged to read direct by suitable prescaling circuitry, is perhaps a more worthwhile approach for the SWL without any form of technical background, but good quality, stable counters are prohibitively expensive. The recently introduced DX-555, a combined RF signal generator and digital display frequency counter is seen by many hobbyists as a better solution to the problem, where the output of the generator is connected to the receiver's antenna input and zero-beat with the desired signal. The counter is then read directly. The current price of around \$190 may be a deterrent, however, when availability of direct readout receivers for around \$300 is now possible.

Over the past year or so, various receivers have appeared on the local scene with quite different circuitry and tuning arrangements. National introduced its portable/compact DR22, then Sony had its portable ICF5900W, and, more recently, National's DR48 was released. Prior to this generation of sets, the Barlow-Wadley XCR30, using the Wadley Loop principle, was probably the first general coverage high quality SW portable set to be made available in quantity at a reasonable price, and offering direct readout down to 5 kHz. No band switching is used — the appropriate 1000 kHz frequency range is selected by a main dial calibrated from 1–30 MHz. A second dial is calibrated at 10 kHz intervals. Another new style receiver that has been available for some time now is the Drake SSR1, incorporating a drift-cancelling system, with claimed readout of better than 5 kHz. The currently available Yaesu-Musen FRG7 has proven to be a versatile type of set for the SWL, but with slightly inferior selectivity features when used for serious DX work, according to some reviewers. It has a similar tuning arrangement to the XCR30, with a claimed readout of 5 kHz.

The very latest receivers are now starting to incorporate digital readout displays, at prices affordable by the average hobbyist. National's DR48 paved the way, selling for recommended retail of \$470, and already proving to be a very popular set for both the SWL and serious DXer, but with some shortcom-

ings when tuning the 3–4 MHz range. The very latest National product, the DR28, just released in Australia, is similar in its overall selectivity and sensitivity features to the DR48, but with a different tuning scale, and it also has the same digital display readout as does the bigger set. This is expected to sell for somewhere around the \$350 mark, based on overseas prices, and reviewers in the USA have already expressed their enthusiasm for its performance, both as a set for the DXer, and also for the program listener. Now, the digital version of the FRG7, the FRG7000, is starting to become available in this country, but its price tag of \$690 may not be a major selling point, when compared with National's DR48.

Previously, digital readout displays have only been available on the most expensive of receivers, but advances in technology, especially in the Asian area, have now made it possible for this feature to be incorporated into relatively inexpensive sets. This form of frequency readout is of course not the ultimate, as various reviewers have suggested, as calibration is often necessary when changing from one band to another, and care is needed in accurately centring the received signal in the pass-band. However, the tuning mechanism used in the DR48 is remarkably free of backlash, using a dual speed concentric geared drive, and should prove to be popular for some time yet. For any receiver, irrespective of mechanical or digital frequency readout, it is essential



The Sony CRF-160 (left) has been popular with SWL's for some years now, while the Grundig Satellit series of receivers is very well known.

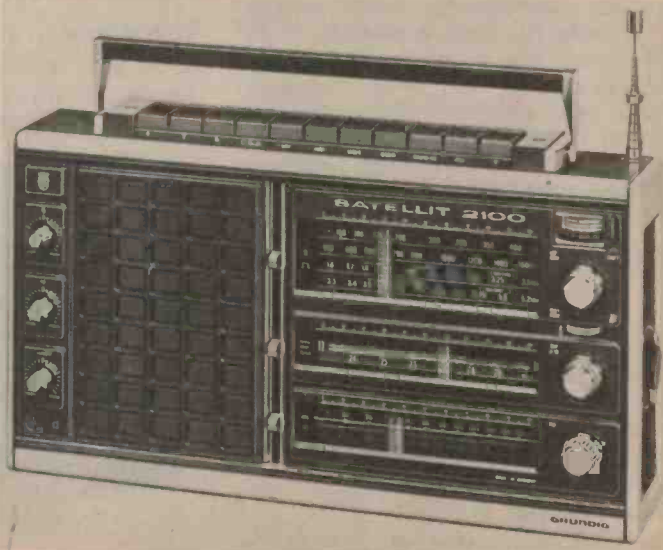

Getting into Short Wave Radio

for proper DX or SWL work for the tuning arrangement to be positive and smooth in its operation, with minimal backlash. Some of the older cord drive dials were terrible affairs, and it required virtually a major repair operation for the cord to be replaced, which occurred often for some models!

Portable Receivers

Many listeners want to continue their DXing or SWLing whilst on holidays, or when travelling. For this application, compactness, ruggedness, weight, size, tuning accuracy, sensitivity are all primary factors which become important when the receiver is used away from home. Power consumption must also be watched if the set is to be operated on internal batteries, away from commercial mains. Some AC/DC sets can be very greedy on a set of batteries, and this point should be checked out before purchase, if the set is to be operated in that mode. Sets having digital display readouts generally have provision for illuminating the display via a front panel switch, and if the receiver is to be used on internal batteries, it is essential that this cut-off feature be provided. Good sensitivity becomes very important for sets used on holidays, with generally inferior antennas, and particularly if serious DX work is desired. The small size Sony ICF5900W has won many kind words for its performance both as a portable, and as a fixed receiver — its battery consumption is remarkably low, and it gives reasonable results with only a few metres of antenna strung over a nearby tree, or with its own rod antenna. When operated off the mains, it offers adequate performance for small initial cost; being small, it has only a small speaker, which may not be suitable for persons wanting to do SWL work with superior audio reproduction wanted. However, its dial readout is very good, and the set is small enough to carry around as a real portable in the proper sense of the word.

Some users may prefer the National DR22, similar in many respects to the ICF5900W, but having a somewhat more complex tuning mechanism and dial arrangement. This set is also a portable, but many are in use for fixed station operation. The Barlow-Wadley XCR30 has led the race in earlier years as the most popular and best performing SW portable, and should not be overlooked when compared with its new-found Japanese competitors.

Other Features

The final choice of a set is up to the



The MacKay Dymek DR33 has fully synthesized tuning.

listener! Good sets have an antenna trimmer as standard, for optimum matching to a variety of antenna impedances. Separate gain controls for RF and AF have been standard on communications sets for many years, and the DR22, DR28, and DR48 all have this facility. Separate controls for bass and treble are finding increased use for noisy reception modes, and if properly designed, can offer considerable advantages in digging out weak signals, where serious DX work is desired. For the SWL, these controls would be essential, for adequate audio reproduction. Noise Limiters are also useful, in reducing the effects of pulse type noise, such as caused by car ignition, lightning discharges, and domestic appliances switching transients. Tuning Meters can have some advantages, to indicate the exact position of the signal peak when used with antenna trimmers or outboard preselectors or tuning units.

Maintenance

Some good used gear is often available

The Realistic DX-300 has just been released, and features digital readout.

through the classified advertisement pages of the local papers, or via ETI. Care is necessary when buying such equipment, as maintenance can be a difficult problem, if the listener has no technical background or access to proper servicing facilities. Such gear should always be accompanied by a circuit, at the very least, and if possible, some sort of operator's manual. Valve sets still give reliable service where DX or SWL is tuned, but some valves are starting to become a little hard to get, when it is considered that the original components are often still in use, many dating back to the early 1940's. These sets need periodical alignment, and unless the hobbyist has adequate facilities for undertaking this work, or knows someone who would be willing to look after it for him, he would be well advised to steer carefully when intending purchase of older secondhand equipment.

With new sets, it is necessary to ensure that the manufacturer/distributor combination maintains proper service





The National DR28 is one of the new receivers to feature digital frequency indication.

facilities, and that some form of warranty is available on purchase. Whilst the failure rate of solid state gear is extremely low, maintenance will be needed at some stage or another, if only to replace a single transistor, and ready access to a service centre is essential, for equipment which may cost around \$400 or more.

Conclusion

It is quite impossible to nominate any particular set as being ideal for a given reception application. Sets designed for portable work invariably display some shortcomings when used for fixed station use — equipment intended for good overall audio reproduction, such as the SWL would want, would not be suitable in many respects for the serious DXer. A set giving continuous coverage from 3–30 MHz might sacrifice some performance features and dial readout accuracy, whereas a receiver intended

The Realistic DX-160 offers bandspread tuning.



Typical of portable radios is Sony's ICF-5800L.

for use only in the international SW bands would offer superior features in the dial and readout areas. No hard and fast rules can be given — the final choice is the listener's, dependent on his own needs how much he is prepared to pay. Many new listeners have been attracted by glossy advertising brochures without really bothering to study what was contained in them — they have rushed out and paid many hundreds of

hard earned dollars for a fancy receiver, only to find that it wasn't all that they thought it would be. Some homework is absolutely essential — all receivers have different performance characteristics, and careful study of the available literature is well worth the time taken. If the new listener is not a member of a reputable DX Club, it would be in his interests to join, if only for a year, to see what receivers are being used, as there are generally some rather forthright opinions about equipment expressed in the pages of DX Club bulletins! If a brochure or literature about a desired set is unavailable, it may not be worth going any further; be wary of rash and unsubstantiated promotional claims about specific performance features, particularly where insufficient technical information supports the comments. If a member of a DX group, whether it be amateur, DX, or SWL, the new listener should make contact with others who have some experience, and who will be able to discuss the relative merits and demerits of currently available equipment.

Receivers in general use

The list which follows shows the most popular receivers in use here in Australia for DX and SWL purposes. The information is based on an analysis of equipment operated by ARDXC members, and where possible, an indication is given as to whether the receiver is suited to serious DXing, or for the general SWL. The list is not meant to be complete, and equipment is not shown in any particular order of merit. Models no longer available are shown in brackets.

Barlow-Wadley XCR30

(Drake SPR4, SSR1)

(Eddystone EC10, 680, 840C, 830/7)

(Lafayette HE30, HA230, HA600,

HA600A, HA700, HA800, HA800A)

(Marconi CR100)

National Panasonic DR22, DR28,

DR48 (Note: DR48 also known as

RF4800)

(RCA AR88D)

Realistic (SX190, DX160)

Selena B-212 (suitable for SW only)

(Selena B-206)

Sony ICF5900W, ICF5800, CRF160

(Trio JR60, ER202, 9R59DE,

9R59DR, 9R59DS)

Trio-Kenwood R-300 (QR-666)

(Vega 250)

Yaesu-Musen FRG7 — the most popular receiver currently in use for both DXing and SWLing.



1.8-28MHz SSB TRANSCEIVER **TS-520S** SERIES

TS-520S / VFO-520S / SP-520



Antenna Coupler

Frequency range.....6 amateur bands from 1.8 to 29.7 MHz
 Input Impedance.....50 ohms
 Output Impedance.....50 to 500 ohms, unbalanced
 Through power.....200 Watts maximum
Wattmeter
 Type.....Through-line wattmeter
 Frequency range.....1.8 to 29.7 MHz
 Measurable RF power.....Up to 20/200 Watts, switched
 Kinds of RF power.....Forward & reflected power, switched
 Impedance.....50 ohms
 Accuracy.....Better than +/-10 percent of full scale



The SP-820 has built-in selectable tone filters to attenuate high and/or low frequencies. You can switch between 2 different receiver sources. Headphones may also be used in conjunction with the filter network.

TRIO-KENWOOD (AUSTRALIA) PTY. LTD.

31 Whiting Street, Artarmon, Sydney. NSW. Australia. 2064. Tel: (02) 438-1277.

Interstate Distributors:

VIC: Vicom Imports Pty Ltd (03) 699-6700

QLD: Mitchell Radio Co (07) 57-6830

SA: International Communications Systems P/L (08) 47-3688

WA: Willis Trading Co. (09) 321-7600

TAS: Advance Electronics (003) 31-5688

NT: R.J. Klose (089) 81-8704

PS Did you know Kenwood are to release a new solid state 30W PEP HF Mobile Transceiver TS-120 with full 10M coverage, digital display and noise blanker in OCTOBER — watch for further details.

TAPE SLIDE SYNCHRONIZER

This unit will let you tape record a commentary for your slide show, so you can even give a talk without being there. . .

WHEN PUTTING ON a slide show for your friends or a business meeting, it is usually necessary to have some commentary with it. If it is a one-time presentation this is no problem, but if the show is to be repeated or if you simply want to be able to recall good memories a couple of years later then a tape recording of the commentary is ideal. The problem now is to keep the slides changing in synchronization with the commentary, without having to record that obtrusive phrase 'change slide now' onto the tape.

This unit allows a control tone (100 Hz) to be recorded on the tape along with the normal voice recording; when replayed the tone will activate a relay which will change the slide while a notch filter removes the tone so it is not heard through the speaker. We published a similar design some six years ago which recorded the tone on the second channel of a stereo recorder. While this worked well, a stereo recorder is not always available, and this design allows an economical mono recorder to be used.

Construction

Assemble the pc board with the aid of the component overlay in fig. 1. With the 240 V wiring it is better not to use pc pins but solder the wires directly onto the pcb. A covering of epoxy glue over the tracks leading to the transformer will help to prevent accidental contact.

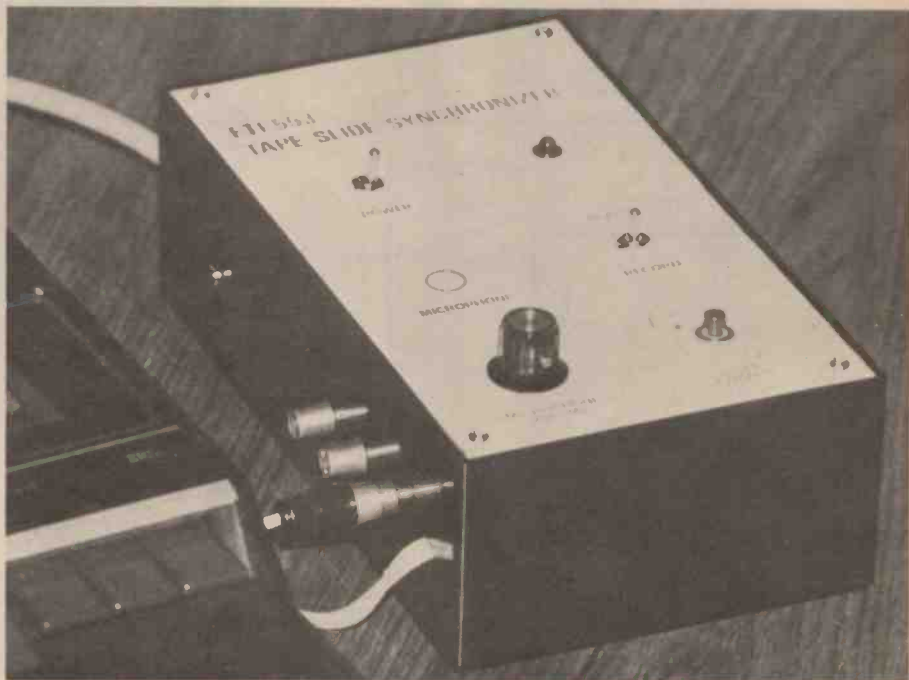

We built the prototype into a large plastic box with the controls on the front panel and the tape recorder/amplifier connections on the rear. The wiring of the front panel is given in fig. 3. We used an electret microphone insert mounted just behind the front panel. A plastic Scotchcal was used with

a 25 mm dia. hole behind to allow the panel to vibrate and transmit the sound to the microphone. However the noise of the relay operating could be heard on the tape and therefore an external microphone is recommended. A socket can be mounted on the front panel in the microphone position.

Project 553

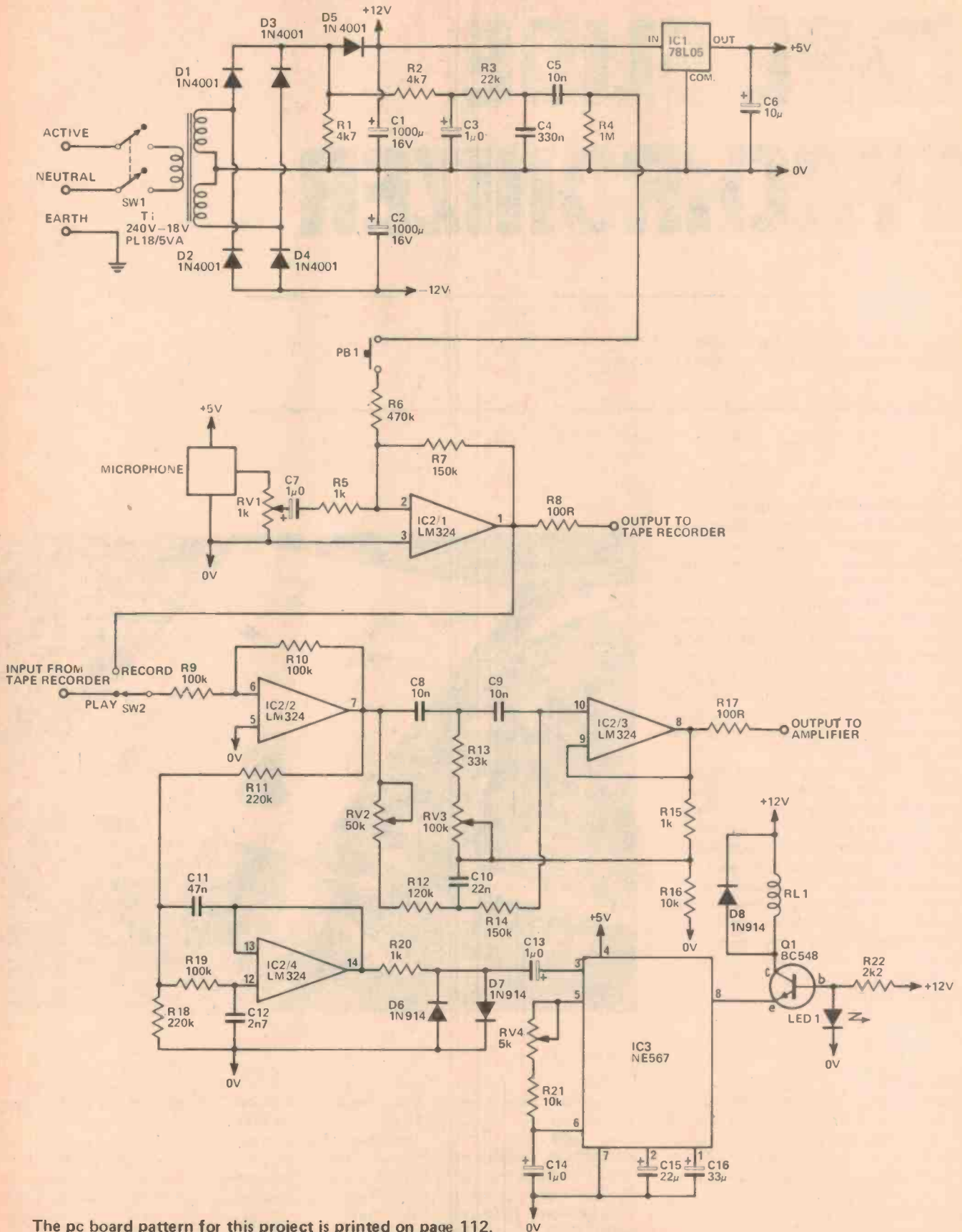

The pc board pattern for this project is printed on page 112.

HOW IT WORKS - ETI 553

With this unit, unlike our previous design, we record a 100 Hz tone burst on the same channel as the speech whenever we require a slide to be changed. The tone is derived by full wave rectifying the output of the transformer and filtering out the harmonics by R2,3/C3,4.

Pressing the slide change button mixes this tone with the output from the microphone which is amplified by IC2/1. This combined output is recorded on the tape.

In the record mode SW2 connects the output of IC2/1 to the buffer amplifier IC2/2. In the playback mode it connects the output from the tape recorder to the amplifier. The output of this amplifier is split into two paths. One of these is through a 100 Hz notch filter to IC2/3 effectively removing the 100 Hz tone without much change to the rest of the spectrum. This is used to drive an amplifier/speaker system.

The other path for the signal after IC2/2 is via a low pass filter IC2/4. This removes frequencies above 150 Hz and has a response as shown in fig. 3. When the 100 Hz tone occurs, this filter passes it, rejecting speech frequencies, and it is passed to IC3. This is a phase locked loop tone decoder and its output on pin 8 turns on when the correct frequency tone is received. The output stage of this IC is an open collector npn transistor which can sink but not source current. With no incoming tone this transistor will be off, preventing any emitter current in Q1, hence turning it off also. The voltage on the base of Q1 in this case will be set at 1.6 V by LED1. When a tone occurs the output of the IC will saturate to about 0.6 V, forward biasing Q1, turning it on, and closing the relay. The current in R22 is now bypassed into the base of Q1, giving about 1.2 V on the base. This is too low for the LED to conduct and it will go out.

The power supply is simply full wave rectified and filtered for IC2, and a 5 V regulator is used for the PLL IC and the microphone amp.

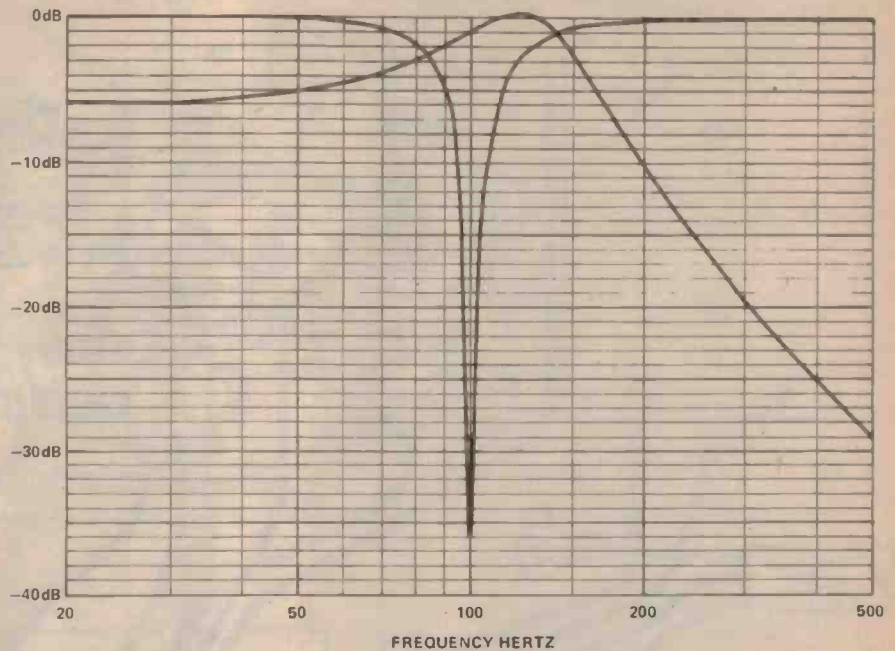

Using the Unit

With this unit a separate amplifier/speaker system is needed. Also the slide projector must have a remote change button using normally open contacts. Connection has to be made between these contacts and the relay in the unit. Check that these wires are isolated from the 240 V mains and if not be very careful with the connections.

Connect the unit to the tape recorder and projector, assemble the slides in the correct order and switch on. With the record/playback switch in the record position and the recorder set to record, commence the commentary, changing slides with the button on the unit. The high level input on the recorder should be used and the microphone level pot set to give the correct recording level.

When playing back simply set the record/playback switch to playback and replay the tape.

Adjustments

Set the unit up to record and with all trim pots at the centre of their travel and the microphone level at minimum, hold the slide change button down. Probably some 100 Hz signal will be heard on the output of the amplifier. Alternately adjust RV2 and RV3 to minimise this signal. It should be necessary to wind up the volume of the amplifier to finally adjust for a minimum level.

The other adjustment is of the phase locked loop centre frequency. With the push button pressed slowly rotate RV4 until the relay either opens or closes. If it closes, continue to rotate it until it drops out then bring the pot back to the half way point. If the relay opened, reverse the rotation to find the other point at which it opens and leave RV4 midway between these two points.

Check the operation of the relay when pressing the button. There should be about half a second delay before it closes.

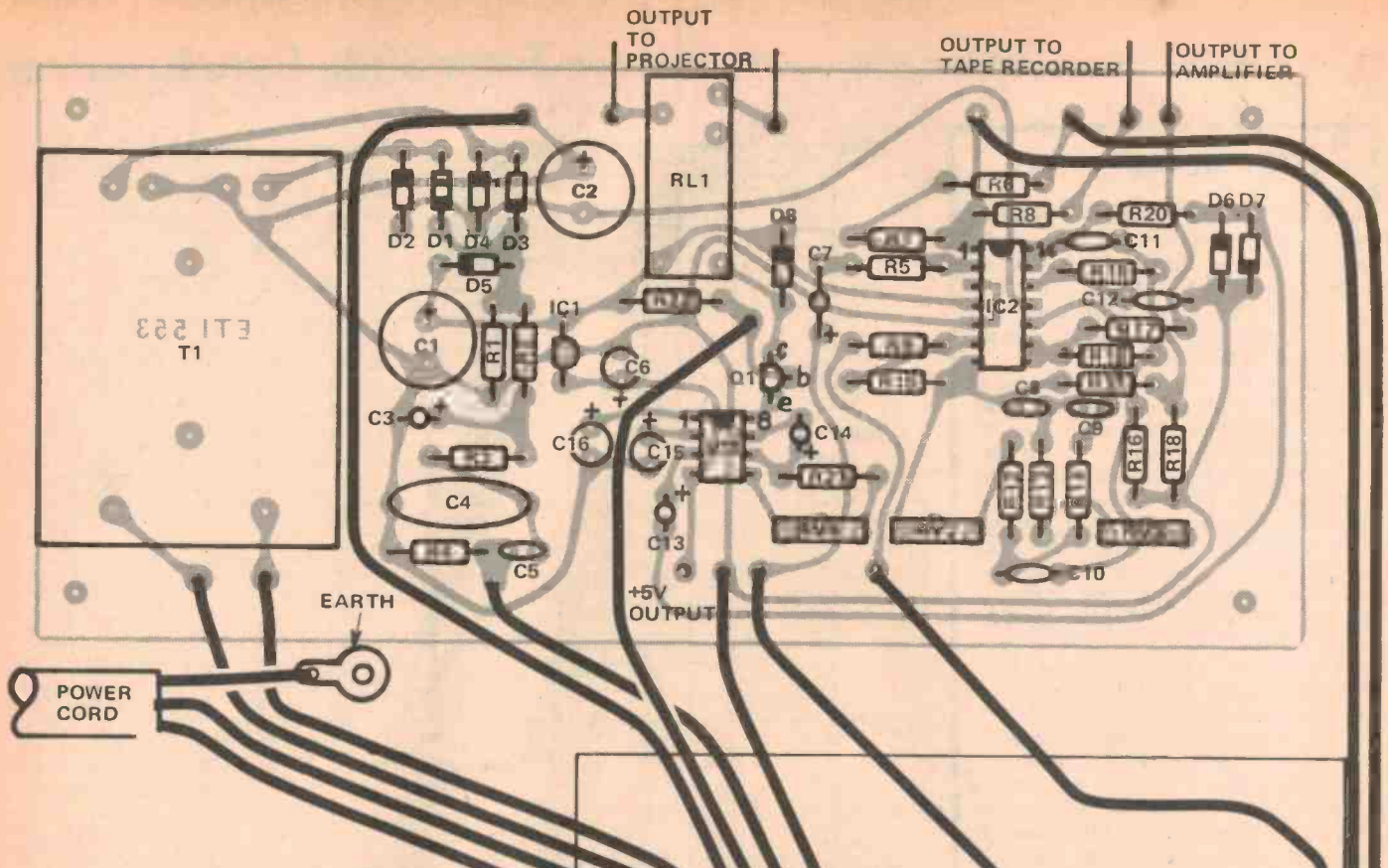

Fig. 3. The component overlay and wiring diagram.

PARTS LIST - ETI 553

Resistors all 1/2W, 5%

R1, 2	4k7
R3	22k
R4	1M
R5	1k
R6	470k
R7	150k
R8	100R
R9, 10	100k
R11	220k
R12	120k
R13	33k
R14	150k
R15	1k
R16	10k
R17	100R
R18	220k
R19	100k
R20	1k
R21	10k
R22	2k2

Potentiometers

RV1	1k log rotary
RV2	50k trim
RV3	100k trim
RV4	5k trim

Capacitors

C1, 2	1000µ 16V electro
C3	1µ0 25V electro
C4	330n polyester
C5	10n polyester
C6	10µ 25V electro
C7	1µ0 25V electro
C8, 9	10n polyester
C10	22n polyester
C11	47n polyester
C12	2n7 polyester
C13, 14	1µ0 25V electro
C15	22µ 10V electro
C16	33µ 10V electro

Semiconductors

IC1	78L05
IC2	LM324
IC3	NE567 (8 pin)
Q1	BC548
D1-D5	1N4001
D6-D8	1N914
LED	

Miscellaneous

- PC board ETI 553
- Relay 12V 280Ω
- Transformer 240V-18V (PL18/5VA)
- Two toggle switches
- One push button switch N/O
- Box to suit
- 3 core flex and plug
- Output sockets etc.

RADIO PARTS

VOLTAGE REGULATORS

LM300H T05 Voltage Regulator	\$3.60
LM304H T05 Negative Regulator	2.83
LM305H T05 Voltage Regulator	1.07
LM309H T05 5 Volt Regulator	2.61
LM309K T03 5 Volt Regulator	2.74
LM317T T0220 3 Terminal Adjustable Regulator	3.19
LM317K T03 3 Terminal Adjustable Regulator	4.59
LM320T T0220 Neg. 1 Amp Regulators 5, 6, 8, 12, 15, 18, 24 volt	2.74
LM320K T03 Neg. 1 Amp Regulators 5, 6, 8, 12, 15, 18, 24 volt	5.04
LM323K T03 Pos. 3 Amp — 5 Volt Regulator	7.09
LM340T T0220 Pos. 1 Amp Regulators 5, 6, 8, 12, 15, 18, 24 volt	1.59
LM340K T03 Pos. 1 Amp Regulators 5, 6, 8, 12, 15, 18, 24 volt	4.02
LM723CH T05 Voltage Regulator	1.20
LM723CN 14 Pin DIL Voltage Regulator	0.71

Prices include sales tax.

OPERATIONAL

AMPLIFIERS/BUFFERS

LH002CN 10 pin dill Current Amp	7.29
LH0042CH T05 low cost FET Op Amp	5.69
LM301H T05 Op Amp	0.69
LM301A 8 pin dill Op Amp	0.41
LM302H T05 Voltage Follower	3.83
LM307H T05 Op Amp	1.15
LM307N 8 pin dill Op Amp	0.66
LM308N 8 pin dill Op Amp	1.10
LM318N 8 pin dill Op Amp	3.17
LM324N 14 pin dill low power quad Op Amp	1.10
LM343H T05 high voltage Op Amp	8.13
LM348N 14 pin dill quad 741 Op Amp	1.50
LM349N 14 pin dill wide-band decompensated quad 741 Op Amp	2.30
LM358N 8 pin dill low power dual Op Amp	0.97
LM709CH T05 operational amplifier	1.10
LM709CN 8 pin dill Op Amp	0.82
LM741CH T05 operational amplifier	0.61
LM741CN 8 pin dill Op Amp	0.41
LM747CN 14 pin dill dual Op Amp	1.15
LN1458N 14 pin dual Op Amp	SC.82
LM3900N 14 pin dill quad amp	0.94
LM4250H T05 Programmable Op Amp	2.32

Prices include sales tax.

VOLTAGE COMPARATORS

LM311N 8 pin dill voltage comparator	0.89
LM319N 14 pin dill high speed dual comparator	4.54
LM339N 14 pin dill low power low offset voltage quad comparator	0.92
LM360H T05 high speed differential comparator	5.23
LM361H T05 high speed differential comparator	3.83
LM393N 8 pin dill low power low offset voltage dual comparator	1.25
LM710H T05 voltage comparator	0.94
LM711H T05 dual comparator	0.94

Prices include sales tax.

AUDIO, RADIO AND TV CIRCUITS

LM370N 14 pin dill AGC/Squelch amp	5.48
LM371H T05 integrated RF/IF amp	4.02
LM372H T05 AM IF strip	4.78
LM373H T05 AM/FM/SSB IF AMP/detector	6.18
LM374H T05 AM/FM/SSB IF video amp/detector	5.07
LM375N 14 pin dill oscillator and buffer with TTL output	5.74
LM377N 14 pin dill dual 2 watt audio amp	3.06
LM378N 14 pin dill dual 4 watt audio amp	3.24
LM379S 14 pin in line dual 6 watt audio amp	6.45
LM380N 14 pin dill audio power amp	1.73
LM381N 14 pin dill dual preamp	\$2.87
LM381AN 14 pin dill low noise dual preamp	4.59
LM382N 14 pin dill low noise dual preamp	2.23
LM384N 14 pin dill 5 watt audio power amp	2.55
LM386N 8 pin dill low voltage audio power amp	1.40
LM387N 8 pin dill dual preamp	2.63
LM388N 14 pin dill 1.5 watt audio power amp	1.72
LM1303N 14 pin dill stereo preamp	1.68
LM1304N 14 pin dill FM multiplex stereo demodulator	2.04
LM1305N 14 pin dill FM multiplex stereo demodulator	2.04
LM3085N 14 pin dill television sound system	1.61

Prices include sales tax.

FLUKE 8020A

Specifications:— Sensitivity: 3½ Digit Liquid Crystal Display (10 Meg all ranges); Dimensions: 180 x 86 x 45 mm; Power Requirement: 9 Volt Battery e.g. 216 Eveready (Further information available upon request). \$205.28 including sales tax.

ESTABLISHED OVER 35 YRS . . . NOW CARRYING IN EXCESS OF 12,000 LINES . . .

DOMINION PRO SERIES. HIGH QUALITY REGULATED POWER SUPPLIES

11 to 16 volts adjustable. Ideal where long continuous use and excellent regulation are required. All supplies are totally short-circuit proof.

NG3 3.5 amps — \$49.00 including tax. For CB, hobbyists, experimenters, school, etc. Input 240V AC, Output 11 to 16V DC, Regulation 0-3.5A 20mV. Ripple at 3.5 amps-4mV. Dimensions: 3¼" wide x 4½" deep x 6" high. Weight approx 5 lb.

NG7 6 amps — \$57.00 including tax. High power single side band CB radios, service bench repairs, 2-way radio base supplies. Input 240V AC, Output 11 to 16V DC, Regulation 0-6A 30 mV. Ripple at 6 amps-4mV. Dimensions: 5" wide x 5½" deep x 6" high. Weight approx 8 lb.

NG12 12 amps — \$115.00 including tax. Heavy duty model. Ideal for operating high power linear amps, hybrid 2-way radios, etc. Input 240V AC. Output 11 to 16V DC, Regulation 0-12A 10mV. Ripple at 12 amps-1.5mV. Dimensions: 10" wide x 5½" deep x 6" high. Weight approx 16 lb.

Manufactured by Radio Parts Group. Trade enquiries welcome.

MULTIMETERS

TMK VF4

Specifications:— Sensitivity: 2KΩ/Volt DC, 2KΩ/Volt AC; DC Voltage: 0.25V, 2.5V, 10V, 50V, 250V, 1000V; AC Voltage: 10V, 50V, 250V, 1000V; DC Current: 0-500 μA, 10mA, 250mA, 10A. Resistance: x1, x10, x100, x1K, (6,60,600,6K Centre Scale); Capacitance: 500 μF to 1 μF (in two Ranges); Decibels: —15 to plus 32dB (in four Ranges); Dimensions: 145 x 95 x 45 mm. \$21.27 including tax.

TMK TP5SN

Specifications:— Sensitivity: 20KΩ/Volt DC, 8KΩ/Volt AC; DC Voltage: 0.5V, 5V, 50V, 250V, 500V, 1000V; AC Voltage: 10V, 50V, 250V, 500V, 1000V; DC Current: 0-50 μA, 5mA, 50mA, 500mA; Resistance: x1, x10, x100, x1K (60, 600, 6K, 60K Centre Scale); Capacitance: 50 μF to 0.1 μF (in two Ranges); Decibels: —20 to plus 36dB; Dimensions: 135 x 95 x 40 mm. \$25.18 including tax.

TMK200

Specifications:— Sensitivity: 20KΩ/Volt DC, 10KΩ/Volt AC; DC Voltage: 0.6V, 6V, 30V, 120V, 600V, 1200V; AC Voltage: 6V, 30V, 120V, 600V, 1200V; DC Current: 0-100 μA, 6mA, 60mA, 600mA; Resistance: 0-10KΩ, 100KΩ, 1MΩ, 10MΩ; Capacitance: .002 μF to 0.2 μF; Decibels: —20 to plus 63dB; Dimensions: 130 x 90 x 35 mm. \$27.91 including tax.

TMK500

Specifications:— Sensitivity: 30KΩ/Volt DC, 13KΩ/Volt AC; DC Voltage: 0.25V, 1V, 2.5V, 10V, 25V, 100V, 250V, 1000V; AC Voltage: 2.5V, 10V, 25V, 100V, 250V, 500V, 1000V; DC Current: .05mA, 5mA 50mA 500mA, 12A; Short Test: Internal Buzzer; Decibels: —20 to plus 56dB; Dimensions: 160 x 85 x 70 mm. \$41.22 including tax.

NEW "SOLDER-EATER" DE-SOLDERING BRAID (1.8m) in cassette package. For standard PCB — Part No. 213. For miniature PCB — Part No. 214. \$1.60 each (exempt).

SINCLAIR PDM35

Specifications:— Sensitivity: 3½ Digit LED Display (10 Meg Input DC); DC Voltage: 1mV to 1000V (Four Ranges); AC Voltage: 1V to 500V (40 Hz-5 kHz); DC Current: 1 mA to 200 mA (Six Ranges); Resistance: 1Ω to 20 Meg Ω. (Five Ranges); Dimensions: 153 x 76 x 39 mm; Power: 9 volt Battery (e.g. 216 Eveready). \$61.89 including sales tax.

LIFE PANEL METERS

VT1 SERIES:

Ranges available: 0-50uA, 50-0-50uA, 0-100uA, 100-0-100uA, 0-200uA, 0-500uA, 0-1mA, 0-5mA, 0-10mA, 0-100mA, 0-500mA, 0-1A, 0-5A, 0-15A, 0-15V, 0-50V, DC, Full 0-300V AC. All one price \$7.36 ea. incl. sales tax.

VT2 SERIES

Ranges available: 0-50uA, 50-0-50uA, 0-100uA, 100-0-100uA, 0-200uA, 0-500uA, 0-1mA, 0-5mA, 0-10mA, 0-100mA, 0-500mA, 0-1A, 0-5A, 0-15A, 0-15V, 0-50V DC. All one price \$6.90 ea. incl. sales tax.

VT3 SERIES:

Ranges available: 50-0-50uA, 100-0-100uA, 0-200uA, 0-5mA, 0-10mA, 0-100mA, 0-500mA, 0-1A, DC Full 0-300V AC. All one price \$6.44 ea. incl. sales tax.

VT4 SERIES

Ranges available: 0-50uA, 50-0-50uA, 0-100uA, 100-0-100uA, 0-200uA, 0-500uA, 0-1mA, 0-5mA, 0-10mA, 0-100mA, 0-500mA, 0-1A, 0-5A, 0-50V DC Plus 0-300V AC. All one price \$5.98 ea. incl. sales tax.

Dimensional Diagrams

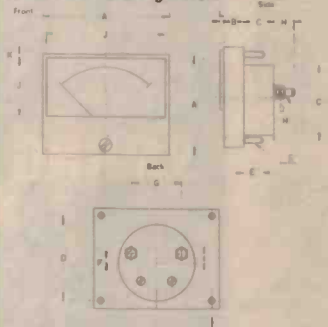

MODEL	VT-1	VT-2	VT-3	VT-4
A	86	78	56	46
A1	78	66	51	44
J1	50	42	31	26
C1	69	55.5	46	37.5
C	24	25	24.5	23.5
B	14	12	10.7	10.5
E1	13	13	10	10
E	3	3	3	2.3
H1	5	5	4	4
H	4	4	3	3
D	57	47.5	28	32.5
D1	57	48	(2 studs)	33

NOW MAKE METAL LABELS IN MINUTES . . . FOR LESS THAN 3c PER SQ. INCH!

Here's all you need: "SCOTCHCAL" Brand Photo-Sensitive Metal Label . . . your blueprint machine or a carbon arc lamp . . . and about 15 minutes per process. That's all it takes. No camera. No darkroom. No developing tanks. This system is at least 4 times faster than any other in-plant process. You get 6 mm aluminium nameplates, dial faces, schematics, instrument panels, any prototype or permanent metal labels — right!

INTRODUCTORY KIT: 8002 KA. Contains: 1 sheet of each of Metal/Plastic/8007 Film, 1 litre 8500 developer, 1 can 3900 Gloss Clear, 1 ML3 Applicator Block, 1 box ML4 Developer/Pads, 1 Sensitivity Guide, Full Instructions. \$52.90 Incl. sales tax.

METAL LABEL: (all prices include sales tax) 8001 RED: 250 x 300 mm 10 sheet pack, \$35.65. 300 x 600 mm 5 sheet pack, \$41.40. 600 x 900 mm 3 sheet pack, \$67.85. 600 x 1200 mm 2 sheet pack, \$59.80. 8005 BLACK: 250 x 300 mm 10 sheet pack, \$35.65. 300 x 600 mm 5 sheet pack, \$41.40. 600 x 900 mm 3 sheet pack, \$67.85. 600 x 1200 mm 2 sheet pack, \$59.80. 8009 LIGHT BLUE: 250 x 300 mm 10 sheet pack, \$35.65. 300 x 600 mm 5 sheet pack, \$41.40. 600 x 900 mm 3 sheet pack, \$67.85. 600 x 1200 mm 2 sheet pack, \$59.80.

PLASTIC LABEL: (all prices include sales tax) 8011 RED/WHITE: 250 x 300 mm 10 sheet pack, \$35.65. 300 x 600 mm 5 sheet pack, \$41.40. 600 x 900 mm 3 sheet pack, \$67.85. 600 x 1200 mm 2 sheet pack, \$59.80. 8012 BLACK/TRANSPARENT: 250 x 300 mm 10 sheet pack, \$35.65. 300 x 600 mm 5 sheet pack, \$41.40. 600 x 900 mm 3 sheet pack, \$67.85. 600 x 1200 mm 2 sheet pack, \$59.80. 8013 BLACK/YELLOW: 250 x 300 mm 10 sheet pack, \$35.65. 300 x 600 mm 5 sheet pack, \$41.40. 600 x 900 mm 3 sheet pack, \$67.85. 600 x 1200 mm 2 sheet pack, \$59.80. 8015 BLACK/WHITE: 250 x 300 mm 10 sheet pack, \$35.65. 300 x 600 mm 5 sheet pack, \$41.40. 600 x 900 mm 3 sheet pack, \$67.85. 600 x 1200 mm 2 sheet pack, \$59.80. 8016 BLUE/WHITE: 250 x 300 mm 10 sheet pack, \$35.65. 300 x 600 mm 5 sheet pack, \$41.40. 600 x 900 mm 3 sheet pack, \$67.85. 600 x 1200 mm 2 sheet pack, \$59.80. 8018 GREEN/WHITE: 250 x 300 mm 10 sheet pack, \$35.65. 300 x 600 mm 5 sheet pack, \$41.40. 600 x 900 mm 3 sheet pack, \$67.85. 600 x 1200 mm 2 sheet pack, \$59.80.

EXPOSURE FILM: (all prices include sales tax) 8007: 250 x 300 mm 10 sheet pack, \$21.28. 300 x 600 mm 5 sheet pack, \$26.45. 600 x 900 mm 3 sheet pack, \$36.80. 600 x 1200 mm 2 sheet pack, \$33.35.

ACCESSORY ITEMS: (all prices include sales tax) 8500 Developer: 1 litre, \$4.60 ea. ML3 Applicator Blocks: \$4.60 ea. ML4 Developer Pads: 100 sheet roll, \$4.03 per roll. 3900 Gloss Clear Coat Aerosol: 368 gm, \$6.90 ea. 3930 Matte Clear Coat Aerosol: 368 gm, \$6.90 ea. 8019 Protective Overlay Film: 10" x 12", 10 sheets, \$12.08. 12" x 24", 5 sheets, \$14.38. 10 S.G. Sensitivity Guide: \$7.48 ea. P.A. 1 Squeegee Applicator: 40c ea.

Further information available on request.
Notes: Metal & Plastic Label and Exposure Film in 600 x 900 mm and 600 x 1200 mm sizes will be available in single sheets at a later date.

Trade enquiries welcome

To: Radio Parts Group, 562 Spencer St., West Melbourne, (03) 329-7888.
1103 Dandenong Rd., East Malvern, (03) 211-8122.

Please send me

I am enclosing cheque money order

or please debit my Bankcard — Number

\$5 minimum order plus \$1 P&P. Orders in excess of \$25 freight free in Aust. Outside Aust. freight on. Write for our comprehensive Semi-Conductor price list.

Signature

Name

Address

P/Code

WOW! TV Games in glorious COLOUR

Here's top value: the very latest microprocessor-controlled TV games (like the ones you've seen in pubs & arcades worth hundreds of dollars!) giving not only full, living colour operation (on a colour set!) but fantastic, action games as well. Like tank battles. Car races. Bike stunts. And so on. You buy the basic control module (which includes the hand controllers) and then buy only those modules you want to play. It's fun for the entire family — and keeps the kids amused for hours!



Cat X-1160

\$59⁹⁰
CONSOLE ONLY

Batteries and game cartridges extra.

OPTIONAL GAME CARTRIDGES



10 game cartridge
Football, hockey,
squash, etc — all
in convenient
plug-in form.
Cat X-1162

Tank game cart.
Realistic warfare
between two tan-
ks. Includes obsta-
cles & mines.
Cat X-1164

Car Race cart.
Race against a
partner or test
your skill in a
speed trial.
Cat X-1165

Stunt Bike Cart.
Enduro, stunt,
motorcross or
drag in an exci-
ting package.
Cat X-1163

\$20 \$29 \$25 \$29

NEW! ECONOMY MAINS POWER ADAPTOR FOR TV GAMES:

9V, 200mA \$5⁹⁵

Top value in a mains power adaptor: at this price it's hardly worth buying batteries! Sturdy construction, fully approved by supply authorities. Ideal for Colour TV games as shown above, plus normal b&w models.

Compare at \$7.95 and more
Cat M-9514

WOT'S NEW? Micro Cassette Recorder

Here's our new recorder — ideal for businessmen, students, interviewers, etc. It's tiny — fits into the hand for easy one finger use — and has inbuilt microphone and auto level. These recorders have been among our more popular lines in the past: we're sure our new model won't be any different. Call in now if you want one to avoid disappointment!

COMPARE SIMILAR MODELS ELSE- **\$39⁰⁰**
WHERE FOR \$59 AND EVEN MORE!

CASSETTES TO SUIT:
30 Minute total play length
(15 minutes per side)
Cat C-3360 \$2.95



Cat A-4040

HO HO HO — CHRISTMAS COMETH!
Get your goodies from Dick Smith this Christmas!

WATCH THIS SPACE

AND FIND OUT WHAT YOU MISSED!
Each month, all of our stores feature an outstanding special which is actually **BELOW COST!** All you have to do is pop into your nearest store to find out what it is. N.B. — Specials are STRICTLY 'while in-store stocks last'. Don't miss out!
LAST MONTH:

A MELOS SWR/POWER/FIELD
STRENGTH METER FOR \$9.50
NORMALLY \$15.50

SAVING \$6⁰⁰

WHAT'S THIS MONTH'S SPECIAL?
CALL IN AND FIND OUT YOURSELF!

Now:

ALL-NEW

Super Dicktracer II

A new, more sensitive radar detector: the Super Dicktracer Mk 11. But the good news is it is still the same price as the old Dicktracer. Why spend a fortune on a radar detector when Dick has the Dicktracer Mk 11?

Cat A-8500

\$49⁵⁰



How's yours?

Cat Q-1370

\$6⁹⁰

Check out your CB or amateur antenna quickly and easily. You can tell what directional qualities your antenna has, and the relative field strength with reference to it or another source. It's the simplest form of check!
Now save \$3.00 — reduced from \$9.90!



SAVE 3⁰⁰

BARGAIN TV GAME IC'S: only few left!

DID YOU MISS OUT LAST MONTH? TV game experimenters — we have only a few of the fantastic AY-3-8500 TV game IC's left. We bought many thousand at a very special price — and they've nearly all gone! If you want to experiment with TV games now or in the future, grab a couple of these before they all go. At this price you can afford to: We sold huge numbers at the regular price of \$19.75 . . . now pay only \$3.75 — including the circuit diagrams. Definitely last chance . . . Hurry! Cat Z-6848

DICK SMITH'S 1978 CATALOGUE *FREE*

Contains a mind-boggling selection of products for electronics enthusiasts, car buffs, home handy-men and hi-fi fiends!

• HUGE 8 PAGE DATA SECTION •

As published in April 1978 Electronics Australia

Get you FREE copy: Send in the coupon TODAY!

Name

Address

State Pcode

INCREDIBLE BARGAIN LEDS

7 segment readouts:
brand new, prime
spec — as used by
Electronics Australia.
LT303 common cathode — exact equiv.
to Texas TIL313 and H/P 5082-7740.

BUY NOW AND SAVE:

\$1.30 each
10+ Cat Z-4103
(OR \$1.50 IN SINGLE QUANTITIES)

LED INDICATORS AT BARGAIN
PRICES, TOO!

Prime spec devices, hundreds
of uses. Be quick for these!
Small red — Cat Z-4010
Large red — Cat Z-4030

20¢ each
10+
or 22c each



Start your own CB service business

Servicing TV sets, etc? Expand your business into the highly profitable CB service area with a minimum of extra equipment. Watch your turnover grow!

This CB transceiver tester is all the average serviceman will need. Use in conjunction with your present test equipment for just about every check you need to make on CB radios.

Cat Q-1380 **\$59⁵⁰**



and for the pro...

We have available just a few of the incredible 'Sencore' CB analyzers. These units do just about every test you could want on a CB — cut servicing time into a fraction. And we're prepared to sacrifice them at a fraction of their true value. Interested? Contact Gary Johnston at our Sydney head office for more details.

NOW WE ARE 10

Yes! Dick Smith Electronics started back in August 1968 from a tiny shop in a car park. Now, ten years later, we have stores in 3 states plus dealers in every major area of Australia. 10 years of reliable service to the electronics enthusiasts of Australia is your guarantee. This Dick Smith bloke is here to stay!

PARTS FOR NEW KITS

TANK TV GAME (See October ETI)
Complete kit, including instructions ... Cat K-34/5 .. \$39.50
SEPARATE PARTS:
PCB (only) ... Cat H-8620 .. \$3.85
AY-3-8710 IC .. Cat Z-6856 .. \$17.50
Fully built RF modulator .. Cat K-6040 .. \$3.00
Fully built audio modulator .. Cat K-6042 .. \$4.50

MODEL TRAIN CONTROLLER (See October EA)
Not produced as a kit - all parts available from stock:
PCB only .. Cat H-8355 .. \$3.75
Zippy box .. Cat H-2752 .. \$3.75
2N3055 transistor .. Cat Z-2145 .. \$0.95
2N3053 transistor .. Cat Z-2130 .. \$0.80

VARI WIPER Mk 2 (See September ETI)
Not produced as a kit - most parts available from stock:
Relay .. Cat S-7125 .. \$4.80
C106Y1 SCR .. Cat Z-4315 .. \$1.00
2N2646 (DS2646) unijunction .. Cat Z-1786 .. \$1.20

UNIVERSAL MOVIE MIXER (See September E.A.)
Complete kit, including instructions ... Cat K-3492 .. \$49.50
SEPARATE PARTS:
PC Board (only) .. Cat H-8354 .. \$2.95
50k A curve 45mm slider pot .. Cat R-1980 .. 85c
Knobs to suit slider pot .. Cat H-3780 .. 40c

FET INPUT AC-DC VOLTMETER (See September E.A.)
Not produced as a special kit - all parts available ex stock:
PC Board only .. Cat H-8353 .. \$2.75
1mA MRA 658 Panel Meter .. Cat Q-2060 .. \$12.50
Fabricate your own meter scale using the Scotchcal process:
8005 black Scotchcal photo sensitive aluminium .. Cat H-5694 .. \$6.00
CA-3140 FET op-amp .. Cat Z-5417 .. \$2.50

DIGITAL DIAL (See September E.T.I.)
Not produced as a special kit - most parts available ex stock.
PC Boards:
ETI 550 .. Cat H-8619 .. \$2.20
ETI 591 A/B (suit special Dick Smith LT-303 7 segment displays) .. Cat H-8617 .. \$4.00
ETI 591 C (suits yellow M/P 5082-7663 displays) .. Cat H-8618 .. \$1.80
ICM 7217A up-down counter IC .. Cat Z-5416 .. \$16.00
5082-7663 yellow 10.9mm 7 segment display .. Cat Z-4160 .. \$4.50
LT-303 red 7.6mm 7 segment display .. Cat Z-4103 .. \$1.50

LIGHT SHOW CONTROLLER
Not produced in kit form - most components normal stock.
UPGRADED 40/200MHz FREQ. COUNTER (See August E.A.)
Same style as previous kit, but new circuitry means it is easier to build, set up and is more sensitive. Basic counter is 40MHz - by adding a single 95H90 IC the range is extended to 200MHz. Complete kit for 40MHz, inc. instructions. Cat K-3437 .. \$99.50
95H90 IC to extend range to 200MHz ... Cat Z-5360 .. \$12.50
SEPARATE PARTS:
PC Boards (set of two top quality boards) .. Cat H-8346 .. \$8.50
MC-10115C IC (tristate differential amplifier) .. Cat Z-5415 .. \$1.95
MM 5369M IC (oscillator - divider) .. Cat Z-5761 .. \$3.50
74C925 IC (4 digit counter) .. Cat Z-5414 .. \$12.00
3.579545MHz crystal (new low price!) .. Cat K-6031 .. \$3.00
LT-303 7 segment display .. Cat Z-4103 .. \$1.50
All other components are normal stock lines at all of our stores.

PHOTO TACHOMETER (See August E.A.)
Although we do not produce a full kit for this project, all parts are normal stock lines at all of our stores.
PCB (only) .. Cat H-8352 .. \$1.80
FPT100 phototransistor .. Cat Z-1950 .. \$2.00

UTILITY TIMER (See August E.A.)
Again, not produced as a special kit - all parts are normal stock lines.
PCB (only) .. Cat H-8345 .. \$3.50
6V buzzer .. Cat L-7009 .. \$1.75
Zippy box case .. Cat M-2753 .. \$1.95

NEW 10 GAME TV GAME KIT (See July E.A.)
Complete kit, including instructions ... Cat K-3491 .. \$49.50
SEPARATE PARTS:
PCB (only) .. Cat H-8344 .. \$3.95
Fully built RF modulator .. Cat K-6040 .. \$3.00
Fully built audio modulator .. Cat K-6042 .. \$4.50
AY-3 8600 IC .. Cat Z-6852 .. \$15.00

LOOK FOR YOUR FREE 'BONUS SALE' MAILER IN THE OCTOBER ISSUE OF ELECTRONICS TODAY AND CB ACTION - AND SAVE A BUNOLE!

IMAGINE BUILDING YOUR OWN WATCH!

Now, Dick Smith brings computer technology to the people! This electronic digital watch kit comes complete with all components, batteries, watchband, etc - and complete instructions showing how anyone can assemble it in just a few minutes.

JUST THINK: YOU CAN TELL ALL YOUR FRIENDS THAT YOU BUILT IT YOURSELF!

12⁵⁰

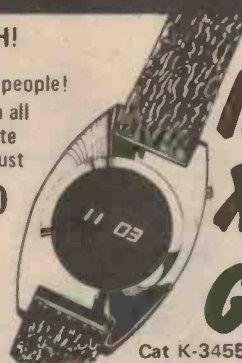

Cat K-3455

IDEAL XMAS GIFT!

SPARE BATTERIES: Pack of 2 ultra-high reliability silver oxide batteries: Cat S-3295 .. \$1.95

LOOKING FOR A SPECIAL SEMI?

We have so many things to tell you about, we often forget our life-blood: semiconductors! Don't forget - we have always tried to help the hobbyist with a large range of special and general purpose semiconductors - and we aim to keep helping you!

ONE IC RADIO Build a radio with one IC and a sprinkling of other components. **\$3⁹⁵**

ZN-414 IC Radio - Cat Z-6520

OPTO COUPLERS Ideal for all circuits where electrical isolation is required. **\$1⁵⁰**

4N28 Optic Coupler - Cat Z-4804

TACHO CHIP Build a tacho using this IC - makes the circuitry simple! **\$3¹⁰**

SAK140 Tacho - Cat Z-6230

VOLTAGE REG Make voltage regulators simply - only 3 connections. **\$1²⁵**

7805, 12 & 15 Regulators - Cat Z-6545, 6552, 6554

CLOCK CHIPS 6 digit, 12 or 24 hour, 50 or 60 Hz. A versatile chip for clock builders. **\$5⁹⁰**

MM5314 Clock - Cat Z-6814

TRANSISTORS We have just about every transistor you'll ever need!

TIMER CHIPS The famous NE555 has so many uses - very handy to have around! **40^c**

NE555 Timer - Cat Z-6145

OP AMPS Keep a couple of 741 op amps in the junk box - you never know ... **60^c**

741 Operational Amplifier - Cat Z-6382

AUDIO AMPLIFIER 5 watt audio amp on a single chip - versatile! **\$2⁰⁰**

LM380 Audio Amp - Cat Z-6080

GAS SENSORS Build a gas sensor that might one day save your life. Petrol, LPG, etc. **\$8⁹⁰**

Figaro TGS 812 - Cat Z-6860

BUCKET BRIGADE The 20th century way to make delay lines, reverb, etc. **\$13⁵⁰**

MN3001 Bucket Brigade - Cat Z-6132

VALVES Top quality from the world's leading manufacturers ...

DICK SMITH ELECTRONICS



SYDNEY 125 York Street, SYDNEY. Ph. 29-1126
147 Hume Hwy, CHULLORA. Ph. 642-8922
162 Pacific Hwy, GORE HILL. Ph. 439-5311
30 Grose Street, PARRAMATTA. Ph. 683-1133

MELBOURNE 399 Lonsdale Street, MELBOURNE. Ph. 67-9834
656 Bridge Road, RICHMOND. Ph. 42-1614
BRISBANE 166 Logan Road, BURANDA. Ph. 391-6233
ADELAIDE 203 Wright Street, ADELAIDE. Ph. 212-1962

MAIL ORDERS P.O. Box 747, Crows Nest, N.S.W. 2065. Post and packing extra.

Dealers across Australia.

MAJOR DICK SMITH DEALERS:

Overland Communications 11/53 Wollongong St, Fyshwick, ACT. Ph 80-4307
Trilogy Elect. Supplies 52 Princes Hwy, Wollongong NSW. Ph 83-1219
Sound Components 78 Brisbane Street, Tamworth NSW. Ph 66-1363
Mitel Hr Fi 145 Queen Street, St Marys NSW. Ph 623-4442
Don House Electronics 2 Merriwa Street, Gordon NSW. Ph 498-1398
DGE Sales 44 Brown Road, Newcastle NSW. Ph 69-1222
M&W Electronics 48 McNamara Street, Orange NSW. Ph 62-6491
Double Diamond 18 Russel Street, Goulburn NSW. Ph 21-5440
G.M. Electronics 99 Fitzmaurice Street, Wagga NSW. Ph 21-3044
Rivercom 9 Copland Street, Wagga NSW. Ph 21-2125
Brian Bambach Electronics 68 William Street, Gosford NSW. Ph 24-7246

Capital Coast Elect. GCG Communications
The Elect. Hobby Centre Premier Sound
Summer Electronics Aero Electronics
Devon Electronics A. E. Cooling
Hutchesson's Communic. Altronics
BP Electronics

Unit 11, Commercial Centre, Ford St, Moruya NSW. Ph 74-2545
385 Mulgrave Rd, Cairns QLD. Ph 54-1035
1045 Gold Coast Hwy, Palm Beach, QLD. Ph 34-1248
239 Musgrave St, Rockhampton, QLD Ph 27-4004
97 Mitchell Street, Ben Lurgon VIC. Ph 43-1977
123A Bathurst St, Hobart TAS. Ph 34-8232
45 Ashburner St, Devonport TAS. Ph 24-4216
Town Centre, Peoples St Bldg, Elizabeth, SA. Ph 255-9196
5 Elizabeth Street, Mt Gambier, SA. Ph 25-6404
105 Stirling Street, Perth WA. Ph 328-1599
11 Duke Street, Albany WA. Ph 41-2681

GRACE BROS

Broadway - Bondi - Chatswood - Liverpool
Miranda - Mt Druitt - Parramatta - Roselands
and Warringah Mall



SHOPS OPEN 9AM to 5.30PM
(Saturday 9AM - 12 noon)
BRISBANE 1/2 Hour earlier

ANY TERMS OFFERED ARE TO APPROVED APPLICANTS ONLY

Many lines available from the Dick Smith Electronics Centres at

TV TANK GAME

'Fun for all the family', is the phrase that comes to mind — but you can have even more fun by building it yourself!

MANY DIFFERENT types of TV games have appeared over the past few years, however few continue to hold the player's interest as long as this one. The 'TV Tank Game' has been designed for two players, each of whom has a completely steerable tank with forward and reverse speed control, clockwise and anticlockwise rotation and a firing button. The tanks are also provided with delays on the movement and firing as well as variable speed to add realism. Anti-tank barricades and mines have been placed in the battlefield to retard the progress of each tank across the screen. The score is kept for each tank above the battlefield and the object of the game is to score as many direct hits on the enemy as possible. The first player to score 16 hits wins the game.

The heart of the game is the AY-3-8710 integrated circuit which is designed to operate from a battery supply with a minimum of components. All the game functions are provided by this IC.

Tank Control

When the forward or reverse button is pressed, the tank will move in the selected direction at low speed. If the button is held down, medium speed will be selected after half a second, and high speed half a second after that. Releasing the button at any speed will cause the tank to continue at that speed. To stop the tank the button for the opposite direction is pressed momentarily.

Rotation either clockwise or anticlockwise is possible when the tanks are moving or stationary.

Firing

Shells can be fired approximately once every four seconds and refire requires release and re-operation of the button. Attempting to fire during the four second delay time will give the firing sound effect, but a shell will not actually be fired.



Rotating the tank while the shell is in flight will cause the shell to follow a curved trajectory in the direction of rotation — even around barriers. The range of the shell is approximately two thirds of the screen depth or width, depending on the firing angle. Gunfire sounds accompany the firing and shell burst sounds are produced when a shell reaches the end of its range or hits a barrier, border or the enemy tank.

Barriers

Barriers can be of two different types. There are 22 fixed terrain barriers on the battlefield and provide protection from shells. Tanks cannot pass through these barriers when the interaction is selected. Six mines are distributed on the battlefield which, when hit, cause a tank to explode and become stationary with its gun inactive for a period of 2 to 4 seconds. The mine then vanishes for the remainder of the game. A mine being hit scores for the enemy tank.

Explosions

Explosion patterns are produced when a

shell is at the end of its range or when the shell makes contact with a barrier. A tank will explode and fragment momentarily when it hits a mine or is hit by a shell. Suitable explosion sounds are produced when a tank hits a mine or is struck by a shell.

Engine Sounds

Four engine sounds are produced, one for each of the speeds and one for the stationary position.

Scoring

Separate scores, one white and one black, are placed above the battlefield for each player. A player's score is incremented when his tank scores a hit on his opponent or his opponent's tank hits a mine. The game ends when one player scores 16, at which time the score flashes.

Reset

The game is reset and the scores are set to zero when the reset button is pushed. The mines are replaced and the tanks are reset to their starting positions.

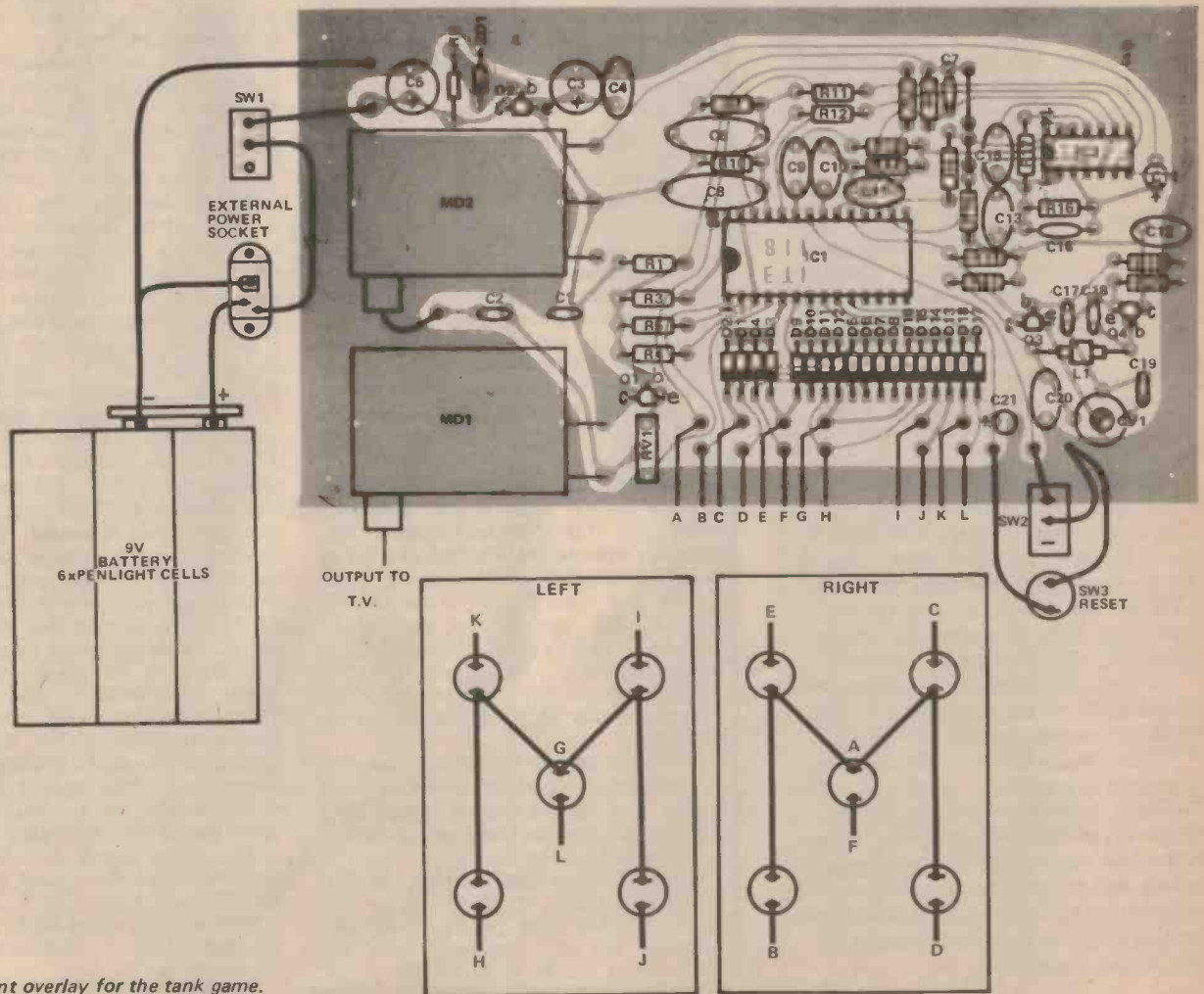
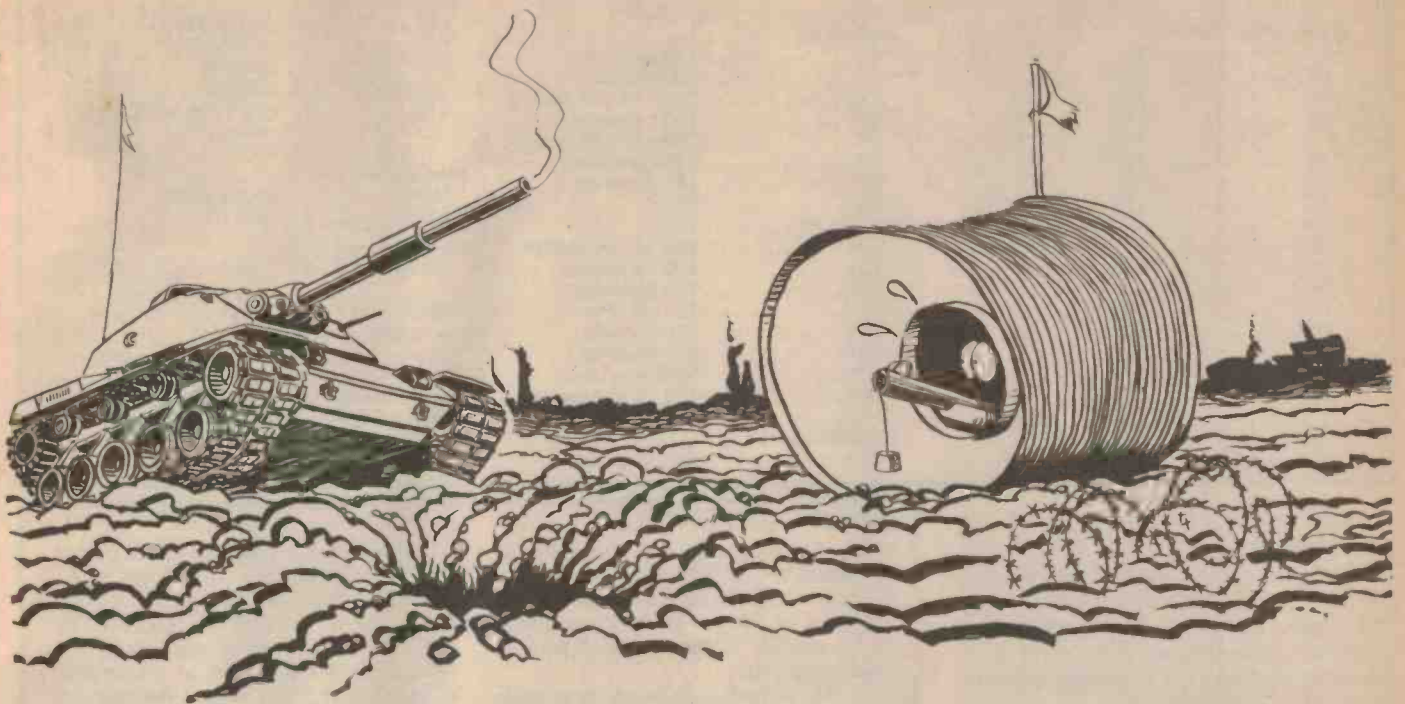

Fig. 1. Component overlay for the tank game.

PARTS LIST – ETI 811

Resistors all ¼ W 5%

R1	1k
R2	270R
R3	10k
R4	1k5
R5	2k2
R6	100R
R7	1M
R8	10k
R9	18k
R10	1M
R11,12	4M7
R13	10k
R14	4M7
R15	47R
R16	10k
R17	22k
R18	4k7
R19	100k
R20	470R
R21	100k

Potentiometer

RV1 1k lin mini trimpot

Capacitors

C1	1n0 ceramic
C2	100p ceramic
C3	100µ 16 VW electro
C4	100n greencap
C5	100µ 16 VW electro
C6	270n greencap
C7	10n greencap
C8	270n
C9 - C13	100n
C14	25µ 16 VW electro
C15	100n greencap
C16	47n greencap
C17	10n ceramic
C18	33p ceramic
C19	47p ceramic
C20	100n greencap
C21	4µ7 16 VW electro

Variable Capacitor

CV1 60p trimmer

Semiconductors

IC1	AY-3-8710
IC2	4001BCN
Q1 - Q4	BC549
D1 - D18	1N914
ZD1	7V5 400 mW zener diode

Modulators

MD1	1082 AUS
MD2	UM1263

Miscellaneous

SW1,2	SPDT miniature toggle switches
SW3 - SW13	SPST push buttons
pc board	ETI 811
28 pin IC socket, six way AA size battery holder, battery clip, length of 75 ohm coax, Belling Lee-type plug, RCA plug, external battery socket, length ribbon cable, plastic box 195 x 113 x 60 mm, two plastic boxes 80 x 53 x 29 mm.	

Construction

The printed circuit board is housed in a plastic box with a metal top panel for the reset, power and interaction switches. Ribbon cable is used for the connections from the two small control boxes to the main unit.

Firstly, mount the components onto the pc board with the help of the overlay in fig. 1. Note that the overlay is viewed from the component, or fibreglass, side of the board. The capacitors C3, C4, C14 and C21 are electrolytics and must be inserted in the correct polarity. The transistors, diodes and the two ICs must also be correctly positioned.

It is recommended, though not essential, that sockets be used for the two ICs. If a 28 pin socket is not available for the main IC, Molex or Soldercon connectors can be used instead. Cut the connector strip into two lengths of 14 pins and solder them into the board. By carefully flexing the connecting strip back and forth, it can be removed, leaving only the pins. The IC can now be carefully inserted.

The two modulators are also mounted on the pcb and a short length of wire is used to connect the output of MD2 to the pcb track. To attach this, remove the cover of MD2 and pass the wire through the centre of the output connector and solder it to the connector's internal solder terminal.

To simplify assembly, all the external connections to the pcb are to pc pins soldered into the board.

Once assembled, the pcb can be mounted into the box. A 15 mm hole is drilled in the back and the output socket of MD1 mounted through it (see photo). Holes are also drilled for the external power socket, and the ribbon cable to the control boxes. Four small holes are drilled in the base and the pc board mounted on spacers.

HOW IT WORKS – ETI 811

Most of the operations in this game are performed by the main IC. Since it would be much too complex to describe the operation of this IC, we shall concentrate on the external circuitry required for it to operate correctly.

A TV picture is made up by a single beam of electrons hitting a phosphorescent screen which is scanned in horizontal lines, with each successive line just under the previous one. By varying the intensity of the beam the brightness of the screen can be varied. With the Australian system each horizontal line takes 64µs (i.e. 0.000064s) and every 312½ lines the beam reverts back to the top of the screen; the second "frame" fits between the first set of lines making up the total picture of 625 lines. So that the TV knows when to start the scan and to start each line, a series of pulses must be provided together with the picture information.

A pulse is needed every 20ms to give this synchronisation. These pulses are negative-going and the line sync is 4µs long while the frame sync is 250µs long. The IC gives the combined sync on pin 18. To simplify the design only 312 lines are used per frame, however this is accepted by the TV set.

All the internal timing pulses for the IC are derived from a high frequency oscillator, (4.09 MHz). Transistor Q4, together with the tuned circuit L1 - CV1, forms a Colpitts oscillator giving a distorted sine wave output at its emitter. Because this waveform is not square enough to feed to the IC, it is fed to Q3, a class C amplifier. The output from this amplifier is still not square but has a fast rise time which the IC requires for correct operation.

The movement of the tanks is controlled by the switches SW4 to SW13 which feed strobed control signals from pin 4, (tank 1 strobe), and pin 24 (tank 2 strobe), via D1-18 to the IC.

Video information appears at five different outputs of the IC. These are: pin 2 - background, pin 3 - composite blanking, pin 18 - composite sync, pin 27 - right player tank, pin 28 - left

player tank.

Because each output contains a part of the total information they have to be added together. This is done by a video mixer (R2 to R5) and the output of this mixer is fed to a buffer stage (Q1). The voltage of the waveform at the emitter of Q1 is 0.6V lower than at the base but has a lower impedance suitable to drive the modulator, (MD1). The TAB pot (RV1) controls the signal level to the modulator and is used to set the background grey level.

The video modulator contains its own oscillator running at the frequency of the TV channel used for the display. The video information is superimposed onto this carrier and fed to the TV set via the output socket and the 75 ohm cable.

So far we have only explained the operation of the video and timing circuits. Outputs are also provided for sound effects of tank engines, shell firing and explosions. These outputs appear at: pin 20 - explosion and gun fire, pin 21 - tank 1 motor sound, pin 23 - tank 2 motor sound, pin 25 - gunfire envelope and pin 26 - explosion envelope.

The output of gunfire and explosions continually appears at pins 25 and 26 and is fed to two sections of a NOR gate package, IC2/2 and IC2/3. Pin 20 is then held down to 0V each time a firing or explosion sound is wanted, which causes a pulse of sound envelope to appear at the output of the NOR gate. The motor sounds from each tank from pin 23 and pin 21 are added together, fed to IC2/4 and the resultant sound from this NOR gate added to the firing and explosion sounds. The sound is then shaped by IC2/1, the pitch being varied by the selection of R16 and C16. Audio is then coupled to the sound modulator (MD2), which is a 5.5 MHz modulated oscillator which provides the 5.5 MHz sound sub-carrier for the video modulator, (MD1).

The power supply is a conventional series regulator using a zener diode (ZD1) and a series transistor (Q2). The voltage at the emitter of Q2 is about 0.6V below the zener voltage. Resistor R6 supplies the bias current for the zener.

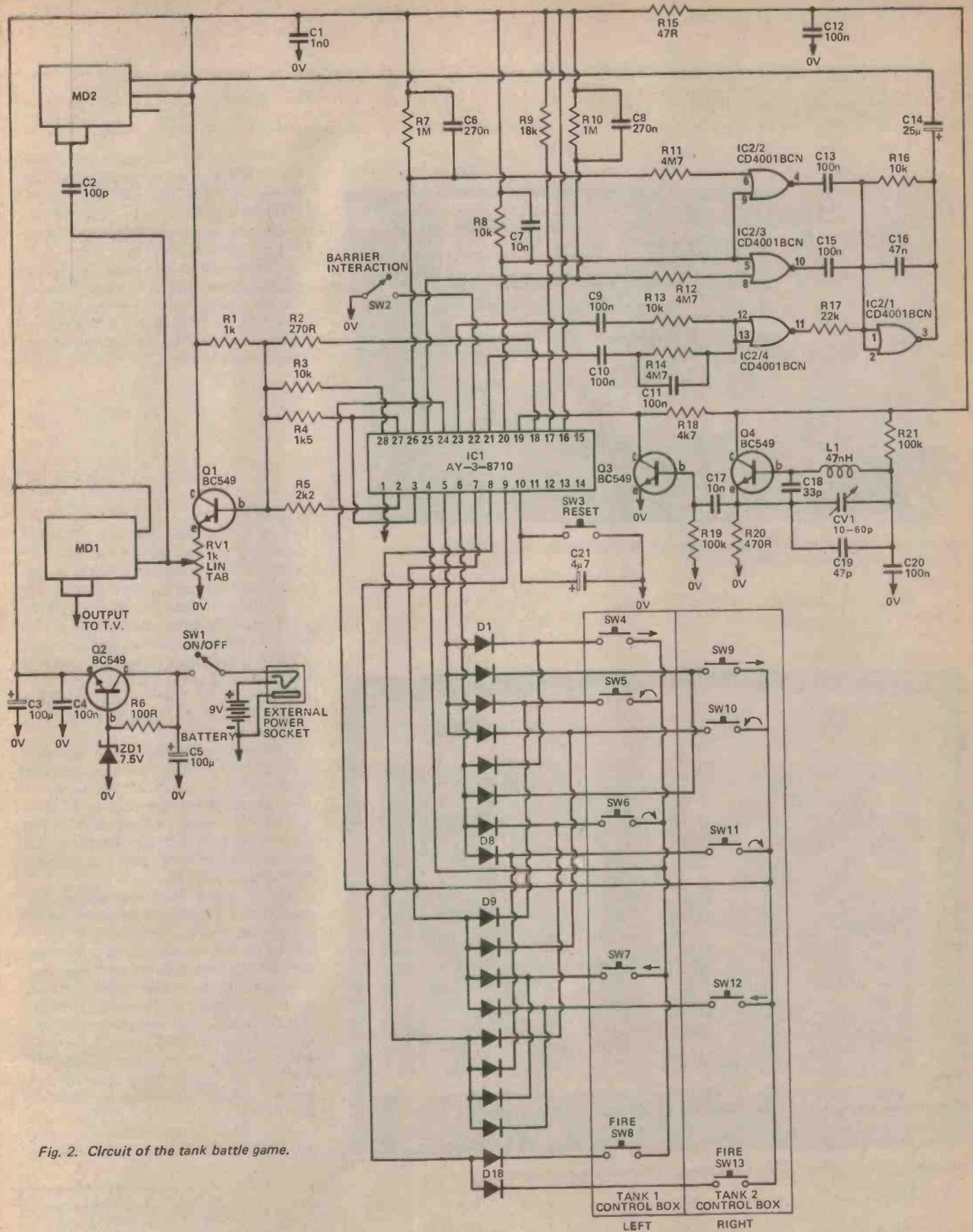
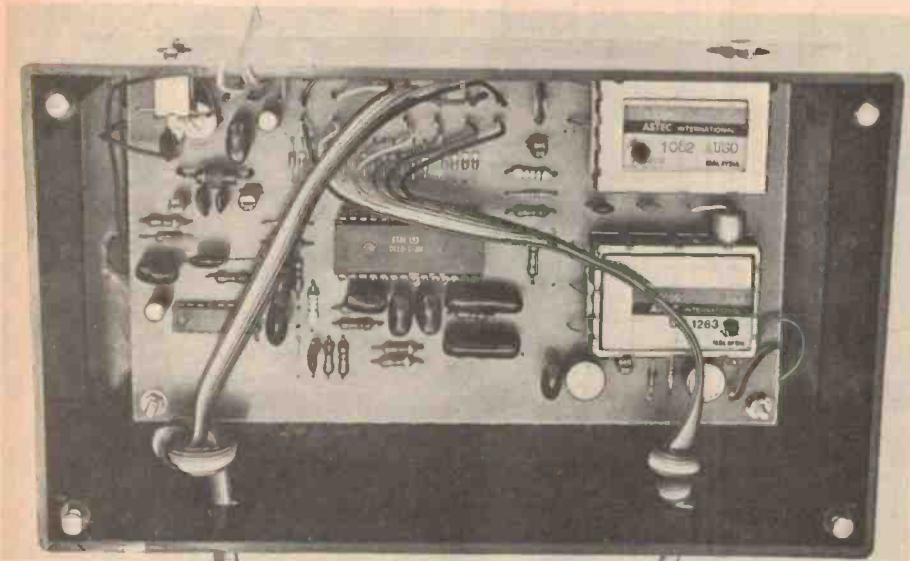
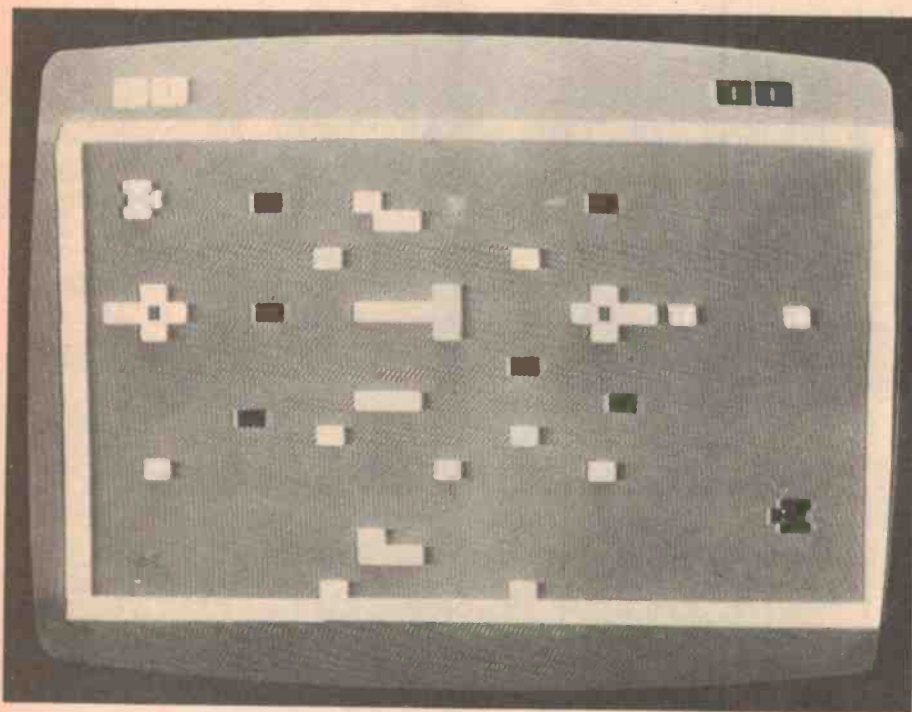

Fig. 2. Circuit of the tank battle game.



The completed unit. Note the position of the pcb flush against the rear of the box so the output connector can pass through it.



The battlefield as it should appear on the screen after the setup adjustments.

After the three switches have been assembled on the front panel they can be connected to the unit with about 150 mm lengths of wire. The battery holder can be placed inside the box in any convenient position.

The next step is to assemble the two control boxes and drill a hole in each for the ribbon cable. The switches are wired to the pc board, via the ribbon cable, as shown by the figures on the component overlay.

Setting Up

Before turning the unit on, doubly check that all the components are in the correct positions and that the transistors, diodes and ICs are the right way round.

Connect the unit to the TV set with a length of 75 ohm coaxial cable. If your set does not have a coaxial input a balun transformer may be necessary to match the 75 ohm output from the game to the 300 ohm input of the television. Set the trimpot RV1 to about mid-range.

When the unit is turned on and the television is tuned to the channel number stamped on the top of the video modulator (MD1), the picture on the screen will probably be unsynchronised. By turning CV1 with a screwdriver, the picture should 'lock' and the battlefield should appear.

By adjusting the trimpot RV1 in conjunction with the brightness control on the set, the background grey level can be set for the best picture. Hitting the reset button will initiate the game.

Next, adjust the fine tuning control on the television so the sound effects can be heard. The sound modulator (MD2) has an internal preset adjustment which can be used in conjunction with the fine tuning control to achieve the correct sound. However, this should not be necessary.

This concludes the setting up — your game should now be ready for play.

A complete kit of parts for this project will be available from Dick Smith Electronics.

Study in a classroom with only one student: You

The great way to learn

We all tend to think of learning as something done in a classroom. With a teacher at a blackboard. And many students competing for his attention. Because this is the way we learnt at school. But experience has shown that the value of this kind of teaching decreases as we get older. Because each of us learns best at our own pace. In a big class, you are tied to the average pace. It may be too fast or too slow. And you don't always have the chance to ask your questions — or get the answers you want. ICS offers you the great way to learn: supervised independent study. A program of learning that is supervised by your tutor, an expert in the field you have chosen. And your study is independent of any other student — so you don't compete for attention.

A carefully constructed course that's easy to understand.

Every course offered by ICS has been constructed in sections. At regular intervals, you complete test papers which your tutor grades and returns to you with his comments. You move on to the next section only when you, and your tutor, are satisfied you have completely understood the previous section. Your tutor guides you all the time.



9 million people can't be wrong. In the years since ICS was founded, almost 9 million men and women have received tuition, in hundreds of different subjects. Some came to ICS because they wanted to increase their ability to earn money. Others wanted to achieve greater job satisfaction, or a better understanding of subjects away from their regular line of work.

CLIP AND MAIL THIS COUPON TODAY!

Listed below are the major categories you can choose to study through ICS. There are many related courses in each one, ranging from single subjects to full diploma courses.

- Automotive Servicing
- Civil and Structural Engineering
- Electrical Engineering
- Mechanical Engineering
- Drafting
- Electronics
- Sales and Marketing
- Colour TV Servicing
- Air Conditioning and Refrigeration
- Business Management
- Hotel/Motel Management
- Accountancy
- Building and Architecture
- Advertising and Public Relations
- Computer Programming and Data Processing
- Institution of Fire Engineers
- Writing
- Art
- Secretarial
- Interior Decorating
- Photography

ICS International Correspondence Schools
 400 Pacific Hwy, Crows Nest, NSW. 2065. Tel: 43 2121
 18-20 Collins St, Melbourne, VIC. 3000. Tel: 63 7327
 New Zealand: 182 Wakefield St, Wellington.

Yes! I'd like a secure future with better pay!

Please send me without charge or obligation, the ICS Career Guidance Kit which tells me everything I need to know about being trained by ICS for bigger pay and a better future in the career marked .

MR/MRS/MISS _____

ADDRESS _____

POSTCODE _____

OCCUPATION _____ AGE _____

Tick here if full-time student

ELECTROCRAFT PTY LTD

68 Whiting St., Artarmon. 2064. Ph. 438-3266.
TRADE AND WHOLESALE SUPPLIED

Spirals.....	\$3.81
Caravan Antennas.....	\$13.70
FM ANTENNA'S	
Channelmaster 7.el H. Gain.....	\$19.68
Hills FM1 Local.....	\$9.35
Hills 353 3.el Met.....	\$14.23
Matchmaster FMG/2 Semi fringe.....	\$18.30
Matchmaster FMG/6 Outer fringe.....	\$40.93
T.V. ANTENNA'S	
Hills outer fringe CA.16 phase array.....	\$48.28
Hills 215 (Australia's best selling high gain 8.el antenna at a new low price).....	\$25.29
Hills EFC.3 (The best of the colour 75 ohm antennas very high gain, good anti-ghosting).....	\$62.41
Channelmaster 3111A 300-75ohm. (metropolitan Anti ghosting antenna).....	\$41.98
Channelmaster 3110 300-75ohm local anti ghosting.....	\$27.96
Belling Lee plugs.....	80c
Belling Lee Coaxial wall sockets.....	\$1.75
R.F. Amplifiers. Mast-head & Distribution for FM & TV from	
16dB Ecraft.....	\$45.00
25dB Ecraft.....	\$53.55
Hills MH1 Masthead 300 ohms.....	\$61.00



SPECIFICATIONS	AMPLIFIERS	
Ecraft. CodeNo.	1.75.D16	1.75.D25
Gain dB ± 2 dB	16	25
Ratio	6:1	18:1
Freq. Response (MHz)	40-860	40-860
Input-Output Z.	75	75
Max. Output (M/v)	100	112
Max. Input (M/v)	16	6
Price Complete	\$45.00	\$53.55



Build your own Amateur Antennas. Insulators for 1" tube, 55c or fit sleeve 30c or 1/2" tube. As used in our 1/4 wave ground plane.

Check our prices
WE ARE THE EXPERTS — 30 YEARS IN THE TV ANTENNA BUSINESS

Please enclose postage with all orders.

SOME OF AUSTRALIA'S LOWEST COMPONENT PRICES

POTS 38c CAPS 5c

POLYESTER FILM CAPS
E12 10% 100V
All values .001 to .01 — 5c ea.

.01 — 5c	.1 — 10c
.012 — 6c	.12 — 11c
.015 — 6c	.15 — 12c
.018 — 6c	.18 — 14c
.022 — 6c	.22 — 15c
.027 — 6c	.27 — 16c
.033 — 7c	.33 — 18c
.039 — 7c	.39 — 19c
.047 — 7c	.47 — 20c
.056 — 8c	
.068 — 8c	All values in uF
.082 — 9c	

10% off 100 same uF
SUPERB LEDs \$12/100

NOTE: REGULAR PRICES NOT TEMPORARY SPECIALS — KEEP US IN MIND FOR THAT NEXT ORDER

DIGGERMAN ELECTRONICS

P.O. BOX 33, CORAMBA NSW. 2466.

BC108—13c, 10 for \$1.20

ELECTROCRAFTS (UPRIGHT) (per 100 prices in brackets)

Cap.	16V	25V	50V
0.47 uF thru to	all	all	all
10 uF	5c(\$3 1/2)	6c(\$3 1/4)	7c(\$4)
22 uF	6c(\$3 1/4)	7c(\$4)	8c(\$5)
33 uF	8c(\$4)	9c(\$5)	10c(\$6)
47 uF	9c(\$5)	10c(\$6)	11c(\$7)
100 uF	10c(\$6)	12c(\$7)	14c(\$11)
220 uF	12c(\$8)	16c(\$10)	35c(\$17)
470 uF	16c(\$12)	22c(\$16)	45c(\$30)
1000 uF	22c(\$18)	30c(\$25)	75c(\$50)
1000 uF/16V axial	— 20c ea. \$8 per 50		
2200 uF/50V axial	— 95c ea. \$8 per 10		
Full axial price list — SAE			

2c RESISTORS — our 2 year old price still current. Opposition hoped we would go broke but our price remains at 2c ea.
1 Ohm to 10 M 1/4W 5% E12 carb. film \$1.80 per 100 same value (or 1/2W 3c, \$2.50 per 100 same value)

SCRs:	TRIACS:	DIODES:
0.8A 30V C103Y —	35 2A 400V ESP240 —	65 1N4001 — 7c (1A 50V)
0.8A 200V C103B —	60 6A 400V SC141D —	\$1.30 1N4002 — 8c (1A 100V)
4A 30V C106Y1 —	40 10A 400V SC146D —	\$1.50 1N4004 — 9c (1A 400V)
4A 400V C106D1 —	75 25A 400V SC260D —	\$2.50 1N4007 — 12c (1A 1000V)
8A 400V C122D —	\$1.05 DIAC ST2 —	35 1N4148 — 9c, \$4/c, \$30/K
8A 500V C122E —	\$1.20 Chart to identify leads —	
25A 400V C37D —	\$2.50 Plus trigger info. —	10c

LEDs: \$12 a 100, \$110 a 1000, or 17c each, 10 for \$1.50. LEDs superb 5mm red well diffused wide viewing angle. Quality mtg. clips 5c ea. \$4 a 100.

Potentiometers: 38c ea. rotary carb linear 500 Ohm, 1K, 5K, 10K, 25K, 50K, 100K, 250K, 500K, 1M, 2M (1/4" alum. shafts) Log: 50c ea except no 500 Ohm or 2M Trimpots: 15c ea 100 Ohm to 2M

ZENER DIODES: 15c each 400mW 5% E24 values 3V to 33V

Trade/govt./S.T. exempt: welcome. Send for special lists (eg. \$26 a 100 pots plus tax if applic.)

Keep electronics a hobby and not a luxury, compare our prices and buy from us. Same day turnaround service (unless swamped). All goods top quality and new. No minimum order. One P/P charge of 45c regardless of quality. Advert current 3 months for late readers.

INCREDIBLE!

A superbly designed 9 band receiver. Sensitivity, selectivity, (the VEF radios will easily separate the proposed 9 kHz B/C station separation) stability, image rejection, and sound quality are all superior to any comparably priced radio. More than that, VEF reliability is legendary and the construction quality incomparably better — hence our 3 year guarantee.

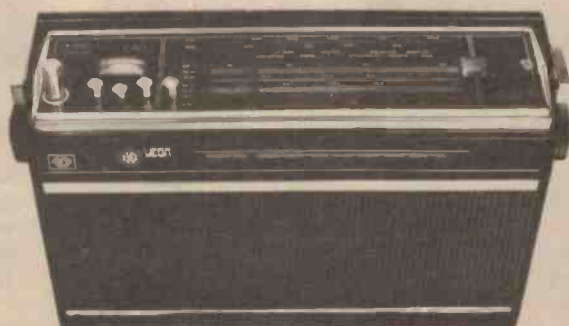

Normally \$89,
this is a special
\$69 offer
extended to
ETI readers.
(Optional AC unit \$4 extra.)

• 279-283 Latrobe St, Melbourne. 3000. Ph. 602-3533.

• 91 Goulburn St, Sydney. 2000. Ph. 212-3576.

ELECTROIMPEX AUSTRALIA PTY. LTD.

• 1st Floor, 75 Grenfell St, Adelaide. 5000. Ph. 223-6150.

• Shops A11 & 12, Local Point Arc, Cnr Brunswick & Wickham Sts, Fortitude Valley. 4006. Ph. 52-2909.

DIGITAL STOPWATCH

When we couldn't get hold of a stopwatch chip that would do the things we wanted, we designed our own stopwatch from scratch.

THE SURVEY we conducted last year on the requirements for a sports timer revealed a requirement for, basically, a good stopwatch. As most stopwatches are used in outdoor sports, it is not really practical to use an LED display. The power requirement of this type of display, if it is to be seen in daylight, is very high for portable use. We therefore decided to wait for the appearance of economical LCD displays before commencing our design.

While the stopwatch described here is not particularly small, it can be easily hand held, and uses a large display which is easily readable 3 - 4 m away, even in strong daylight. It can easily be remotely operated, either by mechanical switches or electronic control circuits.

Design Features

The display we are using is a large (12 mm high) six digit liquid crystal unit. We chose a resolution of 0.01 s, giving a maximum display of 59 min, 59.99 s. We looked around for a single IC which would do all the work, but the only devices we could locate are designed for LED displays. Driving an LCD display usually requires an ac signal with an average dc component across the display of zero. This requirement prevents the display multiplexing as used in most special stopwatch ICs.

The low power consumption of the display indicated that CMOS should be used in the design, thus keeping the total supply current to less than 750 μ A.

SPECIFICATION — ETI 590	
Display	6 digit LCD, 12.5 mm high
Maximum reading	59 minutes 59.99 seconds
Resolution	0.01 seconds
Readability	Up to 5 metres in dim light bright sunlight
Accuracy	Can be calibrated— crystal controlled
Modes	Normal, lap and total
Size	140 x 57 x 32 mm
Battery	9 V (216)
Battery life on off	1 to 2 months shelf life

When deciding what stopwatch modes to provide, we were limited by the package count, as we are using standard CMOS ICs and not a custom LSI chip. We finally settled on the three commonest modes using a single memory.

Initially we did not think that a power switch would be necessary, but the supply current was higher than we expected, giving only about two months

continuous use. We also originally used a slide switch to set each of the three modes, but the cost of these two switches and the space required made us look for an alternative method.

To delete a power switch, the supply current has to be reduced to less than 10 μ A, so by checking where the 750 μ A was going we found that the biggest power consumption was in the 4060 oscillator. Stopping the oscillator

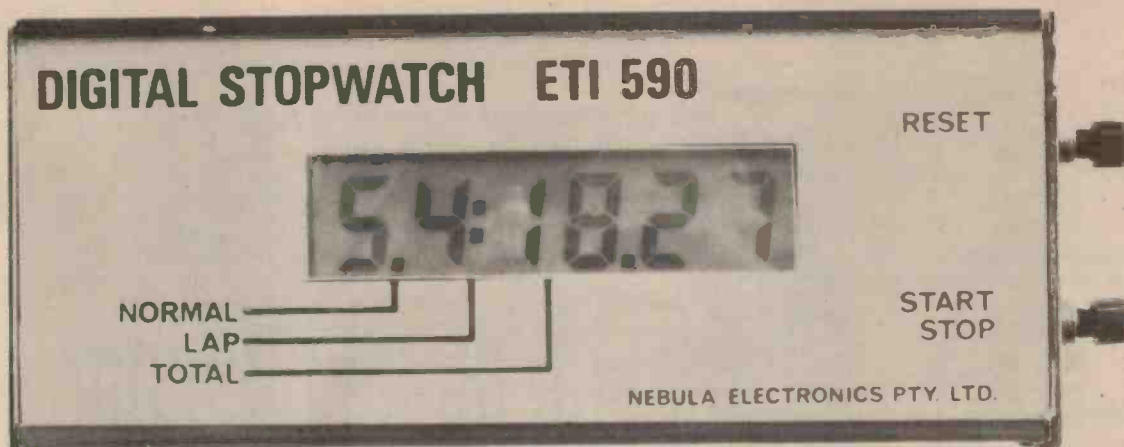

dropped the current but as the output of this IC drives the backplane of the display, stopping it will cause damage to the display.

The method we chose for on/off switching was to remove power to all but three of the ICs in the off mode. To replace the mode switch we used analogue switches and three of the unused decimal points as indicators. Mode selection is performed by holding the reset button pressed while pushing the start/stop button. In the 'fourth' mode, two decimal points will come on, and if both buttons are released the display will turn off. Holding the button closed will turn off. Holding the reset button closed will bring the display back and pressing the start/stop button will move it into mode one.

Calibration

For normal use this is not required and a 33pF capacitor is used for C2. Our prototype was about 0.1s slow in one hour. If greater accuracy is required CV1 can be used along with a 15pF capacitor for C2. If so check the time over a one hour period, record the error, then turn CV1 slightly one way and recheck. Continue until the accuracy is within your limits. Due to the manual operation of the pushbuttons the longer the timing period the more accurate will be the calibration.

External operation

As the watch is simply operated by normally open pushbuttons any number can be paralleled or the leads extended. If electronic operation is required it is preferable that the output stage of that unit be open circuit NPN transistors. If an external voltage pulse is used, it should be between 6 and 9 volts high. It may be necessary to remove or reduce C3 and C4. Remember when designing your interface that the output should normally be high and the timing occurs on the negative going edge.

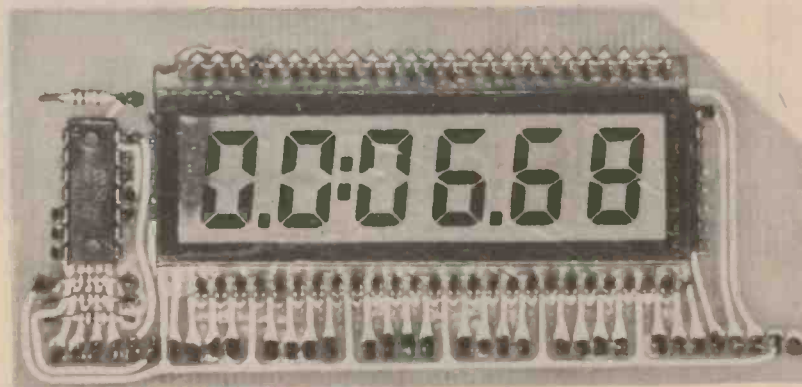
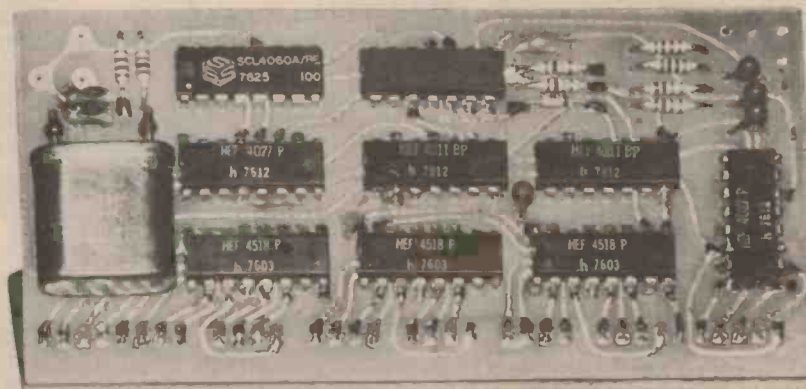

Photo showing the display board with the display board in position. Note that IC2 - IC7 are under the display. Note also that the display is a custom type and will only be available from Nebula Electronics, 15 Boundary St., Rushcutters Bay, 2011.



The logic / control card.

Project 590

Fig. 2. The component overlay of the two boards. Note that the display is shown dotted.

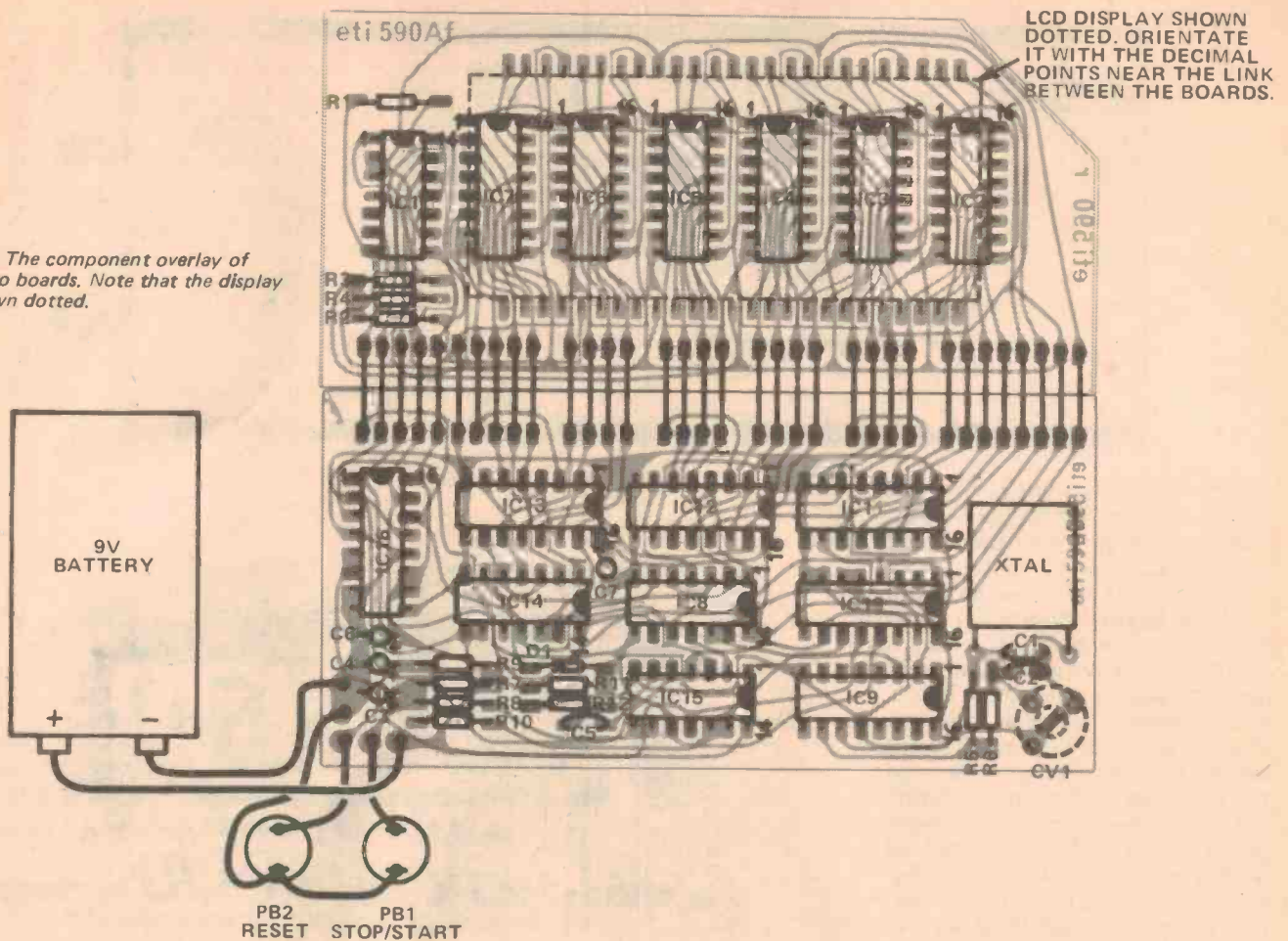

PARTS LIST - ETI 590

- Resistors** all 1/4W, 5%
- R1-R4 100k
 - R5 4M7
 - R6 1k
 - R7 47k
 - R8 1k
 - R9 47k
 - R10 1k
 - R11, 12 100k
- Capacitors**
- * C1, 2 33p ceramic
 - C3, 4 1μ0 tantalum
 - C5 330p ceramic
 - C6, 7 1μ0 tantalum
- Variable Capacitor**
- * CV1 2-30p trim (optional)
- Semiconductors**
- IC1 4016 quad switch
 - IC2-IC7 4056 decoder
 - IC8 4011 two input NAND
 - IC9 4060 oscillator-divider
 - IC10 4027 J K flip flop
 - IC11-IC13 4518 dual decade counter
 - IC14 4011 two input NAND
 - IC15 4093 quad schmitt trigger
 - IC16 4027 J K flip flop
 - D1 IN914 diode
- Miscellaneous**
- PC boards ETI 590A, 590B
 - LCD display (Hamlin 3918 315)
 - Two push buttons
 - Batteryclip
 - Case to suit
- *If CV1 is used reduce C2 to 15 pf.

Construction

With a circuit of this complexity it is virtually essential that the pcbs be used. These boards are double sided and many components have to be soldered on both sides. As a result, sockets cannot be used on the ICs (not that there's room for them anyway!). A small soldering iron with a fine tip is needed to solder the IC pins on the top of the board.

Before starting assembly, inspect the pc boards for any breaks or unwanted joints in the tracks as they are thin in places and it will be difficult to find a break later if it is under an IC! Start assembly with the display board (ETI 590A) inserting the ICs first and soldering them in. Ensure that they are oriented correctly and that they are sitting as close as possible to the pc board. It is recommended that the soldering iron tip be earthed to prevent damage to the ICs. After soldering the ICs in on both sides add the resistors and solder them in.

Now carefully examine the board for any bad solder joints before proceeding. The display is now added (do not remove the protective cover yet) such that it sits over the top of the ICs with the decimal

points closest to the connector (the as yet unused row of holes along the edge of the board). The segments of the display can be seen if it is held at an angle to the light. The display should be sitting right on top of the ICs, as the leads are not too long. It should now be soldered into this position - be careful as the display is glass, and is both delicate and expensive!

The second board can now be assembled similarly. Glue a small (about 20 mm square) piece of thin card on to the pc board to insulate it from the crystal, before gluing the crystal into position.

For normal use, the crystal frequency is probably accurate enough with simply a 33 pF capacitor for C2. The prototype was within 0.1 s over a one hour timing period. The crystal can be trimmed by reducing C2 to 15pF and adding CV1. This adjustable capacitor is fitted to the non-component side of the board and the corner of the display board is cut off to provide clearance for it.

The two boards can now be joined together by sitting them back to back, separating them by 7 - 10 mm, then 'sewing' them together with a long piece of tinned copper wire (see photo). Now

LCD Digital Stopwatch

solder these links on the front surface of the display board, and bend the two boards apart to enable the three pads which are used to be soldered. Before soldering the control board on, the boards must be spaced correctly. This can be done by using the two side pieces of the box as a guide. Only the component side of the control board need be soldered. Once the boards have been soldered the excess leads can be cut off. The battery clip can now be connected along with the pushbuttons.

The operation of the unit can now be checked. When the battery is first connected the display may or may not come on depending on the mode. Pressing either button should bring the display on and it should be possible to step through the modes using the start/stop button while holding the reset button closed. Check that the unit operates in each mode.

The case can now be assembled. The case can be etched slightly in a caustic soda solution if desired, and then painted to give a good finish.

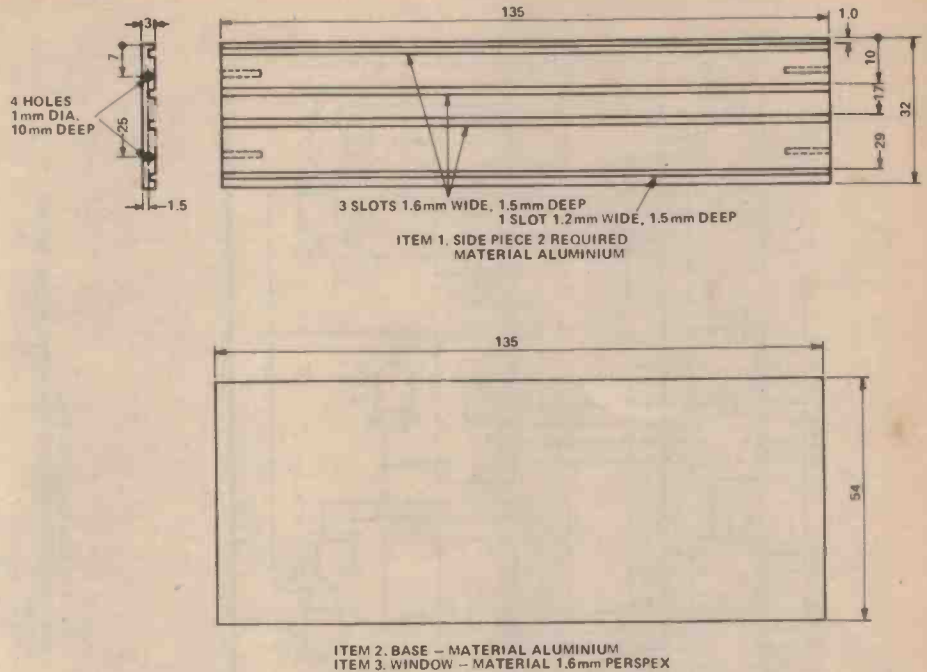
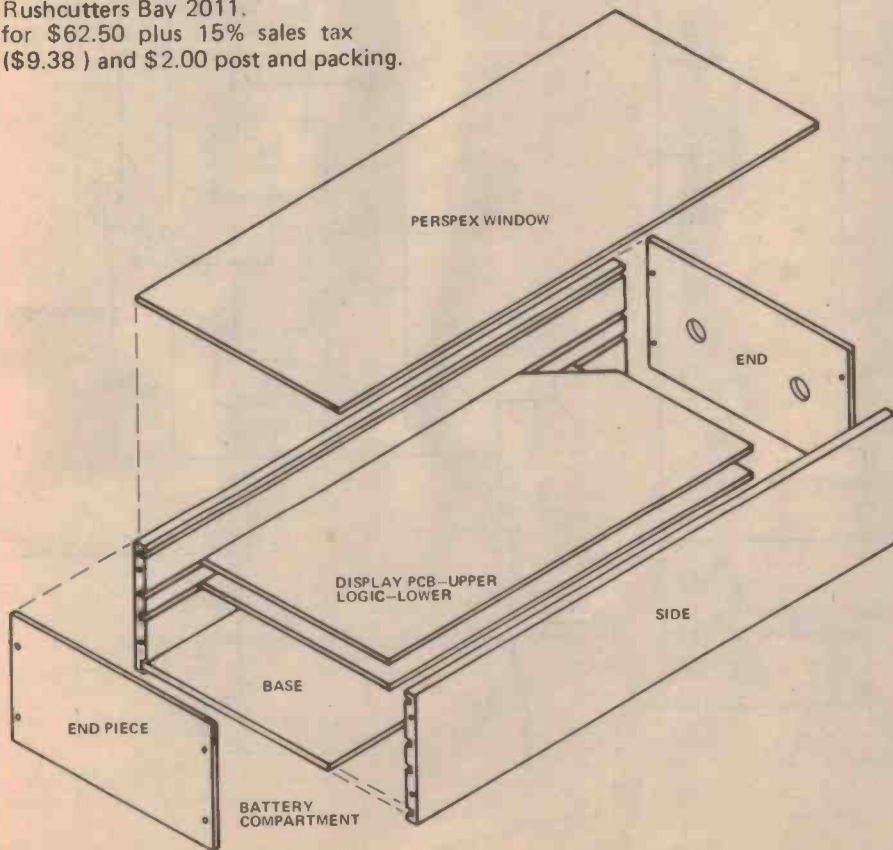
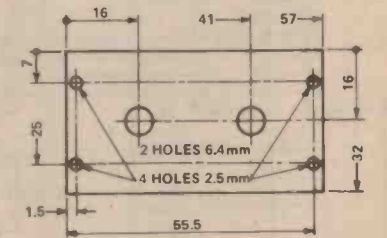
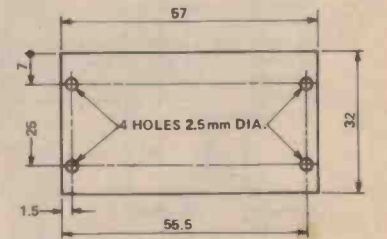
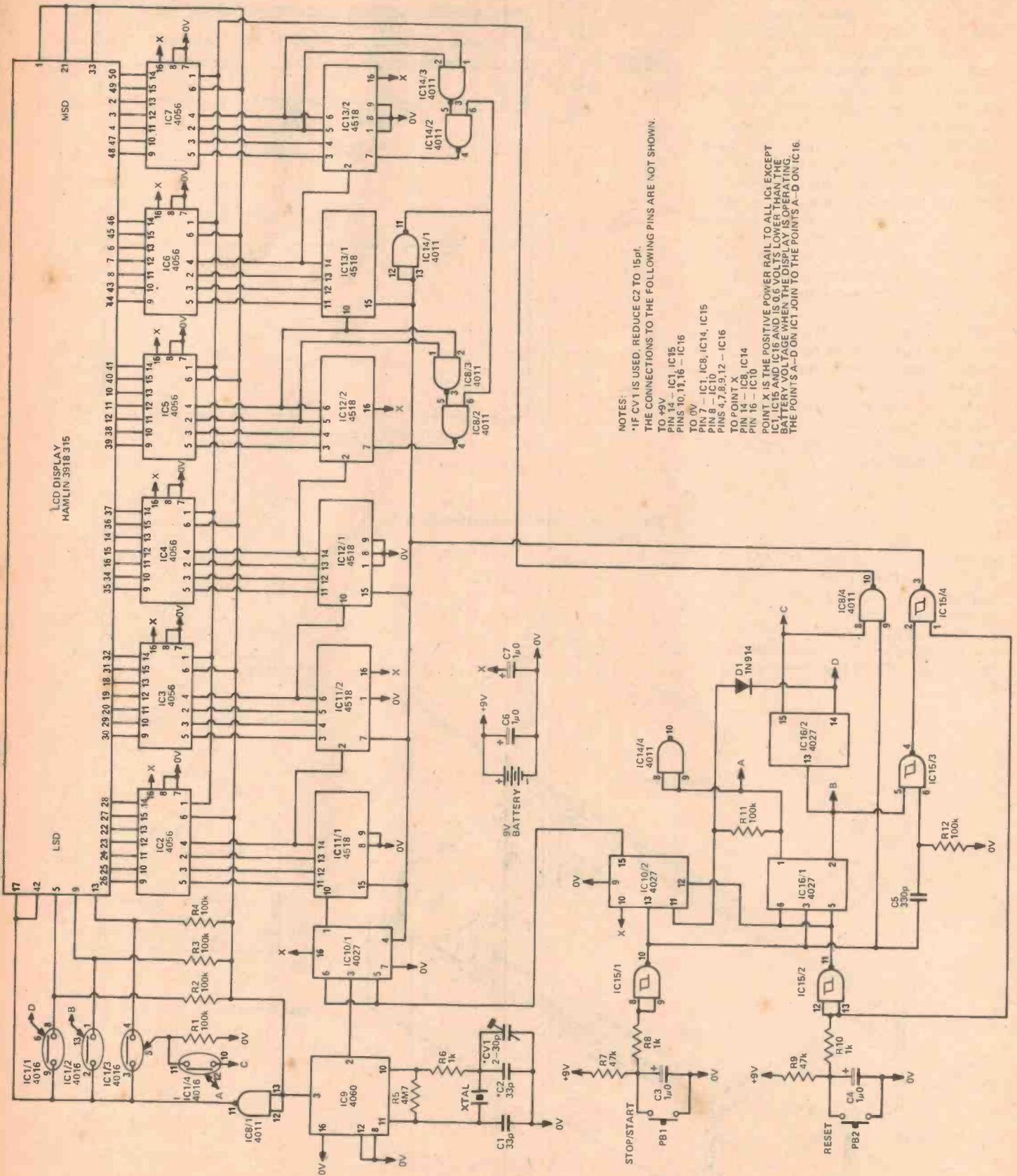

Fig. 3. The details of the metalwork used for the prototype.

A complete kit of parts for this project is available from Nebula Electronics Pty. Ltd. 15 Boundary Street Rushcutters Bay 2011. for \$62.50 plus 15% sales tax (\$9.38) and \$2.00 post and packing.





NOTES:
 *IF CV1 IS USED, REDUCE C2 TO 15pF.
 THE CONNECTIONS TO THE FOLLOWING PINS ARE NOT SHOWN.
 TO +9V
 PIN 14 - IC1, IC15
 TO 0V
 PIN 7 - IC1, IC8, IC14, IC15
 PIN 8 - IC10
 PINS 4,7,8,9,12 - IC16
 TO POINT X
 PIN 14 - IC8, IC14
 PIN 16 - IC10
 POINT X IS THE POSITIVE POWER RAIL TO ALL ICs EXCEPT IC9. POINT X IS LOWER THAN THE BATTERY VOLTAGE WHEN THE BATTERY IS DISCHARGED. THE POINTS A-D JOIN TO THE POINTS A-D ON IC16.

Fig. 1. The complete circuit diagram of the stopwatch.

HOW IT WORKS – ETI 590

Let's start in the middle. IC9 is a crystal oscillator and divider, which, using a 1.6384 MHz crystal, gives 200 Hz on pin 2 and 100 Hz on pin 3. If necessary the crystal frequency can be adjusted by CV1, but normally a 33 pF capacitor for C2 will be accurate enough. The 200 Hz output is divided by 2 in IC10/1 if pins 5 and 6 of that IC are high. The resulting 100 Hz drives IC11/1 which divides by 10, IC11/2 and IC12/1 which also divide by 10, IC12/2 which, due to IC8/2 and IC8/3, divides by 6, IC13/1 (divide by 10) and finally IC13/2 (divide by 6). This is a total division by 360 000, giving an output (not used) from IC13/2 of one hour.

The BCD outputs from each of these dividers is decoded by IC2 - IC7 which are the display decoder/drivers. These ICs need the backplane frequency as an input so that the outputs will either be in phase (display off) or out of phase (on). Also included on these ICs are the latches required to hold a steady display while counting continues.

Keeping It Under Control

Two push buttons are used, one for start/stop and the other for reset. Both are debounced and buffered by schmitt triggers. If the reset button is pressed the reset input to IC10/2 (pin 12) goes high, forcing the Q output (pin 15) low. This stops IC10/1 from dividing, which stops the display. The reset button also places a low on pin 1 of IC15 causing the reset line of the counter to go high, resetting the contents to zero.

Before going any further we had better explain the mode control. This is done by IC16 which is connected as a divide by four counter. If the reset button is pressed a high will be applied to the J-K terminals of IC16/1 and if the start/stop button is now pulsed, each pulse will advance the counter by one. The A-D outputs for the four modes are given below:

	A	B	C	D
Mode 0 (off)	0	1	0	1
Mode 1 (normal)	1	0	0	1
Mode 2 (lap)	0	1	1	0
Mode 3 (total)	1	0	1	0

These modes are selected sequentially with mode 0 following mode 3. Now back to the operation of the main circuit.

In mode 1 we have a '1' on pin 11 IC10 (K input), due to the mode selector, as well as a permanent '1' on the J input. In this mode, the start/stop button will alternate the output of IC10/2 on each press, enabling and disabling IC10/1.

Also in this mode there is a low on pin 9 of IC8/4, forcing the output high. This opens the latch in the decoder ICs and the contents of the counters will be continuously displayed. Counting is therefore alternatively started and stopped by the start/stop button without resetting. If the reset button is pressed the counters are reset and IC10/2 forced into the stop condition.

In mode 2 (lap timing) we have a low on pin 11 of IC10/2, and a high on pin 9 of IC8/4. If the reset button is pressed the counters are reset to zero and IC10/2 is forced into the stop condition. Pin 10 of IC15/1 will be low (push button open) and this signal on pin 8 of IC8/4 will force pin 10 high, thus opening the latches. Zero will be displayed. Pressing the start/stop button will toggle IC10/2 into the start mode, allowing the counters to be advanced. If the button is held pressed the high on the input of IC8/4 is lost and the latches are closed. The result is that although the counters are being advanced the display will still read zero. Releasing the button will cause the display to immediately update to the correct reading and continue to follow the counting.

If the start/stop button is again pressed IC10/2 will not be affected as the J-K inputs are 1,0 and not both high. However, while the button is depressed the latches are closed and the time until the button was pressed will be displayed. Also at the instant the button is depressed a positive pulse of about 25 μ s is generated by C5/R12 and as the other input of IC15/3 is high, this pulse results in a 25 μ s wide negative pulse on pin 4 of that IC. This resets the counter ICs (via IC15/4) back to zero, although this cannot be seen as the latches are closed. Releasing the button

will allow the display to update to the time from the last press. In this mode the result is that the time between presses of the start/stop button is displayed for as long as the button is held down.

In mode 3 the operation is identical to mode 2 with the exception that the reset pulse due to C5/R12 is disabled by a low input on pin 5 of IC15/3. The result of this is that the time displayed is the total since the first press of the start/stop button.

The mode indication is done by IC1; depending on the status of the mode counter one of IC1/1, IC1/2 and IC1/3 will be on. In mode 0 both IC1/1 and IC1/2 will be on.

Power? The astute reader may have noticed that the 9 V supply only goes to IC1, IC15 and IC16! The input protection on CMOS ICs consists of diodes to the power rails, and if any input is taken above the supply rail the protection diode will conduct; if there is enough energy and the load on the power supply is very light the power supply voltage will rise. If there is no power supply and an input is taken to +9 V the power supply will rise to about 8.4 V. Care has to be taken not to damage the protection diodes, however. Getting back to this circuit, in mode 1, the high output on point A (IC16/1) will supply current to the rest of the ICs via the protection diodes in IC14/4. In modes 2 and 3 it is supplied via IC8/4. In the off mode there is no path unless one of the push buttons is depressed. In this case it is supplied via IC10/2 or IC8/4. The current in the off state was measured as about 20 nA, mainly being leakage in C6.

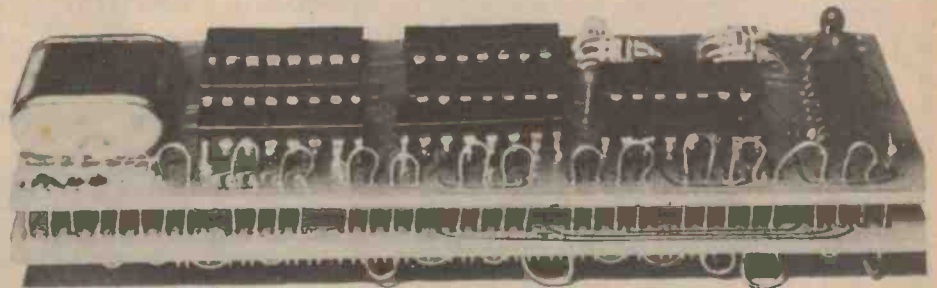

Photo showing how the two boards are wired together. After soldering the loops any excess should be cut off.

**FREE PACK
AND POST
FOR ORDERS
OVER \$10**

SUPER SPECIALS

IN4148 — \$38.00 per thousand.
3 VOLTAGE REGS
7805.....\$1.00
78L05.....\$0.35
78L12.....\$0.35

DENNIS ST.

DAREBIN RD.

MELBOURNE

HIGH ST
(TRAM
STOP
No.35)

CROFTON STN.

OPEN FRIDAY NIGHT TILL 7.00 PM

ULTRASONIC TRANSDUCERS

as used in ETI 585R/T ultrasonic switch
40T.....\$5.95
40R.....\$5.95
As a pair.....\$11.00

ZENERS

400mW E24 Values 3.3v to 33v.....0.20
1 Watt Zeners 3.3v to 33v.....0.33

TRIACS

SC141D.....\$1.30
SC151D.....\$2.10

DIACS

ST2.....0.35
ST4.....0.60

CLOCK MODULES

MA1002B.....\$11.50
MA1003.....\$21.50

MICRO'S

2708 EPROM.....\$15.00
2114.....\$14.00
2102 450nS.....\$2.10
2650.....\$26.00
8080A.....\$13.00
8305.....\$3.30
8317.....\$3.75
8334.....\$3.75
8350.....\$1.80
8368.....\$1.80

**PCB'S PRECISION DRILLED
FIBREGLASS**

ETI 043.....\$1.40
ETI 044.....\$1.30
ETI 047.....\$1.50
ETI 061.....\$1.40
ETI 062.....\$1.80
ETI 063.....\$1.70
ETI 064.....\$1.70
ETI 065.....\$1.70
ETI 067.....\$1.80
ETI 068.....\$1.40
ETI 071.....\$1.40
ETI 072.....\$1.80
ETI 083.....\$1.80
ETI 084.....\$1.70
ETI 085.....\$1.30
ETI 130.....\$1.90
ETI 134.....\$1.90
ETI 135.....\$1.90
ETI 245.....\$1.80

ETI 417.....\$1.60
ETI 445.....\$1.50
ETI 446.....\$1.50
ETI 449.....\$1.50
ETI 450A.....\$1.90
ETI 450B.....\$1.90
ETI 480.....\$2.20
ETI 480PS.....\$2.20
ETI 481M.....\$2.00
ETI 481PS.....\$2.50
ETI 483.....\$2.20
ETI 484.....\$3.90
ETI 485.....\$2.90
ETI 486.....\$2.90
ETI 528.....\$2.20
ETI 541.....\$2.20
ETI 581.....\$2.20
ETI 583.....\$2.20
ETI 585R.....\$1.80
ETI 585T.....\$1.40
ETI 586.....\$2.30
ETI 603.....\$2.50
ETI 604.....\$1.80
ETI 635.....\$2.90
ETI 708.....\$1.90
ETI 713.....\$3.90
ETI 714.....\$1.90

RESISTORS

1/2 watt Metal Glaze.....1-99 100-999
1 ohm to 1M (E12 values).....3a 2.5c
1.2m — 10m (carbon).....5c 4a
1 watt carbon.....
1 ohm to 1M.....8c 7c
5 watt.....
1 ohm to 100 ohm......40 .35

TANTALUMS Resin Dipped

.1, .15, .22, .33, .47, .68uF (all 35V).....1-9 10-99
1uF 35V......25 .20
2.2uF 25V......23 .20
2.2uF 35V......25 .20
3.3uF 25V......25 .20
4.7uF 35V......25 .22
6.8uF 35V......30 .25
10uF 16V......25 .23
10uF 35V......30 .28
15uF 16V......30 .25
15uF 35V......50 .45
22uF 16V......38 .35
47uF 16V......65 .60
68uF 16V.....1.20 1.10
100uF 6.3V......70 .65

MINIATURE TRIMPOTS

0.1 watt, .1" spacing.....1-9 10 up
100, 250, 500, 1K, 2K, 5K, 10K......20 .17
25K, 50K, 100K, 250K, 500K, 1M......20 .17

I C SOCKETS

0	1-9	10 up
8 Pin DIL.....	.25	.23
14 Pin DIL.....	.33	.30
16 Pin DIL.....	.35	.30
18 Pin DIL.....	.55	.50
24 Pin DIL.....	.90	.85
40 Pin DIL.....	1.40	1.20
28 Pin DIL.....	1.20	1.10

POTENTIOMETERS

.25 watt rotary carbon single gang, Log or Lin.
1K, 5K, 10K, 25K, 50K......50
100K, 250K, 500K, 1M, 3M (Lin)......50

CERAMICS

10pF to 680pF......05c
820pF to .0015uF E12 Values......06c
Include 30c postage for free catalogue.

ELECTROLYTICS

4.7 uF	25v	PCB	1-9	10 up
10 uF	25v	PCB	0.08	0.07
10 uF	50v	PCB	0.10	0.08
22 uF	16v	PCB	0.10	0.09
22 uF	35v	PCB	0.08	0.07
33 uF	16v	PCB	0.09	0.08
33 uF	50v	PCB	0.11	0.10
47 uF	16v	PCB	0.10	0.09
47 uF	35v	PCB	0.12	0.11
100 uF	10v	PCB	0.11	0.10
100 uF	16v	PCB	0.12	0.11
220 uF	25v	PCB	0.15	0.14
470 uF	16v	PCB	0.17	0.16
1000 uF	25v	PCB	0.38	0.36
2500 uF	50v	Axial	1.95	1.85
2200 uF	25v	PCB	0.55	0.50
6800 uF	50v	LUG	4.75	4.50
5800 uF	40v	PCB	2.90	
4700 uF	35v	Axial	2.10	

KITS

ETI 480 100W Module Kit
Includes Heat Sink Bracket.....\$19.75
ETI 480 50W Module Kit
Includes Heat Sink Bracket.....\$16.00
12 volt Electronic Siren Kits
1. "Whip".....\$8.00
2. "Wall".....\$8.00
3. "Flying Saucer".....\$8.00
Horn Speaker to suit.....\$8.50

SILICON VALLEY

Products in stock. Also available mail order as per the Silicon Valley catalogue and price list.

Also in stock: Multimeters, relays, veroboard, solder, solderwick, soldering irons, transformers. All components brand new by top companies. Prices current till end of November.

ROD IRVING ELECTRONICS

Shop 499, High Street, Northcote, Vic 3070. Ph (03) 489 8131. Open Mon-Thurs 9.00-5.30, Sat 9.00-1.00. Mail Orders: PO Box 135, Northcote Vic. 3070, Minimum 75c post and pack. Send 30c stamp for free condensed catalogue.

SUPER SPECIALS

BD 139 — 50c ea. MJ2955 — 80c
 BD 140 — 50c ea. 2N3055 — 75c
 BC 547/8/9 — 15c ea. T03 Mounting Kits — 5c ea.
 20 555 Timers for \$5 20 741 Op Amps for \$5

CANNON CONNECTORS

XLP-3-11	\$2 30
XLP-3-12c	\$3 25
XLP-3-31	\$3 25
XLP-3-32	\$3 00
XLR-LNE-11c	\$3 05
XLR-LNE-32	\$4 30

Weller cordless soldering iron kit model WC100DKW — includes batteries, solder, 4 interchangeable tips, battery charger and instructions for only \$29.50.

TTL

7400	28
7401	28
7402	28
7403	28
7404	37
7405	37
7406	50
7407	50
7408	34
7409	34
7410	30
7411	37
7413	54
7414	1.03
7416	60
7417	60
7420	30
7422	30
7426	45
7427	45
7430	30
7432	43
7437	50
7438	50
7440	30
7441	1.50
7442	70
7447	1.25
7448	1.25
7450	35
7451	35
7453	35
7454	30
7460	35
7470	65
7472	45
7473	60
7474	65
7475	65
7476	45
7480	1.25
7483	1.25
7485	1.45
7486	65
7489	1.20
7490	75
7491	1.00
7492	75
7493	75
7494	1.10
7495	95
74100	2.45
74107	65
74121	60
74123	1.10
74132	1.25
74150	1.80
74151	1.10

74153	1.10
74154	1.70
74157	1.10
74160	1.55
74164	1.55
74165	1.55
74173	2.75
74175	1.65
74180	1.35
74192	1.40
74193	1.40
74221	1.50
74367	1.40

74LS

74LS00	30
74LS01	30
74LS02	30
74LS03	30
74LS04	35
74LS05	35
74LS08	30
74LS09	30
74LS10	30
74LS11	30
74LS12	30
74LS14	1.20
74LS20	30
74LS21	30
74LS27	30
74LS28	40
74LS30	30
74LS32	33
74LS37	45
74LS38	45
74LS40	30
74LS42	1.20
74LS73	1.20
74LS74	50
74LS75	70
74LS78	50
74LS85	1.50
74LS86	50
74LS90	1.20
74LS92	1.20
74LS93	1.20
74LS95	1.50
74LS109	50
74LS113	55
74LS114	55
74LS138	1.20
74LS151	1.20
74LS154	1.60
74LS157	90
74LS163	1.20
74LS164	1.30
74LS174	1.00
74LS175	1.00

74LS191	1.20
74LS192	1.20
74LS193	1.20
74LS194	1.20
74LS195	1.20
74LS196	1.20
74LS221	1.20
74LS253	1.85
74LS279	65
74LS365	80
74LS367	80
74LS368	80

CMOS

4000	25
4001	25
4002	25
4006	1.40
4007	25
4008	1.25
4011	25
4012	25
4013	55
4014	1.35
4015	1.20
4016	50
4017	1.40
4018	1.40
4019	75
4020	1.60
4021	1.40
4022	1.60
4023	25
4024	90
4025	40
4027	80
4028	1.25
4029	1.90
4030	40
4040	1.30
4041	1.25
4042	1.25
4043	1.50
4044	1.50
4046	1.95
4049	60
4050	60
4051	1.20
4052	1.20
4053	1.20
4060	2.65
4066	1.00
4068	40
4069	35
4070	40
4071	40

4072	40
4073	40
4074	40
4076	1.85
4077	40
4078	40
4081	40
4082	40
4510	1.50
4511	1.50
4518	1.50
4520	1.45
4528	1.20
4555	1.20
14553	7.50
14584	1.25
74C00	40
74C02	40
74C04	40
74C08	40
74C10	40
74C14	1.90
74C48	2.55
74C73	1.20
74C75	1.20
74C76	1.35
74C90	2.25
74C93	2.25
74C175	1.85
74C192	2.25
74C193	2.25

LINEAR

301	40
307	65
308	1.35
311	85
324	1.35
339	90
349	2.25
356	1.65
380	2.00
381	2.00
382	2.00
386	1.95
555	35
556	85
565	1.95
566	2.50
567	2.65
709	75
723(VR)	55
741	35
747	1.25
3900	90
3909	1.25

VOLTAGE REGS.

309	2.25
317	3.50
323	8.25
325	2.60
723	55
7805	1.30
7806	1.30
7808	1.30
7812	1.30
7815	1.30
7818	1.30
7824	1.30
7905	2.25
7912	2.25
7915	2.25
78L05	50
78L12	50
78L15	50
79L05	85
79L12	85
79L15	85

OPTO

FND507 C/A	1.70
FND 357C/C	1.40
FND 500C/C	1.50
Red LED	22
Green LED	35
Yellow LED	35

DIODES

IN4148	6c — 5c/100
IN4004	9c
IN5625 5A 400V	45c

I.C. SOCKETS

8 PIN DIL	25
14 PIN DIL	30
16 PIN DIL	33

Also in stock Multimeters, relays, veroboard, solder, solderwick, soldering irons, transformers. All components brand new by top companies. Prices current till end of November.

ROD IRVING ELECTRONICS

Shop 499, High Street, Northcote. Vic. 3070. Ph (03) 489-8131. Open Mon-Thurs 8 am — 5.30 pm, Fri 8am — 7 pm. Sat 9 am — 1 pm. Mail Orders: PO Box 135, Northcote. Vic.3070. Minimum 75c post and pack. Send 30c stamp for free condensed catalogue.

**TWO BYTES ARE
BETTER THAN ONE**

IMPACT TECHNICO INC.

TEXAS INSTRUMENTS

What a combination!

TEXAS INSTRUMENTS has produced the 16-bit TMS9900, widely regarded as the most advanced, powerful, and flexible single-chip microprocessor in the world.

TECHNICO INC. has used this as the MPU of its Single-board, Stand-alone microcomputer, the T-9900-SS. This SS board contains the Mighty Monitor, Instant Input Assembler, 2K Bytes of static RAM, 2K Bytes of EPROM — and an on-board EPROM programmer. This is a full microcomputer (all else you need is a terminal and power supply). Or it can be the CPU of a large system with other memory, colorgraphics, and interface boards, peripherals, floppy disks, etc.

Innovative Micro Processor And Computer Technology distributes the Technico T-9900-SS in Australia, provides local service and repair facilities, and offers a wide selection of additional boards and peripherals, ranging from paper tape readers to digital cassette recorders to terminals, etc. We specialize in 16-bit 9900 microcomputers and in the ancillary equipment to go with them. Don't buy an 8-bit microcomputer until you have looked at what the 16-bit 9900 can do for you. Prices start at \$465 (kit) and \$575 (assembled), plus Sales Tax if applicable.

NOTE: The T-9900-SS, software, and most peripherals, are now available from stock.

Innovative Micro Processor and Computer Technology

P.O. Box 177, PETERSHAM
2049 (560-7603)

Please tell me about the T-9900-SS and related equipment.

12

Name:

Address:

State Postcode

BLOB BOARD



FREE POT OFFER

Mr. Blob says:
Come see me and get your free pot . . . come to the Blob stand at the C.E.T.I.A. Exhibition at Melbourne's Exhibition Buildings. See my fabulous range of boards and pick up your free pot with my compliments.

Our demonstration of the Scope Irons with the unique Blob Boards will illustrate how easy it is to solder C & K switches. C.E.T.I.A. Exhibition runs from October 24th to 27th.

FREE INVITATION

Send a stamped, self addressed envelope to:

Mr. Blob

BLOB BOARD ASSOCIATES
P.O. Box 23, SurreyHills,
Vic. 3127 or ring (03) 89-1019

Supeljam™

16K STATIC
MEMORY

\$299

complete kit
tax exempt price

Static 2114 4x1024

16,384 bytes

Configured as four 4K blocks

Each 4K block independently addressable; locate any block at any 4K boundary

Each 4K block write-protectable

COMPATIBILITY

All S-100 systems, per Proposed IEEE Standard (see IEEE Computer, 5/78)

All S-100 bus signals fully buffered, including all address and data lines

A product of

Morrow's Micro-Stuff for

COMPUTER BITS

A DIVISION OF AUTOMATION
STATHAM PTY. LTD.

47 Birch Street, BANKSTOWN
N.S.W. 2200
Phone (02) 709-4144
Telex AA26770

ETI's COMPUTER SECTION

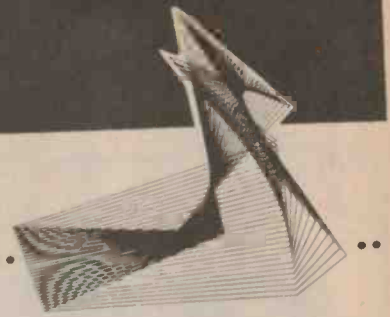

NEWS

Earom now Eeprom

Now that you've learnt that Earom stands for Electrically Alterable Read Only Memory, forget it – Jedec's subcommittee JC-42 has voted in favour of the term Electrically Erasable Programmable Read Only Memory (Eeprom), as a title for the device. We're not too struck on this personally – it sounds like the term for a 2708-type EPROM.

First 16 K Static RAM

The latest milestone in memory technology has been passed by Texas Instruments, who have announced the world's first 16 K static RAM. Organised as 2 K x 8, the TMS4016 is pin compatible with the 2716 EPROM, thus making for extremely flexible memory board design. Samples of the IC will be available in September, with production scheduled for the year's end.

LSI-11 Now Microprogrammable

The Digital Equipment Corp. LSI-11 and LSI-11/2 microcomputers can now be microprogrammed, that is, users can define their own instruction sets. DEC will mask program user-supplied microcode into 512 x 22 bit ROMs, enabling the processors to provide special functions such as FFTs or emulation of other processor instruction sets.

Pseudo-static RAM

Mostek are being very cunning. Although dynamic RAMs are larger by a factor of four and cheaper than static RAMs many memory system designers steer away from them, to avoid problems associated with refresh circuitry. What Mostek have done is to put the refresh counters on a new memory chip itself, so that when the memory is not being accessed, it will automatically refresh

itself. The 2K x 8 RAM has a 100 ns access time and is designed for 5 V operation. Sample quantities of the 4816 are due in November.

Another Printer Driver

In order to use the ETI 641 Printer with the Assembler we run at work, we've had to write a short printer driver program which we reproduce here. It's fairly straightforward, the only odd feature being the way it filters out line feed characters (012Q) which would otherwise be printed. The program was printed on the 641 itself – we could have done an assembly listing, but it looks rather confusing, as each line 'wraps' around twice. The program is written in 8080 code, by the way.

```
1 *PRINTER DRIVER
2      AORG 001:0000
3      SORG 001:0000
4 PRINT CPI 012Q
5      RZ
6      PUSH PSW
7 LOOP IN 0310
8      CPI 1770
9      JZ LOOP
10     POP PSW
11     OUT 310
12     RET
```

Paratronics 150

In order to keep the project lab at ETI fully up to date, we've just taken delivery of a Paratronics Model 150 S-100 compatible logic state analyser. This will be used in the development and debugging of our forthcoming computer projects, and we like to think of it as an example of the kind of effort we're putting into coming up with the best projects anywhere.

COMPUTER CLUB DIRECTORY

Sydney: Microcomputer Enthusiasts Group, P.O. Box 3, St. Leonards, 2065. Meets at WIA Hall, 14 Atchison St., St. Leonards on the 1st and 3rd Mondays of the month.

Melbourne: Microcomputer Club of Melbourne, meets at the Model Railways Hall, opposite Glen Iris Railway Station on the third Saturday of the month at 2 p.m.

Canberra: MICSIG, P.O. Box 118, Mawson, ACT 2607 or contact Peter Harris on 72 2237. Meets at Building 9 of CCAE, 2nd Tuesday of month at 7.30 p.m.

Newcastle: contact Peter Moylan, Dept. of Electrical Engineering, University of Newcastle, NSW 2308. (049) 68-5256 (work), (049) 52-3267 (home).

Brisbane: contact Norman Wilson, VK4NP, P.O. Box 81, Albion, Queensland, 4010. Tel. 356 6176.

New England: New England Computer Club, c/- Union, University of New England, Armidale, NSW 2351. (New club; not restricted to students)

Auckland: Auckland Computer Club, P.O. Box 27206, Auckland, N.Z.

Computer clubs are an excellent way of meeting people with the same interests and discovering the kind of problems they've encountered in getting systems 'on the air'. In addition, some clubs run hardware and software courses, and may own some equipment for the use of members. Try one – you'll like it!

If your club is not listed here, please drop us a line, and we'll list you. The same applies if you are interested in starting a club in your area. Also, if established clubs know their programme of forthcoming events, we can publicise them.

Centaur Industries

THE S100 SPECIALISTS
PO Box 37243, Winnellie, N.T. 5789

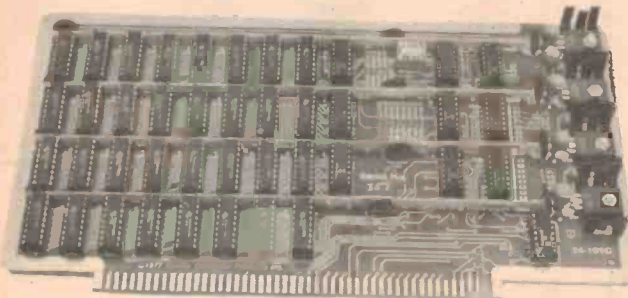

**PRICES
SLASHED**

16K RAM

Fully assembled, tested
using the TMS 4044

FULLY S-100 BUS COMPATIBLE 250 nsec chips — \$439

Z-80A 4 MHz fast — no wait states. If you have a slower CPU now, this board will loaf along — and it WON'T be obsolete when you upgrade!

450 nsec chips — \$399

Fully static is best — Texas Instruments TMS 4044 chips — no clocks — no refresh — DMA compatible.

Easy on your power supply — 8V at 1.7A nominal.

Each 4K block addressable to any 4K slot, separately protected by DIP switches, and supplied through its own regulator. Jumpers to customise to any known S-100 system.

First quality factory parts — fully socketed and buffered — quality plated-through PCB with gold plated edge fingers, silk screened and masked both sides — busbars for lower noise.

8k — 250 ns.....	\$279
8k — 450 ns.....	\$249
4k expansion kit (250 ns).....	\$103
4k expansion kit (450 ns).....	\$93

GUARANTEED FOR ONE FULL YEAR

COMING SOON —

Centaur 2000 disc based S-100 business system.

Post, packing and insurance included in price — add 15 per cent sales tax. Dealer enquiries invited.



SD SYSTEMS

Top quality S-100 kits at unbeatable prices!
All kits feature sockets for all ICs, quality plated-through PCBs, and are also available assembled and tested.

Z80 STARTER KIT

A complete Z80 system on a board\$249
1k RAM with sockets for another 1k — powerful 2k ZBUG monitor — extra PROM socket plus on-board EPROM programmer — Kansas City standard cassette interface — positions for two S-100 edge connector sockets and generous 2½" x 8" wire-wrap area for system expansion — **HEX KEYBOARD AND SIX DIGIT DISPLAY** — twelve command keys — four counter/timer channels — two eight-bit parallel I/O ports — comprehensive documentation package. Power requirements: +5v at 1A; +25 at 30ma. for PROM Programmer.

Assembled and Tested \$399.

SBC-100 SINGLE BOARD COMPUTER

Much more than just a CPU board\$349
Z80 CPU — 1k RAM — 4 PROM sockets — fully programmable synchronous/asynchronous serial I/O, RS232 or current loop — parallel I/O port — 4 channel counter/timer — 4 vectored interrupts — with Versafloppy, memory and CP/M forms a completely compatible system.

Assembled and Tested \$439.

VERSAFLOPPY tm

Control 8" or 5" drives for only.....\$159
Directly controls Shugart SA-400, SA-800; Persci 70 and 277; MFE 700/750 and CDC 9404/9406. Listings for control software included in the price.

Assembled and Tested \$239.

Z80A CPU BOARD

Upgrade your S-100 system
to a 4 MHz Z80.....\$149

Assembled and Tested \$235.

SHUGART FLOPPY DISC DRIVES

SA-400 5" minifloppy	\$379
SA-800 8" floppy.....	\$575
SA-400 cable	\$35
SA-800 cable	\$39

SOFTWARE

CP/M disc operating system.....	\$125
The industry standard DOS, complete with 8080 assembler and BASIC-E, on 8" or 5" floppy disc.	
Versafloppy control software on 2708 PROM.....	\$25
Z80 disc based assembler on 5" or 8" floppy.....	\$70
SD Monitor (on PROM, for SBC-100 and Versafloppy).....	\$50

Comprehensive Z-80 Driver for the ETI 640 VDU

The following program which was contributed by R.J. Long of Kenmore, Qld, handles all the facilities available on the ETI 640 VDU — flashing characters, black on white characters, extended graphic characters (i.e., printing control characters) and chunky graphics.

The program is written specifically for the Z-80, but the assembler has flagged the unique Z-80 codes (with a 'Z' in the left column and a '?' after the op-code) so that 8080 users can adapt the appropriate instructions. Extensive use has been made of bit testing and setting, relative jumps, block moves and 16-bit subtraction. No attempt has been made to minimise the space occupied by the program — rather it uses subroutines extensively so that all functions are self-contained modules.

Modes of Operation

The VDU can be set to any of the following modes:

- 1) Normal
- 2) Flashing
- 3) Black on white
- 4) Extended graphics
- 5) Chunky graphics.

Normal Mode

In this mode the VDU simulates a normal TTY, with some extra features. The cursor is a flashing black on white character. The following control characters are recognised:

- a) Carriage return — moves the cursor to the front of the line.
- b) Line Feed — moves the cursor down one line. After the cursor reaches the bottom line the text on the screen will be scrolled up.
- c) Backspace (^H) — moves the cursor back one character. Does not destroy the characters that it passes over. The cursor does not move backwards past the front of the line.
- d) Forward Space (^), the TAB character) — moves the cursor forwards. Does not proceed past the end of the line.
- e) Vertical Feed (^K) — moves cursor up. Scrolls the text downwards when it reaches the top line.
- f) Form Feed (^L) — clears the screen

and positions the cursor at the top left of the screen.

- g) Home (^Q) — moves the cursor to top left of screen without clearing the screen.
- h) Bell (^G) — rings the TTY bell. Does not print anything on the screen.
- i) Cursor Off (^U) — turns the cursor on or off.

Flashing Mode

This mode is enabled with the control S (^S) character. All characters after the ^S will flash, until another ^S is received, which will then cancel the flashing mode.

Black on White

This is enabled with ^R. All characters following this are then displayed as inverse video. Another ^R cancels the mode.

Extended Graphics

When in this mode (^E) the control characters are displayed as the extended graphic symbols available in the character ROM. Because ^E sets and clears this mode the graphic character corresponding to it cannot be displayed.

Chunky Graphics

This mode is set and cleared with ^T.

Mode Priority

The extended graphics characters and chunky graphic symbols can be made to flash if S is transmitted before the ^E or ^T. Once in extended or chunky graphics mode the flashing cannot be cancelled until the graphics mode is cancelled.

Similarly, the extended graphics symbols can be black on white and/or flashing, if BOW and flashing are set before entering the extended graphics mode. Chunky graphic symbols cannot be made black on white.

Speed Control

Normally, when the text is being displayed on the screen by, say, listing a program, it appears (and disappears!) too quickly to read easily. There is a

memory location (DELVAL, at FE58) which controls the amount of delay which is introduced after each character is processed. The initial value is 0 = fastest (least delay). The value of the location can be changed (by your monitor, or POKE'd from BASIC) to slow the display. 'FF' will give a speed equivalent to about 60 characters per second.

Implementation of the program

The program has been assembled to execute a FC00. If you have an assembler than it can be reassembled at any location you desire.

The routine expects to receive the character in the 'C' register. It returns with the character in the accumulator.

Mr. Long writes: My monitor (the TDL Zapple monitor) has a feature which allows the user to assign the console device to a 'user defined' device and all CALLs to the console input and output routines by-pass the usual monitor I/O routines and are directed to locations above F800. In these locations we insert jumps to the software which handles the 'user defined' device. In this case, the normal TTY port is used for input, so the instructions in the user defined jump vectors jump back to the routine in the monitor which handles the input. These locations are at F800, and F818 for the I/P status of the TTY port. For the output we jump to this VDU driver from location F803. The 'list' device also jumps to the VDU driver.

When the bell character is received the VDU driver which then jumps to the normal TTY routine in the monitor, so that the bell on the TTY can be rung.

The assembler I have used is the TDL Z-80 relocating assembler. The double equals (==) makes the associated identifier a constant, so that it cannot be redefined.

The labels that are preceded by '.' are 'local' labels, which do not create ambiguity with identical labels which are separated by ordinary labels. The label '%LABEL' in the macro is a local label which is automatically generated by the assembler to avoid clashes

between local labels when the macro is invoked more than once between global labels.

The op-codes are generally those of the 8080, with additional ones for the Z-80 instructions. They are not Zilog or Mostek mnemonics.

Note that the 16 bit values are listed with the high byte first rather than the usual low byte first. Of course the assembler generates code with the low byte first.

The program is copyright but may be copied by individuals or clubs for non-commercial purposes.

TDL Z80 RELOCATING ASSEMBLER VERSION 2.2
ETI VDU 640 Z-80 driver
Written by R.J. Long, August 1979

```

; ETI VDU 640 Software controlled VDU driver.
;
; This driver simulates normal TTY scrolling
; as well as providing the VDU features such as
; flashing, inverse video and chunky graphics.
;
; (C) Copyright 1979 by R.J. Long,
; 19 Cedarleigh Rd.,
; Kammora,
; Old, 4069
;
; Flag unique Z80 instructions.
;
FC00      BASE      == 0F800H      ; Locn. of this program
FC40      ZTTY0     == 0F490H      ; Locn. of TTY I/O routine
;
FC15      ZTST5     == 0F61FH      ; Monitor TTY I/O routine.
FC20      MEM       == 0F520H      ; Status of TTY I/O.
FC00      OFFSET   == 0F900H      ; Start of VDU memory.
;
FC03F     LL        == 3FH         ; Max. line length (0-63).
FC00F     LINES    == 0FH         ; No. of lines (0-15).
;
; Recognised control characters:
;
0009      BSCH     == 08H          ; Backspace.
0009      FSCH     == 09H          ; Forward space.
000D      CRCH     == 0DH          ; Carriage return.
000A      LFCH     == 0AH          ; Line feed (cursor down).
000B      VFCH     == 0BH          ; Vert. feed (cursor up).
000C      HFCH     == 0CH          ; Form feed (clear screen).
0011      IMCH     == 11H          ; Home (w/o clear) ("H").
0007      BELLCH   == 07H          ; Bell.
0015      CURCH    == 15H          ; Turn cursor on/off.
;
; Characters to set or clear modes:
;
0005      EXCH     == 05H          ; Ext. graphics mode ("E")
0012      BWHCH   == 12H          ; Black on white ("B")
0013      FLCH     == 13H          ; Flashing ("S")
0014      CHKCH    == 14H          ; Chunky graphics ("T")
;
; Bits in mode register (Req. E)
;
0000      EXGBIT   == 0           ; Ext. graphics
0001      BWHBIT   == 1           ; Black on white.
0002      FSHBIT   == 2           ; Flashing.
0003      CHKBIT   == 3           ; Chunky graphics.
;
; The following bits are also in the 'mode' register
; and are used to reset the cursor properly. For
; example if a character was flashing before the cursor
; was passed over it (by forward space) then that
; character will stay flashing after the cursor leaves.
; Similarly for black on white.
;
0004      AFSBIT   == 4           ; Already flashing.
0005      ABWBIT   == 5           ; Already black on white.
0006      CURBIT   == 6           ; If set turn cursor off.
;
; Bits in the character to set its mode.
;
0007      BOW     == 7           ; in main memory.
0000      FLASH  == 0           ; in control section of memory.
0001      CHUNK  == 1           ; " " " " " "
;
; The following macro inverts the specified bit.
;
DEFINE FLIP (THEBIT, XLABL)=
;
;     BIT     THEBIT,E
;     JRZ    %LABL
;     RES    THEBIT,E
;     JMP    EXIT
XLABL: SET    THEBIT,E
;     JMP    EXIT
;
;
; PABS
;
; The following jump vectors are used by the Zapola
; monitor when in the 'user defined mode'. That is the
; mode which is used so that the output comes to
; this VDU driver and not the normal TTY.
;
FC00      F800     C3 F61F        .LOC  OF800H
FC03      F803     C3 FC00        JMP   ZTTY1 ; Use normal TTY I/O.
;
FC15      F815     C3 FC00        .LOC  OF815H
FC18      F818     C3 F520        JMP   VDUC0 ; Use this driver for I/O.
;
FC00      FC00     C3 FC06        .LOC  OFC00H
FC03      FC03     C3 F490        JMP   VDUC0 ; For List output.
;
FC06      FC06     C5             .LOC  OFC06H
FC07      FC07     D5             JMP   ZTSTS ; TTY I/O status.
FC08      FC08     E5             JMP   VDUC0 ; For List output.
FC09      FC09     3A FE55        JMP   ZTSTS ; TTY I/O status.
;
FC0C      FC0C     47             .LOC  OFC0CH
FC0D      FC0D     3A FE56        MOV   B,A
FC10      FC10     57             LDA   CC
FC11      FC11     3A FE57        MOV   D,A
FC14      FC14     5F             LDA   MODE
FC15      FC15     2A FE59        MOV   E,A
FC18      FC18     79             MOV   CURSOR
;
Z FC19      FC19     C858        MOV   A,C ; Get the character.
Z FC1B      FC1B     200E        BIT   ?CHKBIT,E ; Chunky graphics set?
Z FC1D      FC1D     FE20        JRNZ  ?CHUNKY ; Yes
Z FC1F      FC1F     DA FC34        CPI   #4
;
FC22      FC22     CD FCF7        .NORMAL: CALL CLRCRS ; Clear cursor.
FC25      FC25     CD FD49        CALL  NORM ; Process normal character.
FC28      FC28     C3 FCD9        JMP   EXIT
;
FC29      FC29     FE14        .CHUNKY: CPI   CHKCH ; Cancel chunky mode?
Z FC2D      FC2D     20F3        JRNZ  ?NORMAL ; No, just put into memory.
Z FC2F      FC2F     C89B        JNZ   ?CHKBIT,E ; Reset bit.
FC31      FC31     C3 FCD9        JMP   EXIT
;
FC34      FC34     C843        .CONTROL: BIT   ?EXGBIT,E ; Ext. graphics set?
Z FC36      FC36     2809        JRZ   ?..L1 ; No.
Z FC38      FC38     F805        CPI   EXCH ; Yes - do we reset?
Z FC3A      FC3A     20B6        JRNZ  ?NORMAL ; No.
Z FC3C      FC3C     C8A3        RES   ?EXGBIT,E
FC3E      FC3E     C3 FCD9        JMP   EXIT
Z FC41      FC41     FE05        .L1: CPI   EXCH ; Do we set ext. graphics?
Z FC43      FC43     2005        JRNZ  ?..L2 ; No.
Z FC45      FC45     C8C3        SET   ?EXGBIT,E ; Yes.
Z FC47      FC47     C3 FCD9        JMP   EXIT
Z FC49      FC49     FE14        .L2: CPI   CHKCH ; Set chunky graphics?
Z FC4C      FC4C     2005        JRNZ  ?..L3 ; No.
Z FC4E      FC4E     C8DB        SET   ?CHKBIT,E
FC50      FC50     C3 FCD9        JMP   EXIT
;
FC53      FC53     CD FCF7        .L3: CALL CLRCRS ; Carriage return?
FC56      FC56     FE06        JRNZ  ?..L4
FC5A      FC5A     CD FD9A        CALL  CR
FC5D      FC5D     C3 FCD9        JMP   EXIT
Z FC62      FC62     2006        .L4: CPI   LFCH ; Line feed?
Z FC64      FC64     CD FD9C        JRNZ  ?..L5
FC67      FC67     C3 FCD9        CALL  LF
Z FC6A      FC6A     FE12        .L5: CPI   EXCH ; Set/clear BOW?
Z FC6C      FC6C     200E        JRNZ  ?..L4
;
Z FC6E      FC6E     C848        + FLIP  (ROWBIT) ; Yes, and exit.
Z FC70      FC70     2805        + BIT   ?ROWBIT,E
Z FC72      FC72     C848        + JRZ   ?..0001
Z FC74      FC74     C3 FCD9        + RES   ?ROWBIT,E
Z FC77      FC77     C848        + JMP   EXIT
Z FC79      FC79     C3 FCD9        + .0001: SET  ?ROWBIT,E
;
FC7C      FC7C     FE13        .L6: CPI   ?FLSCH ; Flash?
Z FC7E      FC7E     200E        JRNZ  ?..L7
;
Z FC80      FC80     C853        + FLIP  (?FSHBIT)
Z FC82      FC82     2805        + BIT   ?FSHBIT,E
Z FC84      FC84     C893        + JRZ   ?..0002
Z FC8A      FC8A     C3 FCD9        + RES   ?FSHBIT,E
Z FC89      FC89     C8D3        + .0002: SET  ?FSHBIT,E
Z FC8B      FC8B     C3 FCD9        + JMP   EXIT
;
Z FC8E      FC8E     FE07        .L7: CPI   BELLCH ; Bell?
Z FC90      FC90     2006        JRNZ  ?..L8
Z FC92      FC92     C3 FC03        CALL  TTYOUT ; Send to TTY.
Z FC94      FC94     C3 FCD9        JMP   EXIT
Z FC96      FC96     FE08        .L8: CPI   BSCH ; Backspace?
Z FC98      FC98     2006        JRNZ  ?..L9
Z FC9A      FC9A     CD FDAD        CALL  BS
Z FC9C      FC9C     C3 FCD9        JMP   EXIT
Z FC9E      FC9E     FE09        .L9: CPI   FSCH ; Forward space?
Z FCA2      FCA2     2006        JRNZ  ?..L10
Z FCA4      FCA4     CD FDB3        CALL  FS
Z FCA6      FCA6     CD FDB3        JMP   EXIT
Z FCA8      FCA8     C3 FCD9        .L10: CPI   FFCH ; Form feed?
Z FCAE      FCAE     2005        JRNZ  ?..L11
Z FCB0      FCB0     CD FDCC        CALL  FF
Z FCB2      FCB2     1824        JMP   JPR
Z FCB4      FCB4     FE08        .L11: CPI   ?EXIT
Z FCB6      FCB6     2005        JRNZ  ?..L12
Z FCB8      FCB8     CD FD8A        CALL  VFCH ; Cursor up?
Z FCBE      FCBE     1818        CALL  UP
Z FCC0      FCC0     FE11        .L12: CPI   ?EXIT
Z FCC2      FCC2     2005        JRNZ  ?..L13
Z FCC4      FCC4     CD FD95        CALL  ?HOME
Z FCC6      FCC6     1812        JMP   ?EXIT
Z FCC8      FCC8     FE15        .L13: CPI   CURCH ; Turn cursor on/off?
Z FCCA      FCCA     200E        JRNZ  ?EXIT ; Ignore other control char.
;
Z FCCB      FCCB     C873        + FLIP  (CURBIT)
Z FCCD      FCCD     2805        + BIT   ?CURBIT,E
Z FCCF      FCCF     C8B3        + JRZ   ?..0003
Z FCD1      FCD1     C3 FCD9        + RES   ?CURBIT,E
Z FCD3      FCD3     C8F3        + JMP   EXIT
Z FCD5      FCD5     C8F3        + .0003: SET  ?CURBIT,E
Z FCD7      FCD7     C3 FCD9        + JMP   EXIT
;
;
; The exit routine saves all variables back in
; memory, retrieves the registers and puts a delay
; in to reduce speed of display (variable).
;

```



```

Z FCD9 CH73 EXIT: BIT ?CUNBIT,E ; Turn cursor on?
Z FCD8 2003 JRNZ ?..L1 ; No.
Z FCD7 CD FD19 CALL SETCSR ; Turn cursor back on.
FCE0 78 ..L1: MOV A,E
FCE1 32 FE57 MOV STA A,D
FCE2 7A STA CC
FCE3 32 FE54 MOV A,R
FCE4 78 STA LC
FCE5 32 FE55 SHLD CURSOR
FCE6 E1 POP D
FCF0 D1 POP D
FCF1 C1 POP B
FCF2 CD FE45 CALL DELAY
FCF5 79 MOV A,C ; Return the char. to A reg.
FCF6 C9 RET

;
; This subroutine clears the cursor from the
; current position. If the character was already
; flashing and/or black on white (as indicated
; by the bits in Reg. E) then the character is left
; as flashing and/or BOW.
FCF7 CD FD39 CLRCSR: CALL ADDOFF ; Point to bits in control
; section of memory.
Z FCF8 CB63 BIT ?AFSBIT,E ; Already flashing?
Z FCF9 2804 JNZ ?..L1 ; No.
Z FCFE CBA3 RES ?AFSBIT,E ; Reset mode bit.
Z FCFD 1802 JNPR ?..L2 ; Leave flashing.
Z FD02 C8A6 ..L1: RES ?FLASH,M ; Stop flashing.
Z FD04 C84E ..L2: BIT ?CHUNK,M ; Is current character
; chunky?
Z FD06 2804 JRZ ?..L3 ; No.
Z FD08 CD FD3F CALL DECOFF ; Yes. Can't be BOW so point
; to normal memory and reth.
FD0B C9 RET
Z FD0C CD FD3F ..L3: CALL DECOFF
Z FD11 2803 BIT ?ABWBIT,E ; Already BOW?
Z FD13 CBAB JRZ ?..L4
Z FD15 CV RES ?ABWBIT,E ; Yes.
Z FD16 CBBE ..L4: RES ?BOW,M ; No, stop BOW.
Z FD18 C9 RET

;
; This subroutine sets up the cursor by turning
; on the flashing and BOW (inverse video).
; Also checks if the character that was there
; was flashing or BOW. If so sets bits in the 'mode'
; register (Reg. E) so that CLRCSR
; can reset the character properly.
Z FD19 CD FD39 SETCSR: CALL ADDOFF
Z FD1C C846 BIT ?FLASH,M ; Is character flashing?
Z FD1E 2802 JRZ ?..L1 ; No.
Z FD20 C8E3 SET ?AFSBIT,E ; Yes, so remember it.
Z FD22 C8C6 ..L1: SET ?FLASH,M ; Make it flash anyway.
Z FD24 C84E BIT ?CHUNK,M ; Chunky?
Z FD26 2802 JRZ ?..L2 ; No.
Z FD28 CD FD3F CALL DECOFF ; Yes, can't be BOW.
Z FD2A CV RET
Z FD2C CD FD3F ..L2: CALL DECOFF
Z FD2E C87E BIT ?BOW,M ; Is character BOW?
Z FD31 2802 JRZ ?..L3
Z FD33 C8E8 SET ?AFSBIT,E ; Yes, remember it.
Z FD35 C8FE ..L3: SET ?BOW,M ; Inverse video.
Z FD37 CV RET

;
; Routine adds OFFSET to the current cursor
; position so that the control bit section can
; be looked at.
Z FD38 C5 ADDOFF: PUSH B
Z FD39 01 0400 LXI B,OFFSET
Z FD3C 09 DAD B ; CURSOR = CURSOR + OFFSET
Z FD3D C1 POP B
Z FD3E C9 RET

;
Z FD3F C5 DECOFF: PUSH B
Z FD40 01 0400 LXI B,OFFSET
Z FD43 B7 ORA A ; Clear carry.
Z FD44 E3A2 DSHC ?R: CURSOR = CURSOR - OFFSET
Z FD46 C1 POP B
Z FD47 CV RET
Z FD48 71 NORMV MOV M,C ; Get the character.
Z FD49 C853 BIT ?FSMBIT,E ; Make it flash?
Z FD4B 280A JRZ ?..L0 ; No.
Z FD4D CD FD39 CALL ADDOFF ; Yes.
Z FD50 C8C6 SET ?FLASH,M
Z FD52 CD FD3F CALL DECOFF
Z FD55 1408 JNPR ?..L1
Z FD57 CD FD39 ..L0: CALL ADDOFF ; Stop flashing.
Z FD5A C8A6 RES ?FLASH,M
Z FD5C CD FD3F CALL DECOFF
Z FD5F C85B BIT ?CHK9BIT,E ; Make it chunky?
Z FD61 2010 JRNZ ?..L2 ; Yes, bypass BOW.
Z FD63 CD FD39 CALL ADDOFF ; No, so insure it's not.
Z FD66 C89E RES ?CHUNK,M
Z FD68 CD FD3F CALL DECOFF
Z FD6B C848 BIT ?BOWBIT,E ; Make it BOW?
Z FD6D 200C JRZ ?..L3 ; No.
Z FD6F C8FE SET ?BOW,M ; Yes.
Z FD71 1308 JNPR ?..L3
Z FD73 CD FD39 ..L2: CALL ADDOFF
Z ED74 C8CE SET ?CHUNK,M
Z ED76 CD FD3F CALL DECOFF

;
; Now check if at end of line. If so perform
; CR/LF sequence.
Z ED78 3E3F ..L3: MVI A,LL
Z ED79 BA CMP D ; At end of line?
Z ED7E 2803 JRZ ?..L4 ; Yes, New line.
Z ED80 14 INR D ; No, CC = CC+1
Z ED81 23 INX H ; CURSOR = CURSOR+1
Z ED82 CV RET
Z ED83 CD FD9A ..L4: CALL CR
Z ED86 CD FD9C CALL LF
Z ED89 CV RET

;
Z FDBA C5 FDBA: PUSH H
Z FDBB FDBB MVI B,0 ; Clear B.
Z FDBD 4A MOV C,D ; Put CC into Reg. C.
Z FDBE B7 FDBE: ORA A
Z FDBF ED42 DSHC ?B ; Clear carry.
Z FDC0 C1 POP B ; CURSOR = CURSOR-CC
Z FDC1 1600 MVI D,0 ; (HL = HL-BC)
Z FDC2 C9 RET ; CC = 0

;
Z FDC3 3E0F FDC3: MVI A,LINES
Z FDC4 B8 CMP B ; LC = LINES? (On last line?)
Z FDC5 2004 JRNZ ?..L1 ; No.
Z FDC6 CD FDE3 CALL SCROLL ; YES.
Z FDC7 C9 RET
Z FDC8 04 ..L1: INR B ; LC = LC+1
Z FDC9 C5 PUSH B
Z FDD0 01 0040 LXI B,LL+1 ; (B will be 0, C will be LL+1)
Z FDD1 C9 POP B ; CURSOR = CURSOR + LL
; (HL = HL+BC)

;
Z FDD2 C9 POP B
Z FDD3 AF BS: XRA A ; Clear A.
Z FDD4 BA CMP D ; At front of line?
Z FDD5 C8 RZ ; Yes, finish.
Z FDD6 15 DCR D ; CC = CC-1
Z FDD7 2B DCX H ; CURSOR = CURSOR-1
Z FDD8 C9 RET

;
Z FDD9 3E3F FDD9: MVI A,LL
Z FDE0 BA CMP D ; At end of line?
Z FDE1 C9 INR H ; Yes.
Z FDE2 14 INR D ; CC = CC+1
Z FDE3 23 INX H ; CURSOR = CURSOR+1
Z FDE4 C9 RET

;
; Moves cursor up one line. When cursor
; reaches the top line then scrolls down.
Z FDE5 AF UP: XRA A
Z FDE6 BA CMP B ; At top line?
Z FDE7 2004 JRNZ ?..L1 ; No.
Z FDE8 CD FE14 CALL DSCRLL ; Yes, scroll down.
Z FDE9 C9 RET
Z FDEA 05 ..L1: DCR B ; LC = LC-1
Z FDEB C5 PUSH B
Z FDEC 01 0040 LXI B,LL+1
Z FDED B7 ORA A
Z FDEE ED42 DSHC ?B ; CURSOR = CURSOR-LL
Z FDE8 C1 POP B
Z FDE9 C9 RET

;
; Clear screen by filling with blanks. Also
; clears control bit section of memory.
Z FDEA C5 FF: PUSH B
Z FDEB D5 PUSH D
Z FDEC E5 PUSH H
Z FDED 21 E800 LXI H,MEM ; Start of memory.
Z FDEE 11 E901 LXI D,MEM+1 ; Start of 1st blank.
Z FDEF 01 07FF LXI B,2*OFFSET-1 ; Length to shift.
Z FDF0 3620 MVI M,' '
Z FDF1 ED80 LDIR ?; DO IT!!!
Z FDF2 E1 POP H
Z FDF3 D1 POP D
Z FDF4 C1 POP B
Z FDF5 CD FD95 CALL HOME ; Set up cursor.
Z FDF6 C9 RET

;
; Scrolls up by shifting all lines
; up by 1 then blank filling the bottom
; line. Does the same for the control bits in
; upper memory.
; Does this by shifting the first character of
; second line to first position in first (top)
; line, then incrementing pointers.
Z FDF7 C5 SCROLL: PUSH B
Z FDF8 D5 PUSH D
Z FDF9 E5 PUSH H
Z FDE0 11 E800 LXI H,MEM+LL+1 ; Start of 2nd line.
Z FDE1 11 E800 LXI D,MEM ; Start of top line.
Z FDE2 01 03C0 LXI B,OFFSET-(LL+1) ; Length.
Z FDE3 ED80 LDIR ?
Z FDE4 LXI H,MEM+OFFSET+LL+1 ; Now the control bits
Z FDE5 11 EC00 LXI D,MEM+OFFSET
Z FDE6 01 03C0 LXI B,OFFSET-(LL+1)
Z FDE7 ED80 LDIR ?
Z FDE8 LXI H,MEM+OFFSET-(LL+1) ; Clear last line.
Z FDE9 3E20 MVI A,' '
Z FDEA 0640 MVI B,LL+1 ; Line length.
Z FDEB 77 ..L1: MOV M,A
Z FDEC 23 INX H
Z FDED 10FC DJNZ ?..L1 ; Repeat until done.
; Clear last line of control bits.
Z FDEE 01 03C0 LXI B,MEM+2*OFFSET-(LL+1)
Z FDEF 77 MVI M,A
Z FDE0 INX H
Z FDE1 D1 POP D
Z FDE2 C1 POP B
Z FDE3 C9 RET

;
; Similar to SCROLL, but scrolls down. Starts
; by shifting last character of 2nd last line into
; last character of last line.
Z FDE4 C5 DSCRLL: PUSH B
Z FDE5 D5 PUSH D
Z FDE6 E5 PUSH H

```

RAM

```

FE17 21 E8BF LXI H,HEX+OFFSET-(LL+1)-1
FE1A 11 E8FF LXI D,HEX+OFFSET-1
FE1D 01 03C0 LXI B,OFFSET-(LL+1)
Z FE20 EDB8 LDDW7
FE22 21 E8BF LXI H,HEX+2*OFFSET-(LL+1)-1
FE25 11 E8FF LXI D,HEX+2*OFFSET-1
FE28 01 03C0 LXI B,OFFSET-(LL+1)
Z FE2B EDB8 LDDW7
FE2D 21 E800 LXI H,HEX
FE30 3E20 MVI A,2
FE32 0640 MVI B,LL+1
FE34 77 MOV A,A
FE35 23 INX A
FE36 10FC DJNZ 7..L1
FE38 21 EC00 LXI H,HEX+OFFSET
FE3B 0640 MVI B,LL+1
FE3D 77 MOV A,A
FE3F 23 INX A
Z FE3F 10FC DJNZ 7..L2
FE41 E1 H
FE42 01 POP H
FE43 C1 POP D
FE44 C9 RET

```

; Causes a delay so that the speed of the display
 ; can be reduced so that it is more readable.
 ; The value in location DELVAL can be changed to
 ; change the speed. 'FF' is slowest.

```

FE45 3A FE58 DELAY: LDA DELVAL
FE48 FE00 CPI 0
FE4A C9 PUSH B ; No delay.
FE4B C5 PUSH B
FE4C 47 MOV B,A
FE4D E3 ..DEL: XTHL ; waste time.
FE4E E3 XTHL
FE4F E3 XTHL
FE50 E3 XTHL
Z FE51 10FA DJNZ 7..DEL
FE53 C1 POP B
FE54 C9 RET

```

;
 ;
 ; Line Count.
 ; Character Count.
 ; Mode of operation.
 ; Value for delay.
 ; Cursor position.

```

***** SYMBOL TABLE *****

```

ABRBIT 0005	ADDOFF FD38	AFSBIT 0004	BASE FC00
BEGIN FC06	BELLCH 0007	BDR 0007	BDRBIT 0001
BORCH 0012	BS FDAD	BSCH 0009	CC FE56

```

CHKBIT 0003 CHKCH 0014 CHUK 0001 CHUNKY FC28
CLRCSR FCF7 CONTRL FC34 CR FDR9A CRCH 000D
CURBIT 0006 CUNCH 0015 CURSOR FE59 DECOFF FD3F
DELAY FE45 DELVAL FE58 DSCHELL FE14 EXGBIT 0000
EXIT FCD9 EXTCH 0005 EF FDCC FFCH 000C
FLASH 0000 FLSCH 0013 ES FDR3 FCH 0009
FSHBIT 0002 HMCH 0011 HOME FD95 LL 003F
LF FDFC LFCII 000A LINES 000F
MEM E900 MODE FE57 NORH FD49
OFFSET 0400 SCRLL FDE3 SETCSA FD19
UP FDSA VDUO FCF0 VFCII 0008
ZTTYI F61F ZTTYO F490

```

90 ERRORS WERE DETECTED *****

HEX DUMP

```

FC00 C3 04 FC C3 90 F4 C5 D5 E5 3A 55 FE 47 3A 56 FE
FC10 57 3A 57 FE 5F 2A 59 FE 79 CB 58 20 0E FE 20 DA
FC20 34 FC CD F7 FC CD 4F FD C3 09 FC FE 14 20 F3 C8
FC30 9B C3 D9 FC CR 43 2R D9 FE 05 20 E6 CB 83 C3 D9
FC40 FC FE 05 20 05 CB C3 C3 D9 FC FE 14 20 05 CR DR
FC50 C3 D9 FC CD F7 FC FE 0D 20 06 CD 8A FD C3 D9 FC
FC60 FE 0A 20 06 CD 9C FD C3 D9 FC FF 12 20 0E CR 4B
FC70 2R 05 CB 8B C3 D9 FC CR C3 D9 FC FE 13 20 0E
FC80 CB 53 2R 05 CB 93 C3 D9 FC CB D3 C3 D9 FC FE 07
FC90 20 06 CD 03 FC C3 D9 FC FE 09 20 06 CD AD FD C3
FCA0 D9 FC FE 09 20 06 CD B3 FD C3 D9 FC FE 0C 20 05
FCB0 CD CC FD 18 24 FE OR 20 05 CD BA FD 18 18 FE 11
FCC0 20 05 CD 95 FD 18 12 FE 15 20 0E CB 73 2R 05 CB
FCD0 83 C3 D9 FC CR F3 C3 D9 FC CB 73 20 03 CD 10 FD
FCE0 7R 32 57 FE 7A 32 56 FE 78 32 55 FE 22 59 FE E1
FCF0 D1 C1 CD 45 FE 79 C9 CD 3R FD CB 63 2R C9 A3
FD00 18 02 CB 86 CB 4E 2R 04 CD 3F FD C9 CD 3F FD CB
FD10 6R 2R 03 CB AB C9 CB BF C9 CD 3F FD CB 46 2R 02
FD20 CB E3 CR C6 CB 4E 2R 04 CD 3F FD C9 CD 3F FD CB
FD30 7E 2R 02 CB F9 CB FE C9 C5 01 00 04 09 C1 C9 C5
FD40 01 00 04 B7 ED 42 C1 C9 71 CB 53 2R 0A CD 3R FD
FD50 CB C6 CD 3F FD 1R CR CD 3R FD CB 8A CD 3F CD CB
FD60 5R 20 10 CD 3R FD CB RE CD 3F FD CR 4B 2R 0C CB
FD70 FE 19 08 CD 3R FD CB CE CD 3F FD 3E 3F RA 29 03
FD80 14 23 C9 CD RA FD CD 9C FD C9 C5 06 00 4A B7 ED
FD90 42 C1 16 00 C9 16 00 42 21 00 ER C9 3E 0F RR 20
FDA0 04 CD E3 FD C9 04 C5 01 40 00 09 C1 C9 AF BA CR
FDB0 15 2B C9 3E 3F RA CR 14 23 C9 AF RR 20 04 CD 14
FDC0 FE C9 05 C5 01 40 00 B7 ED 42 C1 C9 C5 05 E5 21
FDD0 00 5R 41 01 ER 01 FF 07 36 20 ED RR 01 CD 03 ED
FDE0 95 FD C9 C5 05 E5 21 40 ER 11 00 RR 01 CD 03 ED
FDF0 80 21 40 EC 11 00 EC 01 C0 13 ED 80 21 C0 5R 3E
FEE0 20 06 40 77 23 10 FC 21 C0 5F 04 40 77 23 10 FC
FE10 E1 D1 C1 C9 C5 05 E5 21 BF EB 11 FF ER 01 C0 03
FE20 ED 8R 21 BF EF 11 FF EF 01 C0 03 ED 8R 21 00 ER
FE30 3E 20 06 40 77 23 10 FC 21 00 EC 06 40 77 23 10
FE40 FC E1 D1 C1 C9 3A 5R FE FE 00 CR C5 47 E3 E3 E3
FE50 E3 10 FA C1 C9 00 00 00 00 00 ER

```

ETI 318 DIGITAL TACHO

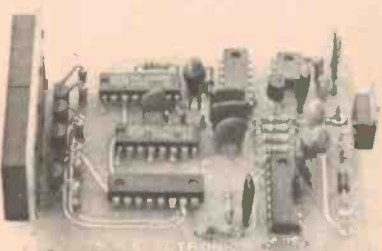

\$ 36
POST FREE
Certified mail

Full kit of parts, including pre-punched case, glass board, all prime components. Suits 4, 6 or 8 cylinder. 0.3 second update. 1/2" LED display. See July ETI for details.

Also available: fully assembled and painted with Aluminium mounting bracket. State number of cylinders required.

\$48 POST FREE

ALL PRODUCTS MADE IN AUSTRALIA

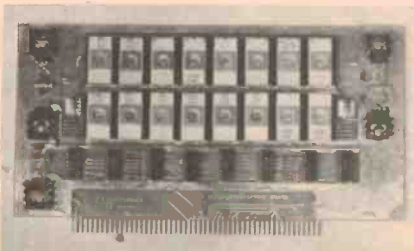

KIT PRICE
\$115 POST FREE
plus 2708's

S100 EPROM BOARD

Switched 8K boundaries, 1-4 wait cycles, low power Schottky chips, sockets on all chips, plated through holes, solder mask.

- S100 Wire Wrap with 81LS95 buffers, F/glass board: \$24.50.
- S100 Extender Board with socket & labeled test points: \$24.50
- S100 Mother Board 8 slot double sided 7"x7": \$24.50
- Eprom Eraser assembled only: \$49.50 plus \$1.50 p&p
- Number Cruncher Kit uses MM57109 data and software: \$56
- Front Panel Display address and data bus in hex and binary, status Leds, 2 port displays 10"x8": \$105.

Coming soon:

S100 16K Ram Board. Computer Main Frame, For S100 & 6800 11 slot 10 amp supply, rack or bench mount.

SUPPORT YOUR LOCAL INDUSTRY



10 Stafford Crt., Doncaster East. Victoria. 3109.
Box 19, Doncaster East. 3109. Ph (03) 842-3950.
Built & tested prices and tax free prices on application.

DIODES/ZENERS				SOCKETS/BRIDGES				TRANSISTORS, LEDS, etc.				
1N914	100v	10mA	.05	8-pin	pcb	.20	ww	.35	2N2222	NPN (2N2222 Plastic)	.10	.15
1N4005	600v	1A	.08	14-pin	pcb	.20	ww	.40	2N2907	PNP		.10
1N4007	1000v	1A	.15	16-pin	pcb	.20	ww	.40	2N3906	PNP (Plastic - Unmarked)		.10
1N4148	75v	10mA	.05	18-pin	pcb	.25	ww	.75	2N3904	NPN (Plastic - Unmarked)		.35
1N4733	5.1v	1 W Zener	.25	22-pin	pcb	.35	ww	.95	2N3054	NPN		.50
1N753A	6.2v	500 mW Zener	.25	24-pin	pcb	.35	ww	.95	2N3055	NPN 15A 60v		.35
1N758A	10v	"	.25	28-pin	pcb	.45	ww	1.25	T1P125	PNP Darlington		.15
1N759A	12v	"	.25	40-pin	pcb	.50	ww	1.25	LED Green, Red, Clear, Yellow			1.95
1N5243	13v	"	.25	Molex pins	.01	To-3 Sockets		.25	D.L.747	7 seg 5/8" High com-anode		1.25
1N5244B	14v	"	.25	2 Amp Bridge		100-prv		.95	MAN72	7 seg com-anode (Red)		1.25
1N5245B	15v	"	.25	25 Amp Bridge		200-prv		1.95	MAN3610	7 seg com-anode (Orange)		1.25
									MAN82A	7 seg com-anode (Yellow)		1.25
									MAN74A	7 seg com-cathode (Red)		1.50
									FND359	7 seg com-cathode (Red)		1.25

C MOS				- T T L -							
4000	.15	7400	.10	7473	.25	74176	.85	74H72	.35	74S133	.40
4001	.15	7401	.15	7474	.30	74180	.55	74H101	.75	74S140	.55
4002	.20	7402	.15	7475	.35	74181	2.25	74H103	.55	74S151	.30
4004	3.95	7403	.15	7476	.40	74182	.75	74H106	.95	74S153	.35
4006	.95	7404	.10	7477	.45	74183	.75			74S157	.75
4007	.20	7405	.25	7478	.50	74184	.75			74S158	.30
4008	.75	7406	.25	7479	.55	74185	.75			74S194	1.05
4009	.35	7407	.55	7480	.55	74186	.75			74S257 (8123)	1.05
4010	.35	7408	.15	7481	.75	74187	.75				
4011	.20	7409	.15	7482	.75	74188	.75				
4012	.20	7410	.15	7483	.75	74189	.75				
4013	.40	7411	.25	7484	.75	74190	1.25				
4014	.75	7412	.25	7485	.55	74191	.95				
4015	.75	7413	.25	7486	.25	74192	.75				
4016	.35	7414	.75	7487	.25	74193	.85				
4017	.75	7415	.25	7488	.25	74194	.95				
4018	.75	7416	.40	7489	1.05	74195	.95				
4019	.35	7417	.15	7490	.45	74196	.95				
4020	.85	7418	.25	7491	.70	74197	.95				
4021	.75	7419	.25	7492	.45	74198	1.45				
4022	.75	7420	.15	7493	.35	74199	1.00				
4023	.20	7421	.20	7494	.75	74200	.75				
4024	.75	7422	.20	7495	.60	74201	.75				
4025	.20	7423	.20	7496	.80	74202	.75				
4026	1.95	7424	.20	7497	.80	74203	.75				
4027	.35	7425	1.15	7498	.80	74204	.75				
4028	.75	7426	.45	7499	.80	74205	.75				
4030	.35	7427	.45	7500	.80	74206	.75				
4033	1.50	7428	.45	7501	.80	74207	.75				
4034	2.45	7429	.45	7502	.80	74208	.75				
4035	.75	7430	.70	7503	.80	74209	.75				
4040	.75	7431	.70	7504	.80	74210	.75				
4041	.69	7432	.50	7505	.80	74211	.75				
4042	.65	7433	.25	7506	.80	74212	.75				
4043	.50	7434	.25	7507	.80	74213	.75				
4044	.65	7435	.20	7508	.80	74214	.75				
4046	1.25	7436	.25	7509	.80	74215	.75				
4049	.45	7437	.40	7510	.80	74216	.75				
4050	.45	7438	.45	7511	.80	74217	.75				
4066	.55	7439	.40	7512	.80	74218	.75				
4069/74C04	.25	7440	.40	7513	.80	74219	.75				
4071	.25	7441	.40	7514	.80	74220	.75				
4081	.30	7442	.40	7515	.80	74221	.75				
4082	.30	7443	.40	7516	.80	74222	.75				
MC 14409	14.50	7444	.40	7517	.80	74223	.75				
MC 14419	4.85	7445	.40	7518	.80	74224	.75				
4511	.95	7446	.40	7519	.80	74225	.75				
74C151	1.90	7447	.40	7520	.80	74226	.75				
		7448	.40	7521	.80	74227	.75				
		7449	.40	7522	.80	74228	.75				
		7450	.40	7523	.80	74229	.75				
		7451	.40	7524	.80	74230	.75				
		7452	.40	7525	.80	74231	.75				
		7453	.40	7526	.80	74232	.75				
		7454	.40	7527	.80	74233	.75				
		7455	.40	7528	.80	74234	.75				
		7456	.40	7529	.80	74235	.75				
		7457	.40	7530	.80	74236	.75				
		7458	.40	7531	.80	74237	.75				
		7459	.40	7532	.80	74238	.75				
		7460	.40	7533	.80	74239	.75				
		7461	.40	7534	.80	74240	.75				
		7462	.40	7535	.80	74241	.75				
		7463	.40	7536	.80	74242	.75				
		7464	.40	7537	.80	74243	.75				
		7465	.40	7538	.80	74244	.75				
		7466	.40	7539	.80	74245	.75				
		7467	.40	7540	.80	74246	.75				
		7468	.40	7541	.80	74247	.75				
		7469	.40	7542	.80	74248	.75				
		7470	.40	7543	.80	74249	.75				
		7471	.40	7544	.80	74250	.75				
		7472	.40	7545	.80	74251	.75				
		7473	.40	7546	.80	74252	.75				
		7474	.40	7547	.80	74253	.75				
		7475	.40	7548	.80	74254	.75				
		7476	.40	7549	.80	74255	.75				
		7477	.40	7550	.80	74256	.75				
		7478	.40	7551	.80	74257	.75				
		7479	.40	7552	.80	74258	.75				
		7480	.40	7553	.80	74259	.75				
		7481	.40	7554	.80	74260	.75				
		7482	.40	7555	.80	74261	.75				
		7483	.40	7556	.80	74262	.75				
		7484	.40	7557	.80	74263	.75				
		7485	.40	7558	.80	74264	.75				
		7486	.40	7559	.80	74265	.75				
		7487	.40	7560	.80	74266	.75				
		7488	.40	7561	.80	74267	.75				
		7489	.40	7562	.80	74268	.75				
		7490	.40	7563	.80	74269	.75				
		7491	.40	7564	.80	74270	.75				
		7492	.40	7565	.80	74271	.75				
		7493	.40	7566	.80	74272	.75				
		7494	.40	7567	.80	74273	.75				
		7495	.40	7568	.80	74274	.75				
		7496	.40	7569	.80	74275	.75				
		7497	.40	7570	.80	74276	.75				
		7498	.40	7571	.80	74277	.75				
		7499	.40	7572	.80	74278	.75				
		7500	.40	7573	.80	74279	.75				
		7501	.40	7574	.80	74280	.75				
		7502	.40	7575	.80	74281	.75				
		7503	.40	7576	.80	74282	.75				
		7504	.40	7577	.80	74283	.75				
		7505	.40	7578	.80	74284	.75				
		7506	.40	7579	.80	74285	.75				
		7507	.40	7580	.80	74286	.75				
		7508	.40	7581	.80	74287	.75				
		7509	.40	7582	.80	74288	.75				
		7510	.40	7583	.80	74289	.75				
		7511	.40	7584	.80	74290	.75				
		7512	.40	7585	.80	74291	.75				
		7513	.40	7586	.80	74292	.75				
		7514	.40	7587	.80	74293	.75				
		7515	.40	7588	.80	74294	.75				
		7516	.40	7589	.80	74295	.75				
		7517	.40	7590	.80	74296	.75				
		7518	.40	7591	.80	74297	.75				
		7519	.40	7592	.80	74298	.75				
		7520	.40	7593	.80	74299	.75				
		7521	.40	7594	.80</						

Fast Fourier Transforms

You may have heard of Fourier Analysis, but more often than not explanations of what this is all about are drowned in mathematics. E.J. Hughson describes how it's done electronically.

MUCH OF ELECTRONICS is concerned with the processing of signals of some sort or another. It is only natural then, that a lot of effort has gone into analysing these signals. On one hand one must know certain basic things about the signals in order to be able to build useful circuits. On the other hand, investigating signal properties with no particular applications in mind, has led to various useful results that later helped to simplify, improve or introduce new circuit designs. The field of study concerning signals is known, naturally enough, as "Signal Analysis".

In order to go deeply into some of the theory in this field, some pretty heavy math must be employed. However, it is quite easy to understand the majority of the material intuitively, and besides, that's a much more entertaining approach.

Think of a Signal . . .

How do most of us think of signals? Probably "signals" conjures up images of a scope with a waveform on it. Let's use this waveform as an example — suppose it's a 1kHz triangle wave. What characteristics does this waveform have? It is a voltage (say) varying up and down periodically, thus it has an "instantaneous amplitude" at any instant in time. This is what we see on the scope, an amplitude versus time graph. We can also say that the waveform has a characteristic we call frequency. Most of us use the term frequency to mean the basic frequency of repetition of the entire waveform. Why this distinction? Here's where a theoretical concept must be just accepted if we're not to get submerged in abstraction.

Fourier Analysis

It is convenient to think of a *sine* wave as the "purest" waveform, and use this kind of wave as a basis for study of other waveforms. It has been found possible to make any other kind of waveform from a combination (sum) of

sinusoidal waves of various frequencies and amplitudes. This is analogous to being able to combine the three basic colours of light, green, red, blue to form other colours.

In fact we have cheated a little bit; we should correct the above to say that any kind of waveform can be made from combinations of *sine and cosine* waves of various frequencies and amplitudes, a cosine wave being simply a sine wave but one quarter wave ahead.

Ok, so what? The next step is to introduce a graph of amplitude versus frequency. Figure 2 is an example in which we plot the "frequency content" of a sine wave of amplitude 1 and frequency 1kHz. There is only one point on the graph, because as we said before, a sine wave is considered to be "pure" or only one frequency.

So how about our triangle wave? What does its frequency content look like? Figure 3 shows that the frequency content is quite complex.

The graph shows that there is a large content of the fundamental frequency, with decreasing content of odd order harmonics.

The process of converting the "time" waveform to the "frequency" graph is called the Fourier Transform. The reverse process is called the Inverse Fourier Transform.

In the case of a repetitive waveform (such as the triangle wave) the Fourier Transform yields a frequency content graph which has non-zero points only at multiples of the fundamental frequency. Thus, a series of numbers may be used rather than a graph to represent this information. For the triangle wave, the series is:

$$.81 \times (1\text{kHz sine} - .09 \times 3\text{kHz sine}) + .032 \times (5\text{kHz sine}) - .017 (7\text{kHz sine}) + \dots$$

For a 1kHz, $\pm 1\text{V}$ square wave the series is:

$$1.27 \times (1\text{kHz sine}) + 424 \times (3\text{kHz sine}) + .255 \times (5 \text{ kHz sine} + \dots$$

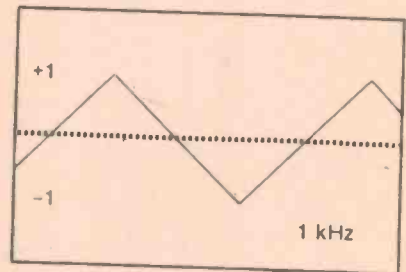

Fig. 1. Scope trace showing triangle wave

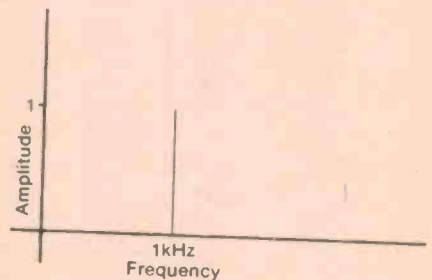

Fig. 2. Amplitude vs. frequency plot of 1kHz sine wave

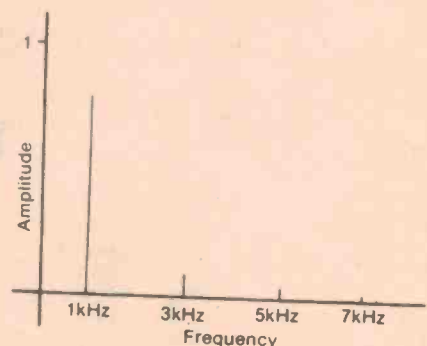

Fig. 3. Amplitude vs. frequency plot for triangle wave.

On the other hand, you are no doubt already familiar with frequency plots of noise, and particularly audio equipment response curves, which are nothing more than the frequency content graphs of the output with "all frequencies" fed in. (Fig. 4.) Note that the frequency plots in this example are continuous rather than just the odd point here and there.

Doing It

A picture of actually doing the transform is shown in Fig. 5. The "transformer" could be a person with a piece of paper working out the graph or more usefully a machine doing the

work. Suppose a computer was used to do the task on an input waveform, how would it do it?

Automatic Transform

If an analog waveform is sampled at regular intervals, we get what is called a discrete time series — discrete because it is a series of separate points and time series because we have something changing with time. Figure 6 shows a sampled sine wave displayed on an oscilloscope.

If we were to measure the level of each of the points we would get a series of numbers. If we do this electronically using analog-to-digital conversion we get a series of digital numbers represent-

ing the discrete time series. OK so far? It is this set of digital samples which a Fourier Transform (or "Discrete" FT in this case) takes and turns into information directly showing the frequency or harmonic content of all signals which make up the original time series. The technique shows any components from DC to half the sampling frequency. (It is not possible to obtain any frequencies higher than this since it would contradict a fundamental rule concerning sampled waveforms, established by Nyquist.)

Adding New Frequencies And Filtering

If the output numbers undergo an inverse DFT we get a series of numbers outputted which represent the original waveform.

By taking a waveform and analysing it using a DFT, then performing an inverse DFT on the output we can arrive back at the original waveform. A filter can be made by performing an inverse DFT only on those numbers representing the frequencies which are required.

Similarly, by adding numbers to represent new frequencies before performing an inverse transform extra frequencies will be present in the output time series (and after digital-analog conversion, in the output waveform).

The DFT does not work on analog or continuous information: only on a set of numbers representing the instantaneous values of a portion of a waveform. The result is a set of numbers corresponding to the frequency content of the waveform. Not only does DFT give us each frequency present in the original waveform, it also gives the relative phase and amplitude of each frequency component.

By performing a power calculation on the output frequencies a power spectrum may be obtained. Of course the more numbers or samples which are input to the DFT, the more information is available at the output. However, for a fixed set of numbers is outputted.

Interpreting The Numbers on the Output

To illustrate how outputted numbers are interpreted consider a DFT performed on a portion of a time series containing 100 samples. The 1000 numbers inputted will have various arithmetic operations performed on them and 1000 numbers (known as frequency cells) will be outputted. Of these 1000 cells only the first 500, representing the frequency range, will have any real meaning.

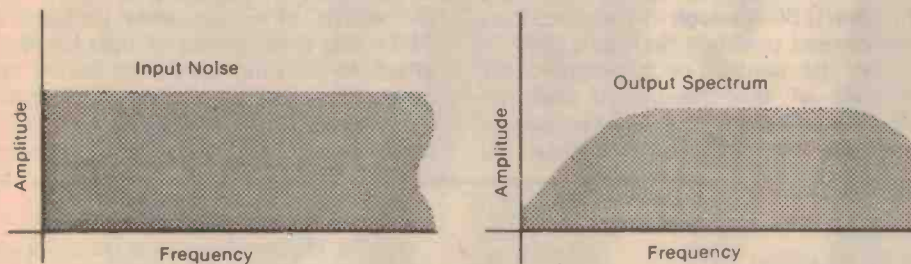

Fig. 4. Noisy amplitude vs. frequency spectra

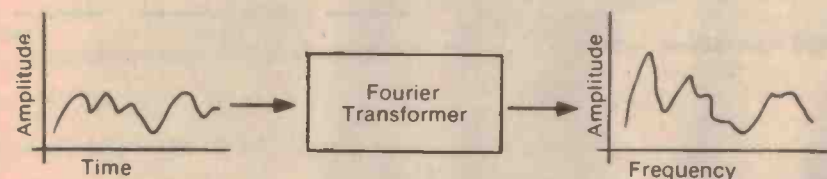

Fig. 5. The transform process

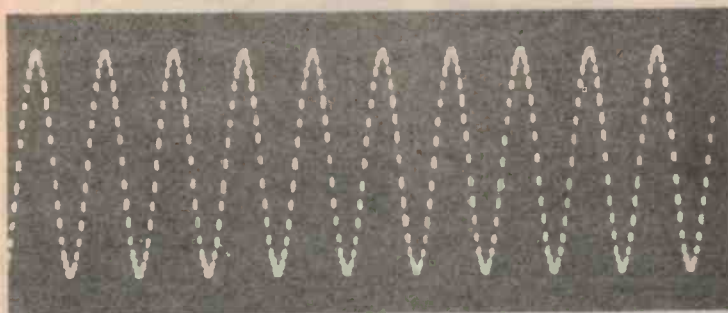

Fig. 6. Analog sine wave sampled at intervals

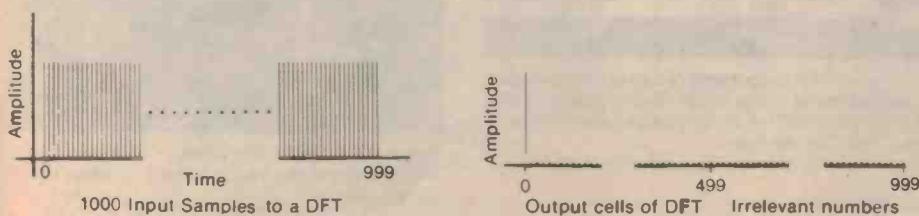

Fig. 7a. Transforming a DC voltage

For example, suppose all input numbers representing samples from an analog-to-digital converter are the same. (This would mean that a constant DC voltage would have had to have been applied to the converter.) Of the 1000 numbers obtained by the forward transform, only the first would have a value other than zero, since this first number is reserved for the DC content of the input series and all the energy of the input is in the form of DC. (See Fig 7a).

Suppose now the output of an analog-to-digital converter is being sampled at 1000 samples/sec, also suppose a sine wave of 1Hz is applied to the input of the converter. One thousand numerical samples or one second's worth of data is collected. If these 1000 numbers are used as the input of a Fourier Transform, then of the 500 numbers output, the first will have zero value (DC) but the second, reserved for frequency of 1Hz, will have maximum value (Fig 7b). All others will have zero value also.

If the frequency of the sine wave inputted to the converter is now increased to 2Hz and the 1000 samples at 1000/sec are collected, the Fourier Transform processor output will consist of zeroes in all 500 numbers except the third corresponding to 2Hz (Fig 7c). The output numbers are the cells, cell 0 to cell 499 in this case being reserved for frequencies of 0 (DC) to 499Hz. Figure 7 gives a graphic representation of these inputs and outputs. (NB, since the output cells are numbered starting from zero so also are the input samples, for clarity.)

Cell Number And Frequency

The example given above assumes a sampling frequency of one thousand per second so that with a 1000 point transformer the cell numbers automatically correspond to the frequencies they represent in the input time series. It is of course, not always practical to have the sampling frequency tied to the number of samples in the DFT as rigorously as this. But it is a very simple matter to obtain the actual frequency to which a cell output corresponds. This is obtained by the following relationship:

$$\begin{aligned} &\text{Frequency corresponding} \\ &\text{to Cell Number (1st cell = 0)} \\ &= \frac{\text{Cell No.} \times \text{Sampling Frequency}}{\text{No. of points in FFT}} \end{aligned}$$

The outputs depicted by Figure 7 are of course idealized. In practice slight errors will occur due to the finite number of bits used in the arithmetic of the calculation.

As so far discussed, the Discrete Fourier Transform both forward and

reverse has been put in terms of numbers which are inputted, the calculation process and numbers outputted. The calculation process is very involved and tedious but could be carried out by a computer or even a hand calculator (if you had the time and patience). To perform a 1000 point transform, it would require over 2 million discrete calculations, tedious indeed!

Fast Transform

The Fast Fourier Transform technique is able to reduce the calculations of a similar size transform to about 22,000 which is a significant reduction in the number of calculations and hence the amount of computer time. (Still a little much for the average pocket calculator, however!) So although digital computers can be used to obtain the results of FFTs under the control of a program, the amount of time needed to load the samples into the machine, to access and compute the data and to output the

results makes even a general purpose digital computer an impractical signal analyser.

For this reason, analysers using dedicated hardware capable of only performing FFTs are a far more practical proposition. Such analysers are capable of taking an analog wave form input performing analog-to-digital conversions on it, sampling accordingly, loading the desired number of samples into a dedicated FFT calculator and presenting the results to some display for presentation. See Fig. 8.

The instruments using FFT analysers usually come complete with accumulators and memories so that frequency spectra may be integrated and compared to each other. Integrating (or summing) the results of continuously computed FFTs over some period of time has the effect of showing up signals buried in noise. No matter how deeply the signal is buried the cell or cells which the signal occupies will eventually build up over

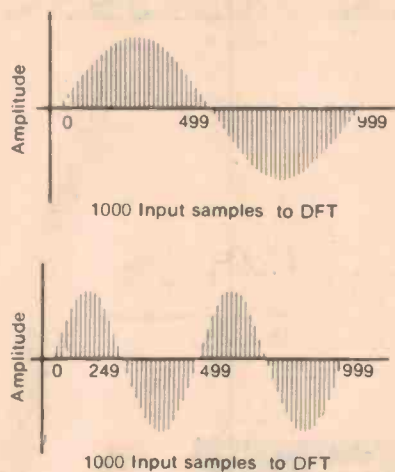

Fig. 7b. Transformation of 1Hz sine wave.

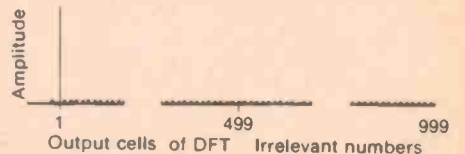
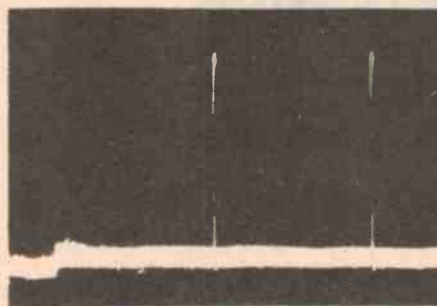

Fig. 7c. 2Hz sine wave sample



Displayed FFT output with two cells only present, corresponding to the series input. Note lines are same height and the second twice as far from zero frequency as the first.



Original sampled time series — two sine waves with one twice the frequency of the other, both same amplitude.

Fig. 9. Actual inputs and output of a FFT processor

all the other cells where the noise will be randomly distributed. This technique is now used, for example, in submarine detection where the noise from the vessel is discriminated over the sea noise by continuous integration of FFT results.

Figure 9 illustrates a sampled wave form consisting of 2 sine waves of equal amplitude and the display results of an FFT performed on a set of numerical samples taken from the time series. The display has its own amplitude graduations and the two lines represent the energy in the cells corresponding to the frequencies of the 2 sine waves. (Note no other lines appear as all other cell values are zero). The display is produced by continuously outputting the cell numbers from FFT result to a digital-to-analog converter and including the amplitude graduations.

The Mathematics

This article is not the place to consider

the in depth mathematical theory necessary to fully understand the processes which form part of the Fourier transform. Numerous books and technical articles now exist on the subject. However the basic operation and its adaptability to digital hardware is quite easily understood.

One major constraint on an FFT processor is that the number of samples inputted to it cannot be varied completely. With most processors, the number of samples in fact have to be a power to 2, e.g., 32 or 54 or 256 or 1024. The more samples taken then the larger the range of frequencies which can be determined or alternatively the narrower the band width between cells. However, the calculation process takes longer. In practice sample blocks of 512, 1024, 2048 are amongst the most commonly chosen as these offer a compromise between frequency range and computation time.

Essentially in the case of a Forward Transform the samples from the time series are loaded into a buffer and combinations of samples are added and subtracted from each other, multiplied by trigonometrical values usually looked up from a Read Only Memory. This process is repeated using different combinations of samples and trigonometrical values. The number of processing stages is related to the number of samples, eg, if 2048 samples were inputted, then 11 processing stages are needed. ($2^{11}=2048$). If 512 samples were inputted, then 9 stages are required, etc. This is illustrated in outline by Fig. 10.

The advantage over the old 'conventional' method of computation is that with the conventional method the number of stages of calculation equals the number of samples. In a 512 point transform the process would be 512/9 or approximately fifty-five times shorter by using an FFT. In a continuous process where FFTs are being continuously computed, obviously a very real saving is made in terms of result presentation.

As mentioned earlier the FFT processing idea lends itself very easily to a dedicated machine and the idea of pipeline processing is used in most of these. Pipeline processing is used where a number of calculations in series are performed and where an unacceptably long delay result for the computing of an answer before the next inputs are applied. Figure 11 shows an arrangement where this is likely to happen.

In this example an adder precedes a multiplier followed by another adder. With no pipelining, no further inputs can be supplied until enough time is allowed for the results of previous input numbers to be stored away. However with a pipeline processor, (Fig. 12) latches are included in strategic places allowing sets of numbers to follow each other as though they were coming down a pipe. Thus after the first set of results have trickled through the latches, a much faster throughput of numbers will result.

This type of arrangement is very suitable in FFT processors since a large throughput of samples with much number crunching takes place.

Present & Future FFT Analysers.

Essentially an FFT processor (which is the heart of modern spectrum analysers, voice print identifiers, etc) usually consist of a memory which stores the samples and intermediate results and a processor which computes intermediate results. The total samples

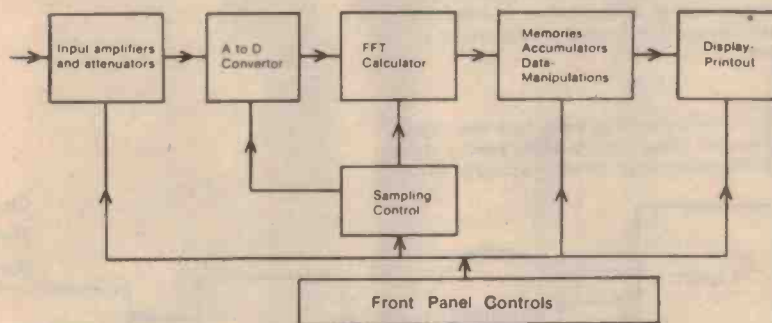

Fig. 8. Typical FFT Analyser basic functions

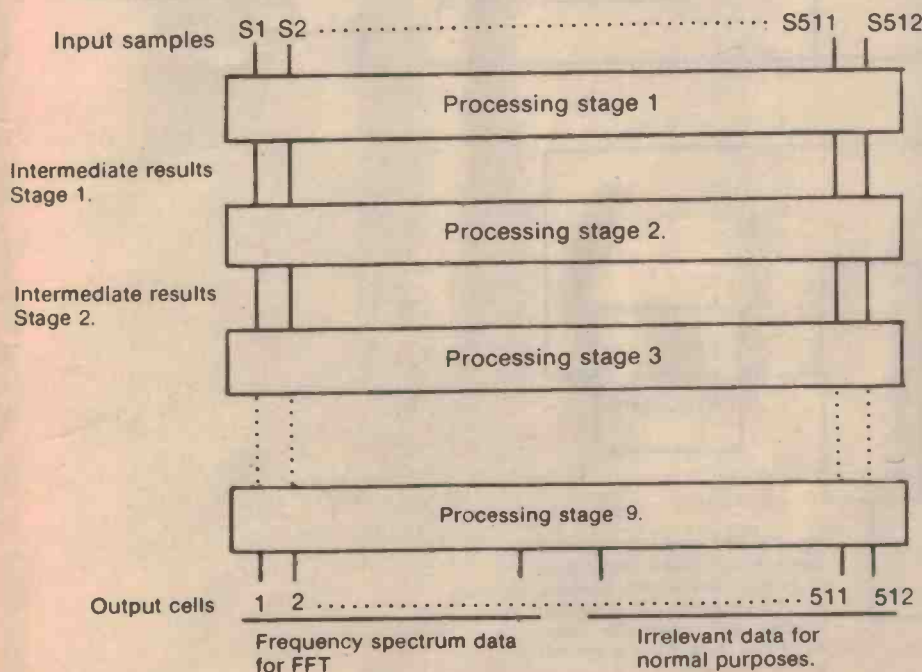

Fig. 10. FFT Processing stages for 512 point transform

are stored internally in the memory and when the FFT process begins, the samples are taken in pairs, arithmetically operated on to form intermediate results and stored ready for the next level of processing. Two memories are sometimes used where samples and results are alternately read from one memory through the pipeline processor into the other memory, where they are ready for the next level of processing. This technique saves still more time in computing FFTs. See Figure 13.

This article has only touched onto the now very broad field of FFT processing technology. The approach lends itself easily to band shifting,

frequency zoom effects and other features made relatively easy with a digital system.

Until the 1970s few people knew of Fourier Transforms. At best the term would evoke a feeling of something obscure, very mathematical and having few, if any practical applications. But in recent years a whole new world of applications has been unleashed.

FFT techniques are today used for a variety of applications including extraction of signals burried deep in noise, sonar processing, spectrum analysis of complex waveforms, voice print analysis and the digital synthesis of music. Research is finding still more uses, such as in the oral

synthesizing interface of talking computers. Some day you may be able to phone a computer and hold an intelligent conversation with it, obtaining such things as account balances, travel reservations, etc, with tonal expressions no different from those of a helpful person!

With the advent of bubble memories and the ever decreasing size but increasing complexity of micro circuits, it appears that the FFT processing field will expand to a point where it will soon be a part of every day life, a truly big step forward from just 10 years ago when the technique was not even heard of.

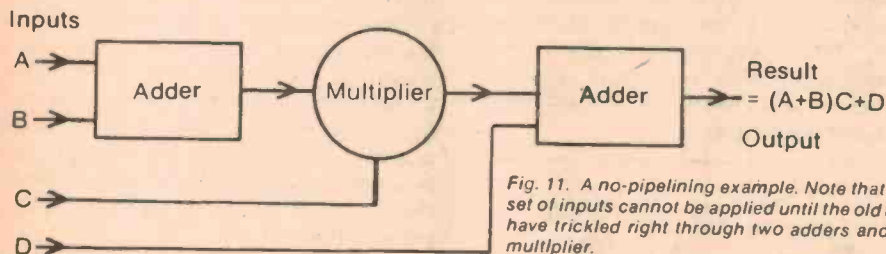

Fig. 11. A no-pipelining example. Note that a new set of inputs cannot be applied until the old inputs have trickled right through two adders and a multiplier.

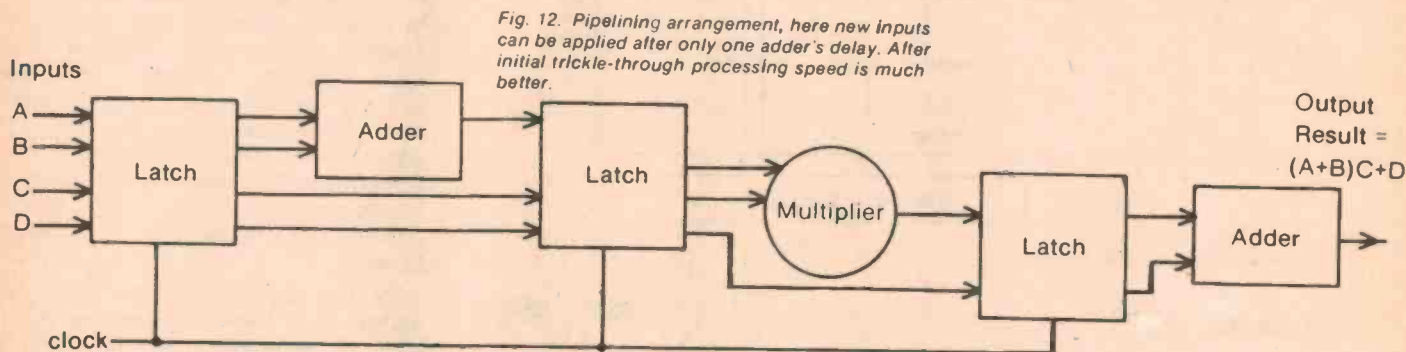

Fig. 12. Pipelining arrangement, here new inputs can be applied after only one adder's delay. After initial trickle-through processing speed is much better.

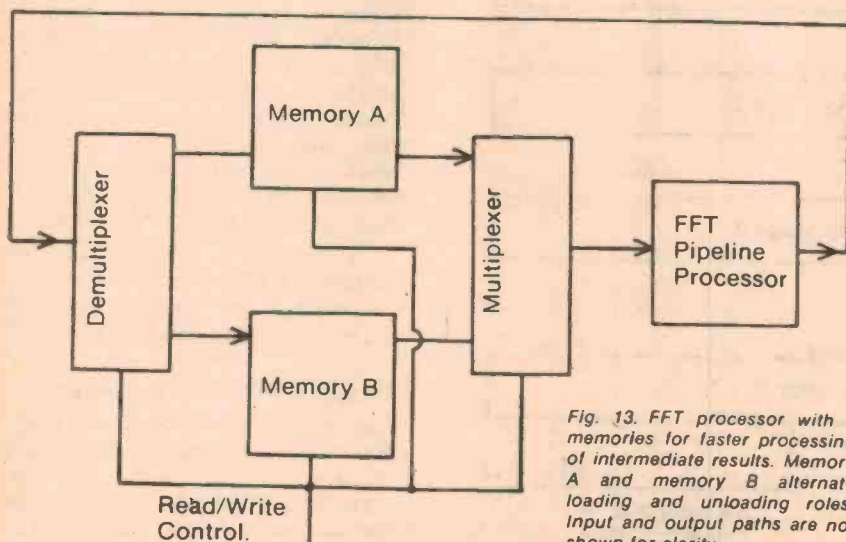

Fig. 13. FFT processor with 2 memories for faster processing of intermediate results. Memory A and memory B alternate loading and unloading roles. Input and output paths are not shown for clarity.



SYNERTEK'S SYM-1

The Complete Microcomputer System.

Synertek one of the world's leaders in Micro processor systems have developed this Versatile Interface Module. It suits all applications which educators, engineers, hobbyists, students and industrial users "actually" need.

Formerly known as VIM-1 recoded SYM-1

The SYM-1 has been designed to grow with your needs, its great features include: —

- The powerful 6502 8-Bit MICROPROCESSOR whose advanced architectural features have made it one of the largest selling "micros" on the market today.
- 4K BYTE ROM RESIDENT MONITOR and operating programs.
- USER PROM/ROM: The system is equipped with 3 PROM/ROM expansion sockets for 2316/2332 ROMs or 2716E PROMs.
- 1K BYTES OF 2114 STATIC RAM onboard with sockets provided for immediate expansion to 4K bytes onboard, with total memory expansion to 65, 536 bytes.
- STANDARD INTERFACE INCLUDE:
 - Audio Cassette Recorder
 - TV Controller Board
 - Full Duplex 20mA teletype
 - CRT Compatible
 - System Expansion Bus

The concept of the SYM-1 has been designed for on board expansion.

Expansion Features That Are Planned:

- TV Interface Card (with ASC11 Keyboard)
- Resident Assembler/Editor
- BASIC Interpreter
- RAM Expansion Kit

Make sure that you see a demonstration of this fantastic micro-computer system. Call into any Cema Silicon Valley Stores for an on-the-spot demonstration.



CEMA ELECTRONICS PTY LTD

SYDNEY

21 Chandos Street, Crows Nest, N.S.W. 2065
Phone: 439 4655

MELBOURNE

208 Whitehorse Road, Blackburn, Vic. 3130
Phone: 877 5311

**CEMA SILICON VALLEY
SYDNEY**

23 Chandos St., St. Leonards, N.S.W. 2065
Phone: 439 2965

MELBOURNE

380 Bridge Rd., Richmond, Vic.
Phone: 429 4780

ADELAIDE

170 Sturt St., Adelaide, S.A.
Phone: 51 4080

DIGITAL ELECTRONICS

BY EXPERIMENT part 8

A SHIFT REGISTER is a set of flip-flops, each of which can be set by its PRESET terminal to store a 1 or 0, so that the whole set stores a "word" (complete number). For example, four flip-flops could store numbers such as 0101, 1000, 1101, and so on. In addition, we can apply clock pulses to all of the flip-flops and so cause the stored numbers to shift from one flip-flop to the next in line on each clock pulse; several designs make this possible in either direction (right-left shift).

Fig. 2 shows an example of this in action. We start with the number 1010 stored, so that LEDs on the B and D outputs will be lit. The input of the first flip-flop is connected with J=0; K=1, so that at the clock pulse its Q output will change to zero. The two outputs of the first flip-flop, however, are connected to the J and K inputs of the next flip-flop in line (compare the Johnson counter, which is very simply obtained from a shift register). With J=1 and K=0 on the second flip-flop, from the outputs of the first, the clock pulse will cause the output of flip-flop C to change from 0 to 1. Similarly, with Jb=0, Kb=1, flip-flop B is forced to change from 1 to 0, and flip-flop A is forced to change from 0 to 1. The effect is as if a zero had been forced in at the left-hand side and has caused all of the stored numbers to shift one place along.

A Simple Shift Register

Use the two 7476 J-K flip-flops (Fig. 2) on your blob-board to make up a four-stage shift register. Connect the clock inputs to one of the spare pads of the blob-board, and run a line from this pad to the output of the slow oscillator or the debounced switch. Blob short connecting wires from each Q output to the next J input, and from each Q output to the next K input. Blob a wire from Ja to the earth line, leaving Ka floating. Connect the reset pins to a reset line (a spare blob-pad) and then to the reset switch so that pressing the reset switch will earth the reset pins. Finish off by connecting LEDs and

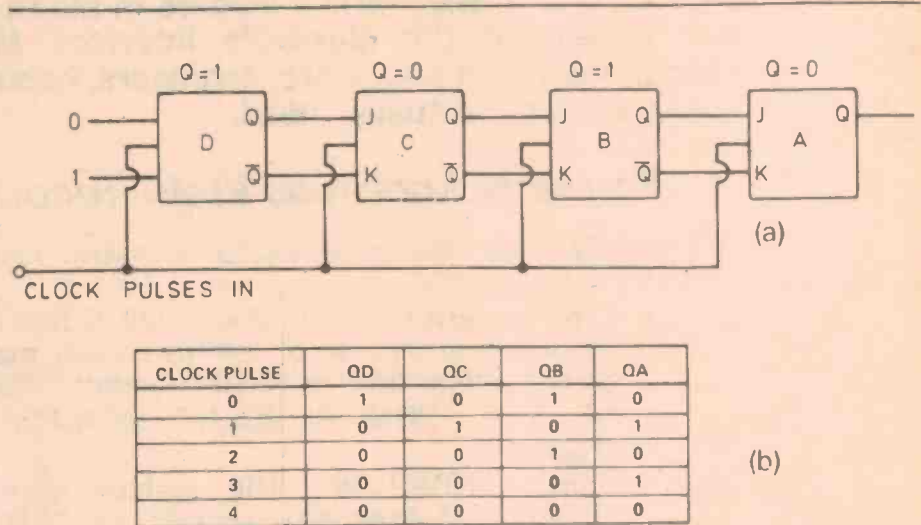

Fig 1. A shift register made up from J-K flip-flops. (a) Arrangement of the flip-flops. (b) Truth table, showing the effect of clock pulses.

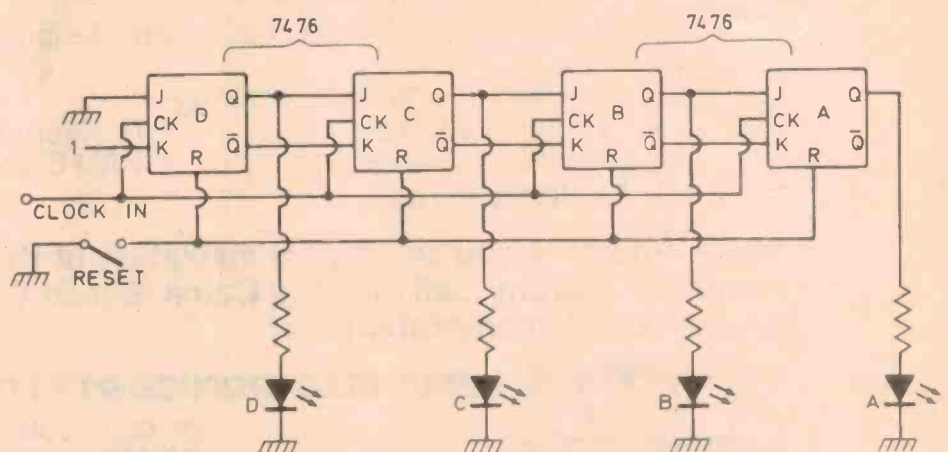

Fig 2. Connections of 7476 flip-flop to form a shift register on the 8-IC Blob-board.

resistors so that the state of each Q output can be read.

Now switch on. One or more of the LEDs may light, but can be extinguished by using the reset switch. Now set up a number by using the preset terminals. By temporarily bridging from each preset pin to earth, using a wire bridge, set two of the flip-flops to 1, preferably so that 1010 is stored. Next apply clock pulses and observe what happens; this is easier to follow if the debounced switch is used.

Now switch off, and disconnect Ja from earth. Connect Ja to Qd and Ka to Q̄d. Switch on again, reset, and set to a display of 1010 again. Now apply clock pulses. What happens? Can you see the possible applications for storing a sequence of operations, such as a traffic lights sequence?

Types of Shift Register

The shift register made up using 7476s can be used as a PISO or SIPO type. PISO means parallel in, serial out, the information is set up on each flip-flop, perhaps at the same time, and is read out in sequence, one digit for each clock pulse. In a SIPO shift register (serial in, parallel out), a number of clock pulses equal to the number of flip-flops is applied at the same time as a varying signal (0 to 1) applied at the input J-K terminals, starting with an empty register. With the register filled, the voltages at the Q terminals can be read (using LEDs for example) in parallel. Each type is important; we need numbers in parallel form for operations such as addition, but in serial form for transmitting down a single wire, or for recording on tape. We can, of course, have SISO (serial in-serial out) and PIPO (parallel in-parallel out) shift registers, and a set of flip-flops can be arranged to act in any one of these ways.

The 7494 Shift Register

This has been chosen as one example (Fig. 3) of the very wide variety of shift registers that are available. Like most integrated shift registers, it is constructed using the clocked S-R type of flip-flops, but the action is the same as that of our J-K flip-flop model; the schematic of the IC is shown in Fig. 4. Four flip-flops are used, with a common clock to each, and a clear input which will reset each flip-flop. A serial input is also available.

The interesting feature of the 7494, however, is the gated parallel inputs labelled 1A, 2A, 1B, 2B and so on. These act through a set of gates on the preset inputs of the flip-flops, so that they are independent of the clock

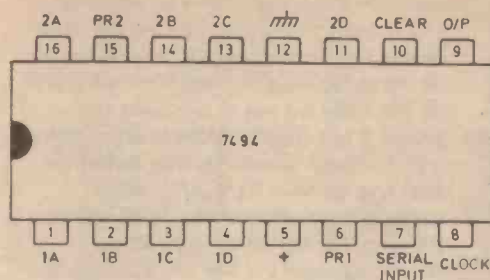
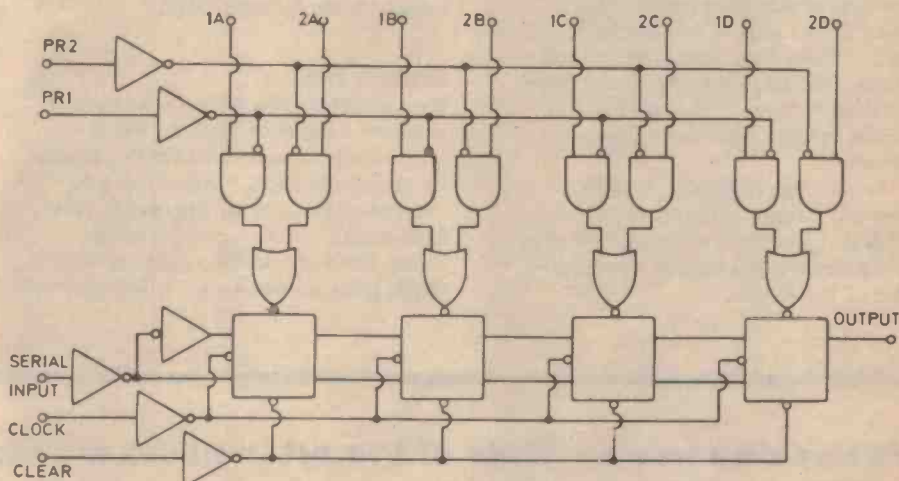

Fig 3. Pinouts of the 7494



Note: In operation, Clear, PR1 and PR2 terminals should be low. To clear all stages, take clear terminal to 1. To enter, take one pre-entry terminal to 1.

Fig 4. Schematic diagram of the 7494 shift register. Compare the number of flip-flops gates and inverters in this single chip with the number of packages needed to make this from 7400's and 7476's.

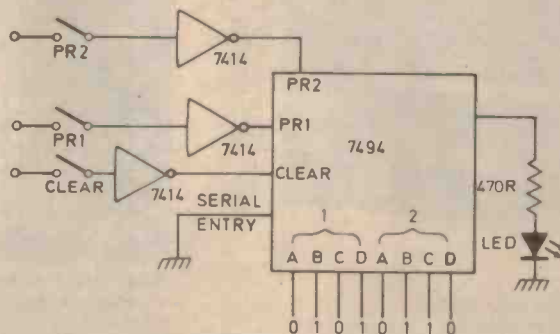

Fig 5. Connecting up the 7494 on the bread-board. Note that inverters have to be used on each switched line, as the preset and clear lines must be held at logic 0 for normal operation.

pulses. The gating is arranged so that either one or the other set of inputs can be "read" into the register. For example, imagine that the inputs with the 1 prefix are each connected to a signal input, 0 or 1, and that the inputs with the prefix 2 are each connected to another set of signals. We can use the pins marked preset 2 and preset 1 now to select which set of inputs is chosen and placed in the register.

Imagine that preset 1 is at logic 1 and the preset 2 is at logic 0. Because of the inverters connected to the preset inputs, all the inputs with the 1 prefix are gated through to the OR gates which control the flip-flop presets. Because all the inputs with the 2 prefix are gated out, there will be no input from these gates. The opposite process takes place if preset 2 is at logic 0 and preset 1 is at logic 1. Note that these inputs must be operated so that both do not enter at the same time. The inputs should remain at logic zero during normal operation.

The output from the register is from pin 9, and will consist of one bit, 0 to 1, for each clock pulse fed in to the clock input, and at the leading edge of the clock.

Blob-board Work

Connect the supply lines to the 7494, +5V to pin 5 and earth to pin 12. Now blob a connecting wire from the output of the debounced switch to clock input of the 7494 on pin 8. Connect the preset 1 pin (pin 6) to an inverter whose input is from a push-button switch so that this pin can be momentarily earthed; leave the other preset entry pin (pin 15) earthed. Now set up signals to enter on the 1-set of inputs, A, B, C, D on pins 1, 2, 3 and 4. For example, we can connect pins 1 and 3 to logic 1, and pins 2 and 4 to logic 0, so setting up the number 1010. This will be entered when the PR1 pin is momentarily set to 1 by the inverter and switch, and the flip-flops will be set up to the number 1010.

Detector Work

We can detect this only at the output, since we cannot connect to the Q outputs of the intermediate flip-flops, by connecting an LED and limiting resistor to the output pin, pin 9. Now blob a connection from the serial input, pin 7, to earth, so that as each clock pulse arrives a zero is fed into the

first stage of the register. This ensures that the register stores 0000 after four clock pulses.

One Clock

Now switch on, and press the enter switch briefly. Use the clock switch to apply four clock pulses, and note the output on each pulse. The contents of the register should now be 0000, so that further clock pulses will not produce any "1" output. Another entry can be made by pressing the entry switch at any time. By connecting the second set of entry pins, and using the second pre-enter (PR2) pin, we can enter another number. Connect up the second set of entry pins (16, 14, 13, 11) to give another number, and connect up the PR2 (pin 15) terminal to the output of another spare inverter. Connect another push-button switch between the inverter input and the earth line, and try out the circuit again, entering the second number (after clearing) by pressing the enter switch momentarily. Check that this number is then read out at the output when the register is clocked.

●●●●●●●●●● state of the art in audio monitoring ●●●●●●●●●●

Chromatec announces the TVD100 SERIES MULTICHANNEL PEAK PROGRAM MONITORS AND REAL TIME SPECTRUM ANALYZERS

(See front cover pic "Hi-Fi and Music, August '78)

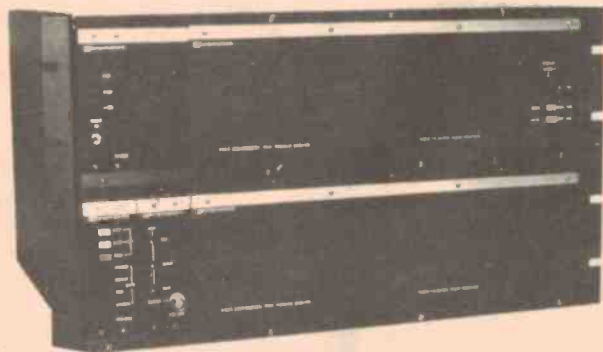

- Australian Designed and manufactured
- Units display information on a standard PAL colour monitor
- Coloured display with alphanumeric character labelling
- Professional specifications: BBC Peak Program Response on up to 32 channels, Third octave filter set for Real Time Spectrum Analysis
- Many customer specified variations including a variety of bar formats
- Quality from around \$3000 for each type, or around \$5000 for combined Peak Program Monitor/Real Time Spectrum Analyzer (TV monitor not included)

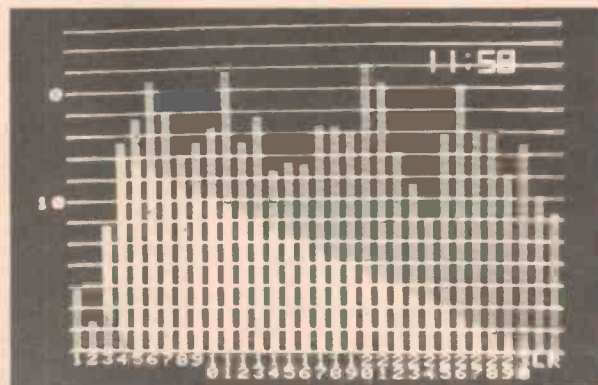

Brief Technical Specifications:

- Logarithmic response — i.e. a linearized dB scale
- Electronically generated graticule and character information
- Standard R,G,B & Sync. outputs to a suitable monitor
- Balanced audio inputs with or without transformers
- Options include: Input bridging transformers; standard PAL colour encoder; on screen clock; pink noise generator; microphone input preamplifier; (the latter two for use with the Spectrum Analyzer), and others

DESIGNED AND MANUFACTURED BY CHROMATEC VIDEO PRODUCTS PTY. LTD. 3 Withers Ave., Mulgrave, Vic. 3170. Tel: (03) 546-2259

ARLEC

PROUDLY ANNOUNCE



Not in age, for our origins go back further than that, but in Transformer Voltage Taps.

Yes 21 Voltage Taps!

Just think of the advantages offered by a single transformer that provides a choice of 21 different output voltages including 3 centre tapped configurations.

FOR EXAMPLE: TRANSFORMER No. 2155A
VOLTAGES AVAILABLE
1.0, 1.2, 2.0, 2.2, 2.4, 3.1, 3.2, 3.5, 4.1, 5.1, 5.5,
6.3, 7.5, 8.5, 8.7, 9.5, 12.6, 15.0 Volts
2.0V CT, 12.6V CT, 15V CT

But that's not all!

With 5 such transformers in our range there is a choice of output currents as well.

And just in the way of a bonus!

We are able to offer these new transformers for a price considerably lower than comparable single tapped units while still maintaining the high standards of quality for which we are renowned.

Like to know more?

Just ring your local Arlec branch.



What do we call them?

**ARLEC
MULTI-TAP TRANSFORMERS**
of course!

A+R ELECTRONICS PTY. LTD.

A MEMBER OF THE A+R-SOANAR ELECTRONICS GROUP

30 Lexton Road, Box Hill, Vic., 3128, Australia. Telex: 32286.

SALES OFFICES PHONES
VICTORIA: 89 0661
N.S.W.: 78 0281
S. AUST.: 51 6981
QUEENSLAND: 52 5421
W. AUST.: 81 5500

Electronics Today International

4600 and 3600 SYNTHESIZERS

Complete plans for the Electronics Today International 4600 Synthesizer are now available in book form. Many hundreds of these remarkable synthesizers have been built since the series of construction articles started in the October 1973 issue of Electronics Today.

Now the articles have been re-printed in a completely corrected and up-dated form.

The International Synthesizers have gained a reputation as being the most flexible and versatile of electronics instruments available.

They have been built by recording studios, professional musicians, university music departments and as hobby projects.

This book is available now as a limited edition of 2000 copies only.

Ensure your copy!

Send \$12.50 to Electronics Today International,
15 Boundary Street, Rushcutters Bay, 2011.

NEW ZEALAND READERS

THE ELECTRONICS CENTRE — NOW OPEN — 179 HOBSON ST, AUCKLAND

The one-stop components shop

Stockists of:

RESISTORS
CAPACITORS
DIODES
TRANSISTORS
CMOS
TTL
LINEAR

REGULATORS
ROMS
RAMS
LEDS
7 SEGMENT DISPLAYS
CLOCK MODULES

SWITCHES
POTENTIOMETERS
POWER SUPPLIES
AERIALS
MULTIMETERS
SOLDERING IRONS
IC SOCKETS

CASES & CABINETS
CABLE & WIRE
SPEAKERS
KNOBS
TRANSFORMERS
WIRE WRAP TOOLS

PLUS — too many to list — all devices by NATIONAL TEXAS, FAIRCHILD.

TV GAMES — Teletennis with GI AY-3-8550 plus joysticks.
Tank Battle with GI AY-3-8710.
Chips available, AY-3-8500, AY-3-8550 AY-3-8710 etc.
PLUS A HUGE RANGE OF KITS.

MUSICOLOUR — Colour Organ
— let there be light in your music.
RADAR DETECTORS
Super Orbit, built-up and kits.

Send for our **FREE PRICE LIST** (please include SAE)
or our **ORBIT CATALOGUE** — only \$2.00.

To: **ORBIT ELECTRONICS LTD.**, PO Box 7176, Wellesley Street, AUCKLAND, 1.

PHONE OR WRITE — FEW MINUTES WILL SAVE YOU DOLLARS — PRICES INCLUDING SALES TAX SHOWN IN BRACKETS

We mean business! If any of these models are advertised in this magazine at a lower price, tell us and we will supply them at that price.

TEXAS PROGRAMMABLE SYSTEMS

PC100A Alpha-Numeric Printer ~~\$278~~ \$210 (\$234)
For TI 59 and 58 — Lists, Traces, Prints Words (64 characters), Plots Graphs, etc.

MODULES \$65 \$32 ea. plug into TI59 or 58. Pre-programmed with approx. 5000 steps.

- Leisure Time
 - Marine Navigation
 - Aviation
 - Real Estate and Investment
 - Statistics
 - Surveying and new!
 - Business Decisions
 - Securities Analysis
- ppx 59 club — pool of programs



TI59 ~~\$228~~ \$245 (\$274)
Programmable to 960 steps or 100 memories, also master module with 5000 steps, magnetic cards, 3 manuals, program pad, charger, carrying cases, etc.

Extra Magnetic Cards
Pack of 40 and case \$15

- Specialty Packages \$10 ea**
Programs for mag. cards —
- Electronic Eng o Civil Engineering o Statistics
 - Programming Aids (Decoders and disassemblers) o Securities
 - Oil/gas energy o Black body
 - Printer utility

ALSO

TI58 ~~\$141~~ \$108 (\$120)
TI57 ~~\$82~~ \$73 (\$82)
TI55 ~~\$67~~ \$52 (\$58)
MBA ~~\$82~~ \$75 (\$83)

GREATEST PACKAGE OFFER EVER!!
A TI59 and PC100A printer ~~\$686~~ only \$450 (\$503)
Open till 30th November only
(Also any extra modules ordered with package only \$30 ea)

TEXAS SR60A — BUSINESS, RESEARCH, PERSONAL COMPUTER



Basic model with extra memory options — up to 7920 program steps or up to 990 memories. Keyboard and display completely alpha-numeric. Pre-programmed card libraries available for: Finance, Electrical Engineering, Surveying, Maths (2), Statistics, Pay Roll.
(Write for details and prices)

LIQUID CRYSTAL CALCULATORS

EXAMS!! Super School and College Specials

TI25 ~~\$35~~ \$27 (\$30) only till Nov 30th
Slimline in billfold wallet — all essential maths, scientific and statistical functions, alpha display of mode, 1000hr. battery life.

ALSO WITH SIMILAR FUNCTIONS
Canon F52 ~~\$82~~ \$35 (\$39.50)
Sanyo CZ8114L ~~\$49~~ \$38 (\$43.00)

AND MORE ADVANCED (with P — R)
National Semiconductor
NS108 ~~\$99~~ \$45 (\$51)
Sanyo CZ0125L ~~\$82~~ \$47 (\$54)
(All the above calculators permitted in N.S.W. H.S.C. Exam)



1. Canon L.C. Quartz clock/calculator ~~\$67~~ \$52 (\$57) Really smart with square root, percentage, memory, time, date, stopwatch, alarm.
2. N.S. 103 Data Checker ~~\$62~~ \$40 (\$45) In Billfold wallet with biro, 3 continuous memories retain cheque account and 2 charge accounts or bankcard even when calculator is turned off.
3. Sanyo CX8181L Card Calculator ~~\$39~~ \$30 (\$34) The size of your Bankcard and 2.9 mm thin — perfect for wallet or purse, square root, percentage, constant, memory, Lithium battery.
4. Canon LC8M ~~\$24~~ \$17.50 (\$19.50) The greatest bargain in quality LCD pocket calculators, square root, percentage, memory and wait for it — 5000 hr battery life!

Packing and Posting — All L.C.D. models \$1.50 anywhere in Australia. Otherwise \$2.00 for N.S.W. Elsewhere \$3.00 per order.

Sales Tax forms must be duly signed and stamped. (Forms available)



ELECTRONIC CALCULATOR DISCOUNTS

Phone (02) 624-8849 (8 am till 3 pm) P.O. Box 106, Baulkham Hills, N.S.W. 2153.



Continuing Education Series—

the fast, easy, low-cost way to learn electronics!

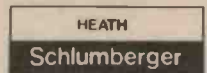

These three basic programmes provide an excellent overview of contemporary electronics—they'll provide you with the fundamentals you need to follow your interests wherever they may lead you. The programmed learning text is clearly written, with technical material fully explained as it is introduced. Built-in quizzes let you test your knowledge at each step. The records give you a "personal" outline of text material and additional information, and electronic parts are included for use in the experiments. Each course leads logically into the next, and when you complete all three, you'll have a thorough knowledge of basic electronics.

Part 1: DC Electronics— electrical fundamentals, theory and practice—

- | | |
|---------------------------|--------------------------------------|
| 1. <i>Electron Theory</i> | 6. <i>Electrical Measurements</i> |
| 2. <i>Voltage</i> | 7. <i>Network Theorems</i> |
| 3. <i>Resistance</i> | 8. <i>Inductance and Capacitance</i> |
| 4. <i>Ohm's Law</i> | |
| 5. <i>Magnetism</i> | |

Includes all texts, records, 56 parts for 20 experiments. Average completion time, 20 hours.
Programme EE-3101 \$65.00

Part 2: AC Electronics— sine waves, inductive and capacitive reactance, impedance, phase shift, transformers and filters

1. *AC Fundamentals*
2. *AC Measurements*
3. *Capacitive Circuits*
4. *Inductive Circuits*
5. *Transformers*
6. *Tuned Circuits*

Includes all texts, records, 16 parts for 8 experiments. Average completion time, 15 hours.
Programme EE-3102 \$65.00

Part 3: Semiconductor Devices— transistors, zeners, SCR's, FET's, digital and linear IC's, LED's, opto-electronics

- | | |
|--|------------------------------------|
| 1. <i>Fundamentals</i> | 7. <i>FET's</i> |
| 2. <i>Diodes</i> | 8. <i>Thyristors</i> |
| 3. <i>Zener Diodes</i> | 9. <i>IC's</i> |
| 4. <i>Special Diodes</i> | 10. <i>Opto-electronic Devices</i> |
| 5. <i>Bipolar Transistor Operation</i> | |
| 6. <i>Bipolar Characteristics</i> | |

Includes all texts, records and 27 parts for 11 experiments. Average completion time, 30 hours.
Programme EE-3103 \$65.00

Heathkit Experimenter/Trainer

For the Heathkit DC, AC and Semiconductor programs—helps you perform each project quickly and easily. And after you finish the programs, it's ideal for "breadboarding" your own design projects. Has solderless breadboarding sockets, 2-range variable sine and square wave signal source, dual-variable power supplies for positive and negative voltages (both variable over 1.2 to 16 volts, 120 mA, both regulated and short-circuit protected). Built-in 1k and 100k linear potentiometers. Center tapped power transformer secondary provides 30 V rms, 50 Hz for line experiments.

Kit ET-3100 \$114.00

**NOW AVAILABLE!
ELECTRONIC CIRCUITS**

Programme EE-3104 \$81.00

Heathkit Digital Design Experimenter/Trainer

Use it to perform all the experiments in the Heathkit Digital Techniques Programme, also to develop projects, build and test prototypes, verify circuit operation, check digital IC's. Has solderless breadboard sockets, four binary data switches, 2 "no-bounce" switches to pulse logic circuits, 3-frequency pulse clock generator, 4 LED's for visual indication of logic states. Three regulated power supplies: +12V, 100 mA current limited; -12V, 100 mA current limited; +5V, 500 mA, overload protected. Accommodates up to eight, 14 or 16-pin dual-in-line IC's, also 24, 28 and 40-pin DIP's.

Kit ET-3200 \$132.25

Digital Techniques Program—For the advanced experimenter, technician, hobbyist or engineer.

Learn digital fundamentals, circuit design, TTL, ECL, CMOS, PMOS, NMOS integrated circuits; SSI, MSI and LSI; ROM's, PLA's; microprocessor theory

1. *Introduction: techniques and uses, binary numbers, digital codes.*
2. *Semiconductor Devices for Digital Circuits.*
3. *Digital Logic Circuits: AND gates, OR gates, NAND / NOR logic, etc.*
4. *Digital Integrated Circuits: TTL, ECL, CMOS, nMOS, pMOS; how to choose.*
5. *Boolean Algebra.*
6. *Flip-Flops and Registers: latches, D & JK flip-flops, storage registers, applications.*
7. *Sequential Logic Circuits: binary, BCD, modulo N, up / down counters, dividers, shift registers.*
8. *Combinational Logic Circuits: encoders, decoders, exclusive OR, comparators, multiplexers, ROM's, PLA's.*
9. *Digital Design: combinational and sequential circuits, procedures.*
10. *Digital Applications: counters, computers, microprocessors.*

Programme EE-3201 \$81.00

ORDER BY COUPON NOW OR COME TO OUR SHOWROOM

Please rush me the programme of my choice. My cheque for \$ _____ is enclosed plus \$5.00 for package & post.

Name

Address

.....P/Code

- Programme EE-3101
- Programme EE-3102
- Programme EE-3103
- Kit ET-3100
- Kit ET-3200
- Programme EE-3201
- Programme EE-3104

Send to: W. F. Heathkit Centre,
 220 Park St., South Melb. 3205. Phone: 699-4999

CB COMMUNICATIONS

Minister Announces Changes

The Minister for Post and Telecommunications, Mr Tony Staley, announced a number of changes that would affect the CB radio service at the official opening of the second National Citizen's Radio Association National Convention held last month over 1st - 4th September.

The Federal Government would introduce changes to the Act and Regulations to establish the Citizen's Band Radio Service as a separate service, removing it from the category under which it is now operated - the Land Mobile Radio Service (Class C).

Mr Staley, in announcing these decisions, said that the rules and regulations for mass broadcasting, professional telecommunications and commercial land mobile services were inappropriate for CB.

Mr Staley also announced that regulations would shortly be introduced that would allow any owner of CB equipment to cover up to five sets on one licence for a single fee.

The two emergency channels, channel 5 on both 27 MHz and UHF, were announced as being reserved for the volunteer emergency services (such as CREST) and for travellers' assistance.

The Government is also planning to increase the number of UHF channels from 40 to 80 following the WARC conference next year. They are also looking at ways of restricting the import of non-licensable equipment and the sale of transmitting equipment to unlicensed persons.

The Minister also announced plans to call a meeting of manufacturers, retailers and CB'ers representatives to examine technical standards and performance specifications for CB equipment, particularly for use on UHF.

The restrictions on 'gain' antennas were to be revised and HF beams would be allowed in certain areas (mainly country), UHF gain antennas being given the OK.

In the discussion session following his speech at the opening of the NCRA Convention, Mr Staley said that the new RB14, amended as per the above suggestions and the pertinent W & T Regulations, would be pushed through as soon as possible and he hoped that the P & T Department would exercise 'administrative discretion' in the intervening period with regard to operators who may be running illegal installations under the new regulations but who would be quite legal under the foreshadowed changes.



Well, it seems that CB'ers have been granted a few concessions along the lines they have been clamouring for over the last twelve months, as foreshadowed at the first National Convention of the NCRA in September last year. It has taken some time and the changes are not what you'd call 'sweeping', but it is progress. More changes may come next year following the WARC 79 conference. It's going to be an interesting time.

NCRA Convention

The NCRA's second National Convention, held at Wrest Point in Hobart, was rather a flop as far as attendance goes. There was little to attract the 'ordinary' CB'er, apart from the Hotel, Casino and local tourist attractions, and there were even insufficient delegates to raise a quorum at the National Assembly!

Nevertheless, it was a great bun fight and both the NCRA and CREST (who held their National Convention simultaneously) managed to plough through their administrative work and get around to addressing themselves to some of the questions facing the CB Service and their respective organisations.

Harvey Milne, Director of President Electronics (Aust.) requested leave to address the National Council of CREST, which he was granted. In his address he told the Council that they should set themselves up as an organisation in their own right, separate to the NCRA and to

foster more authority in the organisation. He said 'CREST should be prepared to work more closely with the industry in order to provide the sort of service the community requires'.

'At the present time, CB is regarded as somewhat of a toy and the emergency service provided by CREST is critical to the future of CB in Australia'. He said that CREST should 'clean up the image' of CB. He reminded them that the emergency service CREST provided was one of the major reasons why CB was legalised last year. Mr Milne urged CREST to reorganise their aims and to cut out the politics and get on with the job! Having berated them he then donated six Washington base station transceivers - no strings attached!

Apparently the message struck home. Motions from the National Councils of both CREST and NCRA brought about a joint sitting at which they voted to constitutionally separate the organisations.

In other developments at the Convention: channel 4 on 27 MHz is now to be known as the 'highway channel' and the UHF highway channel is to be channel 40. The question of 'Dealer's' and 'Demonstrator's' licences is to be looked into as it appears that the requirements and restrictions on these licences are presently open to wide interpretation. The NCRA is looking closely into the design and distribution of membership cards.

Elections saw no radical changes to the faces 'up front'; you can read more about the whole shebang in the October issue of CB Australia.

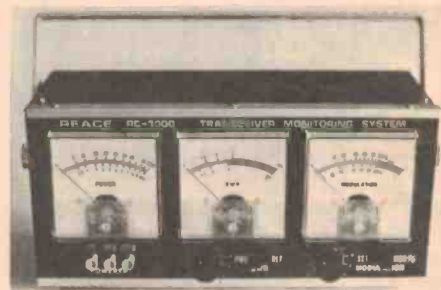

The Reace RC-1000 transceiver monitoring instrument provides continuous indication of power output, SWR and modulation percentage. With three power ranges up to 1000 W, the RC-1000 is claimed to be good up to 150 MHz. Further details from Just CB's at 546 Whitehorse Road, Mitcham, VIC 3132.

Fast dependable mail order service

Prime devices at low prices

THE ELECTRONIC MAILBOX

P.O. BOX 97

PENNNANT HILLS N.S.W. 2120

1. PROVEN QUALITY * prime factory devices, money back guarantee.

2. SAME DAY SHIPMENT * all orders cleared within 24 hours of receipt. Immediate credit or refund out of stock items.



2114 STATIC RAMS:
Add memory to your micro easy to use—
..... 2 for \$19.95

2N6073b ULTRA SENSITIVE GATE TRIAC:
Can be driven off CMOS—
..... \$1.25



1N914 SIGNAL DIODES:
Miniature glass type high speed—
20 for \$1.00



F16 DYNAMIC RAMS:
16K x 1 Arrangement Suit TRS80—
..... \$22.00 ea.



SC/MP MICRO-PROCESSOR CHIPS:
Single 5V supply complete with data
..... \$12.75 ea



JUMBO LEDs:
.2" red LEDs suit most applications—
..... 5 for \$1.00

CMOS

4000	.25		
4001	.25		
4002	.25		
4006	1.40		
4007	.25		
4008	1.25	4046	1.95
4011	.25	4049	.60
4012	.25	4050	.60
4013	.55	4051	1.20
4014	1.35	4052	1.20
4015	1.20	4053	1.20
4016	.50	4060	2.65
4017	1.40	4066	1.00
4018	1.40	4068	.40
4019	.75	4069	.35
4020	1.60	4070	.40
4021	1.40	4071	.40
4022	1.60	4072	.40
4023	.25	4073	.40
4024	.90	4074	.40
4025	.40	4076	1.85
4027	.80	4077	.40
4028	1.25	4078	.40
4029	1.90	4081	.40
4030	.40	4082	.40
4040	1.30	4510	1.50
4041	1.25	4511	1.50
4042	1.25	4518	1.50
4043	1.50	4520	1.45
4044	1.50	4528	1.20

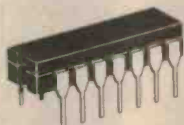

TTL

7400	.28		
7401	.28		
7402	.28		
7403	.28		
7404	.37	7474	.65
7405	.37	7475	.65
7406	.50	7476	.45
7407	.50	7480	1.25
7408	.34	7483	1.25
7409	.34	7485	1.45
7410	.30	7486	.65
7411	.37	7489	1.20
7413	.54	7490	.75
7414	1.03	7491	1.00
7416	.60	7492	.75
7417	.60	7493	.75
7420	.30	7494	1.10
7422	.30	7495	.95
7426	.45	74100	2.45
7427	.45	74107	.65
7430	.30	74121	.60
7432	.43	74123	1.10
7437	.50	74132	1.25
7438	.50	74150	1.80
7440	.30	74151	1.10
7441	1.50	74153	1.10
7442	.70	74154	1.70
7447	1.25	74157	1.10
7448	1.25	74160	1.55
7450	.35	74164	1.55
7451	.35	74165	1.55
7453	.35	74173	2.75
7454	.30	74175	1.65
7460	.35	74180	1.35
7470	.65	74192	1.40
7472	.45	74193	1.40
7473	.60	74221	1.50

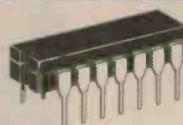

74LS

74LS00.	.30		
74LS01.	.30		
74LS02.	.30		
74LS03.	.30	74LS92.	1.20
74LS04.	.35	74LS93.	1.20
74LS05.	.35	74LS95.	1.50
74LS08.	.30	74LS109.	.50
74LS09.	.30	74LS113.	.55
74LS10.	.30	74LS114.	.55
74LS11.	.30	74LS138.	1.20
74LS12.	.30	74LS151.	1.20
74LS14.	1.20	74LS154.	1.60
74LS20.	.30	74LS157.	.90
74LS21.	.30	74LS163.	1.20
74LS27.	.30	74LS164.	1.30
74LS28.	.40	74LS174.	1.00
74LS30.	.30	74LS175.	1.00
74LS32.	.33	74LS191.	1.20
74LS37.	.45	74LS192.	1.20
74LS38.	.45	74LS193.	1.20
74LS40.	.30	74LS194.	1.20
74LS42.	1.20	74LS195.	1.20
74LS73.	1.20	74LS196.	1.20
74LS74.	.50	74LS221.	1.20
74LS75.	.70	74LS253.	1.85
74LS78.	.50	74LS279.	.65
74LS85.	1.50	74LS365.	.80
74LS86.	.50	74LS367.	.80
74LS90.	1.20	74LS368.	.80

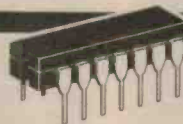

1N4004 POWER DIODES: 
Suitable for any voltage up to 400V—
..... 15 for \$1.00

741 OP AMPS:
Stock up now—
..... 5 for \$1.65

OPTO ISOLATOR:
6 pin Dip with specs 1500V Isolation—
..... \$1.20 ea.

555 Timers: 
Thousands of uses—
..... 5 for \$1.50

Dip Sockets:
8 pin .22 24 pin .45
14 pin .25 28 pin .55
16 pin .28 .40 pin .70
18 pin .30

LINEAR

301	.40
307	.65
308	1.35
311	.85
324	1.35
339	.90
349	2.25
356	1.65
380	2.00
381	2.00
382	2.00
386	1.95
555	.35
556	.85
565	1.95
566	2.50
567	2.65
709	.75
723(VR)	.55
741	.35
747	1.25
3900	.90
3909	1.25

PLEASE ALLOW \$2.00 postage and handling on all orders.

AMATEUR COMMUNICATIONS

New Kenwood Rig

Kenwood will shortly release in Australia their latest, low-power, economy, all-band transceiver — the TS-120V.

Designed to suit those on a limited budget, this rig should be particularly attractive to Novices as it has many of the features of the 'big' rigs and meets the power requirements — and should retail at a very competitive price.

The TS-120V is an all solid-state transceiver featuring digital frequency display with readout to 100 Hz plus an analogue dial with a 25 kHz per turn tuning rate. It covers all bands 80 to 10 metres (including all of the 10m band), plus 15 - 15.5 MHz for WWV time/frequency signals. The receiver incorporates both RIT tuning and IF shift. A crystal calibrator is also included providing calibration markers every 25 kHz. Transmitter power input is quoted as 30 watts PEP on SSB.

The transceiver may be powered from 13.8 Vdc (nominal) or a matching 240 Vac mains power supply, type PS-20. The transceiver itself measures a compact 241 mm wide, by 94 mm high and is 235 mm deep.

The TS-120V is distributed in Australia by *Trio-Kenwood (Australia) P/L* of 31 Whiting Street, Artarmon NSW 2064. Phone (02) 438-1277.

Giant Bargain Sale

A sale and auction of surplus stock of spares, samples, shop-soiled returns and some new equipment, donated by Dick Smith Electronics, will be held at the NSW Division Wireless Institute Centre on Saturday 28 October.

The entire gross proceeds will go to the WIA's Federal Education Scheme for the benefit of Youth Radio work throughout Australia.

There will be over \$30,000 worth of equipment (at normal retail prices) including multimeters, antennas, speakers, transceivers, transformers and a large selection of assorted components.

The sale will be held at the *Wireless Institute Centre, 14 Atchison Street, Crows Nest* commencing at 12 noon on the date mentioned. Any unsold items will be auctioned later in the afternoon.

We are advised that everything must go — there will be no reserve at the auction!

Join in, get yourself some bargains and help support the training of future radio amateurs. Don't forget — 12 noon, Saturday 28 October at 14 Atchison St, Crows Nest NSW.



Videocassettes on Ham Radio

The WIA will shortly have available a number of videocassettes — two suitable for PR purposes, the third being the now famous G6CJ "Aerial Circus", a highly entertaining and instructive programme. One of the PR videotapes is a collection of the ARRL publicity films, in colour, with sound. The second, also in colour and with sound, is a recording of the programme that appeared on Melbourne Channel 7 TV's "This Week Has 7 Days" programme. The latter is particularly suited to showing to general Australian audiences, such as at local 'publicity' displays etc.

All programmes are on standard U-matic cassettes.

The G6CJ Aerial Circus tape is copy-right and we are advised that it will only be loaned out to well-recommended WIA divisional or club officers. The WIA Federal Videotape Coordinator is John Ingham VK5KG. Interested persons can obtain details on the conditions of loan of the videotapes from him (QTHR).

Baghdad on the Air

The club station of the Scientific Welfare Centre, YI1BGD, located in Baghdad, is now operational on 14 MHz (only). It was established following representation to the Yugoslavian government by the Yugoslavian Amateur Radio Society.

Ten Metre Beacons

For those operators currently exploiting the upsurge in good ionospheric conditions to work the DX available on 28 MHz, and who may want to improve their 'yield', here is a list of currently operational beacons:—

28202.5 kHz 0500-0600Z 9J2BBB,
1500-1600Z Lusaka

28205 kHz	24 hours	DLOIGI, West Germany
28207.5	"	N4RD, Florida
28210	"	3B8MS, Mauritius
28215	"	GB3SX, Crowborough
28220	"	5B4CY, Limassol
28225	"	VE3TEN, Ottawa
28230	"	ZL2MHF, Mt Climie
28235	"	VP8BA, Bermuda
28245	"	A9XC, Bahrain
28250	"	KC4, Palmer Station, Antarctica

More 44 MHz TEP Reports

On 8th April this year Ray Cracknell, ZE2JV in Rhodesia worked 5B4AZ and 5B4WR in Cyprus on 144 MHz, the distance being around 5,900 km. Again on the 10th April, ZE2JV worked 5B4WR, signals being reported around strength one and two with doppler flutter. 5B4WR was also reported heard that day by ZE2JE.

The following day, 11 April, ZS6LN in South Africa heard the 5B4CY two metre beacon on Cyprus. Distance between the two stations is 6,340 km. Then, on 12th April ZE2JV worked SV1AB over a distance of 6,275 km with signals reported again around the strength one to two.

It is interesting to note that CW was used for all contacts. The reporting of these transequatorial contacts completes evidence of TEP in the three major TEP zones of the world on frequencies above 100 MHz and should significantly add to the data on this unusual and highly interesting mode of ionospheric propagation.

Novice Band Expanded

The Novice allocation in the 80 metre amateur band was increased as from 8-8-78, the Novice segment now encompassing 3525 kHz to 3625 kHz.

SWL COMMUNICATIONS

Compiled by Peter Bunn, on behalf of the Australian Radio DX Club (ARDXC).



All times are in Greenwich Mean Time (GMT), add 10 hours to convert to Australian Eastern Standard Time. All frequencies are in kiloHertz.

New Transmitters For Gabon

Radio-TV Gabonaise has recently been conducting test transmissions from Moyabi using new 500 kilowatt units. Victor Goonetilleke of Sri Lanka reports that monitored announcements indicate tests are currently scheduled between 0700 and 1900 and 15300 kHz (for Europe), 9650 kHz (for the Middle East), 7200 kHz (to West Africa), and on 6030 kHz for Congo and Zaire. Victor reports that only 6030 kHz was confirmed as on the air, with French language programming until 1800 sign-off. Reports of these test transmissions are sought, and should be sent to: C.I.A.C.M., Post office box 270, Franceville, Gabon.

Monte Carlo

Trans World Radio at Monte Carlo has a daily English service on 7105 from 0625 until 0800. From October 29, this service will be broadcast one hour later on the same channel. A special service on Saturdays is heard 0940-0955 on 9610, which is on air for the weekly DX program entitled "DX Special".

Indian Regional Stations

Reception of Asian stations is generally best during our summer months. Several Indian regionals which should provide reliable signals in coming months include All India Radio at Hyderabad

on 4800, and All India Radio at Calcutta on 4820. Reception is currently noted from approximately 1403 in East Australia, with a relay of the English news from Delhi broadcast at 1530.

New Frequency For Chile

The Voice of Chile at Santiago has introduced a new outlet for foreign language programs. Chile now uses 17865 kHz, and Bob Padula advises of reception of English news at 2215 on this channel. Other frequencies currently used by the Voice of Chile in the 16 metre band include 17715, 17790, and 17800 kHz. Languages used, in 30 minute blocks, include English, French, Spanish, Italian, Arabic and Russian. Meanwhile, Chile's Home Service program, in Spanish, continues to give reliable reception nightly from sign-on at 1100 until past 1300, on 6190 kHz. Interference is present early in the transmission from a Venezuelan station, Ecos del Torbes, which also uses 6190 kHz, but the Venezuelan station's signal fades out soon after 1130.

World Radio and Television Handbook

The Australian Radio DX Club will be helping DXers in Australia to receive their copy of this invaluable publication when the 1979 edition becomes available. The ARDXC co-ordinates bulk ordering of the Handbook, with persons able to receive their copy direct from the publishers in Denmark, by registered airmail to their home address. For further information, write to the DRDXC Secretary at the address given in this column.

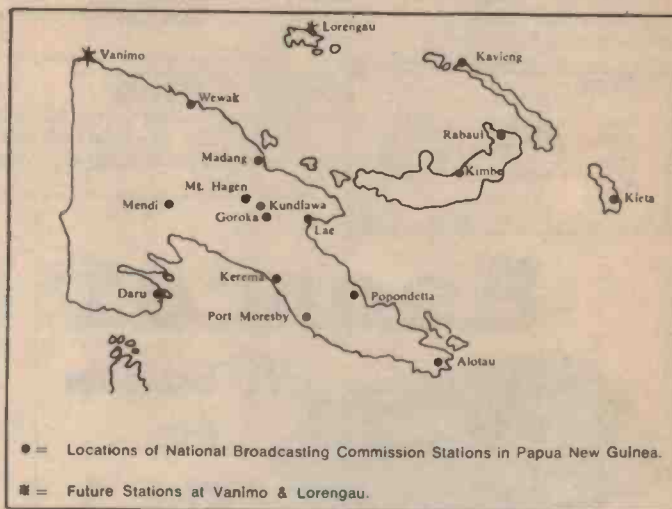

New Outlet For Port Moresby

The National Broadcasting Commission, Port Moresby, has been observed during August on the new frequency of 4785 kHz, replacing 4890 kHz. This may be only a temporary move for Port Moresby, as the station also shifted temporarily from 4890 kHz during June, to 4760 kHz. Port Moresby gives good reception between 0730 and 1400 on the 60 metre band. Morning sign-on is at 1950.

Finland

A schedule to hand from Radio Finland in Helsinki, indicates services in September and October for the Far East and Australia in English are broadcast daily from 0930-1000 on 21495. On Saturdays and Sundays, also on 21495, the special "Radio Finland in its Sunday Best", featuring high-lights of the week on Radio Finland as well as special programs, is aired between 0800 and 0930. For students of languages, a recent innovation is the Monday program entitled "Starting Finnish".

The Voice of the Andes

Radio HCJB, at Quito in Ecuador, currently has broadcasts scheduled for our area between 0600 and 1130 using 11900 and 6130 for English services, while a transmission between 0700 and 1030 on 9745 is also directed to the South Pacific region, in English. Use of the 13 metre band continues during September and October, with programs on 21480, between 1630 and 2200, and including English between 1700 and 1800, and again from 1900-2030.

LISTENING CONVERTERS

VLF 10-500 KHz with 3.6 MHz IF	\$89.00
432 MHz with 28 MHz IF	\$59.00
144 MHz with 28 MHz IF	\$59.00
1296 MHz with 28 MHz IF	\$70.00
432 MHz with 144 MHz IF	\$59.00

GEAR ANTENNAS

Listener-3 3-30 MHz dipole kit	\$49.00
Listener-1 wire antenna kit	\$22.00
GDX-1 Discone 80-480 MHz Tx & Rx	\$84.00
SCAN-X Discone (Receive only) 65-530 MHz	\$35.00

The famous NDR505 professional receiver with all options \$2999.00. Other receivers from \$350 to \$20,000. Give us a call today and tell us your requirements!



RECEIVERS HF, VHF, UHF

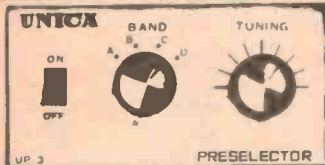

PRE-AMPS

The UP-3 Preamplifier covers 2-30 MHz with a gain of 15dB in four switchable bands. This great little unit can improve sensitivity, selectivity and signal to noise ratio of your favourite receiver. Price \$41.00.



Bearcat

210 Scanner

for
VHF &
UHF



quality
aircraft
receivers

VICOM 747 AIRCRAFT RECEIVER

- * 16 CHANNELS
- * SCAN OR MANUAL
- * AC/DC OPERATION
- * 4 CRYSTALS SUPPLIED

AND OUR PRICE ONLY \$199.00

HAM GEAR

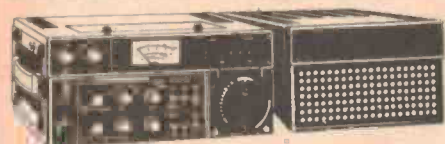

ICOM IC-701 HF transceiver

The NEW IC-701 features: • Solid-state • RF speech processor • 100 W continuous on all bands, all modes • USB, LSB, CW, CW-N, RTTY operation • Double balanced Schottky Diode Mixer used in both RX/TX • Dual built-in digital VFO • Price includes mic



ICOM IC-211 785.00 2m transceiver

Features: • 144 to 148 MHz coverage • Modes: SSB, CW, FM • LSI synthesizer PLL • 4-digit LED readout • Pulse-type noise blanker • VOX, anti-vox • Semi-break-in CW • Built-in SWR bridge • CW monitor and more!

computer compat.

ACCESSORIES

- .HY-GAIN
- .DAIWA
- .ANTENNAS
- .ROTATORS
- .PROCESSORS
- .MORSE KEYS

HK702 deluxe key with marble base	\$39.00
HK708 economy key	\$21.00
HK706 operator's key	\$25.00
MK701 manipulator (side swiper)	\$43.00
EK103Z electronic Keyer	\$169.00
Palomar IC Keyer	\$149.00

KENWOOD

TS520S HF transceiver	\$789.00
TS820S HF transceiver	\$1,279.00
SP820 matching speaker with filters	\$66.00
SM220 station monitor	\$335.00
TL922 Linear Amplifier	\$1,450.00
AT200 matching antenna tuner	\$185.00
TV506 6m transverter	\$236.00
TV502S 2m transverter	\$290.00
TR3200 70cm fm portable transceiver	\$229.00

6146B for Uniden, Kenwood, Yaesu	\$13.00
6KD6 for early Yaesu linears	\$13.00
6JS6C for FT101 series	\$13.50
572B for Yaesu linears	\$59.00

VALVES



ANTENNA CHANGE-OVER RELAYS (DAIWA)

CX-2L 1.8 thru 170 MHz, 100w pep max	\$48.00
CX-2H 1.8 thru 450 MHz, 200w pep max	\$69.00

2M BEAMS

5Y/2M Jaybeam, 7.8 dBd, length 1.6M, 5el	\$39.00
8Y/2M Jaybeam, 9.5 dBd, length 2.8M, 8el	\$47.00
10Y/2M Jaybeam, 11.4 dBd, length 4.4M, 10el	\$79.00

NEW FROM DAIWA, QUALITY ANTENNA ROTATORS COMPLETE WITH 240VAC CONTROL BOX:

Model DR7500S medium duty	NEW \$189.00
Model DR7600S heavy duty	\$259.00

RINGER

RINGO

VICOM

68 Eastern Road
SOUTH MELBOURNE VIC 3205
PH (03) 699.6700 Telex AA30566

Perth	446.3232	Sydney	681.3544
Adelaide	43.7981	Brisbane	38.4480
Gold Coast	32.2644	Hobart	43.6337
Canberra	82.3581	Melbourne	836.8635

COMMUNICATIONS

Sri Lanka

Adventist World Radio (Asia) broadcasts programs via the facilities of the Sri Lanka Broadcasting Corporation in Colombo. Programs in English, according to latest information, may be heard between 0330 and 0400 on 9720 and 15425, between 1430 and 1550 on 6075, 9720 and 15425, and from 1330 until 1345 on 6075, 9720, 15425 and 4940. The first two segments (0330-0400, and 1430-1500) are broadcast on Sundays only, while the program at 1330 is only broadcast on Saturdays. The Saturday service includes an interesting segment entitled "Your Radio Doctor".

German Regional Stations

A schedule to hand from the German commercial broadcaster, Sueddeutscher Rundfunk (Stuttgart) indicates the following schedule for broadcasts via its shortwave transmitter at Muhlacker, which operates on 6030. Monday to Friday 0356-2315; Sundays: 0455-2310; Saturdays: 0356-0000.

Another German regional broadcaster is RIAS (Radio in the American Sector) which operates on 6005 from transmitters at Berlin (20 kilowatts) and at Munich (100 kilowatts). The Munich transmitter is on the air 1730-0315, while the Berlin transmitter is in use between 0325 and 1730. The Munich transmitter provides reliable signals currently between 1730 and 2200, with programs in German.



Guinea

Radiodiffusion Nationale, which also identifies on-air as "La Voix de la Revolution", is currently noted with a special Sunday program from sign-on at 0600 until approximately 0850, on 9650. Programs are in both French

and a local language, and include a good variety of local music and songs. This is an example of the special weekend programs maintained by several African broadcasting stations. Other stations with similar schedules are Radio Mali which operates on weekends only operates on weekends only from 0800 sign-on using 7110, and Radio Ivory Coast, which uses 7215 from sign-on at 0600. Reception of both these stations should improve as our summer approaches, corresponding to the onset of the northern winter.

Oman

For some years, the BBC has operated a mediumwave relay station on Masirah Island off the southern coast of Oman, for broadcasts to the Asian region. Recently, shortwave facilities have also been added to this relay site. Advice received from the station indicates that World Service programs of the BBC, all in English, will be aired via the Masirah relay station according to the following schedule until the first week in November: On frequencies of 11780 and 15310, 0700-0815, on 17770 between 0900 and 1300, on 1530 between 0900 and 1515, on 7250 from 1600 until 2030 and on 7140 between 0000 and 0230, while transmissions of the World Service will be carried on both 9590 and 11955 between 0300 and 0330.

USA

The Family Radio network, station WYFR, with studios in Oakland, California and transmitters located at Scituate (Massachusetts) and Okeechobee (Florida), has special

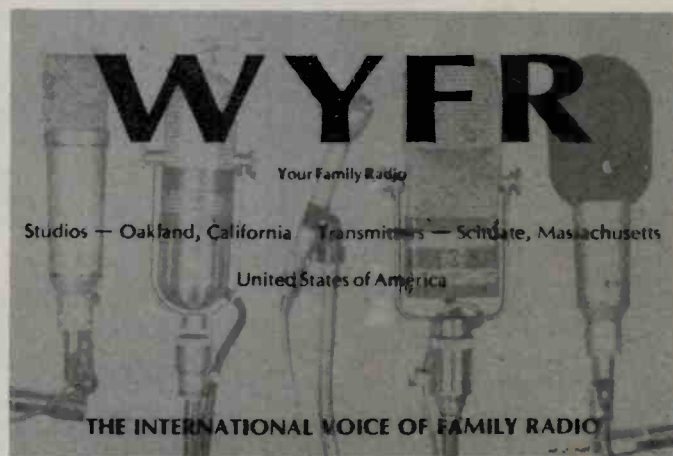

weekend programs in English, beginning at 1230. Between 1230 and 1400, these programs are broadcast on 15110 and 17785, continuing between 1400 and 1500 on 17785 and 21525. Week-day programs include English 2000-2200 on 17845 and 15440.

Holland

Radio Nederland will again be making extensive use of their relay facilities at Bonaire in the Netherlands Antilles, for broadcasts to Australia and New Zealand during period S-78, which concludes on November 5. English is carried by the Bonaire relay for Australia and New Zealand between 0730 and 0825 daily on 9770 and 9715, with English continuing on 9715 until 0925. English for South and East Asia is carried by the Madagascar relay station for Radio Nederland programs between 1430 and 1525 on 21480 and 17855.

Italy

Radio-television Italiana (RAI) has a daily English service for Japan and the Far East between 2200 and 2225, on 11905, 9710 and 5990. There is no English program specifically for Australia, however the above transmission generally offers reliable reception, particularly on the former channel. RAI places strong emphasis on services in Italian for Australian audiences however with two transmissions daily. The morning service for Australia is on the air between 2050 and 2130 on 11800, 9575, and 7290. The evening program is aired between 0830 and 0930 on 21690, 17780, 15330, 11810, and on 9580, according to the RAI schedule which is effective until the beginning of November.

The Australian Radio DX Club (ARDXC) is a non-profit body with headquarters in Melbourne. For further information regarding shortwave radio and DXing, please write to the General Secretary, PO Box 67, Highett, Victoria 3190 enclosing a 30c stamp.

Specs with a purpose!

Sansui's new amplifiers

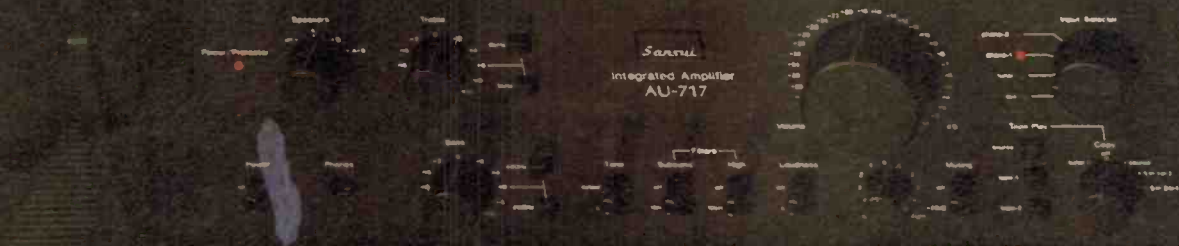

Sansui's all-new integrated amplifiers have absolutely astounding specifications. Compare them with any others in their class, and Sansui comes out far ahead. But what really makes Sansui's new amplifiers so superior is that all these great specs have a single purpose — outstanding sound quality.

Take response speed, for example. Your amplifier doesn't move, but it does respond. The more rapid its response, the cleaner and the more accurate the sound. That's why the AU-717, for example, features an advanced DC power amplifier design. Sansui's DC amplifier eliminates all capacitors in the signal path and even in NFB loop so amplification is direct without coloration and phase delay. Response is astoundingly rapid — the proof is in the ultra-high (60v/μsec.) slew rate and ultra-rapid rise time (1.4 μsec).

But Sansui didn't strive for such outstanding specs just to be able to print impressive figures. On the contrary, Sansui research showed that to achieve accurate reproduction and reduce signal loss, lightning-fast response was essential.

In addition, special circuits were incorporated to achieve new levels in stamping out TIM (transient inter-modulation distortion), a type

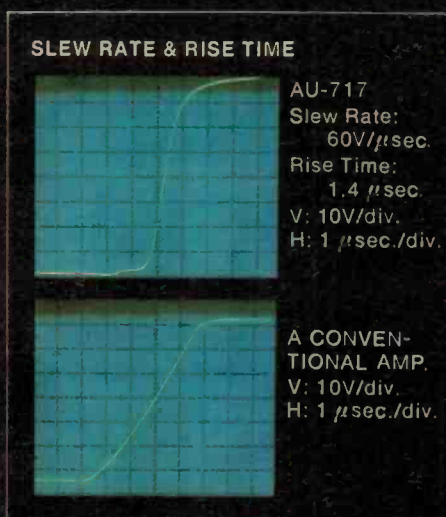

of distortion that is now receiving high priority. Still another important benefit of Sansui's DC amplifier is the ultra-wide frequency response from zero (DC) to 200,000 Hz.

The final result is music with a purity and clarity that must be heard to be believed. All the dimensions of

complex musical sounds — the wide dynamic range, the sudden pulsive signals, the nuances of barely perceptible but critical overtones in the ultra-high frequencies — all these are now crystal clear, all are proof of Sansui's new levels in superior sound quality. Impressive power is 85 RMS watts per channel, 20 — 20k Hz, and total harmonic distortion at rated output is 0.015%. That means it can be considered non-existent as far as the human ear is concerned.

Keep in mind that though the AU-717 is special, it's not special for Sansui. Each and every amplifier on the left-hand page embodies the same Sansui commitment to outstanding sound quality. All controls have been carefully thought out and designed for their specific purposes. Sansui has no place for gadgets and gimmicks in its dedication to the ultimate in hi-fi.

The AU-517 and AU-317 also feature the same DC power amplification as the AU-717, and offer 65 and 50 RMS watts respectively. The AU-217 and AU-117 offer 30 and 20 RMS watts respectively, but are not to be under-rated. In fact, they represent exceptional values in low distortion and true hi-fi performance.

Sansui for specs with a purpose — outstanding musical quality.

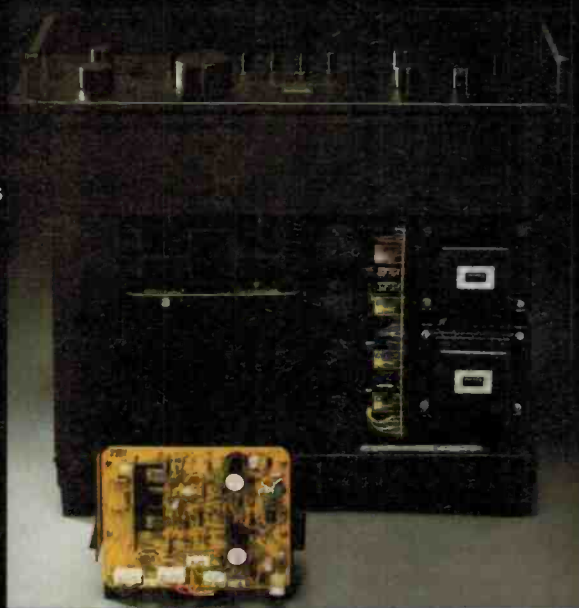

Sansui

Only hi-fi, everything hi-fi.

SANSUI ELECTRIC CO., LTD. 14-1 Izumi 2-chome, Suginami-ku, Tokyo 168, Japan

VANFI (AUST.) PTY. LTD. 162, Albert Road, South Melbourne, Victoria 3205, Australia Tel: 699 5473

Suite 5, Uniline House, 5 Northcliff Street, Milson Point, N.S.W. 2061, Australia Tel: 929 0293

THIS MAN HAS ALL THE INFORMATION



... about TRANSISTORS, INTERFACE IC's, LINEAR IC's, POWER SEMICONDUCTORS, MICROCOMPUTERS, MSI/LSI MEMORIES, OPTOELECTRONICS, MICROWAVE TUBES, SEMICONDUCTOR DIODES, THYRISTORS, DIGITAL LOGIC/COMPUTATIONAL IC's, APPLICATION NOTES REFERENCE. ALSO 5 DISCONTINUED TITLES.

DO YOU?

D.A.T.A. Books are an information system offering the easiest, most logical way to find the specific components you need. They are designed by engineers for engineers. Millions of component characteristics are at your fingertips. You'll know all available devices, how they function, what they look like, and who makes them.

D.A.T.A. Books are organized to make your searching fast and accurate — providing simple solutions to previously difficult problems. You'll find the right component to deliver optimum product performance at the best possible price... without costly mistakes. And since dimensional drawings are included, you can select the devices that conform to the space limitations you are working with.

D.A.T.A. BOOK ORDER FORM: When payment does not accompany your order and an invoice has to be sent — a \$2.00 Handling Charge per subscription or single edition will be made — maximum charge \$6.00.

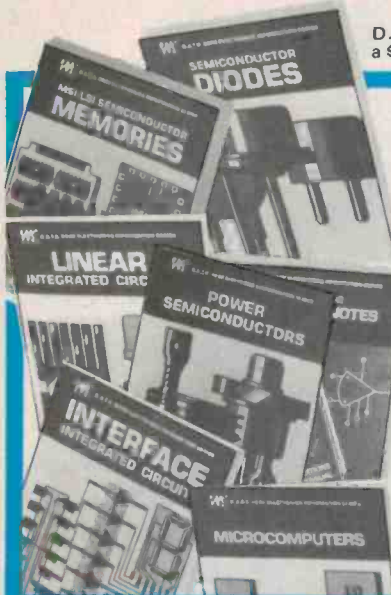

Code	Title	Volumes per year	One-year subscription	Single Edition Purchase
TR	TRANSISTORS	2	\$67.40	\$41.60
DI	SEMICONDUCTOR DIODES	2	78.95	49.20
TY	THYRISTORS	2	56.25	34.95
XT	DISCONTINUED TRANSISTORS	1	31.50	31.50
XR	DISCONTINUED DIODES	1	31.90	31.90
XD	DISCONTINUED THYRISTORS	1	24.65	24.65
LC	DIGITAL LOGIC/COMPUTATIONAL I.C.s	2	68.00	41.90
IF	INTERFACE IC's	2	60.75	37.60
LN	LINEAR IC's	2	65.25	40.50
SM	MSI-LSI MEMORIES	2	57.60	35.75
MC	MICROCOMPUTERS	2	85.90	52.90
XC	DISCONTINUED IC's	1	31.90	31.90
OE	OPTOELECTRONICS	2	85.50	52.75
PW	POWER SEMICONDUCTORS	2	74.25	46.00
AN	APPLICATION NOTES REFERENCE	2	42.70	26.50
MW	MICROWAVE TUBES	2	55.50	34.60
XO	DISCONTINUED OPTOELECTRONICS	1	31.50	31.50

(Prices subject to change without notice)



J.H. BOOK SERVICES PTY. LTD.

A Member of the John Hinton Group of Companies
ALL ENQUIRIES EXCEPT VICTORIA
 P.O. Box 311,
 Chatswood, N.S.W. 2067
 Phone 41 0391 or 419 2386

VICTORIA
 P.O. Box 50
 Toorak, Vic. 3142 Phone 24 3398

ORDER NOW

I enclose cheque for \$ _____
 for D.A.T.A. Books code numbers _____
 Name _____
 Company _____
 Address _____
 P/Code _____
 Phone _____
 Address to: J.H. Book Services Pty. Ltd., P.O. Box 311, Chatswood, N.S.W. 2067

Sole Distributors for D.A.T.A. BOOKS in Australia, NZ and PNG.

Mini-Mart

We'll print your 24 words (maximum) totally free of charge. Copy must be with us by the 7th of the month preceding the month of issue. Please, please write or preferably type your adverts clearly, using BLOCK LETTERS.

—CONDITIONS—

Name and address plus phone number (if required) must be included within the 24 words allowed.

Reasonable abbreviations, such as 25 Wrms, count as one word.

Private adverts only will be accepted. Please let us know if you find a commercial enterprise using this service.

Every effort will be made to publish all adverts received — however, no responsibility for so doing is accepted or implied.

Adverts must relate to electronics or audio — general adverts cannot be accepted.

PLEASE USE BLOCK LETTERS

SEE IN TOTAL DARKNESS INFRA-RED NIGHTSCOPE WITH 12V POWER SUPPLY \$250. EXTRA TUBE AND FILTER \$60. K. FIELD, 1 CONSUL ROAD, BROOKVALE, 2100. PHONE 938-2641.

EXPERIENCED BASIC PROGRAMMERS ARE AVAILABLE FOR WORK IN VARIOUS SUBURBS OF MELBOURNE. PHONE A/H MARK 528-2486 OR ANDREW 842-5679.

SELL SAD-1024 BUCKET BRIGADE I.C.'S FOR ECHO CHAMBERS, PHASERS \$16 EA. BUY LONG THROW FADERS. M. N. DIACK, 16 KIPLING AVE., EPSOM, AUCKLAND N.Z. 60-7810.

SELL: SONY TA-1150 STEREO AMPLIFIER, 35 W RMS A CHANNEL VERY GOOD PERFORMER. EXCELLENT CONDITION. M. STEVENSON, "ATTUNGA", RMB59. HARDEN, NSW, 2587. \$120. PHONE A/H (063) 86-8201.

SALE: AKAI M10 REEL TO REEL TAPE RECORDER DAMAGED IN TRANSIT. ELECTRONICS OK. MIKES INCLUDED \$75 O.N.O. PHONE MELB. 699-5337.

RCA'S COSMAC TINY (2K) BASIC SUITS ALL 1802 SYSTEMS INCLUDING POPULAR ELECTRONIC'S "ELF", \$10 LISTING/USER'S MANUAL, +\$5 KANSAS TAPE. 40 GRETTEL AVE., MELTON, 3337. PH: (03) 743-4614.

MELBOURNE HI-FI AND TAPE-FANS. THE RECORDING SOCIETY OF AUSTRALIA MEETS MONTHLY. YOU ARE INVITED TO COME ALONG. FOR INFORMATION RING OR WRITE TO DON PATRICK, 36 ARGYLE ST., MACLEOD, 3085. (03) 459-1717.

SELL: ETI MAGAZINES AND OTHER ELECTRONIC MAGS. G. M. FOWLES, 10 WHITE ST., MILLICENT, S.A. 5280.

PLAYMASTER 127 AND 128 AMPLIFIER (EAJANZO) 32 WATTS PER CHANNEL. OFFERS TO 8 OSTERLEY TCE., SEA-CLIFF PARK, S.A. OR (08) 296-7384.

AMPLIFIER, MARANTZ 1070, 50 WATTS RMS PER CHANNEL. UNUSED IN BOX.

THREE MONTHS OLD. COST \$400, SELL \$250 O.N.O. RING (02) 349-8795.

SELL: NIXDORF COMPUTER CPU POWER SUPPLY SELECTRIC PRINTER WITH ELECTRONIC COUPLED KEYBOARD MACROS \$650. SPARE GOLF BALL HEAD AND TABLETOP. WATKINS, BOX 1117, ORANGE, 2800.

THANKS FOR THE COPIES, BOB WILLIAMS, BUT I LOST YOUR ADDRESS SO THAT IS WHY I'M USING "MINI-MART" AGAIN, S. JAY.

FOR SALE: BUILT & TESTED, IMSAI COMPUTER \$995, VDU \$195, FLOPPY DISK INTERFACE \$275, MIO BOARD \$325, 8K STATIC RAM \$225. McCREA, SYDNEY 848-0452.

BARLOW WADLEY RECEIVER MARK 2 HARDLY USED. FREQUENCY METER BC 221 WITH 240 V POWER SUPPLY STILL IN ORIGINAL CASE. REASONABLE OFFERS (02) 86-6412 WEEKENDS ONLY.

POWER SUPPLIES, PRIVATELY MADE, 0-12VDC VARIABLE — \$34, FIXED OUTPUTS — \$25, DESIGNED TO SUIT. 1A MAX, REGULATED, INDESTRUCTABLE. 20 SHIRLEY AVE., GLEN WAVERLEY, VIC. 232-9349.

SOUND TECHNOLOGY 1000A/1100A FM ALIGNMENT SYSTEM, BROADCAST OPTION. CURRENT COST APPROX. \$3300. ONLY 1 HOURS USE. SELL \$2000. ALL PACKAGING & INSTRUCTIONS COMPLETE. PHONE (02) 913-2606.

PHONOGRAPH, GRAMOPHONE AND EARLY RECORD COLLECTORS — JOIN 'THE PHONOGRAPH SOCIETY OF AUSTRALIA' — WRITE FOR INFORMATION — VICTORIA: 27 DOVETON AVENUE, DOVETON, 3177 — N.S.W.: P.O. BOX 36 FAIRY MEADOW, 2519.

PROGRAMMABLE CALCULATOR, INC. RECHARGEABLE PACK, BATTERY ELIMINATOR, PROGRAM LIBRARY, ALL AS NEW IN BOXES, UNWANTED GIFT \$59 ONO, OR SWAP FOR BABY 2650. PH (02) 750 4623 OR 799 4151 BH.

SELL: SCMP INTROKIT MICROCOMPUTER FULLY ASSEMBLED AND WORKING WITH ALL DATA, INSTRUCTION BOOKS ETC. \$60. (VDU NOT INCLUDED) PHONE SYDNEY 960-3116.

FOR SALE SANYO H.E. 1/2" ONLY, VIDEO TAPE REELS (2,400FT) \$12 EACH (5 ONLY) — TONY STEVENS 588-2892 BEXLEY.

FOR SALE TRIO CS-1554 DUAL TRACE 10MHz CRO AS NEW \$300 OR OFFER G.BUNT. 354 MAIN ROAD, CARDIFF, NEWCASTLE N.S.W. 2285. PHONE 547696.

TRS-80 MICROCOMPUTER. AS NEW, UNDER WARRANTY. MANUALS AND EXTRA PROGRAMS AS WELL. \$720 (IN). PHONE 887 1686, SYDNEY, NSW 2113.

COMPUTER, KIM-1 COMPLETE INCLUDING ALL MANUALS, POWER SUPPLIES, SOFTWARE & DIAGRAM FOR WORKING \$100 INTERFACE. \$250. R. LORE, 167 COPELAND RD, BEECROFT, 2119. PH (02) 84 4042.

HP25 ACCURATE CLOCK/TIMER \$1, ENCLOSE SELF ADDRESSED ENVELOPE TO PO BOX 275 WENTWORTH BLDG, UNI. OF SYDNEY 2006 FOR PROGRAM.

send your ad to —
ETI MiniMart,
Modern Magazines,
15 Boundary Street,
Rushcutters Bay,
NSW 2011.

PCB's

Using ETI PCB Artwork

This method can be used to make negatives of ETI artwork from October 1977 on, provided the reverse of the page is printed in blue. The film used is Scotchcal 8007 which is UV sensitive and can be used under normal subdued light.

Cut a piece of film a little larger than the PC board and expose it to UV light through the magazine page. The non emulsion side should be in contact with the page. This surface can be detected by picking the film up by one corner - it will curl towards the emulsion side. Exposures of about 20 minutes are normally necessary.

The film can now be developed by placing it emulsion side up on a table, pouring some Scotchcal 8500 developer on the surface and rubbing it with a clean tissue.

Further information on Scotchcal and PCB manufacture can be found in the September and December 1977 issues of ETI. Please note also, that occasionally pressure on space may unfortunately prohibit the printing of blue type behind all PCB's, in which case the reader must resort to more conventional photographic techniques for PCB manufacture.

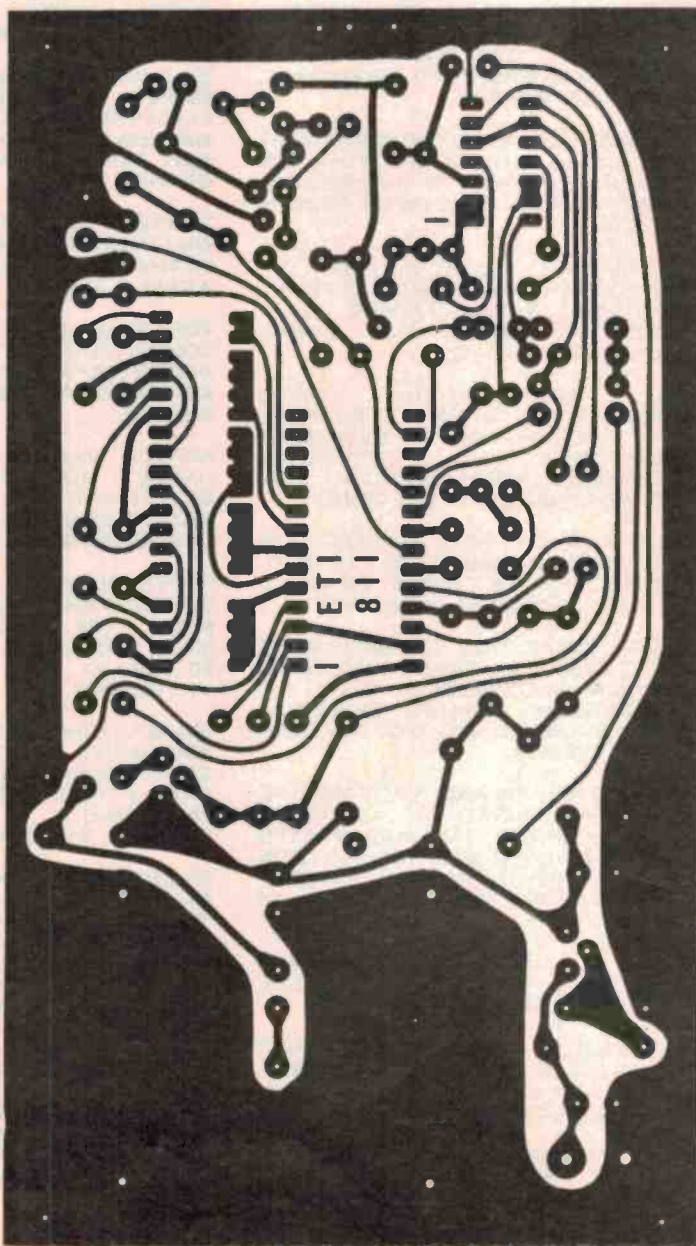
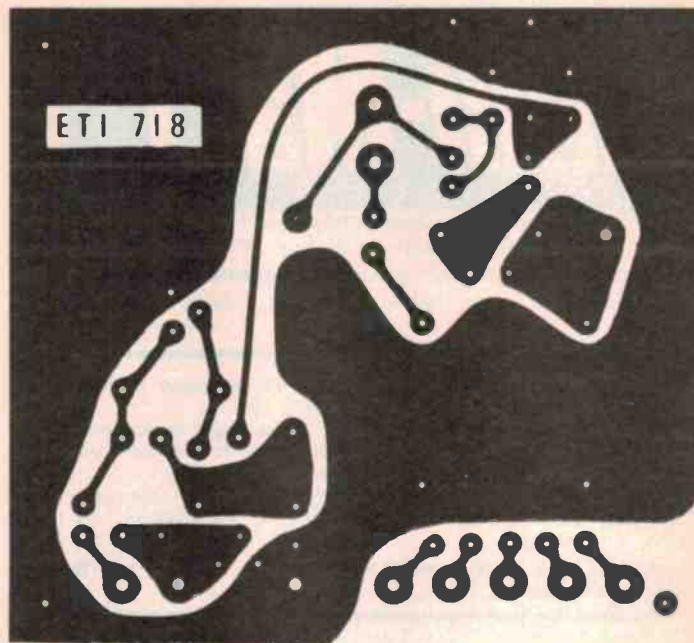
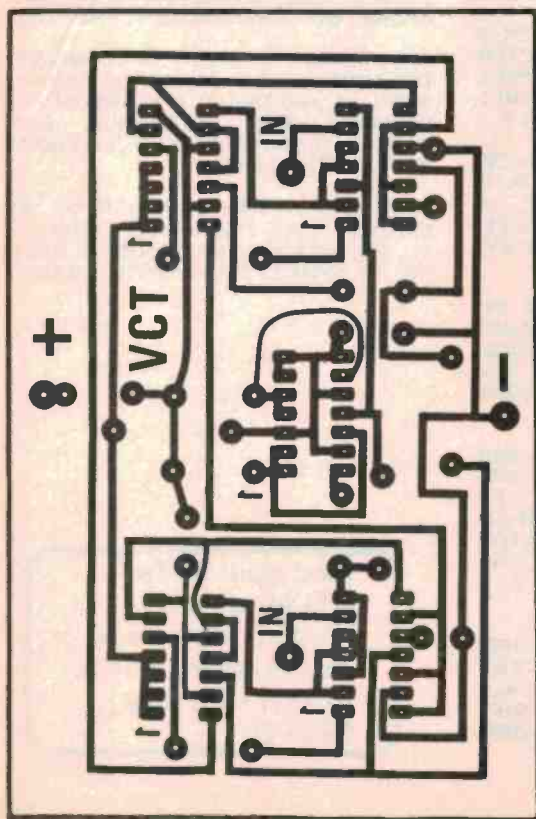

eti 590Af

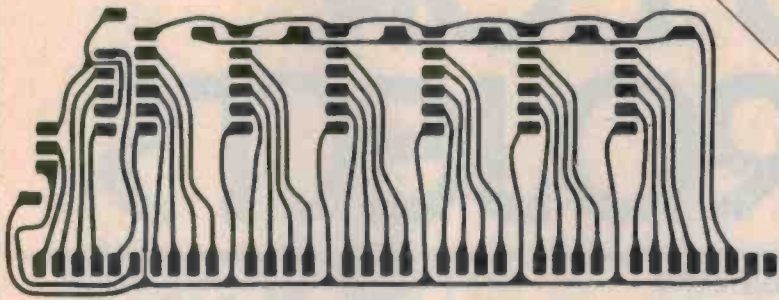

eti 590Ar

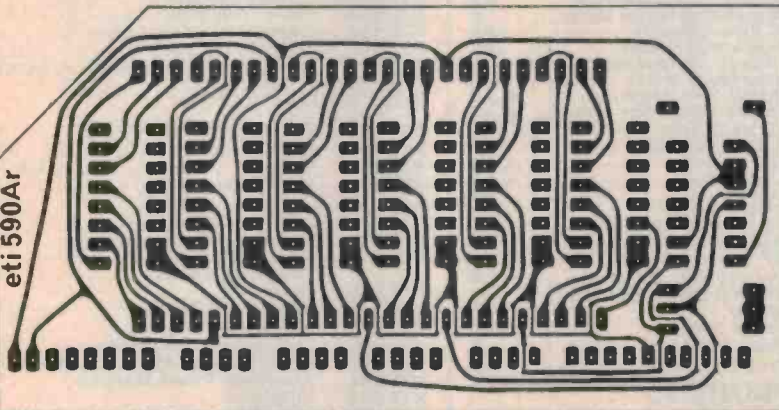

1806 eti 590Bf

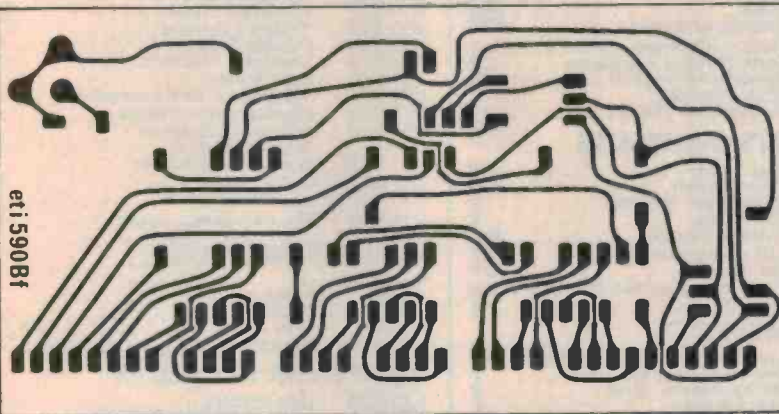

eti 590B r

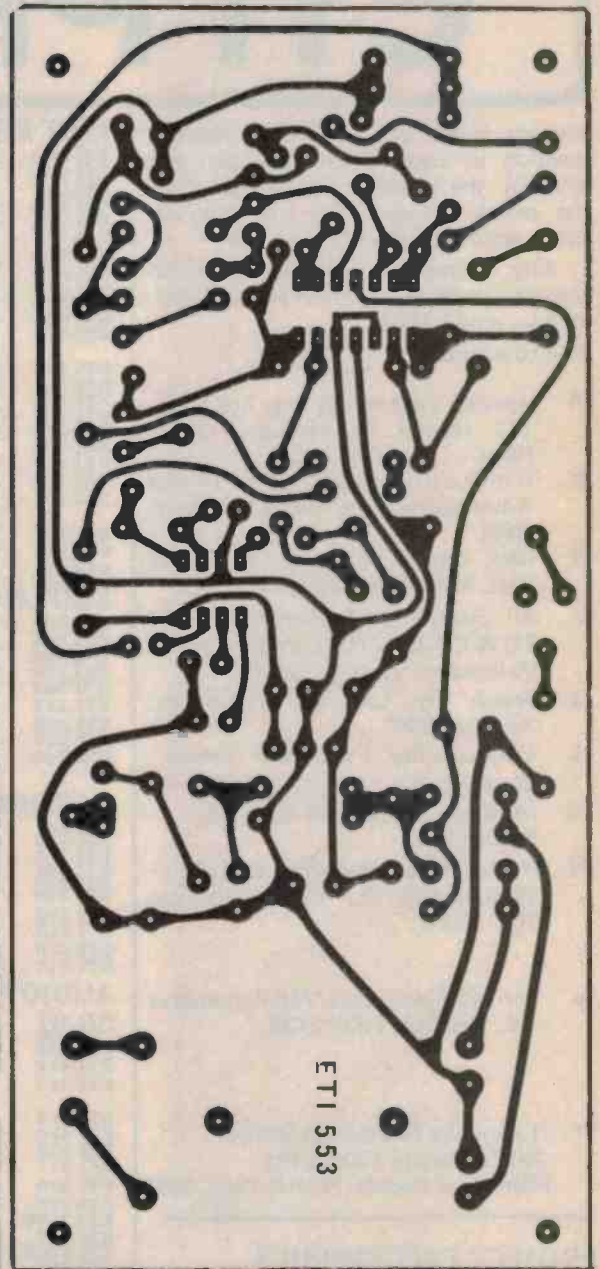
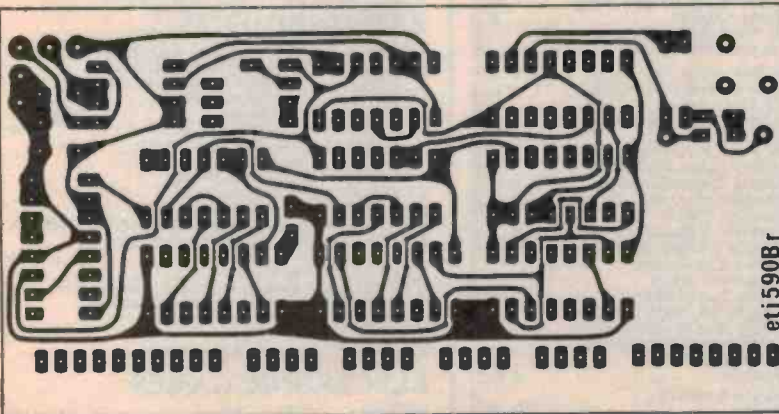

ETI 553

KITS FOR ETI PROJECTS

We get many enquiries from readers wanting to know where they can get kits for the projects we publish. The list below indicates the suppliers we know about and the kits they do.

Any companies who want to be included in this list should phone LES BELL on 33-4282.

Key to companies:

- A** Applied Technology Pty. Ltd. 109-111 Hunter St, Hornsby. 2077. NSW.
- C** Amateur Communications Advancements, PO Box 57, Rozelle, NSW.
- D** Dick Smith Pty. Ltd. of Crows Nest, NSW. (see Ads. for address).
- E** All Electric Components (formerly ED & E Sales), 118 Lonsdale Street, Melbourne, Victoria, 3000.
- J** Jaycar Pty. Ltd. 405 Sussex St., Sydney 2000.
- L** Delsound Pty. 1 Wickham Terrace. Queensland.
- M** Mode Electronics. PO Box 365, Mascot 2020.
- N** Nebula Electronics Pty. Ltd. 15 - 19 Boundary St., Rushcutters Bay 2011. NSW.
- p** Pre-Pac Electronics. 718 Parramatta Rd., Croydon NSW 2132.
- T** Townsville Electronics Centre. 281E Charters Towers Rd, Rising Sun Arcade, Hermit Park. 4812

PROJECT ELECTRONICS

ETI 041	Continuity Tester	DS
ETI 043	Heads or Tails	DA TSE
ETI 044	Two-Tone Doorbell	DA TSE
ETI 045	500 Second Timer	DS
ETI 047	Morse Practice Set	DS
ETI 048	Buzz Board	DS
ETI 061	Simple Amplifier	DA TS
ETI 062	Simple Amplifier Tuner	DSE
ETI 063	Electronic Bongo's	DS
ETI 064	Intercom	ATS
ETI 065	Electronic Siren	DS
ETI 066	Temperature Alarm	ADTSE
ETI 067	Singing Moisture Meter	DS
ETI 068	Led Dice	ADSE
ETI 072	2-Octave Organ	DS
ETI 081	Tachometer	E

TEST EQUIPMENT

ETI 102	Audio Signal Generator	E, DS
ETI 105	Lab Power Supply	E
ETI 107	Widerange Voltmeter	E
ETI 108	Decade Resistance Box	ES
ETI 109	Digital Frequency Meter	E
ETI 111	IC Power Supply	ES
ETI 112	Audio Attenuator	ES
ETI 113	7-Input Thermocouple Meter	P, E
ETI 116	Impedance Meter	ES
ETI 117	Digital Voltmeter	E, AS
ETI 118	Simple Frequency Counter	E, AS
ETI 119	5V Switching Regulator supply	ETS
ETI 120	Logic Probe	L, ES
ETI 121	Logic Pulser	L, ES
ETI 122	Logic Tester	ES
ETI 123	CMOS Tester	ES
ETI 124	Tone Burst Generator	ES
ETI 128	Audio Millivoltmeter	L, ES
ETI 129	RF Signal Generator	L, ES
ETI 130	Temperature Meter	E
ETI 131	General Purpose power supply	E, N
ETI 132	Power Supply	NSE
ETI 133	Phase Meter	E
ETI 134	True RMS Voltmeter	E

SIMPLE PROJECTS

ETI 206	Metronome	T
ETI 218	Monophonic Organ	ET
ETI 219	Siren	ET
ETI 220	Siren	ET
ETI 222	Transistor Tester	ETS
ETI 234	Simple Intercom	T
ETI 236	Code Practice Oscillator	E
ETI 239	Breakdown Beacon	E
ETI 240	High Powered Emergency Flasher	E

MOTORISTS' PROJECTS

ETI 301	Vari-Wiper	ET
ETI 302	Tacho Dwell	ET
ETI 303	Brake-light Warning	E
ETI 305	Car Alarm	E
ETI 309	Battery Charger	P, E
ETI 312	CDI Electronic Ignition	P, ET
ETI 313	Car Alarm	E, DT
ETI 316	Transistor Assisted Ignition	E
ETI 317	Rev. Monitor	E

AUDIO PROJECTS

ETI 401	Audio Mixer FET Four Input	E
ETI 406	One Transistor Receiver	T
ETI 408	Spring Reverb. Unit	E
ETI 410	Super Stereo	E
ETI 413	100 Watt Guitar Amp	P, L, J, DT
ETI 413	x 200 Watt Bridge Amp	SE
ETI 414	Master Mixer	E, J
ETI 416	25 Watt Amplifier	E
ETI 417	Amp Overload Indicator	E
ETI 419	Guitar Amp Pre-Amp	P, E, DT
ETI 420	Four-channel Amplifier	L, E
ETI 420E	SQ Decoder	E
ETI 422	International Stereo Amp	S, L, D
ETI 422B	Booster Amp	E, E
ETI 422	50 Watt Power Module	E, E
ETI 423	Add-on Decoder Amp	E, E
ETI 424	Spring Reverberation Unit	S, L, E
ETI 425	Integrated Audio System	E, E
ETI 426	Rumble Filter	E, E
ETI 427	Graphic Equaliser	S, L, E, J
ETI 429	Simple Stereo Amplifier	E
ETI 433	Active Crossover	J
ETI 435	Crossover Amp	E
ETI 435	Audio Level Meter	L, ES
ETI 438	Simple 25 Watt Amp	L, E
ETI 440	Audio Noise Generator	L, ES
ETI 441	Compressor-Expander	E, J
ETI 443	Five Watt Stereo Preamp	ES
ETI 444	Audio Limiter	J, E, D
ETI 445	Phaser	E, J
ETI 446		
ETI 447		

ETI 449	Balanced Mic Preamp	JE
ETI 480	50 W. 100 W Power Amp	A
ETI 480P	Power Supply	DAT
ETI 481	12V to 40V DC Inverter	E
ETI 482A	Preamp Module	AE
ETI 482B	Tone Controller	AE
ETI 484	Compressor Expander	E
ETI 485	Graphic Equalizer	JSE
ETI 480	50W, 100W Power Amp	ADBE

MISCELLANEOUS

ETI 502	Emergency Flasher	E
ETI 503	Burglar Alarm	ET
ETI 505	Strobe	L, E, D
ETI 506	Infra-Red Alarm	E
ETI 509	50-Day Timer	E
ETI 512	Photographic Timer	E
ETI 513	Tape Slide/Synchroniser	E
ETI 514	Flash Unit - Sound Operated	E
ETI 515	Flash Unit - Light operated	E
ETI 518	Light Beam Alarm	ET
ETI 525	Drill Speed Controller	E
ETI 528	Home Burglar Alarm	P, ET, MS
ETI 529	Electronic Poker Machine	E
ETI 532	Photimer	E
ETI 533	Digital Display	L, E, AS
ETI 534	Calculator Stopwatch	A, D
ETI 539	Touch Switch	E
ETI 540	Universal Timer	ES
ETI 541	Train Controller	ET
ETI 543	Double Dice	A
ETI 544	Heartrate Monitor	AE
ETI 546	GSR Meter	E
ETI 547	Telephone Bell Extender	E
ETI 548	Photographic Strobe	E
ETI 549	Induction Balance Metal Locator	E
ETI 581	Dual Power Supply	E
ETI 582	House Alarm	E
ETI 583	Gas Alarm	ME
ETI 586	Shutter Speed Timer	E

ELECTRONIC MUSIC

ETI 601	4600 Synthesiser	J
	3600 Synthesiser	J
ETI 602	Mini Organ	E, A, D
ETI 604	Accentuated Beat Metronome	E

COMPUTER PROJECTS

ETI 630	Hex Display	AE
ETI 631	VDU Keyboard Encoder	AE
ETI 632	VDU 1 k x 8 Memory Card	AE
ETI 633	VDU Sync Generator	AE

RADIO PROJECTS

ETI 701	TV Masthead Amplifier	E, D
ETI 702	Radar Intruder Alarm	DE
ETI 703	Antenna Matching Unit	E
ETI 704	Crosshatch/Dot Generator	L, A, D, ES
ETI 706	Marker Generator	ES
ETI 707	Modern Solid State Converters	C, E
ETI 708	Active Antenna	E
ETI 709	RF Attenuator	E
ETI 710	2 metre Booster	C, E
ETI 711B	Single Relay Remote Control	AE
ETI 711C	Double Relay Remote Control	AE
ETI 711R	Receiver	AE
ETI 711AR	Remote Control Transmitter	AE
ETI 711DR	Remote Control Decoder	AE
ETI 712	CB Power Supply	E
ETI 740	FM Tuner	AE
ETI 780	Novice Transmitter	E

ELECTRONIC GAMES

ETI 804	Selecta-Game	O, A, DS
---------	--------------	----------

Jaycar New Audio Kits and Components

AUDIO SPECTRUM ANALYSER

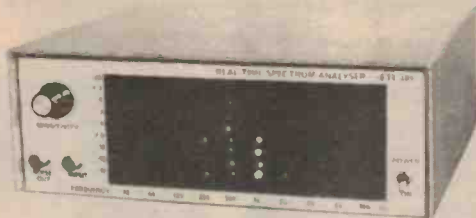

The 489 Analyser can be used in conjunction with a Graphic Equaliser to accurately equalise systems for room acoustics.

Features:

- Ten octave spaced displays.
 - LED readout in 3 dB steps.
 - Input sensitivity control.
 - Inbuilt pink noise generator.
- Complete kit includes matched LED's, polarised plastic display, complete metalwork, etc.

ONLY \$142 plus \$3 freight.

485 GRAPHIC EQUALISER

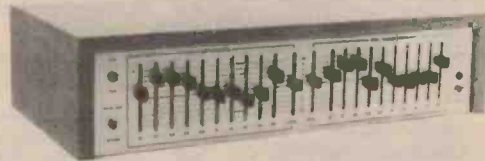

- 10 adjustable controls on one octave centre frequencies (Independent for each channel).
- Symmetrical mirror image boost and cut of 13 dB at any centre frequency.
- Full spectrum gain control for each channel with a range of 14 dB gain to 9 dB attenuation.
- Vertical slide controls give a graphic representation of the resulting response curve.
- 100 percent monolithic active circuitry. Hum, ring and saturation free gyrator design.
- Facility for tape monitoring.
- Optional standard 19" rack mounting adaptor available.

COMPLETE KIT \$105. P&P\$3.

jaycar PTY LTD

PO Box K39, Haymarket,
NSW. 2000, 405 Sussex Street,
Tel: 211-5077.

STEREO INSTRUMENTS

STEREO

LBO-552

5" Horizontal, Dual Trace/ Dual Chan. Oscilloscope

WITH SIMULTANEOUS LEFT/RIGHT
WAVEFORM DISPLAY

A solid state achievement that makes audio testing, on-line quality control and general purpose measurements easier than ever. Features a horizontal dual trace/dual channel format that lets you view two independent signals simultaneously and side-by-side on a bright CRT display. Perfect for inspecting and aligning the most sophisticated stereo equipment, the LBO-552 also provides a single channel input for conventional readout. Sensitivity is 20mVp-p/cm; Vert. B'width is 0C or 2Hz to 2.5MHz. Sweep speeds are from 10Hz to 100KHz in 4 ranges with input impedance 1MΩ shunted by 40pF.
250mm h x 180 w x 380 d; 6.5kg.

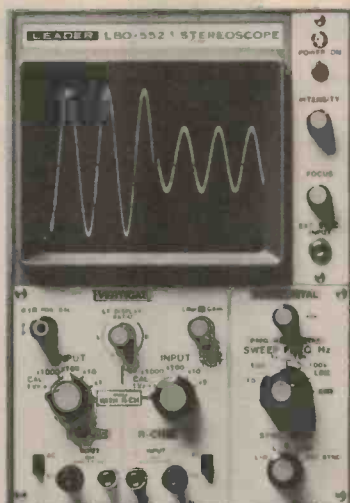

LMV-186A

Dual Chan./ Dual Pointer

AC Millivolt Meter

Check stereo signal quality, especially where a big difference exists in two points. This instrument uses identical switches and amplifiers in each channel to operate without crosstalk effects. Measuring range is 100μV to 300V, 12 steps. It has two dB scales; an easy-to-read meter face; 2 scale readings; built-in dual amplifier output. Accuracy is ± 2% full scale (1KHz). Channels operate individually, or in common at ch. 2. Scale calibration reads effective values. With input cable 240V/50Hz.
150mm h x 200 w x 250 d; 3.5kg.



WARBURTON FRANKI

- ADELAIDE 356-7333 • BRISBANE 52-7255 • HOBART 23-1841
- MELBOURNE 699-4999 • PERTH 277-7000 • SYDNEY 648-1711
- AUCKLAND N.Z. 79-7781 • WELLINGTON N.Z. 698-272

RAVE

PROFESSIONAL
SOUND & LIGHT
SOUND & LIGHT
SOUND & LIGHT
SOUND & LIGHT

Importers of
Quality Electronic Equipment

Complete HIRE • SALES • DESIGN
service to the entertainment industry.

OFFICE and SHOWROOMS
2388 Gold Coast Highway,
Mermaid Beach, Qld. 4218.
Phone (075) 38-3331.

DJ S77 STEREO DISCOMIXER



SUPERIOR DESIGN
CLEAN, CRISP SOUND
REPRODUCTION.

Automatic voice override • tape-in, tape-out • 2 microphone in • 2 x turntables in • T.T. start buttons • slave out • 2 year guarantee.
Available separate or in console C/W turntables and 200 watt power amp built-in. Mono or stereo. Size (mixer only) 17cm x 86.5cm x 9cm. Weight 4.5kg.

LITO 250 PROFESSIONAL EFFECTS PROJECTOR

• New 250W Quartz Iodine Effects projector for use with effects from spectacular Lightomat range • Lens system totally enclosed to eliminate light spill • Cool, quiet operation, high efficiency tangential air blower • Used free-standing or suspended with adjustable handle • Supplied as "Main-Frame Unit" with 50mm lens, 60, 85 & 100mm avail. • 14 attachments available — changed by slide-in rotator system — wide selection of cassettes & 6" Effect Wheels • Mains voltage selector gives range of 6 input voltages.



• STROBES • SOUND TO LIGHT UNITS • DRY ICE FOG MACHINES • ROPELITES • LIGHTING STANDS • BEACONS
• JBL SPEAKERS & CABINETS • Brochures available on request.

ROMTECH

INTRODUCING ROMTECH Special introductory prices

2708 EPROMS.....	\$12.50
2114 1K x 4 RAMS 200 nS.....	12.50
LM309K voltage regulators.....	1.00
HDO165 keyboard encoder.....	3.00
400V 25A power bridge.....	3.00
200V 4A bridge.....	2.00
1N 4148 diode 20 for.....	1.00
1N 4004 diode 15 for.....	1.00
6800P microprocessor.....	13.75
6810P RAM.....	4.50
6820P PIA.....	5.60
6850P ACIA.....	7.80
2513 single 5V character gen.....	12.00
IC SOCKETS	
8 pin.....	0.20
14 pin.....	0.22
16 pin.....	0.24
18 pin.....	0.32
20 pin.....	0.39
22 pin.....	0.35
24 pin.....	0.40
28 pin.....	0.50
40 pin.....	0.80

MICROPROCESSOR CRYSTALS

1 MHZ range.....	\$7.00
2 MHZ range.....	6.00
3 MHZ range.....	5.00
4 MHZ range and up.....	3.00

SOLID TUBULAR TANTALUM CAPACITORS

A case.....	0.40
B case.....	0.50
C case.....	1.20
D case.....	1.95

MIL-C-11015 CERAMIC CAPACITORS

CK05BX102K.....	0.30
CK05BX103K.....	0.40
CK05BX104K.....	0.50

MONOLITHIC CERAMIC CAPS

0.01uF.....	0.20
0.1uF.....	0.25

Plus full range of 74, 74LS, CMOS4000, 74S on stock to 3 weeks delivery.

Repair facility now available on all "Motorola Exorciser 6800 Bus" modules, \$100 + parts, 90-day warranty offered on repair.

• New release 24K static RAM module 6800 bus compatible, complete socketed and guaranteed for 12 months, \$579.00

• Watch this column for future releases, i.e. mother board, PROM module, MPU module, I/O module and VDU module.

• Full PROM programming facility available.

Please add 15 per cent S/T to all prices



For all semi-conductor requirements call Judy or Dick Everett, names synonymous with courtesy and service.

ROMTECH PTY. LIMITED

Office: STC Complex, Moorebank Ave, Liverpool, NSW. P.O. Box 446, Campbelltown, NSW. 2560.
Tel: (02) 601-4511. AH (046) 34-1247.
Telex: AA27064.

Memory - GROW YOUR OWN

ON STACKABLE 4K RAM/ROM PLANES

RAM PLANES

4K Bytes using 32 2102s	
PCB	KIT 450 nS
\$16.75	\$75.25

ROM PLANES

4K bytes using 4 2708s	
PCB	KIT (no 2708s)
\$16.75	\$33.90

EXPANDABLE 16K MOTHER BOARD

- All buffering and control for 1 to 4 RAM/ROM planes
- MEMORY PLANES stack on sockets
- Configurable to any 8K boundary

- Interfaces to 6800, 8080/85, 2650, SC/MP, 6502 etc.
- Edge connector 43 x 2 way 0.156" with Motorola system connections.

KIT - \$49.20

(Prices inc. tax. P & P \$1.50 in Australia)

Pennywise Peripherals

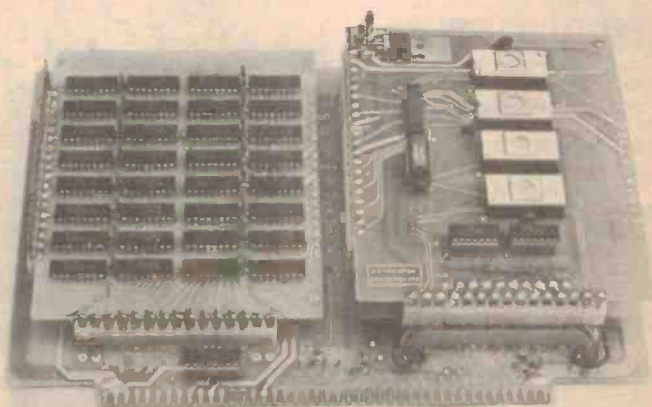

19 Suemar St., Mulgrave, Vic 3170.

Phone (03) 546 0308

Free

1979 Catalogue Available Now!



**DON'T WAIT—
COME IN AND
GET YOUR COPY TODAY
AT ANY TANDY STORE!**

Bigger an' better than ever — 132 Pages! The most wanted electronics catalogue is hot off the press and yours for the asking! See everything new in consumer electronics — nearly 2000 exclusive products. You'll find all our famous brands like Realistic, Micronta, Archer, Science Fair and ArcherKit, plus our breakthrough TRS-80 Computer. Visit the Tandy Electronics Store or participating Dealer near you for your FREE copy today!

NONE SENT BY MAIL

TANDY ELECTRONICS

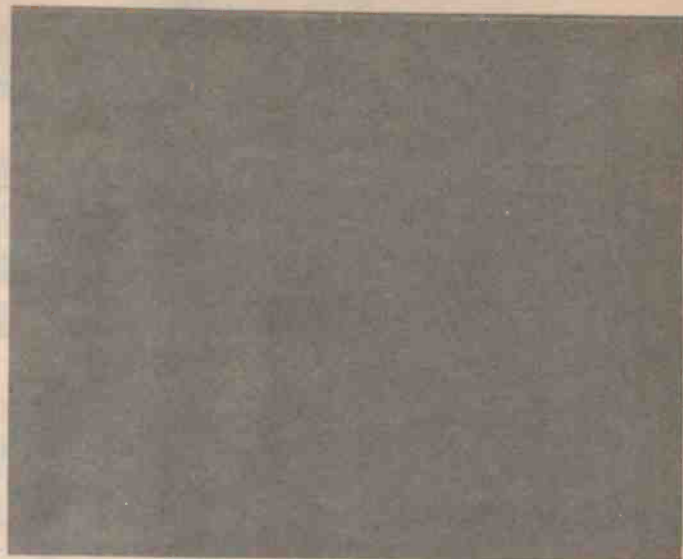

**This is a photograph of
the world's best
symphony orchestra**

(playing in a fog!)

**When the fog is thick they don't sound
so much better than they look!**

M.R. Acoustics can help you remove the fog from your hi-fi system and the first step is to correctly adjust the pick-up cartridge, using the HFS75 test record. For \$8.50 you can optimise tracking weight and bias compensation of the arm and cartridge combination. The Micro-Acoustics TT-2002 test disc (\$13) is also an invaluable aid, containing 7 varied musical examples besides tests.

The second step in fog-elimination is to play high quality audiophile recordings from M.R. Acoustics. Look at this for a range:

ARK recordings by Fulton of the USA — \$12. Artofonic 2 record set cut at 45 rpm — a fine Canadian recording of a symphony orchestra — \$23. Richardson Recordings from the USA — \$13. Note — included in this catalogue is The Spirit of Christmas Brassed, famous and popular Christmas carols played superbly by the Annapolis Brass Quintet. THIS IS A SUPERB CHRISTMAS PRESENT FOR THE HI-FI ENTHUSIAST! Reference Recordings from the USA — \$13. Audio Lab super cut records from Japan — \$14. From the Stereo Review magazine of the USA we suggest the SR12 stereo test record at \$9.50.

And new from Miller & Kreisel Sound Corporation of California, we now offer the famous M&K REALTIME direct-cut records. The first release is FOR DUKE by Bill Berry and his Ellington All-Stars. A fabulous recording of popular Duke Ellington numbers, recorded in January 1978. Price \$19. each.

Postal rates — 1 disc \$1.20, 2-3 discs \$2.70, 4-6 discs \$3.10. For certified mail insurance add 50c per parcel. Write to M.R. Acoustics, P.O. Box 110, Albion, Qld, 4010 to order direct or for further information on our records and other products. Trade enquiries welcome.

predictions

Ionospheric Predictions for the month of November

THESE PREDICTION GRAPHS have been prepared courtesy of the Ionospheric Prediction Service Division of the Department of Science. Any enquiries about these predictions should be directed to ETI, not to the Ionospheric Prediction Service.

The graphs indicate the maximum usable frequency (MUF) on HF circuits between various centres in Australia and selected points overseas. For less than 50% of the days of the month the highest frequencies propagated will be at least as high as the uppermost curve. Between 50% and 90% of the days of the month the MUF will be at least as high as the curve beneath the upper curve. The absorption limiting frequency (ALF), which affects the lowest frequencies that will be propagated, is indicated by the lower curves on the graphs.

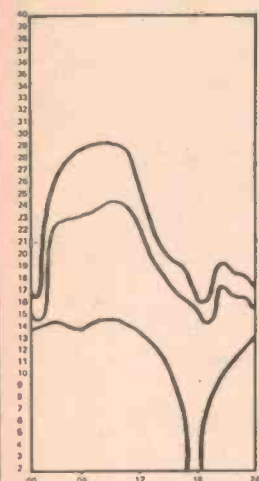

East Coast - South Africa (also serves South Central)

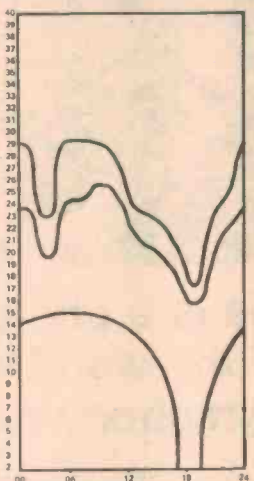

East Coast - North Africa (also serves South Central)

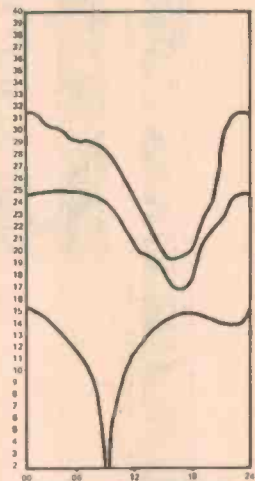

East Coast - South America (also serves South Central)



East Coast - Central USSR (also serves South Central)



East Coast - North America (also NE and South Central)

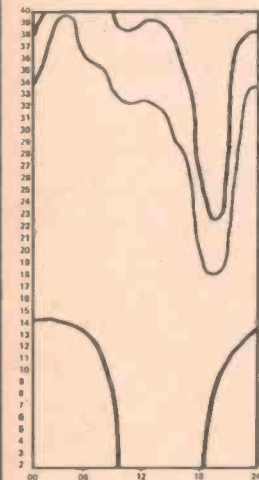

East Coast - Japan (also serves NE and South Central)

East Coast - South Pacific

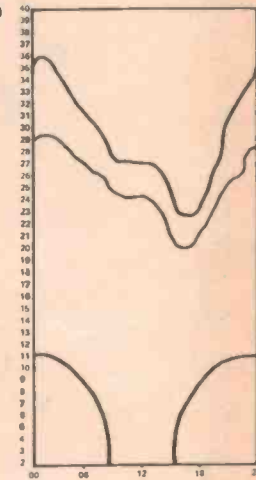

SWL
and
AMATEUR
COMMUNICATIONS

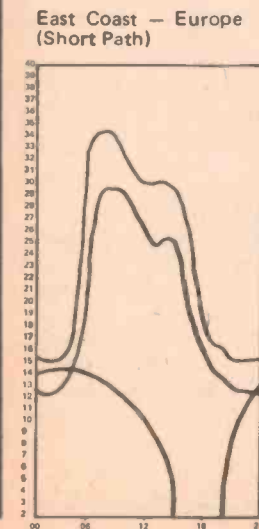

East Coast - Europe (Short Path)

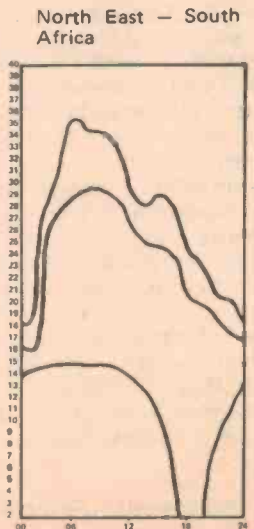

North East - South Africa

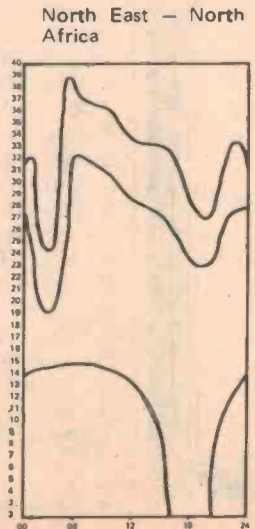

North East - North Africa

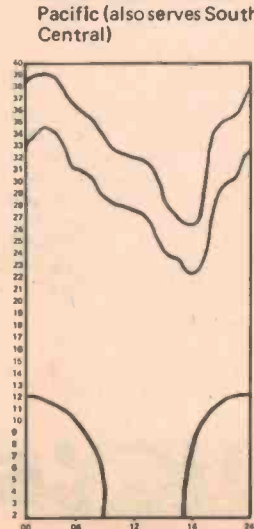

North East - South Pacific (also serves South Central)

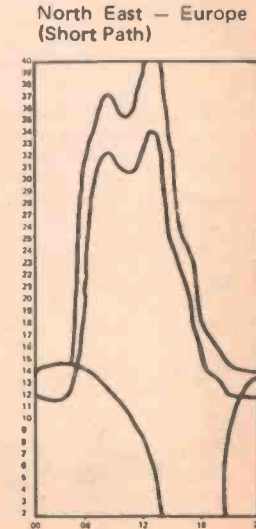

North East - Europe (Short Path)

South Central — Europe
(Short Path)(also West
Coast)



West Coast — North
America

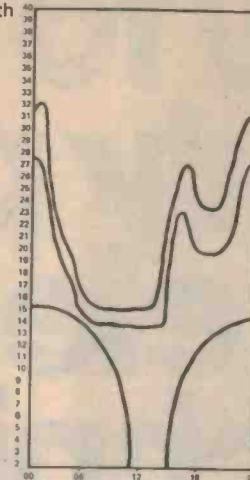

West Coast — North
Africa

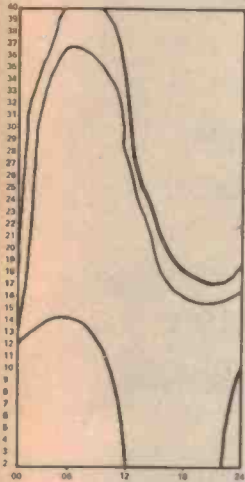
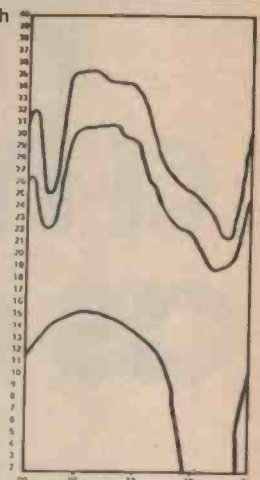

West Coast — Central
USSR

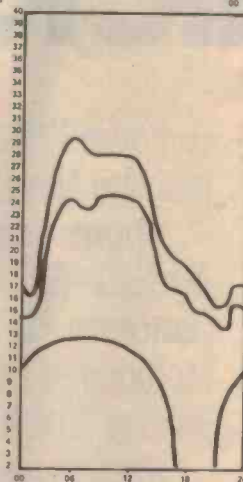

West Coast — South
Africa

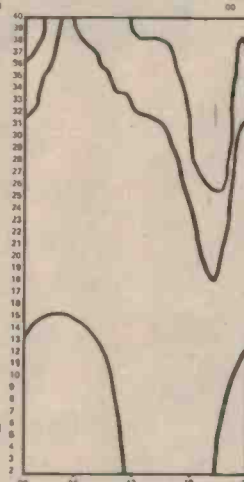

West Coast — Japan

LIGHT DIMMING BY NEBULA

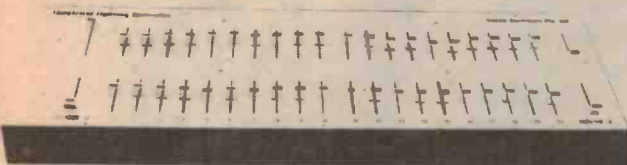

THE FOLLOWING KITS FOR THE ETI 588 THEATRICAL DIMMER SYSTEM ARE NOW AVAILABLE.

10Amp (2400 Watt) dimmer module
This module contains all parts which are mounted on the PC board including the front panel and handle but does not include the edge connector.

KIT \$ 60.00 each
BUILT \$ 90.00 each

20Amp (4800 Watt) dimmer module
Similar to the 10amp except higher current.

KIT \$ 69.00 each
BUILT \$ 99.00 each

5 Way dimmer housing
This accepts up to 5 dimmer modules of either 10 or 20amp rating. When supplied in kit form pop-riveting equipment is needed. It is supplied with the edge connector but no other sockets or plugs and with a blank rear panel. The price of the built version depends on sockets required.

KIT \$135.00 each
BUILT \$165.00 each

10 Way control desk
This is a 10 Way, 2 preset unit. It is supplied with a 12 Way 'Jones' plug and socket but no multicore cable.

KIT \$125.00 each
BUILT \$185.00 each

20 Way control desk
Similar to the 10 Way unit except it has two sets of master controls which allows the desk to be used either two separate 10 Way units or as a single 20 Way desk.

KIT \$195.00 each
BUILT \$275.00 each

NEBULA ELECTRONICS PTY. LTD.
15 BOUNDARY STREET,
RUSHCUTTERS BAY. 2011
PHONE: 33 5850

Prices do not include sales tax (15%) or postage.

How to crack a highly paid job as an electronics technician.



We'll give you excellent training - as good as you'll get anywhere in Australia.

We'll give you free medical, dental and hospital treatment.

We'll provide plenty of good tucker and a comfortable place to stay.

We'll give you substantial leave, and on top of all that, we'll pay you well while you're training.

On your side, you'll give us a period of hard, but interesting and rewarding work. And, when eventually you leave us, you'll find yourself a fully qualified and experienced Electronics Technician. Not a bad thing to be, these days.

So, if electronics is your idea of a great career and you are (at time of entry) approx. 15 to 17 for apprenticeship

and over 17 for an Adult Trainee, join the Navy, Army or Air Force.

Phone us at:

Adelaide 223 2891. Brisbane 226 2626.

Canberra 822 333 Hobart 34 7077.

Melbourne 61 3731. Perth 325 6222.

Sydney 212 1011.

Write to either the Navy, Army or Air Force Electronics Technician Counsellor, GPO Box XYZ in your nearest State Capital City (please

include your date of birth).

**Learn
Electronics
with us.**



Authorised by Director-General of Recruiting, Dept. Defence.
TSAP15.FP.48

NESSSEL LOUDSPEAKERS

PROFESSIONAL SERIES



Rugged cast aluminium

27½" W x 7" High x 19" deep.
90° lip horn
Throat adaptors for screw-on
1 ⅜" and 1" entry.
500 c/s crossover



Range of speakers

Model:

SL1201: 12" 4" coil, 100W, Guitar Bass
PA, 8 kg, 80 c/s.
SL1502: 15" 4" coil, 150W, Guitar Bass
PA, 9 kg, 55 c/s.
SL1403: 15" 4" coil, 200W, Bass PA, 14
kg, 70 c/s.
SL1803: 18" 4" coil, 200W, Bass, 14 kg,
50 c/s.

TRADE ENQUIRIES WELCOME

Available from



NESSSEL AUDIO

9 Nellbern Rd,
Moorabbin East, Vic. 3189
Ph (03) 95 9510

Re-an cabinet fittings

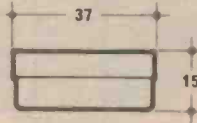

CABINET FEET R332

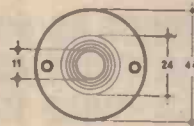

SOCKET RECESS PLATE R303

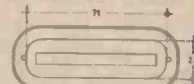

CASTOR CUP R370



RECESS HANDLE FOR
SPEAKER BOX R338

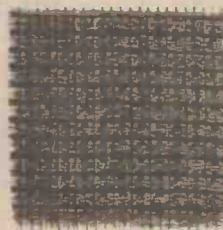

BLACK SEE-THROUGH
GRILLE CLOTH G111

Send for a free catalogue
and price list to:

HOLDEN WASP INTERNATIONAL

PO Box 532, Marrickville, 2204.
39 Chalder St., Marrickville,
or Phone (02) -60-3488.

CARTRIDGES & STYLI

CARTRIDGES

ADC ZLM	\$125
ADC XLM MK3	\$99
ADC VLM MK3	\$82
ADC QLM 36 MK3	\$75
ADC QLM 34 MK3	\$58
ADC QLM 32 MK3	\$42
ADC QLM 30 MK3	\$30
DENNON DL107	\$75
DENNON DL109R	\$85
DENNON DL 109D	\$112
DENNON DL103	\$120
AU310 Trans for DL103	\$70
DENNON DL103S	\$155
AU320 Trans for DL103S	\$90
Shure V15 Type IV	\$159
Shure V15 Type III	\$125
Shure M95ED	\$58
Shure M91ED	\$39
Shure M70EJ	\$16
Shure M55E	\$25
Shure M44E	\$22
Shure M24H	\$79
Shure M70B	\$12
Shure M75CS	\$19
Shure M44-7	\$21
Jelco MC9	\$12
Jelco MC-14D	\$24
Jelco MC-14E	\$39
Jelco MC-45E	\$80

STYLI

Shure VW35E	\$56
Shure N95ED	\$49
Shure N91ED	\$39
Shure N70EJ	\$11
Shure N55E	\$21
Shure N44E	\$18
Shure N24H	\$52
Shure N70B	\$7
Shure N75C	\$15
Shure N44-7	\$16
Jelco ND-9	\$8
Jelco ND-14D	\$12
Jelco ND-14E	\$28
Jelco ND-45E	\$45

STONE ARMS

ADC LMF-1	\$179
ADC LMF-2	\$189
Grace 707	\$89
Jelco SA50	\$39
Jelco SA200	\$69

ACCESSORIES

Headshell JS-10 Blk A1	\$8.50
Headshell JS-20W Nat A1	\$9.50
Headshell JS-50 Solid Blk A1	\$11.75
Stylus Press Gauge	\$4.95
Static Discharge mat	\$7.95
Stylus Microscope	\$4.00
Static Eliminator Gun	\$19.95

Goods listed are offered subject to availability.
Prices include postage anywhere in Australia.
Write, phone or call in. Send SAE for full
cartridge and stylus price list.

CAMPBELLTOWN HI-FI

107 Macquarie Ave,
Campbelltown, NSW 2560

Open all day Saturday

Ph. (046) 25-6067

Audio design

PROFESSIONAL
AUDIO PRODUCTS



POWER AMPLIFIERS

20Hz-20KHz ± 0.025 dB.THD < 0.1% (typ. 0.02% at 1KHz). 100 dB(A) S/N, 50KHz Pbw.

40/60 Watts/channel, \$300.
100/150 Watts/channel, \$520.
225/350 Watts/channel, \$720.



ACTIVE FILTER/AMPLIFIER

Combines a switchable 500/800/1.2KHz active filter with the 40/60 Watt/ch amplifier to drive the high frequency horns in bi-amplification systems, \$428.

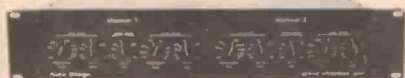

ACTIVE CROSSOVER UNIT

A stereo 2 or 3 way unit of a phase/amplitude coherent design with a 60 dB/decade subsonic filter. THD < 0.05%, S/N 100 dB(A). Class A operation, 5V/uS S.R. \$345.



GRAPHIC EQUALIZER

A stereo octave band unit. THD < 0.05%. 20Hz - 20KHz ± 0.5 dB S/N 100 dB(A), 15V/uS S.R. \$390.



STEREO DISCO MIXER

Inputs for 2 balanced mics, 2 RIAA, equalized phono, 2 tape decks. 200 mW/ch headphone monitor. THD < 0.05%, 5V/uS S.R. \$428.

For further information contact:

AUDIO DESIGN, 3/7 Harvton St., STAFFORD. 4053. Ph: (07) 356.9191.
RAVE, 2388 Gold Coast Hwy. MERMAID BEACH. 4218. Ph: (075) 38.3331.
DYNASOUND. 261-263 Swanston St., MELBOURNE. 3000. (03) 663.2064.

DEK

Model 250

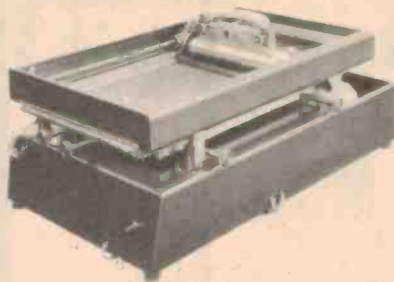

**TWICE AS MANY
OR TWICE AS FAST
OR TWICE THE SIZE**

That's roughly the promise of the new Dek 250 precision screen printer. Double benefits all round. Whether you are resisting P.C.B.'s, printing front panels or producing foil or plastic labels.

The Dek 250 prints an area of 18" x 10" (450 x 250mm) More than twice the size of the well established Model 240.

Of course the model 240 is still available. So is the Dek 1200 specifically designed for thick film work. So too is the Dek 65 for R & D applications.

See the Dekmatic 65 and the 240 at the Australian International Engineering Exhibition, Sydney Showgrounds Sept. 11-16. We are in the British Pavillion, Stand No.6.

DEK

**PRECISION
PRINTING
SYSTEMS**

Represented in Australia by
Findon Machinery Co. Pty. Ltd.

31 Metropolitan Ave.,
Nunawading, Vic. 3131.
Phone (03) 878-0883.

RADCOM

constructor components

EVERYTHING FOR
THE CONSTRUCTOR
AT ONE SHOP
AT PRICES TO SUIT
YOUR BUDGET

SPECIAL!
Make your own PCB's
with our super kit.

ONLY \$8.50

**SILICON VALLEY
stockists**

- CAPACITORS —
- RESISTORS —
- POTS —
- SWITCHES —
- PLUGS —
- SOCKETS —
- PANEL LAMPS —
- TRANSISTORS —
- DIODES —
- BOXES —
- LEDS —
- IC's —

**DE LUXE
CAR RADIO**

Super fringe reception
complete with speaker
and antenna

BARGAIN at \$52.94

Ask at the counter
for our stock list

Cnr. Eldridge & Willfox Rds.
BANKSTOWN, NSW.
709-4706

Ideas for experimenters

These pages are intended primarily as a source of ideas. As far as reasonably possible all material has been checked for feasibility, component availability etc, but the circuits have not necessarily been built and tested in our laboratory. Because of the nature of the information in this section we cannot enter into any correspondence about any of the circuits, nor can we produce constructional details.

Electronics Today is always seeking material for these pages. All published material is paid for — generally at a rate of \$5 to \$7 per item.

Gated 123 Oscillators

The action of two distinct types of gated oscillator is shown in Fig. 1. Type A stops immediately the inhibit signal goes low, and starts immediately it goes high. (Hence fractional output pulses may be produced.)

Type B finishes its current pulse before stopping when the inhibit signal goes low and like A starts immediately it goes high.

A is used when an oscillator has to be synchronized using pulses shorter than the output pulse and B is used when a number of whole pulses are required (the inhibit signal is obtained from the output of a counter).

It can be quite difficult to achieve a type A oscillator that starts up without jitter using TTL. The circuit of fig.2 shows how an SN74123 may be used to construct both types.

Continued

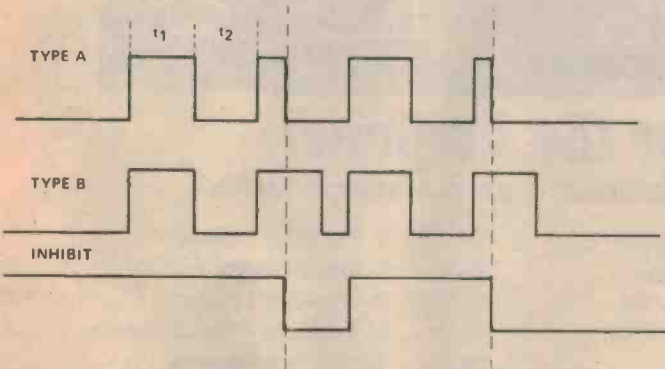
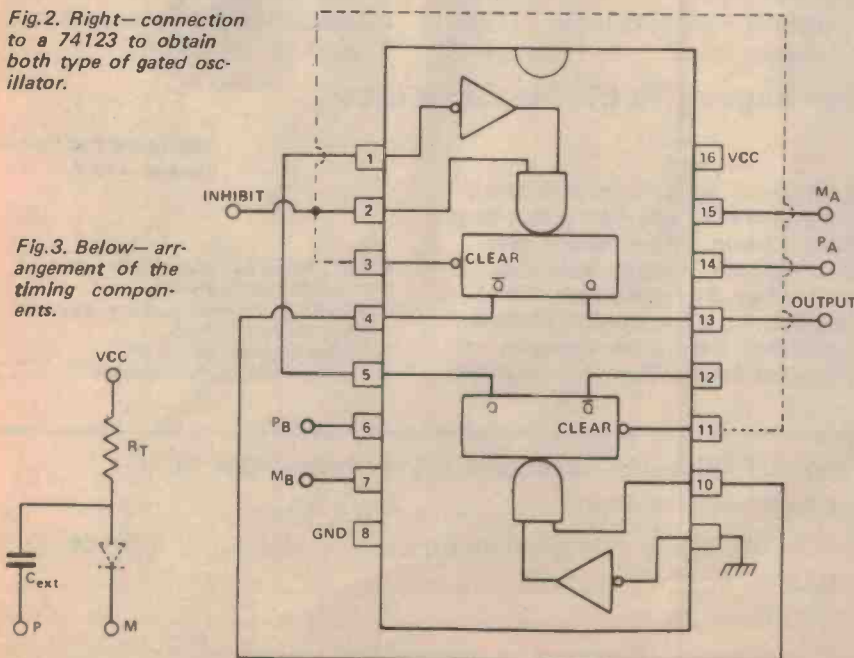

Fig.1. Left— operation of the two types of oscillator with respect to the inhibit signal.

Fig.2. Right— connection to a 74123 to obtain both type of gated oscillator.

Fig.3. Below— arrangement of the timing components.



AUDIO TELEX

VIDEO CASSETTES
TOP QUALITY DUPONT
VIDEO CASSETTES FOR A
VARIETY OF FORMATS

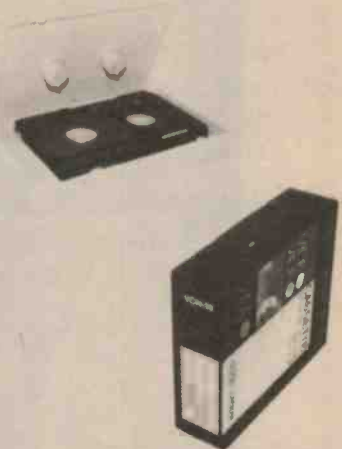

PRICE LIST

ACV-10	U-Matic ¼ inch 10 mins	10.89
ACV-30	U-Matic ¼ inch 30 mins	15.95
ACV-60*	U-Matic ¼ inch 60 mins	22.89
KCS-20	U-Matic ¼ inch Portapack 20 mins	16.55
KCS-30	U-Matic ¼ inch Portapack 30 mins	24.34
VCN-60*	Philips VCR 60 mins	24.00
VCN-72*	Philips VCR 72 mins	25.00
VK-125	VHS format 1-2 hours	16.55
VK-250	VHS format 2-4 hours	22.94
L250	BETA format 1 hour	11.65
L500	BETA format 2 hours	15.65

- Delivery is an extra charge.
- Prices subject to change without notice.

AVAILABLE FROM —

AUDIO TELEX COMMUNICATIONS
PTY. LTD.

SYDNEY
54-56 Alfred Street,
Milsons Point, 2061
Telephone: 929-9848

MELBOURNE
1828 Glenferrie Road,
Hawthorn, 3122
Telephone: 819-2363

BRISBANE
394 Montague Street
West End, 4101
Telephone: 44-6328

KITS for KIDS!

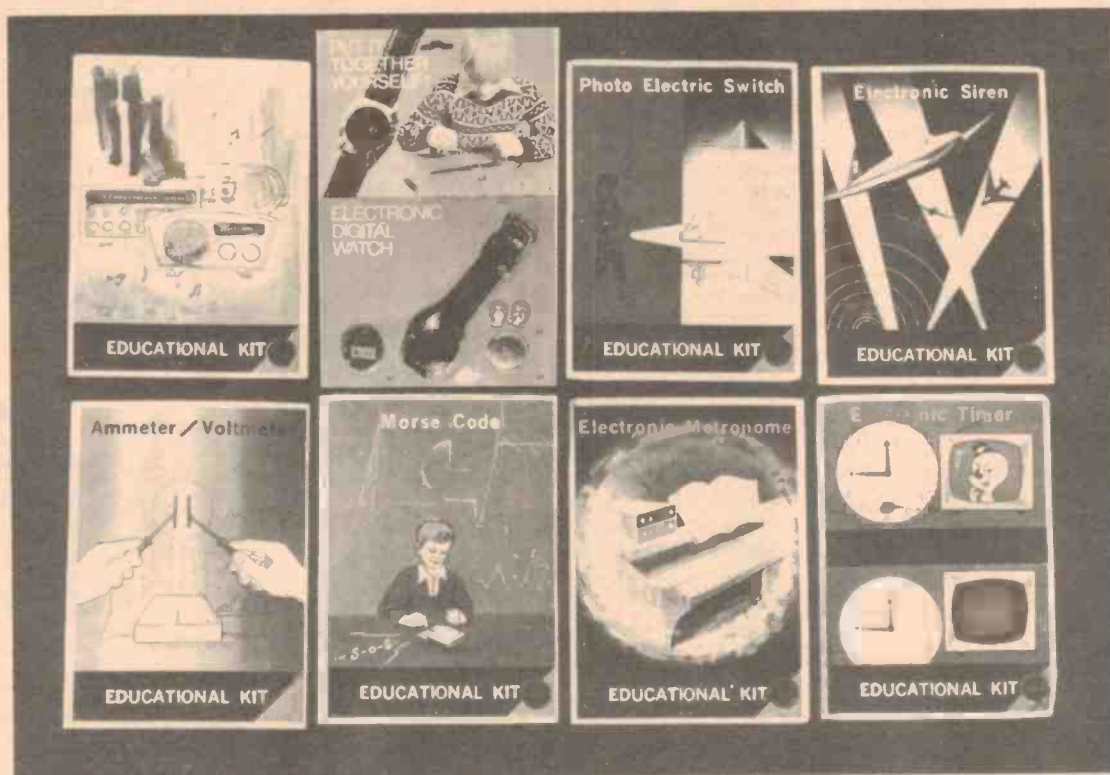

Project kits for the beginner

Completely safe – battery operated* – no mains connection

A. Electric organ	\$5.60	H. Electronic water alarm	\$4.50	O. Electronic metronome	\$4.50
B. Electronic flasher	\$4.50	I. Photo Electric switch	\$4.50	P. Ammeter/voltmeter	\$4.50
C. Electronic sound switch	\$4.50	J. Electronic singing bird	\$4.50	Q. Electronic Timer	\$4.50
D. Electronic touch switch	\$4.50	K. Morse code practice set	\$4.90	R. Electronic mosquito repeller	\$4.50
E. Electronic decision maker	\$4.50	L. Electronic siren	\$4.50	S. Electronic police car siren	\$4.90
F. Electronic sleeping bell	\$4.50	M. Electronic water purity tester	\$4.50	T. Electronic fan and colour wheel	\$4.50
G. Electronic magic touch	\$4.50	N. Transistor radio	\$4.50	U. Watch kit, 5 functions	\$11.50

See July or August '78 ETI for full details.

KIT BITS DEALERS:

NSW:

Gordon Toy Shop, Moree St, Gordon. Edmunds Molr & Co, 186 Parry St, Newcastle, and 94 Manning St, Taree. Madjenk Electronics, 5.246 Princes Hwy, Dapto. Lindfield Electrical Pacific Hwy, Lindfield. Bergs Hobbies, 223 Church St, Parramatta. Allied Communications, 2 Lockinvar Place, Hornsby. Kurri Electronics, Kurri Kurri. Unique Electronics, 383 Merrylands Rd, Merrylands. Manly Toy World, Shop 5, 74 The Corso, Manly. Lloyds Hobby Centre, 24 Railway Ave, Liverpool. Custom Communications, Orchardfield St, Lennox. C.B. Centre, The Corso, Manly. Red Ballon Toy World, 192 Barru Ave, Griffith. The Toy Box, Florence St, Hornsby. In Electronics & Co, 84 Ramsey St, Haberfield. Bladen Brooke Electronics, 111 Bridge St, West Tamworth. Sale by Junk, 282 The Entrance Rd, Erina. Sheridan Electronics, 166 Redfern St, Redfern.

*Batteries not included
in kits A to T.

Mitchell Radio Co, 59 Albion St, Albion.
STH. AUST. DISTRIBUTOR:
International Communications Systems, 77
Dale St, Port Adelaide.
TASMANIAN DISTRIBUTOR:
Tasmanian HI-Fl Co, 87A Brisbane St, Launceston.

KIT BITS

110 Rosemead Road,
HORNSBY. NSW. 2077.
Phone (02) 476-3975.
Trade enquiries welcome.

To: KIT BITS, 110 Rosemead Rd, Hornsby, NSW. 2077

Please send me Kit/s

I enclose Cheque/postal note for \$..... plus 50c p&p.

NAME

ADDRESS

..... P/Code

Ideas for experimenters

oscillator is obtained if the dotted connections are left out. The times t_1 and t_2 are set by the usual timing components see fig.3 — the diode is needed if $C_{ext} > 1000p$ (across PA — MA and PB — MB respectively). The times may be calculated using:—

$$t = 0.32RT C_{ext} (1 + 0.7/RT)$$

if the diode is not required and

$$t = 0.28RT C_{ext} (1 + 0.7/RT)$$

otherwise.

RT is in kilo-ohms, C_{ext} is in picofarads, t is in nanoseconds and the max value of RT is 20K.

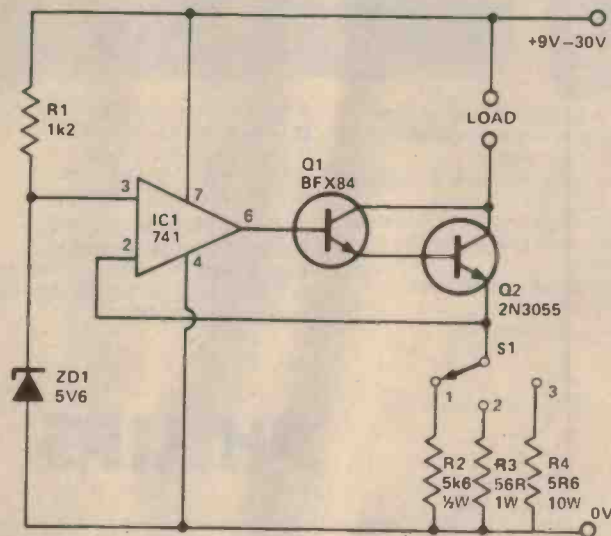

Constant Current Source

The circuit shown will provide 3 preset currents which will remain constant despite variations of ambient temperature or line voltage.

ZD1 produces a temperature stable reference voltage which is applied to the non inverting input of IC1.

100% DC feedback is applied from the output to the inverting input hold-

ing the voltage at Q2's emitter at the same potential as the non inverting input.

The current flowing into the load therefore is defined solely by the resistor selected by S1. With the values employed here, a preset current of 10mA, 100mA or 1A can be selected. Q2 should be mounted on a suitable heatsink.

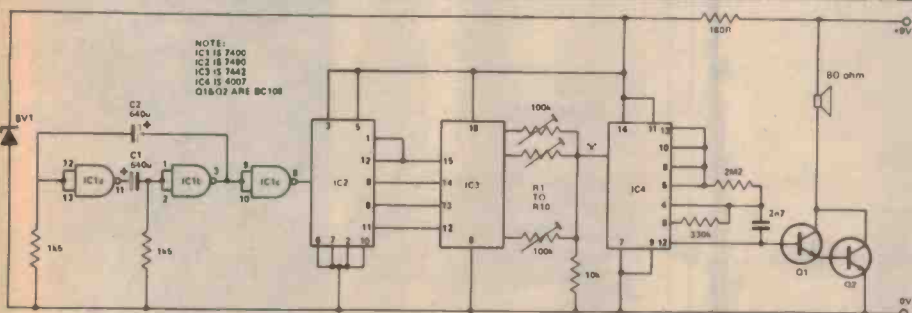

Musical Tone Generator

This circuit provides a means of generating a series of up to ten musical notes.

The 7400 oscillator produces pulses at about 1 second intervals. These pulses, after being buffered are fed to a decade counter which produces a BCD output. The output is fed to the 7442 which produces a decimal output. Each out-

put is taken to a preset forming a potential divider. The VCO senses the voltage at point 'a' and changes the frequency of the output tone. Careful adjustment of the presets can give a reasonable range of notes. The length of each note as well as the time between notes can be varied by changing the timing components in the 7400 oscillator.



LOW PROFILE TRANSFORMERS



20VA CHASSIS OR FRAME MOUNTED

Type No.	Series Connections	Parallel Connections
PL12/20VA	12 volts at 1.67 amps	6 volts at 3.33 amps
PL15/20VA	15 volts at 1.33 amps	7.5 volts at 2.67 amps
PL18/20VA	18 volts at 1.11 amps	9 volts at 2.22 amps
PL24/20VA	24 volts at 0.83 amps	12 volts at 1.67 amps
PL30/20VA	30 volts at 0.67 amps	15 volts at 1.33 amps
PL40/20VA	40 volts at 0.50 amps	20 volts at 1.00 amps

40VA CHASSIS OR FRAME MOUNTING

Type No.	Series Connections	Parallel Connections
PL12/40VA	12 volts at 3.33 amps	6 volts at 6.67 amps
PL15/40VA	15 volts at 2.67 amps	7.5 volts at 5.33 amps
PL18/40VA	18 volts at 2.22 amps	9 volts at 4.44 amps
PL24/40VA	24 volts at 1.67 amps	12 volts at 3.33 amps
PL30/40VA	30 volts at 1.33 amps	15 volts at 2.67 amps
PL40/40VA	40 volts at 1.00 amps	20 volts at 2.00 amps

60VA CHASSIS OR FRAME MOUNTING

Type No.	Series Connections	Parallel Connections
PL12/60VA	12 volts at 5.00 amps	single secondary winding only
PL15/60VA	15 volts at 4.00 amps	single secondary winding only
PL18/60VA	18 volts at 3.33 amps	9 volts at 6.67 amps
PL24/60VA	24 volts at 2.5 amps	12 volts at 5.00 amps
PL30/60VA	30 volts at 2.0 amps	15 volts at 4.00 amps
PL40/60VA	40 volts at 1.5 amps	20 volts at 3.00 amps

Made in Australia and Guaranteed by:



FERGUSON TRANSFORMERS PTY. LTD.
331 HIGH STREET, CHATSWOOD, N.S.W. 2067.

FT4

Counting without Controls

Fully automated 80 & 520 MHz performance

New lower prices



These frequency counters represent the ultimate in easy operation by having no controls, other than the on/off switch. Such simplicity is made possible by the use of advanced LSI circuitry, developed in house, which allows all control functions to be automated. The low power requirements of the Philips LSI LOC MOS circuitry also allows the instruments to be housed in a compact, rugged case without ventilation holes.

Reliability in all operating environments is therefore at the highest possible level.

- Automatic everything:
 - triggering, the input signal is conditioned to give optimum triggering
 - noise suppression, to avoid noise and other interference influencing the measurement
 - 80 or 520 MHz channel selection (on model PM 6664)
 - leading zero suppression

- MHz, kHz, Hz grouped readout
- High 20 mV sensitivity
- High stability timebase
- Lightweight, rugged case
- Bright 8-digit LED display

For more information contact:
Philips Scientific & Industrial Equipment, P.O. Box 119, North Ryde, N.S.W. 2113 or phone Sydney 8888222 Melbourne 6990300



Test & Measuring Instruments

PHILIPS

HRME-1320031

NORTRONICS

AUDIO & DIGITAL TAPE HEADS
 Long Life-Extended Response



Replacement heads for:

- | | |
|------------------------|--|
| Domestic Recorders | Cassette decks.
Cassette players.
Reel to reel.
Cartridge. |
| Professional Recorders | Broadcast recorders in reel to reel & cartridge or cassette.
Studio recorders 1/4" to 2" multi track. |
| Duplicators | Reel to reel & cassette.
Aircraft Recorders, cockpit & background. |

To fit: AMPEX, SCULLY, TEAC, ATC, GATES, PENTAGON, INFONICS and many others.
 ALIGNMENT TAPES - Reel to reel, Cartridge, Cassette.

EMAC INDUSTRIES PTY. LTD.
 9 Meriton Place, Clayton South, Vic. 3169.
 Ph: 544-5157

electronics today

INTERNATIONAL

BINDERS



HOLDS
 12 COPIES
 OF ETI

Protect and file your back issues of Electronics Today with these attractive binders. Price \$4.50 plus postage and packing (90c NSW, \$2.00 other states)

Write enclosing cheque/postal note/money order to:

SUBSCRIPTION DEPARTMENT,
 ELECTRONICS TODAY INTERNATIONAL,
 3rd Floor, 15 Boundary Street,
 Rushcutters Bay, NSW. 2011.

Ideas for experimenters

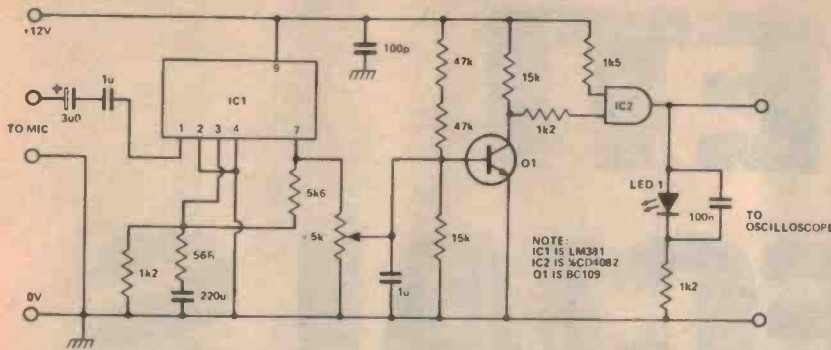

Morse Code On The Oscilloscope

The circuit enables morse code to be displayed as dots and dashes on an oscilloscope screen. By speaking into a microphone, saying 'dit' and 'dah' as appropriate, short and long pulses appear on the screen in a format similar to that of written morse.

One half of an LM381 and a BC109 are used to amplify the signal from the

microphone, which is then clipped into digital form by the AND gate. The output from the circuitry is fed to an oscilloscope set to 2V/cm and 5ms/cm, set to trigger on the start of a 'dit'.

Input to the circuit can be from a microphone, or tape recorder. If words are recorded onto the tape with the microphone and then played back via the circuit, practice at reading morse is possible.

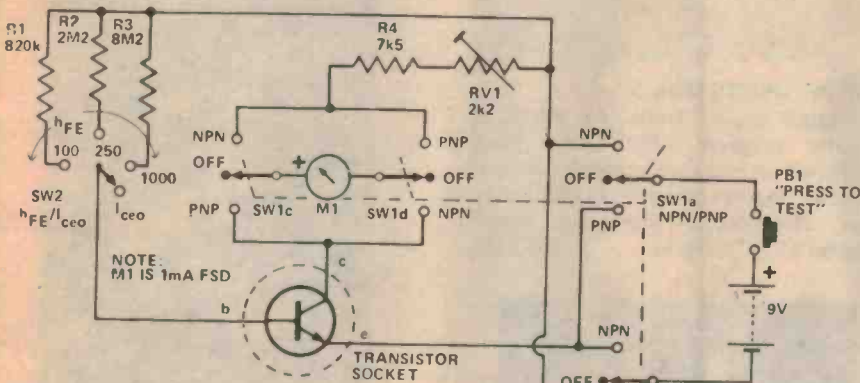

Transistor Tester

This transistor tester works by injecting a known current into the base of the transistor under test, and measuring the collector current. The values of R1, R2 and R3 give a base current of 10, 4 and 1μA which gives a FSD on the meter for transistors with a gain of 100, 250, and 1000 respectively. Since the gain of the transistor is proportional to its I_c , the gain can be easily deduced from the reading on the meter. Leakage current is measured by leaving the base open circuit.

SW2 reverses the polarity of the battery and the meter to allow the

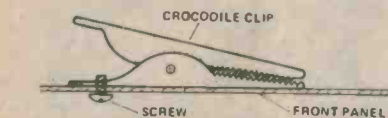

testing of both NPN and PNP transistors. R4 and RV1 protect the meter from excessive currents, and do not affect the reading on the meter. RV1 should be adjusted so that the meter needle just touches the end stop when the collector and emitter terminals are connected together.

A simple transistor socket can be made by mounting three crocodile clips as shown in the diagram.

FRG-7000 Communications Receiver

For the discerning amateur, novice or short-wave listener.



Manufacturer's Technical Data

- Electronic band changing with digital frequency display.
- Full MF/HF coverage from 250 kHz to 29.9 MHz.
- FET front end and "Wadley Loop" heterodyne oscillator for rock-solid stability.
- SSB, AM voice as well as CW.
- Frequency readout gives resolution to 1 kHz.
- Stability within 500 Hz during any 30-minute period after warm up.
- Sensitivity — SSB/CW better than 0.7 μV for S/N, 10 dB AM — better than 2 μV for S/N 10 dB (400 Hz 30 percent modulation).
- Selectivity — SSB/CW 1.5 kHz at -6 dB, 4 kHz at -50 dB AM — 3 kHz at -6 dB, 7 kHz at -50 dB.
- Speaker (built-in) impedance 4 ohms, audio output 2 watts.
- Size 360(W) x 125 (H) x 295 (D) mm.
- Simple modification permits DC operation from 13.5V to 15V at 1.3A.

Specs subject to change.

PRICE AVAILABLE ON APPLICATION

Yaesu, the leader in quality communications equipment proudly introduce the FRG-7000: a high performance general coverage receiver for the discriminating shortwave listener. Explore the wonderful world of radio — hear short wave, broadcast stations, amateurs, ships, aircraft and morse code from stations all over the globe. The FRG-7000 provides an introduction into many aspects of electronics and communications. You can tune into the morse practice transmissions and broadcasts conducted by the Wireless Institute of Australia; the Radio Amateur representative Society in Australia. The FRG-7000 is a set you would be proud to have in your lounge or your den — a set to suit any decor.

Remember, BAIL have been the authorised agent for the YAESU MUSEN CO LTD since 1963. Experience gathered over these years, and a lifelong participation in electronics, places us in a superior position to handle warranty, after-sales-service and advice on the wide range of Yaesu amateur radio equipment. Avoid unauthorised handlers of equipment as it generally results in the supply of non-export 110V sets with 2-core AC power cables, instruction manuals printed in Japanese, lack of service, etc. Consult us for advice on your requirements in the field of short-wave listening and amateur radio. For further information call or write to the amateur radio specialists.

Australian YAESU agents since 1963



ELECTRONIC SERVICES

60 Shamon St, Box Hill North, Vic. 3129. Ph 89-2213

ETI SPECIALS

TOP PROJECTS

FROM ELECTRONICS TODAY INTERNATIONAL
VOLUME 5 PRICE \$3*

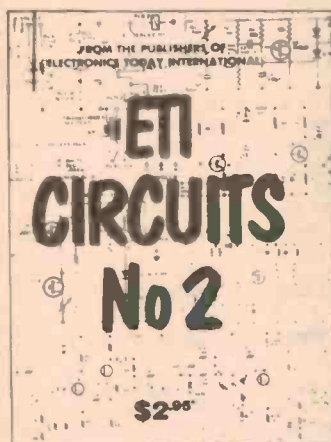

ETI CIRCUITS NO 2

Ideas and data for experimenters. There are about 200 circuit ideas in this book. It's not for the beginner. But someone with a fair bit of experience in electronics will get a lot of use from this book. Invaluable for ideas and inspiration.. . . . \$2.95.

AUSTRALIAN CB

All about CB. . How to buy and install a rig. How to work interstate on skip. What UHF CB is like. How to build accessories. Australian CB is a thorough, simple yet authoritative guide to CB in Australia 1978 \$3.95.



PROJECT ELECTRONICS

If you're just getting interested in electronics this is the book for you. There are lots of projects to build. They're simple, educational and useful too. And there's advice about constructional methods and electronics components \$4.75.

★ If your newsagent has sold out, order directly from us at Modern Magazines, 15 Boundary Street, Rushcutters Bay, 2011. Just add 45 cents to the price for post and packing

electronics today SERVICES ADVERTISERS INDEX

READERS' LETTERS

No charge for replies but a foolscap-size stamped addressed envelope must be enclosed. Project queries can only be answered if related to item as published. We cannot assist if project is modified nor if components are otherwise than specified. We regret we cannot answer readers' enquiries by telephone.

SUBSCRIPTIONS AND BACK ISSUES

ETI subscriptions cost \$17.00 per year (inc. postage) within Australia. Cost elsewhere is \$17.65 (inc. postage — surface mail). Airmail rates on application. Back issues cost \$1.25 each plus 45 cents post and packing. We can supply only the following issues.

1976: Nov., Dec.

1977: All issues except Jan, Feb, March.

1978: All issues.

Photostats are available of any article ever published in ETI. We charge a flat \$1.00 regardless of page quantity from any one issue of ETI. Thus if the article is in three issues the cost is \$3.00. Send orders to address below.

Binders \$4.50 plus 90c post NSW, \$2.00 other States.

Microfiche editions of this publication are available by annual subscription from Microsystems Pty Ltd, PO Box 188, North Sydney, NSW. 2060.

COPYRIGHT

The contents of Electronics Today International and associated publications is fully protected by the Commonwealth Copyright Act (1968).

Copyright extends to all written material, photographs, drawings, circuit diagrams and printed circuit boards. Although any form of reproduction is a breach of copyright, we are not concerned about individuals constructing projects for their own private use, nor by pop groups (for example) constructing one or more items for use in connection with their performances.

Commercial organisations should note that no project or part project described in Electronics Today International or associated publications may be offered for sale, or sold, in substantially or fully assembled form, unless a licence has been specifically obtained so to do from the publishers, Modern Magazines (Holdings) Ltd or from the copyright holders.

LIABILITY

Whilst every effort has been made to ensure that all constructional projects referred to in this edition will operate as indicated efficiently and properly and that all necessary components to manufacture the same will be available, no responsibility whatsoever is accepted in respect of the failure for any reason at all of the project to operate effectively or at all whether due to any fault in design or otherwise and no responsibility is accepted for the failure to obtain any component parts in respect of any such project. Further, no responsibility is accepted in respect of any injury or damage caused by any fault in the design of any such project as aforesaid.

A MODERN MAGAZINES PUBLICATION

PRODUCTION

Art Director:	Sheila Tonsic
Assembly:	Bill Crump/Simon Bracken
Production Manager:	Bob Izzard
Subscriptions & Circulation:	John Oxenford
Project Design:	Nebula Electronics
Acoustical Consultants:	Louis A. Challis & Assoc.

ADVERTISING

Sydney:	Modern Magazines Bob Taylor (Manager), Geoff Petschler (NSW Manager), 15 Boundary St., Rushcutters Bay 2011. Tel: 33-4282.	Perth:	Aubrey Barker, 133 St. George's Terrace, Perth. 6000. Tel: 322 3184.
Melbourne:	Modern Magazines Tom Bray (Manager), Poppe Davis, Suite 24, 553 St. Kilda Rd, Melbourne. Tel: 51-9836.	Hobart:	H.W. Lincone, 23 Lord St, Sandy Bay, Tasmania. 7005.
Brisbane:	Modern Magazines Geoff Horne, 60 Montanus Drive, Bellbowrie, Qld. 4070. Tel: 202 6229.	Tokyo:	Genzo Uchida, Bancho Media Service, 15 Sanyeicho, Shintuku-Ku, Tokyo 160.
Adelaide:	Modern Magazines Tony James, 16 Montrose Ave, Netherby. 5062. Tel: 79 4740.	London:	Electronics Today International, 25-27 Oxford St, London, W1R 1RF. Tel: 01-434-1781/2.
		U.S.A.:	Elmatex International, PO Box 34607, Los Angeles, CA. 90034. Tel: (213) 821 8581. Telex: 18 1059 (Elmatexint USA)

Electronics Today International is published by Modern Magazines (Holdings) Ltd, 15 Boundary St., Rushcutters Bay, NSW 2011. It is printed (in 1978) by Wilke & Co., Browns Rd, Clayton, Victoria and distributed by Australian Consolidated Press.

ADVERTISERS INDEX

Acoustic Research	17
Advanced Computer Products	129
Ampec Engineering	6
Applied Technology	114
A & R Soanar	99
Audio Design	122
Audio Telex	123
Auditec Aust	48
Automation Statham	82
Ball Electronics	127
Blob Board	82
Campbelltown Hi-Fi	121
Cema/Silicon Valley	19, 95
Centaur Industries	84
Chloride Batteries	11
Chromatec Video	98
Convoy	28
Cooper Tool Group	24
David Reid Electronics	32
Defence Recruiting	120
Delsound	32
Dick Smith	41, 64-65
Diggerman Electronics	73
Electrocraft	73
Electronic Calculator Discounts	100
Electro-Voice Aust	18
Electrolmpex	73
Electronic Mailbox	103
Ellitronics	40
Emac Industries	126
Emona Enterprises	31
ETI — Binders	126
ETI — Circuits No. 2	16
ETI — Simple Projects Vol 2	15
ETI — Specials	128
ETI — Synthesizer Book	99
Ferguson Transformers	125
Phone Audio	13
Findon Machinery Co	122
Hagemeyer	2, 131
Harmonix Acoustix	30
Holden Wasp Industries	121
IC's Unlimited	89
Impact	82
Inter. Correspondence Schools	72
Jaycar P/L	115
John Hinton P/L	110
J.R. Components	10
Just Asia/Xenon	33
Kit Bits	124
McGills Newsagency	16
M.R. Acoustics	117
National Panasonic (Aust) P/L	47, 132
Nebula Electronics	119
Nessel Audio	121
Non Linear Systems	48
Orbit Electronics	100
Pennywise Peripherals	116
Phillips	25
Phillips Elcoma	8
Phillips TMI	126
Pre Pak	71
Professional Products	22
Radcom P/L	122
Radio Parts	63
Rank/EMI	20
Rave Electronics	116
Rod Irving	80-81
Roland Aust	16
Romtech	116
Semcon Microcomputers	40
SM Electronics	88
Sounding Distributors	27
Tandy	49, 117
Tasman Electronics	12
Trio-Kenwood Aust	58
Vanfi	108-109
Vicom	106
Warburton Franki	101, 115

JVC gives you more of what the others wish they could.

Cassette recording takes a giant step forward with the new series of JVC cassette decks. Each is designed to give you everything you need to get the most out of any tape. And there are totally new features to help you make better-sounding cassettes.

Exclusive Spectro Peak Indicator System.

25 instant-responding LED indicators offer fail safe protection with almost recording studio vigilance against distortion produced by tape over-saturation.

For the first time, you can constantly visually monitor the levels of five low-to-high musical frequency ranges. Then, on playback ... the Spectro Peak Indicator actually lets you see how accurately the deck has performed.

Expanded Dynamic Range and Better Noise Reduction.

Our JVC Super ANRS circuitry applied compression in recording and expansion in playback to improve dynamic range at higher frequencies. So

distortion is eliminated in sudden high peaks of any musical program. Super ANRS also reduces tape hiss by boosting the deck's signal-to-noise ratio by as much as 10dB over 5000Hz.

New Head Design.

Our refined JVC Sen-Alloy heads give you the sensitive performance of permalloy head construction, combined with the extreme longevity of ferrite, for bright, full-sounding recordings.

Get the most out of any tape.

Because whichever type you select, you'll extract the most from it with our special KD-65

recording equalizer circuit that lets you "fine tune" the high frequency response of the deck to the exact requirements of the tape. These innovations alone set JVC cassette decks apart from all the others. Then, when you consider our other refinements like precision-ground capstans, gear/oil-damped cassette doors, multi-peak LED indicators, independent drive mechanisms, plus top performance specifications, you can understand why we say that JVC gives you more of what other decks wish they could. Visit your JVC dealer and you'll hear why.



the right choice

For details on all JVC Hi-Fi Equipment write to:
JVC Advisory Service, P.O. Box 307, North Ryde, N.S.W. 2113

KD-85

WT82 78

JVC KD-85 STEREO CASSETTE DECK Super ANRS



TECHNICS SU8080 INTEGRATED DC AMPLIFIER: AMPLIFIES...NOT MODIFIES.



The first and foremost function of an amplifier is to amplify. To amplify all the incoming signals as accurately as possible. Technics terms this "waveform fidelity" which simply means that the music that's put in will be the music that comes out, neither adding nor subtracting from the original. In the SU8080 Technics have achieved waveform fidelity by eliminating capacitors—the cause of very low frequency signal blocking—from the signal path stages and all connections in between. Their elimination made DC (Direct Current) in the power amplifier possible, resulting in

ultra-wide frequency response and phase fidelity. Rated power output of the Technics SU8080 is 72 watts per channel, RMS at 8 ohms, from 20Hz-20kHz with no more than 0.02% total harmonic distortion. Real power for real sound. And there's a totally independent power supply for each channel to eliminate transient crosstalk. The phono equalizer input is equipped with Technics developed ultra-low noise transistors, giving an extremely high signal to noise ratio of 88dB at a sensitivity of 2.5mV. The SU8080 amplifier. Achieving waveform fidelity.

For a National Technics catalogue, please write to:
National Technics Advisory Service, P.O. Box 49, Kensington, N.S.W. 2033.



Technics

hi-fi