

DECEMBER 1987 \$4.75 NZ\$6.50

6 PROJECTS MORE PAGES!

Incorporating

**Elektor
Electronics**



ROGER HARRISON'S **AUSTRALIAN ELECTRONICS** *Monthly*

**Dave Jeans' Guide to
MARINE ELECTRONICS
Part 2**

**HF ANTENNA
BALUN PROJECT**

**CHEAP PRINTOUT
FOR YOUR C64 –
USE A SURPLUS
TELEPRINTER**



**Build our
10-BAND
GRAPHIC EQUALIZER**

HI-FI: TOP-LINE KENWOOD SPEAKERS REVIEWED

audio ● video ● computing ● communications ● projects ● engineering ● technology

World Radio History

Fluke. First Family of DMMs.



When accuracy, performance and value are important, professionals the world over look to Fluke — the first family of DMMs.

Reliable Fluke-quality 3½- or 4½-digit DMMs fit every need — from design engineering to industrial troubleshooting.

There's the low-cost 70 Series — the most DMM you can get for the money. The tough 20 Series — totally sealed and built to survive the dirtiest, grimeiest, roughest jobs. The reliable 8020B Series — made to withstand the rigors of the field service environment. The precise 8060A Series — the most powerful and complete test and measurement system available in a hand-held package. And, of course, the versatile Bench/Portables that carry on the Fluke tradition for precision and durability in lab-quality bench instruments.

Fluke comes in first again with the world's largest selection of quality accessories to help extend the capabilities of your DMM even further.

There's no need to look anywhere else. Uncompromising Fluke design and leading edge technology are the reasons why attempts at imitation will never fool the millions of professionals that accept nothing less than a Fluke.

FROM THE WORLD LEADER
IN DIGITAL MULTIMETERS.

FLUKE[®]

ELMEASCO **Instruments Pty. Ltd.**

Talk to your local Elmeasco distributor about Fluke

- **A.C.T.** John Pope Electrical (062) 80 6576 • J Blackwood & Sons (062) 80 5235 • George Brown (062) 80 4355
- **N.S.W.** Ames Agency 699 4524 • J Blackwood & Sons • George Brown 519 5855 Newcastle 69 6399 • Bryan Catt Industries 526 2222
- D.G.E. Systems (049) 69 1625 • W.F. Dixon (049) 69 5177 • Ebson 707 2111 • Macelec (042) 29 1455
- Novacastan Electronic Supply (049) 62 1358 • Obiat Pty Ltd 698 4776 • Petro-Ject 569 9655 • David Reid 267 1385 • Selectoparts 708 3244
- Geoff Wood 427 1676
- **N.TERRITORY** J Blackwood & Son (089) 84 4255, 52 1788 • Thew & McCann (089) 84 4999
- **QUEENSLAND** Auslec (07) 854 1661 • Petro-Ject (075) 91 4199 • St Lucia Electronics 52 7466 • Cliff Electronics 341 4655
- L.E. Boughen 369 1277 • Fred Hoe & Sons 277 4311 • The Electronics Shop (075) 32 3632 • Thompson Instruments (Cairns) (070) 51 2404
- **SAUSTRALIA** Protronics 212 3111 • Trio Electrix 212 6235 • Industrial Pyrometers 352 3688 • J Blackwood & Sons 46 0391
- Petro-Ject 363 1353
- **TASMANIA** George Harvey (003) 31 6533 (002) 34 2233
- **VICTORIA** Radio Parts 329 7888 • George Brown Electronics Group 878 8111 • G.B. Telespares 328 4301 • A.W.M. Electrical Wholesalers
- Petro-Ject 419 9377 • J Blackwood & Sons 542 4321 • R.K.B. Agency 29 7336 • Sirs Sales (052) 78 1251 • Mektronics Co 690 4593
- Truscott Electronics 723 3094
- **W.AUSTRALIA** Atkins Carlyle 481 1233 • Dobbie Instruments 276 8888 • Protronics 362 1044



ANOTHER EVENTFUL YEAR has passed! It's now three years since I set the wheels in motion to launch Australian Electronics Monthly, two and half years since our first issue appeared. We've overcome several hurdles since that time, especially during the past year when the issues were published late for some months. We now have the magazine back on time and our circulation's growing apace. We're very gratified to see such reader support!

Over the past few months we have been planning features and projects for next year and I can say we have some exciting things coming up! As is our philosophy, everything we do must be of a practical nature -- articles and projects you can use, now and in the future. The success of this philosophy is borne out in the popularity and durability of a number of our feature projects -- like the AEM3500 Listening Post, the AEM6000 Series hi-fi projects, the AEM4504 and 4505 Speech Synthesizer projects and the 4600-series modems. We broke "new ground" with a couple of projects this year, such as the AEM3505 Satellite Data Decoder, and we'll continue this trend in the coming year, as well as continuing with projects in perennially popular areas of interest, particularly projects for newcomers. The "Novix" project we've already spoken about, and we're currently discussing a range of interesting project ideas with designers and suppliers.

In features, we'll be looking at a whole range of areas, keeping you abreast of developments in the industry -- particularly new products and new techniques, as well as updating you on the "traditional" topics of interest. Reader reaction to our new "Semiconductor Scene" column has been gratifying -- we'd like to hear more about what you'd like to see here.

We look forward to an exciting year -- bicentenary and all, in 1988! With that, all of us here at AEM wish you, too, an exciting and prosperous year. Best wishes for the season.

Roger Harrison
Editor

Published by: Kedhorn Holdings P/L (Inc. in NSW), Fox Valley Centre, Cnr Fox Valley Rd & Kigle St, Wairoonga 2076 NSW. **Typeset by:** Authotype Photosetters P/L, 397 Riley St, Surry Hills NSW, and Tuddin, 19 Princes St, McMahon's Point NSW. **Printed in 1987 by:** Offset Alpine, Cnr Derby & Wetherill Sts, Silverwater NSW. **Distributed by:** Network Distributing, 52-54 Park St, Sydney NSW. *Cover Price \$4.75 (maximum and recommended Australian retail price only; recommended New Zealand price NZ\$6.50). Registered by Australia Post. Publication No: NBP 7435. ISSN No. 0815-5046.

COPYRIGHT: The contents of The Australian Electronics Monthly is fully protected by the Commonwealth Copyright Act (1968). Copyright extends to all written material, drawings, circuit diagrams, printed circuit boards, computer software and photographs. Although any form of reproduction is a breach of copyright, and we especially point out this extends to the construction of projects produced by our laboratory or our associates, we are not concerned about individuals constructing projects for their own private use, nor by bands for example, constructing one or more units for use in performances. Commercial organisations should note that no project or part project, including printed circuit boards produced by our laboratory or our associates and described in this magazine may be offered for sale, or sold, in fully or substantially assembled form, unless a licence has been specifically obtained to do so from the publishers, Kedhorn Holdings Pty Ltd. or from the copyright holders. We will take strenuous legal action against any person or firm found infringing our copyright as aforesaid.

LIABILITY: Whilst all efforts have been made to ensure that all constructional projects and circuits referred to in this issue will operate as indicated efficiently and correctly and that all necessary components to assemble the same will be available, no responsibility whatsoever is accepted in respect of the failure for any reason at all of the project or circuit to operate effectively or at all whether due to any fault in design or otherwise and no responsibility is accepted for the failure to obtain any components in respect of such project or circuit. In addition, no responsibility is accepted in respect of any injury or damage caused by any fault in the design of any such project or circuit aforesaid. The publisher accepts no responsibility for unsolicited manuscripts, illustrations, computer software or photographic material although all care will be exercised. Comments and test results on equipment reviewed refer to the particular item submitted for review and may not necessarily pertain to other units of the same make or model number.

EDITOR/PUBLISHER
Roger Harrison VK2ZTB

ASSISTANT EDITOR
Andrew Keir VK2AAK

DRAUGHTING
Kym Baillie

PRODUCTION
Val Harrison, Clayton Folkes

READER SERVICES
Elizabeth Beadman

ACCOUNTS
Gavin Parsons

ARCHIVING
Corey Harrison

EDITORIAL ASSOCIATES

Ian Boehm VK3XCD
Neil Duncan VK3AVK
B. App. Sci. Dip. Ed. M. Ed. Studs
Alan Ford VK2DRR/G3UIV
FIAAA MBIM

Michael Heaney
B.M.E., Dip. Mus. Ed., L.T.C.L.,
T.C., M.A.C.E. M.I.M.T.

Tom Moffat VK7TM
Jonathan Scott VK2YBN
B. Sc./B.E. (Hons)

SPECIALIST SERVICES

Jamye Harrison

NATIONAL ADVERTISING MANAGER

Geoff Arthur

INTERSTATE ADVT. SALES

Victoria
Peter Ford

Derrick Lewis & Associates
637 St. Kilda Rd., Melbourne 3004
Ph: (03)51 9984

Queensland

Geoff Horne Agencies
PO Box 247, Kenmore 4069
Ph: (07)202 6813; Fax: (07)202 7133
Tlx: (07) AA41398 (Geoff Horne)

West Australia
Nick Sandeman

Hugh Scott & Associates
Suite 1, 362 Fitzgerald St., North Perth 6000
Ph: (09)328 9177

ACOUSTICAL CONSULTANTS

Robert Fitzell Acoustics Pty Ltd, AAAC

ENQUIRIES

Advertising
(02)487 1207

Editorial
(02)487 1207

Technical

Only after 4.30 pm EAST
(02)487 1483

Roger Harrison or Andy Keir

SUBSCRIPTIONS

\$49.95 Australia,
overseas rates on application

EDITORIAL OFFICES

Fox Valley Centre
Cnr Fox Valley Rd & Kigle St
WAHROONGA 2076 NSW

POSTAL ADDRESS

PO Box 507, WAHROONGA 2076 NSW
FAX: (02)489 1265 TLX: 121822 (SV3296)

COPYRIGHT©1987, KEDHORN HOLDINGS P/L

ADVERTISERS INDEX

COVERS

Benelec OBC
Elmeasco IFC

INSIDE

ABE Computers 21, 58, 69
All Electronic Components ... 103
Arista 105
Data Modems 102
David Reid Electronics 17
Dick Smith Electronics 93-98
Electronic Discounters 25
Electronic World 109
Emona 25
Energy Control 108
Force Electronics 22-23
Geoff Wood Electronics 32
Hi-Com Unitronics 79
Jaycar 60-61
Kenwood 70-71
Maestro Distributors 100
Micro-Educational 81
Mike Boorne Electronics 8
Parameters 6
Powersonic 29
Pre-Pak 104
Ritronics 9
Scope Laboratories 107
WIA 77

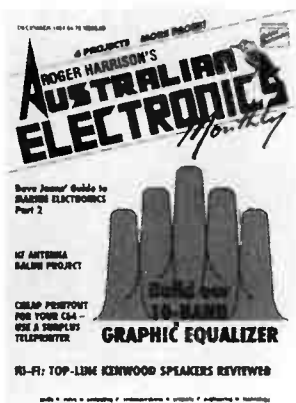

COVER

Our Graphic Equalizer project features this month. Design Val Harrison.

PROJECTS TO BUILD



AEM6507 One-Octave Equalizer 62

Whether your application is in domestic sound equipment or professional sound reinforcement, this one-octave graphic equalizer will be ideal. Designed in a modular form, it is readily adaptable to existing equipment or new designs.

AEM3015 HF Antenna Balun 74

This simple and economical balun is suitable for feeding all sorts of balanced HF antennas with unbalanced feedlines such as coax. It is ideal for use with the aem3014 Trap Dipole.

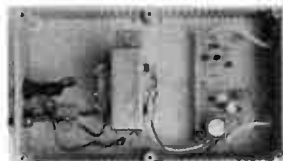

AEM4509 Teleprinter Interface 82

This clever combination of software and hardware allows a cheap solution to obtaining hard copy from your computer. The C64 software described has some great "bells and whistles" and the interface hardware is easily adaptable to a variety of computers and teleprinters.

CIRCUITS & TECHNICAL

Filter Design - without fears or tears, Part 3 26

This month: Chebychev filters

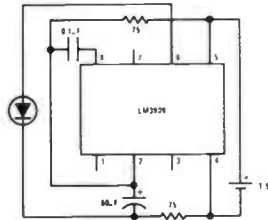

Semiconductor Scene 106

News and notes on what's happening in semiconductors.

ELEKTOR IN AEM

Contents 33

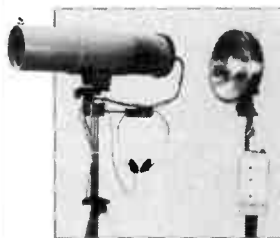

Infra-Red Transmitter - Receiver 42

A complete long range communications project using Infra-Red energy.

SSB Receiver 52

A high performance single sideband receiver for the 20 metre and 80 metre amateur bands.

The Birth of Satellite Communications 38

This article traces the development of satellite communications in the UK and details the changes seen at the Goonhilly Downs earth station since the time of Telstar.

PRACTICAL COMPUTING

Teleprinter Interface with C64 software 82

If you would like hard copy, but can't afford a printer - this project allows the use of surplus teleprinter machines for a cheap alternative. The C64 software described has some very useful features and overcomes many teleprinter limitations.

```
[ Set parameters ]
a) Communications Port
b) Speed (Baud Rate)
c) Parity
d) Data Bits
e) Stop Bits
f) Backspace
g) Linefeed toggle
h) Terminal type
i) Modem setup
j) File transfer protocol
k) Kermit parameters
l) Screen dump file name
m) Video mode and colors
n) Miscellaneous
o) Execute Script file
p) Write new config file
q) QUIT SETUP
```

Dial Up 100

Roy Hill concludes his discussion on public domain data comms software packages.

SPECIAL OFFER 80

Here's a very special offer on modem kits.

COMMUNICATIONS SCENE

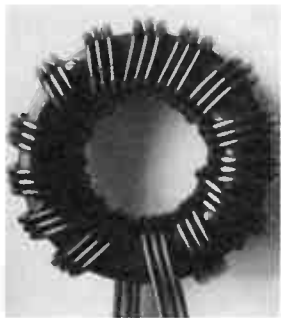

Build a broadband balun for your HF antenna 74

A simple balun that won't break the bank. Ideal for feeding balanced antennas, such as dipoles, with unbalanced lines, such as coax.

The VK2AWI Packet Radio Bulletin Board 70

The story behind the packet radio bulletin board provided by the NSW Division of the Wireless Institute of Australia.

CONSUMER ELECTRONICS



AEM Hi-Fi Review 18

Bob Fitzell Reviews Kenwood's new LS 990 AD loudspeakers – and comes up with a few surprises.

NEWS & GENERAL

News Review 7

Registry for ideas.

Consumer Electronics 16

New Sennheiser headphones.

Professional Products 24

New chart recorder.

Retail Roundup 59

Plugpack enclosure.

Bytewide 78

Avtek's new modem.

Spectrum 68

Kenwood's latest Rx.

Letters 102

Literature Review 105

The Last Laugh 114

NEXT MONTH!

BUILD OUR MIDI-COMPUTER INTERFACE

With a Midi interface now pretty well "standard" on a whole variety of electronic musical equipment, software control of a system or setup using a personal computer is not only feasible, but offers heaps of advantages and opportunities for creative control. This project allows "getting it all together", is economical and simple to build.

INDUCTORS – UNRAVELLING THE MYTHS

Intimidated by inductors? No need. John Day gives a non-sense rundown on coils and coil winding and associated RF components – ferrites and iron powder cores and coil assemblies.

SOLAR CYCLE 22 – ANOTHER BIG ONE?

Last January, we published "Kiss Your Last Big Sunspot Maximum Goodbye". New research may fortunately prove that article's prediction wrong! With the minimum of Cycle 21 passed us (September last year), it's apparent the current cycle is rising faster than expected – that's good news for amateurs and DXers!

BUILD THE "PROFILE 4" 4-WAY HI-FI LOUDSPEAKER

Here's a superb four-way loudspeaker featuring top quality Dynaudio drivers that give low distortion and very wide dynamic range. The simple crossover preserves good phase response and transient performance.

"STOP-MOTION" VIDEO: INSIDE NATIONAL'S M5 CAMCORDER

National's M5 camcorder offers a unique feature – "stop-motion" recording. Malcolm Goldfinch takes us over the functions and features of this top-line machine.

While these articles are currently being prepared for publication, unforeseen circumstances may affect the final contents of the issue.

FEATURE

Dave Jeans' Guide to Marine Electronics – Part 2 10

Dave Jeans concludes his rundown on the latest developments in marine electronics equipment.

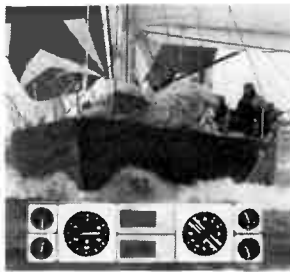

NOTES & ERRATA

In "Practical Filter Design" last month, Figure 2.1 contains an error. The lower circuit shows a capacitor at the input marked as "L1". It should be an inductor. In our October issue, in "Practicalities", the joystick controller circuit was inadvertently omitted. It will be included with John East's concluding article, Part 6.

20 MHz

\$795*

including probes

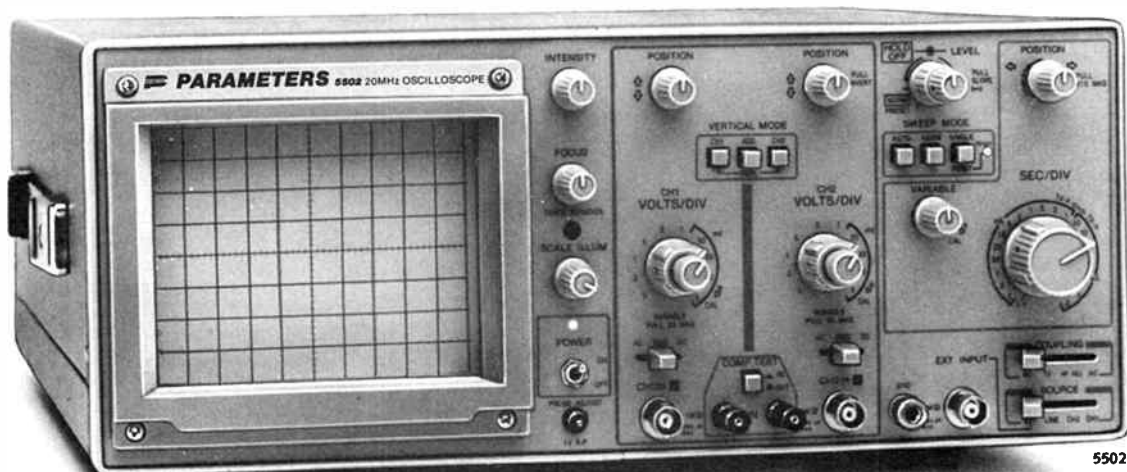

Beat that!

If there's one thing we know about at Parameters, it's oscilloscopes. Over the last 25 years we've sold some of the best brands. In fact we've built our reputation and business on giving our customers the best.

Now we've put that experience and knowledge to work developing our own range of oscilloscopes. Why now? We saw many manufacturers moving away from what our customers were asking for. And prices were simply going through the roof. Instead of genuine performance improvements we were seeing gimmicks. In short, we just couldn't find the CROs our customers needed. So we searched the world and found the right company to make our own.

The new Parameters oscilloscopes are designed to give you high performance and reliability at a realistic price. Everything that matters is built in - including the probes which the competition 'forgets'. The gimmicks have been left out. And of course our famous 'no nonsense' twelve months warranty covers all models.

The range includes three models that will cover the needs of most technicians and enthusiasts.

5502 - Unbeatable value in a 20MHz CRO

- 20MHz dual trace
- 1mV to 5V/div
- Signal delay line
- Channel 1 signal output
- Variable hold-off
- Sweep magnification
- Trigger preset
- Single sweep
- 150mm rectangular CRT
- Illuminated inner-face graticule
- \$795 including probes tax exempt

5504 - 40MHz for a 20MHz price

All the features of the 5502 with 40MHz bandwidth and delayed sweep. \$1258 including probes tax exempt.

6155 - Portable 15MHz

Weights just 4.5 kg and gives you a full featured 15MHz CRO you can take anywhere. Inbuilt rechargeable batteries give two hours of operation. \$998 including probes tax exempt.

Prices are recommended only and don't include sales tax.

Call us now.

Parameters Pty. Ltd.

SYDNEY:

Centrecourt, 25-27 Paul Street North, North Ryde 2113.
Tel: (02) 888 8777
Fax: (02) 887 1283

MELBOURNE:

1064 Centre Road, Oakleigh South 3167.
Tel: (03) 575 0222
Fax: (03) 579 0622

PERTH:

106 Howe Street, Osborne Park 6017.
Tel: (09) 242 2000
Fax: (09) 242 2150



Register your good ideas

Have you ever had a really good idea for something and then wondered how to promote or protect it? You could always patent it, but that can be expensive and time consuming. Now there is an alternative. You can register your idea, invention or creative works with "The Ideas Registry".

The Ideas Registry is an organisation dedicated to helping clients speedily realise the maximum potential on their ideas. Ideas which are registered are kept secret in such a manner that not even the trustees have any idea of the contents of your "security envelope".

The envelopes have a recorded date and should it become necessary to prove the date of your idea in a Court of Law, professionally qualified witnesses are available to prove the relevant date.

The major difference between the Ideas Registry and a normal patent is that, should you desire, the Ideas Registry will promote and market your ideas or inventions. Your genius of wisdom can be promoted both locally and worldwide on the payment of a fee. Should nobody decide to buy your idea or invention, the fee will be refunded.

The fees are quite reasonable, especially when compared to the cost of taking out a full patent. Full details of the services available, together with the applicable charges, can be obtained from: **The Ideas Registry, Locked Bag 1, Mortdale 2223 NSW. (02)579 3010.**

Now isn't that a good idea!

Australia's largest technology event for Sydney

Australian Exhibition Services Pty Ltd will be staging the first major trade show in Australia's new 25 000 square metre, purpose built Sydney Exhibition Centre, in February.

PC88, Office Technology 88 and Communications 88 is expected to attract bigger crowds than ever before when it opens on February 7th. The exhibition will run for four days, from Sunday to Wednesday and will be a major event

during Australia's bicentennial year.

The tenth Australian Personal Computer Show, PC88, will feature. The PC show is held in Sydney and Melbourne each year and is the largest and most comprehensive exhibition of personal computers in Australia today.

International exhibitors in Sydney will include groups from the UK, Singapore, Taiwan and companies from Hong Kong and West Germany. Major companies to be represented include IBM, Epson, Mitsubishi Electric AWA, Imagineering, Commodore, Sharp, Roneo Alcatel, Harris Lanier and Telecon.

For further information on the exhibitions, contact: **Australian Exhibition Services Pty Ltd, 424 St Kilda Road, Melbourne 3004 Vic. (03)267 4500.**

Theft from Dex Audio

Some time between the evening of Sunday 20th and the morning of Monday 21st September, the premises of Dex Audio in Melbourne were broken into and a substantial amount of professional audio equipment was stolen.

Dex Audio estimate the value of the equipment stolen at around \$30 000 and brand names taken include Yamaha, Sony, Akai, Denon, Nakamichi and Teac. Also stolen were two Dex 120 two-channel power amplifiers, one of which was a US model and is the only one of its type ever produced.

Anyone who might hear or see anything about a quantity of professional, studio-type audio equipment should contact **Dex Audio at 97-91 Arden Street, North Melbourne 3051, Vic. Telephone (03)329 2877.** Dex Audio can furnish a complete list of the stolen items including serial numbers and detailed descriptions.

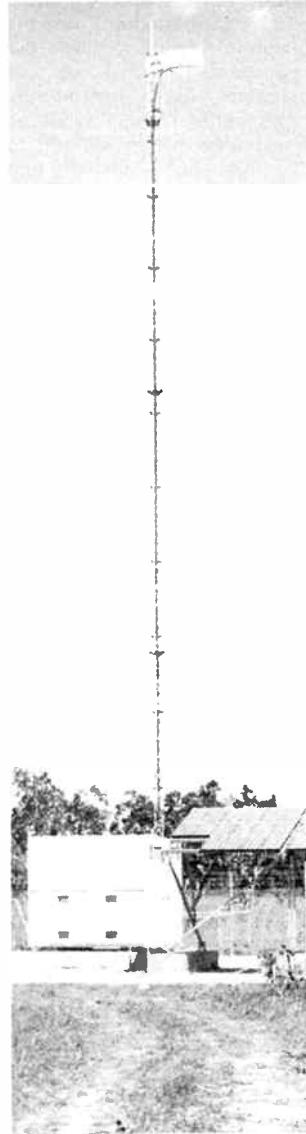

Photovoltaics for telecomms

The advantages of solar power in remote telecommunications applications are well known. Apart from reliability, minimal maintenance and freedom from fuel supply, photovoltaics are environmentally compatible from both a non-polluting viewpoint and electrically. As solar power generation is pure dc, there is no possibility that the power system will interfere with transmission or reception.

The wide selection of photovoltaic modules from Solarex allows design for nearly any application. For unusual requirements, such as the Ford Solar Powered Vehicle, Solarex is prepared to design and manufacture to suit the need.

Solarex can integrate photovoltaics with other energy sources in situations where the sources can complement each other, enhancing reliability or cost-effectiveness. For some installations, a PV system is retrofitted to an existing fuel generator system. In a typical hybrid application such as this, the load is supported by the PV system at all times except during extended periods of reduced sunlight.

Solarex system controllers select and activate the appropriate power source in these hybrid systems, minimizing fuel use and maximizing system efficiency. The controllers also have the capability of sending an alarm signal indicating a system fault, with sufficient warning to correct the problem before system failure.

For further information, contact: **Solarex Pty Ltd, PO Box 204, Chester Hill 2162 NSW. (02)727 4455.**

Two lobes are better than one!

AT&T's newly proven digital microwave system outperforms conventional systems using two antennas by about 500%. This is the claim of AT&T Bell Laboratories engineers who have completed trials in the hot, humid and flat Imperial Valley of Southern California.

Engineer Ernie Lin says "the transmission of both voice and data is virtually error-free. If it works here in the valley, it will work anywhere. The test site is so awful, it's perfect."

The experimental angle-diversity system uses one antenna instead of two and the antenna tower is simple and easy to construct. This represents a substantial reduction in cost over conventional two antenna systems, says Adolf Giger, head of AT&T Bell Labs Protection and Maintenance Systems Department.

The new antenna is a parabolic dish of the same diameter as existing antennae, but with a special design that has two radiation lobes instead of one.

The new angle-diversity system eliminates the performance impact of atmospheric fading for all practical purposes. Digital radio transmission also has the advantage of being extremely quiet, like optical fibre transmission. ▽

Changes for 1988 Perth Electronics Show

Major changes are underway to make the Perth Electronics Show an even more effective voice for the Australian consumer electronics industry, we're told in a recent press release.

These changes are in line with observations made overseas by show committee members Bob Rogers and Mike Goadby and show manager, Chris Gulland, who attended Europe's biggest electronics fair in Berlin in September.

Mr Rogers said a number of ideas on changes to the Perth show had evolved from the trip to Berlin. "The most obvious of these was improving trade and industry commitment to Australia's premier show. Similarities were seen between Perth and the Berlin show, because of Berlin's isolation from the rest of Europe," Mr Rogers said.

The Internationale Funkausstellung Berlin (Audio and Video Fair) is highly promoted throughout Europe, with posters at airports and in the streets.

Shops in Berlin devote product windows to the exhibition using material supplied by the organisers. Rail and bus tour operators from surrounding cities offer Funkausstellung weekends which include an overnight stay in an hotel and tickets to the show.

According to Mr Rogers, similar arrangements in WA would prove very beneficial to both the exhibitors and the show. Multiple media involvement, including live broadcasts, competitions, give-aways and general entertainment, were also seen to be a major drawcard.

A number of other specific recommendations have been put forward for the 1988 Perth Electronics show and a full report of the West German trip was being circulated to Association members.

Aust. communications companies play a part in solar car race

Major Victorian Codan dealers, Telstat Communications of Melbourne and Cob- aus Communications of Cob-

ram, successfully tendered for the total communications package for the jointly sponsored entry by Hughes Aircraft Corporation and the Holden Motor Company in the Solar Powered Car Race from Darwin to Adelaide run last month.

A brand new Jackaroo four-wheel drive was supplied to Telstat and Transaus to follow the convoy of vehicles and provide communications over the whole course.

The project involved the design of an HF radio system to give reliable coverage from Darwin to Adelaide, with the base station located in South Gippsland. It was planned to man the base station 24 hours a day from October 22 to November 15 1987. A UHF system, complete with on-road mobile repeater, was also employed.

All HF radio equipment was Codan with selective calling and scanning facilities. The antenna farm comprised ten 13 metre towers supporting a number of tuned inverted-vee dipoles. The communications vehicles were provided with three Codan HF transceivers and antennas with tuned dipoles and hydraulic pump-up mast for night time camp opera-

tion.

Road convoy communications used a mobile UHF repeater. Ten Midland type 70-530C UHF transceivers were employed, all provided with repeater fail "talk-around" facilities.

One Australian Pacific coach was used for the press gallery fitted with Codan HF and UHF mobiles. One rig was interfaced to a weatherfax printout.

Telstat and Transaus Communications supplied technical backup by way of road technicians to travel with the convoy, responsible for total radio operation for the complete challenge.

7 out of 10 MS people need your understanding ... the other 3 need your support.

MS

For more information contact the MS Society in your state.

SECOND BIRTHDAY CONTEST RESULTS

Our second birthday contest, run over the July, August and September issues, certainly proved popular with readers. Judging the winner was a difficult task as all but two entrants got the three questions correct.

We would like to thank all the entrants for their efforts, some of which were quite clever and amusing. There can, of course, only be one winner and we are pleased to announce that W. M. Schumaker of Hurstville, NSW will receive the prize of the Philips PM2618X/01 digital multimeter.

Congratulations Mr. Schumaker, we are sure that you will be delighted with the performance of your prize.

The answers to the three questions were:

Q1: A Philips PM3050 dual-trace oscilloscope was the prize offered by Philips Test & Measurement (Scientific & Industrial) for AEM's 1st Birthday Contest.

Q2: The last paragraph of Alan Ford's review of the 18 series DMMs in AEM's February 1986 issue reads: "Whatever your choice, a Series 18 DMM will undoubtedly be a handsome and useful addition to your workshop."

Q3: The numeric string "166622800" is, of course, the toll-free number for Philips Scientific and Industrial in reverse.

We asked entrants to tell us why they would like to own the prize and we felt that Mr. Schumaker's response summed up the usefulness of the PM2618X/01 DMM very nicely. He wrote "In my job servicing automatic parking equipment, I use a DMM, analogue multimeter, frequency counter and a logic probe. The convenience of combining them would make my life much easier."

We're sure it will Mr. Schumaker. This is just the sort of application that the Philips DMM has been designed for.

We could not let this occasion pass without a few quick comments on some of the other entries. Michael Baty of St. Ives, NSW caused some mirth amongst the staff with his poetic entries. Michael's first entry, sung to the tune of "Comin thro' the Rye", reads:

I've got a shoddy meter body,
(it's so bad I cry),
I need a Philips - Yes, O Luddy,
Its a damn good buy.

Michael's second entry was even funnier, unfortunately it made some rather derogatory remarks about another manufacturer's product so we can't print it here.

Our sympathy goes out to L. Triplett of Nelson Bay, NSW, who writes:

"My television doesn't work. My microwave oven is playing up. The multimeter is broken and I haven't got a logic probe. My wife is going crook. I need HELP!"

BLITZER MODEMS
LESS THAN 1/2 THE PRICE OF COMPETITIVE MODEMS



BIT BLITZER 123 - V21, V22, V23 SYNCHRONOUS AND ASYNCHRONOUS COMMS BELL 212a (1200 bps) & 103 (300 bps)

Auto-dial, tone or pulse; Auto-answer; Auto redial, Full Hayes AT command set inc. 19 "S" registers; Call progress monitoring; Loop back for remote diagnostic; Internal speaker; 10 status and activity LEDs; Low power consumption 1.5 watts; Professional black anodised aluminium case.

Bit Blitzer 12E, V21/V22 with all above specs. \$349. ex. tax Both Telecom Approved

ONLY \$449 ex. tax



MIKE BOORNE ELECTRONICS PTY. LTD.

Suite 3, 61 A Hill St. Roseville 2069 NSW (02)46 3014, (02)46 3015 Perth: 3 Topaz Gardens Edgewater 6027 WA (09)306 2056

Rod Irving Electronics

The cheaper alternative.



PANEL METERS GALORE!

We have a great range of panel meters at great prices!

Cat. No.	Description	Price
Q10500	MU45 0-1mA	12.50
Q10502	MU45 50-0.500uA	12.50
Q10504	MU45 0-100uA	12.50
Q10510	MU45 0-5A	12.50
Q10518	MU45 0-1A	12.50
Q10520	MU45 0-1A	12.50
Q10525	MU45 0-20V	12.50
Q10530	MU52E 0-1A	14.50
Q10533	MU52E 0-5A	14.50
Q10535	MU45 VU PMetre	14.95
Q10538	MU65 0-50uA	16.95
Q10540	MU65 0-1mA	16.95
Q10550	MU65 0-100uA	16.95
Q10560	MU65 0-20V	16.95



ARLEC "DISCO LITE" CONTROLLER

Give your parties a professional touch with the arlec "Disco Lite". Simply plug your light(s) into the "Disco Lite" and you're instant party life!

3 DIFFERENT MODES!
Music Mode: Place the "Disco Lite" in range of the speakers and it flashes the lights to the beat of the music!
Strobe Mode: Simply adjust to desired speed! Great for mime or theatre!
Dim Mode: Allows you to dim the lights to create moods, effects etc.

Cat. M22003 \$49.50



TEXT TOOL SOCKETS

P17016	16 pin	\$14.50
P17024	24 pin	\$14.50
P17028	28 pin	\$19.50
P17040	40 pin	\$22.50



OMNI-DIRECTIONAL WIRELESS MICROPHONE

Frequency: 2.4GHz
Freq. Response: 50 - 15kHz
Range: Over 300 feet in open field
Modulation: FM
Power Source: 9V Battery
Type: Electret Condenser
Dimensions: 185 x 27 x 38mm
Weight: 160 grams

Cat. A10450 \$19.95



UTILITY BOXES

Plastic boxes with aluminum tops and available in four sizes. Very popular for projects and very economical!

H10101	150x90x50mm	\$ 3.25
H10102	195x113x60mm	\$ 4.50
H10103	130x68x41mm	\$ 2.75
H10105	83x54x28mm	\$ 1.95
H10110	120x65x38mm	\$ 2.95
H10112	120x65x38mm (Metal top)	\$ 2.95

K&W METAL INSTRUMENT CASES

Used in many projects, these cases have handsome finish and are both versatile and economical.

H10478	125 x 40 x 65mm	\$ 5.95
H10479	150 x 55 x 95mm	\$ 6.95
H10480	100 x 92 x 130mm	\$ 8.95
H10481	150 x 55 x 100mm	\$ 7.95
H10482	200 x 80 x 130mm	\$ 9.95
H10485	255 x 92 x 155mm	\$14.95
H10487	255 x 165 x 155mm	\$16.95
H10489	305 x 105 x 200mm	\$16.95



RS232 WIRING ADAPTOR BOX

- Male to female
- 25 Detachable plug on leads
- 2 mini jumpers
- Ideal for experimenting or temporary connections

Cat. X15665 Normally \$49.95 Only \$44.95



HEATSINK COMPOUND

Heat sink compound is applied to the base and mounting studs of transistors and diodes. It maintains a positive heat sink seal that improves heat transfer from the device to the heat sink, thus increasing overall efficiency.

Cat. H11800 (10g)	\$2.95
Cat. H11810 (150g)	\$17.50



"NO BRAND" DISKS!!

Now you can buy absolute top quality disks that are also the cheapest in Australia! They even come with a 5 year guarantee! So why pay 2-3 times the price for the same quality?

Packs of 10. D.I.S.D.I.D. without boxes or brand name - just their white paper jacket, and index labels (5 1/4" disks include write protects)

5 1/4" "NO BRAND" DISKS
 10-DISKS 100-DISKS 1000-DISKS
\$10 \$9** \$8.50****
 (ALL PRICES PER 10 DISKS)

3 1/2" "NO BRAND" DISKS!
 10-DISKS 100-DISKS 1000-DISKS
\$29 \$28 \$27.50
 (ALL PRICES PER 10 DISKS)



VERBATIM DISK SPECIALS!

All prices 10 disk boxes!

Description	1-9	10
3 1/2" 1S/2D	\$47.50	\$46.50
3 1/2" 2S/2D	\$49.50	\$48.50
5 1/4" 1S/2D	\$24.95	\$22.50
5 1/4" 2D/2D	\$29.95	\$28.50
5 1/4" 2S/4D	\$75.00	\$70.00
5 1/4" 2S/HD	\$44.95	\$42.95



SAMSUNG 12" 20MHz COMPOSITE MONITOR ONLY \$149

FEATURES...

- High contrast non-glare screen
- High resolution 80 or 40 character display

SPECIFICATIONS...

Picture tube: 12" diagonal and 90° deflection
 Phosphor: Available in Green (P39) or Amber
Video input signal: Composite
Signal: Negative Sync
Level: 0.5V-2.0Vp-p
Scanning frequency: Horizontal: 15.754 kHz ± 0.1%
 Vertical: 60Hz
Video bandwidth: 20MHz
Active display area: 216(H) x 160(V)mm
Display character: 80 characters x 25 rows
Input terminal: RCA Phono Jack
Controls: Outside: Power Switch, Contrast, Brightness, H-Shift, V-Size Inside: H-Width, H/V hold, H/V linearity, Focus
Power supply: 110/120V 60Hz 220/240V 50Hz
Dimensions: 308(W) x 307(H) x 297(L)mm
Weight: 7.3 Kg
Shipping weight: 8.3 Kg

Cat No.	Description	Price
X14514	(GREEN)	\$149
X14516	(AMBER)	\$149



SCOPE 60W SOLDERING SYSTEM

- Infinitely adjustable temp. 200 C to 470 C
- Sliding control selects desired tip temperature (LED readout monitors tip temp.)
- Safety holder features ceramic burn-proof bush and can be converted to left-hand-side
- Soft and cool hand grip in pliable rubber
- Screw type connector prevents accidental plug removal and guarantees solid contacts
- Temperature lock allows production supervisors to control soldering temperatures
- Anti seize tip retention design reduces risk of thermal seizure by removing locking nut to cooler end of barrel
- Optional 30W soldering pencil is available for finer work

Cat. T12900 Normally \$229 **SPECIAL, \$199**



VIFA/AEM 2 WAY SPEAKER KIT!

This exciting new speaker kit, designed by David Tillbrook (a name synonymous with brilliant design and performance) uses VIFA's high performance drivers from Denmark. You will save around \$800 when you hear what you get from this system when compared to something you buy off the shelf with similar characteristics. Call in personally and compare for yourself!

The system comprises...
 2 x P21 Polycore 8" woofers
 2 x D25T Ferrofluid cooled dome tweeters with Polymer diaphragms
 2 pre-built quality crossovers
 The cabinet kit consists of 2 knock-down boxes in beautiful black grain look with silver baffles, speaker cloth, innerbond, grill clips, speaker terminals, screws and ports

D25T SPEAKER SPECIFICATIONS

Nominal Impedance: 6 Ohms
 Frequency Range: 2 - 24kHz
 Free Air Resonance: 1500Hz
 Operating Power: 3-2 Watts
 Sensitivity (1W at 1m): 90dB
 Nominal Power: 90 Watts
 Voice Coil Diameter: 25mm
 Air Gap Height: 2mm
 Voice Coil Resistance: 4.7 Ohms
 Moving Mass: 0.3 grams
 Weight: 0.53Kg

P21 WOOFER SPECIFICATIONS:

Nominal Impedance: 8 Ohms
 Frequency Range: 26 - 4.000Hz
 Free Air Resonance: 33Hz
 Operating Power: 2-5 Watts
 Sensitivity (1W at 1m): 92dB
 Nominal Power: 60 Watts
 Voice Coil Diameter: 40mm
 Voice Coil Resistance: 5 Ohms
 Moving Mass: 20 grams
These Small Parameters: Qm 2.4 Qs 0.41 Qe 0.35 Vas 80 l

Weight: 1.65kg

Complete Kit	Cat K16020	\$799
Speaker Kit	Cat K16021	\$649
Cabinet Kit	Cat K16022	\$209



SEMICONDUCTORS!

Always check our prices before you buy!

	1-9	10+	100+
MX232	\$11.50	\$10.50	
V-20 8MHz	\$19.95	\$17.95	
V-30	\$39.95	\$34.95	
TEA2000	\$11.95	\$10.95	\$9.95
ZM429	\$9.95	\$8.95	\$7.95
ZM4234	\$39.50	\$37.50	\$36.50
SAB6456... P.O.A.			
2114	\$2.95	\$2.75	\$2.50
2716	\$9.95	\$9.50	\$8.95
2732	\$8.95	\$8.50	\$7.95
2764	\$7.95	\$7.50	\$6.95
27128	\$9.95	\$8.95	\$7.95
27256	\$11.50	\$10.50	\$10.00
27512	\$19.50	\$18.50	\$17.50
4116	\$3.95	\$3.50	\$2.95
4164	\$3.95	\$2.95	\$2.75
41256	\$7.95	\$6.95	\$5.95
555 8 pin	\$0.50	\$0.40	\$0.35
6116	\$3.95	\$3.75	\$3.50
6264	\$7.95	\$6.95	\$6.50
6802	\$5.00	\$4.00	\$3.75
6821	\$2.00	\$1.80	\$1.70
6845	\$5.00	\$4.00	\$3.75
7406	\$0.40	\$0.30	\$0.25
INS8250	\$29.95	\$27.95	
NE5534AN	\$1.95	\$1.85	\$1.75
AM/EP7910	\$19.95	\$18.95	
MEL9501	\$29.95	\$27.95	
SC141D	\$1.75	\$1.50	
SC151D	\$2.50	\$2.25	
555	\$0.40	\$0.38	
741	\$0.50	\$0.45	

8087

Genuine Intel chips with manual and data sheets packed in boxes!

8087-3 (4.77MHz)	\$269
8087-2 (8MHz)	\$385
8087-1 (10MHz)	\$585
80287-6 (6MHz)	\$475
80287-7 (8MHz)	\$799



CODE KEY PAD

- Telephone type digital keypad
- Four digit, changeable code
- Over 5000 possible combinations
- Power consumption: 5mA standby 50mA alarm
- Two sector LED and 1 arm LED
- Wrong number lockout
- 12V DC operation
- Relay output
- Panic button
- Normally open lamp switch
- Dimensions 145 x 100 x 37mm
- AC/3P compatible

Cat. A13014 R.R.P. \$79.95 **SPECIAL, ONLY \$69.95**



ULTRASONIC TRANSDUCERS

Designed to transmit at 40kHz (L19991) with up to 20V IIP on the transmitter. These units can't be heard and so are ideal for TV remote controls, water level detectors, burglar alarms, motion detectors and information carriers as they can be either pulsed or used in the continuous wave mode. Full specifications below for design purposes.

Maximum Input Voltage: 20V rms
Centre Frequency (Hz): 40 ± 1.0
Sound Pressure Level 10V RMS: 110dB min
Sensitivity (dBµV/ubar) min.: -65 min
Bandwidth (kHz):
 Transmit 4.0 (at 100dB)
 Receiver 5.0 (at 73dB)
Impedance:
 Transmitter 500
 Receiver 5000

Cat. L19990 (Transmitter)	\$4.75
Cat. L19991 (Receiver)	\$4.75



ECONOMY TRANSFORMERS

2155 240V 6-15V 1A	1.9
Cat. M12155	\$5.95
2156 240V 6-15V 2A	
Cat. M12156	\$14.95
2840 240V 9V CT	
Cat. M12840	\$5.95
2851 240V 12-6V CT 150mA	
Cat. M12851	\$5.95
2860 240V 15V CT 250mA	
Cat. M12860	\$5.95
6672 240V 15-30V 1A tapped	
Cat. M16672	\$14.95



PC BOARD HOLDER

Better than an extra pair of hands! A must for all PCB work.

Cat. T12444 \$9.95



Rod Irving Electronics

48 A'Beckett St., MELBOURNE
 Phone (03) 663 6151
 425 High St., NORTHCOPE
 Phone (03) 489 8866
Mail Order and Correspondence
 P.O. Box 620, CLAYTON 3168
Telex: AA 151938
Fax: (03) 543 2648



MAIL ORDER HOTLINE 008 335757 (TOLL FREE) [STRICTLY ORDERS ONLY]

LOCAL ORDERS & INQUIRIES (03) 543 7877

POSTAGE RATES

\$1	\$9.99	\$2.00
\$15	\$24.99	\$3.00
\$25	\$49.99	\$4.00
\$50	\$99.99	\$5.00
\$100	\$199	\$7.50
\$200	\$499	\$10.00
\$500 plus		\$12.50

The above postage rates are for basic postage only. Road Freight, bulky and fragile items will be charged at different rates. All sales tax exempt orders and wholesale enquiries to RITRONICS WHOLESALE 56 Renner Rd., Clayton Ph (03) 543 2166 (3 lines)

Errors and omissions excluded
 © Rod Irving Electronics 1999
 Rod Irving Electronics
 425 High Street, Northcote
 Victoria 3168 Australia



More pleasure, improved safety with marine electronics

Part 2 Dave Jeans

Marine electronics has expanded enormously in the past 12 months. Now there's so much more equipment available to make leisure boating – be it power or sail – safer and more enjoyable. Dave Jeans continues his authoritative guide to marine electronics.

IN THE FIRST instalment, we only had sufficient room to cover navigation equipment. In this instalment we continue with communications, performance equipment and entertainment.

Marine communications

In Australian waters marine communications can take place in three separate services:

- 27 MHz marine band using AM and SSB modes.
- VHF band (156 – 165 MHz) using FM mode.
- MF/HF bands (2 – 23 MHz) using SSB mode.

In addition, survival radio beacons operate on the following spot frequencies; 121, 243 and 406 MHz.

Communications Equipment 27 MHz MARINE SERVICE

Tagged with the rather grand title of Inshore Boating Radiocommunications Service (IBRS), "27 Meg Marine," as it is more commonly known, is the largest and most successful two-way radio service in Australia. Spurned by many large vessel owners as a toy, the facilities offered by 27 MHz marine operation are quite staggering. Tens of thousands of small craft owners are active on 27 MHz at weekends, communicating via hundreds of base stations strung along our coastline.

Key to success

The key to the success of the IBRS is twofold – low cost equipment, and a minimum of licencing requirements. Developed from car type CB sets, and thus taking advantage of the low cost of mass produced goods, the allocated band comprises ten channels, from 27.68 to 27.96 MHz. AM type modulation is mostly used, with a sprinkling of stations persevering with SSB on upper sideband.

Such is the value of operation on 27 MHz that Police vessels, civilian SAR helicopters and all inshore rescue services use this band. There is more information available on 27 MHz marine channels about weather and safety matters than on all of the other marine bands combined.



One of the great codes of the sea is being able to help another vessel in difficulties. Fitting 27 MHz in your boat may allow you to more readily assist a vessel in distress, simply by having the ability to communicate directly.

True marine sets from CBs

Although adapted from CB sets, manufacturers have gradually developed true marine radios for the IBRS. Although the Department of Transport and Communications require the set to be licenced and of an approved type, no operator certi-

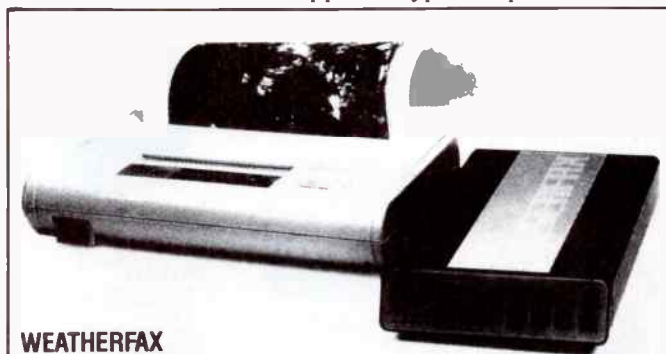

WEATHERFAX

The onboard reception of weather maps brings together data transmission by radio, microprocessor decoding and facsimile printing. Welding these diverse techniques into one small cabinet, complete with radio receiver, has produced a panacea for many a professional mariner.

Although the pleasure craft demand for such exotic equipment is limited, world-wide there has been sufficient impetus to bring several brands onto the market.

Tasmanian Tom Moffat recently launched his "NaviMate" weatherfax unit comprising a small Z80 computer microprocessor, a permanently programmed EPROM and a small Brother thermal printer, all running from 12 Vdc. The NaviMate requires only to be connected into a stable radio receiver to produce instant weather charts.

A weatherfax chart provides several advantages over conven-



This three channel 27 MHz marine handheld transceiver from Dick Smith Electronics is simple to use, fully approved and comes with one channel fitted for \$129. Cat. No. D-1106.

cate is needed. The most common installation operates from 12 volts, but several excellent handheld models are available.

Typical across the water communications range between 5 watt AM sets using quarter wave antennas is 40 nautical miles. Handheld sets provide upwards of 20 nm range if the antenna is deployed properly. A good quality 12 volt AM set costs from \$150-200, with swing-down antennas at around \$60.

Communications Equipment MARINE VHF TRANSCEIVERS

Operating on any of the 55 marine VHF band channels brings you into the international realm of "Public Correspondence." As a result, the operator must hold at least a Restricted Radiotelephone Operators Certificate, and of course the set must be licenced and an approved type. DOTC allow a combined ship station licence, whereby the 27 MHz, VHF and HF equipment on your boat is covered for one fee.

Traffic control and correspondence

All merchant ships carry VHF and the service provides the equivalent of air traffic control, in the way of harbour and coastal traffic control. OTC Coast Radio Stations provide repeater stations near major ports to extend the range of VHF, from a ship-to-ship range of about 20 nm to upwards of 100 nm off a shoreline with high terrain.

Public Correspondence is available in the form of spoken telegrams, through OTC Coast Stations, together with the facility of being patched into the Telecom network for direct communications with any telephone subscriber, worldwide. This service is referred to as "SeaPhone."

Approval

Marine VHF sets must be DOTC approved. However, this requirement is easily met by most imported brands. Power output is 25 watts, with selectable low power of one watt for harbour working. Antennas are generally small quarter wave elements or coaxial dipoles.

Many handheld models are available, the latest models featuring full 55 channel coverage, at 2 WRF output. 12 volt VHF transceivers cost from \$400 up to around \$1000, with handheld sets selling for about \$500.

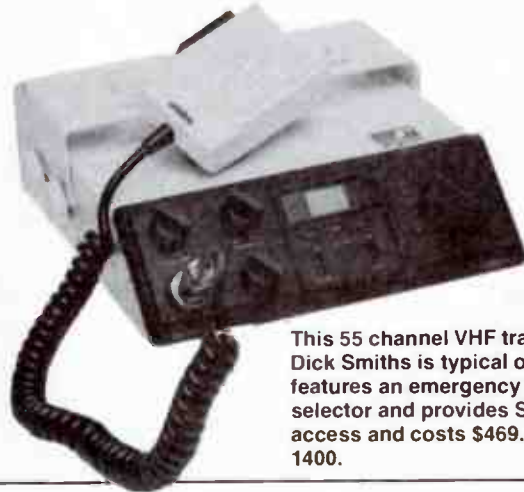

This 55 channel VHF transceiver from Dick Smiths is typical of many units. It features an emergency channel selector and provides SeaPhone access and costs \$469. Cat. No. D-1400.

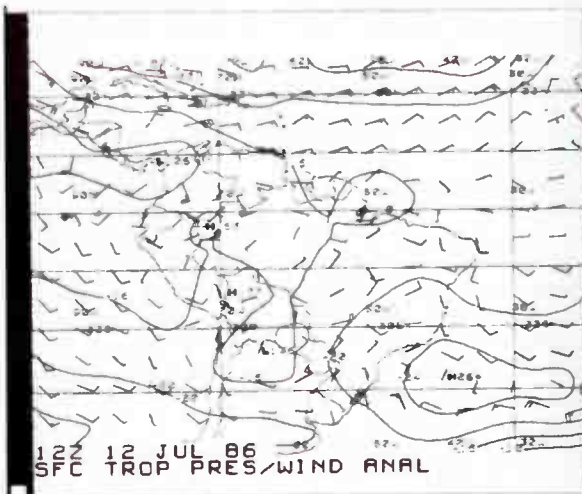

tional forecasts received by radio or TV. The weatherfax machine can operate unattended. It can receive continually updated charts from which weather trends can be deduced, and those charts are more up-to-date than the forecasts transmitted over conventional radio and TV.

In addition, charts of ocean currents are also available. Transmis-

sions are free of charge to all, and the coverage from AXM in Canberra is excellent. Listen out on 5100 kHz anytime to confirm this point.

On the other hand, conventionally transmitted forecasts are the result of professional deduction, whereas the weatherfax chart relies on the yachtsman giving it a correct interpretation.

Communications Equipment MF/HF SSB TRANSCEIVERS

The history of HF/SSB radio in Australia has been a dreary one of high price and limited channel capacity, up until recently. Suddenly a metamorphosis occurred. Where the average set had provided from six to twelve crystal-locked channels (a frustrating limitation for boat owners, particularly those cruising overseas), overnight DOTC approved the ICOM 48 channel (synthesized) transceiver. Actually ICOM had to persevere for almost 18 months with their application for approval, but their persistence won.

Started a rush

A few months later, local manufacturer Wagner Industries gained approval (after minor modification) for an imported +USA transceiver, the Stevens 222. This set features 390 channels, 100 of which can be factory tuned to any authorised user frequency (such as the ham bands). The software aspect of this set is remarkable.

The whole business was then capped by another local manufacturer, Codan in Adelaide, who released their excellent 99 channel model 8525-S transceiver. The startling thing about all of these sets was that they came with automatic antenna tuners of a most sophisticated type.

Not to be outdone, Wagner released a prototype of their new locally built synthesized marine transceiver at the recent Sydney Boat Show. The frustrating aspect of this scene is that the technology has been around for years, whereby boat owners could have enjoyed the added safety and service of these latest sets. It took ICOM to set the pace and open the floodgates.

The bands

The marine MF/HF spectrum is divided into several bands, from 2 MHz through to 23 MHz. Most small craft utilise the 2 - 4 and 6 MHz radiotelephone bands, and it is on these frequencies that routine weather forecasts and navigation warnings are broadcast, by OTC Coast Radio Stations, and by limited coast stations such as Penta Comstat, located near Gosford, NSW.

Here is a fully synthesized HF marine transceiver from the local firm, Wagner. Like all synthesized units, it is simple to operate, requires no tuning and sports pushbutton channel selection.



Local manufacturer Codan were quick to offer this 99 channel HF transceiver, Model 852-S, once the DOTC approved synthesized equipment.

Because of the low frequencies used on MF and HF, the antenna is often a compromise, heavily loaded with lumped inductance by the antenna tuner. Non-metal hulled vessels have difficulty providing an effective earthing system. Nonetheless, communications over distances up to 1000 nm are routine between small craft and shore stations.

Crystal-locked transceivers providing 10 to 12 channels are still available from about \$2000 including antenna tuner. Synthesized transceivers such as the Codan 8525-S sell for \$2610 plus the manual antenna tuner at \$638 or the auto tuner at \$1874, all including sales tax. Most sets run 100 to 150 watts PEP output, and operate from 12 or 24 volts dc.

Communications Equipment SURVIVAL RADIO BEACONS

Emergency Position Indicating Radio Beacons (EPIRBs) were developed in the early 60s for aircraft rescue, but have found acceptance in small craft over the past five years. These (lithium) battery powered devices will transmit an easily recognised swept tone signal simultaneously on 121.5 and 243 MHz, once they are deployed, either on deck or floating in the water.

The frequencies listed above are continuously monitored by all civil aircraft (121.5 MHz) on overwater flights, and by military aircraft on the second harmonic, 243 MHz. Power output of the beacons is about one watt with a transmit duration of from 48 to 96 hours, depending on battery type.

Search and rescue

Any aircraft hearing an EPIRB signal immediately notifies air traffic control, indicating time of first and last reception, and signal strength. This information enables the Search and Rescue Centre to estimate the general position of the beacon.

Aircraft fitted with search meters and/or VHF/DF can then set out for the area to pinpoint the EPIRB location. The search meter comprises a milliammeter with adjustable sensitivity control, and is plugged into the VHF receiver, bypassing the automatic volume control (AVC). The aircraft flies a search pattern once the beacon is heard, and can generally resolve the location to within 5 nm. If survivors can use visual signals this can assist in detection.

The EPIRB's described above sell for about \$170, weigh less than 1 kg and most have a storage life onboard of at least two years.

Satellite search and rescue

A recent innovation is an EPIRB which transmits on 121.5 MHz and also on 406 MHz. This latter signal can be received by SARSAT satellites, whereupon the beacon position can be

established to 1 nm within a few minutes of reception. The cost of these new devices is well over \$3000 but this is expected to tumble once manufacturing competition heats up.

Performance Equipment

Years ago the ocean yachtsman sat down before departure and plotted the track to destination on a chart. The forecast wind speed and direction was then drawn in for the first leg of the voyage. Connecting the wind segment to the first turning point gave the course to steer, and the distance to travel.

When yachtsmen started seriously racing each other around the buoys, course information needed to be updated at frequent intervals. Chart plotting was too slow. Flukey winds meant constant steering changes were needed to give the best speed through the water. Accurate chart work under these conditions was well nigh impossible, yet spot-on navigation helped to win races.

Wind speed and direction sensors were then fitted to the masthead, with indicators installed at the chart table and on deck. The helmsman could now act on wind changes more rapidly, squeezing out the extra speed that wins races.

Masthead sensors however, indicated 'apparent' wind speed and direction, the result of the boat's movement acting upon the true wind. New electronic instruments soon appeared which applied the boat's speed through the water, together with the magnetic heading, to the apparent wind vector. The readout from these instruments was the true wind speed and direction, vital data when planning sail changes for the next leg.

This 'true' data also enabled the navigator to update his chart plot more rapidly, and to advise the skipper when to tack, hopefully assisting the boat to travel at the fastest speed over the shortest possible distance of the course.

The boat speed sensor

The vital performance data came from a variety of sensors. Boat speed was provided by a tiny paddle wheel extending through the hull, and spun by the water flow. Because this type of device was activated mainly by water being partially dragged along with the boat (the boundary layer), errors could be gross and non-linear. Calibration was lengthy and difficult, and the paddle wheel was often fouled by weed and marine growth.

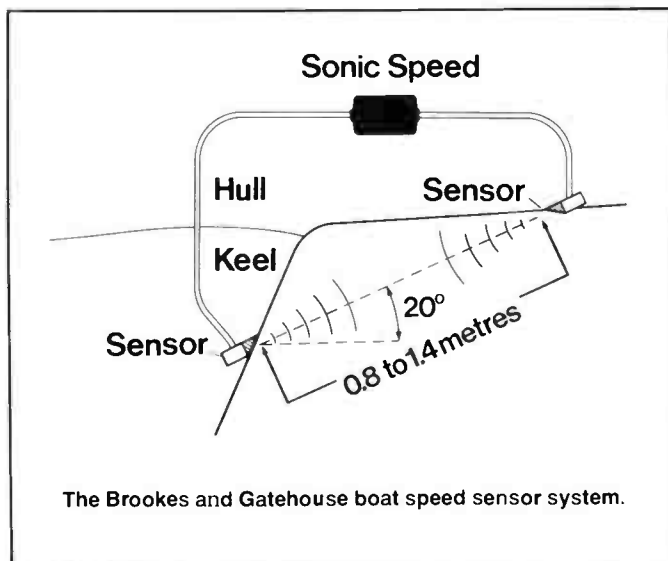

The English company Brookes and Gatehouse solved the water speed sensor problem in an elegant manner. Their 'Sonic Speed' system comprises two ultra-sonic sensors, installed flush in the hull surface, underwater along the fore and aft axis, and separated by about one metre, see sketch.

Pulses of sound energy (at approx. 400 kHz) are transmitted through the water between the sensors, in either direction. Those pulses propagating with the water flow travel faster than the pulses moving against the flow. A simple algebraic calculation from the time difference gives the speed of the water flow along the hull, which in effect is the boat speed through the water.

This system is unaffected by water salinity, debris, water temperature or aeration. Minute changes in boat movement can be displayed down to 0.1 knot. Accuracy is 1% or better.

The course indicator

The traditional direction indicator is the magnetic compass, still unexcelled for low cost and reliability. Remoting the compass bearing was first achieved by fitting a magnetic sensor over the face plate of the compass. This sensor comprised a coil which picked up the magnetic field of the compass needle and relayed positional information to other electronic circuitry such as true wind indicators and auto pilots.

However, owing to the excessive errors of this system caused by heeling and by rough weather, the aviator's fluxgate compass was adapted for marine use. This device uses two parallel sensing coils wound in opposite directions and fed with an AC voltage. When aligned with the earth's magnetic field both coils are equally affected. If moved from this alignment an error voltage develops, proportional to the movement. This error voltage is amplified for use by equipment requiring directional data.

Fluxgate compasses can be insulated from most of the effects of heeling and rough weather by oil bath mounts and sophisticated gimbals. Circuitry has been developed which allows the compass to self adjust for deviation error, and in some brands magnetic variation can be fed in, to provide true heading. ▷

Masthead units

The friction-free techniques offered by opto-electronics and by Hall Effect transistors have been incorporated into mast head anemometers and wind direction vanes. All effort is made to ensure freedom from mechanical lag, together with water proofing of seals. Construction is from lightweight, fatigue resisting materials.

Despite all of these precautions, the sensors must still be fitted in a location affected to some extent by wind shear caused by the movement of air around the mast. These errors can be estimated and used for calibration, together with other errors produced by mast twisting, and by the anemometer and wind vane laying at an angle to the wind as the boat heels.

Bringing it all together

The large mass of performance data available in modern yachts, and the rapidity in which it is updated, is beyond the ability of the human navigator to fully utilise. If a boat has been worked up carefully, a mass of calibration corrections must also be applied to the data.

This is a situation perfectly suited for the micro-processor, and these devices have been incorporated in many different brands of yacht instrumentation. For example, the British made Scorpio yacht performance system will display:-

Time; GMT or Local.

Timer Stopwatch; count-up or count-down.

Heading.

Tack course.

Apparent wind speed, angle or direction.

True wind speed, angle or direction.

Depth; metres, feet or fathoms.

Boat speed in knots, mph, m/s or km/h.

Amplified speed relative to target speed.

Amplified speed zeroed on current speed.

Log or historic log.

Trip log, counting up or down to zero.

VMG (velocity made good) to one or two decimals.

In addition, the equipment will provide alarms for:-

Time; local or GMT.

Upper or lower True wind speed.

Port or stbd true wind direction change.

Heading, upper and lower value.

Depth, upper and lower value.

Boat speed, upper and lower value.

Battery voltage, high or low.

Trip log, various settings ahead.

One vital factor in navigation is speed and direction over the ground, from which set and drift due to tide and current can be calculated. The micro-processor can easily digest inputs from SatNav, Loran or other position fixing devices, to provide this information. This is a two-way street, with speed and course data being fed back to the SatNav to enable it to DR fix between satellite passes.

Of course, yacht instrumentation did not appear overnight as completely engineered systems. It grew like Topsy, as new techniques were mastered. Manufacturers were aware though of a need to integrate the many pieces making up a system, to provide true compatibility, and to avoid a "rat's nest" of wiring.

A system of data interchange was agreed upon, whereby information could be exchanged between segments of a system, with the microprocessor acting as 'mother'. The US National Marine Electronics Association (NMEA) laid down a formatting protocol for transmitting data, known as the NMEA 0183 standard. Yacht systems could also have RS232C ports allowing interaction with external computers.

NMEA compatible equipment can be connected together

by a single cable, in any order, with new items simply plugged into the nearest existing piece in the boat. Datamarine use a coaxial cable in their 'Link' system, with 12 volt dc and 0183 coded data both handled in the same conductor. The 'Link' equipment, though primarily developed for sailing craft, is available in modified form to suit power boat operation.

The interesting VDO NavPac yacht instrumentation system (illustrated on page 13 of the last issue) uses a single five-conductor shielded cable for interconnection, together with a simple mating rack into which the components plug together like Lego pieces.

For your amusement

Getting away from it all on your boat need not mean total isolation. Some of the great pleasures of our civilisation, such as good music and a good movie, can be savoured, perhaps more so in the peace and quiet of a sheltered cove. Even listening to the radio takes on a new perspective when you are able to give it your full attention. Bringing aboard some of the diversions of our urban lifestyle can add to your enjoyment afloat.

Entertainment Equipment VIDEO

Most pleasure craft have a 12 volt dc system only, which means that any video equipment must operate from that power source, or from self contained batteries. The Sony company market a range of video products that will operate from both of those power sources.

The Sony EVM-9010 colour video monitor can operate from either a 12 Vdc source, or from its own Nicad battery



Sony seems to be the only supplier of a 12 Vdc operated colour video monitor. This is their EVM-9010, a 9" (230 mm) screen unit with integral 8 mm video cassette playback unit. Sony's HandyCam video camcorder with a "Sports Pack" or "Marine Pack" is ideal for the boating enthusiast keen on recording boating activities.

pack. It also works from 240 volts ac house power. The EVM-9010 has a high resolution 9" screen, ideal for viewing in the confines of a small boat, plus an integral 8 mm video ("Video 8") playback deck built into the cabinet top. The Video 8 cassette is approximately the same size as a regular audio cassette, but with wider tape (8 mm). The helical recording system features a flying erase head, giving superb edits with stable colour. The rotating audio head provides high quality FM sound. Recently, Sony commenced marketing a library of top rated video movies in the 8 mm format. This means you can take video movies onboard for playback during the leisure evening hours.

Daytime activity on the water has not been forgotten. The Sony Video 8 HandyCam camera can be used to capture the days activities, for playback at any time through the EVM-9010. To ensure trouble free operation in boating activities, the HandyCam comes with an optional waterproof Sports Pack, comprising a tough ABS plastic cover with sealing gasket that allows operation of the video camera on the beach and in water depths to two metres.

For the diving buff, the Sony deep water Marine Pack has extra waterproof capability, enabling full operation of the video camera down to 40 metres (130 ft). Accessories include an underwater Video Light with waterproof rechargeable battery pack, plus special filters to handle awkward lighting situations.

Entertainment Equipment HI-FI AUDIO

Greenwich Marine (GME) of Sydney market two models of their marinised radio cassette deck. The electronics and mechanicals are manufactured by a leading Japanese company, and feature coated circuit boards and special marine housings. The model GR926 comprises an auto reverse cassette deck, with an AM/FM manually tuned radio. In addition



JVC's car radio/cassettes, models RX515, RX615 and RX715 are proving popular with boating enthusiasts, say JVC. By fitting an optional "sleeve unit" (K2-B2K - shown) to your car and boat, the radio/cassette is readily transferred from one to the other.

tion however, this model also incorporates the LF band (200-400 kHz) enabling the boat owner to tune into local aero beacons, some of which continually transmit weather information (the radio can also be adapted by the hobbyist for direction finding).

The GME model GR934 has similar tape playing facilities, but also features a digitally tuned AM/FM radio of quite surprising performance, being particularly noise-free on the FM band. GME market several speaker enclosures suitable for use onboard boats.

Car audio equipment

The amount of quite excellent car audio gear is beyond listing here. In general terms it can be stated that car audio equipment is ideally suited for operation in fully enclosed areas such as the saloons of yachts and power cruisers. There cannot be a more severe testing ground than the automobile, which is why so much boat electronics stems from the auto industry. - to page 113 >

SECURITY

If your boat is moored at a marina, then doubtless you're worried about theft and vandalism. Monitronix, a West Australian firm, has tackled the problem head-on and come up with an economical system they've dubbed "Boat-guard".

Boatguard is a marine security system which, for boat owners using marine or yacht club pens and mooring, provides 24 hour surveillance of each craft linked to the system. The system employs an onboard low power transmitter which is fully self-contained, running from its own batteries. If an intruder enters the boat, an alarm is transmitted to a remote land-based monitor located at a professional security monitoring company. A computer system then provides the security monitor with the boat location, owner's name and contact phone number and any other relevant details from the alarm system

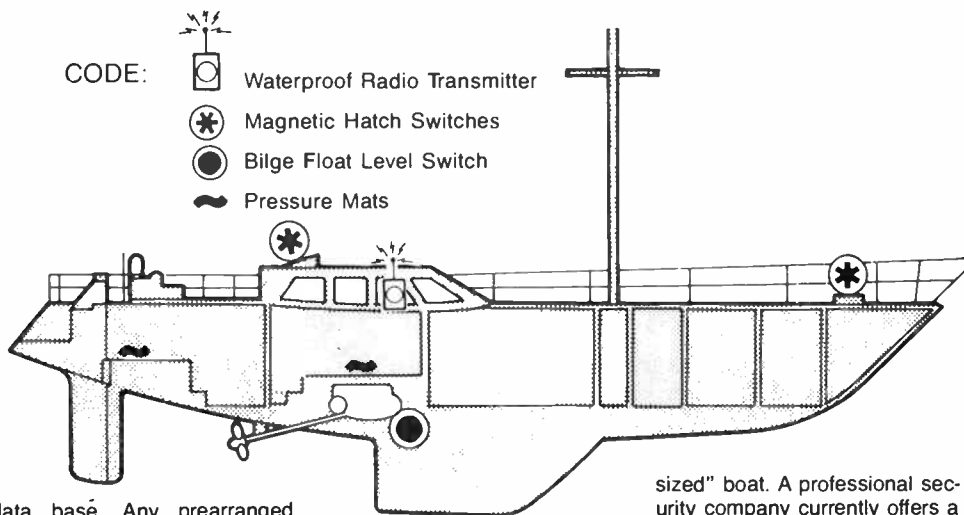
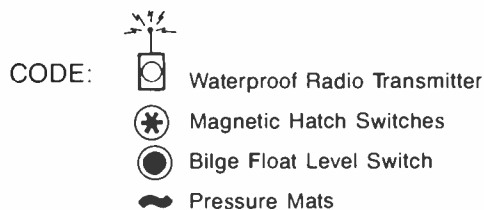

data base. Any prearranged action can then be initiated.

The system can be triggered by hatch switches and pressure mats strategically located on the boat. The transmitter/alarm system continuously checks the status of all such inputs.

In addition, the system may be linked to onboard safety equipment such as a bilge float level, gas or fume detectors. During

your absence, any build up of bilge water, gas or petrol fumes will be detected and relayed to the base station.

Cost of the basic system supplied by Monitronix is approximately \$300. Installation costs depend on boat design, but Monitronix indicate it would be about \$200 for the "average

sized" boat. A professional security company currently offers a monitoring only service for less than \$100 per year. Monitronix hope to convince the many marina operators and yacht clubs around the country to install the land-based monitor systems to provide a service to their subscribers or members. Details from Monitronix, 41 Guthrie St, Osborne Park 6017 W.A. (09)446 8699.

New Sennheiser headphones

Sennheiser has released a new enclosed dynamic type stereo headphone, the HD250 Linear. This model is said to represent the pinnacle of Sennheiser's extensive research and advancement programme of the past three years.

The objective behind the HD250 development was to produce the "ultimate" enclosed dynamic headphone, incorporating totally undistorted sound reproduction. Up until now, this has been difficult due to traditional problems associated with construction caused resonances.

The HD250 boasts many technological innovations in headphone design, according to Sennheiser. The use of new metal alloys in the magnetic system producing a much stronger magnetic field, ensuring closer coupling with the diaphragm thus lessening undesired resonances found in conventional systems. The drive coil is made from lightweight aluminium, reducing the moving mass and resulting in improved pulse behaviour, the makers say.

Weighing 25% less than most enclosed designs, this model



can be worn for long periods without fatigue, according to Sennheiser.

For further information, contact the distributors, Cunningham Consolidated Ltd, who have branches in Victoria (03)353 0791, Queensland (07)862 1234, Western Australia (09)478 3208 and NSW (02)909 2388.

Pioneer launches top-end range of hi-fi

With the release of a new range of hi-fi components, Pioneer once again moves back into the top-end market. Leading their new thrust are three "Reference Series" amplifier components, "designed exclusively for the connoisseur".

Pioneer say performance was a crucial factor in the design of the new range, the amplifiers featuring "third generation" non-switching circuitry and all components incorporating ribbed honeycomb chassis and cases (even heatsinks!) to reduce vibration and resonance effects.

The A91-D Reference Digital amplifier leads the pack. Rated at 120 W/ch, continuous output, 400 W peak (into 2 Ohms), it delivers a quoted 0.003% distortion and features a digital input with four-times oversampling digital filter and twin D-A converters.

The F91 tuner features a "Direct Digital Decoder" that digitizes the signal before decoding it to reduce the effects of interference that mar reception with analogue detectors. You can randomly preset 24 AM/FM stations and it has a three-programme memory for other functions such as time-

set.

The PDM-90X CD player features a 6-disc magazine and random play of up to 32 tracks, amongst other sophisticated programming functions. It sports both analogue and digital output and comes with an infra-red remote control.

See your local Pioneer dealer for further details on the range.

Mordaunt Short's new speakers

Concept Audio has just introduced the Series 2 versions of the highly successful Mordaunt Short loudspeaker range.

All speaker models, with the exception of the MS100 and MS300, sport a smart new look and the Series 2 "Ti" models feature a substantially re-designed bass unit and crossover to give a deeper bass response, "sweeter" mid-range and smooth improved integration with their titanium dome tweeter.

In common with all Mordaunt Short loudspeaker systems, the Series 2 products incorporate POSITEC protection circuitry to provide a total safeguard against all forms of overload and amplifier fault conditions. Prices on Mordaunt Short loudspeakers start at \$450.00 a pair.

For further information, contact: Concept Audio Pty Ltd, 17/98 Old Pittwater Road, Brookvale 2100 NSW. (02)938 3700.

Flush mount speaker system

The Boston Acoustics 360 is a two-way loudspeaker designed for flush installation in the walls or ceilings of rooms where the decor makes conventional speaker cabinets undesirable or inappropriate.

Although it is small enough to install unobtrusively in new or existing construction, the 360 offers the sound quality of a fine home loudspeaker system, the makers claim.

Each 360 features a specially designed long throw woofer for extended bass reproduction and a high performance one inch CFT dome tweeter.

Quoted frequency response extends from 48 Hz to 20 kHz, impedance is eight ohms and the recommended amplifier power is five to 60 watts. The 360 measures 213 mm x 300 mm and requires only 75 mm mounting depth.

Boston acoustics say homeowners will find uses for

the 360 in the recreation room, bathroom, kitchen, living room or as a rear channel speaker system in surround-sound applications.

Commercially, the 360 is an ideal high quality sound source for use in restaurants, lounges, churches and offices, Boston Acoustics say.

The 360 is supplied in a matte white finish, ready to install as is, or it can be painted to match the environment. An optional kit will be available for mounting the 360 in wall where studs are 16 inches apart. Suggested retail price for the 360 is \$599.00.

In addition to the 360, Boston acoustics has introduced the models 350 and 705 in their designer series range. Also designed for flush mounting, the two new models were created in response to an increasing demand for high quality stereo reproduction in

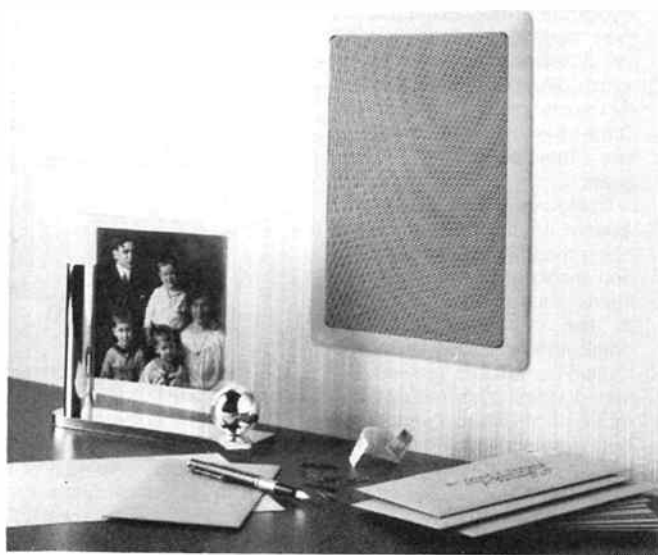

spaces previously thought impractical for conventional box speakers.

For further information on these models, as well as others

in the Boston Acoustics range, contact the Australian distributors: The Falk Electrosound Group, 28 King Street, Rockdale 2216 NSW. (02)597 1111.



DAVID REID ELECTRONICS

For the electronic enthusiast

"FLYING EAGLE" R/C CAR

★ With working lights & horn!



ONLY \$169⁹⁵

"AA" NICADS

1.2 V 450 mAh

limited stocks

\$2.95

HIGH VOLTAGE ELECTRO'S R.T.

1 mfd/350 volt	80¢
2.2 mfd/450 volt	95¢
4.7 mfd/450 volt	\$1.45
10 mfd/450 volt	\$1.75
22 mfd/450 volt	\$3.50
47 mfd/350 volt	\$4.95
47 mfd/450 volt	\$6.95
100 mfd/350 volt	\$5.95
100 mfd/450 volt	\$9.95

MUSIC BUOY

WATERPROOF RADIO

- ★ AM/FM
- ★ FLOATS ON WATER
- ★ FOR THE POOL, BEACH, ETC



ONLY \$49.50

CHRISTMAS FUN FOR THE KIDS!

"LCD" POCKET GAMES

- ★ FOUR DIFFERENT TYPES TO CHOOSE
- All one price



\$15.95 ea.

"MINI-DIN" CONNECTORS

PDM-3 3-PIN PLUG	-\$2.95
PDM-4 4-PIN PLUG	-\$2.95
PDM-5 5-PIN PLUG	-\$2.95
PDM-6 6-PIN PLUG	-\$2.95
PDM-7 7-PIN PLUG	-\$2.95
PDM-8 8-PIN PLUG	-\$2.95

IEC MAINS CONNECTORS

LINE MAIL	\$4.95
LINE FEMALE	\$3.95
CHASSIS PLUG	\$2.95
CHASSIS PLUG (FUSED)	\$5.80

AM/FM FOLDABLE HEADPHONE RADIO

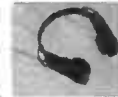

Value at **\$12.95**

EXTERNAL SPEAKERS FOR WALKMANS

- ★ JUST PLUG INTO HEADPHONE SOCKET



\$9.95

COMPACT DISC STORAGE CASE

- ★ HOLDS UP TO 20 DISCS



\$23.50

PORTASOL - BUTANE SOLDERING IRON "For people on the move"

SPARE TIPS AVAILABLE

- 1 mm
 - 2.4 mm
 - 3.2 mm
 - 4.8 mm
- ALL ONE PRICE \$12.95



COMPLETE WITH 2.4 mm TIP AND IGNITOR, COVER

A SPECIAL LOW PRICE AT

\$39.95

INPHONE - CORDLESS TELEPHONE

- Last No. Redial
- Security Coding
- Paging Facility
- 250m range



Ours is only **\$195!**

NEW GENERATION CORDLESS TELEPHONE WITH 2-WAY INTERCOM

- Full Security Coding
- 200m Range
- Wall or Desk Mount
- Last No. Redial

\$295.00

IBM PRINTER CABLE

- ★ 25-pin 'D' plug to Centronics
- ★ 1.75 m long

ONLY \$15.00

RS-232 GENDER CHANGERS

male to male	\$19.95
female to female	\$15.95
patch box	\$9.95

Mains Muffler - YOUR BEST INSURANCE



- Over-voltage protection, filtering out RF noise and spikes

2-outlet \$147.50 **4-outlet \$245.00**

FERGUSON STEPDOWN TRANSFORMERS 240 VOLT INPUT - 115 VOLT OUTPUT

50 watt	\$67.65	300 watt	\$139.50
60 watt	\$76.50	500 watt	\$217.50
125 watt	\$101.50	1000 watt	\$337.50
200 watt	\$107.75		



DAVID REID ELECTRONICS
127 YORK ST
SYDNEY 2000 PH: (02) 267 1385

BUSINESS HOURS
MON.-FRI. 8.30-5.30
THURS. 8.30-7.00
SAT. 8.30-12.00

MAIL ORDERS WELCOME
PO BOX Q103
SYDNEY 2000



\$1-\$25 - \$3.00 P+P
\$26-over - \$6.00 P+P

Kenwood LS 990 AD loudspeaker

Robert Fitzell

Robert Fitzell Acoustics AAAC

Kenwood has a well deserved and long standing reputation as a manufacturer of quality equipment. These loudspeakers gave our reviewer a few surprises.

TRIO KENWOOD Corporation is one of the names of the hi-fi industry that many have come to trust. Justifiably, the company can claim a good reputation marketing, amongst other things, a very well respected range of instruments (oscilloscopes especially) through a range of equally well respected audio system components. Many years ago, I was the proud owner of a Kenwood TK 250 U amplifier which, at 25 watts per channel, really lifted me into the big time. Whilst I was always a little frustrated that the TK 150 U 15 watt amp seemed to be a better amplifier, I was certainly one of the many satisfied Kenwood customers.

A new product on the market from Kenwood is the LS 990 AD loudspeaker. This is a relatively large loudspeaker aimed clearly at the hi-fi market. It is finished in a black walnut grained plastic timber laminate, 670 mm high by 355 mm wide by 320 mm deep. As with all Kenwood equipment, the quality of manufacture is impeccable and apart from the fact that it certainly won't match your antique furniture, the loudspeaker would fit in well with most furnishings.

A manual appraisal

On unpacking the loudspeakers, one of the most obvious features was the manual written entirely in Japanese. This is perhaps not so bad since many manuals for many pieces of equipment spend most of their time congratulating you on your purchase rather than giving any really useful information. Instead of having to wade through self indulgent drivel, the all Japanese manual presents a quite interesting challenge to determine the answers to the questions that are really interesting. The information I gleaned can (I hope!) be summarised as follows. It's a three-way loudspeaker featuring a 330 mm woofer, 100 mm mid range and 25 mm tweeter, with a nominal impedance of 6 ohms providing 92 dB per watt at one metre with power handling capacity probably of 75 watts. The frequency response appears to be a rather astonishing 28 Hz to 47 kHz with crossover frequencies of 600 Hz and 5 kHz. The weight of the enclosure appears to be 22 kg.

Of those figures, I am least certain of the power handling capacity figure since a value of 200 watts is given, probably the peak music power handling capacity, and the value of 75 watts, which is likely to be the RMS power handling capacity.

Having set the manual aside, it was obvious that any real information concerning performance and function would be gained by test and inspection.



REVIEW ITEM:	Loudspeaker
FORMAT:	Three-way vented enclosure
MANUFACTURER:	Trio-Kenwood
MODEL NO:	LS-990 AD
RECOMMENDED RETAIL PRICE:	
DISTRIBUTOR:	Kenwood Electronics (Aust.) 4E Woodcock Place, Lane Cove 2066

Overall features

The loudspeakers are, without doubt, a three-way system with driver dimensions as given. Both the mid-range and tweeter are aluminium chassis units with horn loading. Both drivers suffer from physical obstruction at the throat. The 12 inch (330 mm) bass driver uses a traditional vented enclosure and gives clean performance.

Connections to the rear of the loudspeaker are by banana plug and the remaining feature of significance is mid-range sensitivity and high frequency controls located on the front panel behind the cloth grille. This permits adjustment of the sensitivity of the mid-range and quite markedly changes the audio quality of the loudspeaker performance.

Figure 1. Free-field bass response.

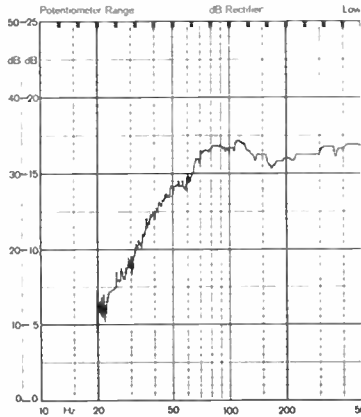

Subjective testing

Surprisingly, the LS 990 AD did not produce the bass response that I had expected. The loudspeaker uses a large enclosure with porting and appears to promise a lot more than it was able to deliver. Our testing used a number of amplifiers so did not appear to be the result of mis-match or other failure in the drive system.

For subjective testing we used a range of music sources, mostly from compact disc. Amongst these were Clannad, Vangelis, the Beethoven Emperor Concerto, Kiri te Kanawa, as well as chamber music compositions by Telemann. If the bass response was there, we certainly would have tapped it.

Nonetheless, the bass response was quite pleasant although lacking. The loudspeaker gives a reasonably tight bass with quite pleasant tonal quality.

More seriously, the mid-range unit I found quite disturbing. Initially, our subjective testing was conducted with the mid-range sensitivity set to the centre detent where most people would probably set the control. At this setting, I found listening fatigue very high and it was necessary to lower the mid-range sensitivity quite severely before colouration was adequately reduced. Perhaps the worst performance was with female voice, although to be honest, it was difficult to choose.

With the reduced mid-range sensitivity, I found the loudspeaker much more comfortable to audition. There remained, clearly, a level of mid-range colouration commonly associated with horn loaded loudspeakers. Whilst the horns in the Kenwood are not large, there are a number of physical obstructions around the throat to both upper range drivers and I suspect at least some of the colouration could be due to these. To be fair, I did not reach any firm conclusion concerning the quality of the tweeter, although this was due to my dislike of the mid-range rather than anything else.

As a subjective summary, I have to say that I did not like the LS 990 AD. As a Kenwood driver from way back, this really was a disappointment since the new products of the old stalwarts is something one usually hopes to feel familiar with. I must also say that whilst I would claim to have rather catholic tastes in music, if I have a leaning at all it is toward classical and acoustic instruments for which horn loading and rock loudspeakers do not produce good results.

My opinion is that the LS 990 AD is a useful loudspeaker for rock music although it does lack the very bottom end that one would normally want. This is likely to be a draw-back to its market penetration since a relatively large loudspeaker would not normally need the support of a sub-woofer. The loudspeaker has plenty of punch in the mid range and could carry percussion and brass instruments very well but is unlikely to be the choice of the classical music enthusiast.

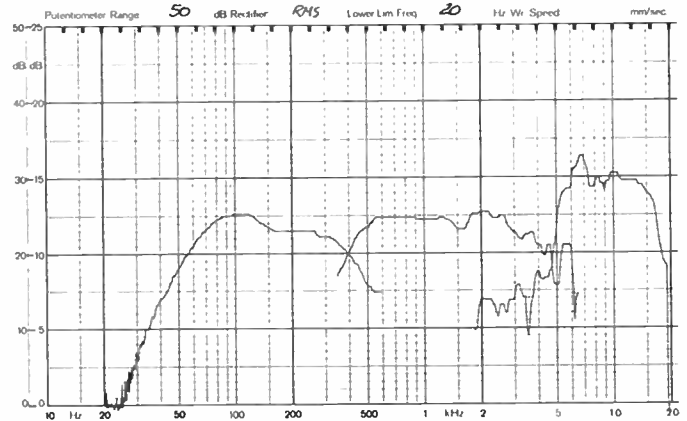

Figure 2. Near field response, mic. placed close to each driver. The "boosted" tweeter response is an artifact of the measuring technique and tweeter directivity.

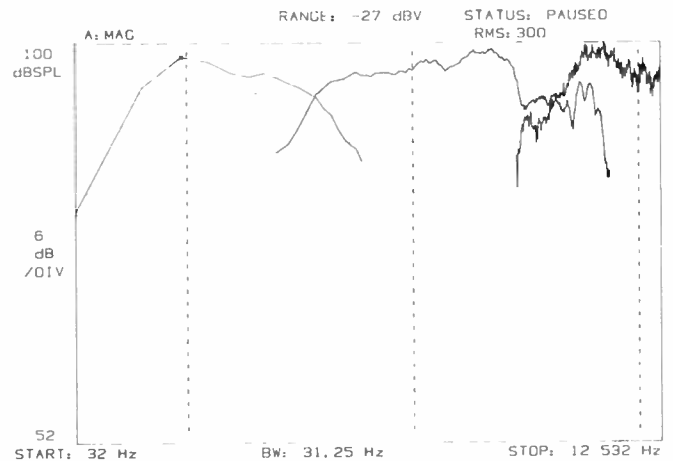

Figure 2a. Near field response with mic. placement adjusted when taking the tweeter response.

Measurements

Having got the disappointments out of the way, it was time to conduct some more objective testing. Initially, we ran some frequency response checks in free field. These provided some of the answers, at least in relation to low frequency performance. We consistently found low frequency roll-off to commence at about 80 Hz for the full range of input sources – swept sine wave, periodic noise and random noise. At the quoted performance of 28 Hz, we found response to be at least 10-15 dB down. Figure 1 shows the frequency response trace for a swept sine wave at far field up to 500 Hz. This trace makes an interesting comparison with the near field response results shown in Figure 2 in which the crossover points may also be seen. Looking at the bass end of Figure 1, the effect of the port may be seen at around 50 Hz.

Figure 2 shows the frequency response for each driver measured using the near field microphone technique. This technique uses a microphone located approximately 50 mm on the driver axis and in the case of the tweeter, is very sensitive to distance. For those that are disturbed by the apparent increase in sensitivity of the tweeter, this effect is partly due to the greater directivity of the tweeter and partly to distance corrections. Figure 2a is a repeat test using the same technique but with minor adjustment to the microphone position for the tweeter. It is clear from Figures 2 and 2a that the crossover frequencies for the LS 990 AD are approximately

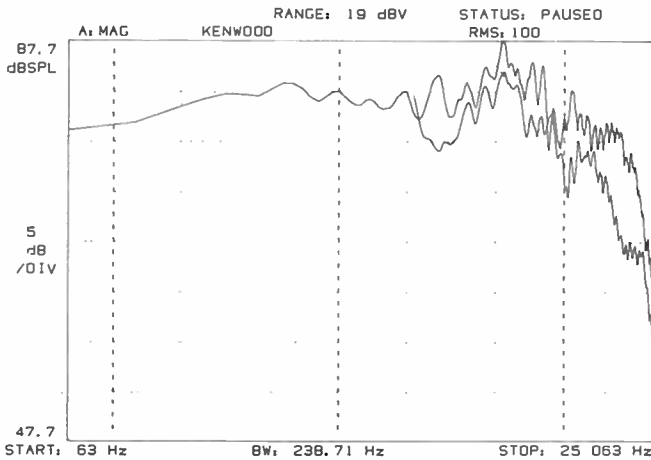

Figure 3. On-axis versus off-axis (at 45 degrees) response. Off-axis response starts to roll off at about 2 kHz.

400 Hz and 4.7 kHz. These values are in reasonable agreement with the owner's manual. Whilst the lower crossover response appears to be nicely symmetrical, crossover between the mid-range and tweeter is a lot less so.

Loudspeaker sensitivity was determined during set up at 93 dB for 1 W at 1 m with sine wave input. This also is very close to manufacturer's specifications.

Dispersion was found to be reasonably uniform in both vertical and horizontal directions. Figure 3 shows the on-axis and off-axis frequency response at a horizontal displacement of 45 degrees. Roll-off commences clearly by about 2 kHz, but is reasonably uniform with frequency. This is a good feature for domestic hi-fi since the frequency response throughout the room is more effectively preserved.

Distortion testing provided more clues to the deficiencies in loudspeakers' performance. Figure 4 shows the total harmonic distortion measured for a sine wave input at 1 W. Particularly bad is the very large increase in distortion seen for the test frequency at 6.3 kHz. We found it was possible to vary the distortion levels quite considerably according to the settings on the mid-range and high frequency drivers. However, the data given in Figure 4 applies to the settings I personally found least coloured and most pleasant for listening. These settings also appeared to give the lowest distortions in mid and high frequencies. However, it appeared impossible to reduce distortion around the upper crossover frequency. So whilst my first impression was that the mid-range driver was responsible for most of the distortion problems, I suspect the crossover might be equally or perhaps predominantly responsible for distortion in the upper mid-range.

Intermodulation test results are shown in Figures 5 and 6. The trace of Figure 5 should be read carefully since the distortion products seen below 1 kHz are in fact, harmonic distortion of the 250 Hz fundamental. Distortion at 8 kHz due to the 250 Hz fundamental is really very satisfactory as are the intermodulation distortions in Figure 6 centred on 11 and 12 kHz. In the latter case, the sidebands are 60 dB down on the fundamental. The distortion of the 250 Hz tone seen in Figure 5 was

typical of all distortion testing where the fundamental was below but close to the crossover frequency, where in all cases, a strong third harmonic content was evident.

A number of tone burst tests were conducted, the results of which are shown in Figures 7, 8 and 9. In each case, the lower trace is shown in compressed mode with the upper trace in expanded time mode. Of these traces, probably the 400 Hz tone burst result is the worst in terms of lack of damping after the transient.

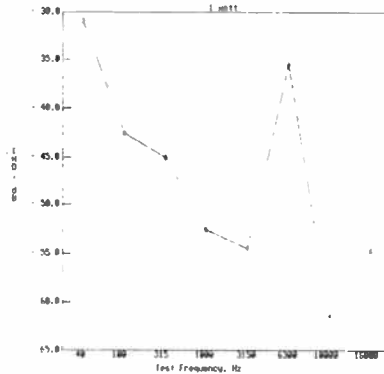

Figure 4. Total harmonic distortion response of the LS 990 AD loudspeakers.

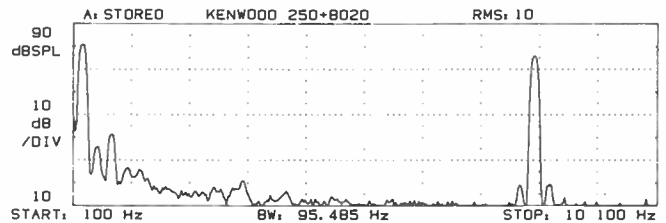

Figure 5. Intermodulation distortion, signals at 250 Hz and 8 kHz. The products below 1 kHz are harmonic distortion products of the 250 Hz fundamental.

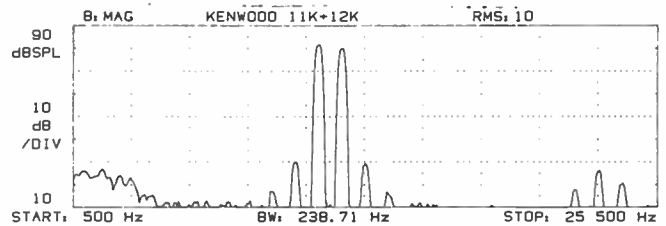
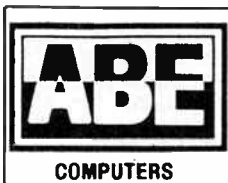

Figure 6. Intermod. distortion again, signals at 11 and 12 kHz. The sidebands are 60 dB down – a good result.

Impulse testing of the Kenwood loudspeaker is shown in Figures 10 and 11 for two settings of the mid-range driver. Both diagrams are magnitude maps showing frequency response on a logarithmic scale between 100 Hz and 20 kHz. Each trace shows time history moving from the top to the bottom of the diagram with an exponential window moving with a one millisecond overlap between traces. Figure 10 shows the time response for the loudspeaker with the mid-range set to the preferred listening condition whilst Figure 11 has the mid-range sensitivity set to maximum. In both cases, frequency response and delayed energy is very poor in the



MODEM OWNERS – FAX OWNERS
Protect Your Investment!
 Don't have your gear zapped by lightning.
 Use our Phone Line Protection/
 Isolation Device.
 Also good for answering equipment.

JUST \$29!

24 Burwood Highway, (Rd.)
 Burwood, 3125
 Telephone: 288 2144
 288 9067
 RBBS: 288 3599
 Fax: 288 0781
 Att: Max Elliott

BANKCARD-VISA-MASTERCARD WELCOME

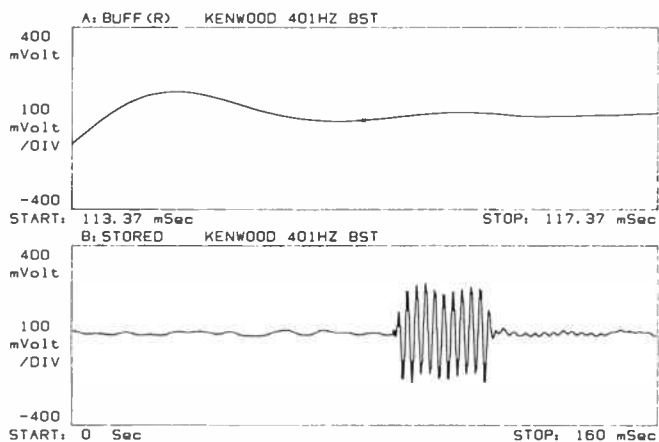

Figure 7. Tone burst testing, 401 Hz. The top trace is the expanded version of the bottom trace.

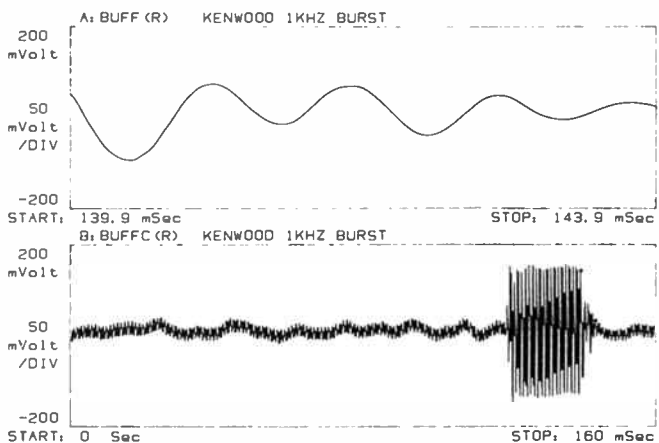

Figure 8. Tone burst testing at 1 kHz. Expanded trace at top.

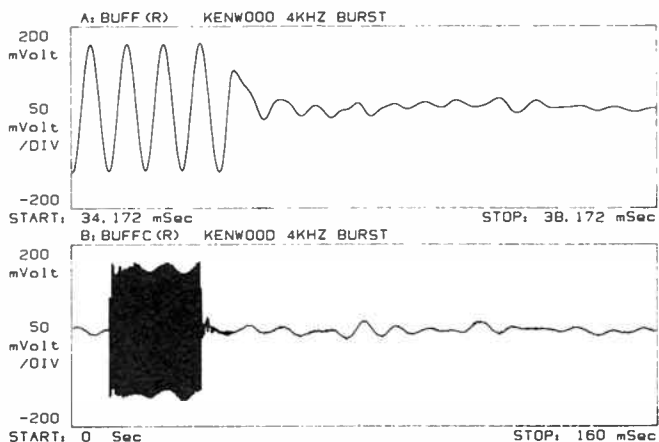

Figure 9. Tone burst testing at 4 kHz. Expanded trace at top, as before.

area centred around 6 kHz whilst with the mid-range set to maximum, there is significant although reasonably smooth, delayed energy throughout the full length of the time trace. Low frequency response also looks rather muddy, although resolution below about 300 Hz is limited by analyser bandwidth. Both magnitude maps show the response of the loudspeaker to be poor in the region of the upper crossover frequency and generally uneven throughout both of the upper driver frequency ranges.

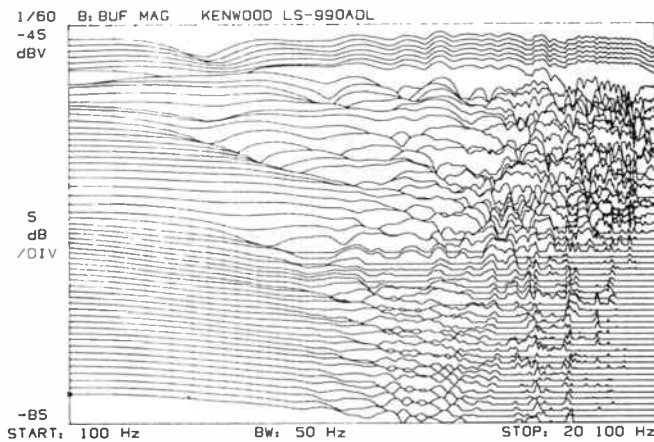

Figure 10. Impulse testing with the mid-range sensitivity control set at the preferred listening position.

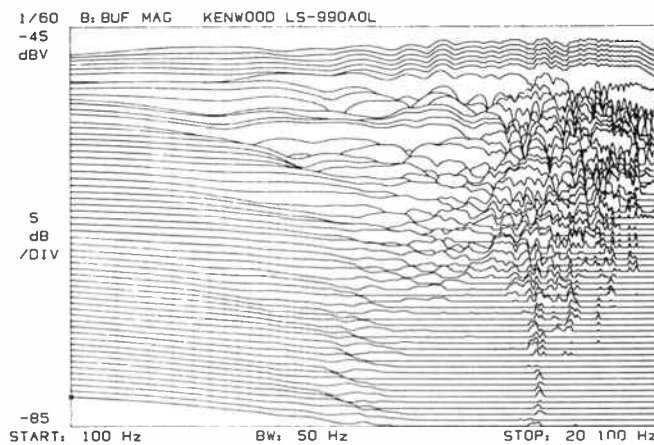

Figure 11. Impulse testing with the mid-range sensitivity set at maximum.

Summary

Overall, it is difficult to recommend the Kenwood loudspeaker. The cabinet work and construction quality is very good but only as we would expect from a manufacturer of this reputation. I feel the most suitable application for the LS 990 AD is with pop music where a reasonably high power handling capacity is sought. The loudspeakers are of robust construction and should perform well in areas where these qualities are important. If you are a lover of classical music I think you would be disappointed if you like jazz, then they are perhaps well worth an audition, although piano will still have clear limitations. Let's hope the Kenwood designers listen to soft strings and delicate chamber music before their next loudspeaker arrives on the scene.

ADMARKET

Readers' free adverts.

SIEMENS M100 Read Only teleprinter. Very good condition, \$40.00. R. Vowels, 93 Park Drive, Parkville 3052.

FIX-A-KIT repair/rebuild your AEM/ETI/EA project for \$15 per hour (parts, P&P extra). No charge for kits that can't be repaired (except P&P). Telephone Steve (02)633 5897 (a.h.).

VZ200/300 information. Le'VZ club: magazines, books, software etc. Send S.A.S.E to: Mr J D'Alton, 39 Agnes Street, Toowong 4066, Qld. Australia. Phone (07)371 3707.

SANTA FORCE

IS COMING TO TOWN



NI-CAD BATTERIES

	NORMALLY	1 UP	10 UP
AA 500mA	\$4.95	\$3.50	\$3.00
AA 600mA	\$6.95	\$4.50	\$4.00
C 1.8Ah	\$12.95	\$10.95	\$10.50
D 4Ah	\$16.95	\$10.95	\$10.50
9V VARTA	\$24.95	\$21.95	—

SCOOP PURCHASE



SOLAR POWERED CHARGER

Charges 4 AA NICAD batteries.

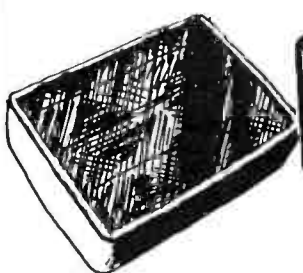

~~\$24.95~~
\$16.95

PLUG PACK NI-CAD CHARGER

M8005. Suits AA, C, D 9V.

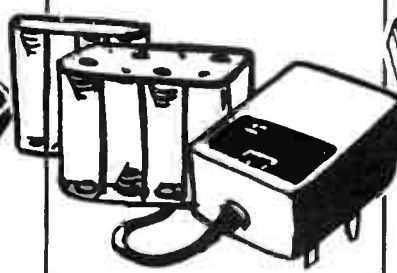

~~\$24.95~~
\$19.95

NI-CAD CHARGING CABINET

Suits most batteries. Even Button Cells. Built in test meter.



~~\$34.95~~
\$27.95

DELUXE CHARGING CABINET

Charges up to 23 cells from 1.2-12 VDC. And you can select current and voltage.

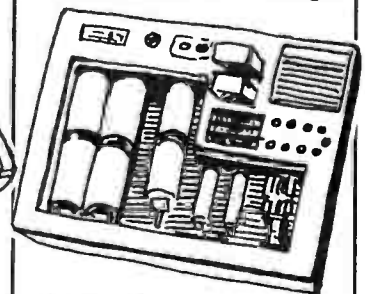

~~\$52.95~~
\$49.95

LABORATORY POWER SUPPLY

(KIT OR FULLY ASSEMBLED AND TESTED)

A truly professional piece of equipment. Digital readout gives greater accuracy. Specs: **Output voltage 0-55 volts, 100W.** Stability against mains variations, less than 1mV. Stability against load variations less than 2mV. Ripple voltage at any load; (50Hz) less than 1mV R.M.S.



CHRISTMAS SPECIAL

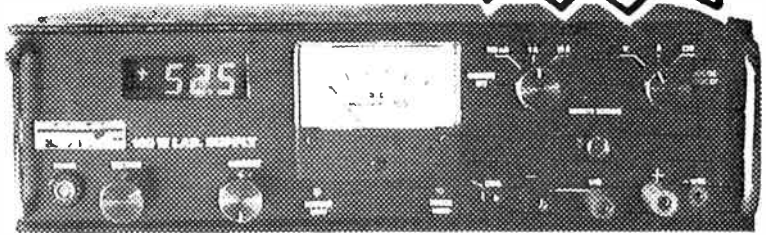

\$579 (KIT)

\$799 FULLY ASSEMBLED AND TESTED



E-36-4 4 SECTOR ALARM PANEL

\$275 INC. BATT. & POWER SUPPLY

FEATURES

- 24 hr. panic circuit
- 24 hr. tamper panic
- Home mode for partial coverage
- EOL monitoring of sectors
- Memory review of alarmed sector

DIGITAL DIALER TO SUIT **\$295**

SA-209 PIR DETECTOR

NORMALLY \$119
NOW **\$69.95** EACH

OR 3 FOR \$185.00

- Adjustable angle head. Multi-directional mounting bracket
- Dual pyroelectric infra-red sensing element
- 9 look out and 5 look down zones
- R.F. protection
- Selectable NC or NO
- Integral micro tamper switch
- Sensitivity adjustment
- Wall or ceiling mount
- Reed switch Relay for ultra quiet operation
- Coverage 12m x 12m at 20°C.

SA209 (40 ft. x 40 ft COVER AT 90°).

LIMITED OFFER
UNTIL SOLD OUT.

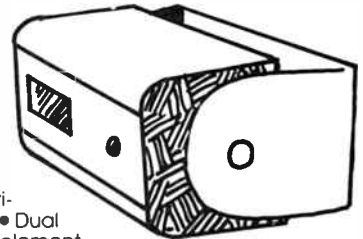

GET YOUR CLAUS INTO THIS!

(LIMITED STOCKS)

5 1/4" DSDD
FLOPPY DISCS



90c EACH

DISC STORAGE
BOX

Holds up to
50 5 1/4"
Floppy Discs

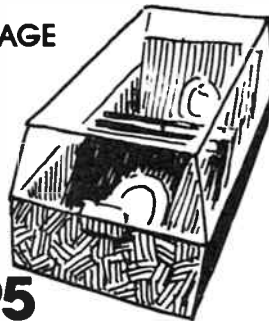

\$49.95

\$12.95

NEGATIVE ION
GENERATOR

Proven to improve the
atmosphere.
Helps clear
the mind!



\$49.95

FORCE

MAIL OR PHONE ORDERS TO ANY STORE
STANDARD MAIL UP TO 2kg \$4
O/N SERVICE UP TO 3kg \$700
ROAD FREIGHT OVER 10kg \$10.00

WE ACCEPT
BANKCARD,
VISA AND
MASTERCARD.

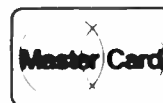

ADELAIDE
203 WRIGHT ST.
(08) 212 5400

ENFIELD
445 MAIN NTH. RD.
(08) 349 6340

CHRISTIES BCH.
24 BEACH RD.
(08) 382 3366

BRIGHTON
504 BRIGHTON RD.
(08) 296 3531

FINDON
129 FINDON RD.
(08) 347 1188

Chart it!



Kent Industries (Australia) Pty Ltd has announced the release of the Goerz/Metrawatt SE110 and SE111 battery/mains operated chart recorders which include digital display of the measured value, plus chart printing of measuring range and chart speed as a standard feature.

The SE110 offers 18 switch-selectable dc voltage ranges commencing at 1 mV dc full scale and with calibrated zero suppression up to 200%. The SE111 has 48 calibrated ranges from 150 mV to 750 V dc/ac and 0.6 mA to 6 A dc/ac.

Operation is by means of on-board batteries, external 12 V dc or mains supply. Twelve chart speeds from 1 cm/hr up to 600 cm/hr are provided and a range of accessories such as shunt resistors and clip-on current transformers are also available.

For further information, contact: **Kent Instruments (Aust) Pty Ltd, 70-78 Box Road, Caringbah 2229 NSW. (02)525 2811.**

Digital effects system from Amber

A new digital effects system has been released by Lexicon and will be distributed in Australia by Amber Technology. The new Lexicon model 480L enables recording studios to create a whole spectrum of dynamic, totally original effects and is the result of a two-year development programme.

This system is capable of 16 million operations per second, enabling the creation of sounds previously out of reach and a major feature of the design is in its ability to accept new generations of sound-producing

hardware and software, Lexicon say.

In a market flooded with reverb and effects devices, the Lexicon 480L is claimed to be unique, with its ability to create effects which are spontaneous and extraordinarily creative.

One of the outstanding benefits of the 480L is its multitasking ability. It can run any two of its programs (i.e. reverb and sampling) simultaneously. The programs can be used independently, or internally "patched" together in any of several flexible configurations.

In addition to its analogue inputs and outputs, the 480L is also equipped with a digital I/O connector. This allows the recordist to add signal processing to a stereo mix without ever leaving the digital domain.

For further information, contact **Amber Technology, Unit 6, Forestview Park Estate, Frenchs Forest 2086 NSW. (02)975 1211.**

Guide to fibre optics

Belden Electronics offers "A Guide to Fiber Optic System Design", an 18-page brochure designed to assist engineers in understanding and specifying fibre optic cable.

The new tutorial explains the considerable advantages of selecting fibre optic systems over typical metallic cable transmission systems.

Basic elements of optical

fibre, construction, system design considerations and cabling design considerations are also detailed. The brochure contains illustrations, graphs and diagrams to ensure precise clarification of terms and definitions.

For a copy of Belden's Guide to Fiber Optic System Design, contact: **Belden Electronics, PO Box 322, Clayton 3168 Victoria. (03)240 0448.**



Breathe easy

One of the greatest fears expressed by employees surrounds the quality of air in the workplace. As a result, an increasing number are demanding a guarantee that their work environment is free from contaminants.

This is the basic premise behind a range of light weight diffusion monitors from 3M. The badge-style monitors are simply clipped to the worker's lapel and worn in the workplace for no longer than eight hours. The sample gathered is then sent away to 3M for analysis of on-the-job exposure levels.

Employed periodically, the 3M monitors provide a cost effective means of monitoring airborne contaminants in such environments as the petrochemical, paint coating, plastics, synthetics, rubber and paint manufacturing industries.

All 3M monitors draw on the principle of diffusion to determine the time-weighted average concentration of airborne contaminants.

This method of sampling draws contaminant molecules from the worker's breathing zone down into a barrier film where it is captured for analysis in an absorbent wafer.

Confidential analysis is

included in the price of the monitors and is carried out by 3M through its subsidiary, Riker Laboratories. Despite their simple design, the 3M monitors exhibit excellent accuracy and high precision.

The head office of 3M is located at **950 Pacific Highway, (PO Box 99) Pymble 2073 NSW. (02)498 9333.**



Taking the static out of field calls

When a technician is servicing static sensitive electronics, there is a great risk of damaging micro-electronic components. The new 8501 static-dissipative portable field kit from 3M can quickly eliminate potentially hazardous static charges and provide a static free working surface.

The 3M 8501 is designed to remove any static charge on the technician and provide a static free surface on which parts can be placed.

The work surface is a red mat constructed from static-dissipative material and measures 5 mm x 560 mm x 610 mm. Two pockets are stitched on the mat's bottom edge, each being 200 x 280 mm in area. A female snap connector is located in the lower corner of the pocket for the kit's ground cord system.

The common-point grounding system consists of a 3M model 3051 ground cord with two coiled sections. One section is 1.5 m in length and the other measures 3 m when extended. The two sections snap together to the work surface using a large centre male snap connector.

The 1.5 m cord is terminated with a banana plug to connect the system to ground whilst the 3 m cord is terminated with a small snap connector for connection to the technician's wrist band. Each cord incorporates a one megohm resistor for safety.

For further information, contact your 3M dealer or the Head Office of 3M at **950 Pacific Highway, Pymble 2073 NSW. (02)498 9333.**

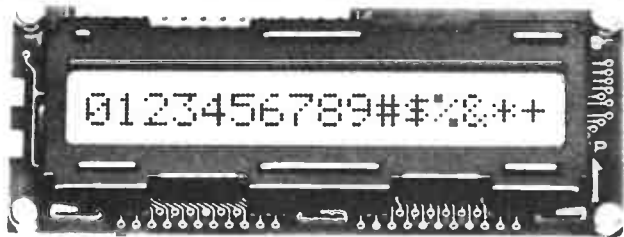

LED backlight LCD display

Amtex Electronics, Australian distributor for Optrex Corporation of Japan, one of the leading manufacturers of LCD displays for electronic, industrial and automotive applications, has extended its range of LCD dot matrix character and graphic displays to incorporate a series of LCD character displays with built-in LED backlighting.

The series is available in a choice of 16 character by one line, 16 character by two lines and 40 character by two lines. The LCD incorporates a single +5 V supply and inbuilt ROM and RAM.

Amtex Electronics stocks an extensive range of Optrex LCD

displays, including LED backlit units. A range of high contrast character displays with electroluminescence backlight is available in both a basic model or with extended temperature range of -20 to +70 degrees Celsius.

For large scale display, Amtex stocks the Optrex DMF series which feature high contrast and wide viewing angle. These units incorporate the new super twisted type LCD with or without electroluminescence and a 640x200 dot display using a cold cathode backlight, one of the most visible LCD displays ever developed, we're told.

For further information, contact: **Amtex Electronics, PO Box 10, Villawood 2163 NSW. (02)727 5444.**

The ultimate editing tool?

Claimed to be the ultimate audio editing tool, the BEL BDE 2600S, recently launched by Rebel Audio here, is a true stereo unit, they say, offering a new standard in stereo off line audio editing and sampling. Even if a performer has an "off" day and belches during a pianissimo phrase, or just "fluffs" a few notes, this editor can be employed to fix it.

The 2600S's versatility is built on its memory. This can be filled all at once, or a little at a time and any section of it can be loaded into any of 100 windows and then edited at both ends, pitch shifted, or triggered either manually or externally.

The windows can be sequ-

enced using one of the four internal sequencers. This means that up to 26 seconds of mono programme, or 13 seconds of true stereo programme can be completely re-arranged with pauses inserted or extracted and individual notes pitch corrected.

If a vocal track is ready for mixing except for one or two flat notes, it is possible to load a single line or complete chorus from the track into the BEL 2600S and pitch correct individual notes to as little as 1/50th of a semitone, giving a perfect performance. Pauses can even be inserted to replace audible breathing.

For further information on the BEL 2600S, contact: **Rebel Audio Pty Ltd, 104-106 Hampden Road, Fivedock 2046 NSW. (02)713 6866.**



Emona Instruments Test and Measuring Instrumentation.



At Emona we specialise in electronic test and measuring instrumentation, from the low cost, affordable models to the latest high-technology instruments.

Our range of instrumentation includes oscilloscopes from 20 MHz to 200 MHz, with digital storage, DC power supplies, electronic loads, function generators, signal

generators and analysers, and a full range of handheld and benchtop digital multimeters.

This list is by no means exhaustive. If its quality Kikusui test instruments and Asahi DPMs or Polar, the unique English electronic workshop fault finding instruments, Emona has all your test and measuring instrumentation needs.

For more information, circle the reader information number below or call Emona at (02) 510 3933, 86 Parramatta Rd., Camperdown 2050. Postal address Emona Instruments, P.O. Box K720, Haymarket 2000. Fax: (02) 550 1378.

EMONA

'THE TECHNOLOGY HOUSE'

Practical filter design — without fears or tears

Jack Middlehurst

Part 3 — Chebyshev filters

When you need a steep rolloff, Butterworth filters get rather complicated! A man called Chebyshev solved the problem of getting more (rolloff) for less (components). Let's hear it for Chebyshev!

AS WE HAVE SEEN, Butterworth filters are fine if you don't want a particularly steep slope in the stopband. What do you do if you need a filter with a cutoff frequency of 10 kHz that is down 30 dB at 12 kHz? If you run the program of Figure 2.2 it shows that you would need a Butterworth filter having an order of 19! Given time, patience, and sufficient money for the components you could build such a thing, but it would be rather bulky and not much fun to tune. For that reason, the program will not calculate the components for you. There are better ways of solving the problem.

If you have a Butterworth LP filter and deliberately mis-tune the sections, the filter response is no longer flat in the passband. Figure 3.1 shows the response of an aligned and a misaligned filter. Your first impression is that the result of misalignment is of no use to man nor beast. However, a second look shows that the slope of the response in the stopband is, at least for the first 10 dB, steeper than that of a correctly tuned filter. Might it be possible to fiddle with the tuning to maximize this slope without having to put up with too much ripple in the passband?

Chebyshev (Note 1) showed mathematically that there is indeed an optimum shape for the "misaligned" filter. He showed that, for filters that tend continually towards infinite attenuation in the stopband, the steepest slope possible is obtained if the tops of all the ripples in the passband are at the same height and the bottoms of the valleys between the peaks are also all at the one height. In other words, in the passband, the frequency response looks a bit like a sine wave. Filters having frequency responses of this shape are known as equiripple filters.

It turns out that, to get zero ripple in the passband, the individual tuned circuits in Butterworth filters have to be critically coupled, whereas to arrive at an equiripple condition those in a Chebyshev filter must be overcoupled. This difference in coupling means that the ratios of the Ls to the Cs in the two types must be different. In general, the Qs of the tuned circuits in Chebyshev filters are higher than those in Butterworth filters of the same order.

Chebyshev filters

The great advantage of Chebyshev filters is that you have more control over the shape of the filter frequency response curve. The amount of ripple in the passband affects the maximum steepness of the filter in the stopband adjacent to the cutoff frequency. The more the ripple you can tolerate, the steeper the slope you can get in the stopband. So you now have an extra variable to play with.

Figure 3.2 shows the enormous improvement in slope that can be achieved by allowing just 0.1 dB ripple in the passband of a 7th order Chebyshev compared with a 7th

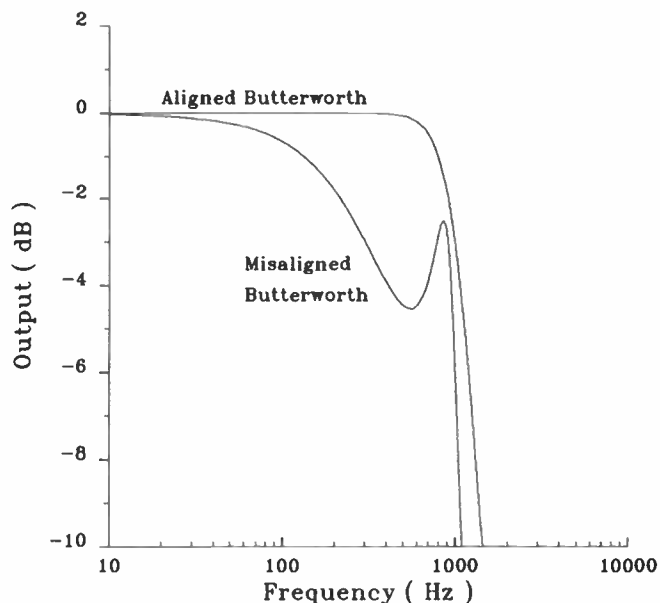

Figure 3.1. Comparison of frequency response of aligned and misaligned Butterworth filters.

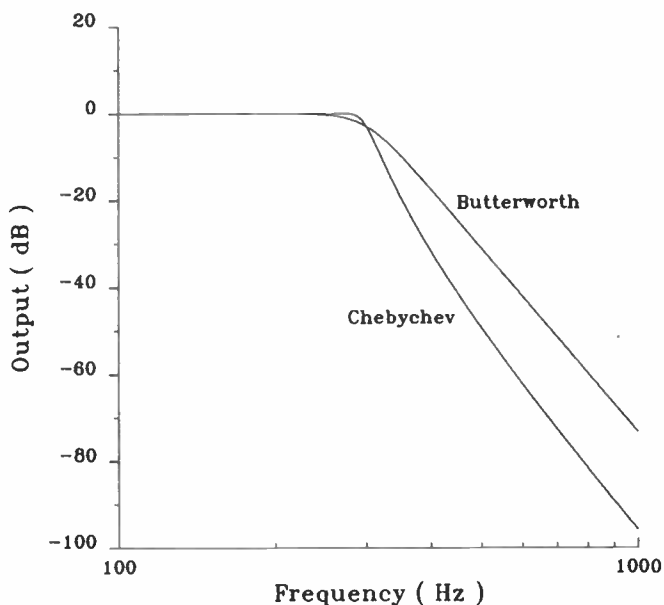

Figure 3.2. Frequency response of 7th order Butterworth and Chebyshev LP filters. $F_c = 300$ Hz, Chebyshev ripple = 0.1 dB.

NOTE 1. Translating the Russian cyrillic alphabet into English characters is a lot of fun. Consequently you will find Chebyshev spelt Tschebysheff, Tschebychev, Chebysheff and so on. They are all the same person; it simply means that, if you can't find him and his filters under C in the index in a book on filters, try looking under T!

order Butterworth filter. At frequencies a long way from cutoff, the slopes of the two filters are the same, but by then the actual attenuation of the Chebychev is 20 dB more than that of the Butterworth. Note particularly the increased sharpness of the "corner" of the Chebychev filter just before the cutoff frequency (300 Hz) and the steep slope at cutoff.

Figure 3.3 shows in detail the ripple in the passband of a 3rd and a 4th order Chebychev LP filter having an allowable ripple of 3 dB (to make it easier to see) and a cutoff frequency of 1000 Hz. As expected, the tops of the peaks are all at 0 dB and the bottoms of the valleys are all at -3 dB. You will also notice that, for odd-order filters, the attenuation is 0 dB at zero frequency. For even-order filters, the response is down by the ripple amplitude at zero frequency.

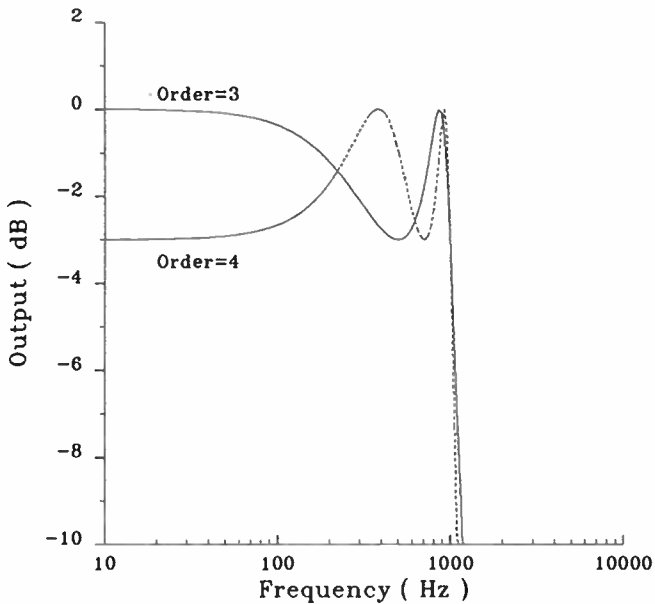

Figure 3.3. Passband ripple of Chebychev LP filters of order 3 and 4. The filter ripple has been deliberately chosen as 3 dB to make the differences easily visible.

Because the ripple amplitude is so important in Chebychev filters, it is common to specify the bandwidth or cutoff frequency as being where the frequency response is down by the ripple amplitude rather than by 3 dB. For both Butterworth and Chebychev filters we will stick to the convention that the cutoff frequency is where the response is down by 3 dB. Incidentally, don't be put off by the apparently enormous ripple in Figure 3.3, the scale has been exaggerated to make it easier to see. For audio work, it would be rare for the ripple to be chosen larger than 0.25 dB, and often it is specified at less than 0.1 dB. However, it is worth repeating that the selection of the ripple amplitude is at the discretion of the designer, in this case you!

Because even-order Chebychev filters do not have 0 dB loss at zero frequency, even-order LC filters cannot be designed to have equal source and load resistors. At high frequencies, filters are usually inserted in 50, 52, or 75 Ohm coaxial lines or 300 Ohm parallel balanced transmission lines. For professional audio work, LC filters would be inserted in 600 Ohm twisted pair or shielded cable. It is extremely inconvenient to have to change impedance levels up and down in such lines; for example, imagine trying to put a filter in a 300 Ohm TV lead if the filter would only work with a source resistance of 425 Ohms and a load resistance of 300 Ohms. Designing and making the necessary transformer is not easy.

Similarly, a transformer is needed to operate even-order Chebychev filters in audio lines. Particularly if high fidelity is being attempted, such transformers are expensive. So, when you read handbooks about Chebychev LC filters, and ▶

Figure 3.4. GWBASIC program to calculate the components of Chebychev LC filters of odd order.

Line 50 defines the hyperbolic trigonometric functions and their inverses needed in the calculations.

Lines 60 & 70 set up the display for output.

Lines 140-280 contain traps against hitting wrong keys.

Line 230 checks whether the frequency requested is in the stopband.

Lines 300-330 WN is the frequency ratio.

Line 340 N is the order.

Lines 380-390 calculate constants needed later. F1 is the factor to convert from the ripple cutoff frequency to the 3 dB cutoff.

Lines 400-420 are the main part of the program.

Lines 450-690 the factors convert the Ls & Cs to practical units.

Lines 730-800 calculate the tuning frequencies for LP & HP filters

Lines 810-840, 850-880, & 940-990 are subroutines to put the values of the components in convenient units.

Lines 890-930 display the tuning components and frequencies.

```

10 PRINT "          Design of"
20 PRINT "          Odd order LC"
30 PRINT "    Chebychev LP, HP, BP, & BR filters."
40 PRINT "    Copyright Aguila Holdings Pty Ltd 1987":PRINT
50 DEF FNACOSH(X)=LOG(X+SOR(X*X-1)):DEF FNSINH(X)=(EXP(X)-EXP(-X))/2:DEF FNASINH(X)=
  LOG(X+SOR(X*X+1))
60 A4$="Tune L("A7$=") to "A9$=")C("A12$="D("A13$=") F("
70 A1$="L("A2$="C("A3$=")":PI=3.141592654#:LGE=.434294481#
80 PRINT "What type of filter would you like to design"
90 PRINT "1. Low pass "
100 PRINT "2. High pass "
110 PRINT "3. Band pass "
120 PRINT "4. Band reject "
130 PRINT "5. None, Quit."
140 INPUT "Please enter the appropriate integer."X
150 IF X=5 THEN 990
160 IF (X<1 OR X>5)THEN 80
170 INPUT "What is the value [ Ohms ] of the source (&load)
  resistance ?":R:IF R<=0 THEN 170
180 IF (X=1 OR X=2)THEN INPUT "What is the cutoff frequency
  [ Hz ] ?":FC:IF FC<=0 THEN 180 ELSE 220
190 INPUT "What is the centre frequency [ Hz ] ?":
  FC:IF FC<=0 THEN 190
200 INPUT "What is the bandwidth [ Hz ] ?":BW:IF BW<=0 THEN 200
210 FL=(-BW+SOR(BW*BW+4*FC*FC))/2:FU=FL+BW:IF FL<=0 THEN PRINT
  "That bandwidth is too wide for the centre frequency.":GOTO 190
220 INPUT "At what frequency [ Hz ] in the stopband is the
  attenuation known ?":F1:IF F1<=0 THEN 220
230 IF (X=1 AND F1<FC) OR (X=2 AND F1=FC) OR (X=3 AND (F1=
  FL AND F1<FU)) OR (X=4 AND (F1=FL OR F1=FU))THEN 240 ELSE 250
240 PRINT "That frequency is not in the stopband.": GOTO 220
250 IF (X=4 AND F1=FC)THEN PRINT "Sorry I can't use the centre
  frequency, please choose another frequency.":GOTO 220
260 INPUT "What is the attenuation [ dB ] at that frequency ?":
  AMAX:IF AMAX<=3 THEN PRINT "There must be more than 3 dB
  attenuation in the stopband.":GOTO 260
270 INPUT "What ripple would you like in the passband [ dB ] ?":
  RIFL: IF RIFL<0 THEN 270
280 IF RIFL/6 THEN PRINT " That ripple is ridiculous.":GOTO 270
290 ON X GOTO 300,310,320,330,790
300 WN=F1/FC : GOTO 340
310 WN=FC/F1 : GOTO 340
320 WN=ABS((F1-F1-FC)/BW/F1) : GOTO 340
330 WN=ABS((F1-BW/(FC-FC-F1*F1))
340 N=INT(FNACOSH(SOR((10^(1+AMAX)-1)/(10^(1-RIFL)-1))
  )/FNACOSH(WN))+1:IF N MOD 2=0 THEN N=N+1
350 IF X=1 OR X=2 THEN N1=N:N2=10 ELSE N1=2*N:N2=19
360 PRINT "This filter is of order "N":ANGLE=PI/N
370 IF N>2 THEN PRINT "Sorry I can only calculate components
  for filters of order less than"IN2 : GOTO 80
380 W0=2*PI*FC : IF (X=3 OR X=4)THEN BW=2*PI*BW
390 EP=SOR(10^(1-RIFL)-1):Y=10^(RIFL/40):GAMMA=
  FNSINH(LOG((Y+1/Y)/(Y-1/Y))/2/N):NF=FNACOSH(FNACOSH(1/EP)/N)
400 FOR I=1 TO N:A(I)=SIN((2*I-1)*ANGLE/2):B(I)=
  GAMMA/2*(SIN(I*ANGLE)) 2
410 IF I=1 THEN G(I)=2*A(I)/GAMMA:GOTO 430
420 G(I)=4*A(I-1)*A(I)/B(I-1)/G(I-1)
430 IF I MOD 2=1 THEN C(I)=NF*G(I)/R ELSE 570
440 ON X GOTO 450,470,490,530,990
450 C(I)=C(I)/W0 : GDSUB 930

```

Figure 3.7. GWBASIC program to calculate the components of the dual circuits in Figure 3.6.

Lines 350-430 the factors convert the Ls and Cs to practical units.

Lines 470-550 calculate the tuning frequencies.

Lines 560-590,600-630, and 680-730 are subroutines to put the values of the components in convenient units.

Lines 640-660 display the tuning components and frequencies.

Calculates the Ls and Cs of Chebychev LP & HP "dual" filters of odd order.

To print the output change PRINT to LPRINT in lines 360,380,420,440,640,650, and 660.

```

10 PRINT "          Design of"
20 PRINT "          LC odd order"
30 PRINT "          Chebychev LP & HP dual filters"
40 PRINT "          Copyright Aquila Holdings Pty Ltd 1987":PRINT
50 DEF FNACOSH(X)=LOG(X+SQ(X*X-1)):DEF FNSINH(X)=(
    (EXP(X)-EXP(-X))/2:DEF FNCOSH(X)=(EXP(X)+EXP(-X))/2:
    DEF FNASINH(X)=LOG(X+SQ(X*X+1))
60 A4$="Tune L(A7$=") to A9$=")C(A12$="O(A13$=" F("
70 A1$="L(A2$="C(A3$=")":PI=3.141592654#:LGE=,434294481#
80 PRINT "What type of filter would you like to design ?"
90 PRINT "1. Low pass "
100 PRINT "2. High pass "
110 PRINT "3. None, Quit."
120 INPUT "Please enter the appropriate integer.,"X
130 IF X=3 THEN 680
140 IF(X<1 OR X>3)THEN 80
150 INPUT "What is the value [ Ohms ] of the source (load)
    resistance ?":R:IF R=0 THEN 150
160 INPUT "What is the cutoff frequency [ Hz ] ?":FC:
    IF FC=0 THEN 160
170 INPUT "At what frequency [ Hz ] in the stopband is the
    attenuation known ?":F1:IF F1=0 THEN 170
180 IF(X=1 AND F1<=FC) OR (X=2 AND F1>=FC)THEN 190 ELSE 200
190 PRINT "That frequency is not in the stopband.":GOTO 170
200 INPUT "What is the attenuation [ dB ] at that frequency ?"
    AMAX:IF AMAX<=3 THEN PRINT "There must be more than 3 dB
    attenuation in the stopband.":GOTO 200
210 INPUT "What ripple would you like in the passband [ dB ] ?"
    RIPL: IF RIPL<0 THEN 210
220 IF RIPL>6 THEN PRINT " That ripple is ridiculous.":GOTO 210
230 ON X GOTO 240,250,750
240 WN=F1/FC : GOTO 260
250 WN=FC/F1 : GOTO 260
260 N=INT(FNACOSH(SQR((10^(1+AMAX)-1)/(10^(1+RIPL)-1)
    )/FNACOSH(WN))+1:IF N MOD 2=0 THEN N=N+1
270 PRINT "This filter is of order ":N:ANGLE=PI/N
280 IF N>9 THEN PRINT "Sorry I can only calculate components
    for filters of order less than 10.": GOTO 80
290 W0=2*PI*FC
300 EP=SQ(10^(1+RIPL)-1):Y=10^(RIPL/40):GAMMA=
    FNSINH(LOG((Y+1/Y)/(Y-1/Y)))/2/N:NF=FNCOSH(FNACOSH(1/EP)/N)
310 FOR I=1 TO N:A(I)=SIN((2*I-1)*ANGLE/2):B(I)=
    GAMMA+2*(SIN(I*ANGLE))^2
320 IF I=1 THEN G(I)=2*A(I)/GAMMA:GOTO 340
330 G(I)=4*A(I-1)*A(I)/B(I)/G(I-1)
340 IF I MOD 2=0 THEN C(I)=NF*G(I)/R ELSE 400
350 ON X GOTO 360,380,750
360 C(I)=C(I)/W0 : GOSUB 690
370 PRINT USING "\#\#\#\#\#\#\#\#\#\#\#\" "\":A2$,I,A3$,S,

```

Line 50 defines the hyperbolic trigonometric functions and their inverses needed in the calculations.

Lines 60 and 70 set up the display for output.

Lines 150-220 contain traps against hitting wrong keys.

Line 180 checks whether the frequency requested is in the stopband.

Lines 240-250 WN is the frequency ratio.

Line 260 N is the order.

Line 290 calculates constants needed later. NF is the normalizing factor to convert from the ripple cutoff frequency to the 3 dB cutoff.

Lines 300-320 are the main part of the program.

```

A6$ : GOTO 400
380 L(I)=1/W0/C(I) : GOSUB 570
390 PRINT USING "\#\#\#\#\#\#\#\#\#\#\#\" "\":A1$,I,A3$,S,
A5$ : GOTO 400
400 IF I MOD 2=1 THEN L(I)=NF*G(I)*R ELSE 460
410 ON X GOTO 420,440,750
420 L(I)=L(I)/W0 : GOSUB 570
430 PRINT USING "\#\#\#\#\#\#\#\#\#\#\#\" "\":A1$,I,A3$,S,
A5$ : GOTO 460
440 C(I)=1/W0/L(I) : GOSUB 690
450 PRINT USING "\#\#\#\#\#\#\#\#\#\#\#\" "\":A2$,I,A3$,S,
A6$ : GOTO 460
460 NEXT I
470 ON X GOTO 480,540,750
480 FOR I=1 TO N STEP 2:C(I-1)=C(I+1)/(C(I-1)+C(I+1))
490 IF(I<>1 AND I<>N)THEN 510
500 IF I=1 THEN C=C(2) ELSE C=C(I-1)
510 F=1/2/PI/SQR(L(I)*C):GOSUB 610:IF I=1 THEN GOSUB 660:
GOTO 530 ELSE 520
520 IF I=N THEN GOSUB 650 ELSE GOSUB 670
530 NEXT I:GOTO 750
540 FOR I=2 TO N-1 STEP 2:C(I-1)+C(I+1)
550 F=1/2/PI/SQR(L(I)*C):GOSUB 610:IF I=1 THEN GOSUB 660:
ELSE GOSUB 670
560 NEXT I:GOTO 750
570 IF L(I)>1 THEN S=L(I):A5$=" Henrys ":GOTO 600
580 IF L(I)>.001 THEN S=L(I)*1000:A5$=" milliHenrys":GOTO 600
590 S=L(I)*1000000:A5$=" microHenrys"
600 RETURN
610 IF F>=1000000 THEN F=F/1000000:A8$=" MHz":GOTO 640
620 IF F>=1000 THEN F=F/1000:A8$=" kHz":GOTO 640
630 A8$=" Hz "
640 RETURN
650 PRINT USING "\#\#\#\#\#\#\#\#\#\#\#\" "\":A4$,I,A9$,
I-1,A7$,F,AB$:GOTO 680
660 PRINT USING "\#\#\#\#\#\#\#\#\#\#\#\" "\":A4$,I,A9$,
I+1,A7$,F,AB$:GOTO 680
670 PRINT USING "\#\#\#\#\#\#\#\#\#\#\#\" "\":A4$,I,
A9$,I-1,A9$,I+1,A7$,F,AB$
680 RETURN
690 IF C(I)>1 THEN S=C(I):A6$=" Farads ":GOTO 740
700 IF C(I)>.001 THEN S=C(I)*1000:A6$=" milliFarads":GOTO 740
710 IF C(I)>.000001 THEN S=C(I)*1000000:A6$=" microFarads":
GOTO 740
720 IF C(I)>1E+09 THEN S=C(I)*1E+09:A6$=" nanoFarads ":GOTO 740
730 S=C(I)*1E+12:A6$=" picaFarads "
740 RETURN
750 END

```

THE WORLD OF ELECTRONICS IS GETTING SMALLER

WE HAVE PRODUCED A BEVY OF
SMALL SEALED LEAD ACID
RECHARGABLE BATTERIES



PS610
6 VOLT 1 AMP PER HR
OF SQUARE CONSTRUCTION



**THE SOPHISTICATED
PS1207**
COMPLETE WITH
PLUG CONNECTIONS



PS605
6 VOLT 1/2 AMP PER HR
SAME SIZE AS 3AA BATTERIES



PS412
4 VOLT 1.2 AMP
PER HR



POWER-SONIC AUSTRALIA
13 Watson Rd, PADSTOW 2211
Ph: (02) 772 4522 Fax: (02) 772 4863

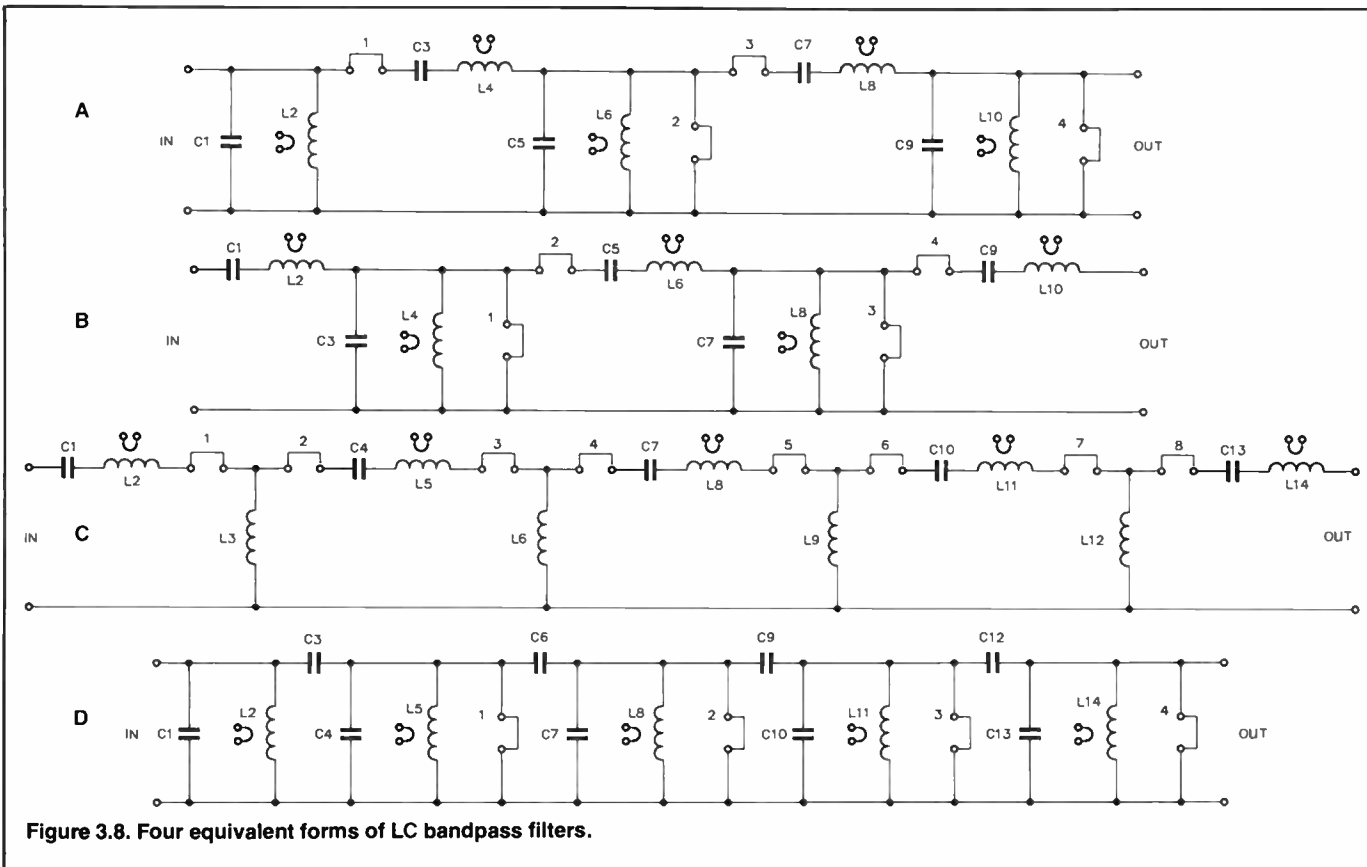

Figure 3.8. Four equivalent forms of LC bandpass filters.

of transmission line filter. For the design of these you will have to consult appropriate text books.

Because of their use in telecommunications, a lot of work has been put into the design of alternative forms of bandpass filters to try and make the component values more practicable. Figure 3.8 shows at a) the standard form that we have

already seen in Figure 2.1; at b) is its dual; at c) is the form in which all the shunt inductors have the same value, and at d) is the form in which all the series capacitors have the same value (the dual of c).

Filters c) and d) contain more components than the original filter and, indeed, should really be called 14th order fil-

Figure 3.9. GWBASIC program to calculate the components of Chebychev BP filters using the four configurations of Figure 3.8.

Line 50 defines the hyperbolic trigonometric functions and their inverses needed in the calculations.

Lines 60 and 70 set up the display for output.

Lines 140-250 contain traps against hitting wrong keys.

Line 220 checks whether the frequency requested is in the stopband.

Line 270 WN is the frequency ratio.

```

10 PRINT "          Design of "
20 PRINT "          Chebychev LC Bandpass Filters"
30 PRINT "Designs odd order filters for the 4 bandpass circuits
in Figure 3.8."
40 PRINT "          Copyright Aquila Holdings Pty Ltd 1987." : PRINT
50 DEF FNACOSH(X)=LOG(X+SQR(X*X-1)):DEF FNSINH(X)=
(EXP(X)-EXP(-X))/2:DEF FNCOSH(X)=(EXP(X)+EXP(-X))/2:
DEF FNASINH(X)=LOG(X+SQR(X*X+1))
60 A4$="Tune C(";A7$=") to ";A9$=")C(";A10$=")L(";A11$="Tune L("
70 A1$="L(";A2$="C(";A3$=")";PI=3.141592654#:
LGE=.434294481#:SW=0
80 PRINT "What type of BP filter would you like to design ?"
90 PRINT "1. Figure 3.8 a "
100 PRINT "2. Figure 3.8 b "
110 PRINT "3. Figure 3.8 c "
120 PRINT "4. Figure 3.8 d "
130 PRINT "5. None, Quit."
140 INPUT "Please enter the appropriate integer.",X
150 IF X=5 THEN 970
160 IF (X<1 OR X>5) THEN 80 ELSE IF SW=1 THEN 380
170 INPUT "What is the value [ Ohms ] of the source (&load)
resistance ?",R:IF R<=0 THEN 170
180 INPUT "What is the centre frequency [ Hz ] ?",FC:
IF FC<=0 THEN 180
190 INPUT "What is the bandwidth [ Hz ] ?",BW:IF BW<=0 THEN 190
200 FU=(BW+SQR(BW*BW+4*FC*FC))/2:FL=FU-BW:IF FL<=0 THEN PRINT

```

Line 280 calculates constants needed later.

Line 290 N is the order.

Line 320 calculates constants needed later. NF is the factor to convert from the ripple cutoff frequency to the 3 dB cutoff.

Lines 330-350 are the main part of the program.

Lines 400-710 the factors convert the Ls and Cs to practical units.

Lines 730-810 calculate and display the tuned circuit components and their tuning frequencies.

Lines 830-860, 870-900, and 910-960 are subroutines to put the values of the components in convenient units.

```

" That bandwidth is too wide for the centre frequency.":GOTO 180
210 INPUT "At what frequency [ Hz ] in the stopband is the
attenuation known ?",F1:IF F1<=0 THEN 210
220 IF (F1)=FL AND F1<=FU THEN 230 ELSE 240
230 PRINT "That frequency is not in the stopband.": GOTO 210
240 INPUT "What is the attenuation [ dB ] at that frequency ?",
AMAX:IF AMAX<=3 THEN PRINT "There must be more than 3 dB
attenuation in the stopband.":GOTO 240
250 INPUT "What ripple would you like in the passband [ dB ] ?",
RIPL:IF RIPL<=0 THEN 250
260 IF RIPL>6 THEN PRINT " That ripple is ridiculous.":GOTO 250
270 WN=ABS((F1-F1-FC*FC)/BW/F1):W0=2*PI*FC:BW=2*PI*BW
280 N1=1/R/BW:N2=R*BW/W0/W0:N3=BW/R/W0/W0:N4=R/BW:N5=R/W0:N6=
1/R/W0:N7=W0/BW
290 N=INT(FNACOSH(SQR((10^(1*AMAX)-1)/(10^(1*RIPL)-1))
)/FNACOSH(WN))+1:IF N MOD 2=0 THEN N=N+1
300 PRINT "This filter is of order ";2*N:ANGLE=PI/N
310 IF N>9 THEN PRINT "Sorry I can only calculate components
for filters of order less than 19.": GOTO 80
320 EP=SQR(10^(1*RIPL)-1):Y=10^(RIPL/40):GAMMA=
FNSINH(LOG((Y+1/Y)/(Y-1/Y))/2/N):NF=FNCOSH(FNACOSH(1/EP)/N)
330 FOR I=1 TO N:A(I)=SIN((2*I-1)*ANGLE/2):B(I)=
GAMMA^2+(SIN(I*ANGLE))^2
340 IF I=1 THEN G(I)=2*A(I)/GAMMA:GOTO 360

```

ters, not 10th order. However the frequency response of all of the filters is the same, so these two are often called modified 10th order bandpass filters. Incidentally, because of the way in which bandpass filters are derived from LP filters, some texts use the same order for both, i.e. the above filters would be called 5th order filters, not 10th. We will stick to the convention of using the number of frequency dependent components as the filter order.

There are many other forms of bandpass filters but we will concentrate on the four shown in Figure 3.8. Clearly, the first two designs are the simplest. They only have N components each, where N is the original filter order. The third and fourth designs have 3N/2-1 components each but N/2-1 of them are the same which makes them only slightly more complicated to build; they are, however, more expensive. All of the filters are quite easy to tune.

Figure 3.9 is a GWBASIC program that calculates the values of the Ls and Cs for the four circuits of Figure 3.8. To show the effect of using the different circuits, Figure 3.10 is a print-out of the components for each circuit for a Chebyshev BP filter with Fc = 1 kHz, Rsource = Rload = 600 Ohms, passband ripple = 1 dB, order = 10. You can see that circuit 3.8a has capacitors up to 3 uF and inductors up to 1/2 Henry (500 mH or 0.5 H), both of which may be inconvenient. Circuit 3.8b reduces the maximum capacitance, but at the price of needing 1.5 H inductors. Circuit 3.8c probably has the easiest range of components to obtain, but circuit 3.8d only uses low value inductors that are easiest to build. So the choice depends entirely on your particular preferences.

Tuning bandpass filters

The program of Figure 3.9, as well as giving the component values, lists those components that make up each tuned circuit. This is to simplify the problem of where to put the links on the pc board so that the circuits can be tuned. The appropriate links are indicated in Figure 3.8 for the 10th order filters shown. With the first two filters, each series or parallel tuned

Figure 3.10. Component values for 4 BP filters calculated using the program of Figure 3.9. a) standard form b) dual of a) c) uniform shunt inductor design d) uniform series capacitor design [the dual of c)].

Component values for the four types of BP filter in Figure 3.8 for a filter having :

Rsource = Rload = 600 Ohms, Centre frequency = 1000 Hz, Bandwidth = 200 Hz, Attenuation = 30 dB at 1200 Hz, passband ripple = 1 dB. Chebyshev BP filter, order = 10.

Circuit 3.8a	Circuit 3.8b	Circuit 3.8c	Circuit 3.8d
C (1) 2.927 uF	24.037 nF	C (1) 24.037 nF	C (1) 2.556 uF
L (2) 8.653 mH	1.054 H	L (2) 920.224 mH	L (2) 8.653 mH
C (3) 47.031 nF	1.496 uF	L (3) 133.575 mH	C (3) 371.041 nF
L (4) 538.582 mH	16.931 mH	C (4) 24.037 nF	L (4) 2.243 uF
C (5) 4.115 uF	17.100 nF	L (5) 807.561 mH	L (5) 8.653 mH
L (6) 6.156 mH	1.481 H	L (6) 112.664 mH	C (6) 312.955 nF
C (7) 47.031 nF	1.496 uF	C (7) 24.037 nF	C (7) 2.301 uF
L (8) 538.582 mH	16.931 mH	L (8) 828.472 mH	L (8) 8.653 mH
C (9) 2.927 uF	24.037 nF	L (9) 112.664 mH	C (9) 312.955 nF
L (10) 8.653 mH	1.054 H	C (10) 24.037 nF	L (10) 2.243 uF
		L (11) 807.560 mH	L (11) 8.653 mH
		L (12) 133.575 mH	C (12) 371.041 nF
		C (13) 24.037 nF	C (13) 2.243 uF
		L (14) 920.224 mH	L (14) 8.653 mH

circuit is easily isolated and tuned. With the last two filters, each tuned circuit is more complicated, consisting of one capacitor and three inductors for the third, and one inductor and three capacitors for the fourth filter. The first and last tuned circuits of c) and d) only have three components.

With band pass filters, all tuned circuits are aligned at the centre frequency. If you have a signal generator with a low output impedance (less than 1 Ohm), you can inject directly into the series tuned circuits. If you like the idea of direct injection and your generator has, say, 50 Ohms output impedance, you can probably get enough signal by dividing the output down with a 47 Ohm and 1 Ohm resistor in series. Taking the output across the 1 Ohm resistor will give the necessary low impedance.

If you do this, you don't really need to have single turn tun-

— to page 110. ▶

```

350 G(I)=4*(I-1)*A(I)/B(I-1)/G(I-1)
360 NEXT I
370 FOR I=1 TO N: G(I)=NF*G(I):NEXT I
380 FOR I=1 TO N: ON X GOTO 390,430,470,590,970
390 IF I MOD 2=1 THEN C=N*(I)+N1:L=N2/G(I):GOSUB 910:
GOSUB B30:GOTO 410
400 C=N3/G(I):L=N4*G(I):GOSUB 910:GOSUB B30
410 PRINT USING "\####\#####.###" ";A2$,
1+2*(I-1),A3$,SC,A6$
420 PRINT USING "\####\#####.###" ";A1$,2*I,
A3$,SL,A5$: GOTO 720
430 IF I MOD 2=1 THEN C=N3/G(I):L=N4*G(I):GOSUB 910:
GOSUB B30:GOTO 450
440 C=N1*G(I):L=N2/G(I):GOSUB 910:GOSUB B30
450 PRINT USING "\####\#####.###" ";A2$,
1+2*(I-1),A3$,SC,A6$
460 PRINT USING "\####\#####.###" ";A1$,
2*I,A3$,SL,A5$: GOTO 720
470 C=N3/G(I):GOSUB 910
480 PRINT USING "\####\#####.###" ";A2$,
1+3*(I-1),A3$,SC,A6$
490 IF (I=1 OR I=N) THEN 530 ELSE L=
N5*G(I)*(N7-1/SQR(G(I)*G(I-1))-1/SQR(G(I)*G(I+1))):GOSUB B30
500 PRINT USING "\####\#####.###" ";
A1$,2+3*(I-1),A3$,SL,A5$
510 L=N5*G(I)/SQR(G(I)*G(I+1)):GOSUB B30
520 PRINT USING "\####\#####.###" ";A1$,
3+3*(I-1),A3$,SL,A5$:GOTO 720
530 IF I=N THEN 570 ELSE L=
N5*G(I)*(N7-1/SQR(G(I)*G(2))):GOSUB B30
540 PRINT USING "\####\#####.###" ";A1$,
2,A3$,SL,A5$
550 L=N5*G(I)/SQR(G(I)*G(2)):GOSUB B30
560 PRINT USING "\####\#####.###" ";A1$,3,
A3$,SL,A5$:GOTO 720
570 L=N5*G(I)*(N7-1/SQR(G(I)*G(I-1))):GOSUB B30
580 PRINT USING "\####\#####.###" ";A1$,
3*-1,A3$,SL,A5$:GOTO 720
590 IF (I=1 OR I=N) THEN 640 ELSE C=
N6*G(I)*(N7-1/SQR(G(I)*G(I-1))-1/SQR(G(I)*G(I+1))):GOSUB 910
600 PRINT USING "\####\#####.###" ";A2$,
1+3*(I-1),A3$,SC,A6$
610 L=N2/G(I):GOSUB B30:PRINT USING "\####\#####.
###" ";A1$,2+3*(I-1),A3$,SL,A5$
620 C=N6*G(I)/SQR(G(I)*G(I+1)):GOSUB 910
630 PRINT USING "\####\#####.###" ";
A2$,3+3*(I-1),A3$,SC,A6$:GOTO 720
640 IF I=N THEN 690 ELSE C=
N6*G(I)*(N7-1/SQR(G(I)*G(2))):GOSUB 910
650 PRINT USING "\####\#####.###" ";A2$,1,A3$,SC,A6$

```

```

660 L=N2/G(I):GOSUB B30:PRINT USING "\####\#####.
###" ";A1$,2+3*(I-1),A3$,SL,A5$
670 C=N6*G(I)/SQR(G(I)*G(2)):GOSUB 910
680 PRINT USING "\####\#####.###" ";A2$,
3,A3$,SC,A6$:GOTO 720
690 C=N6*G(I)*(N7-1/SQR(G(I)*G(I-1))):GOSUB 910
700 PRINT USING "\####\#####.###" ";A2$,
1+3*(I-1),A3$,SC,A6$
710 L=N2/G(I):GOSUB B30:PRINT USING "\####\#####.
###" ";A1$,2+3*(I-1),A3$,SL,A5$
720 NEXT I
730 F=F:GOSUB B70
740 FOR I=1 TO N:ON X GOTO 750,750,760,790
750 PRINT USING "\
###\###\
###.###" ";A4$,
2*I-1,A10$,2*I,A7$,F,AB$:GOTO 820
760 IF (I=1 OR I=N) THEN 770 ELSE PRINT USING
"\
###\###\
###.###" ";A11$,3*(I-1),A9$,
1+3*(I-1),A10$,2+3*(I-1),A10$,3+3*(I-1),A7$,F,AB$:GOTO 820
770 IF I=N THEN 780 ELSE PRINT USING "\
#\#\
###.###" ";A4$,1,A10$,2,A10$,3,A7$,F,AB$:GOTO 820
780 PRINT USING "\
###\###\
###.###" ";A11$,
3*(I-1),A9$,1+3*(I-1),A10$,2+3*(I-1),A7$,F,AB$:GOTO 820
790 IF (I=1 OR I=N) THEN 800 ELSE PRINT
USING "\
###\###\
###.###" ";A4$,3*(I-1),
A9$,1+3*(I-1),A10$,2+3*(I-1),A9$,3+3*(I-1),A7$,F,AB$:GOTO 820
800 IF I=N THEN 810 ELSE PRINT
USING "\
###\###\
###.###" ";A4$,1,A10$,2,A9$,3,
A7$,F,AB$:GOTO 820
810 PRINT USING "\
###\###\
###.###" ";A4$,
3*(I-1),A9$,1+3*(I-1),A10$,2+3*(I-1),A7$,F,AB$:GOTO 820
820 NEXT I: GOTO 970
830 IF L>1 THEN SL=L:A5$=" Henries " :GOTO 860
840 IF L>.001 THEN SL=L*1000:A5$=" milliHenries":GOTO 860
850 SL=L*1000000!:A5$=" microHenries"
860 RETURN
870 IF F>=1000000! THEN F=F/1000000!:A5$=" MHz":GOTO 900
880 IF F>=1000 THEN F=F/1000:A5$=" kHz":GOTO 900
890 A5$=" Hz "
900 RETURN
910 IF C>1 THEN SC=C:A6$=" Farads " :GOTO 960
920 IF C>.001 THEN SC=C*1000:A6$=" milliFarads":GOTO 960
930 IF C>.000001 THEN SC=C*1000000!:A6$=" microFarads":GOTO 960
940 IF C>1E-09 THEN SC=C*1E+09:A6$=" nanoFarads " :GOTO 960
950 SC=C*1E+12:A6$=" picaFarads "
960 RETURN
970 INPUT "Would you like to try a different circuit with the
same data [ Y or N ] ?";Y$
980 IF (Y$="Y" OR Y$="y") THEN SW=1:GOTO B0
990 PRINT "End of programme.":END

```



in AEM

CONTENTS

PROJECTS

IEC-Centronics Interface 34

Low-noise Mic Preamp 38

SSB Adaptor 40

ARTICLES

High Current Switching Regulator Simplifies Supply Design 42

Switch-mode Power Supplies 45

The Positive Impedance Converter 50



The projects and circuits chosen for inclusion in the Elektor section are selected on the basis of interest, local relevance and component availability. Intending constructors should consult our 'PROJECT BUYERS GUIDE' in this issue for a guide to component sources and possible kit suppliers.

The contents of this section are copyright,

© Uitgeversmaatschappij Elektuur B. V. (Beek, the Netherlands) 1986.

Any infringement of this copyright will be prosecuted to the full extent, including unauthorised manufacture of pc boards intended for re-sale.

THE DIGITAL AUDIO TAPEREORDER

Earlier this year, a number of Japanese manufacturers introduced a new type of personal taperecording system, which has become known as Digital Audio Taperecorder-DAT. Although this system ran into immediate problems with the combined might of the western world's record makers and composers' and music writers' organizations (which at the time of writing have still not been wholly resolved), it appears that it is here to stay.

There is as yet no standard for the DAT or the tape cassettes, although proposals have been submitted to the International Electrotechnical Commission. Data, standards, and specifications referred to in this article are as contained in those proposals.

Cassette

The information carrier is a magnetic tape of 3.81 mm width rolled on flangeless hubs installed in a cassette with a slider and a lid protecting the tape from accidental damages. The tape is a metal powder type or its equivalent.

Information is recorded on oblique tracks formed by helically scanning magnetic heads and can be erased by overwriting. Information is read by magnetic heads that follow the tracks with the aid of Automatic Track Finding-ATF.

The external dimensions of the cassette are 73 x 54 x 10.5 mm: it is thus somewhat smaller than the compact audio cassette.

Recorder mechanism

The mechanism of the recorder resembles that of a video cassette recorder-VCR—but it is somewhat smaller (roughly the same size as the mechanism of a Video-8 machine).

The rotary head drum has a diameter of 300 mm and rotates at a velocity of 2000 rev/min. The angle at which the tape lies around the drum is 90°. The nor-

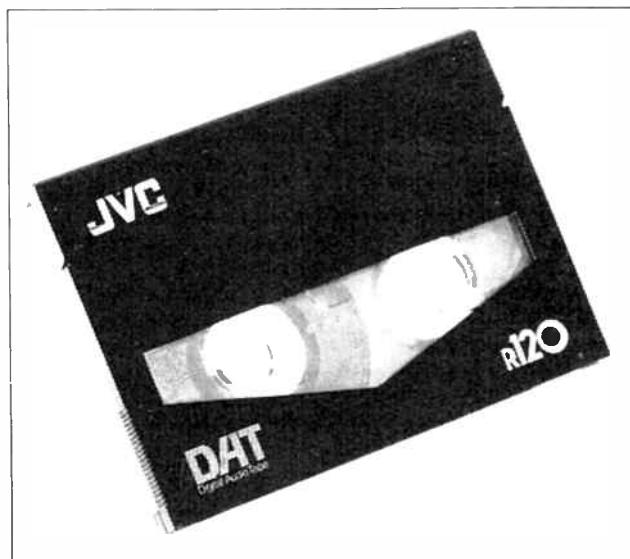
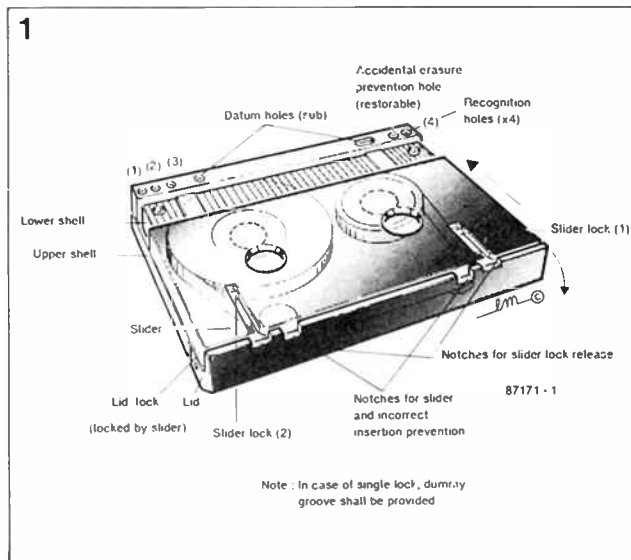

Fig. 1. The digital audio tape cassette is somewhat smaller than the compact audio cassette.

mal tape speed is low: only 8.150 mm/sec. The resulting relative tape speed is, therefore, 3.130 m/sec (the tape speed in a VHS video recorder is 4.85 m/sec). Other tape speeds are: 4.075 mm/sec (half speed) and 12.225 mm/sec (wide track).

The track pitch is 13.591 μ m in normal track mode and 20.410 μ m in wide track mode. The track length is 23.501 mm (normal mode) and 23.471 mm (wide track mode).

The track angle (tape running) is 6°22'59.5" in the normal mode and 6°23'29.4" in the wide track mode. The azimuth angle of the two heads is $\pm 20^\circ \pm 15'$ (see Fig. 3).

The above, and some other, data are summarized in Table 1. Since there are only two heads and the tape runs along only a quarter of the drum diameter

Table 1

Tape width	3.810 mm
Recording width	2.613 mm
Track centre	1.905 mm
Tape speed (normal)	8.150 mm/s
(half speed)	4.075 mm/s
(wide track)	12.225 mm/s
Track length	23.501 mm
Track pitch (normal)	13.591 μ m
(wide track)	20.410 μ m
Track angle (normal)	6°22'59.5"
(wide track)	6°23'29.4"
Head azimuth	$\pm 20^\circ \pm 15'$
Optional track 1	0.5 mm
Optional track 2	0.5 mm

Table 1. Tape specifications (normal mode).

(see Fig. 3), the heads will scan the tape for only half the total usable time. This means that the data have to be stored on the tape in time-compressed form: during reading they have to be expanded again. The output signal of the heads is shown in Fig. 4.

The small angle between the tape and the head drum gives the advantage that pull on the tape is small, and also that even during fast forward or rewind operation the tape can remain in contact with the drum. This is essential to facilitate finding a specific passage on the tape quickly (at 200 times normal tape speed). The pull on the tape is then about the same as that on normal video tape.

Recording parameters

Recording parameters are summarized in Table 2. Information is recorded on a main data area as well as on a sub data area, exactly as on a compact disc. However, the sub data area is about 4.5 times as large as that on a CD.

The composition of a single track is shown in Table 3. It is seen that the largest part of the available space is occupied by modulation and subcodes, but the track also contains synchronization data and Automatic Track Following—ATF—zones. These zones enable automatic tracking of the heads. The individual function blocks are separated by the Inter Block Gaps—IBG. This separation is necessary to enable writing in the sub data area without affecting the modulation data. In principle, only the main data and sub data areas are of importance to the user, because these are the parts that are audible to him.

From analogue to PCM

It is seen from Table 2 that the normal recording and playback sampling frequency is 48 kHz (the other sampling frequencies will be reverted to later). Sampling is carried out at a resolution of 16 bits. This means that every 21 μ s a portion of the analogue input signal is translated into a 16-bit code. This happens simultaneously for the left-hand and right-hand channels. The digital data are

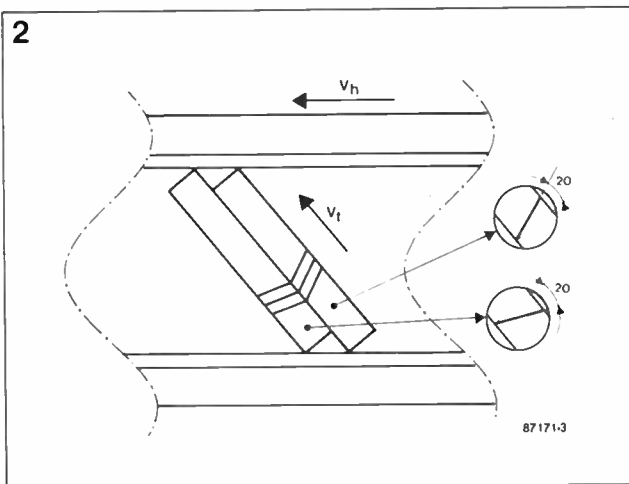

Fig. 2. Arrangement of the tracks on the tape.

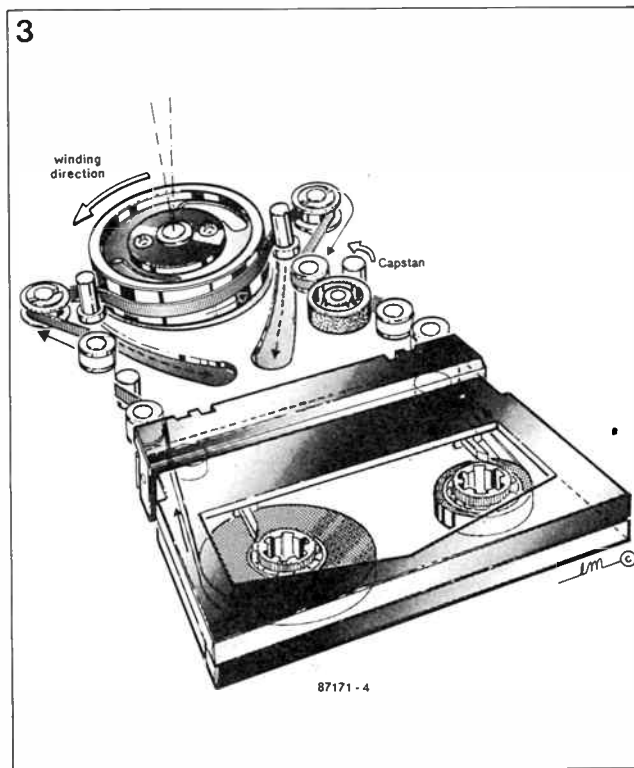

Fig. 3. Exploded view of a digital audio tape cassette.

Table 2

Number of channels	2 (optionally 4)
Sampling frequencies	48 kHz; 44.1 kHz; 32 kHz
Quantization	16 bits linear (optionally 12 non-linear)
Encoding	2 complement
Error correction	double Reed-Solomon code
Sub code	273.1 kbit/s
PCM capacity (each track)	4 kbit
ID codes	68.3 kbit/s
ID capacity (each track)	1 kbit
Transfer speed	2.46 Mbit/s
Information density	114 Mbit/in ²

Table 2. Technical parameters of the DAT system.

subsequently processed in serial form. The data stream consists, therefore, of $48 \times 10^3 \times 16 \times 2 = 1.536$ Mbit/s.

Processing of PCM data

The PCM data are encoded according to the Reed-Solomon code, which is also used in CD technology. However, in contrast to the CD process, the DAT technique uses the product code of two Reed-Solomon codes, which results in an inner and an outer code. The inner code contains the data bits and the parity bits derived from these according to a certain pattern. This encoded block is surrounded by the outer code, which forms its own parity bits form data contained in the inner code. After this, the data are interleaved, i.e., shifted in time, to enable reconstruction of a possibly lost data bit.

The Reed-Solomon coding and interleaving result in a data redundancy of about 37%, which causes the data stream rate to increase to some 2.45 Mbit/s. Added to this are the sub data information, such as the sampling frequency, the number of channels, copy protection, and so on, which finally gives a data stream rate of 2.77 Mbit/s.

The data thus composed are divided into blocks of 288 bits. The modulation zone of a track can contain 128 of these blocks, each comprising 32 bytes: a total of 4096 bytes. Of these, only 2912 bytes are real data: the remainder serve for error correction.

To increase the reliability even further, the data are divided into blocks, each of which contains the even samples of one channel and the odd ones of the other channel. These blocks are cross-interleaved onto the \pm azimuth tracks as shown in Fig. 6. In this way, even when a complete track is lost, or a head malfunctions, reconstruction is possible by interpolation of the adjoining tracks.

Since the heads are in contact with the tape for only 50% of the time, the data can not be read or written in real time. The PCM data are, therefore, stored in a 2×64 kbit auxiliary memory at the sampling frequency, then read at a higher clock frequency, and subsequently writ-

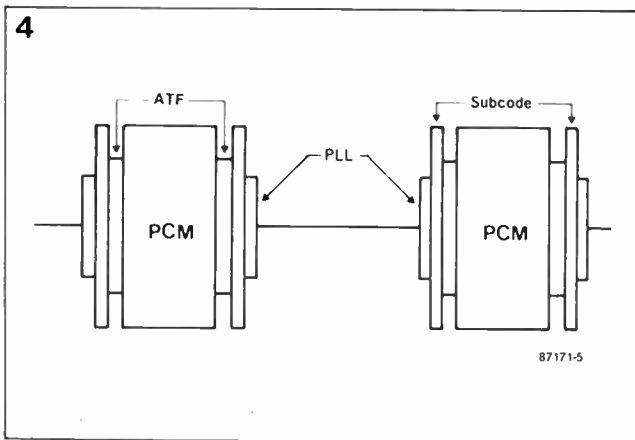

Fig. 4. The output signal of the heads consists of a series of bursts.

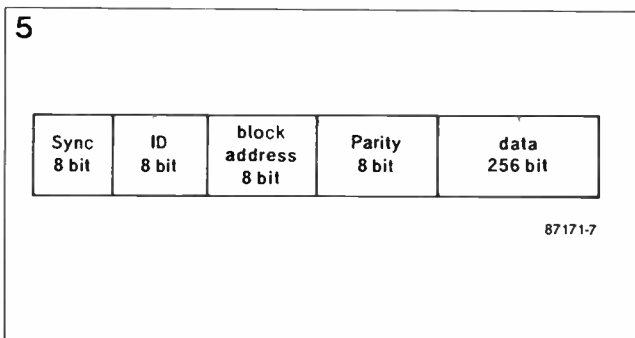

Fig. 5. The composition of the main data area in Table 3.

ten onto the tape. In this manner, the rate of the original 2.46 Mbit/s data stream is increased to 7.5 Mbit/s.

Modulation of data

When writing the data onto the

tape, they are not truly modulated, but subjected to an 8-to-10 conversion. Because of the consequent Non Return to Zero—NRZ—a signal edge is only generated if the bit is 1. In this way, the frequency spectrum on the tape is reduced, which is necessary in view of

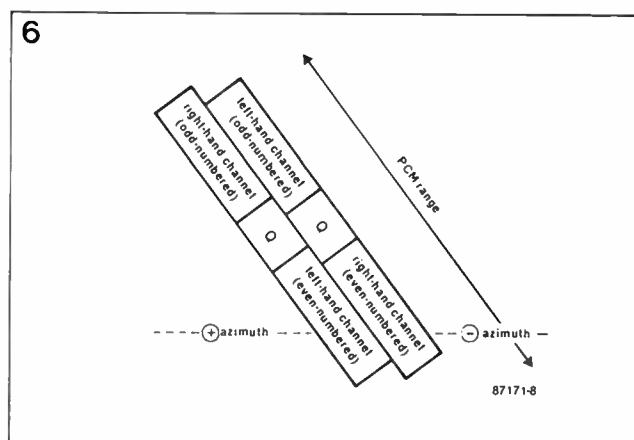

Fig. 6. Illustrating the cross-interleaving of the channels in the modulation range. Areas Q are separation zones between the data areas.

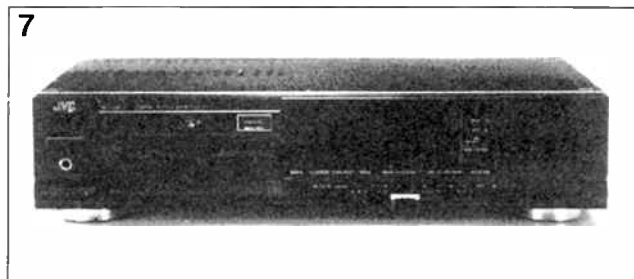

Fig. 7. The JVC Digital Audio Taperecorder.

certain properties of the heads and the tape.

Playback

During playback, the operations of the recording process are carried out in reverse order.

First, the clock frequency is extracted from the HF signal produced by the heads, after which the signal is reconverted from 10 to 8 bits. Subsequently, the cross-interleaving of the data has to be negated, for which the same 2x64 bit auxiliary memory is used. Here, the data are first written and then read again in the correct order. The sub data are separated from the remainder of the information and fed to the system control circuits.

Next, an error correction is carried out with the aid of the double-coded Reed-Solomon code. After this, digital sound data are available which can be processed in a manner similar to those in a CD player. These data are controlled by a digital-to-analogue converter, which may operate with twice or four times oversampling to avoid the necessity of steep-skirted analogue filters.

Sampling frequencies

So far, it has been assumed that the input signal is analogue, for which the sampling frequency is 48 kHz. This frequency is also used for the copying of other DAT tapes (but

Table 3

Areas	Contents	Number of blocks
Marginal area	Margin 1	11
Sub area 1	Pre-amble 1	2
	Sub data area 1	8
	Post amble 1	1
ATF area 1	IBG 1	3 (2)
	ATF 1	5 (7.5)
	IBG 2	3 (1.5)
Main area	Pre-amble 2	2
	Main data area	128
ATF area 2	IBG 3	3 (2)
	ATF 2	5 (7.5)
	IBG 4	3 (1.5)
Sub area 2	Pre-amble 3	2
	Sub data area 2	8
	Post amble 2	1
Marginal area	Margin 2	11

Note: The number in parentheses is for wide track mode.

Table 3. The format of a track (signal allocation) is in accordance with this table.

8

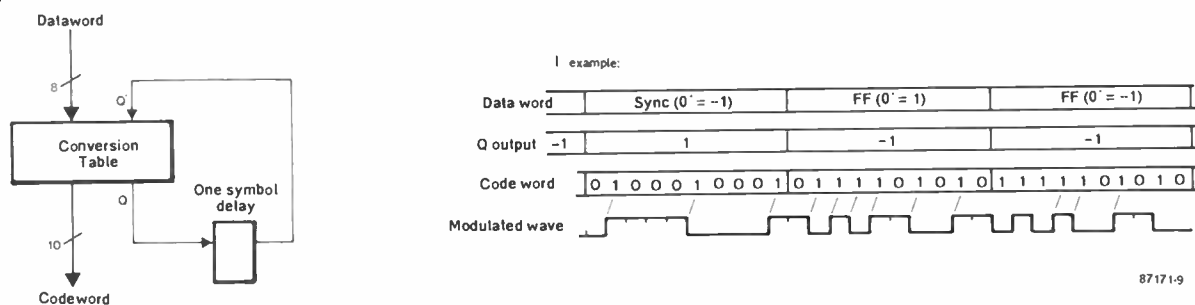

87171-9

Fig. 8. In the NRZ process a signal edge is generated for each logic high bit.

9

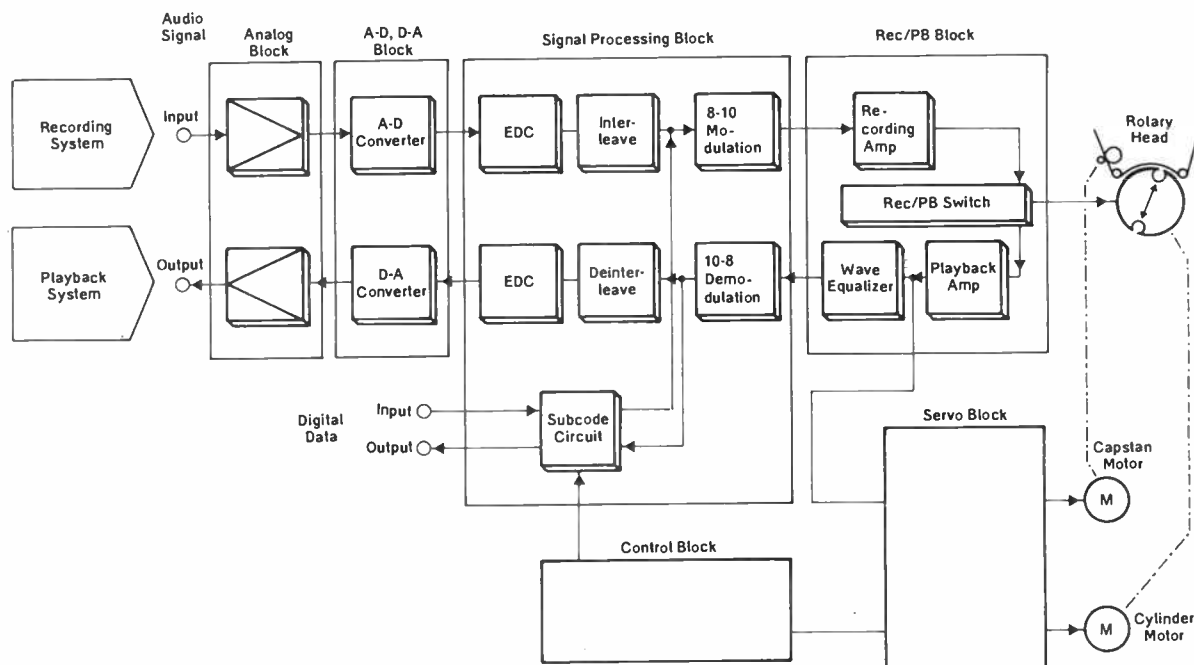

87171-10

Fig. 9. Block schematic of a typical digital audio taperecorder.

not proprietary pre-recorded ones—see under).

The 32 kHz sampling frequency is used for 4-channel recording of analogue input signals. It is also intended for future re-recording of digital satellite channels. With this low sampling frequency, the frequency range is limited to 15 kHz.

The sampling frequency of 44.1 kHz (the same as that of compact discs) is provided for the playback of proprietary pre-recorded tapes. This enables makers of these tapes and CDs to use the same mother tape in the production process.

The DAT has a copy protection circuit that prevents the direct recording from compact discs. This is incorporated at the in-

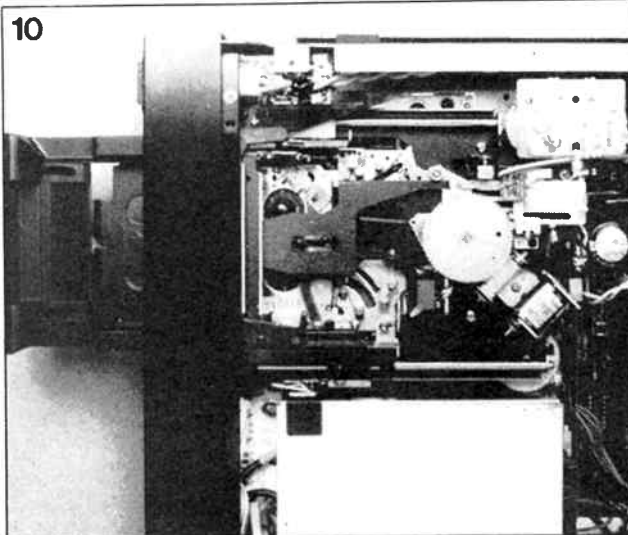

Fig. 10. Typical DAT recorder mechanism.

sistence of the record industry in the western world, backed by their respective governments. In view of the regrettable failure by governments to protect these industries against the nefarious copying of gramophone records, this decision must be welcomed by any sensible person. None the less, there have already been rumours that some DAT manufacturers are threatening to market DATs without copy protection. Fortunately, many governments have already countered these by prohibiting the manufacture or import of such recorders in their countries. It must be hoped that all western countries will be united in this determination.

THE BIRTH OF SATELLITE COMMUNICATIONS

Twenty-five years ago worldwide communications entered a new era. Telstar, the world's first commercial communications satellite, was launched on July 10, 1962, and the first live television signals via satellite were received by British Telecom's Goonhilly earth station in the early hours of the following morning.

In October 1945, the magazine *Wireless World* published an article by Arthur C. Clarke, today probably better known as the author of *2001—A space Odyssey*, entitled *Extra-terrestrial relays—can rocket stations give worldwide radio coverage?*

Arthur C. Clarke commented in his article: "Many may consider the solution proposed in this discussion too farfetched to be taken very seriously." Yet his idea was to prove the blue-print for today's satellite communications network.

He accurately predicted the orbital velocity that a rocket would need to become an artificial satellite, or second moon, circling the world with no expenditure of power. He also predicted that a satellite circling the earth above the equator at a certain height would appear to be stationary to the earth and that three such satellites could give global radio coverage.

He further predicted that development of rocket technology, started by the Germans during the second world war, would soon make it possible to place a satellite in orbit.

Today, reality has caught up with science fiction as British Telecom International-BTI handles more than three million minutes of telephone calls, television pictures, data, facsimile, and telex, every day through Goonhilly and its other inter-continental links.

About 90 per cent of the world's telephones—some 600 million of them—in 173 countries can be dialled direct from the UK. Telephone services are provided to more than 200 countries and each day more than 500,000 calls are connected from the UK to the other countries.

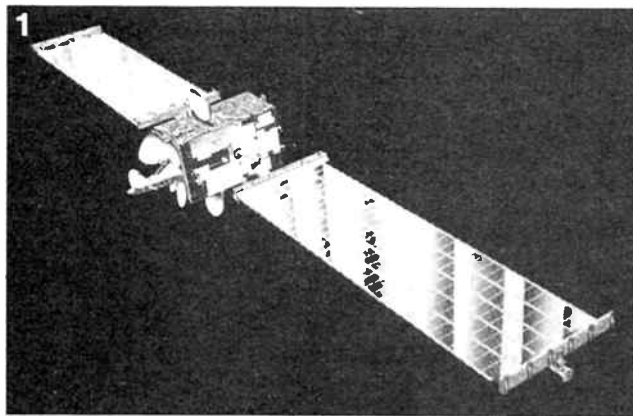

Fig. 1. The Olympus satellite is one of the largest and most powerful in the world. Photograph courtesy of British Aerospace.

The early Telstar demonstrations and tests

In the Spring of 1961 it was jointly announced in the United Kingdom, the USA and France that the US National Aeronautics and Space Administration (NASA), the French Centre for Telecommunications Studies and British Telecom, as its predecessor Post Office Telecommunications, would cooperate in a programme for transatlantic testing of com-

munications satellites.

At the same time it was announced that satellite earth stations would be built in England and France "for the reception and transmission of telephone, telegraph and television signals across the Atlantic using satellites to be launched by NASA during 1962 and 1963."

Work began shortly afterwards to build the UK's first satellite station at Goonhilly Downs in Cornwall. The site was chosen because it was as far west as possible to obtain the maximum

period of visibility to the United States via the satellite, to be remote from sources of electrical interference, and to provide an onobscured view to the horizon for the longest possible contact with the satellite.

In less than a year from gaining access to the site the station was ready. A massive, steerable, dish antenna, weighing 870 tonnes with a 25.9m dish had been built. All of the equipment on the station was of British design and manufacture, with the exception of one American transmitting klystron valve.

The British design was the odd-man-out among the three earth stations to be used for the tests. Both the American station at Andover, Maine, and the French station at Pleumeur Bodou in Brittany were equipped with horn antennas housed in radomes. The British station had cost around £800,000 to complete, about a quarter of the cost of the American and the French stations.

In early July 1962 it was announced that Telstar would be launched from Cape Canaveral on either July 10 or 11.

The successful launch took place at 8.35 GMT on Tuesday, July 10, and the desired orbit was achieved. With Telstar circling the earth at heights varying between 590 and 3500 miles, it was possible to achieve three or four periods during each 24 hours when mutual visibility between Goonhilly and Andover lasted for 30 to 40 minutes.

During these periods the antenna at Goonhilly had to be accurately manoeuvred to follow the satellite from the moment it rose above the horizon until it again disappeared from view. The signal transmitted from the antenna to the satellite was con-

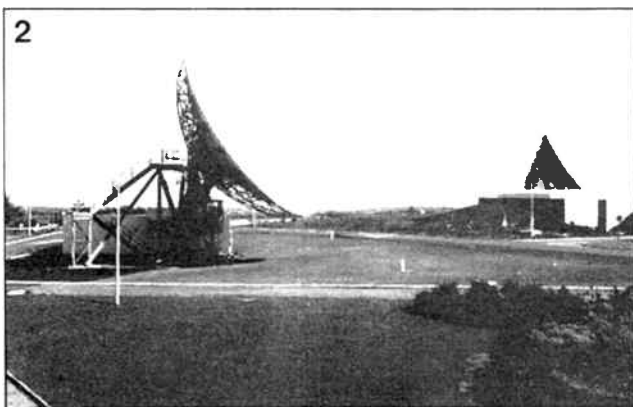

Fig. 2. A small section of Goonhilly Downs Earth Station: in the foreground Aerial No. 7. Photograph courtesy of British Telecom.

centrated into a narrow beam, one-fifth of a degree in width, so absolute precision was necessary. To maintain this accuracy in high wind meant that the antenna had to be massive and sturdy. In order to move the antenna so accurately it was equipped with electric motors of some 100 horse power. However, the engineering design resulted in such good balance and smooth movement of the antenna that normally less than two horse power was required under reasonable weather conditions.

The primary purpose of the Telstar satellite tests was to acquire data on which to base the future design of satellite systems for commercial operation. However, during the period from July 10 to July 27 a number of demonstrations were carried out which illustrated the potentialities of satellite systems for world-wide telecommunications.

In the early hours of July 11 the first usable orbits were the sixth and seventh and the first attempt at television reception was made. Reception was decidedly poor. Some experts were quick to blame Goonhilly's unique antenna design, and *The Times* described the experiment as "an almost total failure". Some experts said the antenna was too heavy and cumbersome to accurately track the satellite, others blamed the driving mechanism. The problem proved to be that one component had been fitted the wrong way round and it was a twenty-minute job to correct it. The effect of the incorrect fitting had been to reverse the direction of the wave polarization of the antenna, relative to that of the satellite, introducing a serious weakening of the strength of signals received. The problem arose because of an ambiguity in the accepted definition of the sense of rotation of radio waves; a difficulty which had been encountered both in the USA and the UK in the period just before the tests. With the correction made, excellent pictures were received on orbit 15 during the evening of July 11, and during orbit 16 the first live television transmission between Europe and the USA was made from Goonhilly to Andover. The pictures and sound received at Andover were reported to be of

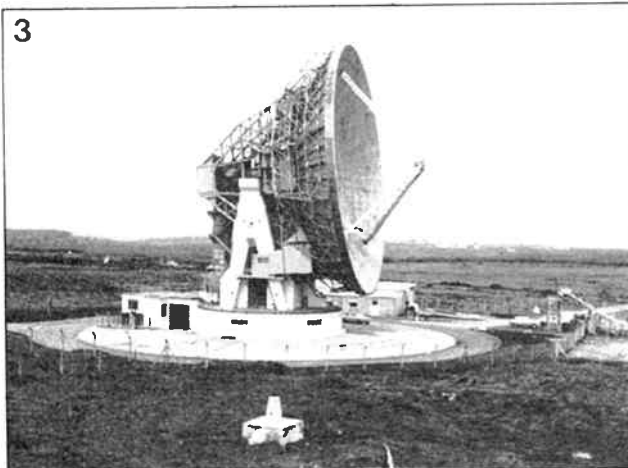

Fig. 3. The first of the dish antennas to be installed at Goonhilly Downs. Photograph courtesy of British Telecom.

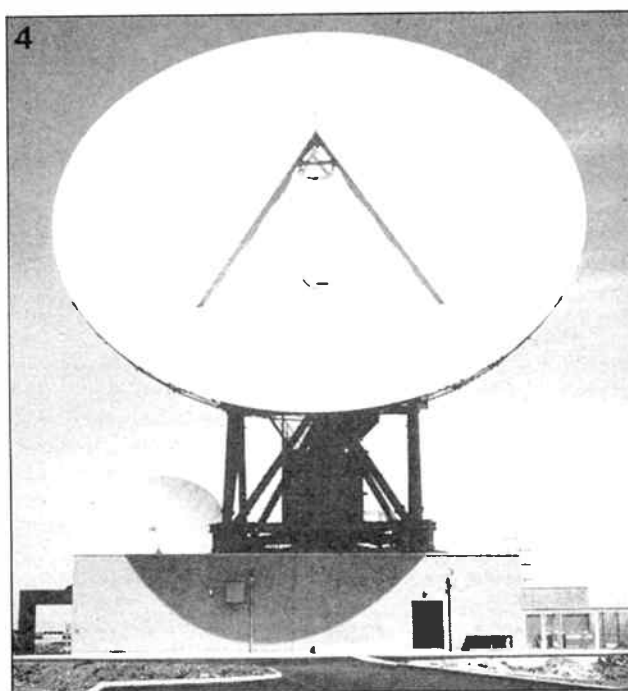

Fig. 4. Aerial 6 is Goonhilly's largest dish with a diameter of 32 m. It was also the first "dual frequency" antenna, able to transmit and receive on two different frequencies simultaneously. Photograph courtesy of British Telecom.

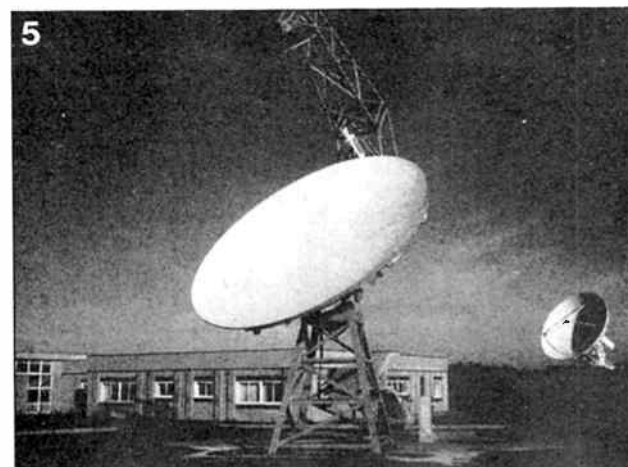

Fig. 5. The latest of the antennas (No. 10) to be installed at Goonhilly Downs. Photograph courtesy of British Telecom.

excellent quality and were broadcast as received throughout the USA.

On July 12 the first two-way transatlantic telephony tests were made, showing that good-quality, stable telephone circuits with low noise levels had been achieved. These tests were to be followed two days later by the first transatlantic telephone call and photo-telegraphy (facsimile) transmission via satellite.

On July 14 during orbit 34, the director general of the Post Office, Sir Ronald German, spoke from his home in London to the president of American Telephone and Telegraph Co (AT&T), Mr. Eugene McNeely, in New York. Simultaneously, one pair of channels was used to send facsimile pictures between London and New York.

On July 15 tests to assess the ability of a communications satellite to carry large numbers of telephone circuits were carried out during orbit 43. These demonstrated that at least 600 first-grade international circuits should be possible by satellite. The first transmissions of colour television signals by satellite were made from Goonhilly during orbits 60 and 61 on July 16. With the co-operation of the BBC's research and designs department, who provided a colour slide scanner and monitor equipment, the signals, on 525-line NTSC standards, comprised captions, test cards and still pictures to assess colour quality. The transmissions were initially made from Goonhilly to the satellite and back to Goonhilly but were also received in Andover. Andover reported: "Colour—good; picture quality—excellent".

During orbit 87 on July 19 satellite communications were opened up to the press. Twenty-four calls were made by the British press from Fleet Building in London, to the American press in New York.

On July 23 during orbit 125 an 18-minute long programme from the European Broadcasting Union was transmitted from Goonhilly to Andover. The programme consisted of scenes from many European countries and was transmitted by the Eurovision link to Goonhilly, from Goonhilly to the satellite, and was received at Andover and broadcast throughout the USA.

During orbit 151 on July 26, the Telstar link between Goonhilly and Andover was used to provide telephone circuits for the US Information Agency involving conversations between "notable persons" in 20 pairs of cities in the USA and Europe for the Agency's "People-to-People" programme. The circuits were reported as excellent.

The Telstar tests confirmed that communications satellites could provide high-quality, stable circuits for television and multi-channel telephony. The performance of Goonhilly earth station was reported as excellent in every respect, and the equipment, almost all of which was of a unique new design, had worked well. In fact, Goonhilly's antenna design was to prove, as had Arthur C. Clarke's idea, to be the blue-print for the future.

A brief history of Goonhilly satellite earth station

The choice of Goonhilly Downs, on the Lizard Peninsula in Cornwall, as the site of the United Kingdom's first satellite earth station, was made for exactly the same reasons that Guglielmo Marconi chose the Lizard for his pioneering work in maritime and international "wireless" telegraphy. The Lizard offers an uninterrupted view across the Atlantic and little electrical interference.

The first transatlantic wireless message was sent from the Lizard on December 12, 1901. Three faint but discernible "dots" of the Morse letter "S" were sent from Marconi's transmitter at Poldhu and received by him in Newfoundland, Canada. A year later Poldhu sent a signal to the vessel *Philadelphia* more than 2000 miles away in the ocean. Long-distance telecommunications had been born.

Sixty years later the advance of technology had made satellite communications, first proposed by the author and scientist Arthur C. Clarke in 1945, a realistic possibility. The United Kingdom, the USA and France announced in 1961 that they would co-operate in a programme for the transatlantic testing of communications satellites.

The search for a suitable site in the UK for the station that would

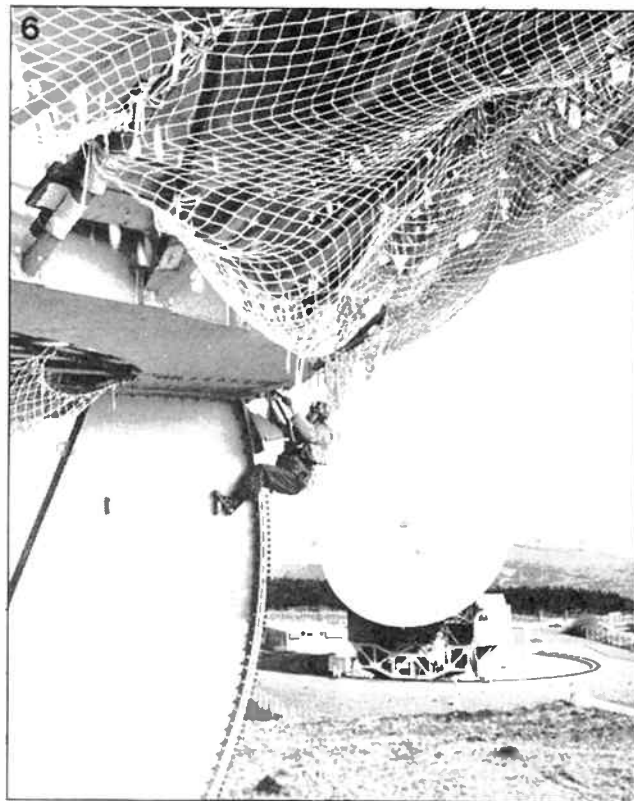

Fig. 6. A British Telecom rigger examines the steelwork of Goonhilly Earth Station's antenna No. 6. Photograph courtesy of British Telecom.

receive the signals from the satellites, ended in the Lizard, on the flat expanse of Goonhilly Downs.

The Lizard offered an unimpaired view of the Atlantic horizon, giving the longest possible contact with the low-orbiting satellites then being used. It suffered from little electrical and radio interference; was well placed to connect with inland communications, power supplies and transport links; and had a climate with

moderate rainfall, little seasonal variation in temperature and only occasional snow.

Equally important was the geology of the area. The serpentine bedrock reaching a thousand feet deep would give vital support to the massive weight of the antennas.

Within a year of obtaining possession of the site, the first antenna, the control room and its associated equipment were installed and ready for the first tests which would use the

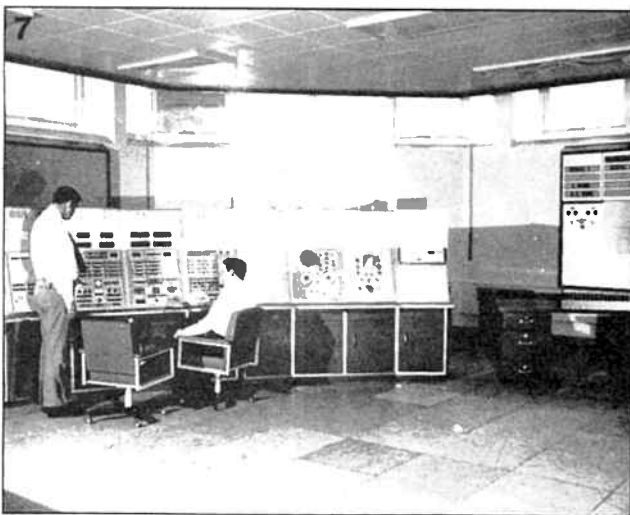

Fig. 7. A section of the control area at Goonhilly Downs. Photograph courtesy of British Telecom.

Telstar satellite, to be launched by the US National Aeronautics and Space Administration (NASA) on July 10, 1962.

Those tests confirmed that satellites could have a commercial future in international communications. During a period of 16 days several world-firsts went into the record books—the first live television transmission between Europe and the USA, and the first telephone calls, facsimile transmission and transmission of colour television by satellite.

Because of the low orbit of Telstar—between 590 and 3500 miles above earth—the satellite was only usable for three or four 30-to-40 minute periods in each 24 hours. As the satellite raced across the sky from horizon to horizon, the antenna had to be nimble enough to follow the satellite to one-fifth of a degree's accuracy during each of these brief visits.

Aerial 1 at Goonhilly was a unique design - an 870 tonnes "dish" antenna, compared to the French and American horn antennas enclosed in radomes. Some initial problems during the first usable orbits of Telstar caused experts to blame the design of the British antenna, but a small problem with a component which had been fitted faultily proved to be a twenty-minute job to correct and the antenna then went on to establish its world-firsts.

Goonhilly Station had cost around £800,000 to complete, about a quarter of the costs of the American and French stations, and it was the unique design of the British dish antenna which was to go on to become the norm for satellite communications throughout the world. The dish design is now used generally by nearly 700 satellite stations in more than 150 countries.

Following the successful tests with Telstar an international satellite organisation was set up in August 1964 - INTELSAT. Interim agreements were signed by 11 member nations - the USA, UK, Canada, Denmark, France, Italy, Japan, the Netherlands, Spain, the Vatican City State and Australia. Today INTELSAT is owned by more than 100 member countries.

INTELSAT launched its first satellite into orbit in April 1965. The satellite, INTELSAT 1, known as *Early Bird*, was a

high-orbiting satellite in "geostationary orbit".

Arthur C. Clarke had proposed in his 1945 paper that satellites, circling the earth above the equator at a certain height, would appear to be stationary to the earth's surface—their period of orbit would exactly match that of the earth's natural rotation. That distance was 22,300 miles above the equator. After INTELSAT I's successful launch to this height, commercial service opened in June 1965.

Arthur C. Clarke had also proposed that three satellites in geostationary orbit could give world-wide radio coverage. A second satellite—INTELSAT II—was launched in December 1966, and at the same time, Aerial 1 at Goonhilly, which now no longer needed to track low-orbiting satellites across the sky, had an extra reflecting surface added, pushing its weight up to 1100 tonnes. Satellite communications had now truly entered commercial operation. As the demand for transatlantic TV and telephone transmission grew, so did Goonhilly with the addition of Aerial 2 in 1968.

By 1969 three geostationary satellites were in orbit, fulfilling Arthur C. Clarke's prophesy of global communications. INTELSAT III was positioned above the Indian Ocean and demand for satellite communications with the Far East grew. To meet this need Aerial 3 was brought into service in 1972. Aerial 4 was added in 1978, to meet an ever-increasing demand for communications across the Atlantic. This was also one of the first antennas in the world to use the 11/14 GHz frequency as soon as it became available for business satellite communications.

Demand for satellite communications grew by 20 per cent a year during the 1970s and early 1980s. Further satellites were put into orbit and in October 1978 a second earth station was brought into service by British Telecom at Madley in Herefordshire.

Demand for specialist services also grew during this period and in 1983 Aerial 5 at Goonhilly was completed to provide satellite services to ships at sea.

At the same time Aerial 6 was being built to provide further capacity on the busy transatlan-



Fig. 8. Children from a nearby primary school being shown a model of the Intelsat V satellite. Photograph courtesy of British Telecom.

tic route. Aerial 6 is Goonhilly's largest dish with a diameter of 32m. It was also the first "dual-frequency" antenna, able to both transmit and receive on two frequencies simultaneously—doubling potential capacity. It entered service in September 1985.

While aerial 6 was being built, Aerial 7 was also being brought into service to provide leased TV services to North America. With continuing growth in de-

mand for satellite communications, British Telecom announced plans in August 1983 to build a third earth station in London's Docklands, primarily for satellite TV distribution and specialised business services. The London Teleport, in North Woolwich, opened for operation in February the next year—less than six months after site clearance began.

Aerial 7 at Goonhilly, initially used for TV circuits, is now be-



Fig. 9. The antennas are painted regularly: each one takes a 1000 gallons of marine paint and two full seasons' painting. Photograph courtesy of British Telecom.

ing used for the trial of *Skyphone*—a telephone service to aircraft in flight—which is due to start by the end of this year.

Meanwhile Aerials 8, 9 and 10 have been built. These are small-dish antennas below 14m in diameter. They are used for research and development, and to provide monitoring and control facilities on the more than 130 satellites currently in use.

Today, development at Goonhilly continues. Aerial 6, the biggest antenna, has been equipped to operate to the latest development in satellite communications—Time Division Multiple Access/Digital Speech Interpolation (TDMA/DSI). TDMA/DSI means that signals from the station are grouped and sent by time rather than frequency, so that, on the principle that during the average telephone conversation either party is only speaking for one third of the time of the call, other groups of signals can be sent along the same channels during the lapses of conversation.

While British Telecom's earth station at Goonhilly provides vital links for today and tomorrow, it has not forgotten its past—a past that goes back far beyond Marconi's early experiments.

The Lizard Peninsula is designated as an Area of Outstanding Natural Beauty and Goonhilly Downs was Cornwall's first National Nature Reserve. In developing the earth station, British Telecom spent £200,000 landscaping the scheme to form natural-looking mounds, or bunds, inside and outside the station's boundaries. Local heathers, gorse and willow were planted in the station, in keeping with the natural character of the Downs. With little intrusion from the public, amidst the silent giants of Goonhilly's antennas, the local flora and fauna have been able to flourish, making Goonhilly not only a pioneer in high-technology but also a botanist's paradise.

LONG-RANGE INFRARED TRANSMITTER-RECEIVER

by J C Stekelenburg

This two-way, infra-red, FM, communication system covers line-of-sight paths of remarkable lengths without the use of expensive optoelectronic devices.

There are many who are convinced that infra-red components are only useful for remote control systems with a range of 10 metres or so. Powerful IR emitters are well out of the financial reach of the average home constructor, and their usefulness is often rightly queried simply because doubling the radiated power hardly increases the effective transmitter range. Notwithstanding the latest achievements in optoelectronic technology, the real key to long-distance communication in the infra-red part of the frequency spectrum is a well-known physical phenomenon: beam convergence.

Principles of telecommunication

Telecommunications engineers use calculated, i.e., hypothetical, models to assess and study the technical feasibility of point-to-point communication links in the available frequency bands. A general model of a link between an FM (frequency modulation) transmitter and receiver is shown in Fig. 1. At the transmitter side, the aerial gain is G_T ; at the receiver side G_R . In the present case, the centre frequency used is 313 THz (terahertz, 10^{12} Hz), which means that the main component in the radiated spectrum has a wavelength of about 950 nm. This is slightly longer than the wavelength of the darkest shade of red visible to the human eye. The fact that infra-red light is transmitted and received makes it possible to use



Long-range IR transmitter-receiver

Technical specifications.

Transmitter.

Modulation:	FM.
Preemphasis, τ :	50 μ s.
Radiant power, P_T :	0 - approx. 10 mW.
Transmitted waveform:	rectangular, duty factor = 0.5.
Supply voltage:	12 V.
Maximum current consumption:	approx. 125 mA.
Wavelength:	950 nm.
Spectral bandwidth (-3 dB), $\Delta\lambda$:	± 20 nm.
Maximum deviation ($f_c = 100$ kHz), Δf :	± 50 kHz.
Sensitivity of line inputs:	250 mV _{rms} .

Receiver.

Supply voltage:	12 V.
Maximum current consumption:	approx. 75 mA.
Deemphasis, τ :	50 μ s.
Wavelength:	950 nm.
VCO range, f_0 :	65 - 150 kHz.
VCO lock range, f_l :	$\pm \frac{1}{2}f_0$.
VCO capture range, f_c :	± 17 kHz.

optical devices, such as reflectors and lenses, as "aerials".

The following step-by-step link budget calculation is purposely simplified, and, where appropriate, based on reasonable assumptions as to the performance of the equipment. Sometimes the (electronic) term *amplification* is used where the (physical) term *magnification* or *convergence factor* is, strictly speaking, more correct. Reference is made to the denotations shown in Fig. 1, and the main technical specifications of the infra-red components used—see Fig. 2. The IRED (infra-red emitting diode) Type LD271 and the photodiode Type BP104 are inexpensive and generally available components.

With reference to Figs. 1 and 2, the radiant power, P_T , at the transmitter side is 10 mW into an aerial with an assumed power gain, G_T , of 20 dB ($\approx 100\times$). The effective radiated power (ERP) is therefore +30 dBm, or 1 W.

Figure 2 shows that the photodiode Type BP104 generates a *noise equivalent power* (NEP) of 4.2×10^{-14} W (Hz^{-1})¹. The effective radiant sensitive area, A , is 5.06 mm². The power gain, G_R , of the receiver aerial of radius r is calculated from

$$G_R = 10 \log_{10}(\pi r^2 / A) \quad [1]$$

$$= 10 \log_{10}(0.621 r^2) \text{ [dB]}.$$

With r given as 50 mm, G_R becomes approximately 32 dB. It is assumed that the receiver input has a noise factor, F_0 , of 3

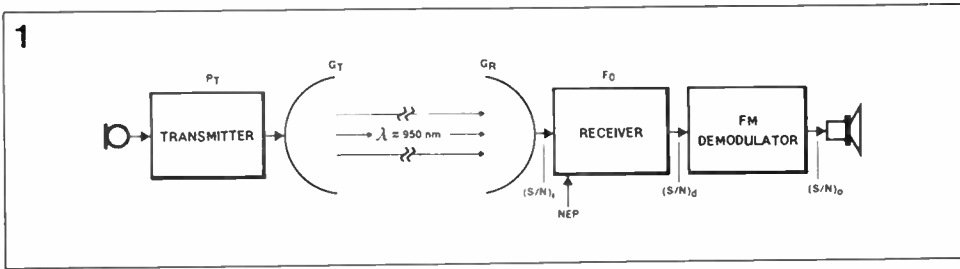

Fig. 1 A hypothetical infra-red communication system.

($\Delta F_{dB} = 4.7$ dB, this is a quite average value), while the transmitter is modulated with a single tone of frequency f_m , producing a deviation Δf . Also assuming that the pre-detection signal-to-noise ratio, $[S/N]_d$, is between 10 and 15 dB, i.e., above the detection threshold for FM signals, and that $\Delta f = \pm 50$ kHz, the output signal-to-noise ratio, $[S/N]_o$, of the ideal FM demodulator is calculated from

$$[S/N]_o = 3/2 (\Delta f / f_m)^2 [S/N]_d \quad [2]$$

where

$$[S/N]_d = (1/F_0) [S/N]_i \quad [3]$$

Returning to the technical

specifications of the LD271, it is seen that the IRED used supplies a radiant intensity, I_e , of 10 mW per steradian (sr) at a continuous, forward, current of 100 mA. The light beam emitted by an IRED is cone-shaped, making it fairly difficult to calculate the radiant intensity received on the flat surface of the photodiode. Figure 3 shows that the distance x between the transmitter and the receiver is a function of the divergence of the transmitter beam. The radiant intensity on the concave area $A_{(TZ)}$ is 10 mW sr⁻¹, since $\alpha = 1$ rad $\approx 57.3^\circ$. In order to avoid complex calculations for determining the ratio of the flat area A with respect to the concave area $A_{(TZ)}$, the beam width

is assumed to decrease from 1 radian (α) to 0.1 radian (Ω). This enables considering the resultant beam area, $A_{(B)}$, flat, as well as A , which forms a part of it (see the front view in Fig. 3). It can be shown that $I_e = 0.1$ mW in 0.1 sr given that $I_e = 10$ mW sr⁻¹. Figure 3 shows that it is reasonable to consider the IR beam to have a flat area $A_{(B)}$ of radius r where it is incident on the photodiode D, so that

$$r = x \tan(\frac{1}{2}\Omega) \approx 0.05x \quad [4]$$

$$A_{(B)} = \pi(0.05x)^2 \quad [5]$$

Assuming no atmospheric attenuation over the distance x , area A receives an amount of incident radiant power, P_R , that is a portion of I_e within 0.1 sr,

whence

$$P_R = I_e \times \frac{5.06 \times 10^{-6}}{(0.05x)^2} =$$

$$10^{-4} \times \frac{5.06 \times 10^{-6}}{(0.05x)^2} =$$

$$\frac{6.443 \times 10^{-8}}{x^2} \text{ [W]} \quad [6]$$

This calculation is valid for transmission through a vacuum. The atmospheric attenuation factor for $\lambda = 950$ nm is approximately 4 km⁻¹ (≈ 6 dB km⁻¹). Provided the calculations remain based on factors rather than decibels, the atmospheric attenuation can be taken into account by rewriting P_R as

$$P_R = \frac{6.443 \times 10^{-8}}{x^2 \times 4^{(\alpha/1000)}} \text{ [W]} \quad [7]$$

The signal-to-noise ratio at the receiver input, $[S/N]_i$, is simply the ratio of P_R (S , the signal) to NEP (N , the self-generated noise of the photodiode) within a given bandwidth. The amplification of P_R in the reflector (G_T , transmitter aerial) and the lens (G_R , receiver aerial) can be in-

2

LD271

Characteristics ($T_{amb} = 25^\circ\text{C}$)

Wavelength at peak emission at I_{max}	λ_{peak}	950	nm
Spectral bandwidth at 50% of I_{max}	$\Delta\lambda$	± 20	nm
Radiant intensity in axial direction at $I_e = 100$ mA, for half angle $\phi = 30^\circ$			
LD = 271 A	I_e	> 7	mW/sr
LD = 271	I_e	15 (≥ 10)	mW/sr
LD = 271 H ¹	I_e	≥ 16	mW/sr
Radiant flux ($I_e = 100$ mA) (typ.) total	Φ_e	16	mW
Half angle (limits for 50% of radiant intensity I_e)	ϕ	25	degrees
Switching times (I_e from 10% to 90%, $I_e = 100$ mA)	t_r, t_f	1	μs
Capacitance ($V_a = 0$ V)	C_o	40	pF
Forward voltage ($I_e = 100$ mA)	V_f	1.35 (< 1.7)	V
Breakdown voltage ($I_a = 100$ μA)	$V_{(BR)}$	30 (< 4)	V
Reverse current ($V_a = 3$ V)	I_a	0.01 (< 10)	μA
Temperature coefficient of I_e or Φ_e	TC	0.55	%/K
Temperature coefficient of V_f	TC	1.5	mV/K
Temperature coefficient of λ_{peak}	TC	-0.3	nm/K

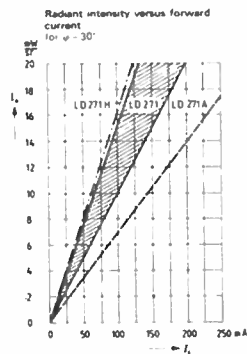
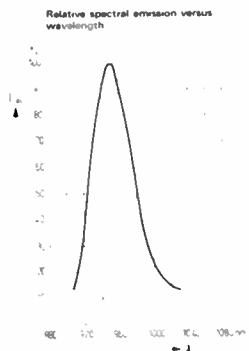

BP104

Characteristics ($T_{amb} = 25^\circ\text{C}$)

Spectral sensitivity ($V_a = 5$ V) ($\lambda = 950$ nm)

Spectral sensitivity ($V_a = 5$ V) ($\lambda = 950$ nm)	S	40 (≥ 25)	μA cm ² / mW
Wavelength of max spectral sensitivity	$\lambda_{s,max}$	950	nm
Quantum yield (Electrons per photon) ($\lambda = 950$ nm)	η	0.92	Electrons / Photon
Spectral sensitivity ($\lambda = 950$ nm, $V_a = 5$ V)	S_s	0.71	A/W
Rise and fall time of the photocurrent from 10% to 90% and from 90% to 10% of the final value ($R_f = 1$ k Ω , $V_a = 0$ V, $\lambda = 950$ nm)	t_r, t_f	125	ns
($R_f = 1$ k Ω , $V_a = 10$ V, $\lambda = 950$ nm)	t_r, t_f	10	ns
Temperature coefficient for I_s or I_{sc} resp	TC	0.18	%/K
Capacitance ($V_a = 0$ V, $f = 1$ MHz, $E = 0$)	C_o	48	pF
($V_a = 3$ V, $f = 1$ MHz, $E = 0$)	C_s	17	pF
Radiant sensitive area	A	5.06	mm ²
Dark current ($V_a = 10$ V)	I_a	2 (< 30)	nA
Noise equivalent power ($V_a = 10$ V)	NEP	4.2×10^{-14}	W
Detection limit	D^*	5.4×10^{12}	cm ² Hz / W

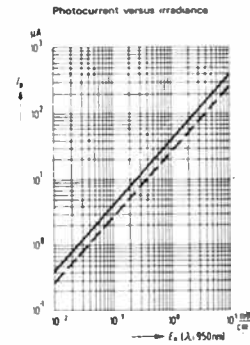
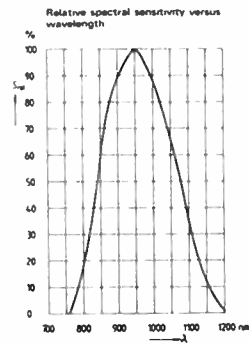

87179-2

Fig. 2 Essential technical characteristics of the infra-red components used in the transceiver (courtesy Siemens).

cluded in the link budget, as well as NEP for $\Delta f = \pm 50$ kHz:

$$\begin{aligned} \text{NEP} &= 4.2 \times 10^{-14} \times 100,000 \quad [8] \\ \text{NEP} &= 1.33 \times 10^{-11} \text{ [W]}. \end{aligned}$$

So:

$$\begin{aligned} \frac{S}{N} &= \frac{P_R}{\text{NEP}} = \frac{6.443 \times 10^{-8} \times G_T \times G_R}{1.33 \times 10^{-11} x^{24} (x/1000)} \\ &= 4844 G_T G_R x^{-24} (x/1000) \\ &= 4844 G_T (\pi r^2 / 5.06) x^{-24} (x/1000). \quad [9] \end{aligned}$$

Where x is in metres, and r in millimetres. In equation [9], the distance, x , is a double variable (it is squared as well as part of an exponent). This means that x can only be resolved with the aid of successive approximation, which will not be discussed here. Instead, 3 sample calculations are given to indicate the (theoretical) potential of the system.

It will be clear that the lens at the receiver side is of radius r , as shown in Fig. 3. This means that all radiant power within the specified solid angle Ω is captured and converged onto the photosensitive area of the IR diode D. Practical aspects of the reflector and the lens will be reverted to.

What is the maximum, theoretical, distance that can be covered by this system, so that the received signal is just about audible in the receiver?

An FM signal exceeds the noise threshold when

$$[S/M]_d \geq 10 \text{ (}\approx 10 \text{ dB)} \quad [10]$$

requiring that

$$[S/M]_d \geq 30 \text{ (}\approx 15 \text{ dB) at } F_0 = 3. \quad [11]$$

Having defined this minimum requirement for the input signal strength, it becomes possible to propose 3 versions of the IR communication link:

1. No optical amplification ($G_T = G_R = 1$):

$$x \approx \sqrt[24]{\frac{4844}{30}} \approx 12.7 \text{ m.} \quad [12]$$

2. Only a lens at the receiver side ($r = 50$ mm):

$$\begin{aligned} x &\approx \sqrt[24]{\frac{4844}{30} \times \frac{\pi(50)^2}{5.06} \times 0.59} \\ &\approx 384 \text{ m.} \quad [13] \end{aligned}$$

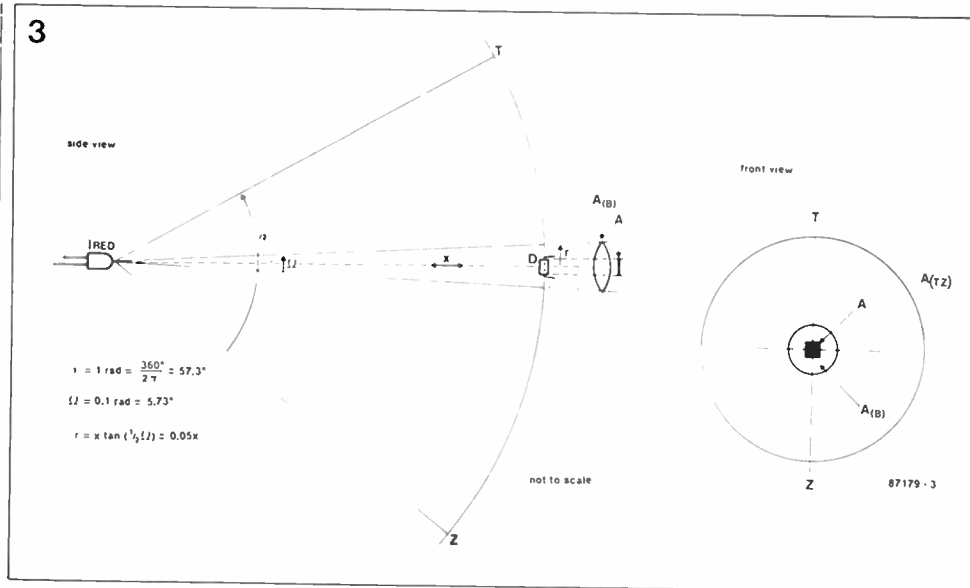

Fig. 3 The theoretical distance covered by the system is the length, x , of the conical infra-red light beam.

3. A lens at the receiver side ($r = 50$ mm), and a reflector at the transmitter side ($G = 100 \approx 20$ dB)—this is the full system shown in Fig. 1:

$$\begin{aligned} x &\approx \sqrt[24]{\frac{4844}{30} \times \frac{\pi(50)^2 \times 100}{5.06} \times 0.1} \\ &\approx 1,625 \text{ m.} \quad [14] \end{aligned}$$

The above calculations also enable a reasonable prediction to be made of the S/N ratio of the received AF signal at a distance of, say, 1,000 metres, with Δf given as ± 50 kHz and $f_{(m)} = 10$ kHz (option 3.):

$$\begin{aligned} [S/M]_d &= 4844 \times 100 [\pi(50)^2 / 5.06] \times 4^{-1} \times 10^{-6} \\ &= 188 \quad [15] \end{aligned}$$

whence

$$\begin{aligned} [S/M]_d &= \frac{1}{2} (50/10)^2 \times \frac{1}{2} \times 188 = 9403 \\ &\approx 40 \text{ dB.} \quad [16] \end{aligned}$$

This is, theoretically, sufficient for receiving speech or music of reasonable quality. The previously given calculations enable determining the minimum system layout for a given range x . It should be remembered, however, that all calculated distances are entirely based on theory, representing the absolute, and in practice virtually unattainable, limits of the system.

Through the atmosphere

It goes without saying that some spare capacity should be designed into the system to ensure a reliable, noise-free link even when there is additional attenuation caused by fog, heavy rain, snowfall, or fading. The latter effect is essentially a variation in the refractive index of air in contact with the heated earth surface (reference (1)). This phenomenon gives rise to turbulence and convection currents in the atmosphere, beam deviation, and hence pronounced fading of the transmitted IR signal. Modulation of

the signal strength in the range 1 to 200 Hz may also affect the quality of the received signal. This effect is caused by scattering of the signal, and fluctuations in the absorption of the air layers. A typical atmospheric absorption spectrum is shown in Fig. 4. The curve is derived from a wider spectrum analysis described in (1). It shows the percentage transmission through 1 km of atmosphere at sea level. It is seen that the IRED LD271 outputs its peak intensity at a wavelength that forms the lower limit of a so-called *atmospheric window*, i.e., a frequency band in which the atmospheric attenuation is

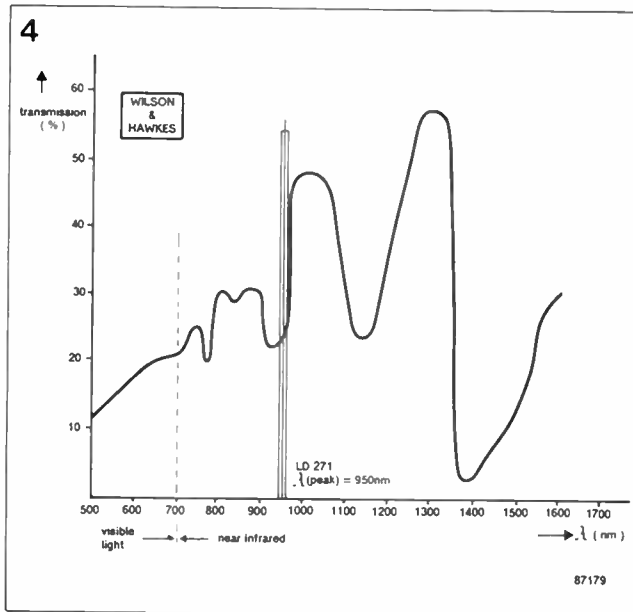

Fig. 4 Correlation between wavelength and percentage transmission through 1 km of atmosphere at sea level (source: reference (1)).

relatively low. Returning to the temperature coefficient of λ_{peak} stated in Fig. 2, it is readily seen that the signal strength at the receiver side may well rise somewhat along with the temperature of the IRED, since the transmitted signal can be thought to shift to the right in the spectrum.

Optical amplification

Radio engineers are familiar with the maxim "the aerial is the best amplifier". This is a proven truth, and fully applicable to the IR transceiver. The previously given transmitter ranges can only be covered with the aid of optical amplification, or, more precisely, beam convergence.

At the receiver side, it is best to use a lens with a relatively large area. Lenses in magnifying or reading glasses are ideal for the present purpose. Elementary aspects of the biconvex lens are shown in Fig. 5a. The well-known *lens equation* is written as

$$1/f = 1/u + 1/v \quad [17]$$

where

f = the focal length
 u = the object distance
 v = the image distance

From this it can be deduced that

$$v = \frac{f \times u}{-f + u} = \frac{f \times u}{u - f} \quad [18]$$

For the distances covered by the IR transceiver, f may be considered small relative to u (the object is at infinity), whence

$$v = \frac{f \times u}{u} = f. \quad [19]$$

The lens and the photodiode are housed in a light resistant enclosure with a blackened inside surface. The photodiode should be accurately positioned in the focus when the distance between the transmitter and the receiver is greater than about 50 metres. An inverted, but otherwise sharp (*real*), image of the area viewed by the lens can be seen on the back of a piece of thin white paper when this is held in the focus. Directly incident light causes a marked increase in the noise output of the photodiode.

At the transmitter side, either a lens or a reflector can be used to ensure the required convergence of the IR light beam. The use of a lens is illustrated in Fig. 5b. The convex lens should be a so-called *condensing* type to ensure a short focal length with respect to the lens diameter. Condensing lenses have an extremely biconvex or planoconvex curvature, and are often used in slide projectors. The construction of the IRED Type LD271 is such that the half intensity angle is about 30° in the axial direction. In the context of the lens diameter, d , and with reference to Fig. 5b, this means that

$$\tan 30^\circ = 1/\sqrt{3} = \frac{1}{2} d/f \\ f = d/\frac{1}{2} \cdot 3 = 0.87d. \quad [20]$$

The beam convergence is optimum when the focal length of the lens satisfies $f \leq 0.87d$. Like the photodiode, the IRED is, of course, co-axially positioned in the focus.

The use of a reflector, i.e., a concave (parabolic) mirror, at the transmitter side is shown in Fig. 5c. Virtually all radiated light emerges as a parallel beam when the IRED illuminates the right section of the concave reflective area. The IRED is not fitted co-axially in the focus of the reflector because in this position it would obstruct the reflected beam, and so absorb a considerable part of its own radiant intensity. Moreover, there is usually a hole at the centre of the type of reflector

used for this project...

Although a condensing lens gave excellent results in a test setup of the transmitter, it is none the less recommended to use a reflector simply because this is less expensive in most cases. Constructional aspects of the reflector and the lens as crucial components in the IR transceiver are discussed further on in this article.

Circuit description of the transmitter

The circuit diagram of the infrared, FM, transmitter is given in Fig. 6. Microphone and line signals are applied to low-noise opamp IC₁ via AF inputs M and L_L-L_R respectively. Stereo signals at the line inputs are made monaural with the aid of summing resistors R₁₇-R₁₈. Attenuation is effected in voltage divider R₂₀-R₁₉. The amplified signal is fed to filter/amplifier A₁ via C₁₅, modulation strength control P₁, and C₁. Opamp A₁ is configured as an active filter to obtain the required preemphasis of the modulation signal, before this is applied to the FM modulator. The computed transfer function of the active filter is given in Table 1. A second-order low-pass with a cut-off frequency of 10 kHz is required to keep the boosting effect of the preemphasis on higher frequencies within reasonable limits. This measure effectively prevents intermodulation with the—relatively low—carrier frequency of about 100 kHz. Without the filter, a 19 kHz pilot tone, for example, would be heavily amplified, causing annoying lispings sounds, noise, and spurious beat notes in the receiver. The 10 kHz filter is represented by the first 2 terms in the denominator of the last fraction in Table 1, so that

$$C_2R_3 = 1/(2\pi \cdot 10^4) = C_5R_5. \quad [21]$$

The roll-off point at the lower end of the spectrum is determined by the term $(1 + j\omega C_3R_4)$, which is dimensioned for a cut-off frequency of about 10 Hz. The standard preemphasis of 50 μ s is created by C₄, which can be resolved from the numerator with the aid of the term $f(C_4)$, as shown in Table 2. The amplification of A₁ is approximately 6.6 ($\approx 1 + R_5/R_4$).

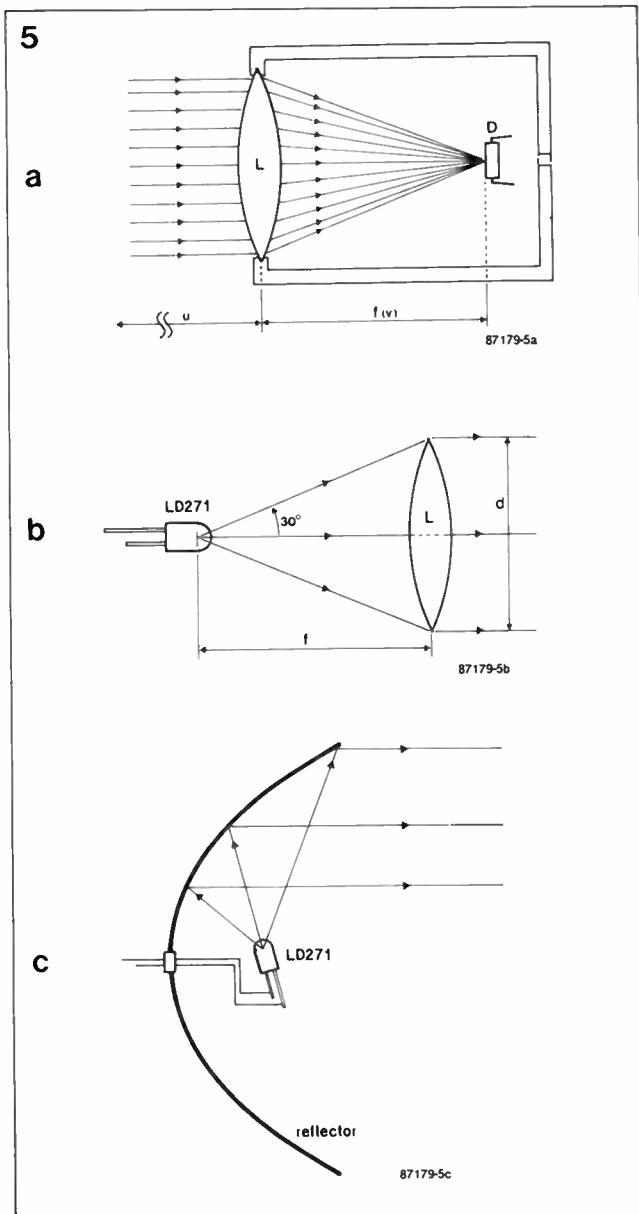

Fig. 5 Essential aspects of the optical components in the IR transceiver.

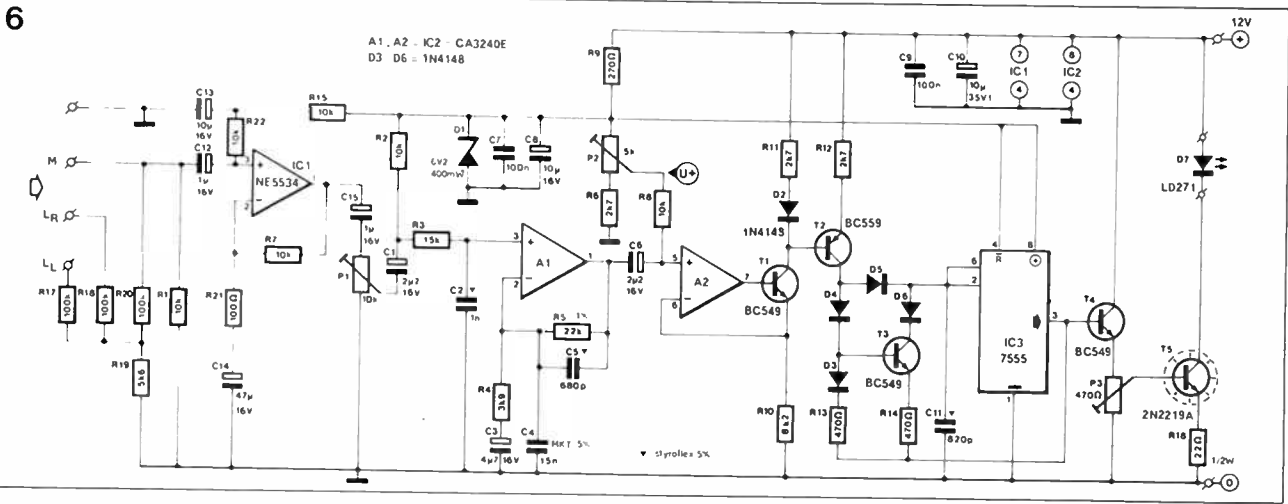

Fig. 6 Circuit diagram of the infra-red transmitter.

The asymptotes in the last fraction of Table 2 are called (A)...(E) for practical purposes. All terms are 6 dB/octave asymptotes. Terms (A) and (B) in the numerator represent *amplification* (U_o), terms (C), (D) and (E) *attenuation* (U_i). It is readily seen that (C) and (D) are virtually equal, and therefore represent an asymptote of $2 \times -6 = -12$ dB/octave.

The theoretical frequency curve of the filter set up around A1 is shown in Fig. 7a. Asymptotes (C) and (D) are coincident and form the second-order roll-off above 10 kHz. Figure 7b shows the results of a test sweep carried out on a prototype of the IR transmitter. Curve A is the preemphasis, curve B the frequency response of the complete IR system, i.e., from the AF input on the transmitter, via an IR link of about 10 metres, to the AF output on the receiver. The results are acceptable given the simplicity of the circuits used.

Returning to the circuit diagram of the transmitter, C_6 passes the amplified and filtered AF signal to a V-I converter set up around A2 and T1. The high amplification, A, of the opamp ensures that U_+ is virtually equal to U_- , since

$$U_o = A/(U_+ - U_-) \text{ and } A \rightarrow \infty \quad [22]$$

This means that $U_{(R10)} = U_+$, whence

$$I_{C(T1)} \approx I_{(R10)} = U_+ / R_{10} \quad [23]$$

This shows that the collector current in T1 is directly proportional to the voltage at the wiper of P2 (U_+). In other words, the operation of the V-I

Table 1

Infra red transmitter: transfer function of A1.

Definition of terms used: $U_i = U_{C1}$ $U_o = U_{C6}$ $U_Z = 6.2 \text{ V}$ $\omega = 2\pi f$ $j^2 = -1$
 $U_i \cdot A(U_+ - U_-) \rightarrow \infty$; $U_+ = U_-$

$$U_+ = \frac{(1/j\omega C_2) \times U_i}{R_3 + 1/j\omega C_2} = \frac{1}{1 + j\omega C_2 R_3} \times U_i$$

$$U_- = U_i \cdot U_{Z5} / (Z_5 - R_5/C_5)$$

$$U_{Z5} = (R_3 + j\omega C_4) Z_5$$

$$U_- = [U_i \cdot (R_3 + 1/j\omega C_3) \cdot U_Z \cdot (1/j\omega C_4)] Z_5$$

$$U_o = \frac{Z_5}{R_4 + 1/j\omega C_3 + j\omega C_4 Z_5}$$

$$1 + j\omega C_4 Z_5 + \frac{j\omega C_3 Z_5}{1 + j\omega R_4 C_3} \text{ and } Z_5 = \frac{R_5/j\omega C_5}{R_5 + 1/j\omega C_5}$$

$$1 + j\omega C_4 \frac{R_5/j\omega C_5}{R_5 + 1/j\omega C_5} + \frac{j\omega C_3 \frac{R_5/j\omega C_5}{R_5 + 1/j\omega C_5}}{1 + j\omega R_4 C_3}$$

$$1 + \frac{j\omega C_4 R_5}{1 + j\omega C_5 R_5} + \frac{j\omega C_3 R_5}{(1 + j\omega C_3 R_4)(1 + j\omega C_5 R_5)}$$

$$U_o = \frac{1}{(1 + j\omega C_2 R_3)} + \frac{j\omega C_4 R_5}{(1 + j\omega C_2 R_3) \times (1 + j\omega C_5 R_5)} + \frac{j\omega C_3 R_5}{(1 + j\omega C_2 R_3) \times (1 + j\omega C_5 R_5) \times (1 + j\omega C_3 R_4)}$$

$$\frac{(j\omega)^2 (C_3 C_5 R_4 R_5 + C_3 C_4 R_4 R_5) + j\omega (C_3 R_4 + C_5 R_5 + C_3 R_5 + C_4 R_5) + 1}{(1 + j\omega C_2 R_3)(1 + j\omega C_5 R_5)(1 + j\omega C_3 R_4)}$$

converter is linear.

D2 and T2 form a current mirror. The voltages across the diode and the B-E junction of the transistor are equal when equal currents are carried. The voltage on R11 is, therefore, equal to that on R12. It is readily seen that $I_{C(T2)} = I_{C(T3)}$ since $R_{11} = R_{12} = 2K7$.

The well-known timer Type 7555 comprises 2 comparators that cause an internal bistable to toggle at voltage levels $2/3 V_{CC}$ and $1/3 V_{CC}$. Timer IC3 is fed from a stabilized 6.2 V rail. When $U_{C(11)} \leq 1/3 V_{CC}$ ($= 2.07 \text{ V}$), the output, pin 3, goes high

Table 2

Infra-red transmitter: preemphasis.

$$\tau = 50 \mu\text{s} = 50 \times 10^{-6} \text{ s} \quad \omega = 2\pi f \quad j^2 = -1$$

$$\frac{U_o}{U_i} = \frac{(1 + j\omega\tau)(1 + j\omega f_{C4})}{(1 + j\omega 1.5 \times 10^{-3})(1 + j\omega 1.496 \times 10^{-3})(1 + j\omega 0.1833)}$$

so that $f_{C4} = (C_3 C_5 R_4 R_5 + C_3 C_4 R_4 R_5)$

$$\tau + f_{C4} = C_3 R_4 + C_5 R_5 + C_3 R_5 + C_4 R_5$$

$$f_{C4} = \frac{(C_3 C_5 R_4 R_5 + C_3 C_4 R_4 R_5)}{\tau}$$

$$C_4 = \frac{C_3 C_5 R_4 R_5 - \tau C_3 R_4 - \tau C_5 R_5 - \tau C_3 R_5 + 25 \times 10^{-10}}{\tau R_5 - C_3 R_4 R_5}$$

$$C_4 = 14.4 \text{ nF} \Rightarrow f_{C4} = 0.12162$$

$$\frac{U_o}{U_i} = \frac{(1 + j\omega\tau)(1 + j\omega 0.1262)}{(1 + j\omega 1.5 \times 10^{-3})(1 + j\omega 1.496 \times 10^{-3})(1 + j\omega 0.1833)} = \frac{(A)(B)}{(C)(D)(E)}$$

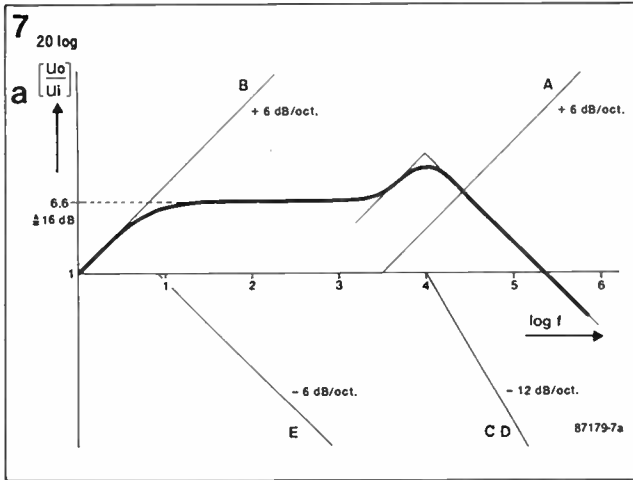

Fig. 7 Theoretical (a) and practical (b) frequency response of the transmitter. Curve B in Fig. 7b shows the overall response of the IR system.

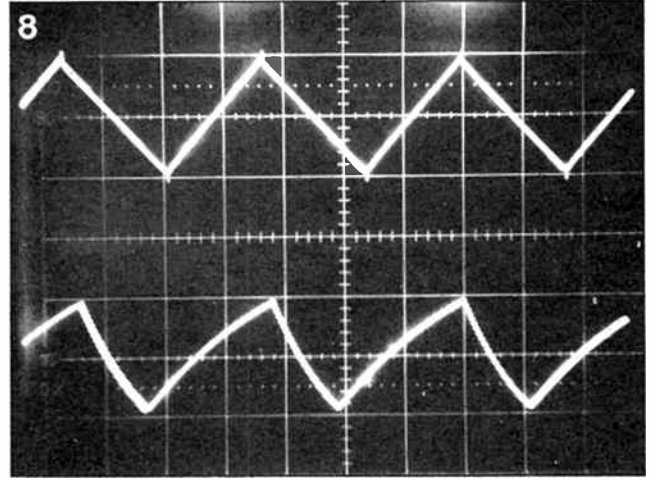

Fig. 8 The voltage on the timing capacitor in the 555 based CCO is triangular (upper curve) rather than exponential (lower curve) to achieve linear frequency modulation. $f_c = 100$ kHz.

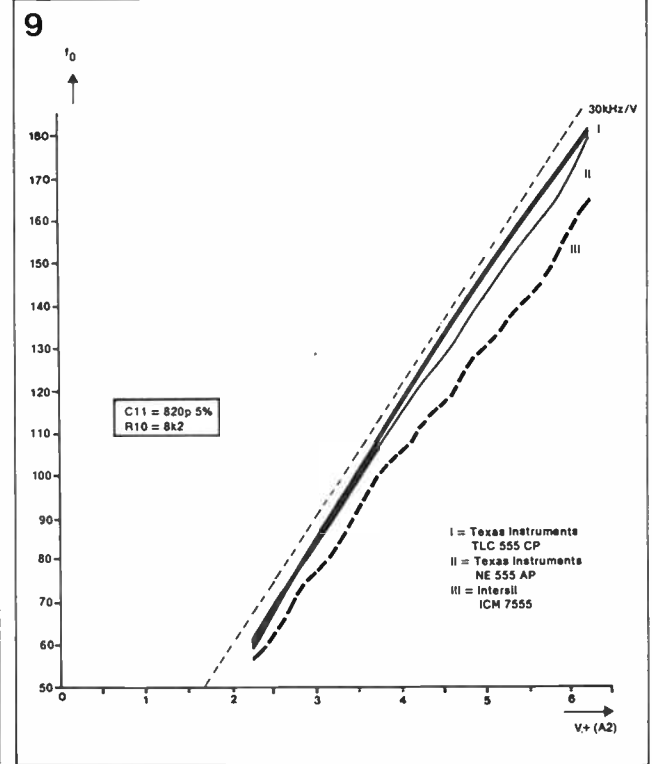
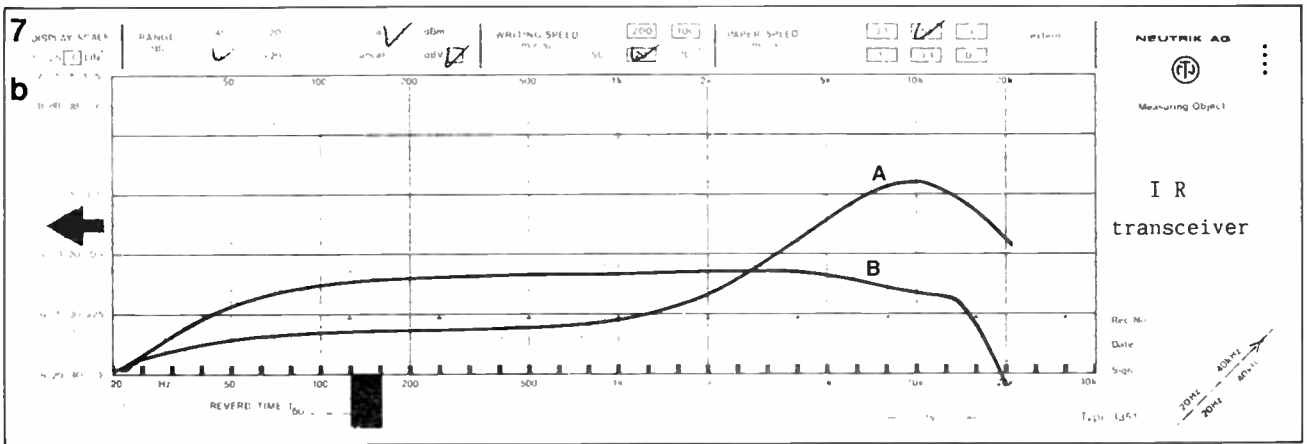

Fig. 9 Curves showing the modulation gradient of the transmitter with various timer chips fitted in position IC3.

(=6.2 V). The current through D_4 and D_6 is blocked, and $I_{C(R2)}$ flows into C_{11} via D_5 . When the voltage on C_{11} exceeds $\frac{2}{3}V_{CC}$ (=4.13 V), the timer output goes low, $U_{C(R2)}$ becomes about 1.5 V, and D_5 blocks the current. In this situation, D_3 and T_3 form a current mirror, so that $I_{C(R3)} = I_{D(3)} = I_{C(R2)}$. Timing capacitor C_{11} is then discharged with the current $I_{C(R2)}$. The frequency of the triangular signal on C_{11} is a linear function of $I_{C(R1)}$, and, therefore, of U_+ , and, therefore, of the instantaneous amplitude of the modulation signal superimposed on U_+ . In brief, this is *frequency modulation*. The 7555 functions as a current controlled oscillator (CCO) thanks to the linearization of the—normally exponential—charge-discharge curve of the timing capacitor, C_{11} . The oscillogram in Fig. 8 shows the output of the CCO in contrast to that of a 7555 based oscillator in the standard configuration. IC_3 , T_1 , T_2 and T_3 thus form a voltage controlled oscillator (VCO), whose central

frequency, f_c (≈ 100 kHz) is determined by U_+ as

$$I = C(d_u/dt) = U_+ / R_{10}$$

$$d_u = 1/3 V_{CC} = 2.07 \text{ V}$$

$$d_t = 1/2 (1/f_c)$$

$$U_+ / R_{10} = C_{11} [2.07 / (1/2 f_c)]$$

$$= C_{11} \times 4.13 / f_c$$

$$f_c = U_+ (1/4.13 C_{11} R_{10}) \text{ [Hz]} \quad [24]$$

In practice, the modulation gradient of the transmitter is about 30 kHz/V when $R_{10} = 8K\Omega$ and $C_{11} = 820$ pF. This means that f_c is about 100 kHz when U_+ is set to +3.3 V with the aid of P_2 . A frequency deviation of ± 50 kHz is achieved when the amplitude of the modulation signal superimposed on U_+ is 1.7 V_p. It was found that the toggle levels of the comparators in 555s and 7555s supplied by various manufacturers are subject to a relatively loose tolerance. Figure 9 shows the $f_c(U_+)$ curves of 2 7555s and a 555 fitted in position IC_3 . The results obtained prove that the calculated modulation gradient of 30 kHz/V may not be achieved in all cases.

Although the modulation index, β , of the transmitter is conventional at

$$\beta = \Delta f / f_{(m)} = 50 / 10 = 5, \quad [25]$$

the resultant deviation of ± 50 kHz (100 kHz_{pp}) is large relative to the carrier frequency of 100 kHz. This observation is important in view of the receiver design, and will be reverted to.

Emitter follower T₄ buffers the rectangular output pulses of the oscillator. Via the carrier power control, P₃, the signal reaches power output transistor T₅, which is capable of building up an emitter potential of about 4.5 V. Emitter resistor R₁₆ carries a peak current of 200 mA, taken from the 12 V supply via IRED D₇, which is so pulsed at a duty factor of about 0.5 to supply its maximum radiant intensity of 10 mW sr⁻¹. The transmitter is fed from a (rechargeable) 12 V battery, and consumes about 125 mA when set to maximum output power. Evidently, it is also possible to use a regulated 12 V, 1 A power supply when the IR transmitter is operated in a fixed location.

Circuit description of the receiver

The IR receiver is a simple design, just like the transmitter. The circuit diagram is shown in

Fig. 10. When $P_R = 30$ NEP, i.e., $[S/N]_1 = 15$ dB, a photon current is generated with an equivalent power of 4×10^{-10} W. The energy, E , of a photon is expressed as

$$E = hc / \lambda = 2.07 \times 10^{-19} \text{ [J]} \quad [26]$$

where

$$h = 6.6262 \times 10^{-34} \text{ [J s}^{-1}\text{]} \text{ (Planck's constant);}$$

$$c = 2.97 \times 10^8 \text{ [m s}^{-1}\text{]} \text{ (velocity of light);}$$

$$\lambda = 950 \times 10^{-9} \text{ [m].}$$

This means that the received power, P_R , of 4×10^{-10} W corresponds to

$$P_R / E = 1.93 \times 10^9 \text{ photons s}^{-1}. \quad [27]$$

Figure 2 shows that the quantum yield, η , of the BP104 is high at 0.92 electrons per photon, so that the given photon current results in a density, D_e , of 1.77×10^9 electrons per second. The electric current, I_f , is then calculated as follows:

$$1 \text{ coulomb (C)} = 1 / 1.6 \times 10^{-19}$$

$$= 6.25 \times 10^{18} \text{ [electrons]}$$

$$1 \text{ ampere (A)} = 1 \text{ C s}^{-1}$$

$$I_f = D_e / 6.25 \times 10^{18} \quad [28]$$

$$= 2.83 \times 10^{-10} \text{ [A]}$$

$$I_{f(\max)} = 2I_f = 566 \text{ pA.}$$

This current corresponds to 32 μ V on R₂₃ (56 k Ω). The effective voltage at $f_c = 100$ kHz is

$\frac{1}{2} \times 2 \times 32 = 11.2 \mu\text{V}$. The signal from the photodiode is raised in a 4-stage direct coupled transistor preamplifier, T₆-T₉, which ensures an amplification of about 10 000. The preamplifier is a slightly modified version of the one discussed in reference (2). The amplified signal is coupled out to limiter IC₄ via R₃₁ and C₂₀. The resistor prevents load variations and feedback effects from upsetting the sensitive preamplifier. Negative feedback control P₄ enables finding the optimum signal-to-noise ratio for a wide range of input signal strengths. A high feedback level also allows suppressing to some extent the interference from nearby luminescent tubes or TV sets.

The well-known Type TBA120S FM demodulator comprises an excellent limiter circuit, which is used here to cancel the effect of the relatively strong AM noise on the received signal. In the present application, the quadrature detector in the chip is only used for driving the S-meter circuit.

This is set up around IC₆ and T₁₁, and enables evaluating the relative signal strength during the testing and setting up of the equipment. Preset P₅ is adjusted for minimum visible meter deflection when no signal is received. The voltage at pin 8 of the TBA120S is smoothed by C₂₆, and rises

with the signal strength. This causes the emitter voltage of T₁₁ to fall, the collector current to increase, and the meter to deflect. The maximum coil current in M₁ can be set with the aid of P₆. Provided the preamplifier operates in its linear range, the meter indication is a direct measure of the received signal strength. It was already mentioned that the ratio of f_c to Δf is remarkably low in the proposed system. This fact makes it virtually impossible to use the quadrature detector inside the TBA120S for obtaining sufficient AF output. With $f_c : \Delta f$ as low as 2, linear FM detection can only be achieved with the aid of a phase-locked loop (PLL) detector. The Type NE565 (IC₅) used here ensures a reasonable S/N ratio while requiring relatively few external components. The central frequency, f_0 , is determined by P₇+R₄₃ (R) and C₂₇ (C):

$$f_0 = 1 / 3.7RC \text{ [Hz]}. \quad [29]$$

Preset P₇ gives a VCO range of approximately 70 to 150 kHz, which is about equal to that of the transmitter. A 50 μ s deemphasis network is formed by R₄₁-R₄₇-C₃₀. The resistors are dimensioned such that the demodulated signal at pin 7 of the NE565 is direct coupled to buffer T₁₂, obviating the need for an additional coupling capacitor. The on-board AF

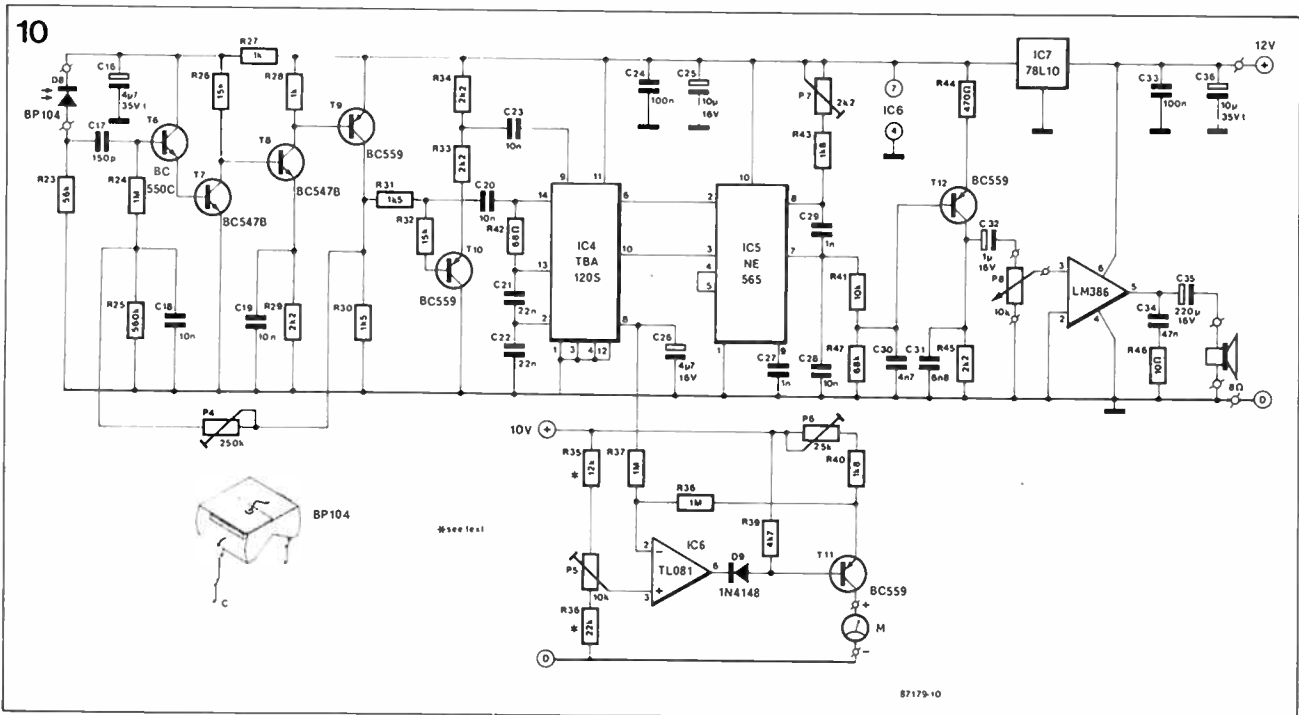

Fig. 10 Circuit diagram of the infra-red receiver.

power amplifier is a standard application of the Type LM386. Some 250 mW of AF power is available for driving a head-phone set, or a miniature 4 or 8 Ω loudspeaker.

For portable applications, the receiver is fed from a 12 V battery. Current consumption is of the order of 35 mA. The transmitter and the receiver should not be powered from a common supply or battery. This is in view of the relatively high peak currents in the transmitter in combination with the high sensitivity of the receiver. The 100 kHz pulses are readily induced direct into the receiver, and so make the correct adjustment of the system virtually impossible. The preamplifier in the receiver is essentially a wideband type, and inter-modulation problems may arise when it is used in the direct vicinity of powerful medium or long-wave transmitters.

Construction: the electronics

The track layout and component overlay of the printed circuit board for the IR transceiver

Parts list

Resistors (± 5%):

- R1;R2;R7;R8;R15;R22;R41 = 10K
- R3 = 15KF
- R4 = 3K9
- R5 = 22KF
- R6;R11;R12 = 2K7
- R9 = 270R
- R10 = 8K2
- R13;R14;R44 = 470R
- R16 = 22R; 0.5 W
- R17;R18;R20 = 100K
- R19 = 5K6
- R21 = 100R
- R23 = 56K
- R24;R37;R38 = 1M0
- R25 = 560K
- R26;R32 = 15K
- R27;R28 = 1K0
- R29;R33;R34;R45 = 2K2
- R30;R31 = 1K5
- R35 = 12K
- R36 = 22K
- R39 = 4K7
- R40;R43 = 1K8
- R42 = 68R
- R46 = 10R
- R47 = 68K
- P1;P5 = 10K
- P2 = 5K0 or 4K7
- P3 = 470R or 500R
- P4 = 250K or 220K
- P6 = 25K or 22K
- P7 = 2K2 or 2K5
- P8 = 10K logarithmic potentiometer

Capacitors:

- C1;C6 = 2μ2; 16 V; radial
- C2 = 1N0J; styroflex/polystyrene
- C3;C26 = 4μ7; 16 V
- C4 = 15nJ; MKT
- C5 = 680pJ; styroflex/polystyrene
- C7;C9;C24;C33 = 100n
- C8;C13 = 10μ; 16 V; radial
- C10;C36 = 10μ; 35 V; tantalum bead
- C11 = 820pJ; styroflex/polystyrene
- C12;C15 = 1μ; 16 V; radial
- C14 = 47μ; 16 V; radial
- C16 = 4μ7; 35 V; tantalum bead
- C17 = 150p ceramic
- C18;C19;C20;C23 = 10n ceramic
- C21;C22 = 22n ceramic
- C25 = 10μ; 16 V; axial
- C27;C29 = 1n0
- C28 = 10n
- C30 = 4n7
- C31 = 6n8
- C32 = 1μ; 16 V; axial
- C34 = 47n
- C35 = 220μ; 16 V; axial

Ceramic capacitors are plate or disc types with a lead spacing of 2.5 mm.

Semiconductors:

- D1 = 6V2; 400 mW zenerdiode
- D2...D6 incl.;D9 = 1N4148
- D7 = LD271 or LD271H
- D8 = BP104

- IC1 = NE5534
- IC2 = CA3240E
- IC3 = 7555 or TLC555
- IC4 = TBA120S (do not use T or U types)
- IC5 = NE565 or LM565C
- IC6 = TL081
- IC7 = 78L10
- IC8 = LM386
- T1;T3;T4 = BC549B
- T2;T9...T12 incl. = BC559B
- T5 = 2N2219A
- T6 = BC550C
- T7;T8 = BC547B

Miscellaneous:

- Suitable heat-sink for T5
- PCB Type 87179 (not available through the Readers Services).
- M = 100 μA...1 mA rectangular S-meter.
- Loudspeaker; 8 Ω; 0.5 W.
- 2 off 5-way DIN sockets (180°).
- 1 off 2-way DIN loudspeaker socket.

* See text.

See our 'PROJECT BUYERS GUIDE' this issue for a guide to component sources and kit suppliers.

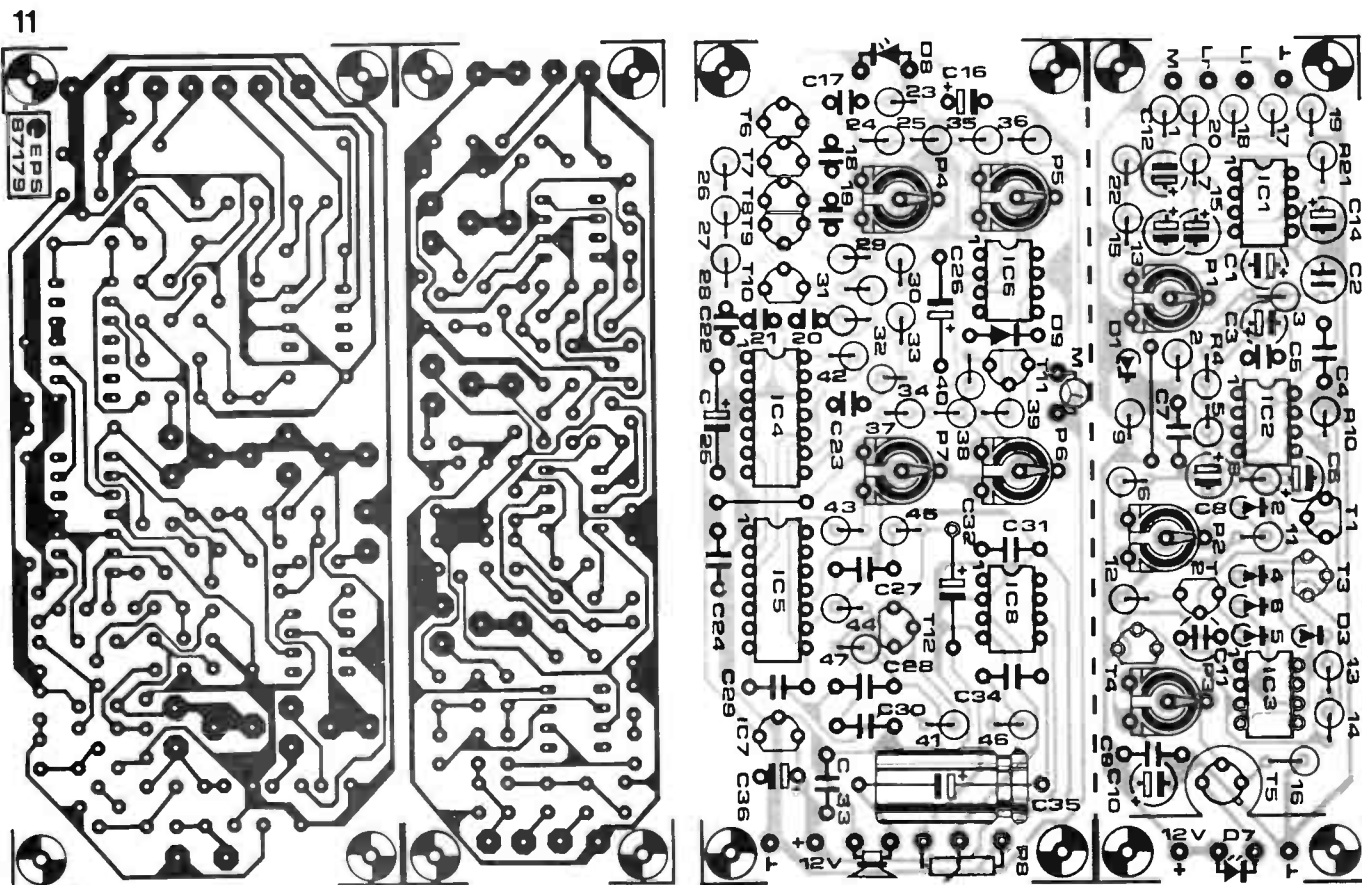

Fig. 11 Track layout and component mounting plan of the PCB for building the IR transceiver.

are given in Fig. 11. The board is cut in two along the dotted line to enable building the transmitter and the receiver separately. Commence the construction with populating the transmitter board, starting with the single wire link to the right of P₁. All resistors and diodes, and most capacitors, are fitted upright. Use sockets for all 3 ICs, and observe the correct orientation before these are plugged in. Also verify the polarity of the radial electrolytic capacitors, and the tantalum bead capacitor, C₁₀. Do not fit T₅ until a suitable heat-sink is to hand. The Ω-shaped heat-sink used in the prototype transmitter was a type for cooling RGB and video output transistors on a salvaged TV chassis. A push-on TO18 or TO5 style heat-sink is only usable when the nearby soldering pins are kept short, and the enclosure of T₅ is well above the surrounding components. Temporarily fit the IRED direct onto the relevant soldering pins, *but do not cut off the leads as yet*.

The receiver board is also fairly densely populated. All resistors are fitted upright, and there is also a single wire link, namely in between IC₄ and IC₅. Use sockets for all ICs. Fit the photodiode straight onto the soldering pins, observing the correct polarity. Push-fit T₆...T₁₀ incl. and the ceramic plate or disc capacitors as far as possible towards the PCB surface before soldering. Volume control P₈ is temporarily fitted direct onto the relevant soldering pins. Connect a small loudspeaker, and a suitable S-meter, to the relevant terminals on the board.

An initial test

Place the transmitter some 3 metres away from the receiver, and point the IR components at each other. Set the presets on the transmitter as follows: P₁ ¼ cw; P₂ to mid-travel; P₃ ¼ cw. Connect the +12 V and 1 terminals on the transmitter to a regulated 12 V supply, and apply a -20 dB; 1 kHz sine-wave to the L_L-L_R inputs. Power up the transmitter. The current consumption should not exceed 100 mA. Set U₊ to +3.5 V. Switch the transmitter off.

Turn the presets on the receiver board as follows: P₄ ¼ cw; P₅ and P₆ to mid-travel;

P₇ ¾ cw. Feed the receiver from a separate 12 V supply or battery. Switch on the power, and turn up the volume control until steady noise is heard. Some rattle may be audible if the photodiode "sees" sources of interference such as the light from luminescent tubes. Switch on the transmitter, and adjust VCO preset P₇ until the signal is heard. Optimize the reception by adjusting P₄; this is fairly critical. Reduce or increase the modulation strength as required. Verify that the transmitter power can be adjusted with P₃.

Block the incident IR beam with an available object, and measure the direct voltage at pin 8 of IC₄. Null the S-meter by adjusting P₅. Restore the IR link by removing the object, and reduce or increase the S-meter

deflection by adjusting P₆ until the f.s.d. indication is reached. Due to the tolerance on the bias voltage on pin 8 of the TBA120S, it may be necessary to redimension R₃₅ and/or R₃₆ to ensure a narrow enough span of the sensitivity preset, P₅. It should be noted that every change in the setting of feedback preset P₄ requires readjusting P₅. Thanks to the use of current source T₆, the S-meter can be almost any type with a sensitivity of 100 μA to 1 mA.

Properly aligned, and without the use of lenses or reflectors, the system should have a range of 6 to 8 metres. Verify this with the transmitter set to maximum power, and peak P₄ and P₇ for

optimum reception when there is considerable noise on the received signal.

The optics

The lens for the receiver is a type removed from an inexpensive looking or reading glass, available from opticians or stationers. The quality of the glass is not important, and the handle is, of course, not used. A diameter of about 100 mm is convenient because it allows the lens to be fitted into a length of PVC draining tube, purchased complete with a suitable PVC end cap. Two 10 mm wide rings are cut from the tubing. A 10 mm wide gap is cut into each of these rings to enable push-fitting them in the tube, where they keep the lens securely locked at either side, still allowing its position to be adjusted in accordance with the focal length. Provisionally fit the lens at one extreme of the tube and ascertain the focal length as indicated under *Optical amplification*. Most lenses with $r=50$ mm have a focal length of about 25 cm. Make a note of the empirically found focal length, and mark the envisaged, approximate, position of the photodiode on the outside of the tube. The receiver board is mounted lengthwise inside the tube, with the photodiode connected direct to the input pins.

A perspex disc with a central hole for the photodiode is cut to fit into the tube. The front side of this disc should be painted

mat black, or covered with black cardboard.

The receiver board is held on a rectangular piece of perspex fitted between the disc and the PVC end cap. The photodiode should be level with the front side of the blackened perspex disc, and exactly at the centre of the hole to ensure the correct position on the axis of the lens. The rectangular block of perspex is cut, glued to the disc, and screwed onto the end cap for additional stiffness of the receiver assembly. The end cap is drilled and cut to hold the volume control, the S-meter, and a 5-way DIN socket for connecting the headphones or the loudspeaker, and the power supply. The cap is secured to the tube with the aid of 3 screws, which, unlocked, should enable sliding the receiver assembly about 40 mm horizontally.

The tube is fitted on a photographer's tripod with the aid of a suitable mounting plate and bolt. As a finishing touch, an adjustable finder may be mounted onto it. The receiver assembly is shown in Fig. 12.

It should be noted that the use of infra-red rather than visible light results in an increase of about 2% in the stated focal length of the lens. The average beamwidth of the previously discussed receiver system is of the order of 2°.

The reflector at the transmitter side is a round headlight or fog lamp picked up at a car breaker's yard. The reflective area should be smooth and unstained. Rectangular reflectors for use with halogen lights are less suitable. Select a fairly concave lamp that is complete with an intact, non-coloured glass cover, a bulb and mounting hardware.

Consult Fig. 5c and Fig 12 for the suggested way of mounting the IRED. Never attempt to clean the reflective surface with anything but a dry cloth. Remove the bulb and carefully break and remove the glass. With some mechanical skill, the bayonet fitting can be converted into the positioning system for the IRED. It is possible, for instance, to divide the copper surface of a piece of un-etched circuit board into 3 insulated areas; 2 small ones for connecting the IRED terminals to the wires to the transmitter,

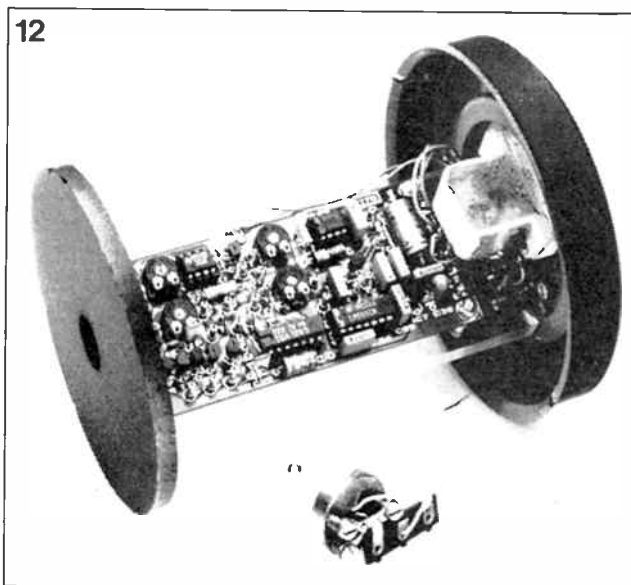

Fig. 12 The positioning system for the IRED, and the receiver assembly ready for fitting into the tube.

while the larger area is used for fitting 3 spring-loaded, M30 x 3 adjustment screws, which are accessed at the rear side. Before mounting the IRED onto this plate, the beam must be converged with the aid of a standard red, 5 mm LED, which is temporarily powered from a 12 V supply via a 1 k Ω series resistor. Place the reflector assembly in a darkened room, and find the LED position that results in a clear red spot projected onto a vertical surface at a distance of 6 to 8 metres. Make the spot as bright and sharply defined as possible by adjusting the inclination of the LED with respect to the axis of the reflector. The LED can then be replaced by the IRED, which should have *exactly* the same position. The author's prototype mounting system is shown in Fig.12. Replace the glass cover, and re-assemble the lamp. Provide a mounting system for fitting it onto a photographer's tripod, or build a wooden cross for placing the reflector securely onto a horizontal surface. The elevation system of the lamp should be retained and kept operational.

The transmitter board can be fitted in a suitable ABS enclosure for securing onto the vertical rod of the tripod. Do not forget to drill holes in the top or bottom lid to enable accessing the presets. The transmitter input is a 5-way DIN plug, the output to the IRED a 2-way DIN plug as used for loudspeakers. Drill additional holes to prevent

overheating of Ts. The zener diode, D₁, also gets fairly warm, but requires no cooling. The relatively thick supply wires are secured with a strain relief and fed through a grommet.

Field trials, duplex operation, applications

Find a line-of-sight path of about 50 metres for an initial trial, and increase the distance covered with, say, 10 metres at a time. The reflector and the lens have extremely narrow beamwidths, and their aiming requires some experience. Carefully slide the receiver assembly in the tube, and adjust the IRED position, until reception is optimum. For distances over 1,000 metres it is recommended to use field-glasses and, if possible, a set of PMRs

for maintaining the contact. A well-aligned finder fitted on the receiver will soon prove indispensable. Never aim the receiver tube at the sun when this is bright; the destruction of the photodiode will be immediate. Two-way communication is possible with a complete transceiver at both ends. Provided the reflector is placed ahead of (but not in front of) the local receiver, it is not even necessary to use different frequencies.

Applications of the present transceiver include wireless car security systems, and permanent, wireless, intercoms between homes. A security system can be set up for the home by placing plane mirrors at suitable locations. The transmitter is powerful enough to project an invisible beam all around the house. In this application, the disappearance of the carrier could be detected

by the sounding of an alarm. It may not always be necessary to use a reflector and lens of the size indicated above. Even the plastic reflector from a pocket torch, in combination with a 40 mm lens, will enable communication over considerable distances. Convex or plane mirrors could be used for changing the direction of the IR beam. More powerful IREDs, and perhaps even lasers, in combination with more sensitive photodiodes may increase the distances covered without the use of lenses or reflectors, but care should be taken to select a combination for the same wavelength.

Finally, the maximum distance covered with prototypes of the transmitter-receiver was 1,750 m in a single-way link, and 1,350 m in a duplex link. The author is interested in hearing about your experiences with the system through *Elektor Electronics*.
D;FYZ,Bu

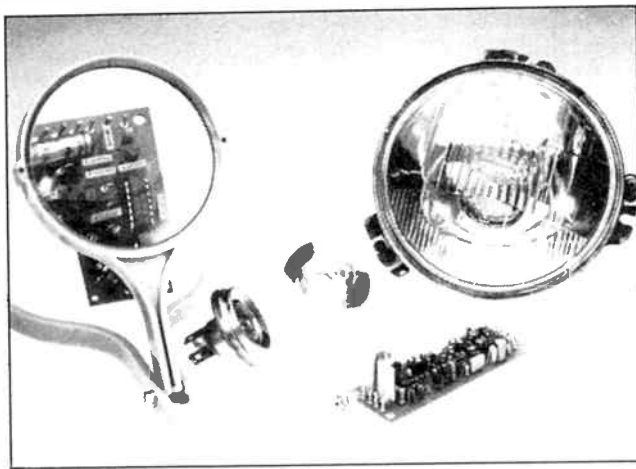

Various components for building the infra-red transceiver.

References:

- (1) *Optoelectronics: An Introduction*. J Wilson and J F B Hawkes (Prentice Hall).
- (2) *Single channel infra-red remote control system*. Elektor Electronics, January 1982.

A good general introduction into optoelectronics can be found in:
Optoelectronic components. Siemens handbook, ed. 85/86.

— from page 55

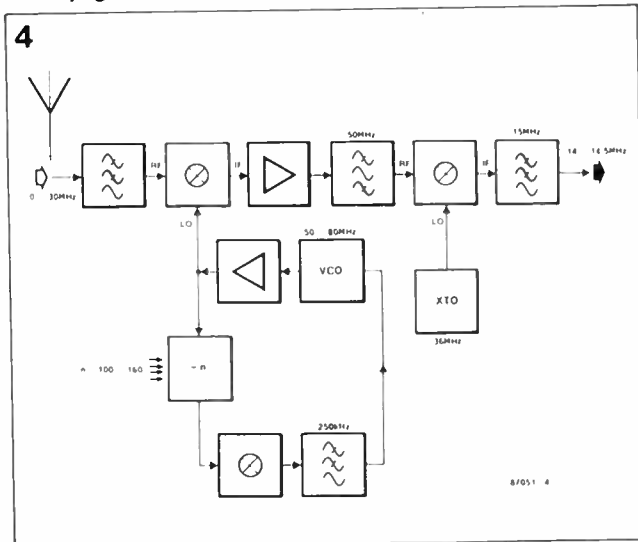

Fig. 4 Suggested block diagram of a 0 – 30 MHz converter.

aerial input. Connect a 10 M Ω , 5 pF scope probe to the RF side of C₄. Peak C₁ for maximum rejection of the 9 MHz signal. Set the band switch to 80 m, place the scope probe on the RF side of L₇, and adjust C₇ similarly.

A general coverage receiver

The unit described can form the tuneable IF section of a 0–30 MHz communication receiver. A suggested block diagram is given in Fig. 4, while the practical circuit of the synthesizer can be found in (1). The output of the converter is fed to the 20 m input of the present receiver, whose 80 m input can be omitted. Computer control of the receiver so made is rela-

tively simple since all adjustments are effected by direct voltages, which can be generated with the aid of DACs. Also, the computer is likely to be required in any case for decoding slow-scan transmissions, RTTY, morse, or FAX. B

Reference:

- (1) *Synthesizer for SW receiver*. Elektor Electronics, July/August 1987, Supplement page 61. Designs for a mixer, an RF input amplifier, morse filters, and a computer interface appear in the same issue.

Radio Wave Propagation (HF bands) by F C Judd G2BCX. Heineman Newnes; ISBN 0-434-90926-2.

SSB RECEIVER FOR 20 AND 80 M



Experienced DXers as well as novice SW listeners will appreciate this compact, sensitive, and relatively simple to build single-sideband receiver for the popular 20 and 80 metres bands.

The 80 m band extends roughly from 3.5 to 4.0 MHz, and its propagation characteristics enable "local" communication over distances up to about 1,000 km. The 20 m band (14 to 14.5 MHz) is ideal for global communication, provided the right "paths", i.e., tropospheric propagation modes, are available and "open". Very long distances can be covered using low power transmitters, but some knowledge is required of the maximum usable frequency (MUF) in the direction of reception at a given local time.

Sections of both the 20 and the 80 m band are assigned to radio amateurs, but the exact band limits are not the same throughout the world.

Actually listening to radio amateurs and utility stations in these bands is undoubtedly the best way to learn about their peculiarities as to optimum propagation conditions for different regions of the world.

The receiver discussed in this article is a straightforward design, with manual control.

Block diagram

When the band switch is set as shown in the block diagram of Fig. 1, the aerial signal is fed to

a bandpass filter dimensioned for 14 to 14.5 MHz. A 9 MHz notch filter is fitted at the input to prevent strong signals at this

frequency causing break-through, interference or intermodulation in the intermediate frequency (IF) section of the re-

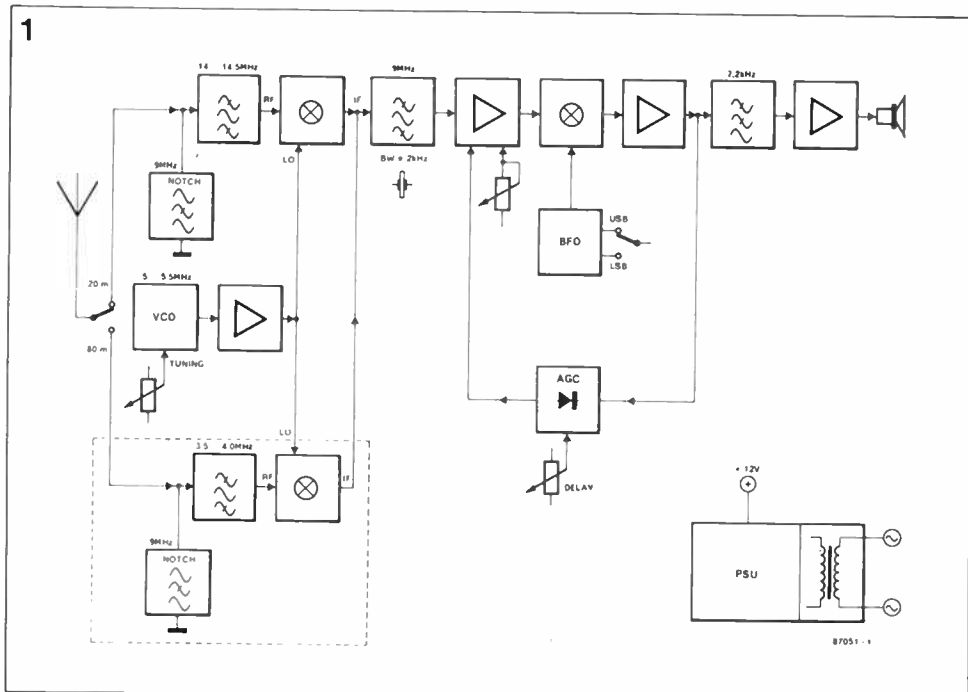

Fig. 1 Block diagram of the SSB receiver for 20 and 80 metres.

ceiver. The output of a voltage-controlled oscillator (VCO) with a tuning range of 5 to 5.5 MHz is buffered, and fed to the local oscillator (LO) inputs of the active mixers that follow the 20 m and 80 m input sections. The IF signal is fed to a 9 MHz quartz crystal filter which ensures a bandwidth of about 2 kHz. After the IF amplifier stage comes the product detector for demodulating the SSB signals. The beat frequency oscillator (BFO) enables detection of the upper or lower sideband (USB/LSB). The output signal of the detector is filtered and fed to the AF power amplifier, but it is also used for driving an AGC (automatic gain control) circuit with adjustable delay. The AGC controls the gain of the IF amplifier.

Circuit description

The circuit diagram of the receiver is shown in Fig. 2. It is seen that a single DPDT switch, S_1 , selects reception in the 20 m or 80 m band. The 9 MHz, series resonant, notches are formed by L_4 - C_6 - C_7 (80 m) and L_1 - C_2 - C_1 (20 m). The aerial signal is applied to a bandpass composed of a T-filter, L_5 - L_6 - C_8 , and a damped, parallel resonant, circuit L_7 - C_{10} - R_5 . It is seen that gates g_2 of DG MOSFETs T_1 and T_2 are connected in parallel to enable optimum, DC coupled, driving by the VCO buffer, T_6 . The drains of T_1 and T_2 are also joined for feeding the mixers via the damped primary of IF transformer L_8 . Switch section S_{1B} takes the source of the relevant mixer to ground. The non-used MOSFET has its source taken to +12 V via a 100 k Ω resistor, and forms a high impedance at the drain. Trimmer C_{13} is used for peaking L_8 at 9 MHz. The bandpass filter for 20 metres is a series-parallel combination with 2 trimmers for setting the correct frequency response.

The VCO is formed by oscillator T_7 and DC coupled buffer T_6 . Its output frequency range of 5 to 5.5 MHz is set by C_{24} , while tuning is effected with the aid of the direct voltage from P_1 applied to double varactor D_2 . The high impedance at g_1 of MOSFET T_7 guarantees minimum loading of the parallel tuned circuit that determines the frequency of oscillation. Positive feedback is created in

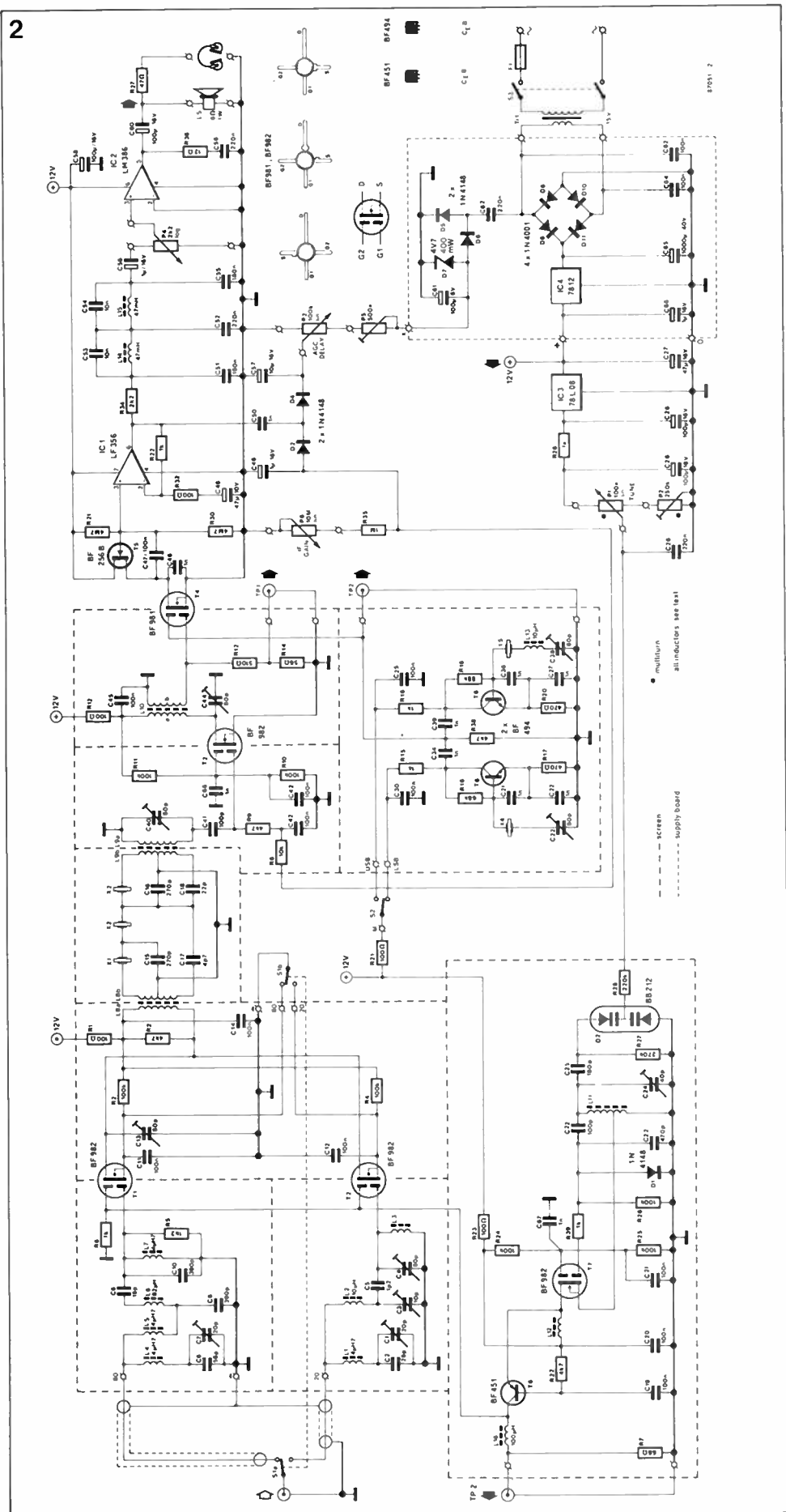
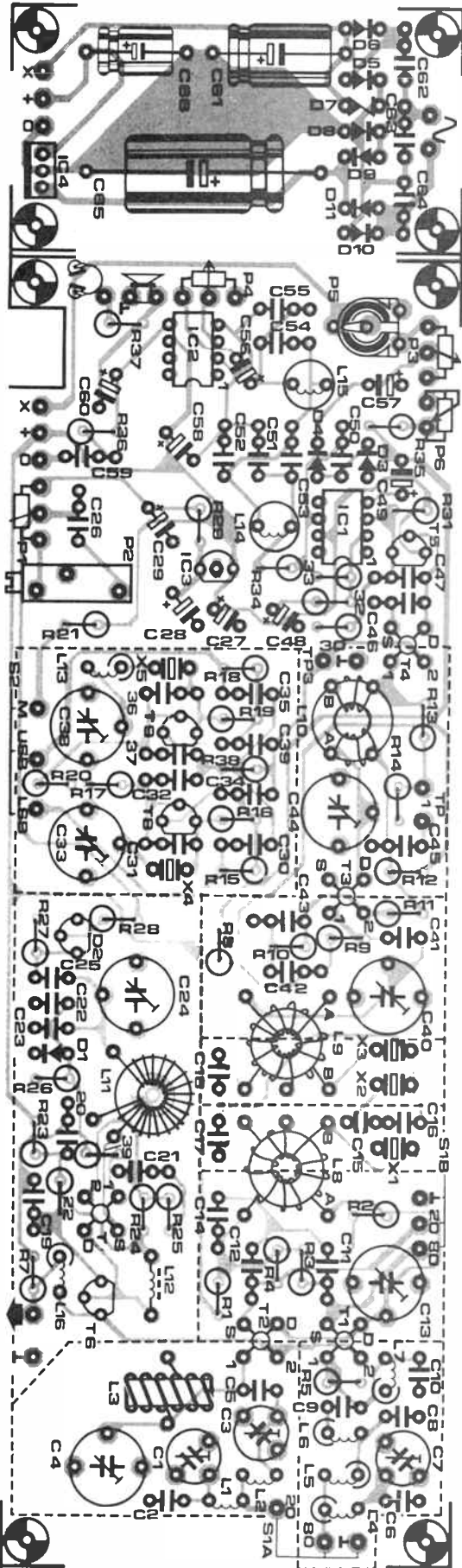

Fig. 2 Circuit diagram of the SSB receiver. The dashed lines represent metal screens on the board.



Parts list

Resistors ($\pm 5\%$):

R1;R2;R21;R23;R32 = 100R
 R2;R9;R22;R38 = 4K7
 R3;R4;R10;R11;
 R24;R25;R26 = 100K
 R5 = 1K2
 R6;R15;R18;R29;R33;R39 = 1K0
 R7 = 68R
 R8 = 10K
 R13 = 560R
 R14 = 56R
 R16;R19 = 68K
 R17;R20 = 470R
 R27;R28 = 220K
 R30;R31 = 4M7
 R34 = 2K2
 R35 = 1M0
 R36 = 12R
 R37 = 47R
 P1 = 100K multiturm poten-
 tiometer
 P2 = 250K multiturm preset
 P3 = 100K linear potentiometer
 P4 = 2K2 logarithmic poten-
 tiometer
 P5 = 500K
 P6 = 10M linear potentiometer

Capacitors:

C1;C7 = 20p foil trimmer (green)
 C2 = 39p
 C3 = 10p foil trimmer (yellow)
 C4;C13;C33;C38;C40;C44 = 80p
 foil trimmer (purple)
 C5 = 1p2
 C6 = 56p
 C8;C10 = 390p
 C9 = 18p
 C11;C12;C14;C19;C20;C21;C30;
 C35;C42;C43;C45;C47
 ;C63;C64 = 100n
 C15;C16 = 270p
 C17 = 4p7
 C18 = 22p
 C22 = 470p
 C23;C41 = 100p
 C24 = 40p foil trimmer (red)
 C25 = 180p
 C26;C52;C59;C62 = 220n
 C27 = 47 μ ; 16 V
 C28;C29;C60 = 100 μ ; 16 V
 C31;C32;C34;C36;C37;C39;C46;
 C50 = 1n0
 C48 = 47 μ ; 10 V
 C49;C56;C66 = 1 μ 0; 16 V
 C51;C55 = 180n
 C53;C54 = 10n
 C57 = 10 μ ; 16 V
 C61 = 100 μ ; 6 V
 C65 = 1000 μ ; 40 V
 C67;C68 = 1n0 SMA capacitor

Semiconductors:

D1;D3...D6 incl. = 1N4148
 D2 = BB212
 D7 = zener diode 4V7; 400 mW
 D8...D11 incl. = 1N4001
 T1;T2;T3;T7 = BF982
 T4 = BF981
 T5 = BF256B
 T6 = BF451
 T8;T9 = BF494
 IC1 = LF356
 IC2 = LM386
 IC3 = 78L08
 IC4 = 7812

Inductors:

L1;L4;L5;L7 = 4 μ H7
 L2;L13 = 10 μ H
 L3 = 24 turns \varnothing 0.3 mm
 (SWG30) enamelled copper
 wire on core Type T25-6.
 L6 = 82 μ H
 L8A;L9A;L10A = 25 turns \varnothing 0.3
 mm (SWG30) enamelled copper
 wire on core Type T50-6.
 L8B;L9B = 5 + 5 turns turns
 \varnothing 0.3 mm (SWG30) enamelled
 copper wire.
 L10B = 8 turns \varnothing 0.3 mm
 (SWG30) enamelled copper
 wire.
 L11 = 42 turns \varnothing 0.2 mm
 (SWG36) enamelled copper
 wire on core Type T50-6. Tap
 at 4 turns from ground.
 L12 = 10 turns \varnothing 0.2 mm
 (SWG36) enamelled copper
 wire through a ferrite bead.
 L14;L15 = 47mH
 L16 = 100 μ H

Miscellaneous:

S1 = miniature DPDT switch.
 S2 = miniature SPDT switch.
 S3 = DPDT mains switch.
 F1 = 100 mA fuse plus holder.
 X1...X5 incl. = quartz crystal
 27.005 MHz (third overtone).
 Tr1 = 15 V; 250 mA mains
 transformer.
 LS = 8 Ω ; 1 W loudspeaker.

See our
**PROJECT
 BUYERS
 GUIDE** this
 issue for a
 guide to
 component
 sources and
 kit suppliers.

Fig. 3 Component mounting plan of the SSB receiver.

the oscillator by taking the source of T₇ to ground via a tap on inductor L₁₁. Test point TP₂ at the output of the buffer stage is useful for connecting a frequency meter that can so take the function of a digital frequency readout.

Mixing is additive for the 80 m band (3.5+5.5=9 MHz), and subtractive for the 20 m band (14-5=9 MHz). From this it can be deduced that the tuning direction is reversed on the 80 m band, i.e., a higher VCO frequency results in tuning to a lower input frequency.

A narrow IF bandfilter is set up with the aid of 3 27.005 MHz, third overtone, quartz crystals. Each of these resonates at a very small offset from its *fundamental* frequency, as determined by the particular capacitive arrangement around it. Each of the crystals forms a series tuned circuit with a very high Q (quality) factor. Together with the capacitance and inductance around them, the crystals form a 9 MHz IF filter with a bandwidth of about 2 kHz. MOSFET T₃ forms the IF amplifier whose gain is AGC controlled, as well as adjustable with P₆. The amplified IF signal is coupled out inductively via L₁₀. Test point TP₁ carries the filtered IF signal, and can be used for alignment purposes. The product detector for demodulating the SSB signal is formed by T₄, which is fed from current source T₅. The sideband (USB/LSB) oscillators are virtually identical. The crystals oscillate at the fundamental frequency with a very small offset from 9 MHz. The output signal of a sideband oscillator forms the reference against which the SSB signal is demodulated. USB/LSB selection is effected with the aid of S₂. Trimmer capacitors C₃₃ and C₃₈ enable adjusting the output frequency of the respective oscillator. The oscillator frequencies can be checked with a frequency meter connected to TP₃.

The unfiltered AF signal is raised in IC₁. Diodes D₃ and D₄ rectify the AF signal to provide the AGC (automatic gain control) voltage. The negative bias voltage on C₅₇ is made adjustable with the AGC DELAY potentiometer, P₃. The bias voltage on C₅₇ is derived from a stabilized -4.7 V supply set up around zener diode D₇. The AGC works in conjunction with

the IF GAIN control, so that the negative voltage effectively controls the amplification of T₃ by pulling the g₁ potential below that of the source.

The 2.2 kHz AF filter discussed under *Block diagram* is a double π type between the output of buffer IC₁ and AF power amplifier IC₂.

The power supply for the receiver is a conventional type based on the well-known 78 series of integrated regulators. The output of 12 V regulator IC₄ is reduced to 8 V in IC₃ to obtain the required span of the tuning voltage at the wiper of P₁. The minimum tuning voltage can be set with the aid of preset P₂.

Construction

The printed circuit board for the receiver is a double-sided, but not through-plated, type, whose component mounting plan is given in Fig. 3. The component side of the board functions as a large earth surface. The power supply section on the board may be cut off for mounting as a separate unit in the cabinet.

Commence the construction with winding inductors L₃, L₉, L₁₀, L₁₁ and L₁₂ as per the indications in the parts list. Secure the wire on the cores using Araldite or wax, then fit the completed inductors on the board as orientation points, observing the right connection of the primary and secondary windings, and the taps. Proceed with fitting the soldering pins, resistors, ready-made inductors, diodes, crystals, and all fixed capacitors except SMA types C₆₇ and C₆₈, noting that

soldering is sometimes required at the component side also. Pay attention to the polarization of the radial electrolytic capacitors! Then fit the transistors and ICs. Ascertain the pinning of MOSFETs T₁...T₄ incl., and T₇, before these are fitted. Push-fit the leads of these transistors securely into the relevant holes before soldering. The source connections on T₃ and T₄ are also soldered at the component side of the board. Now fit SMA capacitors C₆₇ & C₆₈ direct onto the source and g₂ terminals of the relevant MOSFET. The presets (P₂; P₅) are then mounted, followed by the trimmer capacitors. Care should be taken not to deform the PTFE material in the trimmers when soldering the two ground pins to the copper surface at the component side.

It is absolutely necessary to fit 20 mm high screens at the component side as indicated by the dotted lines on the overlay. Cut these screens from tin plate or brass sheet, and solder them vertically onto the board, taking care not to damage nearby components. Cut a clearance in any screen that runs across an inductor, or a MOSFET with nearby components. The IF section is completely screened with a top plate after setting up the receiver.

The transformer, mains fuse, mains entrance socket, and, if applicable, the supply board, are fitted at suitable (and safe) locations in the metal cabinet. The layout of the front panel is a matter of personal preference; a suggestion is shown in the introductory photograph of this article. Screened wire should

be used for connecting the USB/LSB and the 20/80 m switch on the front panel to the respective soldering pins on the PCB. Twist the wires for connecting the IF GAIN, AF GAIN, AGC DELAY, and TUNING potentiometers. Note that the latter is a multiturn type fitted with a suitable knob and dial. The aerial input is an Amphenol SO239 (Type UHF) or BNC socket mounted onto the rear panel of the receiver. The connection to the relevant soldering pins is made in coax. Test point TP₂ can be connected to a BNC socket on the rear panel via a length of thin coax, e.g. RG174. Remember that this is a DC coupled, low impedance, output.

Setting up

Check the operation of the power supply before connecting it to the receiver.

Set all presets, trimmer capacitors and potentiometers to the centre of their travel. Connect a frequency meter to TP₂, and adjust C₂₄ and P₂ such that the tuning range of P₁ corresponds to 5.0 to 5.5 MHz. Set the band switch to 80 m, and connect an aerial. Some noise should be audible. Initially, C₁₃, C₄₀ and C₄₄ are adjusted for maximum noise output. These adjustments are fairly critical. Check that the noise level varies slightly when the IF GAIN control is operated. Use TP₃ to measure the output frequency of the sideband oscillators. Select LSB and adjust C₃₃ for 8.9985 MHz. Select USB and adjust C₃₈ for 9.0015 MHz. Tune across the band to find a relatively strong SSB or RTTY transmission. Optimize the setting of the above trimmers while reducing the IF gain as appropriate. Check the function of the AGC by tuning to a weak signal. The adjustment of P₅ is to the operator's preference regarding the response of the AGC circuit. Redo all the adjustments to optimize reception across the whole of the 80 m band. Switch to 20 m, and peak the input bandfilter for optimum reception. The notch filters are adjusted for highest attenuation at 9 MHz. One of the 9 MHz oscillators can be used temporarily as an RF signal generator. Attenuate the signal at TP₃ with a suitable resistance network, and connect it to the

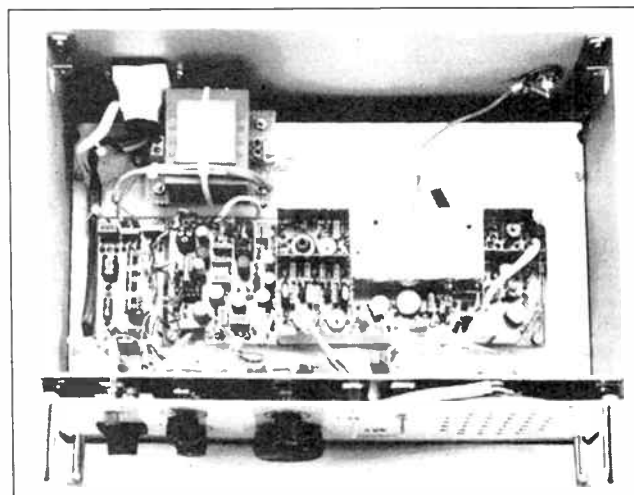

Inside view of the prototype receiver.

— to page 51 ▾

DIMMER FOR INDUCTIVE LOADS

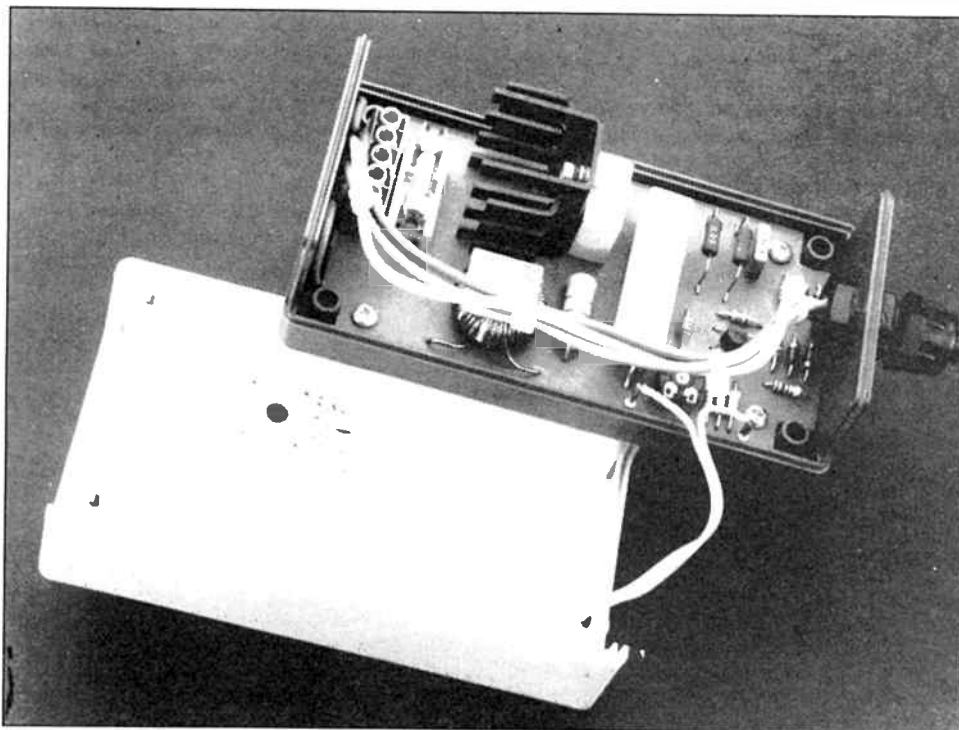

A simple circuit overcomes the well-known difficulty in maintaining the triggered condition of a silicon controlled rectifier when this is used for regulating inductive loads.

The vast majority of dimmer circuits is only suitable for regulating resistive (*non-reactive*) loads, i.e., when there is no phase difference between the mains voltage and the load current. This means that the trigger pulses can be kept relatively short, since the load current is in phase with the mains voltage immediately after triggering has taken place. Normally, the load current is greater than the holding current, so that the triac or thyristor is triggered immediately, and remains on.

When the load is mainly inductive (e.g. a transformer, or a choke for a fluorescent lamp) the load current lags the voltage, and may either not have reached, or exceeded, the holding level. The SCR then conducts briefly, but is switched off at the end of the trigger pulse. This unwanted effect can be kept within limits by means of stretching of the trigger pulse, triggering by pulse trains, or the use of an R-C network. The first approach calls for a control circuit with appropriate drive power. The pulse duration requires exact controlling to prevent pulses occur-

ring after the zero crossing of the mains voltage, causing erroneous triggering. Suitable circuits to accomplish this are, understandably, relatively complex.

A simpler way out is the R-C network, which in essence raises the current to the holding threshold, so that the SCR remains on when the trigger pulse is inactive. Although SCR manufacturers usually provide the relevant design data for this application, it is still fairly difficult to dimension the circuit for optimum and reliable triggering. In most cases, therefore, trial and error adjustments are required, as well as signal analysis with the aid of an oscilloscope.

Triggering by pulse train

The circuit described here is based on gate triggering by a pulse train, yet is composed of discrete components only.

Figure 1 shows 3 ways of controlling a triac.

Figure 1a illustrates a phase angle control circuit for the load Z_L . It is composed of a

triac T, a diac D, and a timing network R-C, where R is (P), connected in parallel with D-A₂, and C is connected in parallel with D-A₁. In this circuit, the triggering is load dependent, in other words, synchronization is by the voltage across the triac, and this is a function of the load current. The circuit is, therefore, unsuitable for regulating highly inductive loads requiring a small conduction angle. Also, there exists a strong tendency to asymmetrical operation, which can be dangerous in view of saturation of the inductance due to the relatively high direct current.

Figure 1b shows a basic circuit for triggering the triac by the mains voltage. Here, timing resistor (P) is connected to the neutral line instead of parallel to D-A₂. The trigger pulses occur with a fixed phase difference of 180°, irrespective of the load current. Although this circuit offers more accurate control of the load than the previous one, its operation becomes completely asymmetrical if the gate angle is smaller than the angle rep-

resenting the current lag in the load. Another disadvantage is the requirement for connection to the phase and neutral lines as shown in the diagram.

Figure 1c shows a slightly more complex triac control circuit. Following the trigger pulse, additional pulses are generated up to the next zero crossing of the mains voltage. The operation of the circuit is illustrated in timing diagram Fig. 2. Assuming a phase difference, φ , of 85° between the mains voltage and the load current, and a gate angle, Φ , of 60°, the triac is triggered after the trigger delay has lapsed (A), and remains on up to about 240° (B) thanks to the pulse train. It is blocked at point B, but is immediately retriggered by the next repetitive gate pulse. The operation is slightly asymmetrical during the first half periods, but the duration of conduction gradually becomes more balanced, as shown by the dotted curve.

The practical circuit

The circuit diagram of the dimmer for inductive loads is given

in Fig. 3. A small, sensitive, auxiliary triac, Tri2, generates the pulse train necessary for maintaining the gate control signal for Tri1. Capacitor C1, compensation resistor Rs and potentiometer P2 define the gate angle ϕ . Preset P1 enables setting the minimum conduction angle, so ensuring reliable triggering of Tri1 even when the load current is fairly low.

Capacitor C1 is charged from 0 V, and diac Di1 triggers as soon as its breakdown voltage is reached. The set conduction angle is equal for both half periods. A first pulse is applied to the gate of Tri1, and the voltage surge on Rs triggers Tri2. Once this is on, it bypasses resistance $(R4 + P2 // R3 + P1)$, so that the remaining charge cycles of C1

have a much shorter period $(Rs + R6)C1$. After this delay, Tri2 is triggered, starting a new cycle. A succession of pulses is applied to the gate of the main triac, Tri1, until the mains voltage reaches the zero crossing. Triac Tri2 is then blocked, so that the charging of C1 during the following half period is determined by the time constant set by the resistance

$(R4 + P2 // R3 + P1)$. Once more consult the timing diagram of Fig. 2 for further details on the operation of the circuit. Zener diodes D5...D8 incl. afford protection against over-voltage, and at the same time ensure a stable supply voltage for the trigger circuit, eliminating instability due to fluctuations on the mains. Diodes D1...D4 incl. and resistors R1 and R2 ensure that C1 is completely discharged during the zero crossings, so that the hysteresis remains within acceptable limits. Damping network C2-R7 has a stabilizing effect on the control circuitry because it suppresses needle pulses originating from the inductive load when this draws less than the holding current of the main triac.

Construction: safety first

The dimmer is constructed on the printed circuit board shown in Fig. 4. Power resistor Rs should be fitted slightly off the board to allow for its dissipated heat. Inductor L1 is a common triac suppressor choke, which is not strictly required for in-

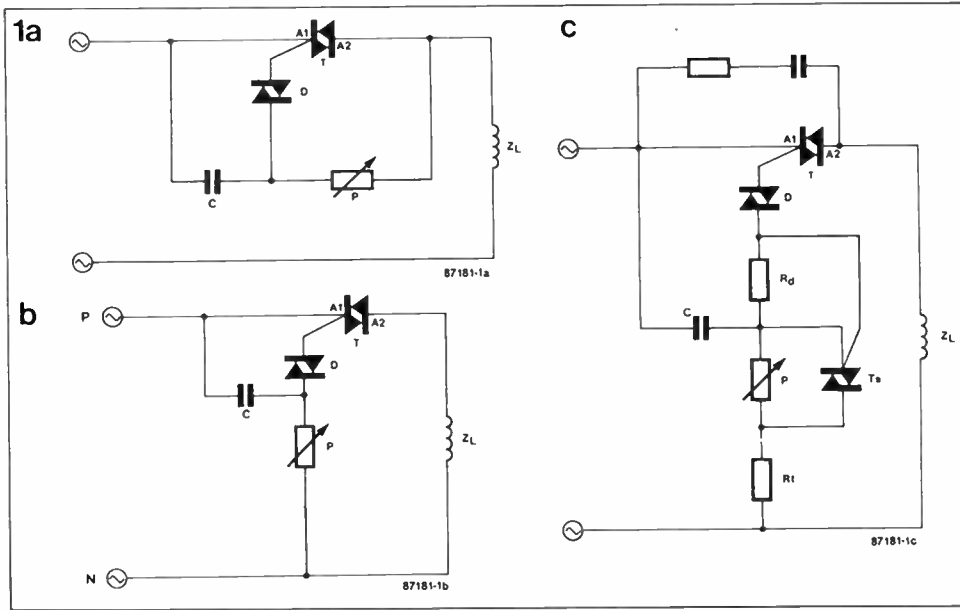

Fig. 1 Three ways of controlling the gate angle in a triac based dimmer.

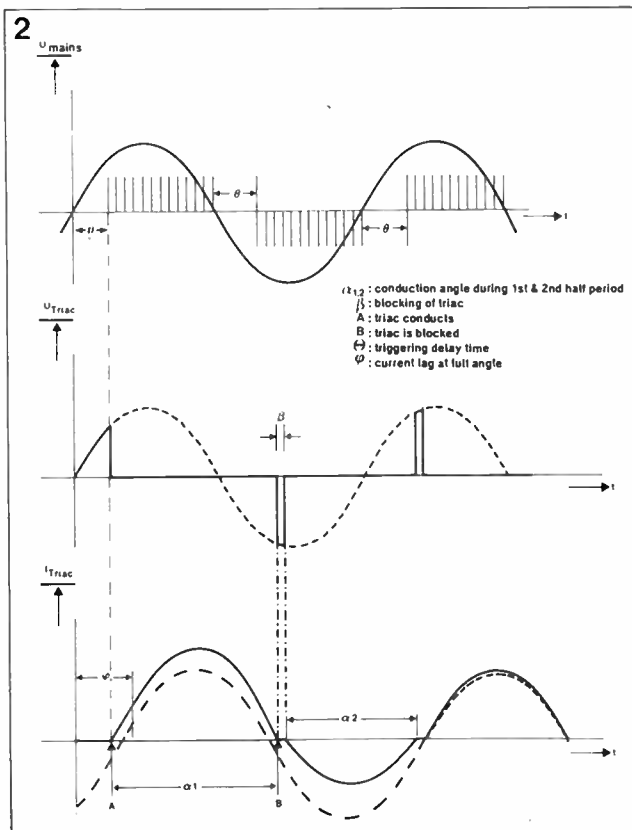

Fig. 2 Triggering by a pulse train synchronized with the mains voltage.

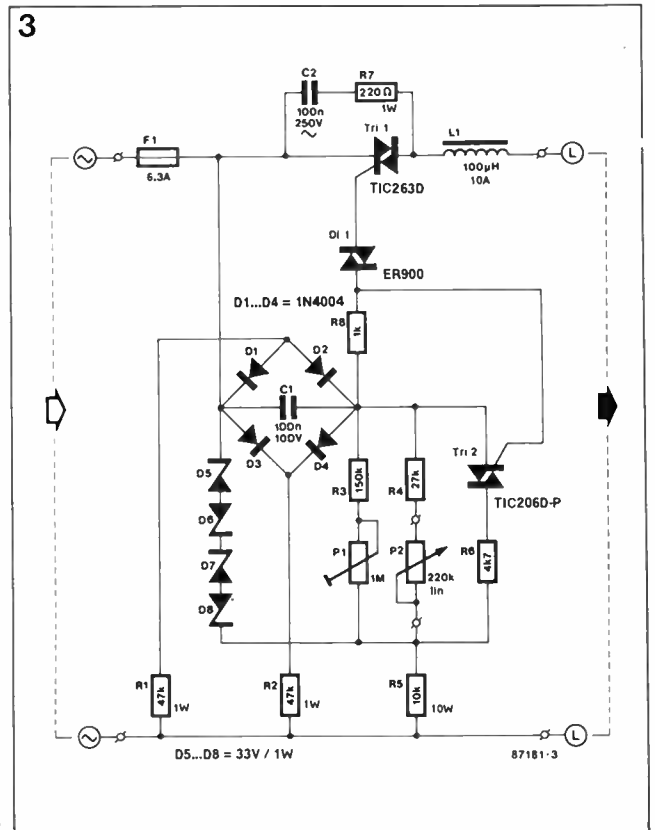

Fig. 3 Circuit diagram of the dimmer for inductive loads.

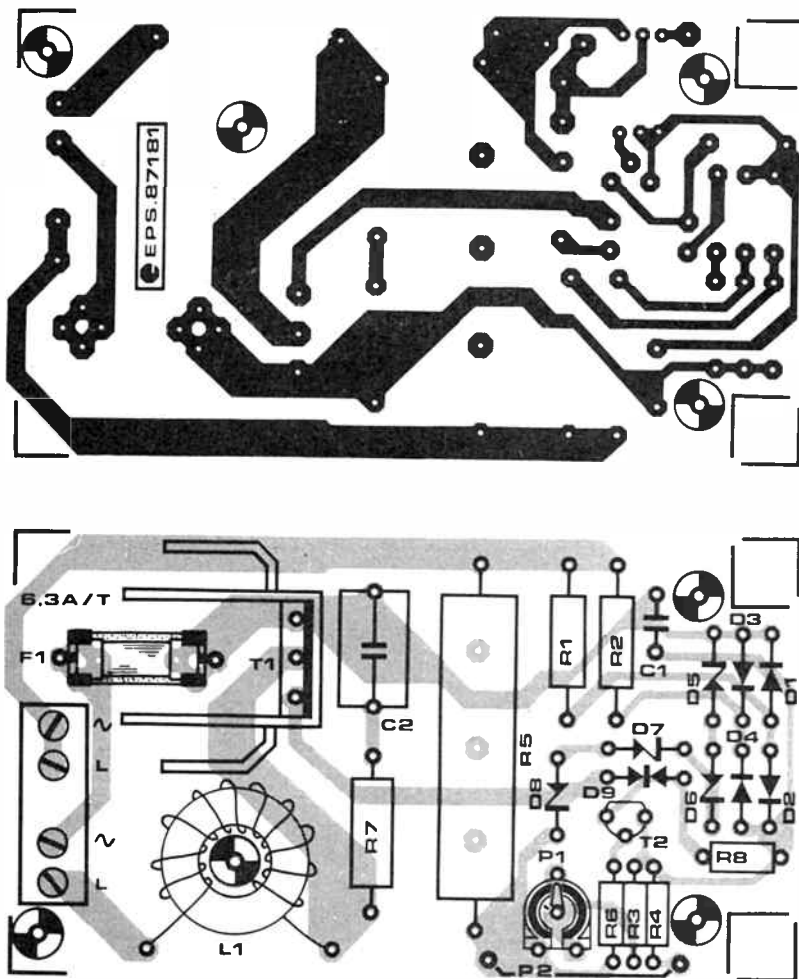

Fig. 4 Track layout and component mounting plan for the dimmer PCB.

ductive loads. For resistive loads, however, it should not be omitted because it limits the switch current surges. The inductance and current rating of L_1 are as required by the load; the indicated values of $100 \mu\text{H}$ and 10 A are only required when the dimmer is used for regulating loads of the order of 750 W and more. The size of the heat-sink for T_{r1} is mainly determined by the available space in the ABS enclosure. A few

holes should be drilled in the lid to ensure sufficient cooling of R_s and T_{r1} . Make sure that the whole unit is rugged and properly insulated. If used, the input and output cable should be fed through a grommet, and secured by a suitable strain relief. Be sure to use a potentiometer with a plastic shaft.

VARIOUS PARTS IN THE DIMMER CARRY THE MAINS VOLTAGE AND ARE, THEREFORE, DANGEROUS

TO TOUCH WHEN THE UNIT IS OPERATIONAL.

Finally, the circuit described offers good accuracy of control without the need for an additional supply. It enables virtually complete variation of power on inductive loads rated up to approximately $1,000 \text{ W}$. *Sv*

Source:

Triac Applications, Thomson Semiconductors.

Parts list

Resistors ($\pm 5\%$):

$R_1, R_2 = 47\text{K}; 1 \text{ W}$

$R_3 = 150\text{K}$

$R_4 = 27\text{K}$

$R_5 = 10\text{K}; 10 \text{ W}$

$R_6 = 4\text{K}7$

$R_7 = 220\text{R}; 1 \text{ W}$

$R_8 = 1\text{K}0$

$P_1 = 1\text{M}0$

$P_2 = 220\text{K}$ or 250K linear potentiometer with insulated shaft.

Capacitors:

$C_1 = 100\text{n}; 100 \text{ VAC}$

$C_2 = 100\text{n}; 250 \text{ VAC}$

Inductor:

$L_1 =$ dimmer suppression choke
e.g. $47\mu\text{H}; 10 \text{ A}$

Semiconductors:

$D_1 \dots D_4$ incl. = $1\text{N}4004$

$D_5 \dots D_8$ incl. = $33 \text{ V}; 1 \text{ W}$
zener diode

$D_{i1} =$ general purpose 32 V diac,
e.g. $\text{ER}900, \text{ST}2, \text{D}132\text{AC}$, or
 $\text{BR}100\text{-}03$

$T_{r1} = \text{TIC}263\text{D}$

$T_{r2} = \text{TIC}206\text{D-P}$

Miscellaneous:

$F_1 = 6.3 \text{ A}$ fuse with PCB mount holder.

Suitable ABS enclosure.

Grommet and strain relief for mains wire.

5-way screw terminal block for PCB edge mounting.

TO220-style heat-sink for T_{r1} .

PCB Type 87181 (available through the Readers Services).

See our
'PROJECT BUYERS GUIDE' this issue for a guide to component sources and kit suppliers.

ABE
ABE

COMPUTERS

MODEM KITS

24 Burwood Hwy (Rd)
BURWOOD 3125 (03)288-2144
(03)288-9067. FAX:(03)288-0781
BANKCARD-VISA-MASTERCARD WELCOME

Simple to build direct-connect modems on single-sided boards for easy building.

LOOK!

300/300 - 1200/75 - 75/1200 Modem Kit - \$95. Built & Tested - \$155, c/w Phone - \$240

FROM \$95!

PC-Internal Kit - \$125
Auto-dial - extra \$45

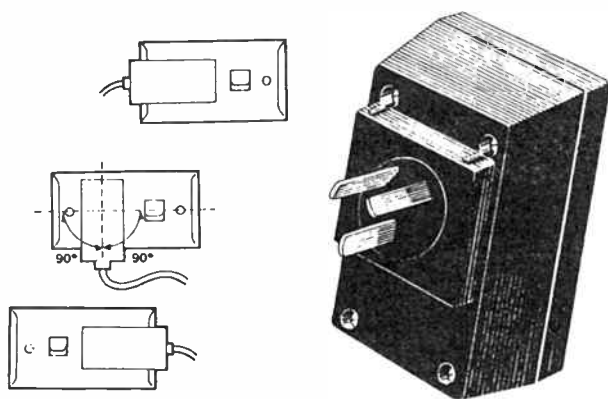

"Plugpack" enclosure

This clever new product from Jaycar should find dozens of uses amongst project builders, designers and enthusiasts.

The enclosure, which measures 78 mm long x 50 mm wide x 40 mm usable depth has a moulded 240 V 3-pin insert which can be rotated through 180 degrees, allowing the adaptor to mount in any of three positions.

There is generous space inside the enclosure to mount relays, electronics or whatever you like. By fitting a small transformer, it would even be possible to build your own custom plug packs.

The enclosure costs just \$14.95 and carries Jaycar's catalogue number HB-5950. We have no doubt that many mains powered projects will be making use of this unique and useful product.

For further information, see your nearest Jaycar outlet, five in Sydney, two in Melbourne and one in Brisbane.

Cheaper coax relays

Any radio amateur will tell you the advantages of using proper coaxial relays. The low loss and correct impedance makes them a far better choice than normal relays and in VHF/UHF designs, their use is almost mandatory.

Dick Smith Electronics are currently offering their S-7402 pc mounted coaxial relay at only \$29.95 which puts them back to the same price advertised in the 1986 DSE catalogue!

This represents a very good sav-

ing as the last time I looked, they were over \$37.00 each.

The mini pc board mounting relays have fully enclosed contacts and the coil is rated at 12 Vdc at 80 mA. The size is 35 mm square x 15 mm high and the relay is suitable for use up to 1000 MHz.

Ideal for bypass switching in power amplifiers, preamplifiers or antenna switching units, it would be worth grabbing a couple at this special price.

See your nearest Dick Smith Electronics outlet for further information.

Precision trimpot

All Electronic Components in Melbourne currently has stocks of genuine Bourms precision panel mount trim pots.

These fully sealed 2.5 k ohm trim pots are ideal where you don't want to sacrifice quality, but don't want to pay a fortune either.

The metal body of the trim pot is 13 mm in diameter and the 15 mm long shaft is 3 mm in diameter. A slot is provided in the end of the shaft for screwdriver adjustment or a suitable knob could be used if desired.

Each pot is supplied with a matching nut and lock washer for mounting on a panel.

Connection to the pot is by means of small wire leads at the end of the body, so it is possible to use it for direct pc board mounting as well as panel mounting if

PROJECT BUYERS GUIDE

The AEM4609 Computer-Teleprinter Interface project uses commonly available, off-the-shelf components so you should not experience any component supply problems. The M-2155 transformer and 4N28 opto-isolator IC can be obtained from a great many retailers. The ones for our prototype came from Geoff Wood Electronics in Sydney.

The AEM3015 Balun project uses very few parts so you should not have any difficulty with this one! The case used in our prototype was a plastic jiffy box available from Jaycar with the catalogue number of HB-6013. Geoff Wood Electronics also carry a similar range of jiffy boxes with plastic lids. The SO239 socket is widely available from most retailers. The single hole mounting type are quite adequate for this application, but make sure you choose one with a ground lug.

The Amidon toroids for the 3015 Balun are obtainable by mail order from Stewart Electronic Components Pty Ltd, PO Box 281, Oakleigh 3166, Vic. Telephone (03)543 3733. Cost is \$11.20 inc. tax and postage for the T200-2 and \$3.90 for the T68-2. Melbourne residents will find their store in Huntingdale. Phone first to check stock availability. We understand that Geoff Wood Electronics of Sydney also carry the T200-2.

The AEM6507 equalizer project should not present any difficulties. The 45 mm 50k linear slider pots are available from Jaycar under their catalogue number RP-3912. The MKT caps are available from both Geoff Wood Electronics in Sydney and Eagle Electronics in Adelaide, although other retailers will probably carry suitable devices as well. The TL074 quad op-amps are available from Dick Smith Electronics, Jaycar, Altronics, Ritronics and a host of other retailers. If you have any difficulties you can use LF347N devices as a substitute (it's an equivalent).

The Long-Range Infrared Transmitter-Receiver in this month's Elektor section is for the adventurous enthusiast. The design hinges on the two Siemens infrared semis - the LD271 IR LED and the BP104 IR detector diode. These are scarce devices, so be prepared to shop around. Stewart Electronics in Melbourne can supply some GE devices which may be substituted if you're prepared for a little experimentation to make it work. The relatively more common CQY89/BPW50 combination may be tried, but you will have to be prepared to accept some performance degradation as they don't match the performance of the Siemens devices. The receiver uses a TBA120S FM detector, carried by some suppliers as a replacement part. Again, this is obtainable from Stewart Electronics in Melbourne, or you could try Geoff Wood Electronics in Sydney and Radio Parts in Melbourne. Pretty well everything else is readily available.

The SSB Receiver for 20 and 80 Metres should present few difficulties in component supply, provided you don't expect to get everything at your local electronics shop. Pretty well the full complement of semiconductors and coil components may be obtained from Stewart Electronics in Melbourne, and you might as well hit them for the rest of the parts, too. They might even be able to order the crystals for you.

The Dimmer for Inductive Loads should find wide application. The parts present few difficulties, with the exception perhaps of the suppression choke. Its value is non-critical, so all you need do is wind enough turns on a suitable iron powder of 15-22 mm diameter to fill the core (wind insulation tape on the core first). Jaycar stock a suitable core for the application, cat. no. LF-1240. Stewart Electronics in Melbourne may be able to suggest a suitable Amidon ring core. The semiconductors may be obtained from a number of suppliers. The TIC range (as specified) includes a variety of types that may be readily substituted, but note that whatever's used for Tri1 must be able to handle the intended load. Geoff Wood Electronics in Sydney stocks a range of TIC-type triacs. Various types of the diacs specified are stocked by many suppliers, the ST2 and BR100-03 probably being the most common.

you wish.

Priced at just \$3.50 each, the pots are available from All Elec-

tronic Components, 118-122 Lonsdale Street, Melbourne 3000 Vic. (03)662 3506.

JAYCAR No1 FOR NEW & EXCITING KITS



NEW KITS FOR DECEMBER

24 TO 12V CONVERTER

Ref: Silicon Chip Dec '87
Well suited to run 12 volt appliances from 24 volt. Can deliver up to 5 amps.
Complete kit
Cat. KC-5017
\$59.00

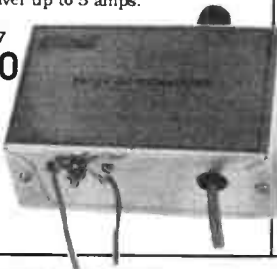

TELEPHONE RINGER

Ref: Silicon Chip Dec '87
If you are tired of the sound of your phone, try this kit. Mounts inside phone - includes buzzer.
Cat. KC-5015
\$19.95

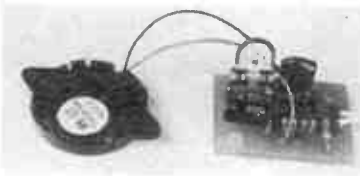

HIGH IMPEDANCE AC/ DC MILLIVOLTMETER

Ref: EA Dec '87
This kit will measure AC and DC signals down to a couple of millivolts, with negligible circuit loading. Complete kit with case and meter.
Cat. KA-1695
\$46.50

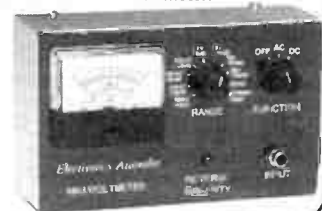

SOLAR GENERATOR

Ref: ETI Dec '87
This is a cheap, no fuss way to trickle charge a 12V car battery. PC board and parts.
Cat. KE-4730
\$12.95

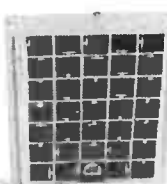

UNIVERSAL SPEED CONTROL & LAMP DIMMER

Ref: Silicon Chip Dec '87
Use for control of drills, fans, electric blankets, soldering irons or a dimmer. Complete kit with box, mains leads, etc.
Cat. KC-5016
\$18.95



SUB CARRIER ADAPTORS FOR FM TUNERS

Ref: Silicon Chip Dec '87
Listen to hidden transmissions on FM broadcasts. PC board and components.
Cat. KC-5014
\$22.95



OCTAVE EQUALISER MODULE

Ref: AEM Dec '87
This one octave EQ module is suited for PA and professional use. Kit supplied with all components, pots, PCB. No box or hardware.
Cat. KM-3064
\$49.95

PASSIVE "BANDPASS" SUBWOOFER

Ref: AEM Sept '87
After much interest in this project, we will have available the 3mH inductors. The woofers, speaker terminals, cable and innerbond are normal stock lines.
P25WO-08 10" woofer
Cat. CW-2136
\$196.00 each
3mH Inductor
Cat. CX-2610
\$13.50 each

CAPACITANCE METER FOR D.M.M.

Ref: Silicon Chip Nov 1987
A great project from a new monthly electronics magazine - Silicon Chip. Add a two range capacitance tester for only \$27.95. Ranges are 0 - 2200pF and 0 - 2.2µF. Complete kit.
Cat. KC-5010
\$27.95

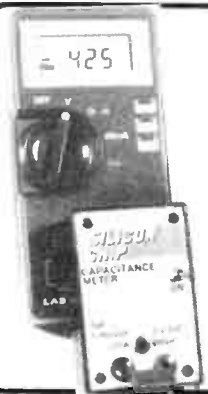

1GHz Digital Frequency Meter!

Ref: Silicon Chip Nov '87
This superb 1GHz digital frequency meter will outperform any other instrument in its price range. It uses the highest performance ICs, provides both frequency and period measurements, and features an 8 digit LED readout.
Cat. KC-5013
ONLY \$299.00



VOICE OPERATED RELAY

Ref: EA Nov 1987
Elevates the need to push the button when using a microphone. Shortform kit, no hardware.
Cat. KA-1692
\$24.95



OFF HOOK INDICATOR FOR PHONE

Ref: Silicon Chip Nov 1987
If you have two or more telephones on the one line, with this project a LED will flash on the phones not used to indicate the line is in use. One kit is needed for each telephone. PC board and components supplied. (Unit mounts in telephone).
Cat. KA-5011
\$19.95

HIGH QUALITY GUITAR PREAMP

Ref: ETI Nov 1987
Features of the ETI 1424 include a top boost and normal input, two pre-eq line inputs, bass & treble controls, effects send and return, sweep eq, 4 post eq & line inputs and master volume. PCB pots supplied when available. 6.5mm sockets, transformer and knobs are not supplied.
Cat. KE-4729
\$45.00

CAR RADIO POWER SUPPLY

Ref: Silicon Chip Nov 1987
Put that old car radio that's laying around to good use as a mantle/kitchen/garage/sunroom radio. Our kit includes PCB, transformer and components. You need the radio and speakers. 6 x 4 speakers \$10.95 each (Cat. AS-3014)
Cat. KC-5012
\$28.95



METRONOME

Ref: EA Nov 1987
Printed circuit board and electronics supplied. No box.
Cat. KA-1693
\$19.95

**JAYCAR MANAGEMENT
AND STAFF WOULD LIKE
TO WISH ALL OUR
CUSTOMERS A VERY
MERRY CHRISTMAS
& A HAPPY NEW YEAR**

VOLTAGE & CONTINUITY TESTER

Ref: EA Nov 1987
This handy voltage and continuity tester tests AC and DC voltages and also continuity in wires and cables.
Cat. KA-1694
\$29.95

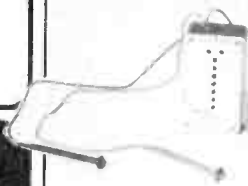

NEW KITS FOR NOVEMBER

A one-octave equalizer module

David Tilbrook
 Technical Systems Australia Pty Ltd

Here's a ten-band graphic equalizer that delivers top performance at an affordable price. It's ideal for sound reinforcement and PA system applications and teams well with projects we've previously published for such applications.

IN THE PAST we have described several MOSFET power amplifier modules and associated equipment, much of which is suitable for use in professional sound re-enforcement and public address applications. The widespread use of these modules in such applications has led to a requirement for the development of a good quality one-octave graphic equalizer module. The octave equalizer module described in this article provides good distortion and noise figures making them suitable for inclusion in a wide range of systems.

Background

A graphic equalizer is a device which divides the audio spectrum into a set of pass bands and allows independent adjustment of the relative levels of signal frequencies within these pass bands. In a one-octave equalizer such as this one the audio spectrum is divided into ten overlapping frequency regions. The centre frequencies of each of these regions have been set according to the industry standard frequencies: 32 Hz, 64 Hz, 125 Hz, 250 Hz, 500 Hz, 1 kHz, 2 kHz, 4 kHz, 8 kHz and 16 kHz. Notice that these frequencies are one-octave apart.

It is also possible to design graphic equalizers with a larger number of frequency bands spaced at either one-half octave or more commonly, one-third octave, intervals. A one-third octave graphic equalizer allows greater flexibility owing to the greater number of adjustments over the audio passband but it also necessitates the use of sharper or higher Q filters which have greater audible anomalies and phase shifts.

The project

The AEM6507 One-Octave Equalizer is based on the same principle that is employed in most modern graphic equalizers. A series resonant circuit is incorporated into the negative feedback loop of a high quality operational amplifier in such a way that an associated slide potentiometer can vary the amount of feedback applied within the frequency range determined by the series resonant circuit. In this design we have employed three TLO74 operational amplifiers (or its equivalent, the LF347) which are quad JFET-input op-amps

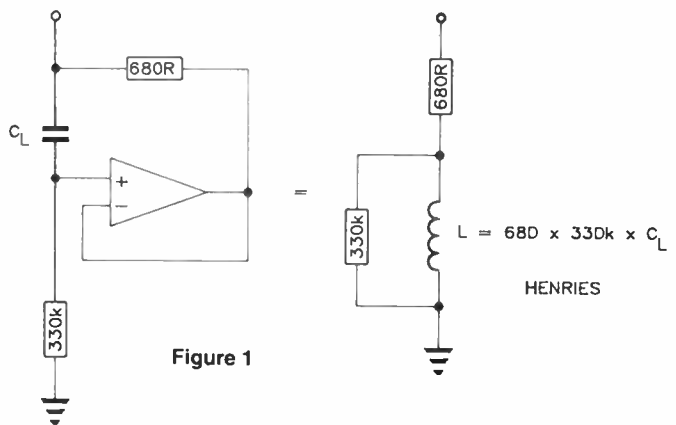

Figure 1
 CIRCUIT DIAGRAM OF THE SIMULATED INDUCTOR OR GYRATOR AND ITS EQUIVALENT CIRCUIT

AEM6507 OCTAVE EQUALIZER SPECIFICATIONS

Centre Frequencies

— industry standard:
 32 Hz, 63 Hz, 125 Hz, 250 Hz, 500 Hz,
 1 kHz, 2 kHz, 4 kHz, 8 kHz, 16 kHz

Boost and cut 12 dB

Frequency Response 10 Hz to 100 kHz, +0/-3 dB
 (all controls at centre)

THD 0.008%, 20 Hz-10 kHz (with respect to 1 V input signal)

S/N ratio 105 dB "A" weighted (with respect to 1 V input signal).

Voltage gain approx 5, i.e: 14 dB
 (controls at centre)

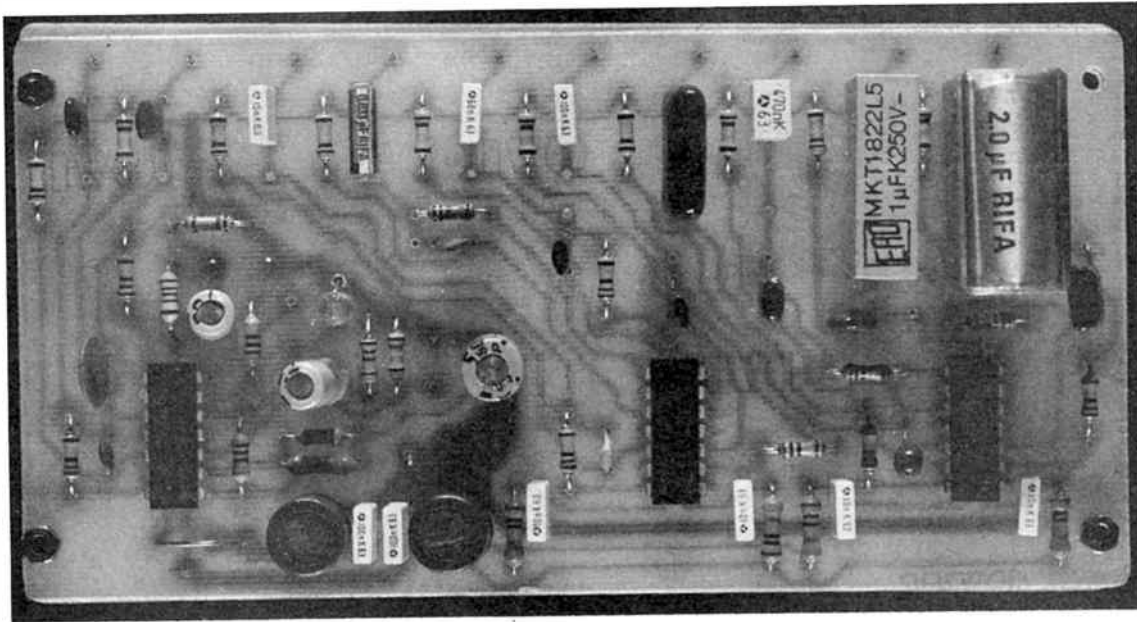

The module comprises two boards, one for the "electronics" (above) and one for the slide pots (below), mounted back-to-back. The view below shows the interconnections. Measuring 75 x 150 mm, two modules will fit side by side in a standard two-unit high 19" rack cabinet.

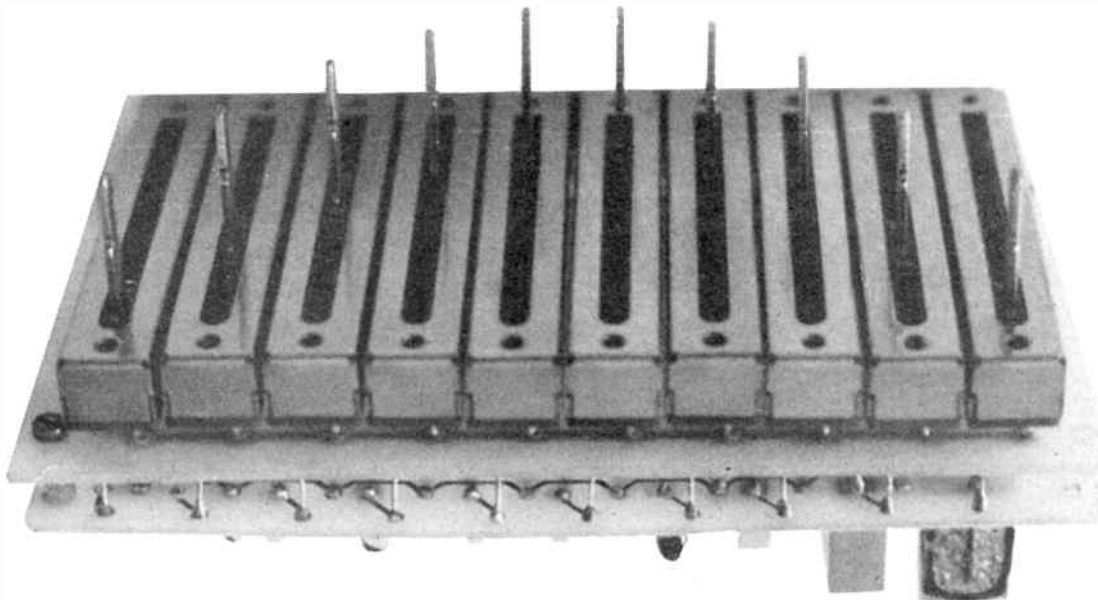

with good slew-rate and noise performance.

To form the series resonance circuit we have employed a capacitor in series with a "simulated inductor", rather than an actual inductor. The simulated inductor or "Gyrator", as it is known, is formed from an operational amplifier which is used to convert the phase shift introduced by a capacitor to that which would be introduced by an inductor. The circuit shown here represents the fundamental circuit of the Gyrator.

Notice that this Gyrator circuit simulates an inductor with a parallel and series resistance just like a real inductor. Of course, a real inductor does not have a parallel resistance of 330k, its parallel resistance would be many thousands of megohms depending on the quality wire used to wind the coil, but the relatively low value of parallel resistance does not cause a problem in our application. In fact, this circuit

can be used in the vast majority of circuits requiring an inductor. The value of inductance simulated by the circuit is simply given by the product of the two resistors and the capacitor.

One problem associated with all Gyrator circuits, however, is that of phase shifts introduced by the operational amplifiers at higher frequencies. To overcome this problem it is necessary to use an op-amp with an adequately large slew-rate figure and extended open-loop bandwidth. This is one of the reasons we elected to use a TLO74 op-amp for this design since its slew-rate and bandwidth figures are excellent and well suited to the task.

Using a graphic

All graphic equalizers, be they one-octave or one-third octave instruments, must be used with skill. A good general rule ▾

Component overlay for the slider pot board.

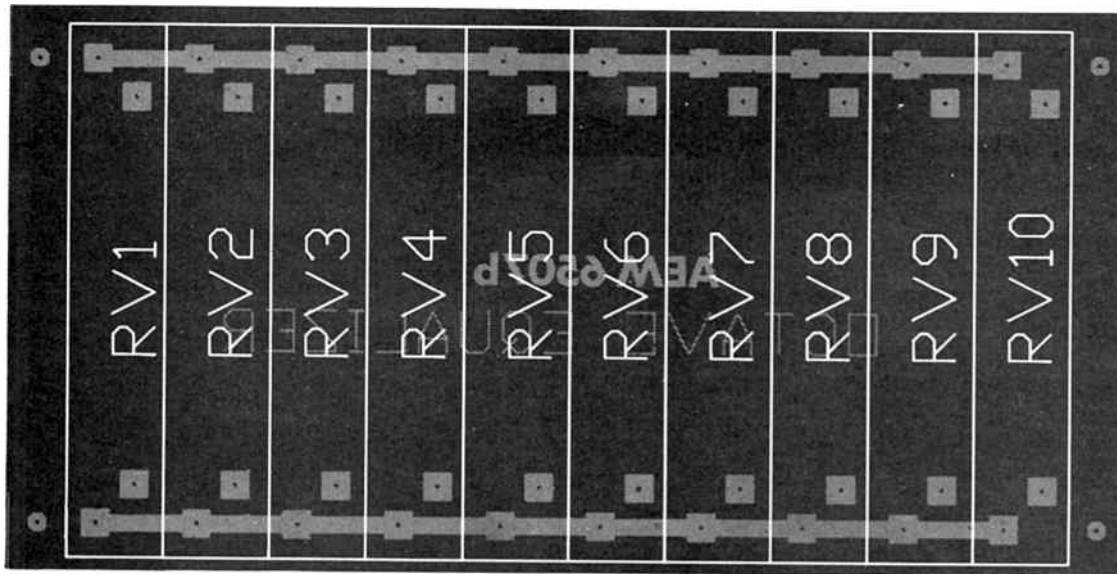

TO "A" ON BOARD A

TO "B" ON BOARD A

when employing any equalizer is to use as little equalization as possible. Unfortunately, in many listening environments it is necessary to employ reasonably substantial modification to the frequency response of the listening area or perhaps the loudspeakers. Many professional applications take place in "difficult" listening environments such as large reverberant halls or rooms with generally poor acoustic properties.

In listening venues which feature both long reverberation times and a large degree of reverberation, the intelligibility of speech and other sound sources can be greatly impaired. Unfortunately, little can be done to correct serious problems of reverberation with a graphic equalizer, something must be done about the environment – cure the cause, an equalizer can only attack the symptom.

When the problem is less severe, however, the subjective effect is usually one of a "brightening" of the overall sound characteristic.

The opposite problem to this occurs in a listening environment which is too highly damped. In such an environment a "lifeless" or dull acoustic performance will result due to the excessive attenuation of certain frequency bands within the audio spectrum. This is where a graphic equalizer can play its part since it enables the operator to increase or decrease the amount of energy within certain frequency bands. A graphic equalizer can also be very useful to assist in the reduction of oscillation – feedback – of the sound system. In bad cases of acoustic feedback, or "howl-round" as it sometimes referred to, a one-third octave graphic equalizer is preferred, while for severe cases notch filters or phase shifters are usually employed.

The one-octave graphic equalizer described here is suitable for modification of the overall frequency response of the listening area or of the loudspeakers employed. It is not really suitable for major modifications over short frequency ranges ▶

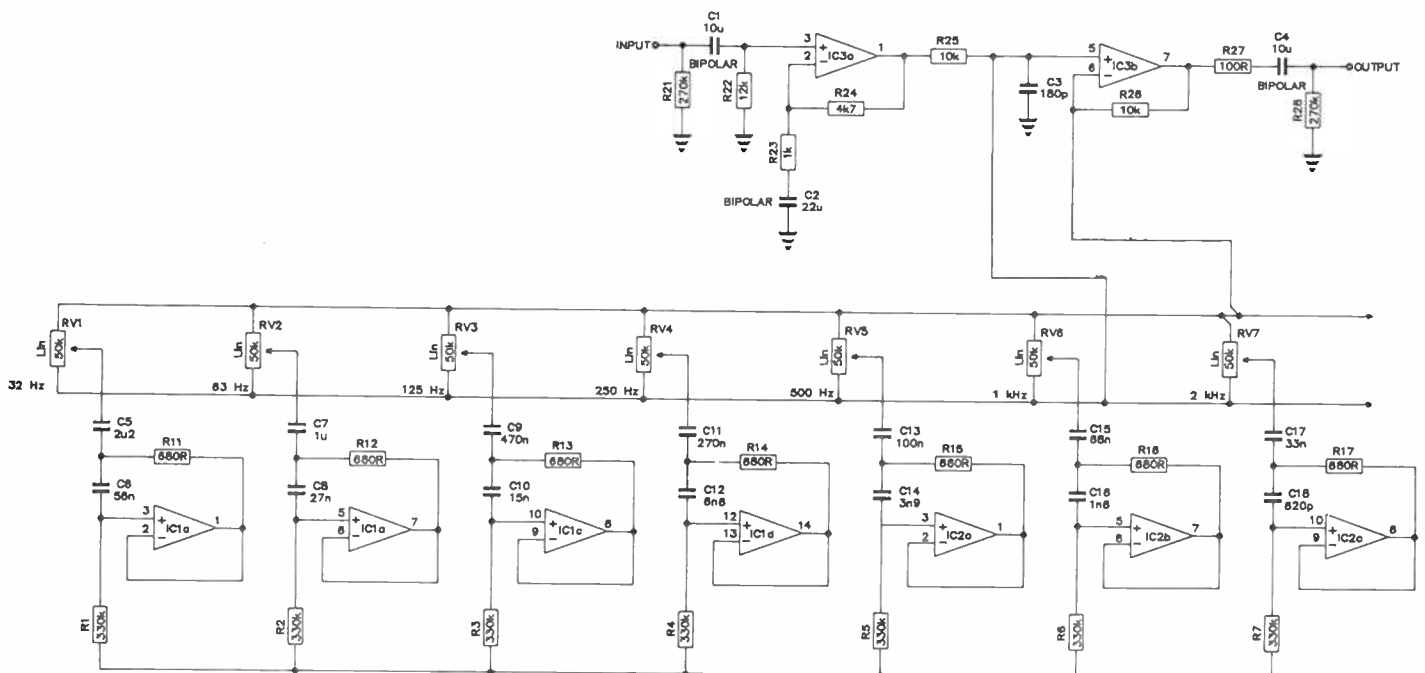

CIRCUIT DESCRIPTION

In order to best understand the operation of the graphic equalizer it is useful to look at a simplified circuit diagram shown in Figure A. Here an input signal is applied to the non-inverting input of an IC operational amplifier via a 10k resistor. Negative feedback is applied to the inverting input of the op-amp via another 10k resistor. A slide potentiometer is attached between the non-inverting and the inverting inputs and its wiper is connected to ground through an impedance network.

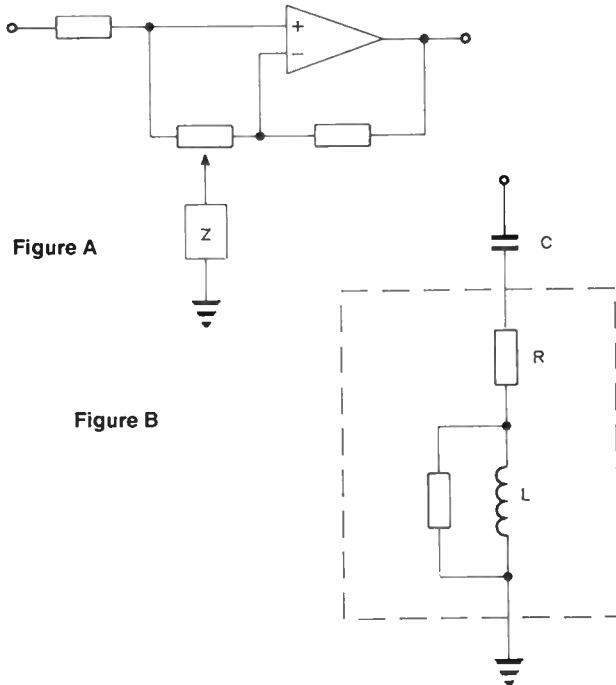

If it is assumed for a moment that the impedance network is a simple resistor and that the slide potentiometer is set at its centre position, then the input 10k resistor and the resistance of one half of the slide pot and the resistor representing the impedance to ground combine to form a potential divider which decreases the input signal applied to the non-inverting input of the op-amp. At the same time the 10k feedback resistor, the other half of the slide pot and the resistive element to ground combine to form a similar potential divider which sets a gain for the operational amplifier which will exactly cancel the attenuation provided by the first potential divider. In this position the overall gain of the circuit is unity (1).

If the pot wiper is now moved toward the end of the pot connected to the op-amp's inverting input then the gain of the stage is increased as the amount of the overall negative feedback is decreased. At the same time, the amount of attenuation provided by the input 10k resistor and its associated potential divider is decreased so the overall gain of the circuit increases dramatically. The amount of voltage gained provided will be determined by the impedance of the impedance network, Z. A precisely opposite effect occurs if the wiper is moved towards the non-inverting input of the IC operational amplifier. In this case the gain of the op-amp is decreased at the same time as the input attenuation is increased.

If the impedance network Z, which we have assumed until now was a simple resistor, is replaced by a series resonant circuit, then this scheme will ensure that the gain of the amplifier can be increased or decreased within the frequency passband established by the Q and the centre frequency of the series resonant circuit.

To form the series resonant circuits, capacitors are placed in series with Gytrators to form an LCR resonant circuit. The operation of the Gytrator was discussed in the main body of the article. The formula given in Figure 1 in the main article can be used to calculate the value of inductance that is simulated by the Gytrator. Once this has been calculated, the resonant frequency of the series resonance circuit is given by the standard formula shown in Figure B.

The input to the octave equalizer module is coupled via the 10 uF bi-polar capacitor C1 to the non-inverting input of IC3a. The 12k resistor R22 provides a dc ground reference for the non-inverting input of the op-amp, while the 270k resistor R21 ensures that both sides of capacitor C1 remain at ground for dc purposes. IC3a is configured as a non-inverting amplifier with a gain of approximately 5.7, as determined by the network consisting of R24 and R23. Capacitor C2 is incorporated to reduce the gain of IC3a to unity at dc so as to minimise the effect of dc offsets on the output of IC3a. Resistor R25 is the 10k resistor discussed in Figure A above while IC3B provides the op-amp function discussed in Figure A. Similarly, R26 is the feedback resistor discussed in Figure A.

In the actual graphic equalizer we have ten slide pots instead of one, and ten series resonant circuits. Each resonant circuit is set at a centre frequency corresponding to one of the ten industry standard frequencies. Resistor R27 is provided to buffer the negative feedback loop of IC3B to ensure stability of the circuit with difficult loads while the 10 uF bi-polar capacitor C4 decouples the output for dc. Resistor R28 (270k) has been included to ensure that the output remains at zero volts dc.

ICs 1 and 2 are provided with supply decoupling while IC3 is connected directly to the supply lines. This decoupling is there to ensure that the operation amplifiers do not interact with one another to produce instability, a problem which can often occur in multi op-amp circuits. The supply decoupling is provided by resistors R29, R30, R31 and R32 and capacitors C29, C30, C31 and C32. The electrolytic capacitors C25 and C26 and their parallel 100n capacitors C27 and C28 provide onboard supply filtering.

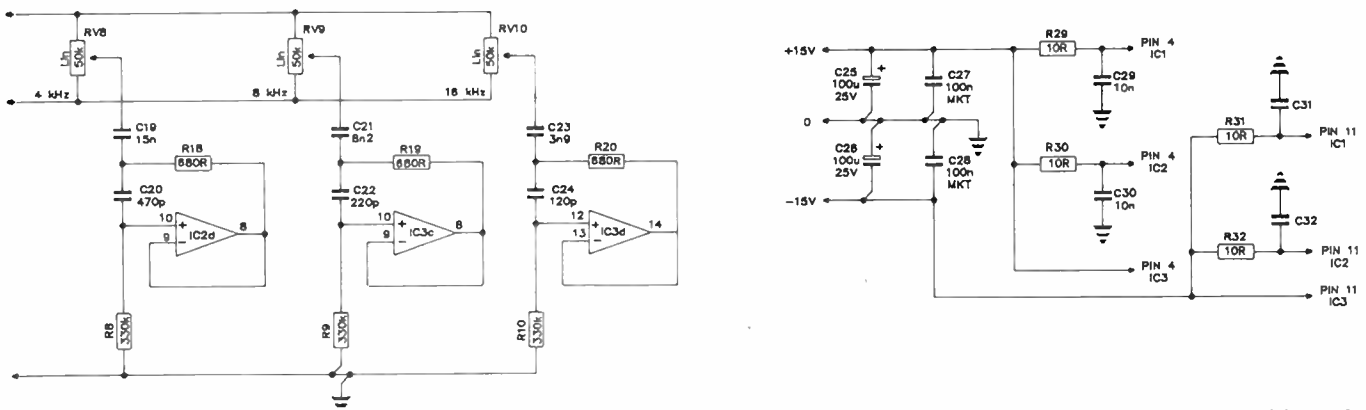

The "electronics" board component overlay.

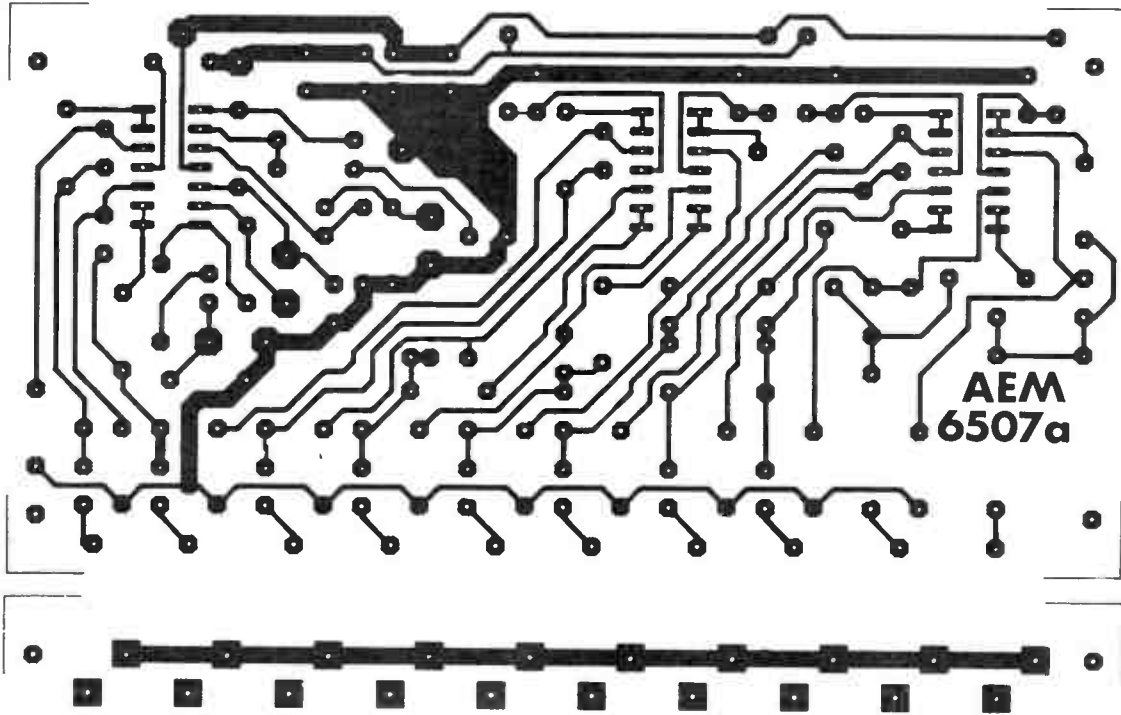
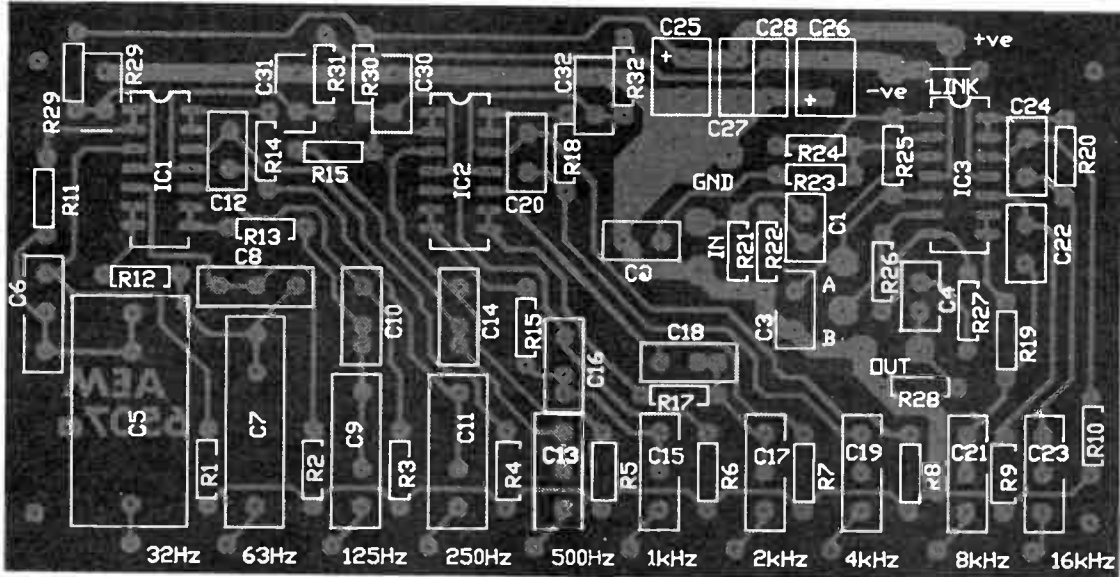

AEM 6507b

OCTAVE EQUALIZER



COMPONENT PINOUTS

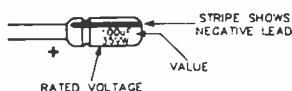
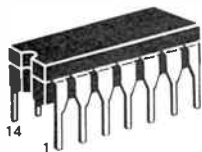

See our
'PROJECT BUYERS GUIDE' this issue for a guide to component sources and kit suppliers.

AEM6507 PARTS LIST

Semiconductors

IC1-IC3 TLO74, LF347

Resistors all 1/4 W, 5%

R1-R10 330k
R11-R20 680R
R21 270k
R22 12k
R23 1k
R24 4k7
R25-R26 10k
R27 100R
R28 270k
R29-R32 10R
RV1-RV10 50k/A,
45 mm slide pot.

Capacitors

C1 10u/25 V bi-polar
C2 22u/25 V "
C3 180p styroseal
C4 10u/25 V bi-polar
C5 2u2 MKT, metallised poly
C6 56n MKT, " "
C7 1u MKT, " "
C8 27n MKT, " "
C9 470n MKT, " "
C10 15n MKT, " "
C11 270n MKT, " "
C12 6n8 MKT, " "
C13 100n MKT, " "
C14 3n9 MKT, " "
C15 68n MKT, " "
C16 1n8 MKT, " "
C17 33n MKT, " "
C18 820p styroseal
C19 15n MKT
C20 470p styroseal
C21 8n2 MKT
C22 220p styroseal
C23 3n9 MKT
C24 120p styroseal
C25, C26 100u/20 V RB electro.
C27, C28 100n MKT
C29-C32 10n MKT

Miscellaneous

AEM6507a/b pc boards; four 12 mm spacers; four 15 mm 6 BA bolts and nuts; 22g tinned copper wire; short length of hookup wire.

Estimated cost: \$95-\$108

mm slide pots. If you are using the slide pot printed circuit board the ten slide pots simply solder into position on the circuit board then the entire circuit board can be bolted to a front panel using several of the tapped holes provided on the front side of the slide pots.

The interconnections between the slide pots are minimal so this optional slide pot pc board is not absolutely necessary. Any type of linear slide pot of a value between 10k and 50k can be used. The only requirement is that all of the ends of the slide pots must be connected together and connected to the points on the main pc board provided for this purpose and ten connections must be made from the wipers of these slide pots to the ten points provided for this purpose on the main pc board. In the prototype module we elected to use the slide pot pc board and to bolt the main printed circuit board to the rear of the slide pot board using four spacers. The main pc board and the slide pot have been made the same size so that this is possible.

Construction of the main pc board is not difficult. The usual precautions should, of course, be observed. Start by mounting the resistors since several of these are located between large capacitors and access to their positions will become difficult once several of the capacitors have been soldered in place.

Once all resistors have been soldered into their positions, the non-polarized capacitors can be tackled next. Be careful not to confuse the 10 uF bi-polar electrolytic capacitors C1 and C4, or the 22 uF bi-polar capacitor C2, with the polarized 100 uF electrolytics required for the power supply filtering.

Next, solder the polarized electrolytics in place being careful to ensure that they are inserted into their correct positions on the pc board and with the right orientation. Finally, the three integrated circuits can be soldered into their positions on the pc board. All three are mounted in the same direction as shown on the component overlay.

Make the connections between the slide pot printed circuit board and the main printed circuit, being careful not to confuse points A and B with each other. If these are confused the wipers will work up side down with maximum attenuation occurring with the slide pot set to the top position and visa versa. No damage will result, however, and this problem is easily reversed.

Powering up

Once the construction is complete, check all the wiring and the location of the components. Check the orientation of polarized components, in particular the orientation of the ICs. Correct any mistakes you find at this stage. If, or when, all is well, the unit can be connected to a plus and minus 15 Vdc supply which should be well regulated. We have provided only a pair of 100 uF electrolytic capacitors on the octave equalizer pc board since it is assumed that the unit will be incorporated within equipment from which a well regulated dc supply will be able to be obtained. If this is not the case, a supply can be fabricated using a pair of standard 15 V regulators (type 7815 or LM340-T15) and a small transformer. You could use our AEM9501 Dual Rail Supply Module, published in the August 1986 issue.

The input and output connections to the octave equalizer pc board should be made using shielded cable. The output of IC3B is buffered with a 100 ohm resistor to isolate its negative feedback loop from the load impedance so the module should be able to drive a large number of devices without difficulty. The input impedance of the octave equalizer module is around 10k which should represent a minimal load to most sources. ♪

within the audio spectrum, such as might be required in particularly bad acoustic situations. A one-octave equalizer, however, is the optimum solution for certain problems. A loudspeaker system which lacks bass or is too bright, for example, is best corrected using a one-octave equalizer since the 'low Q' associated with each of the frequency bands minimises the extent of the phase shift anomalies which all equalizers will introduce.

Construction

Since the one-octave equalizer module divides the audio frequency spectrum into ten segments, a total of ten slidepots are used which must be connected to the printed circuit board containing the bulk of the circuitry. To facilitate ease of mounting of these slide potentiometers we have provided a pc board which will accommodate a group of common 45

New Kenwood receiver

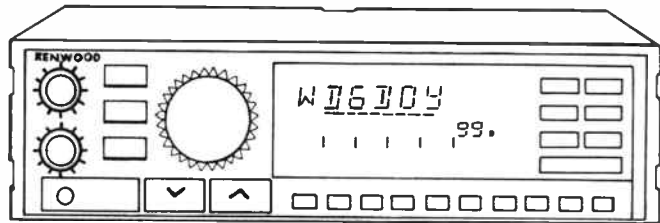

Kenwood Electronics Australia will launch this month a new "Wideband Receiver" which provides continuous coverage from 500 kHz to 905 MHz and 100 multi-function memory channels.

The new receiver is a triple conversion type providing AM plus narrowband and wideband FM reception. It features both keyboard and dial frequency selection, auto-mode and auto-step operations and 10-band programmability.

The large LCD display provides both frequency, operational status and "message" displays—the latter apparently enables you to write a special message or note to appear on the display.

The unit has a built-in speaker and is powered from 13.8 Vdc, drawing less than one

amp. Up-down keys are provided for stepping through channels with the VFO or through memory channels.

Accessory output terminals include external speaker, audio line out and a video output, which suggests TV reception possibilities. It's not known at this stage whether or not the latter is built-in or an option.

Kenwood's new Wideband Receiver is expected to retail for a little under \$1100. See your nearest Kenwood dealer, or contact **Kenwood Electronics Australia**, PO Box 348, Lane Cove 2066 NSW. (02)428 1455.



Icom's newest all-mode HF rig

The newly released Icom IC-761 HF amateur band transceiver is designed for the operator who wants more than just a radio, in fact, it's more like a complete shack in one package!

The IC-761 is a true all-mode transceiver, incorporating SSB, CW, RTTY, AM and FM modes. Standard features include a built-in antenna tuner, electronic CW keyer, general coverage receiver and 100% duty cycle power supply.

The rig incorporates full computer control capability as well as provision for connecting an external manual or automatic linear amplifier, external automatic antenna tuner, RTTY or AFSK terminal unit or SSTV unit. 12 Vdc power is available from a rear panel jack to power your accessories.

Inside the IC-761 can be seen the results of Icom sponsorship of many amateur radio DXpeditions and the feedback received from operators who have used Icom equipment in some of the harshest locations on earth, we are told.

Radical new rules for Ross Hull VHF contest

In an effort to arrest the flagging interest in what should be Australia's prestige VHF/UHF amateur radio contest, the Ross Hull, some new rules have been introduced for the 1987 event.

Probably the major change in this year's contest is the introduction of the Maidenhead locator system. The Maidenhead system is widely used in overseas contests, but never seems to have taken off in Australia.

Many amateur radio texts provide details of how to work out your locator square and the Wireless Institute of Australia should be able to help with details if you are stuck.

The other major change in the rules this year is the fact that contacts through orbiting satellites are acceptable, provided the uplink frequency is in the permitted contest band. This rule change will open up some interesting possibilities, especially when propagation isn't too good.

There has been a lot of criticism made of the Ross Hull contest rules in the past and these latest changes are bound to cause some controversy in some quarters. You can't please every-

Major advances in circuit design have produced increased dynamic range for better reception and a higher quality final amplifier for maximum reliability and purity of signal output, say Icom.

Icom involvement in Arctic and Antarctic expeditions has led to the development, for the IC-761, of a high stability crystal unit incorporating a built-in temperature compensating oven providing frequency stability of better than 100 Hz over a range from -10 to +60 degrees Celsius, Icom claim.

For the DXer or contester, the IC-761 includes a low distortion speech compressor with full metering, long and short duration variable pulse level noise blanking, front panel control of VOX operation, receive and transmit incremental tuning and an ultra-deep (30 dB) notch filter to eliminate annoying carriers.

True IF monitoring, 20 dB preamplification with minimal signal quality degradation,

body as the beleaguered contest manager will no doubt tell you, but the locator system should find some support.

Many amateurs are still of the opinion that the major failing of the contest is its length. The upcoming event will run from December 19th 1987 to January 10th 1988 and many feel that unless they can operate for the whole period, there is little point in submitting a log. This is particularly true when considering that the contest is held over the Christmas and New Year period, when family commitments take a high priority.

A recent VHF contest was held in NSW and was based on the "sprint" concept, running for just two hours. The organisers of the contest were amazed at the level of participation and other events along the same lines are planned in the near future.

Perhaps it is provoking controversy, but it is strongly suspected that if the Ross Hull contest was run over say one weekend around Christmas, we might see a similarly level of participation.

Full rules for the 1987 Ross Hull Memorial Contest are published in the November 1987 issue of the Wireless Institute's journal, *Amateur Radio*. For non-members of the Institute who don't get the journal, writing to your local WIA division or listening to divisional broadcasts should get you the required information.

switchable AGC, passband tuning, IF shift and switchable filtering are also included.

To store all the stations you find using the many scanning mode variations available, the IC-761 is provided with 32 full function memories storing frequency, mode and split.

Memory 1 and 2 set the limits for programmed scanning between upper and lower limits, whilst MODE-S provides mode selective scanning. Memory contents are selected by a rotary switch and displayed at the touch of a button. All memories are backed up by a lithium cell with a ten year lifetime.

For further information or a demonstration of the IC-761, contact your nearest authorised Icom dealer.



Handheld HF SSB transceiver

Possibly the smallest commercially available HF transceiver available in the world, Codan's type 8332 was designed and is manufactured by Codan (NZ) Ltd. The unit was initially designed to meet the requirements of the New Zealand Mountain Rescue Service, who had found that VHF and UHF transceivers gave inadequate coverage in the mountains.

Weighing only 510 grams including batteries, the transceiver is ideal for those working on foot in such applications as search and rescue, bushwalking, exploration and survey.

Transmitter power is one watt PEP and two channels may be fitted within the range of 1.6 to 6 MHz. The 8332 operates from eight AA size batteries fitted internally and may be fitted with an optional socket enabling operation from a 12 Vdc external source.

As originally conceived, the transceiver was to be used with a simple dipole antenna cut to the appropriate length for the frequency in use. However, an optional collapsible 2.5 metre whip antenna is now also available for those operations requiring such a facility.

The whip, which stows in a carry bag only 500 mm long, was designed and manufactured by Tasmanian antenna specialists, Moonraker Australia Pty Ltd.

Using the dipole antenna, reliable operating ranges of up to 200 km are achieved assuming use of the correct frequency for the propagation path. With the whip antenna, the range is naturally somewhat reduced.

The Transceiver is approved by the Department of Transport and Communications to specification RB.210 and is available ex-stock from Codan. For further details, contact any Codan dealer, or Codan Pty Ltd, PO Box 227, Chatswood 2057 NSW. (02)419 2397.

The "Gosford Field Day" on again soon

To give it its correct title, the 1988 Central Coast Amateur Radio Club field day will be held at the Gosford Showground on Sunday, 21st February 1988. "Gosford" must almost certainly rank as the "prestige" amateur radio event of the year, with its wide range of activities and attractions and the 1988 event is set to be no exception.

Attractions at the 1988 field day include: Homebrew contest; homebrew antenna evaluation (70 cm); childrens events; lucky door prizes; the ever-popular disposals; QSL Bureau; trade displays; amateur television displays; packet radio displays. For those not "hanging around", there are complimentary tickets for a local bus tour and the nearby reptile park.

The gates will open at 8:00 am, wet or dry as all displays are under cover. Registration is \$4.00 for gents, \$2.00 for ladies and \$1.00 for children. A 50% concession is available for pensioners on production of a pension card and a special group concession is available on application.

Companies, persons, groups or clubs wanting further information or wishing to set up a table or display should contact the Central Coast Amateur Radio Club at PO Box 238, Gosford 2250, NSW before January 1st 1988. Disposal forms and lot numbers can be obtained in advance from Reg Brook, VK2AI at PO Box 148, Gosford 2250 NSW.

MS

For information about multiple sclerosis please contact the MS Society.

New Release

FOUR SPEED SUPER MODEM!

The MAXWELL-5

2400/2400 1200/1200
1200/75 75/1200 300/300
CCITT and BELL standards.

Fantastic value!

JUST \$790!

inc. tax

LOOK AT THESE FEATURES:

- AT Command Set • Auto-dial/Auto-answer • Auto Speed Select • Auto Test • Tone or Pulse Dialling • Ten 16-digit Memories, Battery-backed • Test Facilities • 10 LED Status Indicators • Inbuilt Speaker.

Don't Delay, Call Max Today!



COMPUTERS

BANKCARD-VISA-
MASTERCARD WELCOME

24 Burwood Highway (Rd)
BURWOOD 3125 Vic.
Ph: (03)288 2144, 288 9067
FAX: (03)288 0781

RECEIVE WEATHER FAX, RADIOTELETYPE AND MORSE CODE TRANSMISSIONS USING YOUR COMPUTER

Build the Australian Electronics Monthly "Listening Post" (AEM3500), a simple add-on decoder project - it goes between the audio output of a HF (shortwave) communications receiver and the I/O of your Commodore 64 or Microbee computer, software then decodes the transmissions for you. Print weather maps, foreign news service broadcasts, amateur and commercial radioteletype or Morse transmissions. 'Fascinating' Useful, too.

SOFTWARE ONLY: \$25.00

- includes all instructions on the decoder & software

LISTENING POST "PACKAGE": \$35.00

- you get software, quality fibreglass pc board with component overlay and full now-to-build instructions plus software operating details (Components are widely sourced by electronics retailers)

* C64 software does not provide Morse decoding

Send coupon to: AEM Software Service, PO Box 507
WAHROONGA 2076 NSW.

Send us a blank C10 cassette or a formatted disk for us to transfer the software onto

SEND ME THE
LISTENING POST:
 SOFTWARE ONLY
 FULL PACKAGE

My computer & printer are:
 Microbee/C. Itoh 8510-type
 Microbee/"Epson" FX80-type
 C64 or C128/(most printers)

I am paying by Cheque Money Order B card M card Visa
(Make out cheques or money orders to: Aust. Electronics Monthly)

Card No Expiry

Signed

Name

Address

P code

Or phone and pledge your plastic: (02)487 1207.

KENWOOD

SUPER SUMMER SPECIALS

RZ-1 WIDEBAND RECEIVER

Features: Wideband Frequency Coverage (500KHz — 905MHz), including FM Stereo Broadcast and Multi-Channel Television Sound 100 Easy-To-Operate Multi-Function Memory Channels with Message Capability 10-Band Programmable Capability Keyboard Frequency Selection Auto-Mode and Auto-Step Operations Multi-Scan Function Easy-To-Read Large LCD Display Compact and Lightweight Auto-Selectable Dual Antenna Terminals Built-in speaker Front-mounting phones jack Easy-to-operate, illuminated keys Accessory terminals are Line Out/Video Out/External Speaker Terminal Squelch circuit for FM (narrow) mode UP/DOWN Keys for VFO and memory channel

Specifications Frequency Range 500KHz — 905MHz Mode: A3[A3E] (AM), F3[F3E] (FM) Circuitry AM, FM(N) = Triple conversion system FM(W) = Double conversion system Sensitivity AM (S-N N = 10dB) = Less than 5 μ V (BC band 10 μ V) FM (N) = 12dB SINAD less than 6 μ V (500KHz — 60MHz) less than 3 μ V (60 — 905MHz) Operating Temperature -10 — +60 C Audio Output Power 2W (at 8 ohms load 10% distortion). Current Drain Less than 1A (audio power output 1W) Antenna Impedance 50 - 300 ohms Power Requirement 13.8VDC \pm 15% Dimensions 180(W) x 50(H) x 158(D) mm Weight 1.5kg.



COVERS
500 KHz — 905 MHz
RANGE

KENWOODS' GREAT
IN '88
\$1049

NEW
FOR 88

R-5000 COMMUNICATIONS RECEIVER

The R-500 is a competition class communications receiver with superior dynamic range, having every conceivable feature, and is designed to receive all modes (SSB, CW, AM, FM, FSK) from 100 kHz to 30 MHz. With the optional VC-20 "VHF Converter Unit" coverage of the 108—174 MHz frequency range is provided.

Advanced microprocessor technology controls various features, including dual digital VFOs, 100 memory channels, memory scroll, memory and programmable band scan, superb interference reduction and other features for ease of operation to enhance the excitement of listening to stations around the world.

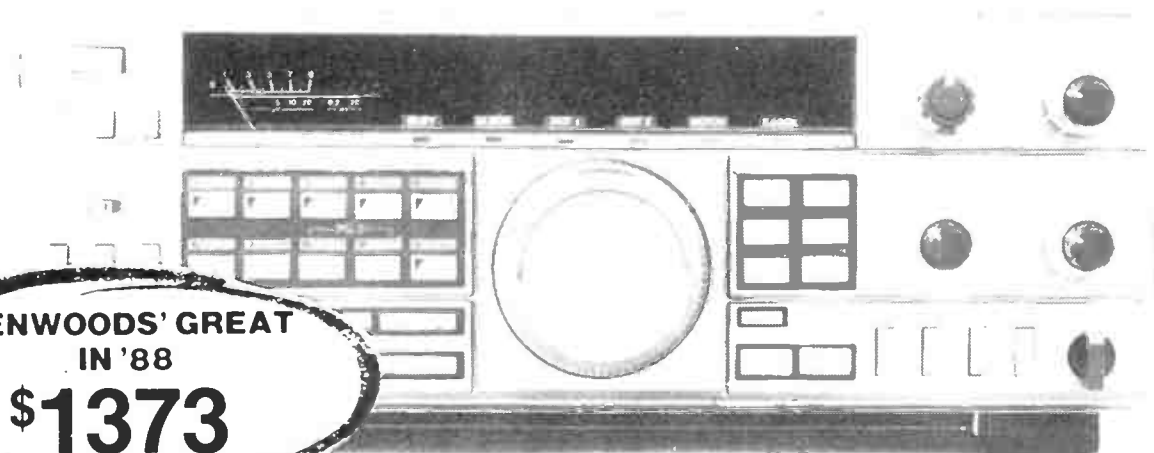

KENWOODS' GREAT
IN '88
\$1373

TS-140S

HF TRANSCEIVER

The TS-140S is a high-performance HF transceiver designed for SSB, CW, AM and FM modes of operation on all Amateur bands. It incorporates an outstanding 500 kHz to 30 MHz general coverage receiver with superior dynamic range, combining the ultimate in compact size with advanced technology.

All-Mode operation (includes USB, LSB, CW, AM and FM)

Compact and lightweight. Measures only 270 Wx96 Hx270mm and weighs only 6.1kg (13.45lbs). CW Full Break-In, Semi Break-In and VOX Circuit. Superior receiver dynamic range. The receive front end has been specifically designed to provide superior dynamic range. The intermodulation dynamic range is 102dB, with an overall intercept point of -12dBm, noise floor level of -138dBm (when the optional 500 Hz CW filter YK-455C-1 installed). 31 Memory channels with split memory channels and memory scroll. Built-in dual-mode noise blanker ("Pulse" or "Woodpecker"). IF shift circuit. Adjustable VFO tuning torque. Switchable AGC circuit (FAST SLOW) and built-in speech processor. RF output power control and "F LOCK" switch. Non-volatile operating system. Fluorescent tube digital display and squelch circuit (for FM mode). RF power output — SSB 110W, CW 100W, FM 50W and AM 40W.

**KENWOODS' GREAT
IN '88
\$1532**



**JUST
ARRIVED**

NEW FOR 88

**KENWOODS' GREAT
IN '88
\$1584**

TS-680

HF TRANSCEIVER

Includes all the above features for the TS-140S PLUS
Covers Amateur bands
160 meters to 6 meters
both Transmitting and Receiving.
160 meters to 6 meters, 100 Watts output.
6 meters, 10 Watts output.



KENWOOD ELECTRONICS AUSTRALIA PTY. LTD.

4E WOODCOCK PLACE, LANE COVE, SYDNEY, N.S.W. 2066. Ph. (02) 428 1455.

Further beware of dealers not listed in this advertisement who are selling Kenwood communications equipment. All Kenwood products offered by these are not supplied by Kenwood Electronics Australia Pty. Ltd. and have no guarantee applicable.

- N.S.W.:** EMTRONICS — 94 WENTWORTH AVENUE, SYDNEY (02) 211 0988
REG STOCKMAN COMMUNICATIONS — CNR BANOOKBURN ROAD & SHIRLEY STREET, INVERELL (067) 22 1303
WORMALD COMMUNICATIONS — 51 DENNISON STREET, HAMILTON, NEWCASTLE (049) 69 1999
MACELEC PTY. LTD. — 99 KENNY STREET, WOLLONGONG (042) 29 1455
ALEX JOHNSON — 19 BANKSIA STREET, O'CONNOR, ACT (062) 47 9125
DX ENGINEERING — 158 GRANITE STREET, PORT MACQUARIE (065) 84 9922
FRANK BOUNDY — LISMORE (066) 86 2145

- INTERSTATE**
VIC.: PAPANETERS PTY. LTD. — 1064 CENTRE ROAD, SOUTH OAKLEIGH (03) 575 0222
EMTRONICS — SHOP 5 TO 7, 288-294 QUEEN STREET, MELBOURNE (03) 670 0330
BRIAN STARES — 11 MALMSBURY STREET, BALLARAT (053) 39 2808
SUMNER ELECTRONICS — 78 KING STREET, BENDIGO (054) 43 1977
TAS.: WATSONS WIRELESS — 72 BRISBANE STREET, HOBART (002) 34 4303
MARINE & COMMUNICATION — 19 CHARLES STREET, LAUNCESTON (003) 31 2711
V.K. ELECTRONICS — 214 MOUNT STREET, BURNIE (004) 31 7733
MITCHELL RADIO CO. — 59 ALBION ROAD, ALBION (07) 357 6830
QLD.: EMTRONICS — 416 LOGAN ROAD, STONES CORNER, BRISBANE (07) 394 2555
S.A. & N.T.: INTERNATIONAL COMMUNICATIONS SYSTEMS PTY. LTD. — 8 NILE STREET, PORT ADELAIDE (08) 47 3688
W.A.: WILUS ELECTRONICS — 165 ALBANY HIGHWAY, VICTORIA PARK (09) 470 1118
BAY RADIO — 22 GRACE STREET, FERNDALE (09) 451 3561
FORD ELECTRONICS — UNIT 19, 70 ROBERTS STREET, OSBORNE PARK (09) 242 1766

The VK2AWI packet radio bulletin board

Andrew Keir VK2AAK

Packet radio is growing rapidly in popularity all over the world where licensing administrations permit packet radio operation for amateurs. The development of packet radio parallels somewhat that of dial-up data communications using the switched telephone network, where dial-up "bulletin boards" provide the "glue" that binds the enthusiasts in the group. On-air open access packet radio bulletin boards serve a similar purpose on the amateur bands.

IT'S NOT CERTAIN whether the NSW Division of the Wireless Institute of Australia was the first division to introduce a packet radio bulletin board, but it is strongly suspected that this is the case. In view of the fact that this system is now well established and gaining popularity, it may be a good time to describe exactly what it is and what it does.

A little history

The VK2AWI bulletin board first went on air in March 1987 under the callsign of VK2AAK. This was a "public" system for all amateurs and was set up by Andy VK2AAK at Seven Hills (NSW) in an effort to clear some of the congestion which was apparent on the primary Sydney area frequency of 147.575 MHz. Several bulletin boards were active on that frequency and because of the large amount of traffic being handled, many users experienced frustration when trying to access them. For this reason, VK2AAK was established on 147.600 MHz to serve the local packet community whilst leaving existing systems on 147.575 to handle more of the "trunk" traffic from interstate and overseas.

Although the equipment and software were available to provide "gateway" facilities to HF channels, a deliberate decision was made not to do so in keeping with the concept of a "local" system.

The choice of frequency proved to be quite an advantage, with many users finding that they could read messages or download files without heavy congestion of the channel causing the system to slow down or "retry-out". The biggest disadvantage in using 147.600 was that there were no dedicated digipeaters to extend the range as there were on 147.575. This meant that, initially, there were some areas of Sydney which had difficulty in accessing the system.

In early April, Andy VK2AAK went to work at Australian Electronics Monthly. It was immediately apparent that the location of the Magazine's office in South Wahroonga, a northern Sydney suburb, high on a ridge not far from Pierce's Corner, offered an excellent VHF site with high elevation and an almost clear take-off in all directions. The decision was made to move the system to the magazine's premises. Once this was done, coverage improved markedly and popularity started to climb.

At about this time, one of the topics being examined by the VK2 Divisional Council of The Wireless Institute of Australia was the establishment of a packet radio bulletin board. It did not take long to realise that the simplest solution was to make use of an existing system and Andy, who was a member of the council, volunteered the use of VK2AAK. This was accepted and in mid-May, the system became the "official" VK2 divi-

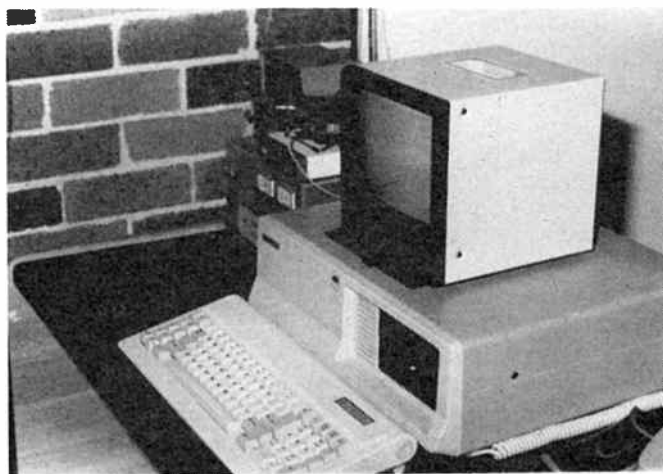

The VK2AWI BBS runs on a PC XT compatible which is primarily used as a word processor during office hours. The TNC is a TNC2-A by GLB.

sion bulletin board. The callsign was changed to VK2AWI on June 1st.

So, what does it do?

For those who are not familiar, a packet bulletin board is a system along similar lines to the many telephone bulletin boards which have become popular over the last few years. It allows users to connect to the system and read or leave "mail" or general bulletins. Files containing items of interest such as satellite predictions or even computer programs can be uploaded to, or downloaded from the board.

Where a packet system differs from the telephone system lies in the fact that access is via radio instead of telephone lines. Any suitably licenced amateur station who has a computer and packet terminal node controller (TNC) can gain access.

To avoid tying up the channel unnecessarily, the prompts and system messages generated by the bulletin board are short and to the point. Packet radio bulletin boards are far less verbose than their telephone counterparts, although systems such as VK2AWI provide extensive "help" files which can be requested by the user.

One of the major assets of packet radio bulletin boards is their ability to forward messages or bulletins to other similar bulletin boards. If, for example, a Sydney amateur wanted to send a message to an amateur in Newcastle, he could send it to his local bulletin board addressed to the board nearest the ▶

A broadband balun for HF antennas

Andy Keir VK2AAK

Centre fed antennas, such as the common-or-garden dipole, have a balanced feedpoint, and for a wealth of good reasons coaxial cable is the preferred antenna feedline – but coax is an unbalanced line. Just hooking coax to a balanced feedpoint antenna will work, but at best it's not "ideal", and at worst, you're asking for problems. A balanced-to-unbalanced transformer, or "balun", is the answer.

CENTRE FED antennas, such as the trap dipole design published in our November '87 issue, are essentially a balanced radiator. If you feed a balanced antenna with a balanced line such as parallel open wire or "ribbon" cable, the balance of the system is maintained and all will be well. These days however, most radio amateurs – and "professional" communicators – favour the use of coaxial cable to feed their antennas and whilst this is quick and convenient, coax is an unbalanced feeder and should not be connected directly to a balanced radiator.

In a balanced line such as open wire feeder, fields which are produced by one of the conductors are cancelled by those of the other conductor. This is not the case when coaxial feeder is used as one side of the antenna is connected to the shield of the cable and the other side to the inner conductor. Fields set up in the shield cannot be cancelled by those produced by the inner conductor as they cannot escape through the shield from the inside of the cable. As a result, RF currents can flow on the outside of the cable and can be responsible for radiation from the line.

Radiation from the transmission line is clearly an undesirable situation. Apart from distorting the radiation pattern of the antenna, there is a good possibility of RF entering your shack down the outside of the coax line and that can play havoc with all sorts of things, especially as most modern transmitters have the shield side of the antenna connected to the chassis.

To overcome this problem, a device is required which will match the balanced antenna to the unbalanced feeder by decoupling the RF currents from the line. Such a device is called a "balun" transformer, the word balun being simply a contraction of "balanced-to-unbalanced".

Many readers will be familiar with the commonly available "TV baluns" which are used to transform the balanced 300 ohm feedpoint of many types of TV antennas, particularly the older types – to the 75 ohm unbalanced coaxial feed used on most modern TV sets. These devices consist of a simple broadband transformer, wound on a ferrite or powdered iron "core". We can use the same approach to build a transformer to match the unbalanced 50 or 75 ohm output impedance of a transmitter to the balanced 70 ohms or so or a dipole antenna. In the case of the TV balun, an impedance transformation from 300 ohms to 75 ohms is required, meaning a transformer ratio of 4:1. In the case of the dipole mounted at a reasonable height above ground, the impedance of the transmission line is close to that of the antenna's feedpoint, so a transformer with a 1:1 ratio can be used.

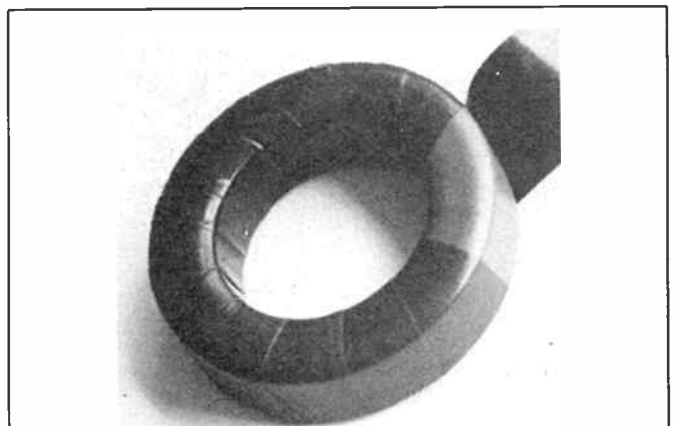

It is wise to wrap the toroid with insulating tape or rubber tape before winding the wire. This prevents abrasion of the wire's insulation by rough edges on the toroid and also increases the breakdown voltage of the completed balun.

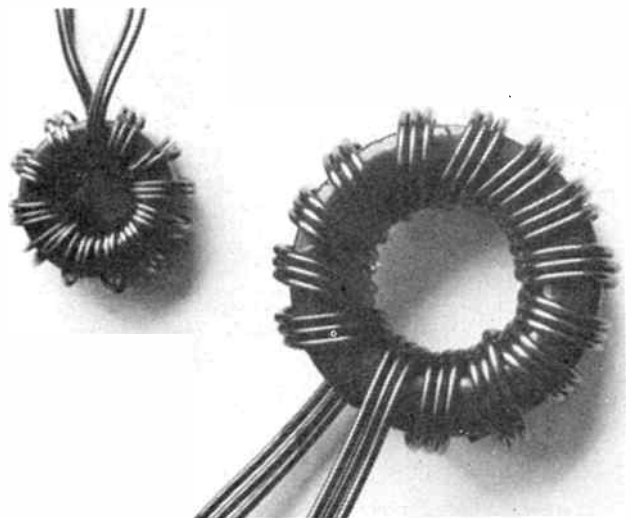

This is how the balun should look with the windings in place. Note how the turns are spaced equally around the circumference of the toroid. At least 10 turns are required, but you should be able to manage 12 on the larger T200-2 toroid.

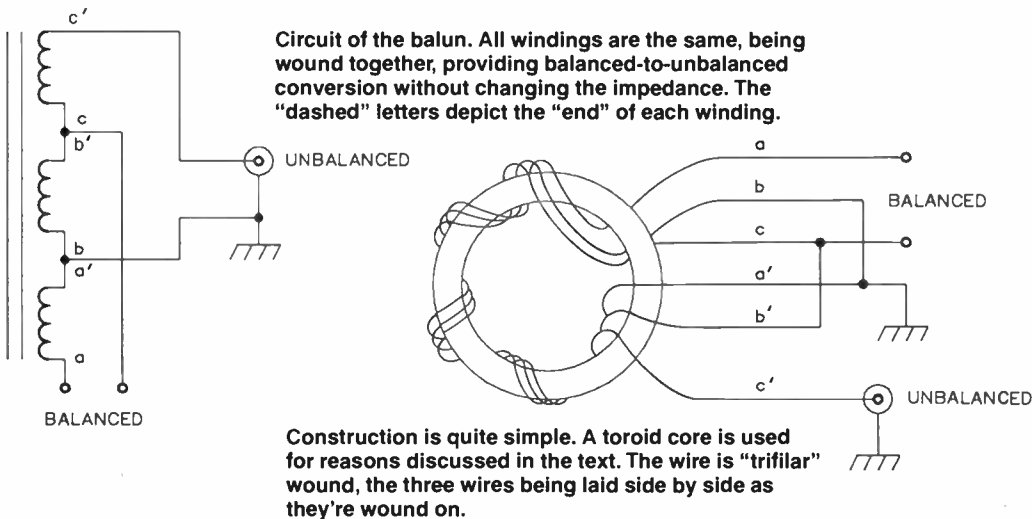

LEVEL

We expect that hobbyists who are **BEGINNERS** in electronics construction should be able to successfully complete this project.

The windings of the transformer actually form sections of two transmission line, closely coupled by being laid side by side, the core serving to electrically "lengthen" the line. One winding is common to the other two, forming a common "side" of the two transmission line sections. This is connected so as to provide a phase reversal of the common currents, thus providing the balanced-to-unbalanced conversion.

Because we are going to be coupling appreciable power through the transformer, it will need to be constructed of much heavier materials than the TV balun. Also, if the balun is going to be useful over the whole HF band, the core material will need to be made of a suitable low-loss, high frequency material. We will use a toroidal former made from powdered iron and enamelled copper wire of a suitably heavy gauge for the windings.

Toroidal formers are available in a wide variety of materials and sizes, but referring to manufacturer's data, it was found that the Q2 type best suited our requirements. Two suitable toroids were chosen from the Amidon range of products which are available through several suppliers. Samples for our project were supplied by Stewart Electronics in Melbourne who import and stock the complete range of Amidon products. The T200-2 toroid measures approximately 50 mm outside diameter and is capable of handling 1 kW continuous power. The T68-2 toroid, also from Amidon, is made from the same powdered iron material but is only 22 mm outside diameter and can be used to make a balun capable of handling powers up to around 150 watts. Both these toroids can be identified by their dark red and grey colour coding.

Construction

Referring to the circuit diagram, you will see that the transformer's three windings are labelled a, b and c. Construction of the transformer consists of winding at least ten turns of the three wires side by side around the toroid, known as a "trifilar" winding. Although this sounds simple, there are a number of ways to go about it which will make the job much easier.

See our 'PROJECT BUYERS GUIDE' this issue for a guide to component sources and kit suppliers.

AEM3015 PARTS LIST

For 1 kW version:

One Amidon toroid type T200-2; three metres enamelled copper wire 2 mm dia.; plastic box to suit.

For 150 watt version:

One Amidon toroid type T68-2; three metres enamelled copper wire 1 mm dia.; plastic box to suit.

For both versions:

One SO-239 panel socket, two plastic tie-wraps; Perspex ofcut approx 200 mm x 50 mm x 8 mm; nuts, bolts and hardware to suit.

Estimated cost:

This will depend to some extent on the method used to house the balun. Our prototype 1 kW version cost just under \$18.00 using off-the-shelf components. Using the same construction methods, you should be able to complete the 150 watt version for about \$11.00.

The Amidon toroids are obtainable by mail order from Stewart Electronic Components Pty Ltd, PO Box 281, Oakleigh 3166, Vic. Telephone (03)543 3733. Cost is \$11.20 inc. tax and postage for the T200-2 and \$3.90 for the T68-2. We understand that Geoff Wood Electronics of Sydney also carry the T200-2.

The 1 kW version will require windings made from enamelled copper wire of about 2 mm diameter. This stuff is very awkward to handle as it is so stiff and considerable effort will be required to get the windings reasonably tight. You will probably need to use two pairs of pliers to grip the wire whilst winding it on the toroid and unless care is taken, this can cause breakage of the toroid or damage to the copper wire's insulation where it contacts the toroid. If you do use pliers, make sure you only grip the windings at the ends as the insulation will be damaged by the plier's jaws.

To avoid damage to the insulation of the copper wire, it is recommended that a layer of insulating tape is wrapped around the toroid before commencing the windings. This will not affect the operation of the transformer, but will prevent the insulation being scraped off the wire by any rough edges on the toroid and also serves to increase the breakdown voltage of the balun.

When you have prepared the former, cut three lengths of wire, each about one metre long. Twist or tape the ends of the three wires together to stop them separating whilst winding and feed all three through the hole in the toroid so that equal lengths protrude each side. It is much easier to start from the centre of the winding and work in both directions than it is to start at one end. Reference to the photographs will give you the general idea of how the wound transformer should look. The windings should be spaced as shown and you should have at least ten turns around the toroid. In our prototype of the 1 kW version, we managed to get twelve turns. Take care not to twist the wires so that the turns cross over each other as this restricts the space you have for winding.

The lower power version is constructed in exactly the same manner, except that enamelled copper wire of about 1 mm

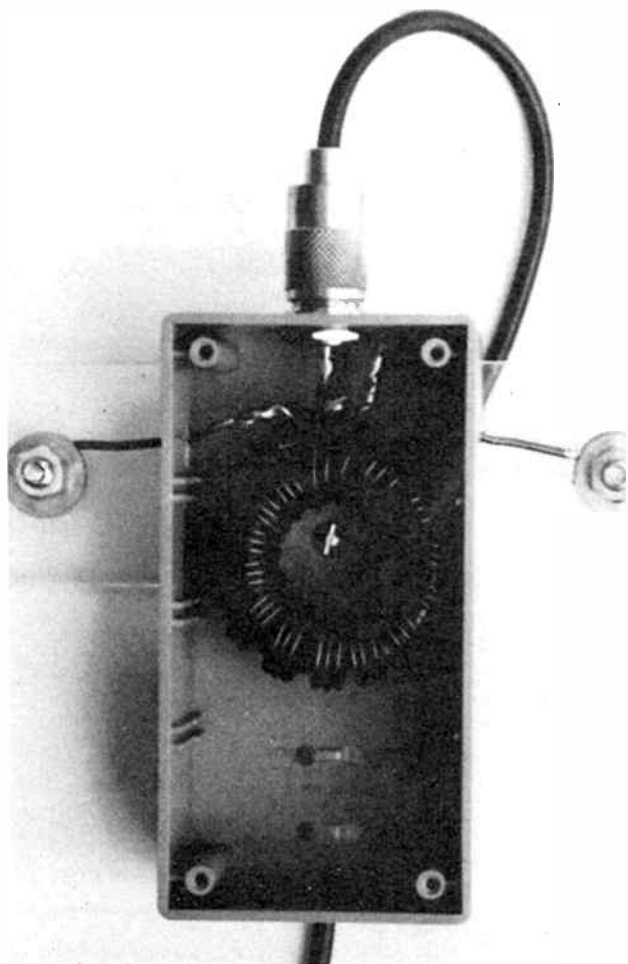

This picture shows the completed balun with the lid removed. Heavy nuts, bolts and washers are used to terminate the balun windings where they attach to the dipole ends. You should drill the holes in the case after trial fitting the wound balun and use silicone sealant to block the holes after everything is in place. Don't forget to drill a small drain hole in the bottom of the case to prevent moisture from collecting inside.

diameter is used. We found that 10 or 11 turns would fit on the T68-2 toroid

Once you have wound the transformer, you will need to get your multimeter out and determine the start and ending of each winding by using the resistance ranges. Use adhesive tape to label the windings a, b, and c as in our diagram and then put it aside until ready to connect it.

The next step is to provide a suitable enclosure for the balun. There are a number of ways to do this, but we chose to use a plastic "zippy" box of suitable dimensions. A standard size box measuring 130 mm x 68 mm x 43 mm was found to be ideal for the 1 kW balun. A smaller box could be used to house the 150 W version. Whatever method you choose, you should provide some sort of strain relief for the dipole ends and the coax feed line. The method we chose for our prototype was a fairly thick piece of perspex, bolted to the back of the zippy box. Holes can be drilled in the perspex and bolts inserted which are used for anchor points for the balun windings and the dipole ends. Reference to the photographs will show you the sort of thing required.

A panel mount SO239 socket was used to terminate the coax feedline. You should not let the coax simply dangle from the socket on the balun as there is a good possibility that the cable will pull free from the plug. We used a couple of

plastic tie-wraps secured through holes drilled in the bottom of the zippy box to provide strain relief for the coax cable. Once again, reference to the photographs will show you how things can be arranged. As the exact hardware required will depend on individual preference and circumstances, I have not given exact details in the parts list.

Connection

When you have prepared the enclosure, you can trial fit the transformer inside and ascertain how long the wire tails need to be. When the wire tails have been trimmed to size, (allow a little excess for errors) you can prepare the ends by scraping off the insulation with a sharp blade. Tin the ends of each wire with solder, taking care not to get the windings mixed up.

Start by connecting the START of winding "c" to the END of winding "b". This connection will become one side of the balanced output of the balun and will be connected to one of the dipole ends. Now connect the START of winding "b" to the END of winding "a". This connection will be the ground side of the unbalanced input of the balun and should be connected to the ground lug of the SO-239 socket. You should now be left with the START of winding "a" and the END of winding "c". The START of winding "a" is the other side of the balanced output and will be connected to the other dipole end. The END of winding "c" will be the other side of the unbalanced input and should be connected to the centre conductor of the SO239 socket. The connections should be kept as short as possible, so try to install the toroid in the enclosure to facilitate this.

All holes should be sealed with silicone sealant, as well as around the lip of the lid and the four screw holes, but DON'T seal the drain hole in the bottom. The accompanying photographs and captions detail how to finish off the project.

At the dipole's feedpoint, each wire may be terminated by twisting an "eye" in them and securing these between a flat washer and a star washer beneath an extra nut on the balun's termination bolts. Alternatively, large automotive-style crimp-type eye lugs may be attached to the wires, the crimp providing mechanical strength, but the wire should be cleaned, tinned and soldered to the lug to provide a good electrical connection.

Your balun is ready to be hauled into place. With the antenna up, a quick check with a VSWR meter will be all that's necessary before putting your new antenna/balun into active service.

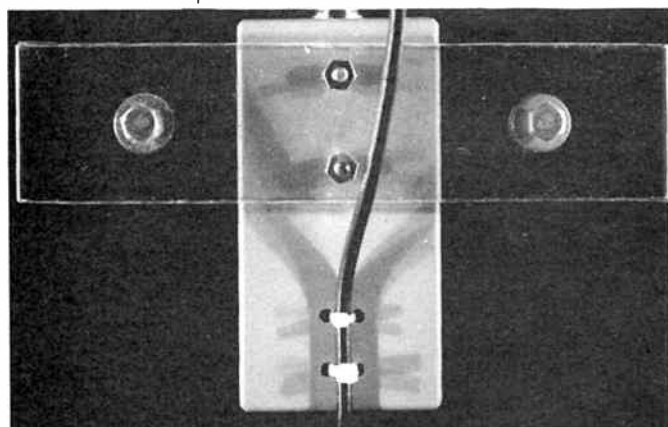

Another view of the completed balun, this time showing the method used to provide strain relief for the coax connection. It would be wise to wrap some self amalgamating rubber tape around the coax plug and socket after fitting to stop the ingress of water into the cable.

AT A LOSS TO KNOW WHAT TO GIVE THAT SPECIAL RELATIVE OR FRIEND FOR CHRISTMAS?

What better gift than one years membership to the
Wireless Institute of Australia.



Your gift will be remembered throughout the year when they receive the monthly magazine *Amateur Radio* which is full of information to all interested in the hobby.

As well as joining the world's first amateur radio society, the recipient will receive numerous other benefits, such as:

- Technical Books at discounted prices
- Information on Reciprocal Licensing
- Use of the Video Tape Library
- Free Hamads.



Bankcard Visa Mastercard

FACILITIES ARE AVAILABLE FOR YOUR
CONVENIENCE

87.2948SC.BKP



FOR FURTHER INFORMATION BY
RETURN MAIL, PLEASE WRITE TO:
**SECRETARY
WIRELESS INSTITUTE OF
AUSTRALIA
PO BOX 300
CAULFIELD SOUTH, VIC. 3132**

Regd Addr 3/105 Hawthorn Road, Caulfield

Avtek releases new modem range



Avtek, one of Australia's longest established modem manufacturers, has just launched a new range of "smart" modem products.

Totally designed and built in Australia, the new Megamodems are compact, fully Hayes compatible and available in either V.21/V.22 or V.21/V.22/V.23 configurations. An internal "in-modem" is also available as a half card unit, suitable for IBM PCs and compatibles.

The Megamodems are upward compatible and carry a 12 month extended warranty and access to Avtek's technical support line.

A recent equity injection by an offshore investor has allowed Avtek to significantly increase its R&D and to expand its operations to take advantage of the growing communications market.

Mr. Phil Gleeson, Managing Director, was quoted as saying "we are now in a position to offer locally designed and manufactured products with on-going R&D commitments and with direct end user support at a price not only competitive with local modems, but lower than "cheap" imports".

Priced at just \$375.00 and \$449.00 respectively (including tax), the new Avtek range looks set to put the cat amongst the pigeons! For further information, contact: Avtek Electronics Pty Ltd, 21 Bibby Street, Chiswick 2046 NSW. (02)712 3733.



Super capacity micro floppy

TDK, well known as a supplier of audio and video tape, has recently released an enlarged storage capacity 3.5 inch double-sided, high density micro floppy disk providing up to two megabytes of storage capacity.

Depending on the operating system in use, TDK claim the disk, designated MF-2HD, can provide either 1.6M or 2M.

The secret to the increased storage capacity is attributed partly to TDK's ultra thin coating technology which involves controlling their high density Avilyn magnetic formulation to within 0.05 microns surface thickness.

The MF-2HD is the first disk to utilize an Electron Beam Cured

Binder technique which was originated by TDK. This technique involves the high density coating of the disk to be penetrated by an electron beam causing excitation and ionization of the binder molecules.

This process results in an extremely hard structure and is claimed to assure reliability and data safety even after 20 million passes!

TDK claim that every single track of every disk is tested and certified 100% error free before leaving the TDK factory. The MF-2HD has a recommended retail price of \$13.50 each and compliments TDK's range of existing 3.5 and 5.25 inch floppies.

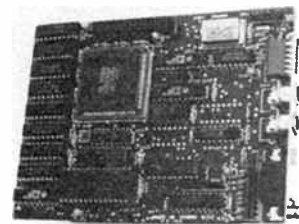

Hypertec's speediest PC speedup card

Hypertec Pty Ltd claim to have developed an accelerator board that boosts the speed of a standard PC by up to 1000 per cent - double that of IBM's fastest AT.

Called Hyperformance, the board is the second in a group of speed-up boards designed by the Sydney-based Hypertec.

The first of these was Hyperace 286 Plus and it's younger brother, Hyperace 286 which were released late last year.

They effectively replace the host computer's 4.77 MHz 8088 processor with their own 80286 processor running at 10 MHz and 6 MHz respectively.

Hyperformance goes a step further by once again replacing the host 8088 processor with an 80286, this time running at either 12.5 MHz or 16 MHz (available from November).

Operating at 12.5 MHz, Hyperformance lifts speed by up to 700 per cent - around 50 per cent faster than the fastest IBM AT, according to Hypertec. With the 16 MHz version, speed is increased by up to 100 per cent, they say - double that of the fastest IBM AT.

One megabyte of 16-bit RAM

on the Hyperformance board ensures speed is unrestricted by the slow, byte-wide memory of the standard PC. All existing memory, including that contained in any EMS board, is instantly available for RAM disks, spooling or expanded memory.

Hypertec says the board is designed for computer professionals who require maximum performance from their PC, XT or compatible. These include CAD and desktop publishing users, software developers and those who utilise large spreadsheets.

One of the major features of Hyperformance is it's unique automatic slow-down facility. The board actually detects whether a slow peripheral or speed sensitive application such as a communications or networking program is struggling at the higher speed and adjusts its speed to accommodate the device or software.

In addition, the Hyperformance board allows the operator to slow the machine down to normal PC or XT speed, without having to flick switches or re-boot the machine.

The recommended retail price for Hyperformance is \$2400.00, including tax. Further information can be obtained from Hypertec Pty Ltd on (02)819 7222.

New computer courses from TAFE

NSW TAFE's new School of Computing and Information Systems is developing two associate diploma courses to train for commercial computer careers in programming, systems analysis and management and microcomputing. It hopes to begin teaching the courses in 1988.

Both courses are expected to be offered as two year full-time courses, as well as four year part-time courses. These courses would incur no tuition fees and the \$250 tertiary administration fee would also not apply to them.

The Commercial Data Processing course will provide a sound knowledge of data processing principles and systems training, with a large component of programming and systems work directed towards commercial usage.

The Microcomputer Systems course is to provide broad train-

ONE STOP computer shop

PRICED FOR HOME, BUILT FOR WORK!

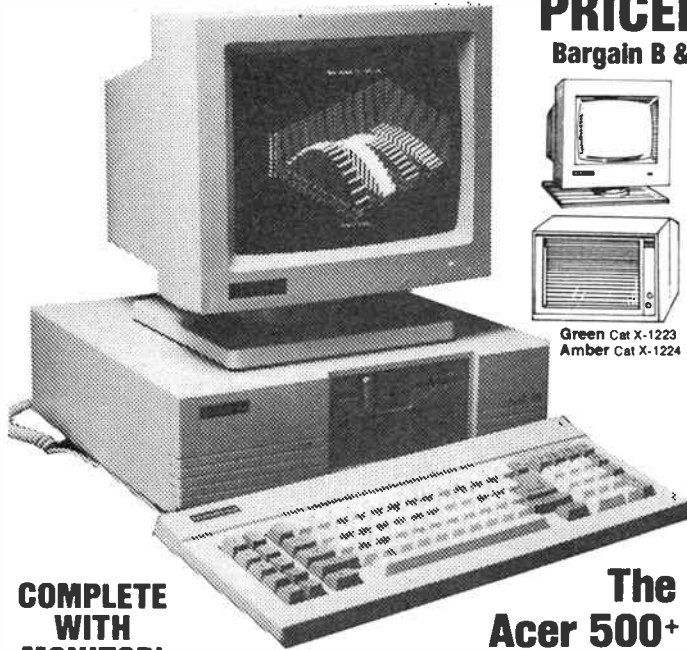

COMPLETE WITH MONITOR!

**The Acer 500+
By Multitech**

Now there's an affordable computer system with all you need for work or play! The ACER 500+ comes with 256K or 640K RAM, single or twin floppy disk drives, optional 20Mb hard drive, keyboard selectable 4.77/8MHz clock speeds, 12 months warranty, MS.DOS software and more!!

System 1

256K RAM, single floppy disk drive, MS.DOS (version 3.2) software and monitor! Cat X-8050

System 2

With 256K RAM, twin floppy disk drives, MS.DOS (version 3.2), serial and parallel ports and monitor! Cat X-8051

System 3

Amazing 640K RAM, single floppy disk drive PLUS 20Mb Hard Drive and MS.DOS (version 3.2) plus monitor! Cat X-8052

Complete! \$995

ONLY \$1295

Hard Drive! \$1995

Bargain B & W Monitor

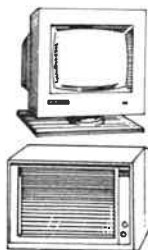

Green Cat X-1223
Amber Cat X-1224

Check it out for value! 12" B & W TTL Monitor with anti-glare screen, pan/tilt base and front mounted controls. Exceptional value and quality! Cat X-2400

\$249

Save \$50!!

Green or Amber composite monitors at this great low price! Both feature anti-glare screen, wide video bandwidth for clearer sharper picture, 30cm screen size with front mounted controls!

WAS \$249 NOW \$199

Makes Working Easier!

Quality monitor swivel bases. Two great models to choose from. Both feature robust construction, 360 degree horizontal movement and 25 degree vertical adjustment.



Budget Base!

With anti-skid feet! Takes 22cm to 35cm screens. Cat X-1190

\$24.95



Deluxe Base

With front mounted locking knob. Lets you adjust the angle without removing the screen!

Cat X-1191 **\$39.95**

VALUE!

Disk Savers



Don't pay more! DSE quality 5 1/4" Diskettes are so good — we use 'em! In hard plastic storage box they make good sense.

SS/DD Cat X-3500 Box Of 10

DS/DD Cat X-3501 Box Of 10

\$24.95

\$26.95

Budget Beaters!

Our new Budget DS/DD 5 1/4" Diskettes! Look at the fantastic low price! Cat X-3521

Pack Of 10 \$18.95

Letter Quality or Lightning Fast!



The best of both worlds! Fast 135cps Dot Matrix printer. Choose between super speed or near letter quality. Ideal for graphics, correspondence, invoicing... anything! 101mm to 254mm paper widths and with inbuilt tractor feed! Cat X-3225

\$499

20% Off Gender Bender!

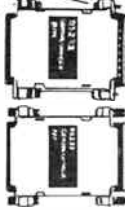

Female/Female! Adapts male Serial cables without rewiring or resoldering! Simply plug it in. Twin female DB25 sockets with all wired pin to pin! Cat X-3566

\$12.95

Save \$3!!

The Male/Male Gender Bender is really kinky! It does just what the female one does only differently! Save 20% now! Cat X-3565

\$12.95

RS232 Breakout Box.

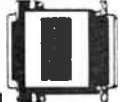

\$27.50

Just what you need for serial applications like modems, etc! Anywhere connections need constant changing! DB25 male to female with pin 1 permanently wired. The others are open with wire links supplied. Cat X-3568

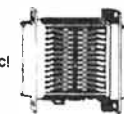

WAS \$17.50 NOW \$9.95

Almost 1/2 Price!

Permanent RS232 Jumper box! Just like the breakout box except that the connections are made internally and soldered for permanent connection. All 25 pins are open and wire links supplied! Cat X-3569

Printer Switching



\$59.95

The Parallel Switch Box will save you heaps! Lets you run one printer from two computers or even two printers from one computer. No more cable changing! Just plug it in and it does the rest! Cat X-3571



\$39.95

Save Desk Space!

With the CPU Floor Mount Stand you can mount your CPU on its side — beside the desk! Gives you back your desk for working on. Great idea! Cat X-3810

Magic Modem!

The Bit Blitzer 12E, the best thing to happen to modems in years! With selectable full duplex 1200/1200 or 300/300 baud, auto answer/dial/disconnect, Telecom authorised, quality construction. Hayes AT command set compatibility, fully keyboard controllable. Cat X-3306



\$399

\$499

Also available Bit Blitzer 123E, same as above plus 1200/75 Viatel operation. Cat X-3307

Bit Blitzer Buyer's Bargain Bonus!

Buy a Bit Blitzer this month, and we'll throw in the serial cable... FREE! That's right: your choice of either 25/25 pin "D" cable (X-3564) or 25/9 pin "D" cable (X-8007).

SAVE UP TO \$29.95 — THIS MONTH ONLY!

DSX PRESS

Order by phone: 24 hour despatch through DSXpress. Call TOLL FREE (008)22 6610 (Sydney Area, call 888 2105)

DICK SMITH ELECTRONICS



PTY LTD

MAKE YOURSELF A MODEM!

Build yourself a modem. Save money, learn about the technology and enjoy the pride and satisfaction that comes from having made it yourself. By special arrangement with Maestro Distributors, we're able to offer these kits to AEM readers. And these Maestro kits look "just like a bought one". They're complete to the last nut and bolt, right down to comprehensive building instructions and user manuals. And Maestro offer a fix-it service for a reasonable charge should you strike problems.

Select a modem to suit your computer and your budget.

SPECIAL OFFER



THE AEM4622 BIT STREAM FLYER

Here's the most economical way to get going at 1200 bps (V22) full duplex. Upgrade your current datacoms system without throwing your existing modem away. This one's just like any other "dumb" modem. All you need is a computer with an RS232 serial interface and a terminal program or communications software. Powered from 12 Vac plugpack.

Now only **\$169.00!**

The components would cost you over \$200 alone at retail prices.

12 Vac plugpack to suit: **\$14.00**



THE AEM4610 MAESTRO SUPERMODEM

Described in AEM over April-August 1986, this popular "smart modem" project now comes with a "new look" and many software enhancements over the original version. Just look at these features:

- Hayes compatible • auto-answer/auto-dial/auto-hangup • baud rate sense • built-in bit rate converter • meets Telecom requirements • expansion bus for easy upgrades • V21, V23 (300/300, 1200/75, 75/1200 bps) operation • V22 (1200/1200 bps) upgrade board available • RS232 interface • powered from 16 Vac plugpack.

Choose from two kits:

(a) AEM4610 with V21, V23 – **\$250.00!**

(b) AEM4610 with V21, V22, V23 – **\$350.00!**

With falling component costs and other economies, Maestro can now offer it at less cost than the original kit offer!

16 Vac plugpack to suit – **\$14.00**

I wish to order the following kit(s):

AEM4610 MAESTRO SUPERMODEM

___ (a) V21, V23 kit(s) at \$250.00 ea.

___ (b) V21, V22, V23 kit(s) at \$350.00 ea.

Please include ___ 16 Vac plugpack(s) at \$14.00 ea.

AEM4622 MAESTRO BIT STREAM FLYER

___ kit(s) at \$169.00 ea.

Please include ___ 12 Vac plugpack(s) at \$14.00 ea.

APPLE MODEM

___ kit(s) at \$249.00

Add \$8.00 each for delivery

TOTAL: \$ _____

I enclose \$ _____ total, payment by:

Cheque No: _____

Money Order No: _____

(make cheques or money orders payable to "Australian Electronics Monthly")

Bankcard No: _____

Visa: _____

Mastercard: _____

Signature: _____

(unsigned credit card orders cannot be accepted)

Name: _____

Address: _____

Postcode: _____

(Please allow for normal mail and bank clearance delays)

APPLE OWNERS!

So you thought you'd been deserted by the card makers of yesteryear? Here's a "Hayes Micro-Modem Compatible" modem with 1200/1200 bps full duplex (V22) plus 1200/75, 75/1200 (V23) and 300/300 (V21) modes plus auto-dial and auto-answer. No serial card required!

This is a new release from Maestro.

Kit price: **\$249.00!**

This offer is made by Maestro distributors and AEM is acting as a clearing house for orders.

ORDER & DESPATCH CYCLE

The incoming orders are collated, cleared and despatched twice a week to Maestro who then fulfill your order.

FILL IN THE ORDER COUPON NOW!

Send completed orders to:

**AEM/MAESTRO MODEM KITS OFFER
PO Box 507, WAHROONGA 2076 NSW**

OR – you can 'phone us and "pledge your plastic" to order. Call (02)487 1207 ext. 12 and give your name, address and credit card details.

ing in the installation, operation and management of stand-alone and networked microcomputer systems.

For more information regarding these courses, contact: Mr. Roy Hill, School of Computing and Information Systems, Sydney Technical College, Building G, Mary Ann Street, Ultimo 2007, NSW. Telephone (02)217 3828 or (02)217 3498.

AWA wins award for local area network

For the second year running, Amalgamated Wireless (Australia) Ltd has taken out the prestigious Engineering Product Excellence Award.

AWA's winning entry this year is AWANET, an advanced local area network (LAN) system which took five years and some \$2.8 million to develop.

The system is already in use as the communications backbone for the Sydney Police Centre Radio Control System and it will also be incorporated into the air traffic control system to be installed at the RAAF's F/A-18 fighter base at Tindal in the Northern Territory.

AWANET uses an innovative mix of multipair copper cable and optical fibre cable to interconnect computers, peripherals, telephones, intercoms, radios, sensors and displays.

It can be installed in old or new buildings, in ships or in transportable cabins and AWA sees it as the answer to many of the internal communications wiring and interface problems that confront large organisations daily.

A major design breakthrough in the development of AWANET permits a virtually unlimited number of users to "conference", without the need for a "press-to-talk" switch for each speaker or a VOX system, which locks other speakers out.

This feature allows police and emergency service officers to talk together in an emergency,

interjecting with new information as necessary.

The "computerised" World Expo 88

Next year's World Expo 88 will be the most computerised international exposition in history. Computers will make easier the location of everything from lost children to lost umbrellas, provide more effective security and allow visitors easy interactive information seeking.

Expo has installed a communications system with the largest local cable system of its kind in Australia, consisting of 26 km of data transmission cable laid on the site.

The lost children computer, called "Lostots" should make a visit to Expo a lot less traumatic for both parents and children. Lost and distressed children would be taken to one of five centres on the Expo site where they would be able to see and talk to their parents on a colour screen equipped with automatic video camera, microphone and speaker.

Children are not the only things that get lost at large events. It is possible that as many as 20 000 umbrellas, 20 000 wallets, handbags and purses and 30 000 other personal items will be left behind or misplaced during the six months of Expo.

The location of these items will be made quicker and easier with the Expo "Finders" computer. Details of all items lost or found will be recorded by the computer allowing a quick cross-reference check to be made.

The Expo "Info" system will give visitors information about the pavilions and exhibitors, what's on at entertainment venues, food and beverage services and outlets, maps of the site, transport facilities and tourism information. Touch screens will

be employed to provide a friendly, interactive system for information seeking visitors.

Another system, Expo "Accsys" will control quickly and efficiently the entry of season pass holders and accredited personnel at designated entrance gates. The "Accsys" system works with infra-red scanning equipment to read and check that the pass is valid and has not been reported stolen or missing.

All participants at Expo will be linked with Expo's offices through a major communications system driven by an IBM System/38 computer which will be the largest one of its kind in Australia. Other manufacturers and suppliers represented at Expo include the American based Datapoint Corporation, Intermec and Telecom Australia. In addition, negotiations are being held to sell some of the software developed to overseas organisations.

the PEGA card can be configured from outside the system.

An easy to use utility is supplied with the card to allow users to switch between modes.

Flicker-free scrolling is performed in all modes and 256K of RAM is installed on-board.

The card fits straight into a "short slot" and is fully compatible with monochrome, RGB and enhanced RGB monitors. It can be configured to work in a "twin monitor" arrangement, in conjunction with another video card.

The price of the PEGA card is \$495.00 including tax and carries a 14-day money back guarantee. For further information, contact: **Electronic Solutions, PO Box 426 Gladesville, 2111 NSW. (02)427 4422.**

Phone line zap stopper

They may seem like four unrelated words, but they'd take on a new importance if your modem and computer were zapped by a lightning charge conducted via the phone line, according to Max Elliot of ABE Computers in Melbourne.

A Canberra journalist reported recently that his modem and computer had been damaged severely from a substantial "spike" conducted via the Telecom phone line.

Max had the answer for him, a little solid-state "button" that connects across the Telecom line with a wire going to the household ground.

It can be installed in a standard phone line plug or socket.

The device has been tested by a local university and found to do the job, according to Elliot.

It's also good for protecting FAX machines, or anything else that uses a direct connection to the Telecom phone line, he claims.

The device costs just \$29.00. On a clear day, call Max at **ABE Computers, 24 Burwood Hwy, Burwood 3125 Vic. (03)288 2144.**



New EGA card

Electronic Solutions of Sydney has introduced the "PEGA" card, an EGA compatible video card for PCs and compatibles which is claimed to provide important extra facilities at a much lower price than competing products.

Among its extensive facilities, the PEGA card offers complete compatibility with software written for all the other video standards, including Colour Graphics (CGA), Hercules Graphics and Plantronics "ColourPlus" modes.

External switches mean that

FREE!

PUBLIC DOMAIN SOFTWARE

Specify the computer you have

IBM-APPLE-AMIGA

* Macintosh Library Discs

Full of the best of the available Public Domain Software

Send 6x36¢ stamps for postage.

* Add \$10 for MAC 3.5" Disks

MICRO-EDUCATIONAL P/L

8/235 Darby Street
Newcastle 2300
(049) 26 4122

Australia's Largest Computer Mail Order Company

Low cost hard copy for the Commodore 64

Andrew Pierson

Here's how to interface a cheap Telecom-surplus teleprinter to your Commodore 64. A program called "Baudprint" converts the computer's normal output of ASCII characters to Baudot characters required by the teleprinter, and provides unambiguous "codes" for the C64's special characters so printouts miss nothing.

SECONDHAND teleprinters are an attractive proposition for cheap computer printout, but until now the big problem has been that the Baudot character set does not include a number of vital ASCII characters. With the Commodore 64, the problem is compounded by those ubiquitous "quote-mode" graphics characters. Baudprint is a two-part program (machine code and BASIC) which not only solves these problems, but includes all sorts of other "goodies" as well.

Interfacing the Commodore to a teleprinter is a relatively simple exercise. It is the software which performs the "tricks", so let us examine that first.

The program is comprised of two sections – a machine code part which is "the works", and a BASIC part. The machine code part is loaded into the cartridge RAM area of the C64 and this is then accessed by a BASIC driver program which runs either by itself, or attached to a host program. The machine code can also be accessed directly from other machine code programs, or from BASIC via SYS calls. Some of the features of Baudprint include:

- A screen dump with several graphics driven editing features, including starting row selection, line abort, line feed, a "paper out" sequence and a stop code.
- Subroutine printing (the normal printing mode), which allows you to lift text out of a screen "window" of any defined size and then return to your host program in BASIC.
- Direct printing from tape or disk files without having to load the files into the C64.
- A TTY (teletype) test section which includes two test messages and also a continuous alternating signal for margin selector adjustments.
- A merge facility which allows you to add a previously written program to the BASIC section of Baudprint.
- Common teleprinter speeds are supported, including 45.45, 50 and 75 baud. The speed can also be changed in small increments if you don't want to fiddle with the TTY governor.

The principles of Baudprint

To overcome the problem of missing characters in the Baudot character set, Baudprint substitutes special two letter groups in lieu of unprintable ASCII characters, "quote mode" symbols or graphics. The derivation of the groups have been carefully thought out so that they are unambiguous and easily remembered. The groups are made easily distinguishable by

FIGURE 1. Baudprint's two-letter substitutes for unprintable ASCII characters and "quote mode" symbols.

ASCII	BAUDPRINT	DERIVATION
a	..AT..	AT
[..OB..	Open square Brackets
]	..CB..	Close square Brackets
↑	..UA..	Up Arrow
←	..LA..	Left Arrow
!	..EM..	Exclamation Mark
"	..QQ..	Quote Quote
#	..NR..	Number
&	..AN..	AND
*	..AS..	Asterisk
:	..SC..	Semi Colon
<	..LT..	Less Than
>	..GT..	Greater Than
C-64 'QUOTE-MODE'		
CURSOR-LEFT	..CL..	Cursor Left
CURSOR-RIGHT	..CR..	Cursor Right
CURSOR-UP	..CU..	Cursor Up
CURSOR-DOWN	..CD..	Cursor Down
CLEAR-HOME	..CH..	Clear Home
HOME-CURSOR	..HC..	Home Cursor
REVERSE-ON	..RN..	Reverse ON
REVERSE-OFF	..RF..	Reverse OFF
C-64 GRAPHICS		
␣	..PI..	PI
All remaining graphics characters are identified by their Commodore Screen Display Code; eg		
	..SDC-092..	
	..SOC-123..	

printing two periods either side; e.g: an asterisk is printed as ..AS.. and a cursor-down "quote mode" character appears as ..CD.. and so on. The two periods should never appear in normal programs, so you can't mistake the groups. When consecutive groups are printed, there will be four periods between them. This makes counting of a number of cursor movement characters very easy since the groups are separated by both distance and profile.

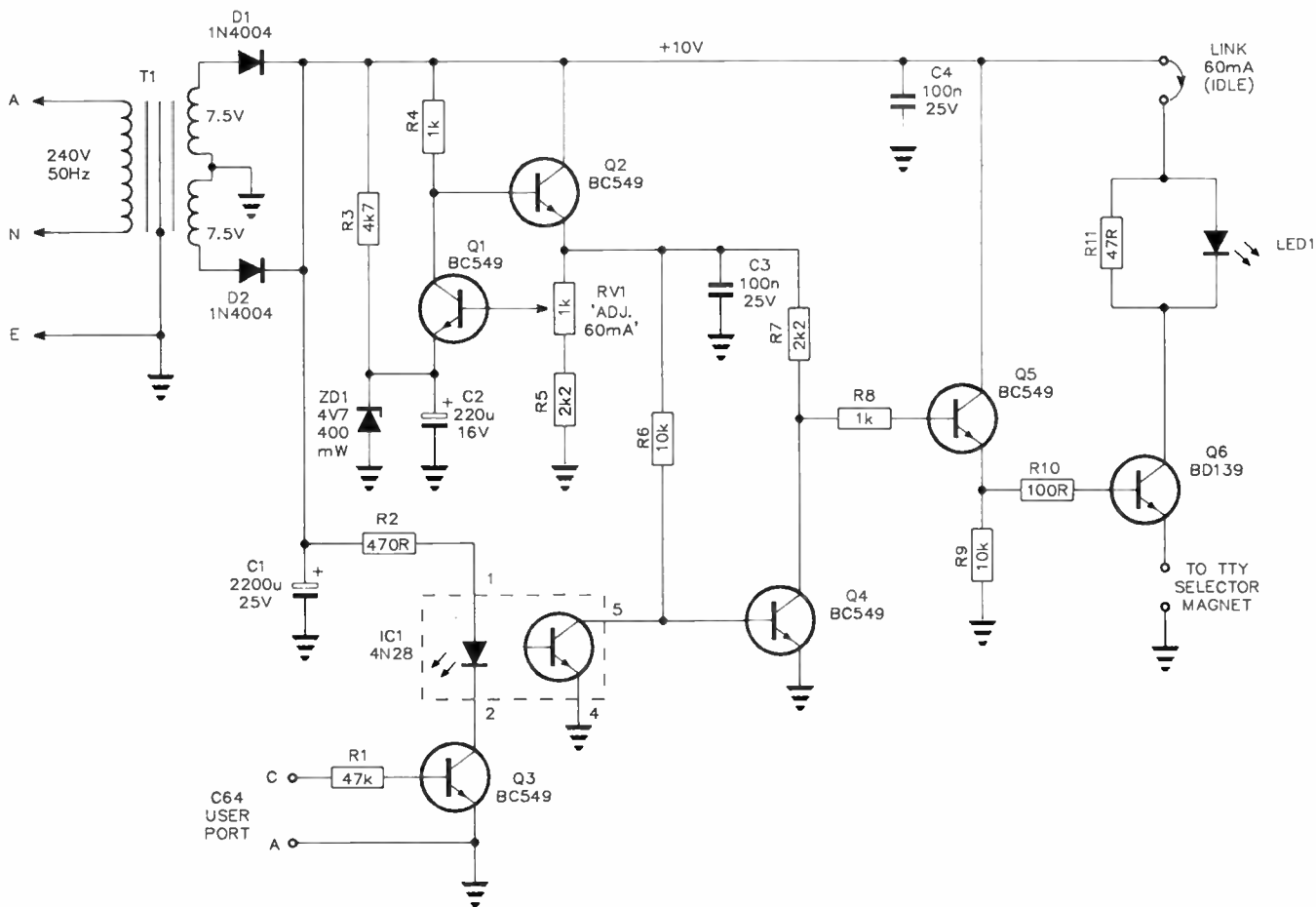

CIRCUIT DESCRIPTION

The circuit is powered from the 240 V mains via a 15 V centre tapped transformer T1. The transformer drives a full wave rectifier which delivers about 10 V and from which the regulator, comprised of Q1 and Q2, develops a variable potential of around 6 V. The Baudot code at TTL level appears on pin C (PB0) of the C64's user port and when this line goes high, transistor Q3 will turn on allowing current to flow through the LED part of the opto-isolator, IC1. The transistor part of the opto-isolator will turn on, depriving transistor Q4 of base current, thus turning it off. Since Q4 is used to control the output voltage of the regulator, the Baudot code will appear at its collector. The lower point of the voltage swing at the collector of Q4 is 0 V and the upper point is made variable by changing the regulator output voltage. The selector magnet coil of the teleprinter is then driven by the "super-alpha" darlington pair, Q5 and Q6.

The disc ceramic rail bypass capacitors C3 and C4 and the base feed resistors associated with the emitter followers are measures against parasitic oscillations which can sometimes plague high gain common collector stages. Excess voltage available for the collector of Q6 is used to power the indicator LED; 20 mA passes through the LED whilst the remaining 40 mA passes through the parallel 47 ohm resistor R11. The LED will illuminate if idle current is passing and will blink when data is being transmitted.

Transistor Q6 does not require any additional heatsinking, provided air can pass freely around it. During the "idle" or non-printing periods, a current of 60 mA must be maintained through the teleprinter's selector magnet coil. The value of this current is set by removing the link at the left of the LED and measuring the current between the two ends of the link. The current is adjusted to 60 mA during idle by adjusting the 1k preset RV1.

Graphics

Graphics characters which are not in Baudprint's repertoire are identified by their Commodore screen display code, so you can easily look them up. This means that it is not necessary to hand annotate anything on the printout. To further facilitate reading, Baudprint will not break up any substitute group. If there is insufficient space at the end of a line, the group will be printed at the beginning of the next line. When this happens, the end of the previous line will be marked by the Baudot "stop" or EOT symbol. This symbol is very distinctive and is not used in computing.

The hardware

In order to use a teletype machine with your computer, you will need some additional hardware to convert the TTL level signals of the computer to the current loop interface of the teleprinter. The design presented here is an efficient low voltage unit which is ideal for use with the Siemens 100 type of teleprinter currently quite commonly available on the surplus market.

Construction

Construction of the interface is quite straightforward if you use the pc board designed for the project. Check the board before fitting the components, making sure that all holes are drilled correctly and that there are no shorts or fractured tracks. ▷

AEM4509 PARTS LIST

Resistors all 1/4 watt 5%

R1	47k
R2	470R
R3	4k7
R4	1k
R5	2k2
R6	10k
R7	2k2
R8	1k
R9	10k
R10	100R
R11	47R

RV1 .. 1k vertical 5 mm trimpot

Capacitors

C1	1000u/25 V RB electro
C2	220u/16 V RB electro
C3-C4	100n ceramic

Semiconductors

D1-D3	1N4004 diode
ZD1	4V7/400 mW zener
Q1-Q5	BC549
Q6	BD139 transistor
IC1	4N28 opto-isolator
LED1	TLR107 red LED

Miscellaneous

T1 M-2155 transformer

AEM4509 pc board; mains lead and plug; mains cord clamp grommet; 2-way mains connector block; panel mount fuseholder; 500 mA fuse; two small rubber grommets; C64 user port connector and backshell; one metre hookup wire; two metres single core shielded cable; nine pc board pins; plastic or aluminium case to suit; nuts, bolts, spacers, washers, lockwashers and earth lug.

Estimated cost: \$50-\$55

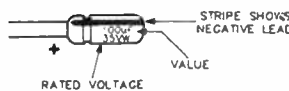
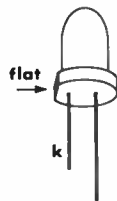
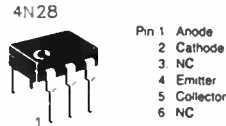

COMPONENT PINOUTS

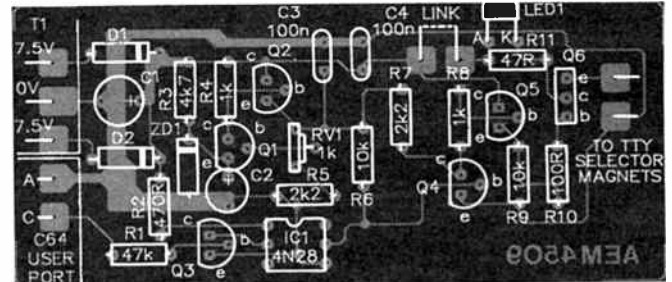
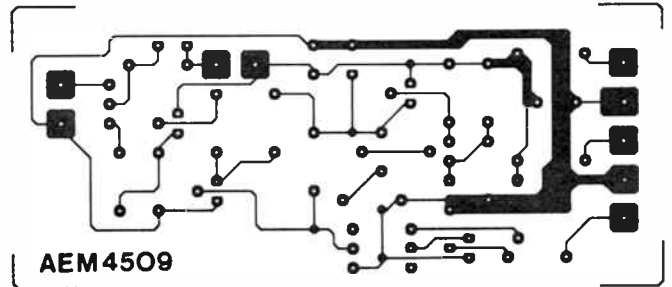

Component overlay, showing placement of all the components. Note that all the off-board connections are marked, too. The LED may be mounted on the lid of the case enclosing the unit.

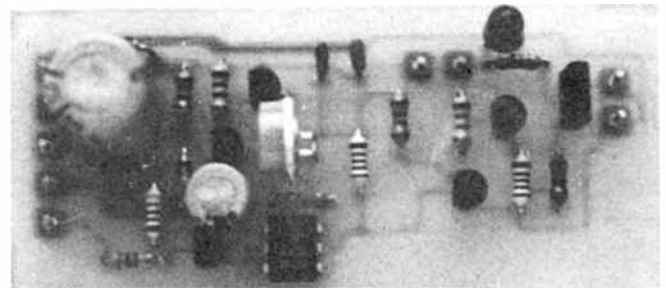

This photograph shows the completed interface pc board ready for installation in a suitable case. In our prototype, we put the LED on the board, but there is no reason why it could not be mounted on the case using a suitable bezel.

Commence by fitting all the passive components such as resistors and capacitors and take care with the polarisation of the two electrolytic caps C1 and C2. Use pc board pins for the connections to the transformer secondary, the C64 user port connections and the selector magnet connections. It is also a good idea to use pc board pins in the two holes associated with the link as the link can be re-fitted after adjusting the magnet current without having to remove the board from its case.

Construction can now proceed with the semiconductors. There are two silicon diodes, one zener diode, five BC549 transistors, one BD139 transistor and the 4N28 opto-isolator. Take care that all these components are inserted with the correct polarisation before soldering them in place.

Once you have completed the pc board, you can turn your attention to the case. We used a diecast aluminium case for our prototype, but there is no reason why a plastic case of suitable dimensions could not be used. Drill the holes for mounting the transformer and pc board after trial fitting them in place and also drill holes in the end of the case for the panel mount fuseholder and mains cord grommet. The wir-

LEVEL

We expect that constructors of an **INTERMEDIATE** level, between beginners and experienced persons, should be able to successfully complete this project.

CIRCUIT VOLTAGES

To assist constructors, we have provided an analysis of the voltages that can be expected at the electrodes of each of the six transistors in the project. Because of variations in components, there might be some slight differences in the readings obtained in your project. Slight differences are nothing to worry about, but if the readings you obtain are markedly different, the information presented here should enable you to narrow down the suspect area.

The measurements were made with the 240 V mains input connected and turned on, the teleprinter machine connected and turned on, the loop current adjusted for 60 mA and idle (no signal) conditions. A 100 kV meter was used to make the measurements and all are with respect to ground.

Transistor	emitter	base	collector
Q1	4.5 V	5.2 V	6.7 V
Q2	6.0 V	6.7 V	9.9 V
Q3	0.0 V	0.65 V	9.9 V
Q4	0.0 V	0.035 V	6.0 V
Q5	5.35 V	6.0 V	9.9 V
Q6	4.6 V	5.3 V	7.8 V

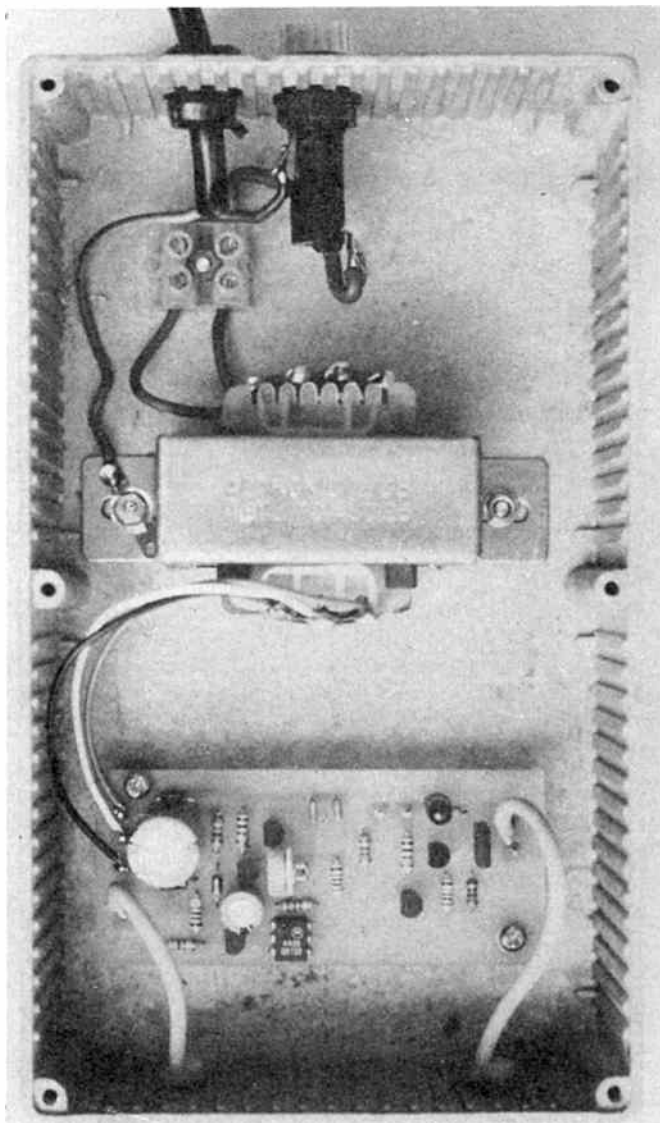

An internal view of the completed interface. Notice the use of pc board pins for terminating the flying leads. For clarity, we have not insulated the mains wiring in the prototype. For safety, you should use insulating tape, "spaghetti" or heatshrink tubing to cover all exposed mains wiring and the connections to the fuseholder.

ing diagram shows what connections are required, but take extra care with the mains wiring and cover any exposed mains connections with insulating tape or "spaghetti" after they are made.

If you are using the M-2155 transformer as specified, you should make the centre tap connection to the pc board from the 7.5 V tap. The 0 V and 15 V taps are then used for the other two connections. This will result in a 7.5-0-7.5 V configuration which is what's required.

The price estimate quoted in the parts list covers the purchasing of all components and is dependent principally on the cost of the "hardware" items. You may elect to use a plastic utility box for a saving of perhaps \$10 in cost. You may use a transformer you have on hand, provided it has the required secondary voltage rating. Only about 100 mA is drawn, so a low-current transformer only is required. It is strongly suggested you use a proper edge connector for the C64's user port.

This section of the internal view of the interface clearly shows the layout of the mains wiring. Make sure you use a proper cord-grip grommet for the mains cable, not a simple rubber type. When you drill the hole for the grommet, make sure it will be a snug fit and the cable is held tight. Note that the required hole has two flat sides to prevent twisting of the grommet. Drill the hole to the diameter of the flat sides, then file it to shape.

The neutral (blue) wire is connected to one side of the transformer primary via the terminal block. The active (brown) lead is terminated directly to one side of the fuseholder. The other side of the fuseholder is then connected to the other side of the transformer primary via the terminal block.

The earth (green & yellow) wire is cut somewhat longer than the active and neutral wires and is terminated to a solder lug firmly clamped to the chassis under one of the transformer mounting bolts. You should use a shakeproof washer under the nut to ensure a good connection and to prevent the nut from coming loose.

With all mains wiring it is important to insulate any exposed parts with tape or "spaghetti". For the sake of clarity, we have not done this in the unit pictured.

If you wish, a degree of additional electrical isolation between the C64 and the interface/teletypewriter may be obtained by disconnecting the end of R2 that connects to C1, replacing R2 with a 220R resistor and connecting the 'free' end to pin 2 of the user port.

About the teleprinters

Currently, the most readily available teleprinter in Australia is the Siemens 100 and large numbers have been released onto the surplus market by Telecom. These units are well engineered and providing the motor brushes and bearing are in good condition, they will probably give many more years of reliable service. Motive power is provided by a high speed governor controlled 240 Vac motor, running at 5000 rpm and consuming only 35 watts. You should be aware that there are some 100 Vac versions around and whilst these will be entirely adequate for our purposes, you will need a suitably rated stepdown transformer to use the machine on the 240 V mains in Australia.

Several variants of the Siemens 100 were made, with the 50 baud keyboard/printer model being the most common. Some models have tape readers and punches, but these are not of much use in our application and only increase the bulk of the machine. The "prize catch" is the 75 baud printer only. These were used for the transmission of telegrams to post offices and are a good choice because of their higher speed and lower bulk as they have no keyboard. If you have a choice when buying your teleprinter, choose one that looks clean inside as this probably means it has been recently serviced.

Teleprinter consumables

Paper for the Siemens 100 is readily available and if you have no cheaper source, it can be obtained from many office stationery suppliers. The ribbons are a standard item (DIN 2103) and should be stocked by most typewriter specialists. Two types of lamps were used for interior illumination; ▶

This project actually arose out of the efforts of a number of contributors working independently. While Andrew Pierson wrote the Baudprint software published here, and provided a circuit for an interface, Frank Rees, a keen computer/electronics enthusiast from Victoria, and Roger Graham, a teacher from NSW, contributed ideas and practical circuits which we have drawn upon. (Roger Graham has contributed simple Baudot output software for the Apple II, which we hope to publish in the future given sufficient interest). The contribution of Ian Jellings from South Australia, published in our Commodore Codex Column of February 1986 is mentioned in the text. The interface circuitry given here is an amalgam of the ideas contributed by the above-mentioned authors.

either 6 V festoon bulbs or a single 6 V, 18 W globe having a single contact bayonet cap. Both of these can be obtained from Lucas Industries Australia Pty Ltd, or from auto electrical dealers.

Wiring

The physical arrangements of feeding 240 Vac to the teleprinter will have to be left up to you as there are a number of different configurations depending on the type of machine used. The Siemens 100 was meant to be used with a control unit and connections to the machine were made by a special multi-pin connector. Most hobbyists elect to remove the multi-pin socket on the teleprinter and wire the mains directly to the machine. If this method is used, it would be wise to install a 500 mA slow-blow fuse in the active lead.

If you are uncertain about the teleprinter wiring, a good source of advice may be found in amateur radio circles. Many radio amateurs are familiar with teleprinter machines and some guidance on re-wiring them is usually forthcoming. All wiring associated with mains voltages should be secure, well insulated and installed well away from rotating shafts etc. The active and neutral wires have been found to be transposed on some surplus machines, so take the cover off and trace the wires through to the power socket with an ohmmeter.

The current loop wiring from the interface to the teleprinter must be connected directly to the selector magnet and not connected to anything else. It is strongly suggested that a diode is placed across the selector magnet coil to prevent voltage spikes from damaging Q6 in the interface. Make sure this is connected in the right polarity, with the cathode to the emitter side of Q6 and the anode to the ground side. If you do get it the wrong way around, it is unlikely that damage will occur due to the current limiting characteristics of the interface. The diode used should be a 1N4002 or 1N4004 type which are rated sufficiently to withstand the voltage spikes.

Do's and don't's

Idle current must be maintained whilst the teleprinter motor is running. If you switch off the C64 or the interface without first turning off the teleprinter, it will go into paroxysms, rapidly alternating between the LTRS and FIGS modes. The rule is to switch on the C64 and interface first and don't turn off the C64 or interface before the machinery in the teleprinter has come completely to rest. Also, you should always leave the type basket parked at the left of the carriage as this is much kinder to the return spring. When operated manually, Baudprint will always do this for you.

The usual precautions regarding the interface of the C64 should be observed. Never plug anything into the C64's user port or disconnect anything from the port whilst the computer is turned on as it is very easy to damage the VIA chip in the computer. Always make sure the computer is off before plugging in the interface and always use a user port plug which has a key fitted. I don't know how many C64s I have seen damaged when the user port plug is inserted the wrong way up or slightly out of alignment, but it's a lot!

Compatibility and other teleprinters

Whilst the interface described here was designed for use with the Siemens 100 type machine, there is no reason why it can not be used with other models instead. Teleprinter machines invariably use a current loop interface and whilst this is not always 60 mA as in the Siemens machine, the interface is adjustable and should work without modification. Machines

such as the Model 15 teleprinter can still be obtained, but are getting rarer.

For those wishing to use other types of teleprinter machines, the comments accompanying the "Commodore Codex" article by Ian Jellings in the February 1986 issue will be useful. It should be noted that other machines may require the extension of the STOP bit time from 1½ to two character bits. Baudprint and Ian Jellings' program are hardware compatible, meaning that if you have already constructed an interface for the latter, Baudprint will run by simply loading the software. Conversely, Jellings' program should run with the Baudprint interface.

Where to find teleprinters

There are a number of ways to go about finding sources of surplus teleprinters. You could try scanning the classified in amateur radio magazines or government auction ads in the local press. Another alternative would be to get in touch with an organisation such as ANARTS who are a national organisation of radio amateurs whose interests lie in radio teletype. ANARTS should not only be able to suggest possible sources of supply, but may be able to assist you with wiring modifications and spare parts. The address of ANARTS is PO Box 860, Crows Nest 2065, NSW. If writing, please include a self-addressed, stamped envelope for your reply as this is an amateur organisation, funded entirely by its members.

Another possible source of used machines is your local salvage or scrap metal dealer. Readers in NSW could try a phone call to Cavions Scrap Metal in Bulli on (047)846 838. Readers in other states could perhaps consult their telephone directory and call a few likely looking dealers.

Operations

All of Baudprint's operations (with the exception of paper movement and merge) are essentially screen dumps, in that some of the screen memory is used for the temporary storage of the text to be printed.

The BASIC section PEEKs the appropriate characters (in screen display code) from the C64's screen memory and transfers these to the machine code section. The mathematics associated with screen memory housekeeping are handled by BASIC and the printer housekeeping is handled by the machine code routines. The screen display code of the current character to be printed is POKEd into memory location 49209 and the machine code routine is then invoked by a SYS49210 call.

Due to the overall complexity of Baudprint, there is insufficient room here to detail all of the BASIC operations, let alone the machine code which extends from memory location 49200 to 51583. With a program of that size, it would be impractical to provide a full assembly listing and therefore, it is presented as a hex dump. A machine code monitor such as the Octabyte monitor program published in our November '87 issue will be needed to enter and save the program.

The BASIC listing has been produced with a conventional dot-matrix printer, with the translations of the "quote mode" characters printed out in full. This listing could just as easily been produced with Baudprint, but we didn't want to throw you in at the deep end just yet! Take note that the backslash before the \$ symbol in line 63160 should be entered on the C64 as a British Pound symbol.

Machine code operation

Since the machine code section is common to all of Baudprint's operations with the exception of merge, we will proceed with a general description of what goes on inside it. The

screen display code (SDC) of the current character is POKEd into memory location 49209 and the printing sequence is started. The first step is to load the SDC value into the accumulator where it is compared with the SDC values of all directly printable characters. When a match is found, operations jump to the character assembly area. If no identification is made by the time the end of the table is reached, the SDC of the character will be printed.

The next section of the program generates the correct Baudot code at the selected speed for all printable Baudot characters, including space, carriage return, line feed, "shift to letters" and "shift to figures". Instead of the conventional method of loading a suitable value into a register and rotating the bits out at the correct intervals, the code is generated using a system of three subroutines as follows:

1. Set output bit low, then a time delay equal to one character bit (LOW).
2. Set output bit high, then a time delay equal to one character bit (HIGH).
3. Set output bit high, then a time delay equal to one stop bit (STOP).

Each Baudot character is assembled by calling these routines in the correct order until the complete code for that character has been transmitted. The routines for each character therefore consist of a number of JSR (Jump to Subroutine) instructions to the appropriate bit routines. Every character always starts with a LOW bit and finishes with a STOP bit. As soon as the first bit of a character is received, the teleprinter starts its mechanical decode cycle. Depending upon the polarity of each following bit, the selected character is then printed.

Character assembly area

This area of the program supervises the printing of each character or group. In the case of a single printable Baudot character, the printer shift status is evaluated to see whether it is in the LTRS or FIGS mode. If the mode is incorrect for the character to be printed, the appropriate shift command is sent first, followed by the code for the character. The printer line character counter (LCC) is then incremented by one and the resulting value is compared with the current line length (normally 69) to find out if the printer is at the end of its line. If it isn't, an RTS (Return from Subroutine) instruction sends operation back to the BASIC program to get the next character. If the printer line is full, carriage and line-feed characters are sent, the LCC is reset to zero and control is then returned to the BASIC program.

When a substitute group is to be printed, the remaining length of the printer line must be checked to see if there is enough room. If enough room exists, the group is printed and the LCC is incremented by six. If insufficient room is left on the line, the STOP character is printed, carriage return and line feed characters are sent, the LCC is reset to zero and the group is then printed at the beginning of the next line.

Print SDC routine

If the character PEEKed from the screen memory is not identified, the "print SDC" routine is put into action. Since the screen display code (SDC) is already in the accumulator, you may think that printing it would be easy. Unfortunately, it isn't so simple in machine code, as the SDC value must first be split into its three separate digits.

The routine works like a mechanical three-digit counter, with each digit represented by a memory location. The counter starts off at 000 and is then incremented up, one digit

at a time. After each increment, the counter value is compared with the SDC value until they are equal, at which time the counter stops. The three digits can then be read from their respective locations and used in a routine which prints ..SDC-123.. or whatever the case may be. Before the group is printed, a line length check needs to be carried out as before, but this time for 11 characters.

Carriage return delay

There is a delay subroutine associated with the carriage return to allow for slow machines. The value of the delay can be specified in the setup area of the BASIC program. Tests with a Siemens-100 running at full machine speed indicated that no additional delay was required, but other machines may be different. Just for safety, a delay of 200 milliseconds has been installed as a default setting.

BASIC operations

As described, Baudprint is intended to be used with a cassette data recorder. If you're using disk, the relevant statements in the BASIC listing and in the preparation of the files will need to be changed. A list of the required changes appears at the end of this section. Comments in the following description will refer to cassette tape operation.

Using the BASIC LOAD command, load BAUDPRINT-MC (the machine code) first. After entering NEW to reset the BASIC system, load BAUDPRINT (the BASIC part). You will now need to LIST the setup area starting at line 63420. Lines 63480 to 63500 are used to install the speed of the Baudot output code and line 63620 needs to be set for the type of monitor in use. As printed, the program is set for 75 baud and a monochrome monitor. Line 63480 sets the Baudot character bit time and the values for both 50 and 75 baud are indicated. Line 63500 sets the stop bit time which is set to 1½ character bits. Line 63490 is an incremental adjustment for fine speed variations. For 45.45 baud, change the values POKEd in lines 63480, 63490 and 63500 to 17, 233 and 26 respectively. Speeds other than those mentioned may be catered for by simply scaling the values given.

Set the type of monitor you are using and leave the setup table alone for the present. We will come back to the other options a little later. If you RUN the program at this stage, you will enter the master menu. Baudprint carries out a check of machine code integrity so if there is anything amiss, the message "MC PROGRAM CORRUPTED OR NOT PRESENT" will appear. If you have entered and saved the program correctly, you should never see this message.

The master menu

From this menu you can select three paper movement modes, enter "file and list" printing, TTY test and merge. The screen dump is entered directly and the printing subroutine is called from the host BASIC program, once Baudprint is attached to it.

The first step after initially firing up your teleprinter is to run the TTY test facility. Select continuous RY and adjust your margin selector so that it is midway between the points where the teleprinter starts to print errors. The reason why the letters R and Y are used for testing is that in the Baudot code, they contain the maximum number of signal alternations. If there are any errors in the decoding, they will usually appear when printing these characters.

If after running the test you still cannot obtain error free printing, the teleprinter speed should be checked. To find out if this is the problem, try changing the speed adjustment in ▶

line 63490. For a 75 baud machine, the acceptable range is about plus or minus 10 so try altering the value by increments of 5 in each direction.

Paper movement

You can now try out the paper movement modes. The one which will be most useful is the "paper out" routine which advances the paper sufficiently for the printout to be torn off. The default value is set at 20 line feeds, but you can change the value to suit yourself by editing line 63530. File and List printing and Merge require a specially prepared file, so don't try them yet.

Screen dump

With this facility, the contents of the screen memory up to the end of row 22 may be dumped to the printer. The remaining two rows are required for communication with Baudprint. To start the screen dump, move the cursor to row 23 and enter RUN60000. After the prompt message, enter the starting row number and the dump will commence with the nominated row. The dump will finish at the end of row 22, but you can nominate the end point by using the editing options.

The graphics driven editing options are implemented by simply overtyping the text with certain graphics characters. The editing commands are line abort, line feed, paper out and stop. Line abort appears as a vertical bar (a shifted negative sign), which causes the program to stop reading the current screen row and continue with the next. Line feed appears as a horizontal bar (a shifted asterisk) and causes single line feeds to be added to the printout. Paper out appears as a triangle (a shifted Pound) and implements the "paper out" routine. Stop will be the most used used com-

mand and appears as a diamond (a shifted Z), which causes the screen dump to halt. The screen is then cleared and the master menu reappears.

If no stop code is used, the dump will finish at the end of row 22 and will be spaced one line away from subsequent printout. If you want to remove this blank line, change the last number in line 60100 from 60260 to 60510. On the assumption that you may need to edit, use of the stop code does not add a line feed.

Once the screen dump is running, you will see that Baudprint doesn't waste time printing spaces at the end of a line. By means of the routine in lines 60150 - 60180, each screen line is scanned backwards from the right hand side until characters other than a space are encountered. This means that the length of each line is known before it is printed. As the text is transferred to paper, it is erased from the screen with the exception of any text that has been edited out by use of the line abort and stop codes.

Printing subroutine

In this mode, Baudprint runs as a subroutine and is used to print information from within a host program. If you are writing the program from scratch, load Baudprint first and then start writing your program. When you save your program, the BASIC part of Baudprint will go with it. If your program is already written, you will need to merge it with Baudprint. We will describe how to accomplish this after we have covered some other necessary information.

In order for Baudprint and the host program to happily co-exist, you must not use line numbers greater than 59879. Also, don't name any strings or variables with two letters where the first letter is Z.

BASIC LISTING

PLEASE NOTE

WHEN SUBSTITUTE GROUPS ARE PRINTED FOR COMMODORE GRAPHICS AND REVERSED CHARACTERS, THE FOLLOWING CONVENTIONS ARE OBSERVED

- 1 AN UNDERSCORE IS PRINTED ON EITHER SIDE OF THE GROUP. E.G. _ (CLEAR-HOME)
- 2 IF INSUFFICIENT SPACE FOR A SUBSTITUTE GROUP IS AVAILABLE AT THE END OF A LINE, IT WILL BE PRINTED AT THE BEGINNING OF THE NEXT LINE. THE END OF THE PREVIOUS LINE WILL THEN BE MARKED BY A BACKSLASH (\)
- 3 FOR COMMODORE GRAPHICS AND REVERSED CHARACTERS WHICH ARE NOT QUOTE-MODE SYMBOLS, THE CORRESPONDING SCREEN DISPLAY CODE WILL BE PRINTED. E.G. _ (SDC 90) _ OF _ (SDC 129) _

```

59880 REM
59890 REM *****
59900 REM ***** BAUDPRINT *****
59910 REM *****
59920 REM
59930 REM BY ANDREW PIERSON, 1985/1987
59940 REM ENQUIRIES PHONE (08) 258 0510
59950 REM PLEASE COMMUNICATE !!!
59960 REM
59970 REM NO 1 - SCREEN DUMP PROGRAM
59980 REM
59990 GOT060500
60000 GOSUB63450 SVS51530
60010 PRINT _ (CRSP-UP) _ "SPC(11)" ENTER ROW NUMBER (00 TO 22) " FORZT=1T01500 NEXT
60020 PRINT _ (CRSP-UP) _ "SPC(11)" ENTER BOTH DIGITS " FORZT=1T01000 NEXT
60030 GETZ# IFZ#="" THEN60010
60040 GETZ# IFZ#="" THEN60040
60050 Z#=(10*(ASC(Z#1)-48)+ASC(Z#2)-48) IFZ#="" OR Z#>22 THEN60010
60060 PRINT _ (CRSP-UP) _
60070 PRINT _ (CRSP-UP) _ " DUMP FROM ROW"ZR" PROGRAM RUNNING" ZV=1022+(40+ZR)
60080 POKEZV,32 ZV=ZV+1 ZL=ZL+1 IFZL=1 THEN60150
60090 IFZV>ZE THEN60200
60100 IFZV=94 THEN60260
60110 ZZ=PEEK(ZV) POKE49209,ZZ IFZZ=90 THEN60260
60120 IFZZ=93 THEN60220
60130 IFZZ=105 THEN60230
60140 SVS49210 GOT060080
60150 ZE=ZV+39
60160 ZD=PEEK(ZE) IFZD<>32 THEN60090
60170 ZE=ZE-1 IFZE<ZV THEN60190
60180 GOT060160
60190 ZV=ZV+39 ZL=0 SVS50643 GOT060080
60200 ZV=ZV+41-ZL ZL=1 IF PEEK(49205)=0 THEN60150
60210 SVS50643 GOT060190
60220 ZV=ZV+40-ZL ZL=0 SVS50643 GOT060080
60230 ZI=0
60240 SVS50621 ZI=ZI+1 IFZIKZF THEN60240
60250 GOT060080
60260 SVS50643 GOT060510
60470 REM
60480 REM MASTER CONTROL MENU
60490 REM
60500 PRINT _ (CLEAR-HOME) _ _ (CRSP-DOWN) _ _ (CRSP-DOWN) _ _ (CRSP-DOWN) _ _ (CRSP-DOWN) _ _
_ (CRSP-DOWN) _ _ " GOSUB63450
60510 PRINT _ (CLEAR-HOME) _ _ (CRSP-DOWN) _ _ (CRSP-DOWN) _ _ (CRSP-DOWN) _ _
_ (CRSP-DOWN) _ _
_ (RVS-OFF) _ _
60520 PRINT _ (RVS-ON) _ _ BAUDPRINT - MASTER MENU _ (RVS-OFF) _ _
60530 PRINT _ (RVS-ON) _ _ _ (RVS-OFF) _ _
60540 PRINT _ (CRSP-DOWN) _ _ (CRSP-DOWN) _ _ (CRSP-DOWN) _ _ KEY F1 "ZF" LINE FEEDS (PA
PER OUT) _ _
60550 PRINT _ (CRSP-DOWN) _ _ FD CONTINUOUS PAPER ADVANCE"
60560 PRINT _ (CRSP-DOWN) _ _ FR CANCELS PAPER ADVANCE"
60570 PRINT _ (CRSP-DOWN) _ _ FT SINGLE LINE FEEDS
60580 PRINT _ (CRSP-DOWN) _ _ F FILE AND LIST PRINTING"
60590 PRINT _ (CRSP-DOWN) _ _ T TELETYPE TEST FACILITY"
60600 PRINT _ (CRSP-DOWN) _ _ M MERGE FACILITY"
60610 PRINT _ (CRSP-DOWN) _ _ X EXIT TO BASIC" POKE198,0
60620 GETZ# IFZC#CHR#135 THEN60700
60630 IFZC#CHR#134 THEN60750
60640 IFZC#CHR#136 THEN60760
60650 IFZC#F THEN62000
60660 IFZC#M THEN63000
60670 IFZC#H THEN63900
60680 IFZC#X THEN63700
60690 GOT060620
60700 ZI=0
60710 SVS50621 ZI=ZI+1 IFZIKZF THEN60710
60720 GOT060620
60730 SVS50621 GETZ# IFZS#="" THEN 60730
60740 IFZS#CHR#135 THEN60730
60750 GOT060620
60760 SVS50621 GOT060620
60970 REM
60980 REM NO 2 - PRINTING SUBROUTINE
60990 REM
61000 Z0=1 GOSUB63450
61010 ZV=1022+(40+ZR)*ZC ZE=ZV+ZV
61020 ZV=ZV+1 ZL=ZL+1 IFZV=ZETHEN61090
61030 ZZ=PEEK(ZV) POKE49209,ZZ IFZZ=90 THEN61090
61040 IFZZ=105 THEN61060
61050 SVS49210 GOT061020
61060 ZI=0
61070 SVS50621 ZI=ZI+1 IFZIKZF THEN61070
61080 GOT061020
61090 IF PEEK(49205)=0 THEN61110
61100 SVS50647
61110 ZL=0 RETURN
61970 REM
61980 REM NO 3 - FILE AND LIST PRINTING
61990 REM
62000 PRINT _ (CLEAR-HOME) _ _ (CRSP-DOWN) _ _ (CRSP-DOWN) _ _ (CRSP-DOWN) _ _ (CRSP-DOWN) _ _
_ (CRSP-DOWN) _ _ OPENL,0, "FILEPRINT"
62010 PRINT _ (CLEAR-HOME) _ _ "SPC(255)SPC(191)" *** PRINTING IN PROGRESS *** _ _
_ (HOME-CRSP) _ _
62020 GETL,ZF# PRINTZF#, IF ST THEN62130
62030 IFZF#CHR#13 THEN62800
62040 ZE=1147 ZV=1063
62050 ZD=PEEK(ZE) IFZD<>32 THEN62090
62060 ZE=ZE-1 IFZE<1064 THEN62010
62070 GOT062050
62080 SVS50643 GOT062010
62090 PRINTSPC(255)SPC(255)SPC(148)ZE-1063" _ (HOME-CRSP) _ _
62100 ZV=ZV+1 IFZV=ZETHEN62050
62110 ZZ=PEEK(ZV) POKE49209,ZZ
62120 SVS49210 GOT062100
62130 SVS50643 CLOSE1 GOT060510
62970 REM
62980 REM NO 4 - TTY TEST FACILITY
62990 REM
63000 PRINT _ (CLEAR-HOME) _ _ (CRSP-DOWN) _ _ (CRSP-DOWN) _ _ (CRSP-DOWN) _ _ (CRSP-DOWN) _ _
_ (CRSP-DOWN) _ _ " GOSUB63450
63010 PRINT _ (CLEAR-HOME) _ _ (CRSP-DOWN) _ _ (CRSP-DOWN) _ _ (CRSP-DOWN) _ _
_ (CRSP-DOWN) _ _
_ (RVS-ON) _ _
63020 PRINT _ (RVS-ON) _ _ _ (RVS-OFF) _ _ TTY TEST _ (RVS-OFF) _ _
63030 PRINT _ (RVS-ON) _ _ _ (RVS-OFF) _ _
63040 PRINT _ (CRSP-DOWN) _ _ (CRSP-DOWN) _ _ (CRSP-DOWN) _ _ (CRSP-DOWN) _ _ (CRSP-DOWN) _ _ K

```

As explained previously, the screen memory is used to temporarily hold the text to be printed. If the host program does not need to retain information on the screen, then a typical printing sequence will look like this:

```
PRINT"[CLEAR-HOME]THE PHASE
ANGLE IS"AB"DEGREES"CHR$(122):GOSUB61000
```

When these statements are executed, the screen will clear and the printed message will appear on row 0. After the printer has done its thing, operation will return to the host program. The CHR\$(122) tells Baudprint to stop transferring text from the screen memory. If you don't use it, the transfer will continue until the number of characters specified in line 63520 have been dumped.

If you need the screen all of the time, simply choose a small "window" where the text to be printed will appear. Print the text to be output by using BASIC cursor movements or by calling the Kernel for the PLOT routine. You then tell Baudprint where to get the text from by setting the variables ZR (row number) and ZC (column number). If you re-define ZR in line 63520 to the window length, you won't have to worry about sending a stop code character.

Whilst in the subroutine mode, Baudprint suppresses all changes in border, background and cursor colour, since these may be controlled by the host program. If you wish to retain Baudprint's colours, delete the colour quit flag (zq 1) from line 61000. The printing subroutine responds to all the screen dump graphics control characters except the line abort function, which is not applicable here. This printing facility only amounts to 12 lines in the BASIC listing, but it certainly opens up a lot of possibilities!

File and list printing

This facility is accessed from the master menu and enables a file, or a list stored as a file, to be printed directly from a tape. The file must be stored with the name FILEPRINT. Baudprint accesses this file and transfers the contents to paper without any further intervention, except to press the "play" button on the data cassette.

In order to print a LISTing, the list must first be stored as a file. With the appropriate file in the C64 and a blank tape in the cassette recorder, enter the following:

```
OPEN1,1,2,"FILEPRINT":CMD1:LIST
```

When the tape stops, enter PRINT#1:CLOSE1 before pressing STOP on the cassette recorder. When the tape stops a second time, the job is done. What the above achieves is to create a file under the name FILEPRINT with the listing in ASCII format, just as it would appear on the screen. The CMD1 statement has caused this by switching the listing from the screen to the tape recorder. There is also an "end of file" marker which is detected by a change in the Status variable and this causes the file printing to halt.

In use, characters from the retrieved file are printed on to the screen, one line at a time. A scanning process is carried out to determine the length of the line and then the line is transferred to the printer, together with all the necessary character to group translations.

Merge

This facility is accessed from the master menu and allows a previously written program to be merged with Baudprint. The program is first stored as a file, as described in the preceding section. Operation is very simple, just press "play" when asked and when the master menu reappears, the job is done. The retrieved file is printed on the screen, just as in file printing. The difference here is that the C64's BASIC operating system is tricked into thinking that the RETURN key has been pressed, thus entering the new line. The final line in the listing is the READY message, and this is detected by line 63940 which concludes the merge.

Baudprint from machine code

As BAUDPRINT-MC contains all the necessary housekeeping routines to maintain the printer, it is possible to use it directly from other machine code programs, dispensing with the BASIC section. Firstly, all of the data in the setup area must be transferred to memory. The SDC (not ASCII) of the character to be printed is then loaded into the accumulator and the print routine invoked by a JSR49213 instruction. You will also need JSR50643 to call a carriage return and line feed sequence and JSR50621 to call a line feed only. If you don't use JSR50643, Baudprint will automatically call a carriage return and line feed when the LCC reaches the currently set printer line length.

Back to setup

Having covered a few of the operating options, we will return to the setup area and tie up a few loose ends. Line 63510 POKES the printer line length into the machine code program. The default line length is set at 69 characters to make maximum use of the printer page width. If you need a narrower format for any reason, just change it and all the checking operations will follow the new value.

The last option you should know about is listed between lines 63550 and 63580. This enables the line feed and Baudot EOT characters to be selected by graphics and will be of most

```
EV=0 FOR "QUICK BROWN FOX MESSAGE"
63050 PRINT"[CRSR-DOWN]_[CRSR-DOWN] B FOR COMPLETE BAUDOT REPERTOIRE"
63060 PRINT"[CRSR-DOWN]_[CRSR-DOWN] R FOR CONTINUOUS ALTERNATING R-V"
63070 PRINT" (MARGIN SELECTOR ADJUSTMENT)"
63080 PRINT"[CRSR-DOWN]_[CRSR-DOWN] M FOR EXIT TO MASTER MENU" POKE198
63090 GETZC:IFZC#""THEN63140
63100 IFZC#""THEN63160
63110 IFZC#""THEN63180
63120 IFZC#""THEN60510
63130 GOT063090
63140 PRINT"[CLEAR-HOME]THE QUICK BROWN FOX JUMPS OVER THE LAZY DOG"CHR$(122)
63150 GOSUB61000 GOT063010
63160 PRINT"[CLEAR-HOME]_ABCDEFGHIJKLMN0PQRSTUVWXYZ 0123456789 \< > , - / # % ^
_[SDC 91 ]_"CHR$(122)
63170 GOSUB61000 GOT063010
63180 PRINT"[CLEAR-HOME]_RVRVVRVVRVVRVVRVVRVVRVVRVVRVVRVVRVVRVVRVVRVVRVVRV
RVRVVRVVRV"
63190 PRINT"RVRVVR"SPC(255)SPC(201)"** PRESS ANY KEY TO CANCEL **" GOSUB61000
63200 GETZC:IFZC#""THEN63180
63210 GOT063010
63420 REM
63430 REM M/C INTEGRITY CHECK & SETUP
63440 REM
63450 IFZJ=1THEN RETURN
63460 IF PEEK(49200)<085 OR PEEK(49943)<085 OR PEEK(50610)<085THEN63660
63470 IF PEEK(50031)<085 OR PEEK(51526)<085 OR PEEK(51503)<085THEN63660
63480 POKE49201,10 REM 500D=15/750D=10
63490 POKE49202,240 REM FINE SPEED ADJ
63500 POKE49203,15 REM 500D=23/750D=15
63510 POKE49204,69 REM PRINTER L/L
63520 ZX=69 REM MAX CHARS (PRINT SRT)
63530 ZF=20 REM L/FEEDS FOR PAPER OUT
63540 POKE51540,2 REM CR DELAY X100 MS
63710 REM LF & EOT BY GRAPHICS (OPTION)
63550 REM POKE49641,17 TO DISABLE
63570 REM POKE49641,3 TO ENABLE
63580 POKE49641,3
63590 IFZ0=1THEN63650
63600 POKE49207,PEEK(53200) POKE49208,PEEK(53201) PRINTCHR$(142)"_[CRSR-UP]_"
63610 REM COLOUR ZG=1 MONOCHROME ZG=0
63620 ZG=0 IFZG=0THEN63640
63630 POKE53200,11 POKE53201,0 PRINT"[CTRL-G]_[CRSR-UP]_" GOT063650
63640 POKE53200,0 POKE53201,11 PRINT"[COMM-7]_[CRSR-UP]_"
63650 Z0=0 POKE56579,1 POKE56577,1 SV550594 SV550697 ZJ=1 RETURN
63660 IFZ0=1THEN PRINT"[CLEAR-HOME]_[CRSR-DOWN]_[CRSR-DOWN]_[CRSR-DOWN]_[
_[CRSR-DOWN]_[CRSR-DOWN]_"
63670 PRINT"[CRSR-UP] M/C PROGRAM CORRUPTED OR NOT PRESENT ":FORZT=1TO1250 N
EXIT
63680 PRINT"[CRSR-UP]_"
63690 FORZT=1TO250 NEXT GOT063670
63700 PRINT"[CLEAR-HOME]_"SPC(7)"_[CRSR-DOWN]_[CRSR-DOWN]_"** EXIT FROM BAUDP
RINT **_[CRSR-DOWN]_"
63710 POKE53200,PEEK(49207) POKE49207,0
63720 POKE53201,PEEK(49208) POKE49208,0 PRINT"[COMM-7]_[CRSR-UP]_" END
63870 REM
63880 REM NO.5 - MERGE FACILITY
63890 REM
63900 PRINT"[CLEAR-HOME]_"OPEN1,1,0,"FILEPRINT"
63910 POKE104,1 POKE105,96 POKE106,1 POKE107,1 PRINT"[CLEAR-HOME]_[
_[CRSR-DOWN]_"
63920 GET#1,ZH$:PRINTZH$:
63930 IFZM#<>CHR$(13)THEN63920
63940 IFPEEK(1104)=18 AND PEEK(1109)=46THEN63960
63950 PRINT"GOT063910.[HOME-CRSR]_" POKE631,13 POKE632,13 POKE633,13 POKE190,3
END
63960 CLOSE1:GOT060500
```

49776	C270	00	00	00	00	00	00	00	0	50416	C4F0	C3	60	20	18	C3	20	18	C3	793	
49784	C278	8D	10	C3	A9	30	8D	11	922	50424	C4F8	20	18	C3	20	18	C3	20	18	1351	
49792	C280	8D	12	C3	8D	13	C3	A2	1793	50432	C500	C3	20	2A	C3	20	3C	C3	60	2198	
49800	C288	E8	EE	13	C3	EC	10	C3	F0	3164	50440	C508	20	18	C3	20	2A	C3	20	2A	2792
49808	C290	27	A9	3A	CD	13	C3	F0	0A	4099	50448	C510	C3	20	2A	C3	20	18	C3	20	3539
49816	C298	A9	3A	CD	12	C3	F0	0E	4C	5074	50456	C518	18	C3	20	3C	C3	60	20	18	4197
49824	C2A0	88	C2	EE	12	C3	A9	30	8D	6213	50464	C520	C3	20	18	C3	20	2A	C3	20	4944
49832	C2A8	13	C3	4C	98	C2	EE	11	C3	7299	50472	C528	2A	C3	20	2A	C3	20	2A	C3	5719
49840	C2B0	A9	30	8D	12	C3	4C	88	C2	977	50480	C530	20	3C	C3	60	20	18	C3	20	666
49848	C2B8	AD	35	00	18	69	08	8D	14	1696	50488	C538	2A	C3	20	2A	C3	20	18	C3	1423
49856	C2C0	C3	AD	34	00	CD	14	C3	30	2776	50496	C540	20	18	C3	20	2A	C3	20	3C	2835
49864	C2C8	03	4C	D5	C2	20	FE	C5	20	3777	50504	C548	C3	60	20	18	C3	20	2A	C3	2846
49872	C2D0	92	C3	20	D3	C5	A9	2E	20	4805	50512	C550	20	18	C3	20	2A	C3	20	2A	3440
49880	C2D8	3D	C0	A9	2E	20	3D	C0	A9	5727	50520	C558	C3	20	2A	C3	20	3C	C3	60	4287
49888	C2E0	13	20	3D	C0	A9	04	20	3D	6297	50528	C560	20	18	C3	20	2A	C3	20	18	4863
49896	C2E8	C0	A9	03	20	3D	C0	A9	2D	7160	50536	C568	C3	20	2A	C3	20	18	C3	20	5610
49904	C2F0	20	3D	C0	AD	11	C3	20	3D	763	50544	C570	2A	C3	20	3C	C3	60	20	18	676
49912	C2F8	C0	AD	12	C3	20	3D	C0	AD	1799	50552	C578	C3	20	2A	C3	20	18	C3	20	1423
49920	C300	13	C3	20	C0	A9	2E	20		2545	50560	C580	18	C3	20	18	C3	20	2A	C3	2162
49928	C308	3D	C0	A9	2E	20	3D	C0	60	3394	50568	C588	20	3C	C3	60	20	18	C3	20	2828
49936	C310	00	30	30	30	00	00	00	55	3623	50576	C590	18	C3	20	18	C3	20	2A	C3	3567
49944	C318	A2	00	8E	01	DD	AC	31	C0	4562	50584	C598	20	18	C3	20	18	C3	20	3C	4161
49952	C320	AE	32	C0	CA	D0	FD	88	D0	5985	50592	C5A0	C3	60	20	18	C3	20	18	C3	4954
49960	C328	F7	60	A2	01	8E	01	DD	AC	7027	50600	C5A8	20	18	C3	20	18	C3	20	2A	5530
49968	C330	31	C0	AE	32	C0	CA	D0	FD	1320	50608	C5B0	C3	20	18	C3	20	3C	C3	4C	889
49976	C338	88	D0	F7	60	A2	01	8E	01	2313	50616	C5B8	5E	C9	55	00	00	20	18	C3	1440
49984	C340	DD	AC	33	C0	AE	32	C0	CA	3567	50624	C5C0	20	18	C3	20	2A	C3	20	18	2016
49992	C348	D0	FD	88	D0	F7	60	00	00	4715	50632	C5C8	C3	20	18	C3	20	18	C3	20	2745
50000	C350	20	18	C3	20	2A	C3	20	2A	5309	50640	C5D0	3C	C3	60	20	A2	C5	20	8D	3708
50008	C358	C3	20	18	C3	20	18	C3	20	6038	50648	C5D8	C5	60	AD	36	C0	F0	03	4C	4739
50016	C360	18	C3	20	3C	C3	60	20	18	6696	50656	C5E0	E3	C5	60	20	18	C3	20	2A	5584
50024	C368	C3	20	2A	C3	20	18	C3	20	7443	50664	C5E8	C3	20	2A	C3	20	2A	C3	20	6349
50032	C370	18	C3	20	2A	C3	20	2A	C3	757	50672	C5F0	2A	C3	20	2A	C3	20	3C	C3	793
50040	C378	20	3C	C3	60	20	18	C3	20	1423	50680	C5F8	A2	00	8E	36	C0	60	AD	36	1666
50048	C380	18	C3	20	2A	C3	20	2A	C3	2180	50688	C600	C0	C9	01	F0	03	4C	09	C6	2586
50056	C388	20	2A	C3	20	18	C3	20	3C	2792	50696	C608	60	20	18	C3	20	2A	C3	20	3234
50064	C390	C3	60	20	18	C3	20	2A	C3	3603	50704	C610	2A	C3	20	18	C3	20	2A	C3	3991
50072	C398	20	18	C3	20	18	C3	20	2A	4179	50712	C618	20	2A	C3	20	3C	C3	A2	01	4710
50080	C3A0	C3	20	18	C3	20	3C	C3	60	5008	50720	C620	8E	36	C0	60	AD	34	C0	CD	5816
50088	C3A8	20	18	C3	20	2A	C3	20	18	5584	50728	C628	35	C0	F0	01	60	20	D3	C5	6838
50096	C3B0	C3	20	18	C3	20	18	C3	20	729	50736	C630	60	EE	35	C0	20	24	C6	60	941
50104	C3B8	18	C3	20	3C	C3	60	20	18	1387	50744	C638	4C	48	C6	CD	34	00	F0	01	1980
50112	C3C0	C3	20	2A	C3	20	18	C3	20	2134	50752	C640	60	20	18	C3	20	92	C3	20	2964
50120	C3C8	2A	C3	20	2A	C3	20	18	C3	2891	50760	C648	D3	C5	60	AE	35	C0	EB	8A	4257
50128	C3D0	20	3C	C3	60	20	18	C3	20	3557	50768	C650	20	38	C6	EB	8A	20	38	C6	5205
50136	C3D8	18	C3	20	2A	C3	20	18	C3	4296	50776	C658	EB	8A	20	38	C6	EB	8A	20	6266
50144	C3E0	20	2A	C3	20	2A	C3	20	3C	4926	50784	C660	38	C6	EB	8A	20	38	C6	20	7214
50152	C3E8	C3	60	20	18	C3	20	18	C3	5719	50792	C668	FE	C5	20	58	C4	20	58	C4	8297
50160	C3F0	20	18	C3	20	2A	C3	20	18	576	50800	C670	20	DA	C5	60	20	FE	C5	20	1058
50168	C3F8	C3	20	2A	C3	20	3C	C3	60	1423	50808	C678	58	C4	20	58	C4	AE	35	C0	2077
50176	C400	20	18	C3	20	18	C3	20	2A	1999	50816	C680	EB	EB	EB	EB	EB	EB	EB	35	3664
50184	C408	C3	20	2A	C3	20	18	C3	20	2746	50824	C688	C0	20	24	C6	60	00	00	55	4383
50192	C410	18	C3	20	3C	C3	60	20	18	3404	50832	C690	20	38	C6	20	58	C3	20	F2	5170
50200	C418	C3	20	2A	C3	20	2A	C3	20	4169	50840	C698	C4	20	74	C6	60	20	DA	C5	6255
50208	C420	18	C3	20	2A	C3	20	18	C3	4908	50848	C6A0	20	50	C3	20	31	C6	60	20	6969
50216	C428	20	3C	C3	60	20	18	C3	20	5574	50856	C6A8	DA	C5	20	66	C3	20	31	C6	7992
50224	C430	2A	C3	20	2A	C3	20	2A	C3	775	50864	C6B0	60	20	DA	C5	20	7C	C3	20	926
50232	C438	20	2A	C3	20	18	C3	20	3C	1387	50872	C6B8	31	C6	60	20	DA	C5	20	92	1894
50240	C440	C3	60	20	18	C3	20	18	C3	2180	50880	C6C0	C3	20	31	C6	60	20	DA	C5	2911
50248	C448	20	2A	C3	20	18	C3	20	18	2756	50888	C6C8	20	AB	C3	20	31	C6	60	20	3713
50256	C450	C3	20	2A	C3	20	3C	C3	60	3603	50896	C6D0	DA	C5	20	8E	C3	20	31	C6	4824
50264	C458	20	18	C3	20	18	C3	20	18	4161	50904	C6D8	60	20	DA	C5	20	D4	C3	20	5838
50272	C460	C3	20	2A	C3	20	2A	C3	20	4926	50912	C6E0	31	C6	60	20	DA	C5	20	EA	6894
50280	C468	2A	C3	20	3C	C3	60	20	18	5602	50920	C6E8	C3	20	31	C6	60	20	DA	C5	7911
50288	C470	C3	20	18	C3	20	18	C3	20	729	50928	C6F0	20	00	C4	20	31	C6	60	20	635
50296	C478	2A	C3	20	2A	C3	20	18	C3	1486	50936	C6F8	DA	C5	20	16	C4	20	31	C6	1579
50304	C480	20	3C	C3	60	20	18	C3	20	2152	50944	C700	60	20	DA	C5	20	2C	C4	20	2426
50312	C488	18	C3	20	18	C3	20	18	C3	2873	50952	C708	31	C6	60	20	DA	C5	20	42	3314
50320	C490	20	2A	C3	20	2A	C3	20	3C	3503	50960	C710	C4	20	31	C6	60	20	DA	C5	4332
50328	C498	C3	60	20	18	C3	20	18	C3	4296	50968	C718	20	58	C4	20	31	C6	60	20	5055
50336	C4A0	20	2A	C3	20	2A	C3	20	18	4890	50976	C720	DA	C5	20	6E	C4	20	31	C6	6087
50344	C4A8	C3	20	2A	C3	20	3C	C3	60	5737	50984	C728	60	20	DA	C5	20	84	C4	20	7022
50352	C4B0	20	18	C3	20	2A	C3	20	2A	594	50992	C730	31	C6	60	20	DA	C5	20	9A	976
50360	C4B8	C3	20	2A	C3	20	18	C3	20	1341	51000	C738	C4	20	31	C6	60	20	DA	C5	1994
50368	C4C0	2A	C3	20	3C	C3	60	20	18	2017	51008	C740	20	B0	C4	20	31	C6	60	20	2805
50376	C																				

- continued from previous page.

51056	C770	DA	C5	20	1E	C5	20	31	C6	953
51064	C778	60	20	DA	C5	20	34	C5	20	1809
51072	C780	31	C6	60	20	DA	C5	20	4A	2705
51080	C788	C5	20	31	C6	60	20	DA	C5	3724
51088	C790	20	60	C5	20	31	C6	60	20	4456
51096	C798	DA	C5	20	76	C5	20	31	C6	5497
51104	C7A0	60	20	FE	C5	4C	E6	C6	20	6612
51112	C7A8	38	C6	20	08	C5	20	50	C3	7410
51120	C780	20	74	C6	60	20	38	C6	20	760
51128	C788	42	C4	20	50	C3	20	74	C6	1675
51136	C700	60	20	8C	C5	20	31	C6	60	2515
51144	C708	20	38	C6	20	08	C3	20	58	3316
51152	C7D0	C4	20	74	C6	60	20	38	C6	4240
51160	C7D8	20	80	C4	20	80	C4	20	74	5196
51168	C7E0	C6	60	20	38	C6	20	6E	C4	6114
51176	C7E8	20	C6	C4	20	74	C6	60	20	7014
51184	C7F0	FE	C5	4C	DC	C6	20	FE	C5	1428
51192	C7F8	4C	D2	C6	20	38	C6	20	50	2310
51200	C800	C3	20	6E	C4	20	74	C6	60	3285
51208	C808	20	FE	C5	4C	54	C7	20	FE	4413
51216	C810	C5	4C	04	C7	20	FE	C5	4C	5448
51224	C818	0E	C7	20	38	C6	20	50	C3	6254
51232	C820	20	DC	C4	20	74	C6	60	20	7176
51240	C828	FE	C5	4C	9A	C7	20	FE	C5	8539
51248	C830	4C	22	C7	20	FE	C5	4C	A0	1028
51256	C838	C6	20	FE	C5	4C	18	C7	20	2040
51264	C840	FE	C5	4C	86	C7	20	FE	C5	3383
51272	C848	4C	36	C7	20	FE	C5	4C	40	4335
51280	C850	C7	20	FE	C5	4C	7C	C7	20	5448
51288	C858	FE	C5	4C	08	C6	20	FE	C5	6856
51296	C860	4C	4A	C7	20	FE	C5	4C	5E	7858
51304	C868	C7	20	FE	C5	4C	90	C7	20	8991

51312	C870	FE	C5	4C	68	C7	20	FE	C5	1313
51320	C878	4C	F0	C6	20	FE	C5	4C	2C	2430
51328	C880	C7	20	FE	C5	4C	84	C6	20	3598
51336	C888	38	C6	20	DC	C4	20	7C	C3	4651
51344	C890	20	74	C6	60	20	38	C6	20	5411
51352	C898	42	C4	20	F2	C4	20	74	C6	6489
51360	C8A0	60	20	FE	C5	4C	72	C7	20	7489
51368	C8A8	38	C6	20	D4	C3	20	F2	C4	8652
51376	C880	20	74	C6	60	20	FE	C5	4C	1001
51384	C888	AA	C6	20	8D	C5	60	20	FE	2169
51392	C8C0	C5	4C	8E	C6	20	38	C6	20	3148
51400	C8C8	9A	C4	20	00	C4	20	74	C6	4072
51408	C8D0	60	20	38	C6	20	7C	C3	20	4837
51416	C8D8	92	C3	20	74	C6	60	20	38	5708
51424	C8E0	C6	20	C6	C4	20	6E	C4	20	6702
51432	C8E8	74	C6	60	20	38	C6	20	EA	7664
51440	C8F0	C3	20	84	C4	20	74	C6	60	997
51448	C8F8	20	38	C6	20	7C	C3	20	C6	1864
51456	C900	C4	20	74	C6	60	20	38	C6	2788
51464	C908	20	7C	C3	20	08	C5	20	74	3524
51472	C910	C6	60	20	38	C6	20	C6	C4	4530
51480	C918	20	8E	C3	20	74	C6	60	20	5421
51488	C920	38	C6	20	7C	C3	20	EA	C3	6487
51496	C928	20	74	C6	60	20	38	C6	20	7247
51504	C930	7C	C3	20	42	C4	20	74	C6	959
51512	C938	60	20	38	C6	20	8C	C5	20	1742
51520	C940	8C	C5	20	74	C6	60	55	00	2606
51528	C948	00	02	A2	48	A9	20	9D	9F	3359
51536	C950	07	AD	21	D0	9D	9F	D0	CA	4517
51544	C958	D0	F2	60	00	02	00	AE	5C	5331
51552	C960	C9	8E	5D	C9	AE	5D	C9	F0	6676
51560	C968	10	A0	48	A2	F0	CA	D0	FD	7992
51568	C970	88	D0	F9	CE	5D	C9	4C	64	1269
51576	C978	C9	A2	00	8E	35	C0	60	55	2200

- 2AWI BBS, from page 73.

extensive precautions have been taken to ensure that failures do not cause interference. Apart from the internal "watch-dog" timer in the TNC, a separate monitor is provided which detects the presence of RF and shuts off the power supply if the transmitter stays on-air for more than two minutes.

Both the transceiver and the computer are arranged so that they will re-initialise in the event of a mains power failure. The computer will automatically reload and execute the software and the transceiver automatically returns to 147.600 MHz. Backups of all the current messages are made when the system is started from the local console so that users are not inconvenienced in the event of a major crash.

System management

In common with all bulletin boards, the system is maintained and managed by a system operator or "sysop". In the case of VK2AWI, this is Andy VK2AAK. The software also allows any user to be nominated as a "remote sysop". This is useful with a system such as VK2AWI, allowing undesirable messages to be deleted or system parameters to be changed without having to actually be present at the main computer.

Many aspiring sysops would possibly change their minds if they knew how much time and effort was required to maintain a system. In the case of VK2AWI, this usually takes 30 minutes to an hour each morning to read and answer the mail, delete old or duplicate messages, check the content of messages for possible infringements of the regulations etc.

The future

The establishment of VK2AWI as the NSW divisional packet bulletin board was initially something of an experiment to see if such a system would be popular. Over the past few months, the experiment has proved to be a great success with a regular user base of some 80 amateurs and many hundreds of messages being handled each month.

The success of the system is very gratifying, but considering its status as the NSW divisional packet BBS, it seemed to the Council that we were neglecting all those amateurs who didn't live in the Sydney area and thus could not access the system. As a result, the VK2 Council has decided that the "experiment" is over and the system will be expanded in an attempt to serve all NSW amateurs. The expansion of the system will be made in a number of steps and the first of these will be a change in the frequency of the VHF port from 147.600 MHz to 144.850 MHz on the first of December 1987.

The new frequency has been chosen in accordance with the agreed bandplan for packet radio systems, but also has a number of other advantages. By moving to the low end of the band, the frequent problem of pager interference which is common at the top end of two metres will be avoided. The other significant advantage is that the expansion plan calls for the relocation of the system to the NSW division's transmitting facility at Dural. By choosing a frequency at the low end of the band, it should be possible to diplex the system onto the antenna used for the divisional repeater VK2RWI on 147.000 MHz without causing conflict or desensing.

To serve the country areas of NSW, a second TNC and transceiver will be fitted to allow operation in the 80 metre band. Once suitable equipment has been obtained, tests from the Dural site will be conducted. Experiments by other groups with packet radio on 80 metres have proved quite successful and it is hoped that many of the more isolated groups, clubs and individuals in NSW who are known to have packet capability will be able to take advantage of the facility.

Perhaps in the future, other divisions of the Wireless Institute will set up similar systems and an Australia-wide network can be established. Apart from being a lot of fun, packet radio lends itself to the efficient distribution of news and information and with a bit of thought and planning, amateur radio operators can build a network which would be the envy of many organisations. 

HI-COM UNITRONICS INTERNATIONAL P/L

7 PRESIDENT LANE CARINGBAH NSW AUSTRALIA
 PH: 02-524 7878 TELEX: 72573MAMS P/CODE 2229



LAPTOP AT \$4500

SPECIFICATIONS

CPU
80286-10, 10MHz

Memory
32KB ROM expandable to 64KB
640KB RAM expandable to 2640KB

Disk Drives
One 3.5" micro-floppy disk drive
Optional second 3.5" micro floppy disk drive

Video
Super-twist LCD (640x200), with contrast adjustment
Connector for external RGB mono monitor

Keyboard
82-key low profile keyboard

Expansion
One 9-pin RS-232 port
One parallel printer port
Optional 300/1200 baud modem (Hayes compatible)
One 16 bit expansion bus

Indicators
Power-Low, Caps-Lock, Num-Lock, Disk-in-Use

Power Supply
12V/3Ah sealed lead-acid battery
External AC to DC adapter

Experimental Plug-in cards for IBM PC/XT

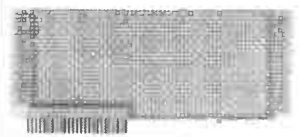

- XT SHORT CARD **\$30**
- XT LONG CARD **\$40**
- AT LONG CARD **\$48**
- APPLE II **\$28**

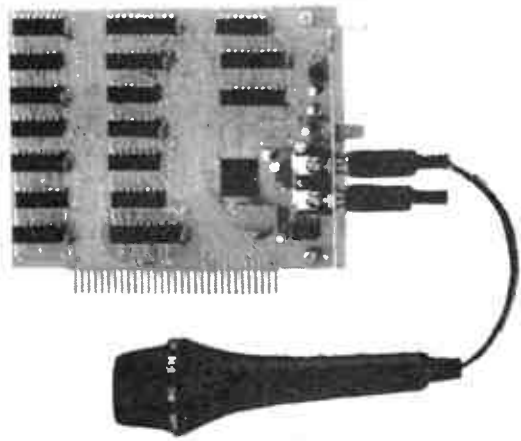

ADD-ON CARDS NEW!!!!!!! VOICE RECORD & PLAY BACK CARD **\$199**

The voice record card includes microphone & speaker plug directly into the IBM PC/XT/AT & ready to be used.
 Application includes voice communication, dictation for secretary, language learning tool & computerized security system

Hicom AT286 **\$3990**

6/12 MHz switchable 1.2M & 360K Floppy Drive
 20M Miniscribe Hard Disk
 Extended keyboard 101 keys with mechanical "click"
 1024K RAM
 Multivideo display card (EGA, CGA, MGA)
 Version 6 G. Mouse with 3 Button EGA Colour Monitor

**TURBO XT 4.7/10 MHZ SUPER FAST
 XT COMPATIBLE**

FULL SYSTEM WITH 2 DRIVES 640K \$1290
 FULL RANGE OF ADD-ON CARDS AVAILABLE

SECOND SERIAL PORT KIT FOR XT **\$32
 FOR AT **\$45****

Super Simple Modem

AEM4605
 300FDX, 1200/75, RS232 interface to any computer.

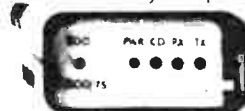

\$125

Elektor CMOS RAM CARD for Commodore 64

CALL

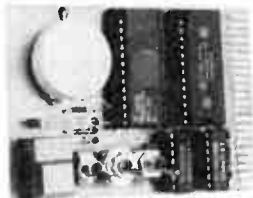

MULTI SERIAL CARDS (4 SERIAL PORTS) **\$290**

Programmable baud rate 50-9600. RS232 Interface 1488, 1489 SIO 8250

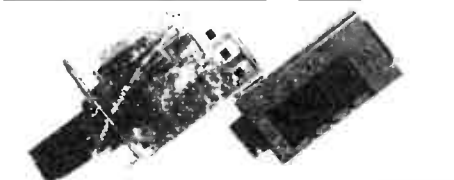

EPROM WRITER CARD **\$320**

Program 2716 to 27512, 27C64, 27C128, 27C256, one time prom. VPP 12.5V, 21V, 25V includes external four zif sockets.

ILP TOROIDAL TRANSFORMER

VA	PRICE	DUAL SECONDARY VOLTAGE	(Made in UK)
15	35.50	0 9 12 15 18 22 25 30 35 40 45 50 55	
30	39.50		
50	45.50		
80	49.50		
120	54.00		
160	65.00		
225	74.00		
300	83.00		
500	115.00		
625	132.00		

NEW!!!!!!



12 BIT AD/DA CARD **\$290**

1 channel D/A 0-9V output, 12 Bit 16 channel input 0-9V

ELEKTOR SERIAL DIGITIZER

For your computer PCB 86090-1,2
 AEM 10/86 **\$175.00**
 8 channels with 8V max I/P, serial I/O comm (150 9600 baud)

Main PCB with 2 channels only **\$105.00**
 each additional 2 channels **\$30.00**



CODE TO SPEECH KIT FOR COMPUTER

AEM 4505 KIT

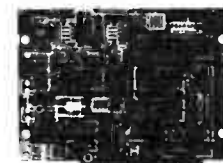

Parallel version for IBM PC/XT/AT **\$129.00**

Serial version for other computers **\$149.00**



Merry Christmas and a Happy New Year...

We've got your wire and cable needs all rolled up! From the finest copper wire to building mains cable (and everything in between), you'll find it at your nearest DSE store. Buy by the metre and save, buy by the roll and really save!

300 Ohm Ribbon

Indoor/outdoor (black) TV ribbon for strong signal areas and/or 300 ohm only antennas. (No balun required) Cat W-2070

30¢ per metre

Builder's Light Cable

Standard twin and earth, 1/113. For new building or replacement work. Buy in bulk and save more! Cat W-2060

95¢

12 Core Data Cable

Ideal for parallel and serial data cables, 12 different coloured multistrand conductors plus foil and drain wire. Grey outer insulation. Cat W-2041

\$2.50

Builder's Power Cable

Similar to left, but 1/178 (25A) for power circuits. Cat W-2062

\$1.50

RG59U Solid Dielectric TV Coax

75 ohms, as used by installers everywhere, 8.5dB/100m @ 100MHz, solid centre conductor with foil and braid. Black insulation. Cat W-2081

60¢ per metre

75 Ohm Air Space

The pro TV coax, 6.9dB/100m @ 100MHz, only 26.5dB at 1GHz! Air space dielectric. When low signal loss is important, you want the best! Cat W-2082

80¢ per metre

2 Core Microphone Cable Pro Quality

Extra heavy duty outer insulation, cotton reinforcement for extra strength and dual multistrand insulated cores, with close-woven braid. Cat W-2035

\$1.75

Mains Circuit Breakers make sense!

Fuses always blow at night. Where's the fuse wire? (Murphy's corollary No 326).

Replace all the fuse blocks in your box with Martec Circuit Breakers. They're just as effective as fuses (perhaps even more so) but restoring power is as simple as pushing a button!

Available in metric and imperial ratings, fits standard (Federal type) fuse boxes.

Imperial	Metric
8A Cat P-5908	10A Cat P-5910
16A Cat P-5920	15A Cat P-5915
20A Cat P-5925	30A Cat P-5929

ALL ONE PRICE: \$12.95 ea

High Power Hand Held

2m has never been so good! Hand held powerhouse includes push button control, 10 memories, scanning, etc. And up to 5W with appropriate NiCad. (Includes NiCad for 3.5W output). Cat D-3503

\$599



Just Listening?

Get your ears around a Bearcat 175XL. All the action on VHF and UHF to listen in on.

- Aircraft
- Business
- Etc Etc Etc!
- Carphones
- Amateurs

\$499

Hard of Hearing?

What did you say? Fit a telephone extension bell! Just plug it in to the socket — includes 5m cable so you can use it in another room, etc. Bewdy!

Cat F-5119

\$1995

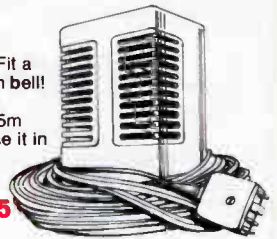

DSE's Magnificent Meter Muster!

For the beginner:



Small enough to go anywhere, ranges just right for the hobbyist, auto electrical, etc. Keep a couple handy — just in case! Cat Q-1010

\$16.95

Pouch to suit: Protects your Q-1010 meter from damage. Cat Q-1011

Audible tester too!

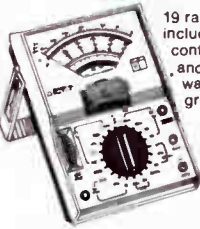

19 range multimeter includes an audible continuity tester and goes all the way to 10A DC! A great all-rounder. Cat Q-1022

\$34.95

Logically Speaking...



This is the one to go for. More than a multimeter — it also checks logic levels and displays hi, lo or pulse states. 20k/V sensitivity multimeter is no slouch, either. Cat Q-1026

\$44.95

Digital Workbench!

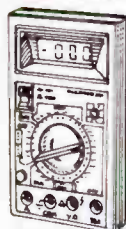

3.5 digit meter, capacitance checker, transistor checker — just about everything the hobbyist or service bench could want. 10A AC & DC ranges, also has buzzer/continuity. Cat Q-1500

\$129



Frequency reading DMM

Yes — it's got a 200kHz DFM built in too. Very handy — also checks transistors, diodes, capacitors. And it's a multimeter! Cat Q-1505

\$169

"4000 Count" model is twice as accurate



Most m'meters go to 2000 counts. This one is double. That's double the resolution. And it also features an analogue display to give you "dynamic" readings. It's great, mate. Cat Q-1666

\$249

Want Cannon connectors? No, not those cheap cardboard imitation "Cannon-types" every man and his dog flogs. Genuine, 100% Cannon plugs and socket. For when quality really counts.

Type No	Description	DSE Cat No	Price
AXR-3-11	In Line Audio Socket	P-1620	\$5.25
AXR-3-32	Panel mtg. Audio Plug	P-1622	\$4.00
AXR-3-12	In Line Audio Plug	P-1624	\$4.95
AXR-3-31	Panel mtg. Audio Socket	P-1626	\$5.75
AXR-PDN-12W	Hi level audio line plug white	P-1632	\$10.50
AXR-PDN-11B	H/lev aud line socket blue	P-1634	\$9.95
AXR-PDN-31W	H/lev aud chas sock white	P-1636	\$7.50
AXR-PDN-14B	H/lev aud chas plug blue	P-1638	\$8.50
Orange Boot	(fits all plugs & sockets)	P-1615	50¢
Yellow Boot	(fits all plugs & sockets)	P-1616	50¢
Green Boot	(fits all plugs & sockets)	P-1617	50¢
Blue Boot	(fits all plugs & sockets)	P-1618	50¢
AXR-LNE-12	240V mains line plug	P-1627	\$9.95
AXR-LNE-11	240V mains line socket	P-1631	\$9.50
AXR-LNE-31	240V mains panel socket	P-1630	\$7.95
AXR-LNE-32	240V mains panel plug	P-1629	\$7.50

DICK SMITH ELECTRONICS now boasts **56 stores** **Australia-wide** — if one of these are not near you... check our list of dealers...

Your local reseller is:

- **NW** • **Balina**: A. Cummings & Co. 86 2284 • **Bowral**: F.R.H. Electrical 61 1861 • **Broken Hill**: Hobbies & Electronics 88 4098
- **Charleston**: Newtronics 43 9600 • **Cofts Harbour**: Cofts Harbour Electronics 52 5684 • **Deniliquin**: Deni Electronics 81 3672
- **Forster**: Forster Photo Sound 54 5006 • **Inverell**: Lyn Willing Electronics 22 1821 • **Leeton**: Leeton Record Centre 53 2081
- **Lightning Ridge**: Lightning Ridge Newsagency 29 0579 • **Lismore**: Decro 21 4137 • **Morree**: More Electrical Services 52 3458
- **Newcastle**: Newtronics 43 9600 • **Port Macquarie**: Hall of Electronics 83 7440 • **Orange**: Fyfe Electronics 62 6491 • **Springwood**: Wellington's Electrical Discounts 51 4888 • **Taree**: Brad's Electronics 52 6643 • **Tumut**: Tumut Electronics 47 1631 • **Ulladulla**: Pauls Electronics 55 3989 • **Wagga**: Phillips Electronics 21 6558 • **Wellington**: Wellington Electrical Service 45 2325 • **Windsor**: M & E Electronics 206 George St, 77 5935 • **Young**: Keith Dinges Electronics 82 1279 • **VIC** • **Boronia**: Ray Cross Electronics 762 2422
- **Colac**: Colac Electronics 31 2847 • **Dunolly**: Ken Roberts (Finders) 68 1333 • **Echuca**: Webster Electronics 82 2956 • **Mildura**: McWilliams Electronics 23 6410 • **Morwell**: Morwell Electronics 34 6133 • **Rosebud**: Penitronics 86 7888 • **Shepparton**: G.V. Electronics Centre 21 8866 • **Sunbury**: Calico Electrical 744 1564 • **Warrambond**: Martronics 62 9870 • **Werrisbee**: Gobies Photographic & Video 741 7089 • **QLD** • **Bundaberg**: Bob Elkin Electronics 72 1785 • **Cairns**: Electronic World 51 8555 • **Caloundra**: Hume's Electro-Mart 91 4270 • **Dysart**: Dysart Videotronics 58 2107 • **Gladstone**: Supertronics 72 4321 • **Mackay**: Stevens Electronics 51 1723 • **Mooloolaba**: Mal's Electronics 44 6588 • **Maryborough**: Keller Electronics 21 4559 • **Mt Isa**: Outback Electronics 43 3331 • **Nambour**: Nambour Electronics 41 1604 • **Noosa Heads**: Sunshine Phone Systems 47 4444 • **Townsville**: Tropical T.V. 79 1421 • **WA** • **Mt Gambier**: Hutchessons Communications Centre 25 0400 • **Whyalla**: Eyre Electronics 45 4764
- **WA** • **Albany**: Micro Electronics 41 3432 • **Karratha**: Dave's Oscitronics 85 4836 • **TAB** • **Devonport**: A.I. Electronics & Hobbies 24 8322 • **Launceston**: Wills Electronics 31 5688 • **NT** • **Alice Springs**: Farmer Electronics 52 2967



ORDER BY PHONE
TOLL FREE DSXpress ON
(008)22 6610

For 24 hour despatch
SYDNEY (02) AREA 888 2105

from all at DSE

FRG-9600 Scanning Receiver



Unbelievable! Covers the complete 60 to 905MHz VHF/UHF spectrum! What's more — It's all mode, FM, AM, CB, SSB... the lot! With keypad or dial selection, selectable scanning functions, memory scanning and much, much more!
Cat D-2825 (* SSB to 460MHz)

\$1199

The Complete Amateur Station!

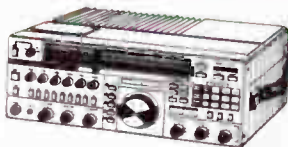

The incredible Yaesu FT767GX all mode, all band Transceiver! With every possible feature to drag the signal in or get yours out. HF, VHF, UHF — every amateur band from 160 metres to 70 centimetres!! With auto antenna tuner, built-in mains power supply and much more! It's the best!!
Cat D-2935

3 Transceivers in one!! \$4995

Heavy Duty Power!



When you're working hard — you don't want to lose your cool! The FP757HD power supply is just what the avid dx'er wants. Plugs straight into the 757 but it's also suitable for other 12V transceivers. Rated at a superb 13.8V, 20A continuous!
Cat D-2945

\$599

Budget Hobbyists Iron



Ideal for hobbyist, general service, production line, etc! The Adcola RS-30 12 watt mains powered soldering iron.
Cat T-1820

\$29⁹⁵

Duotemp - A little boost



Professional quality — hobbyist price! Adcola's Duotemp solder iron with 21 watts of power PLUS a push button boost for fast heating or heavy soldering.
Cat T-1830

\$49⁹⁵

HD 12V 30 Watt



The low voltage heavy duty iron at such a low price! Comes with 2 metres of cable and car cigarette lighter adaptor.
Cat T-1910

ONLY \$78⁵⁰

Royal Professional Soldering Station



The best work deserves the best! Variable temperature soldering station with the quality, reliability and performance you expect.
Cat T-2050

\$189

Super Slim Mini!



Ideal for quick, on the spot repairs. 6 watt capacity in a super slim lightweight! 12 volt operation it comes with one metre of cable!
Cat T-1920

\$17⁹⁵

Computer Tool Kit!



A 12 piece computer tool kit for those repairs, alterations, etc. With IC inserter/remover pin straightener, screwdrivers, reversible torque screwdriver, pliers and more. All in handy zippered case!
Cat T-4839

\$49⁹⁵

Lug Crimping Tool



Makes wire connections a breeze! Eliminates soldering and saves time! Reliable crimping tool also cuts and strips wire. Comes with assorted lugs — ready to use!
Cat T-3520

VALUE \$6⁵⁰

Economy Wire Stripper



Great value! Large adjustable range, hardened jaws and insulated handles. About 1/2 the price you'd expect!
Cat T-3630

\$3⁹⁵

Save \$10!



The amazing Arlec Supertool! It drills, grinds, polishes, engraves, mills... just about anything! 10,000 RPM with a fantastic range of attachments. A workbench isn't the same without one!
Cat T-4754

NOW \$59⁹⁵ WAS \$69.95

Precision Screwdriver Set



6 chrome plated screwdrivers with free running heads! Quality tools in handy plastic case. Both Phillips and flat head.
Cat T-4360

\$5⁹⁵

Switched on Savings!

MINIATURE TOGGLES	Cat No.	Price
SPDT 8mm x 13mm (240V AC 2A)	S-1173	Reduced to \$1.25
DPDT 13mm x 13mm (240V AC 2A)	S-1174	Reduced to \$1.50
Ultra Mini DPDT (240V AC 1.5A)	S-1245	Reduced to \$2.75
Heavy duty DPDT (125V AC 10A)	S-1168	\$3.75
Right angle PCB mount	S-1180	\$2.50
STANDARD TOGGLES	Cat No.	Price
Centre OFF DPDT (125V AC 10A)	S-1217	\$2.50
Illuminated SPST (12V DC 16A)	S-1214	\$3.95
Piano Key DPDT (12V DC 10A)	S-1393	\$3.50
Waterproof SPDT (12V DC 10A)	S-1195	Reduced \$6.95
PCB Mount Push button (120V 1A)	S-1253	\$2.95

Special Purchase

Save! Bank of 8 interlocking switches. Great for audio work! Special price now! Cat S-1005

Bargain \$2⁹⁵

Transformers!

Transistor Audio Transformers

Model M-0222

Miniature size for transistor projects etc. requiring coupling. With 3k ohm primary and secondary. Iron core. Measures 17(l) x 15.5(w) x 15(h)mm. Cat M-0216

WAS \$1.40 NOW \$1

Model M-02156

Similar to M-0222 but with 1k ohm primary and 8 ohm secondary. For 350mW O/P Ferrite core. 15 x 14 x 11.5mm. Cat M-0216

WAS \$1.40

ONLY \$1

Multitap 240V Models

DSE 2155

Primary — 240V, 50Hz
Secondary — 6.3, 7.5, 8.5, 9.5, 12 & 15V
Secondary current — 1 amp
Cat M-2155

\$7⁹⁵

Audio Line Transformer

Designed to cover PA — BGM applications. Suits all speaker impedances. Multitapped for use with 100V or 70V lines. 2, 4, 8, 16 ohm secondary. 2.5k, 5k ohm primary. Cat M-1100

\$6²⁵

Isolation Transformer

600ohm/600ohm. For modems and other telephone line applications. Complies with Telecom regulations. Isolates line from device.
Cat M-1210

NOW \$12⁹⁵

Positive Photoresist Spray

Fast drying photoresist for one to one reproduction of circuits, diagrams, etc on metals. 200g can ideal for PCB work. Cat N-1000

\$15⁹⁵

Air Duster

400g of high pressure compressed inert gas for cleaning circuit boards, equipment, etc. Ideal for those fragile or hard to get at places! Cat N-1050

\$15⁹⁵

Butane Refill

Refill your Portasol Soldering iron with this 30g Ronson Multifill. Even works with refillable cigarette lighters!
Cat N-1080

\$1⁷⁵

Silastic Sealant/Adhesive

RTV 38 silastic sealant specially designed for high voltage applications. Neutral curing in 85g tube. Sticks and insulates just about anything! Cat N-1226

\$12²⁵

Power Supplies! Better than batteries!

9V DC @ 200mA

Ideal for anything that requires 9V transistor type battery. Just plugs into mains power socket! Cat M-9514

\$11⁹⁵

AC Supply 16V 900mA

A healthy 16V at 900mA. Perfect for 12V DC supplies. Plugs straight into mains socket! Cat M-9567

\$14⁹⁵

3-6-9V DC @ 200mA

One of the most popular supplies. Ideal for many battery powered devices. Select any of three voltages! Cat M-9525

WAS \$17.50

NOW \$15⁹⁵

Six Voltage Selections

Incredibly versatile! Switch selectable 3-4-5-6-7-5-9 or 12 volts at 300mA. Fantastic value! Cat M-9526

WAS \$18.95

ONLY \$15⁹⁵

Multi-Volt Powerpack

3-6-9-12V DC at 1 amp! Invaluable around the home or workshop. Plugs into AC power socket. DC connections via screw terminals on front of unit. Cat M-9530

SAVE \$10 WAS \$32.95 NOW \$22⁹⁵

DICK SMITH ELECTRONICS



Bar Graph

Multimeter



\$149

Finally, an LCD Multimeter which accurately shows analog-type readings! All those essential dynamics that are often lost on a DMM... often it's not so much a reading you're after as the change in readings!

But there's more: the information is displayed in "bar graph" format for instant recognition and ease of reading. And if you need to expand the scale, it's a simple one-button operation to go to a 10x magnification!

Plus a data hold function (last reading retained), a maximum hold function (highest reading retained & marked, but readings continue), diode check & continuity, etc, etc: it's one of the best general purpose multimeters available today — simply because it does everything better!

- 105 step LCD bargraph display giving 1% resolution on any scale (eg 10 volts on 1000V range with mag pressed).
- Fast 10/second sampling rate for virtually instantaneous display (much faster than most digitals).
- Automatic positive or negative indication
- DATA Hold key freezes reading immediately previous to pressing. This can then be magnified (by up to 10:1) for a more accurate and precise reading.
- 6DCV V ranges (down to 100mV with virtual 1mV sensitivity), 4 AC V ranges, 5 resistance, 3 DC plus diode check and continuity ranges.
- Single input terminals mean no swapping of leads when you change to different scales. Fully shrouded test leads supplied, with full instructions.

Cat Q-1777

Specifications:

DCV: 100mV, 2.5V, 10V, 50V, 250V, 1000V, 5Mohm impedance

ACV: 10V, 50V, 250V, 750V (minimum 5k/V, 25k/V on 10V)

DC: 2.5mA, 25mA, 250mA

Res: 250 ohms, 2.5k, 25k, 250k, 2.5M

Cont: 250 ohms max, continuity beeper approx <100 ohms

Diode: Test current approx 0.5mA, reads Vf on display

Measuring Method: dual integration mode

Sampling: 10 times per second

Power: 1.5V (AA) x 2

Battery Life: Approx 800 hours or more.

Size: 145 x 86 x 34mm (w x h x d)

Weight: Approx 250g (inc batteries).

**Available exclusively from
Dick Smith Electronics**

**ORDER BY PHONE: TOLL FREE
DSXpress ON (008) 22 6610
For 24 hour despatch**

**DICK SMITH
ELECTRONICS**

More Kits For Kitmas



Here's a great case for a good project . . .

We've had these superb cases made especially for our new Economy Stereo Amp Kit (see below). But they're SO good we thought we'd stock them as a normal line as well. Cad plated steel case with pre-punched front and rear panels (suits anything!), cover is grey crinkle finish, pre-slotted for heat dissipation. Magnificent!
Size 370 X 70 X 135mm
Cat H-2900

\$34.95



Build an amplifier: economically!

Here's a great first "big" project. When you've finished mucking around, build an amplifier! It's not too difficult — our new Economy Amplifier Kit makes it a cinch! Kit is "short form" — does not include case (H-1900) or transformer (M-6672). Over 8W per channel at <0.05% distortion. CD, tuner, disc and aux inputs. Cat K-4001



\$129.95



Universal Heatsink

Universal hole pattern allows the mounting of virtually all "power" type semiconductors. Ribbed walls and black anodised finish for maximum efficiency. Cat H-3401

\$1.40

100W HF Linear Amplifier

Designed for our HF Transceiver (K-6330) but also perfect for use with a huge range of QRP commercial gear, in the range of 3 to 15 watts output. Gives around 10 to 14dB gain so up to 100W output could be obtained from a very modest input.
Cat K-6331



\$349

Radio Direction Finder

Great news for radio amateurs, CB operators and marine enthusiasts! The DSE Radio Direction Finder Kit is real value for money! When coupled with a suitable FM receiver it rapidly indicates the direction of the RF signal being received.



\$149

Cat K-6345

Aluminium Cases

Superb range of cases based on a specially made 18 gauge aluminium extrusion giving cases which are ultra strong.

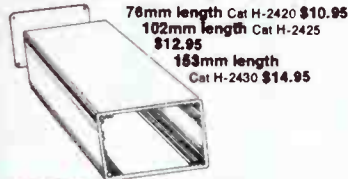

76mm length Cat H-2420 **\$10.95**

102mm length Cat H-2425 **\$12.95**

183mm length Cat H-2430 **\$14.95**

"Pocket" Case

A tiny (57 x 36 x 17mm) case intended for pocket or keyring transmitters: infra-red, ultrasonic, UHF, etc. for alarms, garage openers, etc. Cat H-2497



\$2.95

Store 'em

Resistors, transistors, screws, etc. etc: all those little bits'n'pieces you keep losing can now be stored. Even millions of 'em — just keep on stacking these nifty parts drawers together!

Two styles: Single Drawer, 103 X 83 X 120mm Cat H-2581
Two Drawer, 137 X 98 X 56mm Cat H-2580

\$4.75

ea.

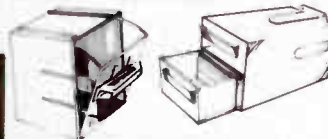

Slightly imperfect, won't affect wear!

Our case manufacturer has boo-boos! Minor imperfections and blemishes in our H-2505 cases meant they didn't pass QC inspection. And the manufacturer didn't want 'em back! So we're selling them off (while they last) as is. If you're looking for a bargain . . . this is it! Fawn plastic finish, black front and rear panels.
Measures 200 X 63 X 160mm. Cat J-2505



\$9.95

USUALLY **\$16.95**

50W Module

Incredibly reliable — yet very simple to build. The complete amplifier on one pcb — all you do is add a heatsink, connect to power... and go! Cat K-3440

\$22.95

100W Amp Module

Use two for stereo, or even use in bridge for double output! (Get up to a massive 200W output!) Cat K-3442

\$29.95

Walkabout Wadio

This portable radio kit puts the life back into AM reception! Using a cunning TRF circuitry system the original audio bandwidth transmitted by the station is largely maintained — AM comes alive!

\$19.95 Cat K-2720



Optical Motion Detector

Perfect as part of your alarm system or as a door minder etc. Self contained and battery operated!
Cat K-2721

\$29.95

Microwave Leakage Detector

If your microwave oven is leaking dangerous radiation? Check it out with this handy meter.
Cat K-3095



\$17.45

Musicolor IV

The Musicolor Mk IV is four chase patterns plus auto chase and reverse chase AND four channel colour organ with built-in microphone means you're ready to start a lightshow!
Cat K-3143

\$135

Beat Triggered Strobe

Really makes your music come alive by flashing in time with the music. You can also use it in conventional strobe mode. With a variable flash rate up to about 30 flashes per second. Cat K-3153

\$59.95

Look Mum. No bike!

Fit a bike alarm to your bike and it'll scream its head off if some light fingered larrikin tries to lift it. Easy to build, easy to fit — suits most motorcycles. Cat K-3249

\$39.95

Car Alarm

The ultimate in protection! One of the best alarms around. Includes its own siren output. Cat K-3252

\$79.95



Digital Counter

A 1GHz Digital Frequency Counter with sensitivity of around 20mV. Based on the very latest technology LSI chips, this outstanding design features specifications at least the equal of commercial units costing many times the price.
Cat K-3437

\$259



Power Supply

The electronics to suit either two 50 watt modules or one 100 watt module, including speaker de-thump circuitry but not including transformer. Cat K-3438

\$23.95



FUNWAY

Dick Smith's own FunWay into Electronics

Here's a great value: the FunWay One Gift Box. All the components needed to build any of the projects in FunWay One... and the book is included too! Cat K-2605

\$26.95



FunWay Three

The real professionals! Build the FunWay Three kits and you'll be ready to tackle most projects. The FunWay Three Bonus Pack includes the FunWay Three books and TWO popular FunWay Three kits.
Cat K-2670

\$29.95



FunWay One Project Packs

Two project packs to allow you to build any of the kits. Project Pack One allows you to build any of the first ten, Project Pack Two gives you the additional components to build any of the 20 kits (needs Pack One too!)



FunWay One: Project Pack One. Cat K-2600 **\$8.95**



FunWay One: Project Pack Two. Cat K-2610 **\$9.95**

FunWay Two

Ready for something more advanced? FunWay Two has another twenty projects to build — all on modern printed circuit boards. And we even teach you how to solder! Cat K-2620

\$26.95



One, Two and Three Gift Box

If they're really into electronics, they'll LOVE the Gift Box. It has kits to build from all three FunWay Books.
Cat K-2680

\$59.95



And the really big one... Get the Jumbo Gift Box!

Over thirty great projects to build from all three FunWay books. And the books are included! Over \$120 worth of goodies crammed into this value-packed box.
Cat K-2690

\$99.95

CALL DSXpress TOLL FREE ON

(008)22 6610

For 24 hour despatch
SYDNEY (02) AREA 888 2105

DSX PRESS
DICK SMITH ELECTRONICS EXPRESS ORDER SERVICE

DICK SMITH ELECTRONICS

PTY LTD

World Radio History

Ready for the BIG ones in '88?

What a year on TV! The Bicentenary — think of the coverage that'll have. And the Olympics — sensational!

Is your TV antenna system up to it?

If it's typical of most, it's not (up to it, that is!). Probably put up when TV started (that's over thirty years ago!): the antenna's probably broken, corroded or bent, the lead-in's probably pretty suspect too.

Fix them — before '88. And get ready for the Big Events of '88!

The Right Antenna for YOUR Area . . . at the Right Price!

ALL PACKS ONE SPECIAL LOW PRICE: \$49⁹⁵ EA!!!

That's right: DSE's special VHF/UHF antenna pack suiting EVERY local area translator in Australia! We've put together a number of special antenna packs to ensure that no matter what combination of VHF & UHF bands, or polarities, you're covered! Don't know which one you need? Ask us!

(Note: Many areas do not yet have local area translators. In that case the L-4025 antenna will normally suffice).

Specific Area Packs:

- Most areas: Combination VHF/UHF band IV (SBS) L-4001
- Canberra: Two antennas in pack (VHF & band V UHF) L-4002
- Newcastle/Wollongong: Two antennas in pack L-4003
- Ballarat: Special channel 3 & 6 VHF Antenna L-4006
- Bendigo: Special channel 1 & 8 VHF Antenna L-4007
- Albury: Special channel 1 & 4 VHF Antenna L-4008

Order by phone. 24 hour despatch through DSXpress.
CALL TOLL FREE (008) 22 6610 (Sydney Area, call 888 2105)

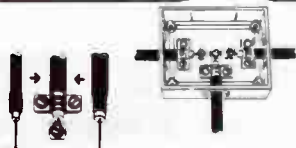

More than one TV?

Don't just connect them together: it doesn't work! Use a splitter for optimum performance — sets won't interfere with each other.

Cat L-4472

\$5⁴⁵



Two Antennas?

UHF & VHF Antennas don't need two lead-ins. Save money by using a diplexer — one lead in is much more convenient (saves madly swapping leads!) Cat L-4470

\$4⁹⁵

Cable:

DSE stocks top quality TV cable in both 75 ohm coax and 300 ohm twin lead.

75 Ohm — Air dielectric, low loss cable for external/internal installations. Dual shielded (foil/braid) with UV stabilised outer cover. Cat W-2082

300 Ohm — UV stabilised twin flat ribbon, low loss. Cat W-2070

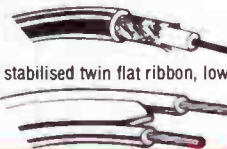

Need more Signal?

We have two amplifiers which might solve your problems . . .



Masthead Amp

Especially for long range viewing, a masthead amp often works wonders. Amplifies signal right at the antenna — away from the noise — for best possible results. Complete with mains supply.

Cat L-4200

\$75



In-line Amp

Especially suitable for multi-set use, great for VCR signal amplification. Simply plugs into output of VCR, splitter, etc, and lead to TV plugs into it. Mains power adaptor required. Cat L-4202

\$29⁹⁵

Need that extra range on VHF?

For country viewing (deep fringe area) or where signal levels are very low (shielded, etc) you'll probably need one of the "big guns": the phased array. High gain, high performance on all high VHF channels. Suitable for horizontal or vertical mounting.

Cat L-4025

\$99



How About FM Radio?

For best results an outside FM antenna is essential. Ours is specially designed for the FM band, can be erected in either polarity. 300 ohm type.

Cat L-4054

\$34⁹⁵



Coax Extension Lead

Perfect for wall socket to TV, VCR to TV, etc. 1.2m coax lead with male plugs both ends. Cat L-4506

\$4⁵⁰

Wall Sockets for Coax Cable

Two different types to choose from for that really professional installation: Skirting board type — Small and unobtrusive Cat L-4504

\$4⁹⁵



Wall Plate type — fits over standard wall box, can also be used as 75 ohm splitter for second or third TV. Cat P-2042

\$4³⁵



DICK SMITH ELECTRONICS

PTY LTD

World Radio History

Want a Hot Tip?

PORTASOL won't let you down.

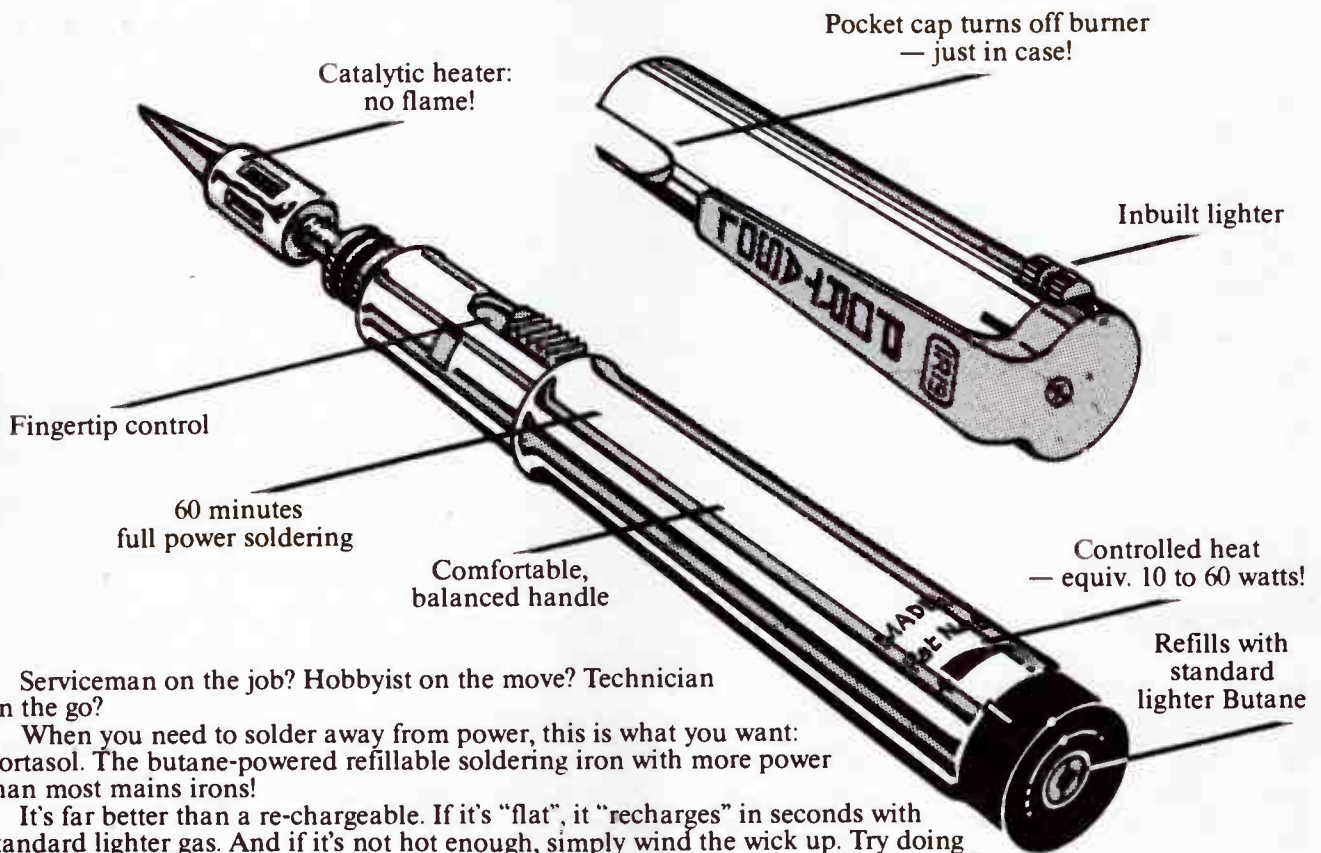

Serviceman on the job? Hobbyist on the move? Technician on the go?

When you need to solder away from power, this is what you want: Portasol. The butane-powered refillable soldering iron with more power than most mains irons!

It's far better than a re-chargeable. If it's "flat", it "recharges" in seconds with standard lighter gas. And if it's not hot enough, simply wind the wick up. Try doing that with a NiCad!

Perfect for all soldering applications — even those heavy jobs you'd normally want a "big gun" for. Yet it's small enough to slip into the shirt pocket (and in case you leave it on, the cap turns it off for you!)

Just think of the applications apart from electronics: Boat wiring and repairs. Auto electrics. Builders/electricians. Antenna installers. And so many more.

Portasol: it's a breakthrough in soldering. Throw away your old ideas about soldering. Get a Portasol and you'll get the difference. Cat T-1370

Spare tips including Catalytic Heater

\$12⁹⁵

Cat T-1371

Only **\$39⁹⁵** at **DICK SMITH ELECTRONICS**

PTY LTD

Available at all DSE stores . . . or phone DSXpress on (008) 22 6610 (Sydney 888 2105)

A financial request

Regular readers of this column will be well aware of my enthusiastic support for BBS operators. Indeed, this is not the first time that I have asked for financial assistance or sponsorship for a struggling BBS operator. It has been drawn to my attention that ALWYN SMITH (3/3 on the OPUS Network) is in dire need of some corporate sponsorship to help meet the enormous bills that he is currently footing from his own pocket. Alwyn, however, is not a normal BBS (which ones are?, I quite rightly hear you ask) – Alwyn runs the Echomail Gateway in Queensland. It is his BBS that is responsible for seeing that all Echomail messages are distributed to other countries. If Alwyn has to close down, goodbye Gateway and Goodbye Echomail.

If anyone out there is prepared to help with the cost of running this entirely voluntary service, would they please leave a message on Echomail on any OPUS board.

Whilst on the subject of bulletin boards, the same operator that was telling me about Alwyn Smith, was also lamenting the work he had to do to rebuild his hard disk after a Trojan slipped through. Sure, he did his backup, but for a BBS operator, to fully recover his system, he'd need to backup every hour. Most BBS operators I know of usually run their BBS whilst they're off at work, so recovery can be a very messy process. I am at a total loss to explain the mentality of these worms (not the programs, the coelenterates that write and distribute them). It must be a very twisted mind that performs this type of foul deed. Perhaps some psychologist who reads my column (there must be at least ONE who does) would like to offer some explanation as to what motivates these lower forms of animal life.

Networking

I recently had the pleasure of attending a demonstration of networking at ICL House (100 Arthur Street, North Sydney). A Mr Phil Dodd was showing a group of us ICL's networking hardware and software, and very nice it was too. ICL even have a TRUE multi-user, multi-tasking version of MS-DOS operating (Version 4.1). This version of DOS enables ICL's series of PC clones to talk to their minis and mainframes of an Ethernet link. It all worked. ICL's version of "Windows" was also quite impressive.

The other interesting part of the session was a talk on the implementation of OSI (Open Systems Interconnection) which is the International standard for LAN and WAN networking. ICL have a very informative little booklet available, which explains all the ins and outs of OSI. I am sure that they would be only too glad to provide a copy to any interested party. Phil Dodd also discussed a new type of standard for networking of which I was unaware. This is the ODA (Office Document Architecture), which provides for an International standard on the way a WP document or FAX message can be

transmitted between inherently incompatible computers and their individual WP packages. ODA provides a means for standardising such things as headers, footers, in-text styling (bold, underline, italics etc.), as well as providing standard codes for inclusion of graphics images (both scanned and digitised) and any other option want could possibly wish for in a document. The ODA uses a software package called ODIF (Office Document Interchange Format) to handle the conversion in a transparent fashion. ODA is not only supported by ICL, but by other computing/electronics heavyweights such as Honeywell-Bull, Olivetti and Siemens.

Once again, ICL have a very informative brochure on ODA which I am sure they would be glad to make available. I admit to having a special place in my heart for ICL. The first computer I ever used in a big way was an ICL 1004, which we had to program by hard wiring a huge plug-board. Those were the frustrating days of programming, where there were suggestions made about uses of programming wires which I am sure ICL never dreamed of – at one stage one of our office partitions was held up by several of the longer ones.

Comms programs

Last month I promised to discuss two more Public Domain comms programs – Boyan and Pibterm. These are the last two packages that I intend to discuss and next month we will move onto a different topic. If any readers are aware of the omission of an important package, however, I will be only too glad to include it in a future column if they provide me with the necessary details (Name, BBS service it lives on and approximate size of the package).

PIBTERM

Pibterm is very similar to Procomm in its operation, with several important differences. Firstly, Pibterm uses the ALT/I for a pull-down help menu, rather than the HOME key and the prompt for this help screen is not always present on the screen. Secondly, Pibterm provides its own rudimentary line editor, which is sufficient for 95% of all editing requirements. I used the in-built editor to correct mistakes in commands. Invoking the editor uses the almost standard ALT/A command. One of the first things I did to Pibterm was to change the screen colour. Some of these packages come with the most ghastly (to my thinking, anyway) combinations of colours that one could imagine. Pibterm is not my favourite comms package for the manner in which it goes about this task. All of the available settings are called up using the ALT/P key (shown in Figure 1) and the video mode and colour is shown as Option m from this menu. Unfortunately, Pibterm does NOT show you the effect of these colours as you change them, so it's possible to end up with a rather ghastly combination and so it's back to square one.



The Bit Stream Flyer

Undoubtedly the cheapest 1200/1200 bps (V22) modem in Australia – and all Australian made!

ONLY \$199! (Allow \$8.00 delivery).

BANKCARD & MASTERCARD accepted.

MAESTRO DISTRIBUTORS

Calool St,
5th Kincumber 2256 NSW
(043)68 2277, 68 2278

A feature about Pibterm that I do like, however, is the ability to Toggle the checks for CTS (Clear To Send) and DSR (Data Set Ready). This prevents the program from hanging on those computers that don't support these lines. Figures 1, 2 and 3 show the selections available from the ALT/P set-up menu.

```
[ Set parameters ]
a) Communications Port
b) Speed (Baud Rate)
c) Parity
d) Data Bits
e) Stop Bits
f) Backspace
g) Linefeed toggle
h) Terminal Type
i) Modem setup
j) File transfer protocol
k) Kermit parameters
l) Screen dump file name
m) Video mode and colors
n) Miscellaneous
s) Execute Script file
w) Write new config file
q) QUIT SETUP
```

Figure 1

Figure 2

```
[ Default file transfer protocol ]
a) Ascii
b) Xmodem (Checksum)
c) Xmodem (CRC)
d) Kermit
e) QMODEM
f) Modem7 (Checksum)
g) Modem7 (CRC)
h) Ymodem
i) Ymodem (Batch)
j) None
```

```
[ Miscellaneous Parameters: ]
a) EXEC PC BBS Commands
b) CompuServe B Protocol
c) Exploding menus
d) Review scrolled lines
e) Xmodem download buffer size
f) Greenwich mean time lag
g) Write directly to screen memory
h) Check Clear To Send
i) Check Data Set Ready
q) QUIT
```

Figure 3

As can be seen from these figures, Pibterm offers several features that are unavailable on all the previously mentioned packages. Hopefully, you'll all be able to pick and choose and end up with the package that most suits your needs. Everything considered, Pibterm would be in the top four PD packages.

BOYAN

Boyan is a comms program written by an individual, rather than a committee. The designer has chosen to go his own way and not use the standard types of function keys. I found Boyan to be a bit of a problem, because Mr Justin Boyan has used the CTRL/HOME combination to invoke the help screen and my little Bondwell laptop has a real problem with this combination. I have included a diagram of the command help screen here to assist readers in making a judgement as to Boyan's worth.

Figure 4

BOYAN v. D1	COMMAND MENU	FILE/DOS COMMANDS	On-line Help
MODEM COMMANDS			
Dial a number	Alt-D	Directory File Manager	Del
Queue Redial Menu	Alt-Q	Upload File	PgUp
Hang up	Alt-H	Download File	PgDn
Parameter change	Alt-P	Free space on disk	Alt-F
Send modem break signal ***	Ctrl-End	Info about a file's size	Alt-I
MISCELLANEOUS COMMANDS			
Configure BOYAN	Alt-C	New drive/subdirectory	Alt-N
Scroll back last text	↑	Issue DOS command	Ins
Zap (Clear) screen	Alt-Z	Jump to DOS	Alt-J
Save screen image to disk ***	Alt-S	View file	Alt-V
Use default text color	Alt-U	TOGGLES (now)	
Enter macro manually	Alt-M	Beeps and bells ***	CON) *** Alt-B
Run script file block	Alt-R	Echo keyboard	COFF) *** Alt-E
EXIT BOYAN	Alt-X	ANSI Graphics	CON) *** Alt-A
FURTHER HELP	Ctrl-Home	Translation table **	CON) *** Alt-T
ENTER COMMAND, or <ESC> to exit. ■ BOYAN v. D1 ■ by Justin Boyan, Feb, 1987			

As I have spent a large amount of space telling you all about these PD programs, let me now rank them in order of preference:-

1. Telix
2. QModem
3. Procomm
4. Pibterm
5. ZComm
6. Boyan
- 7.
- .
- .
- .
40. All the rest

Honestly, if you can't pick a winner from the first six on the list, then you'd probably be better off buying a commercial package. The order of the first two is not important, either, as I rank them about equal.

That's all for this month, next month I will discuss all the features of a modern BBS. 🐁

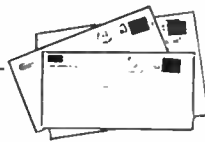

Question on crossover for our 6103 3-way speakers

Dear Sir,

I have recently built a pair of VIFA/AEM three-way speakers which were purchased from a local supplier. My query relates to the crossover network supplied.

The first indication that something was different was that the leads were of insufficient length to reach the speakers when the crossover was mounted in the base of the speaker box. Also, the lead colours did not correspond with the instructions. As a result, I contacted Scan Audio in Melbourne to clarify the situation. I was told that the crossover had been changed to give a "better performance".

The units supplied do not use third order filters throughout, but a mixture of orders for the various drivers. My question is, what is the effect on the speaker performance of these crossovers and what is your opinion of the situation?

I find it hard to believe that the result could be anything but detrimental, considering the effort which went into the design and the results obtained from the prototypes. I might add that the instructions supplied with the speakers quote the kits as "VIFA/AEM6103". (the writer supplied a sketch of the crossover circuit - Ed.)

Subjectively, the bass response seems excessive, but without a comparison, it is difficult to assess.

I intend in the near future to build an AEM6000 amplifier to drive the speakers, so the speaker quality is important to me. I am concerned, especially considering the outlay involved.

I would also like to congratulate you on your excellent magazine which I have been buying since the first issue.

A. Williams,
Canberra, ACT.

Thank you for your letter and for your support of the magazine. I can understand your concern with the situation, but hopefully, I can put your mind at ease. I spoke with Mike Henriksen of Scan Audio to get some background information and details on the kit you put together.

The original AEM6103 design is now nearly three years old and since that time, there has been significant development in loudspeaker design theory. The modified crossover is based on the results of this research and in particular, the research conducted in Canada by Floyd E. Toole, Scan Audio say.

If you refer to the response graph in the original design, you will notice that there is something of a depression in the response between about 100 Hz and 5 kHz. Also, the original crossover design slowly rolled off the top end response from around the upper mid-range. The result of this design was that the system was considered "too flat" for some domestic listening situations.

The modified crossover corrects both of these qualities and, as Scan Audio explain, provides a wider linear dispersion. I should add that the modified crossover is "Tilbrook approved" and certainly does not degrade the performance in any respect. In answer to your question (written on the circuit diagram) concerning phasing, the speaker phasing is correct as shown with the modified crossover. (The original design required the mid-range drive to be connected in reverse with respect to the woofer and tweeter connections. In the 'new' crossover, all drivers are connected with the same phase).

With regard to the perceived excessive bass response, I feel that this may be due in part to the placement of the speakers. If you have the speakers placed on the floor, try mounting them a little higher and check the results.

Scan Audio advise that the speakers supplied by them which include the modified crossover are identified by the model number SA130. They can still provide the original system, identified as 6103, if desired.

I trust this information is of some assistance to you and I hope you are as impressed with the AEM600 power amplifier as many of our other readers indicate.

Andrew Keir

Synth circuits for the guitarist - again

Dear Sir,

Having read the letter and reply about a guitar to music synthesiser interface (June issue, page 8), I thought I would write and perhaps shed some light on the subject.

John East is right regarding the technical difficulties in the design and implementation of accurate pitch (frequency) to voltage converters, but a number of designs have appeared in print over the last 10 or more years, and not only in *Electronotes*.

Craig Anderton (Editor of *Electronic Musician*) published a series of guitar to synthesiser circuits in a now defunct magazine called *Device*. The publica-

tion later merged with the magazine *Polyphony* which recently became *Electronic Musician*.

This instrument, the AMS 100 ("Audio Modification System") consisted of some unique modules, such as "envelope pluck followers", voltage controlled (VC) phase shifters, VC flangers, VC distortion and rhythm pattern generators; various other modules have appeared in *Polyphony* and *Electronic Musician*.

Although this unit was monophonic, Craig already has a six voice polyphonic system up and running which he intends to publish at a later date.

Another unit can be found in the May '86 edition of the British magazine *Practical Electronics*. This unit is called the guitar tracker and is essentially a pitch to voltage converter and a VCA in one package. The control voltage of the VCA can be anything.

I hope this information is of some use to you.

Tim Corfield,
Wiley Park, NSW

Assistance with the 4504 Speech Synth.

Dear Sir,

On reading the letter from Mr L. Ross of Canley Heights regarding the connection of the AEM4504 speech synthesiser to his SEGA SC-3000 computer, I decided I may be able to offer some assistance.

Of the Sega's I/O ports, only the serial port used for serial type printers would seem to be suitable for use with AEM4504. The 44-way card edge connector would appear to be impractical as there is no pinout information available, connectors are difficult to find and the BASIC cartridge uses all the lines.

If Mr. Ross is desperate, he could invest in a "Super Control Station" which includes extra memory, a three-inch disk drive and a parallel printer port. Information on this unit is available from P.H. Computers, 89b Foster Street, Dandenong 3175 Vic. This company may also be able to supply a parallel printer interface.

Whilst the Sega has no decent interfacing and is terribly slow, it does have excellent graphics and sound which is why I run one in addition to my PC compatible. I hope this information will be of some help.

"Merlin"
Mentone, Vic.

ALL ELECTRONIC COMPONENTS

118-122 LONSDALE STREET, MELBOURNE, VIC. 3000. TEL: 662-3506

Division of DOTHAIN Pty. Ltd.
FAX (03) 663-3822

TALK ABOUT A HUGE RANGE OF KITS!

STEREO UNITS

S2 ETI 482 50 watt per channel Amplifier
S3 ETI 482A Preamp Board
S4 ETI 482B Tone Control Board
S6 ETI 480 50 watt Amplifier
S7 ETI 480 100 watt Amplifier
S9 ETI 443 Expander Compressor
S10 ETI 444 Five watt stereo
S12 ETI 438 Audio Level Meter
S16 ETI 426 Rumble Filter
S35 ETI 470 60 watt audio amplifier module
S36 ETI 4000 Series 60 watt stereo amplifier
S37 ETI 451 Hum Filter for Hi-Fi systems
S38 E.A. Stereo Infrared Remote Switch
S39 ETI 455 Stereo Loudspeaker Protector
S40 E.A. Super-Bass Filter
S42 E.A. Stylus Timer
S43 ETI 3000 Series Amplifier 25 w/ch
S44 ETI 477 Mostel power amp module inc. brackets
S45 ETI 457 Scratch/Rumble Filter
S46 ETI 458 VU Level Meter
S47 ETI 479 Bndging Adaptor
S48 ETI 5000 Series Power Amplifier
S49 ETI 494 Loudspeaker Protector
S50 EA Infrared TV Sound Control
S51 HE 121 Scratch & Hiss Filter
S52 EA 100W Sub Woofer Module
S53 EA Stereo Simulator
S54 EA Headphone Amp
S55 AEM 6500 60W Utility Amp Module
S56 AEM 6500 100W Utility Amp Module
S57 ETI 1405 Stereo Enhancer
S58 ETI 442 Master Play Stereo
S59 EA Led Bar Graph Display (Stereo)
S60 EA AM Stereo Decoder
S61 EA 1 Watt Utility Amp
S62 ETI 453 General Purpose Amp
S63 EA Bndge Adaptor
S64 AEM 6503 Active Cross-Over

STAGE

ST1 ETI 592 Light Show Controller (3 ch.) (1000 w ch)
ST2 ETI 593 Colour Sequencer (for use with ETI 592)
ST4 E.A. Light Chaser 3 channel
ST5 E.A. Twin Tremolo for Organs Stage Amps
ST7 ETI 499 150 w Mostel P.A. Module
ST8 ETI 498/499 150 w Public Address Amplifier
ST9 E.A. Musicolor IV
ST10 EA Musicolor III
ST12 ETI 287 LEO Light Chaser

PRE-AMPLIFIER AND MIXERS

P1 ETI 445 Stereo Pre-Amplifier
P2 ETI 449 Balance Mic Pre-Amplifier
P6 ETI 419 Mixer Pre-Amplifier — 4Ch or 2Ch
P11 ETI 446 Audio Limiter
P12 ETI 471 High Performance Stereo Pre-Amplifier
P13 ETI 473 Moving Coil Cartridge Pre-Amp
P14 ETI 474 High to low impedance Interface
P15 ETI 467 4 Input Guitar Mic. Pre-amp suits ETI 466
P16 E.A. Moving Coil Pre-Amplifier (Battery)
P17 E.A. Moving Coil Pre-Amplifier (Plug pack)
P18 ETI 478 MM Moving Magnet Pre-amp (Series 5000)
P19 ETI 478MC Moving Coil Pre-amp (Series 5000)
P20 ETI 478 Series 5000 Pre-Amplifier
P21 E.A. Vocal Canceller
P22 ETI 461 Balanced Pre-Amplifier
P23 HE 112 Micromixer
P24 EA Effects Unit
P25 ETI 1404 4-Channel Mixer
P26 ETI 588 Theatrical Lighting Controller

GUITAR UNITS

G1 ETI 447 Audio Phaser
G14 ETI 452 Guitar Practice Amplifier
G15 ETI 466 300 watt Amp module
G16 ETI 454 Fuzz Sustain
G17 HE 102 Guitar Phaser
G18 ETI 450A Bucket Brigade
G19 ETI 450B Mixer for above
G20 E.A. guitar Pre-amplifier
G21 Sonics ME2 Sonics ME2 Wah Wah Pedal-less pedal
G22 EA Effects Unit
G23 ETI 1410 Bass Guitar Amp (150W)

AUDIO TEST UNITS

AT1 ETI 441 Audio Noise Generator
AT2 ETI 128 Audio Millivolt Meter
AT7 ETI 137 Audio Oscillator
AT9 HE 105 Bench Amplifier
AT10 E.A. Audio Test Unit
AT11 E.A. Function Generator
AT12 ETI 464 Audio Test Unit

TIMERS

T1 ETI 650 STAC Timer
T2 ETI 564 Digital Wall Clock
T4 ETI 540 Universal Timer
T5 ETI 265 Power Down

T6 EA 4 Digit L.C.D. Clock or Control Timer

COMMUNICATION EQUIPMENT

CE1 ETI 711 Remote Control Transmitter Switch
CE2 ETI 711R Remote Control Receiver
CE3 ETI 711D Remote Control Decoder
CE4 ETI 711B Single Control
CE5 Double Control
CE6 ETI 711P Power Supply
CE9 ETI 708 Active Antenna
CE11 ETI 780 Novice Transmitter
CE12 ETI 703 Antenna Matching Unit
CE33 ETI 718 Shortwave Radio
CE34 ETI 490 Audio Compressor
CE35 ETI 721 Aircraft Band Converter (less XTALS)
CE37 ETI 475 Wide Band A.M. Tuner
CE38 E.A. Masthead Pre-amplifier
CE39 ETI 731 R.T.T.Y. Modulator
CE40 ETI 729 UHF TV Masthead Preamp
CE41 ETI 735 UHF to VHF TV Converter
CE42 HE 104 AM Tuner
CE43 HE 106 Radio Microphone
CE44 E.A. R.T.T.Y. Demodulator
CE45 E.A. Voice Operator Relay
CE46 ETI 733 RTTY Converter for Microbee
CE47 ETI 1517 Video Distribution Amp
CE48 EA Video Enhancer
CE50 ETI 1518 Video Enhancer
CE51 EA VCR Sound Processor
CE 52 EA Motorcycle Intercom
CE 53 ETI 1405 Stereo Enhancer
CE 56 ETI 755 Computer Driven RTTY Transceiver

METAL DETECTORS

MD1 ETI 549 Induction Balance Metal Detector
MD2 ETI 561 Metal Locator
MD3 ETI 1500 Discriminating Metal Locator (undrilled case)
MD5 ETI 562 Geiger Counter with ZP 1310 Tube
MD6 ETI 566 Pipe and Cable Locator
MD7 E.A. Prospector Metal Locator including headphones

TEST EQUIPMENT

TE2 ETI 133 Phase Meter
TE9 ETI 124 Tone Burst Generator
TE16 ETI 120 Logic Probe
TE17 ETI 121 Logic Pulser
TE34 ETI 487 Real Time Audio Analyser
TE35 ETI 483 Sound Level Meter
TE36 ETI 489 Real Time Audio Analyser
TE37 ETI 717 Cross Hatch Generators
TE38 E.A. 3 Mhz Frequency Counter
TE39 EA High Voltage Insulation Tester
TE42 E.A. Transistor Tester incl. BiPot & F.E.T.S
TE43 ETI 591 Up Down Pre-settable Counter
TE44 ETI 550 Digital dial (less case) includes ETI 591
TE46 ETI 148 Versatile Logic Probe
TE47 ETI 724 Microwave Oven Leak Detector
TF48 ETI 150 Simple Analog Frequency Meter

TE51 E.A. Digital Capacitance Meter
TE52 ETI 589 Digital Temp. Meter
TE53 E.A. T.V.C.R.O. Adaptor
TE54 E.A. XTAL Locked Pattern Generator
TE55 E.A. Decade Resistance Sub Box
TE56 E.A. Capacitance Sub Box
TE57 E.A. Decade Capacitance Sub Box
TE58 E.A. Tantalum Capacitance Sub Box
TE60 ETI 572 PH Meter
TE61 ETI 135 Panel Meter
TE63 HE 103 Transistor Tester
TE64 HE 111 Ohm meter
TE65 ETI 157 Crystal Marker
TE66 ETI 161 Digital Panel Meter
TE67 ETI 255 Analog Thermometer
TE68 EA Transistor Tester
TE69 ETI 175 20 MHz Dig. Frequency Meter (Hand held)
TE70 ETI 166 Function Pulse Generator
TE 72 AEM 5505 Hash Harrier
TE 74 ETI 183 OP-Amp Tester
TE75 ETI 572 Digital pH Meter

MODEL TRAIN UNITS (see also "SOUND EFFECTS")

MT1 ETI 541 Model Train Control
MT2 E.A. 1974 Model Train Control
MT3 EA Railmaster — Including Remote

SOUND EFFECTS

SE1 E.A. Sound Effects Generator
SE3 E.A. Cylon Voice
SE4 E.A. Steam Whistle
SE5 ETI 607 Sound Effects
SE6 E.A. 492 Audio Sound Bender
SE7 E.A. Electronic Sea Shell Sound Effects
SE8 ETI 469A Percussion Synthesiser
SE9 ETI 469B Sequencer for Synthesiser
SE10 EA Effects Unit
* set as for Steam Train and Prop Plane noise

VOLTAGE/CURRENT CONTROLS

V1 ETI 481 12 volt to ± 40v D.C. 100 watt Inverter
V2 ETI 525 Drill Speed Controller
V6 E.A. 1976 Speed Control
V10 E.A. Zero-voltage switching heat controller
V11 E.A. Inverter 12v D.C. input 230v 50 Hz 300VA output
V12 ETI 1505 Fluorescent Light Inverter
V13 EA Electric Fence
V14 ETI 1506 Xenon Push Bike Flasher
V15 ETI 1509 DC-DC Inverter
V16 ETI 1512 Electric Fence Tester
V17 EA Fluro Light Starter

V19 HE126 Nicad Charger

V20 ETI 578 Simple Nicad Charger
V21 EA Heat Controller
V22 ETI 563 Fast Ni-Cad Charger
V23 EA High Voltage Insulation Tester
V24 EA Electric Fence Controller
V25 ETI 1532 Temp Control for Food Sealing Irons

WARNING SYSTEMS

WS1 ETI 583 Gas Alarm
WS3 ETI 528 Home Burglar Alarm
WS4 ETI 702 Radar Intruder Alarm
WS7 ETI 313 Car Alarm
WS12 ETI 587 House Alarm
WS14 E.A. 1976 Car Alarm
WS15 E.A. 10 Ghz Radar Alarm
WS16 E.A. Light Beam Relay
WS17 ETI 247 Soil Moisture Indicator
WS18 ETI 250 Simple House Alarm
WS19 ETI 570 Infrared Trip Relay
WS20 ETI 585 T&R Ultrasonic Switch
WS21 ETI 330 Car Alarm
WS22 ETI 322 Over Rev Car Alarm incl case
WS24 ETI 1506 Xenon Bike Flasher
WS25 ETI 340 Car Alarm
WS26 EA Deluxe Car Alarm
WS27 EA Ultrasonic Movement Detector
WS28 ETI 278 Directional Door Minder
WS 29 EA Multisector Home Security System
WS30 EA Infra-Red Light Beam Relay
WS31 EA Deluxe Car Alarm
WS32 EA Doorway Minder
WS33 EA "Screacher" Car Alarm
WS34 ETI 1527 4 Sector Burglar Alarm

PHOTOGRAPHIC

PH1 ETI 586 Shutter Speed Timer
PH3 ETI 514B Sound Light Flash Trigger
PH4 ETI 532 Photo Timer
PH7 ETI 513 Tape Slide Synchronizer
PH12 EA Sync-a-Slide
PH15 ETI 553 Tape Slide Synchronizer
PH16 E.A. Digital Photo Timer
PH17 ETI 594 Development Timer
PH19 F.A. Sound Triggered Photoflash
PH20 HE 109 Extra Flash Trigger
PH21 E.A. Photographic Timer
PH22 ETI 182 Lux Meter
PH23 ETI 1521 Digital Enl Exposure Meter
PH24 ETI 279 Exposure Meter

POWER SUPPLIES

PS1 ETI 132 Experimenters Power Supply
PS2 ETI 581 Dual Power Supply
PS3 ETI 712 CB Power Supply
PS4 ETI 131 Power Supply
PS9 E.A. 1976 Regulated Power Supply
PS11 E.A. C.B. Power Supply
PS12 ETI 142 Power Supply 0-30 V 0-15 A (fully protected)
PS13 ETI 472 Power Supply
PS15 ETI 577 Dual 12V supply
PS16 E.A. Power Saver
PS17 ETI 480 PS Power Supply for ETI 480 (100 watt Amp)
PS18 E.A. Bench Mate Utility Amplifier Power Supply
PS20 ETI 163 0-40 V 0-5 A
PS21 EA Dual Tracking Power Supply
PS22 ETI 162 1-3-30 Volt, Fully Adjustable
PS23 ETI 251 OP-AMP Power Supply

COMPUTER AND DIGITAL UNITS

C1 ETI 633 Video Synch Board
C2 ETI 632M Part 1 Memory Board V.O.U.
C3 ETI 632P Part 1 Power Supply V.O.U.
C4 ETI 632A Part 2 Control Logic V.O.U.
C5 ETI 632B Part 2 Control Logic V.O.U.
C6 ETI 632C Part 2 Character Generator V.O.U.
C8 ETI 632 U.A.R.T. Board
C9 ETI 631-2 Keyboard Encoder
C10 ETI 631 A.Sch Keyboard Encoder
C14 ETI 638 Eprom Programmer
C15 ETI 637 Cuts Cassette Interface
C16 ETI 651 Binary to Hex Number Converter
C17 ETI 730 Getting Going on Radio Tele Type
C24 ETI 760 Video RF Modulator

C25 E.A. Eprom Programmer
C26 ETI 668 Microbee Eprom Programmer
C27 ETI 733 RTTY Computer Decoder
C28 EA Video Amp for Computers
C29 ETI 649 Microbee Light Pen
C30 ETI 675 Microbee Serial — Parallel Interface
C31 ETI 688 Programmer for Fusable — Link Bipolar Proms
C32 ETI 676 RS232 for Microbee
* all V.D.U. projects priced less connectors
C33 ETI 678 Rom Reader For Microbee
C34 ETI 659 VIC 20 Cassette Interface
C35 ETI 683 Mindmaster — Human Computer Link
C36 EA Eprom Copier/Programmer
C37 ETI 699 300 Band Direct-Connect Modem
C38 AEM 3500 Listening Post
C39 AEM 4600 Dual Speed Modem
C40 ETI 1601 RS 232 For Commodore
C41 AEM 4504 Programmer for Fusable — Link Bipolar Proms

C42 ETI 181 Breakout Box

BIO FEEDBACK

BF1 ETI 546 G.S.R. Monitor (less probes)

BF2 ETI 544 Heart Rate Monitor

BF3 ETI 576 Electromyogram

AUTOMATIC UNITS

A1 ETI 317 Rev. Monitor
A2 ETI 081 Tachometer
A3 ETI 316 Transistor Assisted Ignition
AA ETI 240 High Power Emergency Flasher
A6 ETI 312 Electronic Ignition System
A7 ETI 301 Van-Wiper
A14 E.A. Dwell Meter
A22 ETI 318 Digital Car Tachometer
A23 ETI 319A Variviper Mk 2 (no dynamic braking)
A24 ETI 319B Variviper Mk 2 (for dynamic braking)
A25 ETI 555 Light Activated Tacho
A26 ETI 320 Battery Condition Indicator
A27 E.A. Transistor Assisted Ignition
A28 ETI 324 Twin Range Tacho less case
A29 ETI 328 Led Oil Temp Meter less V.D.O. probe
A30 ETI 321 Auto Fuel Level Alarm
A31 ETI 332 Stethoscope
A32 ETI 325 Auto Probe Tests Vehicle Electricals
A33 ETI 333 Reversing Alarm
A34 E.A. Low fuel indicator
A35 ETI 326 Led Expanded Voltmeter
A36 ETI 329 Ammeter (expanded scale)
A37 ETI 327 Turn and Hazard Indicator
A38 ETI 159 Expanded Scale Voltmeter
A39 EA Diodelectronic Ignition
A40 ETI 335 Wiper Controller
A41 EA Ignition Killer for Cars
A42 EA L.C.D. Car Clock
A44 ETI 337 Automatic Car Aerial Controller
A45 ETI 280 Low Battery Volt Indicator
A46 ETI 322 Over Rev Alarm
A47 ETI 345 Demster Timer

ELECTRONIC GAMES

EG1 ETI 043 Heads and Tails
EG2 ETI 068 L.E.D. Dice Circuit
EG3 E.A. Electronic Roulette Wheel
EG4 ETI 557 Reaction Timer
EG5 ETI 814 Dinky Die
EG6 E.A. Selector
EG7 HE 107 Electronic Dice
EG8 E.A. Photon Torpedo
EG9 HE 123 Alien Invaders
EG11 EA Chase-N-Chomp (Pac Man)

MISCELLANEOUS KITS

M1 ETI 604 Accentuated Bell Metronome
M4 ETI 547 Telephone Bell Extender
M7 ETI 044 Two Tone Doorbell
M10 ETI 539 Touch Switch
M25 E.A. Digital Metronome
M37 ETI 249 Combination lock (less lock)
M46 E.A. Power Saver for induction motors
M48 E.A. Lissajous Pattern Generator
M53 ETI 247 Soil Moisture Alarm
M55 E.A. Pools Lotto Selector
M56 ETI 256 Humidity Meter
M57 ETI 257 Universal Relay Driver Board
M58 E.A. Simple Metronome
M59 ETI 1501 Neg. Ion Generator
M60 ETI 1516 Sure Start for Model Aeroplanes
M61 ETI 412 Peak Level Display
M62 ETI 1515 Motor Speed Controller
M63 ETI 1520 Wideband Amplifier
M64 EA Phone Minder
M66 EA Simple L.C.D. Clock
M67 EA Ultrasonic Rule
M68 AEM 1500 Simple Metronome
M69 AEM 5501 Negative Ion Generator
M70 AEM 4501 8-Channel Relay Interface
M71 EA Pest Off
M72 ETI 606 Electronic Tuning Fork
M73 ETI 184 In-Circuit Digital IC Tester

PLUS MANY, MANY MORE KITS WHICH WE CANNOT LIST HERE!!!
JUST CONTACT US FOR PRICE & AVAILABILITY.

PLUS — A HUGE RANGE
OF COMPONENTS
COMPANY & SCHOOL ACCOUNTS AVAILABLE.

1N5404

400PIV 3 AMP RECTIFIERS

Cat No 26-0115 **20c**
100+ 15c ea

4 & 5 Pin Utilux CONNECTORS

PLUG and SOCKET
Take your pick -
4 pin Cat 16-8050
5 pin Cat 16-8051

50c ea

12-15V DC Regulated 3A POWER SUPPLY KIT

Ideal for CB, car stereo alarms & battery charger
Has LM723 regulator, all parts + instructions

\$29 ea
Cat 11-1540

Electronics Australia's DIGITAL ELECTRONICS LOCK KIT

WITH PUSH-BUTTON KEYBOARD

The modern foolproof combination lock with easily changed access code and endless applications

\$29.50
Cat 11-1542
12V elect. lock release 19-4090 \$39.90

COMPUTER PAPER

2500 Sheets
11x9.5" letterheads **\$35**
11x9.5" blue-lined **\$33**
Usually about 11x15
\$48-\$64 each blue-lined **\$42**

2732 or 2732A EPROMS

250ns
32K 4Kx8

\$5.95
Cat 35-8142
10+ \$5.50 ea
50+ \$4.95 ea

BEST QUALITY

600/600Ω LINE TRANSFORMERS

(Removed from new equipment PCBs, never used)

\$3.95 EA
1-9
10+ \$3.50 ea
25 \$2.95 ea

Negative ION Generator kit

(Based on AEM5501 Sept. 1985)
A deluxe version of this most popular kit with HIGH/LOW output switch, higher voltage (-9500v), extra ion emitter, professional cabinet and ion emitter tester. Users claim a greater feeling of well being and relaxation. Cleans air of tobacco smoke and bacteria; increase concentration. Full instructions are included.

Was \$39.50
\$29.50
Cat No 11-1550
Built & Tested **\$49.50**
Cat No 11-1551

COMPUTER GRADE CAPS

N	100,000uf	10v	18-3501	\$ 6.00
E	120,000uf	15v	18-3502	\$ 7.50
W	6,800uf	16v	18-3503	\$ 4.00
A	10,000uf	16v	18-3504	\$ 6.00
B	68,000uf	16v	18-3505	\$ 9.50
C	22,000uf	25v	18-3506	\$ 9.00
D	33,000uf	25v	18-3507	\$12.00
F	4,700uf	40v	18-3508	\$ 6.00

41256

Big name manufacturers!

41256-15 (150ns) \$5.90
Each \$7.50 Qty 100 \$5.50 ea Qty 10+

41256-12 (120ns) \$6.90
Each \$8.50 Qty 100 \$6.20 ea Qty 10+

ASSORTED POTS

18-5001
20 MIXED VALUES \$5
Linear, log, our choice Cat 18-5002
100 MIXED VALUES \$20
Dual, switched, all new Cat 18-5003
250 MIXED VALUES \$35

IBM COMPATIBLE CARDS

Take 20% OFF these prices which already may be the lowest

XT Motherboard 4.77MHz **\$235**
expandable to 640K, add 41256's x 18
XT Turbo Motherboard 4.77 **\$289**
plus 8MHz, to 640K, add 41256's x 18
Multi I/O plus 2 disk controller \$199
card with serial + parallel ports.
Twin 360K disk drive cards **\$ 69**
Colour graphics card RGB or **\$180**
monochrome (640 x 200 dots) output
NEC 20MHz hard disk drive **\$795**
plus controller card.
Serial to parallel converter, lead **\$150**
DB25 to Centronics printer lead **\$ 24**
All new with full warranty. Limited qty

ALARM CONTROL PANEL

\$129
Cat 01-0939

Ideal for home, shop, office NO/NC instant and delay, complete with 12V rechargeable batteries, **WAS \$199**

Fuji 3.5" FLOPPY DISKS

Fuji 3.5" BEST QUALITY DISK Boxes of Ten only

55DD \$ 49
MF100 Cat 50-1020
D5DD \$ 59
MF200 Cat 50-1022
D5HD \$135
MF240 Cat 50-1023

COMPUTER ADD-ON BARGAINS!

Micron-Eye image digitizer **\$395**
for Commodore 64 etc (new, was \$595)
Commodore 64 power supply, **\$ 39**
Commodore Vic20/64 parallel **\$115**
printer interface (new, was \$199.00)
Commodore Vic20/64 30CPS **\$245**
dot matrix printer with graphics (new)
Microfazer by Quadram (USA) **\$150**
64K RS232 serial printer buffer (s/h)
Microfazer 64K Centronics **\$150**
printer buffer (s/h)
DB-10 (Japan) 64K printer **\$295**
buffer with copy function (new, \$450)
MODEMS, WITH PHONE HANDSETS (s/h)
Cicada 300 baud modem **\$110**
Sendata 300 + 1200/75 baud **\$255**
Microbee 300 baud Beemodem **\$150**

RM/FM Stereo Radio Headphones

by Toshiba/EMI
Working OK 100% but damaged (broken) plastic headbands

\$8 pr
Ideal to repair or rebuild
Original price \$69.95

Ferguson Transformers

9Vdc 200mA plug-pack SCOOP BUY!

240V AC input
9V DC 200mA out
Usually around **\$7.50** ea
Cat 02-2046

ELECTRONIC SIREN

Ideal for internal car or home alarm siren.
Mini size 90mm diam.
Warbler sound effect.
Input 12Vdc 300mA.
Output 98dB at 1m.

Was \$18, now **\$12** ea
Cat 03-2013

Complete ALARM SYSTEM

Covers doors and windows etc. Add infra-red detector if needed. Includes digital keypad + control module with 4 reed switches and siren. Programmable entry/exit delays, sited, easy instal. wiring supplied. Batt. oper.

\$39
Cat No 01-0920

EXTRA SIREN AVAIL. **\$15**
Plugs into existing module. 01-0921

ACCESSORY KIT **\$11**
3 extra reed switches. Cat 01-0922

INFRA-RED DETECTOR **\$119**
Requires 12Vdc power. Cat 01-5302
source at 25mA e.g. rechargeable batt.

SYNCHRONOUS MOTORS

With gearbox
3 models - Cat

6 RPM 24-1006 **\$9.50** ea
10 RPM 24-1010

WAREHOUSE CLEARANCE SALE!

Economy ALARM Control Module

inbuilt siren, NO instant + NC delay, 20 sec exit delay and reset 3 mins, on-off

\$18
Cat 01-0946 switch, 12Vdc 2Ma

INNOVATIVE WALL-MOUNTING PANEL SPEAKERS

Thin flat-panel styrene foam wall speakers (8Ω 15W 360x280x52mm) styled as a print or use your own photo/painting
Freq. 90-17000Hz
were **\$49** now **\$25** each

Miniature Side-Cutting PLIERS

High quality, 115mm long, insulated handles, best for electronics assembly etc.

Were \$17.45
\$8 EA
Cat 20-2320

SOLDERING TOOL KIT

Includes heatsink, reamer, scraper, brush, tweezers and screwdriver.

Was \$7.95 Save \$3
Cat 20-2456 **\$4.95**

VIDEO CASSETTE HEAD CLEANER

VHS OR BETA

Were **\$12.50**
Cat 04-1148
Now only **\$6** EA
Cat 04-1149

ULTRASONIC DETECTOR FOR CAR ALARMS

ONLY **\$49**
Cat 19-5252

Use with most alarms, detects movement inside the vehicle, relay N.O./N.C., 12Vdc

STEREO HEADPHONES FOR DIGITAL COMPACT DISC

The difference in bass, treble and sound dynamics is amazing! Clean and crisp with outstanding clarity yet lightweight L/R volume controls, 20-20KHz resp, 1000dB at 1KHz sensitivity, normally

RRP \$44.95, below cost at **\$20** pr.

3.5mm mono SOCKETS

These normally sell for 40 cents! But now you can buy them for -

1-19 10c ea
20-99 8c ea
100+ 5c ea

FANS

5" 220V AC
All tested OK
Cat No 06-1100

\$10 ea EX-COMPUTER

24-12Vdc CONVERTERS

Ideal for trucks, buses etc. Input 24Vdc Output 13.8Vdc, 2 models
4A Output (5.5A max) **\$69**
Cat 24-1050
10A Output (12A max) **\$105**
Cat 24-1055

New DIGITAL REMOTE SWITCH

Radio control, single trans and receiver, programmable code, range 12-15 metres.

Cat 01-0970
\$89

HI-FI STEREO TURNTABLES

SCOOP PURCHASE!

Fully Automatic model, **\$33**
rim/direct drive
(BSR replacement) Cat 03-2057
As made for AWA, 2 speed 33/45 RPM ceramic cartridge, 12V DC operation, 240V AC plug-pack \$7.50 All new!

PARTS VALUE PAKS

Lucky Dip Assortments

500 0.5w resistors
200 1w resistors
100 ceramic caps
30 greencaps
45 electrolytics
20 potentiometers
25 preset pots
30 mica caps
40 radio/TV knobs
15 various fuses
25 rf chokes
20 rt/it/osc coils
10 audio transformer
50 legstrips

\$2 EACH PAK
250 0.25w, 0.5w, 1w resistors
15 PAKS TO CHOOSE FROM

NEW FANS

High Quality from C I C Co Taiwan Ltd

10-49 \$16 ea
50-99 \$14 ea
100+ \$12 ea

\$20 EA Buy Now!

3" (80mm) 115V AC Cat 06-1019
3" (80mm) 240V AC Cat 06-1020
5" (120mm) 115V AC Cat 06-1029
5" (120mm) 240V AC Cat 06-1030
Finger Guards now available!
3" (80mm) \$1.50 ea Cat 06-1022
5" (120mm) \$1.50 ea Cat 06-1032

12V ROTATING FLASH LAMP

Motor-driven reflecting mirror flashes up to 150/minute, orange or blue lens, waterproof, for tow trucks, warning light etc. 12V DC 1A

Cat 01-5315
\$42

DIGITAL REMOTE CONTROL

Wireless trans/rec remote switch
2x10 Amp outputs to lock/unlock car central locking systems.
Programmable code, 12Vdc.
Cat 01-0972 LEO indic

\$149

TURNTABLE DRAWER

Glides in and out at the touch of a button. 240V AC and includes 12V supply

Cat 03-2058 Was \$60 Now **\$40**

LUCKY DIP Offer

13 is a lucky number! An interesting collection of samples, manufacturer's over-runs and excess incl. IC's, pots, diodes, resistors, capacitors, knobs, switches and lots of other useful junk!

\$13
Cat 04-0023

8,000uF 75vW ELECTROLYTICS

New, top quality 34mm diam x 85mm high

Cat no 18-5500 ea **\$8**
10+ ea **\$7.20**

PUSH-BUTTON DIGITAL TELEPHONE DIALERS

with last number memory re-dial feature

\$15 ea
Cat 24-3070

PRE-PAK electronics

1a West St, LEWISHAM, 2049
(02) 569-9797
Mon-Fri 9:00-5:30 Sat 9:00-1:00
BANKCARD MASTERCARD VISA AMEX
Pack/Post - \$3 plus 5% of order value, extra for heavy items.
WANTED: Electronic parts, computers, test equipment, CASH paid.

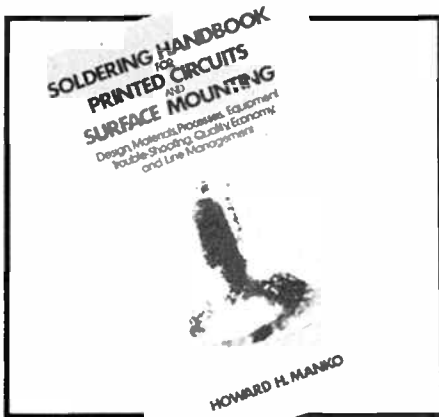

SOLDERING HANDBOOK FOR PRINTED CIRCUITS AND SURFACE MOUNTING by Howard H. Manko. Van Nostrand Reinhold, 1986. Hard covers, 430 pages 234 mm x 155 mm. ISBN 0442-26423-2. Priced at \$110.00. Review copy from Nelson Wadsworth, 480 La Trobe Street, Melbourne 3001, Vic.

Written as a reference text with the production engineer in mind, this book covers in depth all aspects of the design, assembly, soldering, repair and inspection of printed circuits in the industrial arena.

This is not a book intended for the individual or technician working with printed circuit boards. It is a complex and specialised text written by a person who has a great deal of experience with the large scale manufacture of electronic equipment employing printed circuit technology. Although some parts of the book may be of general interest to those working in various aspects of the electronics industry, much of the text and many of the terms used would be beyond the casual reader or those not involved in the manufacturing process.

Particular emphasis is placed on the special techniques required for the production of boards using surface mount technology, making the book not only useful as a reference text for current practices, but introducing those changes necessary to adapt to newer technologies.

The book is organised in a logical manner, commencing at the design stage with the first chapter titled "Design for good soldering and cleaning." Progressing through the whole manufacturing process, subsequent chapters include: storage, kitting, assembly and other pre-solder operations, soldering and cleaning materials, the soldering process and the equipment, surface mount soldering technology and the cleaning process and equipment.

The important subjects of troubleshooting the printed circuit, quality and inspection and touchup and repair are covered in chapters 7, 8 and 9. The final chapter gives some indication of the intended audience for this book and is titled "process economy and managing the line".

As well as a complete index at the end of the book, each chapter is broken down into numerous sub-headings in the list of contents making it easy for the reader to quickly find information on a wanted topic.

The book will almost certainly find a place in the technical library of many manufacturing organisations and I have no doubt that it will contain information of use in even the most sophisticated plant. For less sophisticated facilities, there is a wealth of information to help improve quality and efficiency and to assist in choosing the correct equipment, materials and techniques.

As we are not involved in the manufacturing process, we are sending our review copy to Bob Barnes of RCS Radio as a gesture of goodwill.

— Andrew Keir

SEMICONDUCTOR POWER ELECTRONICS by Richard G. Hoft. Van Nostrand Reinhold 1986. Hard covers, 324 pages 228 mm x 150 mm. ISBN 0-442-22543-1. \$105.00 rrp. Review copy from Nelson Wadsworth, 480 La Trobe Street, Melbourne 3000 Vic.

As well as a guide for advanced electrical engineering students, this book is intended as a reference for engineers responsible for power electronics circuit analysis, design and development.

The book covers both transistor and thyristor circuits for power electronics systems and includes introductory material on devices, magnetics, current circuit applications and circuit concepts relevant in modern design.

Although the book contains a good number of circuit diagrams and much practical information, the main thrust of the text lies in the analysis of the various circuits and concepts involved. Because this book is intended to convey the theory behind the designs, it is highly mathematical in its approach to the subject. For the student or engineer this would present no problem, but the casual reader without a good background in mathematics, particularly calculus, would find the book very heavy going.

Following the introductory chapter, the book covers aspects of diodes and power transistors, thyristors, circuit and component concepts, transistor switching regulators and transistor inverters. Subsequent chapters deal with phase-controlled rectifiers and line commutated inverters, cycloconverters, ac phase control, thyristor choppers and self-commutated thyristor inverters.

There are four appendices covering general device parameters as well as application data for a range of specific power semiconductor devices.

No doubt this book will prove a valuable addition to university bookshelves and the technical libraries of those involved in the design of high power semiconductor circuits. A good text book, but very specialised and not for the casual reader.



Andrew Keir

Problems?

...and you don't have our 112 page catalogue...

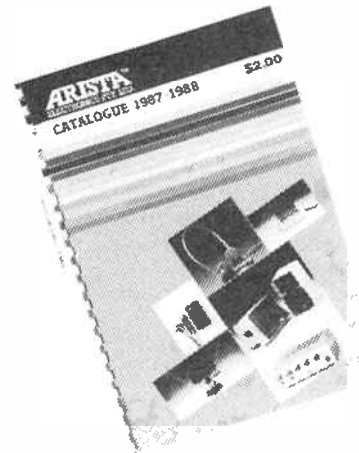

you've got real problems!

ARISTA ... your one-stop problem solver. Audio leads

... Batteries ... Chargers ...

Battery holders ... Cables

... Car accessories ...

CD accessories ... Converters

... "Cutec" ... Earphones ...

Fuses ... Headphones ...

Intercoms ... Knobs ...

Microphones and accessories

... Mixers ... Multimeters ...

Plugs/Sockets, etc ... Plug

adaptors ... Power packs and

leads ... PA ... Disc and Tape

care ... Security equipment ...

Signal modifiers ... Solderless

terminals ... Storage boxes ...

Switches ... Telephone and

TV accessories ... Tools and

Technical aids ...

Video accessories ... Wiring

accessories ... **You name it**

and we're bound to have it

...Try us ... **NOW!**

Get your catalogue...it'll solve a whole lot of your problems! Just send \$2 + 50c p&h and your return address to:

ARISTA™
ELECTRONICS PTY LTD
PO BOX 191, LIDCOMBE, NSW 2141

George Brown secures Samsung

The giant Korean industrial company Samsung Semiconductor and Telecommunications has appointed the George Brown Group as their Australian distributor for semiconductor products.

The Korean-based company has become increasingly successful as a supplier of high quality memory products, we're told, and is now emerging as a major force in the world market.

George Browns say they will initially focus on the Samsung range of RAM product, covering the 64K, 256K and 1M families. Good news is, this announcement is not just a "signal of intention" – George Browns say they have stocks on the shelf. Contact your nearest George Brown Group office: Sydney (02)519 5855, Melbourne (03)878 8111, Adelaide (08)212 3111, Canberra (062)80 4355, Newcastle (049)69 6399 or Perth (09)362 1044.

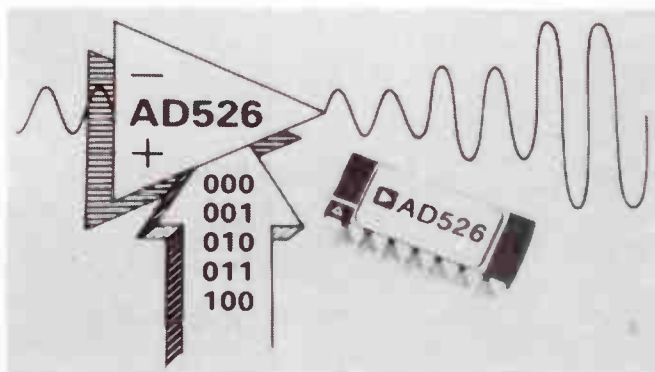

First monolithic programmable gain amplifier

A new monolithic software programmable gain amplifier (SPGA) from Analog Devices, features an on-chip amplifier, a resistor network and TTL compatible input latches, making it the industry's first complete device of its kind.

The AD526 SPGA allows users to digitally select binary gains of 1, 2, 4, 8 and 16, which are necessary for precision data acquisition applications. Gains of 32, 64 and 128 are implemented by cascading two AD526s, with no additional components required. Previously, designers needing programmable gains relied on in-house solutions or hybrid devices, both of which occupy more space and are more costly.

The AD526 provides the required precision for floating-point analogue-to-digital conversion and the "gain code" simplifies setting the exponent. When used in conjunction with a 12-bit A/D converter, the AD526 extends dynamic range from 72 to 96 dB. Additional uses include gain-ranging pre-amplification, such as audio, where input or output gain is required.

Key dc performance specifications include guaranteed maximum gain error of 0.01% for gains of 1, 2 and 4 and 0.02% for gains of 8 and 16. Over temperature and all gains maximum non-linearity is guaranteed at 0.01% of full scale. The FET input stage yields a maximum 150 picoamp input bias current and settling time is guaranteed at 4 microseconds to 0.01% with a slew rate of 4 V/microsecond at low gains and 18 V/microsecond at high gains.

The AD526 is available in a 16-pin 0.3 inch wide, side-brazed ceramic DIP and operates from a +/- 15 V supply.

Operation is specified over two temperature ranges: -40 to +85 degrees Celsius for the AD, BD and CD grades and -55 to +125 degrees Celsius for the SD and military SD/883B versions.

For further information, contact : Parameters Pty Ltd in Sydney on (02)888 8777, Melbourne (03)575 0222 or Perth (09) 242 2000.

Advice on saving power with CMOS

CMOS devices offer a designer many desirable features, the most important being low power consumption. However, in some systems, a designer will find that even the low power consumption of CMOS is insufficient to meet power supply constraints. Some designers will therefore utilize partial system power-down or multiple Vcc supplies to meet their system power requirements.

Whenever a system incorporates the use of multiple Vcc supplies or partial power-down, the designer must take into account several important device parameters if he is using High-Speed CMOS (HC) or Advanced CMOS (ACL) devices. This is necessary to avoid excessive power dissipation and prevent damage to a device that could lead to a degradation in its reliability.

The information booklet from Texas Instruments titled "Partial System Power-Down with CMOS Devices" explains those parameters which need to be considered as well as detailing methods which can be used to overcome problems.

The diagram shows an example of a simple solution to the protection of driving and receiving devices during partial power-down. This method uses current limiting resistors, the value of which is chosen to limit the current into the receiving device to less than 20 mA. The major disadvantages of this method are power dissipation and the effect on the input transition time at the receiving device during normal operation.



(a) RESISTOR CURRENT LIMITING

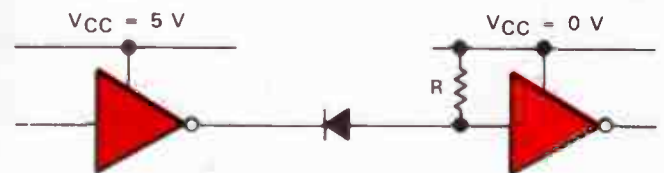

(b) RESISTOR-DIODE CURRENT LIMITING

A second method of current limiting shown in the diagram involves the use of a pull-up resistor and a diode. The advantage of this method is that it allows the use of a higher value resistor, thus limiting power dissipation.

Several other schemes are discussed in the TI booklet, not only for partial power-down situations, but multiple Vcc systems as well.

Further information is available by writing on your company or departmental letterhead to Texas Instruments, 6 Talavera Road, North Ryde 2113 NSW.

TOP GUN!

A recent survey of cordless soldering irons in a leading US science magazine gave "top marks" to Australian iron manufacturer, Scope Laboratories', Model C60. In the survey of eight cordless irons available in the United States, seven powered by rechargeable nickel-cadmium batteries and one butane-burning type, Scope's C60 proved to have the highest wattage rating and the highest heat capacity of the irons surveyed.

The article's author said that, when it came to heating large areas of metal and melting fat solders, the Scope "outclassed the competition." The other irons surveyed, with the exception of the butane-burning model, ranged in power from nine to 25 watts. These were found to work best with solders of 0.052-inch diameter or less, while the Scope handled solder of 0.125-inch

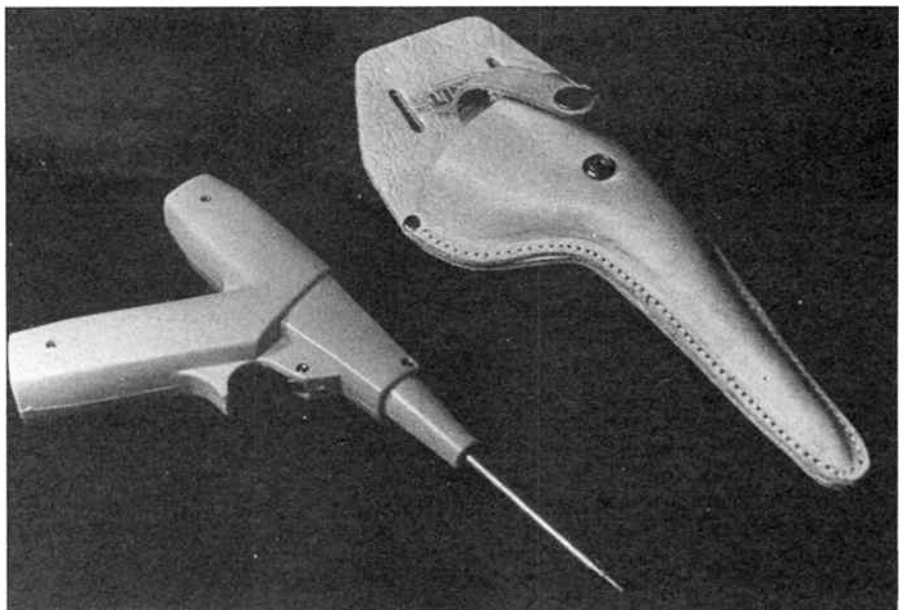

(one-eighth inch, or 3 mm) diameter.

The Scope C60 is a gun-type iron. It employs the same technology as the popular Scope Super-Scope and Mini-Scope irons. A small carbon plug is carried on the end of an insulated, spring-loaded stem. The stem is moved by a lever on the handle so that the carbon plug contacts the rear of the screw-in copper tip. Current from a low voltage source passes through the stem, carbon plug and barrel. Heat is generated from the contact resistance and this heats the iron tip, temperature control and heating

capacity being achieved by operating the lever as required. Rechargeable batteries are carried in the handle of the C60 and a squeeze "trigger" operates the stem inside the barrel.

The C60 cordless iron is ideal for applications where soldering away from power sources is necessary, where safety is a consideration requiring isolation of the iron, or where leakage from a conventional iron may bring the risk of damage to sensitive solid-state components. It has found particular favour with service personnel in the aviation industry where it is used for servicing aircraft on the tarmac.

The C60 is readily carried in toolkits and an accessory leather pouch is available allowing it to be carried on your belt. It comes with five tips and a 12 V charger for it is available.

If you'd like to receive a copy of the survey, write to **Scope Laboratories, PO Box 63, Niddrie 3042 Vic.**



S SCOPE LABORATORIES
INCORPORATED AS SCOPE ELECTRICAL PTY LTD IN VICTORIA

3 WALTON STREET, AIRPORT WEST, MELBOURNE, AUSTRALIA
MAIL . P.O. BOX 63, NIDDRIE, 3042.
TELEPHONE : (03) 338 1566
TLX : AA38318

New V.22 modem chip from Fairchild

The uAV22 1200 bps full duplex modem IC is fabricated in Fairchild's advanced Double-Poly Silicon gate CMOS process. The monolithic IC performs all the signal processing functions required of a CCITT V.22 compatible modem. Handshaking protocols, dialling control and mode control functions can be handled by a general purpose single chip microprocessor.

The modem chip performs the modulation, demodulation, filtering and certain control and self-test functions required for a CCITT V.22 modem, as well as additional enhancements. Both 550 Hz and 1800 Hz guard tones, notch filters and DTMF tone generator are on chip. Switched capacitor filters provide channel isolation, spectral shaping and fixed compromise equalisation. A novel switched capacitor modulator and a digital coherent demodulator provide 1200 bps DPSK operation.

Additional features of the uAV22 include call progress tone detection for smart dialler applications, pin and function compatibility with the uA212A and operation from +5 and -5 V supplies. The on-board oscillator uses a widely available 3.6864 MHz crystal.

For further information, contact your local George Brown outlet or the George Brown Group Marketing Division, 456 Spencer Street, West Melbourne. (03)329 7500.

A blinking clever chip

For some reason, the National Semiconductor LM3909 LED flasher/oscillator never seems to have gained the popularity it deserves, despite having been around for a good few years. Perhaps some designers wonder why you would bother to use an 8-pin IC just to flash a LED, but a closer look at the device will reveal some of the special characteristics which make it useful in many applications.

The most important feature of the chip is its incredibly low power consumption. With the addition of only a single external capacitor, the LM3909 will flash a LED for up to one year using a standard "C" size torch battery. Imagine some of the applications this would allow such, as finding your torch in total darkness or locating emergency light switches or fire extinguishers in a blackout!

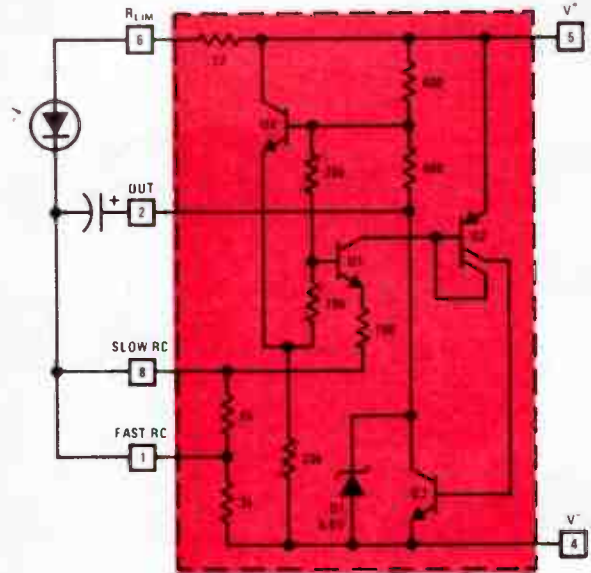

Internal circuit of the LM3909.

The LM3909 achieves low power consumption by using the external timing capacitor for voltage boost. It can supply pulses of 2 V or more while operating from a supply of 1.5 V or less and has been optimised for low power drain and operation from weak batteries so that continuous operation exceeds that expected from the battery rating. The estimated battery life extends from about three months using a standard "AA" battery to around 2.6 years using a "D" size alkaline cell.

The flash rate of the LM3909 is, for the main part, controlled by the value of the external timing capacitor. By using lower values, it is possible to configure the chip as a test oscillator or to flash an LED so fast that it appears to be on continuously. The maximum dissipation of the chip is 500 mW and as an oscillator, it can drive an 8-ohm speaker directly.

Timing capacitors will generally be electrolytic or tantalum types and a small, 3 V rated part is suitable for any LED flasher circuit using a supply of up to 6 V.

Let's look at some typical applications.

FANTASTIC FORTH TARGET BOARD EC 1F12

APPLICATION: process controllers • remote terminal units
• robotics • security systems • intelligent computer peripherals
• printer controller • data-loggers • instrument controllers
• multi-processing applications.

energy CONTROL Energy Control International Pty Ltd, 26 Boron St, Sumner Park Qld 4074. Phone (6107)376 2955. FAX (6107)376 3286. Telex AA43778.

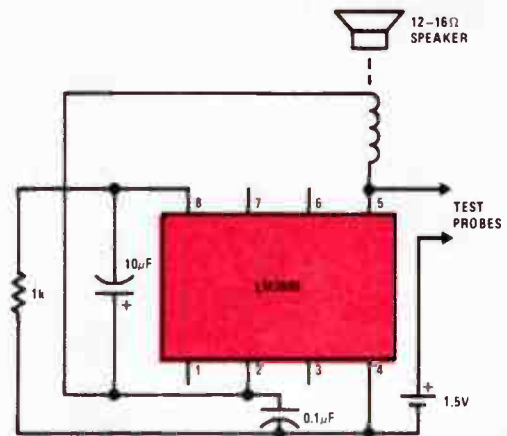

Continuity tester.

This novel continuity checker uses only a minimum of external components, yet it is possible to hear the difference between short circuits, coils and resistances of only a few ohms.

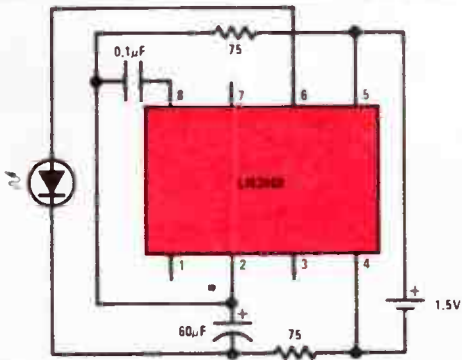

Low consumption light.

Another application shown here provides a pulsed light that appears to be on continuously (the "persistence of vision" effect), supplying short, high current pulses to the LED with higher voltage than that available from the battery.

High performance BiFET op-amp

A new monolithic op-amp guarantees the industry's fastest settling time for a BiFET op-amp, along with outstanding dc and dynamic specifications, according to Analog Devices. Their newly released AD744 typically settles to 0.01% in 500 ns and a maximum of 900 ns.

Along with a tested slew rate of 50 V/microsecond minimum, specifications for dc performance are also excellent. The 100%-tested maximum voltage offset of 250 microvolts and drift of 3 µV per degree Celsius are claimed to be approximately half that of competitive products. Systems with 14 and 15-bit requirements benefit from this combination of ac and dc performance.

The extremely low 0.0003% total harmonic distortion (THD) and very low noise make the AD744 suitable for high-speed applications such as DAC output buffers and cable drivers, as well as active filters, wideband preamps and demanding audio designs. Noise is tested and guaranteed to be below 4 microvolts peak-to-peak over the 0.1 to 10 Hz band. Open loop gain is a minimum of 250 V/mV.

Internal compensation provides stable operation in a unity-gain inverting configuration or as a gain of 2 follower, with a gain bandwidth product of 13 MHz. Optional external compensation increases the gain bandwidth product significantly: a product of greater than 200 MHz with an inverting gain of 1000 is typically achieved. The external load compensation also allows driving higher capacitance loads of at least 2000 pF with a 12.5 V/microsecond slew rate.

The result of BiFet technology, laser drift trimming and ion-implanted JFETs, the AD744 operates from a supply range of between ± 4.5 V and ± 18 V, with quiescent current of 3.5 mA typical and 5.0 mA maximum. Packages available include hermetic 8-pin CERDIPs and TO-99 cans, as well as plastic mini-DIPs.

For further information, contact the Australian distributors: Parameters Pty Ltd in Sydney on (02)888 8777, Melbourne (03)575 0222 or Perth (09)242 2000. 📧

PHONECOM

AUTO-DIAL AUTO-ANSWERING MODEMS

Featuring:

- AT Command Set Compatible
- RS-232 Interfacing



#8685 - 300/1200/2400 + 1200/75 Modem
Both CCITT and Bell standards

\$675 !

inc. tax

Mail order - add \$8.00.

PROVIDES: full or half duplex operation on 2400 bps with auto-fallback (adjusts to phone line conditions); call tone progress on inbuilt speaker - dial tone/ringing/busy; full test facilities; internal phone number storage - up to 10 sets of 16 digits.

300/1200 MODEL - \$345!

ELECTRONIC DISCOUNTERS PTY LTD

305 Morphett St, ADELAIDE 5000 S.A.

Telephone (08)212 1799. FAX:(08)231 0412



COMPLETE HANDBOOK OF
ELECTRONICS TROUBLESHOOTING - A
Six-Step Guide, by James W. Jacox.

\$66.50

PRACTICAL MICROPROCESSOR
INTERFACING by S.A. Money. Collins
\$68.00

DP Education (Books)
PO Box 380, Avalon 2107

997 1611



– Filter Design, from page 31.

ing windings on all of the inductors e.g: L2 and L4 in circuit a). Nonetheless it is good practice to put such windings on all filter inductors. Later on you may pull the filter apart and want to use the inductors in another filter. If the tuning windings are already in place, it can save you the trouble of having to strip the inductor just to get a single turn winding on it; not much fun if you have poured potting compound into the inductor. We will assume that you just have an ordinary signal generator and have put tuning coils on all inductors and that you have a suitable meter or CRO.

For the BP filter of Figure 3.8a, start with all links out. Apply the meter to the input terminals and the signal to the tuning pins of L1. Tune L1 for maximum meter reading. Insert links 1 and 2 and short-circuit the input terminals. Apply the signal to the tuning pins of L2 and the meter to the junction of L2 and C2; tune L2 for maximum reading. Remove links 1 and 2, apply the signal to the tuning pins of L3 and the meter to the top of link 2; tune L3 for maximum reading. Insert links 2, 3, and 4, apply the signal to the tuning pins of L4 and the meter to the junction of C4 and L4; tune L4 for maximum reading. Remove links 3 and 4, apply signal to the tuning pins on L5 and the meter to the output terminals. Tune L5 for maximum reading. Insert all odd numbered links, remove all even numbered links and the filter is ready for use.

Since the circuit of Figure 3.8b consists of circuit a) with an additional series tuned circuit at the beginning and one less parallel tuned circuit at the end, the tuning procedure is similar to that of circuit a). Link 1 is inserted, the signal applied to the tuning pins of L1, the meter to the junction of L1 and C1, and L1 is tuned for maximum reading. Link 1 is removed and L2 tuned in the same way as L2 for circuit a) and so on.

With circuit c) it is essential that the shunt inductors be as close as possible to their design value since they are not sub-

ject to the tuning procedure. The input terminals are short-circuited, link 1 is inserted, the signal is applied to the tuning pins of L1, the meter to link 1, and L1 is tuned for maximum reading. Link 1 is removed, links 2 and 3 installed, the signal is applied to the tuning pins of L3, and L3 is tuned for maximum reading. Links 2 and 3 are removed, links 4 and 5 installed and L5 is tuned, and so on. L9 is tuned by inserting only link 8, shorting the output terminals, applying the signal to L9, the meter to link 8 and tuning L9 for a maximum. All links are inserted and the filter is ready for use.

You would have noticed that only the series inductors are altered when tuning this circuit. This is necessary since each of the shunt inductors is part of two tuned circuits, so tuning one circuit would probably mistune the other. Since the series inductors are each only in 1 tuned circuit, they don't cause this problem.

With circuit d) it is essential that all of the capacitors be as close to their design values as possible. Link 1 is inserted, the signal is applied to the tuning pins of L1, the meter to the input terminals, and L1 is tuned for maximum reading. Link 1 is removed, link 2 installed, and the input terminals short-circuited. The signal is applied to the tuning pins on L2 and the meter to the top of link 1; L2 is tuned for maximum reading. Links 1 and 3 are now installed, the signal applied to the tuning pins on L3, the meter to the top of link 2, and L2 tuned for maximum reading. Link 3 is removed, links 2 and 4 inserted and L3 tuned. Link 4 is left in place and L5 is tuned. All links are removed and the filter is ready for use.

Chebyshev active filters

The Sallen and Key circuits of Figures 2.6 and 2.8 can also be used to construct active Chebyshev filters. The GWBASIC

Figure 3.11.

GWBASIC program to calculate the component values for Sallen and Key active Chebyshev LP and HP filters. The equations are derived using the point where the attenuation is equal to the ripple amplitude as the cutoff frequency. To allow for this, the normalizing factor NF is calculated on line 210 and inserted into the equations so that the cutoff frequency is where the attenuation is 3 dB.

Since odd-order filters need additional calculations, there are lots of IF ODD = 0, statements to skip over these parts of the program if the filter order is even.

To print out the results, change PRINT to LPRINT from line 460 onwards.

Lines 40-60 set up the expressions for the display. RSW,CSW,RSW1, and CSW1 are switches that control the displayed comments if resistors or capacitors are out of range.

Line 70 defines the hyperbolic trigonometric functions and their inverses needed in the calculations.

```

10 PRINT "          Design of "
20 PRINT "          Chebyshev active LP & HP filters."
30 PRINT "          Copyright Aquila Holdings Pty Ltd 1987":PRINT
40 A1$="C1(";A2$="C2(";A3$="C3(";A4$=")": P1=
3.141592654#:CSW=0:RSW=0
50 AB$="Tuning frequency=";A9$="", Q= "A10$="
"RC circuit, 3 dB down at "
60 B1$="R1(";B2$="R2(";B3$="R3(";CSW1=0:RSW1=0
70 DEF FN SINH(X)=(EXP(X)-EXP(-X))/2:DEF FN ASINH(X)=
LOG(X+SQR(X*X+1)):DEF FN COSH(X)=(EXP(X)+EXP(-X))/2:
DEF FN ACOSH(X)=LOG(X+SQR(X*X-1))
80 PRINT "Would you like to design : "
90 PRINT "1. a low pass filter ?"
100 PRINT "2. a high pass filter ?"
110 PRINT "3. neither, quit."
120 INPUT "Please enter the appropriate integer.":X
130 IF (X<1 OR X>3)THEN B0
140 IF X=3 THEN B90
150 INPUT "What is the cutoff frequency [ Hz ] ?":FC:
IF FC=0 THEN B10

```

Lines 130-190 contain traps against hitting incorrect keys.

Line 210 WN is the ratio of passband to stopband frequencies.

Line 220 N is the order of the filter.

Line 260 calculates some constants needed later, including NF.

Lines 340-360 are the heart of the program and calculate the normalized (angular frequency = 1) components.

Lines 390-430 solve the cubic equation for the values in the circuits of Figure 2.8, needed when the order is odd.

Line 420 is needed because GWBASIC will not take the cube root of a negative number.

Lines 480-680 the factors convert the normalized values to practical units.

Lines 740-790, 800-830, and 840-870 are subroutines to convert the display to convenient units.

```

160 INPUT "At what frequency [ Hz ] in the stopband is the
attenuation known ?":F1:IF F1<=0 THEN B60
170 IF ((X=1 AND F1<FC) OR (X=2 AND FC<F1))THEN PRINT
"That frequency is not in the stopband.":GOTO B60
180 INPUT "What is the attenuation [ dB ] at that frequency ?":
AMAX:IF AMAX<=3 THEN PRINT"The attenuation in the stopband must
be more than 3 dB.":GOTO B60
190 INPUT "What is the allowable ripple [ dB ] in the
passband ?":RIPL:IF RIPL<=0 THEN B90
200 IF RIPL>6 THEN PRINT "That ripple is ridiculous.":GOTO B90
210 WN=F1/FC : IF X=2 THEN WN=FC/F1
220 N=INT(FNACOSH(SQR((10^(1*AMAX)-1)/(10^(1*RIPL)-1))
)/FNACOSH(WN))+1
230 PRINT "The filter order is ";N:ANGLE=PI/N/2:DDD=0:
IF N MOD 2=1 THEN ODD=1
240 IF N>9 THEN PRINT "Sorry, I can only calculate components
for filters of order less than 10.":GOTO B0
250 IF N=1 THEN PRINT "A filter of order 1 does not require
a Chebyshev filter.":GOTO B0

```

Figure 3.12. Circuit of Chebychev HP rumble filter, $F_c = 15$ Hz, ripple = 0.25 dB, 60 dB attenuation at 7.5 Hz, order = 7.

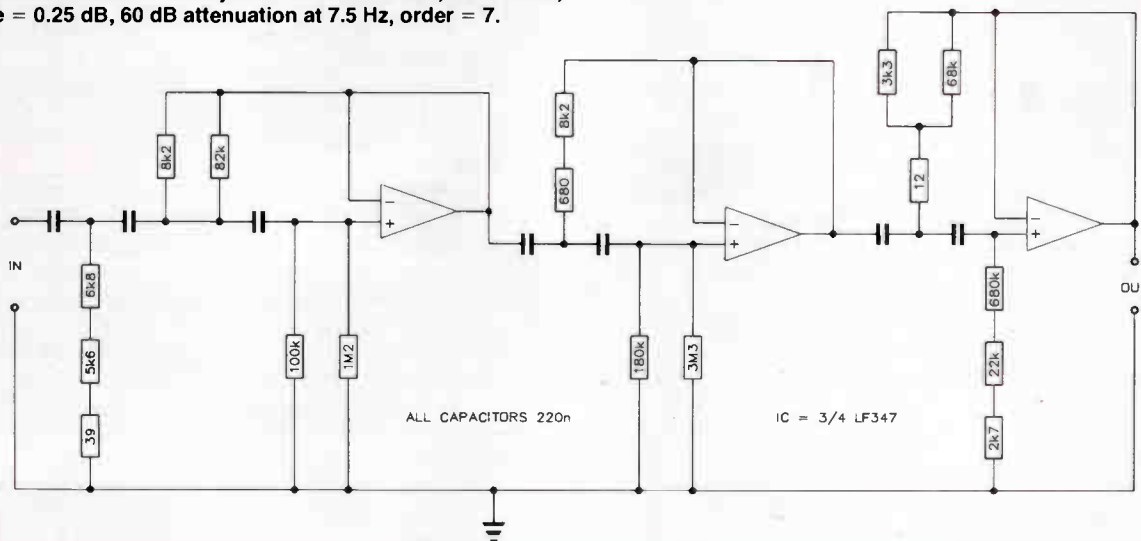

music.

Since the rumble is introduced with the signal, it is subject to the full bass boost of the RIAA compensation built into the preamplifier. This often leads to overloading and the generation of beat frequencies that were definitely not in the original music. So the rumble filter has to be as close to the input

of the preamplifier as possible, certainly before the low frequency part of the RIAA compensation.

Figure 3.12 show the design of a suitable Chebychev rumble filter. It has a cutoff frequency of 15 Hz, an allowable pass band ripple of 0.25 dB, and attenuates frequencies of 7.5 Hz by 60 dB or more. Most tonearms have a resonance around

Figure 3.13. GWBASIC program to calculate the attenuation, phase shift, and time delay of Chebychev filters.

GWBASIC program to calculate the attenuation, phase shift and time delay of Chebychev filters.

Line 50 sets up the expressions for the display.

Line 60 defines the hyperbolic trigonometric functions and their inverses needed in the calculations.

Lines 130-170 contain traps against hitting incorrect keys.

Line 180 calculates constants needed later. NF converts the ripple cutoff frequency to the 3 dB cutoff.

```

10 PRINT "          Calculation of"
20 PRINT "    attenuation, phase shift, & delay of"
30 PRINT "      Chebychev filters."
40 PRINT "    Copyright Aguila Holdings Pty Ltd 1987":PRINT
50 B$=" dB":D$=" degrees":PI=3.141592654#:LGE=.43429448#
60 DEF FNSINH(X)=(EXP(X)-EXP(-X))/2:DEF FNASINH(X)=
LOG(X+SDR(X*X+1)):DEF FNCOSH(X)=(EXP(X)+EXP(-X))/2:
DEF FNACOSH(X)=LOG(X+SDR(X*X-1)):
DEF FNACS(X)=PI/2-ATN(X/SDR(1-X*X))
70 PRINT "Would you like the properties of :":
80 PRINT "1. a low pass filter ?":
90 PRINT "2. a high pass filter ?":
100 PRINT "3. a band pass filter ?":
110 PRINT "4. a band reject filter ?":
120 INPUT "Please enter the appropriate integer.":X
130 IF (X<1 OR X>4)THEN 70
140 INPUT "What is the order of the filter ?":N:IF ((X=3 OR X=4)
AND N MOD 2<>0)THEN PRINT "The order of BP & BR filters must
be even.":GOTO 140
150 IF N<2 THEN PRINT "I cannot compute an order less than 2.":
GOTO 140 ELSE ANGLE=PI/2/N
160 INPUT "What is the allowable ripple [ dB ] in the
passband ?":R1PL:IF R1PL<=0 THEN 160
170 IF R1PL>6 THEN PRINT "That ripple is ridiculous.":GOTO 160
180 ER=10*(.1*R1PL)-1:EP=SDR(ER):A1=FNASINH(1/EP)/N:ES=
FNSINH(A1):EC=FNCOSH(A1):NF=FNCOSH(FNACOSH(1/EP)/N)
190 IF (X=3 OR X=4)THEN N=N/2:GOTO 220
200 INPUT "What is the cutoff frequency [ Hz ] of the filter ?":
FC:IF FC<0 THEN 200
210 GOTO 250
220 INPUT "What is the centre frequency [ Hz ] of the filter ?":
FC:IF FC<0 THEN 220
230 INPUT "What is the bandwidth [ Hz ] of the filter ?":BW:
IF BW<0 THEN 230
240 BW=BW/NF:FU=(BW*SDR(BW*BW+4*FC*FC))/2:FL=FU-BW:
IF FL<=0 THEN PRINT "That bandwidth is too large for that centre
frequency !": GOTO 220
250 INPUT "At what frequency [ Hz ] would you like to start the
calculation ?":FSTART:IF FSTART<=0 THEN 250
260 INPUT "At what frequency [ Hz ] would you like to stop the

```

Line 240 calculates the upper and lower cutoff frequencies.

Line 290 allows for the starting frequency being higher than the stopping frequency.

Lines 330-410 calculate the attenuation in the passband and stopband.

Lines 420-440 calculate the phase and delay.

Lines 470-510 and 520-550 are subroutines to put the values of the frequency and delay in convenient units.

```

calculation ?":FSTOP:IF FSTOP<=0 THEN 260
270 INPUT "What frequency step [ Hz ] would you like to use ?":
FSTEP:IF FSTEP<=0 THEN 270
280 IF FSTEP>ABS(FSTOP-FSTART)THEN PRINT "That frequency step is
too large.":GOTO 250
290 IF FSTOP<FSTART THEN FSTEP=-ABS(FSTEP)
300 PRINT "    Frequency    Atten    Phase shift    Time delay"
310 FOR F=FSTART TO FSTOP STEP FSTEP:T=0:P=0
320 ON X GOTO 330,340,350,350
330 FU=FC/NF:FL=0:Z=F/FU:GOTO 380
340 FL=NF*FC:FU=1E+30:Z=FL/F:GOTO 390
350 IF (X=4 AND ABS(F-FC)<.0001*FC)THEN A=999:GOTO 420
360 IF F<FC THEN Z=FC*FC/F-F ELSE Z=F-FC*FC/F
370 IF X=3 THEN Z=Z/BW:GOTO 400 ELSE Z=BW/Z:GOTO 410
380 IF F<FU THEN A=10*LGE*LOG(1+ER*(COS(N*FNACS(Z)))^2):GOTO 420
ELSE A=10*LGE*LOG(1+ER*(FNCOSH(N*FNACOSH(Z)))^2):GOTO 420
390 IF F>FL THEN A=10*LGE*LOG(1+ER*(COS(N*FNACS(Z)))^2):GOTO 420
ELSE A=10*LGE*LOG(1+ER*(FNCOSH(N*FNACOSH(Z)))^2):GOTO 420
400 IF (F>=FL AND F<=FU)THEN A=10*LGE*LOG(1+ER*
(COS(N*FNACS(Z)))^2):GOTO 420 ELSE A=10*LGE*LOG
(1+ER*(FNCOSH(N*FNACOSH(Z)))^2):GOTO 420
410 IF (F<=FL OR F>=FU)THEN A=10*LGE*LOG
(1+ER*(COS(N*FNACS(Z)))^2):GOTO 420 ELSE A=
10*LGE*LOG(1+ER*(FNCOSH(N*FNACOSH(Z)))^2)
420 FACTOR=(1+FU*FL/F/F)/2/PI/(FU-FL):OMEGA=
(F-FU*FL/F)/(FU-FL):AOMEGA=ABS(OMEGA)
430 FOR I=1 TO N:THETA=(2*I-1)*ANGLE:S=
ES*SIN(THETA):W=EC*COS(THETA)
440 T=T+ABS(S)/(S*S+(AOMEGA-W)^2):P=P-ATN((OMEGA-W)/(-S)):
NEXT I:T=T*FACTOR:P=P*180/PI:GOSUB 470:GOSUB 520
450 PRINT USING "###.### \ \ ###.# \ \ +####.
#\ \ ###.### \ \":FF,H$,A,B$,P,D$,G,F$,
460 NEXT F: GOTO 560
470 IF T>1 THEN G=T:F$=" sec":GOTO 510
480 IF T>.001 THEN G=T*1000:F$=" msec":GOTO 550
490 IF T>.000001 THEN G=T*1000000:F$=" usec":GOTO 510
500 G=T*1E+09:F$=" nsec"
510 RETURN
520 IF F>=1000000! THEN FF=F/1000000! :H$=" MHz":GOTO 550
530 IF F>=1000 THEN FF=F/1000:H$=" kHz":GOTO 550
540 FF=F:H$=" Hz "
550 RETURN
560 END

```

this frequency so this design should be of general use. You can use the program of Figure 3.11 to tailor such a filter to the needs of your particular tonearm-turntable combination.

Capacitor values of 220n (0.22 uF) were chosen as a reasonable compromise and this gives an acceptable set of values for the resistors. Also, the maximum Q is only 7.47, so we would not expect to have any difficulty with component drift. The entire filter can be built using one IC of the 47 series, e.g: LF347, TL047 etc., or, if you prefer, two of the LF353 type. For stereo you would need two such filters.

Since FET IC amplifiers generate too much noise to be used at the input of a high quality pickup preamplifier, it is essential that the filter be preceded by a good low noise IC such as an OP37A or, better still, a discrete low noise design similar to David Tilbrook's 6000 Series Ultra-fidelity Preamplifier. The gain would need to be 5 or more to mask the FET noise, but not more than about 15 so as not to amplify the rumble too much and risk overloading the filter.

Phase shift and delay

The phase shift and time delay of Chebychev filters are not the smooth functions of frequency that we saw with Butterworth filters. This is because of the effective overcoupling of the circuits in Chebychev filters. The GWBASIC program of Figure 3.13 calculates the attenuation, phase shift and time delay of Chebychev filters in each of the four standard forms. When you run the program you will find that the ripples in the attenuation in the generate corresponding ripples in the phase shift and the delay. Large passband ripples generate correspondingly large ripples in the phase shift and delay.

Because of the higher Qs in the Chebychev filters, the actual value of the time delay is larger than for a Butterworth filter of the same order, particularly near the cutoff frequency. This is why the cutoff frequency for Chebychev filters is usually chosen to be somewhat higher for LP filters, and lower for HP filters than would be the case for Butterworth filters.

Because of their sharp cutoff, Chebychev filters are used in some high quality cassette recorders to remove the bias frequency from the audio parts of the circuit. Since the bias frequency is 100 kHz or higher in these recorders, the cutoff frequency can be set to 30 or even 40 kHz so that the phase shift and time delay of the filter have negligible effects on the audio range of frequencies but the filter can still achieve considerable attenuation at 100 kHz and higher.

Qualities of Chebychev filters

The good things about Chebychev filters are:

- Steeper slope in the stopband than Butterworth filters, particularly near cutoff.
- Can have flatter (but not smoother) response in the passband.
- Steepness of cutoff can be traded against passband ripple.
- Fewer sections needed for a given stopband attenuation and therefore
- Cheaper.
- Easy to tune.

The not so good things are:

- Passband response not as smooth as Butterworth filter.
- Greater phase shift and time delay.
- Ripples in the phase shift and time delay.
- Higher Qs needed and therefore
- Greater sensitivity to drift in component values.

THE PROGRAMS published in the first three parts of this series, plus the programs for obtaining non-standard resistors and capacitors from standard values (published in November '87) are available on 5.25" disk (MS-DOS) ready to run on an IBM PC or compatible, for just \$29.95, post paid. Send your order to: AEM Software Service, PO Box 507, Wahroonga 2076 NSW.

- Marine Electronics, from page 15.

The sophistication of current AM and FM car stereo receivers easily handles the difficulties of reception in out of the



ONBOARD 240 VOLTS AC

Vessels not fitted with a diesel powered 240 volt generator have been deprived, until recently, of the ability to operate low power consuming appliances.

The Australian made solid state inverter (Cat. No. K6754), marketed by Altronics of Perth, (tollfree 008 999007 with outlets in all states), provides 230 volts ac from a 12 volt battery source. This device will supply up to 250 watts of ac power, sufficient to operate a range of small hand tools.

The Altronics inverter has been successfully tested in supplying the ac for operation of a 240 volt TV set and video recorder. The picture was quite stable and the sound was clear and free from hum. The 12 volt current drain during the test was approximately eight amps. The inverter retails for about \$350.

For those boat owners who already have a 12 volt TV set on board, a 12 volt video cassette player has recently been released by Zarnit Enterprises of Sydney (02-331 7689), retailing for \$399.

way bays and waterways, provided high ground does not create excessive shadow areas. But perhaps more valuable are the in-built cassette and compact disc decks which provide the desirable option of hearing your own music selections.

The Sony company market an interesting compact disc deck able to hold up to ten compact discs, giving ten hours of non-stop playback with track pre-selection features. This system allows the vibration and heat proof deck assembly to be mounted out of the way below deck, with only the slim control panel accessible to the user. An optional tuner unit gives off-air reception.

Pioneer and several other manufacturers market 'quick release' radio cassette decks which are housed in a special cradle. This system allows the valuable deck to be removed easily when the vehicle is vacated. If a second optional quick release cradle is fitted in your boat, wired to 12 Volts, speakers and a suitable antenna, your car audio system can do double duty, with far less chance of being stolen in either location.

In conclusion

Clearly, there's a wealth of electronics equipment to suit the many and diverse marine applications. If none of what's been described in these articles can help improve your pleasure and safety, then you've either "got it all" already, or you just need a bigger budget! 🐦



IT'S "THE SILLY SEASON"! That time of year when people go silly with their plastic money, television stations go silly with their programs, certain service industries are plagued by silly strikes, politicians make silly statements and things get generally out of hand.

The great stock market crash of '87 came and went on Black Tuesday (Monday in New York), and the value wiped from shares around the world was measured in trillions of dollars.

Trillions of dollars. Think about it for a moment. Forget the money – us mere mortals will never see an amount approaching even a tenth of it. How big a number is that? It seems to depend on cultural factors – whether you're American, or not American. A million is "ten to the sixth", one with six noughts behind it. A billion in US terms is (we think), a thousand million, or ten to the ninth. But it seems the derivation of the word elsewhere stems from a million-

This month's picture comes courtesy of Rhode & Schwarz who recently won an order from the Australian Army to supply 67 units of their new RF test set. A representative from Rhode & Schwarz sealed the deal with a top wallah from the Army with a handshake. We couldn't help but muse on the conversation.

million, a "bi"-million, hence "billion". Or ten to the twelfth.

So. How much is a trillion? It might be a thousand-thousand million, or a million-million million. Is it ten to the twelfth or ten to the eighteenth?

OK. Enough pondering about money. Too much of that and you'll go silly. Let us cast about for other quantities and measurements to ponder – just as an intellectual pursuit to avoid the insanities of the silly season. Better still, why not have a contest?!

Here are a few questions to exercise your intellect over the silly season, and keep you entertained for hours in

research, argument and discussion with colleagues. We'll give the winner a copy of the fascinating and magnificently illustrated Kevin Weldon book "Silicon Valley High Tech – a window to the future" (reviewed in our August '86 issue – just the thing for your coffee table/study/shack) and a Dick Smith Electronics Q-1512 handheld digital multimeter for the most interesting/erudite/amusing answers to the following questions:

- Q1. How large is a "poofteenth"?
- Q2. How long is a "femtofortnight"?
- Q3. What is infinitely shorter than a nanometre?
- Q4. Would you have time for a beer on an "atto-arvo"?
- Q5. How long does a "teratwilght" last?

Send your entries: to AEM Silly Season Competition, PO Box 507, Wahroonga 2076 NSW, by last mail December 31, 1988. 🐣

**SUBSCRIBE NOW
AND SAVE OVER \$20!**

Buying AEM from the newsagent every month will cost you \$57 for 12 issues. For a limited period, we're offering subscriptions for

Just \$3.00 per issue! **\$36!**

Roger Harrison's
**Australian
ELECTRONICS**
Incorporating
Elektor Electronics
Monthly

The ionosphere and radiowave propagation — an update

So what's new in modems?

aem project 6005
A 100 watt 'ultra-fidelity' topology MOSFET amp module

Consumer to win in the DAT versus CD battle

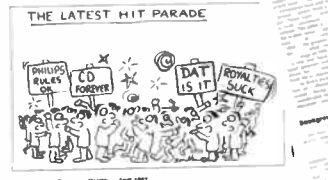

Recent developments in silicon sensors

Understanding 'switched-mode' power supplies



aem data sheet

oem hi-fi review
The Marantz PM-94 'digital monitoring' amplifier

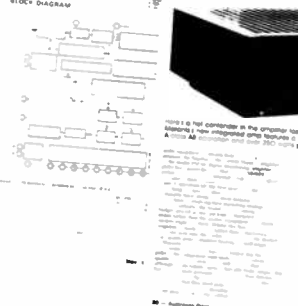

Australia's independent technical electronics journal, providing a balanced coverage of the fields of audio, broadcasting, pro sound, video, communications, computing, engineering and technology. Edited and published by industry identity, Roger Harrison.

FOR ONLY \$36/12 ISSUES, YOU GET:

- 5 to 10 projects to build each month — the best from our Australian designers and the cream from the British Elektor.
- Monthly Project Buyers Guide — each issue we detail where you can get the components featured in our projects as well as which firms are stocking kits of our projects.
- Telephone technical enquiries — yes, you can speak to the editorial team direct and have your queries answered. We don't live in an ivory tower!
- Hi-Fi, sound and video news, reviews & features — independent, professionally conducted reviews from Robert Fitzell Acoustics; features from well-known writers like Dennis Lingane and Malcolm Goldfinch.
- Practical computing articles — a whole section each month devoted to electronics enthusiasts exploring computing and computing enthusiasts exploring electronics.
- Communications coverage — news, reviews and practical features on RF techniques and radio communications, covering everything from circuit techniques to cellular radio, from satellites to amateur radio.
- Topical technical features — covering consumer electronics, topical technological and scientific fields, current issues and circuit techniques.
- What's new in the market — occasional features on new products and developments, giving topical and informative coverage of specific fields and product groups.

You'll find something to interest you every month in Australian Electronics Monthly, no matter what your special interest might be. The magazine is "sectioned" into categories for easy reading and easy reference, each section headed by its own news column.

If you've found AEM hard to get in your newsagent, DON'T DELAY, SUBSCRIBE TODAY!

If you work in electronics, communications, computing or servicing, a subscription to Australian Electronics Monthly could be tax deductible.

LAST CHANCE — Offer closes 31 December 1987

Yes! Put me down for a subscription to Australian Electronics Monthly for 12 issues. I am paying by (please circle payment method):

Cheque: (No:) _____

Money Order (No:) _____
(Cheques or Money Orders should be made out to 'Australian Electronics Monthly')

Bankcard Visa Mastercard Amex

Card No: _____ Expiry: _____

Signature: _____
(Note: unsigned credit card orders cannot be accepted)

Name: _____

Address: _____

Postcode: _____

BENELEC



For Australia's most comprehensive range of communications equipment, look no further.

BENELEC Pty Ltd

581 Gardeners Road, Mascot 2020. Telephone (02) 693 5111. Fax: (02) 669 6783.