

AUGUST 1987 \$4.75 NZ\$6.50

Incorporating
**Elektor
Electronics**

WIN A PHILIPS DMM!

ROGER HARRISON'S

AUSTRALIAN ELECTRONICS



Monthly
**GREAT V.22
MODEM OFFER!**

**ECONOMY
STEREO AMP**



**Enhancing
your VZ200/300**

**Driving the
Yaesu 757
with a C64**

**Completing
the Lab.
Supply**



Good as Gold

The 70 Series Multimeters: the shining standard by which others are measured.

These multimeters are produced through advanced technology that assures you a wealth of product features. Giving you solid value for your money.

Security of a 3-year warranty.

A 3-year warranty reduces your cost of ownership. So you don't have to pay the price over and over for lesser-quality multimeters.

More features for your money.

Choose from either the basic 73 or the feature-rich 75 and 77. You'll find the features you need at the price you can afford. Touch Hold™ for capturing and holding readings. Audible tones to signal you for continuity. Autoranging for simple operation. And a sleep mode for extending battery life up to 2000 hours.

Made in the U.S.A.

Like other Fluke products these multimeters offer you uncompromised quality at competitive prices. So get your hands on a 70 Series Multimeter at leading electronics distributors nationwide.

FROM THE WORLD LEADER IN DIGITAL MULTIMETERS.



FLUKE 73, 75, 77

0.7%, 0.5%, and 0.3% basic dc accuracy	3 year warranty
Analog/digital display	Audible continuity (75 & 77)
Volts, ohms, 10A, diode test	Range hold (75 & 77)
Autorange	Multi-range holster (77)
2000+ hour battery life	Touch Hold function (77)



Talk to your local Elmesco distributor about Fluke —

- **A.C.T.** John Pope Electrical (062) 80 6576 • J Blackwood & Sons (062) 80 5235 • George Brown (062) 80 4355
- **N.S.W.** Ames Agency 699 4524 • J Blackwood & Sons • George Brown 519 5855 Newcastle 69 6399 • Bryan Call Industries 526 2222 • D G E Systems (049) 69 1625 • Petro-Ject 550 1388 • David Reid 267 1385 • W F Dixon (049) 61 5628 • Macelec (042) 29 1455 • Ebson 707 2111 • Selectroparts 708 3244 • Geoff Wood 427 1676 • Novacastran Electronic Supply (049) 62 1358
- **N. TERRITORY** J Blackwood & Son (089) 84 4255, 52 1788 • Thew & McCann (089) 84 4999
- **QUEENSLAND** Auslec (07) 8541661 • Petro-Ject (075) 91 4199 • St Lucia Electronics 52 7466 • Cliff Electronics 341 4655 • L E Boughen 369 1277 • Fred Hoe & Sons 277 4311 • The Electronic Shop (075) 32 3632 • Thompson Instruments (Cairns) (070) 51 2404
- **S. AUSTRALIA** Protronics 212 3111 • Tno Electrix 212 6235 • Industrial Pyrometers 352 3688 • J Blackwood & Son 46 0391 • Petro-Ject 363 1353
- **TASMANIA** George Harvey (003) 31 6533 (002) 34 2233
- **VICTORIA** Radio Parts 329 7888 • George Brown Electronics Group 878 8111 • G B Telespars 328 4301 • A.W.M. Electrical Wholesalers • Petro-Ject 419 9377 • J Blackwood & Sons 542 4321 • R.K.B. Agency 29 7336 • Sirs Sales (052) 78 1251 • Mektronics Co 890 4593 • Truscott Electronics 723 3094
- **W. AUSTRALIA** Atkins Carlyle 481 1233 • Dobbie Instruments 276 8888 • Protronics 362 1044





AUSTRALIAN MADE

IS IT POSSIBLE these days for the 'ordinary' enthusiast to actually participate in some of the technological developments that make the news on a seemingly daily basis? When "wireless" (broadcasting and communications) was developing, it was possible for hobbyists to join in and gain that enormously motivating sense of excitement. Where has all that gone? Are we viewing the technological development going on around us with a certain amount of "ho hum"?

Very probably. It would seem to many people that it's no longer possible to participate in any emerging, let alone maturing, technological development these days at something akin to the "string and sealing wax" level that made radio (or "wireless") accessible to ordinary enthusiasts in days gone by.

As the importance of the commercial and scientific exploitation of space grows for Australia, it would seem that "grass roots" participation by enthusiasts, let alone school-children, would be well nigh impossible, for space research and application is dominated by huge, wealthy government agencies and multinational companies with financial and other resources that would swallow the city council. It would seem that successful participation at even a modest level requires equipment of professional standard and performance, with price tag to match. It seems this feeling permeates even the amateur radio fraternity, to whom satellites have been a familiar part of the scene since the first amateur satellite flew in 1961, barely three years after Sputnik, which started it all.

But it needn't necessarily be so.

Nudged by a few enthusiastic readers, we've been looking into ways and means of showing hobbyists, teachers and students how it's possible to participate in space and space related activities without requiring a bank balance to match that of "the professionals". We not only believe it's possible, but readily affordable, too.

Over the coming months you'll be seeing the results of our endeavours appearing as features and projects in the magazine. Joining in developments in space technologies can be easier and cheaper than you'd expect.

It's enormously exciting, and we think you'll find it exciting, too!

Roger Harrison
Editor

Published by: Kedhorn Holdings P/L (Inc. in NSW), Fox Valley Centre, Cnr Fox Valley Rd & Kiogle St, Wahroonga 2076 NSW. **Typeset by:** Authotype Photosetters P/L, 397 Riley St, Surry Hills NSW, and Tuldin, 19 Princes St, McMahon's Point NSW. **Printed in 1987 by:** Offset Alpine, Cnr Derby & Wetherill Sts, Silverwater NSW. **Distributed by:** Network Distributing, 52-54 Park St, Sydney NSW. *Cover Price \$4.75 (maximum and recommended Australian retail price only; recommended New Zealand price NZ\$6.50). Registered by Australia Post, Publication No: NBP 7435. ISSN No. 0815-5046.

COPYRIGHT: The contents of The Australian Electronics Monthly is fully protected by the Commonwealth Copyright Act (1968). Copyright extends to all written material, drawings, circuit diagrams, printed circuit boards, computer software and photographs. Although any form of reproduction is a breach of copyright, and we especially point out this extends to the construction of projects produced by our laboratory or our associates, we are not concerned about individuals constructing projects for their own private use, nor by bands for example, constructing one or more units for use in performances. Commercial organisations should note that no project or part project, including printed circuit boards produced by our laboratory or our associates and described in this magazine may be offered for sale, or sold, in fully or substantially assembled form, unless a licence has been specifically obtained to do so from the publishers, Kedhorn Holdings Pty Ltd, or from the copyright holders. We will take strenuous legal action against any person or firm found infringing our copyright as aforesaid.

LIABILITY: Whilst all efforts have been made to ensure that all constructional projects and circuits referred to in this issue will operate as indicated efficiently and correctly and that all necessary components to assemble the same will be available, no responsibility whatsoever is accepted in respect of the failure for any reason at all of the project or circuit to operate effectively or at all whether due to any fault in design or otherwise and no responsibility is accepted for the failure to obtain any components in respect of such project or circuit. In addition, no responsibility is accepted in respect of any injury or damage caused by any fault in the design of any such project or circuit aforesaid. The publisher accepts no responsibility for unsolicited manuscripts, illustrations, computer software or photographic material although all care will be exercised. Comments and test results on equipment reviewed refer to the particular item submitted for review and may not necessarily pertain to other units of the same make or model number.

EDITOR/PUBLISHER

Roger Harrison VK2ZTB

ASSISTANT EDITOR

Andrew Keir VK2AAK

DRAUGHTING

Kym Baillie

PRODUCTION COORDINATOR

Val Harrison

EDITORIAL ASSOCIATES

Ian Boehm VK3XCD

Neil Duncan VK3AVK

B. App. Sci. Dip. Ed. M. Ed. Studs

Alan Ford VK2DRR/G3UIV

FIAA MBIM

Tom Moffat VK7TM

Jonathan Scott VK2YBN

B. Sc./B.E. (Hons)

SPECIALIST SERVICES

Jamye Harrison

NATIONAL ADVERTISING MANAGER

Richard Parker

INTERSTATE ADVT. SALES

Victoria

Rowan Wyeth & Associates

1/128 Dandenong Rd, Dingley 3172

Ph: (03)551 1212

Queensland

Geoff Horne Agencies

PO Box 247, Kenmore 4069

Ph: (07)202 6813; Fax: (07)202 7133

Tlx: (07) AA41398 (Geoff Horne)

West Australia

Stephen Knight

Hugh Scott & Associates

122 Aberdeen St, Northbridge 6000

Ph: (09)328 9204

ACOUSTICAL CONSULTANTS

Robert Fitzell Acoustics Pty Ltd, AAAC

CONTRACT PROJECTS

Technical Systems Australia

ENQUIRIES

Advertising
(02)487 1207

Editorial
(02)487 1207

Technical

Only after 4.30 pm EAST

(02)487 1483

Roger Harrison or Andy Keir

SUBSCRIPTIONS

\$49.95 Australia,

overseas rates on application

EDITORIAL OFFICES

Fox Valley Centre

Cnr Fox Valley Rd & Kiogle St

WAHROONGA 2076 NSW

POSTAL ADDRESS

PO Box 507, WAHROONGA 2076 NSW

FAX: (02)489 1265 TLX: 121822 (SY3296)

COPYRIGHT ©1987, KEDHORN HOLDINGS P/L

ADVERTISERS INDEX

COVERS

Elmeasco IFC
 V.22 Modem Offer IBC
 Philips OBC

INSIDE

ACE Radio 16
 Arista 9
 Assoc. Calibration Labs 18
 Aust. Maritime College 28
 CLC 80
 Dick Smith Electronics 21-27
 Electronic World 47
 Emona 13, 15
 Force Electronics 63
 Geoff Wood Electronics 10
 Hewlett-Packard 11
 Hi-Com Unitronics 40-41
 IPS Radio & Space Services 47
 Maestro 85
 Micro-Educational 87
 Nice Computer Co 9
 Pre-Pak Electronics 65
 RF Devices 14
 Scan Audio 20, 28
 Statronics 7
 Sound On Stage 47

WIN A PHILIPS DMM!

Special Message

Australian Electronics

Enhancing your VZ209 300

Driving the Yeasu 757 with a C64

Completing the Lab. Supply

COVER

This snazzy little economy stereo amp won't break the bank, looks good and performs well. See page 69. Pic by Allen Hedges. Design by Val Harrison.

PROJECTS TO BUILD

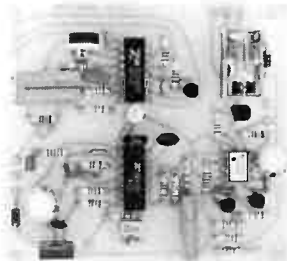

AEM3505 Packet Radio Modem for the C64

..... 92
Here's the low-cost way to get into packet radio, if you've got a Commodore 64.

AEM2000 Lab. Standard Power Supply

..... 56
Completing the construction.

AEM6012 High Performance Mic Preamp

..... 64
Here's a versatile mic preamp that can be used in a number of configurations and delivers top performance.

STAR PROJECT



Build This Economy Stereo Amp

..... 69
Here's a simple to build stereo amp that includes many features found on commercial equipment. And it won't break the bank.

CIRCUITS & TECHNICAL

ELEKTOR IN AEM

Contents 33

Section Indication for a Model Railway

..... 34
Shows a train's position with a series of LEDs. Keep track of your train. Great for large layouts.

The MAC TV System

..... 48
Inside the "multiplexed analogue components" television system, from A to E!

Fault-finding, Tools & Techniques

..... 12
Covers everything from visual skills to customer relations!

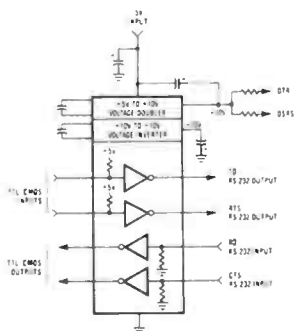

DATA SHEET

..... 78
The Maxim MAX231 and MAX232 RS232 line driver ICs, soon to be featured in up-coming projects.

PRACTICAL COMPUTING



SPECIAL OFFER

AEM4622 V.22 Modem

..... IBC
Here's how to upgrade your existing modem system for 1200 bps operation at modest cost.

New Life for an Old VZ

..... 82
Here's how to get full Level II BASIC for your old VZ by installing a ROM produced by some local enthusiasts.

Dial Up

..... 84
This month's topic covers ISDN, the "integrated systems digital network", soon to supersede our switched telephone network.

Bee Buzz

..... 86
Using the Microbee in your amateur shack, part 3. Calculating great circle beam headings and distances.

COMMUNICATIONS SCENE



Commanding the Yaesu FT757 using a C64

Here's how to "get the jump" on your FT757 – scan the bands, scan stored channels, etc. Computer control via the rig's CAT interface is easier than you think.

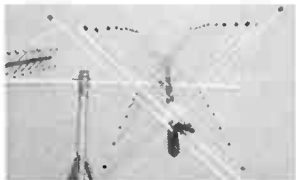

PRODUCT REVIEW The Satracker SA270 Amateur Satellite Antenna System

Accolades for a local product. If you want to get your feet wet in satellite operation, you'll need to look at this.

Build a Packet Radio Modem for your Commodore 64

Get going on packet the easy, low-cost way with our project and some AAPRA software.

FEATURE

Fault-finding, Tools & Techniques

Covers everything from visual skills to customer relations!



CONSUMER ELECTRONICS



Beautiful Amplifiers – Onkyo's M-308/P-508 System

Bob Fitzell had his perception altered about the influence of the "sound" of amplifiers when he reviewed this preamplifier system from Onkyo.

NEWS & GENERAL

News Review 6
Finer chip structures.

Consumer News 20
VCR hassles reduced.

Retail Roundup 55
AEM & Elektor PCBs.

Project Buyers Guide 55
Project kits & bits.

Professional Products 77
Pick-&-place SMD system.

Bytewide 81
Pulsar beats the world.

Spectrum 88
New Icom 2m rig.

Letters 8

Subscriptions 46

The Last Laugh 98



BIRTHDAY CONTEST 17
Win a fabulous Philips digital multimeter!

NEXT MONTH!

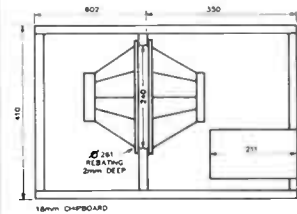

A BANDPASS SUB-WOOFER PROJECT

Here's a passive stereo sub-woofer which you simply connect to your amplifier and existing stereo speakers to get the benefit of that exciting bottom end on your discs and tapes. Build this and you'll realise what you've been missing up to now! The unit is quite small and can be tucked away out of sight in a room – and it's so simple to build!

BUILD OUR "RS-TRUE-32er" INTERFACE

So many popular computers sport a "serial" interface that does not generate proper RS232 signals. They work fine with many peripherals – but, as Murphy's law would have it, not yours! This simple project uses a relatively new chip – the MAX232, to generate "true" RS232 level signals but it only requires a single 5 V supply – which can be sourced from your computer!

DECODING WEATHER SATELLITE DATA ON AXM TRANSMISSIONS

If you're thinking of dabbling a little in space technology, a good place to get started is with the polar-orbiting weather satellites. But how do you find them? The weather bureau's HF station AXM, apart from transmitting the bureau's FAX weather pictures, transmits coded data which can be used to predict when the satellites will pass over. This article shows how to decode that data if you can receive AXM's RTTY transmissions.

While these articles are currently being prepared for publication, unforeseen circumstances may affect the final contents of the issue.

“Racetrack” produces finer chip structures at low cost

West Berlin's Fraunhofer Institute has developed, and is currently commissioning, a compact low-cost electron storage ring which produces highly directed high energy, short wavelength X-rays to be used in making structures on silicon of less than 0.5 micrometres.

Current methods of making chip structures on silicon wafers, employing optical lithography, cannot create structures much less than one micrometre in size.

At present, light is shone through a mask of the required chip structure onto a silicon wafer coated with a photosensitive resist. The resist is developed and the chip chemically etched. This 'optical lithography' process cannot produce the fine structures required for the next generation of memory chips as it is limited by the wavelength of light.

The shorter wavelengths of X-rays, around 0.2 micrometres or so, overcomes this problem, but X-rays of the necessary wavelength have been difficult to produce in the required beam that can be focussed on a silicon wafer, until now.

Work on the problem began at the Institute in 1977. The machine stores electrons in a "ring" only three metres across and shaped like a racetrack.

Dubbed COSY, for "compact storage ring for synchrotron radiation", superconducting magnets at the bends of the racetrack circulate the electrons in a tight curve, driving them around the loop. This produces highly directed X-rays of energies up to 600 mega-electronvolts (MeV), which are ideal for lithography.

Machines such as the large 15 metre diameter synchrotron radiation storage ring in Berlin (BESSY) were used to produce X-rays of this energy level previously. Costing DM200 million, such machines are out of the reach of chip manufacturers.

The Fraunhofer Institute workers claim COSY costs one-

tenth that of BESSY and can be linked to some ten lithography stations, readily justifying its cost.

To commercialise the machine, the West German companies of Leybold-Hereaus, Siemens, Valvo and Telefunken last year formed COSY Microtec in Berlin. It is predicted that X-ray lithography will come into its own in the production of the of 16M DRAMs.

Long optic

Olex cables has produced what they claim to be, at 10 km, the longest continuous run of fibre optic cable ever made in Australia.

It was made to a Telecom spec. for use in the Perth to Kalgoorlie stage of the East-West fibre optic link across Australia which calls for cables of various lengths up to the record-breaking 10 km.

The exceptionally long cable lengths used in this project will lead to cost-savings for Telecom because fewer joints are required. At least one complete cable joint is saved over a repeater length.

Conventional metal cables are not used in single lengths of such distances because of the handling problems associated with their heavier weights.

Opportunities to knock

Since its launch in early May, response to the Innovation Centre of NSW's Australian Innovation Sourcing Service has been enthusiastic, we are told.

Companies subscribing to the service include AWA, Alcan,

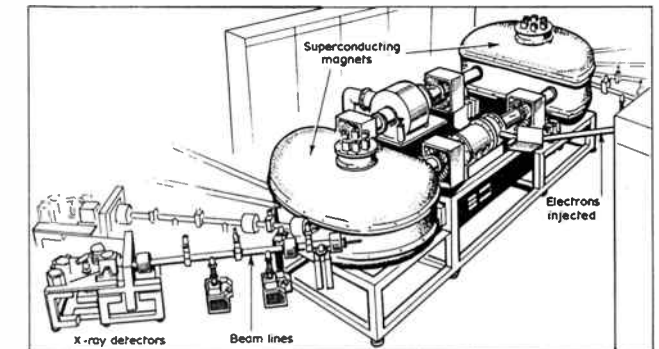

James Hardy, Plessey Pacific, 3M, Hanimex, Monitronix, CIBA-Geigy and Dupont, among others.

For small companies with a new product or process listed with the AISS, "opportunities for success" are created by speedy introduction to senior executives of manufacturing or marketing companies who can finance, develop and/or distribute the product.

The service is said to provide vitally needed development opportunities for Australian manufacturers to be competitive in local and world markets. We are told the service is cost efficient and affords direct contact with innovators.

Details from **Harold Graycar, The Innovation Centre of NSW, (02)399 6111.**



New MD for National

National Panasonic Australia has a new Managing Director, Mr Morohiro Sato, who comes from Matsushita (National's parent) in Osaka where he was Manager of the North American Export Department.

Prior to the position he held in Osaka, Mr Sato was Managing Director of Panasonic Deutschland, from 1972 to 1984. Mr Sato is 46, and joined Matsushita in 1963. He replaces Mr Harry Yokoi who has returned to Matsushita in Tokyo.

Advanced defence comms system

Our armed forces will receive the world's most advanced battlefield communications system following a \$350 million agreement between Plessey and the Australian government.

Plessey is to produce some 2000 HF and 3900 VHF radios, plus associated ancillary equipment and frequency management systems under the agreement.

Code-named RAVEN, the system incorporates the latest advances in tactical communications systems, included state of the art technology designed to prevent eavesdropping or jamming during field operations, we are told. It is the largest defence contract ever awarded to Plessey.

Plessey's Managing Director, Mr Edwin Matiuk, said the RAVEN project will provide a substantial boost to the local electronics industry.

The company hopes to exploit the facility set up in Sydney to manufacture state of the art defence communications systems for friendly nations throughout the Pacific region, the company says.

It is expected the facility will result in some 600 extra job places and with the addition of further projected orders, production at Plessey's Meadowbank plant is expected to continue into the early 1990s. ▲

PROTECT YOUR HOME OR BUSINESS WITH



PROFESSIONAL ALARMS.

FORCE ELECTRONICS — SPECIALISTS IN PROFESSIONAL ALARM EQUIPMENT

STOP PRESS
NEW STORE
129 FINDON RD.
FINDON, S.A.

★We stock IEI professional quality alarm equipment — as used by Australia's major alarm companies.

★12 month's warranty on all equipment — same day service.

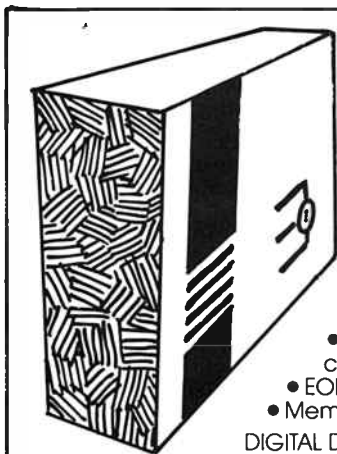

E-36-4 4 SECTOR ALARM PANEL

\$275 INC. BATT. & POWER SUPPLY

FEATURES

- 24 hr. panic circuit
- 24 hr. tamper panic
- Home mode for partial coverage
- EOL monitoring of sectors
- Memory review of alarmed sector

DIGITAL DIALER TO SUIT **\$295**

SA-209 • SA-210 PIR DETECTOR NORMALLY \$119

NOW **\$79⁵ UP** ~~\$69.95~~

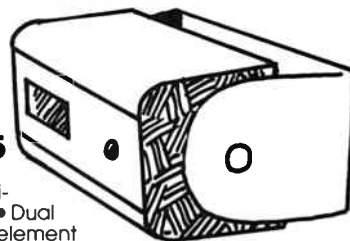

LIMITED OFFER
UNTIL SOLD OUT.

- Adjustable angle head. Multi-directional mounting bracket
- Dual pyroelectric infra-red sensing element
- 9 look out and 5 look down zones • R.F. protection • Selectable NC or NO
- Integral micro tamper switch • Sensitivity adjustment
- Wall or ceiling mount • Reed switch Relay for ultra quiet operation
- Coverage 12m x 12m at 20°C.

SA209 (40 ft. x 40 ft COVER AT 90°). SA210 75ft x 3ft (CORRIDOR WORK)

ALARM ACCESSORIES:

Horn speaker 10W 8Ω	\$12.95
Horn Tamper Cover + SW	\$19.95
Strobe Light 12 V DC	\$24.95
Surface Reed Switch	\$4.95
Flush Reed Switch	\$4.95
100m Roll 4 Core Cable	\$50.00
Emergency Panic Switch	\$4.95
Window Warning Stickers	\$1.00
Alum. Window Foil Roll 45m	\$14.95
Tape Blocks Pair	\$1.00
Pressure Mat	\$19.95

MEMORY:

4164	\$1.95
41256	\$5.95
6116	\$3.95
6264	\$6.95
2764*	\$6.95
27C 64	\$6.95

*2IV prog. voltage.

CANNON CONNECTORS:

DB 15 Male	99c	79c
DB 15 F/male	99c	79c
DB 25 Male	\$1.95	\$1.75
DB 25 F/male	\$1.95	\$1.75
DB 37 Male	99c	79c
DB 37 F/male	99c	79c

FANS:

12V 80mm Brushless Motor	Were \$49.95	Now \$24.95
240V 80mm Ball Bearing	\$49.95	\$29.95

Connecting Lead Included!

T.V. TECH'S SPECIALS:

BU 326	\$7.95	\$3.95
BUX 80	\$8.95	\$4.95
BU 208	\$8.95	\$3.95
BC 547	25c	10c
BC 557	25c	10c
IN 4007 1,000V 1 Amp Diode	16c	7c
IN 5408 1,000V 3 Amp Diode	45c	20c
R-250D 400V 6 Amp Diode	\$1.10	75c
75 Ω Metal Plug	\$1.70	60c
75 Ω Metal Line Socket	\$1.85	95c

RF MILLIVOLT METER KIT



*KIT PRICE INCLUDES 1 YEAR'S FREE SUBSCRIPTION TO EITHER E.A., E.T.I. OR A.E.M. MAGAZINE

\$269*

Specs.:
Sensitivity — 40dBm (without attenuator).
Input range 22.3mV max. to +23dBm (with attenuator).
See Jan.-Mar. issue, A.E.M.

AEM 2000 100W LABORATORY POWER SUPPLY KIT

\$575

Refer A.E.M. article this issue for details.

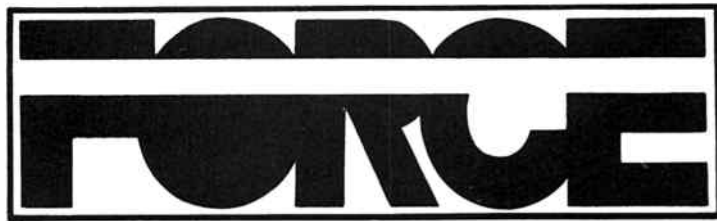
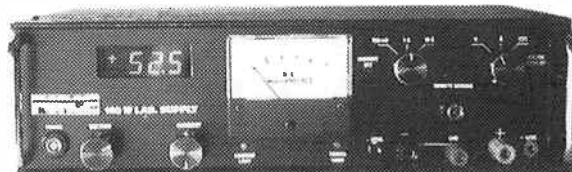

ADELAIDE
PH. (08) 212 5505
203 WRIGHT ST.

CHRISTIES BEACH
PH. (08) 382 3366
24 BEACH RD.

ENFIELD
PH. (08) 349 6340
445 MAIN NTH. RD.

BRIGHTON
PH. (08) 296 3531
504 BRIGHTON RD.

WE ACCEPT
BANKCARD, VISA
& MASTERCARD

MAIL OR PHONE ORDERS TO ANY STORE
STANDARD MAIL UP TO 2kg \$4 O/N SERVICE UP TO 3kg \$7 ROAD FREIGHT OVER 10kg \$10

NiCad ad. misleading?

Dear Sir,

I am very concerned about the advertisement for NiCad cells appearing in June AEM, ETI, EA and inserts placed by Dick Smith Electronics. The text contains statements and draws conclusions which are at variance with well known facts about these cells. I have enclosed copies of technical articles on NiCads which have appeared in the same publications and have highlighted the relevant portions.

It appears to me from studying the advertisement and a conversation I had with its author, that he is not well informed on the subject of batteries and their applications.

Firstly, I consider the text of the ad. to be very vague. (e.g: figures are quoted without reference to cell type, size or brand). However the general thrust is obvious and might be summarised as . . . "replace the dry batteries in your portable electronic equipment with NiCads and enjoy large savings in cost, improvements in performance and longer running time per charge than before".

There are many well known problems with this proposition, making it doubtful advice at best. Taking the four paragraphs in order, the objections are:

1. Four hundred charges MIGHT be obtained, but only under laboratory controlled test conditions. Series discharge of unmatched cells and recharge before complete discharge will severely limit the life of a cell. The high cost of changeover to NiCads (\$50 to \$300 including charger/s), means a break-even point of about 50 to 100 cycles. In many cases this may not be reached due to cells deteriorating. Also, many users will find waiting 12 to 14 hours before reuse very inconvenient, necessitating purchase of a second set of cells so as to have a charged set on hand. More cost, hence longer to the break-even point.

2. The constant discharge voltage of a NiCad is not disputed and may be good in a few applications. BUT the normal terminal voltage of only 1.2 V is very close (within 0.1 V) to the END point voltage of a dry cell. Your torch or cassette player will perform as if it had nearly flat dry cells in it. Some equipment will barely work at the reduced voltage offered by NiCads.

3. The internal resistance of a NiCad is

very low, allowing high discharge currents – sometimes dangerously high – if the equipment is not designed for them. Stalled motors in toys can be burned out, flash units may overheat and fail. (see National PE 2002 flash unit operating instructions). Accidental fires are likely if shorts occur inside equipment or to cells. A "C" size NiCad can deliver 100 amps-plus if shorted.

4. The energy capacity (amp hours) of a NiCad is superior only to the poorest grade of dry cells. The figures in the Plessey brochure (quoted as the source of the information by D.S.E.) were obtained by comparing a NiCad with a light duty dry cell in a heavy duty situation. Arguing from a single example is logically erroneous.

I performed a 90 mA discharge test on Eveready "red" cells (as sold in Dick Smith stores) and found they lasted over five hours to 1.1 volts. The specifications for Eveready "black" and alkaline cells indicate 10 hours or more is to be expected. ANYONE considering investing in NiCads would have to be using their equipment regularly and heavily. They would be most unlikely to be using light duty dry cells.

The example given in the ad. is not typical, not explained (what dry cell?) and is therefore misleading.

There is a further misleading assertion in the text accompanying the "Multi-Cell Charger", where it is claimed one can "properly" check a NiCad cell by measuring its voltage under load. This is nonsense. The paragraph two statement about constant voltage discharge means that the state of charge CANNOT be found by measuring the voltage under load. It is likely that users of this device will believe cells to be fully charged when they are not and/or to overcharge only partly discharged cells. Either of these errors will shorten the life of a NiCad cell.

A charger which overcomes this difficulty appeared in EA in March this year.

I am aware that some people will claim satisfactory results with NiCads in their dry cell battery equipment, however, many others tell a different story. Poor performance and running time, damaged cells and equipment are typical.

I would hope that some form of correction or retraction appears shortly.

P. Allison
Summer Hill NSW.

Attenuating circumstances

Dear Mr Harris, (sic)

Thank you for the free copy of AEM you sent me (a recent promotional drive – Ed.).

After reading the attenuator article by DSE, one can't have a lot of faith in your published material. I would guess DSE sent you the article to promote the kit they are peddling and you or your staff had neither the time or equipment to check the accuracy of the claims.

Wherever can you buy an attenuator having a maximum loss of 63 dB for under \$40? Have you ever used an attenuator having such a high insertion loss at 500 MHz? Such high attenuation is very difficult to achieve and even more difficult to measure.

Compare an attenuator made by Morelli or STC, and the simple box described in the article. A simple box like the DSE design will have difficulty getting an attenuation of 40 dB at 10 MHz.

No Mr. Harrison, it would not meet the claimed specification.

Think of all the poor youngsters who have faith in the designs you publish and who are going to waste their money. Of course, they will be ignorant of the shortcomings, but that is no reason for you to publish this kind of thing.

I have never found those cheap Japanese slide switches particularly satisfactory. They may be alright for switching small amounts of power, but when it comes to switching small levels of ac and where the contacts are not "wetted", the contact resistance can be erratic.

D. Maxwell-Gill
Gordon NSW.

Thank you for your letter and your interest in the magazine.

I am familiar with the attenuator project to which you refer. It appeared in our April 1987 issue and was indeed designed by the R&D department of Dick Smith Electronics.

I can understand that if you are used to dealing with attenuators such as the Morelli or STC types to which you refer, you might assume that the subject of this project would not meet the same standard. You are undoubtedly correct, it would not and neither does it pretend to.

Attempting to make a comparison between this attenuator and a professional

quality switched attenuator costing maybe hundreds or even thousands of dollars, is a bit like comparing a mini with a Rolls-Royce. Both will do a similar job, but you could reasonably expect a level of quality and performance commensurate with the cost.

To answer another of your questions, yes, I have used an attenuator with very high insertion loss at 500 MHz, and no, it is not difficult to measure provided one uses suitable equipment. I must assume that you have not actually measured the performance of the attenuator described in the article. Had you done so, I feel sure that you would not have been prompted to write. Your statement that "a simple box like the DSE design will have difficulty getting an attenuation of 40 dB at 10 MHz" only serves to reinforce this feeling.

I would agree that if we were attempting to produce an attenuation of 63 dB in a single stage, it would be most difficult to achieve any sort of predictable performance. This is why the designers of the project opted to use a maximum attenuation step of only 16 dB. The graph which accompanies the article shows the measured performance of each of the individual steps available from the attenuator from 0 dB to 16dB and is plotted from below 2 MHz to 600 MHz.

Should you doubt the accuracy of the equipment used in the derivation of these measurements, the following was used: a Marconi model 6950 thermal power meter, a Hewlett-Packard model 8640 signal generator, a JFW calibrated attenuator and a Takeda-Riken model 4113 spectrum analyser. The technicians who made the measurements are very familiar with the use of this equipment, often being required to test radio frequency equipment for type approval by the Department of Communications. I have worked with them personally and can vouch for their competence.

I have used the prototype on which these measurements were made and found it to perform as described in the article. The accuracy is such that the unit's usefulness extends well beyond the 144-148 MHz amateur band, and is still quite good at the 430-440 MHz band. I don't think that the "poor youngsters" need loose faith in our published designs and they certainly won't be wasting their money if they buy and build the kit.

Yes Mr Maxwell-Gill, it does meet the claimed specifications.

Andrew Keir

Problem?

If you needed to solve a real problem, would you

1: ask a chicken what makes a great omelette?

2: ask a lunatic to lead a moon mission?

3: ask a hypochondriac a question on health?

4: ask a politician any question at all?

The ARISTA™ Solutions

If the answer to three or more of the above is a resounding **NO!** then, by the same reasoning, you would appreciate that only an **ARISTA Retailer** can provide the solution to your accessory problem for audio...microphones...computers...public address...tools and technical advice...TV...video...batteries...headphones...styli...burglar alarms...telephones...sound reinforcement...car sound...plugs...jacks...sockets...etc...etc...

So...go ahead and ask him...
he's got a good ear!

For further information on the **ARISTA solutions** and the name of your nearest retailer, please contact:

ARISTA™
ELECTRONICS PTY LTD
Telephone (02) 648 3488

ALL THE FEATURES YOU'D EXPECT IN A \$1500 MODEM AT HALF THE COST



FEATURES INCLUDE

- Intelligent modem, with enhanced Hayes "AT" command set.
- Baud Rates (CCITT & Bell): 300/300 (V21, 103), 1200/1200 (V22, 212A) 1200/75, 75/1200 (V23).
- Baud rate buffering & conversion at all speeds.
- Auto-dial (pulse & tone), auto-answer, auto-disconnect.
- True baud rate scanning.
- Advanced ring back security.
- Visual & audio indicators.
- Compact elegant rugged design.
- Fully Australian designed & manufactured.
- 12 month warranty.
- Telecom engineering authorisation No. C86/37/1544.
- Compatible with any RS232 interface.

\$749 Rec. retail, inc. sales tax.

Nice Modem Three has all the features as Nice Modem Two other than 1200 bps, full duplex, for \$549.

Software for IBM & Apple available

CONTACT YOUR LOCAL COMPUTER DEALER OR CALL
GEOFF ARTHUR (02) 869 8777
TONY ROWLAND (09) 321 6636



THE NICE
COMPUTER
COMPANY OF
AUSTRALIA PTY. LTD.

Suite 3, 41 Rawson St., Epping, NSW, 2121.
36 Parliament Place, West Perth, 6005.

TRADE ENQUIRIES WELCOME

UNCHALLENGED!

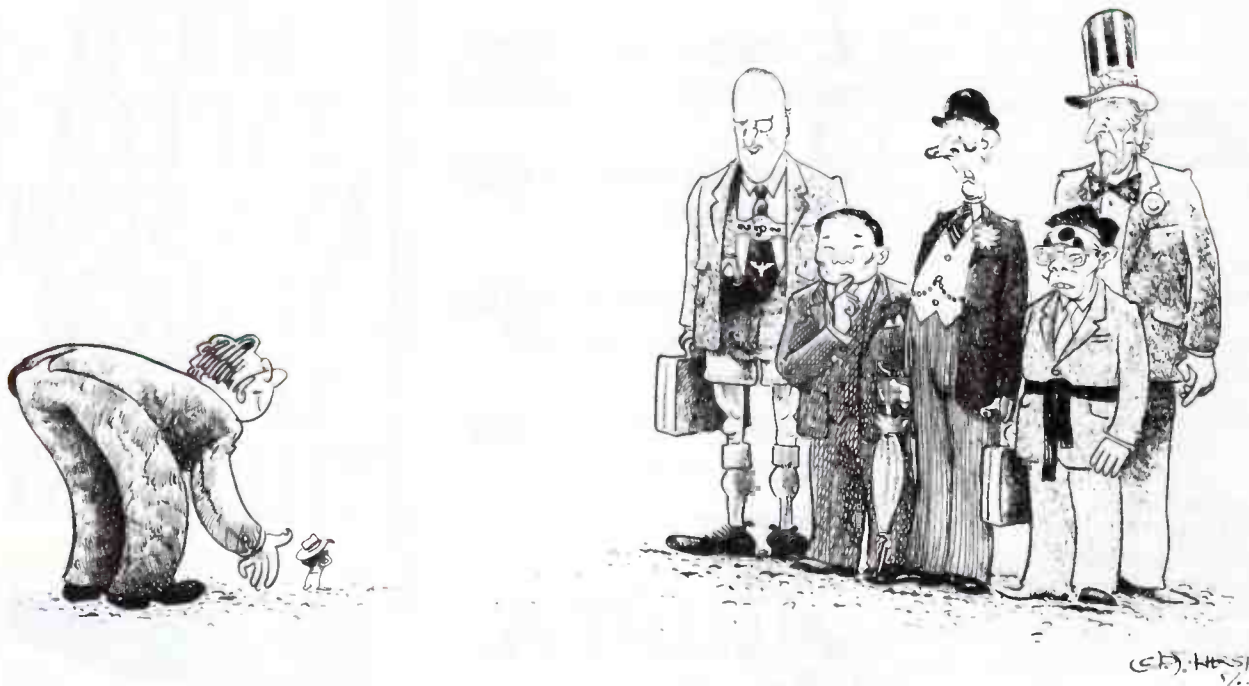

For two months we challenged the power supply importers to show us a smaller power supply than our **Australian** designed and manufactured off-line switchers. But no one could show us a 10W, 20W, 30W or even a 70Watt switcher anywhere near our power density!

There just is *nothing* to compete with them.

If you're concerned with board space and minimising footprints then look no further than these locally produced switching power supplies and dc converters-

Brief Specification

Nominal ac input voltage	:	240V rms, 50Hz \pm 10%
Nominal dc input voltage	:	21 - 63V
MTBF	:	Better than 50,000hr at 60°C with natural cooling and no extra heatsinking
Outputs	:	Triple - 12V, 12V and 5V
Efficiency	:	80% approx
Isolation	:	3750V
Ripple and Noise	:	Better than 100mV p-p
Regulation	:	Better than 5% combined line, load and cross regulation
Dimensions	10W	: 72 x 27 x 18mm (4.7W/cu in)
	20W	: 72 x 40 x 27mm (4.2W/cu in)
	35W	: 127 x 58 x 24mm (3.3W/cu in)
	70W	: 136 x 71 x 28mm (4.2W/cu in)



STATRONICS POWER SUPPLIES

Rifala Pty Ltd trading as Statronics Power Supplies
 103 Hunter Street, Hornsby N.S.W. 2077
 Tel : (02) 476 5714, 477 5152 Fax : (02) 476 6914

*we never
stop
asking*

"What if..."

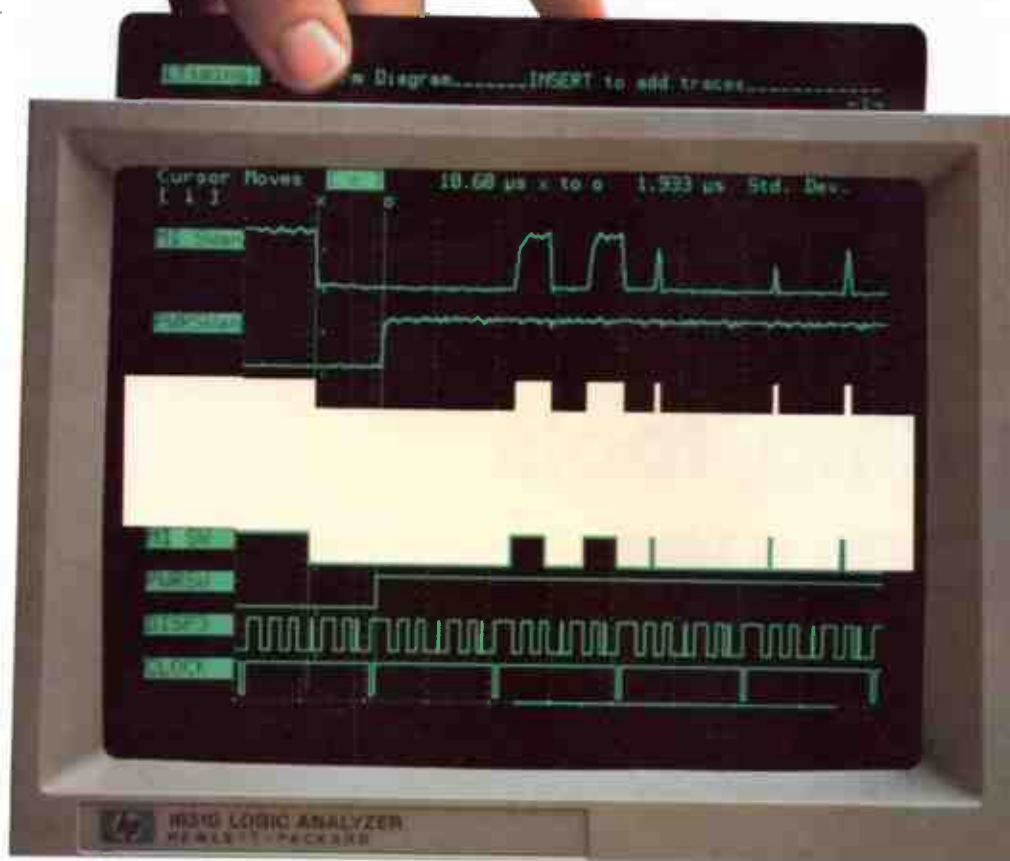

Get a Logic Analyzer and a dual-channel Oscilloscope in one package.



The HP 1631 A/D.

HP put the two most important diagnostic tools used in logic design together for you. In one, easy-to-use instrument!

The HP 1631A/D is a high-performance logic analyzer. It's also an advanced dual-channel digitizing oscilloscope with 200 Mega-sample/second performance.

So now you can measure complex, simultaneous digital and analog signals with confidence. And view results on a single time-

correlated display...making your cross-domain analysis quick and easy.

The HP 1631A/D examines digital systems at the global level (system performance analysis), the functional level (state and timing analysis), and the parametric level (analog waveform analysis).

You can store test data, waveforms, and instrument setups on HP disc drives. And even get hard-copy records of test results.

Call HP today!

Phone your local HP sales office for more information on the HP 1631A/D.

Adelaide (08)272 5911
Brisbane (07)300 4133
Canberra (062)51 6999
Melbourne (03)895 2895
Perth (09)242 1414
Sydney (02)888 4444



**HEWLETT
PACKARD**

EI15606CA

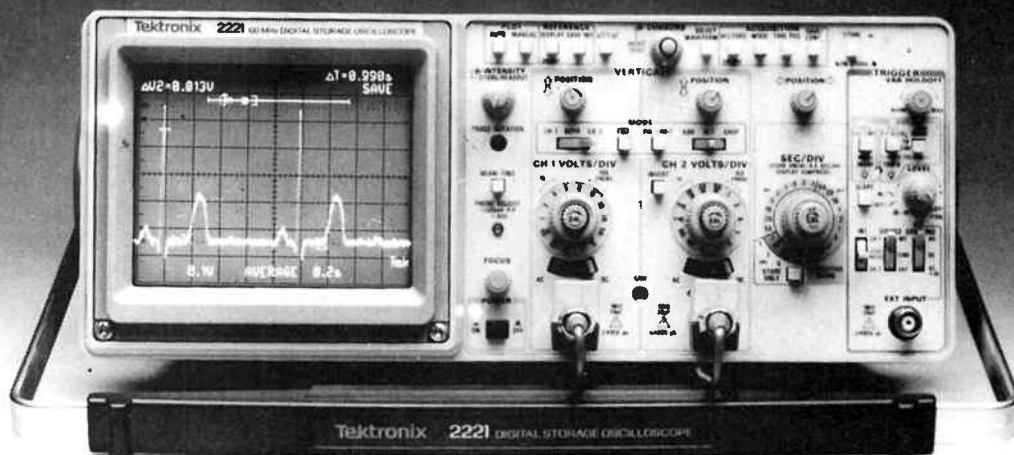

Fault-finding, tools and techniques

Andrew Keir

The 'art' of fault-finding involves a combination of diagnosis, deduction and drudgery, some wag once wryly observed. But it's only part of the story. For the whole story, read on!

WITH THE PROLIFERATION of electronic equipment encountered in our daily lives, it comes as no surprise to learn that the industry which services and maintains that equipment is a large and very competitive one. To remain competitive, a service organisation must be able to provide a fast and efficient turn-around with the minimum inconvenience to their customers.

Assuming an adequate supply of spare parts, the major factor in providing an efficient service is how fast the technician or serviceman can locate and repair the fault in a piece of equipment. If you ask anybody who has worked in the service industry, they will tell you that in the majority of cases, finding a fault takes about 90 percent of the time spent on a job. Once the fault has been located, it is usually a quick and simple job to fix it. If you have ever wondered why some organisations are reluctant to give free quotes on repairs, now you know!

Obviously, anything that can assist the serviceman to locate a fault faster or easier, is going to be of great benefit to both the service company and the customer. On the domestic scene, it can be quite an inconvenience to be without your TV for a few days, but in the business world time is money. Imagine the consternation when a mainframe computer fails and the payroll can't be done or the accounts can't go out!

Preliminaries

In part, this article will be concerned with the many service and fault-finding aids which are in use today. Whilst these can be of enormous advantage in increasing efficiency, we should not ignore the basic techniques required for successful fault finding.

In many cases, you can find a fault in a piece of equipment by using your "intrinsic" tool kit, and like a doctor, your first approach should be to examine the symptoms. In our case, the patient can't tell you how it feels or where it hurts, but by looking at the evidence produced by the fault, you can often nar-

row down the area of the malfunction. As an example, take the case of a domestic stereo amplifier. Are both channels faulty?, if so then the fault must lie in some part of the circuit which is common to both. If one channel is working then you have immediately narrowed the fault to half of the circuit and you have the added advantage of a working channel with which to compare the faulty one.

This sort of approach is the basis of all service work, you attempt to narrow down the area where the fault lies. How you go about this process will determine the speed with which you will find the fault. Imagine a very long piece of wire which has a break somewhere along its length and which you can't see. You could take a continuity tester and start at one end of the wire checking it off a foot at a time. Eventually you would find the break. A more sensible approach would be to check the continuity from one end of the wire to a point half way along its length. If that test shows the wire is intact, you have eliminated half the likely area immediately. Now do the same with the faulty half and you are down to a quarter. It would only take a few such checks to have the fault down to a few centimetres.

All electronic equipment can be divided into individual areas or sub-circuits regardless of how complex it is and so the same approach towards eliminating the working parts can be used. In practical terms, it is not always quite so straightforward because the equipment may have more than one fault, or the fault may affect other parts of the device. This is where experience comes in.

When attempting a diagnosis, the next thing to do is to perform a physical examination. A lot can be learned by simply looking, listening and feeling. Can you see any charred components?, is there smoke coming out? (turn it off, quickly!), does anything feel unduly hot?, can you hear arcing? These sort of things are fairly obvious but it is surprising how many servicemen will overlook simple things like broken wires or loose connectors which would have been picked up by a quick "visual".

THE TOOL FOR ALL SEASONS!

True, but true. The oscilloscope is an invaluable, if not essential, tool in a wide variety of servicing work, ranging from television service to process control systems.

This is the new Tektronix Model 2221 60 MHz analogue and digital storage oscilloscope (DSO). The analogue mode provides the familiar setup, while the DSO mode simplifies many servicing and calibration procedures as it offers reference waveform storage and measurement cursors. The unit provides readout for stored waveform analysis and an accumulated peak mode for monitoring signal drift.

As this instrument can be ordered with either a GPIB (general purpose interface bus) or RS232C interface, it can be employed with a personal computer for automation of particular or regular service procedures.

Further information is available from Tektronix, (02)888 7066.

Fault finding aids

Once you have covered the preliminaries, it is time to start making use of the specialised tools and instruments to assist you in finding the fault. The sort of instruments and tools which you use will be largely determined by the type of equipment you are working on and can range from a humble multimeter to a logic analyser.

We can broadly divide most electronic equipment into two categories, digital and analogue. Some equipment will, of course, contain elements of both types of circuitry, and similarly there are instruments and tools which can be used in the repair of either type. Because the field is so vast, it is convenient for our purposes to examine these two categories separately. In the first part of this article, we shall take a look at those instruments and service aids which are predominantly suited for working on analogue equipment.

The two most commonly used "general purpose" instru-

ments would undoubtedly be the multimeter and the oscilloscope. The multimeter is most frequently employed for simple checks on continuity, resistance, current or voltage. The digital multimeter is fine for accurate measurements of parameters which remain fairly stable. If the quantity under test is changing to any great degree then an analogue meter or a digital type with a bargraph display would be better. A surprising amount can be learned by the judicious use of a multimeter. It is possible to perform limited "in circuit" testing of components as well as checking the more obvious things such as power supplies, switches and fuses.

It is usually possible to use a multimeter to indicate that a given device in a circuit is functioning. You could, for example, measure the terminal voltages of a transistor and get some idea of whether it is intact or not. This is all very well if you are dealing with straightforward switching circuits and the like, but it can be misleading and time consuming when dealing with the "signal" parts of a circuit.

As is often said, a picture is worth a thousand words, so once you get into the signal areas of any equipment, you will be better off using an oscilloscope to find out what is going on. Whereas a multimeter will happily indicate the presence of an ac voltage, only an oscilloscope can tell you whether the waveform of that voltage is correct. Many multimeters are dc coupled on their ac ranges and you can imagine the results when trying to check an ac signal that is superimposed on a dc voltage. By using a dual trace oscilloscope to display the signals into and out of a particular stage or stages, you can quite quickly narrow down a faulty stage or component.

Beyond these two almost "universal" tools, the type of instruments used in fault-finding become more specific to the type of equipment being worked on. Examples of these more specific tools include things like audio and RF signal generators, signal injectors and tracers, frequency counters and sophisticated instruments such as spectrum analysers. ▶

Polar

PCB FAULT LOCATORS

Workshop money savers – Workshop time savers



TONE OHM series

with
**CURRENT
TRACER**

Specifically for locating SHORT CIRCUITS on analogue and digital boards. No more cutting tracks! Features three techniques for finding shorted or leaky components, including current tracer, milli-ohm and microvolt ranges.



T-series

with
**TRANSISTOR
CURVE
TRACER**

Designed to locate faulty components in-circuit, without the need for desoldering or cutting tracks. Dynamically tests all components and semiconductors on unpowered boards. Also includes curve tracer to test and match semiconductors for gain and performance.



EMONA INSTRUMENTS

NATIONAL DISTRIBUTORS

DIVISION OF EMONA ENTERPRISES PTY LTD

VIC Radio Parts Group, Melbourne. Phone 329 7888

QLD Baltec Systems Pty Ltd, Brisbane. Phone 369 5900
Nortek, Townsville. Phone 79 8600

WA Hincro Engineering Pty Ltd, Perth. Phone 381 4477

ACT Electronic Components Pty Ltd
Fyshwick. Phone 80 4653.

SA Int. Communication Systems Pty
Ltd. Port Adelaide. Phone 47 3888.

SHOWROOM SALES

86 Parramatta Rd Phone: (02) 519 3933
Camperdown 2050 Fax: (02) 550 1378

TAS George Harvey Electronics.
Hobart. Phone 34 2233.
George Harvey Electronics.
Launceston. Phone 31 6533.

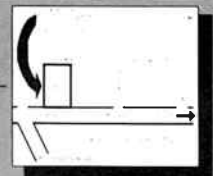



The multimeter is as indispensable to a serviceman as a wrench to a plumber. These days, digital multimeters offer facilities that used to require a whole tote-bag of instruments. This Philips DMM, from the Series 18 range, Model 2618X, includes a 200 kHz digital frequency counter, a logic tester, audible continuity tester and temperature measurement facility (with a plug-in probe). Philips Scientific & Industrial can supply further details. (008)22 6661.

question "what seems to be the problem?" usually goes something like "it doesn't work". You should not just accept this sort of response, you could be neglecting valuable information.

Customers do not usually like to volunteer information because they think it will make them look silly if they say the wrong thing. As a serviceman, you will have to extract the information from the customer. You should ask questions such as "did the fault occur suddenly or has the equipment been playing up for some time?" or "have you had this same problem with the equipment in the past?". How much detail you get will depend on how well you ask the questions. Don't be afraid to pursue things with the customer, but by the same token, don't get bogged down in pointless lines of questioning and don't make the customer feel threatened.

If you are working in a service workshop where there is no contact with the equipment's owner or operator, you will usually get a cryptic description of the fault written on the job card. How much information you get in this case will depend on the person who took delivery of the faulty equipment, but is usually along the lines of "faulty" or "no go". With this sort of information, it is going to be up to you to examine the equipment and find out for yourself what the symptoms are. This can be quite difficult when the fault is not immediately obvious and often leads to the equipment being returned to the owner marked as "no fault found". The way to avoid this is to have the person taking delivery of the equipment asking relevant questions of the owner and writing down a descriptive summary of the symptoms. As well, the service technician should make a thorough test of the equipment with regard to all its parameters and functions before assuming that no faults exist.

Learning from the customer

Possibly the best way to illustrate the use of tools and instruments in fault-finding is to describe some typical faults and how to go about tracking them down. We will start with something simple, such as a hi-fi stereo amplifier.

The first thing to do is to try and find the nature of the fault and the symptoms exhibited. How much you learn here will depend on how the faulty equipment gets to you. If you are a field serviceman, or have the opportunity to talk directly with the owner or operator of the equipment, you can ask for an explanation of the problem. The standard response to the

A practical example

Getting back to our example, assume you have been given the job of repairing a hi-fi stereo amplifier. You are not able to talk to the customer, and the job card simply states "not working". We will assume that you have access to all the normal facilities of a good workshop and have all the relevant circuit

IN-CIRCUIT TESTING

A low-cost In-Circuit digital IC Tester. This versatile instrument combines a minimal investment with maximum utility enabling comprehensive dynamic tests to be performed on a wide range of digital IC's — EVEN IF THE IC TYPE IS UNKNOWN.



The ABI In-Circuit Tester means business. Five comprehensive tests are performed as follows:

- identifies orientation of the IC within the test clip.
- checks if any of the IC pins are shorted to either supply rail.
- identifies those IC pins which are linked together
- identifies floating/high impedance pins.
- performs functional checks on the IC under test in accordance with its truth table. Displays any non-standard logic levels encountered.

The test result is displayed almost instantaneously; accurate interpretation of the screen information enables rapid pin-pointing of fault areas.



**R.F. DEVICES
PTY. LTD.**

P.O. BOX 161 MILLER
NSW 2168
SYD (02) 607 8811
MELB (03) 726 8061

diagrams etc. Where do you start? Well as stated at the outset, the first thing to do is give it a good "visual". On removing the lid and having a good look around inside, you fail to see anything obvious. There does not appear to be any loose wires or burned components.

The next thing to do is to plug it in and turn it on. One quick hint here, check that if the equipment has a mains voltage selector, it is set to the correct local mains voltage. Many people who bring back electronic equipment bought duty free overseas find that it only works for a nano-second or two after plugging it in because it was set for a lower mains voltage. The result is usually a quick trip to a service centre. If your workshop is equipped with protective devices such as core balance relays, you probably won't do this sort of thing yourself.

On powering up the amplifier, you discover that the power indicator on the front panel lights but that when you connect up some speakers and an input source, there is no output from either channel. After selecting and checking the other inputs of the amplifier, you ascertain that none of them will produce an output. Because both channels have failed, you can safely assume that the fault lies in some part of the circuit that is common to both. You know that power is getting in because the power indicator lights, but further examination reveals that this indicator is simply a neon lamp in the mains input side of the power supply.

The most obvious thing to check now is the power supply itself. Examination of the circuit diagram shows that it is a straightforward linear supply consisting of a multi-tapped transformer and rectifiers. There are two supply rails produced by the supply; a 70 V rail which for the power amplifier section and an 11 V rail which powers the preamplifier section. Digging out your multimeter, you measure the both the supply rails and find that whilst the 11 V rail is OK, the 70 V rail reads 0 V. Tracing the circuit through, you find that the 70 V rail has a separate fuse mounted on the power amplifier

board. Checking the fuse, you find it has blown. Oh good, you think, this is going to be easy. You replace the fuse with another of the correct value, turn the amplifier on and . . . flash! . . . another fuse bites the dust. Should have thought of that, fuses don't usually blow for no reason.

Where do you turn to now? Well, by checking the power supply output when disconnected from the power amp section, you discover that both the 70 V and 11 V rails are OK, it's also a fair bet that the preamp section is intact. The fault obviously lies somewhere in the power amp section. Because you have two power amp sections (it is a stereo amp), you could try some comparison checks between the two, but as you can not apply power, you would be limited to resistance checks. A slightly different approach could be taken if it is possible to isolate the two power amp sections from each other and from the power supply. In this case you could isolate each power amp section and check the resistance across its supply rails. One or other or both is going to have a very low resistance across the rails which is causing excess current to be drawn from the supply.

We will assume that the latter is the case and by using your multimeter you discover that one channel has what appears to be a direct short across the supply rails. By isolating the faulty channel, you could now reconnect the other one to the supply and test it. On doing this, you find that the channel works correctly so you can now direct your attention to the faulty channel. Your experience will probably tell you that a good place to start is at the output devices because any stage which handles large currents or handles appreciable power can be more prone to failure.

On this occasion you get lucky. Whilst checking the interelectrode resistances of the output transistors you discover that they are both short circuit between emitter and collector. As these two devices are connected between the supply rails with only a couple of very low value, high wattage

MICROPROCESSOR SYSTEM FAULT-FINDING INSTRUMENTS

The fault-finding instrument's personality pod replaces the microprocessor and runs the board under test. No assembler programming knowledge is required, as only the system memory map need be known to enter test programs. The system memory and peripheral ICs can be tested directly, while a "loop program" allows decoding type problems to be traced using an oscilloscope.

16 & 32 bit Systems

ANTRON MST 16/32

Specifically designed as a 16 and 32 bit tester, it provides 16 predefined single key tests, plus BASIC and Quick Code assembler. 58K total program memory. The large battery backed RAM stores user test programs in the form of a virtual disk. Dual RS232 ports provided for printout and computer control.

8 bit Systems

Polar B2000A

Low cost production or field service instrument. Provides 12 predefined single key tests. Integral printer records all results. Non-volatile memory stores up to 15 test programs.

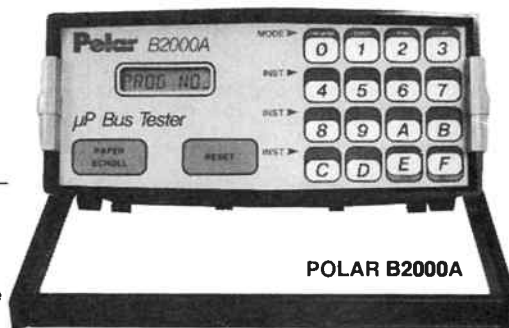

EMONA INSTRUMENTS

NATIONAL DISTRIBUTORS

DIVISION OF EMONA ENTERPRISES PTY LTD

VIC Radio Parts Group, Melbourne. Phone 329 7888

QLD Ballec Systems Pty Ltd, Brisbane. Phone 369 5900

Nortek, Townsville. Phone 79 8600.

WA Henco Engineering Pty Ltd, Perth. Phone 381 4477.

ACT Electronic Components Pty Ltd
Fyshwick. Phone 80 4653.

SA Int. Communication Systems Pty
Ltd. Port Adelaide. Phone 47 3888.

TAS George Harvey Electronics.
Hobart. Phone 34 2233.

George Harvey Electronics.
Launceston. Phone 31 6533.

SHOWROOM SALES

86 Parramatta Rd Phone (02)519 3933
Camperdown 2050 Fax: (02)550 1378

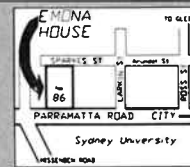

WOOD FOR CHIPS ... WOOD FOR CHIPS ... WOOD FOR CHIPS ... WOOD FOR CHIPS ... WOOD FOR CHIPS ... WOOD FOR CHIPS ... WOOD FOR CHIPS ... WOOD FOR CHIPS ... WOOD FOR CHIPS ... WOOD FOR CHIPS ... WOOD FOR CHIPS ... WOOD FOR CHIPS ...

Genuine Fujitsu Relay for only \$3.50



Geoff has managed to obtain a quantity of genuine Fujitsu 4 pole changeover relays type FRL263. They have solder/plug-in terminals and offer four changeover contacts rated at 3A. The coil is 24V nominal (650ohm). Fully enclosed.
Measures 22 x 28 x 40mm approx.
Fujitsu FRL263.....only \$3.50

10 pin SIL Resistor Networks

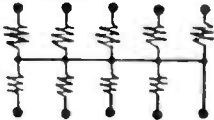

By popular request Geoff is now stocking resistor networks. They consist of nine resistors sharing a common connection in a ten pin in-line package. Available in the following values:
220, 330, 470, 680, 1k0, 2k2, 3k3, 4k7, 10k, 22k, 33k, 47k, 100k and 200k.
1/8W rating. Fits 0.1" grid.
Specify value... all 60cents

68000 Processor Chips on Special

Thomson brand 10MHz CPU chips. Yes the 68000 microprocessor for under \$25!
TS68000CP10.....\$24.00

IBM Printer Cables

Approx 1.5m long with quality connectors on each end. You couldn't make one yourself for the price. We only hope our stocks last till this advertisement appears because you'll be paying more than \$15 for the next shipment!

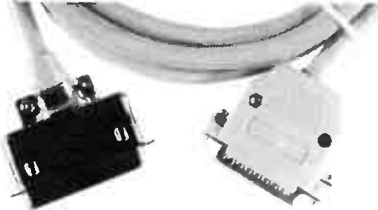

IBM Cable.....\$15.00

- * 4000hour battery life
- * LCD display
- * Audible continuity



Escort Battery/Main operated Bench Type Multimeters

EDM2116 3 1/2 digit with capacitance		EDM2347 4 1/2 digit with true rms, dB, frequency	
Ranges	Accuracy	Ranges	Accuracy
Vdc 200mV to 100V	0.5%	Vdc 200mV to 100V	0.03%
Vac 200mV to 100V	1%	Vac 200mV to 100	0.5%
Adc 200uA to 20A	1%	Adc 200uA to 20A	0.3%
Aac 200uA to 20A	1.5%	Aac 200uA to 20A	1%
Ohms 200 to 20M	0.75%	Ohms 200 to 20M	0.1%
Caps 2nF to 20uF	2%	Freq 20kHz to 200kHz	0.5%

**EDM2166.....\$216 ex tax
\$254 inc tax**

**EDM2347.....\$406.35 ex tax
\$471.36 inc tax**

SPECIAL PRICES ON 'D' & CENTRONICS CONNECTORS



'D' Connectors

	1-9	10 UP	100 UP
DE9P	\$1.68	\$1.51	84c
DE9S	1.80	1.44	90c
DA15P	2.34	2.11	1.17
DA15S	2.42	2.18	1.21
DB25P	2.20	1.98	1.10
DB25S	2.72	2.45	1.36

Covers Metallised

9 pin	1.80	1.62	1.25
15 pin	1.80	1.62	1.25
25 pin	1.80	1.62	1.25



Covers Plastic

9 pin	1.60	1.44	90c
15 pin	1.60	1.44	90c
25 pin	1.65	1.48	95c

Centronics Solder

24 way male	9.60	8.64	4.80
24 way fem	10.00	9.00	5.00
36 way male	6.60	5.94	3.30
36 way fem	9.50	8.55	5.28

Centronics I.D.C.

36 way male	8.00	7.20	5.20
36 way fem	8.40	7.56	5.40

Microprocessor Transformer - ideal for projects

The JT348 is a locally made transformer specifically designed for you microprocessor enthusiasts. It features three secondary windings giving you -



- 12V at 1A
- 12V at 1A
- 9V at 2.5A

Measures 115 x 70 x 65mm
JT348.....only \$18.50

8.30 to 5 Monday to Friday. 8.30 to 12 Sat.
Mail Orders add \$5.00 to cover postal charges.

All prices INCLUDE sales tax.

Tax exemption certificates accepted if line value exceeds \$10.00.

BANKCARD, MASTERCARD, VISA, CHEQUES



GEOFF WOOD ELECTRONICS P/L (02) 427 1676

229 BURNS BAY RD. (CORNER BEATRICE ST.) LANE COVE WEST N.S.W.

INC IN NSW
TWX 71996
P.O. BOX 671
LANE COVE N.S.W 2066

OR CASH CHEERFULLY ACCEPTED

specialising in electronic components for the professional and hobbyist.

SECOND-BIRTHDAY CONTEST

WIN THIS SUPER PHILIPS DMM!

PM2618X/01

The Philips Series 18 digital multimeters are packed with features to meet all types of portable measuring requirements: from general servicing to both analogue and digital testing, R&D and even calibration!

The PM2618X/01 features a four-digit (+1) liquid crystal display, 0.1% accuracy, fourteen functions, measurement to 20 A and 100M, dB readout, a 200 kHz frequency counter, a highly sensitive analogue bargraph and logic testing to speeds of 10 MHz with duty cycle info included!

Don't miss this opportunity to own what is one of the top-line portable multimeter available today!

Prize kindly donated by Philips Test & Measurement Division.

All you have to do is answer the questions here, then tell us in 30 words or less why you'd desperately love to own this fabulous instrument!

RULES: You may enter as many times as you wish, but you must use a separate entry form for each entry and include a month and page number cut from the bottom of the contest page. You must put your name and address on each entry form and sign it where indicated. That is, photocopies are acceptable but an original month/page number from a copy of this month's magazine must accompany each entry form. The contest is open to all persons normally resident in Australia or New Zealand, with the exception of members and families of the staff of Australian Electronics Monthly, the printers, Offset Alpine, Network Distributors and/or associated companies. Contestants must enter their names and addresses where indicated on each form. Photostats or clearly written copies will be accepted if accompanied by an original page number and month cut from the bottom of this page. This contest is invalid in states where local laws prohibit entries. Entrants must sign the declaration that they have read the rules and agree to abide by their conditions. The winning entry will be drawn by the Editor whose decision is final; no correspondence will be entered into regarding the decision. Winners will be notified by telegram the day the result is declared and the winner's name and contest results published in the next possible issue of the magazine.

Send entries to:
Philips/AEM Birthday Contest
PO Box 507, Wahroonga 2076 NSW

Q1: You remember AEM's 1st birthday? What was the prize offered by Philips Test & Measurement (Scientific & Industrial)?

Q2: The 18 Series DMMs were reviewed in AEM's February 1986 issue. What does the last paragraph in Alan Ford's review say?

Q3: Consider the following numeric string: 166622800. No to-ing and fro-ing now! You've seen it before. Philips advertise it a lot. What is it?

Now, on a separate piece of paper, tell us in 30 words or less, why you'd desperately love to take home this prize!

Name

Address

Postcode

I have read the rules of the contest and agree to abide by their conditions.

Signed



FUNCTION SELECTION	Range	Accuracy
Ω	1 k, 10 k, 100 k, 1 M, 10 M, 100 M (Manual only)	< 10% \pm - - < 1% \pm
V _{DC}	1 V, 10 V, 100 V, 1000 V, dB V _{DC} 50 Ω - 47 ... + 53.8 dB	
V _{rms}	1 V, 10 V, 100 V, 1000 V, dB V _{rms} 600 Ω - 51 ... + 43.1 dB	
Hz	19.999 kHz 199.99 kHz Gate open 1 s	
Hz LOGIC	OPEN, bAd, Logic 1, Logic 0 positive pulse, symmetrical pulses negative pulse	
Hz LOGIC	As Hz logic plus high tone = Logic 1 low tone = Logic 0 intermittent high tone = pulse(s)	
CONT	Continuity check < 10% \pm - - < 1% \pm Diode measurements 1 V, 1 mA	
$^{\circ}\text{C}$	-60 ... +200 $^{\circ}\text{C}$ with Pt-100 Ω probe PM9249	
A _{rms}	20 mA, 200 mA, 2 A, 20 A	

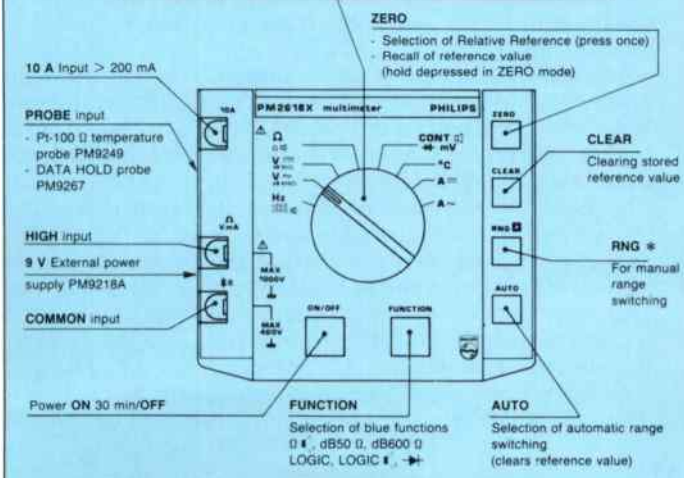

resistors in series, the result is the blown supply fuse.

After replacing the faulty devices, a poor serviceman would assume that the fault has been fixed and dispatch the equipment back to the customer. A good serviceman would give some thought to what had caused the fault to occur, check adjoining stages for other possible faults and give the unit a thorough test to ensure that all functions are correct and to specification. These few extra minutes spent on details can save a lot of equipment from subsequent return trips to the service department.

So, you thought you had it fixed!

Let's assume you are a good serviceman and make some checks around the output stage before powering the amplifier up again. The resistance across the supply rails is now correct and compares with that of the good channel and the stage driving the output stage seems to be intact. You power up the amplifier and provide it with an input signal. Both channels now produce an output and the fuse does not blow. So far, so good, but you notice that the sound from the channel you have just repaired seems to be distorted.

A fault such as this is not going to be quite so "black and white" as the previous one. In the earlier fault, it either worked or it didn't, but this time you are dealing with degrees of working. Although the fault is of a different nature, you can approach it in a similar fashion. You don't need to go through all the preliminaries again and you already have the fault narrowed down to a section of the amplifier, or do you? How do you know that the fault is not in one channel of the pre amplifier section?

In this instance, we will make use of different types of instruments. After all, a multimeter is not going to be of great assistance in tracing distortion. What you need to do is compare the input of various stages to the output, so that the point

where the distortion is introduced can be tracked down. Naturally you will need an oscilloscope to examine the waveform at various points, but you need to go a little further than that. Trying to see distortion on a waveform is not easy unless it is very pronounced so, you really need to use a dual trace instrument in which the two signals of interest can be substituted. This way, even small amounts of distortion can be detected. Secondly, you are going to require a clean, undistorted waveform as the input signal so you will need an audio signal generator.

After setting up the required equipment, you can start eliminating possible suspect stages of the amplifier. You can start with the preamplifier, bearing in mind that controls such as tone and loudness as well as high or low filters may introduce some colouration of the signal. After setting the various controls to a neutral position, and switching out any filters or equalisers, you compare the input signal from the generator to that from the output of the preamplifier stage and discover that the signal is essentially undistorted and within specification.

Having eliminated the preamplifier, you can start working your way through the power amplifier stage. Commencing at the output transistors, you detect that the waveform is badly distorted. Working backwards, you check the signal at the input to the final stage and find that it is similarly distorted as is the signal from the output of the previous stage. Moving further back through the circuit, you check the input to the pre-driver stage and find that it is clean and undistorted. We will assume that you have the oscilloscope set up for ac coupling and miss the fact that there is a large dc bias associated with the signal, but you do have the fault tracked down to a particular stage.

By referring to the circuit diagram, you find that it provides typical voltage measurements for various points in the circuit. Using the oscilloscope set up for dc coupled input, you can start checking these around the suspect stage. On doing this, you discover that the voltage measured at the base of the transistor in this stage is much higher than indicated by the circuit diagram. You now refer to the circuit diagram to try and isolate some likely culprits. The circuit is quite straightforward, having some resistors which set up the bias conditions for the stage, as well as some bypass capacitors across some of them.

With power removed from the circuit, you can make some in-circuit resistance checks with a multimeter. Be aware that results may be misleading due to the presence of other components which may be in parallel with those under test. In your case, the bias circuit consists of what is essentially a voltage divider, the centre point of which is connected to the base of the transistor. Because the voltage on the base is higher than it should be, there are two possibilities; either the resistor between the base and the 0 V rail has gone high in value, or the resistor between the base and the positive rail has gone low. You measure from the positive supply rail to the base of the transistor and find that the resistance indicated compares with the indicated value of the resistor. Performing the same check from the 0 V rail to the transistor's base indicates an open circuit.

You have found the faulty component so you turn the printed circuit board over to remove the resistor. As you start to de-solder the component, you see that the joint is dry and in fact the resistor leg is not making proper contact with the pc board pad. You de-solder the joint, clean it, and re-solder it. After checking the resistance between the transistor base and the 0 V rail, you find that all is now in order. As a precautionary check, you examine some of the other solder joints on the printed circuit board and re-solder any which look at all suspect. Now you can re-test the amplifier and check all its functions. Once satisfied that everything is OK, you can despatch it back to the, no doubt happy, customer.

Of course, the above scenario is simplistic, but serves to illustrate some of the techniques and procedures you should

COM 3 SERVICE MONITOR



ECONOMICAL — SIMPLE COMMUNICATIONS SERVICING

The COM-3 Communications Service

Monitor incorporates:

Signal Generator
AM/FM Receiver
Deviation Meter
Frequency Counter
CTCSS Tone Generator
Frequency Error Meter
Cordura Carry Case
Front Cover

All these functions with
MICRO-PROCESSOR CONTROL
and a Frequency Coverage
of 100KHz to 1000MHz

ALL FOR \$5,800

(Plus Tax)

Contact us now for further details. Ask for Andrew Shipley.



ASSOCIATED CALIBRATION LABORATORIES
27 ROSELLA ST, EAST DONCASTER, VIC. 3109
PH: (03) 842 8822 TLX: 35011 FAX: (03) 842 5730

follow. In the real world, not all faults are as easy to find. Some types of equipment seem to exhibit failures more than others. Take for example, the high voltage sections of TV sets or video monitors. These seem to contribute more than their fair share of problems and should always be high on the list of suspects. Another example is any high power stage, be it the output stage of an audio amplifier or a transmitter, any part of a circuit which produces appreciable heat should always be looked at carefully.

Experience can also play a major part in fault finding. If you are familiar with a piece of equipment, you will often know the common faults associated with it. Observation can also be important. Take the example of a TV serviceman who gets five calls on the same morning, all the customers reporting weak and snowy pictures and all appearing to have failed at the same time. It is a fair bet that the thunderstorm the previous evening has taken out the front end of all the tuners so you can arrive at the customer's house well prepared with suitable parts.

Intermittents . . . goddam intermittents!

One of the most difficult and frustrating types of fault to deal with is the intermittent. These faults have an annoying habit of not manifesting themselves whilst you are looking for the problem, but become immediately obvious when the equipment is returned to the customer. There are a few techniques which can be used to track down these annoying faults.

Many intermittent faults are heat related. You can use a hair dryer to heat areas of the equipment or even a soldering iron placed close to suspect areas will provoke the fault into occurring. Similarly, a spray can of "freezer" can be used to cool localised areas and is often very helpful in tracking down dry solder joints. Mechanical stress can also help in tracking intermittents. Carefully tapping areas with a screwdriver handle can sometimes produce results.

Intermittent faults can be very time consuming to find and often there is a fair degree of luck coupled with intuition involved in curing them. I remember one occasion when my own TV set developed an intermittent problem. Every so often, the picture would collapse into a single bright line through the centre of the screen. As soon as I moved out of my chair, the fault would disappear, in fact, the slightest vibration would bring back normal operation. Now I had a fair idea of where the fault may lie so I went over the set carefully checking solder joints, heating things, cooling things, tapping things. All to no avail.

Over a period of time, the fault started to get worse and progressed to the point where I could walk across the room and try to examine things whilst the fault was evident. Of course, as soon as I attempted to remove the back of the set, the fault would go away. The eventual solution was to run the set with the back removed (not recommended if you have kids or inquisitive visitors) and one evening I was lucky enough to see a small arc occur in the area of the horizontal output transformer where it was soldered to the pc board. Visual inspection revealed nothing out of the ordinary, but re-soldering all the connections to the board solved the problem which has never re-occurred.

This sort of fault was just a minor inconvenience to me, and as it only occurred occasionally, I was in no particular hurry to fix it. It was a lot easier to just thump the floor and fix it temporarily. You can imagine the headaches this would cause for the average customer, not to mention the serviceman, and had it been a customer's set, I would have had to make a few guesses, re-soldered all the joints in the suspect area, and been a bit more thorough in my approach.

A different type of service work

Up to now we have concentrated more on "one off" type service jobs. In service centres which are part of a large manufac-

turing organisation, things are usually a little different. Here you will probably be working on a fixed range of equipment and many of the faults will be well known through experience. In this sort of operation, it is common for whole assemblies to be replaced in the interest of a hasty turnaround in repair time. The faulty assemblies or circuit boards are repaired later and returned to spare parts stock.

Increasingly we are coming across equipment which is designed for this "substitution" type of repair, and particularly with the emergence of surface mounting technology, it is uneconomical to attempt repair to the component level.

One example of this type of servicing occurs in the computer field. Because computer failures tend to be very time critical, the field technician often limits repair work to replacement of whole boards or assemblies. At first sight, you may think this is an easy way out, but believe me, there is a lot of expertise required to find which board or assembly is at fault and don't forget, somebody eventually has to repair the faulty one. I will be discussing the techniques for servicing digital equipment in part two of this article, so I will leave the subject alone for the time being.

Apart from the assistance of experience gained from working on a fixed line of equipment, there are often other advantages to be found in "in house" service departments. You will almost always have a working example of the equipment available for comparison purposes and frequently there will be available special purpose test equipment designed for troubleshooting the particular item. These can range from the "in circuit" type test sets to sophisticated, computer based test jigs which will give you a detailed report of the item under test and even suggest possible remedies to any faults found. This type of equipment is more likely to be found in production line testing at large manufacturers, but the in circuit type tester, being more universal in its application, can be a big asset in any service organisation.

These instruments are designed to aid troubleshooting by comparing the characteristics of two assemblies or circuit boards, one faulty and one known to be working. The probes of the instrument are connected between two points on the faulty board and the display, which is usually an integral CRT or an external oscilloscope, will indicate the impedance signature seen by the probes, i.e: the current/voltage characteristic of the components between the probes is plotted. Recognition of faulty signatures or comparison with the signature of a known working board, allow a faulty component to be rapidly located. One advantage of this type of instrument is the fact that they are designed to work on unpowered boards. Thus if a fault precludes the application of power, troubleshooting can still be readily accomplished.

Horses for courses

Choosing the right piece of test equipment is really a matter of "horses for courses". Apart from the general instruments such as multimeters, oscilloscopes and to some extent the "in circuit" testers described above, most test equipment is designed to perform specific tasks on a limited range of equipment. In a service department that predominantly works on RF equipment, you will find instruments such as wattmeters, RF signal generators, spectrum analysers and the like. By comparison, these instruments would be useless in a workshop engaged in the repair of audio equipment.

Common sense will tell you which types of instrument are best suited to your application, but remember, most test and measurement equipment is usually only as good as the technician or serviceman who operates it. There is no substitute for a good, basic technical knowledge and a fair bit of experience, intuition and occasionally, luck. ♣



Barcode system takes the hassle out of VCR programming

National has launched a range of five VCRs that can be simply programmed with barcodes read by a handheld "wand" that then transmits the code to the VCR by an infrared transmitter.

The system was designed to eliminate the complicated setting up procedures necessary

for "time-shift" recording with a VCR.

A "programming sheet" pro-



vided with the machine contains printed digital bar codes. By wiping the digital scanner across the appropriate codes in sequence, the channel number, date, recording start and end times are read into the scanner wand.

The wand verifies each successful "take" of a code with an audible 'pip', and verifies the sequence with a series of pips. The entire code is then transmit-

ted to the VCR by aiming the wand at the recorder and pressing a button - as you would with a remote control.

The VCR displays all the programming on its multi-function display, allowing a quick check. Timer controls are all duplicated on the machine.

The five new barcode programmable models are - the NVG21A, NVG22A, NVG25A, NVG65A and NVD80A. The last two include dual-channel/stereo sound capability, and all but the NVG65A include "double super fine slow motion" capability which provides stable, noise-bar free slow motion playback. All have full HQ circuitry and auto tape load and eject operation.

Further details from your local National dealer, or National Panasonic (Australia), 95-99 Epping Rd, North Ryde 2113 NSW.

Slim-line Sennheisers

Sennheisers' new lightweight stereo headphones, model HD50, have been principally designed for Walkman-type use, providing a high degree of comfort for the wearer, according to the manufacturers.

Sennheiser say the HD50s will appeal to those portable player users who demand excellent bass response together with clean, uniform sound reproduction, similar to that found in domestic hi-fi.

They are equally suited for use with CD players, stereo TVs and VCRs, as well as conventional hi-fi gear, Sennheiser say.

Further details from the suppliers, Cunningham Consolidated, 15a Anderson Rd, Thornbury 3071 Vic. (03)484 0791, or 4-8 Waters Rd, Neutral Bay 2089 NSW. (02)909 2388.



ADD A BASE OCTAVE OR TWO

A small 2-way speaker has many advantages over larger systems. Stereo imaging is often better because of the smaller front baffle. But lack of deep bass is the price you have to pay - but no longer!

A passive stereo subwoofer is now available which you simply connect to your amplifier and the sidespeakers to the output terminals on the subwoofer. Will match any speakers with an efficiency of 85 to 88dB, and will add true deep bass to any small

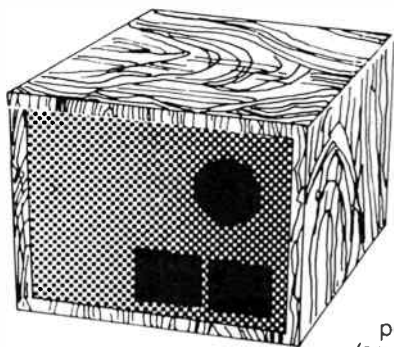

speaker system. This Scan Audio subwoofer uses the latest band-pass bass reflex technology and consists of 2 front-to-front mounted 10" polycone woofers (one for each channel).

Power handling 100 RMS. Frequency response 25-88 Hz. Priced at under \$600, this is a great way to add an extra octave or two you've never heard before.

For full information and your nearest stockist, contact: **SCAN AUDIO Pty. Ltd.**, 52 Crown Street, Richmond, Victoria 3121.

Telephone: (03) 429 2199.

vifa

ARLEC

Famous Aussie brand from the famous Aussie stores: Dick Smith Electronics!

ARLEC'S FAMOUS SUPERTOOL!

What versatility! It sands. It polishes. It engraves. It mills. It's one of the handiest tools you can have in your arsenal! This fantastic hobby machine is a 10,000 RPM power head which does all of the above with the attachments supplied. And because it operates from low voltage (240V plugpack included!) it's safe. Includes the Supertool and plugpack, 2 milling cutters, 1 wire brush, 1 grinding wheel, 4 high speed drills, 5 chuck collets (0 to 4mm), eraser sticks and instructions. Cat T-4754

ONLY
\$59⁹⁵

Supertool: for • Hobbyists • Model Makers • Technicians • Gem & Lapidary • Antiques • You name it!

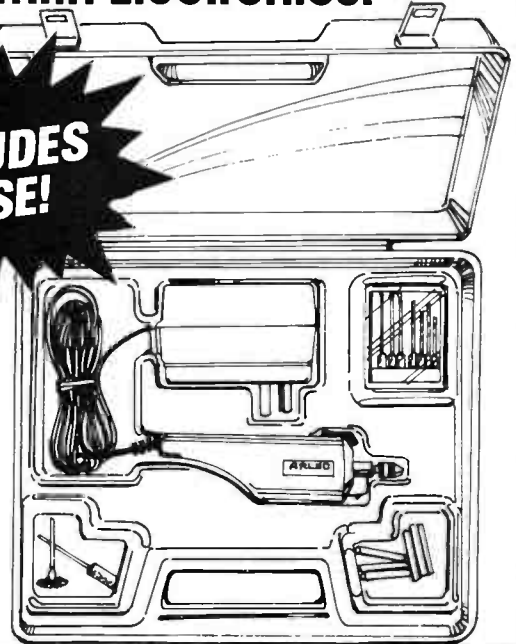

SUPERTOOL ACCESSORIES:

Cutting Discs

Set of 6 mini cutting discs, with arbor, for cutting metal and plastic. Essential for the serious hobbyist. Cat T-4766

\$11⁹⁵

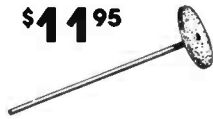

Grinding Bits

Shape, sand and grind your projects to perfection. 3 piece, different shapes. Cat T-4758

\$11⁵⁰

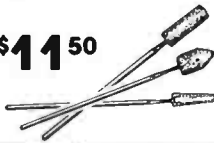

Wire Brushes

Pack of 3 wire brushes for polishing, cleaning, etc. Cat T-4768

\$15⁹⁵



Set 4 PCB Drills

Top quality high speed steel twist drills in all popular PCB sizes: 1.2, 1.0, 0.8, and 0.6mm. Cheaper than buyer singly! Cat T-4756

\$7⁹⁵ set



Erasers

Make short work of rubbing out! Two different types to cover both ink and pencil! Set 5 ink \$5¹⁵ Cat T-4760

Set 5 pencil \$2⁹⁵ Cat T-4762



Engraving/Milling Bits

Set of three cutters designed to make short work of any engraving or milling job. Fine and medium hex head plus fine round head. Cat T-4764

\$9⁹⁵



OTHER FINE ARLEC PRODUCTS...

ARLEC MINI VICE

Need a third hand? Here's one that won't let go! The mini vice from Arlec attaches to any table, desk, bench, etc. (up to about 40mm thick). 50mm wide jaws hold tight — opens up to around 60mm for those big jobs. More than strong enough for cutting, filing and other testing applications. Cat T-4748

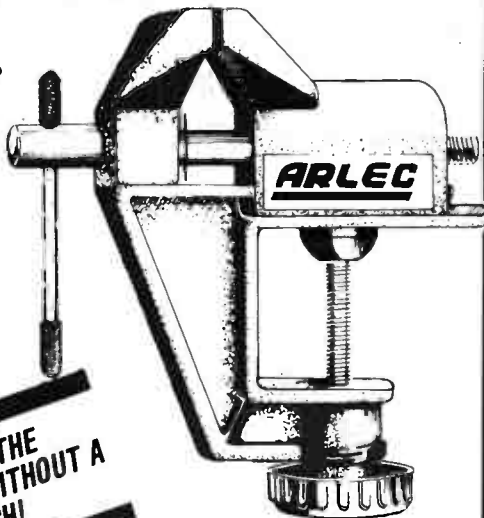

A MUST FOR THE HOBBYIST WITHOUT A WORK BENCH!

ONLY **\$12⁹⁵**

ARLEC NICAD CHARGERS

"D" Charger

Want to charge "D" NiCads? This one will handle two or four D size cells — even the heavy duty 4A types (the ones most chargers take forever doing!) Perfect for radio control cars, video cameras, etc — anything with a D size NiCad. Rated at 2x 3V, 400mA. Cat M-9400



\$39⁹⁵

Multi Current Arlec Charger

In-situ charger for all NiCad types (AAA to 9V) with 4 different charging currents and 6 different connector types to suit all device sockets. Handles up to 10 NiCads at one time. Cat M-9510



\$29⁹⁵

M-9521

Universal model accepts all types, automatically adjusts charging current to suit type. Includes battery tester. M-9521

\$39⁹⁵

DICK SMITH ELECTRONICS

PTY LTD

LISTEN & LEARN, Software made Simple

Why spend time and money on training courses for your computer programs? Now a revolutionary new training program is available exclusively through Dick Smith Electronics!

The Listen & Learn audio cassette system lets you TEACH YOURSELF to master those complex programs such as MS-DOS, Lotus 1-2-3, Multimate, dBase3+, Wordstar, Displaywrite3 and many more.

Simply by playing the audio tapes and following the simple colour coded exercises you can learn to master even the most complex programs in as little as 10 hours. You'll save a fortune on training courses, seminars, etc. PLUS you can use the tapes over and over again! Executives as well will find this system invaluable! In your own time you can master the programs used in your office — and it's fun!

What you get

Each Listen & Learn pack comes with audio cassette tapes and colour coded instruction manual. Or, you can buy the Professional Pack which includes a portable cassette player and quality, lightweight headphones. For the new common sense approach to learning programs. Listen & Learn eliminates the need for heavy, hard to follow manuals. With DSE, Multitech and Listen & Learn — you've got the problem solved!



MS DOS Cat X-9800

\$99

Lotus 123 Executive Pack

Cat X-9802

Multimate Executive Pack

Cat X-9804

dBase 3+ Executive Pack

Cat X-9806

Wordstar Executive Pack

Cat X-9808

Display WRT3 Executive

Pack Cat X-9810

\$129

Lotus 123 Prof Pack Cat X-9801

Multimate Prof Pack Cat X-9803

dBase 3+ Prof Pack Cat X-9805

Wordstar Prof Pack Cat X-9807

Display WRT3

Prof Pack

Cat X-9809

\$199

DSE Multitech All the best for less!!

The DSE Multitech PC-500 System 1 started the Affordable PC compatible revolution by being the first to break the \$1000 price hurdle. It's still the leader when it comes to quality, versatility and value! With 256K memory (expandable to 512K), single 360K disk drive, 4.77MHz clock speed, CGA card, parallel and serial ports and MS-DOS — it's not hard to see why!

Specifications:

- IBM PC standard 4.77MHz clock speed
- On-board memory 512K maximum (256K fitted)
- 8088 CPU chip
- CGA card, parallel and serial ports fitted
- 67W power supply
- Supplied with MS-DOS 3.20, plus software depending on model.

System 1: Single 360K disk drive, 256K memory. Cat X-8000

DSE Diskettes

Why pay more? Top quality computer media at a realistic price, made exclusively for Dick Smith Electronics by one of the world's leading disk manufacturers. They're so good we use them ourselves! Double sided disks, soft sector, in 5¼" (13cm) standard size.

Single density: \$27⁵⁰

Double density: \$29⁵⁰

Box 10 disks
Cat X-3500

Box 10 disks
Cat X-3501

\$995

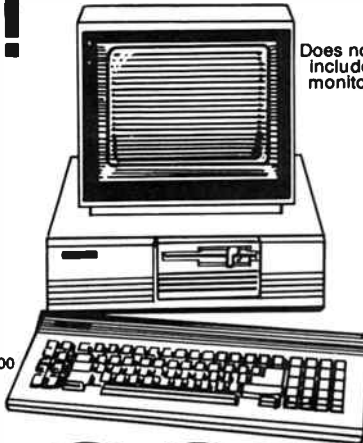

Does not include monitor

Protect those disks!

Your disks need help... and protection. Look after your data and software properly by storing your disks away in a disk box.

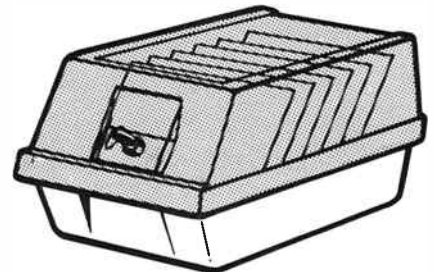

50 disk hinged box, lockable with 5

movable dividers.
180 x 160 x 250mm Cat X-3531

\$22⁵⁰

100 disk hinged box, lockable with 9

movable dividers.
180 x 160 x 380mm Cat X-3534

\$24⁹⁵

3½" (9cm) format. 40 disk hinged box,

lockable with 4, movable dividers.
125 x 130 x 250mm Cat X-3533

\$28⁹⁵

DICK SMITH ELECTRONICS COMPUTERSTOP

York St 267 9111 • ACT • Canberra 80 4944 • VIC • Elizabeth St 67 9834 • Richmond 428 1614 • Springvale 547 0522 • QLD • Brisbane City 229 9377 • Buranda 391 6233 • SA • Adelaide 232 1200 • WA • Perth 481 3261 • NT • Darwin 81 1977 • TAS • Hobart 31 0800

NSW • Brookvale 93 0441 • Chullora 642 8922 • Gore Hill 439 5311 • Miranda 525 2722 • Newcastle 61 1896 • North Ryde 88 3855 • Parramatta 689 2188 • Tamworth 66 1711 • Wollongong 28 3800

Get more for your dollar!!! With peripherals from DSE.

MASTERING SOFTWARE... The Easy Way!



Now with Listen & Learn you can master those complex computer software programs in your own time, at your own pace! You'll save money on training programs AND you can

use Listen & Learn over and over again. Each pack comes with four audio cassette tapes PLUS the easy to follow, colour coded instruction manual. Look at these current titles!! Lotus 1-2-3, Multimate, dBaseIII+, Wordstar, Displaywrite3, MS-DOS... with many more on the way! Cat X-9800 to X-9810

From \$99

Monitor Bases

Budget Swivel Base

Nylon slide assembly and non-skid feet for positive action. Allows full 360° rotation and 25° vertical adjustment. Suits all monitors (or even your home telly!) from 22cm to 35cm screen size. Cat X-1190

\$24⁹⁵

Deluxe Swivel Base

Similar to above, offering same degree of rotation and angle, but this one has knurled knob on

front for locking and freeing monitor. If you want to turn then monitor frequently (eg for others to see screen) this is the one to choose, as the monitor does not have to be removed to adjust angle.

Cat X-1191 \$34⁹⁵

Dataphone 1200 Modem

Dataphone enables you to enjoy all the benefits and advantages of data transference without the high cost. Now information transmission and reception is as easy as using the telephone. X-3300

\$349

Dataphone 300 Modem

The economy modem that will keep you in touch! Dataphone 300 is a 300 Baud, full duplex modem that comes complete with push-button phone for greater convenience.

\$199

Gas-Lift Monitor Arm

Ergonomically designed gas-lift arm allows you to place monitor exactly where you want it — with no effort. Even push it up and out of the way... anywhere. And more than that, the monitor connection cables are hidden away neatly inside the arm. One of the best designed arms we've seen (apart from Racquel, Bo...) Cat X-1192

\$345

Budget DSE Diskettes Why pay more? Top quality computer media at a realistic price, made exclusively for Dick Smith Electronics by one of the world's leading disk manufacturers. They're so good we use them ourselves!

(13cm) standard size.
Single sided: \$27⁵⁰
Box 10 disks Cat X-3500

Double sided:
Box 10 disks \$29⁵⁰
Cat X-3501

Add-on Boards Graphics Card

Industry-standard graphics adaptor cards for the type of graphics to suit your application/software. Most computer systems include one or other of these boards. If your application requires a different type of graphics card, or if you want to upgrade, the card supplied with your Multitech can be substituted for another type (with price adjustment if necessary). These cards simply plug into a vacant slot. All include the appropriate connection socket.

CGA Card

(Colour Graphics Adaptor) Essential for many of the games programs you'll play. (You're not going to use your computer for games? Who's kidding whom!!!) Cat X-8140

\$199

MGA Card

(Mono Graphics Adaptor) Hercules-compatible card for software requiring MGA standard. Also includes a second parallel printer port. Cat X-8141

\$249

EGA Card

(Enhanced Graphics Adaptor) Switch selectable to simulate MGA, CGA or EGA format. The most versatile "all rounder" board you can get — and essential for most of today's highly graphics oriented software (eg desktop publishing) Cat X-8142

\$699

RS232 Breakout Box

Ideal for modems, other serial applications where connections need changing. DB25 male to DB25 female, pin 1 permanently wired, all others open with wire links supplied. Cat X-3568

\$27⁵⁰

Permanent RS232 Jumper Box

Similar to above, but connections made internally and soldered for permanent applications. All 25 pins open. Wire links supplied ready for soldering. Cat X-3569

\$17⁵⁰

Female/Female Gender Bender

Adapts male serial cables without resoldering or reconnecting. Simply plug in — twin female DB25 sockets with all 25 pins wired pin to pin. Cat X-3566

\$15⁹⁵

Male/Male Gender Bender

As above, but twin male plugs permanently wired. Cat X-3565

\$15⁹⁵

Famous Xidex Diskettes

One of the world's leading disk manufacturers! If you want the best, you want Xidex. All soft sectored type, 5 1/4" (13cm) format.

Single sided, double density (40 track):
Single disk Cat X-3510 \$4⁵⁰

Single sided, double density (40 track):
Box 10 disks Cat X-3512 \$44⁹⁵

Double sided, double density (40 track):
Box 10 disks Cat X-3514 \$49⁹⁵

For "AT" machines with high (1.2Mb) capacity drives: Double sided, high energy (80 track):
Box 10 disks Cat X-3516 \$79

For laptops and other machines using 3 1/2" (9cm) format disks: Double sided, double density: \$85
Box 10 disks Cat X-3503

Protect those disks!

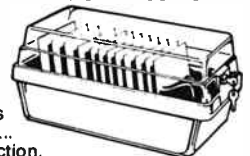

Your disks need help... and protection. Look after your data and software properly by storing your disks away in a disk box. Everything from 30 to 100 disks can be stored with this range. 5 1/4" (13cm) format

30 disk hinged box
Cat X-3528 \$15⁹⁵

50 disk hinged box
Cat X-3531 \$22⁵⁰

100 disk hinged box
Cat X-3534 \$29⁹⁵

3 1/2" (9cm) format
40 disk hinged box
Cat X-3533 \$28⁹⁵

Serial Data Cable

2 metre serial cable with male DB25 plug one end, female DB25 socket the other. All 25 pins wired 1-1, etc. For serial printers, modems, computer/computer connection, and other data applications. Also ideal as extension lead for parallel printer cable (gives over 4m). Cat X-3564

\$39

Parallel Printer Cable

Standard "Centronics" type printer cable with 36 pin Centronics plug (as used on 99% parallel printers) one end, 25 pin D socket the other. 1.7m long Cat X-8614

\$34⁹⁵

**DICK SMITH
ELECTRONICS**

PTY LTD

Don't forget the DSE Computer Hotline! For product information and advice ring (02)888 2002.

When you need a third hand...

To hold the light, that is! Don't strain your eyes with small pcb's, circuits, etc: use our nifty little headband light. You might look like a real goof — but you won't strain your eyes!



\$4.95

Cat Y-1073

Buy in bulk and \$\$\$ave

Every hobbyist, every technician knows that a well-stocked "junk box" is one of life's biggest assets. You never know when you want a... and a good junk box should be able to yield one! Stock your junk box with DSE bulk bargain packs. Prices up to 50% and more off single prices!



1/4 Watt Resistor Pack Ceramic Pack

300 computer selected carbon resistors, at huge savings. Cat R-7010 **\$875**

Over 60 ceramics of various values, with voltages as high as 630VW! Cat R-7050 **\$625**

Metal Film Resistor Pack 300 1% tolerance metal films. A great buy! Cat R-7015 **\$1755**

Diode Pack 100 pieces signal diodes in both Ge and Si. From OA90 to 1N914's. Cat Z-3005 **\$1315**

Greencap Pack 60 greencaps from .001 to 0.22uF. All 100V types. Cat R-7040 Around \$22 worth **\$1260**

LED Pack 100 premium quality (matched brightness & colour) LEDs in red, green & yellow Cat Z-3015 **\$2635**

Electro Pack 55 quality pcb mounting electros from 2.2 to 470uF. Cat R-7030 Around \$15 worth! **\$875**

Read all about it!

ARRL Handbook

The amateur's "bible". A fantastic reference source for those who have a licence or those who haven't. Cat B-2220

\$49.95

1987 EDITION



ARRL Antenna Handbook

Everything you ever wanted to know about antennas — and then some! Highly valuable in any library. Cat B-2207

\$29.95



Amateur Electronics and Study Guide

"Students own notes" format makes it so easy to understand. A must for the beginner — right through to full licence level. Cat B-2319

\$16.95



VHF/UHF Manual

Recommended for "Z" calls and all others interested in working above DC! One of our most popular manuals. Cat B-2054

\$29.95



Magnavox is Back!

Famous Magnavox speakers are back in production, and back at DSE stores. Build your own speaker systems with these superb models:

80mm Tweeter

30W maximum rated, 8 ohms impedance. Frequency response to 18kHz. Cat C-2070 **\$9.95**

100mm Midrange

Superb high quality speaker for smaller systems. 3W, 8 ohms. Ideal replacement speaker, too. Cat C-2062 **\$9.95**

125mm Midrange

High power version: 30W rating, with 800 to 7000Hz. Smooth and precise. Cat C-2060 **\$19.95**

200mm Woofer

Huge 80W rating with excellent bass response. Frequency response to 500Hz. Cat C-2054 **\$29.95**

250mm Woofer

Similar to above, but slightly lower (65W) rating, lower resonant frequency. Cat C-2052 **\$39.95**

300mm Woofer

The Big Gun! 80W rating, 30Hz resonant frequency. Also 8 ohms. When you want the best... Cat C-2050 **\$49.95**



Near Half Price!

Great for computer buffs — or just as a gift! Computer shaped LCD desk clock now at a huge saving. Cat Y-1039



\$6.95

One for the Girls...

Cat Y-1010

Big savings too on this travel alarm. It's pink, so it's just right for mum or sis! Last year sold for \$14.95 — now look! **\$6.95**

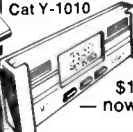

Value!

No, we don't know what they're from, but they're great! 240V AC motor, geared to 5RPM, with cam driving microswitch 3 times each rev. So you get the motor and microswitch for this crazy price! Cat J-1041 **\$1.50**

"4000 Count" Bargraph Digital Shows Analog!

\$249

The usual complaint with a digital multimeter is you can't see changes. Problem Solved: this new LCD gives you the best of both worlds: digital accuracy, with an analog indication AS WELL which shows both magnitude AND variation at the same time. But there's even more than that: this outstanding design counts to 4000, rivalling the accuracy of 4.5 digit meters, while keeping the price down to 3.5 digit types! 4000 counts means it has double the resolution of 2000 count meters. One of the best meters we've ever seen! Cat Q-1666



Bargain of the Century

BUY AN FT757GX

Yaesu's superb all mode, all band HF transceiver with 100 watts out from the size of a (small) shoebox. Already one of the greatest buys in amateur radio. . . Cat D-2940

\$1799 AND GET A HANDHELD FREE!!!

Yes while strictly limited stocks last, we'll also throw in a Yaesu FT203 2 metre hand-held. That's around FIVE HUNDRED DOLLARS saving! Yes, 500 big ones that the assets test, the taxation department, not even a Royal Commission can get you for!

HURRY! STRICTLY LIMITED STOCK!!! OFFER APPLIES ONLY WHILE CURRENT STORE STOCKS LAST.

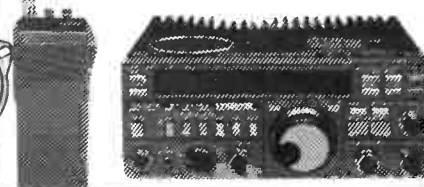

Sennheiser 'Phones

Top quality Sennheisers — for when you want REAL quality.

HD40

The budget model. Lightweight and comfy, 22-18000Hz response. Complete with 6.5/3.5 multi-plug & cable. Cat C-4120 **\$49.95**

HD410SL

The BEST! Superb sound reproduction, 20-18000Hz response and generous 3 metre cable. Highly comfortable, ideal for monitoring 'phones. Cat C-4115 **\$74.95**

Digital Capacitance Meter Too!

Few pF to 200uF range — very handy to sort through "unknowns" (saves you having to remember codes too!) Much more accurate than "combined" meters. A must for the lab or the service bench. Cat Q-1221 **\$99**



At Last! DSE's Dipper

Budget priced dipper with 1.5 to 250MHz range (6 plug-in coils) for all those amateur and communication uses. Inbuilt xtal oscillator (1-15MHz), 2kHz sine wave modulation. Cat Q-1335 **\$129**



Checking Cables? It's E-Z!

The best device we've ever seen for checking cables and connections. The perfect roadie's friend. Handles RCA, BNC, Cannon, 6.5mm etc. Rugged, too. Cat Q-1532. **\$59.95**



Bench meter Bargains

When you want high visibility and don't want to tie up a multimeter, try these. DCV and DCA, huge scale and two ranges. Ideal for techs, schools too. **0-1A, 0-10A DC** Cat Q-2130 **0-10V, 0-20V DC** Cat Q-2140 **EACH \$29.95**



Fuses

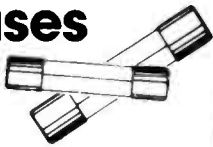

We've got the LOT!

Whatever your requirement in fuses, see DSE. You'll save! And if you buy in bulk, you'll save even more!

Fast Blow

3AG	S-4494
100mA	S-4451
150mA	S-4453
250mA	S-4455
350mA	S-4457
500mA	S-4461
1A	S-4465
1.5A	S-4467
2A	S-4469
3A	S-4471
5A	S-4473
7.5A	S-4475
10A	S-4477
15A	S-4479
20A	S-4481
25A	S-4485
30A	S-4487
35A	S-4487

M-205	ALL
250mA	S-4412
500mA	S-4415
1A	S-4421
2A	S-4423
5A	S-4425

45¢ EACH

Slo Blo Fuses

3AG	M205
250mA	S-4350
500mA	S-4355
1A	S-4360
2A	S-4365
5A	S-4370
250mA	S-4300
500mA	S-4305
1A	S-4310
2A	S-4315
5A	S-4320

Auto (Blade Type) Fuses



5A	S-4505
7.5A	S-4507
10A	S-4510
15A	S-4515
20A	S-4520
25A	S-4525
30A	S-4530

ALL 50¢ each

Mains Circuit Breakers

Plug-in replacements for "Federal" type fuses in your fuse box. Saves ever having to search for fuse wire again!

16A	P-5920	10A	P-5910
20A	P-5925	15A	P-5915

ALL \$10.95 each



THE ROLLS-ROYCE OF HAND TOOLS: PIERGIACOMI

You asked for quality - you've got quality. Around the world, Piergiacomini tools are known for their outstanding performance and precision. Stainless steel, beautifully honed cutting edges - you owe it to yourself to try them!

Back Angled Cutter

Reverse to normal cut especially for fine pcb work. Cat T-3261



\$16.95

Needle Nose Pliers

Really a needle! Ultra fine with flat blades. Cat T-3266



\$17.95

Inclined frontal cut.

Full frontal! Leaves 1.5mm lead length for soldering. Cat T-3263



\$19.95

Inclined cutter and bender

Bends pcb leads as well as cutting them. Clever! Cat T-3264



\$18.95

Standard Cutter

Just feel the precision! 4mm blade opening. Cat T-3262



\$16.95

Shears

Cut through metal, plastics, even RG213 coax! Cat T-3265



\$22.95

Building Or Renovating?

Find the power cable or pipe before your drill or saw does! Hand held detector detects metal to several cm; a must for builders & handymen. Cat Y-1060



WAS \$17.95 NOW \$14.95

Assorted Metric Screw Pack

Over 200 pieces of the most popular small sizes: M2.5, 3 and 4 nuts and screws - cross, round and counter-sunk head. Plated finish.



\$9.95 10 up \$8.77

BOXES AND CASES FOR PROJECTS

No matter what your project, there's a DSE box just right for it. Professional finish, made to last. Here are just two styles from our large range:

Extruded Aluminium Plastic

High degree of RF shielding, close fitting ends. Extrusion size 76 x 102mm, supplied in three lengths:

76mm length	H-2420	\$10.95
102mm length	H-2425	\$12.95
153mm length	H-2430	\$14.95

As used by world-wide manufacturers. Three different styles of case, one to suit your requirements.

155 x 65 x 160mm	H-2508	\$9.45
200 x 95 x 140mm	H-2506	\$15.00
200 x 65 x 100mm	H-2505	\$16.75



FROM

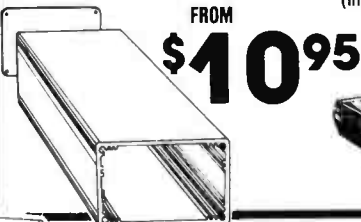

\$10.95



Slimline UHF CB: Royce

Slimline so we've given it a slim price! It's superb - electronic control, full 40 channels - and add the optional carry case for go-anywhere type. Cat D-1810

\$599 Optional Carry Case (turns mobile CB portable) Cat D-1812 **\$189.95** Optional Tone Squelch (ideal for business use) Cat D-1808 **\$129**

Less than \$1 per piece!

Our T-4830 tool kit is outstanding value! 21 pieces including mini spanners, screwdrivers, spintights, etc etc. Handy plastic carry pack. Cat T-4830



\$14.95

Stick it by Gum!

Glue nearly anything to anything with a hot melt glue gun. Easy to use, makes a really strong, tough bond. Great for the hobbyist, ideal for the serviceman.



Cat T-4840

\$19.95

Own a Frog 8800?

Want wide band FM? Here's how to get it: fit an FM wide module. We ordered hundreds more than we needed so you save! Normally around \$50, now almost half price! Cat D-2824

Protect those Mags!

Electronics magazines are too expensive to throw away. And they make good reference too. So protect them with DSE's magazine binders. Holds up to 12 copies of your favourite mag (fit EA, ETI, AEM, AR, ARA, etc etc). Cat B-4045



VALUE! \$6.95

NEEDA TRANSFORMA? SEE DSE

Our range will get you the voltage and power you want. All electricity authority approved, versatile, ready-to-go-to-work transformers just right for a hobby project or a commercial design - and anything in between!

DSE2851. Primary: 240V, 50Hz. Secondary voltage: 6.3-0-6.3V. Secondary current: 150mA. Terminations: Flying leads. Cat M-2851 **\$5.50**
10 up \$4.70



DSE2155. Primary: 240V, 50Hz. Secondary voltage: 6.3, 7.5, 8.5, 9.5, 12 & 15V. Secondary current: 1 amp. Terminations: Flying leads. Cat M-2155 **\$7.95**
10 up \$6.80

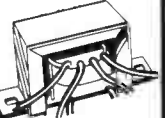

DSE6672. Primary: 240V AC. Tapped: 15, 17.5, 20, 24. Secondary voltages: 27.5 & 30V. Secondary current: 1 amp. Terminations: Solder lugs. Cat M-6672 **\$11.95**
10 up \$10.95

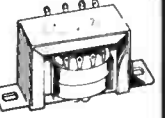

DSE2000. Primary: 240V AC. Secondary: 18 volts @ 6A. Terminations: Flying leads. Cat M-2000 **\$29.50**
10 up \$28.35



DSE0144. Primary: 240V AC. Secondary: 28-0-28V. Secondary current: 2A. Cat M-0144 **\$29.50**



DSE0153. Primary: 240V AC. Secondary voltage: 35-0-35V. Secondary current: 2.5A. Cat M-0153 **\$29.50**



FERGUSON Low Profiles Too

Famous Ferguson low profile transformers offer low levels of flux leakage (very quiet!) as well as their small profile. All 20VA models, all with twin windings which can be paralleled or seriesed for greater current or voltage output.



2 x 6V@1.7A	M-3596
2 x 7.5V@1.3A	M-3597
2 x 9V@1.1A	M-3598
2 x 12V@.85A	M-3599
2 x 15V@.69A	M-3600
2 x 20V@.51A	M-3601

ALL ONE PRICE! \$24.75 EACH

PLUG-PACKS AS WELL

Plug packs make great sense. The bulky transformer is left on the power point while the whole of the case can be devoted to the circuitry! And your choice of AC or DC output - depending on application.

12V AC at 500mA
Cat M-9555 **\$19.95**

16V AC at 900mA
Cat M-9567 **\$14.95**

9V DC at 200mA Cat M-9514
\$11.95 **\$14.95**

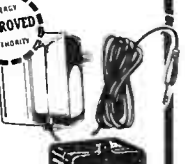

DICK SMITH ELECTRONICS

PTY LTD

Want a Hot Tip?

PORTASOL won't let you down.

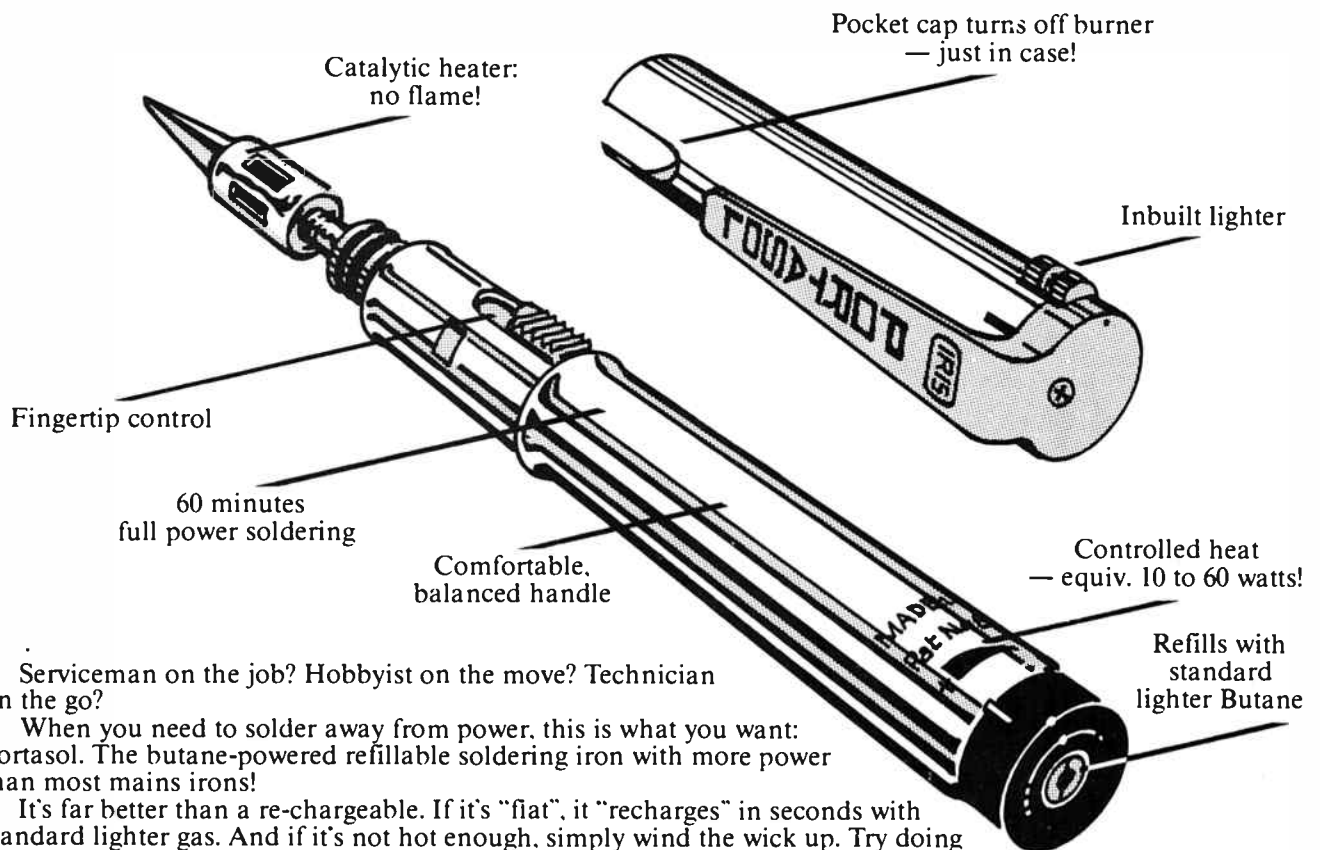

Serviceman on the job? Hobbyist on the move? Technician on the go?

When you need to solder away from power, this is what you want: Portasol. The butane-powered refillable soldering iron with more power than most mains irons!

It's far better than a re-chargeable. If it's "flat", it "recharges" in seconds with standard lighter gas. And if it's not hot enough, simply wind the wick up. Try doing that with a NiCad!

Perfect for all soldering applications — even those heavy jobs you'd normally want a "big gun" for. Yet it's small enough to slip into the shirt pocket (and in case you leave it on, the cap turns it off for you!)

Just think of the applications apart from electronics: Boat wiring and repairs. Auto electrics. Builders/electricians. Antenna installers. And so many more.

Portasol: it's a breakthrough in soldering. Throw away your old ideas about soldering. Get a Portasol and you'll get the difference. Cat T-1370

Spare tips including Catalytic Heater

\$1295

Cat T-1371

Only **\$59⁹⁵** at

DICK SMITH ELECTRONICS
PTY LTD

Available at all DSE stores . . . or phone DSXpress
on (008) 22 6610 (Sydney 888 2105)

• NICAD SAVINGS • NICAD SAVINGS •

GET UP TO 400 CHARGES OUT OF OUR HEAVY DUTY NICADS.

Ideal for all your toys, radios...

Why buy Nicads?

You should expect at least 400 charges from a NiCad battery. If looked after, this can easily be doubled. Taking worst case, each charge for a "AA" cell costs about 1c (electricity costs are negligible). Compare this to 400 dry batteries at about 60c each. . . the savings are enormous!

But there's more!

A NiCad cell holds its voltage virtually constant over 90% of the discharge cycle. A dry cell starts dropping voltage immediately. You don't get the same "drop off" in a NiCad as a dry cell. Therefore motors continue to run at the correct speed, lamps glow at the right brightness, and so on — very close to complete discharge.

And even more!

The internal resistance of a NiCad Cell is much lower than a dry cell. (less than 0.05 ohms Vs 0.4 to 0.8 ohms) Therefore devices which require high currents (e.g. photoflashes, high torque motors, etc) are much better off with NiCad cells than dry cells.

Still not convinced?

You can get much higher continuous current ratings in a NiCad cell than a dry cell. While not rated the same way, a dry cell discharged at 90mA is considered "flat" (1.1V) after approx. 2.5 hours. A NiCad cell lasts almost 5.5 hours under the same conditions. Even under non-continuous discharge conditions, the NiCad cell wins hands down: because the NiCad can be re-charged between uses!



Information supplied courtesy Plessey Ltd & SAFT (Pte) Ltd

Battery Packs

Qty	Type	Cat No.	Price
4 x AA	500mAh	S-3150	\$16.95
2 x C	1.2Ah	S-3152	\$15.95
2 x D	1.2Ah	S-3154	\$16.50
4 x AA	600mAh	S-3160	\$19.95
2 x C	2.0Ah	S-3162	\$24.95
2 x D	4.0Ah	S-3164	\$27.95

Extra Heavy Duty NiCads

Type	Cat No.	Price
C 2.0Ah	S-3311	\$14.50
AA 600mAh	S-3312	\$5.50
D 4.0Ah	S-3310	\$14.50
Sub C Fast Charge	S-3324	\$6.50

CHARGERS • SAVE ON CHARGERS • SAVE ON CH

Eveready NiCad Charger



Multi-size (AA, C, D or 9V) NiCad battery charger. Takes two 1.2V cells at a time or one 9V. Complete unit including plug-pack: nothing extra to buy. Cat M-9515

\$27⁵⁰

Multi-cell Charger

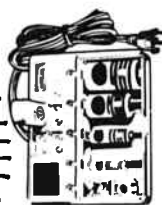

Charge up to 4 batteries at a time — AA, C, D, 6V or 9V. AND you can also charge AAA, and button cells too! But there's more: a test meter to check NiCad voltage under load — the only way to check your battery properly. Fully approved plug-pack included.

\$34

Cat M-9518

BATTERY HOSPITAL

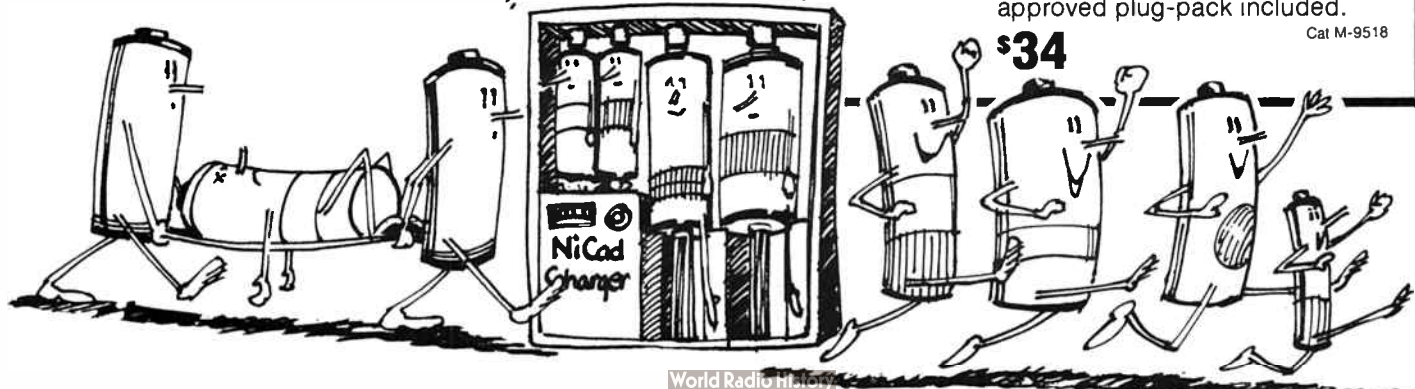

FOR MUSIC LOVERS DISCERNING ENOUGH TO WAIT FOR DIGITAL TO IMPROVE:

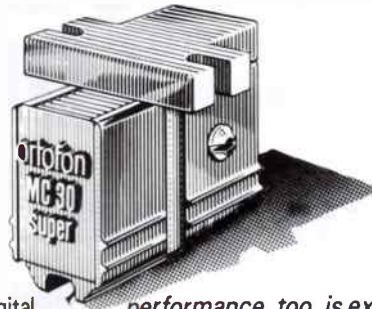

Many people have been mass-marketed into believing that digital 'music' is superior to analogue reproduction. This new ORTOFON MC-30 Super Cartridge will most certainly show you where this theory goes completely wrong! Using pure silver wiring, Ortophase phase/amplitude linearity and a pure platinum damping disc, the ORTOFON MC-30 Super delivers directly to both ears the superior musicality of high-class analogue reproduction. As others have already said:

"ORTOFON has been terribly clever with this cartridge ... Yes, folks, this little beauty is a real champion."

Ken Kessler. Hi-Fi News, March 1987.

"The MC-30S is a superlative tracker ... low frequency

performance, too, is excellent. Highs are gorgeous - smooth, open and sparkingly crisp."

J. Gordon Holt. Stereophile, January 1987.

"Tracking performance was first-class, channel separation excellent ... go for this cartridge if you want a sharp, incisive sound of real refinement and explicit stereo."

Alvin Gold. Hi-Fi Answers, April 1987.

ortofon
accuracy in sound

For full details and free brochures, please contact the Sole Australian Distributor, SCAN AUDIO or your nearest ORTOFON specialist.
SCAN AUDIO Pty. Ltd., 52 Crown Street, Richmond, Victoria 3121. (03) 429 2199.



**Australian
Maritime College**

Courses in Maritime Electronics and Radiocommunication

The Australian Maritime College offers Associate Diploma courses in Maritime Electronics and Marine Radiocommunication.

Both are two year, full-time courses. Successful graduates qualify for a wide range of positions in the public and private sector - on shore as engineering assistants, technical officers, design draftsmen and technicians; or at sea as radio officers.

Both diplomas are recognised by the Australian Public Service Board and the Australian Institute of Engineering Associates.

ENTRY REQUIREMENTS: HSC or equivalent level passes in mathematics, a science subject and preferably English. Mature age applicants with relevant experience will also be considered.

FEES: There are no course fees, other than the \$250 p.a. government fee. The courses are approved under AUSTUDY.

FACILITIES: The College is fully equipped with the latest training facilities to provide students with the practical experience and technical knowledge required for their chosen career.

FOR FURTHER INFORMATION, CONTACT:

**The Admissions Officer
Australian Maritime College
PO Box 986
LAUNCESTON, Tas. 7250**

or telephone, toll free (008) 02 0377

Onkyo's M-308/P-508 amp/preamp system.

Robert Fitzell AAAC

Robert Fitzell Acoustics

"Excellence has its own reward" is a particularly European homily, but it applies here to these Japanese amplifier components such that you might be caused to think it was an anglicised version of a Japanese work ethic.

IN RECENT MONTHS, Onkyo has been reveling in the praise received for the Grand Integra Series Amplifiers. I have yet to review the top of the Grand Integra range, credited by some as the world's number one amplifier. If the P-308/M-508 amplifiers are anything to go by, that task, I expect, will be a pleasure worth waiting for.

The last few years have been an interesting period in audio, principally through the advent of the CD player. Perhaps due to the pressure of this new sound source there has been a tendency to push some of the other components of audio systems into the background, and to concentrate more on the market areas in which the CD player is dominant.

I think it is fair to say that the CD player has revolutionised the 'mid-fi' market, and is knocking firmly on the doors of the 'hi-fi' quarter. It will be an interesting period following the next phase in audio, particularly once digital audio tape is available as a firm alternative. Digital sound has, if you like, booted the door down – now comes the phase of wooing the inhabitants. If that area of audio interests you as listeners, one of the steps that you will inevitably have to ensure is that the rest of your system has the finesse (perhaps fitness?) to keep up.

This has been a review I have enjoyed immensely. Perhaps the most exciting part, to me, is that I will have to retract many of the statements I have made in the past concerning the role in the quality chain played by the amplifier. Many times I have expressed the view that the components at each end of the sound system are ones most responsible for overall system quality. At one stage recently, I found myself believing that the choice of amplifier was so far secondary as to be almost irrelevant, provided that the power requirements and broad quality range are both appropriate. The Onkyo P-308/M-508 combination is a very, very good amplifier. I am glad to say it has made me entirely rethink the importance of amplifiers.

The bells and whistles

Aesthetically, the two Onkyo products reflect clear state of the art styling – black satin-finished metal cabinets with brilliantly polished timber side panels. Both components are relatively large, are designed with the concern for appearance which shows the engineers (or marketers) fully expect the equipment to be proudly displayed. If you tripped over them



in semi-darkness they could be one of a number of manufacturers' current products.

Both components are beautifully designed. The gain control, or more properly the attenuator, on the preamp is a large knob with stepped control sitting adjacent to a row of micro switch selectors. All of the secondary controls for the P-308 are concealed behind an elegant drop down panel cover – output level controls for a second output pair, bass and treble controls, cartridge capacitance matching selection, and recording source selector controls.

The M-508 power amplifier is a real eye catcher with two large power meters indicating output power into 8 ohms (for left and right channels), left and right channel level attenuators and a row of press-buttons selecting the input, the output choice between speakers one and two, and the meter control. The front panel metering is superb, with red illumination when first turned on switching to green in five seconds or so when output power becomes available. Meter range is from zero to 500 watts with selectable sensitivity adjustment for zero to 50 watts, and will probably be a real boon for those who don't have the flickering of an open fire to gaze at instead.

On the rear of the P-308 are a row of gold-plated input and output jacks providing phono, CD, tuner, lines one and two, ▶

REVIEW ITEMS

Onkyo P-308 preamplifier	\$1,700 rrp
Onkyo M-508 power amplifier	\$3,000 rrp

and tapes one, two and three, the first of which is designated digital audio tape (DAT). Line two input jacks are duplicated on the front and rear panels to make life a lot easier for temporary connection of say a friend's new CD player.

Bass and treble controls on the P-308 incorporate a couple of unusual features. Treble control is nominally ± 8 dB at 20 kHz with a high cut low pass filter of 6 dB/octave above 7 kHz incorporated into the control at -8 dB. Bass tone control is a shelving type with a selectable frequency limit to the boost range – below 450 Hz for 'bass' selector position and below 200 Hz for 'Contrabass' position. There is no channel balance control provided on the P-308. If you want channel balance control it is necessary to use the variable input sockets together with the level attenuators on the front of the M-508 power amplifier.

The P-308 provides far more facility than normal for record output selecting, allowing up to three separate concurrent record and listen facilities. This feature shows the manufacturer's awareness of the potential market for a high quality, high powered amplifier system such as this in professional audio-audio/visual applications using various additional processors incorporated for each separate record destination.

The M-508 power amplifier provides two input pairs, one direct input over which no amplifier gain control is possible, and a second pair routing through selectable attenuator circuitry operated from the front panel. This arrangement allows, for example, connection of a preamplifier collecting multiple input devices together with a high output level device such as a CD player into the other pair. In fact, it would be quite possible to use the M-508 amplifier alone with a CD player and a pair of loudspeakers and have a functioning sound system.

Test results

Figure 1 shows the magnitude and phase response of the P-308 on a log frequency scale using a periodic noise source. For my money 2.5 dB down at 400 millihertz is not at all bad, and the phase response as can be seen is exemplary.

At the top of the frequency scale in Figure 2, the analyser simply runs out of steam at 100 kHz with the P-308 still going ever upward. The frequency scale on Figure 2 is linear, chosen to show the superb straight line phase response of the P-308. Once hot, the P-308 appeared to roll off more significantly at very high frequencies, still well over 50 kHz.

Bass tone controls are shown on Figure 3 for full boost and cut 'bass' and full boost 'contrabass'. The arrows shown on Figure 3 indicate the 200 Hz and 450 Hz points.

Treble tone control was found to be slightly over specs at +10 dB full boost, but spot on -8 dB for full cut just prior to the high cut filter point. Figure 4 shows treble control on a logarithmic frequency scale, again showing the shelving filter effect. At full boost or cut the plateau is effective only over 20 kHz, although the benefits of the shelf filter will still be felt in improved harmonic balance.

Figure 5 shows two traces indicating square wave performance of the P-308 – the left-most and slightly larger amplitude trace is output from the preamp, the right trace is output from the CD source. I agree, there is a difference! Similarly for the toneburst of Figure 6, there is some small evidence of ringing although overall, the result is very satisfactory.

Figure 7 is interesting. This shows the results of testing of linearity of the output attenuator setting, and requires some explanation. Were the output attenuator perfect, the error

would be zero at all attenuator settings. Apparent from the graph is a systematic error at attenuator settings of more than $-15/20$ dB, together with an abrupt error between 0 and -5 dB. This effect is deceptive, since the input source used during this test was a CD player test signal disc, for which the output at 0 dB disc level was 1.8 volt, or roughly +5 dBV. Above 0 dBV input level the P-308 preamplifier clearly commences clipping, and the output level cannot rise. The abrupt error in Figure 7 is therefore due to the test source being over 0 dB, and is not a true indication of attenuator scale non-linearity. The systematic error in Figure 7 is a straight line, and whilst it represents inaccuracy of attenuator scales it is quite linear. The output attenuator stage should therefore be judged as quite stable.

My own opinion is that testing for crosstalk and possibly signal-to-noise also at full output levels does not really reflect realistic listening levels. I found that most of my listening tests of the Onkyo system using music source material were conducted at around -24 dB attenuator scale setting, or a true level approximately 20 dB below full output potential. This level is, of course, probably 30 dB or more below system clipping since the input power of a music source is certainly well below 0 dB. Figure 8 shows the results of crosstalk testing at discrete frequencies at 'normal' listening level. At low frequencies the results are excellent, at high frequencies the results less spectacular, and overall just a little less than expected. Whilst separation at high frequencies is still well over 50 dB the results at 10 kHz perhaps go some way to supporting the subjective impressions concerning imaging given later.

Total harmonic distortion examination for the P-308 was limited to a 1 kHz test at normal listening levels. The result of -105 dB is excellent – a low level second harmonic distortion faintly visible above the measuring system noise floor. This value of course reflects more truly the signal-to-noise ratio of the preamp in the presence of a signal, although testing for residual noise with a shorted input, relative to full pure tone output at 1 kHz, gave a typical residual noise of -98 dB for a 20-20 kHz bandwidth, again at normal listening level. Relative to full power output, the residual noise level is probably on the order of -115 dB.

Turning to the M-508 power amplifier, I found a unit with much to offer the audiophile and semi-professional user. The amp is clearly robust enough to be used in many sound reinforcement applications, and whilst the output terminals are more suited to domestic uses it will not surprise me at all if I see the amp in some commercial sound systems.

I found, surprisingly, that the M-508 was clipping before it was possible to drive the P-308 preamp up to full output power with a 0 dB input tone. This is not a serious failing since, as I noted earlier, we rarely encounter 0 dB for any duration with music sources. However, it does warrant recognition.

The M-508 is, nonetheless, a powerful amplifier. I measured 43.2 volts output into 8 ohms at three percent distortion, one channel driven, or 233 watts maximum useful power output. The superb front panel peak power meters showed 215 watts at this output, and in fact refused to go above 215 watt even when the amp was driven well into clipping to produce 54.6 volt into 8 ohms. I didn't look at waveforms at this output but I am sure they would have been interesting to a carpenter.

Figure 9 shows distortion at 1 kHz at both clipping power and 16 dB below clipping. At normal listening levels, THD in

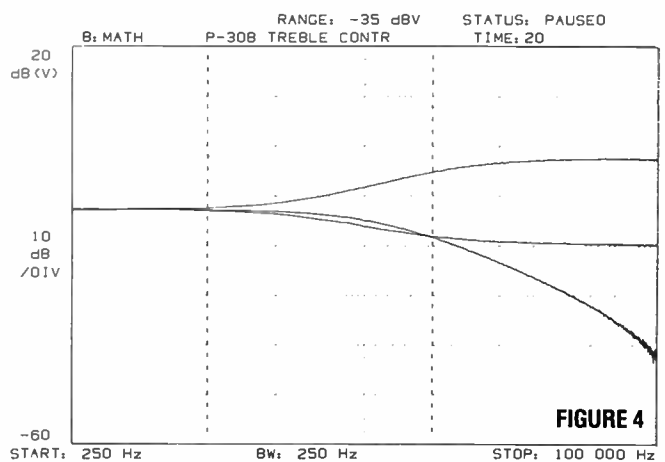
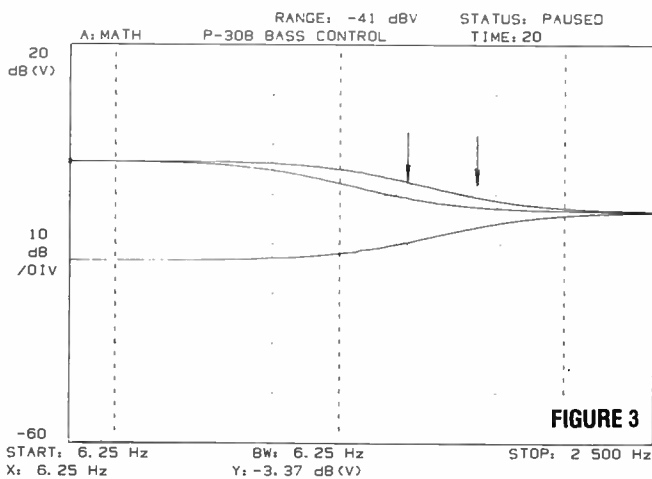
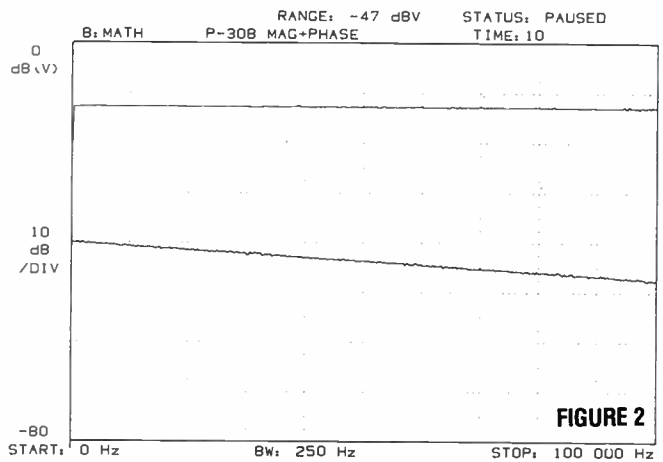
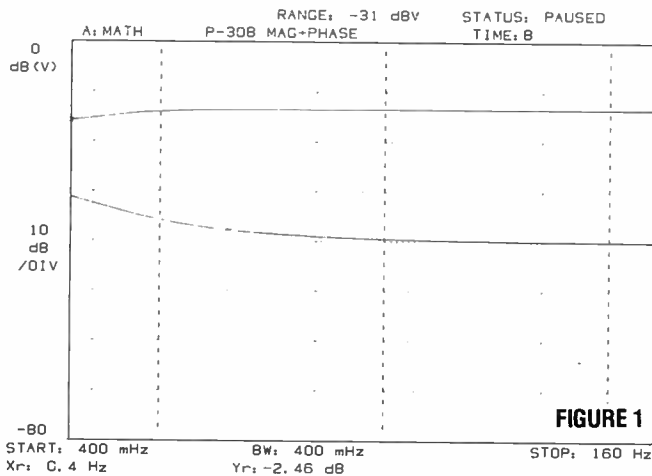

the M-508 is in the order of -70 dB or a little better, and clearly shows higher distortion levels than the preamplifier.

Figures 10 and 11 show the upper and lower frequency response limits for the power amp on logarithmic frequency scales. No, I didn't draw the low frequency response trace with a ruler, it really is a test result! Half a dB down at 400 mHz is, for my money, not bad going at all! The 3 dB down point at the top end for a well and truly hot amp was found at 56 kHz (Figure 10).

Residual noise testing for the M-508, 20-20 kHz band sum relative to full power out with a 1 kHz in put signal (with shorted input) was found to be -103 dB(A). This is an excellent result.

Subjective testing

To the most interesting part. Initially, I found the impact of the P-308/M-508 little short of stunning. The most outstanding quality immediately apparent with the amplifier is detail, so much so that many things previously unnoticed became patently obvious. Subjectively, the two components are very well matched, giving very comparable audio quality. Within the performance bandwidth available with small monitor loud speakers – e.g. Celestion SL600s – it is difficult to fault the amplifiers. There is immense detail, tonal quality is excellent, available power and transient capability is excellent and the operation is simple.

Going to larger monitors – B&W 801's – I found the amplifiers showed a shade too much brightness – a feature for which transistor amplifiers are occasionally criticised. The bass response is definitely weak, lacking definition and punch, perhaps indicating overdamping. Changing preamplifiers didn't reduce this apparent failing, suggesting the power amplifier is the guilty party. Measured against perfect expectations, my major remaining criticisms are a slight lack of imaging and a definite lack in depth of field, the pluses being definition, tonal quality and presence. The amplifiers' weakest performance appeared to be with classics, perhaps due to the bass response leaving Celli and Bass a little struggling.

These criticisms must, however, be viewed in proper context. The amplifier is a stunner and passes what is, in my view, \blacktriangleright

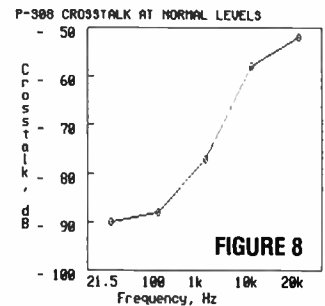
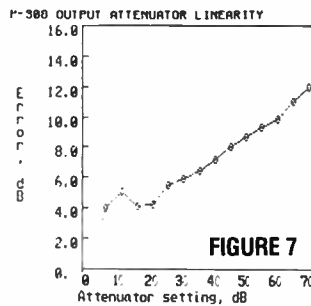

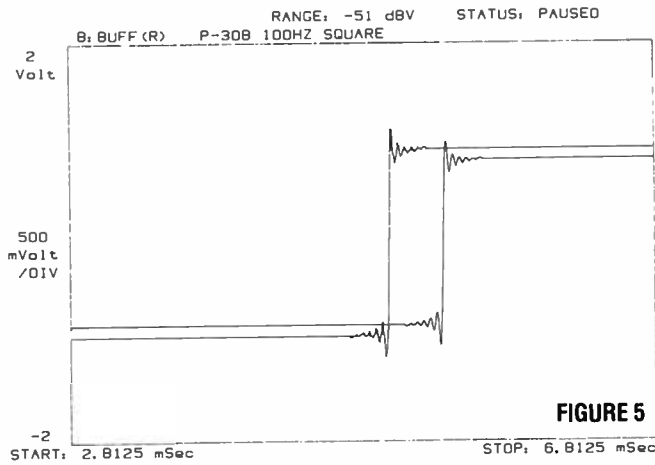

FIGURE 5

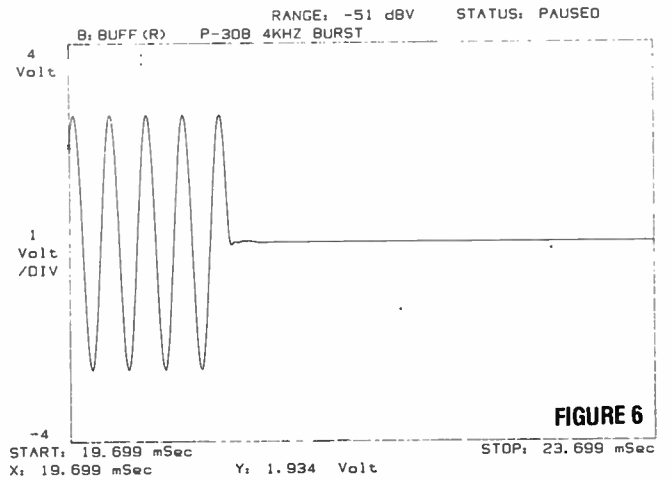

FIGURE 6

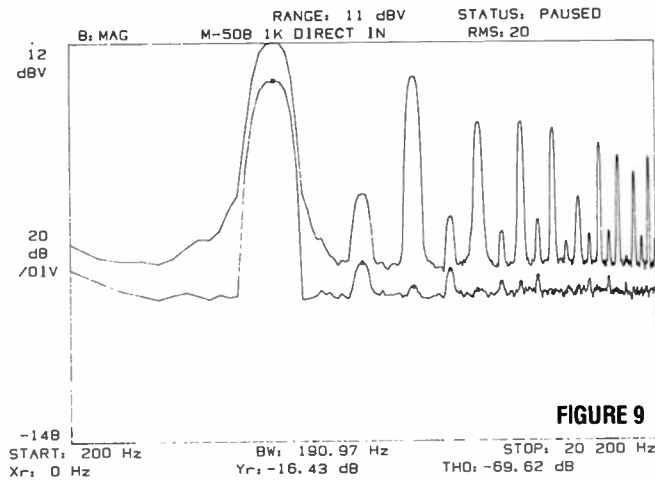

FIGURE 9

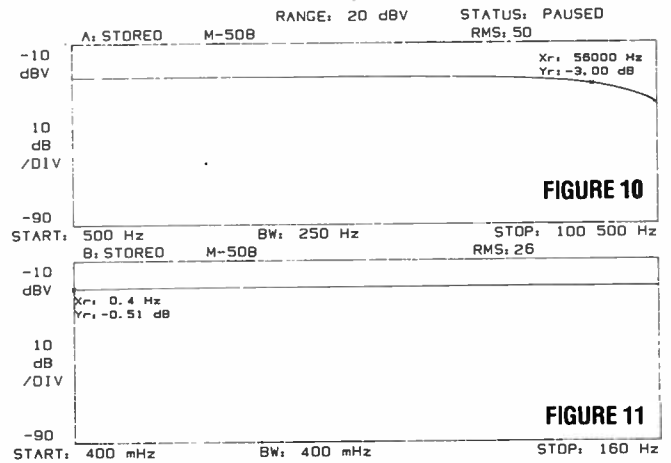

FIGURE 10

FIGURE 11

one of the critical litmus tests for true high fidelity equipment – I found many complaints voiced during listening tests were nothing to do with the amplifiers. Instead, quality of source material, particularly quality of engineering, microphone placements, inter-track balance of multi-track recordings, realism of mixing quality etc, became the dominant listener concern. If the equipment is highlighting these types of deficiencies then clearly it has made the grade. It is an eye (or perhaps ear) opener to note how poor the production engineering quality of some well-respected source material really is.

The Onkyo P-308/M-508 amplifier system is not the best amplifier that I have had the pleasure of auditioning, but it is

clearly audiophile quality, is an amplifier system that proves its own worth, and sits comfortably across a wide range of system requirements. For small loudspeaker systems, I believe the amplifiers would be difficult to beat. With a top quality monitoring loudspeaker system, the amplifiers are left only faintly wanting, but still enormously rewarding to hear.

Beautiful amplifiers. 🐱

The Onkyo range is distributed in Australia by Hi-Phon distributors, Unit 1, 356a-358 Eastern Valley Way, Chatswood 2067 NSW (02) 417 7088.

TEST RESULTS SUMMARY

P-308/M-508 in combination

Frequency Response 1 Hz to 56 kHz, ±3 dB
Residual Noise better than -103 dB(A), 20-20kHz band sum (P-308: -115dB)

THD 100Hz -72 dB
 1 kHz -70 dB
 10 kHz -63 dB

Crosstalk at 1 kHz -79 dB

Maximum output power 233 watt into 8 ohms at 3% THD, one channel driven

Elektor Electronics

in AEM

CONTENTS

PROJECTS & CIRCUITS

Section Indication for Model Railways	34
Level Adaptor for Analogue Joystick	34
6-Way Channel Selector	35
Toilet Pointer	35
Flashing Rear Light	37
A-D Converter for Joysticks	38
Simple Preamp	39
Flashing Light	39
Speed Control for R/C Models	41
Compressor	42
Discrete DAC	43

ARTICLES

Communications Program for Commodore 64	36
Decoupling in Logic Circuits	40
The MAC System	48

The contents of this section are copyright,

© Uitgeversmaatschappij Elektor B. V.
(Beek, the Netherlands) 1986.

Any infringement of this copyright will be prosecuted to the full extent, including unauthorised manufacture of pc boards intended for re-sale.



The projects and circuits chosen for inclusion in the Elektor section are selected on the basis of interest, local relevance and component availability. Intending constructors should consult our 'PROJECT BUYERS GUIDE' in this issue for a guide to component sources and possible kit suppliers.

SECTION INDICATION FOR MODEL RAILWAY

By E J Carroll

This section indication system may be a just the thing you have been looking for when you own a fairly large model railway with tunnels and tracks at several levels, and are sometimes at a loss find the wherabouts of a particular train. This circuit uses LEDs to indicate the train's position. Each track block is split up into 8 sections, whose starting points are marked with reed contacts (S₁-S₈). A ninth reed contact is fitted at the end of the block, to enable turning off the indication for the relevant length of the track. The circuit is composed of 8 set-reset (S-R) bistables, which drive a LED each. All SET inputs are combined in a NOR gate, N₁, which drives a pulse shaper and buffer to reset the bistables with a brief pulse to ensure that only the LED for the last passed track section is lit. The reed contacts are actuated with the aid of a small magnet fitted to the underside of the engine. Depending on the most suitable location of the magnet, the reed contacts are fitted in between the tracks or alongside the left or right hand rail.

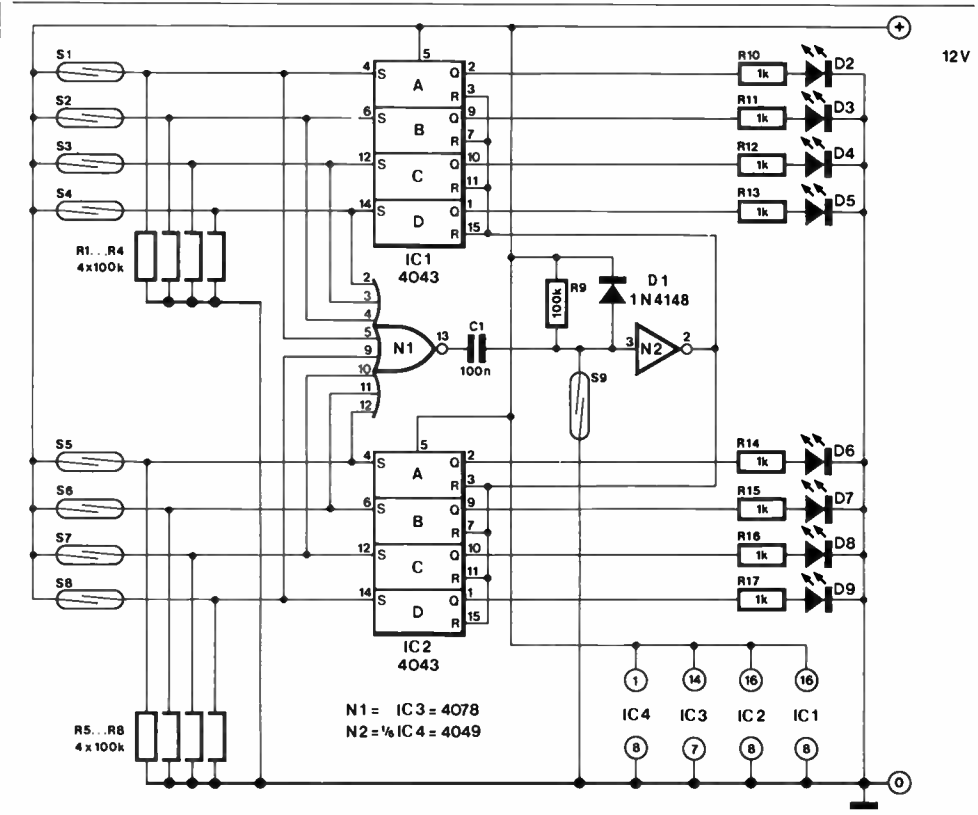

Several of these section indication systems may be fitted in series to enable making a control panel with many lights to

indicate the train positions. Observing the direction of travel of the trains, section junctions are fitted with S₉ (end of

previous section) and S₁ (begin of section) located next to each other.

D

LEVEL ADAPTOR FOR ANALOGUE JOYSTICK

An analogue joystick usually contains two potentiometers, whose wipers are controlled from the central handle on the unit. Unfortunately, the angle covered by the handle is generally only about 90°, whereas the potentiometer's spindle and wiper can be rotated over 270°. The voltage range provided by a potentiometer in a joystick is, therefore, relatively small. Two of the circuits described here make it possible to enlarge the output voltage range of both potentiometers in the joystick. The circuit is readily doubled, thanks to the use of dual CMOS operational amplifier Type

TLC272.

Each of the two wiper voltages from the joystick is processed separately, which enables interesting effects to be achieved. The amplification of the circuit is determined by P₃. This preset enables the enlarging of the potentiometer's "range" to individual requirements. Preset P₂ serves to shift the operative range of the potentiometer within the limits of the supply voltage, which may lie between 3 and 16 V. Setting up this circuit is straightforward. Commence with setting P₃ for minimal resistance, i.e., A₁ should give unity gain.

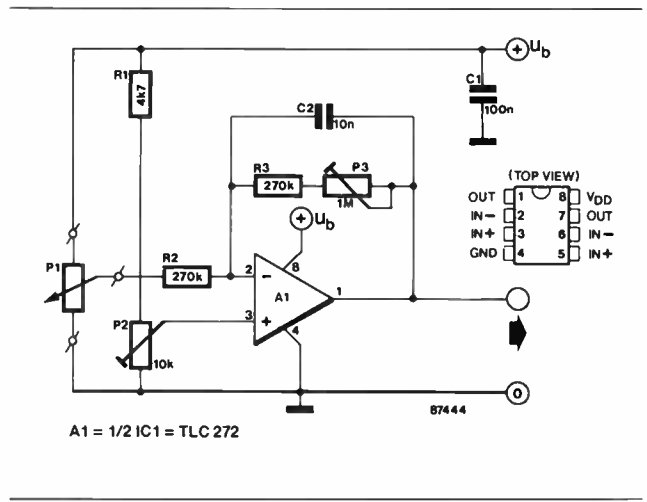

Set the joystick handle to its centre position, so that the wiper of P_1 is at mid-travel. Adjust P_2 to make the output voltage of the circuit equal to $\frac{1}{2}V_{dd}$. Move the joystick handle to the outer positions in the relevant plane, and note the corre-

sponding output voltages from the circuit. Adjust P_3 such that the circuit outputs the required voltage span. The adjustment of P_2 enables changing the toggle point of the circuit, that is, the voltage it outputs when the joystick handle is set to its

centre (rest) position. The current consumption of the circuit depends on the supply voltage level, and also on the value of P_1 . When $V_{dd}=5$ V, and $P_1=4K7$, the current drain is less than 10 mA. The Type TLC272 was chosen because it

works fine from a single supply voltage, and also because it has an extensive input voltage range, 0 to $V_{dd}-1.5$ V.

Th

6-WAY CHANNEL SELECTOR

by U Günther

This design proves that a latching 6-way channel selector with debounced switch inputs need not always be based on the use of special integrated circuits.

When none of the break-type SPDT push buttons is pressed, the data inputs of IC₁ are held at +5 V, while input CLK is held low via R₈. When a switch is operated, the associated input of IC₁ goes low, while CLK goes high, so that the logic state of the D₀-D₅ lines is latched and transferred to outputs Q₀-Q₅. Each of these can drive a LED or relay based output circuit as shown.

When more than six switches are required, a 74LS174 may be added, whose clock input is connected to IC₁.

Note that the LS chip may be replaced by a corresponding

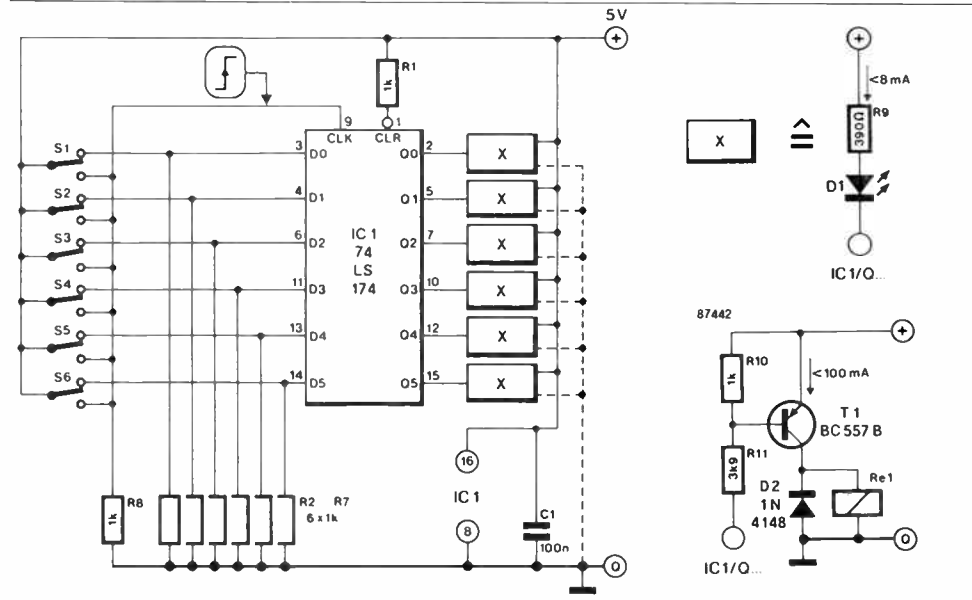

version from the HC or HCT family. This will reduce the cur-

rent consumption from about 20 mA to 6 mA. The maximum

output current supplied by IC₁ is 8 mA in all cases.

W

TOILET POINTER

by R Kambach

It often happens on parties that numerous guests are at a loss in finding the toilet, and politely but urgently require to be given directions to that effect. The

ful to many, since it captures the attention by successively lighting LEDs that are arranged to form an arrow. The circuit is based on a single Type 4049 integrated circuit, which contains six CMOS inverters. Each of these has an R-C network at its output to ensure an appropriate delay before enabling the next inverter. The outputs of

the chip are capable of driving one LED direct, although some heating is expected to arise

from this. The circuit is conveniently fed from a PP3 (9 V)

battery, and consumes a mere 50 mA.

Th

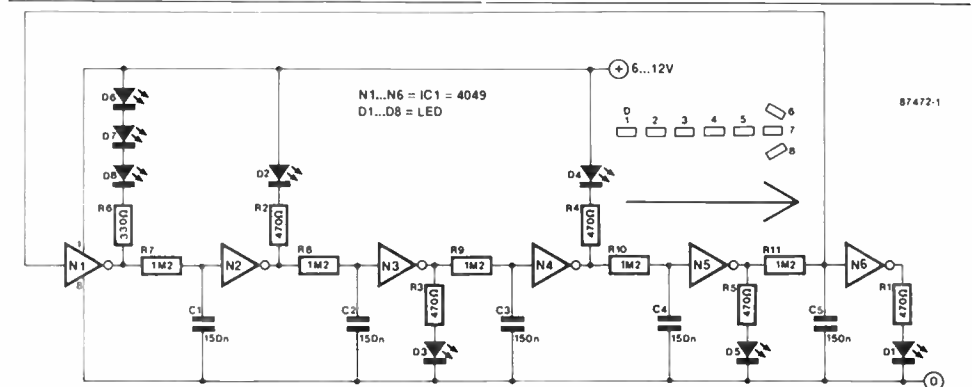

COMMUNICATION PROGRAM FOR C64

This program enables users of the popular Commodore C64 home computer to exchange messages between two machines.

No hardware whatsoever is needed to accomplish:

- communication over several tens of metres using a three-wire connection—see Fig. 1. Longer distances, or communication over the telephone, of course require the use of a modem.

- split screen operation: the upper half of the screen displays the operator's input (LOCAL), the lower half displays the received messages (REMOTE).

- full duplex communication, i.e. transmission and reception are quasi-simultaneous processes.

The flowcharts in Fig. 2 illustrate the structure of the proposed program. TX is short for transmitter, RX for receiver. Note that screen pointer updating routines are not apparent from these diagrams.

Unfortunately, since the C64 BASIC interpreter does not allow structured programming to be carried out, the constructs shown in the flowcharts are not readily detected in the practical BASIC program listed in Fig. 3. Keyed-in text is transmitted to the far computer after pressing the RETURN key. The BORDER colour changes to warn the user when the screen is full. Typing errors can be corrected in the usual way with the aid of the INST/DEL key. A short beep is sounded to signal the receipt of a message from the REMOTE computer.

Testing the program is straightforward, and does not require two computers. Figure 4 shows the connections that can be made temporarily on the computer's user port. This creates a zero modem, and causes LOCAL text to be echoed on the REMOTE screen.

For those computer enthusiasts interested in analysing the BASIC program, and for those who intend to rewrite it for

1

I (C64):

II:

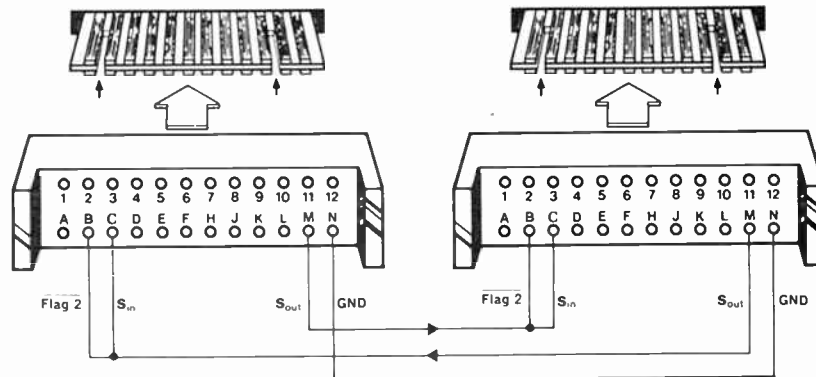

2

* MAIN LOOP

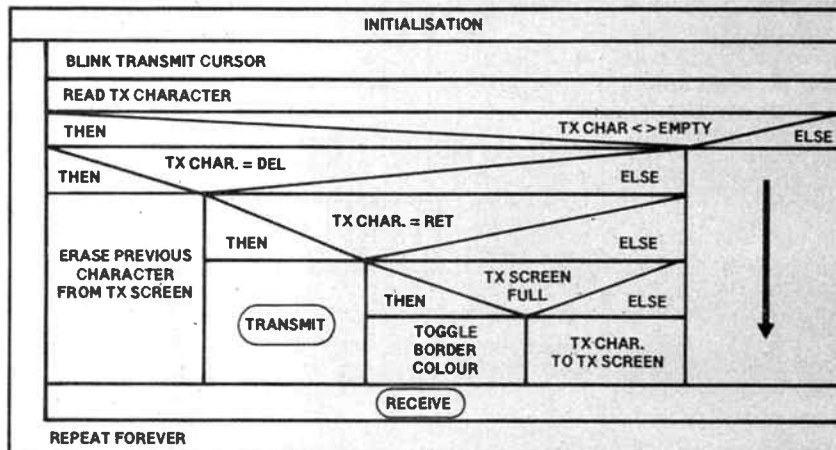

* TRANSMIT SUBROUTINE

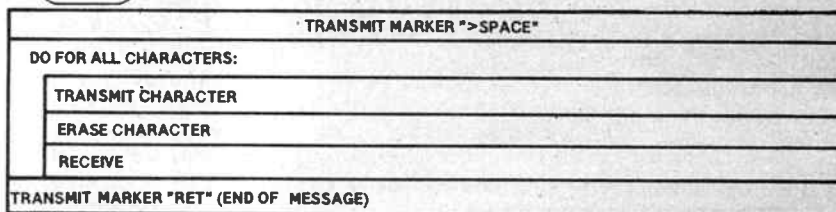

* RECEIVE SUBROUTINE

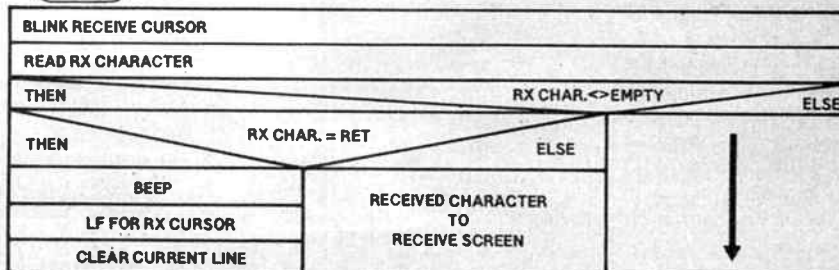

87461-2

other types of computer, the function of the major lines can be summarized as follows:

100-125: initialize the screen and the sound generator.

130: open the serial port with parameters 300 baud, 8 data bits, 1 stop bit, no parity, no handshaking, full duplex.

140: T is the base address of the transmit screen, and T0 is the associated index. R and R0 are similar variables for the receive screen, while R1 in addition gives the maximum number of character per line.

160: blink the cursor and read the keyboard buffer.

180-200: test for DELETE, and erase the previous character.

210-230: test for RETURN and transmit message.

240-260: toggle the BORDER colour when the screen is full.

270: go to the receive subroutine.

280: repeat the above loop.

710: transmit the "begin of message" marker.

720-750: transmit and erase all characters. Monitor the receive channel for messages, after transmission of every character; reception has the highest priority.

760: transmit the "end of message" marker.

810: blink the cursor and read the receive buffer.

820: buffer empty?

830: end of message.

840: have the sound generator produce a beep.

850-870: advance the cursor to the next line.

880: clear the new line.

900: display received character on REMOTE screen.

910-920: advance cursor to next position. W

3

```

100 POKES3281,12:PRINT"":POKE53280,9:POKE53281,0:PRINT CHR$(152):POKE53272,23
110 SI=54272:POKE 24+SI,15:POKE SI,207:POKE 1+SI,34:POKE 5+SI,10
120 FOR H=1033 TO 1044: READ A: POKE H,A: NEXT H
125 FOR H=1273 TO 1283: READ A: POKE H,A: NEXT H
130 OPEN 2,2,0,CHR$(6)+CHR$(0)
140 T=1104: T0=0: R=1344: R0=0: R1=0
150 REM MAIN
160 POKE T+T0,60: POKE T+T0,32: GET T$
170 IF T$="" THEN GOTO 270
180 IF T$<>CHR$(20) THEN GOTO 210
190 IF T0>0 THEN T0=T0-1
200 POKE T+T0,32: GOTO 270
210 IF T$<>CHR$(13) THEN GOTO 240
220 GOSUB 700
230 GOTO 270
240 IF T+T0>=R-80 THEN GOTO 260
250 POKE T+T0,ASC(T$): T0=T0+1: GOTO 270
260 POKE 53280,1: FOR H=0 TO 15: NEXT H: POKE 53280,9
270 GOSUB 800
280 GOTO 150
700 REM TRANSMIT
710 PRINT#2,CHR$(62);: PRINT#2,CHR$(32);
720 FOR K=T TO T+T0-1
730 PRINT#2,CHR$(PEEK(K));: POKE K,32
740 GOSUB 800
750 NEXT K
760 PRINT#2,CHR$(13);: T0=0
770 RETURN
800 REM RECEIVE
810 POKE R+R0,60: POKE R+R0,32: GET#2,R$
820 IF R$="" THEN GOTO 930
830 IF R$<>CHR$(13) THEN GOTO 900
840 POKE 54276,0: POKE 54276,33
850 IF R1=40 OR R1=0 THEN GOTO 870
860 POKE R+R0,32: R1=R1+1: R0=R0+1: GOTO 850
870 R1=0: IF R+R0=2024 THEN R0=0
880 FOR H=R+R0 TO R+R0+39: POKE H,32: NEXT H
890 GOTO 930
900 POKE R+R0,ASC(R$): R0=R0+1: R1=R1+1
910 IF R1=40 THEN R1=0
920 IF R+R0=2024 THEN R0=0
930 RETURN
950 DATA 42,32,84,82,65,78,83,77,73,84,32,42
960 DATA 42,32,82,69,67,69,73,86,69,32,42
970 END

```

READY.

4

C64:

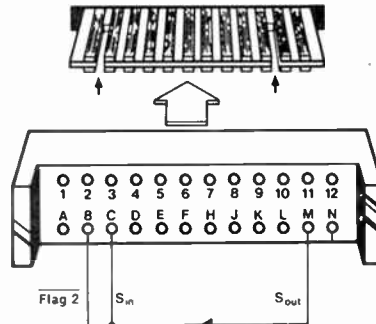

FLASHING REAR LIGHT

by J Donhauser

This rear light for bicycles is fed from a battery charged with current from the dynamo, and starts to flash when the cyclist halts. To preserve battery power, the unit automatically switches off 4 minutes after halting.

The circuit is essentially composed of a battery charger and a logic switching section. The NiCd battery is charged from a voltage doubler C₁-C₂-D₁-D₂-C₃ to ensure a charge current of about 20 mA when riding at a reasonable speed. This makes it possible for a charge of 3 mAh to be available after a 10

minute ride, i.e., enough for the light to flash for about 4 minutes after the bicycle is halted. A relay is used to switch between operation while riding and while standing still. When the bicycle is in motion, the voltage from the dynamo, G, ensures that N₄ is enabled, so that T₁ actuates Re, and the small 6 V

bulb is illuminated. Since C₃ is only slowly discharged via R₁, N₄ remains enabled for about 4 minutes after halting. Push-button S₁ enables immediately switching off the rear light, because R₂ then discharges C₃ in a few seconds. Gate N₁ monitors the dynamo voltage, which is rectified by

D₄-C₄-R₃. When the direct voltage drops below approximately 2 V, N₁ switches on multivibrator N₂-N₃-N₄ which causes the relay to toggle at a rate determined by R₄-C₅. The 5 V DIL relay requires only 11 mA, while the current consumption of the 4093 is virtually negligible at about 1 μA.

It should be possible to fit the circuit and the battery in a somewhat larger than normal bicycle headlight, equipped with terminals for connecting the dynamo and the rear light. Of course, due care must be taken to avoid the battery contacts touching the metal inside of the light.

R

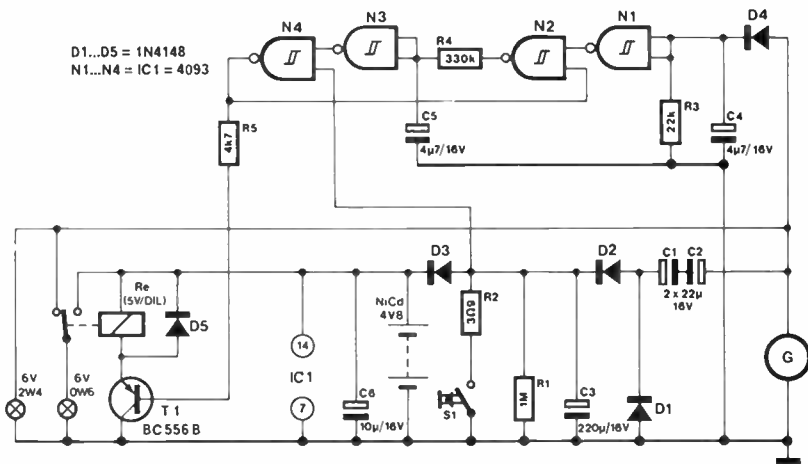

87446

A-D CONVERTER FOR JOYSTICKS

From an idea by F Berben

Although joysticks come in an astounding variety of versions, their internal organization is virtually always a standard concept, based on either a set of relatively fragile, springy, membrane contacts, or two potentiometers. Many computer enthusiasts will agree that the latter, analogue, type offers better reliability and quality. Unfortunately, however, these can not be used in conjunction with a popular home micro such as the Commodore C64, and that is where the present circuit comes in.

The four comparators in IC₁ function as switches to translate the handle movement into digital signals. The outputs of the comparators are buffered in IC₂ to enable interfacing to the computer's joystick port. The two remaining inverters in IC₂, N₅ and N₆, along with two inverters in IC₃, function as drivers for the LEDs that indicate the handle position. Gates N₉-N₁₂ are set up as a wired NOR function to enable LED D₅ to light when the joystick handle is in the centre position. Finally, the current consumption of the converter is about 25 mA.

D

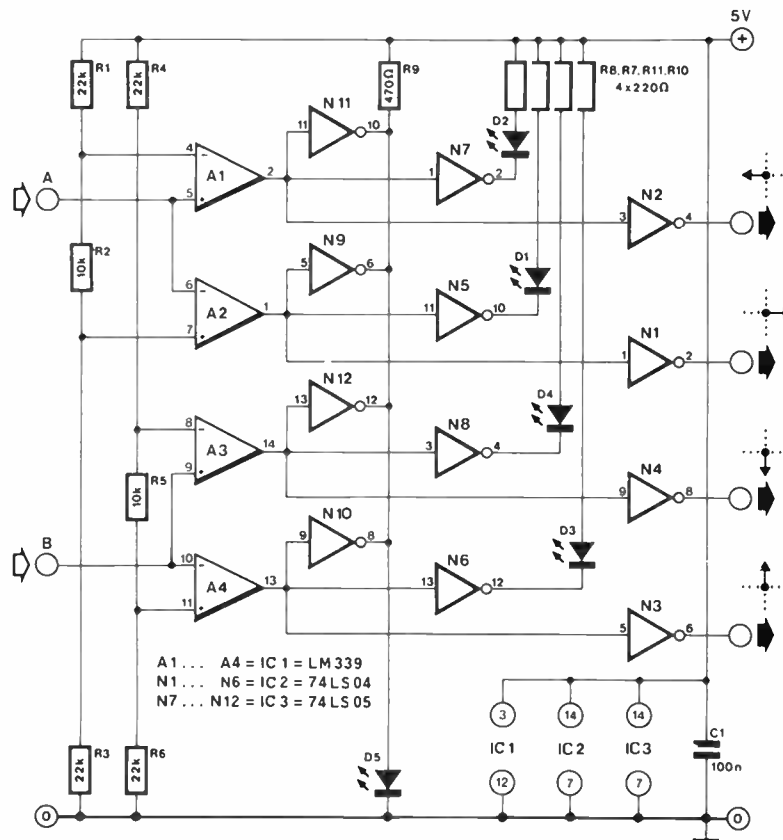

87417

SIMPLE PREAMPLIFIER

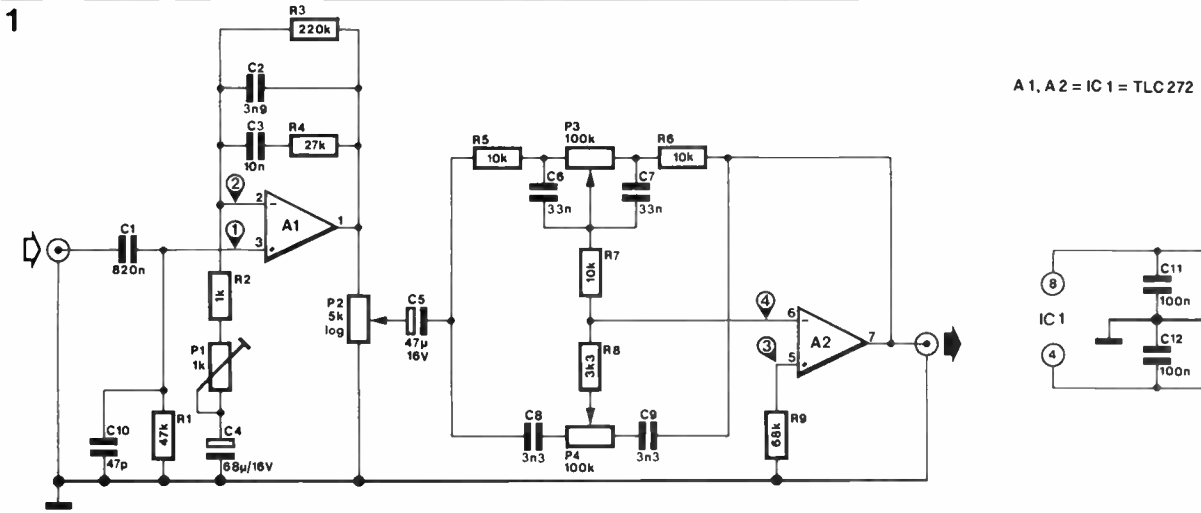

This design answers the need for an inexpensive, yet good quality, preamplifier equipped with a tone control section. Fig. 1 shows the circuit diagram. The amplification of the input stage set up around opamp A₁ is adjustable between 10 and 20 with preset P₁. The 0 dB level at the input is 50 mV, while the input impedance and capacitance are 47 K Ω and 47 pF, respectively to enable ready connection of most record players and cassette decks. The tone control section is a standard Baxan-

dall type with P₃ and P₄ as the respective bass and treble controls. The gain vs frequency curves for various settings of the tone controls appear in Fig. 2. Here the 0 dB level corresponds to 1 V. The current consumption of this preamplifier is modest at about 5 mA. When the circuit is correctly balanced, the indicated measuring points should all be very nearly at ground potential. The circuit shown here must, of course, be duplicated to obtain a stereo preamplifier.

St

2

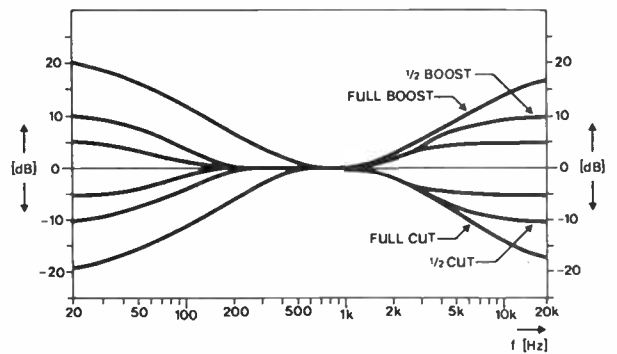

FLASHING LIGHTS

This application of the well-known Type 555 timer is intended for model railway enthusiasts wishing to construct a two-lamp flashing beacon with a minimum of components. With reference to the circuit diagram, the number of LEDs need not be restricted to two: several may be connected in parallel to achieve a higher light intensity, but a total current consumption of 200 mA should not be exceeded to prevent the destruction of the output stages in the 555. Each LED added

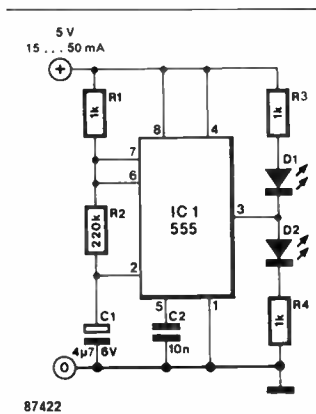

should have its own current limiting resistor, similar to D₁-R₃ or D₂-R₄. The flashing rate is defined with C₁. The stated value of this component is likely to be optimum for applications in model railways. The supply voltage for the circuit is not critical, but should remain within the range from 5 to 10 V. With two LEDs fitted and a 5 V supply, the flashing circuit should consume less than 50 mA. The intensity of the LEDs can be adapted to individual pre-

ference by changing R₃ and R₄, but too low resistance values should be avoided to prevent the destruction of the LEDs.

St

DECOUPLING IN LOGIC CIRCUITS

Failing to heed the importance of adequately decoupled supply rails is one of the most serious mistakes a constructor of digital circuits can make. Two important facts necessitate a reappraisal of the effectiveness of decoupling: the introduction of the fast HC and HCT series of CMOS chips, and the general availability of ever larger dynamic RAM (DRAM) devices. The 41256 256Kbit DRAM and 6264 CMOS SRAM, for instance, have become commonly used integrated circuits, available at relatively low cost. The fast spreading use of the new CMOS series of logic circuits has created the widely heard misunderstanding that these devices can be used without paying the least attention to decoupling of the supply lines. However, a reduced current consumption relative to TTL devices is by no means a carte blanche for designers to skimp on decoupling provisions, as will be seen below. Why does a logic circuit draw current? The current consumption of TTL chips goes mainly on account of indispensable, internal, resistors. CMOS structures are complementary, and theoretically consume no current at all in the static mode. As soon as any kind of switching is to be done, both by TTL and CMOS circuits, the charge of the capacitance at the output must be reversed as illustrated in Fig. 1. The switch currents internal to the IC are only a fraction of those required for the load capacitance, and can, therefore, be disregarded, except in the case of counters. TTL and CMOS circuits thus consume an equal peak current during switch operations. Decoupling capacitors are fitted direct to the IC supply terminals to prevent the instantaneous supply voltage from briefly dropping to an unacceptable level when the switching takes place. The graph in Fig. 2 is reproduced from a Texas Instruments data-book, and shows the correlation between the capacitor-to-package distance and the peak amplitude of the spikes on the

supply line to a typical HCMOS gate. This shows beyond doubt that decoupling capacitors must be fitted as close as possible to the IC supply terminals, to rule out the stray inductance of supply tracks on the PCB, however neatly these may run in parallel. Often, tuned circuits are designed with long supply tracks and a wrongly placed decoupling capacitor. Any spike is then subject to ringing effects, which further deteriorate the operation of the logic circuit in question. Not surprisingly, Mullard recommend a multi-path supply track when it is impossible to fit the decoupling capacitor close to the IC. This solution is called a *grid structure*, and is definitely preferable to creating relatively wide, single tracks—see Fig. 3. The value of the decoupling capacitor must be based on the foreseeable number of IC outputs that are *simultaneously* active. A conventional starting point is 20 to 100 nanofarad for every three ICs. Further reflection on this theme leads to the conclusion that the supply for a 256Kbit DRAM is far more difficult to decouple than that for, say, a 16 Kbit DRAM. Fortunately, the problems are not as serious as one would expect. In practice, the size of the chip carrier, and hence the parasitic capacitance, is constantly reduced by the manufacturers, whose foremost aim is to ensure optimum response of the device at high operating frequencies. Certain DRAM manufacturers recommend the use of 330n decoupling capacitors (see Fig. 4), but in practice no problems evolved from the use of the standard value of 100n.

W

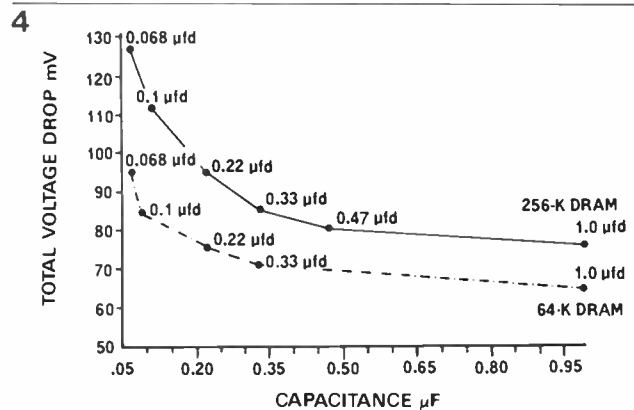
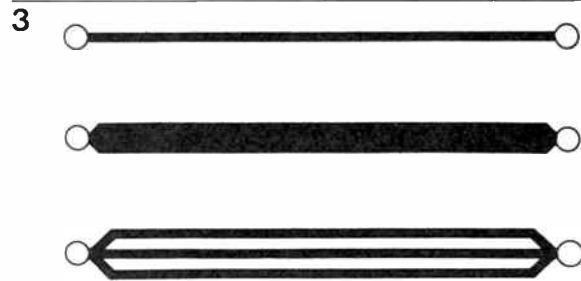
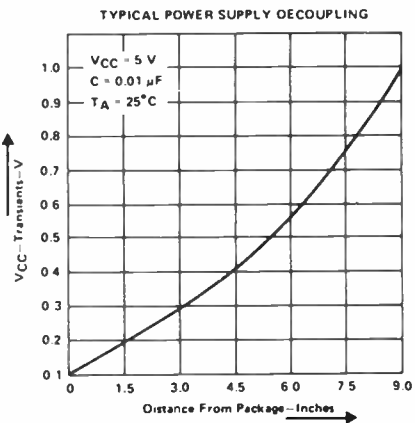
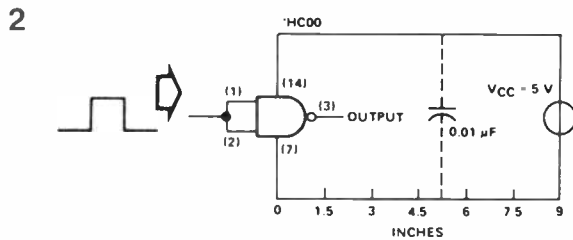
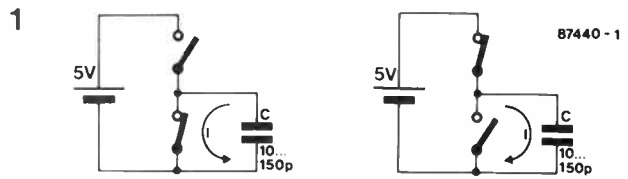

SPEED CONTROL FOR R/C MODELS

by P Techer

The speed and direction of rotation of a motor in a radio controlled model aeroplane or boat is generally controlled by pulse width modulation of the supply voltage to the motor driver stage.

In the present circuit, shown in Fig. 1, bistable FF₁ is set up rather unconventionally to function as a monostable multivibrator, whose period is set with R₁-C₁-P₁. This period determines the toggle point at which the motor's direction of rotation is reversed. Output Q of FF₂ goes high when the pulse at the D input (PWM signal) is shorter than that at the CLK input (signal from FF₁). This causes T₁ to actuate Re₁, so that the motor direction is reversed. The PWM control signal applied to the circuit is also fed to N₂, whose output pulse width is the difference between that of the input signal and that from FF₁. The pulse width at the output of N₂ therefore increases as the relevant control handle on the transmitter is moved further towards either extreme, and is maximum when the handle is in the central position. The output of N₂ is integrated by A₁ to obtain an output voltage proportional to the pulse width. A₄ compares this output voltage with the triangular signal at the wiper of P₃, so that a variable duty factor signal is obtained for driving the power output stage comprised of T₄-T₅. Meanwhile, A₂ compares the proportional voltage from A₁ to the level set with P₂. When the output of A₁ is lower than the threshold, i.e., when the motor speed exceeds the preset level, T₂ activates Re₂. This causes the collector-emitter junction of series regulator T₃ to be bypassed by the relay contact, and so enables the motor to run at full speed, because the forward drop across T₃ is eliminated.

The frequency of the triangular signal from A₃ is of the order of 2 kHz, which is suitable for most motors. Capacitor C₆ may be increased to lower the frequency for non-standard

1

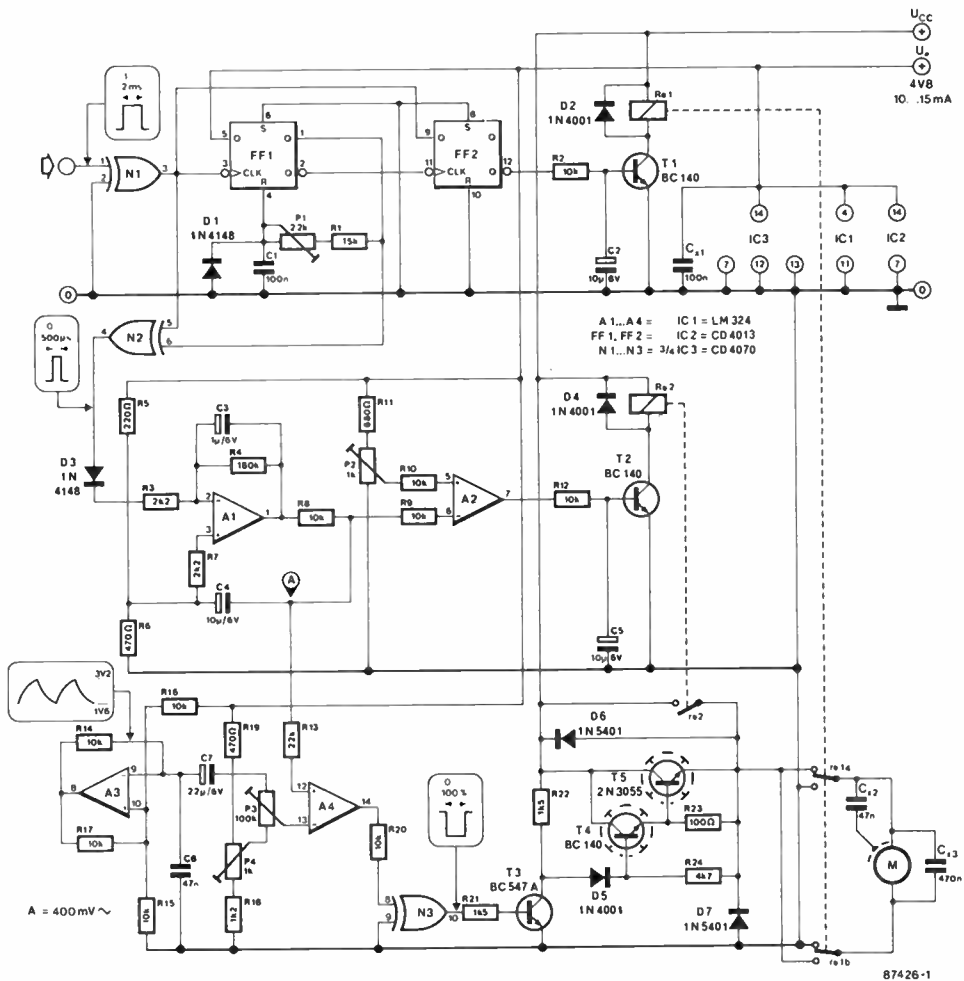

87426-1

motors. Conversely, if the frequency is increased, care should be taken to observe the maximum switching speed of T₅, which is a commonly available, but relatively slow power transistor. Presets P₄ and P₃ determine the limits of the inoperative range of the handle, and the point that corresponds to maximum motor speed, respectively. More specifically, P₃ sets the amplitude of the triangular signal, while P₄ sets the offset level, to enable A₄ to output the triangular wave undistorted and with the maximum possible voltage swing. Preset P₂ is used to define the point at which the motor is switched to full speed. Some care should be taken in this setting to allow a suf-

ficiently large control range for the handle, and also to avoid the risk of Re₂ clattering or being blocked.

Be sure to fit the 470nF capacitor across the motor terminals, and the 47nF capacitor between one of these and the motor body—see Fig. 2. The coil voltage of the relays should be equal to the voltage for the battery that powers the motor, while the contacts must be capable of handling the current demand of the motor. Transistors T₄ and T₅ should be fitted with a heatsink. Note that although the Type 2N3055 can handle currents up to 10 A, it may be a good idea to fit two in parallel with 0R1 emitter resistors for equal current distribution when heavy loads are to be controlled. The cur-

2

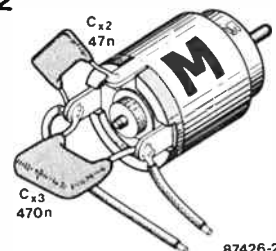

87426-2

rent rating of D₆ and D₇ must also be observed: for the stated 1N5401s, I_{I(max)} = 3 A, and two may have to be connected in parallel when this current is approached. Finally, U₊ is the model's battery voltage (4.8 V), and +U_{cc} is the supply voltage for the motor.

W

COMPRESSOR

by S G Dimitriou

This versatile circuit serves to raise the average output power of an AF amplifier. Its simplicity makes it suitable for applications in intercom systems, public address and discotheque equipment, and also in various types of transmitter.

Compression of music and speech essentially entails reducing to some extent the dynamic range of the AF input spectrum in order to drive an AF power amplifier with a fairly steady signal level just below the overload margin, thus increasing the average output power of the system. However, some distortion is inevitably incurred in the process of amplifying the relatively quiet input sounds and attenuating the louder sounds. It is evident, therefore, that the control of the amplifier/attenuator function in the compressor determines to a large extent just how much distortion is introduced by the circuit.

Before inserting any type of

compressor in an AF signal path, due consideration should be given to the *attack time* i.e., the time it takes the circuit to detect and counteract a sudden increase in the amplitude of the incoming signal. Allowing for personal preference and the character of the input signal (speech, popular music, etc.), the attack time of a compressor generally lies in the range from 0.5 to 5 ms. The *release time* of the compressor is the time it takes the circuit to return to the settings that existed before the rise in amplitude occurred. Contrary to the attack time, the release time is usually of the order of seconds. If it is made too short, the compressor's attenuating action may cause interference with the lowest components in the frequency spectrum. On the other hand, too long a release time (10-15 s) is also undesirable as this will give rise to an unrealistic and unpleasant effect caused by the output sound remaining com-

pletely muted long after the increase in input signal amplitude. In practice, the release time of a compressor will need to be adapted to meet the demand of the particular input signal; speech generally requires a longer release time than music. Some compressors have a provision for the setting of the release time, but the one proposed here is an auto-ranging type, that is, it arranges for the release time to change automatically with the instantaneous amplitude of the input signal.

Figure 1 shows the circuit diagram of this compressor. Despite its simplicity, the design responds adequately to a good number of contradicting requirements. As to its dynamic characteristics, an input signal change from 25 mV_{PP} to 20 V_{PP} (≈ 58 dB) is compressed into an output signal change from 1.5 V_{PP} to 3.4 V_{PP} (≈ 7.1 dB). For a less extreme signal change, e.g., from 25 mV_{PP} to 2.5 V_{PP}

Measurement values:

- A = 0 V
- B = +4.5 V
- C = 6 mA
- D = 3.9 V

All values are typical and within 10%.
All voltages measured with respect to ground with a DMM ($Z_{in} = 1M\Omega$).

(≈ 40 dB), the compressed output signal changes from 1.5 V_{PP} to 2.25 V_{PP} (≈ 3.5 dB). The circuit has an extended frequency response from about 20 Hz to 40 kHz nominally, thanks to the use of a fast opamp, the Type LF357 (IC₁), which is set up here to provide an amplification of about 471 $[(R_6 + R_5)/R_3]$. Capacitor C₃ blocks the direct voltage at the inverting input of IC₁, and with R₅ sets the low-frequency roll-off of the opamp alone at about 16 Hz.

Resistors R₃ and R₄ bias the non-inverting input of the opamp—and hence its output—at half the supply voltage, ensuring optimum linearity. Capacitor C₂ feeds the input signal to the opamp while blocking the bias voltage at pin 3. Its value is not critical, but it has some effect on the low-frequency response of the compressor. The attenuator section in this circuit is essentially composed of R₂ and T₁. The collector of this transistor is held at 0 V with the aid of R₁ and R₂. In this way, T₁ is always operated in its saturation region, and its collector-emitter junction acts as a variable resistance controlled with the current fed to the base. The higher this current, the lower the c-e resistance, and the higher the instantaneous attenuation of the signal fed to IC₁. The controlling rectifier is composed of D₁-C₅-R₇. Transistor T₂ functions to provide the charge current for C₇ so as to avoid distortion otherwise incurred by too heavily loading the IC₁ output. The rectified voltage across C₅ is a direct measure of the output signal amplitude, and forward-biases the base of T₁, which regulates the attenuation as dis-

1

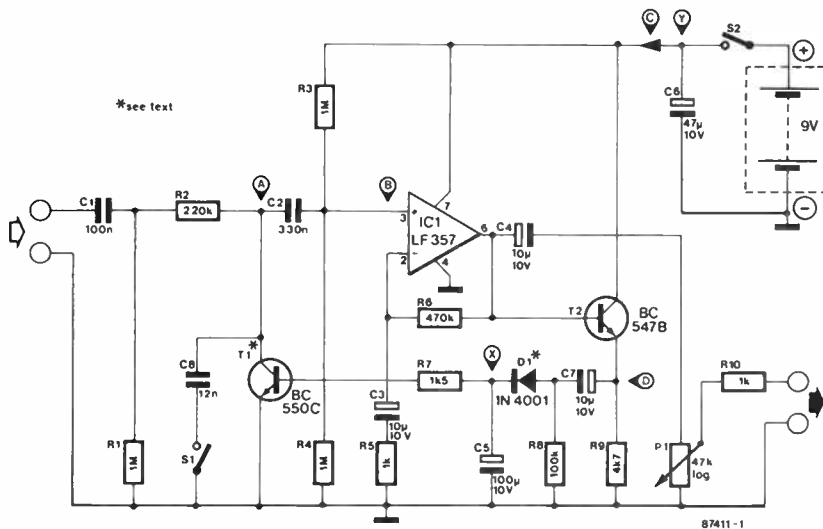

2a

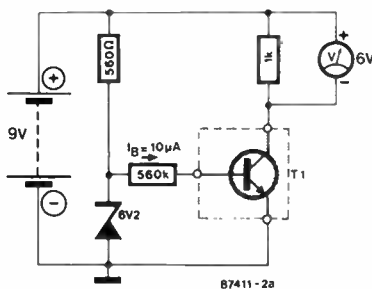

b

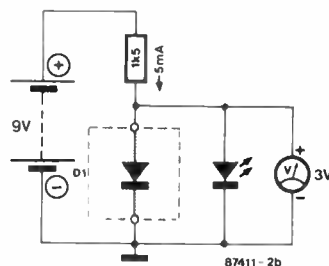

cussed. The use of a diode with a low internal resistance, D_1 , and a buffer, T_2 , ensures fast charging and slow discharging of C_s , and thus a short attack time and a long release time, respectively. As C_s is discharged via R_7 and the base resistance of T_1 , the release time of the compressor is the product of the value of these three components. When the base bias is reduced, the base resistance of T_1 increases, lengthening the release time. This is a most welcome feature, especially with speech signals. The output of the opamp is fed

to C_4 - P_1 - R_{10} , which provide DC insulation and level adjustment. Two compressors are readily combined to make a stereo version by feeding them from a common battery and connecting points X and points Y (never X to Y!). In this case, T_1 and D_1 in both compressors must be matched types to ensure proper operation. Figure 2 shows two simple test circuits for selecting transistors and diodes with matching DC characteristics. The basic method is to start with noting the voltmeter reading for a particular device, and then find a

matching type from an available lot by inserting devices until one is found that gives the previously noted test voltage. In the diode test circuit, the LED lights to indicate the absence or reverse connection of a diode under test.

Provision has been made to use the circuit as a noise suppressor. Referring to Fig. 1, closing S_1 connects C_s across the regulator transistor to form a low-pass filter in conjunction with R_1 and R_2 . The cut-off frequency of this LPF is a function of the current sent into the base of T_1 . The overall effect thus

obtained is an effective elimination of noise from quiet passages in the programme. For louder passages, the suppression of noise is not so important, as it is then virtually inaudible. Finally, when using this compressor, make sure that your amplifier has ample cooling provision, because it may well be continuously operated at the top of its power rating. For the same reason, check whether the loudspeakers can handle the available power.

Sv

DISCRETE DAC

A digital-to-analogue converter (DAC) that is easy to build from a handful of readily available parts. The 8-bit digital input for the circuit is applied to resistors R_{17} - R_{24} incl., each of which drives an associated current source composed of two series-connected diodes, a transistor and a current defining resistor fed from the positive supply rail. A logic high level at the input causes the relevant current source to be switched on, a logic low level switches it off. The sum of currents from T_1 - T_8 incl. is arranged to pass through preset P_1 , which thus drops a voltage U_o in accordance with

the magnitude of the 8-bit word written to the circuit.

The current supplied by each current source is about $700/R_x$ [mA], where R_x is the value of the associated resistor between the emitter and the +V rail. In order to ensure satisfactory linearity of the analogue output voltage, resistors R_1 - R_8 incl. must be dimensioned to obtain a current ratio of 1:2 between any two adjacent sources. In practice, it is wise to first apply a logic high voltage to the MSB (most significant bit) input of the circuit, leaving the remaining inputs low, and measure U_o with the aid of a good-quality

voltmeter. Next, drive D_6 high and all other inputs low, and make sure that U_o drops to half the previously obtained level by dimensioning R_7 as required. The other current determining resistors are similarly established; the value of R_1 - R_8 incl. that gives the correct level of U_o is obtained by making suitable combinations of series and/or parallel connected high stability resistors. Alternatively, it is possible to use multi-turn presets. As all resistors R_1 - R_7 incl. must be dimensioned starting from a particular value of R_8 , this resistor must first be calculated considering that the

output linearity of the circuit is affected unless

$$1.4P_1/R_8 < IU_b - 2$$

In practice, the maximum feasible level of U_o is about $\frac{1}{2}U_b - 1$ [V] with only MSB high, and this level should be observed in the dimensioning of R_8 and the setting of P_1 .

Although this 8-bit DAC should be sufficiently accurate for most practical applications, it is of course possible to opt for a greater or smaller number of current sources with a corresponding increase or decrease in the available resolution of U_o .

AR

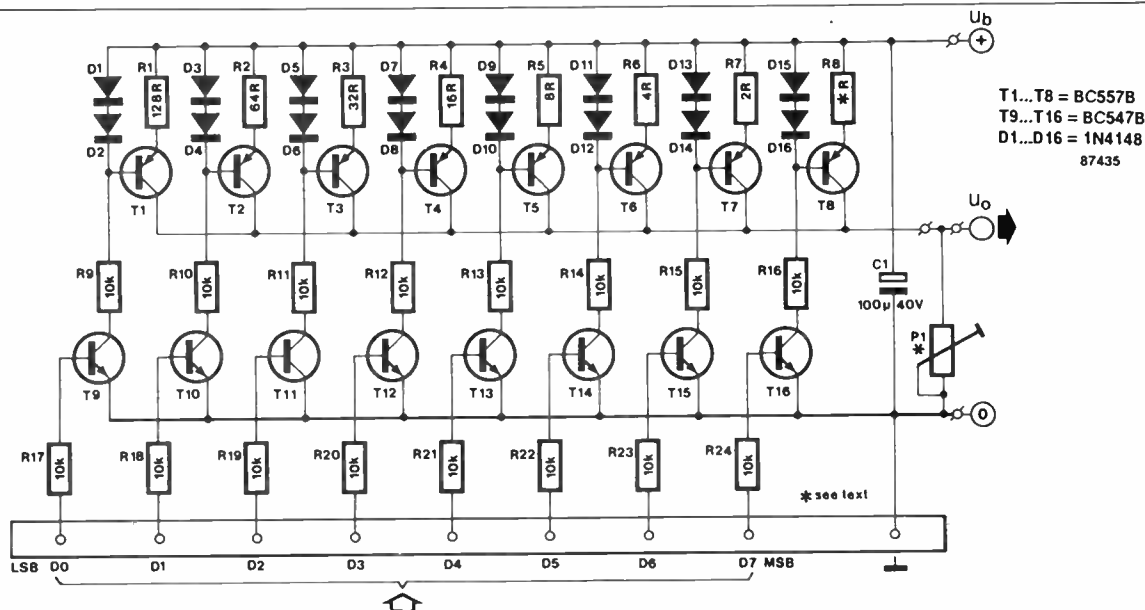

COMPUTER CARDS

CA1601 Super XT 640K mother PCB 8088 CPU 4.77MHz 8 slots 8087 socket quality PCB	\$390.00
CA1602 Turbo XT 640K mother PCB v20 CPU 4.77 and 8MHz 8 slots 8087 socket quality PCB	\$440.00
CA1604 Turbo XT V20 with 1024k RAM	\$520.00
CA1610 Mini AT 1024K mother PCB 80286 CPU 6 and 10MHz 8 slots 80287 socket quality PCB	\$1,150.00
CA1612 Mini AT 1024K Main PCB 80286 CPU 6 and 12MHz 8 slots opt 80287 quality keyboard	\$1,250.00
CA1613 Color graphic card RGB and composite, light pen ad'r	\$125.00
CA1615 Diskdrive card 4X360k D/D w/ cable	\$95.00
CA1617 Disk drive card short stem 2 int drive with cable	\$69.00
CA1620 512K RAM card O RAM	\$135.00
CA1621 Printer card with cable	\$58.00
CA1625 High resol monochrome and par printer port adaptor	\$165.00
CA1616 Multifunction card 384K parallel serial clock and joystick ports w/ O RAM	\$190.00
CA1614 Same as CA1613 w/384K RAM	\$330.00
CA1616 Multi I/O card w/ clock/ parallel/2 serial/joystick	\$135.00
CA1617 Multi I/O plus card same as CA1616 w/ d/drive card	\$195.00
CA 1618 Serial card RS232	\$65.00

COMPUTER POWER SUPPLIES

CA1670 Power supply side sw 150W w/ 4 drive cables	\$135.00
CA1672 Power supply rear sw 135W 4 cable drives	\$155.00
CA1675 Power supply side sw 180W suit IBM AT 4 drive cables	\$245.00
CA1677 Power supply side sw 220W suit large AT PCB 4/D cables	\$295.00

VIDEO MONITORS

CA1800 Amber 12 inch monitor 18MHz Swivel base, RCA plug	\$199.00
CA1801 Green 12 inch monitor non-refl Screen, swivel B. RCA plug	\$190.00
CA1803 Amber 12 inch TTL high res suit both hercules & RGB of CGA	\$240.00
CA1805 Amber 14 inch TTL high res suit both TTL mono & RGB of CGA	\$285.00
CA1830 TVM 14 inch RGB colour monitor 640 x 200, AMB/GN/Colour	\$650.00
CA1833 TVM MD-3V 14 inch RGB colour monitor 640 x 200 6 back gd colours, video & audio I/P plus speaker	\$650.00
CA1837 TVM 14 inch EGA Col monitor 640 x 350 Amb/gn/colour	\$1,050

DRIVES, BACKUPS & ACCESSORIES

CA1630 Computer case w/ hinged flip top and 8 slots	\$110.00
CA1631 Computer case w/rear SW	\$110.00
CA1622 Hard disk cont'ler 2HD	\$199.00
CA1625 Enhance colour graphic ADR 640 x 200/400 selectable	\$450.00
CA1642 5.25" DS/DD disk drive 360k half height Chinnon	\$220.00
CA1643 1.2 M8 floppy drive NEC	\$295.00
CA1645 5.25" 1.2 M8 chinnon drive Half height suit IBM AT/XT	\$295.00
CA1648 Miniscribe 21M hard disk fast access time, half HT	\$650.00
CA1650 Miniscribe 44M voice coil half ht	\$1,400.00
CA1652 44M8 tape back-up for hard'k	\$995.00
CA1660 XT keyb'd 10 functions and 83 keys w/ 5 pin DIN plug	\$140.00
CA1662 AT/XT keyb'd 10 functions and extra large return 3 leds	\$165.00
CA1664 Deluxe auto AT/XT 101 keyb'd	\$199.00

COMPUTER SYSTEMS

CXE640 640K 8088 system w/ 2 drives colour graphics, parallel/serial clock/games ports Keyboard & 135W power supply	\$1,290
CX0646 1024K Turbo XT V20 CPU 4.77 & 8MHz, 2 drives, CGA parallel serial/game/clock	\$1,390
CX0650 Turbo AT 512K system with 2 floppy drives 360 x 2 CGA	\$1,950
CX0652 Turbo AT system w/1.2M drive & 20MB miniscribe hard disk 6 & 12MHz 1024K RAM	\$2,990
CX0655 Turbo AT 6/10MHz 80286 CPU 20MB hard disk 1.2MB floppy	\$2,950

If you need to add a 20MB
Miniscribe hard disk inc.
controller card **\$800.00**

A-102-OAT 80286-10 System:
6/10MHz mini AT with 512K RAM, 2X360K
floppy drives, colour graphics card, serial/
parallel ports, 83 key keyboard, High res TTL
monochrome monitor **\$1999.00**

AT 80286-10 System With 1 x 1.2M drives
& 20M Miniscribe hard disk &
controller **\$2995.00**

AT 80286-10 System with 1 x 1.2M drives
& 40M Miniscribe hard disk & controller. **\$3650.00**

**40M hard disk system with 40M
tape back-up built-in \$4600.00**

PRINTERS

CP1000 Super 5 EP1000 dot matrix printer 100cps NLQ IBM GR	\$550.00
CP1001 Super 5 EP1201 dot matrix printer 120cps NLQ IBM GR	\$590.00
CP1002 Super 5 EN1802 dot matrix 180cps NLQ heavy duty	\$890.00
CP1005 Super 5 EN1805 dot matrix 180cps 15 inch paper NLQ W/LF select IBM GR 3K buffer	\$1,190.00
CP1100 Printer ribbon for EP1201	\$22.00

EXTRA BITS

Battery Back-up Power Supply

With noise filter
250 watts 15 minute back-up
..... **\$950.00**
500 watts 15 minute back-up
..... **\$1,150.00**

Power Surge Protection Magic Button

Plug in existing power outlet to
absorb power surge. **\$29.90**

Tycor Power Line Filters

One of the best on the market with proven
test results. Removes transients over the
entire frequency range, attenuating up to
99% of all spikes and noises, 9 different
sizes from 1A (240 watt)
to 50A (12kW) price from **\$350.00**

COMPONENTS

2716	\$9.00	8284	\$7.50
2732	\$9.00	1488	\$1.10
2764	\$9.00	1489	\$1.10
27128	\$10.50	2102	\$6.00
27256	\$14.00	PAL16LB	\$11.00
RAM 4164 64Kx8	\$2.95	58167	\$18.00
RAM 41256-15		75452	\$2.50
256K x 8	\$6.50	CA3140	\$1.45
RAM 41256-12		AY3-1015D	\$12.50
256K x 8	\$7.00	AY5-3600	\$12.50
V-20 CPU 70108D)	\$26.00	6502	\$11.00
8087	\$377.40	6802	\$9.00
8088-2	\$16.00	68821	\$5.00
81C55	\$6.99	6809	\$16.00
8237	\$14.50	Z80A PIO	\$5.90
8250	\$22.50	Z80A CTC	\$6.00
8253	\$6.00	Z80A CPU	\$6.00
8255	\$6.00	Z80A DART	\$12.90
8259	\$6.00	Z80 UART	\$PO. A
8237	\$14.50	Z80 SIO	\$12.50
SL490	32 channels Transmitter		\$10.50
SL486	Infra red preamp		\$10.50
ML926	Channel 1-16 decoder mont.		\$16.00
ML927	Channel 17-32 decoder mont.		\$16.00
ML928	Channel 1-16 decoder latch		\$16.00
ML929	Channel 17-32 decoder latch		\$16.00
ML923	Analog & digital decoder		\$16.00
LD271	Infra-red LED		\$3.00
BP104	Infra-red receiver		\$3.00

POLYPROPYLENE CAPACITORS

KP Range Polypropylene capacitors 2.5% 63V 5mm spacing

100pF-470pF	\$0.70
560pF-1500pF	\$0.75
1800pF-12nF	\$0.85
15nF-18nF	\$0.90
MKP 1uF/250V	\$3.90
MKC 1.5uF/100V	
audio	\$2.50

Suzuki 2uF/440V
modem \$12.50

Other values on MKP, MKC available

MKT capacitors Full range

Electrolytic RB & Axial type from 1uF to
4700uF, 16V, 25V, 50V

Special electrolytics

100uF/100V axial EYMA	\$1.80
100uF/100V R8 type	\$1.50
220uF/100V RB type	\$2.00
470uF/100V R8 type	\$2.50
4700uF/100V CAN	\$13.50
10,000uF/100V CAN EYNA	\$59.00

Filter capacitors for computers

Miniature size monolithic ceramic blue caps	
0.033/50V	\$0.35
0.1uF/50V monolithic ceramic	\$0.35
AC Power Line Filter Capacitors	
0.01uF/250VAC	\$1.20
0.1uF/250VAC	\$1.60

RESISTORS

	Each
1/4watt 5% carbon film	\$0.04
1/2watt 5% carbon film	\$0.05
1 watt 5%	\$0.10
1/4watt 1% metal film	\$0.07
1/4watt 1% M/F low noise	\$0.12

Other high power metal films
available

HI COM

KITS

HI COM

ELEKTOR MIXER KIT

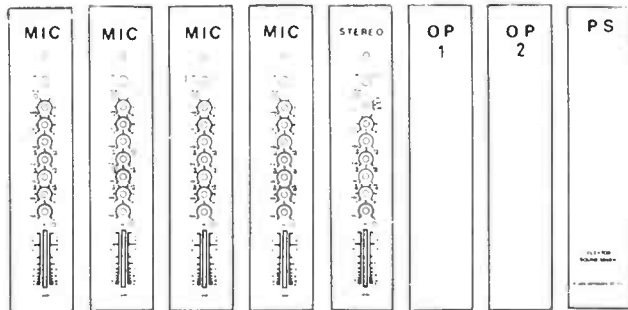

The ultimate mixer kit which can be expanded to 16 channels.

All modules available separately; each with screened pre-drilled anodised aluminium front panels, European slide pots, high quality KP capacitors, & low noise metal film resistors.

SPECIAL OFFER!

5 module kit
\$465.00 without case



ELEKTOR CODE-LOCK KIT

(Summer Circuit 46/1983)
4 digit code-lock for security system or door opener.
Kit includes code-lock IC LS7220, 12 key keypad, components relays but without PCB (standard IC pattern PCB is supplied).
\$22.00

ELEKTOR SERIAL DIGITIZER

For your computer
PCB 86090-1.2
AEM 10/86 **\$175.00**
Main PCB with 2 channels only
\$105.00
each additional 2 channels **\$30.00**

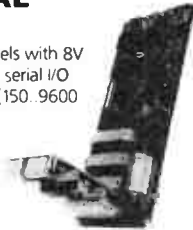

CODE TO SPEECH KIT FOR COMPUTER

AEM 4505 KIT
Parallel version for IBM PC/ XT/ AT
\$129.00
Serial version for other computers
\$149.00

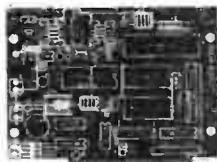

AUDIO/VIDEO TRANSMITTER

Send audio/video signals to any T.V set in your home/office without cables or complicated installation.
\$85.00 Inc DC 12v plug pack (Not a kit)



Tape Copier kit

For Commodore. Includes edge connectors



\$49.00

RS232 Conversion kit for Commodore

\$27.00
24 way edge connector for Commodore **\$7.50**

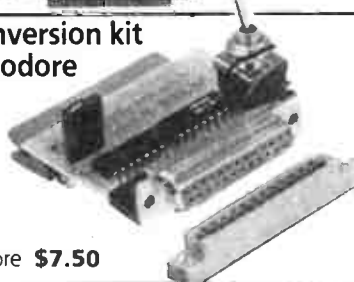

Universal 3 1/2 LCD ELEKTOR panel meter kit.

Kit includes 7106 IC & 3 1/2 LCD display, Elektor PCB 84012-2 as used in all Elektor Instrument kits, components & a hand held case with battery compartment.
With case \$48.00
Less case \$39.50

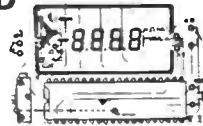

Elector BAROMETER KITS

3 1/2 Digit LCD display.
Measure in MB or altitude. Ideal instrument for car race in mountain area, air flight, hang-gliders etc.
\$159



Elector Autoranging 3.99 digital multimeter kit

PCB No. 87099
\$CALL



Super Simple Modem

AEM4605
300FDX, 1200/75, RS232 interface to any computer.
\$125



Experimental Plug-in cards for IBM PC/XT

Short card **\$30.00**
Long card **\$40.00**
For Apple II+, IIe **\$25.00**



Handheld instrument case as used in Barometer kit, Autoranging digital multimeter
\$14.50

Handheld instrument case as used in EA remote control kit
\$29.50

TOP QUALITY HEAT SHRINK TUBE

Made in U.S.A. All 1 1/2 m long. Fire retardant, shrink 50%. Clear, blue, red, yellow, green, white, black

1 mm	\$1.60
1.5 mm	1.80
3 mm	2.10
5 mm	2.60
6 mm	3.00
10 mm	3.70
13 mm	4.20
19 mm	5.80
25 mm	8.50
38 mm	16.60



KEYBOARD SALE

12 key keypad with single pin output, one common & 12 signals
Normally \$11.00. This month only **\$10.00 for 2**
16 key keypad with 4 x 4 matrix output.
Normally \$12.50. This month only **\$12.00 for 2**

ILP TOROIDAL TRANSFORMER

VA	PRICE	DUAL SECONDARY VOLTAGE
15	35.50	6 9 12 15 18 22 25 30 35 40 45 50 55
30	39.50	
50	45.50	
80	49.50	
120	54.00	
160	65.00	
225	74.00	
300	83.00	
500	115.00	
625	132.00	

(Made in UK)

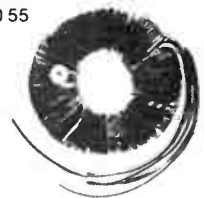

HI COM UNITRONICS

7 President Lane, Caringbah, NSW 2229
P.O. Box 626, Caringbah 2229
PHONE (02) 524 7878

Mail Order Postage
less than \$50 \$3.50
\$50-\$99 \$4.50
\$100-\$250 \$7.00
above \$250 \$10.00
Heavy items adds extra

Visa, Bankcard and Mastercard welcome.

SUBSCRIBE!

TO AUSTRALIA'S TOP ELECTRONICS JOURNAL

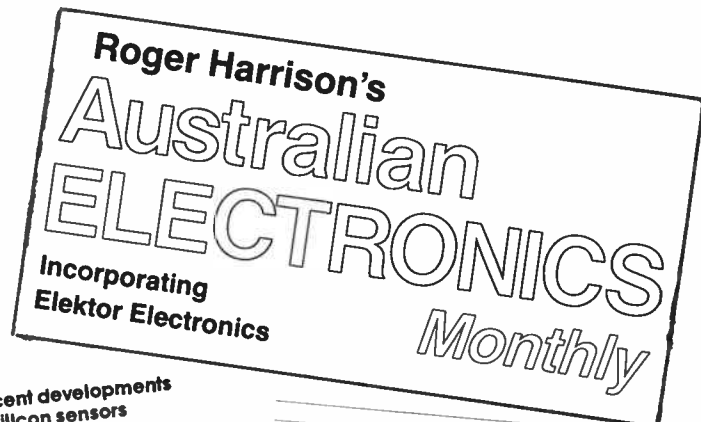

The ionosphere and radiowave propagation — an update
John Edmondson

So what's new in modems?
Andrew Fair

Recent developments in silicon sensors
J. Macdonald

Understanding 'switched-mode' power supplies
Roger Harrison

Consumer to win in the DAT versus CD battle
Dennis Lingane

The Marantz PM-94 'digital monitoring' amplifier
Robert Fittell

THE LATEST HIT PARADE

oem project 6005
A 100 watt 'ultra-fidelity' topology MOSFET amp module
David Wilson

Recent developments in silicon sensors
J. Macdonald

Understanding 'switched-mode' power supplies
Roger Harrison

Consumer to win in the DAT versus CD battle
Dennis Lingane

THE LATEST HIT PARADE

oem data sheet
EFG7515 CMOS SINGLE CHIP DPEX AND PEK MOD (BELL 102 - V22 A/1)

oem hi-fi review
The Marantz PM-94 'digital monitoring' amplifier
Robert Fittell

BLOCK DIAGRAM

FEATURES

DESCRIPTION

CONNECTIONS

TESTING

CONCLUSION

Australia's only independent technical electronics journal, providing a balanced coverage of the fields of audio, broadcasting, pro sound, video, communications, computing, engineering and technology.

For only \$49.95 for 12 issues, you get:

- **5 to 10 projects to build each month** — the best from our Australian designers and the cream from the British Elektor.
- **Monthly Project Buyers Guide** — each issue we detail where you can get the components featured in our projects as well as which firms are stocking kits of our projects.
- **Telephone technical enquiries** — yes, you can speak to the editorial team direct and have your queries answered. We don't live in an ivory tower!
- **Hi-Fi, sound and video news, reviews & features** — independent, professionally conducted reviews from Robert Fittell Acoustics; features from well-known writers like Dennis Lingane and Malcolm Goldfinch.
- **Practical computing articles** — a whole section each month devoted to electronics enthusiasts exploring computing and computing enthusiasts exploring electronics.
- **Communications coverage** — news, reviews and practical features on RF techniques and radio communications, covering everything from circuit techniques to cellular radio, from satellites to amateur radio.
- **Topical technical features** — covering consumer electronics, topical technological and scientific fields, current issues and circuit techniques.
- **What's new in the market** — occasional features on new products and developments, giving topical and informative coverage of specific fields and product groups.

You'll find something to interest you every month in Australian Electronics Monthly, no matter what your special interest might be. The magazine is "sectioned" into categories for easy reading and easy reference, each section headed by its own news column.

If you've found AEM hard to get in your newsagent, **DON'T DELAY, SUBSCRIBE TODAY!**

If you work in electronics, communications, computing or servicing, a subscription to Australian Electronics Monthly could be tax deductible.

COUPON

Yes! Put me down for a subscription to Australian Electronics Monthly at \$49.95 for 12 issues. I am paying by (please circle payment method):

Cheque (No:) _____

Money Order (No:) _____
(Cheques or Money Orders should be made out to 'Australian Electronics Monthly')

Bankcard Visa Mastercard Amex

Card No: _____ Expiry: _____

Signature: _____
(Note: unsigned credit card orders cannot be accepted)

Name: _____

Address: _____

Postcode: _____

THE ART OF SOUND

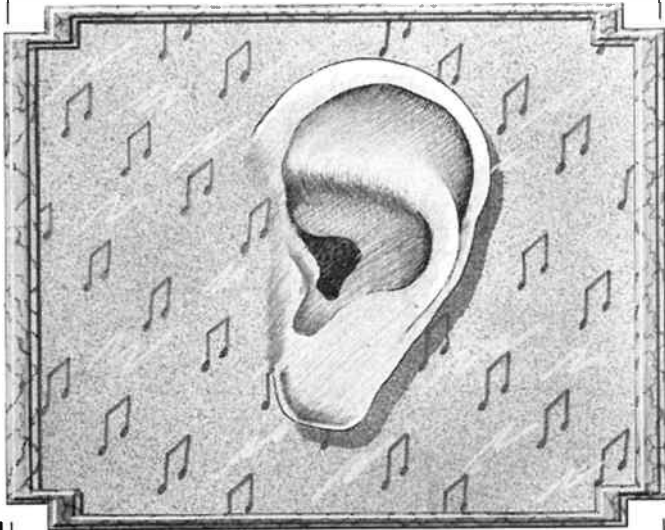

NOW IN STOCK!

**NEW YAMAHA DIGITAL MIXER
DMP-7**

**PHONE FOR DEMONSTRATION
264-9783**

**SOUND
ON
STAGE**

400 Kent St, Sydney. 264 9783.

208 Pyrmont Bridge Rd, Glebe. 660 4555.

5 Byres St, Newstead, Brisbane. (07) 52 9083.

ELECTRONIC WORLD

**THERE IS AN ALTERNATIVE FOR
THE ELECTRONIC HOBBYIST
COME TO**

**IAN J. TRUSCOTTS
ELECTRONIC
WORLD**

- * TEST GEAR
- * DATA BOOKS
- * FLUKE MULTIMETERS
- * AMIDON FERRITE PRODUCTS
- * HUGE RANGE OF ACTIVE AND PASSIVE COMPONENTS

WE ALSO SPECIALISE IN CORDLESS PHONES AND ANSWERING MACHINES

MAIL ORDER ENQUIRIES MOST WELCOME

WE GUARANTEE TO ACKNOWLEDGE EVERY ENQUIRY FOR MAIL ORDER

IAN J. TRUSCOTTS

**ELECTRONIC
WORLD**

CNR LACEY STREET AND
WINDSOR ROAD
CROYDON VICTORIA 3136
PHONE (03) 723 3860
(03) 723 3094

IPS GRAFEX PREDICTIONS TAKE THE GUESSWORK OUT OF HF RADIO FREQUENCY SELECTION

Grab a GRAFEX and, during any particular month, GRAFEX will recommend the best:

- *Times*
- *Frequency Bands*
- *Average radio wave elevation angles for radio wave propagation between any two places.*

From \$16 a year GRAFEX will improve your transmission and reception.

For further information and to order your GRAFEX predictions, please contact:

GRAFEX PREDICTIONS
Australian Government, Department of Science
IPS RADIO AND SPACE SERVICES

P.O. BOX 702
DARLINGHURST 2010
Telephone: (02) 269 8617



Name:

Address: Postcode:

THE MAC SYSTEM

An introduction into the characteristics of the television transmission format generally expected to become the follow-up of the by now technically outdated PAL and SECAM systems.

The curious thing about the new Multiplexed Analogue Components (MAC) TV format is that everybody seems to be waiting for everybody else to start doing something about it. Workers in laboratories of most broadcasting authorities have long since established that MAC is superior in nearly every respect to PAL, SECAM, and certainly NTSC; they laid down the target technical characteristics, and conducted many experiments to verify the performance of MAC in satellite links and cable networks. Why then is MAC not being used at present, when it is such a powerful standard? Answering this question is not easy, and requires considering some aspects not directly related to technical matters, our main concern here.

To begin with, there is the evolution of the MAC standard to study—see Fig. 1. From this it is immediately apparent that there is no single MAC standard, but a series of versions derived from the original A-MAC system, which, like I-PAL, never got out of the laboratory test phases. E (extended)-PAL, with the IBA as the main protagonist, was rejected by the Government's Advisory Panel in favour of D2-MAC four years ago. B-MAC was supported mainly by Plessey for use in TV studios and microwave links, but proved impossible to implement on TV satellites. C-MAC has three subsets, developed and supported by different authorities and satellite operators, who are, of course, keep on winning the general acceptance of their particular system. That a single MAC transmission format will be with us soon is very unlikely, however, considering that every system has its own merits for a given application, as will be seen further on. Of the three C-MAC subsets, D-MAC, the version optimized for cable networks using 10.5 MHz band-

width and AM VSB (vestigial sideband), can be disregarded in the coming discussion on who is to rule the airwaves. Although both C-MAC and E-CMAC (enhanced C-MAC) are claimed to be suitable for the future HDTV format and its BBC-supported derivative, DATV, there are other, important, considerations to this matter, and this will be reverted to in due course.

Waiting for MAC

Currently, the majority of satellite TV programmes are transmitted in PAL, using analogue FM and low-power transponders operating in the CSS band (10.9-11.7 GHz). The D2-MAC TV standard is only used for experimental transmissions by the NOS on the ECS-1 transponder

formerly used by Europa-TV, while the Swedish national TV programmes are transmitted in a version of C-MAC via Nordic-1 at OP 1°W.

Semiconductor manufacturers intent on producing MAC decoder chip sets are waiting for the DB satellites to come into operation, while transponder leaseholders are afraid to choose a particular MAC format simply because... chips and ready-made multistandard decoders are not yet available. So far, it seems that only ITT Semiconductors have managed to state the target specification of a D2-MAC decoder. The difficulties in getting the French, German, Luxemburgian and pan-European DB satellites in orbit, and transmitting (E)C-MAC and/or D2-MAC signals from these, have the doubtful benefit of allowing more time

for semiconductor manufacturers to spring into action and come up with competitive products, which are expected to become widely available once the first MAC signal is being beamed down. Until then, there is nothing but secrecy, preliminary specifications, and confusion on the part of cable network operators and individual viewers.

The shortcomings of PAL

In a standard PAL signal, the luminance and chrominance components are separated in the frequency domain—see Fig. 2a. The presence of the chrominance subcarrier in the transmitted spectrum gives rise to an overlap area with luminance components above some 2.5 MHz. The effect of this can be seen on any PAL compatible colour TV set as spurious cross-colour patterning on areas of fine detail in the picture, and is caused by the receiver's decoder circuits mistaking fast luminance (black-white) transitions for chrominance information. Also, sound-on-vision patterning and vision buzzing occur readily when the PAL TV receiver is not properly aligned, or when the transmitter produces intermodulation owing to non-linear operation or improper filtering.

Figure 2b is a simplified representation of the time structure of one of 625 lines in a PAL colour test signal. The duration of the line is 64 μ s, but of this only 52 μ s contains picture information, namely 8 colour bars. The remaining time (12 μ s) is the line blanking period, composed of the line sync pulse, front and rear porch, and the 4.43 MHz colour burst. A MAC picture is still made up of 625 lines, but the luminance (Y) and chrominance (U/V) components are separated in the time

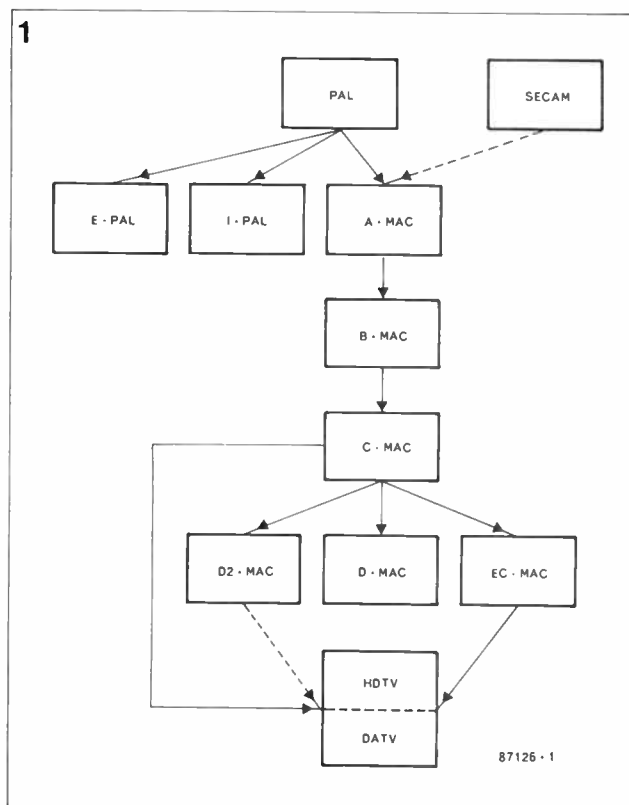

Fig. 1. Illustrating how the various TV transmission formats came into existence.

domain, i.e., transmitted sequentially within the available line time of $64 \mu\text{s}$. Figure 2d shows that the analogue Y and U/V components are extracted from the composite input signal, time compressed, and multiplexed together with a data burst, whence the acronym MAC. The process of time-compressing may be carried

out digitally or with analogue means (CCDs mainly), but both methods inevitably result in an increase in the bandwidth of the baseband signal. Consider, for instance, the Y component: in the PAL and D2-MAC signal it has a duration of 52 and $34 \mu\text{s}$ respectively. The compression rate is therefore $52:34 \approx 3:2$, and results in the frequency being

increased by a factor 0.5, since a shorter period is available for the same number of level transitions. Similarly, the colour difference signal, U/V, is compressed by a factor 3:1. The resulting time multiplexing scheme is shown in Fig. 2c. Note that the sound & data block is entirely digital, and transmitted in 2-4 PSK, a

modulation mode that will not be discussed here. Some lines in the D2-MAC picture are reserved for particular applications—see Fig. 3 and consult the technical specification in Table 1. The frame organization of an enhanced C-MAC (E-CMAC) picture is schematized in Fig. 4. E-CMAC has been developed specifically with

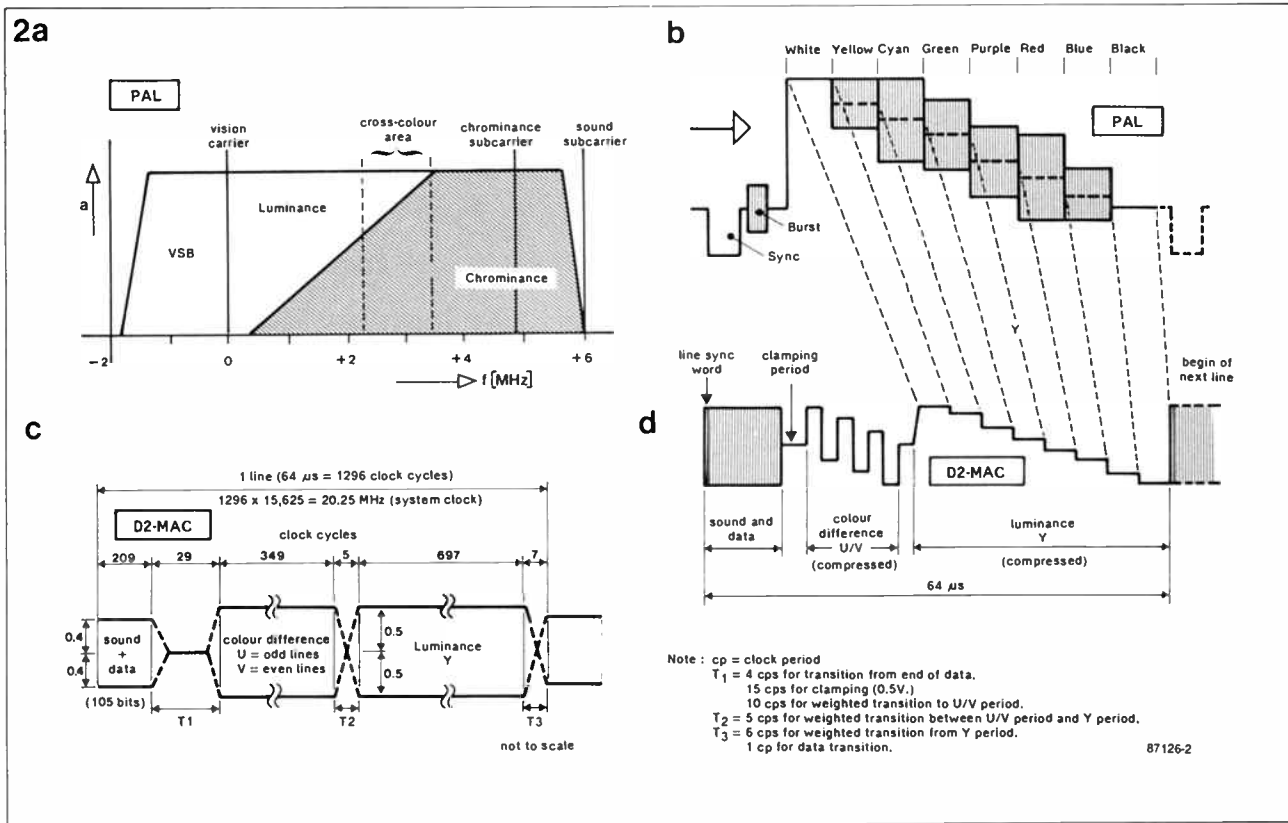

Fig. 2. Showing how the D2-MAC signal is given its basic time-division multiplex scheme.

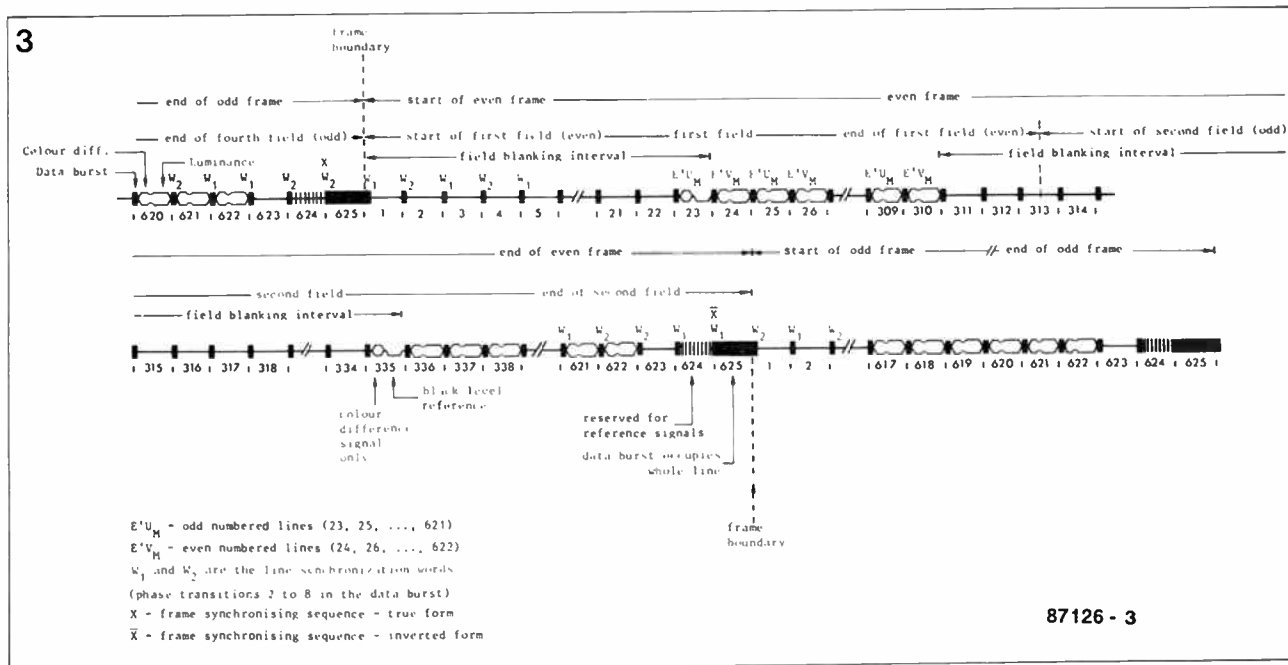

Fig.3. A MAC picture analyzed. Note the special function of lines 624 and 625 (courtesy EBU).

Table 1.

D2-MAC/Packet

D = version indication.
 2 = bit rate division factor with respect to C-MAC.
 MAC = Multiplexed Analogue Components.
 Packet = digital sound and data are transmitted as composite bursts.

Transmission multiplex characteristics:

- Duobinary coded, AM/VSB and FM compatible.
- Instantaneous bit rate during data burst halved with respect to C-MAC.
- Recommended deviation (FM): 13.5 MHz/V; pre-emphasis transition at 1.37 MHz; energy dispersal $f(d) = \frac{1}{2}f(V)$
 $\Delta f = \pm 300$ kHz
- Lines per picture: 625
- Lines with data burst: 1 to 625
- Lines with video signal: 24 to 310 and 336 to 622
- Lines with luminance signal: Y in each line
- Lines with chrominance signal: U in odd lines, V in even lines
- Interlace ratio: 2:1
- Aspect ratio: 4:3 (5.33:3)
- Luminance compression ratio: 3:2
- Chrominance compression ratio: 3:1
- Sampling clock frequency: 20.25 MHz
- Instantaneous bit rate of data burst (2-4 PSK): 10.125 Mbit/s
- Samples per line: 1296
- Chrominance samples: 349
- Luminance samples: 697
- Bits per data burst: 105 (6 bits HSW and 99 bits data)
- Line 624: 105 bits and analogue reference signals
- Line 625: 648 data bits
 - 6 for H sync
 - 32 for clock run-in
 - 64 for VSW
 - 546 for service identification

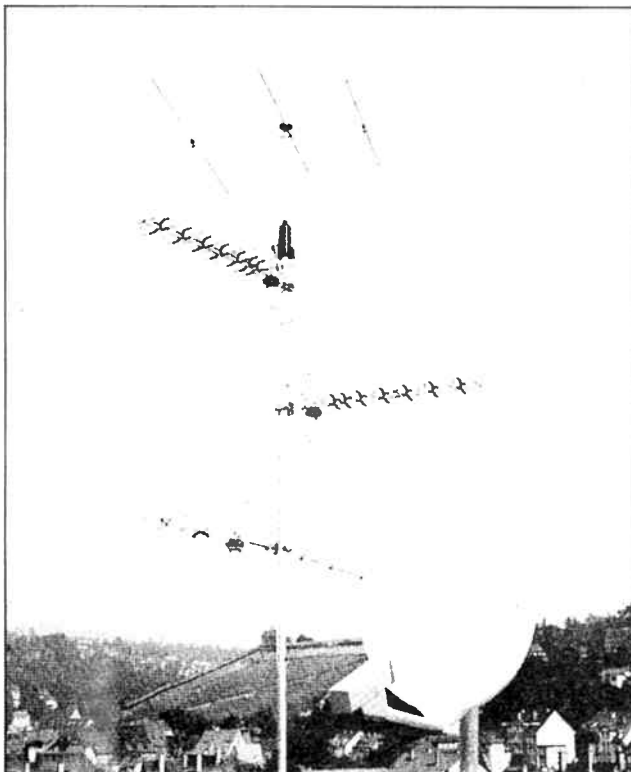

Aerials for terrestrial and satellite TV services.

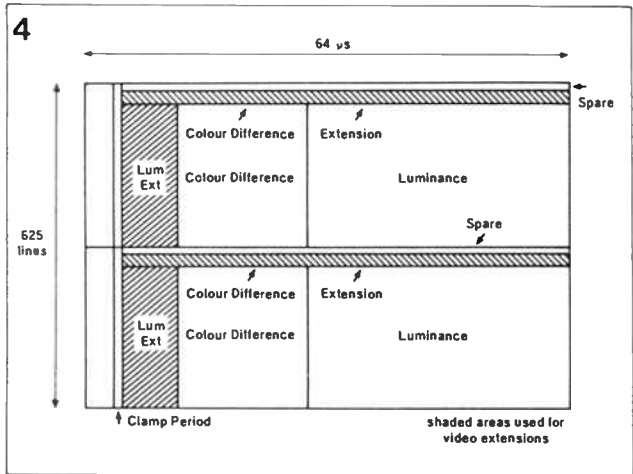

Fig. 4. A frame of E-CMAC, showing that the length of the sound/data burst is reduced to achieve a wide-screen picture, allowing extra luminance information to be carried (courtesy IBA).

HDTV-compatible DB services in mind, and is strongly propagated by the IBA in co-operation with the EBU.

MAC: some essential points

A discussion of all the technical characteristics of C-MAC, E-CMAC and D2-MAC is beyond the scope of this article, and interested readers are referred to the publications for further reading. A few basic considerations as to the composition of the signal will help in understanding the implications of an essentially digital transmission format. The discussions apply to both D2-MAC and C-MAC.

Synchronization. Each data burst contains one of two 6-bit line synchronization words (LSWs—see Fig. 3), which are defined as follows: $W_1 = 001011$, while $W_2 = W_1 = 110100$. The data processor in the MAC decoder keeps track of the samples in each line, and arranges for the appropriate circuitry in the TV set to be actuated when an LSW is recognized. The pattern of the LSWs at the frame boundaries (odd/even) also provides the interlace information. The data burst in line 625 contains a frame sync sequence which immediately follows the LSW and which is defined as four bytes 55_h followed by the 64-bits FSW $65AEF3153F41C246_h$. This is transmitted in its true form preceding even-numbered frames, and in its inverted form preceding odd-numbered frames.

Encryption. Whatever its version, MAC is inevitably tied up with viewers' fears of intricate encryption methods. The fact that picture components U/V and Y are separated in time rather than in frequency makes it possible to use two effective scrambling methods. One is defining so-called *cut points* whereby the U/V and Y components are cut into two segments, and transposed within the relevant period. To restore the signal to its intelligible form, the cut points (i.e., relative sample numbers) must be identified to reconstruct the time scheme shown in Fig. 2c. The cut points within the periods R_c and R_L are derived from a 16-bit pseudo-random sequence generator, whose validation key is only known in authorized receiver systems. The method illustrated in Fig. 5a is called *double cut component rotation* for now obvious reasons (note that the cut points shown are but examples). The second scrambling method available for MAC entails making the PSK data block unintelligible in the receiver. Bits can be processed as shown in Fig. 5b: a pseudo-random binary sequence is added modulo-2 to the digital sound and data stream, so that another authorization key is required for correct processing in the receiver. The data block enables satellite operators to implement not only pay-per-view systems, but also entitlement checking, multi-channel sound, selective Teletext, over-air addressing for automatic controlling of VCRs, and viewers' status registration.

Sound. Contrary to conventional sound transmission systems, the MAC format employs a fully digital, multiple-channel audio format. As already shown, no subcarriers are used: instead, the transmission is switched at RF from an FM signal to a 20.25 Mbit/s (C-MAC) or 10.125 Mbit/s (D2-MAC) 2-4 PSK modulated signal. The 99 data bits of lines 1 to 623 are combined into 82

packets of 751 bits, and interleaved at 94-bit intervals. A packet is thus a combination of sound and data, and consists of a 23-bit header, an 8-bit packet code to distinguish between two types of sound and data, and 720 bits of sound or data. A cyclic (23,12) error correcting Golay code is implemented in the header to ensure correct packet recognition when reception is impaired. C-MAC

and D2-MAC support 8 and 4 high quality sound channels respectively ($S/N \geq 80$ dB when $C/N \geq 18$ dB), but more can be carried when these are compressed (multi-language commentaries).

Compatibility. All versions of MAC are totally incompatible with PAL and SECAM. This means that foreseeably MAC-decoders are in essence

transcoding interfaces which perform all the functions discussed, and in addition process and stretch the compressed U/V and Y components to give the correct length and content for a PAL/SECAM TV set. Inevitably, however, there would be pressure on TV set manufacturers to come up with multistandard, that is, PAL - SECAM - D2-MAC - C-MAC - E-CMAC compatible, sets

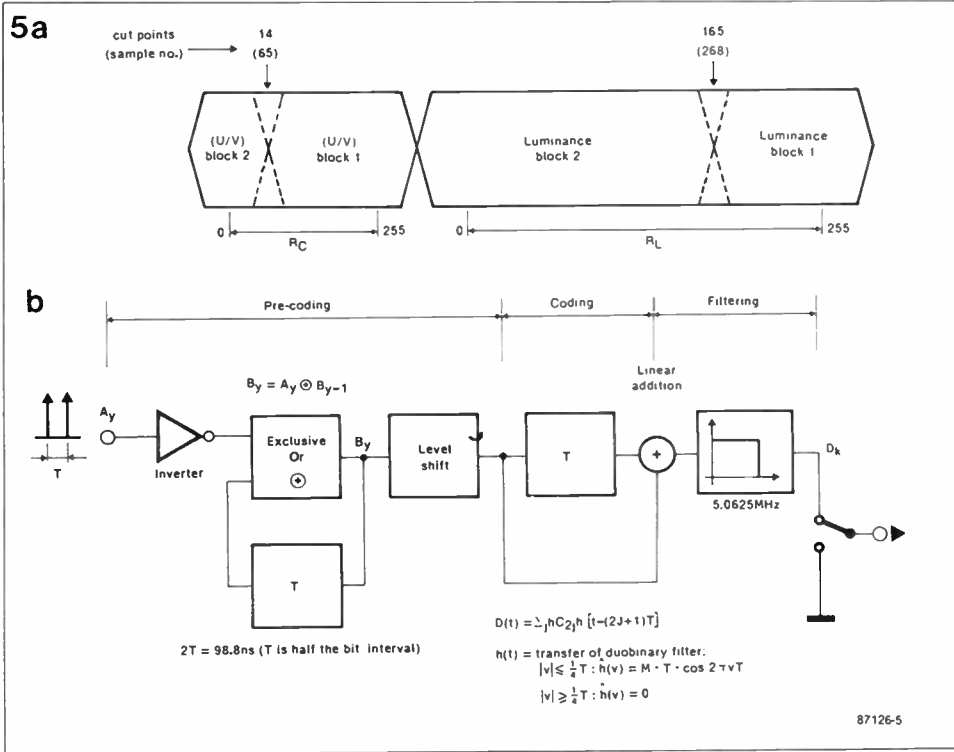

Fig. 5. Two methods of encoding a MAC signal: double-cut component rotation (a), and Boolean encryption of the data block (b).

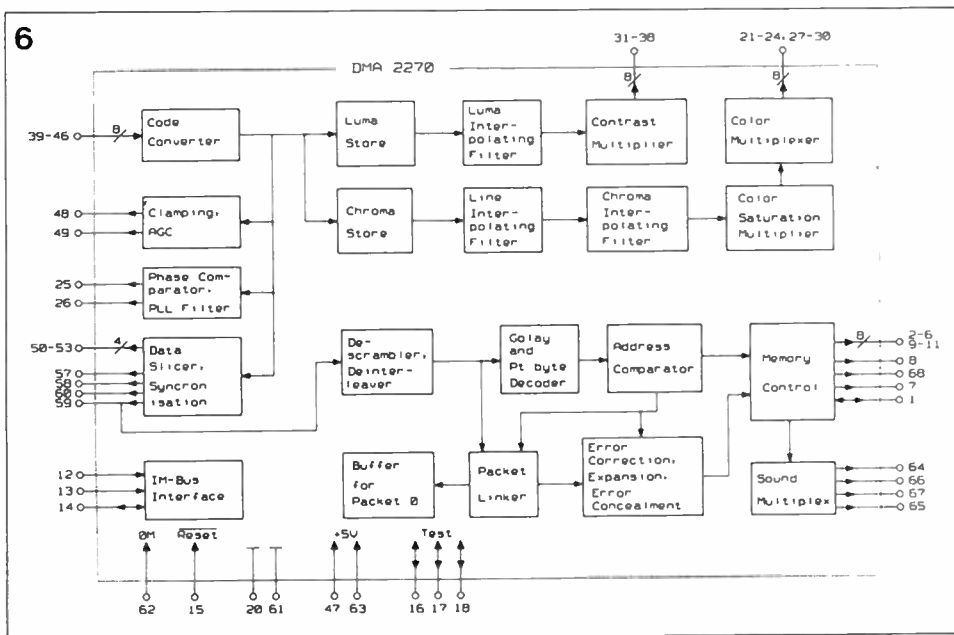

Fig. 6. Block diagram of the Type DMA2270 D2-MAC decoder (courtesy ITT Semiconductors).

Abbreviations and terms used in this article:

- AM = amplitude modulation.
- BBC = British Broadcasting Corporation.
- DBS = direct broadcasting satellite.
- DATV = digitally assisted television.
- EBU = European Broadcasting Union.
- CCD = charge-coupled device.
- CD = compact disc.
- CSS = communication service satellite.
- EIRP = effective isotropic radiated power.
- FM = frequency modulation.
- f (V) = vertical sync frequency (50 Hz).
- HDTV = high-definition television.
- IBA = Independent Broadcasting Authority.
- IARU = International Association of Radio Unions.
- IRT = Institut für Rundfunk-technik.
- NHK = Nippon Hoso Kyokai, the national Japanese broadcasting authority.
- NOS = Nederlandse Omroep Stichting, the national Dutch broadcasting authority.
- NTSC = National Television System Committee.
- OP = orbital position.
- PAL = phase alternation line.
- PSK = phase shift keying.
- QPSK = quadrature phase shift keying.
- RTL = Radio Television Luxembourg.
- SECAM = Séquentiel Couleur A Mémoire.
- SES = Société Européenne des Satellites.
- S/N = signal to noise ratio.
- VCR = video cassette recorder.
- VLSI = very large scale integration.
- U/V = quadrature components of the chrominance signal: $U = 0.49(B-Y)$ and $V = 0.88(R-Y)$.
- VSF = vestigial side band.
- Y = luminance signal.
- Δf = deviation from the RF carrier in an FM transmitter.

equipped with high quality audio processors also. The first steps towards proposing an all-digital TV receiver were those from ITT Semiconductor. The functional organization of their Type DMA2270 VLSI D2-MAC decoder appears in Fig. 6. A pity the device is not yet generally available!

Advantages over PAL. In conclusion of this section, a summary is given of the main advantages of MAC over PAL (and possibly SECAM and NTSC) systems:

- Excellent picture quality thanks to separate transmission of luminance and chrominance components. No cross-colour or cross-luminance effects.
- Ready driving of the decoder from the FM detector's baseband output.
- Less chrominance noise.
- Significantly improved S/N ratio at the same receiver input signal strength.
- Capacity for carrying 4 or 8 CD quality audio channels.
- Provision for additional digital services at 190 Kbit/s.
- Ready implementation of all-digital, highly secure, encryption systems without increasing the baseband bandwidth.
- Eminently suitable for incorporation in microprocessor based timing and remote control systems.

MACs, cables and satellites

The coexistence of C-MAC, D2-MAC, and E-CMAC is a result of research carried out in various broadcaster's laboratories. The comparison between these formats focuses on a few main themes as discussed below:

Cable networks: C-MAC has been optimized for satellite transmission, where the channel bandwidth is 27 MHz. This is generally not available in existing cable networks, which allow for a channel spacing of about 8 MHz. Reception of a standard C-MAC signal results in a compressed video bandwidth of about 8.5 MHz, interspersed with data bursts at 20.25 Mbit/s. If re-modulated into VSB AM, the bandwidth is still around 15 MHz, due

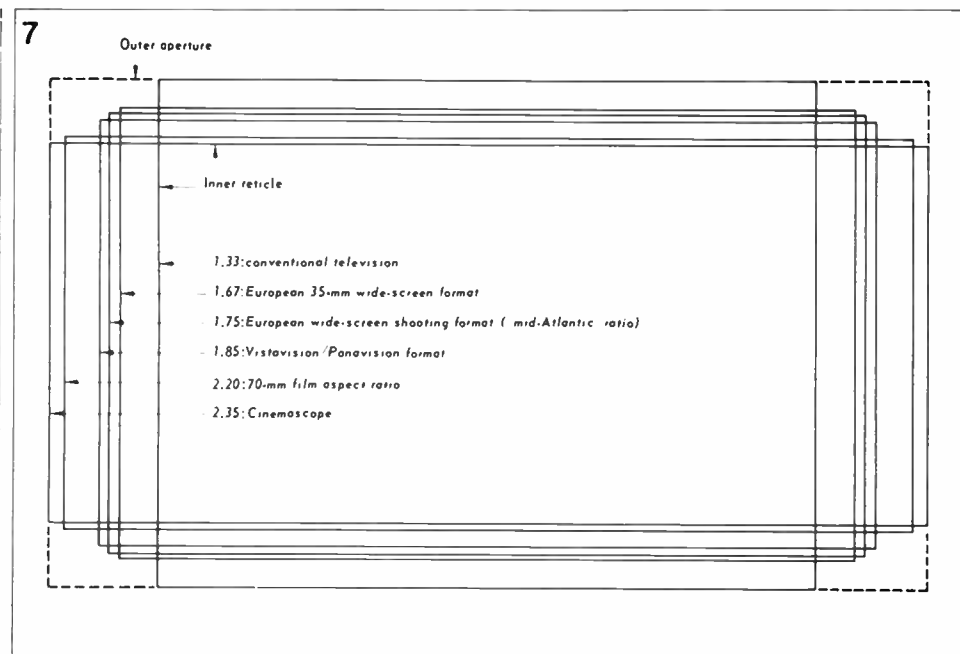

Fig. 7. Commonly used picture aspect ratios normalized to unit area (courtesy EBU).

largely to the sound/data burst. When the sound/data packet is recorded into duo-binary form, i.e., the data signal is at one of three levels, the 20.25 Mbit/s data stream can be conveyed within a bandwidth of about 8.5 MHz, which then equals the vision bandwidth. This enables the complete signal to fit within the available bandwidth on cable systems. The format so made is called D-MAC. D2-MAC is an even narrower signal that can be derived from D-MAC by halving the bit rate in the data burst. This format results in a baseband bandwidth of around 5.3 MHz, and can therefore be transcoded into VSB AM for use on cable networks where the channel spacing is not less than about 7 MHz. It should be noted here that transcoding always results in some degree of picture impairment, and is, of course, to be abandoned as soon as wideband cable systems and MAC compatible TV sets are available.

Satellites: Clearly the development of MAC formats was originally prompted by the need for good quality TV transmission via geostationary satellites. The EBU recommends the use of standard C-MAC on their future Olympus satellite, while the IBA proposes the E-CMAC format. The BBC is likely to agree upon using D2-MAC, just as the German and French DBS consortia. RTL on the SES-owned

Astra satellite are expected to keep using PAL until MAC decoders are available everywhere. Knowing that the BBC and IBA are likely to be assigned quite a few channels on Astra, this one satellite may well beam down TV signals in various formats once it is operative. Its transponder bandwidth should be sufficient for conveying all 16 programmes simultaneously without running into cross-channel interference.

MAC formats, HDTV and DATV

Although a separate discussion is undoubtedly required to describe the technical characteristics of the many formats already proposed for HDTV, it is

worth while to study the compatibility of this wide-screen format with the MAC systems described. Successful demonstrations of high-quality large screen pictures with an aspect ratio of about 5.33:3 based on an 1125-line standard proposed by NHK of Japan have given a new impulse to researchers engaged in developing a new wide screen standard, as a follow-up of the 4:3 aspect ratio currently dictated mainly by the size of colour picture tubes. Some of the most commonly used picture aspect ratios are shown in Fig. 7. The system proposed by NHK is called MUSE, and its main technical characteristics are summarized in Table 2. The question now arises which of the MAC transmission formats is most suitable

Table 2

Characteristics of the MUSE HDTV system

- System: Motion-compensated multiple subsampling; multiplexing of colour signal by time-compression and integration.
- Scanning: 1125 lines, 60 fields/s, 2:1 interlace.
- Baseband bandwidth: 8.1 MHz (−6 dB)
- Re-sampling clock rate: 16.2 MHz
- Horizontal bandwidth: Y: 20-22 MHz for stationary picture portions; 12 MHz for moving portions.
C: 7.0 MHz for stationary picture portions; 3.1 MHz for moving portions.
- Synchronisation: positive digital sync.
- Audio and additional information: PCM multiplexed in vertical blanking interval using 4-state DPSK at 2048 Kbit/s

for conveying HDTV and higher aspect ratio pictures via satellite. Although all systems have been tested in this respect and found to be compatible to some extent, the E-CMAC format developed by the IBA looks particularly promising, since it is claimed to be able to provide pictures of aspect ratio and resolution comparable to those of the NHK proposals. This is mainly thanks to E-CMAC making very efficient use of the available time for the sound & data packet, at the expense of a few audio channels. The sampling rate is 27 MHz, while the

video bandwidth of an E-CMAC signal is about 12 MHz, bearing in mind that the picture is composed of 625 lines, and that the uncompressed sampling frequency is 22.5 MHz. Research has shown that E-CMAC 5:3 pictures can be transmitted using conventional DBS channels in the 12 GHz band. The reduced sound/data capacity with respect to C-MAC is still sufficient to convey 2 high quality sound channels. A high degree of compatibility with standard MAC receivers is ensured by virtue of the proportions of left and right extension of the pic-

ture being signalled in line 625, the service identification line. The IBA claims that the quality of an E-CMAC picture approaches that of HDTV systems using around 1,000 lines, without the need to resort to a new and incompatible standard. Enhanced C-MAC pictures were demonstrated at the Royal Television Society Convention in Cambridge during September 1985, and were shown to press and industry representatives at the IBA's Brompton Road headquarters in December of that year. The transmission of true



The BBC's satellite test station at Kingswood Warren.

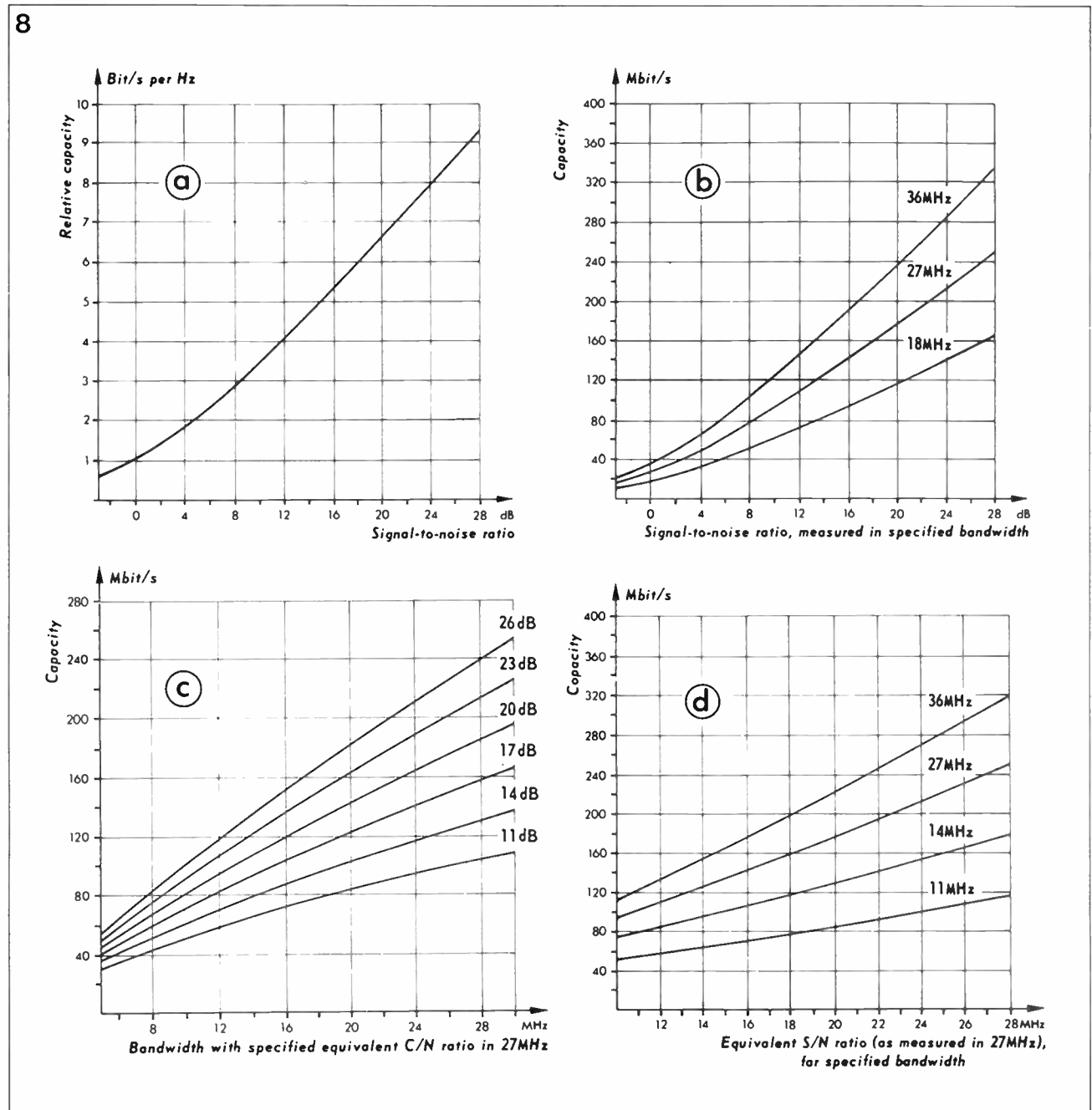

Fig. 8. Shannon's theoretical channel capacity as a function of four parameters. Note that 27 and 36 MHz are the most commonly used bandwidths for satellite TV, and that C/N=11 dB is roughly the FM threshold (courtesy EBU).

1125-line HDTV pictures by satellite poses problems, however. The reason for this is that the unprocessed HDTV baseband signal from the TV studio is likely to require a bandwidth of about 40 MHz, which equals a bit-rate will over 600 Mbit/s if transmitted digitally. The following considerations will show that this exceeds the capacity of the currently used 12 GHz band, because the required data compression ratio of about 10:1 is as yet technically impossible.

Shannon has defined the maximum bit rate (capacity), D , achievable in a communication link with bandwidth B as

$$D = B \log_2(1 + C/N) \text{ bit/s}$$

where C/N is the carrier to noise ratio expressed in dB. Figure 8 shows the capacity of the channel in relation to various parameters. Although some researchers have reached within a few dBs of the theoretical Shannon limit, this is only at low bit-rates using substantial processing in the receiver. With the sort of bit-rate required for HDTV it will be difficult, if not impossible, to approach half the Shannon bound. Two examples may be considered to illustrate the foreseeable difficulty in transmitting an all-digital HDTV signal:

$B = 30$ MHz and $C/N_0 = 94.3$ dB:
 $D \approx 195$ Mbit/s

$B = 19.18$ MHz and
 $C/N_0 = 94.3$ dB: $D = 125$ Mbit/s

C/N_0 is the noise spectral density expressed in dB/Hz, and can be shown to equal a C/N ratio of 20 dB in 27 MHz. Assum-

ing that half the capacities D can be achieved, the limit is between 60 and 100 Mbit/s depending on the maximum foreseen degree of interference.

QPSK signals have been shown to enable transmissions at about 34 Mbit/s, while a relatively simple extension to 8-PSK should allow 51 Mbit/s to be achieved. This may be adequate for HDTV if 3:1 bandwidth reduction is applied in analogue systems, and 10:1 bit-rate reduction (compression) in all-digital systems. In any case, the resulting bandwidth is still far beyond the capacity of the existing DBS band, where channels are allocated with a regular 19.18 MHz spacing, and where the RF bandwidth of transponders should not exceed about 35 MHz to ensure acceptable levels of interference. Conclusion: 1125 line, all-digital HDTV is currently impossible to implement in the 12 GHz DBS band, and already experiments have been conducted to assess the propagation and attenuation characteristics of higher bands allocated to DB services, i.e., 23, 42 and 85 GHz. The results obtained by HDTV researchers T Long and L Stenger are valid for the average European temperature climate, and appear in Table 3. Note that the stated bands are not available in all IARU regions in the world. Based on these data, calculations have been made as regards downlink budgets and satellite EIRP figures. Depending on the assumptions made for the bandwidth, receiver aerial diameter, and minimum figure of merit, the radiated power is foreseeably of the order of 750 to 1,500 W per

channel in the 23 GHz band, and between 12 and 25 kW for the 42 GHz channels. Evidently, regulating action is required from broadcasting authorities to timely avoid allocating too narrow channels for the 40 to 50 MHz wide HDTV services. Unfortunately, the international frequency planning timetable is such as to make HDTV on 23 GHz impossible before the beginning of the next century. The BBC has recently proposed the concept of DATV, whose main advantage is found in the very effective bandwidth reduction of HDTV signals originating from TV studios. Using DATV it becomes possible to operate bandwidth reduction procedures at the studio level, and arrange for the receiver to be instructed continuously, via the data channel, on the organization of particular parts in the picture. The importance of DATV is that it enables a significant improvement to be achieved in the quality HDTV pictures that can be conveyed in relatively narrow DBS channels, thus efficiently using the available spectrum space. DATV is fully MAC compatible, and can be used to give an aspect ratio of 16:9 with slightly higher horizontal resolution than C-MAC. Like the MUSE system, it can make use of so-called *motion vectors* to effect high spatial resolution in picture areas of predictable motion.

Conclusions

Although the first MAC signals will almost certainly be transmitted within a year or so, there is no certainty as yet on the preferred format for the various services. In this context, it is hoped that semiconductor manufacturers will provide multistandard MAC decoder chips based on design information from the research and engineering departments of the various broadcasting authorities mentioned. As to the future of HDTV, the main concern of researchers in this field will be further studies into baseband compression, strong bit-rate reduction, and ways of improving and enlarging existing frame store devices. The IRT in co-operation with the EBU has planned field trials

with HDTV for this and next year using experimentally operated transponders in the Olympus and Kopernikus satellites. Bu

For further reading:

1) *Specification of the systems of the MAC/Packet family*. Document Tech. 3258, available from the EBU Technical Centre ■ Avenue Albert Lancaster 32 ■ B-1180 Brussels ■ Belgium. The price is BF 2,000 including postage.

2) IBA Technical Review no. 21: *Compatible Higher Definition Television*. Available from the Independent Broadcasting Authority ■ Engineering Information Service ■ IBA Crawley Court ■ Winchester ■ Hampshire SO21 2QA.

3) *EBU Review (technical) no. 219* (special issue on HDTV). For availability see 1).

Table 3

Attenuation and cross-polarization for different frequency bands.

Frequency (GHz)	12		23**		42**		85*	
Percentage of worst month (1%)	99	99.9	99	99.9	99	99.9	99	99.9
Attenuation (dB)	1.5	4.5	4.5	13.5	11.6	35	19	57
Cross-polarization (dB)	30	20	25	15	24	13	—	—
Sky temperature (K)	85		200		270		—	

* The values given are not precise; cross-polarization data for 85-GHz are not available.

** Cross-polarization due to ice crystals is still a largely unknown phenomenon and care needs to be taken when considering the re-use of these frequencies by means of orthogonal polarization.

AEM and Elektor pc boards to be widely available

Arrangements have been made, or are currently being completed, with a range of retailers around Australia to make AEM and Elektor-in-AEM pc boards widely available over the counter and via mail order.

Retailers in New South Wales, Queensland, Victoria and South Australia are cooperating with the magazine and pc board manufacturers to make and distribute a wide range of the pc boards for the projects published in past and current issues of the magazine.

Prime pc board supplier is Jemal in Perth, W.A. They are represented by All Electronic Components in Melbourne and Queensland, who will be supplying wholesale to retailers in those two states.

All Electronic Components in Lonsdale St, Melbourne has agreed to stock the majority of boards published. Truscott's Electronic World in the outer eastern suburb of Croydon in Melbourne can source hobbyists' requirements either over the counter or on order.

In Brisbane, Fred Hoe & Sons at 246 Evans Rd, Salisbury (07)277 4311 may supply a limited range, or obtain boards on order.

In Sydney, Hi-Com Unitronics in Caringbah (524 7878) is already sourcing a range of boards for both AEM and Elektor-in-AEM projects, and plans to expand his range. Geoff Wood Electronics in Lane Cove (427 1676) is able to supply boards to order. Jaycar sources boards, for the AEM projects they carry, through Jemal.

In Adelaide, Force Electronics is gearing-up to supply both AEM and Elektor-in-AEM boards, both over the counter and by mail order. Force has five stores in the Adelaide area. Over in Unley, Eagle Electronics can supply a small range of AEM boards, particularly for the popular audio and computer add-on projects.

Retailers wishing to stock AEM and Elektor-in-AEM pc boards should contact the Pub-

lisher/Editor, Roger Harrison on (02)487 1207. RCS Radio in Bexley and Acetronics in Bass Hill, Sydney, have not joined in these arrangements for reasons of their own.

Boards for NZ enthusiasts

For the New Zealand enthusiast, pc boards for projects published in AEM are being manufactured by Mini Tech Manufacturing Ltd in Auckland, who have been in the business of making pc boards for quite a few years now.

To check availability and price, you should contact Mini Tech at PO Box 9194, Auckland. Phone 542-598.



Wetailer wound up about wonderful windings

All Electronic Components in Melbourne has quite a bargain at the moment in a useful little mains transformer from Arlec.

The tranny in question has two secondaries, one delivering 9 V at 5 A (!), the other 24 V at 500 mA. They're about the size

PROJECT BUYERS GUIDE

This month's Star Project, the Economy Stereo Amp, is available from Dick Smith Electronics in both short-form and as a complete kit. See your local Dick Smith Electronics store.

Jaycar Electronics will be stocking both the AEM6012 Balanced Mic. Preamp and the AEM3505 Packet Radio Modem for the Commodore 64. Jaycar has five stores in Sydney and two in Melbourne.

Geoff Wood Electronics at Lane Cove in Sydney can supply a bag of bits for the AEM3505 Packet Radio Modem project. Geoff also has the appropriate connectors in stock, along with a variety of cases you may choose from.

The AEM2000, as you are probably already aware, is stocked by Force Electronics in Adelaide, and kits are now available off the shelf.

Components for all the circuits in this month's Elektor section are, in general, widely available from many electronics retailers. The few exceptions would be the TL272 op-amp used in several circuits, the C64 edge connectors specified for the Commodore Communications project, and the LF357 specified for the Compressor.

The TLC272 op-amp is obtainable from Hi-Com Unitronics in Sydney, who maintain stocks for several Elektor projects. The C64 connectors are obtainable from Geoff Wood Electronics in Lane Cove, Sydney, and Jaycar stores in both Sydney and Melbourne.

The LF357 op-amp should be available through Active Wholesale in Melbourne and Geoff Wood Electronics in Sydney.

of the popular 6672 and can be snapped up for just \$5.00!

Wing over to All Electronic Components, 118 Lonsdale St, Melbourne 3000 Vic. (03)662 3506.

Hi-Com Unitronics are located at 7 President Lane, Caringbah 2229 NSW. (02)524 7878.

Ace's cases

Ace Electronics has introduced a new line of instrument cases for 1987. Made by Hammond, the cases are available in both diecast metal and heavy-duty ABS plastic.

Prices range from \$3.43 for the smallest plastic case to only \$13.95 for the largest diecast model.

Ace Electronics are at 10B/3 Kenneth Rd, Manly Vale 2093 NSW. (02) 949 4871.



for the electronics and computing professional

DP Education (Books)

P O BOX 380, AVALON NSW 2107
Ph: (02) 997 1611

"I've got MS – but I'm still smiling"

Like most people with MS, my symptoms are mild. They come and go, but in between, I'm fine.

Some people with MS are more disabled than I am. They need the activity therapy centres, the nursing homes and the many other services which MS Societies provide. For their sakes, keep up your donations.

MS

For more information about multiple sclerosis, contact the MS Society in your state.

Handheld case

Sydney retailer, Hi-Com Unitronics, stocks a great little handheld instrument case that's just the thing for portable instruments.

It features a cutout at the top of the front panel that suits common 3½-digit and 4-digit LCD displays, a cutout on the left hand side to take a slide switch and a battery compartment in the rear with slide-off cover to suit a 9 V No. 216 (transistor radio) battery.

The case is in two halves and secures with four screws at the rear. Internally, the 'back' features three pc board supports to take small PK screws.



A true 'laboratory standard' 0-55V, 10A max. output power supply

Part 4 Gerald Reiter

Here's where we get to putting the whole thing together.

REGARDLESS of whether the parts have been purchased individually or as a kit, they should all be laid out to check if everything is there. Also make sure that you have all the hardware and other necessities like screws nuts, wires, solder, thermal compound, washers, spacers etc.

Several different varieties of hookup wire are required, designated as follows, with the necessary lengths shown in brackets:

Multi-colored rainbow cable (0.6 m) – MCRC.

Figure 8 speaker cable, 14 x 0.2 mm (1.0 m), grey with one wire marked by a black stripe – FIG 8.

Heavy duty cable, 24 x 0.2 mm, (2.5 m), any color – HDC

Ultra heavy duty, 32 x 0.2 mm, (1.5 m), any color – UHDC

Plus 3.5 metres of 1.25 mm insulated copper wire, 5.0 metres of 0.4 mm insulated copper wire and 1.0 metre of ordinary thin hookup wire.

I recommend to use a temperature controlled soldering iron, such as the Weller with exchangeable tips for different temperatures and heat capacities.

Some mechanical work on the box will be necessary. Identify and drill the required holes, then put the whole box together and check if everything fits properly. Do not tighten any of the screws as the whole box will be dismantled again.

I recommend you file the rear holes in the side panels into slots as this will assist in removing and fitting the rear panel at various stages of assembly. (Drawing 1). Small slots for the banana socket locating spigots need to be filed in the appropriate holes, also. Cut two large square holes on the back panel (for airflow). Then the two heatsinks should be drilled and checked against the back plate.

If the box is obtained from Force Electronics, the front and back panels as well as the bottom plate are completely pre punched and the black anodised front comes with silk screen printing. Force also supplies the 9 x 20 mm ferrite cores pre-cut.

The small aluminum box can be prepared next. (See Drawings 2 and 3). After all the holes are drilled, check for alignment with the back panel of the box. It is advisable to drill a number of holes for airflow on the cover of the small aluminum box. About six to 10 holes of around 7 mm diameter on each side and on the top will suffice.

The blank boards end-piece boards for the switched-mode section should be fitted into the aluminum box; drill the mounting holes first, then secure these boards – copper side out – with short 10 mm screws. These boards must be

mounted hard against the box end panels so that the cant move. The securing nuts, which are on the inside, should be soldered on to the boards. (Drawing 3).

Now the holes for the feedthrough capacitors can be drilled. With the small boards still installed drill the holes to suit the diameter of feedthroughs. Remove the boards and enlarge these holes in the aluminum box to clear the feedthroughs.

At all times when drilling, it is advisable to make sure that all holes are deburred and all shavings cleaned out and removed.

The feedthroughs can now be soldered in place. A reasonably high temperature iron is needed for this. However, care must be taken not to 'cook' the board to prevent the copper lifting. Check the fit of the boards against the aluminum box, making sure that the insulated centre pins on the feedthroughs do not make contact with the box.

Take board B and solder C35 and C45 in place. Screw the small board with the five feedthroughs into the aluminum box. Then place board B against this board and make sure that C35/C45 have at least 3 mm clearance between the bottom of the box and that it is aligned to the centre. (Drawing 4). Then solder board B against the small board.

Now the potentiometer and switch shafts should be shortened to suit the knobs used. If you're not sure, cut all shafts to a length of 13 mm. This should cater for most knobs.

Next, the brackets required for boards A and E, two for each, should be made as per Drawing 5.

The Schadow switches can be assembled now. There are two different panel-mount halves to be identified. The pushbutton has an "on" indicator inside it. It is important that this button is put on the right way as it is very hard to get it off once its been pushed onto the switch assembly. See Drawing 6. The half marked "O" goes to the top, and the half marked "U" goes to the bottom. While fitting the upper half, secure the little plastic pin from the pushbutton into the groove of the upper half and test the indicator by toggling the pushbutton. Screw one of the nuts over this assembly.

Bottom plate assembly

Now dismantle the Horwood box completely and start with the assembly of the bottom plate. First fit the 0.05R resistor (R73). There are two ways of fitting this resistor. You can use two short (about 8 mm) self-tapping screws or drill the holes to 3 mm diameter and fit the resistor with 3 mm diameter screws and nuts. It is advisable to put some thermal compound between the resistor and the chassis.

Solder a 170 mm length of FIG8 wire to this resistor's lugs, putting the wires between the lug eyelets and the body as per Drawing 7 (viewed from the front panel edge of the bottom plate). The wire with the black stripe goes to the right. Then solder a 30 mm length of UHDC wire to the left lug's eyelet. This wire should have about 4 mm of insulation removed at each end.

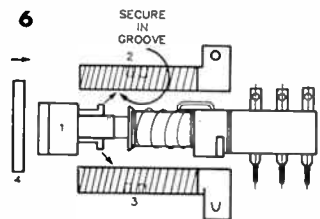
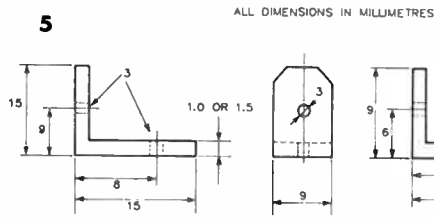
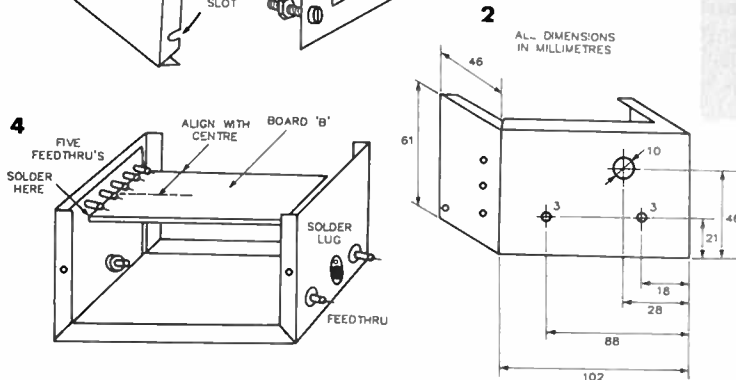
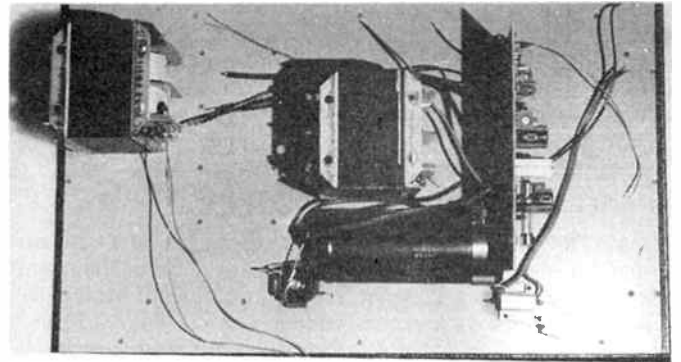
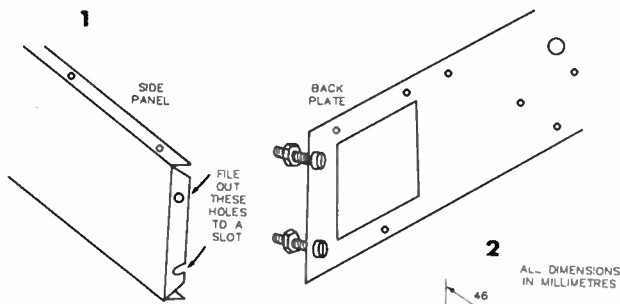

ALL DIMENSIONS IN MILLIMETRES

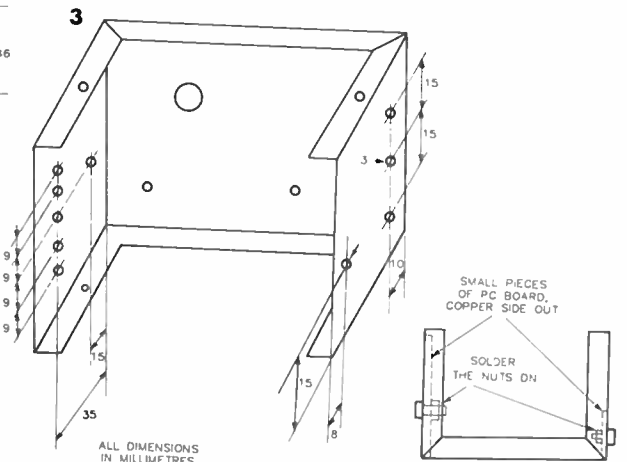

ALL DIMENSIONS IN MILLIMETRES

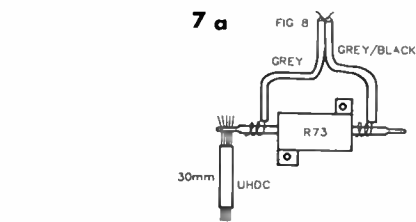

ALL DIMENSIONS IN MILLIMETRES

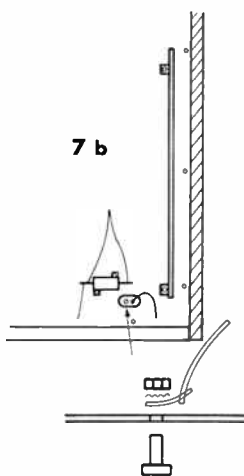

A hole is located adjacent to this resistor, towards the front panel edge of the bottom plate. It's for the unit chassis earth connection. Clean the paint around this hole with emery paper so that good contact can be made with the earth lug to be fitted. Fit the earth lug, using a spring-washer beneath the nut.

The 10 000 uF main supply reservoir capacitor (C6) is fitted to the bottom plate next. First, the bracket supplied with this capacitor must be modified as per Drawing 8. Fit the capacitor to the bracket but do not over tighten as this may damage the capacitor.

Fit the assembly loosely to the bottom plate and then fit board C to the bracket, making sure that the small cutout on the edge fits over the bracket. (Drawing 9). Move the bracket to the right and make sure that the board is snugly between the bracket and the nut, then tighten the bracket to the chassis. I

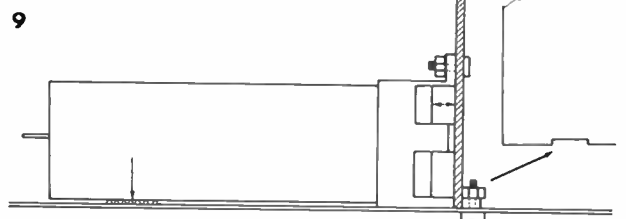
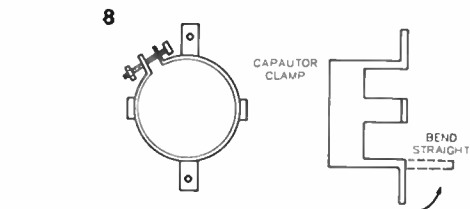

recommend you put some Silastic under the capacitor as indicated in Drawing 9. Make sure that none of the tracks of board C are shorted by the bracket.

Now the bridge rectifier can be fitted. First clean the surface around the rectifier's mounting hole with some emery paper, then smear some thermal compound on the underside of the bridge and screw it into position with a 10 x 3 mm bolt and nut. Then solder capacitors C8 to C11 (10n/630 V) to the bridge. Short lengths of insulated HDC are used to connect C6 to the terminals of the bridge. The pc board can now be removed.

Mount the three transformers next, orientating them with their 240 Vac connections to the rear. I recommend you put some industrial rubber under all transformers as the bottom plate is made of steel and this reduces mechanical hum which

would be produced by the transformers if directly mounted. The thickness of the rubber I used was 1.5 mm. However, thicker rubber could be used, but you must be careful as T2 may touch the fuse holder on the rear panel, which sits directly above the transformer.

Wire the 32 V secondaries of T1 and T2 in series and to the ac terminals of the bridge using HDC wire.

The front panel

Mount the 240 V Schadow switch, then the two ten-turn potentiometers, followed by all the banana sockets, the panel meter and the two LEDs (red for the current limit indicator). Use two nuts on each potentiometer, one on the inside and one on the outside. Do not install the remote sensor switch and the two rotary switches. Install the output connectors and their solder lugs.

Solder the components shown in Drawing 12 in place next, but slip some spaghetti over R99/C81 beforehand. The leads of C79 and C80 must be as short as practicable. Solder four wires 80 mm in length (normal thin hookup wire) to the sensor connectors, as shown. (Drawing 12).

Screw the two side panels to the front via the handles and make sure that the sides are the right way up as the holes will not match otherwise. As this will be the final assembly tighten the screws properly.

Final box assembly

Attach the bottom plate with the three self-tapping screws to the front and use only one screw per side for the meantime (do not tighten them too much as they will be removed several times).

Solder the blank wire from the earth connection (near R73) to the GND banana socket. solder the short wire from the left side of R73 to the negative power output socket. Do not connect this wire to the internal sensor connection. Connect the primary of T3 to T2 and connect the primary of T2 to T1, using HDC. Referring to Drawing 13, solder a 240 mm length of HDC between the 240 V Schadow switch (SW1) and T2 (L), solder a 320 mm length of HDC to the second connection at SW1. Last of all solder a 120 mm wire to T2 (N), as shown.

Clean the paint from around the hole next to T3 and fit solder lug using a 10 x 3 mm bolt and nut. Attach a 120 mm length of HDC to this lug. These cables will be cut shorter at a later stage. Insulate any loose wires from the secondary of T3 and T2. This is only temporary for testing purposes.

The external sensor Schadow switch and the rotary switches can be fitted now. On the rotary switches it is recommended to use two nuts and also bend the location pin to fit the location hole. Referring to Drawing 14, solder R90/C75 to the right side of SW4, R91/C76 to the left and then solder the wires from the sensor terminals to the switch, as shown.

Install the fuseholder and the 240 V IEC line socket on the rear panel now. If you haven't already done so, assemble board D, remembering to solder the 1M resistors to the track side of the board. Mount the board to the rear panel, between the fuseholder and the IEC input socket. Use a 6 mm and a 9 mm spacer (4.5 mm dia.), as shown in Drawing 15. Wire-up board D as per Drawing 16.

Now we come to the inter-wiring of the pc boards. The tables here indicate where the wires come FROM, what position at each pc board the holes are, the colors and lengths of the wires. The single rows indicate one wire only. Also, some of the wires' colours are not indicated as the colours may not be available. You can choose whatever's available. None of these boards must be wired to each other at this stage as each will be tested individually before final assembly. The "TO"

indicates only for clarity where the wires go and will be used in the final assembly.

Take the right number of cables from the rainbow cable as indicated and cut to length as required. The left overs are also used, to save cable. All the ends of any wire shorter than 150 mm should be stripped to about 4 mm. The longer wires may be shortened later on to fit neatly.

The indicators: v ^ < > >> << have the following meanings:

- v – below xx
- ^ – above xx
- < – left of xx
- > – right of xx
- >><< – between xx

Note that, if the boards are viewed from the component side, then the < and > have to be reversed. Also, you should use a generous amount of solder on any board where heavy current flows.

Wiring of Board A

Board viewed from solder side, L13/L12/L11 at the bottom.

FROM	Position at board	color	Length	TO
E/014-E/015-L12	P48	85 mm UHDC	P73
L10	v L13	450 mm UHDC	positive out
F83	C70	brown	3	FV13/1
F77	P63 P70	red	450 mm	RV13/2
F78	C70 +	orange	MCPC	RV13/3
F73/C6B+	C19	yellow	2 x	FV7/1
F54/C64	P54/C64	green	400 mm	FV7/2
PV4/PV5/PV6	v PV4	blue	MCRC	RV7/3
D10 emitter	v D10	purple	2 x	LED3/cathode
F29	v D10	gray	330 mm MCPC	LED3/anode
F73/C6B+	P67/C19	white	2 x	M1 / +
PV14	> PV14	black	410 mm MCPC	M1 / -
PV10	RV10 (top)	brown	4 x	SW2/a 1
PV11	RV10 (mid)	red	280 mm	SW2/a 2
R66/R72	RV10 R67	orange	MCRC	SW2/a 3
D17 emitter	P81	yellow	2 x	SW2/a 0
P51	v P51	brown	4 x	SW2/c 1
P58	v P58	red	210 mm	SW2/c 2
R60	v R60	orange	MCRC	SW2/c 3
P50/ZD3	P50	yellow	2 x	SW2/c 0
P67	> ZD9 / P67	green	2 x	SW2/b 0
FV8	PV8 P7C	blue	250 mm MCPC	SW2/b 3
P81/P82	>P81 P82	green	2 x	SW3/a 2
P84	> P84	blue	150 mm MCPC	SW3/b 2
P94/R95	> P95	brown	2 x	SW3/b 3
P94/P96	P96	red	90 mm MCPC	SW3/a 3
P87/P89	P85	purple	FIGB	SW4/b 0
P85/P88	P87 / LED5	gray	140 mm/MCPC	SW4/a 0
P85/P86	P85 P86	gray	80 mm MCPC	SW3/a 1
L11	v L11	180 mm/UHDC	C48/C54
L12	v L12	180 mm/UHDC	C49/C54
L13	L13 / R62	160 mm/UHDC	D12 Emitter
C50+	C59	160 mm/UHDC	D12 Collector
O11 collector	P52	gray	160 mm/FIGB	O12 Base
D1/D3	v D1/D3	purple	3 x	T1 BV AC
C12/C13	>>C12/C13	gray	340 mm	T1 center BV
D2/D4	v D2/D4	white	MCRC	T1 BV AC
P40	v R40	bl/gray	120 mm/FIGB	D5/C31 board C
L13	^ L13	yellow	150 mm/MCPC	R29 board C

The rainbow cable should have 15 wires, from black to yellow. Remove a strip from black to purple inclusive (8 wires). This will be use for the digital panel meter (board F). Remove the next wires in pairs: gray/white, black/brown, red/orange – and cut 250 mm off the black/brown wire to use for the external meter input at R95/R96.

Connect black to R95, brown to R96 on board "A", the rest of the wires will be used on board "C". ▶

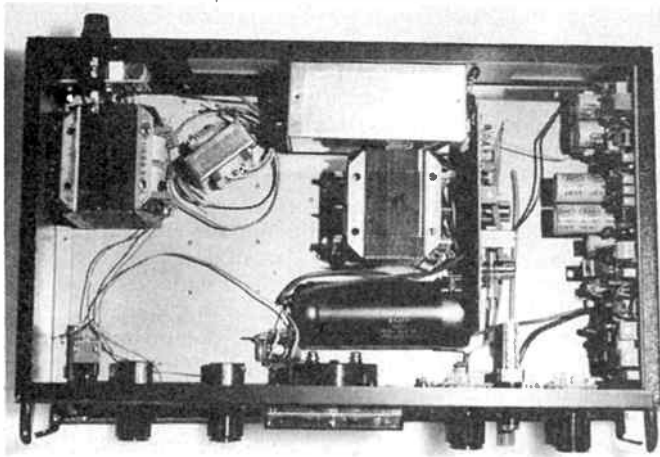

20

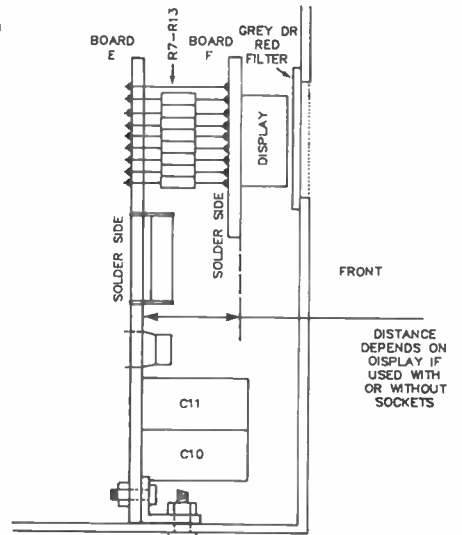

10

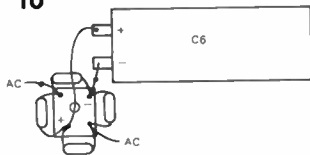

12

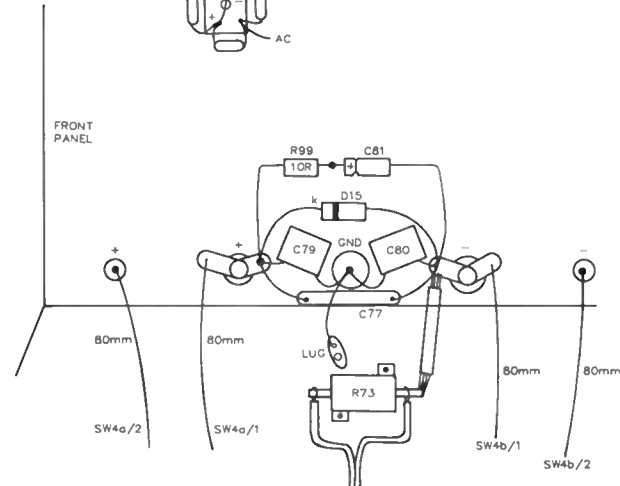

11

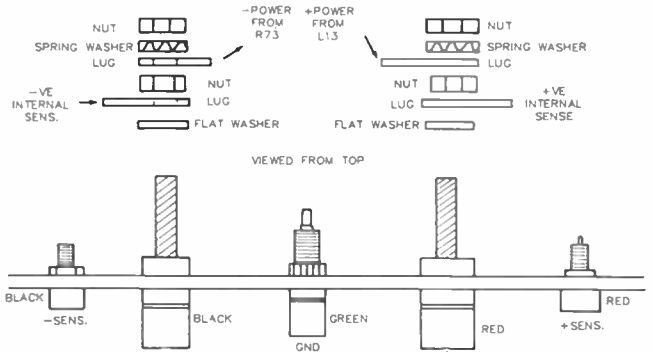

14

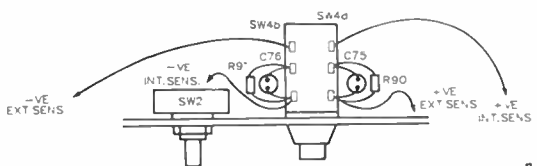

13

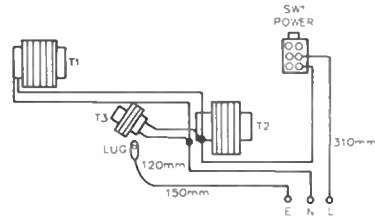

15

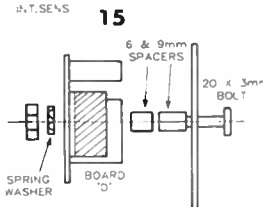

17

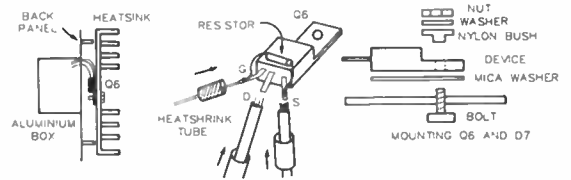

18

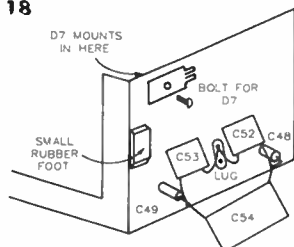

16

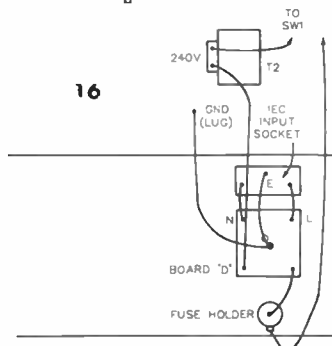

19

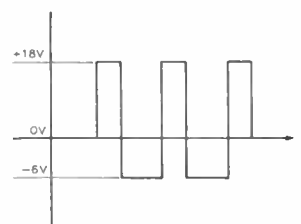

Wiring board C

All wires are soldered on the track side, except the two wires from board "A". Table 2 here is your guide. View the board with the fuse at the left hand bottom.

FIG8	Position at board	Color	Length	TO
Fuse "B"	Fuse	165 mm/UHDC	C16 positive
Fuse "B1"	Fuse	240 mm/UHDC	C26 board b
D6/23/24/25/1	D6 @ C25	gray	240 mm/FIG8	C25 board b
R6/R5	5 mm v. from FC	185 mm/UHDC	C16 negative
R6/R4/24/25/1	5 mm v. from FC	200 mm/UHDC	C28 board b
C20/R3/21/1	R4 @ C20	bicolor	150 mm/FIG8	T1/T2 center 32V
R100/21/21/1	R10	gray	110 mm/FIG8	C29 board b
Output collector "B"	OB @ C20	bicolor	200 mm/FIG8	C27 board b
LED	LED, anode	gray	75 mm /FIG8	C48 board b
A1 F	110 x 150mm	black brown	2 x 150mm	LED1 a LED1 b
A1 D5/1	110 x 150mm	red orange	2 x 140mm	T2 BV AC T2 BV AC
FIG8/11/11/1	Fuse	gray	2 x 220mm	T1 11V AC T2 12V AC
D6/23/24/25/1	D6	white		

Now for board B

First, screw the aluminum box to the back panel, put some thermal compound between the box and back panel so the box has good thermal contact. Also make sure that the two screws are tight and use spring washers to make good electrical contact.

Fit the power FET, Q6, to the heatsink. As its gate can be damaged by high voltage static it is advisable to take the same precautions as with CMOS. Before wiring the FET, I recommend you solder a 1M resistor between its source and gate leads. (See Drawing 17). Then solder 80 mm of UHDC to the source and drain, and 100 mm of grey FIG8 to the gate. Slip some heatshrink over the wires at the FET. Mount the heatsink to the back panel while feeding the wires from the FET through the hole of the aluminium box. Make sure there is no short between the FET's metal tag and the heatsink.

The small board with the two feedthroughs should now be installed in the aluminium box; use a spring washer and a solder lug on the outside. Board "B" can be placed into position. Cut the wires from the FET as short as possible to reach the designated holes and remove about 4 mm of the insulation at the ends. To do this board "B" must be removed again. After having prepared the wires for the FET, install Board "B" properly and tighten the screw: use a spring washer. Solder the wires of the FET onto the board from the component side.

The wires from feedthroughs C25 to C29 can be soldered in place now. Use five short wires (40 mm) and solder to them each capacitor. Slip a ferrite bead over each wire and push it all the way against the feedthroughs. Use the shortest possible route for C28 (A1) and C26 (B1). All these wires are soldered to the track side of the board. Solder all the other wires to their destinations.

The wire from the feedthrough C48 should be a UHDC and is soldered to the track side of the board at L9. The wire from C49 should also be a UHDC and is soldered through the hole near L10 on the board.

The diode D7 is now installed on the end of the aluminium box. Bend over the anode lead to reach the board and solder it near the negative side of C45. If it is too short, extend it with a length of UHDC. The cathode of D7 should be wired via a length of UHDC to L8 (source of Q6) on the track side of this board. Keep this lead as short as possible. Before soldering it to the board, slip a piece of spaghetti over the wire towards the diode.

Capacitors C52, C53, C54 can now be soldered on the outside of the box as per Drawing 18. A small rubber foot can be

stuck on to the corner as shown. This prevents board C from touching the box. Screw the lid on the box, making sure no wires are jammed or that screws are jamming the wires.

The board should now be tested for shorts. Connect one probe of your multimeter to the chassis of the box. Switch to the highest ohms range and connect the other probe in turn to the seven feedthroughs. There must be no reading, other than a short kick from the capacitors charging.

Q12 should now be fitted to the smaller heatsink, afterwards checking there is no short between its tag and the heatsink. Do not mount the heatsink to the back panel at this stage.

After checking board A thoroughly, fit the brackets to the component side. The FIG8 leads from R73 should be soldered to it first before screwing it down to the bottom plate. It may also be advisable here to stick a small rubber foot against the side cover so that the board can never touch it.

Now fit all the wires to the switches, pots, meter, LED, T1, positive output, and so on. If you follow the list from the Table 1 from top to bottom you should have no problems.

It does not matter which section you designate a,b,c,d on the rotary switches, as long as the positions 1-2-3 are coordinated from left to right when viewed from the front. If you're not sure, take a multimeter to test the connections.

Insulate the black/grey wire from R40 and the yellow wire from above L13. There should be four more loose wires left, two UHDC and a twin black/brown rainbow cable for the external meter. This rainbow cable should be insulated for the time being. All the wires going to the front panels should be routed along the right side panel to avoid hum and noise pickup. Route wires to T1 along the rear of the chassis.

Now wire up the 240 V IEC socket from the back plate as shown in Drawing 16. The wires should be long enough that the back panel can lay behind the power supply whenever it's undone. Insulate the socket, filter and fuse temporarily with wide insulation tape so it can't be touched accidentally. Put a 1 A fuse into the 240 V fuse holder. Solder the wires to Q12 and let the heatsink hang over the side cover or keep it out of the way so the wires do not touch anything.

Checking the linear section

While testing and aligning this section, be careful not to short circuit or touch any of the 240 V wiring or terminations, the 10 000uF capacitor. The latter will charge to about 95 V and it is also dangerous to touch! Whenever the unit is switched off, this capacitor should be discharged with a 5 W resistor of 10-100 ohms. Do not discharge it with a screwdriver as this may turn your screwdriver into molten metal, apart from damaging the capacitor as they are not made for such high discharge currents. It may be advisable while making test, to solder a 10k 5W resistor across this capacitor so it will always discharge should you forget.

Before starting, double check everything and make sure it looks all OK. Set the switches and trimpots as follows:

- SW1 – off
- SW2 – left (100 mA)
- SW3 – left (volts)
- SW4 – off
- RV2/RV3/RV9 – fully right
- RV4/RV5/RV6/RV8/RV10/RV11 – fully left
- RV12/RV14 – mid range
- RV7 (current limit), RV13 (volts adj.) – mid

If you're using a mains-operated oscilloscope or a multimeter, make sure that the test probes are insulated from the mains earth.

You will need a power supply with an output of 14-16 V at 2A, with a current limit facility. The current limit should be

set to about 1.5 A. Connect the negative terminal to the UHDC from L12 and connect the positive terminal via a 10R resistor to the UHDC from L11. Switch on the power from the external power supply and monitor the current, which should be smaller than 5 mA after the input capacitors have charged.

Now plug in the 240 V mains cable into the rear panel of the 2000 power supply and switch on the power at SW1. The current from the external supply should not be higher than 65 mA. None of the ICs should get hot. The red current LED may light up. If smoke appears and the current is excessive, switch everything off and check for the possible cause. If everything seems OK, remove the 10R resistor and complete the connection.

Connect the negative end of a digital meter input to the negative output terminal at the front of the AEM2000 and the positive terminal to D11 cathode. The meter should read some negative voltage at this point. Turn RV3 to the left until this voltage is about 2-3 V positive. The red LED may go off. Remove the meter from D11 and connect it to the positive terminal on the front panel. Adjust RV12 so M1 reads zero. Now adjust RV13 (voltage set.) to 10 V at the digital meter. If you can't get any voltage, or no change, with RV13 there may be something wrong. If so, switch off and trace the fault.

Put a 100R, 2 W resistor across the output of the AEM2000. The voltage may drop from the preset 10 V to some low value. Don't worry about this, set RV7 (current set) fully to the left and adjust RV3 so panel meter reads about 2-10 mA. Turn RV7 fully to the right and adjust RV4 so M1 reads approximately 100 mA. If it only goes to 70 or 80 mA, do not worry. The voltage at the output should now be 10 V again, unless the voltage setting has been disturbed. Adjust RV10 so M1 reads exactly 100 mA. Remove the 100R resistor and check if meter M1 still reads zero. If not, readjust RV12 to set M1 to zero. Turn RV4 all the way to the left. The voltage should still read 10 V. Connect a 10R, 5 W resistor to the output terminal; the voltage may drop. Adjust RV4 so M1 reads a little over 100 mA (say, 105 mA). Turn RV2 to the left so the red LED is off, and turn slowly back until the LED goes back on, and leave it there.

Turn SW2 to 1 A. The voltage at the output may still be low. Turn RV5 all the way to the right. Adjust RV11 until the meter reads 1 A and turn RV13 one turn to the right, then adjust RV5 so M1 reads a little over 1 A. Set RV13 back to 10 V and switch SW2 to the 10 A position. Set RV8 so M1 reads approximately 1 A. Now check the Current operation by turning RV7 fully to the left. The current should almost go to zero. (RV3 controls the lower range). This should be working also on the 1 A and 100 mA range.

This now completes the preliminary adjustment from the linear section. Switch everything off and discharge C16. Disconnect the 240V mains cable. Disconnect the other power supply and put some insulation over the loose wires (from L12, L11). Disconnect Q12 and insulate the wires.

If anything does not work, then switch everything off and look for the cause. To help in pinpointing any problems the PC-board has to be unscrewed and the side panel removed. Refit the pc board and trace the fault.

Force Electronics has a service available where the whole unit or individual pc boards can be tested, repaired and aligned.

The heatsink with Q12 should be installed to the back panel now.

Testing the Switchmode section

Make sure that everything looks OK on board C, then screw it onto the bracket at C16. Check that C16 is completely discharged and wire everything except the lines to boards A and B. Follow Table 2 for the wiring. IMPORTANT: RV1 must be

turned fully to the right. Remove the fuse on board C. Slip some spaghetti over the wires which go to board B so that they can't accidentally short to anything.

To test this board, an oscilloscope should be used. However, if no oscilloscope is available an analogue multimeter with an ac range will do. All measurements are taken from the line A1 against any other point.

Switch the power on. The voltages measured should be as follows:

C30+:	about 38 V, positive.
C34+:	17-19 V, positive.
C39-:	5.8-6.3 V, negative.
C16+:	90-100 V, positive.

The voltage measured between \pm at C32 should be 14 to 18 V. The square wave at collector Q8 should be approximately as per Drawing 19. If an oscilloscope is not available, use the analogue meter on the ac range and connect to the collector via a capacitor of about 100n. This should read about 4-10 Vac, depending on frequency response of the meter used. If all is OK, switch everything off and discharge C16. disconnect the 240 V cable from the mains.

Connect all the wires from board C to the aluminum box (board B), except the wire from LED2 and the wire from Q8 collector (H); keep these wires insulated. Solder a 470R, 1/2 W resistor across the solder side of the fuse. Solder a 10k, 1 W resistor across C54.

Now switch the power on. Make sure RV1 is turned fully to the right. The 470R resistor may get slightly warm, but must not blow up! Measure the voltage at the output of the aluminum box (C54), negative at the bottom, positive on top. This should read between 0 V and max. 3 V. If not, check for possible faults. If it's OK switch off the power and discharge C16.

Connect the wire from Q8 collector to C27 at the aluminum box. Switch on the power and measure the voltage at C54. This should be about 40 to 65 V. If this checks out OK, switch the power off, discharge C16 and remove the 470R resistor behind the fuseholder and the 10k resistor at C54. You may also remove the resistor across C16, if installed. Refit the fuse in the fuseholder (it's a 3A slow-blow type).

Now wire the remaining unconnected wires; black/grey from board A, R40 to D5/C31, and the yellow from board A, L13 to R29.

The back panel can now be installed. Remove the screws from one of the side panels, and if you have cut the slots into the side panels as previously suggested, then screws and nuts can be fitted to the rear panel first, so you can slide the side panels into place.

Remove all the insulation you have previously fitted, unless you want to leave it there so that nothing can touch the transformers. Tighten the screws properly, turn the unit upside down and fit all the small self-tapping screws. Check that there is at least 3 mm clearance between any 240 V connections and the transformer T2.

Now these following wires can be connected:

UHDC from L12 to C49 on the aluminum box (bottom).

UHDC from L11 to C48 on the aluminum box (top).

Grey cable from LED2 to C48.

Three wires to Q12 (slip some spaghetti over these wires before soldering and push towards Q12).

MCRC (black/brown) to external meter input sockets.

Also, the wires from the 240 V section can be shortened and neatly fitted.

Check everything again visually and make sure no wires are jammed or shorted. Also, check that no metal parts are rolling ▶

around (stray screws, nuts, etc). Test with an ohmmeter if there are any leakages between the \pm terminals and the chassis. There should be none; the meter should only register some small 'kick' from the capacitors charging. If there is any leakage, trace the problem.

Switch SW2 to 100 mA and turn RV7 (current control) to the mid position. Turn RV13 (voltage control) all the way to the left. Connect a Multimeter at the \pm output and switch power on. If all is well, nothing should happen, no smoke no fire – GOOD NEWS!

If the voltage control is turned to the right, the multimeter at the output should indicate some voltage and should be adjustable from 0 to 55 V. Switch the power off.

Now the digital meter can be tested and calibrated.

The digital meter

Turn RV1/1 and RV2/1 fully to the left and short the input (this is R3/1) to analogue GND. Viewing the board from the track side, locate R3/1 and connect the right hand side of R3/1 to pin 1 of IC3/1. Extend the 8 Vac wires from T2 to about 400 mm and insulate the joint. Take board E and connect it to the ac input via a 10R, 1 W resistor. Switch on the power. The ac voltage across the 10R resistor should not be higher than 0.8 Vdc. If it's OK, switch the power off and fit board F to board E. The distance between the boards will be different if you use sockets for the displays, rather than soldering them in. To align this, fit the brackets to board E. With some wires and resistors soldered to board F (the wires should be longer than needed), fit it onto board E. See Drawing 20.

You can align this properly by fitting board E into the box, the slide board F into position and solder a few of the wires at board E. Remove the boards again and solder all 16 connections between the boards. Make sure that power is disconnected while doing this fitting and discharge C16. Now, with the 10R resistor still in series at the 8 Vac line, switch the power back on.

The display should show all zeros with the \pm changing; it may flicker a bit and the numbers may be jumping. The voltage at the 10R resistor should be 2 to 3 Vac. The resistor can now be removed and the wire directly connected. Switch power off while soldering. Power on again; the meter should be very stable at zero with \pm changing only.

If this checks OK the rainbow cable designated for the meter can be installed. Also, the extension between T2 and the digital meter can be removed. Remove the short at R3/1 and fit a 300 mm length of shielded cable (center to R3/1).

After installing the digital meter, the final alignment can be tackled.

Final alignment

Set SW2 to 100 mA and SW3 to V; SW4 must be off (no orange indicator) RV7 to mid position. It is important that a good quality digital multimeter is used for calibration. This meter should have 3½ digit accuracy, or better, and a current range to at least one or two amps.

Put a bridge between GND and minus at the power supply output. Connect the digital multimeter to the \pm terminals at the output. Set RV13 (voltage control) to get 15.00 V on the multimeter, then adjust RV2/1 at board E so the internal meter also reads 15.00 V. Set the voltage to 25 V (on the multimeter) and adjust RV1/1 so the internal meter also reads 25.0 V. Go slowly back with the voltage control and check that the autorange changes at exactly 18.0 V to 17.99 V. You may have to repeat the adjustments a few times while monitoring the external meter. It may be hard to get the adjustment spot on,

but a 0.02 error in 19.99 V is only 0.1%, so if you get within 0.1 V in 19.99 V, you are still within 0.5% accuracy.

If you are satisfied with the internal meter calibration, the rest can now be calibrated.

Remove the positive cable from the external meter; this should be done every time when changing range from voltage to current, or a different current range. From now on, for the sake of clarity, I will call the internal digital meter IDM, and the external digital meter XDM and the panel meter M1. Take note: when the IDM is reading current, the minus sign is displayed.

Turn the voltage control to zero and adjust RV9 so the IDM reads zero. Adjust the voltage to 15.00 V. Switch SW3 to A, and with SW2 still at 100 mA, adjust RV12 so the IDM reads zero. Adjust the voltage to 5.00 V. Set the XDM to current (200 mA) and connect the positive probe to the output. Adjust RV7 so the XDM reads exactly 100 mA.

If any of these currents can't be reached, turn any of the corresponding preset trimmers to the right. These are for the max. current limit range.

100 mA – RV4

1.000 A – RV5

10.00 A – RV6

Adjust RV10 so the IDM reads exactly -100 mA, RV14 so M1 reads exactly 100 mA. Now turn RV7 all the way to the left and adjust the minimum current with RV3 so the IDM reads -1 to -2 mA. Remove the XDM, set the range to 2 A, and reconnect. Turn SW2 to 1 A turn the RV7 (current control) to the right until the XDM reads 1.000 A. Adjust RV11 so the IDM reads 1.000 A (M1 should also read 1 A).

Turn the current control fully to the left. Change SW2 to 10 A and turn RV7 slowly back to the right – you can turn the current to the maximum reading permitted on the XDM, up to 10 A, if possible. Whatever the maximum, set RV8 so the IDM reads the same as the XDM. Remove the XDM.

Now that all the current ranges are calibrated we can set the maximum current on each range. First turn RV4/RV5/RV6 all the way to the left. Turn the current control all the way to the left and connect approximately one metre of speaker cable across the output. Turn SW2 to 100 mA and turn the current control all the way to the right (this may not reach 100 mA). Now turn RV4 so the IDM reads 105 mA.

Turn the current control all the way to the left. Turn SW2 to 1 A and turn RV7 all the way to the right (this may not reach 1 A). Turn RV5 so the IDM reads 1.050 A. Turn the current control all the way to the left. Switch SW2 to 10 A and turn RV7 all the way to the right (it may not reach 10 A). Turn RV6 so the IDM reads 10.50 A.

Remove the wire and set SW2 to 100 mA and SW3 to V. Adjust the voltage to 10 V. Connect a 100R, 1 W or 5 W resistor to the output terminals and adjust RV7 to 80 mA at M1. Turn the voltage control slowly back until the current reads 76 mA and adjust RV2 so that LED3 just lights up.

The last adjustment is the power limit. With RV1 set fully right, the power limit is about 80 W, fully left it's about 130 W. The best way to adjust this would be with a 2R, 100 W resistor as a load, but such are hard to get. Two 12 V, 50 W car headlamps will do the job.

Set the supply to 12 V and read current with the lamps connected. Calculate the power. Set RV1 so LED1 comes on at 100 W load. 🐭

OPEN FOR BUSINESS: Monday to Friday 8.30 am to 5.00 pm.
Saturday Morning 8.30 am to NOON.

A.C.E. RADIO

ELECTRONICS CENTRE

ESTABLISHED OVER THIRTY YEARS

10B/3 Kenneth Road, Manly Vale 2093

Phone: (02) 949 4871

ETONE SPEAKER SPECIALS

38 cm (15 inch) WOOFERS

Model	Size	Cone Type	V Coil	Reson Hz	Freq Hz	Watts RMS	Price Each	2 for
4180	38cm	14-Pi	8 or 15 Ohms	30	70-2500	100	\$104.95 ea.	\$209.90
4310	38cm	Straight surround	8 or 15 Ohms	45	40-6000	60	\$100.00 ea.	\$200.00
4570	38cm	Straight surround	8 or 15 Ohms	45	40-6000	100	\$150.00 ea.	\$300.00
4360	38cm	14-Pi	8 or 15 Ohms	30	30-4000	100	\$127.50 ea.	\$255.00

Pack and Post for 1 speaker NSW/VIC \$4.75 Q.T. \$13.50 NT/WA \$17.50 SA \$11.30
Pack and Post for 2 speakers NSW/VIC \$11.00 Q.T. \$23.00 NT/WA \$30.00 SA \$16.00

ETONE 50 WATT RMS

A PAIR FOR \$60.95 OR \$34.95 EACH

RUGGED TOP QUALITY HI-FI WOOFER 30cm 8 ohms
• 90 DAYS FACTORY WARRANTY • FOAM POLY SURROUND
• STURDY SUSPENSION FOR RICH REPRODUCTION • 3.5cm VOICE COIL • FERRITE MAGNET • FREQ RESPONSE 35-4500Hz
RESONANCE 35Hz

P & P for 1 Speaker NSW \$4.80 VIC \$5.20 TAS \$6.25 WA/NT \$7.95 QLD/SA \$5.80
P & P for 2 Speakers NSW \$5.30 VIC \$7.20 TAS \$9.35 WA/NT \$11.45 QLD/SA \$8.20

POLYPROPYLENE CONE TOP QUALITY HI-FI WOOFERS

50mm Voice Coil — Foam Poly Surround —
Sturdy Suspension — Filled Molded Gabarit —
Ferrite Magnet — 90 days factory warranty

Model	Size	Reson Hz	Freq Hz	Watts RMS	Price Ea. (incl. P & P)
12-POL-12"	12"	30-4000	45	80	\$47.50
12-POL-12"	12"	30-4000	50	80	\$49.95
6-POL-6"	6"	45-6000	57	27	\$36.95

P & P for 1 Speaker NSW \$4.80 VIC \$5.20 TAS \$6.25 WA/NT \$7.95 QLD/SA \$5.80
P & P for 2 Speakers NSW \$5.30 VIC \$7.20 TAS \$9.35 WA/NT \$11.45 QLD/SA \$8.20

5" Polypropylene Mid-Range Speaker to suit above Woofers P.O.A.

NEW FOR '87 CONVENIENT DISKETTE FILES

Includes Lock + 2 keys

Features

- Capacity: 50 pcs 3-1/2" diskette
- High impact plastic lid and base
- Easy access handle for opening and carrying

\$28.95 ea.

P & P \$2.00

Features

- Double row display filing systems
- Protective racks for diskette separation
- Smoked PS plastic cover with lock
- High impact plastic lid and base
- Easy access handle for opening and carrying
- One hundred disk capacity 3-1/2" disk

\$26.95 ea.

★ ★ PROFESSIONAL VIDEO UNITS ★ ★

BRAND NEW IN CARTONS

14inch GREEN SCREEN MONITOR
COMPOSITE VIDEO INPUT

Cabinet & Fully Adjustable Swivel Tilt Base
All metal construction, fully shielded.

PRICE \$180.00 EA
LIMITED STOCK

FREIGHT P.O.A.

Internal regulated power supply 12V/5VDC output with sufficient capacity to supply up to 2 disk drives & also power your computer



12" Professional VDUs

Brand new in Cartons
Composite video input.

Green screen
\$180.00

Amber screen
\$185.00

P&P

NSW \$8.70, Vic \$13.20

Qld/SA \$16.20

Tas \$18.45, WA/NT \$22.00

NEW 10" TILT/SWIVEL BASES

\$21.95 ea. p & p \$2.50

NEW FOR '87
IBM PARALLEL
PRINTER CABLES
INTRODUCTORY
PRICE

\$14.95
p & p \$2.50

3 WAY CROSSOVERS

200 Watts RMS

Crossover Freq. 1Kc and 5 Kc

12dB/Octave

\$34.95 ea. or \$85.90 a pair

P & P \$2.50 ea. P & P \$5.00 pair



COMPONENTS

Computer Keyboard Switches

1" for \$2.00 P & P \$1.50

New PC Boards (No components)

New PC Boards (components mounted)

AS PER JULY ADVERT.

★ KONICA SPECIAL ★

Floppy Disk Single Sided Double Density

2 1/4" MF11DD \$52.50/PC of 10

P and P \$2.00

TOP QUALITY JAPANESE 5.25" MINI FLOPPY DISKS

"DUE TO PRICE WE CAN'T MENTION BRAND"

SUPER VALUE PACK OF 10 DISKS

\$18.00/PK

P & P \$2.00

I.C.'s

LM555 10 for \$4.95

LM3301 10 for \$8.20

749287 5 for \$6.00

74LS181 5 for \$6.00

7406 5 for \$5.00

7417 5 for \$5.00

7441 5 for \$6.00

MC1488 5 for \$7.50

ABOVE P & P \$2.00

VALVES - SPECIAL

KT66 \$19.95

KT88 \$65.00

EL34 \$19.00

ECLL800 \$125.00

EM87 6HU6 \$9.50

EAF801 \$37.50

ECH81 6AJ8 \$6.00

E68CC \$10.50

ECC88 \$10.50

MANY OTHER VALVES

IN STOCK p & p \$2.50

NEW FOR '87

YES WE NOW STOCK

COMPUTER PRINTER PAPER

STANDARD FAN-FOLD

ACERTY 127X2112500 (10) SINGLE PAINT

PLAIN 30 GSM 90X6

PRICE \$48.00/100 OR 5 - \$41.00/50

P&P BYD. METRO \$3.50 NSW \$4.50

QLD/SA \$11.20 TAS \$13.20

WA/NT \$19.75 VIC \$6.70

NEW FOR '87

MASTER TV AERIAL

DISTRIBUTION AMP

MOD MUV32 UHF-VHF

INTRODUCTORY PRICE

\$89.00 p & p \$4.90

* SPECIAL *

MJE 15003 \$5.50

MJE 15004 \$5.50

2SD113-Y \$5.11

25A708A 10 FOR \$9.50

MJE 340 10 FOR \$9.20

p & p \$2.50

★ KONICA FLOPPY DISK ★

3 1/4" MF11DD \$72.00/PC

5 1/4" MD11DD \$42.00/PC

P and P \$2.00

DIODES

Part No.	Price 1/10	20+	100+	1000+
1N4001	\$0.75	\$0.50	\$0.30	\$0.15
1N4002	\$0.75	\$0.50	\$0.30	\$0.15
1N4003	\$0.75	\$0.50	\$0.30	\$0.15
1N4004	\$0.75	\$0.50	\$0.30	\$0.15
1N4005	\$0.75	\$0.50	\$0.30	\$0.15
1N4006	\$0.75	\$0.50	\$0.30	\$0.15
1N4007	\$0.75	\$0.50	\$0.30	\$0.15
1N4008	\$0.75	\$0.50	\$0.30	\$0.15
1N4009	\$0.75	\$0.50	\$0.30	\$0.15
1N4010	\$0.75	\$0.50	\$0.30	\$0.15
1N4011	\$0.75	\$0.50	\$0.30	\$0.15
1N4012	\$0.75	\$0.50	\$0.30	\$0.15
1N4013	\$0.75	\$0.50	\$0.30	\$0.15
1N4014	\$0.75	\$0.50	\$0.30	\$0.15
1N4015	\$0.75	\$0.50	\$0.30	\$0.15
1N4016	\$0.75	\$0.50	\$0.30	\$0.15
1N4017	\$0.75	\$0.50	\$0.30	\$0.15
1N4018	\$0.75	\$0.50	\$0.30	\$0.15
1N4019	\$0.75	\$0.50	\$0.30	\$0.15
1N4020	\$0.75	\$0.50	\$0.30	\$0.15

Zener Diodes

Part No.	Price 1/10	20+	100+	1000+
1N4733	\$0.25	\$0.15	\$0.10	\$0.05
1N4734	\$0.25	\$0.15	\$0.10	\$0.05
1N4735	\$0.25	\$0.15	\$0.10	\$0.05
1N4736	\$0.25	\$0.15	\$0.10	\$0.05
1N4737	\$0.25	\$0.15	\$0.10	\$0.05
1N4738	\$0.25	\$0.15	\$0.10	\$0.05
1N4739	\$0.25	\$0.15	\$0.10	\$0.05
1N4740	\$0.25	\$0.15	\$0.10	\$0.05
1N4741	\$0.25	\$0.15	\$0.10	\$0.05
1N4742	\$0.25	\$0.15	\$0.10	\$0.05
1N4743	\$0.25	\$0.15	\$0.10	\$0.05
1N4744	\$0.25	\$0.15	\$0.10	\$0.05
1N4745	\$0.25	\$0.15	\$0.10	\$0.05
1N4746	\$0.25	\$0.15	\$0.10	\$0.05
1N4747	\$0.25	\$0.15	\$0.10	\$0.05
1N4748	\$0.25	\$0.15	\$0.10	\$0.05
1N4749	\$0.25	\$0.15	\$0.10	\$0.05
1N4750	\$0.25	\$0.15	\$0.10	\$0.05

Bridge Rectifiers

Part No.	Price 1/10	20+	100+	1000+
1N5401	\$0.25	\$0.15	\$0.10	\$0.05
1N5402	\$0.25	\$0.15	\$0.10	\$0.05
1N5403	\$0.25	\$0.15	\$0.10	\$0.05
1N5404	\$0.25	\$0.15	\$0.10	\$0.05
1N5405	\$0.25	\$0.15	\$0.10	\$0.05
1N5406	\$0.25	\$0.15	\$0.10	\$0.05
1N5407	\$0.25	\$0.15	\$0.10	\$0.05
1N5408	\$0.25	\$0.15	\$0.10	\$0.05
1N5409	\$0.25	\$0.15	\$0.10	\$0.05
1N5410	\$0.25	\$0.15	\$0.10	\$0.05
1N5411	\$0.25	\$0.15	\$0.10	\$0.05
1N5412	\$0.25	\$0.15	\$0.10	\$0.05
1N5413	\$0.25	\$0.15	\$0.10	\$0.05
1N5414	\$0.25	\$0.15	\$0.10	\$0.05
1N5415	\$0.25	\$0.15	\$0.10	\$0.05
1N5416	\$0.25	\$0.15	\$0.10	\$0.05
1N5417	\$0.25	\$0.15	\$0.10	\$0.05
1N5418	\$0.25	\$0.15	\$0.10	\$0.05
1N5419	\$0.25	\$0.15	\$0.10	\$0.05
1N5420	\$0.25	\$0.15	\$0.10	\$0.05

TRANSISTORS

Part No.	Price 1/10	20+	100+	1000+
2N2222	\$0.25	\$0.15	\$0.10	\$0.05
2N2222A	\$0.25	\$0.15	\$0.10	\$0.05
2N2222B	\$0.25	\$0.15	\$0.10	\$0.05
2N2222C	\$0.25	\$0.15	\$0.10	\$0.05
2N2222D	\$0.25	\$0.15	\$0.10	\$0.05
2N2222E	\$0.25	\$0.15	\$0.10	\$0.05
2N2222F	\$0.25	\$0.15	\$0.10	\$0.05
2N2222G	\$0.25	\$0.15	\$0.10	\$0.05
2N2222H	\$0.25	\$0.15	\$0.10	\$0.05
2N2222I	\$0.25	\$0.15	\$0.10	\$0.05
2N2222J	\$0.25	\$0.15	\$0.10	\$0.05
2N2222K	\$0.25	\$0.15	\$0.10	\$0.05
2N2222L	\$0.25	\$0.15	\$0.10	\$0.05
2N2222M	\$0.25	\$0.15	\$0.10	\$0.05
2N2222N	\$0.25	\$0.15	\$0.10	\$0.05
2N2222P	\$0.25	\$0.15	\$0.10	\$0.05
2N2222Q	\$0.25	\$0.15	\$0.10	\$0.05
2N2222R	\$0.25	\$0.15	\$0.10	\$0.05
2N2222S	\$0.25	\$0.15	\$0.10	\$0.05
2N2222T	\$0.25	\$0.15	\$0.10	\$0.05
2N2222U	\$0.25	\$0.15	\$0.10	\$0.05
2N2222V	\$0.25	\$0.15	\$0.10	\$0.05
2N2222W	\$0.25	\$0.1		

A high performance microphone preamp

Anthony Tilbrook

Technical Systems Australia Pty Ltd

This preamp features dc-coupling throughout and achieves a signal-to-noise ratio of 80 dB, common-mode rejection ratio exceeding 80 dB well beyond the audio band and provides for phantom powering up to 18 volts. In addition, it can be employed in a variety of balanced and unbalanced configurations.

THIS PROJECT is a high-performance preamplifier module capable of amplifying low input voltages of around of 2 mV and producing a line-level output. In this application it has been designed specifically with microphone use in mind and with the ability to supply up to 18 volts phantom powering for microphones which require this.

The circuit has been designed so that it is capable of driving both single ended and balanced lines, ensuring its compatibility with a large number of applications. The balanced input and balanced output makes the unit ideal as a replacement for balanced microphone transformers often used in professional applications.

Configurations and CMRR

The preamp can be used in a number of different configurations. It has the capability to run balanced input to balanced output, balanced input to single ended output, single ended input to balanced output and single ended input to single ended output. The balanced output and input capabilities enable the module to be driven by or to drive very long lines

SPECIFICATIONS AS MEASURED ON PROTOTYPE AEM6012 HIGH PERFORMANCE BALANCED PREAMP

Voltage gain 170 (approx 45 dB)
(with component values shown)

Slew rate 18 V/us

Large-signal bandwidth >130 kHz

Frequency response ± 0.1 dB; dc to 120 kHz

Total harmonic distortion
(600 ohm load, 10 V RMS out)

100 Hz	<0.01%
1 kHz	<0.01%
10 kHz	<0.01%

Total equivalent input noise
(20 kHz bandwidth, balanced mode FLAT measurement)

Source Impedance

0	200nV
200R	353nV
600R	441 nV

Signal-to-noise ratio approx. 87 dB
(re 10 mV input, 600 ohm source, flat)

Common-mode rejection ratio (CMRR)

100Hz	>110dB
1 kHz	>110 dB
10 kHz	>100 dB
100 kHz	>80 dB

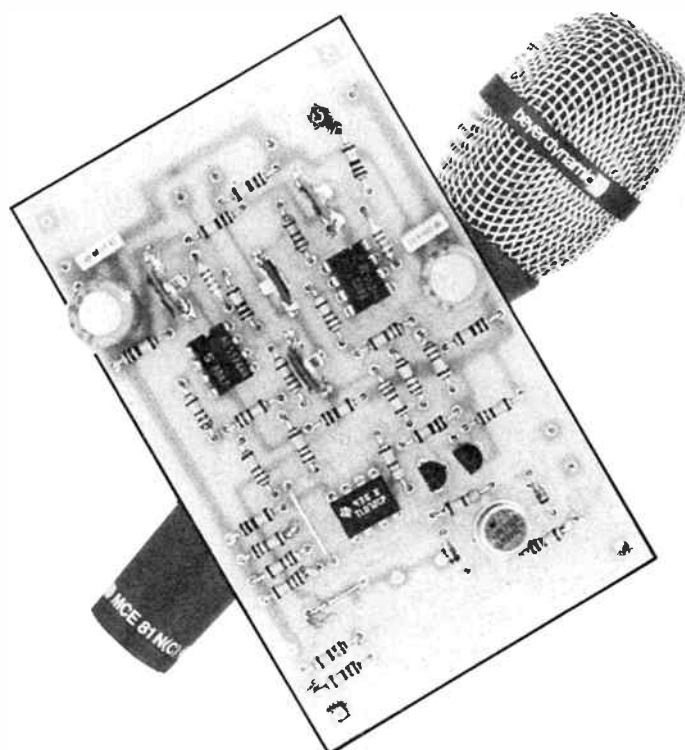

and the balanced input configuration ensures that the amplifier's common-mode rejection will cancel common-mode signals.

A common-mode signal is one which appears equally on both inverting and non-inverting inputs of the amplifier. Hum and noise signal voltages for example, which may be injected into the input lines, tend to be inserted equally into both inverting and non-inverting inputs and hence these signals will be rejected by the amplifier.

The ability of a balanced microphone, or indeed any balanced amplifier, to reject common-mode signals is referred to as the common-mode rejection ratio (CMRR). The 6012 features a common-mode rejection ratio in excess 80 dB at all frequencies up to 100 kHz which is an extraordinarily good specification. The AEM6012 is completely dc-coupled, using no input or output coupling capacitors. Such capacitors are usually included in an amplifier to prevent it from supplying a dc voltage which, if left uncorrected, will cause dc offsets in amplifiers following it. ▸

2732 EPROMS
32K 4Kx8
250ns
\$5.95
Cat 35-8142
10+ \$5.50 ea
50+ \$4.95 ea



BEST QUALITY

NE555 Usually \$1.40
DUAL TIMER **70c**
Integrated Circuit
Cat 26-0556 100+60c 100+50c ea
Usually \$1.80
1489 IC
90c R5232 line receiver
10+80c 100+65c ea Cat 35-1489

LM3900 EQUIV RCA3401
HALF PRICE! **45c** 10+ less 10%
C106 50V 4A **40c**
Popular SCR Buy 10, less 10%
600V 4A **60c**
26-7331

Complete ALARM SYSTEM
Covers doors and windows etc. Add infra-red detector if needed
Includes digital keypad + control module with 4 reed switches and siren. **\$39**
Cat No 01-0920
Programmable entry/exit delays, g.ted. Easy instal, wiring supplied, batt. oper.
EXTRA SIREN AVAIL \$15
Plugs into existing module. 01-0921
ACCESSORY KIT \$11
3 extra reed switches. Cat 01-0922
INFRA-RED DETECTOR \$119
Requires 12Vdc power. Cat 01-5302
source at 25mA e.g. rechargeable batt.

12V 2.6AH RECHARGEABLE SEALED LEAD ACID BATTERIES now **\$22 EA**
Scoop buy - discontinued model but 100% g.ted. ideal for alarms etc.
Size 134x54x95mm(H)
Cat 02-1007

ALARM or EMERGENCY STROBE FLASHER
12V RED, ORANGE
Magnetic Base Cat 01-5311 **\$24**

ULTRASONIC DETECTOR FOR HOME, SHOP, OFFICE
Was \$69 now **\$55**
Cat 01-5301
Ideal for large areas upto 40 sq metres, adjustable sensitivity, walk-test plus memory LEDs, N.O./N.C. output, 12Vdc

ALARM CONTROL MODULE
Build your own system at low cost! Has 22K end-of-line resistors, N.O./N.C. instant and delay, inhibit siren, entry/exit delay, auto reset, 12Vdc oper. **\$25 ea**
Cat 01-0947

ELECTRONIC SIREN
Ideal for internal car or home alarm siren. Mini size 90mm diam. Warbler sound effect. Input 12Vdc 300mA. Output 98dB at 1m.
Was \$18, now **\$12 ea**
Cat 03-2013

PHONE LINE TESTER
For latest USA type 4 pin phone connectors. Dual colour LED indicates status e.g. pos, neg or open circuit. Were \$4.95, what a BARGAIN this is!
Cat 24-3068 **\$1.00 EA**

41256-15 (150ns)
Big name manufacturer!
Qty 10+ **\$5.90 EA**
Qty 1-9 **\$7.50 ea**
Qty 100+ **\$5.50 ea**

MOTOROLA **\$6**
MRF-603 Similar to 2N5590 Cat 26-1259
LM-376 **50c**
VOLTAGE REGULATOR POSITIVE, ADJ Cat 26-0573

RESISTORS
All wanted values 1 ohm to 10 Meg **\$2**
Packs of 100 same value 0.5W or 0.25W Carbon film

8 Fuses for \$1
3RG
You choose:- 250mA, 500mA, 750mA, 1A, 1.5A, 2A, 3A, 4A, 5A, 8A, 10A, 15A, 20A.

ULTRASONIC DETECTOR FOR CAR ALARMS ONLY **\$49**
Cat 19-5252
Use with most alarms, detects movement inside the vehicle, relay N.O./N.C. 12Vdc

New DIGITAL REMOTE SWITCH
Radio control, single trans and receiver, programmable code, range 12-15 metres **\$89**
Cat 01-0970

DIGITAL REMOTE CONTROL
Wireless trans/rec remote control 2x10 Amp outputs to lock/unlock car central locking systems. Programmable code, 12Vdc. **\$149**
Cat 01-0972 LED indic.

Negative ION Generator kit
Was \$39.50 **\$29.50**
Cat No 11-1550 (Based on AEM5501 Sept. 1985)
A deluxe version of this most popular kit with HIGH/LOW output switch, higher voltage (-9500v), extra ion emitter, professional cabinet and ion emitter tester. Users claim a greater feeling of well being and relaxation. Cleans air of tobacco smoke and bacteria; increase concentration. Full instructions are included.
Cat No 11-1551

Mini PIEZO INDICATORS
45mm diam 5-15Vdc 90dB High-pierced Cat 03-2005 **\$8.95**
Two tone 85mm 12Vdc 350mA 105dB 03-2006 **\$16.90**

RECHARGEABLE ELECTRIC SCREW-DRIVER
Heavy duty professional tool, ni-cad batteries, forward and reverse, 4 tips + charger Incl **\$55**
Cat 20-2308

Value plus range

GREENCAPS
2 FOR THE PRICE OF 1

HI-FI STEREO TURNTABLES
SCOOP PURCHASE!
Fully Automatic model, rim/direct drive. (BSR replacement) Cat 03-2057
As made for AWA, 2 speed 33/45 RPM ceramic cartridge, 12V DC operation, 240V AC plug-pack **\$7.50**. All new!

8 Fuses for \$1
3RG
You choose:- 250mA, 500mA, 750mA, 1A, 1.5A, 2A, 3A, 4A, 5A, 8A, 10A, 15A, 20A.

TURNTABLE DRAWER
Glide in and out at the touch of a button! 240V AC and includes 12V supply Cat 03-2058 Was \$60 Now **\$40**

0-2 mins MECHANICAL TIMER
240V AC oper.
10A switching contacts, 0-120 secs fully adjustable delay, synchronous motor driven, reliable **\$7.50 ea**
Cat 04-0195

AUDIO AND VIDEO ENHANCER **\$69**
IN-LINE VCR/VCR
Connect between two VCR machines to improve audio and video signals, with separate controls and multi-purpose leads, 240V AC power. Cat 24-1027

Macintosh CABLES
Registered trade mark of Apple Computer
512K to modem **\$24.95**
512K to printer **\$22.50**
(ImageWriter I, II or some others)
Plus to modem **\$29.90**
Plus to printer **\$27.50**
(ImageWriter I, II or some others)
Custom made to order here in Oz

SOLDERING TOOL KIT
Includes heatsink, reamer, scraper, brush, tweezers and screwdriver. **\$7.95** Save **\$3**
Cat 20-2456 **\$4.95**

CONDENSER MIKE **\$15**
Cat 03-0387

1N5404
400PIV 3 AMP RECTIFIERS
Cat No 26-0115 **20c**
100+ **15c ea**

CERAMIC CAPS
1pf-100nf 50v
Packs of 100 same value **\$4**

PREMIUM QUALITY LEDS
5mm long life
RED Cat 26-0150 **20c**
GREEN 26-0151 **25c**
YELLOW 26-0152 **25c**
100+ less 20%

Ex-Computer Electro
150,000uf 5v 34,800uf 40v
42,000uf 10v 20,000uf 45v
60,000uf 15v 12,000uf 50v
90,000uf 20v 22,000uf 50v
50,000uf 25v 7,800uf 60v
34,000uf 30v 4,500uf 64v
15,000uf 35v 3,000uf 150v
31,000uf 40v 4,800uf 200v
Cat 26-0150 **20c**
26-0151 **25c**
26-0152 **25c**
100+ less 20%

NEW FANS
High Quality from C.I.C. Co. Taiwan Ltd.
10-49 **\$16 ea**
50-99 **\$14 ea**
100+ **\$12 ea**
Buy Now!

FANS
5" 220V AC
All tested OK
Cat No 06-1100
\$10 ea EX-COMPUTER

Floppy DISKS
Fuji 3.5" BEST QUALITY DISK Boxes of Ten only.
SSDD..... \$49
HF100 Cat 50-1020
DSD..... \$59
HF200 Cat 50-1022
DSHD..... \$175
HF240 Cat 50-1023

No-Name Floppy Disks but 100% guaranteed!
Famous maker no label diskettes in plain white envelope, with write-on sticky labels.
5 1/4 DS:DD..... \$16.95 Box of 10
Cat 50-1013 \$15.95 per 100 disks

TRANSFORMER SPECIALS!
9-0-9V 2A Cat 20-1024 **\$ 7.50**
12.6V 1Amp Cat 20-1026 **\$ 5.00**
14-0-14V 300mA Cat 20-1028 **\$ 5.95**
16V 3Amps Cat 20-1030 **\$17.50**
17V 100mA Cat 20-1032 **\$ 5.00**
24V 1.25A Cat 20-1034 **\$ 7.50**
30V 1.5 A Cat 20-1036 **\$ 6.50**
20-0-20V 1.5A 20-1038 **\$15.00**

MINIATURE LAPEL MICROPHONES
Condenser Mike **\$15**
Cat 03-0387

Wireless FM **\$19**
Cat 03-0393

LUCKY DIP Offer
ASSEMBLED PARTS **\$13**
24-0023
13 is a lucky number! An interesting collection of samples, manufacturer's over-runs and excess, incl. IC's, pots, diodes resistors, capacitors, knobs, switches and lots of other useful junk!

PARTS VALUE PAKS
- Lucky Dip Assortments
500 0.5v resistors
200 1v resistors
100 ceramic caps
30 greencaps
45 electrolytics
20 potentiometers
25 preset pots
30 mica caps
40 radio/TV knobs
15 various fuses
25 rf chokes
20 rf/1f/osc coils
10 audio transform
50 tagstrips
\$2 EACH PAK
250 0.25v, 0.5v, 1v resistors
15 PAKS TO CHOOSE FROM

STEREO SOUND
from TV's
Cat 24-1015 **\$24.95**
Active circuitry creates simulated stereo sound from your TV or other mono source, connects to Hi-Fi system!

PILLOW SPEAKER
Slim-line 8 ohm speaker; place under your pillow for music before bed-time or repetitious learning while sleeping.
Cat 19-6002
Buy 2 for stereo! **\$9.95**

New POCKET MULTIMETER
2K Ohm/V
A superior shock-resistant case, mirror scale, 16 test ranges, 0-1KV AC + DC, 0-250mA DC, ohms x 1K and dB
Only **\$13.50**
Cat 17-0155 RRP \$19.50 Save \$6 now

0-1% digital multimeter
with 32 ranges
AC/DC 100uv-1KV,
AC/DC 0.1ua-2Amp
0.1ohm-20Megohm
SABTRONICS USA
17-0160 **\$69.50**

MAGNETIC BULK ERASER
Best and quickest way erase tapes and floppy disks with strong 240V AC demagnetizer. Gives low background noise. Cat 01-0450 **\$29.90**

PRE-PAK electronics
1a West St, LEWISHAM, 2049
(02) 569-9797
Mon-Fri 9:00-5:30 Sat 9:00-1:00
BANKCARD MASTERCARD VISA AMEX
Pack/Post - \$3 plus 5% of order value, extra for heavy items
WANTED: Electronic parts, computers, test equipment, CASH paid

In order to overcome this problem, the module is fitted with a pair of dc offset adjustment potentiometers which enable the dc voltage on the output of the preamplifier to be adjusted to zero. As mentioned, the 6012 has an extremely good common-mode performance. This can be improved even further by preset potentiometers which are included to enable optimization.

Noise performance

One of the most important characteristics for a balanced microphone preamplifier is its noise performance. The very low signal voltages typically supplied by most microphones make it essential that any microphone preamplifier contribute as little noise as possible. The 6012 excels in this area having one of the lowest noise figures for an electronic balanced microphone preamplifier we've seen or measured.

In order to obtain a signal-to-noise ratio of around 80 dB, then the total equivalent input noise generated by the microphone preamplifier must be in the order of one nanovolt per root Hertz; i.e. around 140 nanovolts total, if it is assumed that a typical signal level from the microphone is around 10 mV. Achieving a figure as low as one nanovolt per root Hertz, however, is not easy and requires careful consideration to the input stage bias current and input loading, etc.

To achieve noise figures of this order of magnitude in the AEM6012 we employed a high quality, low noise "super-matched transistor pair", the LM394 manufactured by National Semiconductor. This device has been around for some time and consists of a highly matched pair of transistors in a single encapsulation, each of which consists of 50 integ-

rated transistors connected in parallel. The result is a "super-matched" pair with extraordinary noise performance capabilities.

Aspects of the design

We have designed the amplifier modules specifically for use with high-quality audio and professional sound systems and have therefore enabled the module to drive to its full output voltage into a 600 ohm load, as 600 ohm balanced lines and input loads are the industry standard, without generating excessive distortion.

This is achieved by the use of NE5534N ICs in the output stage (IC2 and IC3 on the circuit) which are capable of driving a 600 ohm load. The NE5534N is manufactured by Signetics and is designed specifically for audio applications. It is a high-quality op-amp with extremely good slew rate as well as excellent common-mode rejection performance.

In order to extract the best possible performance both in terms of noise and distortion from any op-amp circuit, particularly one which requires noise figures as low as this, it is essential to pay very great attention to the earthing scheme. In this design we have employed two separate earthing systems. Firstly, there is a "noisy" earth, which is the common line that carries power supply filtering and provides general power supply earthing requirements. If this earth is connected to the signal earth there is a possibility of having supply ripple and noise inserted into the signal path from the modulating supply rails. In order to prevent this from happening, all signal earths are connected to what is called a clean earth which carries the earth reference for all signal voltages. As the name implies, this earth is clean from power supply irregularities

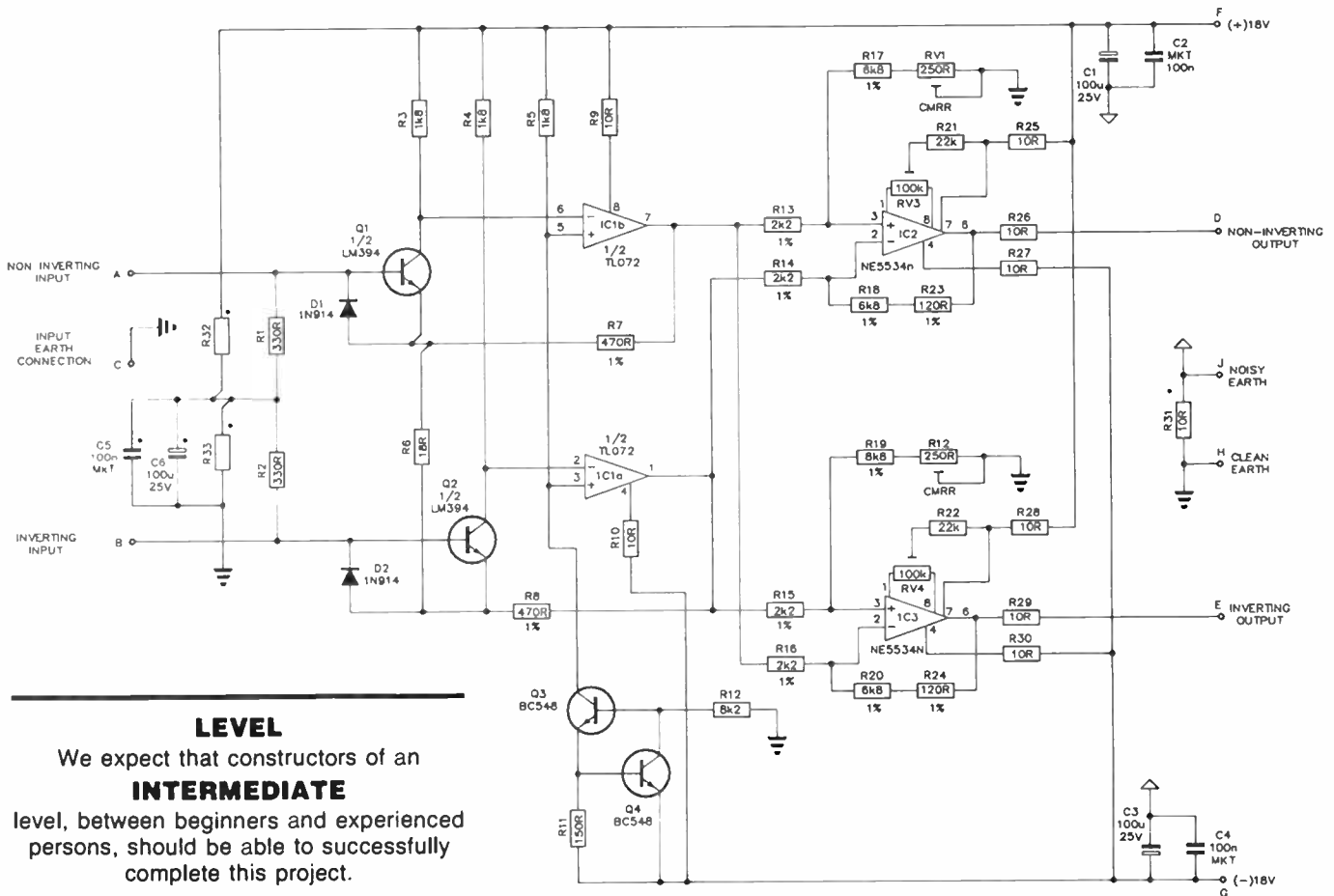

LEVEL

We expect that constructors of an **INTERMEDIATE** level, between beginners and experienced persons, should be able to successfully complete this project.

and so on.

To overcome the possibility of interaction which inevitably occurs between these two earth lines, they are separated completely on the pc board, and joined only at the centre of the main power supply filtering capacitors by means of two separate wires. For this reason, we strongly recommend you use the AEM6012 pc board as the development of a board for an amplifier circuit such as this is as important to the overall performance as the development of the circuit itself. In fact, all the specifications of any amplifier, be it a power amp, a preamp or line level amplifier, are greatly determined by the pc board layout. All parameters including the slew rate, the total harmonic distortion figures, the noise figures and the common-mode rejection ratio can be seriously compromised by an inadequate pc board layout. The common-mode rejection ratio at high frequencies is particularly likely to be affected by stray capacitances between neighbouring tracks and neighbouring components and problems related to this can be extremely difficult to find. During the development of the 6012 we experimented with several pc board layouts, finally settling on the one which is included with this article.

Two other parameters of substantial importance for a microphone preamplifier are slew rate and head room. In order to ensure good slew rate figures, the amplifier must be capable of excellent large signal frequency response performance. The 6012 provides a large signal bandwidth in excess of 100 kHz so that it should be impossible to drive the module into slew rate limiting from any practical microphone input signal level.

Similarly, since the module is powered from ± 18 volts supplies it has good headroom figures and most microphones should not be able to cause clipping of the output stage. If the module were to be used with microphones with particularly large output signal level, so that it then became possible to cause clipping of the microphone amplifier, then the gain of the 6012 should be reduced by increasing the value of resistor R6.

Construction

Before commencing the construction of the 6012, make a thorough check of the pc board to ensure that it is free of any copper bridges or open circuit tracks. Also check that all holes have been drilled and are of the correct diameter. The PC board has been designed to be as small as practical so that it can be incorporated within other pieces of equipment with ease. Consequently, some of the track are necessarily close and they should be checked to ensure that no short circuits exist.

Once this check is complete, the construction can commence with the wire links, resistors, small capacitors and pre-sets. Resistors R32, R33 and capacitors C5 and C6 are optional components and are fitted if the microphone with which you intend to use the preamplifier requires phantom powering. If phantom powering is not required then resistor R32 should be omitted as should capacitors C5 and C6, while resistor R33 should be replaced with a wire link. If, on the other hand, phantom powering is required, then resistor R32 and R33 ▷

CIRCUIT OPERATION

The AEM6012 is a high performance microphone preamplifier featuring both balanced inputs and outputs. The module presents a balanced 600 ohm input impedance and is capable of driving a balanced 600 ohm output line. The circuit is based around two identical input stages, each of which consist of one half of an LM394 super-matched pair and one half of a TLO72 JFET input IC operational amplifier.

Input is applied between the bases of Q1 and Q2. The collectors of these devices are connected to the 1k8 resistors R3 and R4. They also connect to the inverting inputs of each half of the TLO72. The emitters of Q1 and Q2 are connected to the output of each half of the TLO72 so that the emitter current of the two input devices is controlled by the IC op-amp. Furthermore, since the input transistors are within the feedback loops of the first stages, any distortion generated by the input transistors will be reduced.

The non-inverting inputs of each half of the TLO72 are connected together and to the positive supply by the 1k8 resistor R5. A constant current source is formed from transistors Q3 and Q4 and their associated resistors R11 and R12. The current set by this constant current source produces a voltage drop across R5. Since each half of the TLO72 and its associated input transistor are wired with overall negative feedback, the voltage on its output pins (1 and 7) will settle at that voltage which minimises the voltage difference between the inverting and non-inverting inputs of each half of the device. Hence, whatever voltage is established across resistor R5 by the action of the constant current source will be the voltage which is established across resistors R3 and R4 since R3, R4 and R5 are all of equal value.

The input current flowing through each of the input transistors is therefore controlled by the constant current source and this current can be optimised for any particular application. In the case of a balanced microphone, a good figure for input current is around 4 mA and this is the current set by the default value resistors. If you wish to change the value of input current to suit another application this is easily accomplished by changing the value of R11. The input current will be given by the simple formula $0.6/R11$.

The setting of input current for minimum noise is determined by the source impedance of the device connected to the input of the preamplifier. If the circuit were used as a moving coil balanced input

amplifier for example, the input stage current should be increased to around 6 mA. For use with moving magnet inserts, use the 4 mA figure already discussed. If the module were used following a 10k potentiometer however, the input current should be decreased to around 500 μ A.

Another advantage of this scheme to set the input stage current is that the loads represented to the collectors of Q1, Q2 and Q3 are identical for all practical purposes. The input impedance of the TLO72 is extremely high, on the order of many thousands of megohms, so they represent negligible impedance to these collectors. Since all of the collectors are connected by a 1k8 resistor to the positive supply rail, any power supply ripple or noise present on the positive power supply will be coupled equally to the inverting and non-inverting inputs of ICs 1a and 1b and will therefore be rejected by these devices. This helps to ensure good power supply rejection figures which are essential if good noise figures are to be obtained from an amplifier like this.

The second stage of the 6012 consists of two identical differential input amplifiers, each of which consists of an NE5534N. Since the operation of these two stages is identical we will discuss that involving IC2. This is a conventional stage in which the outputs of the two halves of the TLO72 are applied to the non-inverting and inverting inputs respectively. Resistors are matched so that the best possible common-mode rejection ratio figures can be obtained. In order to enable an adjustment of the CMRR, RV1 is included. This configured so that, when set at its centre position, a good common-mode rejection ratio will be obtained without further adjustment. Since the amplifier has dc-coupled outputs, RV3 is supplied to enable adjustment of the dc offset voltage.

Resistors R26 and R29 are provided to isolate the feedback loop of IC2 and IC3, respectively, from the output line so that the capacitances associated with this line will not cause instability of the op-amps.

Capacitors C1, C2, C3 and C4 provide on-board power supply filtering, although it is important that this module be provided with a high quality regulated dc supply. Resistor R31 is incorporated to ensure that the printed circuit board has both a noisy and clean earth should either of these be omitted. It is important that both points J and H on the board are wired separately to the zero volts of the power supply. When this is done the 10 ohm resistor R31 is shorted out for dc but provides increased impedance at ac of the loop so formed.

form a potential divider which enables the phantom voltage to be set anywhere between zero and 18 volts. If R32 and R33 are made equal at 1k, the voltage will be set to nine volts. In order to decrease this voltage, decrease the value of R32. To increase this voltage it is necessary to decrease the value of resistor R1.

The diodes D1 and D2 can now be positioned. Be careful since these are polarized components and need to be positioned with the correct orientation on the printed circuit board. Follow the component overlay to ensure their correct placement. The transistors can now be soldered into place followed by the integrated circuits IC1, IC2, IC3. These components are also polarized and must be positioned with the correct orientation. Finally, the larger electrolytic capacitors can be positioned and soldered into place.

Once all of the components have been positioned and soldered correctly it is wise to make a final check of the orientation of all polarized components and check the quality of all solder joints. See that no unwanted solder bridges have occurred during the construction process before powering up.

Input, output and all supply connections are shown clearly in Table (1).

Powering up

Before powering up check that the power supplies have been connected correctly. The positive rail at point F and the negative rail at point G should not be confused with each other or damage to the ICs and transistors will result. Also be sure there are wires from both points J and H back to the earth of the power supply. These points correspond to the noisy and clean earths and must be wired via separate wires to the power supply filter capacitors.

If you have an oscilloscope, connect this to the outputs of the amplifier prior to applying power. Adjust all preset potentiometers to their centre positions and then power up. If an

input signal is now applied to either the non-inverting or inverting inputs an output signal should appear on the outputs of the preamplifier. Non-inverted and inverted outputs should show a phase difference of 180 degrees.

Adjusting the common-mode rejection is easy if you have an oscilloscope. Simply attach the CRO leads to the output of the amplifier and join the two inputs together and apply a signal. In this configuration the same input signal is applied equally to the two inputs and an ideal balanced amplifier would produce zero at the outputs. Set the CRO input attenuator to a sensitive voltage setting and adjust the preset potentiometers RV3 and RV4 to minimise the output signal.

Without an oscilloscope, this adjustment can be made using an audio millivoltmeter. Set up the preamp as for the oscilloscope procedure, connecting the millivoltmeter to the output. Adjust RV3 and RV4 for minimum output.

If the module is to be used with a single ended input then the unused input should be connected to clean earth. If, on the other hand, the module is used as a single ended output the unused output should not be connected to ground. This would short circuit the output of one of the NE5534N IC op-amps which would cause excessive power dissipation in this device. ⚡

TABLE 1.

A	NON-INVERTING INPUT
B	INVERTING INPUT
C	INPUT EARTH
D	NON-INVERTING OUTPUT
E	INVERTING OUTPUT
F	POSITIVE SUPPLY
G	NEGATIVE SUPPLY
H	CLEAN EARTH
J	NOISY EARTH

AEM6012 PARTS LIST

Semiconductors

IC1 TL072
 IC2, IC2 NE5534N
 Q1, Q2 LM394
 Q3, Q4 BC548
 D1, D2 1N914

Resistors

all 1/4W 5%
 unless noted.

R1, R2 330R
 R3-R5 1k8
 R6 18R
 R7, R8 470R, 1%
 R9, R10 10R
 R11 150R
 R12 8k2
 R13-R16 2k2, 1%
 R17-R20 6k8, 1%
 C6 100u/25 V RB electro.

Miscellaneous

AEM6012 pc board; suitable interconnecting cable; suitable 18 Vdc supply; housing as required.

Estimated cost:
\$38-\$42

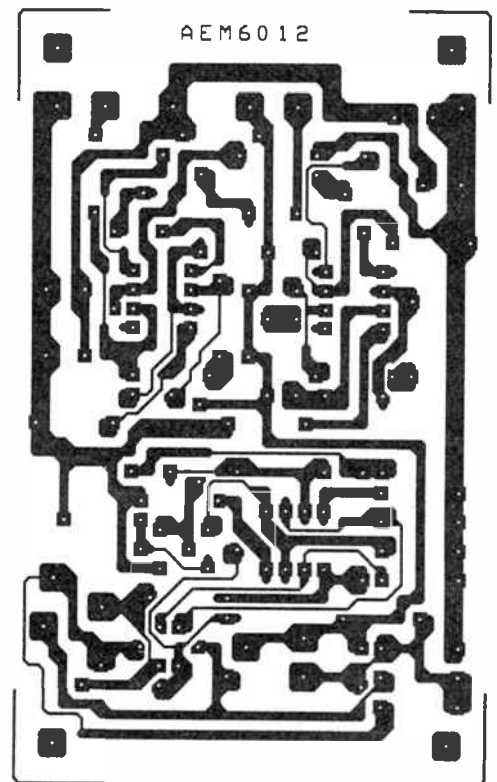
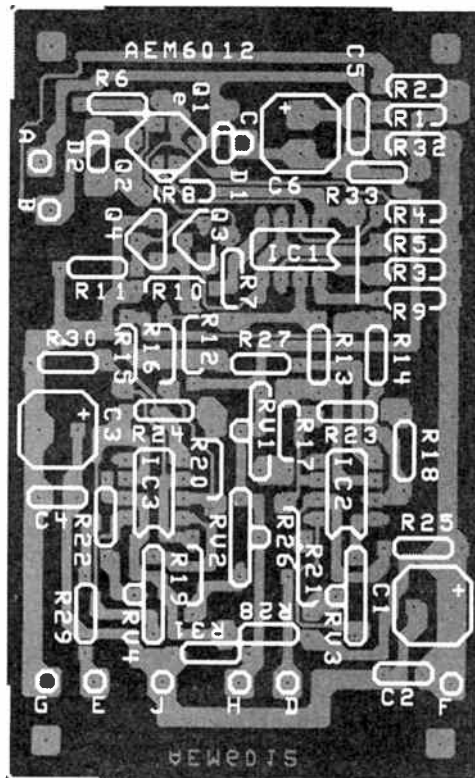

Build this



economy stereo amp

Dick Smith Electronics

Here's a great little stereo amp that's ideal for the enthusiast just getting into audio. It features inputs for compact disc, record player, tuner and tape plus an auxilliary. The project is easy to build with the electronics being almost wholly contained on a single pc board which is housed in a compact, attractive metal case measuring just 380 x 135 x 75 millimetres.

THERE IS NO DOUBT that audio equipment is popular with electronics enthusiasts – just witness the range of audio kits available! A stereo amplifier is probably one of the most satisfying projects one can build as it can provide considerable enjoyment, not just from the satisfaction that comes from successful construction, but through its use in reproducing music and entertainment from available sources – records, tapes, compact discs, radio stations via a tuner, a VCR or whatever.

A variety of stereo amp projects have been described over the years. However, prices for kits for these projects have steadily increased – along with facilities offered, power output and other performance features. That's fine if you want it, but what about the enthusiast who needs something less expensive and is prepared to accept something less sophisticated? This project should redress the balance.

Dubbed the "Stereo 2000" amplifier, the project delivers creditable performance for its remarkably low price and offers all the facilities required of any stereo amplifier used as the heart of a basic sound system.

In designing this amplifier, ease of construction was considered of prime importance. Hence, the "electronics" is assembled on a single printed circuit board – which includes most of the front panel controls, thus only a minimum of external wiring is required. The array of RCA input sockets, and even the speaker terminal set, are pc-mounting types.

The disc (phono), tuner, CD and auxilliary (aux) source inputs are selected by a four-button interlocking pushbutton switch array. This arrangement is convenient and provides rapid source-to-source switching, between CD and disc, for example. Tape selection and the mono/stereo switch are also

The Stereo 2000 project is smartly styled and measures just 380 mm wide by 75 mm high and 140 mm deep, in keeping with the size of popular 'midi' hi-fi components – tuners, CD players, etc.

pushbutton types. The volume control is a detent type for positive setting of the level, while the balance, bass and treble controls each have a centre position detent allowing easy, accurate setting of the tone controls to the "flat" position.

This amplifier could be readily constructed by anyone who has had a modicum of experience building electronic projects. It is not recommended you undertake building it as a first project unless you can seek help from an experienced friend or family member. Firstly, to be reasonably assured of success, you need some soldering experience in order to confidently make reliable joints. Secondly, as it is mains operated, you need to be aware of mains safety procedures in construction and testing. It is, however, ideal as a first audio system project as the circuitry is straightforward and simple to understand and simple to fault-find, if necessary.

Kits may be purchased in two forms – a full kit at \$129.95, which includes everything down to the last nut and bolt, and a "short form" kit of the 'electronics', front panel and knobs, but without the 'hardware' – case, transformer, mains cord and terminal block, etc. This enables constructors who so wish to purchase the latter components separately at a later date. The case will be a stock item, along with the transformer, cord and terminal block which are all current stock components.

Before tackling a project like this, it is always advisable to understand something of the circuitry and its workings. You'll ▶

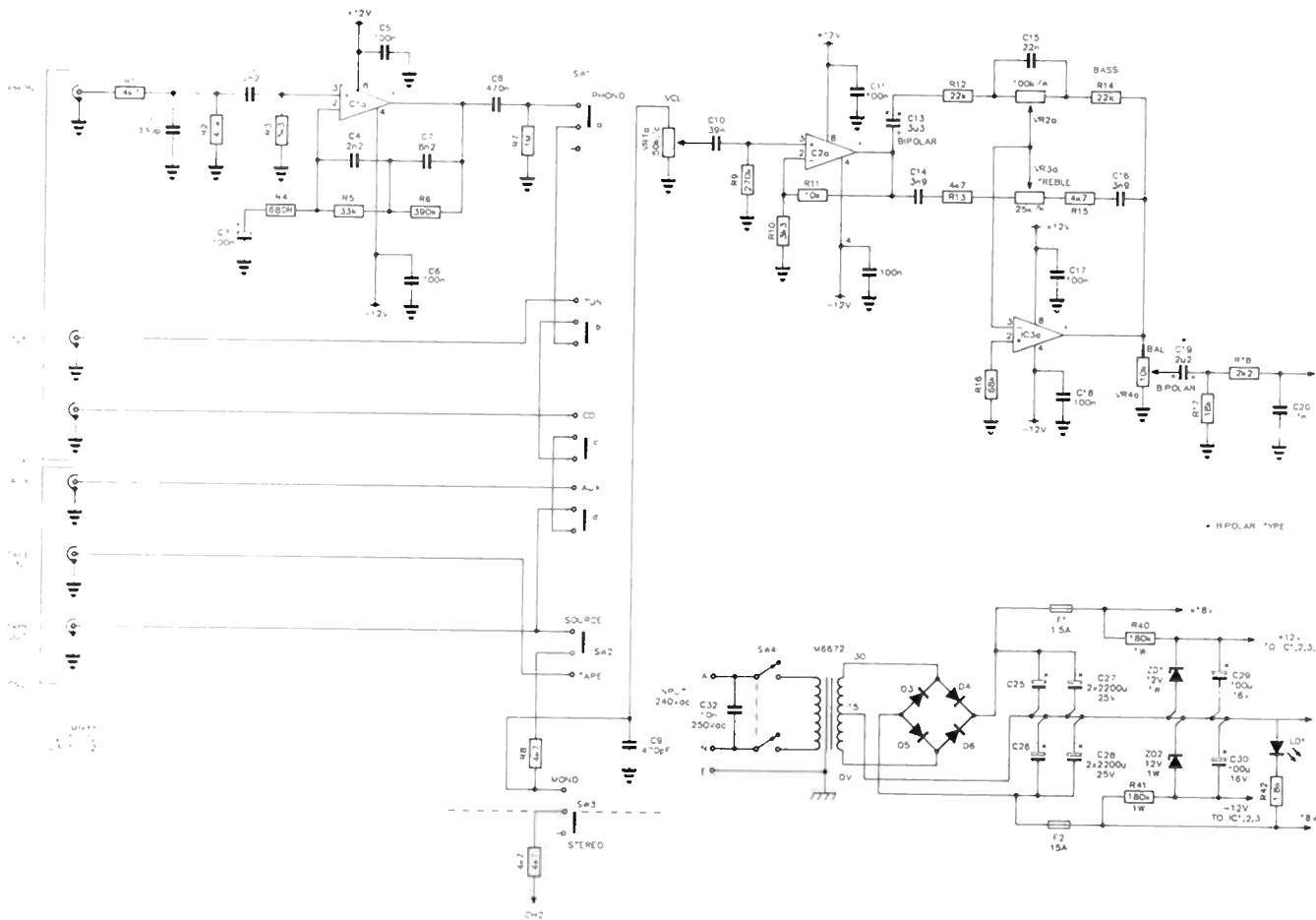

learn something about electronic circuitry and at the same time become familiar with the project which will enable you to more speedily trace any construction faults or errors (nobody's perfect!) and to service it at any future time.

Circuit description

Before we commence, note that, as both channels are identical this description applies to both, though only one is actually described.

Five inputs (or "sources") are provided for: phono (record player), tuner, CD, auxiliary and tape. The output of common phono pickups is typically only in the millivolts to tens of millivolts range, while that from the other sources is typically hundreds of millivolts to a volt or so. Hence, the phono input requires a stage of amplification so that more or less equivalent level signals are applied to the rest of the amplifier. In addition, the frequency response of this stage must be "tailored" as the output from a cartridge tracing the grooves in a record is not constant across the frequency range. When making a record, the amplitude of the lower frequency range sounds are limited during the cutting of the master so that adjacent tracks in the spiral groove may be spaced relatively close without the possibility of overlapping. This permits a greater number of grooves to be cut in the available space, optimising the replay time. To achieve this, the bass end of the audio range applied to the cutting head is "rolled off" according to an internationally agreed-on standard known as the "RIAA" (Recording Industry Association of America) curve.

In addition, the treble range is accentuated which has the effect, in the end, of reducing the effects of noise in the record-replay system.

In order to restore the frequency response of the record-replay system to the required "flat" response across the frequency range, the preamplifier section must have its frequency response accurately "tailored" to a response which is opposite that of the recording curve (the "playback" curve).

The phono preamp here involves IC1a and surrounding components. The IC is a low noise dual operational amplifier (type NE5532 or LM833). This sort of amplifier has two inputs: non-inverting (+) and inverting (-). Signals applied to the non-inverting input (pin 3) are amplified and appear at the output (pin 1) with the same phase, while signals applied to the inverting input (pin 2) appear, amplified, at the output with the opposite phase. Here, the signal coming from the phono cartridge is passed to the non-inverting input of IC1a. Tailoring of the response to the required RIAA playback curve is achieved in the feedback network between the output and the inverting input. This involves R4-5-6, C4 and C7. The low frequency gain is determined by the ratio of R5+R6 to R4, capacitors C4 and C7 rolling-off the response at the mid and high frequencies as required. Capacitor C3 returns the feedback network to ground for all but the very low frequencies, isolating it at dc so that small dc "offsets" (inherent in all op-amps) at the inverting input are not subsequently amplified which can upset the operation of the stage.

Resistor R2 and capacitor C1 provides the "load" generally

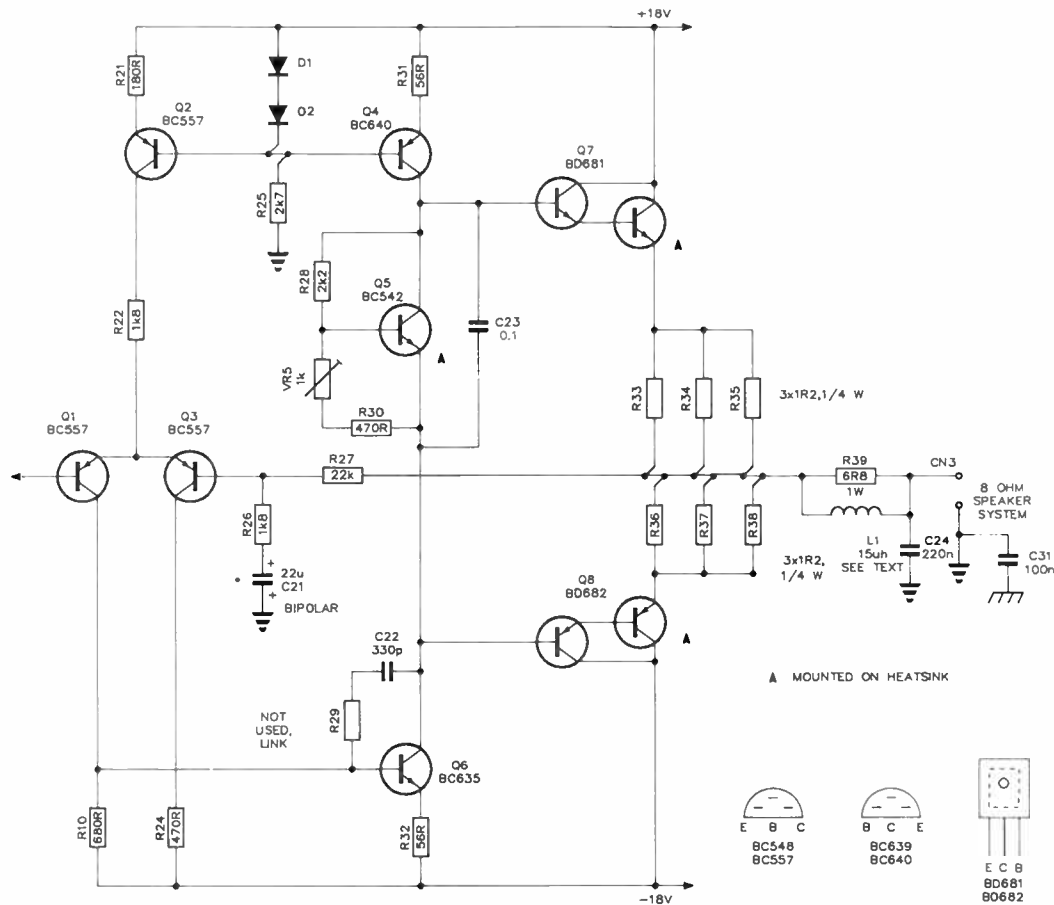

COMPONENTS SHOWN FOR RIGHT HAND CHANNEL ONLY

required by common magnetic phono cartridges, while C2 provides ac coupling to the op-amp input. Some roll-off at the very low frequencies is provided by C2-R3 (which form a simple "high pass" filter), reducing the deleterious effects of turntable rumble. Resistor R1 provides some isolation between the cartridge and the op-amp input, and, acting in conjunction with C1, provides a high frequency roll-off outside the audio band, preventing possible interference from nearby radio frequency sources (from a CB radio, for example).

The IC is powered from ± 12 V rails, bypassed near the chip by C5 and C6. The output of this stage is coupled to the next stage via C8-R1, selected by the front panel pushbutton switch, SW1a.

All input sources with the exception of tape are selected by the interlocked pushbutton set, SW1a-SW1d. The signal from the selected source is passed to the volume control (VR1) via R8-C9, which forms a low-pass filter cutting off above the audio band. The purpose of this is to prevent any possible RF interference picked up on leads interconnecting the source equipment (tuner, CD et al).

From the volume control, the signal passes to a two-stage amplifier and tone control stage comprised of IC2a and IC3a (each type TL072, LM353) with surrounding components. Signals are applied to the non-inverting input (pin 3) of IC2a which provides some amplification. Its output (pin 1) drives the tone control network which is in the feedback path between IC3a's output and inverting input. Potentiometer VR2 controls the bass, while VR3 controls the treble. This network,

comprising C13-C16 and R12-R15 with VR2 and VR3, is known as a "Baxandall" circuit, after its British inventor. The volume, treble and bass controls all employ 'ganged' (mechanically coupled) potentiometers so that the controls are varied in step for each channel.

Both ICs are powered from ± 12 V rails, each bypassed close to the chip with 100n capacitors, C11-C12 and C17-C18.

The output of IC3a is passed to the power amplifier stage input via the balance control, VR4.

The power amplifier is quite straightforward in design. The input stage is a "differential pair" employing Q1 and Q2. This is a type of circuit that amplifies the difference between its two inputs, these being the bases of Q1 and Q2 here. The input is applied to the base of Q1, while feedback from the power amp's output is applied to the base of Q2. The feedback is arranged so that signals which are not the required signal - which will be distortion components produced in the amplifier - are subtracted at the output of the differential input stage, thus greatly reducing any distortion that develops in the amplifier.

The power amplifier is quite straightforward in design. The input stage is a "differential pair" employing Q1 and Q3. This is a type of circuit that amplifies the difference between its two inputs, these being the bases of Q1 and Q3 here. The input is applied to the base of Q1, while feedback from the power amp's output is applied to the base of Q3. The feedback is arranged so that signals which are not the required signal - which will be distortion components produced in the

amplifier – are subtracted at the output of the differential input stage, thus greatly reducing any distortion that develops in the amplifier.

The emitters of Q1-Q3 are supplied by a constant current source comprised of Q2, diodes D1 and D2, and resistors R21, R22 and R25. The two diodes “clamp” the base voltage of Q2 at about 1.2 volts below the +18V rail. This “fixes” the collector current of Q2, and thus the collector-emitter current of each of Q1 and Q3, at a value set by R21. The same two diodes also clamp the base of Q4 at about 1.2 V below the +18V rail. Q4 provides a constant current source for the driver stage which comprises Q6, R29, C22 and R32.

The base of Q6 is driven from the collector of Q1, the signal here being the amplified difference between the signals on the bases of Q1 and Q3. The network comprised of R29-C22 provides feedback to reduce the gain of Q6 at high frequencies. It was found on the final prototype that R29 was best replaced by a link.

The output stage consists of Q5, Q7 and Q8 and surrounding components. The latter are Darlington devices which provide high current gain. The bases are maintained at a constant voltage difference of about 2.4 volts by Q5. This ensures that Q7 and Q8 are correctly biased and that, as the collector voltage of Q6 swings with signal, the bases of Q7 and Q8 swing up and down together. When no signal is present, Q7 and Q8 are just turned on and the output to the speaker sits at 0 V (within a 100 mV or so – called the “output offset”). With signal applied, the collector voltage of Q6 swings positive and negative. When it swings toward the positive rail, Q7 is turned on further the further it swings, while Q8 is turned off. When the collector voltage of Q6 swings toward the negative rail, Q8 is turned further on, while Q7 is turned off.

Trimpot VR5 sets the base current of Q5 and thus its collector-emitter resistance. As its c-e current is held constant, this will vary the c-e voltage drop and thus the voltage between the bases of Q7 and Q8, thus determining the base bias applied to them. Capacitor C23 provides an ac bypass for Q5.

Resistors R33-35 and R36-38 ensure that the collector current of each of Q7 and Q8 are pretty much the same value throughout the whole signal cycle. The junction of these six resistors is the output. Feedback to the input differential pair is taken from here. The feedback network comprises R21, R26 and C21. Resistors R21 and R26 divide the output signal down to provide the appropriate level of feedback to the base of Q3. Capacitor C21 provides an ac return for the signal, but blocks dc to avoid upsetting the circuit's dc conditions as it is “direct-coupled” throughout. Note that C22 is a bipolar type for best results as it has to carry ac, but very little dc.

The network comprised of L1-C24-R39 isolates the feedback network from the loudspeaker at high frequencies. This avoids instability problems as the impedance of loudspeakers does not look much like a resistance at the upper end of the audio band and this ‘reflects’ on the feedback network and can change the phase of the feedback, turning the amplifier into an oscillator! This LCR combination on the output of an amplifier is often referred to as a “Zoebel” network.

The bandwidth of the power amp is set by the RC network comprised of R18-C20 at the input to Q1. This ensures the bandwidth is controlled by the RC network alone which ensures intermodulation and other types of distortion are minimised.

The output devices are mounted on a simple L-shaped heat-sink bolted to the pc board. The bias transistor, Q5, is also mounted on the same heatsink, between the two output devices, so that they are thermally linked and maintained at much the same temperature. This is to ensure that the bias to the output devices is maintained with changes in temperature

and output stage dissipation. It works like this: With increasing temperature, the collector-emitter resistance of a transistor will decrease which, normally, will cause the collector-emitter current to increase. Here, with the c-e current held constant, the decrease in c-e resistance will decrease the base-to-base voltage of Q7-Q8. This will tend to counteract any tendency in the c-e current of the output devices to rise with temperature as their c-e resistance decreases.

Capacitor C31 ties the chassis to the circuit common (or ground) at this one point only, ensuring that the case does not act as an antenna and pick up interfering signals.

The power supply develops ± 18 V rails for the power amp and ± 12 V regulated rails for the preamp. A type M6672 transformer steps-down the mains to provide a 30 Vac centre-tapped secondary. This is rectified by the ‘bridge’ of diodes D3-4-5-6 to develop the ± 18 V rails which are ‘smoothed’ by capacitors C25-27 and C26-28, respectively. Fuses F1 and F2 protect the power supply and output stage in the event of faults or overload.

The ± 12 V rails to supply the preamp are derived by two zeners, ZD1 and ZD2, from the ± 18 V rails. Resistors R40 and R41, respectively, supply the required zener bias current. Capacitors C29 and C30 provide bypassing for the ± 12 V rails and shunt to ground noise developed by the zeners, ensuring no noise is passed to the preamp from this source.

The power-on indicator LED, LD1, is supplied from the -18 V rail via R42. A two-pole power switch is provided to switch the unit on and off. Noise conducted via the mains input is bypassed by C32.

STEREO 2000 AMPLIFIER, PROTOTYPE PERFORMANCE

Continuous output power:

	Both channels	One channel
Load – 8 ohms	8.8WRMS	11.8WRMS

Harmonic distortion:

<0.05% (both channels driven, 8 WRMS into 8 ohm load)

Frequency response:

Phono input	RIAA/IEC equalisation within ± 2 dB (30 Hz to 15 kHz)
Line level inputs	-2 dB at 20 Hz and 20 kHz

Channel separation (crosstalk):

(output 9WRMS) 43 dB

Input sensitivity:

(10 WRMS 1 kHz)

Phono	3.8 mV
overload point (at 1 kHz)	140 mV
Line inputs	200 mV

Hum and noise:

Phono	(ref. 10 mV/1 kHz, unweighted)
-73 dB	
Line inputs	(ref 200 mV/1 kHz, unweighted)
-81 dB	

Tone controls:

Bass	± 12 dB at 60 Hz
Treble	± 12 dB at 15 kHz

Damping factor:

at 20 – 160 Hz	>40
at 1 kHz	>28

Construction

Before you start, lay everything out and make sure you have all your requirements. First thing to do is examine the pc board and familiarise yourself with the layout, location of major components, identify the links, etc. If you tackle the assembly in the order suggested, you should find it all comes comfortably together and be assured of a successful result.

Start by inserting the links, as shown on the component overlay, using tinned copper wire. Bend the wire over onto the copper pad at each end (this is called "clinchng"), solder it, then cut off the excess. Next, load all the resistors and solder them in place. When inserting each component lead, bend it, on the track side of the board away from the component body (but not right over against the board), then solder it. Follow with all the capacitors, treating the leads in the same manner.

The trimpots and the three board-mounted variable controls (volume, bass and treble) can be mounted and soldered in place next. Make sure that they sit flat and straight before soldering the lugs. The balance control is mounted off the pc board, on the front panel, and connected by means of tinned copper wire. But we'll get to that later.

All the diodes and transistors, excepting the output stage devices – Q5-Q7-Q8/Q105-Q107-Q108, are mounted next. Carefully note the orientation of each device before soldering the leads. The four TO-126 package output devices and the two bias transistors (Q5, Q105) are attached to the L-shaped heatsink that runs down the length of the pc board, as can be seen in the internal pictures. This heatsink is secured to the pc board with three M3 x 8 mm (6BA x 3/8") screws, nuts and washers. Bolt it in place first, then insert the transistors in the board and bolt them to the heatsink. The TO-126 package devices mount with the metal face of the package toward the heatsink and are each secured with an M3 x 8 mm screw, nut and washer. A mica washer smeared with a thin layer of thermal compound is placed between each TO-126 package and the heatsink. The bias transistors, Q5/Q105 are mounted with the flat face of their package against the heatsink, first smeared with a thin layer of thermal compound. They are held by a solder lug shaped around the body to apply pressure on the transistor package, pressing it to the heatsink.

The output inductors (or "chokes"), L1/L101, have to be pre-wound before soldering to the board. They are constructed by winding three layers of 0.8 mm (20 gauge B&S) enamelled wire onto a 10 mm diameter former. We used the shank of a 10 mm drill to wind 24 turns, closely wound for the first layer. Use sticky tape to hold this first layer in place. Wind on the second layer, but not quite to the shoulder of the first layer so that the external turn does not run off the edge. Again, hold this winding in place with sticky tape then wind on the third and last layer. Secure with tape.

To hold all the windings in place, a suitable diameter piece of heatshrink tubing, cut a little longer than the coil, can be shrunk over the assembly. Cut the trailing wires to an appropriate length, scrape the enamel from the ends for about 5-6 mm until bright, clean copper shows. "Tin" them by first heating the ends with the hot soldering iron and then applying solder so that it covers the copper in a thin, bright film. Afterwards, shape the leads to fit the pc board hole positions then fit the inductors to the board and solder them in place.

Mount and solder the three pushbutton switches. Fit the two input socket assemblies and speaker connector block and solder them in place, making sure they first sit flush to the board. Solder in the four fuse clips. It may be necessary to squeeze the fingers together so that the fuses fit tightly in place.

Now go over your assembly thoroughly and check for mistakes, bad solder joints and shorts across tracks or closely-spaced pads. Fix any problems at this stage. Suspect joints should be reheated until the solder "wets" the joint properly. A solder sucker or braided solder "wick" may be used to clean up excess solder or solder "bridges" between tracks or pads.

Mains and general case wiring

The DSE case for the kit comes in three parts – a U-chassis sporting a large rectangular cutout in the front riser and holes in the rear for the input sockets, speaker connector and mains lead, a pre-punched front panel and a lid. ▶

Internal view, showing the general assembly.

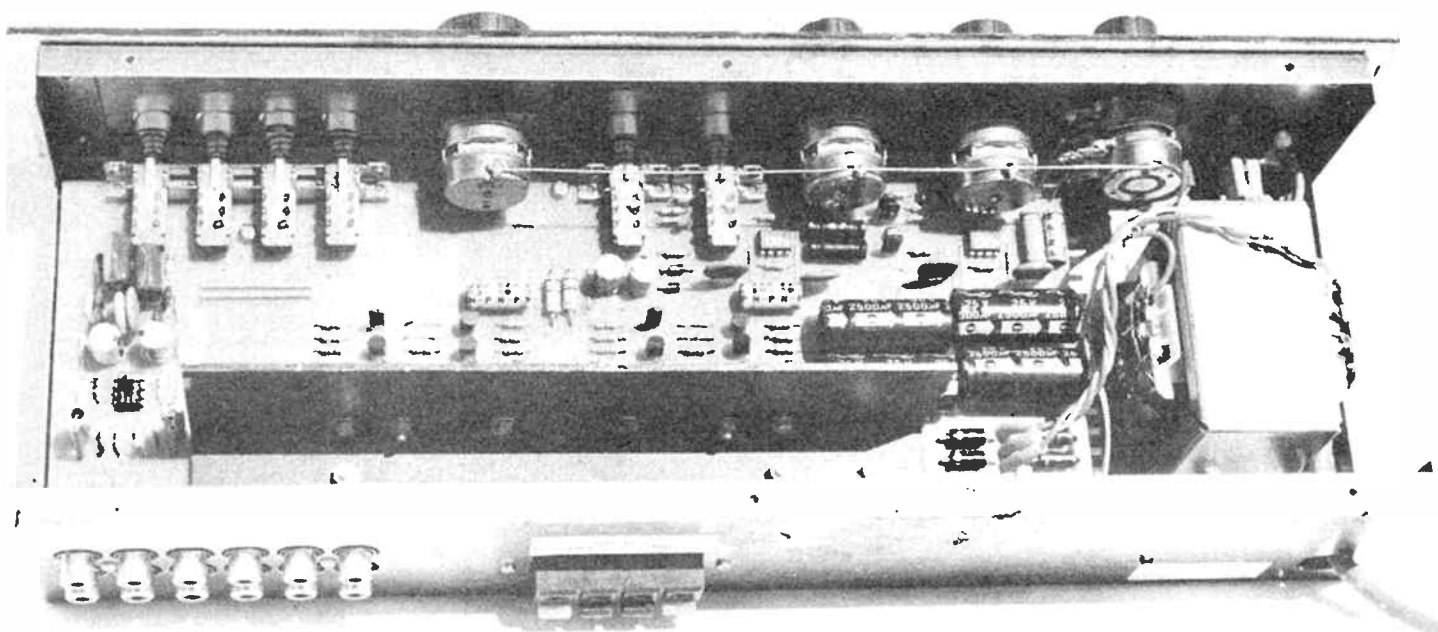

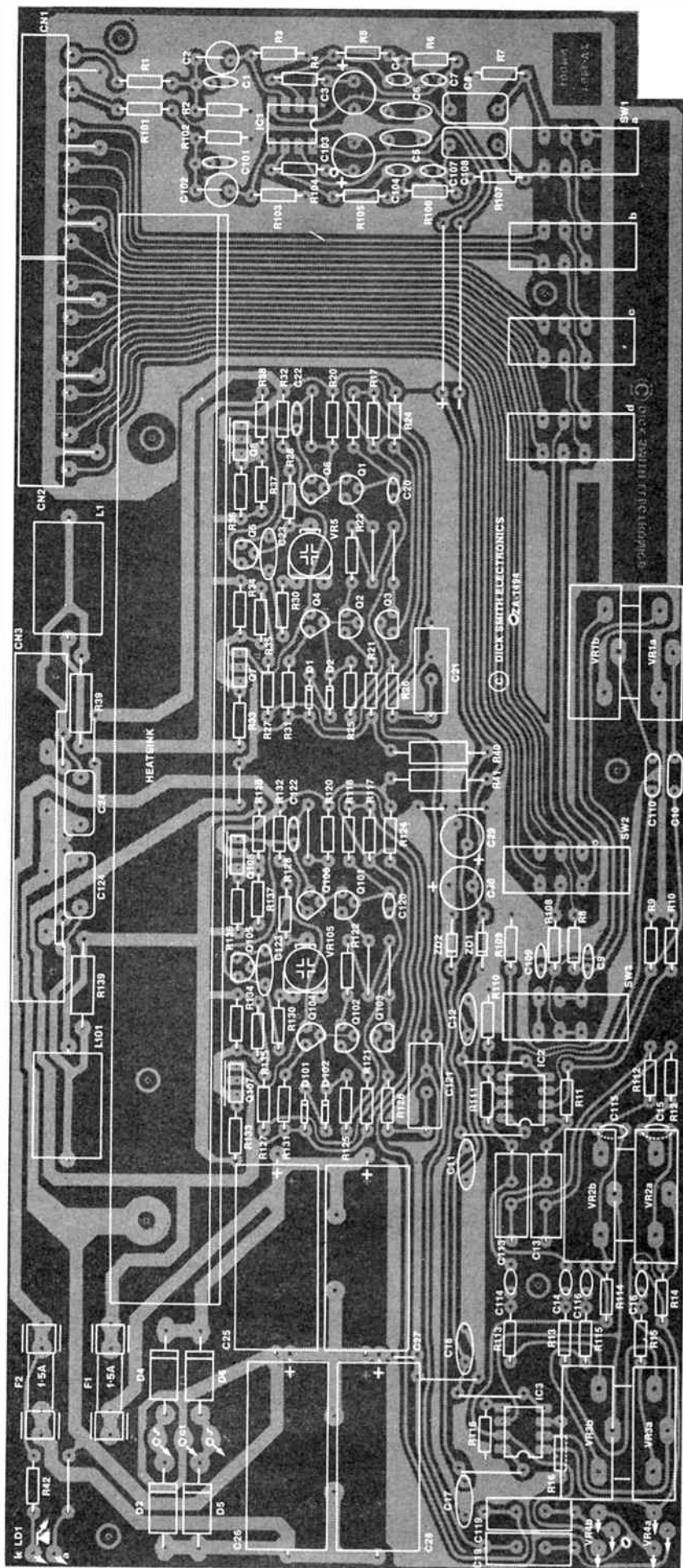

PARTS LIST STEREO 2000 AMP.

Semiconductors

D1, D101	1N914, 1N41486
D2, D102	1N914, 1N4148
D3-D6	1N5404
IC1	LM833, NE5532, XR5532
IC2	LM353, TL072
LD1	3 mm red LED
Q1-3	BC557
Q101-103	BC557
Q4, Q104	BC640
Q5, Q105	BC548
Q6, Q106	BC548
Q7, Q107	BD681
Q8, Q108	BD682
ZD1, ZD2	1N4742, 12 V/1 W zener

Resistors

all 1/4 W, 5%
unless noted

R1, R101	4k7
R2, R102	47k
R3, R103	390k
R4, R104	680R
R5, R105	33k
R6, R106	390k
R7, R107	1M
R8, R108	4k7
R9, R109	270k
R10, R110	3k3
R11, R111	10k
R12, R112	22k
R13, R113	4k7
R14, R114	22k
R15, R115	4k7
R16, R116	68k
R17, R117	18k
R18, R118	2k2
R19, R119	link
R20, R120	680R
R21, R121	180R
R122	1k8
R23, R123	link
R24, R124	470R
R25, R125	2k7
R26, R126	1k8
R27, R127	22k
R28, R128	2k2
R29, R129	not used
R30, R130	470R
R31, R131, R32, R132	56R
R33, R133, R34, R134	1R2
R36, R136, R37, R137	1R2
R38, R138	1R2
R39, R139	6R8/1 W
R40, R41	180R/1 W
R42	1k8
VR1	50k/C (log) dual pc mount pot.
VR2	100k/A (lin) dual pc mount pot.
VR3	25k/A (lin) dual pc mount pot.
VR4	10k special dual pot.
VR5, VR105	1k, 10 mm hor. trimpot.

Capacitors

- C1, C101 330p ceramic
- C2, C102 2u2 bipolar
- C3, C103 100u/16 V RB electro.
- C4, C104 2n2 greencap
- C5, C6 100n ceramic
- C7, C107 8n2 greencap
- C8, C108 47n greencap
- C9, C109 470p ceramic
- C10, C110 39n greencap
- C11, C12 100n ceramic
- C13, C113 3u3 bipolar
- C14, C114 39n greencap
- C15, C115 22n greencap
- C16, C116 3n9 greencap
- C17, C18 100n ceramic
- C19, C119 2u2 bipolar
- C20, C120 1n greencap
- C21, C121 22u bipolar
- C22, C122 330p ceramic
- C23, C123 100n ceramic
- C24, C124 220n greencap
- C25-C28 2200u/25 V axial electro.
- C29, C30 100u/16 V RB electro.
- C31 100n ceramic
- C32 10n/250 Vac poly.

Miscellaneous

- CN1, CN2 ... 3-way, pc mount RCA sockets
- CN3 ... 2-way, pc mount spring speaker socket
- L1, L101 3 m of 0.8 mm EC wire (see text)
- SW1 4-bank DPDT interlocking P/B switch (S-1904)
- SW2, SW3 single DPDT P/B switch (S-1906)
- SW4 DPDT 240 Vac toggle switch (S-1174)
- TR1 240 V/15-0-15 V/1 A transformer, M6672

ZA-1494 pc board; 5 x pc pins; 4 x M205 pc mount fuse clips; 2 x M205/1.5 A fuses; heatshrink tubing; one metre of 0.7 mm tinned copper wire; knobs to suit; heatsink - 20x50x3 mm by 200 mm long; four solder lugs; four TO-126 mica washers; heatsink compound; two-way terminal block; chassis and accompanying hardware; four rubber feet (H-1745); 2 m of 3-core mains cable (W-2057); clamp grommet (H-2097); small nylon cable ties; sundry nuts, bolts, washers and hookup wire.

Kit cost: \$129.95
(full kit)

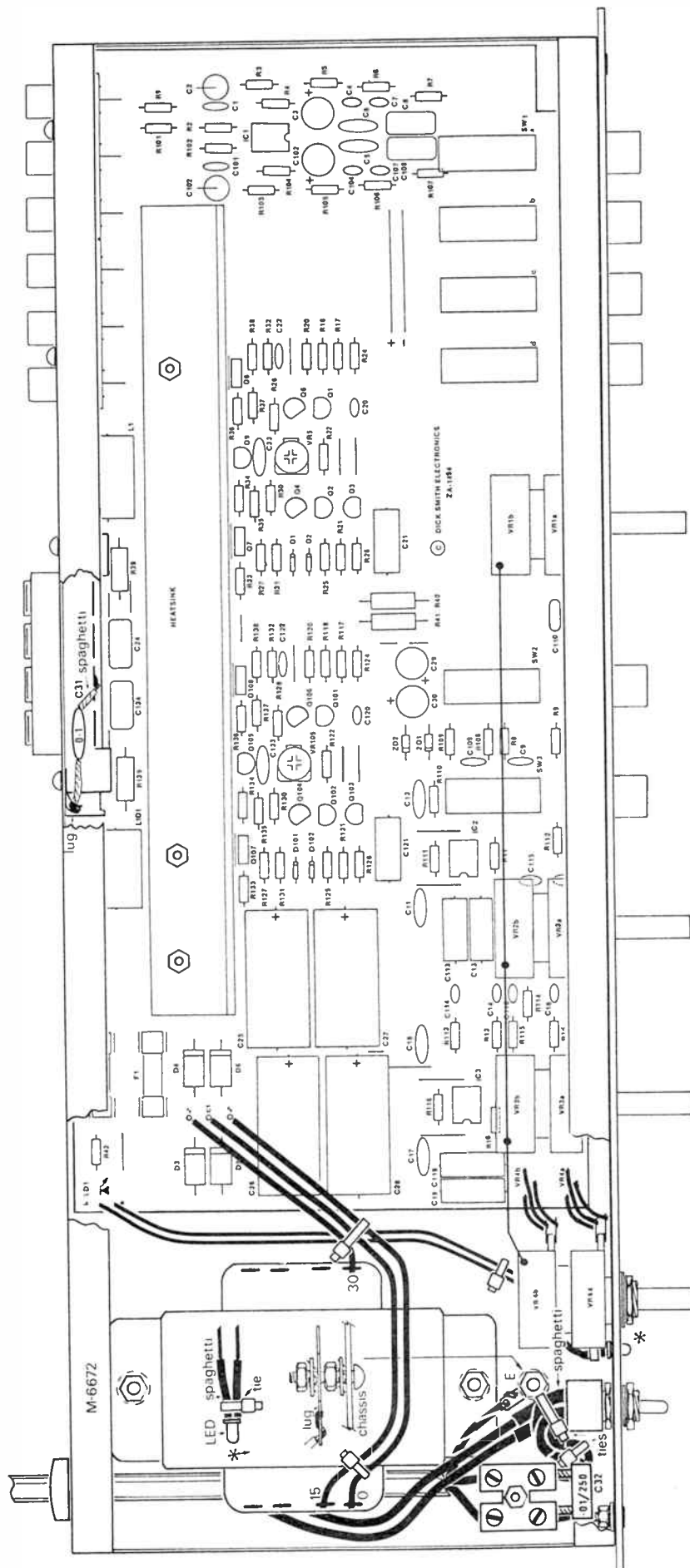

Most of the mains wiring can be done with the transformer, terminal block and on-off switch outside the chassis before they are mounted. Cut the connecting lengths of cable to size before wiring to the appropriate points. The suggested layout is shown in the diagram. With regard to safety, it is advisable to cover all mains terminations with spaghetti, heatshrink or PVC tubing. The mains suppression capacitor, C32 should have the legs cut short, the exposed length covered with spaghetti and the free ends twisted with the mains lead that is terminated in the screw terminal block.

Where joints carrying mains are to be soldered, all strands of the mains cable should be through the eyelet of the components' solder lugs. Use nylon cable ties as shown in the wiring diagram to maintain the wires in position. The leads of the indicator LED should be securely insulated. The body is glued into the front panel during final assembly.

Final assembly

Final assembly depends on your choice of housing. You can house the unit in the DSE chassis as shown in the pictures or mount the pc board and front panel in a wooden cabinet, etc. Suit yourself with the latter arrangement. The drawings and pictures here show how the unit is assembled into the DSE chassis.

The printed circuit board is supported by five 15 mm insulated spacers. Two at the rear and three at various positions along the front edge of the board. Mount these in the chassis first. Then position the board and loosely screw it in place. The speaker connector and RCA input connector block are secured by two 15 mm screws each. Note that a solder lug is required between the speaker connector housing and the chassis, held by the screw adjacent to the left channel connector pair. The ceramic capacitor C31 is soldered between this lug and the left channel "earth" (black) connector.

The front panel is attached with four M3 x 6 mm counter-sunk black screws, nuts and washers. Mount the balance control with the pot nut and washer, then solder the tinned copper wires leading from the board to its appropriate lugs. Note that the three other controls are not attached to the front panel.

Mount the power on-off switch but tighten the securing nut carefully so as not to scratch the panel surface. As previously mentioned, the LED is now glued in position in the front panel. Solder a length of tinned copper wire between the bodies of each pot to provide earthing via the balance control to the chassis.

Fit the control knobs now. It may be necessary to hold the rear of each pot as you push the knob onto the shaft. This original fitting tends to be a little tight. Self-adhesive labels are supplied in the kit for the rear panel connections. Neatly cut these out, just on the inside of the lines indicated. Fix them to the appropriate area above the sockets.

First power-up and setup

Before any fuses are inserted and the amplifier section is connected to the mains supply, recheck all mains and transformer secondary wiring. If all appears correct, plug into the mains and switch on.

Using a multimeter, check the two 18 V supply rails (positive and negative, with respect to common). Both should be around 22 V without signal applied. Remove the power and discharge the rails by "bridging" a 1k resistor from each rail to ground for ten or twenty seconds.

For the purposes of testing, substitute the two on-board fuses with 10 ohm ¼ W resistors. These can be temporarily soldered to the outside of the fuse clips. Attach some form of

"dummy" load to the speaker output terminals. This should comprise a number of ½ W or 1 W resistors connected in parallel to make a load resistance of around eight or perhaps 16 ohms. e.g: four 33 ohm resistors (about 8 ohms) or three 47 ohm resistors (about 16 ohms).

Turn the volume control to minimum. Set the two trimpots VR5/VR105 fully clockwise. Power up again. If the two 10 ohm resistors across the fuses have not burnt out at this stage, check the voltage at the amplifier end of the resistors. The reading should be around 19 V with respect to common on both supply rails.

Check the voltage at the speaker terminals (across the load). This should be less than 100 mV on both channels. Measure the voltage across the zener diodes. This figure should be around 11 to 13 volts. Check that the voltage on the outputs of all three op-amps are close to zero.

A great variance from these figures would tend to indicate something wrong. If this is the case, recheck for shorts on the board caused by solder bridges.

With all these conditions correct, turn the power off and remove the two resistors across the fuseholders. Refit the 1.5 A fuses. Connect a set of speakers, set the volume control at minimum and power up. Other than a soft initial "plop", nothing should be heard in the speakers.

If any condition occurs contrary to this, quickly remove the power. If the condition warrants it, resolder the two 10 ohm resistors in place of the fuses and fit dummy loads to the output terminals. This will facilitate fault-finding procedures.

Assuming these procedures prove successful, now you can try a signal source at one of the inputs from, say, a cassette deck or record player. Swing the volume, tone and balance controls each through their full range and not the effects. If all is in order, the next step is to set the quiescent current in the output stages. For this, you will need a multimeter capable of measuring 200 mA.

Remove the fuse F1 in the +18 V supply rail and substitute the multimeter (which should be set to read 200 mA). Turn both presets VR5/VR105 fully clockwise. Switch on the power. The meter should read between 90 mA and 150 mA. Leave the system like this to warm up for a minimum of 15 minutes. This allows stabilisation of the output stages. Now adjust VR5 so that the initial reading increases by 10 mA; e.g: with an initial reading of, say, 120 mA increase it to 130 mA. Adjust VR105 for a further increase of 10 mA – 130 mA to 140 mA.

The output stages are now correctly set. Switch off the power and reconnect the fuse. This completes the setup procedure and your stereo amp is ready to roll! 🎧

The input and output connectors.

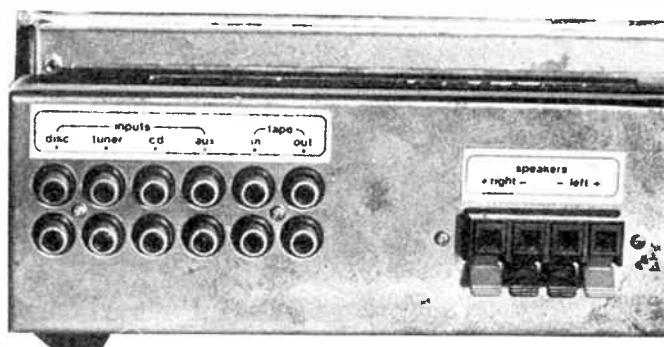

SMD pick-and-place system for rework and development

Cooper Tools has released, through the George Brown Group, a pick-and-place system (PPS) for surface mounting techniques designed for small batch production, rework and electronic development applications.

The new Weller unit features a mounting arm that facilitates highly accurate placement of SMDs with glue or solder paste on pcbs, the company claims.

Soldering and desoldering can be accomplished with hot inert gas techniques on the same unit.

The system is built upon an 800 x 400 mm work table with a temperature controlled pre-heating plate. This is regulated by a Weller W-BU power unit incorporating digital readout of working temperature of all the system's heating devices.

The PPS also incorporates a turntable vacuum and positioning tube, and inert hot gas soldering nozzles.

A 30-compartment carousel with protective cover is included in the work table for storage of assorted SMD components.

The unit is available in three parts - the workbench, the mounting arm and the W-BU power unit which features a temperature control range variable between 50 and 300 degrees Celsius, allowing reflow soldering.

Nozzles with the PPS allow soldering and desoldering of special SMDs - quad-packs, PLCCs, etc. The W-BU unit includes connectors for other soldering accessories.

Further information from the George Brown Group Marketing Division, 456 Spencer St. West Melbourne 3003 Vic. (03)329 7500.



The 1987 IC Master

The new, expanded 1987 IC Master is a truly comprehensive selection guide which should prove invaluable to engineers and designers. This reference source provides specifications and information on more than 40 000 commercially available ICs from over 500 suppliers.

Over 75 000 pin-for-pin replacements are detailed and the IC Master even lists sales offices and distributors.

For further information, contact A.J. Distributors Pty Ltd on (08)269 1244 in Adelaide, (03)699 8365 in Melbourne or (02)736 1564 in Sydney.

Low cost logic analyser

Elmeasco Instruments Pty Ltd has announced

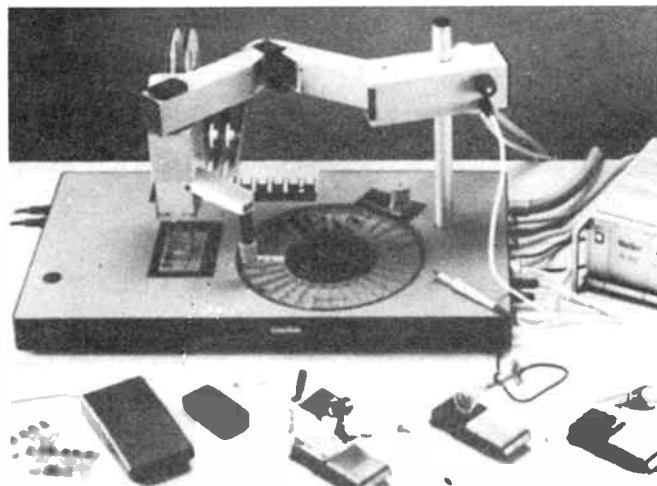

the availability of a new low cost, general purpose logic analyser. The Gould model K50 can be configured from 32 channels at 25 MHz (1K samples/channel) to 8 channels at 100 MHz (4K samples/channel). Glitches as narrow as 5 ns are captured and stored in memory.

The unit's high resolution, non-glare 175 mm CRT displays up to 17 channels across the complete memory or it may be expanded for detailed viewing of fewer channels.

The model K50 comes with IEEE-488, RS-232 and

Centronics ports as well as trigger, restart and video outputs.

An optional microprocessor analysis package includes disassembler software and interface adaptors. These are available for the Z80, 8085, 6502, 6809, 8086/8 and 68000 processors.

For further information contact Elmeasco Instruments Pty Ltd in NSW at PO Box 30, Concord 2137. (02)736 2888, or their offices in Victoria, Queensland, Western Australia or South Australia. ♀

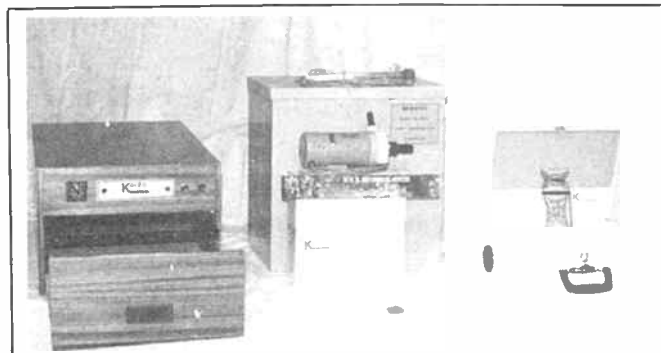

SMALL PRODUCTION PCB EQUIPMENT

For development work needing fast, in-house pcb production, and for small-volume production runs, Melbourne manufacturer Kalex has produced a set of equipment to do the complete job. They have UV processing equipment and etched tanks, all locally designed and produced for off-the-shelf delivery. See their advertisement on page 91 last month's issue, or contact Kalex, 40 Wallis Ave, East Ivanhoe 3079 Vic. (03)497 3422.

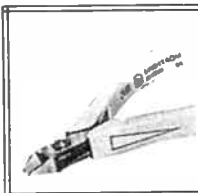

LINDSTROM HAND TOOLS

The Superior Swedish Hand Tool



CLC AGENCIES

51 Armitree St.,
Kingsgrove NSW 2208
Tel: (02) 750 4005 Fax: (02) 708 5556

MEKTRONICS CO. PTY. LTD.

Corner City Rd. & Ferrars St.,
South Melbourne, 3205
Tel: (03) 690 4593 Fax: (03) 690 5082

MAX232 *

+5V Powered Dual RS-232 Transmitter/Receiver



General Description

The MAX232 is a dual RS-232 receiver/transmitter that meets all EIA RS-232C specifications while using only a +5V power supply. Significantly simplifying system design by removing the need for power supply voltages other than +5V, the MAX232 has two onboard charge pump voltage converters which generate +10V and -10V power supplies from a single 5V power supply.

The MAX232 contains four level translators. Two of the level translators are RS-232 transmitters which convert TTL/CMOS input levels into ±9V RS-232 outputs.

The other two level translators are RS-232 receivers, which convert RS-232 inputs to 5V TTL/CMOS output levels. These receivers have a nominal threshold of 1.3V, a typical hysteresis of 0.5V, and can operate with up to ±30V inputs.

Features

- ◆ Operates from Single 5V Power Supply
- ◆ Meets all RS-232C Specifications
- ◆ 2 Drivers and 2 Receivers
- ◆ Onboard Voltage Quadrupler
- ◆ ±30V Input Levels
- ◆ ±9V Output Swing with +5V Supply
- ◆ Low Power CMOS: 5mA

Typical Applications

The MAX232 is suitable for all RS-232C communication links. It is particularly useful where the ±12V power supplies required for other RS-232 drivers are not available. The power supply section of the MAX232 can be used as a voltage quadrupler for input voltage up to 5.5V.

Computers
Peripherals
Instruments
Modems
Battery Powered Systems

Pin Configuration

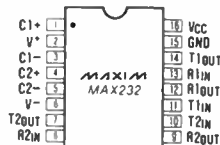

Typical Operating Circuit

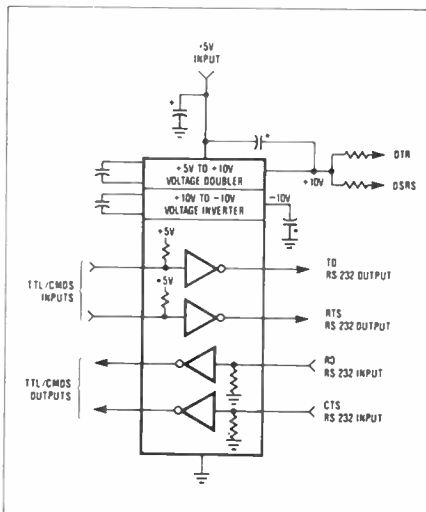

* Patent Pending

ABSOLUTE MAXIMUM RATINGS

V _{CC}	6V
V ₊	12V
V ₋	12V
Input Voltages	
T _{1IN} , T _{2IN}	-0.3V to (V _{CC} + 0.3V)
R _{1IN} , R _{2IN}	±30V
Output Voltages	
T _{1OUT} , T _{2OUT}	(V ₊ + 0.3V) to (V ₋ - 0.3V)
R _{1OUT} , R _{2OUT}	-0.3V to (V _{CC} + 0.3V)

Short Circuit Duration	continuous
T _{1OUT} , T _{2OUT}	continuous
Power Dissipation	
CERDIP	500mW
derate 9.5mW/°C above 70°C	
Plastic DIP	375mW
derate 7mW/°C above 70°C	
Small Outline (SO)	375mW
derate 7mW/°C above 70°C	

Stresses above those listed under Absolute Maximum Ratings may cause permanent damage to the device. These are stress ratings only and functional operation of the device at these or any other conditions above those indicated in the operational sections of the specifications is not implied. Exposure to absolute maximum rating conditions for extended periods may affect device reliability.

ELECTRICAL CHARACTERISTICS

(V_{CC} = 5V ± 10%, T_A = operating temperature range, test circuit unless otherwise noted)

PARAMETER	CONDITIONS	MIN	TYP	MAX	UNIT
Output Voltage Swing	T _{1OUT} , T _{2OUT} loaded with 3kΩ to ground	+5V	±9	±10	V
Power Supply Current	T _A = +25°C		5	10	mA
Input Logic Threshold Low	T _{1IN} , T _{2IN}			0.8	V
Input Logic Threshold High	T _{1IN} , T _{2IN}	2.0			V
Logic Pullup Current	T _{1IN} , T _{2IN} = 0V		15	200	μA
RS-232 input Voltage Operating Range		-30		+30	V
RS-232 Input Threshold Low	V _{CC} = 5V, T _A = +25°C	0.8	1.2		V
RS-232 Input Threshold High	V _{CC} = 5V, T _A = +25°C		1.7	2.4	V
RS-232 Input Hysteresis	V _{CC} = 5V	0.2	0.5	1.0	V
TTL/CMOS Output Voltage Low	I _{OUT} = 3.2mA			0.4	V
TTL/CMOS Output Voltage High	I _{OUT} = -1.0mA	3.5			V
Propagation Delay	RS-232 to TTL or TTL to RS-232		0.5		μs
Instantaneous Slew Rate	C _L = 10pF, R _L = 3-7kΩ, T _A = 25°C (Note 1)			30	V/μs
Transition Region Slew Rate	R _L = 3kΩ, C _L = 2500pF Measured from 3V to -3V or -3V to +3V		3		V/μs
Output Resistance	V _{CC} = V ₊ = V ₋ = 0V, V _{OUT} = ±2V	300			Ω
RS-232 Output Short Circuit Current			±10		mA

Note 1: Sample tested

V₊, V₋ LOAD IMPEDANCES VS. V_{CC}

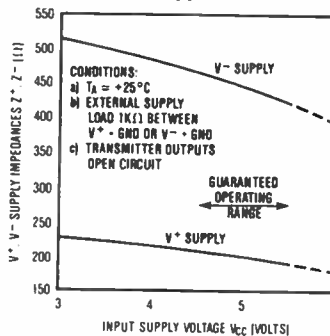

V₊, V₋ OUTPUT VOLTAGES VS. LOAD CURRENT

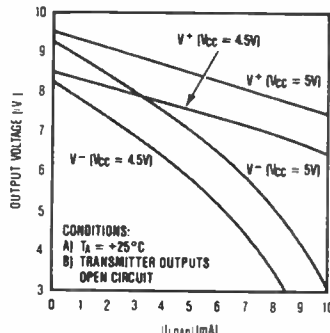

Ordering Information

PART	TEMP. RANGE	PACKAGE
MAX232CPE	0°C to +70°C	16 Pin Plastic DIP
MAX232CWE	0°C to +70°C	16 Pin Small Outline
MAX232C/D	0°C to +70°C	Dice
MAX232EPE	-40°C to +85°C	16 Pin Plastic DIP
MAX232EWE	-40°C to +85°C	16 Pin Small Outline
MAX232EJE	-40°C to +85°C	16 Pin CERDIP
MAX232MJE	-55°C to +125°C	16 Pin CERDIP

Detailed Description

The MAX232 has three sections: a dual transmitter, a dual receiver, and a +5V to ±10V dual charge pump voltage converter.

+5 to ±10V Dual Charge Pump Voltage Converter

The MAX232 power supply section contains two charge pumps. The first uses external capacitor C1 to double the +5V input to +10V, with an output impedance of approximately 200 ohms.

The second charge pump uses external capacitor C2 to invert the +10V to -10V, with an overall output impedance of 450Ω (including the effects of the +5 to +10 voltage doubler impedance).

The test circuit uses 22μF capacitors for C1-C4, but the value is not critical. Normally these capacitors are low cost aluminum electrolytic capacitors, or tantalum if size is critical.

Increasing the value of C1 and C2 to 47μF will lower the output impedance of the +5V to +10V doubler by about 5 ohms and the +10V to -10V inverter by about 10 ohms. Increasing the value of C3 and C4 lowers the ripple on the ±10V power supplies, thereby lowering the ripple on the RS-232 outputs. The value of C1-C4 can be lowered to 1μF in systems where size is critical, at the expense of an additional 20 ohms impedance in the +10V output, 40 ohms additional impedance at the -10V output, and 250mV of 16kHz ripple on V₋.

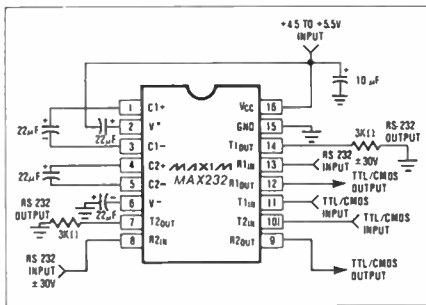

Figure 1 Test Circuit

Transmitter Section

Each of the two transmitters is a CMOS inverter powered by the $\pm 10V$ internally generated supplies. The input is TTL and CMOS compatible, with a logic threshold of about 26% of V_{CC} (1.3V for 5V V_{CC}). The input of an unused transmitter section can be left unconnected; an internal 400 kilohm pullup resistor connected between the transmitter input and V_{CC} will pull the input high, forcing the unused transmitter output low.

The open circuit output voltage swing is from $(V^- - 0.6V)$ to V^- . The output swing is guaranteed to meet the RS-232C specification of $\pm 5V$ minimum output swing under the worst case conditions of both transmitters driving the 3 kilohm minimum load impedance, the V_{CC} input at 4.5V, and maximum allowable ambient temperature. Typical voltage swing with 5 kilohm loads and $V_{CC} = 5V$ is $\pm 9V$.

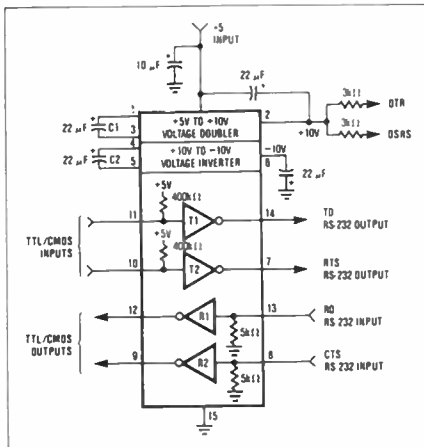

Figure 2 Typical Application -5V Powered RS-232 Dual Transmitter/Receiver

As required by the EIA RS-232C specification, the slew rate at the output is limited to less than $30V/\mu s$, and the powered-down output impedance will be a minimum of 300 ohms with $\pm 2V$ applied to the outputs with $V_{CC} = 0V$. The outputs are short circuit protected and can be short circuited to ground indefinitely.

Receiver Section

The two receivers fully conform to RS-232C specifications; their input impedance is between 3 kilohms and 7 kilohms, they can withstand up to $\pm 30V$ inputs (either with or without 5V power applied), and their input switching thresholds are within the $\pm 3V$ limits of the RS-232C specification. To ensure compatibility with either RS-232 inputs or TTL/CMOS inputs, the MAX232 receivers have a V_{IL} of 0.8V and V_{IH} of 2.4V. The receivers have 0.5V of hysteresis to improve noise rejection.

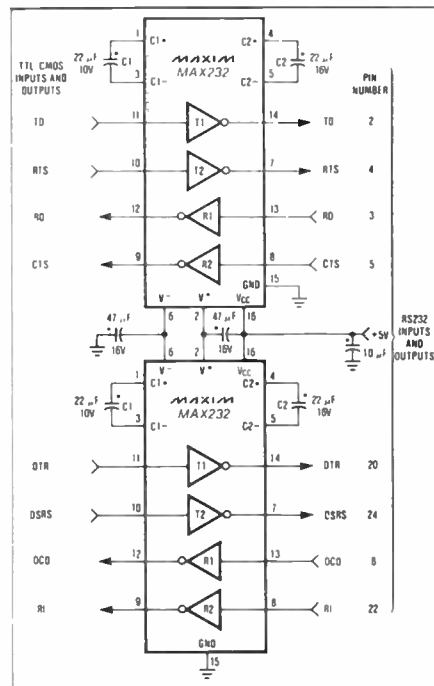

Figure 3 Combining 2 MAX232 For 4 RS-232 Inputs and RS-232 Outputs

The TTL/CMOS compatible output of the receiver will be low whenever the RS-232 input is greater than 2.4V. The receiver output will be high when the input is floating or driven between $-0.8V$ and $-30V$.

MAX231 +5V and +12V Powered Dual RS-232 Transmitter/Receiver

General Description

The MAX231 is a dual RS-232 transmitter/receiver that meets all EIA RS-232C specifications while operating from +5V and +12V. The MAX231 contains an onboard charge pump voltage inverter, eliminating the need for a -12V supply. The MAX231 can be operated from a 9V battery since the +12V supply can range from 7.5V to 13.2V.

The MAX231 contains four level translators. Two of the level translators are RS-232 transmitters which convert TTL/CMOS input levels to $\pm 9V$ RS-232 outputs.

The other two level translators are RS-232 receivers, which convert RS-232 inputs to 5V TTL/CMOS output levels. These receivers have a nominal threshold of +1.4V, a typical hysteresis of 0.5V, and can operate with up to $\pm 30V$ inputs.

Features

- ◆ Meets all RS-232S Specifications
- ◆ 2 Drivers and 2 Receivers
- ◆ Onboard Voltage Inverter
- ◆ $\pm 30V$ Input Levels
- ◆ Low Power CMOS: 5mA

Applications

The MAX231 is particularly useful where +5V and +12V supplies are available but there is no -12V supply. The MAX231 is also suited for battery powered systems which have a $5V \pm 10\%$ supply and a battery voltage between 7.5V and 13.2V.

- Computers
- Peripherals
- Instruments
- Modems
- Battery Powered Systems

ABSOLUTE MAXIMUM RATINGS

V_{CC}	+6V
V^-	$(V_{CC} - 0.3V)$ to +15V
V^+	-15V
Input Voltages	-0.3V to $(V_{CC} + 0.3V)$
$T1_{IN}, T2_{IN}$	+30V
$R1_{IN}, R2_{IN}$	+30V
Output Voltages	$(V^+ + 0.3V)$ to $(V^- - 0.3V)$
$T1_{OUT}, T2_{OUT}$	$(V^+ + 0.3V)$ to $(V^- - 0.3V)$
$R1_{OUT}, R2_{OUT}$	-0.3V to $(V_{CC} + 0.3V)$

Stresses above those listed under "Absolute Maximum Ratings" may cause permanent damage to the device. These are stress ratings only and functional operation of the device at these or any other conditions above those indicated in the operational sections of the specifications is not implied. Exposure to absolute maximum rating conditions for extended periods may affect device reliability.

ELECTRICAL CHARACTERISTICS

$(V_{CC} = 5V \pm 10\%, 7.5V; V^- \leq 13.2V, T_A = \text{operating temperature range, test circuit unless otherwise noted})$

PARAMETER	CONDITIONS	MIN	TYP	MAX	UNITS
V_{CC} Range		4.5		5.5	V
V^+ Range		7.5		13.2	V
Output Voltage Swing	$T1_{OUT}, T2_{OUT}$ loaded with 3k to ground	± 5			V
Supply Current	I_{CC}		0.4	1	mA
	I^+ , No load on $T1_{OUT}, T2_{OUT}$		1.8	5	mA
Input Logic Threshold Low	$T1_{IN}, T2_{IN}$	0.8			V
Input Logic Threshold High	$T1_{IN}, T2_{IN}$			2.4	V
Logic Pullup Current	$T1_{IN}, T2_{IN} = 0V$			200	μA
RS-232 Input Voltage Operating Range		-30		+30	V
RS-232 Input Threshold Low		0.4	1.2		V
RS-232 Input Threshold High			1.7	2.4	V
RS-232 Input Hysteresis		0.2	0.5	1.2	V
RS-232 Input Resistance	$R1_{IN}, R2_{IN}, T_A = +25^\circ C$	3		7	k Ω
TTL/CMOS Output Voltage Low	$I_{OUT} = 3.2mA$			0.4	V
TTL/CMOS Output Voltage High	$I_{OUT} = -0.5mA$	3.5			V
Propagation Delay	RS-232 to TTL or TTL to RS-232		0.7		μs
Instantaneous Slew Rate	$C_L = 10pF, R_L = 3-7k, T_A = +25^\circ C$ (Note 1)			30	$V/\mu s$
Transition Region Slew Rate	$R_L = 3k, C_L = 2500pF$ Measured from +5V to -5V or -5V to +5V		3		$V/\mu s$
Output Resistance	$V_{OUT} = \pm 2V$	300		± 10	Ω
RS-232 Output Short Circuit Current					mA

Note 1: Sample tested

MAX231

Typical Operating Circuit

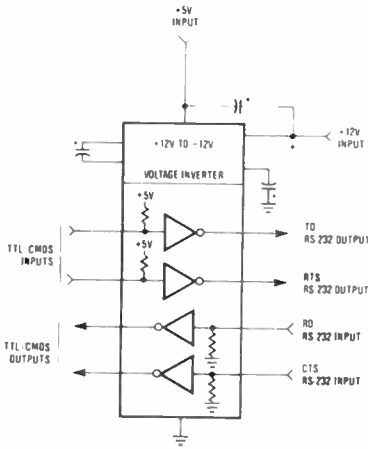

Pin Configuration

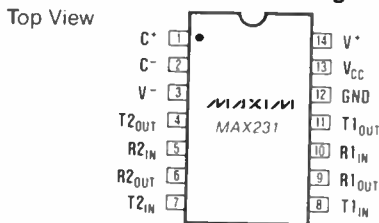

14 Lead Plastic DIP

Detailed Description

The MAX231 has three sections: a dual transmitter, a dual receiver, and a +12V to -12V charge pump voltage inverter.

Charge Pump Voltage Inverter

The MAX231 does not require a -12V power supply because it uses external capacitors C1 and C2 to invert the V+ supply voltage. The V- output impedance is about 200 ohms with +12V applied to V+, increasing to about 300 ohms when V+ is 75V (see graph). Small amounts of current can be drawn from the V- output, as shown in the graph on the adjacent page.

The test circuit uses two external 4.7μF capacitors, but the value is not critical. Decreasing the capacitor value to 1μF will increase the V- ripple voltage and slightly decrease the negative output voltage of the RS-232 transmitters, but will not otherwise affect operation. A larger value output filter capacitor can be connected between V- and ground to reduce the V- ripple if the V- is used to provide power for a negative supply.

Normally these capacitors are low cost aluminum electrolytic capacitors. Use tantalum capacitors if size is critical.

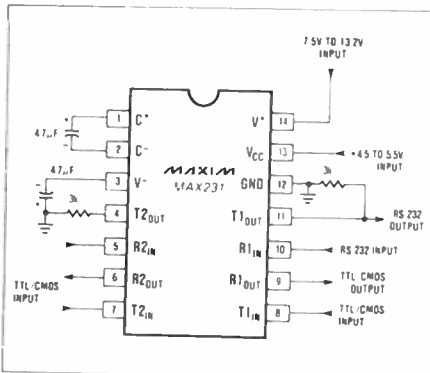

Figure 1 Test Circuit

Transmitters

The two transmitters are level translators whose inputs are TTL and CMOS compatible, and whose outputs meet the EIA RS-232 specification. The input has a logic threshold of about 24% of VCC (1.2V for 5V VCC). The input of an unused transmitter section can be left unconnected; an internal 400 kilohm pullup resistor connected between the input and VCC will pull the input high, forcing the output negative.

The open circuit output voltage swing is from (V+ - 0.6V) to V-. The output swing is guaranteed to meet the RS-232C specification of +5V minimum output swing with both transmitters driving the 3 kilohm minimum load impedance, as long as the V+ supply voltage is above 75V.

As required by the EIA RS-232 specification, the slew rate at the output is limited to less than 30V/μs, and the powered-down output impedance will be a minimum of 300 ohms with +2V applied to the outputs with VCC and V+ equal to 0V.

The outputs are short circuit protected and can be short circuited to ground indefinitely.

Receivers

The two receivers fully conform to the RS-232C specification; their input impedance is between 3 kilohms and 7 kilohms, they can withstand up to +30V inputs (either with or without V+ and VCC power applied), and their input switching threshold is within the +3V limits of the RS-232C specification. The MAX231 receivers have a VIH of 0.4V and VIL of 2.4V allowing their use with either RS-232 levels or CMOS logic levels. The receivers have 0.5V of hysteresis to improve noise rejection.

The TTL/CMOS compatible output of the receiver is low whenever the RS-232 input is greater than +2.4V. The receiver output is high whenever the RS-232 input is floating or is driven between -0.4V and -30V.

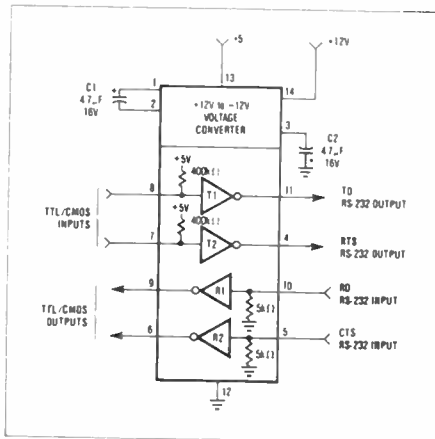

Figure 2 Typical Application RS-232 Dual Transmitter Receiver

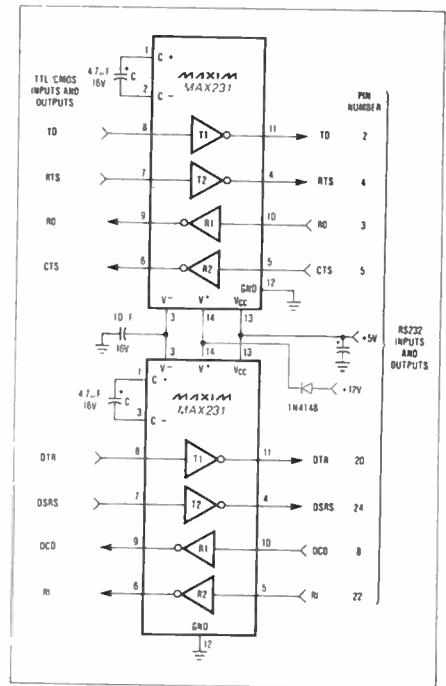

Figure 3 Combining 2-MAX231s for 4-RS-232 Inputs and 4-RS-232 Outputs

Power Supply Sequencing

As noted in the Absolute Maximum Ratings, V+ should always be more positive than the VCC input. There is a parasitic diode between V+ and VCC, and large fault currents will flow if V+ is grounded while 5V is applied to VCC. These fault currents can also cause SCR latchup and destruction of the MAX231 during system power-up if the +12V power supply is slower to start up than the +5V power supply.

All devices in the system can be protected by connecting a Schottky diode between the +12V and +5V supplies such that the +5V supply will pull the +12V power bus up to 4.7V, even if the +12V power supply fails, is disconnected or turned off, or is slow in powering up. Figure 3 shows a second method of protecting one or more MAX231 by inserting a diode in series with the V+ supply. This prevents any reverse current flow out of the MAX231 V+ pin.

MAX231 V- OUTPUT VOLTAGES vs. LOAD CURRENT

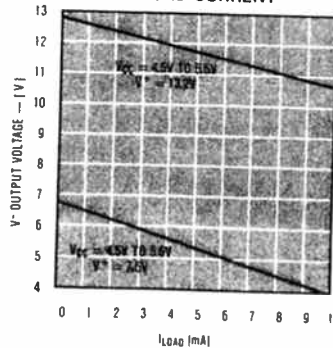

Data supplied by Geoff Wood Electronics, courtesy of the distributors, R&D Electronics who have offices in Melbourne and Sydney.

Ordering Information

PART	TEMP. RANGE	PACKAGE
MAX231CPD	0°C to +70°C	14 Lead Plastic DIP
MAX231CWE	0°C to +70°C	16 Lead Small Outline
MAX231C D	0°C to +70°C	Dice
MAX231EPD	40°C to +65°C	14 Lead Plastic DIP
MAX231EWE	-40°C to +85°C	16 Lead Small Outline
MAX231EJD	40°C to +85°C	14 Lead CERDIP
MAX231MJJD	55°C to +125°C	14 Lead CERDIP

Local team beat the world with high speed controller card

Being first-in, best-dressed with rapidly developing technology in computer hardware has often been the successful strategy of many Silicon Valley companies. But it seems Melbourne-based computer hardware manufacturer, Pulsar Electronics, has beaten Silicon Valley at its own game.

Pulsar has released a controller card for connecting "enhanced small device interface" (ESDI) Winchester-type mass storage drives (85 megabytes capacity) to PCs.

The Pulsar ESDI controller transfers data at just under 1Mbyte/second, offering an improvement of some 400% over conventional drives.

In local area network (LAN) systems, the rate of data transfer to and from the file server is one of the most inhibiting factors to performance. For example, an AT (80286 uP) running at 10 MHz can only transfer data to and from a voice coil drive at 250Kbytes/second.

In CAD systems, where large files of 150-350 Kbytes or more are common, screen re-writes or file calls may take 30 seconds to several minutes, wasting considerable operator time when accumulated over a period. Pulsar's ESDI controller can make massive time savings here, the company said at the launch in June.

So, for anything that's I/O or drive intensive, this ESDI interface gives higher throughput and access to higher capacity drives.

Based on the Advanced Micro Devices (AMD) just-released AMD9590 controller chip, the product took six months to design and get production units on the market.

Pulsar's R&D team started working with prototype devices last December. The AMD9590 was only released at the end of May and Pulsar started their first production runs that week, Managing Director Phil Delacretaz said at the launch.

For the first time, Pulsar says, this controller enables PCs to carry and service data files as large as one Gigabyte under MS-DOS, without the need for special drivers.

The card, including Golden Bow disk management software, costs \$498 inc. tax, and is available with the US-made CAST ESDI 85M drive unit for \$3490, inc. tax. The card will be marketed by CAST in the US and Pulsar expect sales of 10 000 pieces within six months. Further details from Pulsar, Lot 21, Catalina Drive, Tullamarine 3043 Vic. (03)330 2555.

Attention Sydney enthusiasts

Sydney computer enthusiasts will be interested to know that the Sutherland Micro Computer Users Group (formerly the Sutherland Super-80 Group) meets on the third Sunday each month at 1.30 pm at various venues around Sydney.

The group's interests cover all aspects and applications of home computers, peripherals

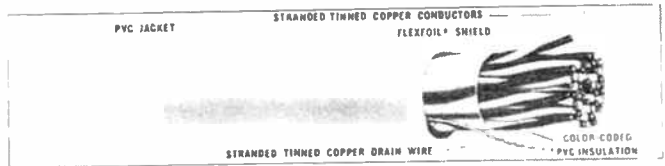

Carol cables

The first three types of specialised electronic cable to be imported into Australia from Carol Cable Company of America are now available from Multi-Contact Australia Pty Ltd.

Carol Cable Company, the largest cable and wire manufacturer in North America, recently appointed Multi-Contact as its first and exclusive Australian distributor.

Multi-Contact can now supply ex-stock, two types of Carol paired shielded computer cables specially designed for use in data transmission, control circuits and signal applications in computers and industrial equipment. Both are direct Belden equivalents.

These cables feature semi-

rigid PVC insulation, UL style 1061, CSA Type SR-PVC, conductors cabled in pairs, overall 100% flexfoil aluminium foil/polyester shield and stranded tinned copper drain wire. Conductor strand is 7/32.

Carol cable C0601 (Belden 9502) contains two pairs of conductors while Carol cable C0602 (Belden 9503) has three pairs of conductors.

The third Carol cable available from Multi-Contact is a shielded quad cable with PVC jacket designed for audio, communications and instrumentation use.

All three Carol cables are immediately available from Multi-Contact Australia Pty Ltd, Sydney (02) 438 3600; Melbourne (03) 383 3733; Brisbane (07) 369 0544; Perth (09) 443 3944.

and related hobby-constructed hardware.

Further information is available from the Secretary/Treasurer, E.J. Wiseman, on (02)522 5411.



An open and shut case!

Electronic Solutions, claiming to be Australia's largest importer of enhancement products for the IBM PC and compatibles, has just the box if you're bolting together your own system.

The cases are sturdily constructed to "regulation" IBM PC size, according to Ian Hardwick, the brains behind Electronic Solutions. It features a flip-up, hinged lid and sells for a mere \$95.00 inc. tax.

Contact Electronic Solutions, PO Box 426 Gladesville 2111 NSW. (02)427 4422.

FORTH for Zilog's Super8

Zilog has further enhanced its microcontroller product family, introducing a new version of its powerful 20 MHz Super8 MCU, now equipped with machine level FORTH.

FORTH, not widely known until recently, is rapidly gaining a following in the process control and automotive industries, according to Zilog's director of marketing, Al Hamilton.

The Super8 is marketed in Australia through the George Brown Group - Marketing Division, 456 Spencer St, West Melbourne 3003 Vic. (03)329 7500.

LASERLINK
LASERLINK
LASERLINK

INTRODUCES 24 "NEW" COMMANDS FOR YOUR VZ200/300

Your VZ can now be Level II compatible for only **\$35**

Telephone Gavin Williamson - (049)62 1678 - for name of agent in your state

LARGE RANGE OF SOFTWARE & HARDWARE AVAILABLE FOR VZ

New life for an old VZ

Graeme Meager

Since the introduction of the VZ200 computer in early 1983 many users have been mystified by the fact that the computer did not support full level II BASIC. This article describes a method of gaining 24 extra level II BASIC commands for the VZ 200 or 300 without sacrificing any memory or software compatibility.

RECENTLY a team of enthusiasts released a revamped 16K ROM (read only memory) for the VZ with the convenience of LEVEL II BASIC on power-up and with some technical knowledge, every user can smarten up their computer.

As many users may remember, the existing ROMs were a major cause of breakdowns and possibly there are still many old VZs put away in cupboards which can be brought back to life with these new ROMs. This particular occurrence prompted one user to investigate the viability of producing an EPROM to replace the original BASIC ROM. When it was discovered an EPROM was available that was pin compatible with the old 16K ROM, the task for VZ300 owners was made very simple. VZ200 owners should not despair, with the addition of just two diodes and one resistor both 8K ROMs can be replaced by this single 16K chip.

Before entering into details of the hardware modifications, I will briefly describe the extra facilities the new ROM will provide and how they have been implemented.

THE ADDITIONAL BASIC COMMANDS:

TROFN	TROFF	DELETE	AUTO
FIX	CINT	ERROR X	ERR
POS	ON	DEFINT	DEFSNG
RANDOM	MEM	ON ERROR	VARPTR
DEFDBL	RESUME	FRE	CDBL
ERL	STRING\$	DEFSTR	ON (GOTO)

Inverse characters

Owners of GP 100 and compatible printers will be familiar with the badly represented inverse character set; these errors have been corrected in the new ROM. For the owners of EPSON and compatible printers, a version of the EPROM with the modified control codes and inverse character tables is currently being compiled.

The above BASIC commands have been integrated with the original command set, which as a major consideration, enables all existing software to run unimpeded in the new system. The new ROM provides all commands without those messy loader routines, machine code calls and it is DOS (disk operating system) compatible.

The software

Statement and command execution in the VZ is by interpretation. This means that a routine dedicated to the statement type or command is called to interpret each line and perform the necessary operations. This is a common method of system command execution and is used by many other BASIC systems. Within the BASIC ROM there is a table known as the RESERVE WORD LIST. This table contains all of the words reserved for use by the BASIC interpreter.

When a line is read by the interpreter it scans this list and if the word (command) is present it will allocate a TOKEN value in the range 80 (HEX) to FB (HEX). This token will be

written into memory as the BASIC command. From here on the interpreter will act on these tokens and not the original word. Each of the new commands have their own token with the allocated range and will be acted on in the same way the existing commands are. At this stage it should be noted that the original LEVEL II BASIC did not support routines for commands such as COPY, COLOR, MODE, SOUND, CRUN, CLOAD and VERIFY. These commands have used tokens originally set for other LEVEL II reserved words. The new VZ ROM actually supports more BASIC commands than the original LEVEL II ROM in the TRS-80 and SYSTEM 80 (for non-disk systems).

Once a value has been allocated, execution is passed to the VERB ADDRESS TABLES. Here the table is used to direct the interpreter to the routines specified by each TOKEN. There are two VERB ADDRESS TABLES: the first is used for statements that begin with a — VERB — for example END, RANDOM or PRINT. If the statement does not begin with a token, control goes to the assignment statement processing. The second table contains the addresses of verb routines which only occur on the right side of an equals sign or complement the first verb — for example PEEK, FRE, SGN.

The new commands have been implemented by writing new values into the above tables, so the interpreter can be directed to the relevant processing routines.

As mentioned earlier, a number of areas in the ROM had to be re-organised. For example, the token 9E in the VZ ROM is allocated to the word SOUND and not the word ERROR, as originally written. Routines within the ROM had to be corrected so that when the interpreter was confronted with a format such as "ON ERROR GOSUB . . ." it would recognise the line as correct syntax.

Other commands and routines are under investigation, and as they are proven compatible I understand they will be released as an update to enhance the new ROM on a change-over basis at a minimal price to purchasers. Each of the EPROMS released carry a programmed serial number to identify their generation and is apparent in the start-up header which reads as follows:

```
LASERLINK BASIC  
VER. 2 #2130  
READY
```

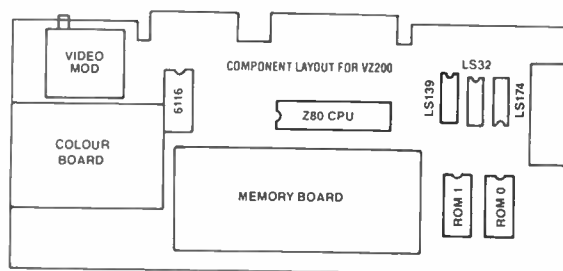

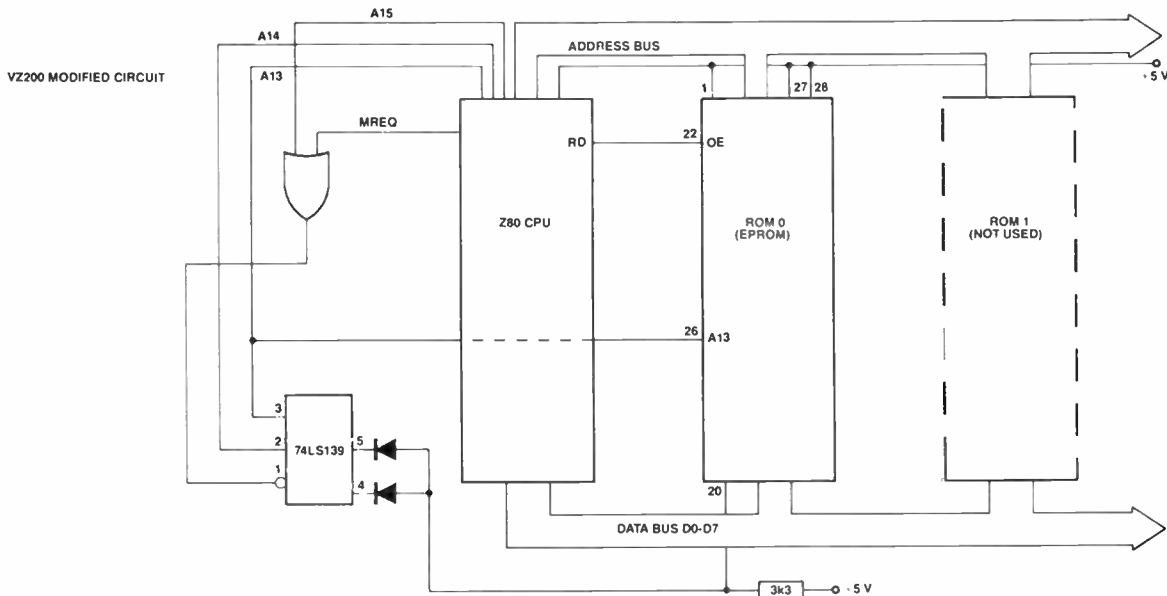

The hardware

Firstly, readers should be aware of the following points:

- (a) any hardware modifications will void any warranty if current,
- (b) this project should only be attempted by someone with reasonable soldering and desolder skills,
- (c) to date, the modification has been carried out on VZ200s, both early and recent VZ300s (brown keyboard) and the LASER 200/310.

A check of compatibility with the following details should be made before commencement.

The case of the computer can be separated by removing the six screws from the bottom half. Care should be taken not to snap any of the keyboard cables. The main circuit board must then be separated by removing the screws holding it to the base. The wires to the piezo transducer will not have to be disconnected if they are long enough to rotate the board to gain access to the solder side.

The next step is to remove the RF shield by desoldering the lugs and braids attaching it to the board. For the VZ300, the diagram here should help locate the 28-pin ROM. The old ROM should be carefully desoldered and removed to be replaced by a DIL socket that is provide with the new EPROM. The unit can then be assembled and tested.

For the VZ200, two 8K ROMs can be replaced with a single 16K ROM by adding the necessary addressing circuitry and one extra memory address line. From the extract of the VZ200 circuit shown here, the 74LS139 decoder allows addressing of 000-1FFF(HEX), the first 8K ROM and 2000-3FFF(HEX) for the second 8K. These outputs need to be combined by diodes to access the full 16K. A resistor is needed to pull the chip select pin (active low) high during non-access periods. To read the full 16K, address line 13 is

needed. The second diagram will help locate the two 24-pin ROMs which can be removed in the same manner. As it will be noticed, the board caters for a 28-pin socket so no extra holes are needed.

The 28-pin socket should be inserted in the position nearest the regulator heatsink. Pin 26 of the socket should be disconnected from the +5 V common with a sharp knife to cut the printed circuit track. Pin 27 should then be connected to pin 28 (+5 V). A piece of hookup wire will be needed to connect pin 26 (A13) to pin 3 of the Z80 CPU. As shown in the diagram the two diodes and the 3k3 pullup resistor can be soldered on the bottom of the board using spaghetti to insulate them from other components. The diodes are connected between pins 4 and 5 of the 74LS139 and pin 20 of the EPROM, which is in turn tied high by the 3k3 resistor.

Check carefully for any solder bridges on both sides of the board, and when you are certain everything is correct, you can re-assemble and test.

At \$35 (postage paid) the new EPROM is available from **LASERLINK**
20 Brunner Rd
Broadmeadow 2292 NSW
(049) 62 1678

The EPROM comes complete with socket and full documentation which includes demonstration listings for each of the 24 new commands. A list of state agents can be obtained from the above address. All in all, you'll find it a worthwhile enhancement. 📌

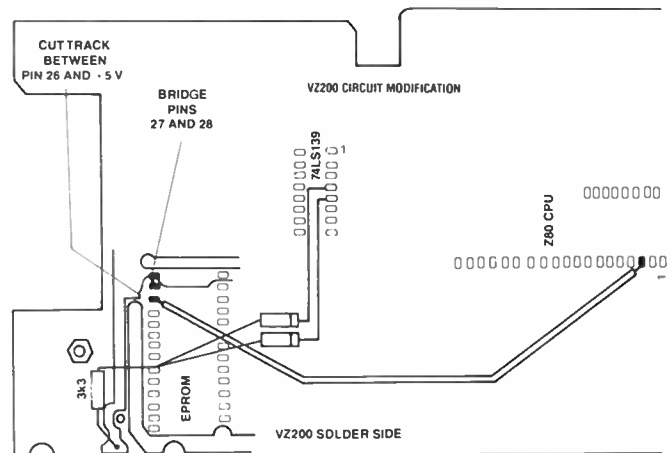
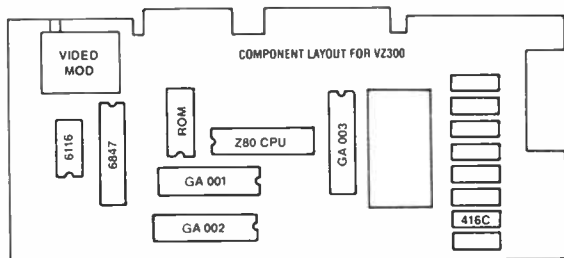

ISDN

THE TOPIC for general discussion this month is the newly emerged ISDN telephone network proposal. This is being sponsored under the patronage of the CCITT (the international telephone and telegraph consultative committee) and several trial systems are already running in at least three different countries (France and Canada are already operating – Japan has just installed their first). Basically, ISDN (Integrated Services Digital Network) is the combination of all existing telecommunications services into a single network, based on digital transmission principles. This means that the normal analogue voice-type line must have the signal converted to a digital representation, using DSP chips such as were discussed in last month's column. ISDN transmission is expected to be far more cost effective than existing methods of voice/data transmission. A graph⁽¹⁾ showing the node cost for each of the existing telecommunications services is shown below. This graph shows that ISDN should have become the cheapest method of service provision by mid-way through this year.

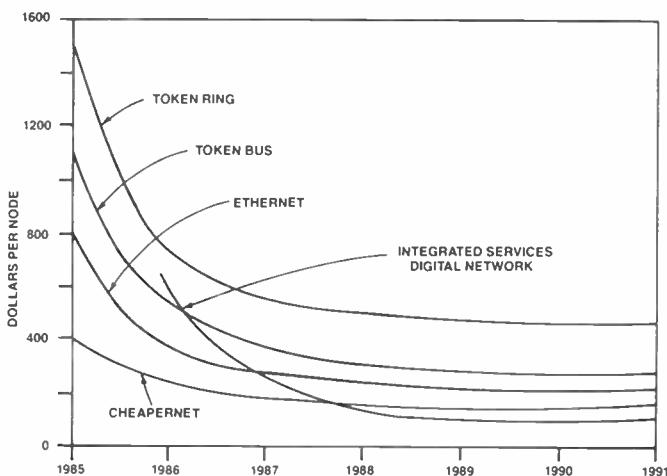

FIGURE 1.
Cost per node of various telecommunications networks.

A typical implementation of ISDN is shown in the diagram here. There are two "layers" to the plan, designated as "Basic Access" and "Primary Access", based on the size of the proposed user installation.

The Basic Access mode is defined by the CCITT as being the one to service small installations, such as homes and small offices. This ISDN channel will handle 192 kb/s. The Primary Access channel, designed for larger system users, will handle data transfer rates of 1.544 Mb/s in the continental US and 2.048 Mb/s in Europe and Japan. I will quote from the source used for this article:

"In basic access service, the interface between the customer premises and the central office, designated as U by the CCITT, is the point where the 192 kb/s channel is divided into two 64 kb/s data or voice-carrying channels, designated B channels, and a 16 kb/s signaling channel, designated the D channel. This allocation is commonly referred to as 2B + D and gives an effective channel capacity of 144 kb/s. The remainder is used for framing and other overhead signals.

"In the CCITT formulation, the network termination point 1 converts the channels from the two-wire local-loop format to the four-wire format used on customer premises. The S and T interfaces provide the link to the customer's telephones and/or terminals. The S and T interfaces are identical for most practical purposes and are combined in the basic access format.

In the CCITT's primary access format, the North American 1.544 Mb/s channel is converted to 23 x 64 kb/s B channels plus a 64 kb/s D channel (23B + D). Europe will use a 30B + D format in its 2.048 Mb/s channel. In this format, the S interface provides the interface to the loop at NT1, the first network termination point, and the T interface provides the interface to the PBX."

It is not yet known which route Telecom is planning to travel, although I suspect it will follow the European format. It should be fairly obvious from the above that fast DSP chips will be required to provide the 64 kb/s channels. Remember that most of our current serial terminals and boards only operate up to 19.2 kb/s. This requirement is providing quite a challenge for the manufacturers of fast A/D converters.

Some chip makers are falling over themselves to provide chip sets to implement the ISDN set, but not all of these chip sets are compatible. Motorola and AMD⁽³⁾ are two companies with totally different philosophies on how the CCITT standard should be implemented. It would appear that the CCITT will also have to provide some form of standard specifying the inter-connection method to be used when implementing systems from different manufacturers. American megacompany AT&T is pushing hard⁽⁴⁾ for such a standard to be implemented. We don't want to see another Beta/VHS or 3.5/3.25" microfloppy type of battle appear to confuse the issue even further. It would appear from the total silence in some IC fabrication houses that a large number of manufacturers are also sitting in the wings, waiting to see which way major Telecom consumers jump, before committing themselves to silicon.

When ISDN is completely installed in a country, the requirement for modems will cease overnight. A large number of current modem manufacturers are investigating the move into ISDN S, T and U interface equipment, which will probably have to be installed by Telecom, rather than by buying "approved" units and performing the connection oneself.

It is rumoured that cable television facilities could also be provided over the ISDN network, so the next five years should see some interesting developments. For those interested in further reading on this topic, I have included some additional references in the bibliography.

Encore Telecom

I mentioned in my last column that Telecom was considering introducing timed charges for Bulletin Board access via modems. It would appear that this is to be the case as from the middle of next year. The way it will work is that the caller will pay the local call fee and the Bulletin Board provider will cop the rest of the charge. It is extremely public spirited of Telecom (HO! HO!) to slug the people trying to provide a public service, often at large costs to themselves, whilst still raking in the dough from all over Australia.

I sometimes think that these large government organisa-

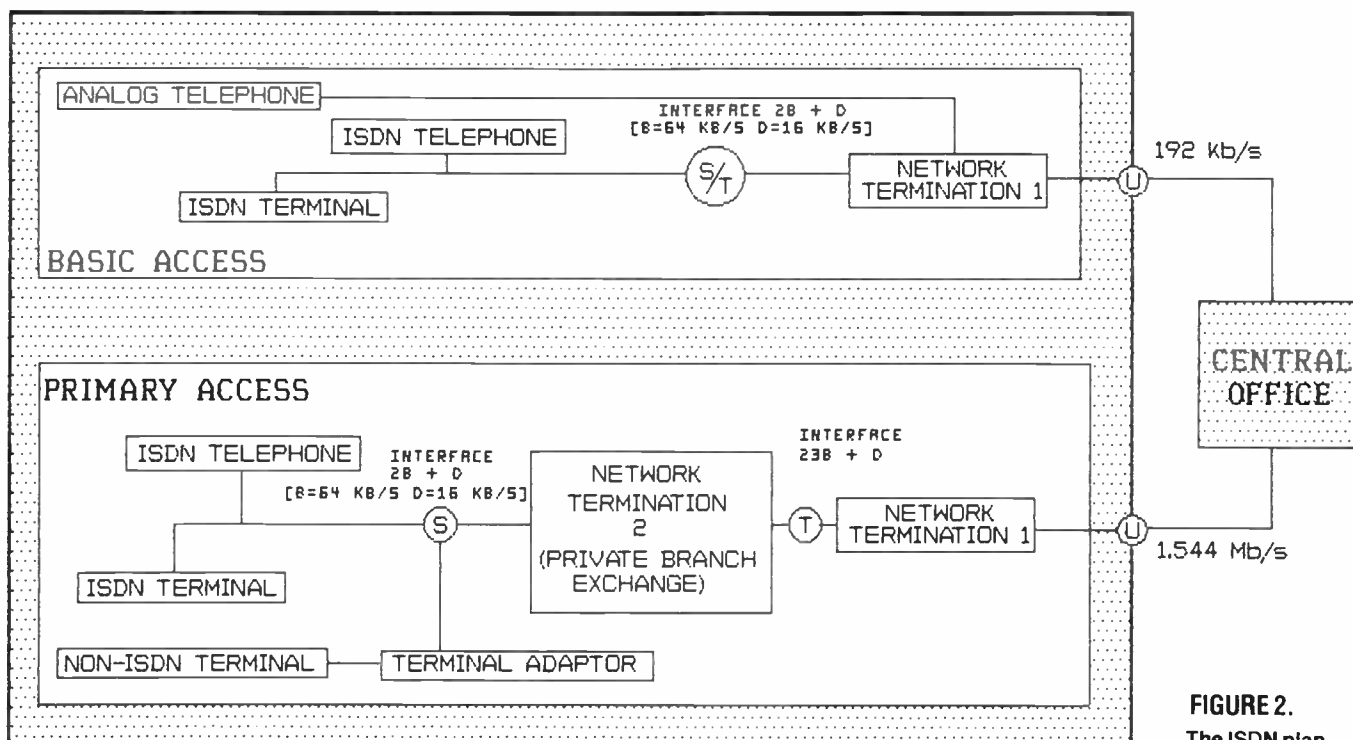

FIGURE 2.
The ISDN plan.

tions live in a different world from the rest of us. The only possible conclusion I can draw from this proposal is that Telecom is determined to close down all the BBS. I can't see many operators forking out the large sums of money that 24 hour services will accrue. Likewise, I can't see the average hobbyist being slugged with exorbitant phone bills, either. Perhaps the answer is to seek some form of advertising support from firms, or alternatively, let's sell Telecom to private enterprise. Now there's a thought!

On the same theme, Telecom has also sent out a letter to all modem manufacturers advising of increased costs for applications to connect data and voice equipment to the Telecom network. A technical assessment of a new modem is now \$700 (up by \$100), and an application involving no assessment is \$400. There is also an annual registration fee of \$150.

WOW, I wish I could do the same sort of trick with my wages. Perhaps an annual registration fee for persons wishing to use my services. It would be a great pity if these measures being taken by Telecom were to make access to dial-up services cost prohibitive. The average "hobbyist-enthusiast-hacker" is usually not sufficiently financial to be able to absorb these costs. Perhaps we should all start making loud noises to our local Federal MPs and the Minister for Communications.

Novix chips

Chris Darling has received the NC4000 kit from Charles Moore and I am impressed. Only a half dozen chips to the whole board and that includes two RAM and two ROM chips. Chris has decided that he is going to optimise the board for speed. He wants the final product to be capable of at least 6 MIPS. Any takers for kits? Also, we would like to hear from any prospective kit builders who have thoughts as to what use the board may be put when completed.

Some of the suggestions we have had so far are a graphics co-processor board for the IBM, a multi-channel logic analyser using a host computer and its monitor as a display, and a high speed speech recognition board. Let's hear of your suggestions. Eric Lindsay is gearing himself up to produce a newsletter, so it's now over to all the enthusiasts out there to provide some ideas.

REFERENCES:

1. Electronics, April 1, 1985; p. 16.
2. Electronics, August 21, 1986; pp 57-61.
3. Electronics, June 9, 1986; pp 14 & 15.
4. Electronics, January 21, 1985; p 29.
5. Electronics, May 6, 1985; pp 57-61.

MAESTRO DISTRIBUTORS

Calool St, Sth Kincumber 2256 NSW
ph: (043) 69 2913.

present

THE AEM4610
SUPERMODEM



A smart, stand-alone direct-connect serial modem •
6809 microprocessor controlled • plugs into any RS232
(serial) port • fully software controlled (Hayes-
compatible) • auto-answer, auto-dial, auto-disconnect
• 300/300 and 1200/175 bps CCITT V21 and V23 modes
• IBM and Apple Viatel software available • automatic
baud rate select • internal expansion slot • on-board
speaker • plug-pack powered • 3 months warranty.

AEM4611 1200 bps full duplex add-on now available!

AEM4610 SUPERMODEM

\$349.17 ex. tax, \$399.00 inc. tax. Fully
built and tested.

AEM4611 V22 board

\$173.58 ex. tax, \$199.00 inc. tax. Fully
built and tested. Kit less EFG7515 —
\$119.00. Kit complete — \$169.00

BANKCARD WELCOME

Using the Microbee in your amateur station

G. J. Wilson VK3AMK

3) Calculating great circle beam headings and distances.

ONE OF THE FIRST THINGS which the new radio amateur finds is that many conventional ideas of maps and country locations no longer apply. What would appear to be the correct direction to a distant country using a standard atlas projection can be quite inaccurate when compared with a great circle map. These are special maps drawn to show the true direction and distance, using the shortest path, to all other places from a given location. The point of origin upon which the map is based is always placed at the centre of these maps.

As an example of the difference between a conventional map projection as found in an atlas and a great circle map, check the path from Melbourne to Mexico City. The atlas shows it as running approximately 60 degrees east of north. The great circle or true path is actually almost 90 degrees east of north.

Great circle maps are available but are only really accurate if you are located at or near to the place for which the map has been drawn. Because they are a specialised product it is unlikely that they will be available for more than a couple of major locations in a country.

What this means in general terms is that if you are using a great circle map based on say Hobart, it will be of very limited value if you happen to live in Alice Springs or even less so in Cairns. The map can still be a guide but the accuracy will be greatly reduced. Even if you have a map centred on your area only a limited number of locations that you need will be clearly shown and the more distant countries are usually grossly distorted from their conventional shape. In most instances you will be forced to rely on estimation to find the direction and distance you are seeking.

The program described here can be used to produce a list of locations (either as a DXCC type list or other as you require) and shows the beam heading for both the short and long paths as well as the distance to the remote location. By inserting your own latitude and longitude in the program a completely individual list is produced of quite adequate accuracy for almost all amateur radio purposes.

I make no claim for originality in the mathematics used as that is based on two previously published items, both of which appeared in *Amateur Radio* (W.I.A.); the first by VK1MM in Sept. '85 p.21. and the other by VK6ZBU in Feb. '86 p.13. Reference to this material will show the basis of the operation for making individual calculations. The program here goes a step further and produces a list in booklet form for ready reference.

Only a small number of countries are listed for demonstration purposes as a full listing of all DXCC countries runs to many pages. The principle, however, remains the same whether the list is short or long. To be as accurate as possible the latitude and longitude of each location to be used must be carefully checked. This can be done by using maps such as those produced by the National Geographic Society and others. Many of the better atlases accurately list the locations of major cities, islands etc in their indexes. Local libraries, navigation material, even DX-pedition QSL cards are all useful sources for finding this information.

All "country" locations refer to the capital city (where such exists) but there is no reason why more than one location within a country cannot be listed such as states, prefectures or other subdivisions. With a 32K memory it may not be possible to go much beyond DXCC plus a few extras, check the remaining memory as you go.

```
Call sign: VK3HAA
GREAT CIRCLE BEARING AND DISTANCE
TO ALL DXCC LOCATIONS FROM:
Melbourne 3000
Latitude: -37.817
Longitude: -144.967
All distances are in KILOMETRES
to the CAPITAL of the country,
unless otherwise stated.
Bearings are from TRUE NORTH.
[ VK3HAA PRINT ]
```

FREE!

PUBLIC DOMAIN SOFTWARE

Specify the computer you have

IBM-APPLE-AMIGA

* Macintosh Library Discs

Full of the best of the available Public Domain Software

Send 6x36¢ stamps for postage.

* Add \$10 for MAC 3.5" Discs

MICRO-EDUCATIONAL P/L

8/235 Darby Street

Newcastle 2300

(049) 26 4122

Australia's Largest Computer Mail Order Company

Latitudes and longitudes must be reduced to a whole number and rounded off to three decimal places. To do this proceed as follows: e.g. 38 deg. 25 mins. 45 sec. is converted thus, $38 + (25/60 \times 1) + (45/60 \times 0.1) = 38.492$ deg. When entering locations, all latitudes SOUTH of the equator and all longitudes EAST of the 0 meridian are entered as a NEGATIVE value. i.e: -38.492, -145.238 etc.

As with previous programs this one has been kept as simple as possible but there is no reason why it can't be expanded and made more versatile. It could for example have a section for making individual calculations based on the original VK6ZBU article or have provision for changing the callsign and location to allow other stations to use the program. Both these provisions were incorporated in my original version.

Check your own location as accurately as possible and enter it and your callsign in the program where shown. The format used is for pages 11" x 8.25" and prints a cover page and then produces a page heading plus number and nineteen entries on each subsequent page. When printing is completed the pages can then be stapled into booklet form.

GREAT CIRCLE BEARING AND DISTANCE FROM: Melbourne 3000				Page 1.
A2	BOTSWANA	BEARING: 233 DEG. (S.P.)	53 DEG. (L.P.)	S.P. DISTANCE: 10594 KM.
A3	TONGA	BEARING: 75 DEG. (S.P.)	255 DEG. (L.P.)	S.P. DISTANCE: 4233 KM.
A4	OMAN	BEARING: 291 DEG. (S.P.)	111 DEG. (L.P.)	S.P. DISTANCE: 11272 KM.
A5	BHUTAN	BEARING: 313 DEG. (S.P.)	133 DEG. (L.P.)	S.P. DISTANCE: 9277 KM.
A6	UNITED ARAB EMIRATES	BEARING: 291 DEG. (S.P.)	111 DEG. (L.P.)	S.P. DISTANCE: 11654 KM.
A7	QATAR	BEARING: 289 DEG. (S.P.)	109 DEG. (L.P.)	S.P. DISTANCE: 11975 KM.
A9	BAHRAIN	BEARING: 289 DEG. (S.P.)	109 DEG. (L.P.)	S.P. DISTANCE: 12107 KM.
AP	PAKISTAN	BEARING: 307 DEG. (S.P.)	127 DEG. (L.P.)	S.P. DISTANCE: 10865 KM.
BV	TAIWAN	BEARING: 338 DEG. (S.P.)	158 DEG. (L.P.)	S.P. DISTANCE: 7464 KM.
BY	CHINA (BEIJING)	BEARING: 339 DEG. (S.P.)	159 DEG. (L.P.)	S.P. DISTANCE: 9110 KM.
C2	NAURU	BEARING: 33 DEG. (S.P.)	213 DEG. (L.P.)	S.P. DISTANCE: 4714 KM.
C3	ANDORRA	BEARING: 292 DEG. (S.P.)	112 DEG. (L.P.)	S.P. DISTANCE: 16880 KM.
C5	GAMBIA	BEARING: 219 DEG. (S.P.)	39 DEG. (L.P.)	S.P. DISTANCE: 16700 KM.
C6	BAHAMAS	BEARING: 97 DEG. (S.P.)	277 DEG. (L.P.)	S.P. DISTANCE: 15787 KM.
C9	MOZAMBIQUE	BEARING: 237 DEG. (S.P.)	57 DEG. (L.P.)	S.P. DISTANCE: 10029 KM.
CE	CHILE	BEARING: 150 DEG. (S.P.)	330 DEG. (L.P.)	S.P. DISTANCE: 11268 KM.
***	ANTARCTICA (SOUTH POLE)	BEARING: 181 DEG. (S.P.)	1 DEG. (L.P.)	S.P. DISTANCE: 5798 KM.
"	CASEY	BEARING: 204 DEG. (S.P.)	24 DEG. (L.P.)	S.P. DISTANCE: 3841 KM.
"	MC.MURDO-SCOTT	BEARING: 173 DEG. (S.P.)	353 DEG. (L.P.)	S.P. DISTANCE: 4560 KM.

PROGRAM LISTING

```

00010 REM PROGRAM DESIGNED TO BE USED WITH 16 / 32 K MICROBEE AND EPSON RX-80 PR
INTER. OTHER EQUIPMENT MAY REQUIRE PROGRAM MODIFICATIONS. COPYRIGHT G.J.Wilson 1
987.
00020 E0$ = "VK3HAA"; REM ENTER YOUR CALLSIGN AS E0$
00030 E1$ = "Melbourne 3000"; REM ENTER YOUR LOCATION AS E1$
00040 B7 = -37.817; REM ENTER YOUR LATITUDE AS B7
00050 D0 = -144.967; REM ENTER YOUR LONGITUDE AS D0
00060 B6 = 57.295779; D1 = 111.12; D4 = 0; GOTO 280
00070 DUT#1 ON
00080 IF D4 = 19 THEN LET D5 = D3 + 1; GOTO 90 ELSE 130
00090 PRINT CHR$(12);
0100 PRINT\
01110 PRINT TAB (12) "GREAT CIRCLE BEARING AND DISTANCE FROM:" TAB (52) E1$ TAB
(72) "Page " TAB (77) D5; D4 = 0
0120 PRINT\
01130 B1 = B7; D2 = D0; B1 = B1 / B6; B2 = B2 / B6; B3 = (D2 - D3) / B6
01140 B0 = SIN (B1) * SIN (B2) + COS (B1) * COS (B2) * COS (B3)
01150 B4 = - ATAN (B0 / SQR (ABS (1 - B0 * B0))) + 1.57079
01160 B5 = (SIN (B2) - SIN (B1) * B0) / (COS (B1) * SIN (B4))
01170 IF B5 > 1 THEN LET B5 = 0; GOTO 190 ELSE IF B5 < -1 THEN LET B5 = 180
01180 B5 = - ATAN (B5 / SQR (ABS (1 - B5 * B5))) + 1.57079
01190 C = INT (B5 * B6); IF SIN (B3) = < 0 THEN LET C = 360 - C
00200 R = 180 + C; IF R > 360 THEN LET R = R - 360
00210 PRINT TAB (12) E2$
00220 PRINT TAB (12) "BEARING:" TAB (20) C TAB (25) "DEG. (S.P.)" TAB (36) R TAB
(41) "DEG. (L.P.)";
00230 PRINT TAB (55) "S.P. DISTANCE:" TAB (69) INT (D1 * B4 * B6) TAB (76) "KM."
00240 PRINT
00250 D4 = D4 + 1
00260 DUT#1 OFF
00270 RETURN
00280 DUT#1 ON
00290 PRINT\
00300 PRINT CHR$(14); PRINT TAB (15) "Callsign:" TAB (25) E0$
00310 PRINT\
00320 PRINT CHR$(14); PRINT TAB (5) "GREAT CIRCLE BEARING AND DISTANCE"
00330 PRINT\
00340 PRINT CHR$(14); PRINT TAB (8) "To all DXCC locations from:"
00350 PRINT\
00360 PRINT CHR$(14); PRINT TAB (15) E1$
00370 PRINT\
00380 PRINT CHR$(14); PRINT TAB (15) "Latitudes:" TAB (26) B7
00390 PRINT\
00400 PRINT CHR$(14); PRINT TAB (15) "Longitudes:" TAB (26) D0
00410 PRINT\
00420 PRINT CHR$(14); PRINT TAB (5) "All distances are in KILOMETRES"
00430 PRINT\
00440 PRINT CHR$(14); PRINT TAB (6) "to the CAPITAL of the country."
00450 PRINT\
00460 PRINT CHR$(14); PRINT TAB (8) "unless otherwise stated."
00470 PRINT\
00480 PRINT CHR$(14); PRINT TAB (6) "Bearings are from TRUE NORTH."
00490 PRINT\
00500 PRINT CHR$(14); PRINT TAB (15) " " E0$ " PRINT "
00510 PRINT CHR$(12);
00520 PRINT\
00530 PRINT TAB (12) "GREAT CIRCLE BEARING AND DISTANCE FROM:" TAB (52) E1$ TAB
(72) "Page 1."; D5 = 1
00540 PRINT\
00550 DUT#1 OFF
00560 E2$ = "A2 BOTSWANA"; B2 = -24.676; D3 = -25.873; GOSUB 70; REM 630 > CO
UNTRY PREFIX, NAME, LAT. & LONG.
00570 E2$ = "A3 TONGA"; B2 = -21.134; D3 = 175.205; GOSUB 70
00580 E2$ = "A4 OMAN"; B2 = 23.456; D3 = -58.583; GOSUB 70
00590 E2$ = "A5 BHUTAN"; B2 = 27.609; D3 = -89.569; GOSUB 70
00600 E2$ = "A6 UNITED ARAB EMIRATES"; B2 = 25.357; D3 = -55.424; GOSUB 70
00610 E2$ = "A7 QATAR"; B2 = 25.273; D3 = -51.482; GOSUB 70
00620 E2$ = "A9 BAHRAIN"; B2 = 26.194; D3 = -50.583; GOSUB 70
00630 E2$ = "AP PAKISTAN"; B2 = 33.623; D3 = -71.045; GOSUB 70
00640 E2$ = "BV TAIWAN"; B2 = 25.678; D3 = -121.600; GOSUB 70
00650 E2$ = "BY CHINA ( BEIJING )"; B2 = 39.894; D3 = -116.460; GOSUB 70
00660 E2$ = "C2 NAURU"; B2 = -0.517; D3 = -166.933; GOSUB 70
00670 E2$ = "C3 ANDORRA"; B2 = 42.510; D3 = -1.500; GOSUB 70
00680 E2$ = "C5 GAMBIA"; B2 = 13.060; D3 = -16.591; GOSUB 70
00690 E2$ = "C6 BAHAMAS"; B2 = 25.000; D3 = 77.313; GOSUB 70
00700 E2$ = "C9 MOZAMBIQUE"; B2 = -25.839; D3 = -32.500; GOSUB 70
00710 E2$ = "CE CHILE"; B2 = -33.444; D3 = 70.666; GOSUB 70
00720 E2$ = "*** ANTARCTICA ( SOUTH POLE )"; B2 = -90.000; D3 = 0.000; GOSUB 7
0
00730 E2$ = " " CASEY"; B2 = -66.283; D3 = -110.533; GOSUB 70
00740 E2$ = " " MC.MURDO-SCOTT"; B2 = -77.800; D3 = -166.700; GOSUB 70
00750 E2$ = " " MAWSON"; B2 = -67.600; D3 = -62.883; GOSUB 70
00760 E2$ = " " MIRNY"; B2 = -66.557; D3 = -93.191; GOSUB 70
00770 E2$ = "CE0 EASTER IS."; B2 = -27.158; D3 = 109.416; GOSUB 70
00780 E2$ = "CE0 SAN FELIX IS."; B2 = -26.277; D3 = 80.125; GOSUB 70
00790 E2$ = "CE0 JUAN FERNANDEZ IS."; B2 = -33.641; D3 = 78.919; GOSUB 70
00800 E2$ = "CM CUBA"; B2 = 23.156; D3 = 82.403; GOSUB 70
00810 E2$ = "CN HONGKONG"; B2 = 35.941; D3 = 6.888; GOSUB 70
00820 E2$ = "CP BOLIVIA"; B2 = -19.030; D3 = 65.270; GOSUB 70
00830 E2$ = "CT PORTUGAL"; B2 = 38.715; D3 = 9.132; GOSUB 70
00840 E2$ = "CT2 AZORES IS."; B2 = 37.703; D3 = 25.676; GOSUB 70
00850 E2$ = "CT3 MADEIRA IS."; B2 = 32.609; D3 = 16.912; GOSUB 70
00860 E2$ = "CX URUGUAY"; B2 = -34.909; D3 = 56.143; GOSUB 70
00870 E2$ = "CV9 SAO PAUL IS."; B2 = 43.931; D3 = 60.000; GOSUB 70
00880 E2$ = "CY0 ST. PAUL IS."; B2 = 47.192; D3 = 60.151; GOSUB 70
00890 DUT#1 ON
00900 PRINT CHR$(12);
00910 DUT#1 OFF
00920 END

```



New Icom IC-275A to "take two metres by storm"

Icom's latest VHF amateur transceiver, the IC-275A is set to "take two metres by storm", the company says. Icom's IC-271A, considered "the benchmark" two metre rig since it was launched, had one drawback – mains-only operation.

The new IC-275A overcomes that problem, providing operation from a nominal 13.8 Vdc supply. Mains operation is available by fitting an internal 100% duty cycle power supply (IC-PS25).

The new rig features a direct digital synthesiser, coupled with an advanced double-PLL system, providing fast (5 ms) lock-on to a selected frequency; the company claims, plus fast PTT switching for packet and AMTOR operation.

Microprocessor control is provided by Hitachi's powerful HD64B180 CPU, providing 99 programmable memory channels, storing frequency, mode, duplex operation, and offset, together with subaudible tones, where used. Four separate, versatile scanning functions are provided.

It employs a GaAsFET front end and JFET balanced mixer for low noise and high dynamic

range. All-mode operation, like the IC-271A, is a feature. Transmitter power can be continuously adjusted over the range 2.5 W to 25 W under front panel control, essential for satellite operation.

A variety of "enhancement" modules is available – including noise blanking, notch filtering, speech compression, satellite interface, tone squelch, etc.

Further details from Icom Australia, 7 Duke St, Windsor 3121 Vic.

RF power amps

Scientific Devices Australia Pty Ltd has been nominated by E.N.I. Inc. (Electronic Navigation Industries) as its exclusive Australian representative.

E.N.I. manufactures a complete range of broadband solid state RF power amplifiers which have application in communication transmission, NMR

spectroscopy, RF/EM susceptibility, laser modulation and general laboratory instrumentation.

For more information, contact Scientific Devices Australia Pty Ltd, 2 Jacks Road, South Oakleigh 3167 Vic. (03) 579 3622.

Club news

Butch Chapman VK2BYS, Publicity Officer for the Tumut and District Amateur Radio Club, advises that their meeting times are 7.30 pm each Wednesday at the Tumut High School.

Participation is open to all ages and levels of experience. The club's two metre repeater, 146.800/146.200, should be on the air by now and locals welcome a call from visitors.

The Tumut and District Amateur Radio Club can be

contacted via 55 Herbert St, Tumut 2720 NSW. 1987 Club President is B. Minogue VK2DPZ. Club Secretary is V. Nugent VK2ALZ.

The Shepparton and District Amateur Radio Club will hold the fourth of its popular Communications Day events on Sunday 20 September.

We are advised there will be participation by disposals dealers and trade suppliers. Catering will be available and tea/coffee is supplied free of charge.

Talk-in will be on the 2m repeater VK3RGV (146.650) and on HF on 3590 and 7063 kHz. The UHF Ch. 3/33 repeater will also be monitored.

If you're interested in packet radio and satellites, we understand there are to be working displays.

Further details from the Shepparton Club, PO Box 692, Shepparton 3630 or to Peter O'Keefe VK3YF on (058)21 6070.

INTRODUCING AUSTRALIAN ELECTRONICS MONTHLY'S "ENTHUSIAST SYMPOSIUM SERIES"

Australian Electronics Monthly is planning to host a series of short symposiums for enthusiasts featuring practical and topical talks and demonstrations from staff and specialists covering aspects of topics which interest readers

Here's our first one!

FOR THE AMATEUR RADIO ENTHUSIAST:

THE "MODERN MODES" SYMPOSIUM

Covering: "VHF for the novice", "Satellites are such fun", "Dabbling in the digital modes",

"Propagation – you can't get anywhere without it", etc.

When? – Sunday September 27, from 9.00 am

Where? – Amateur Radio House, Wigram St, Parramatta, Sydney

Cost? \$12.00, includes lunch, handouts, etc.

Further details and registration to Val Harnson at AEM, (02)487 1207,

or PO Box 507, Wahroonga 2076. Registration closes Friday 18 September 1987

Commanding the Yaesu FT757 transceiver from a Commodore 64

Graham Blanchett VK2CJB

Here's a way to exploit the versatile and convenient functions available through use of the 757's "CAT" interface using a Commodore 64

THE YAESU FT757 transceiver is a modern, digitally controlled transceiver capable of receiving instructions from a computer. This article describes how a Commodore C64 computer can be connected to a Yaesu FT757 transceiver and used to send commands to the FT757 at the high (for this computer!) speed of 4800 baud. A number of menu selected routines that activate 10 switch functions and set the transmit/receive frequency to suit everybody's scanning requirements will also be detailed.

Scanning modes

There are three ways in which scanning can be used:

- (a) a slow continuous scan can be made across an amateur band;
- (b) you can select frequencies stored on a disk, such as those used by WWV, and automatically scan them to provide an indication of the M.U.F.;
- (c) or choose a scanning interval like 5 kHz and jump from one shortwave broadcast station to another. This technique is also useful when plotting the SWR performance of an antenna.

One of the most useful attributes of modern transceivers is their very high bandwidth. But this makes large changes in frequency, say 200 kHz, tedious to say the least. This is no longer a problem with the Commodore Commander. Just enter the desired frequency on the keyboard and the transceiver switches to it.

This system is very convenient in practice. I leave my C64 permanently hooked up to the FT757, even when the kids want to play games. It is a simple matter of loading the program from disk whenever it is needed.

The Yaesu interface standard

The crux of this project is, of course, the "CAT" (Computer-Aided Transceiver) system in the FT757 which allows use of an external microcomputer such as the C64 to control the memory and operating frequency functions of the transceiver. Control signals are passed to the transceiver on a non-standard RS232 serial data line, accessible at the EXT CNTL

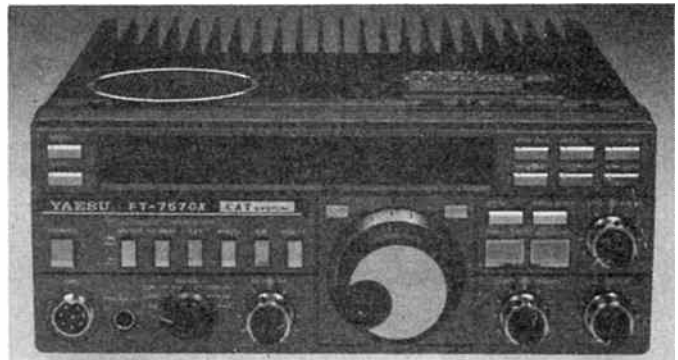

jack on the rear of the transceiver. Now the C64 also has a non-standard RS232 output which is very convenient because it allows a direct connection of the 5V TTL signal from the Commodore to the FT757. I have not used any isolation or protection and my system still works! All that is required is to connect a single pair cable from the Yaesu remote connector to the C64's user port. (See Figure 1). The only tricky part about this is sourcing the connectors — but more about this in Part II of the article.

Data format

The data format is shown in Figure 2. Five bytes of eight bits are required. Figure 3 shows how the digits are paired before being converted to binary coded decimal (BCD) values.

Once the 5-byte command has been sent to the transceiver, it will respond with the appropriate change indicated on the front panel display. Note that the controls on the front panel of the transceiver are not disabled when exercising external control; touching any control on the transceiver will still activate the respective function. This is useful if you want to fine-tune a station without computer control.

Software

The heart of the software is a machine code routine that transfers each of the required five serial bytes to the transceiver. This part of the program is loaded from data statements at

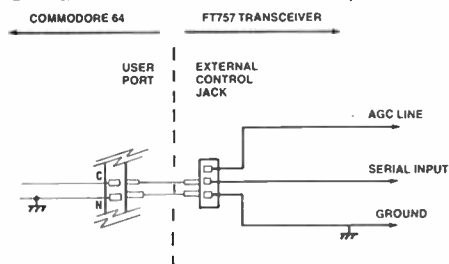

Figure 1. The Commodore 64/Yaesu transceiver connection.

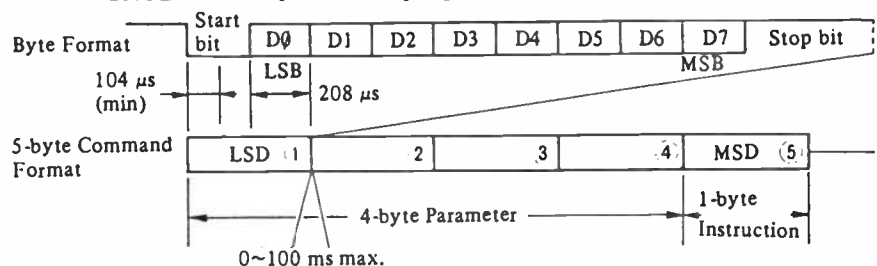

Figure 2. Format of the 4800 bits/second signal required by the Yaesu FT757 transceiver.

USING THE COMMODORE 64 TO SET A FREQUENCY ON THE YAESU FT757

Enter F on C64 keyboard
e.g: F 12.34567 (MHz) *

Group digits into pairs *

01 23 45 67

Yaesu needs least significant pair of digits last *

67 45 23 01

Convert each pair of digits to BCD and calculate the decimal equivalent of the pairs *

01100111 01000101 00100011 00000001

Calculate decimal value of each pair and add frequency set command (10) *

103 69 35 1 10

Use these decimal values in POKE 33280,A(J) command *

Machine code sequence uses 'rotate right and look at carry' command.
(Reverses order of bits)

11100110 10100010 11000100 10000000 01010000

Yaesu FT757 interprets this as:

1 2 . 3 4 5 . 6

* These steps are further explained by the flow chart.

Figure 3. Example frequency command

the beginning of the program and is described in some detail as many readers will be newcomers to machine language and assembler. Refer to Figure 4 for the disassembled listing as provided by the well known SUPERMON64 package and to Figure 5 for the flow chart. Now would be a good time to get your Commodore 64 Programmers Reference Guide out so that you can refer to the memory locations and commands used.

Firstly, the interrupt disable is activated so that the microprocessor won't be interrupted while it is carefully timing our 4800 baud word — if it's not 4800 baud then the FT757 will not recognise it.

Next, the user port is configured so that pin C is made an output. Or in other words, the input/output line PBO is designated as the pin to provide our RS232 signal. This is done by loading hex (ie: \$)01 into register A and then storing this number at hex (\$) location DD03. This address is reserved for just this purpose — refer the Commodore 64 Programmers Reference Guide. In a similar manner, address \$DD1 is set to 00 so that data is not transmitted until required.

Since our data word must have eight bits, we set the register X to \$08.

To make our pulses the correct length, the micro must be instructed to perform another operation for a precise period of time. This is done with a delay loop; that is, by setting the register Y to 30 and then decreasing this 1-by-1 until its value is zero. Since this loop will be required many times

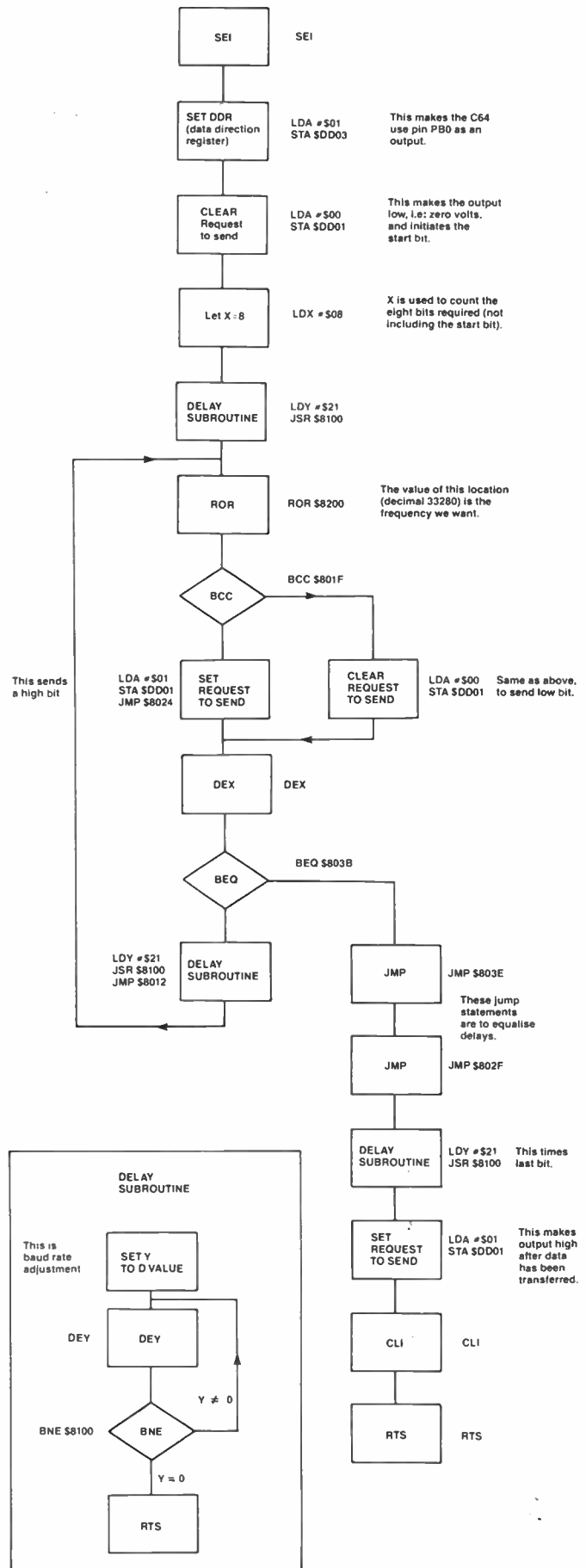

Figure 5. Flow chart of machine code serial data generator.

8000 78	SEI	Set interrupt disable status
8001 A9 01	LDA #01	Load accumulator with value 01
8003 8D 03 DD	STA \$DD03	Store the value in the accumulator at DD03
8008 A9 00	LDA #00	Load accumulator with value 00
8008 8D 01 DD	STA \$DD01	Store the value in the accumulator at DD01
800B A2 08	LDX #08	Load the index X with the value 08
800D A0 21	LDY #21	Load the index Y with the value 1F
800F 20 00 81	JSR \$8100	Jump to subroutine at address 8100 (delay)
8012 6E 00 82	ROR \$8200	Rotate value at 8200 1 bit thru' carry
8015 90 08	BCC \$801F	Branch on carry clear-ie-if a 0 was rotated
8017 A9 01	LDA #01	Load accumulator with value 01
8019 8D 01 DD	STA \$DD01	Store the value in the accumulator at DD01
801C 4C 24 80	JMP \$8024	Jump to 8024
801F A9 00	LDA #00	Load accumulator with value 00
8021 8D 01 DD	STA \$DD01	Store the value in the accumulator at DD01
8024 CA	DEX	Decrease the value of the index X by 1
8025 F0 14	BEQ \$803B	Branch to location 803B if index X = 0
8027 A0 21	LDY #21	Load index Y with value 21
8029 20 00 81	JSR \$8100	Jump to subroutine at address 8100 (delay)
802C 4C 12 80	JMP \$8012	Jump to location 8012
802F A0 21	LDY #21	Load index Y with value 21
8031 20 00 81	JSR \$8100	Jump to subroutine at address 8100 (delay)
8034 A9 01	LDA #01	Load accumulator with value 01
8036 8D 01 DD	STA \$DD01	Store the value in the accumulator at DD01
8039 58	CLI	Clear interrupt disable bit
803A 60	RTS	Return from subroutine
803B 4C 3E 80	JMP \$803E	Jump to location 803E
803E 4C 2F 80	JMP \$802F	Jump to location 802F
8100 88	DEY	Decrease the value of the index Y by 1
8101 D0 FD	BNE \$8100	Branch to location 8100 if Y not equal to 0
8103 60	RTS	Return from subroutine

Figure 4. Machine code serial data generator.

it is set up as a subroutine. This first delay corresponds to the start bit in our data word. Now for the real data.

Returning from the subroutine the frequency derived data is poked into 33280 (ie: \$8200) and is inspected by rotating the contents of address \$8200 one bit to the right. The C64 Reference Guide tells us that this is through the carry register so that if the rightmost bit is a 1 then carry is made a 1. Depending on whether the carry register holds a 1 or a 0 and with the branch on carry clear instruction, the \$DD01 address is either set to 1 or cleared to 0. ie: the next bit transmitted is either a logic 1 or 0. Register X is decremented by 1 to 7, and the delay routine used again to complete the formation of the first data bit (after the start bit).

When X has been reduced to 0 and this has been detected by the BEQ (branch on result zero) instruction the 8-bit data word is completed by a final delay loop (accessed via two jump instructions to even-up small timing differences caused by branching at the BEQ instruction). The stop bit is sent by setting the 'request to send' address. Housekeeping is completed when the micro's interrupt is cleared and control is returned to the BASIC calling program.

Note — \$8200 is decimal $(4096 \times 8) + (265 \times 2) = 33280$. ie: the address to which the basic program pokes the required data.

You might think that the above simple little routine covers all possibilities. Not so! Even though the interrupt is set, the screen updates are still exercising the micro through the so-called VIC-II colour chip. This is prevented with a poke 53256,11 comand before the 4800 baud word is formulated and followed by a poke 53265,27 after data transmission is complete. This is why the screen goes blank briefly when a command is sent.

Using the machine code routine

Refer to Figure 3 which shows the way the required data format can be obtained. Notice how the digits need to be grouped in pairs and how the binary value of the BCD pair must be converted to its decimal equivalent. This can be calculated by giving each binary bit a value (1, 2, 4, 8, 16 etc)

Figure 6. Development of an algorithm to convert BCD pairs into decimal equivalents.

Two-digit decimal number	Expressed as two BCD groups	Decimal equivalent of binary code
06	0000 0110	06
16	0001 0110	22 = 16 + 6
26	0010 0110	38 = 26 + 2*6
99	1001 1001	153 = 99 + 9*6
N		$N + INT(N/10)*6$

```

S . SPLIT VFO A/B * COMMODORE
M . MEMORY OR VFO * C64
> . WRITE VFO INTO MEM* COMMANDER
L . DIAL LOCK ON/OFF * FOR YAESU
V . VFO A/B * FT757
< . WRITE MEM INTO VFO* BY
U . BAND STEP UP * GRAHAM
D . BAND STEP DOWN * BLANCHETT
C . CLARIFIER ON/OFF * VK2CJB
= . SWAP MEM/VFO FREQ * INSTRUCTIONS
F . ENTER FREQUENCY * IN AUS EL MON
N . NEXT PAGE OF MENU * AUG 1987
ENTER CHOICE ..?

```

Figure 7. Menu, page 1.

```

R . BAUD RATE ADJUSTMENT
? . TEST F=1-30 MHZ
B . TEST F = 5.55555 MHZ
E . SCAN
G . SELECTED FREQ'S FROM KEYBOARD
H . SELECTED FREQ'S FROM DISK
$ . DIRECTORY
T . UPDATE TIME
X . TURN CLOCK ON/OFF
N . NEXT PAGE OF MENU
ENTER CHOICE ..?

```

Figure 8. Menu, page 2.

```

ENTER FILENAME --- ? WHV

2.5      MHZ ** WHV
5         MHZ ** WHV
10        MHZ ** WHV
15        MHZ ** WHV
20        MHZ ** WHV
25        MHZ ** WHV

ANY OTHER *** S SAVES TO DISK
KEY FOR   *** R SAVES TO REPLACE
NEXT FREQ *** 1 FOR MENU PAGE 1
          *** 2 FOR MENU PAGE 2
          *** A FOR AUTOMATIC
          *** P FOR PAUSE
          *** CONT FOR CONTINUE
          *** $ FOR DIRECTORY
          *** T FOR TOGGLE(MANUAL)

DWEIL (SEC)?

```

Figure 9. Screen display when switching between selected frequencies (automatically or manually). These particular frequencies have been retrieved from disk storage but could have been entered manually.

and summing. But this gets a bit messy. It is much simpler to use an algorithm (magic procedure that seems to defy mathematical explanation but gives desired result quickly and easily — my definition!). Algorithms can sometimes be found by looking for patterns in numbers. Refer to Figure 6 and see if you can find the pattern.

Apart from this, the flow chart in Figure 5 is fairly straightforward. The frequency is progressively multiplied by 100 to evaluate the pairs of numbers. After the decimal equivalent of each pair has been found it is stored in an array called A(). Then each element of the array is poked to 33280 and the machine language routine to generate the output signal is started with a SYS 32768.

Next month

Next month, detailed operating instruction will be presented together with a program listing. The availability of software and connectors will also be covered. 🐘

A complete packet radio system for the Commodore 64

Part 2

Andy Keir VK2AAK

In the first part of this article, published last month, we provided a general overview of the project as well as detailing the circuit operation. This month, we are going to conclude the article by describing how to construct and align the unit, and also some suggestions as to where to find the parts.

WHILST IT IS POSSIBLE to construct this project in any manner you wish, it should be realised that any circuit which is going to be operated near transmitters or in strong RF fields, should be adequately by-passed and enclosed in a metal case. For this reason, and for the fact that it makes construction neater, easier and less prone to errors, we strongly recommend that you use the printed circuit board designed for the project.

We have not provided details for a case in which to house the project, but would suggest that one of the commonly available die-cast aluminium boxes would be eminently suitable. Alternatively, some of the sturdy metal cases commonly available might suit you. Anyway, our experience is that many constructors (amateurs in particular!) like to suit themselves with projects like this. The printed circuit board measures approximately 80 by 85 mm and allowing for the various connectors which need to be mounted, a case of around 95 by 120 mm with a depth of about 35 mm would be suitable.

I don't intend to give a blow-by-blow description of the circuit board assembly, after all you will need an amateur radio licence to be able to use the project, so you should be familiar the basic procedures involved (or is that just a hopeful wish?). I should point out at this point however, that if you have sent away to AAPRA for the software and documentation, part of that documentation refers to construction and provides a step-by-step guide. In our presentation of this project, we have re-designed the pc board and added a few components. Whilst much of the AAPRA documentation will still be applicable, you should be aware that component placement and nomenclature may have changed.

Commence by fitting all the resistors. There are 25 of these, not including trimpots etc. I understand that at least one supplier is using 1% resistors in their kits and if you are supplied with these, take particular care as it is quite easy to confuse the colour codes.

After the resistors are fitted and soldered in place, you can continue with the other passive components. There is no particular order to follow but I found it easier to fit all the capacitors, then the trimpots and relay. Some of the capacitors are tantalum types, so take care with their orientation.

You can conclude construction of the board by fitting the semiconductors. There are two diodes, four transistors, three integrated circuits and a three terminal voltage regulator. Do NOT fit the 7805 voltage regulator IC4 yet. For the sake of tidiness, you can if so desired, fit pc wiring stakes or pins to all those holes from which flying leads are to be connected.

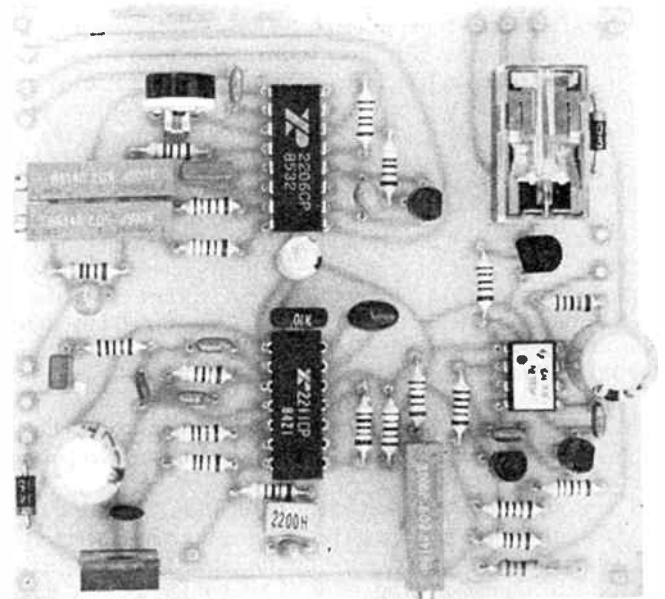

The completed packet modem board. It measures approximately 80 x 85 mm.

Alignment

Once you have completed construction of the pc board, you will need to align the modulator and demodulator sections before fitting the unit into the case of your choosing. This is not a difficult procedure, but you will need access to an accurate frequency counter. Do NOT make any connections to the computer or the transceiver yet.

We will commence by aligning the demodulator section of the modem. With power removed from the board, temporarily connect pins 2 and 10 of the XR2211 (IC2) together with a short jumper wire. Apply +12 V to the modem at the correct pad or pc pin near diode D2. Now connect your frequency counter to pin 3 of the XR2211 (IC2) and adjust the multi-turn trimpot RV1 to obtain a reading of 1700 Hz. Once you have this reading correct, you may remove the short between pins 2 and 10 and you can now fit the three terminal regulator IC4.

Having aligned the demodulator, we will turn our attention to the modulator section. In this step, you will be setting up

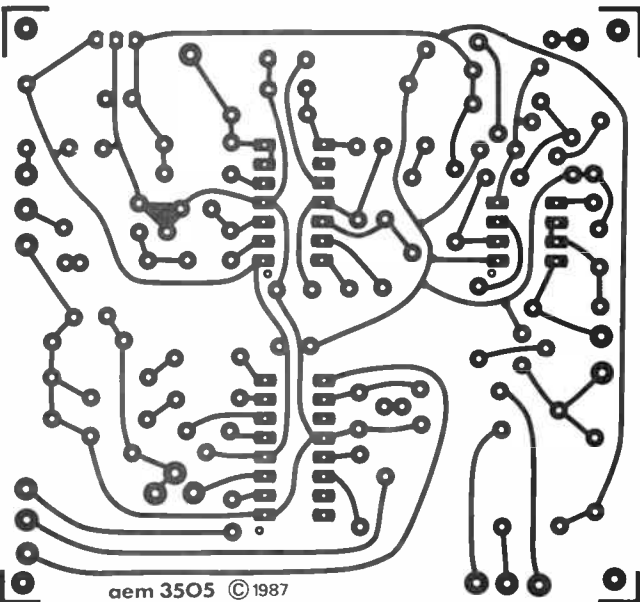
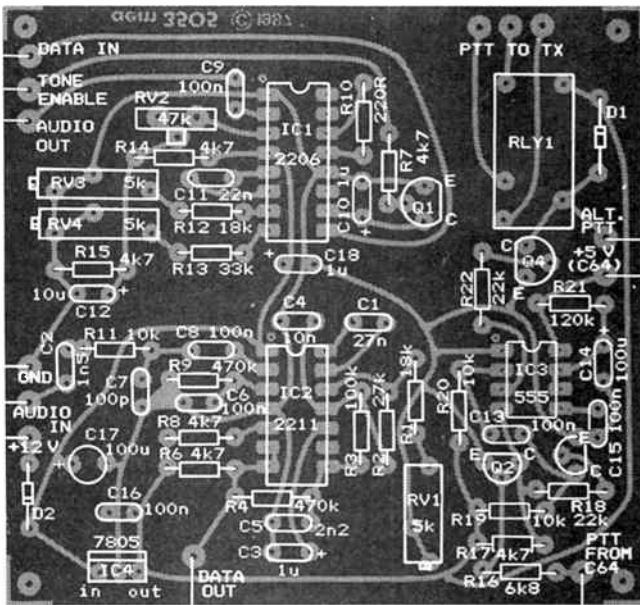

the two tones produced by the XR2206 (IC1). Commence by applying +12 V to the pad or pin near diode D2. Because you have now fitted the 7805 regulator, you will have the +5 V rail active as well. You will need a +5 V signal in the next step so this can be obtained from the on board supply by connecting one end of a short jumper wire to the end of resistor R6 nearest the electrolytic capacitor C17. This point corresponds with the output terminal of the 7805 regulator, but is a bit easier to connect to.

Connect your frequency counter to the audio output pad or pin which is near the multi turn trimpot RV3. Connect the other end of the +5 V jumper to the DATA IN pad which is near the audio output pad and adjust the multi-turn trimpot RV3 for a reading of 2200 Hz on the counter. Now remove the end of the jumper wire from the +5 V source and connect it instead to the 0 V rail (GND). This will produce a 0 V level at the DATA IN pad. You should now adjust the multi-turn trimpot RV4 for a reading of 1200 Hz on the counter.

You will find that it is necessary to repeat these two adjust-

ments a number of times as there is some interaction between them. When you are satisfied that a +5 V level on the DATA IN pad provides a reading of 2200 Hz and a 0 V level on the DATA IN pad produces 1200 Hz, you have completed alignment of the modem.

There is one further adjustment to be made and this is the setting of the output level of the audio signal fed to the microphone input of your transceiver. This is accomplished by means of the 47k trimpot RV2. This adjustment is best left until you have completed the interconnecting wiring between the pc board and the various connectors mounted on the case. ▽

AEM3505 PARTS LIST

Semiconductors

Q1-Q4	BC547/548
IC1	XR2206
IC2	XR2211
IC3	555
IC4	7805
D1, D2	1N4002

Resistors all 1/4 W, 5%

R1	18k
R2	27k
R3	100k
R4	470k
R5	not used
R6-R8	4k7
R9	470k
R10	220R
R11	10k
R12	18k
R13	33k
R14, R15	4k7
R16	6k8
R17	4k7
R18	22k
R19, R20	10k
R21	120k
R22	22k
RV1	5k 10-turn trimpot
RV2	47k vert. trimpot
RV3, RV4	5k 10-turn trimpot

Capacitors

C1	27n greencap, MKT
C2	1n5 greencap, MKT
C3	1u/25 V tant.
C4	10n greencap, MKT
C5	2n2 greencap, MKT
C6	100n MKT
C7	100p ceramic
C8-C9	100n MKT
C10	1u/25 V tant.
C11	22n greencap, MKT
C12	10u/25 V tant.
C13	100n MKT
C14	100u/25 V electro
C15-C16	100n MKT
C17	100u/25 V electro
C18	1u/25 V tant.

Miscellaneous
 AEM3505 pc board; mini 5 V relay (Matsushita HB1-DC5V); pc pins (13); 24-way plug & backshell to suit C64 user port; 5-pin DIN plug and panel socket; 5-core shielded cable; 2-core shielded cable; single core shielded cable; hookup wire; dc power plug & socket; metal case; suitable nuts, bolts, washers & spacers; on/off switch.

Estimated cost: \$80-\$90
 plus \$45 for software & manual.

Connecting to the computer and the radio

There are three sets of connections which need to be made to the modem. These are to the computer, to the transceiver and to the external 12 V power supply. We will commence with the connections to the computer.

Refer to Figure 1 for details of the pin numbering of the C64 user port and to figure 2 for the connections from the pc board to this port. Start by soldering a short jumper between pins B and C on the back of the 24 way plug. You may then make up a cable for the connection from the pc board to the plug. I would suggest the use of shielded cable for this purpose, you will need four cores plus the shield making a total of five wires.

You may notice that there are actually six points shown in Figure 2, but two of the points on the pc board are common. These are the PTT signal from the computer and the TONE ENABLE signal. Both these points on the pc board can be jumpered together on the board and a single wire used to connect them to pin F of the 24 way plug. Note that the DATA OUT connection on the pc board is shown as connected to B/C on the plug. As you have jumpered pins B and C together on the plug, you may make the connection to either of these two pins. The shield of the multi core cable should, of course, be connected to the Ground pad of the pc board and the other end to pin A of the 24-way plug.

Before making the connections to the pc board, you should ensure that you have an adequate length of shielded cable and you should drill a hole at an appropriate point in the case through which to feed it. Fit a grommet to the hole and pass the cable through, then cut and tin the individual wires to the appropriate length and solder them to the proper points on the pc board. For security, you can use a tie wrap or a knot in the cable to stop it pulling through the grommet.

Connection to the transceiver

To facilitate connection to the transceiver, the modem is provided with a five pin DIN socket which should be mounted on the case. Figure 3 details the connections from the pc board to the DIN socket.

You will notice that both the common leg of the PTT relay and the ground connection are designated as connecting to pin 3 of the DIN socket. You should use this connection method if your transceiver requires the PTT line to be connected to ground when you want to transmit. If your transceiver uses some other method of PTT switching, such as switching the PTT line to a voltage, you can still use the relay contacts provided as they are isolated from supply and ground. In that case, you would not connect the common leg of the relay to ground.

You will also notice that there is a pad on the pc board shown as "alternate PTT". This is simply a connection made to the collector of transistor Q4. When the PTT is activated, this point will be switched to ground through the transistor and could be used in place of the relay. Unless you are sure about the nature of the PTT switching in your transceiver, I would be inclined to stick with the relay switching as it might be safer. The remainder of the connections from the pc board to the DIN socket can now be made. It is not really necessary to use shielded cable for these connections inside the case.

The only connections which remain to be made are those for the external power supply and the cable between the modem and the transceiver. The power supply input to the modem can be hard wired or you could use a small DC jack mounted on the case. We have not detailed an on/off switch, but one can be mounted on the case if you wish. An external supply of 12 V is required to power the modem. The modem

does not draw much current and for the sake of convenience, you could power the unit from the same supply used to power the transceiver if it is of the dc powered type. If the supply is much above 12 V, you should fit a 100 Ohm resistor in series with the supply lead. This could be fitted inside the modem case if necessary.

The cable which connects the modem to the transceiver can be tackled next. It is essential to use screened cable for this. The simplest method of making this cable is to use two separate shielded cables. One of these only needs to be a single core type and is terminated in a suitable jack plug to match the external speaker socket of your transceiver. The other end of this cable is terminated at a DIN plug to match the socket mounted on the modem case. The shield should be connected to pin 3 of the DIN plug and the centre conductor connected to pin 4 (see figure 3).

The second cable of the pair needs to have two cores and a shield and will carry the PTT line to the transceiver as well as the microphone audio. It should be terminated in a suitable plug to match the microphone jack of your transceiver. The other end of this cable is also terminated at the DIN plug, again with the shield connected to pin 3. The microphone audio from the modem to the transceiver is on pin 2 of the DIN plug and the PTT output from the modem is on pin 1.

Setting the input and output levels

The level of audio from the transceiver to the modem is not particularly critical and can normally be set to the same level as you would for comfortable listening. The level of audio from the modem to the microphone input of the transceiver is another matter. This needs to be correctly set or the transmitter will be overdriven resulting in poor performance. Failure to adjust this level properly is probably the single greatest cause of problems experienced when setting up for packet radio. This applies to commercial TNCs as well as this project.

To perform this adjustment, you will need to have your modem powered up and connected to the transceiver, but do not connect the modem to the computer. If you are lucky enough to have access to an FM deviation meter, you can use this to adjust the modem output. If you do not have a deviation meter, you will have to use a second radio or a scanner to receive your own transmission and adjust the level using a slightly different method.

After ensuring that the transmitter is connected to a dummy load and making absolutely sure that the modem is not connected to the computer, use one or two jumpers to simultaneously connect both the PTT (from the computer) and TONE ENABLE pins on the pc board to ground (0 V). If you have previously jumpered these two point together on the board, you will only need one jumper.

The transceiver should go into the transmit condition. Using another jumper, connect the DATA IN pin on the pc board to +5 V. You should now be able to monitor the higher of the two modem tones (2200 Hz) on the other receiver. Now adjust the trimpot RV2 so that the level of the monitored signal (amplitude, not signal strength) decreases to it's minimum. Start adjusting RV2 again so that the monitored audio gets louder and continue adjusting until you reach the point where any further adjustment of RV2 does not result in an increase in the level of the monitored audio.

Now you should back off the level using RV2 until the monitored audio is slightly, but noticeably reduced from maximum. This completes the setting of the output level. If you find that the range of adjustment will not allow the level to go low enough, you can try adding a resistor in series with the microphone audio signal to reduce it's level. You may now remove all the jumper wires, tidy things up and after remov-

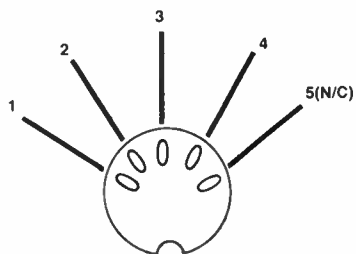

DIN SOCKET
(LOOKING INTO SOCKET)

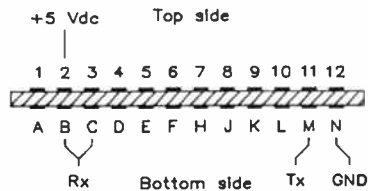

C64 USER PORT

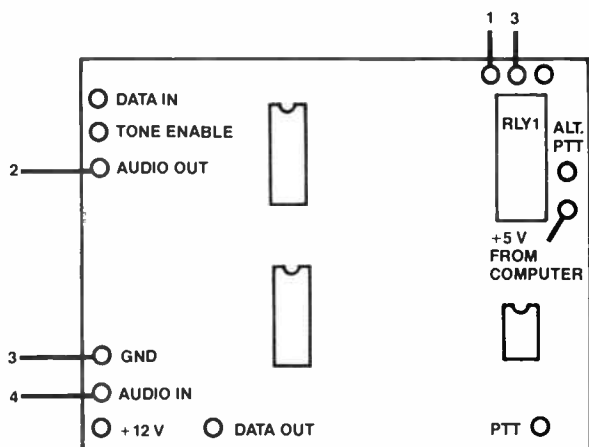

CONNECTIONS TO DIN SOCKET

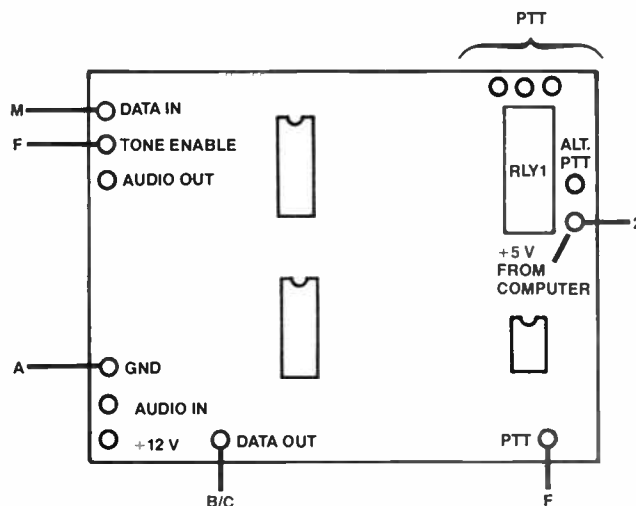

COMMODORE USER PORT CONNECTIONS

ing power from the modem, connect it to the computer. You should always follow this rule of powering up the computer before powering the modem.

You are now ready to start "packetting". As you will need the appropriate software from AAPRA, and as the deal also includes instructions on how to drive it, I do not intend to repeat that information here.

On HF

Before concluding, I said last month that details of how to modify the modem for use on HF would be provided. When using packet on HF, we use a narrower shift. Instead of 2200 Hz and 1200 Hz tones, we use 1800 Hz and 1600 Hz. When aligning the unit, these are the two frequencies that should be used. The centre frequency of the XR2206 will not need to be changed as it is still half way between these two frequencies at 1700 Hz. You will need to change a few components and these are as follows:

- R13 change to 24k
- R12 change to 22k
- R2 change to 120k
- C5 change to 4n7

Happy packetting, and I look forward to seeing you on the air soon.

Parts and software availability

I understand that a number of suppliers will be supplying parts or full kits for this project. Geoff Wood Electronics in Sydney can provide a bag of all the necessary components excluding the case, 24-way connector and pc board. They do, however, stock suitable cases and the 24-way connectors as separate items. Geoff Wood electronics is at 229 Burns Bay Rd, Lane Cove West, NSW. Their postal address is: Box 671, Lane Cove 2066, NSW and their telephone number is: (02)427 1676.

Jaycar Electronics will be marketing a complete kit for this project which includes all the parts, the pc board and the 24-way connector, in fact everything you will need with the exception of microphone plugs to suit your transceiver and the necessary software. Contact your nearest Jaycar store for details.

The software for this project is available only from the Australian Amateur Packet Radio Association (AAPRA), and is copyright to them. For the sum of \$45, which includes postage, you will receive a customised version on disk as well as an assembly and operating manual. Don't forget to include your callsign with your order so that the software can be customised for you. You can contact AAPRA by writing to: The Secretary, AAPRA, 59 Westbrook Avenue, Wahroonga 2076, NSW.

If you intend to become active on packet radio, you would do well to enquire about membership of AAPRA when submitting your order. The organisation has many members who can provide you with assistance and advice and the cost of joining is very reasonable. 🐾

LEVEL

We expect that constructors of an **INTERMEDIATE** level, between beginners and experienced persons, should be able to successfully complete this project.

The Satracker SA270 amateur satellite antenna system

Andy Keir VK2AAK

Probably one of the most fascinating and rewarding "frontiers" in amateur radio today is satellite communications. Each of the "tools" required for the task are important, and there can be no weak links in the system. This set of Australian made antennas for the two-metre and 70 cm bands, distributed and promoted by local identity and noted satellite operator, Grahame O'Brien VK2ZZV, seem set to command a great deal of attention on the amateur satellite scene.

HAVING BEEN something of an enthusiast in the area of amateur satellite communications for some time, I was quite pleased to be offered the opportunity to review the Satracker SA270 antenna system.

The system was conceived by well-known Newcastle amateur Grahame O'Brien VK2ZZV (also now VK2KZV we understand – congrats Grahame!), and was born out of frustration with the high price of imported satellite antenna systems. With Grahame's persuasion, the Newcastle manufacturer Satellite Antennas developed the system which is comprised of crossed Yagi antennas for both the two metre and 70 cm bands, featuring remotely switchable left and right hand circular polarisation.

Assembling them

Assembly of the antennas is quite straightforward if you follow the comprehensive instructions supplied. Both the elements and the booms are constructed from anodised aluminium, the elements in silver and the booms in black. All the elements are colour coded so it is very difficult to make a mistake assembling it, and as both the booms and elements are supplied pre-drilled, you will have no problems getting things in the right place.

When assembled, these antennas are not small. The two metre antenna is 4120 mm long and the 70 cm antenna is 3630 mm long. For this reason, each boom is supplied in two bolt-together parts. The system used for interlocking the two boom sections eliminates the possibility of errors and provides a very secure arrangement.

After the booms have been assembled, the next job is to mount the driven element. These are of the folded dipole type and terminate in a grey plastic box which is pre-assembled and drilled to fit over the square section boom. You will need to pay attention to the instructions for this step as it is possible to get the driven elements in the wrong order. You also need to get the driven elements the right way

up so that when the antennas are mounted on the mast, water does not collect in the terminating boxes.

The plastic boxes at the centre of each dipole contain the relays used for switching the polarisation of the array. A coaxial cable emerges from each of these boxes and are terminated in a single "N" type connector. Also the cables from the polarisation relays exit from the boxes. These cables are colour coded and terminate in crimp-on "bullet" type connectors.

Once you have the dipoles mounted on the booms, you can progress to fitting the parasitic elements. There are a lot of these, 38 for the 70 cm antenna and 22 for the two metre antenna. As mentioned previously, all the elements are colour coded so the possibility of errors here are slim. Each element is inserted in the pre-drilled boom and secured in place by means of a pop rivet. All the rivets required are supplied, in fact the pop rivet gun is about the only thing you will need to supply yourself.

When all the elements are mounted, you

View of the whole antenna system.

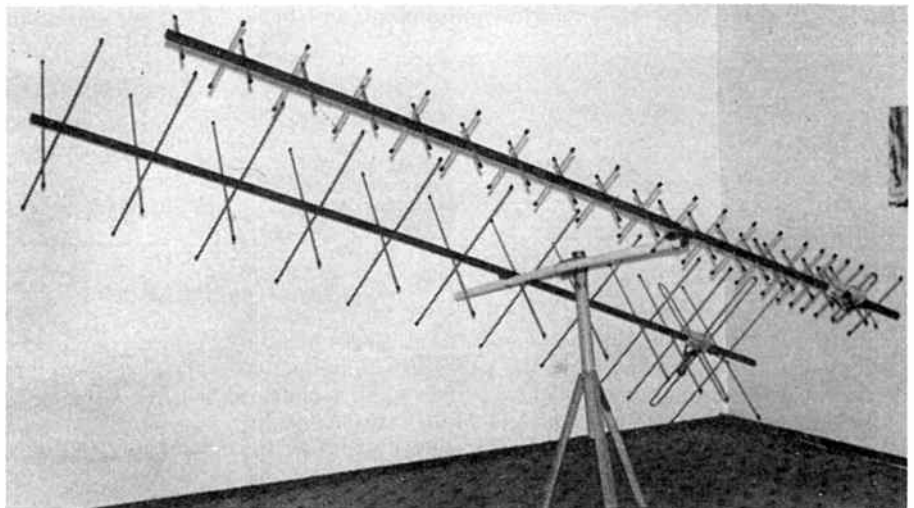

can dress the coaxial cables along the rear section of the booms and secure them in place with the supplied insulating tape. Again you will need to refer closely to the instructions for this operation. Correct placement of the cables is essential if the antennas are to perform as specified.

A few finishing touches are all that is required before mounting them. The specially made brackets are attached to the booms. These ensure the correct mounting angle of each antenna when fixed to the cross boom. The last job to perform and I might add, the most time consuming, is to fit all the plastic end caps to the end of all the elements. These are quite stiff and if you are attempting this on a cold day, you might like to try softening the end caps in a bowl of hot water before fitting them.

Mounting

The completed antennas can now be mounted on the supplied fibreglass cross boom in readiness for mounting on your mast. Mounting the completed array to your mast will depend on what type of rotator system you are using. If you are set up for satellite work, you will generally have both an azimuth and elevation rotator system. If the elevation rotor is of the "straight through" type, you will need to remove one of the antennas from the cross boom so that it can be fed through the rotator.

Finally, connect your feedlines and the dc cables for polarisation control, keeping in mind that you will need plenty of slack to prevent fouling when the antennas are rotated or elevated.

On the air

Up in the air, the array certainly provides an impressive sight. It really gave my neighbours something to think about! In my case, I mounted the array temporarily on a large wooden surveyor's tripod which had an elevation rotor clamped to the top. Before attempting satellite communications, I decided to try

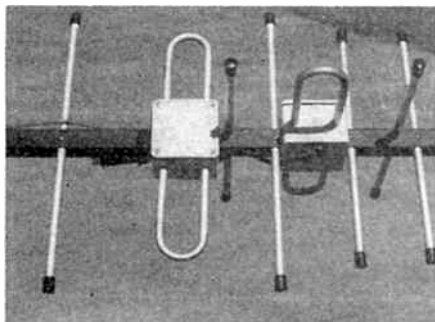

View of the folded dipole construction and feedpoint.

the array out on some terrestrial signals. After checking the VSWR of the array (well within specifications), I pointed the antennas towards Canberra and dialled up the VK1 two metre beacon frequency. There it was! Not strong, but not bad either considering that the array was only about three metres above ground level and no preamps were in use.

I compared the signal strength with my own system of two horizontally polarised, eight element Yagis on an 11 metre tower. The signal from the Satracker array was only a couple of "S" points down, which is quite good considering that there is going to be around 3 dB polarisation loss with the horizontally polarised signal and the circularly polarised antennas. My location incidentally, is in the Western area of Sydney, so the path was around 240 Km.

I was unable to find any suitably weak 70 cm signals so I decided to have a go at OSCAR-10. It was mid afternoon on a Saturday and the satellite at that time was only around ten degrees above the horizon. I aimed the array at the satellite and tuned to the beacon frequency. The results were instant. A good strong S5 signal.

Having satisfied myself that all was in order, I tuned to the centre of the downlink passband and keyed up the transmitter with an unmodulated carrier on the appropriate uplink frequency. I almost fell off my chair! My downlink signal was over S8! I must have driven the satellite into AGC with such a strong uplink signal so immediately I reduced power from the 40 or so watts I was running, to under 10. My downlink signal was still somewhat stronger than the beacon so I reduced power even further, settling on about 4 or 5 watts output, measured at the transmitter.

Looking "up the spout". Left: the 70 cm array. Right: the two metre array.

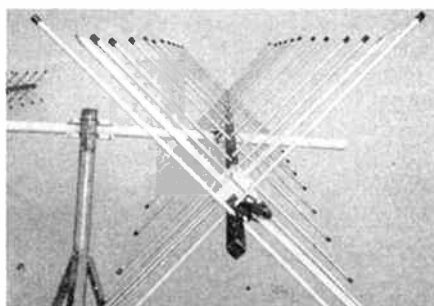
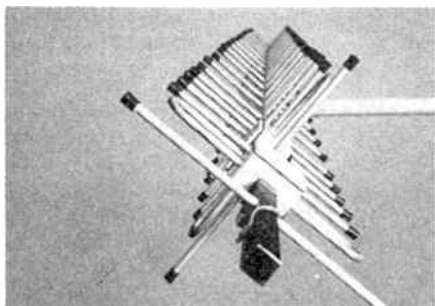

		UPLINK	DOWNLINK
FREQUENCY	MHz	430-440	144-146
GAIN	dbi	14-16	12-14
ELECTRICAL LENGTH	X	4.5	1.8
POLARISATION	CIRCULAR	LH/RH	LH/RH
ELEMENT NUMBER	2X	20	12
VSWR		1.1-1.5	1.1-1.5
BEAM WIDTH	DEGREES	30	35
POWER	W MAX	100	100
IMPEDANCE	OHMS	50	50
CONNECTOR	FEMALE	N	N
POLARISATION RELAY	POWER	12V/30mA=	12V/30mA=
LENGTH	mm	3630	4120
MASS	Kg	4	4
STACKING BOOM	mm	1800 LONG	43 O.D.

Specifications as supplied by the manufacturer

There was a fair bit of activity on the satellite with quite a few European stations working. After listening around for a few minutes I decided to try a CQ. Again, results were instant and in the hour or so before the satellite dropped below the horizon, I was able to work Germany, Luxembourg, Holland and the UK (my first VK/G contact via OSCAR-10!).

Since that time, I have had the opportunity to repeat that sort of operation with the satellite just above the horizon and was able to compare results with my own linearly polarised array of two eight element Yagis on two metres and two 18 element Yagis on 70 cm. There was not a great deal of difference in the signal strengths obtained but a number of factors such as additional feedline losses and more forward gain in my array would need to be taken into account for a meaningful comparison. The biggest difference I noticed was the considerable reduction in fading when using the circularly polarised array.

I have also tried the array through the FUJI-OSCAR 12 satellite with similarly good results. This satellite uses opposite polarisation to OSCAR-10 and also has the uplink and

downlink bands reversed. Because FUJI-OSCAR 12 is in a low orbit, I had to be very careful about the amount of power I was running and had successful contacts with only a few hundred milliwatts from the transmitter.

And...?

To sum up, if you are thinking of setting up for satellite operation, then the Satracker SA270 would certainly be the way to go. With the launch of the next high orbit amateur satellite planned for early 1988, there is likely to be an increase in the popularity of this mode and now would be the time to get thing organised at your station.

If you are in the process of setting up a VHF/UHF station but can't decide whether you want horizontal polarization for terrestrial DX or vertical polarisation for FM and repeaters, why not consider circular polarisation and get the best of both worlds as well as being ready for satellites. It certainly cuts down the amount of hardware you have to have up in the air and reduces the cost and complexity of multiple antenna systems.

Review system kindly provided by the distributor. For further information on the Satracker SA270, contact ZZV Antenna Farm, 5 May St, Cardiff 2285 NSW or telephone (049)54 8688. I understand that the Dick Smith Electronics retail chain will also be handling the Satracker, so you could examine this source also. The current advertised retail price of the Satracker SA270 is \$690 and they come with a 12 month warranty.

The Last Laugh



This is the road scourer. They're so fussy about keeping the road clean in front of the New Parliament House! That button takes off the tyre marks, this button removes TV reporters' remains . . .

NO DOUBT by now you've noticed the latest "technology" in video cassette recorders – National's bar code programmer. This wondrous little gadget – a "wand" which you run across a set of printed bar codes on a "programming pad" or codes printed with the TV guides, gets over the widespread problem faced by all VCR consumers – how to programme the multi-function, multi-facility clock/calendar/station selector. Many consumers fix the problem by getting their kids to do it. They learn the complexities with ease, apparently. The wrinklies ("olds", "fossils", etc) find it either beyond their ken or just too time-consuming.

Well, as was inevitable we suppose, this "magic" technology has been turned to other purposes and a craze is about to sweep the nation's youth: using the bar-code wand on the codes printed on food packets, etc – just to see what crazy result you get!

Acronym aids

Acronyms can play perverse tricks on their creators. A second, or outside, opinion is always a wise precaution we are advised. Maybe OTC's grand masters slipped one day.

The Overseas Telecommunications Commission is currently full steam ahead getting its new optical fibre telephone cable installed. Touted as the most advanced of its kind in the world, it runs between Sydney and San Francisco.

Working title for this worthy undertaking is the "Pacific Ocean Optical Fibre" project. A POOF between the gay capitals of the US and Australia was not quite what the good technocrats of OTC had in mind, perhaps?

Hazards of the job

The great white shark – the fish, not the golfer – has attracted attention from

researchers in recent years. They eat people. Not as a steady diet, not as a steady diet, but if you get in the way when they're foraging, your flesh is as good as any other.

We learned recently that an intrepid South Australian researcher, was looking into the digestion (literally!) of *Carcharodon carcharias*. Having attracted a suitable specimen with (with blood and horsemeat), he measured the shark's stomach temperature by feeding it a tuna in which was embedded an electronic thermometer and radio transmitter.

Maybe the Guinness Book of Records has yet to record it, but this fellow would seem to be the world's first scientist to drop a thermometer down the throat of the world's biggest flesh-eating fish. The biblical Jonah's tale, pales by comparison. ♣

Here's a great offer, exclusive to AEM readers.

GET FLYING ON 1200 BPS! BUILD THE "BIT STREAM FLYER"

— the low-cost way to high-speed dial-up data communications.



Looking to upgrade from your old V.21/V.23 modem? Here's how to do it without the expense of discarding your existing modem!

Build yourself this 1200 bps full duplex (V.22) modem and make that data really fly! The unit is used just like any other "dumb" modem. It works with any computer having an RS232 serial interface or adaptor. All you need is an RS232 serial cable to your computer and suitable communications software or terminal program.

Don't miss this opportunity to own a high speed modem and to enjoy the pride and satisfaction that comes from having built it yourself!

By special arrangement with the designers, you can obtain a complete kit to build the AEM4622 Bit Stream Flyer by Maestro for just

The components alone would cost you over \$200 at retail prices!

An optional plugpack power supply is available for an additional cost of \$14.00.

The kit is complete to the last detail; all components, semiconductors, switches, connectors, IC sockets and cabinet.

This offer is made by Maestro Distributors and the magazine is acting as a clearing house for orders.

\$179.00 Delivery, anywhere in Australia: \$7.00

OFFER CLOSES LAST MAIL AUGUST 31 1987.

DON'T DELAY, COMPLETE THE COUPON NOW AND SEND IT, TOGETHER WITH YOUR CHEQUE, MONEY ORDER OR CREDIT DETAILS, TO:

AEM4622 MODEM KIT OFFER
Australian Electronics Monthly
PO Box 507, WAHROONGA 2076 NSW

Or you can phone us and "pledge your plastic" to order. Call (02)487 1207 and give your name, address and credit card details.

COUPON Please deliver _____ AEM4622 Bit Stream Flyer Modem kit(s) priced at \$179.00 each, plus \$7.00 for delivery. Please include _____ plugpack(s) at \$14.00 each.

I enclose \$_____ total, payment by (please circle method):

Bankcard Mastercard VISA AMEX

Card No. _____

Signature: _____

(Note: unsigned credit card mail orders cannot be accepted)

Name: _____

Address: _____

Postcode: _____

Cheque (No: _____)

Money Order (No: _____)

Make cheques or money orders payable to "Australian Electronics Monthly"

(Please allow for normal mail and bank clearance delays)

Low cost pattern generator simplifies testing

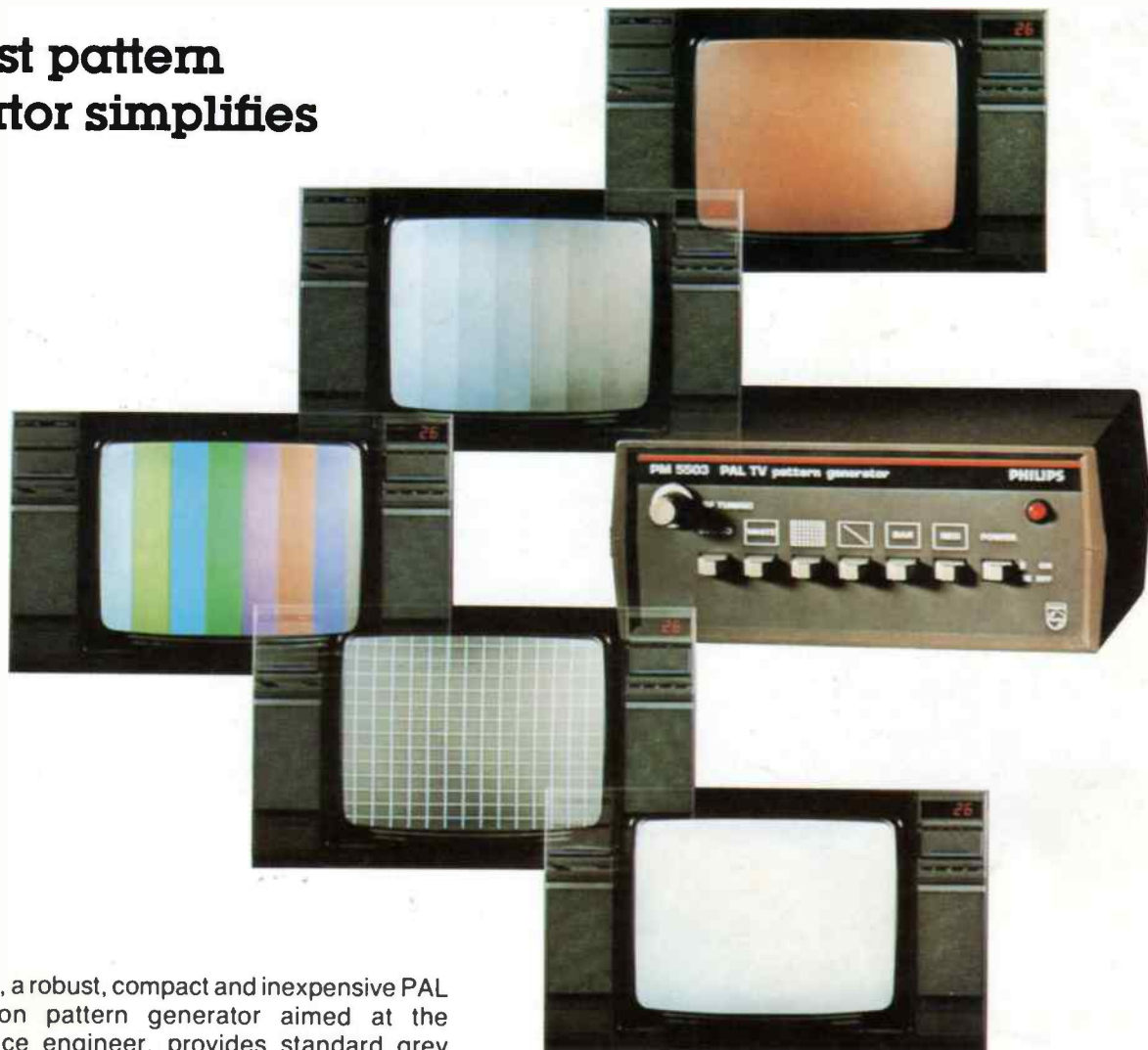

The PM 5503, a robust, compact and inexpensive PAL colour television pattern generator aimed at the travelling service engineer, provides standard grey scale, cross-hatch, red pattern and colour bar as well as a 100% white pattern.

Five test patterns

The five test signals provide information for the adjustment of the vast majority of television parameters. The 100% white pattern with alternating burst aids beam current adjustment and is essential for checking the white setting to guarantee optimum colour performance.

Centering, vertical/horizontal linearity, and dynamic and static convergence can be adjusted using the cross-hatch pattern, which consists of 15 vertical and 13 horizontal lines.

An eight-step grey scale is provided to check the linearity of the luminance amplifier, the focus setting and the grey scale adjustment of colour televisions.

Overall colour performance, burst keying, delay colour versus luminance and PAL delay line circuitry can be checked with the colour-bar pattern.

Finally, the saturated red pattern facilitates colour purity adjustments.

Durable simplicity

The low weight, small size and compactness of the PM 5503, combined with the 1 kHz tone, straightforward RF tuning, video output and easy selection of the five essential test patterns, make it the ideal instrument for field service.

Contact, Philips Scientific and Industrial,

Sydney - tel. (02) 888 8222
Canberra - tel. (062) 95 6140
Melbourne - tel. (03) 542 3600
Brisbane - tel. (07) 844 0191
Adelaide - tel. (08) 348 2888
Perth - tel. (09) 277 4199

Other areas - toll free (008) 22 6661.



Test & Measurement

PHILIPS