

Ray Allsop and Don. B. Knock — Technical Editors

7 FEB 1929
SYDNEY.

Wireless Weekly

3^p

INCORPORATING "RADIO IN AUSTRALIA & NEW ZEALAND"

VOL. 13, NO. 7

FRIDAY, FEBRUARY 8, 1929

(Registered at the G.P.O., Sydney, for transmission by post as a newspaper).



Radio Echoes
Shot Back
from Space

The Movie-Tone
Examined

Look to Your
Batteries
By Ray Allsop

Tone Quality in
Modern Receivers
By D. B. Knock



PHILIPS
RADIO

MANUFACTURERS OF RECEIVING VALVES (BOTH AC & DC), TRANSMITTING TUBES, LOUD SPEAKERS, POWER UNITS, LIGHT AND HEAVY DUTY BATTERY CHARGERS, AUDIO TRANSFORMERS, — ETC. ETC.

STROMBERG-CARLSON RADIO RECEIVERS

are wholly

MADE IN AUSTRALIA

Backed up by the Research Laboratories of the
Stromberg-Carlson Co., of Rochester, N.Y., U.S.A.

THE STROMBERG-CARLSON ELECTRIC 3

£27/5/-

Plus Speaker

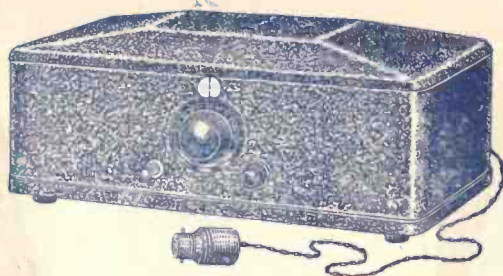

£27/5/-

Plus Speaker

DO NOT CHOOSE YOUR NEW ELECTRIC RECEIVER
WITHOUT FIRST SEEING AND HEARING

THE NEW STROMBERG-CARLSON ELECTRIC 3

No Batteries - Just Plug in - Perfect Tonal Qualities

Price **£27'5'/-** Plus Speaker

Speakers from £2/10/- upwards.

Free installation in Metropolitan area.

Manufactured and guaranteed by

STROMBERG-CARLSON (Australasia), LTD.

72 WILLIAM ST., SYDNEY — 374 POST OFFICE PLACE, MELBOURNE

Inquiries invited from the Trade in regard to making Chassis and Receivers under their own name.

THE MOST HIGHLY RECOMMENDED BATTERIES ON THE BRITISH MARKET



No. 1040, 45 Volts (large capacity).
This battery is similar in size and style to the 45 volt batteries designed for use with American apparatus, but embodies the special constructional features exclusive to Siemens H. T. Batteries. Normal discharge rate 5 millamps—max. economical discharge rate 10 Millamps.

SIEMENS RADIO BATTERIES

- ☞ The specially prepared electrolyte employed overcomes rapid deterioration and so ensures **LONG LIFE**.
- ☞ Exceptional insulation between the individual cells of the battery ensures noiseless operation throughout its entire life. The units are solidly embedded in the highest grade paraffin wax.
- ☞ Nickelled spring clip terminals are used, thus ensuring a very positive Electrical Connection. Tappings are provided to give five intermediate voltages.

Siemens H.T. Dry Batteries embody every modern worth-while improvement. They ensure clear, "noiseless" reception, long life, and the general satisfaction which is expected from a Siemens product.

Continuous experiment and Research, combined with unrivalled manufacturing experience, extending over 50 years, is your guarantee of Quality and Reliability.

SIEMENS RADIO BATTERIES British Built throughout

At all Radio Dealers

SIEMENS

257 CLARENCE ST. SYDNEY
45 WATT ST NEWCASTLE



or Direct from

(Australia) Pty. Ltd.

MELBOURNE BRISBANE
ADELAIDE HOBART

For the Manufacturer
and Amateur Constructor

PILOT RADIO PARTS

Products of the World's greatest
Radio Parts Plant

Variable Condensers



- No. 1623—0.0050 mfd., 23-plate, 14/6
- No. 1617—0.0035 mfd., 17-plate, 13/6
- No. 1618—0.0025 mfd., 13-plate, 12/-
- No. 1608—0.0016 mfd., 8-plate, 11/3
- Condenser Couplings, for Ganging together 2/6

Midget Condensers



- No. J7, Midget, 7-plate 5/6
- No. J13, Midget, 13-plate 6/6

Pilot Micrograd

- No. V.M. 80, 2-plate 5/-
- No. V.M. 81, 4-plate 5/6



Pilot Transformer

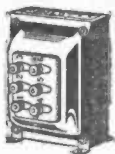

- No. 388. — A.C. Tube Filament Lighting Transformer, for A.C. Sets, 220-240 V., 50 to 60 cycles, £2/12/6.

Pilot Drum Controls

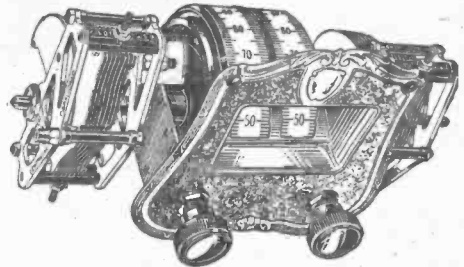

- No. 1284L—Single Illuminated Drum Controls, with bulb £1/2/6
- No. 1283L—Double Illuminated Drum Control, with bulb (illustrated) £1/19/6

Pilot Vernier Art Dials

- No. 1278—Black.
- No. 1279—Walnut. 7/6 each



SOLE AUSTRALASIAN AGENTS:

Harringtons Ltd

"Goodwill built on Public Confidence since 1889."

Retail Radio Department and Showrooms:

386 George Street, Sydney.

Wholesale Warehouse:

213 Clarence Street, Sydney.

Also at Katoomba, Newcastle, Melbourne, Brisbane, Adelaide, Hobart, Auckland (N.Z.), Wellington (N.Z.).

WALLY BAYNES LAUGHED BEST



There was really no need for Mr. Charles Lawrence to look so downcast—he came second in the popular vote.



Could you believe that Mr. Carlton Fay could look like this? He is attempting to register disapproval.



"Hmm!" says Mr. Sayles, frowning over the whole business, "now why didn't I win?"

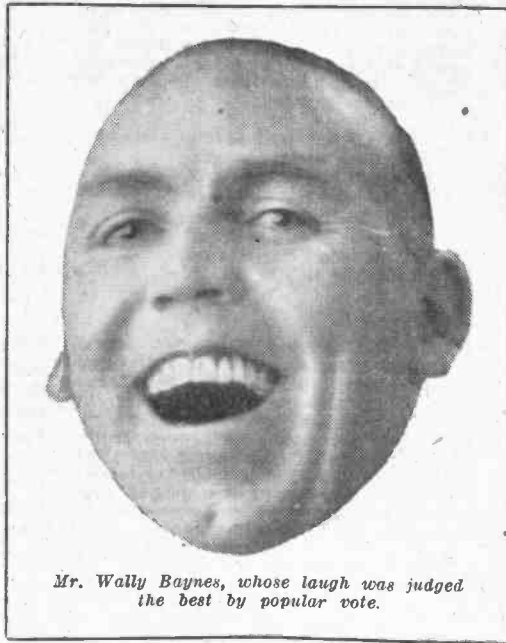

Mr. Wally Baynes, whose laugh was judged the best by popular vote.



"Redgum" never laughs in public for dental reasons. However, there is always a twinkle in his eye—even when he loses.



Mr. Scott Alexander looks up admiringly at Mr. Baynes, and wonders how he did it—even though Mr. Alexander was absent.



Mr. Montgomery Stuart even went so far as to put on "make-up" in order to cloud his otherwise cheerful features with a forbidding frown.



Miss Dorothy Manning tried her best to look dissipated, but didn't quite succeed.



Miss Willa Hokin only succeeded in looking sad. Try as she might, she could not frown.

MORE than a thousand entries were received for the "Laughing Competition" which was held at 2BL on January 28, in conjunction with "Wireless Weekly" and the N.S.W. Broadcasting Company. Thirty-three replies resulted. These were placed in a ballot box, and the entry sent in by Mr. W. R. Peberdy, "Bebrew," Gundal, via Muswellbrook, was chosen as the winner of the £2/2/ prize offered to the competitor who most nearly approximated the popular vote.

The immense popularity of this competition is undoubted, and, judging from the many congratulatory letters received, one and all seem to look forward to a further series of "Laughing Competitions."

"We could hardly catch what was said for our own laughter," writes one listener at

THE ORDER OF VOTING.

1. Mr. Wally Baynes.
2. Mr. Charles Lawrence.
3. Mr. Carlton Fay.
4. Mr. Montgomery Stuart.
5. Mr. J. G. Lockley ("Redgum") and Miss Willa Hokin tied.
7. Miss Dorothy Manning.
8. Mr. S. Sayles.

(Mr. Scott Alexander was called away to Melbourne at the last minute, and was unable to appear.)

Mullumbimby, "and we are now waiting to hear of further novelty competitions." One sympathetic Grenfell listener says "it certainly must have been hard for each person to stand in front of 'Mike' and laugh at nothing. We all had sore sides through laughing with the competitors." Another entrant states that during the competition the electric lights went off, and she feels sure the laughing caused it, she is seriously considering suing the company. We trust, however, that she will not go to this extreme.

Mr. Wally Baynes was unanimously chosen as the competitor with the heartiest laugh. Mr. Charles Lawrence was voted second, whilst Carlton Fay ran a very close third.

In the very near future we hope to carry out a further competition in conjunction with the N.S.W. Broadcasting Company.

BETWEEN YOU AND ME AND THE MICROPHONE

Gentlemen, the King!

THE singer of the patriotic record, "Gentlemen, the King!" (Captain Stephens) is NOT the Captain Stephens who puts it over the air. A strange coincidence, made stranger still by the fact that Miss Dorothy Manning's father, Mr. E. B. Manning, is the composer of the song. Mr. Manning is the president of the London Savage Club of Artists and Composers, and wrote this song to be sung instead of the King's toast at the club dinners.

Whims of Genius

IT has just come to light that when William Backhaus, the pianist, was at 2FC, he positively refused to leave until everything

in the studios and control room had been explained to him in detail. Percy Grainger had similar characteristics; but they were confined to a study of every musical instrument in the studio. He finally chose the xylophone, and practised on it for twenty minutes. These things were told to us by Mr. Chapple; and will, doubtless, appear in forty years' time among his memoirs. We should have told you in the beginning that Mr. Chapple proposes to write a book, "Reminiscences of a Radio Pianist," or "The Things I May NOW Tell You." It should prove extremely interesting.



We Make Inquiries

"WHAT would the world be like without wireless?" asks Mr. Harold Finson, "A Constant Listener and Music Fan," of 2FC, in a breathless postscript. The Pacific Ocean, on being interviewed by our representative, remarked that its attitude would not be affected. The continents—Europe, Asia, Africa, America, and our own fair land—would make no statement; but there is an unconfirmed rumor that the world in general desires still to roll on.

Another Tall One

WE saw Mr. M'Neil, Mr. Allsop's chief of staff, with his head deep buried in 2BL's loud speaker, listening to the G.P.O. chimes.

We were rather surprised, because, good heavens! the man has been there long enough to be used to them by now. But his was not the mood of sentimental appreciation. He had just been down to readjust the microphone in the G.P.O. tower. It hadn't been functioning too well for a week or two. "Hundreds and hundreds of steps," he said. "What

do you want with stairs?" asked someone. "All you've got to do is, stand in Martin Place and reach down to the Clock Tower." We feel this to be rather an over-statement; but it serves to explain the 2BL rumor: that Mr. M'Neil is writing a book, "Every Man His Own Aerial Mast." He is six feet three inches high; measured by us and found correct.



At Their Own Game

"MR. LAWRENCE, is your house on the tram line?" asked Mr. Jack Barnett. "Yes, why?" asked the humorist. "Well, you'd better take it off—there's a tram coming out there soon," replied Mr. Barnett, and began to cheer loudly, because Mr. Lawrence was the first in twelve to bite. And in five minutes' time Mr. Wally Baynes became a victim. Which was remarkably good fishing. It isn't often that you get a fish to swallow his own bait.

**OSWALD A. is back again
After three weeks' holiday;
Feeling fit and right as rain,
Feeling most remarkably gay.**

**Do his Station's programmes get
Stale, monotonous, or grim?
Well, he took a six-valve set
All the way on tour with him!**

Hot Scotch!

BILLY MORRIS, the well-known legless Sydney swimmer, writing to 2BL, wants the announcer (whom he has christened "Cheerio," because he does not know his name) to put on as often as possible a record called "Hot Scotch and Two of Irish." He says this bright number makes him "JAZZ!" Such a spirit is worthy of emulation, especially by those who, blessed with full health and strength, find themselves at thirty, "too old to dance!"

RADIO TRAGEDY, NO 4

*O, let the sad winds blow-blow-blow.
Blow softly to and fro-oh-oh;
For I shall soon be dead-dead-dead,
With seaweed round my head—my head.*

*O, Sorrow!
To-morrow,
I sha-hall . . . he . . . dead!*

*I am not really bad-ad-ad—
It really was too sad-ad-ad—
I did not mean to do-do-do
What I'll confide to you—to you;*

*O, Sorrow!
To-morrow,
I sha-hall . . . he . . . dead!*

*The sun had ceased to glow-to-glow.
When in the studio-oh-oh
I sang a little song-song-song,
Like this; but not so long—so long.*

*O, Sorrow!
To-morrow,
I sha-hall . . . he . . . dead!*

*It broke the microphone-phone-phone.
Which was their only one-one-one!
This put them off the air-air-air,
And made the announcer swear-swear-swear!*

*O, Sorrow!
To-morrow,
I sha-hall . . . he . . . dead!*

*I'm standing at the Gap-ap-ap,
With this sad note in my lap-ap-ap!
I watch the fluting time-time-time;
For midnight noon will chime—will chime!*

*O, Sorrow!
To-morrow,
I sha-hall . . . he . . . dead!*

(And a good job, too.—Ed.)

Radiating Tragedy

ONE of the most harrowing sights was to be seen in a radio control room, where an announcer listened in to a race on which he had ten shillings. His horse was beaten by a short head or a long neck or something; and the announcer, who had never backed a horse before, retired to the studio with a greater fund of understanding, and a deeper sympathy with the feelings of listeners-in.



He Who Laughs Laughs Laughs

WE watched the entrants in our Laughing Competition through the window of the 2BL control-room. They were all feeling self-conscious. Laughing to order is rather difficult. Stories ranged from tales about Baby Austins to traditions concerning Englishmen, Irishmen, and Scotsmen; and not a few of these were drawn, at the last moment, from Mr. Charles Lawrence's repertoire. Artists resorted to all kinds of tactics to ensure enthusiastic laughter; and the spectacle of Mr. Charles Lawrence tickling himself to get the desired effect moved us to copious tears. Mr. Lockley "Didn't know why they sent for him to laugh," but did very well. Mr. Montgomery Stuart's kookaburra laugh brought us vivid memories of that funny old bird. Mr. Carlton Fay's sporting effusions added a touch of raciness to the evening's hilarity. Miss Hok'n (Aunt Willa) found an excuse for exquisite, trilling merriment in the fact that Bacchus was the God of the Bookmaker. Miss Dorothy Manning laughed cheerfully at a domestic anecdote. Mr. Wally Baynes's laughter kept us interested in his story; and the laughter of Mr. Sayles was rural, and devoted to vines that grow up so quickly as to wear the pumpkins out.

Wirelessleep

A POLICEMAN arrived at 2BL, taking a census, or something like that. He saw Uncle Bas. "How many people live here?" he asked. "No one lives here," replied Uncle Bas. The bobby looked surprised. "No one at all!" he exclaimed. "You mean to say they don't provide bedrooms here?" "Of course not," answered Uncle Bas. "Why, do you think they should?" "Well," said the cop, "I hear them talking here from early in the morning until late at night, and I shouldn't think they'd find it worth while to go anywhere else to sleep." In this light, of course, it would seem as though Announcers had to go without sleep; but for anyone who feels inclined to pity them we have the happy information that the Government may soon be taking over the broadcasting stations.



RADIO ECHOES FROM SPACE

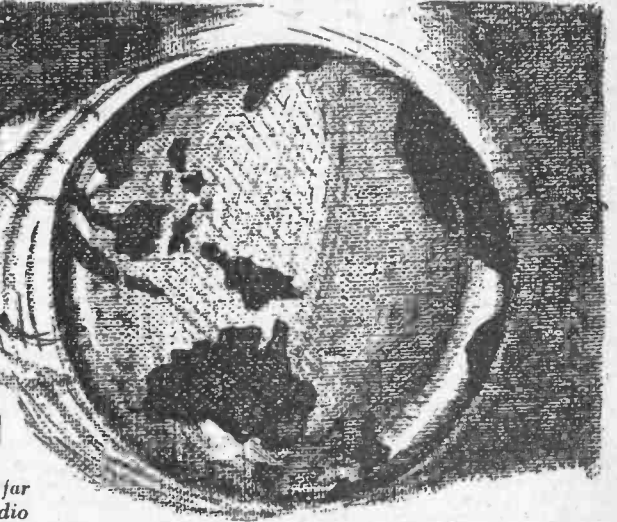

Scandinavian Says Electric Waves Meet Particles from the Sun far beyond the Moon, and are Thrown Back to Earth as Radio Echoes--Explanation Based on Theory of the Northern Lights.

RADIO echoes from space somewhere beyond the moon's orbit have been detected by Jorgen Hals, a Scandinavian radio expert. They may account for some of the "Messages from Mars" that are picked up from time to time. Professor Carl Stormer, of Oslo University, gave what was termed a "sensation lecture" on the subject at a recent meeting of the Academy of Science at Oslo, Norway.

He described how Mr. Hals first conducted experiments with his private wireless outfit, and in April, 1927, received the first echo. The customary reception of the radio waves after their flight around the earth took place one-seventh of a second after transmission. Three seconds later came a repetition of the message, this message more faintly heard than the first. However, as later experiments proved, the reception was undoubtedly authentic. A breakdown in his generator forced Mr. Hals to continue his work over the Philips radio station, Eindhoven, Holland, which operated on the same wave length. Both in July and in September the echoes were heard distinctly.

Mr. Hals communicated his first results to Professor Stormer, who was greatly interested and urged him to continue his experiments. Experiments made during the spring and summer of 1928 were without results. On October 11 an attempt again was made, and the conditions being especially favorable that day the echoes came in remarkably strong and distinct. The time between the transmission of the radio waves and the reception of the echoes varied greatly, the time being from 4½ seconds to 15 seconds. The results were immediately wired to the Eindhoven station. This station the following night conducted experiments on the same line, and verified the work of Mr. Hals.

Professor Stormer considers the proof of the phenomenon very definite, as the results obtained from Mr. Hals's and his experiments

and those of the Eindhoven station have been consistent.

THEORY OF NORTHERN LIGHTS.

The explanation, the professor says, is based upon mathematical calculations in connection with his research into the theory of the northern lights. He points out that when electrical particles from the sun, radiating toward the earth, meet the magnetism of the earth, an enormous vacant space is created around the Equator. Through this space the particles can never penetrate. The vacant space grows less toward the Poles, here permitting the particles to break through manifesting themselves as northern and southern lights. On lower altitudes, however, the electrical waves sent out through the atmosphere will travel unhindered through this space until where it ends they meet the particles from the sun, and are thrown back to the earth as echoes.

Scientifically, Professor Stormer contends that the observations will be of great interest when studying the electrical waves radiating from the sun into space, waves which cause enormous disturbances both in the broadcasting activity and in telegraphy in general.

Mr. Hals considers it improbable that the echoes will take place with a wave length of more than 35 metres.

"To me the explanation of the phenomenon is of greatest interest," Professor Stormer told a representative of the Morgenbladet. "This is because the explanation is based on my first mathematical calculations in connection with research into the cause of the northern lights, calculations which I published in 1904. I have weighed the possibility of other explanations of the phenomenon, and I discussed the question with other physicists. The idea was advanced relative to the possibility of interference caused by radio waves in our atmosphere. But we abandoned the theory for this reason: If the idea were true the radio waves sent out from the Eindhoven station would have travelled around the earth from 28 to 100 times in the space of

time between the first transmission and the reception of the echo, this lapse of time being from 4 to 15 seconds. In this prolonged flight around the earth the waves would have grown so weak as to make reception rather improbable.

WAVES IN COLLISION.

"People ask what kind of wall it is that throws the waves back to earth? It is no wall in the material sense," said Professor Stormer. "The 'wall' is a barrier caused by the collision of the electrical waves from the sun and the magnetism from the earth. This idea I had already worked out along mathematical principles as early as 1904. The main points are as follow: When electrical particles from the sun radiating towards the earth (in accordance with the theory which Professor Birkeland advanced as to the origin of the northern lights) meet the magnetism of the earth, a space is created through which electrons from the sun cannot penetrate. This space is greater in width near the Equator than it is near the Poles. This lessening as the Poles are approached allows the sun's electrons to come into the atmosphere of the earth. When this takes place a manifestation known as the northern and southern lights is seen. In lower latitudes, however, the radio waves sent out from the earth will pass through this space to its outer border, where the electrons from the sun are met. Then, like an echo from a wall, the waves are thrown back to the earth."

Professor Stormer was asked what effect these observations would have, and of what importance they would be. He replied that it was hard to predict just what the observations might lead to. "Scientifically, however," the professor said, "they will be of great interest when studying the electrical waves radiating from the sun into the atmosphere of the earth, waves which cause enormous disturbances to broadcast and telegraphy. If the attempt to send waves further out into space is ever to be successful it must first be learned how to escape those disturbing electrical currents. This is a problem to be worked out in the future.

"If these observations carry the value I think they do (I have not yet given up my own scepticism on the subject), they will be

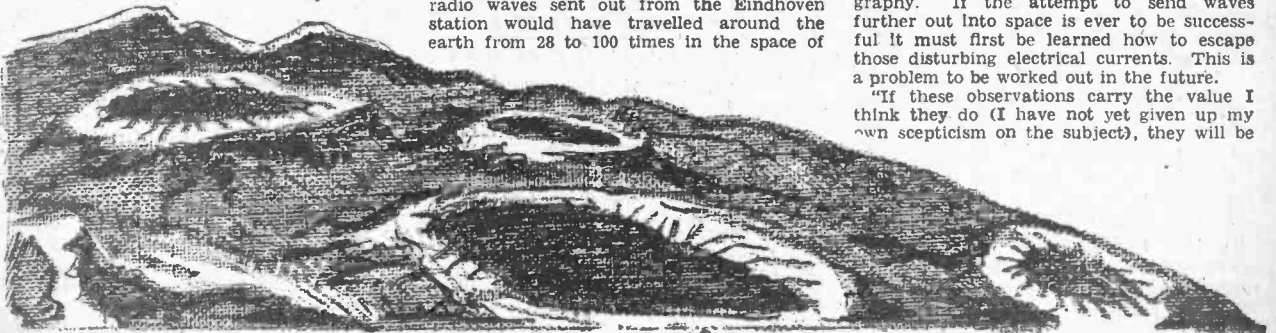

an illustration of the value which mathematical research can be in various branches of science years after the first announcement. One should never discard theoretical research as a useless waste of time merely because its practical application and scientific use do not immediately present themselves."

ECHOES FROM ROUND THE GLOBE.

Radio echoes have been observed frequently by Australian amateur experimenters, but not on as vast a scale as did Jorgen Hals. Dr. A. H. Taylor, of the Naval Research Bureau, U.S.A., observed round-the-world signals and the echo effects produced, also nearby echoes, which have a very short time of arrival. The observations began at Bellevue in 1927 with the expectation that the studies would throw additional light upon the structure of the heaviside surface, which scientists call a "radio mirror," because it reflects radio waves back to the earth.

Radio echoes are multiple signals. The signal is heard more than once. Hertzian waves travel in all directions from the transmitter in much the same fashion as the ripples travel in a pond when a stone is cast into the water. The signal that takes a short route around the globe is heard first, and then the one that travels in a longer direction registers a trifle later. In some instances the echoes are as strong as the direct signal or main wave and almost equally clear cut, according to Dr. Taylor's observations. The direction in which the signals come is determined by directive antennae.

"Echoes from the naval station NPG at San Francisco on a frequency of 16,700 kilocycles," said Dr. Taylor, "are rarely picked up with strong westerly directivity, and when they are so intercepted they indicate by their timing that they have travelled around the world in the same direction as the direct signal. Such echoes, however, are usually weaker than the reverse direction type, but can be at times very annoying. It is not believed that these round-the-world signals follow a curvilinear path around the world, but that they

encounter the heaviside surface at intervals, and are turned down and reflected back up again from the earth. Some of the reflections correspond to time intervals of the order of 0.035 of a second.

"Another important observation can be made upon the performance of stations to the south of us," said Dr. Taylor. "Strong signals are received from station HJG at Bogota, both in the 13,700 kilocycle and in the 27,400 kilocycle bands at certain hours of the day, but never have echo signals been observed on this station or on any of the stations in Argentine and Brazil on similar frequencies. Theoretically, no echoes would be expected because such echoes would have to pass over both Poles, and one or the other is bound to be in total darkness during its winter period even in the daytime, and, therefore, probably has too high a layer to permit such frequencies to be carried around. Whether it will be possible during the equinoctial period to observe echoes on such southern stations is a point of considerable interest, but upon which we have, so far, no positive information. It is barely possible that during these periods the average layer height might be low enough to get certain frequencies around."

Dr. Taylor points out that violent fading of short-wave signals at points only moderately distant from the transmitter may be partly due to nearby echo signals which overlap and in continually shifting phase thus contribute to this fading. At points of very much greater distances it is believed that the nearby echoes would be much reduced in strength and of corresponding lesser importance in producing fading effects.

"The hours of the day and the seasons of the year when round-the-world signals can be expected can be predicted for any given pair of stations by reference to the simple principle that a round-the-world signal must make most of its night transit in the summer hemisphere, and if the great circle between two stations is such that this is not possible, round-the-world echoes will not occur," said Dr. Taylor in a report to the

Institute of Radio Engineers. "There is entirely too little information at hand to predict in the matter of the short time echoes. Upon low-speed telegraphy the short time echoes will have little or no effect, their main results being to produce a slight fuzziness of the signal. But upon telephony they will have a very disastrous effect, and probably equally annoying effects for facsimile transmission and television."

Radio echoes have been recorded at the University of Chicago on high-speed photographic film.

It has been found that radio signals on short wave lengths under favorable conditions travel around the world as many as three times, being received at intervals of one seventh of a second, since radio waves, being a form of light waves, travel at the rate of light, 186,000 miles a second.

In the laboratory photographic film moving at the rate of five feet a second on a revolving drum shows a series of multiple diminishing echoes, which cannot be detected by the ear, coming in at an interval of .01 to .04 of a second after the main signal, too short for the circum-terrestrial or "round-the-world" path and too long for direct reflection from the Kennelly heaviside layer. This layer is believed to reflect all radio waves below 30 metres which strike it at a low angle, thus accounting for "skip distances," where the ground waves have been absorbed and there is an area of silence before the "sky wave" comes down.

The vagrant waves which were recorded apparently took an excursion of several thousand miles more than the direct path from transmitter to receiver. This path is unknown, and we are recording and classifying the signals in hopes of coordinating them with definite phenomena on or above the earth's surface, which are capable of bending or reflecting the waves along the longer paths. The energy sent out in all directions by the transmitter comes in after traversing the direct path, and apparently many longer ones, none of which are as great as the great circle of the earth.

:: New Programmes at Interstate Stations ::

Broadcast Talks on Farming

ON February 11 Mr. F. De Castella, Viticulturist, will give seasonable hints from 3LO regarding the cultivation and marketing of table grapes, and February 15 will be devoted to a utility talk on potato culture by Mr. J. T. Ramsay, the potato expert of the department.

Stories of the Operas

THE series of musical talks under the title of "The Story of the Opera" will be continued from 3LO on February 12, when "Carmen" will be "staged." These performances are under the direction of Mr. William James, and for the benefit of listeners who have not heard any of the previous productions we would mention that, while one artist is telling "the story of the opera," the principal solos and choruses gradually "fade in" and die away, thus enabling the listener to supply the connecting link between the vocal item and the spoken word. Mr. James has spared no pains to make this series as instructive and as interesting as possible: special soloists and a well-trained choir will be heard in the familiar numbers, and a most attractive programme is promised.

Pastoral Music

A DELIGHTFUL programme of pastoral music, which will embrace both vocal and instrumental selections, will be broadcast by 3AR on Tuesday, February 12. Bertha Jorgensen has chosen "Shepherds Dance" and "Pastoral Dance" for her two violin solos. John Byrne and Victor Baxter will contribute appropriate vocal numbers. Vida Lugg will play the brilliant piano solo, "Shepherds Hey," by Percy Grainger, while the Station Orchestra, under the direction of Fred Hall will be heard in Beethoven's familiar Pastoral Symphony.

Return of Imperial Russian Trio

THE Imperial Russian Trio has signed a further contract with 3LO, and will make their re-appearance at the studio on February 4, when some very fine recitals may be anticipated. The artistry of the Russian Trio is too well known to need further comment in these pages; the individual soloists, Arvid Norit (violin), John Berzinsky (cello), and William Ilster (piano), have all won their spurs in the great musical centres of the Continent, and their ensemble work has been compared very favorably with that of many world-famous trios.

Epics of the Icelandic Saga

LOVERS of literature will appreciate the somewhat unusual but highly interesting series of talks arranged by the Rev. William Bottomley, who has taken for his subject "Sigurd, the Volsung," the famous epic of the Icelandic Saga, by William Morris. The story of this work, which the author regarded as his highest achievement in literature, has been specially written with a view to broadcasting by the Rev. Bottomley, and will be given in four parts, Part I. introducing Sigurd and Regin, commencing on February 4, during the Education Hour. The talks will be "illustrated" with suitable vocal and instrumental music, the soloist being Miss Myrtle Walscott, who will be heard in some gems from Grieg.

Father and Son Musicians

EDOUARD and RAYMOND LAMBERT are making a re-appearance at 3LO on Sunday, February 10, when in instrumental solos and duets they will contribute greatly to the artistic side of the programme. It will be remembered that Edouard Lambert was professor at the Brussels Conservatorium, and his brilliant son Raymond studied under the world-famous pianist, De Greef.

MOVIE-TONE

This week we examine the principle of the movie-tone system of movie-talkies as installed at the Regent and Prince Edward Theatres. The movie-tone differs considerably from the cine-sound system.

By Don B. Knock
(Associate Technical Editor)

WITH critical ears, those to whom amplification in all its forms has been an absorbing subject, whether in the research laboratory or at home, are sitting through "talkie" performances with mingled feelings. Something comparatively new is suddenly launched into prominence—the public Stop, Look, and Listen—and it is a safe deduction that in perhaps the minds of 80 per cent. the present-day silent drama is doomed.

Last week I gave my impressions of the Cinesound system, with technicalities explaining the operation. Following on this I am able to discuss the Fox system of sound "movies," technically known as the Movie-tone.

The Fox Movie-tone is showing at two prominent cinema theatres in Sydney at present, and, although to the uncritical ear the result as seen and heard on the screen is in effect the same as the Cinesound pro-

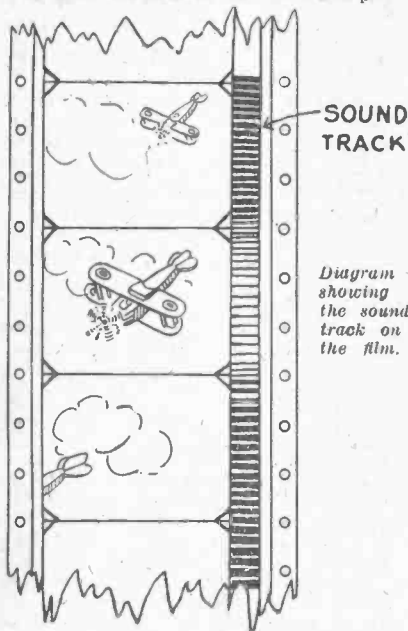

ductions, there is a tremendous difference in the application.

The heart and soul of the Movie-tone lies in the photography of sound. To the layman this means nothing, and such a statement may sound a little ridiculous. Nineteen years ago an American university student, Theodore Case, and Earl Sponable produced, as a result of extensive experiments, a light bulb, or tube, known as the AEO tube. By means of this tube it was found possible to make a visual record on a film of all sounds occurring near a camera.

This visual record is in the form of minute light flashes, which produce lines of varying thickness and intensity on the film. It will readily be seen how this system is applicable to the usual cinematograph film. By making the film a little wider than usual a strip on one side may be reserved as a sound track, and if a high quality sensitive microphone is used, with its associated apparatus, all the sounds occurring adjacent to the camera may be "shot" photographically at the same time.

Allowing for time lag in sound waves by the designing of special sound-proof studios, the synchronisation cannot be much less than perfect. For reproduction of the sounds together with the showing of the film, the process is reversed. The usual projector is provided with an attachment containing a photo. electric cell, known in America as a Kinolamp.

A fine beam of light shining through the sound track will naturally be varied continually in intensity owing to the degrees of fine and heavy shade produced. As the film is running through, it would be impossible for the human eye to detect these minute variations, but the Kinolamp is an extremely sensitive device which is actuated by the faintest light ray. In effect it is a relay which turns the light variations into electrical impulses corresponding to the original impressions made on the sound track from the microphone source. What remains is a subject

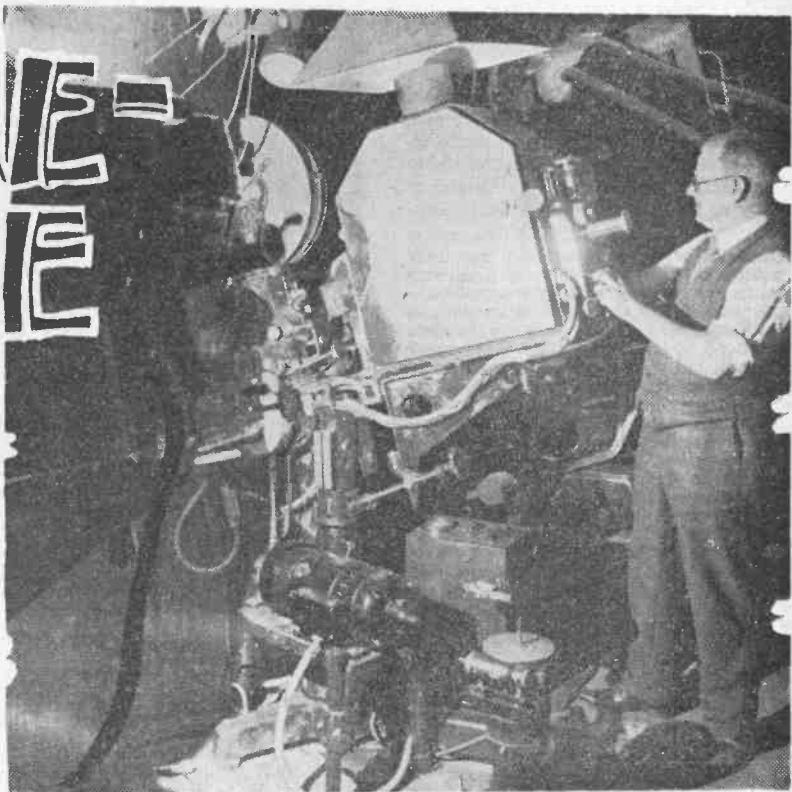

In the projection room at the Regent Theatre, showing the synchronous cinematograph machine.

dear to the heart of every real wireless engineer, a matter of amplification and reproduction.

Passing through a high quality amplifier in the projecting room, the output is taken along the theatre to power reproducers located at the back of the screen. The Movie-tone system seems to have a decided advantage over the Cinesound system, in that it is an easy matter to take cameramen and sound-recording apparatus at short notice to any location and photograph visually and orally events of the day with a minimum of trouble.

This fact I found brought forcibly home to me in the Movie-tone productions at the Prince Edward Theatre. A special News Bulletin is included in the programme showing interesting events. A race meeting is portrayed. One hears the voice of the starter warning impetuous riders to keep within the barrier—the thunder of the horses' hoofs as they round a corner before the camera. With similar realism a football match swims before the eyes, and it seems very real to hear the referee's whistle and the roars of the crowd.

Undoubtedly the most interesting of all "talkies" has so far been the impromptu chat of that famous playwright and delightful personality, George Bernard Shaw. He starts off by walking towards the camera down a gravel path, his footsteps easily audible. Stopping before the camera, he expresses his surprise at the number of people present (a well-timed pleasantry), and goes on in his delightful educated voice with a heart to heart talk.

This particular "talkie" is superb, and outclasses any I have yet heard. Although in the film, "The Street Angel," the players themselves do not speak, the synchronised music played throughout is beautiful to listen to, and at times I found myself unconsciously looking for the theatre orchestra. At the Regent Theatre are to be seen this week some new Movie-tone productions, including

one of historical interest made by His Majesty the King. His Majesty's voice sounds perfectly natural. For the first time a drama is screened in which the players speak. This is entitled "Mother Knows Best," and, although the reproduction was no doubt up to standard in this film, I found difficulty in my position at the back of the theatre in identifying the spoken words on many occasions. This I blame solely on the actors themselves, who, unfortunately, are very American in their intonation. Perhaps this explains the reason why so little actual talking is done in this and other productions to date. One would imagine that the directors are almost afraid to let their stars speak too much, but at the same time one looks forward to the time when the English-speaking actors, such as Clive Brook, will be heard.

There are vast possibilities ahead of the Movietone, and, whereas synchronisation is naturally perfect, there is room for development in the final reproductions. Theatres will have to be built with acoustic consideration, otherwise a very real difficulty may be present in some theatres if used as they are now. The placing of reproducers behind the screen alone does not seem to be the final solution, as, unless the amplifiers and reproducers used have ample reserve, much of the sound will be lost on the audience at the rear of the theatre.



A dramatic moment in a film at the Regent in which the people pictured talk.

UNIQUE WATER-COOLED VALVE AT 5CL

5 CL, ADELAIDE
 The call is now well known all over Australasia, but how many people, when they hear the cheery announcement, have any idea of the organisation and apparatus responsible for the transmission of the call sign and programmes of the Adelaide station? And how many of those who have any technical knowledge of broadcasting know of the height of efficiency that has been reached in the little building at Brooklyn Park that houses the transmitter of 5CL?

Here, amid much complicated apparatus, are to be seen in operation those valves or tubes, to use the American term, which are a unique feature as far as wireless stations in Australia are concerned. No other Australian wireless station employs these tubes, and their use in connection with 5CL is a striking example of the height of efficiency which may be reached by a broadcasting company, owning and operating its own station. These improvements were completely installed by 5CL's engineering staff.

Before the installation of water-cooled tubes at 5CL transmitting station, Brooklyn Park, the main panel at that station contained two rows of five valves each, ten in all, which constituted the oscillators and modulators, there being three oscillators and seven modulators.

However, the later policy of 5CL altered this system for the more modern and flexible water-cooled tubes, similar to the plants used by the big stations in the United States and Great Britain. The water-cooled valve is a distinct departure in valve design from the previously used air-cooled type, the object of the cooling being to increase the power capacity of the valve. All valves have great internal losses which become evident in the form of heat, and as it is this heat which limits the possible output of the valve, if, by means of a water flow, the heat is removed, the valve capacity can be greatly increased.

the point at which the greatest heat is evident, and the water-cooled valve is so constructed that the anode, made of copper, is the bottom portion of the valve, and can be immersed in a metal jacket, with water swirling round it continuously, while the upper portion, made of glass, contains the grid and filament supports.

Great manufacturing difficulties had to be overcome in producing dependable water-cooled valves, perhaps the greatest of which was the production of the metal-glass container for the elements. By an ingenious method the metal is made to taper into the glass, and is given such a thin edge that it bends to the dimensions of the glass under expansional strains.

It is only the metal portion which comes in contact with the water, as the upper part of glass stands above and clear of the circulating water; in fact, the water must be kept clear of the glass under all conditions, lest the valve be destroyed.

The type of valve used at 5CL has a rated output of 20 kilowatts, and two of those are at present in use, and have been for 15 months, giving every satisfaction. One does the work of an oscillator or amplifier, and the other of a modulator. The plate voltage is to the order of from 10 to 15,000 volts, and the filaments, which are lit from a D.C. generator, carry, at 22 volts, about 50 amps. each.

The regulations provide that 5CL shall supply an input of 5 kilowatts to each of these valves, so that it can easily be seen how very much under-worked the transmitting plant is at present, and how 5CL could, if desired, greatly increase its power without alteration to its system. The water supply is provided by two big tanks filled with pure water. The whole supply system, of course, must be insulated because the water comes in direct contact with the high tension supply, and to further the interests of insulation the water from the tanks is fed by a small centrifugal pump through about 25 feet of 1 1/2 inch rubber hose to the valve jackets, while the tanks are mounted on carefully insulated stands.

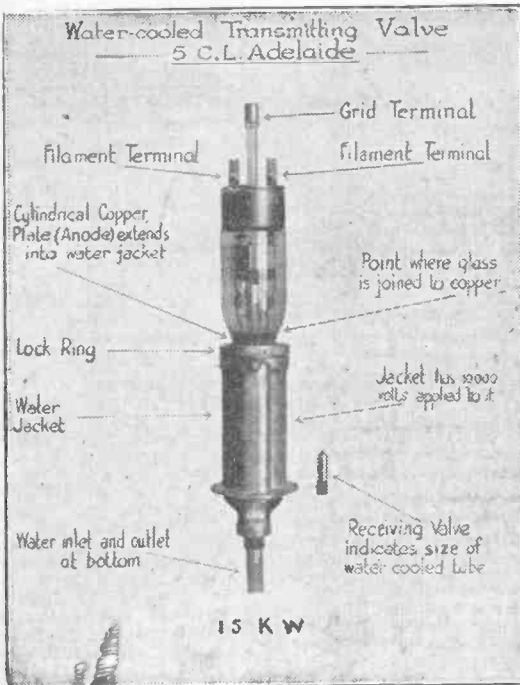

Commercial Television

As outlined by Mr. M. Openshaw, vice-president of the Pilot Manufacturing Co., in a talk from 2BL recently, television has reached a certain experimental stage which makes it highly interesting, but yet not a commercial possibility. In this article the chief engineer of Mr. Openshaw's company explains just how far commercial television has developed,

(Fig. 2.)

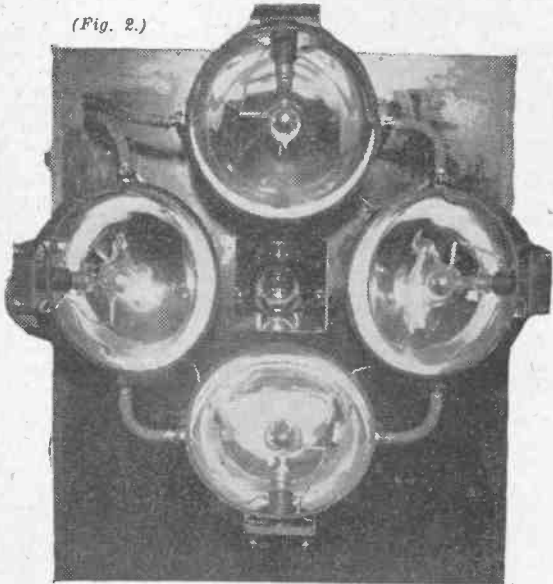

This is what the subject to be televised faces. The large lamps highly illuminate the features, and the reflected light waves impinge upon the photo-electric cell behind the centre aperture.

(Fig. 3.)

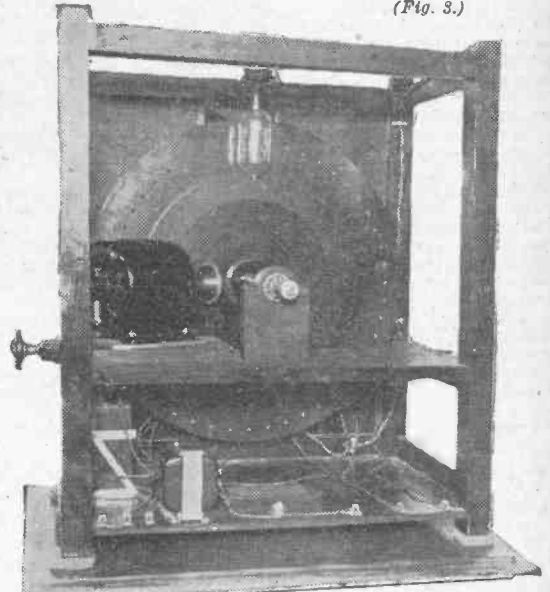

A rear view of a television receiver. Note the scanning disc, which rotates before listener's or "looker's" eyes, allowing the Neon lamp behind to produce a certain pattern.

(By JOHN GELOSO.)

CONSIDERING the almost revolutionary aspect of the art of television, it must be considered a great achievement indeed that it is to-day possible to transmit images between places widely apart with any success at all. The demonstration which we are going to describe in the following paragraphs constitutes a very considerable advance in perfection over the first demonstration given some months ago.

In order to give the reader a clear picture of what has recently been achieved, it is perhaps well to point out briefly the importance of experimental work previously done, and which has allowed the art to advance, even to its present still-very-imperfect stage.

Before television, so termed at first, became really practical, the best that could be obtained by laboratory experiments was only a raggedly outlined and blurred image of the subject televised and only from a distance of a few feet. From this actually accomplished beginning the art has gradually advanced to a point where to-day clearer images, good definition and synchronisation of receiver and transmitter is an accepted fact.

The first public television demonstration took place in July of last year, and while it by no means demonstrated the immediate commercial possibilities, it at least established the fact that television is practical. The apparatus used at first was very elementary, but even at that a very fair degree of success was obtained. As a matter of fact, a regular daily schedule of television transmission was inaugurated by

one of the leading broadcasting American stations, and these transmitters are still on the air and growing in popularity, day by day.

Anything but perfection for these first attempts was claimed, even though, considering the difficulties in the way, the success then obtained was nothing short of phenomenal. At that time the apparatus used was not only criticised in operation, but also considerably expensive. To-day it is both practical and less expensive, which certainly must be considered a great and most practical step forward.

Those witnesses of the first successful demonstration, and who also saw the working demonstration of the latest development were amazed at the progress shown. In order to obtain the improved transmission of television images there was perfected, and made available, an extremely ingenious method for picking up reflections of light from the person that was being televised—a method as practical in comparison with other systems used up to the present time, that it is well worth a brief description.

Instead of using three or four special-handmade photo-electric cells of the order of twelve inches or more in diameter and costing from £70 to £80 a piece, four of the regular small photo-electric cells, costing approximately £5 each, were used. The same relative light pickup with the small cells, however, was attained as when using the large cells, for the cells were placed in focal arrangement with parabolic mirror reflectors, and in turn focused the reflector on the object to be televised. With the old system the light sensitive surface of each photo-

electric cell points directly at the object being scanned, while, in this system, the light sensitive surface of the photo-electric cell is focused with the parabolic mirror and the closed portion of the cell actually faces the televised object.

Just exactly what progress has been made can best be seen by a glance at the accompanying illustrations showing the latest television transmitter as developed by the Pilot Electric Co.

Figure 1 shows the arc light generator, which directs a very strong light beam into the precisely designed square holes of the 48-hole disc revolving in front of it. The stream of light (broken up into 48 strips at every revolution of the disc, which revolves 450 times per minute) is directed through the lens system shown just in front and at the top of the disc.

Looking at this light stream with the scanning disc revolving and without the aid of the lens system, one would be led to believe that there was a 1½ in. square hole cut into a stationary disc, through which the intense light beam was directed.

Further analysis, however, shows that the light seen is made up of 48 strips of light running horizontally across, in a slightly curved line from the top of the square to the bottom. As just explained, each picture is broken up into 48 horizontal parts, but due to the speed with which the light is split up and the persistence of vision of the human eye, the projected beam appears in all respects to be that of a photographic image of the subject being televised.

As the beam projected by the arc light generator passes through, say the first (top-

most) hole of the disc, this beam travels over the topmost part of the object being televised. Instantaneously the photo-electric cells pick up the reflected light from the subject over which the light beam is swept by the scanning disc. The small inexpensive photo-electric cells can be seen mounted within the shielded magnifying mirror frames.

Connections to the cells are made by means of insulated silver wires, encased in a grounded copper meshed cable. These connections can be seen leading into a sensitive shielded amplifier system incorporated in the steel transmitter cabinet. The control panel and meters are mounted on one side of the steel transmitter cabinet, as shown in the illustration. To the right of the transmitter cabinet is located the compartment containing the batteries for the special amplifiers; located in a panel compartment opposite the control panel.

Figure 2 shows a close-up of the photo-electric cell system and the aperture, in whose centre can be seen the lens system in front of the scanning disc.

Figure 3 is that of the television receiver scanning apparatus which reverses the action of the transmitter. The radio impulse (originating from an electrical impulse whose intensity and continuity are controlled by the photo-electric cell current) is picked up by a standard radio receiver tuned to the frequency of the transmitting station. A receiver having good selectivity and audio frequency transmission characteristics is necessary, but a special receiver need not be

constructed in case the television enthusiast is the owner of a modern set with a reasonably distortion-free amplifier from 60 to 5000 cycles.

In the television receiver the usual loud speaker is replaced by a Neon lamp which is capable of varying its light intensity extremely, rapidly and in conformity to the television signals received and amplified.

The Neon valve is very simply constructed, consisting of two metal plates usually 1½ in. square, separated and insulated from one another and enclosed in a glass tube. The tube or lamp bulb is filled with Neon gas, rendering the tube conductive to small electric current flow and giving the light from the tube a pinkish color, characteristic of the Neon gas.

The Neon valve used in the television receiver corresponds to the photo-electric cell used in the television transmitter. The photo-electric cell at the transmitter converts light into electrical energy, and the Neon tube in the receiver converts electrical energy into light.

We have seen how the scanning disc arrangement at the transmitter decomposes the subject televised into a series of near horizontal strips of light, and then scans each strip with an image unit area, and modulates for instance a radio transmitter with the resultant electrical energy picked up by the photo-electric cell system and amplified. At the television transmitting station, we have transformed the subject to be televised into a large number of electrical impulses, each impulse representing truthfully the degree

of light and shade of each unit area of the subject and each systematically broken into units, so that our problem of the receiver becomes one of re-assembling these unit areas represented by electrical energy.

Just as we employed the scanning disc at the transmitter to decompose the subject, so we use the scanning disc at the receiver and place the Neon valve behind the scanning disc. With the receiver scanning disc running at exactly the same speed as the transmitter scanning disc, one may see at the receiver the decomposed subject originally televised, built up again into a near perfect picture with every movement plainly visible, such that the result is as if we were looking at the subject televised in front of our own eyes.

Figure 3 illustrates the television receiver scanning apparatus and portrays its simplicity and the few parts required for its construction. On the shelf to the left is a driving motor. In the centre the bearings and scanning disc with Neon lamp at the top.

On the lower shelf is shown the 4mf. by-pass condenser and output filter system for modulating the Neon lamp. Constructors should particularly note the four sponge-rubber shock absorbers which insulate the television receiver scanning apparatus from vibration. This eliminates one of many sources of disturbance detrimental to the Neon lamp.

The front panel of the television receiver has three controls and a millimeter to indicate the current across the Neon lamp. The control on the right is for the scanning disc motor speed adjustment.

Fig. 1.



The television transmitter erected by the Pilot Company. Mr. Geloso, the author of the article, is seen seated before the televisior.

MOVING COIL

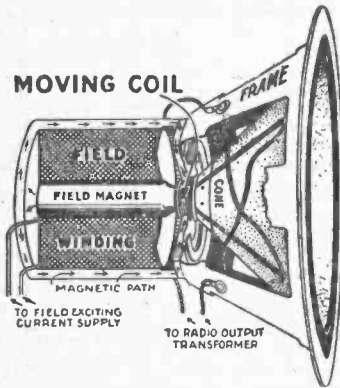

Showing the internals of a moving coil or Dynamic reproducer, the most powerful re-producer capable of delivering undistorted volume yet devised.

obtain volume beyond the capacity of the valves in the set.

Valves, no matter how good or accurately designed they may be, have their limitations, and distortion may be present, not only when an inferior reproducer is used, but as a result of forcing the set more than the valve in the last audio stage will stand. The effect is disastrous from another point of view, which is that heavy distortion emanating from a reproducer will often create a wrong impression in the minds of people who may not have had an opportunity of listening under good conditions.

One of the simplest rules if you are not acquainted with tuning is to adjust the set until the loudest notes of an orchestra come through without distortion. There is the chance that if you had tuned in at the time a particularly soft passage was being played the first thing you would do (not being a musician) would be to turn up the volume control to make the music louder. Although you may not be aware of it distortion has already set in, and the fact of the music being soft allows it to pass unnoticed. Suddenly the orchestra passes on to a "cristisimo" passage, and now there is no longer any doubt about the distortion, for your ear soon tells you that something is wrong.

After re-adjusting the controls and assuming that you have a good set and reproducer you get real music. After a little of this experience you will leave the dials set in this manner even though a few moments afterwards the volume dies down to a mere whisper. Unless there is something wrong with the broadcasting station itself or your receiver the music is being played as written, hence the softness.

A wireless receiver is really simplicity itself to operate, but, like the motor car, it must be

properly handled. Here is a point to remember in the tuning of distant stations. In most cases it would be out of the question to leave the controls in the same position when tuning back to local stations. Distortion would probably occur again, and readjustments must be made to check up with the increase in power or signal strength of the local. One's ear should be the guide in all cases. It is safe enough to say that drums and pianos, quartets and soloists, tenors and basses are all reproduced faithfully in the best sets obtainable to-day, and the manner in which you tune your set will make all the difference in harmony and pleasure and distortion and disgust.

Always wait for extreme volume before you make the final adjustments to your set, and if a burst of music comes through louder than before, and the tone is raspy, turn your controls back until there is no distortion when the volume is approximately equal. You may have to do it again and again before you are able to reproduce the maximum permissible volume without distortion, but when you can do so you can pat yourself on the back and realise that you have really tuned your set.

Now for a little dissertation on other factors governing tone quality. It is well known that a crystal detector will not produce anywhere near the volume that is obtainable from a valve-grid leak combination. Volume should have nothing to do with the detector valve for the reason that the use of the detector for sensitivity and volume as well always results in impaired tone quality.

There was a tendency when the screen-grid valve first made its appearance to cut down audio amplification, and rely on the RF amplifier and detector alone to provide the volume. This was very poor practice, and unless a circuit is designed to give sufficient audio amplification the immediate outcome of attempting to obtain the volume from the RF end of the circuit is **DISTORTION**.

From the beginning the greatest source of bad quality has been in the audio amplifier,

with the result that engineers have worked unceasingly to devise hundreds of audio amplifier circuits. A fallacy has been the result of this work for a long time, which is that it is not practicable to use more than two stages of audio amplification because of a certainty of introducing distortion. I wonder how many of you have at some time or other tried to add another stage of audio amplification to your existing set with disastrous results? Yet there are probably a dozen audio amplifiers on the telephone lines between Sydney and Melbourne!

Probably if these amplifiers were all straight transformer-coupled a little trouble would be encountered if the transformers were of a high ratio. Two to 1 or 1 to 1 ratio transformers will enable distortionless amplification and ensure greater stability.

To safeguard entirely the whole amplifier it is customary to include at intervals a resistance capacity coupling, as shown in the diagram. By this means not only is there no sacrifice in amplification gain, but the whole amplifier is rendered silent in action, provided, of course, that the resistances are constant and of unimpeachable quality.

Experimenters will do well to follow this telephone line practice wherever possible, as there is no chance of feed-back or interaction occurring in the circuit. The resistance coupling effectively separates the transformers, and gives at the same time good audio amplification at all frequencies. Such an amplifier may be used behind any detector, crystal or otherwise.

There are ways of getting the most in quality out of your speaker, and as an interesting example of how a cone may be utilised to the best advantage I ran across an idea by an American enthusiast. If you have a piano in the house it may be effectively used as an indirect baffle. Any housewives reading this may set their minds at rest, as Hubby will not have to get busy on the piano with hand drill and screw-driver!

The panel in the lower half of the piano is simply removed, thus exposing the sounding board. Stand your Cone reproducer underneath, as in the sketches, and cover the opening with light cloth, preferably silk. This places the Cone fairly close to the piano sound board, and produces an excellent tone.

Sometimes a stand in the form of a hollow box with holes in the side is effective as a baffle, and considerably improves the tone of a speaker. Just try standing an ordinary horn type speaker on different surfaces and note the results.

Finally, remember these points in connection with **TONE QUALITY**. A good reproducer is not judged by its volume alone. Do not use too much volume for the room, and do not overload the last valve

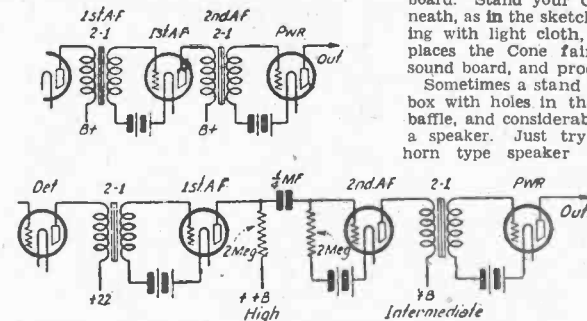

Illustrating the stabilisation of a transformer coupled amplifier by the inclusion of an intermediate resistance capacity coupled stage, and do not overload the last valve. A completely distortionless gain is effected at all frequencies.

Unified Religion

IT is reported that an English congregation listens in to the evening broadcast from Westminster Abbey. Listens in is not the right word. The congregation takes part in the service, singing the hymns, kneeling to pray, and following the Bible readings. The vicar has been a wireless enthusiast for twenty years.

A Clap in Time

IT is not unworthy of note that at one of 2FC's recent classical concerts things fell out and happened as follows:—The trio was playing two movements from a composition in a key we have unfortunately forgotten. Down in the stern of the studio music-lovers were gathered in abundant quantities. Very

interested. Very appreciative. And at the conclusion of the first movement these devoted followers of the Sport of Strings CLAPPED!

Modern Radio Equipment

A MALGAMATED WIRELESS has just completed a radio equipment in Wollongong Hospital, where each of the 83 beds has been provided with head 'phones. The receiver is a Radiola, operated off the electric mains. Four Marconi speakers have been provided, being placed in the matron's room, nurses' quarters, domestic staff dining-room, and isolation block... Owing to some geographical peculiarity the best station received is 2UE, Sydney. The other Sydney stations come in well also, except 2FC, which is not received

nearly so clearly. It will be interesting to see whether Wollongong Hospital has the same experience as other institutions, where it has been found that radio tends to shorten the average term of a patient's stay.

Study in E Unnatural

EDITORS of the "South African Wireless Weekly" have little faith in human nature. There have been no prosecutions of pirates for some time in South Africa; and the paper wants to know why. The same paper, by the way, gives an extremely extreme notice of our old friend, Mr. Raymond Ellis, "who has just returned from Australia. There is no doubt that Australia takes its radio as seriously as it does its cricket." But the worst they can say of Mr. Ellis is that he is "a REAL broadcasting artist."

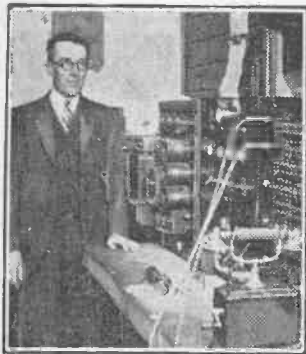

Look to Your BATTERIES

An Article for Every Listener

ONE of the commonest causes of the gradual deterioration of the quality and volume given by a radio set is the lack of attention given to the batteries operating in the various circuits. The filament, or "A" Battery, second, the plate, or "B" Battery, and third, the "C" Grid Bias cells.

In order to understand why attention should be paid to the various batteries, we will see what effect the variation of each has on the quality and volume of the set's output.

WHEN SPEECH GETS WEAKER

Assuming that the "B" battery and "C" battery are in good condition, and that the "A" battery is running down, we shall find that the received music or speech begins to get weaker and weaker without any great loss of quality, until, if the "A" battery is completely discharged, no music or speech at all will be heard.

There is no need for this to happen if the battery is regularly tested with a hydrometer. Make a point of testing the batteries every few days, and keep a record chart of their condition, and the hours of use.

Another use for the hydrometer is to check up the battery after it is returned from being charged. Never allow the "A" battery to totally discharge, or remain discharged for a long period.

PLATE SUPPLY BATTERY

The next battery to consider is the plate supply, or "B" battery. If the other two are in order, and the "B" battery voltage is reduced, a decided falling off in quality and volume will be observed. If the battery is of the dry cell type, and is fairly old, and the other two batteries are known to be in order, what will be noticed is that on switching on the set, signals are fairly loud, though perhaps the quality is not so good as it had been before, but after a time the signals become weaker, and the quality becomes worse. This is due to the "B" battery becoming discharged, and recuperating to some extent in the periods in which the set is not used. Of course, these batteries should have been discarded before this happens, but it is difficult, if not impossible, to know when to replace if no means of measuring are available.

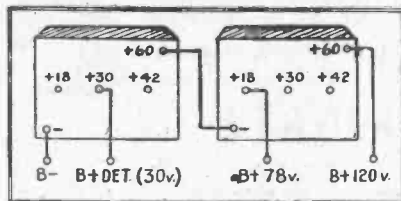

Showing the correct connections for the B batteries.

USEFUL VOLTMETER

For this purpose a voltmeter will be most useful. The usual type of voltmeter require a current to operate it, which, although very small, is quite sufficient load in itself for testing a "B" battery.

The "B" battery voltage on the set should be kept within 10 per cent. of the intended voltage, if really good results are required, and the dry battery should be completely discarded when it shows a reading of less than two-

thirds of its rated voltage—before this, if it can be afforded.

EXPENSIVE TO OVERLOAD

It will be found that it is very expensive to run a loud speaker set of three to five valves with the cheap small capacity dry battery if good quality is to be maintained, since with a heavy load these little batteries last for so short a time, and it is more economical to use the long-capacity type, which, although they may cost two or three times as much, will last five or six times longer.

If the plate supply is drawn from accumulator "B" batteries, a 90 volt battery should not be allowed to discharge below 80 volts before being charged again. When testing the voltage of an accumulator "B" battery, do so after the set has been in operation for about five minutes. Occasionally test the gravity of each cell in the battery.

THE GRID BIAS CELLS

The remaining battery, the "C" or grid bias cells, is one which usually receives little or any attention at all, although it certainly requires the least of the three. It must be remembered that a dry battery does not last for ever, even if no current be taken out of it. In fact, a life of twelve months under these conditions is all that can reasonably be expected. The electrolyte in the battery gradually dries up completely in the course of time, rendering the cell useless, even if it is not used at all during the time, so that the grid bias battery should be renewed as a matter of course every nine months. The voltage, as shown on a meter, will decrease gradually owing to the increase of resistance of the battery, due to drying up of the electrolyte. If the grid bias to the audio amplifier value is too small, or becomes too small, serious distortion will be noticed, and a serious drain on the "B" batteries will take place. Also, the life of the valves will be materially shortened. It would not be out of place to point out the great importance of carrying out the valves manufacturers' advice as to providing the correct grid bias for each stage of amplification. The usual all-purpose valves require in the vicinity of 9 volts grid bias, with 135 volts on the plate. But if a power valve is to be used in the last stage it will be found that the manufacturer recommends 15 to 22½ volts bias.

TEST REGULARLY

To conclude, if you do not possess a voltmeter and hydrometer, purchase one, and make a point of testing your batteries regularly, and keep a chart of the hydrometer and voltmeter readings, so that you will know when your "A" batteries want charging, and the "B" batteries renewed.

If these suggestions are carried out, the radio will always be in good condition for special broadcasts you may want to hear.

By
**Ray
Allsop**

(Associate
Technical
Editor)

PEOPLE *in the* PROGRAMMES

John Mitchell

MR. JOHN MITCHELL is the very good-looking young man. He broadcasts from 2FC almost every week, and has been doing so for the past five months. Not without notice. You will know his voice—it reminds you of Alfred O'Shea.

A suburb of the Coaly City—Mayfield to wit—has the honor of presenting him to New South Wales radio audiences. "I learnt from Rupert Thompson in Newcastle for three years," he said, "and one evening at a friend's



John Mitchell

place I met Alfred O'Shea, who gave me some encouragement." Also several lessons. As might be expected, he "learnt a great deal from one night's lesson by Mr. O'Shea." Mr Mitchell is something of a draughtsman, and spends some of his spare time drawing portraits. His living may be described in one of the ready-set phrases of contemporary journalism as precarious, "right on top of the surf." He looks very slim and very brown, and has the youthful ambitions, the nature of which, as is usual in such cases, he will not disclose. Well, in nine cases out of ten our youthful promise is made to break us; and so we hope, indeed we trust—in fact, we are almost sure, that Mr. Mitchell will be the tenth case. If he is not, we shall, at least, have had the satisfaction of hearing him from 2FC.

Aunt Willa

MOST people who have Aunts, or preconceived ideas of Aunts, will be surprised to hear that the picture is really and truly of Aunt Willa, of 2BL. And when they see the drovin' of her by her partner in the children's session, the clever young Cousin Marjorie, they will probably be more than surprised.

She looks like a Dream of Fair Aunts. She has the smile we have never seen on Auntie's face. She has the laughter which would absolutely discomfort our worldly Aunties' unrelaxable dignity, and she has an Auntly-voice, whose softness, roundness,

and modulation of tone can give the lie to the best loud-speaker advertisement in town, and certainly to any other Aunt in Sydney. That is, of course, if you look at the question impartially. Not everyone can do this.

Aunt Willa kind of drifted into the Aunt business. She was at one of the 2BL Saturday morning gatherings, when there was no pianist, and volunteered to fill the breach. That she did this satisfactorily is no small commendation of her musical honors, which included A.S.C.M., L.S.C.M., and F.S.C.M., the last, being interpreted, meaning Fellow of the Sydney College of Music.

In fact, she became very popular at the children's gatherings, and was soon invited to come to play in the 2BL Studio during the children's session. Her visits grew more and more frequent, until at last, on a certain day, the precise date of which we do not remember, she was elected unanimously by the Studio Uncles to the position of Studio Aunt, which she continues to occupy to the satisfaction of thousands of nephews and nieces, and with no little honor to herself.

She sings, croons fairy songs, talks to children, and answers letters. And does it well.

We believe, also, that there is very little difference between Aunt Willa and a certain Billy Creswell, who has been singing from 2BL lately. Only the name, and, as Napoleon said, "What's in a name?"

A distinguished Violinist

AFTER a brief absence from 3LO, a warm welcome will be extended by musical listeners to Rene Bergozzo, the distinguished young Continental violinist, who made such a favorable impression on his last visit to the studio. It will be remembered that Mons. Bergozzo received his musical education at the Conservatorium at Bologna, and was the youngest student to carry off the prize for violin playing. He gave many recitals at Nice, and immediately received an invitation to play in the Continental Orchestra. Mons. Bergozzo has been closely connected with Grand Opera, and



Rene Bergozzo



Aunt Willa

has had the distinction of being a member of the orchestra at performances of "Cavalleria Rusticana" and "L'Amico Fritz," which were conducted by the world-famous composer and maestro, Mascagni. His violin, which charms the "listening ear," is quite modern, but is built on the lines of antique instruments, made famous by the great violin makers.

"I like your country," said Mons Bergozzo, in his quaint, singing accent; "it is so—so different! It is very nice to broadcast from your studio, but I do miss my audiences. The people, you see—they help me so. But I do not worry."

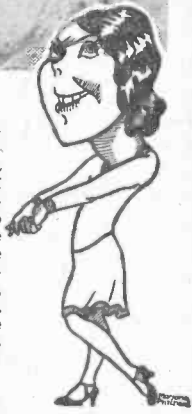

Our inspiration: A young lady of taste and fashion whose name we guard jealously.

Returning from the accomplished task, They ask her softly "How'd it go?" And she replies, "Why need you ask? It was SO nice! I liked it SO!"

Which leaves them all quite satisfied; For flattery, of course, they hate; To ask opinions is their pride And hers is to discriminate!

"Oh, what is Truth?" cried Plate bold— Thus answers aye the woman's wit: "The truth is only truly told When everyone is pleased with it!"

And thus the sunny nights go by Laughing their way with this bright gai; And artists, leaving, sadly sigh "Ah, to remain at 2BL!"

She is a most important she As all who know her well know well— Hers the responsibility Of answering for 2BL!

WHY THE STARS TWINKLE

Her hair is gold, as though the sun Had drenched it in his shimmering light; That, when the other lands he's run, He'll be remembered here at night.

Her eyes are—well, they may be grey, And yet again they may be blue; We're not quite sure; but every day (We're sure of this) they'll smile for you.

She minds the nightly telephone From six to ten at 2BL; She answers the disgruntled groan, And for this purpose answers well.

She answers when you ask the name Of that nice man who's singing now— The weather—score—it's all the same— She finds it out for you somehow.

And every evening, as the glow Of purpling sunset fades away, With scissors plying to and fro She clips the Sporting Resume.

Now, when these harrowing demands Upon her time and patience cease, She takes a book in two small hands And sits in perfect arm-chair'd peace.

And then the eight chimes slowly sound And artists come in one by one; They bring their chairs, and gather round Like stars that hover round the sun.

With laughter, talk, and compliment, These artists all the waiting while, Pleased if the bad coin so well spent Can gain the blessing of her smile.

Their jokes are sad; their wit is small; Their compliments are flat and stale; Their puns are puny—one and all; But yet, with her, they never fail.

She likes to let them think she thinks They're clever, as they wish they were; She understands their funny kinks And silly ways, you may infer.

And with the women artists, too, She talks on strange domestic things, Like men, and matters not a few Connected with engagement rings.

And so the artists go upstairs And speak or play or sing a song; Sure in their hearts that ONE WHO CARES Listens below, the whole night long.

The Microphone Presents

2FC—2BL

A Genial Personality

JOHN WARREN, who possesses that type of voice eminently suited for broadcasting, is busy preparing new numbers for his appearance at 2BL on the evening of Wednesday, February 20. His is a personality which creates that genial glow of goodfellowship—an atmosphere the microphone is peculiarly susceptible to. Listeners are always pleased to read his name on the programme.

Composer-Pianist to Broadcast

EDITH HARRHY, the delightful Welsh composer-pianist, who has given many successful recitals in Sydney, will broadcast through 2FC on Monday, February 18. Her programme on this occasion favors a number of her own compositions—captivating musical trifles which make a wide appeal to listeners.

Hospital Concert

ON SATURDAY, FEBRUARY 23, the 2FC Hospital Concert Party will visit the Thomas Walker Convalescent Hospital at Concord West. "The nurses are anticipating your visit as eagerly as the patients," the secretary of the hospital told the New South Wales Broadcasting Company. "Your party is creating a red-letter day for us all." Charles Lawrence is taking with him on this occasion Harrison White, Dorothy Dewar, and Frank Ryan.

All-round Programme

ON THE EVENING of Tuesday, February 19, there is a good all-round programme through 2FC service. The vocalists are Daisy Mangan and Theodore Atkinson; Miss Mangan is well-known in the Sydney musical world, and Mr. Atkinson is one of the recent Eisteddfod discoveries. The Metropolitan Band, under the baton of John Palmer, will contribute some very fine numbers, and the sketches to be produced by R. D. Maunsell are up to the usual high standard of his work. Through 2BL service on the same evening the programme prepared by the Rose Bay Music Club under the direction of Oliver King will be broadcast. The artists are:—Alfred Cunningham, Heather Bell, Harold Whittle, Beatrice Tange, and Rene Rich. During the interval between 9.0 and 9.20 "Bringa" will give one of his interesting talks on the aborigines from the studio.

Charles Lawrence in a New Role

THERE are few artists who are so versatile as Charles Lawrence, but the curious part of it is listeners are not disposed to encourage his versatility. He is the possessor of a pleasing baritone, which is never permitted full scope in the comedy numbers which find such favor, and his straight monologue work is a decided adjunct to any broadcasting programme. "But if I feature one of the better class monologues," he complains, "I invariably receive a dozen requests for —," he hesitated. "For?" he prompted. His eyes twinkled. "THE LOST DOGGIE!" And he laughed heartily. "You see, they won't LET me be different." During March, however, Mr. Lawrence intends to concentrate on monologues—grave and gay—if for no other reason than to prove they can be developed into a successful broadcast item. It is well known this type of work is particularly hard to transmit successfully, and it requires an artist of more than ordinary ability to avoid the pitfalls the microphone presents. 2BL listeners will have ample of judging Mr. Lawrence in his new role.

Smart Word Pictures

HARRY GRAHAM'S REVUE on the evening of Thursday, February 21, promises something refreshingly new in the way of radio entertainment. His "Snapshots" are—as their name implies—smart little word pictures, which break right away from the cloying type of "laugh, clown, laugh" comedy.

Really Interesting People

FREDA STERNBERG'S talk on Tuesday afternoon, February 19, promises an entertaining quarter of an hour for 2FC listeners. "One hears a lot about interesting people," says Miss Sternberg, "but are 'interesting' people REALLY interesting?" She should know, for her experience covers a wide field.



Browning Mummery, the noted tenor, who appeared with the late J. C. Wilham-Melba Opera Co., has postponed his departure for America for a month, and, in consequence, the series of appearances, extending over one week, prior to his sailing, are now set down for from February 28 to March 6. The picture above shows him as he appeared in a recent opera.

Grace Quine

GRACE QUINE, a vocalist who handles the popular type of song to distinct advantage, is again in Sydney, and will entertain 2BL listeners on the evening of Monday, February 18.

Popular Night

FRIDAY NIGHT is generally looked on as a popular night through both 2FC and 2BL. Through 2FC service, the Light Music Four play bright popular music, and on Friday, February 22, Charles Lawrence and Rae Foster have a number of duets of the lighter type for the entertainment of radio fans. Ad Cree will contribute a spice of Scottish humor, and Peggy Dunbar, whose voice a popular periodical has likened unto a magnolia, will complete a programme guaranteed to please everybody. Nicolas Robins at the Wurlitzer organ (Chatswood Theatre) will open 2BL's programme on that evening, followed by Frank Ryan in humorous numbers, and dance music by the Savoyans. Later in the evening there are solos by Terence Nugent, and C. R. Dexter will give his last-minute racing information.

Imaginative Raconteur

VIGNETTES OF HUMANITY by the Storyteller are offering 2FC listeners some of the most intriguing stories ever heard on the air. "The Storyteller" is a master raconteur, and his material is vibrant with emotion—laughter and tears merging in a quicksilver stream. Some are culled from life; some are born of his own vivid imagination. The tale on Thursday night, February 21, creates its own atmosphere, but "The Storyteller" offers a hint to listeners. "Make your own setting," he says. "A brilliantly lit room spoils the illusion; turn out the lights, or take the speaker on to the front verandah. The effect is so much better in dim seclusion."

3LO—3AR

The Blind Pianist

MUCH interest is centred around George Findlay, the blind young Melbourne pianist, who is giving another recital from 3LO on February 11, when he will submit a most interesting programme, in which he hopes to include some of his own compositions. Mr. Findlay showed exceptional ability on the piano at a very early age, and every facility was provided by the authorities of the Royal Victorian Institution for the Blind to enable him to further his studies. He is an Ormond Exhibitioner, also winner of the 3LO Exhibition, which permitted him to continue his musical education at the University for another year.

Stephanie Deste to Recite

LOVERS of literature will be delighted with the programme arranged by 3AR for Sunday, February 10, when, in addition to vocal items from Miss Bessie Banks and Mr. John Byrne, a recital from the works of Australian poets will be given by Miss Stephanie Deste. On many occasions Miss Deste has electrified listeners with the sheer brilliance of her literary recitals, her excerpts being culled from the Scriptures, the sonorous Psalms, and the colorful song of Solomon; but for this recital she has confined her charms to our native poets, and will include "Sea Grief," by Dowell O'Relley, "When I was Six," by Zora Cross, and "The Gray Company," by Jessie Mackay. Attractive instrumental solos and trios will be given by the Strad Trio, and listeners may anticipate a most enjoyable time.

Wireless Weekly

Incorporating "Radio in Australia and New Zealand."

FRIDAY, FEBRUARY 8, 1929.

Going Back to the Crystal Set

IN placing before readers this week a simple crystal circuit similar in almost all respects to those which delighted our hearts five years ago, we cannot refrain from appreciating the changes which receivers have undergone in that time.

This strange little contraption, with its "hay-wire" and hand-wound coils, makes a strange comparison with the set of to-day. A visitor from Mars would hardly believe that they were constructed for the same purpose. And withal, reception on this crystal receiver and on a modern receiver is very much the same.

Where, then, is the difference?

It lies in comfort, reliability, range, and variety more than in actual reception. We all remember the time when we were satisfied with the performance of a set as long as it produced some results. The crystal set got results, but only at short range. The valve set appeared, and for a time it did not much matter whether or not the noise was a reasonably true reflex of the sounds heard in the studio, so long as it was loud. The novelty of the thing was responsible for this.

Later we prided ourselves on the performance of sets containing a minimum of components—even if a complexity of arrangement. These sets invariably caused us to become enemies of our neighbors when we allowed our receivers to oscillate. New listeners, too, were confronted with the obvious fear, "I'll never be able to manipulate all those gadgets: I haven't the necessary technical knowledge."

But listeners became more critical. They did away with the discomfort of headphones; they eliminated the oscillating receiver as much as possible; they wanted reliable reception of distant stations so that they could have variety of programmes; they wanted simplicity so that anybody could operate a receiver; they wanted neatness; and they wanted the purity of tone of the old crystal set.

The result is the receiver of 1929, restrained in taste and design, easy to operate, simple, and capable always of reliable performance and good tone.

And yet hundreds of readers have requested that we describe a crystal set again.

Some Oscillating Figures from 3LO

IN the year 1928 no fewer than 18,146 songs were broadcast by 3LO—sopranos, tenors, baritones, contraltos, bassos, and others vibrated the air we breathe with their songs of love and woe for a total of 55,248 minutes, equal to about 38 days. Classical, orchestral, and instrumental numbers occupied 36,000 minutes, or about 25 days; and for 31,515 minutes dancers all over Australia stepped merrily to the tunes of modern jazz and old-time, dance strains, of which more than 15,000 numbers were played! Scotty, "the Man fra' Auld Reekie," who plays the Sousaphone, puffed through his instrument sufficient air to inflate a small airship. Extraordinary, but, nevertheless, a fact.

Eric Welch spoke for 7920 minutes on race-courses and at the Stadium, while Agnes Fortune, the studio accompanist, touched the keys of the grand piano which once belonged to Paderewski, more than seventeen million times. Church services claimed over 16,000 minutes, and about 9750 miles of telephone trunk lines were used for outside transmissions. Talkers talked for over 20,000 minutes upon all manner of subjects from suet puddings to the ancient tombs of Egypt.

The Melbourne Hospital was kept for 16,224 minutes by the Junior Birthday League, which is conducted during the 3LO Children's Hour, and which collected no less than £2028/10/ for the year.

It took over 17,000 minutes to tell Australia the latest news, whilst 7320 minutes were required to inform farmers of the price of pigs, onions, and other produce, and to acquaint investors of the latest stock reports, and men who go down to the sea in ships of approaching storms; whilst real life tragedies and romances claimed the attention of listeners for more than 1000 minutes in the form of urgent police messages.

Indeed, the task of preparing these programmes is colossal, and one's brain whirls the more one delves into and dissects the intricacies of their make-up. And yet, withal, the studio staff and those responsible for three big concert programmes a day every day in the year are cheery souls. Imagine a mail of 100,000 letters a year—each to receive attention the day of receipt! Phew! Let's change over; my head doth oscillate.

Two Minutes S.O.S.'s

A LULL in the evening programme . . . then the voice of the announcer: "We have been asked to broadcast the following message . . ." Follows a police notice, repeated once; in all, two minutes elapse, and then the entertainment proceeds. Just two minutes, but we wonder if listeners realise what that broadcast message may mean to those vitally interested. In thanking the New South Wales Broadcasting Company for just such a transmission, a resident of Croydon (N.S.W.) brings home clearly the inestimable value of radio. "We had been for twenty-four hours trying to get in touch with my brother," she said. "Eventually, thanks to your efforts, no less than TWENTY people got in touch with him almost immediately after your first message."

Latin Programme

TOULOUSE, the ancient capital of part of Gaul when Caesar's legions conquered the country, paid a compliment to its early invaders when its radio station broadcast a message in Latin. Thus one of the oldest tongues was conveyed by the newest scientific means. Latin scholars were invited to transmit their impressions in Latin.

People a Radio Fan Meets.—No. 1

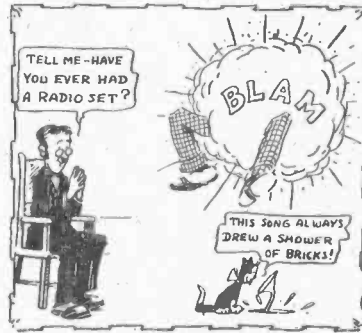

Introducing Henry, who is a little bit of every radio fan, and some of the people he meets. Next week we will introduce some of his particular wireless friends.

The Safety Valve

Readers are urged to express their opinions on matters pertaining to broadcasting. If you have some grievance, if you have some constructive criticism to offer, here is your chance for expression—your safety valve. The



editor assumes no responsibility for statements made by readers and published on this page, as opinions of correspondents do not represent our editorial policies or beliefs. Anonymous letters are not considered

"Laughing Water"

Dear Sir,—The correspondence in these columns displays to great advantage a fundamental weakness in the reasoning powers of the average woman. I refer to their fatal liking for generalisations, based upon a particular case. For instance, I read "the majority of listeners are quite satisfied with the programmes now being provided by the A-class stations," and, without further ado I am willing to bet a "tenner" to a tin tuck that the revealing letters, Mrs., will be found to preface your correspondent's name. Mrs. X. is entirely satisfied (knowing no better) with the status quo. Therefore, everybody else must be. Controversialists of this calibre should stick to their frying-pans—thank you, gentlemen.

Now to business. In our little corner of the great metropolis, we know Captain Stevens as Minnehaha, or Laughing Water, on account of his charming innocence (destructively criticised by "Non-Egotist" (who must be one of these Bolsheviks I've heard about). He never, by any chance, tells us anything that is not fit for us to hear, so we always call the children when he's on. So different to those terrible News Sessions, when the headphones have to be plugged in. We also like his garrulous reminiscences, they remind us that even announcers are human, and subject to the usual risks of mortality. Finally, his patriotism is, so far as we are concerned, stainless, and wholly creditable to a (late?) member of his Britannic Majesty's Forces. Captain—your hand, sir, or, perhaps you would prefer a military salute? Long may you flourish.

Yours, etc.,
FAIRPLAY 2.

Rushcutters' Bay.

The Irish Ire Aroused

Dear Sir,—Mr. Gunn states that I have done him a great honor in criticising some of his remarks. I can quite believe this, for the mere reading of them flattered him not a little.

In his latest illuminating letter, I have found, however, instances of weak and puerile reasoning, wholly unworthy of one whose object is to reform the "ignorant and uneducated," e.g. Since the public do not agree with Mr. Gunn in his conception of a programme (1) "They are fundamentally low-minded and depraved." (2) "They lack all sense of artistic balance and proportion"; and (3) "They are intemperate livers!"

He refers also to a "low, vulgar, and particularly distasteful habit of punning in names," a habit I have in common with Dickens, with Byron, with Shakespeare, with Pope, etc., etc. In the case of these writers, picked out at random, punning did NOT lend merit to their distinction as Irishmen, thus Mr. Gunn may see that the Irish have not the monopoly of this "unhighbrow-like" habit.

I should be obliged also if Mr. Gunn would explain the relation between my nationality and the alleged improvement of the programmes, remarks about which were as foreign to the subject under discussion as to good manners. Bad manners may be ex-

cused in a "low-brow," but not in an admitted civilised "highbrow" and "thinking man."

Mr. Gunn, despite his war on "comedians," has been supplying the greater part of the amusement in the "amusing rag" for several issues back, and so far has demonstrated his inability to do more than abuse others, and praise himself, his letters being principally composed of frenzied abuse and weak, unsubstantiated statements.

We will now examine one of the more cogent of Mr. Gunn's statements. "The programmes are bad enough to make every thinking man in Australia a perfect snob." Personally, I believe this is a mis-statement for what apparently has happened is that the programmes have been bad enough to make a "thinking man" OUT OF a snob. For, are not the patronising letters of advice to the broadcasters, and the bouquets he has presented himself, indications of the esteem in which he holds himself as a thinking man?

On carefully re-reading this gentleman's rambling letter, I discovered some vague references to the subject we are supposed to be discussing. Is he really abandoning it for abuse, having found that although the public may not "know what it wants," it is well aware of what it does NOT want?

On ending off my letter, I must thank very sincerely "one of the genius highbrow" for replying to something corresponding to the name of

V. SHANE, O.G.

Blackheath.

What Has Been Done? Nothing!

Dear Sir,—Mr. Ray Allsop raises a very pressing question in your issue of January 25.

It must be about 18 months ago since a Royal Commission sat to inquire into the wireless question in Australia. It made many recommendations, and the report was very comprehensive. The cost of the Commission sitting in the various capital cities must have been considerable, but apparently both time and money were wasted (quite a usual thing with Commonwealth Commissions), as not one single recommendation has been carried out, and country listeners are still not catered for. As Mr. Allsop suggests, 5 k.w. stations have not sufficient range to cover the wide distances, especially as the actual aerial power is not 5 k.w., but, according to the tests made, only 4100 watts.

When the Commission had finished its report, we were told that nothing would be done until Mr. Brown returned from the International Radio Conference in U.S.A. He prolonged his absence by many months, remaining in England, and on his return was promptly given a huge increase in salary. The only thing he has done is to announce that the stations are to be taken from private ownership, and transferred to Government control and ownership. Listeners, and they are the people who pay, are very much concerned, as Government enterprises generally turn out to bear excessive overhead costs, and are eventually run at a loss. If this happens, both programmes and services will suffer, and certainly improvements

will never be made. In a short time Australia would be further behind than ever in broadcast matters.

I am quite convinced that if, say, one high-power station of 50 k.w. were erected, say, 100 to 150 miles from the coast in each State, many more licenses would result, and people would have the real pleasure of wireless. To-day one must have a powerful receiver, and even then so many months of the year it is impossible to listen, owing to fading and atmospherics. Curiously enough, yet easy to explain, country listeners use, or try to use, their receivers much more than suburban residents, for the simple reason that they have no other entertainment. Go to any home in the country, at any time of the day, and you will hear the receiver working, and many listeners do not know what it is to receive a programme free from disturbance and fading. They think radio has not developed sufficiently. One day they go to the city or suburbs, and at a friend's house they hear a programme, and are astounded at the freedom from static and fading.

As in everything else the man in the country is left out of all calculation. He bears the burden, pays for everything he gets at high rates, and receives the least consideration.

Another recommendation of the Royal Commission was an immediate re-allocation of wave-lengths. What has been done? Nothing! A correspondent in the same issue raises the point by quoting the fact that our stations are being interfered with nightly by the heterodyne of Japanese stations. I wrote to the P.M.G. a long time ago, also to 3LO, Melbourne, who passed my letter on to the P.M.G., but from the latter not a word in reply.

I have here two of the latest and most selective six-valve receivers, and it is impossible to cut the whistle out, simply because the wave-length of the Japanese stations is right on the wave-lengths of 4QG and 3LO, and also 5CL. After these stations close down, the Japanese come in with a roar, on increasing the volume in the receivers.

The suburbanite can get all he wants from a small 3-valve receiver, which must be selective, but not necessarily sensitive, but the country listener must have a multivalve sensitive receiver to get any reception at all, and if he lives on the southern tablelands he has to put up with distortion, fading, and statics. In four years I have not received a single programme after dark without one or all of these troubles.

Now, sir, you and your technical men can render great service by hammering away until Mr. Brown does act, and if only the Listeners' League (rather a mysterious body, which never answers letters), were an active co-operation of all listeners, which would assist you, then we might get something done, and thereby place Australian radio on the same plane as that of any other country.

As regards programmes, well, that is another story, and I will leave the subject over to another occasion.

Yours, etc.,
50 KILOWATTS.

Exeter.

Ask For Your Money Back

AND YOU'LL GET IT, IF GOODS SUPPLIED BY US ARE NOT EXACTLY AS REPRESENTED IN OUR ADVERTISEMENTS. THIS APPLIES TO MAIL ORDERS ONLY. LOCAL CUSTOMERS WE WOULD PREFER TO CALL AND SEE FOR THEMSELVES THE VALUES OFFERED

THE ECO BATTERY CHARGER
Sold in Kit form.
55/-

AT
OUR RADIO STORES
AT
**SYDNEY, PARRAMATTA
NEWCASTLE & ORANGE**
Same Prices and Goods at All Shops

THE ECO CHARGER
USES THE NEW METALLIC RECTIFIER, and charges at a 2 amp rate.
NOT a Fiddling Trickle Charger.
It charges your battery overnight.

Lower Prices

LET US SHOW YOU HOW TO BUILD IT IN ONE HOUR
The Original Economic B'Eliminator
Ample Current at Voltages to 150.
IT'S A REVELATION 59/6
No Trouble, No Hum, No More "B" Batteries.

Service That Satisfies

ELECTRIFY YOUR GRAMOPHONE WITH THE PACENT PICK-UP
OUR PRICE 55/-

PARTS FOR THE KUG CRYSTAL SET

1 Panel, hard rubber, 12 x 7	s. d.
1 Baseboard, 11 x 7	4 3
1 .0005 Continental Condenser	1 1
1 4in. Card Tube	9 6
1 3½in. Card Tube	0 6
2 4in. Dials, 1/-	0 6
¼ lb. 24 D.S.C.	2 0
5 Terminals, Black	3 4
1 Crystal Det. (Silverix)	1 3
1 Crystal Det. (Silverix)	3 6
2 Yards Flex (Lewcos)	0 8
1 Variometer Parts	1 6
•2 Bus Bars	0 2

FRESH B BATTERIES
for those who are not fortunate in having an electricity supply.
Heavy Duty, 45-volt, 20/- & 26/-

LET US HAVE YOUR ENQUIRIES.
WE CAN SUPPLY ALMOST ANYTHING RADIO.

ENQUIRE ABOUT OUR NEW "A" BATTERY ELIMINATOR.
SHORTLY AVAILABLE.

"Yours for Lower Prices and Service that Satisfies."

THE ECONOMIC RADIO STORES,

Address Mail Orders, 492 George Street, Sydney

COUNTRY CLIENTS.—Our parts are absolutely guaranteed to give satisfaction. Send your orders to us conditionally that your money is refunded if you are not satisfied with the goods upon receipt of same. Goods must be returned to us within ten days. We Pay Carriage on All Orders of 10/- and over. Valves and goods specially procured cannot be exchanged. Terms Cash. No discounts.

SYDNEY
25 New Royal Arcade,
near
Palace Theatre.
'Phone, M6138.

NEWCASTLE
13 Union Street,
off
Hunter Street West.
'Phone, New. 1622.

PARRAMATTA
Corner Church and
Macquarie Streets.
'Phone, UW 9601.

ORANGE
120A Summer Street.
'Phone, Orange 735.

By DON B. KNOCK
(Associate Technical Editor)

How to Build

- List of parts for the KUG crystal receiver:—
- 1 Panel 12 by 7 inches.
 - 1 Baseboard 11½ by 8 inches.
 - 1 0005 mfd. variable condenser.
 - 1 1 Length 3 in. diameter card former.
 - 1 Length 3 in. diameter card former.
 - 2 Blain or vernier dials.
 - 1lb. 2½ D.S.C. copper wire.
 - 5 Moulded top terminals.
 - 1 Crystal detector.
 - 1 Yard silk flex.
 - 1 Variometer assembly.
 - Busbar, solder, screws, etc.

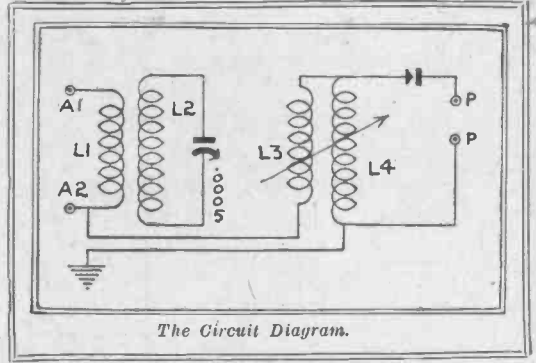

The Circuit Diagram.

The KUG Crystal Receiver

An efficient little crystal receiver built by a listener, and forwarded to "Wireless Weekly." So excellent was its performance that the Associate Technical Editor decided to give constructional details for those readers who have been requesting a crystal circuit.

There is room for development in everything. Even though one may imagine that the crystal set has reached a stage where it cannot be materially improved, this is far from being the case, as this article will show.

A week or two ago I received a letter from Mr. Theo. Kugler, of Maroubra, Sydney, who was good enough to inform me that he had devised something exceptional in the way of crystal sets. Readers will understand that the technical editor of a wireless journal is often harassed by "Cranks," who claim to have discovered the theory of the Thermionic Valve all over again and what not, and always fail to substantiate their argument by something in concrete form. The least that said Technical Editor can do is to be harrowingly polite, and when Mr. Crank has departed, turn to the W.P.B. and get on with his work. If only those people who really have something worth while up their sleeves for the wireless community in general, would come to light with "the goods," and prove their statements, there would be no time wasted.

Far be it from the idea that I would suggest the man of an inventive turn of mind to give his idea, which might be patented, indiscriminately away, but whereas inductance, capacity, rectification, etc., are already the subject of apparently life-long patents by prominent wireless engineers, those patents can always be turned and twisted inside out for better or worse, as the case may be.

Mr. Kugler wrote me a letter outlining his crystal set, and he accompanied it, not only with detailed drawings, but with the set itself, which convinced me that it was not done just for the fun of the thing.

Quite rightly he had named the set after himself in abbreviated form, and, after my trial, I am pleased, through the courtesy of Mr. Kugler, to place before "Wireless Weekly" readers what I consider the most efficient crystal

receiver yet designed in these days of split frequencies.

The KUG crystal receiver is selective to an unparalleled degree, and amply bears out the claims made for it by its enterprising designer. When I tested the set at my workshop at Randwick, with 2BL "just over the fence," there was absolutely no difficulty in cutting 2BL right out of the picture, and in tuning in without interruption 2KY, 2UE and 2FC.

Nothing wrong with that for the inherently unselective crystal, is there?

To thoroughly enlighten readers as to the performance of this modest little set, I will quote the letter accompanying it.

"Dear Sir,—As a reader of the old journal since May, 1924, the copies of which I have consecutively from that date to the last issue, unsoiled and complete, I take this opportunity of writing to you, and sending my crystal set, with details of circuit, etc., and the results it gives. This circuit is my own idea, and it delivers the goods as follows:—

"I made one for Currency Creek (via Windsor). Up there they get 3LO, 4QG, 2BL, 2FC, and sometimes 2UE and 2HM (experimental). Another one I made for a friend at Bundoock (via Gloucester), and he gets 3LO, 4QG, 2FC, and often 2BL. Please don't faint at this one!

"I made one for a friend in Denley Street, Randwick. Go out of the back door and 2BL's aerial is over the top of the yard. To

cut a long story short, at this location they can cut 2BL out dead, and tune in 2FC, 2UE, and 2KY, when 2UE is off the air. The aerial used is only a small outside affair.

"I myself live alongside 2UE, and his aerial is not more than 150 yards distant from mine, yet I can cut him clean out in favor of 2BL, or vice versa. It is difficult in my own case to hear 2FC, unless 2BL is closed down.

"Don't you think, Mr. Technical Editor, that this is a good performance for a crystal receiver in such a buffer location? You will be interested when I mention that both 2UE and 2BL operate my ARC Jamillon speaker, to hear it and understand every word three rooms away. A most important point, at least, in my own experience, is that if there is any departure from the coils with regard to the gauge of wire used, size of former, number of turns, etc., is that the same success seems to be missing etc., etc."

A glance at the circuit diagram will show that the KUG crystal receiver incorporates a wave-trap, while the tuning is really done by means of a variometer. The drawings indicate clearly the whole assembly and details of the coils, but in order that no confusion will arise, as it often, unfortunately, does, even with the simplest of circuits, I am describing in detail the construction. The list of parts shows what is actually required.

Begin by cutting off 4 inches from the 4-inch diameter former. After having trimmed the edges, centre for the holes for the spindle shaft of the variometer. Next cut off 1½ in. of the 3½ in. former, trim this also, and centre for the shaft holes. Starting half an inch from the edge of the 4-inch former, wind on 15 turns of the wire (24 D.S.C.), cross over as shown in the diagram, and wind another 15 turns from the other end. Make a note of

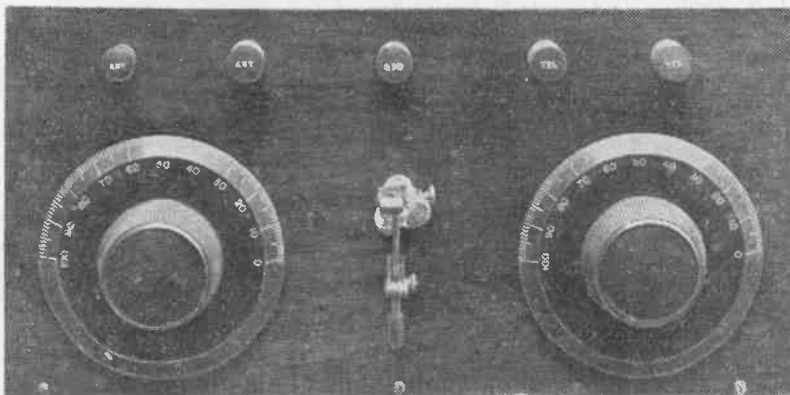

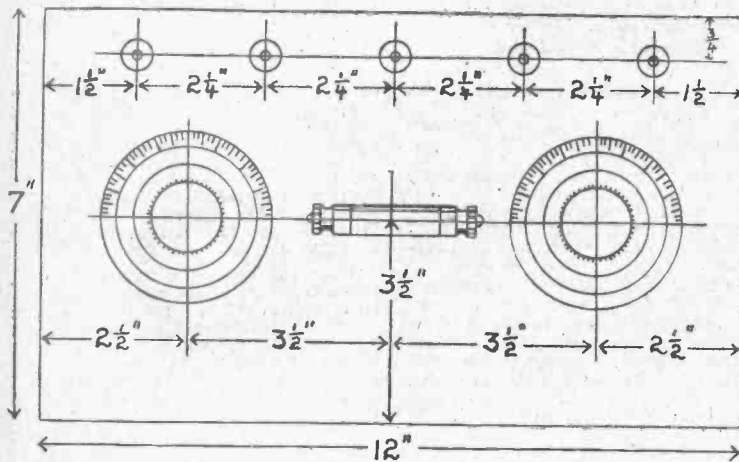
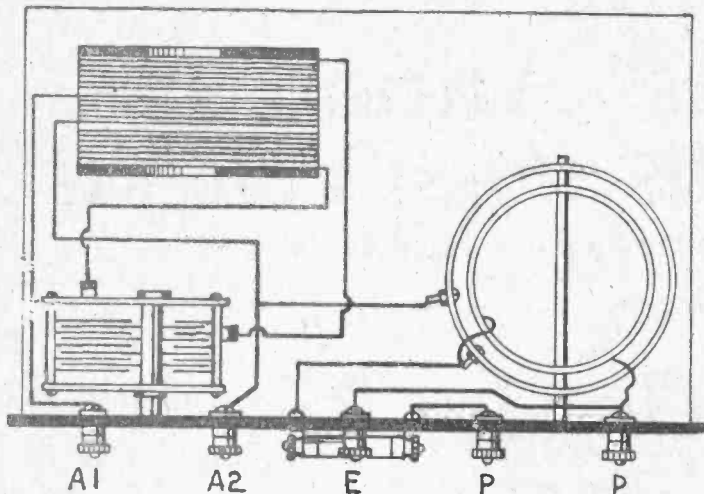

which is the finishing end. Dealing with the 3in. former, L4, start at the extreme edge and wind on 17 turns, leaving in for cross-over, continuing with the other 17-turn winding, thus making 34 turns in all. Make sure that both coils are wound in the same direction.

Next we deal with the wave-trap coils, which are marked L1 and L2 in the diagrams. Cut 2in. from the remainder of the 4in. former, and, starting in. from the edge, wind on 50 turns of the wire. Make a note of how much room 15 turns take up on the former. Find the centre of the 50 turns, and over the top of L2 wind on 15 turns, in such a manner that this winding is centralised with the other.

Secure the beginning and end of this 15-turn winding with a little sealing-wax. It will be advisable to wind this over L2 with a little insulation in between the two. This may be ordinary brown paper. Next assemble the 3in. coil, L4, inside the 4in. coil, L3, and see that the windings run in the same direction. Join the end of L3 to the beginning of L4 with about five inches of flexible wire, and about 8in. of flex to the end of L3 to the crystal.

Take another eight inches of flex, and solder it to the other end of L4, and to one 'phone terminal. The wiring may be done

throughout with flexible wire of the Celastite variety, although it will be just as easy to use 18 tinned copper. Run a wire from A1 to the start of L1. Next, from the end of L1 to A2, and the beginning of L3. Next run a lead from the beginning of the trap coil, L2, to the stator plates of the variable condenser, with the other end to the rotor plates of this condenser.

Next a wire is run from the earth terminal to the 'phone terminal, which already has the flex wire from the end of L4 connected, and then a lead is run from the other 'phone terminal to the other side of the crystal detector. This is all the wiring of this simple little job, and if it has been properly constructed, a really selective crystal receiver should be the result.

I know of many a home, yes, even in Sydney, where some members of a family retire early, and so the supervoludyne must be shut off, but the other sit quietly and listen, via a comfortable pair of headphones, to 2BL relaying "the dear old Strand," with a handy little crystal set.

A short vertical aerial seems to work out best with the KUG crystal. The crystals are located where interference is not really acute, the terminal, A2, can be used. The volume will be greater with the aerial attached here. If the crystal is connected direct to the start of L3 the volume will be further increased, but then the why and wherefore of the set will disappear, which is the selectivity.

Any good crystal detector will do—the one on the original consists of a triple cup, with three crystals for comparison. I hope, in conclusion, that this will satisfy those readers who have been inundating me with requests for a really selective crystal set.

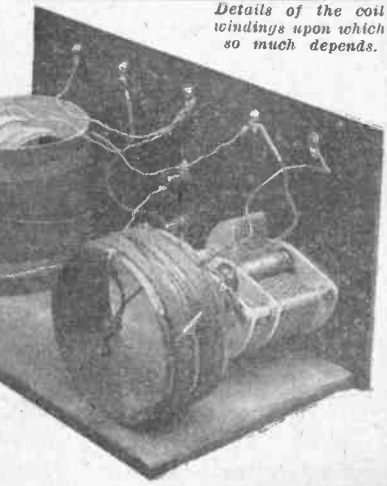
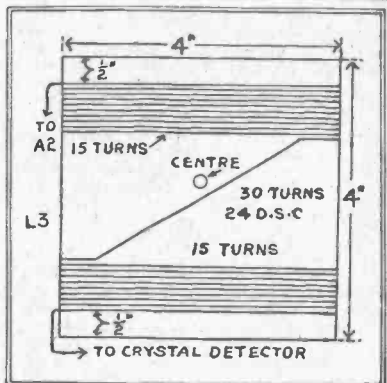
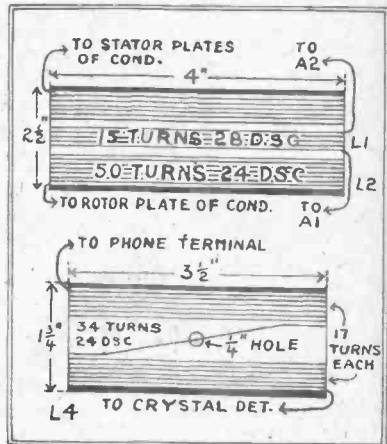

Details of the coil windings upon which so much depends.

Radiokes Announces

THE WORLD'S FINEST COIL KIT

FOR SHORT WAVES—RANGE, 15 TO 115 METRES

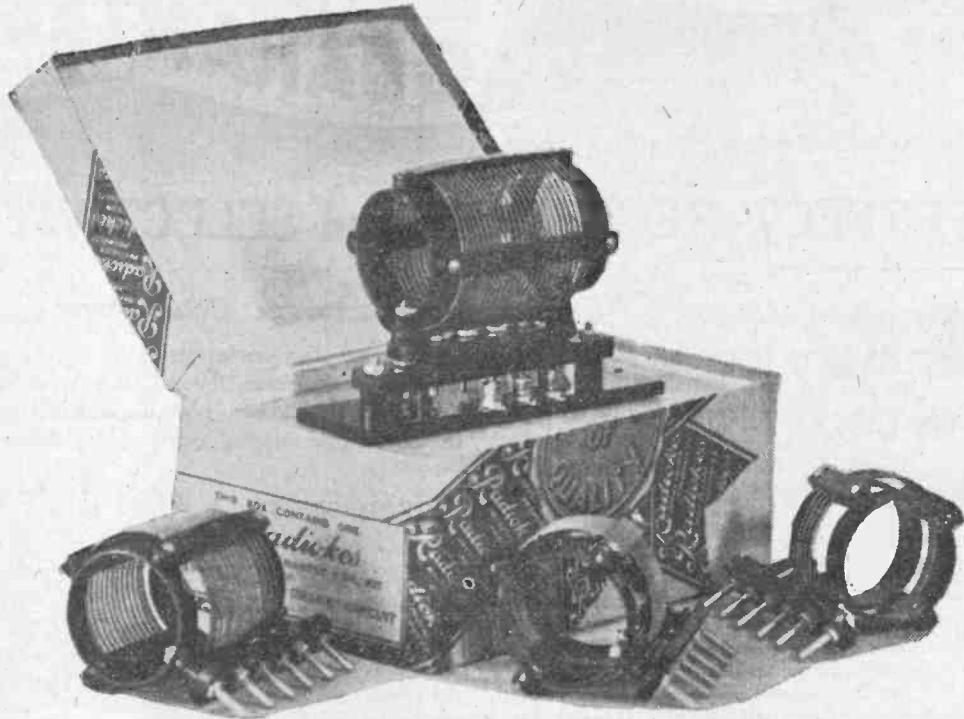

A new and better Short-wave Tuner Kit has been developed for a new and better Receiver. This receiver was recently described in "Wireless Weekly," under the name of "Short Wave Screen Grid Four." Above is an illustration of the masterpiece developed by the laboratories of Radiokes, and produced by the well-equipped and well-staffed Radiokes factory, for use under Australian Broadcasting conditions.

This new Coil Kit embraces many noteworthy features and improvements. Uses the latest design of interchangeable Radio Frequency Transformers, which are specially wound to make best use of the peculiar characteristics of the Screen Grid Tubes.

The new small diameter coils make for more robust construction, while limiting the field and making for greater sensitivity and efficiency. These new units make control considerably easier, and reduce noises which are inherent in the ordinary short wave receiver.

This Coil Kit, made up into a single control receiver, is specially adapted to musical broadcast, for, in addition to bringing in the broadcasters on the lower wavelengths, additional units can be procured whereby the usual broadcast channels may be brought within range of the receiver.

These new Radiokes units carry a special six pin horizontal mount, which is plugged into the new Bakelite mounting base. This base is equipped with a special high-grade silver spring system, which makes the interchanging of the units quite a pleasure. The beautiful velvety action saves any possible damage to units through use, and the specially-designed silver springs make positive electrical contact with the plated contact pins, thus assuring quiet and efficient operation of kit.

The New Kit, complete as illustrated above, is Priced at 72/6 per Kit

FROM ALL GOOD DEALERS EVERYWHERE, OR DIRECT FROM

METROPOLITAN ELECTRIC Co. Ltd.,

RADIOKES HOUSE, 126-130 SUSSEX STREET, SYDNEY

Or YORK HOUSE, LITTLE COLLINS STREET, MELBOURNE



PERFECT RECEPTION and SELECTIVITY

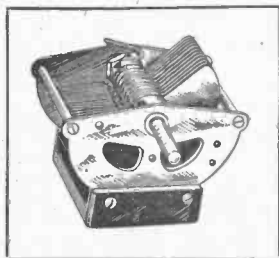

Emmco Manufacturers Condensers.

Rigidly built to withstand transportation or abuse, of sturdy construction, bakelite base, low minimum, these Condensers have a remarkably true capacity, removable shaft, pigtaills, automatic constant tension, perfectly insulated, and adaptable for either base, panel, or gang mounting.

PRICES: .0005, 12/6; .00035 and .00025, 12/-.

Emmco Simplex 3-Gang Condenser

The Emmco Simplex 3 Gang one control condenser has exclusive features, which give it undoubted superiority over all others. The solid construction and simple operation of a single tuning dial control ensure satisfactory results. The Simplex has insulated Unions, with lugs attached to the condenser, thus enabling them to be wired together to earth the Rotor Adjustable Mounting Bracket. The condensers have trimmer plates to facilitate perfect balancing in gang work. Any standard Dial can be used. $\frac{1}{4}$ in. shaft.

MADE IN TWO CAPACITY, .0005 AND .00035. PRICE, £3.

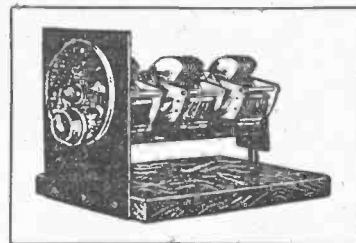

Emmco Super-stratylene Condenser

The results obtainable with the new EMMCO Super-stratylene Condenser are remarkable. This improved condenser has a cast Bakelite base and Brass Frame, it gives absolutely correct maximum and minimum capacities.

Perfectly insulated, cut away Brass Plates in both Rotor and Stator, pigtaills, and adaptable for either base, panel, or gang mounting

PRICES: .0005, 12/6, .00035 & .00025, 12/-.

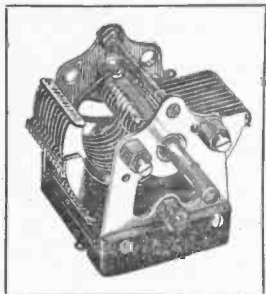

MADE BY ELECTRICITY METER MFG. CO., LTD.

EXCLUSIVE FACTORY REPRESENTATIVES:

139 Clarence St. Sydney
TELE. BW 1328



Sugden Place off Little Collins St.
MELBOURNE

ALL EMMCO PRODUCTS ARE FULLY GUARANTEED

HITTING BELOW the BROADCAST BELT



Short-wave and Amateur Notes by VK2NO

New Regulations

A LARGE number of readers have written asking for further information about the new amateur experimental regulations. In answer to these requests we reproduce below the circular issued by the P.M.G.'s Department on this matter:—
CIRCULAR TO ALL LICENSED EXPERIMENTERS AUTHORISED TO TRANSMIT.

(1) The Wireless Telegraphy Regulations concerning the activities of amateurs have been amended.

2. The principal amendment relates to frequencies (wavelengths) to be used for experimental transmissions. The Postmaster-General has approved of the following frequencies (wavelengths) to be used for that purpose:—

- 60,000 kilocycles (5 metres) to 56,000 kilocycles (5.35 metres).
- 30,000 kilocycles (10 metres) to 28,000 kilocycles (10.7 metres).
- 14,400 kilocycles (20.8 metres) to 14,000 kilocycles (21.4 metres).
- 7300 kilocycles (41 metres) to 7000 kilocycles (42.8 metres).
- 1990 kilocycles (150.8 metres) to 1715 kilocycles (175 metres).
- 1715 kilocycles (175 metres) to 1200 kilocycles (250 metres).

These bands are the only bands available for amateurs at present, and it will probably be found necessary to rearrange them in about 12 months' time, particularly the band 1715-1200 kilocycles.

3. In allotting these bands, the department necessarily had to take note of the requirements of commercial and official services, and thus had been unable to grant any further facilities for experimental transmissions. In this connection, the department has an obligation under the International Convention to ensure that transmissions by Australian stations will not interfere with stations in other countries.

4. Transmissions on these wavelengths must be confined to experiments and tests, but the department has decided to permit the exchange between amateurs of messages relating to the experiments. In no circumstances, however, can messages for a third party be transmitted without the permission of the department.

5. In order to avoid interference with other services, particularly on the higher frequencies, experimental licensees will be required to pay special attention to the correct tuning of their transmitters, and will be required to install approved frequency meters (wave-meters).

6. The call signals for experimental stations have been altered to accord with the International Regulations. In consequence, the existing call signals will in future be prefixed with the letters VK.

7. The new regulations will come into force forthwith, so as to ensure that the new conditions are fully effective as from midnight, Greenwich mean time on 31/12/1928.

8. The fees for experimental licenses henceforth will be £1 per annum

J. MALONE,
for the Director-General.

SINCE we have opened this week's article with a letter I see no reason why we should not finish with a letter (this being an easy way out of work this hot weather), especially as the letter below contains a great deal of information, and may be said to represent the Australian amateurs' viewpoint in certain important matters. It is addressed to Captain Eckersley, of the British Broadcasting Corporation, from Mr. H. Russell Crane. It reads:—

"Dear Sir,—I have to thank you for your cable in reply to mine advising you that the Beam is interfering with your mid-day transmission. It was a very strange coincidence that the evening of the day I had your cable I listened as usual, and there was no beam trouble at all. I knew that you had great powers, but was surprised to find no beam operating—next morning's papers reported the fire at Ballan, Victoria, in consequence of which the beam was for a time out of action. I am enclosing a page from one of our local journals that gives you an idea of reception here just now that may be of interest to you. I have been a very enthusiastic follower of short waves. I was one of the first to hear PCJJ (now PCJ) in this State, and I certainly got the first word of your historic 24-hour transmission, and practically all that followed during that test. I have consistently logged and reported on short wave stations.

"I have had a set in this State (Queensland), the whole of the route from Sydney to Java, and Java to Singapore, and I am now asking myself the question: 'Is it worth while?' and 'what is it leading to?' Going back to the start of short wave telephony reception in this country I recall our one and two valve sets with basket coils. If we met good conditions we sometimes got KDKA and other Yanks on the speaker; more often we got nothing. Then Eindhoven started up, and very soon I was getting good L.S. at certain times of the day or night. Other stations came on the air, and then your magnificent regular transmissions, and in all this time I can safely say that I have never had a

consecutive two hours on the L.S. that I could entertain anyone but a real DX enthusiast with. At odd times I have received you with a simple two-valve set on the L.S.; at other times, do what I will, I cannot get any decent reception on screened grid detector and two audio, including a final Pentode. I have tried a very large assortment of sets—Schnell, Supers, Screened Grid, etc., and, so far as certainty of good reception is concerned, I am no further or very little further advanced than when you first went on the air. The best reception I ever had was from you at Eindhoven, when I was in the East at Kuala Lumpur, near Singapore (I reported to you on this). My original idea was that in following up the short wave transmissions I was helping along something that would do a lot for Empire. I admit that this is a particularly bad time in Australia, and possibly all over the world, for wireless; but what do you think, Sir, is international broadcasting going to be any practical use? It is true that the bulletin you put out at 11 p.m. our time every week night has been very interesting during the King's illness. I missed it but one or two nights. Apart from this there has been nothing of great interest to us here; in brief, the thrill of DX reception is over. We have heard every country that is transmitting on short wave. We now want:—

"1. Something of greater interest than lunch-hour music.

"2. Higher power transmission and better receivers.

"Please do not think I am offering criticism of your splendid efforts; I am just setting out my ideas. I doubt if I have a friend or relative who would be bothered to listen for half an hour to your transmission. They have had the thrill of first long-distance reception, and, truly, I cannot blame them. If at any time there was news or some prominent man speaking it would revive our flagging interest, provided the transmission got over strongly enough to be heard consistently on L.S.

"Roughly speaking, during our summer you are received for one hour from 10.30 p.m. to 11.30 p.m., and at odd hours very early in the morning at varying strength, and during our winter you come over best in the early hours of the morning, and up to, say, 7 a.m. You can see, therefore, that our summer time is the only rational time for anyone but an enthusiast to hear you, and we are confined to one hour (10.30 to 11.30 p.m.) often spoiled by:—

"1. Our local static.

"2. Morse and beam interference.

"I think that the best overseas transmission any of us have heard has been from PCJ during Saturday afternoons in the months of July and August, and occasionally they have been really worth while. Paris and Germany, though intermittent, come over very strongly; the latter, we hear, is to go on high power and regular schedule in February.

"I trust my comments will be accepted by you in the spirit in which they are made. My earnest desire is to help, and my hope is that an Empire service will really mean something to the people of Australia."

"Wireless Weekly," What Have You Done?

THIS actually happened to one of our readers who is a prominent radio dealer outbreak.

Phone: Ting, ting, ting. . . .
DEALER: Hello, hello. . . . yes?
BOL: I say, old man, that set you sold me isn't much good. . . .
DEALER: Why? What's wrong. . . .
Went O.K. when I saw you last. . . .
BOL: Yes. . . . On 2FC and that lot, but I set the dials on 32, 79, 32. . . as they say in "Wireless Weekly," and it won't get WGY, Schenectady, N.Y., so I tried RFN, Moscow, on 29, 60, 50, and it wouldn't get them either. . . .
DEALER:????? 1,111 ting, bang!

Improve Your Radio Reception!

THESE ACCESSORIES INSURE PERFECTION

*Terms can be arranged if preferred.
Small Deposit. Easy Instalments.*



BRITISH MADE FERRANTI TRANSFORMERS

A.F.3.

(As illustrated.)

Uniform amplification from 100 cycles upwards. Over 80 per cent. amplification at 50 cycles.

PRICE 45/-

A.F.4.

Uniform amplification from 300 cycles upwards. 50 per cent. of maximum amplification, even at 50 cycles.

PRICE 34/-

A.F.5.

Uniform amplification from 100 cycles upwards. Over 90 per cent. amplification at 50 cycles. One can almost say uniform amplification from 50 cycles upwards.

PRICE 57/-



THE FERRANTI BRITISH MADE PERMANENT TRICKLE CHARGER

For charging accumulators at home from the Alternating Current Mains. Suitable for use on voltages from 200 to 250 and 40 to 60 cycles.

OUTPUT: The Charger will supply 2 ampere continuously to 2 volt, 4 volt, or 6 volt cells.

The FERRANTI Trickle Charger consists of a step-down Transformer designed for operation from Alternating Current Mains having any voltage from 200 to 250, and frequencies from 40 to 60 cycles, feeding a Westinghouse patent metal rectifier. The Unit is silent in operation, and will last indefinitely. The Charger is simple and safe.

Dimensions: 7 1/2 in. x 4 1/2 in. x 4 in.

PRICE £4/15/-



THE FERRANTI BRITISH MADE TRUE EXPONENTIAL SPEAKER

The Ferranti Speaker is capable of giving good reproduction from any ordinary set.

It consists of a tone conduit of true exponential shape, suitably mounted, and connected to a FERRANTI Speaker Unit. The Unit, which has been carefully designed, has a large and flexible diaphragm, capable of good response to a wide range of frequencies. The shape of the sound box in conjunction with the tone conduit is such that there is no objectionable resonance

PRICE £5/5/-

OPEN UNTIL 9 p.m. FRIDAY

HOME RECREATIONS (Australia) LTD.
388 George Street, Opp. Beard Watson's, Sydney

PROVING RADIO!

No. 7 We make progress this week. Condensers, Batteries, and Resistances are treated in series and parallel. We make our own galvanometer, and our eyes are further opened to the mysteries of magnetism and induction.

ARE YOU ALL ready to commence construction of the galvanometer? Cut out a strip of cardboard, 7in. wide and 1 1/2in. long, and bend and glue it so that it will have a rectangular shape, as shown in Fig. 1, at A. Now wind twenty turns of 30-gauge D.C.C. wire on it, and secure these in place with a few drops of paraffin wax.

To prove that magnetism sets up electricity, connect the ends of a loop of wire to the terminals of your galvanometer, and place the needle of the galvanometer so that it runs parallel with the turns of wire. Hold the loop in one hand, and a permanent magnet (bar or horseshoe magnet) in the other. Now pass the north or positive end of the magnet near the wire loop, and each time you do so you will see the galvanometer needle swing a little one way or the other. The galvanometer is used for measuring very small electrical currents. Therefore, when your needle swings, you will know that magnetism (from the magnet—by means of "induction," Parts 5 and 6) has set up a flow of electricity in the loop of wire, and this current has caused the galvanometer needle to be deflected (Fig. 2).

as at B, 120 ampere-hours at 3 volts. In arriving at these figures we have assumed the cells to be capable of supplying 30 ampere-hours at 1 1/2 volts each, as does the Columbia dry cell. Notice the difference in the connection shown at A and B.

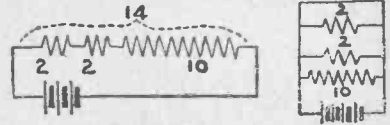
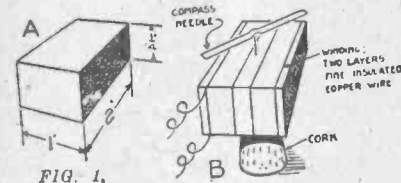

FIG. 6. A. B.

RESISTANCES IN SERIES AND PARALLEL.—Resistance, as we learned in a previous article, is measured in ohms. Resistances for use in radio or other electrical circuits are rated in ohms or megohms (million ohms). Now, if we wish to increase the resistance of a circuit, we connect resistances in it. If we have a resistance of 2 ohms and one of 4 ohms, connected in series, they will offer a total resistance of 6 ohms. If we have two resistances of 2 ohms each, and one of 10 ohms, they will offer a total resistance of 14 ohms, when connected in series (A, Fig. 5). Thus we have the rule that the total resistance of a series of resistances is the sum of the first resistance plus the second resistance plus the third resistance, and so forth, for any number of resistances. The formula for this is:— $R_1 \text{ plus } R_2 \text{ plus } R_3 \text{ plus } \dots \text{ equals } R.$

"What are series and parallel?" This is a question often asked by the newcomer to

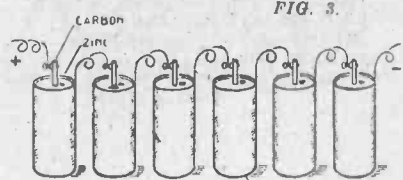

FIG. 3.

radio. We often hear of resistances, batteries, or condensers being "connected in series," or being "connected in parallel." I have already told you (Part 3) that if a number of dry cells are connected in series, the total voltage of the group is the sum of the individual cells; that is, if six 1 1/2-volt cells are connected, as in Fig. 3, the output voltage will be six times 1 1/2 volts—9 volts. But if one of those cells deliver, say, a current of two amperes (Part 3), the group (or battery, as it is called) will deliver no greater amount of current (than two amperes) for the same time, nor will it deliver the same amount for a greater period. To put this in other words, the battery will not have a greater "ampere-hour capacity" than has a single cell (if the cells are connected in series), though it will have a higher voltage.

Note.—R-resistance.
Now, were we to connect the resistances in parallel instead of in series, the total resistance would be less than the individual resistance of any of the resistors, as each would be offering a separate path for the passage

Over this layer, wind twenty turns more of the same wire. Twist the ends together (B), and drop on some paraffin wax, to hold the windings in place. This done, take a cork, a sewing needle, and a compass needle (a toy compass can be bought for a few pence, or you can magnetise a piece of steel watch spring, one inch long, as explained in a previous issue), push the sewing needle into the cork, and then through the cardboard form, so that the end of the needle comes above the top layer of wire. Finally, place the compass needle (or piece of watch spring) on top of the sewing needle, and the galvanometer is ready for use.

By connecting one wire of the galvanometer to one terminal of your battery, and touching the other wire on the other battery at timed intervals, you can make the needle spin at a high rate of speed, and so have a miniature motor.

This comes about because the needle is



FIG. 2.

deflected when a current flows through the connecting wires (Part 6), and owing to the sudden make and break in the circuit, the needle is not allowed to come to rest, but is forced round, gaining momentum all the time. If the connections to the battery are reversed, the needle will spin in the opposite direction, showing that the current is flowing in a different direction.

Now, curious as it may seem, electricity sets up magnetism, and magnetism sets up electricity. Let us prove first, then, that the former statement is correct.

To prove that when a current flows through a wire, magnetic lines of force are set up by it, push a thick copper wire through a business card, and connect the top of the wire to one side of the battery (say, negative), and the other end of the wire to positive. Have the wire standing upright. Now sprinkle a few iron filings on the card close to the wire, and you will see the filings arrange themselves in little rings round the wire, just as though it were a magnet. Thus, electricity sets up magnetism.

The term "ampere-hour" relates to the total number of amperes a cell or battery of cells will deliver for a given number of hours. Thus, if we have an accumulator with capacity of 80 ampere-hours, we mean that it will deliver a current of one ampere

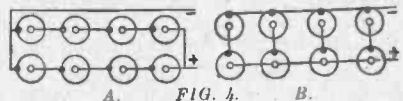

FIG. 4. A. B.

steadily for 80 hours, or two amperes for 40 hours, or four amperes for 20 hours, etc. Thus, if we wish to increase the voltage, we connect cells in series, and if we wish to increase the amperage we connect cells in parallel. If it so happens that we wish to increase both voltage and ampere-hour capacity, we must connect the cells in series-parallel. If connected, as shown at A in Fig. 4, they will deliver 60 ampere-hours at 6 volts, and if connected



FIG. 5. A. B.

of electrical current. (Refer to B in Fig. 6). To figure out the resulting resistance we add the reciprocals of the number of ohms (or megohms) contained in each resistor, and find the reciprocal of the sum. The reciprocal of a whole number is simply 1 divided by that number. If we use the same resistances as in the previous case we get:—

1/2 plus 1/2 plus 1/10 equals 1/R.
5/10 plus 5/10 plus 1/10 equals 11/10.
Therefore, R equals 10/11 ohms, as the reciprocal of a fraction is merely the fraction inverted. For any number of resistances in parallel the formula is:—

1/R plus 1/R2 plus 1/R3 plus .. equals 1/R.

CONDENSERS IN SERIES AND PARALLEL.—Exactly the opposite of the foregoing is true in the case of condensers. When condensers are connected in parallel the total capacity is the sum of the individual capacities (A, Fig. 5):—

C1 plus C2 plus C3 plus ... equals C.

When connected in series a group of condensers (B, Fig. 5) are figured in the same way as are resistances in parallel—that is:— $1/C_1 \text{ plus } 1/C_2 \text{ plus } 1/C_3 \text{ plus } \dots \text{ equals } 1/C.$

A.C. Operation for the 222 Screen-Grid Valve

An Ingenious Application of Battery Type Four-Element Valve in an A.C. Valve Set for Simplicity and Efficiency.

By GEORGE J. ELTZ.

ALTHOUGH it is but a comparatively recent innovation, the screen-grid valve has already gained wide favor among radio experimenters and engineers. Until recently, however, the absence of a satisfactory A.-C. screen-grid valve served to prevent manufacturers from making extensive use of this truly remarkable device. Today the accepted standard of broadcast reception is the A.-C., or electrified, set, with its simple, uniform, positive, and economical operation. No promise of greater efficiency or lower cost could possibly outweigh those advantages.

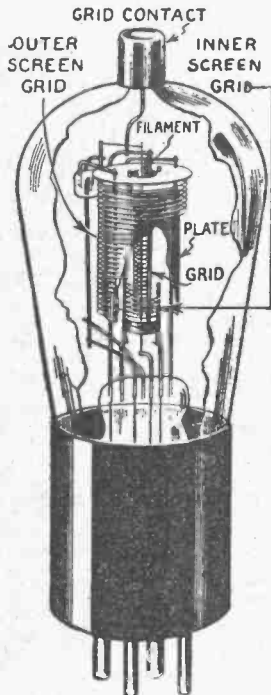

An exploded view of the Radiotron screen-grid valve, showing connection.

The most important advantage gained, namely, the elimination of all feed-back through coupling between grid and plate, usually due to capacity between these elements, was immediately appreciated. The higher voltage amplification per stage, or something like 25 to 50 in the broadcast range, as against the usual range of 5 to 12 per stage with three-element valves, was also appreciated. However, with the radio market definitely committed to the A.-C. receiver, it was realised that only if the shield-grid valve could be operated in company with A.-C. valves, would there be any real commercial application for the greatest development in valves since Dr. Lees de Forest introduced the grid or third element in 1906.

The 222, or shield-grid valve, is a distinct departure from the usual three-element valve in that a second grid, placed between the usual grid and the plate, and also carried over outside the plate, is employed. In this

manner the plate is completely shielded from the control grid. The control grid terminates in a metal cap at the top of the bulb. The usual grid prong connects with the screen-grid. To obtain the higher radio-frequency amplification of which this valve is capable it must be shielded by means of a metal case that slips over it.

Now, if the plate is left disconnected and the screen-grid is used as the plate electrode the valve operates nearly the same as the usual, or three-element, valve. But in operation as a four-element valve a potential of approximately 45 volts is applied to the screen grid, while a higher voltage—90 to 135 volts—is applied to the plate. The screen grid, with its applied voltage, serves to eliminate all feed-back through coupling between grid and plate. External means of preventing, or, at least, neutralising, this feed-back action have long been employed in R.F. amplifier circuits. For the most part these methods have been of the "losser" type, which means that they have introduced certain losses in the circuit for throttling the tendency of the R.F. valve to oscillate. A considerable loss in efficiency results in following the usual methods, although some method of preventing oscillation in the R.F. circuit is absolutely essential.

Fully convinced of the marked advantages of the screen-grid valve, the engineers were faced with the problem of applying it to the usual R.-C. valve circuit. A separate battery to operate the screen-grid valve would obviously be impractical, as would the use of rectified current for the filament of the screen-grid valve.

However, the engineers finally evolved an entirely practical method of operating the screen-grid valve, with its 3.3 volt filament, on raw A.-C. stepped down to the proper voltage. This was done by keeping the grid bias rather high, in order to prevent modulation due to the A.-C. supply, yet not high enough to prevent a fair voltage amplification. In fact, the R.F. amplification averages from 25 to 40, despite the limitations imposed by operating the filament on raw A.-C., with a high grid bias. A single stage of this A.-C. operated screen-grid valve is superior to two stages of the usual A.-C. valve R.F. amplification, and nearly equal to three such stages.

The use of the screen-grid valve as the R.F. amplifier has resulted in the development of the remarkably simple yet highly efficient circuit shown in the accompanying diagram. This is the so-called "Mystery Set," or Q circuit, which attracted so much attention at the R.M.A. Trade Show in Chicago last June. It will be seen that the Q circuit makes use of just four valves, namely: An R.F. amplifier with the 222 shield-grid valve; a detector of the 227 A.-C. heater type; a 226 filament type; and a 171-A power amplifier. It is believed that these valves are the best obtainable at present for A.-C. operation, and make for maximum sensitivity and clarity of reception. A fifth valve, the 280 full-wave filament type rectifier, supplies all the plate potentials, while raw A.-C. heats the filaments of all the valves.

In order to ensure still greater sensitivity and volume, this circuit is partly regenerative. This regeneration is automatically maintained well below the oscillating point so as to avoid anything approaching tone distortion.

The volume control is an ingenious device comprising a wire-wound rheostat of 3000 ohms, arranged to give that logarithmic variation of resistance so essential for uniform volume control. This volume control is shunted across the antenna and ground terminals. It ensures desirable signal strength without overloading the radio-frequency valve or detector, and provides greater clarity of reception. On local signals, an adjustment of the rheostat will increase the selectivity of the receiver to such a degree that powerful near-by stations may be tuned out with ease. The coupling condenser, placed between the antenna and the grid circuit of the first or R.F. valve, is designed so that a higher coupling is employed with increased wave length, in order to compensate for the inevitable drop in amplification at higher wave lengths. Under normal conditions, this condenser serves as an efficient volume control.

Due to the fact, the efficiency of a tuned-radio frequency receiver depends largely upon its R.F. coils, much research has gone into these units. We have paid particular attention to these components, and have been rewarded with a considerably greater R.F. gain than is usually obtained. In the Q circuit the two R.F. coils vary slightly as to their number of turns, the first one having four turns less, to compensate for the additional capacity of the antenna circuit. The second coil has a large primary wound on a tube placed over the main one.

The two main condensers are carefully matched by means of a routine calibration in production. They are mounted on a single shaft for uni-control operation, and constitute the main tuning units. It is absolutely essential that the condensers be shielded

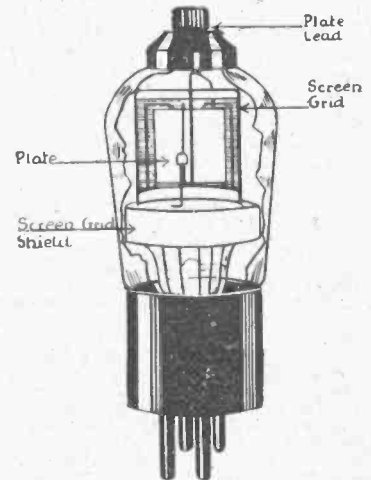

An exploded view of the Philips screen-grid valve. The connections are slightly different.

from each other at all times, even the rotors being shielded through their entire arc of swing.

While we have been mainly concerned with the radio-frequency end of the Q circuit, the audio-frequency amplifier has also come in for certain novel features borrowed from other Freshman circuits. In studying the cause of distortion we traced the trouble to overloaded valves and saturated transformer cores. The former factor has been taken care of by using proper voltages on the valves; the latter, by the novel use of thoroughly lapped transformer laminations, instead of the usual butt-end laminations. Saturation is limited to a definite value, and an automatic control of valve overloading obtained. The thorough lapping of the

transformer laminations, although involving ingenious production methods, has proven more effective than the use of special and costly alloys or bulky cores. In addition to controlling core saturation, we have developed the most desirable characteristics in the audio transformers used. We have an amplification curve which has an appreciable volume at 60 cycles, rises to a good volume at 120, and continues to rise to a high level at 175 cycles, which is maintained practically constant to 10,000 cycles. Since there is little broadcast music below 120 cycles, almost nothing is sacrificed in this audio amplifier. In fact, with a properly selected speaker a remarkably deep bass note response is obtained without fear of overloading.

In the power supply end of the circuit

there is nothing noteworthy except the high safety factor of the filter condensers. Condensers of a far higher working voltage rating than is actually applied to them are used, so as to ensure long life without danger of breakdown.

The Q circuit made possible through the use of the screen-grid valve operated on raw A.-C. supply, has produced a simple and inexpensive broadcast receiver. Thanks to the ingenious use of pressed metal base plates and covers, eyeletted assembly, harness cable wiring, and other modern methods of production, a remarkably efficient broadcast receiver is now available at a price that has established new low levels in the radio industry.

Science Throws New Light on Cone Action

Study of Actual Waves in Vibrating Surface Reveals What Takes Place and Serves to Provide Basis for Unique Cone Material

By AUSTIN C. LESCARBOURA,

Mem. I.R.E., Mem. A.I.E.E.

MANY discussions, based upon incomplete data, have been written concerning the relative merits of sound production by horns over that generated by surfaces, principally those of cone shape. These discussions, however, have been more or less futile, inasmuch as they have proved nothing.

It has recently been demonstrated, by elaborate precision methods, that there is no difference in the reproduction of the two systems if properly designed. The "if," however, is a very large one. It relates not only to structures difficult to execute commercially, but also to materials difficult to obtain.

In the case of the horn type, the horn should have an exponential curve, and be made of non-resonant material. To sustain properly a 60-cycle note, it must be 9ft. long, while for one of 48 cycles, it must be 13ft. Furthermore, it must be perfectly straight, as any bends will always set up some false overtones. The best curve is the logarithm of 3deg. circular. Unfortunately, this shape does not readily lend itself to commercial manufacture. A commercial non-resonant material has been far more difficult to find than is commonly realised. Laboratory horns are made of sheet-lead, 1in. in thickness, and weigh 1000 pounds. The horn of the speaker which won the Franklin Institute prize for purity of reproduction was 13ft. long, made of cast iron 1in. thick, and weighed 1 ton.

Furthermore, the diaphragm also presents a problem. At the power necessary for satisfactory volume, a diaphragm made from the bottom of a milk-can or the punching from a tin-type plate, cannot be used. A proper diaphragm is a complicated, hand-made structure requiring the same degree of skill as the construction of a Stradivarius violin.

On the other hand, it has been found that a cone, correctly designed and properly actuated, and when built of the correct materials will sustain a note of as low frequency as an exponential horn. The opening of a 9ft. horn having a curve of the logarithm of 3deg., is 2ft. in diameter. A cone of this diameter, without the expensive diaphragm, can be made to do the work of a 9ft. horn, so far as the low frequencies are concerned. It is obvious, therefore, that not only is the cone structure much cheaper and smaller, but that it is also infinitely lighter as well. This is the real reason why cone speakers are so popular.

There is, however, an inherent difference in the characteristics of the two systems in proportion as the ideal structures are departed from. The horn type is always correct in sound reproduction detail, and consequently produces those rich overtones which give music its beauty. In the commercial or curved types of horns, in which a partly non-resonant material is used for the horn, or in which the horn is made square of heavy oak plank (as in the Vitaphone, for instance), the false overtones are all in the low register, and are weak. On the other hand, the cone type, even when made of inadequate material, will always reproduce the low registers, but many of the high frequencies, with their accompanying rich overtones, are lost. Hence, the music lacks the richness and beauty which satisfies the trained ear, and may even be "fuzzy" with high false overtones.

The reason for the inadequacy for the surface type of reproducer is that, until very recently, the only commercial material available has been paper. Scientific investigation shows that paper is about the poorest material to select, especially in the absence of any existing specifications. To begin with, there are manufactured at the present time more than ten thousand varieties of paper (see Lockwood's Directory), and only about ten or twelve of these will work at all well. Furthermore, chemists can, from these ten thousand varieties, make, by treatments and impregnations, over a million, but only about twenty-five of these combinations are useful. It has therefore been necessary for each manufacturer to develop, at his own expense, a proper paper combination which best fits his own particular speaker requirements, and to keep his formula secret. Thus, the amateur is totally "out-of-luck," and the cost of entering the speaker-manufacturing business has been prohibitive.

It is true that there has been one patented paper on the market for some time, but it only works passably well in a very limited range of sizes, viz., from 18in. to 24in. in diameter. Below 18in. it requires too much power, and the detail is lost, while above 24in. the flat areas developed by unequal changes resulting from moisture and temperature variation, always present in all sizes, make the false overtones too prominent.

But all varieties of paper have inherent disadvantages:—

(1) The cones must have a seam, which

interferes with proper rendition more than is commonly supposed.

(2) The sides must be straight, and this limits the power absorption unless an angle causing internal reflections be used.

(3) Because of the straight sides, it is supposed by many that the edges must either be "controlled," unless made very large, or that two cones must be used, opposed and fastened at the edges. Both ideas are alleged to be patented, and are involved in complicated litigation.

(4) The slightest mechanical shocks shatter the fibre, and mar the performance of the cone.

For several years past a manufacturing corporation has been developing a unique material which has proved far better for cones. A modified form of this material is also adaptable to exponential horns, which are light in weight but non-resonant. This company has used this material in its own speakers for some time, and has supplied it to a number of other speaker manufacturers.

This material for cones or surface sound generators is a thin fabric formed from one piece under high pressure, and impregnated with a compound which is both waterproof, and has valuable acoustic properties. Another type of this is formed into exponential horns, both straight and coiled, wherein the material comprises many layers of fabric, and is impregnated with a compound which is waterproof and non-resonant.

Cones and speakers fitted with the thin material have recently been submitted to scientific laboratories for investigation and standardisation. This study has not only widened the applications of the material by establishing standard specifications for different types of speakers, but the reports of the investigating scientists show that it is worthy of much wider attention. They have found that these cones, or surface sound generators, are not only free of the troubles caused by paper cones, and reproduce with better fidelity of detail, but that they also make possible new results.

All of the results so obtained have not yet been published, and need not be mentioned here. It is sufficient to give enough from the laboratory reports to show why this material works better than any kind of paper. Paper was initially adopted by various speaker manufacturers on the assumption that a cone moved as a whole like the

(Continued on Page 56.)

List of World's Broadcasting Stations Which Can be Received in Australia on Long and Short Waves

AUSTRALIA		Metres. Watts.		Metres. Watts.		Metres. Watts.					
New South Wales.		Melbourne.		2103 Silent Tues.		JAPAN.					
2FC—N.S.W. Broadcasting Co. Ltd. Market St., Sydney, 0700-2230	443	5000	285	500	4YA—Radio Broadcasting Co. of New Zealand, Dunedin, 1700-2200. Silent days Mon. and Thurs.	463	750	JOAK—Tokio Central Broadcasting Co., Tokyo, Japan. Jap. stations received best about midnight on Sunday	375	1000	
2BL—N.S.W. Broadcasting Co. Ltd., Market St., Sydney, 0800-2230	553	6000	388	5000	FOREIGN		JOBK—Osaka Central Broadcasting Co., Osaka	385	1000		
2GB—Theosophical Broadcasting Station, 29 Bligh St., Sydney, 1000-2200	316	3000	294	100	GREAT BRITAIN.		JOCK—Nagoya Central Broadcasting Co., Nagoya	360	1000		
2KY—Trades and Labour Council, Goulburn St., Sydney, 0900-2200	280	1500	South Australia		2LO—British Broadcasting Co., Savoy Hill, London, 1900-0850	361.4	3000	JODK—Keijo Broadcasting Co., Keijo, Japan	345	1000	
2UW—Radio Broadcasting Ltd., Paling's Building, Ash St., Sydney, 1200-2230	267	500	4CL—Central Broadcasters, Ltd., 59 Franklin St., Adelaide, 1100-2310	409	5000	5XX—British Broadcasting Co., Davenport, 1900-0850	1604.3	5000	DUTCH EAST INDIES.		
2UE—Electrical Utilities Ltd., 619 George St., Sydney, 0730-2230	293	250	5DN—SDN Pty., Ltd., 2-4 Montpelier St., Parkside	313	500	UNITED STATES.		JFC—Bataviaische Radio, Jereeninging, Batavia	220	40	
2MK—Stockler Bros. Ltd., Hawick St., Bathurst	275	250	5KA—Sport Radio, Ltd., 51 Kintore Av., Prospect	250	1000	KDKA—Westinghouse Electric and Manufacturing Co., E. Pittsburgh, Pa.	316.5	50000	PHILIPPINE ISLANDS.		
2HD—H. A. Donohoe, King St., Newcastle	288	100	West Australia.		KFI—Earle C. Anthony Inc., 1000 So. Hope St., Los Angeles	468.5	6000	KZRM—Radio Corp. of the Philippines, Manila	413	1000	
2BE—Burgin Electric Co., 340 Kent St., Sydney, At present on the air	318	100	6WF—Commonwealth Government Broadcasting Station, Perth, 1230-2230	1250	5000	KGO—General Electric Co. Ltd., 1370 Krammea St., Denver, Colorado	828.9	5000-10000	KZKZ—Radio Corp. of the Philippines, Manila	270	500
Victoria.		318	100	Tasmania.		KOA—General Electric Co. Ltd., 1370 Krammea St., Denver, Colorado	828.9	5000-10000	7CA—Indian Broadcasting Co., Calcutta. Indian stations received best about 1.30 a.m. Monday	370.4	3000
2LO—Dominions Broadcasting Co., 120A Russell St., Melbourne, 0715-2340	371	5000	7ZL—Tasmanian Broadcasters Pty., 95 Elizabeth St., Hobart 1130-2204	535	3070	WBAF—National Broadcasting Co., 195 Broadway, New York	491.5	60000	7BY—Indian Broadcasting Co., Bombay	357.1	3000
2AR—Dominions Broadcasting Co., 120A Russell St., Melbourne, 1000-2200	484	5000	NEW ZEALAND.		WGY—General Electric Co., Scenectady, N.Y.	378.5	50000	INDIA.			
2UZ—O. J. Nilson and Co., Bourke St., Melbourne	319	100	1YA—Radio Broadcasting Co. of New Zealand, 419 Queen St., Auckland 1500-1900. Silent day Mon.	333	500	WJZ—National Broadcasting Co., 195 Broadway, New York	454.3	30000	WAMG—Africa Broadcasting Assn., Capetown	375	1500
2DB—Drusleish Bus.			2YA—Radio Broadcasting Co. of New Zealand, Christchurch 1500-	420	5000	EUROPE.		JB—African Broadcasting Assn., Johannesburg	450	500	

International Short Wave Stations: Times Stated are S.M.T.

AUSTRALIA.		Metres.	from 0930	Metres.	2400 Sat.: 0100-0400 Sun.	Metres.	2300. Mon.: 0820-0700.	Metres.	
2ME—A.W.A. (Syd.), 2FC, times irregular, usually Mon. from 0430-0500	28.5		WBZ—Springfield, Relays WBK	65.04	PCP—Kootwijk, Wed. and Fri., 0300-0600; Sat., 0900-2400; Sun., 0100-0400	21	Wed.: 0900-0930. Sun. Picture transmissions, 0900-1100. Tues. and Sat.	42.12	
2YG—Ray Allison (Syd.), relays 2BL, times various	32.5		2XAF—Scheneectady, Tues. 0900-1500; Wed. 0900-1430; Fri., 0900-1500; Sun., 0900-1500	32.4	PCY—The Hague, 0200-0600, Wed. and Fri.; 0900-2400, Sat., 0100-0400, Sun.	27			
2ME—A.W.A. (Melb.), relays 3LO, times various. Usually heard about 0430-0530	32		WLV—Ohio, 0900, except Sat. and Mon.	52.03	UNION OF SOVIET SOCIALIST REPUBLICS.		AUSTRIA.		
2AG—W. E. Coxon (Perth), relays 6WF, Times various. Usually 2130-0200 daily	32.9		KDKA—East Pittsburgh, Daily from 0800	43.35	RFN—U.S.S.R., Moscow	29.60	50	OKK3—Vienna	70
GREAT BRITAIN.			WIZ—New Brunswick, Irregular, usually after 0900	43.35	RFM—U.S.S.R., Siberia	60.30	30	OKK2—Vienna Mon., 0400-1100	70
2SW—Marconi Co. (London), relays 2LO, 0400-0800, daily, except Sun. and Mon. From 0330 on alternate Saturdays, and 2100-2230 daily	25		7XAO—Portland, Oregon, Daily from 0900-2300	51.06	ITALY.		SPAIN.		
2YT—Marchal Radio, Faldub Times various 25, 32	92		2XGO—Rocky Point, from 2400 Mon. and Fri.	16.02	IMI—Milan	45	—Casablanca	51	
2NM—Gerald Marcuse, Caterham, Surrey, 1700-0400-0600 (Sun.), 1000, Thurs. and Sat.	32.5	28	2XR—Richmond Hill, Relays WABC daily, from 0800	22.1	IDO—Italy	33.5	FRANCE.		
2LW—Beam Station, all times (Dorchester)	15.7		WOWO—Fort Wayne, Indiana, Relays Columbian stations daily, 0800	22.8	IAX—Rome	45	GC—Paris	61	
2GLQ—Beam Station, all times (throughout day) (Ongar)	34.5		2XK—E. Pittsburgh, Relays KDKA, 0300-0600, Tues. and Wed.	26.8	IM—Rome 0700 Sun. 0300-0530, Mon.	34.6	YR—Lyon	40	
2BH—Beam Station, Grimsby (Beam Station) All times	25.9		2XAG—New York Telephone, Irregular	26.92	SOUTH AFRICA.		YB—Paris, Daily, 0230-0330	32	
UNITED STATES.			2XAL—New York Relays WOVN, 0800-1400, 1500-1900, Wed.; 1200-1300 Sat.	30.91	JB—Johannesburg	20.25	FL—Paris, Time signals, 1706-0556	20	
2XAD—G.E.C., Scheneectady Relays WY, 0830-1200 Mon., 0900-0600 Tues. and Fri., 0800-1300 Thurs. and Sat.	21.96		2XAE—Detroit, Mich. Relays WJR daily	32	JAPAN.		FL—Paris, Time signals, 1706-0556	20	
2XZR—San Francisco, 1000, daily	33		WVG—Brooklyn, Daily, 0900	54	JHRB—Ibaraki, nightly	37.5	FW—Ste. Assise, At odd times throughout day	14.29	
2XL—Boundbrook, Relays WJZ	59.93		2XEE—New York, Relays WARC and WBOQ daily, 0900	68.5	JHAP—Tokyo	79	Radio Villa, Paris, 0700-0900	37	
2XU—Council Bluffs, Relays Columbian Broadcasting stations	41.08		2XAA—Houlton, Transatlantic telephony	22.99	JKZB—Tokio	80	Radio Aken, France, Wed. and Sat., 0900-0915	39.75	
2XBA—Newark, N.J., Relays WAAM, 1000-1500 Wed. Fri., and Sat.	85.13		HVA—Hanoi, No information available	31.85	GERMANY.		SWITZERLAND.		
2XF—Cleveland, daily from 1500	68.04		INDO-CHINA.		AGJ—Nauen Daily, 0.500	50.7	EH9XD—Zurich, Relay work, Tues., Thurs. and Sun.	85	
2XAT—Inglewood, daily			HOLLAND.		AGN—Nauen, Press and news reports to ships 19	26.4	EH90C—Bern, 0500-0600	32	

Local Programmes, Friday, February, 8

2FC

EARLY MORNING SESSION.

Announcer: A. S. Cochrane.

7.0: "Big Ben" and announcements. 7.2: Official weather forecast, rainfall, river reports, temperatures, astronomical memoranda. 7.7: "Sydney Morning Herald" summary. 7.12: Shipping intelligence, mail services. 7.15: Studio music. 7.25: Investment market; mining sharemarkets, metal quotations, wool sales, breadstuffs markets, inter-State markets produce markets. 7.40: Studio music. 8.0: "Big Ben," close.

MORNING SESSION.

Announcer: A. S. Cochrane.

10.0: "Big Ben" and announcements. 10.2: Pianoforte reproduction. 10.10: "Sydney Morning Herald" news service. 10.25: Studio music. 10.45: A talk on Home Cooking and Recipes by Miss Ruth Furst. 11.0: "Big Ben;" A.P.A. and Reuter's cable services. 11.5: Close.

MIDDAY SESSION.

Announcer: A. S. Cochrane.

12.0: "Big Ben" and announcements. 12.1: Stock Exchange, first call. 12.3: Official weather forecast; rainfall. 12.5: Studio music. 12.10: Summary of news, "Sydney Morning Herald." 12.15: Rugby wireless news. 12.18: A reading. 12.30: Studio music. 1.0: "Big Ben;" weather intelligence. 1.3: "Evening News" midday news service; Producers' Distributing Society's report. 1.20: Studio music. 1.28: Stock Exchange, second call. 1.30: Studio music. 2.0: "Big Ben;" close.

AFTERNOON SESSION.

Announcer: Laurence Halbert.

Accompanist: Ewart Chapple.

2.30: Programme announcements. 2.32: Educational session for the schools; a short musical recital. 2.45: A talk. 3.0: "Big Ben;" pianoforte reproduction. 3.15: Popular music. 3.30: Miriam Pope, soprano. 3.37: Hilda Nelson, mezzo. 3.44: Cricket results, N.S.W. v. Tasmania, played at Hobart. 3.45: A Reading. 4.0: "Big Ben;" Miriam Pope, soprano. 4.7: Hilda Nelson, mezzo. 4.14: Studio music. 4.30: Cricket results. 4.32: Popular music. 4.45: Stock Exchange, third call. 4.47: Studio music. 5.0: Close down.

EARLY EVENING SESSION.

Announcer: A. S. Cochrane.

5.40: The chimes of 2FC. 5.45: The children's session, conducted by the "Hello Man," letters and stories, music and entertainment. 6.30: Dalgety's market reports (wool, wheat, and stock). 6.40: Fruit and vegetable market. 6.43: Stock Exchange information. 6.45: Weather and shipping news. 6.48: Rugby wireless news. 6.50: Talk by the 2FC Racing Commissioner. 7.0: "Big Ben;" late news service. 7.10: Dinner music.

EVENING SESSION.

Announcer: Laurence Halbert.

Accompanist: Ewart Chapple.

7.40: Pianoforte reproduction. 7.45: Programme announcements. 7.48: Cricket scores, New South Wales v. Tasmania, played at Hobart. Popular music. 8.0: By courtesy of J. C. Williamson, Ltd., a transmission will be taken from one of Sydney's leading theatres. 9.0: From the Studio—
"Big Ben;" weather report.
9.1: The Light Music Four—
(a) Selection, "The Girl Friend" (Rodgers).
(b) "Softly Awakes my Heart" (Saint-Saens).
9.15: Rae Foster and Charles Lawrence, entertainers.
9.25: Tom Foggitt, pianist.
9.32: Ad Cree, comedian.
9.39: The Light Music Four—
(a) Suite, "Yankiana" (Thurban).
(b) "Mariette-Coquette" (Ancliffe).
9.51: Charles Lawrence and Rae Foster, entertainers.
10.0: "Big Ben;" Tom Foggitt, novelty pianist.
10.7: Ad Cree, comedian.

10.14: Light Music Four—
(a) Suite, "Nautical Scenes" (Fletcher).
(b) "Turkish Patrol" (Michaellis).
10.27: To-morrow's programme.
10.30: National Anthem; close down.

2BL

MORNING SESSION.

Announcer: A. C. C. Stevens.

8.0: G.P.O. chimes; metropolitan weather report; State weather report. 8.2: Studio music. 8.15: G.P.O. chimes; news from the "Daily Telegraph Pictorial." 8.30: G.P.O. chimes; news service continued. 8.40: Information; mails; shipping, arrivals, departures, and sailings. 8.45: Studio music. 9.15: Half an hour with silent friends. 9.45: Studio music. 10.0: G.P.O. clock and chimes; close down.

MIDDAY SESSION.

Announcer: Basil Kirke.

11.0: G.P.O. clock and chimes; 2BL Women's Sports Association, conducted by Miss Gwen Varley. 11.30: Advertising hints. 11.40: Women's session, conducted by Mrs. Cranfield. 12.0: G.P.O. clock and chimes; special ocean forecast and weather report. 12.3: Pianoforte reproduction. 12.30: Shipping and mails. 12.37: Market reports. 12.45: "Sun" midday news service. 1.0: G.P.O. clock and chimes; studio music. 1.30: Talk to children and special entertainment for children in hospital. 2.0: G.P.O. clock and chimes; close.

AFTERNOON SESSION.

Announcer: Basil Kirke.

Accompanist: Kathleen Roe.

3.45: G.P.O. clock and chimes. 3.46: Popular music. 3.50: Cricket scores, N.S.W. v. Tasmania, played at Hobart. 3.52: Popular music. 4.0: G.P.O. clock and chimes; from Romano's—Romano's Cafe Dance Orchestra, under the direction of Bennie Abrahams. From the Studio. 4.7: Camp Fire Yarns by Captain A. C. C. Stevens. 4.22: From Romano's—Romano's Cafe Dance Orchestra, under the direction of Bennie Abrahams. 4.30: From the studio—Ann Stuart Gurr, contralto. 4.37: "Sun" news service. 4.40: From Romano's—Romano's Cafe Dance Orchestra under the direction of Bennie Abrahams. 4.50: From the studio, Frank Botham, baritone—(a) "Farewell in the Desert" (Adams), (b) "Give a Man a Horse He Can Ride" (O'Hara). 4.51: "Sun" news service. 5.0: Our serial story.

5.10: Ann Stuart Gurr, contralto. 5.17: Frank Botham, baritone—(a) "Prince Ivan's Song" (Allitsen), (b) "The Hand of a Friend" (Russell). 5.24: Popular music. 5.34: Poultry report. 5.37: Features of the evening's programme.

EARLY EVENING SESSION.

Announcer: J. Knight Barnett.

5.40: Children's session, conducted by Uncle Peter; music and entertainment. 6.0: Letters and stories. 6.30: "Sun" news and late sporting. 6.30: Special dinner recital. 7.10: Cricket scores, N.S.W. v. Tasmania, played at Hobart. 7.12: Australian Mercantile, L.A. and Finance Co.'s report; weather report and forecast by courtesy of Government Meteorologist; Producers' Distributing Society's fruit and vegetable market report, grain and fodder report ("Sun"). 7.25: Mr. Pitt and Miss Pam in advertising talks and nonsense. 7.55: Programme and other announcements.

EVENING SESSION.

Announcer: J. Knight Barnett.

Accompanist: G. Vern Barnett.

8.0: G.P.O. clock and chimes.
Topical Chorus.
8.3: Margaret Madden and Frances Lea—
(a) "Chiquita" (Wayne).
(b) "Blue Bird" (Smith).
8.10: From the Arcadia Theatre—
Nicholas Robins at the Wurflitzer organ.
8.30: From the studio—
The Savoyans' Dance Band.
8.40: Frank Ryan, entertainer.
8.50: Trumpet solo by Livingston Gilles.
8.57: Weather report and announcements.
9.0: "Big Ben;" the Savoyans Dance Band.
9.15: Terence Nugent, tenor.
9.22: Margaret Madden and Frances Lea—
(a) "Mother, I Still Have You" (Aliberts).
(b) "Angela Mia" (Alberts).
(c) "Old-fashioned Town" (Chappells).
9.32: The Savoyans' Dance Band.
9.45: Frank Ryan, entertainer.
9.52: Terence Nugent, tenor.
10.0: "Big Ben;" from the Arcadia Theatre—
Nicholas Robins at his Wurflitzer organ.
10.20: From the Studio—
The Savoyans' Dance Band.
10.30: Late weather report.
10.32: The Savoyans' Dance Band.
10.57: To-morrow's programme.
10.59: The Savoyans' Dance Band.
11.30: National Anthem; close down.

2GB

10 a.m.: Music. 10.10: Happiness talk by A. E. Bennett. 10.20: Music. 10.30: Women's session by Miss Helen J. Beegling. 11.30: Close down. 2.0 p.m.: Music. 2.5: Women's radio service, by Mrs. Dorothy Jordan. 2.50: Music. 3.30: Cookery demonstration. 4.30: Close down. 5.30: Children's session by Uncle George. 7.0: Stock and market reports by New Zealand Loan and Mercantile Agency Ltd. 7.15: Music. 8.0: Violin solos by Mr. Cecil Berry. 8.10: Songs by Miss Heather Kinnaird. 8.20: A humorous interlude by Mr. Jack Win and Mr. Heath Burdock. 8.25: Instrumental music. 8.35: Songs by Mr. Robert Scott. 8.45: Pianoforte solos by Miss Ada Brook. 8.55: A humorous interlude by Mr. Jack Win and Mr. Heath Burdock. 9.0: Weather report. 9.3: Address. 9.15: Songs by Miss Heather Kinnaird. 9.25: Violin solos by Mr. Cecil Berry. 9.35: A humorous interlude by Mr. Jack Win and Mr. Heath Burdock. 9.40: Instrumental music. 9.50: Songs by Mr. Robert Scott. 10.0: Orchestral items. 10.30: Close down.

2UW

MID-DAY SESSION.

12.30: Music. 1.0: G.P.O. clock and chimes music. 2.30: Close down. 4.30: Musical programme.

EVENING SESSION.

5.30: Children's Hour, conducted by Uncle Jack. 6.30: Close down. 7.0: G.P.O. clock and chimes; music. 8.0: To-day's Anniversary; music. 9.0: G.P.O. clock and chimes. Comments on Foreign Affairs, by Mr. J. M. Prentice. 9.10: Music and request numbers. 10.10: Close down.



MR. NICHOLAS ROBINS, who is scheduled to broadcast a Wurflitzer organ recital from the Arcadia Theatre to-night.

Interstate Programmes Friday, February 8

3LO

EARLY MORNING SESSION.

7.15: Morning melodies. 7.20: Morning exercises to music. 7.30: Stock reports, market reports, general news, sporting information. 8.0: Melbourne Observatory time signal. 8.1: Morning melodies. 8.15: Close down.

MORNING SESSION.

Announcers: C. J. O'Connor. 11.0: 3LO's different dainties for the daily dinner. To-day's radio recipe: Italian spaghetti. 11.15: Tyers will speak on great Russian writers and their stories, Turgenev, "The Sportsmen's Sketches." 11.20: Musical Interlude. 11.25: "Au Fait" will speak on "Fashions." 11.40: Musical Interlude. 11.45: Under the auspices of the Health Department. 12.0: Melbourne Observatory time signal; express train information; prices received by the Australian Mines and Metals Association from the London Stock Exchange this day; British official wireless news from Rugby; Reuter's and the Australian Press Association cables; "Argus" news service. 12.15: Newmarket stock sales; report by the Associated Stock and Station Agents, Bourke Street, Melbourne.

MID-DAY SESSION.

Announcer: J. O'Connor. Accompanist: Mabel Nelson. 12.20: The Station Orchestra overture. 12.30: Diana Belmont, contralto. 12.37: Stock Exchange information. 12.40: The Station Orchestra, selection. 12.50: Courtney Ford, humorist. 12.57: The Station Orchestra. 1.1: Meteorological information, weather forecast for Victoria. New South Wales, South Australia, and Tasmania, ocean forecast, river reports, rainfall. 1.11: Diana Belmont, contralto. 1.18: The Station Orchestra, selection. 1.23: Courtney Ford, humorist. 1.35: The Station Orchestra. 1.45: Close down.

AFTERNOON SESSION.

Announcer: Maurice Dudley. Accompanist: Mabel Nelson. 2.15: The Strad Trio, "Op 49 D Minor" (Mendelssohn). Allegro vivace ed agitato, andante con moto, scherzo, finale. 2.2: Gertrude Gray, mezzo-contralto. 2.42: Cecil Parkes, violin. 2.56: John Byrne, bass. 3.3: The Strad Trio. 3.13: Frances Fraser will speak on "The Charm of J. M. Barrie." 3.28: The Station Orchestra, overture. 3.38: Amy Boehm, soprano. 3.45: The Station Orchestra, selection. 3.55: Gertrude Gray, mezzo-soprano. 4.2: Dorothy Roxburgh, viola. 4.3: John Byrne, bass. 4.16: The Station Orchestra, selection. 4.25: Amy Boehm, soprano. 4.35: Guilford Bishop, violin. 4.40: The Station Orchestra, selection. 4.50: Joseph Barille, flute. 4.55: News session: "Herald" news service; Stock Exchange information. 5.5: Close down.

EVENING SESSION.

Announcer: Maurice Dudley. 8.0: Answers to letters and birthday greetings by "Billy Bunny." 8.25: Musical Interlude. 8.30: "Billy Bunny" has a new story for the children.

NIGHT SESSION.

Announcer: John Stuart. Accompanist: Mabel Nelson. 6.50: Madame Soward, "French Without Tears." 7.8: Stock Exchange information. 7.15: Official report of the Newmarket stock sales by the Associated Stock and Station Agents, Bourke Street, Melbourne; latest truck orderings for next week's markets; fish market reports by J. R. Borrett, Ltd.; market reports by the Victorian Producers' Co-operative Company, Ltd.; grain, hay, straw, jute, dairy produce, potatoes, onions; market reports of fruit by the Victorian Fruit Growers' Association; retail prices; wholesale prices of fruit by the Wholesale Fruit Merchants' Association; citrus fruits. 7.30: News session. 7.43: Birthday greetings. 7.45: Out of the past. 7.48: Under the auspices of the Department of Agriculture, J. Brake, Senior Inspector of Agriculture, will speak on "Wheat Growing—Summer Fallowing." 8.0: A maker of history will speak on "The Olden Days and Antiquities." 8.10: Collingwood Citizens' Band, march, "The Commodore" overture "Red and Black." 8.20: John Byrne, bass, "Old English Love Song" (Allison). "Banjo Stron." 8.27: Collingwood Citizens' Band, selection "The Desert Song" (Romberg). 8.34: Diana Belmont, contralto, "The Daily Question" (Helmond). "Beloved Slave" (Slaters). 8.41: French Brothers, banjoists. Latest Banjo Hits. 8.48: Collingwood Citizens' Band, selection "Wildschutz." 8.58: Captain Donald MacLean will continue his series of pirate stories. 9.13: Collingwood Citizens' Band, intermezzo, "Onket Fichte." 9.20: Jack Lumsdaine, whispering baritone, selections from his repertoire. 9.27: French Bros., banjoists, request items. 9.34: Collingwood Citizens' Band, march "The Bandit." 9.44: Eric Welch will speak on to-morrow's races at Williamstown. 9.54: John Byrne, bass, "Mayourneen" (Allsen). "Down Among the Dead Men" (Old English). 10.1: Collingwood Citizens' Band, selection, "Wilfred Sanderson's Songs." 10.3: Diana Belmont, contralto, "A Black-bird Singing (Svend)." "Nocturne." 10.18: Mabel Nelson, piano, "Toccata" (Schumann). 10.22: Jack Lumsdaine, whispering baritone, request numbers. 10.30: "Argus" news service; British official wireless news from Rugby; meteorological information; road note supplied by the Royal Automobile Club of Victoria. Announcements. Weekly seasonable gardening reminders, supplied by Leslie Brunning. 10.45: Courtney Ford, humorist, "What Funny Things (Scott) Are Riding Hood" (Randolph). 10.52: Radi-o-Aces, "I Just Jog Along" (Rose).

"I Can't Do Without You" (Berlin). "Mississippi Mud" (Harris). "Tin Pan Parade" (Whiting). "Day Dreams" (Hallan). "Jeanning" (Gilbert). "Dream House" (Fox). "Mother, I Still Have You" (Julson). "Out of the Dawn" (Donaldson). "Get Out and Get Under the Moon" (Tobias). "Sleepy Baby" (Kabn). "Good-night Waltz" (Bibot). "Good-night Chorus." 11.30: God Save the King.

3AR

Announcer: C. J. O'Connor. 10 a.m.: G.P.O. clock says "Ten." 10.1: "Age" market reports, farm and station produce, fruit, fish, vegetables, etc. 10.25: "Age" shipping reports. Ocean forecast. 10.30: Mail notices. Express train information. 10.35: "Age" news service, exclusive to 3AR. 10.50: Weather forecast. 11.0: Ned Tyrrell's Radi-o-Aces. 11.20: Masterpieces of the famous Musicians. 11.25: Ned Tyrrell's Radi-o-Aces. 11.45: Musical masterpieces. 11.52: Ned Tyrrell's Radi-o-Aces. 12.2: Musical masterpieces. 12.8: Ned Tyrrell's Radi-o-Aces. 12.20: British Official Wireless news. Announcements. John McNamara and Co., Pty. Ltd., auctioneers, Melbourne, report on to-day's Newmarket fat cat sale, direct from the wards. 12.30: Close down.

EVENING NEWS SESSION.

Announcer: J. Stuart. 6.0: A Bravura of beautiful Ballads and orchestral Chef d'Ouvre. 7.0: "Herald" news service. 7.5: John McNamara and Co., Pty. Ltd., auctioneers, Melbourne, report on to-day's Newmarket fat cat sale. 7.10: Gramophone recital continued.

NIGHT SESSION.

Announcer: J. Stuart. 8.0: Eric E. Aikens will speak on "To-morrow's events at the Motorrome." 8.15: Did you know that? 8.30: Community Singing, transmission from Central Hall, Geelong. 10.30: "Age" news service, exclusive to 3AR. Announcements. God Save the King.

Index to Inter-State Programmes

Friday, February 8—	
3LO, 3AR, 4QG, 5CL, 6WF, 7ZL	30
Saturday, February 9—	
3LO, 3AR, 4QG, 5CL, 6WF, 7ZL	34
Sunday, February 10—	
3LO, 4QG, 5CL, 6WF, 7ZL	37
Monday, February 11—	
3LO, 3AR, 4QG, 5CL, 6WF, 7ZL	40
Tuesday, February 12—	
3LO, 3AR, 4QG, 5CL, 6WF	44
Wednesday, February 13—	
3LO, 3AR, 4QG, 7ZL	48
Thursday, February 14—	
3LO, 3AR, 4QG, 7ZL	62

4QG

EARLY MORNING SESSION.

Announcer: J. Tyson. 7.43: Time signals. 7.45: News service. 8.0: Some electric records. 8.15: News service. 8.30: Close down.

MORNING SESSION.

Announcer: Rita M'Auliffe. 11.0: Music. 11.5: Social news. 11.15: Lurette: A cookery and household talk by "The Etiquette Girl." 11.30: Music. 11.35: More social news. 11.48: From the Wintergarden Theatre, Wurlitzer organ. 12.0: Close down.

MIDDAY SESSION.

Announcer: R. Wight. 1.0: Market reports and weather information. 1.20: Lunch-hour music. 2.0: Close down.

AFTERNOON SESSION.

3.0: From the studio. 3.30: Mail train running times. 3.31: A recital by Mr. George Sampson, F.R.C.O. (City Organist). 4.0: Afternoon news. 4.30: Close down.

EARLY EVENING SESSION.

Announcers: R. Wight and H. Humphreys. 6.0: Mail train running times; mail information; shipping news. 6.5: Dinner music. 6.25: Commercial announcements. 6.30: Bedtime stories conducted by "The Sandman." 7.0: News in brief. 7.5: Stock Exchange news. 7.6: Metal quotations. 7.7: Market reports. 7.25: Fenwick's stock report. 7.30: Weather information. 7.40: Announcements. 7.43: Standard time signals. 7.48: To-morrow's sporting fixtures reviewed.

NIGHT SESSION.

Announcer: H. Humphreys. Another Radio Mystery—"The Eye of Tayo Lang." The first portion of to-night's programme will comprise the presentation of another radio mystery play, "The Eye of Tayo Lang." The play is set in Burma, and tells of the adventures of a party of tourists and residents who become enmeshed in an adventure concerning the eye of an old lord. The play culminates in the

perpetration of a most baffling crime, and when this point is reached it breaks off, leaving listeners to work out their own solution and to answer the following questions:—(1) Who has the Jewel "The Eye of Tayo Lang"? (2) Who killed Arnold Preston? Listeners will be asked to post their attempts to 4QG, marking the envelope "Tayo Lang." The play will be summarised on the night of Monday, February 18, and then will be continued and completed. At the conclusion the attempts at solution will be opened in the studio, and a prize of £3/7 will be awarded to the first listener who is correct. 8.0: From the studio—The Radio Mystery, "The Eye of Tayo Lang" (by W. S. Mew).—Arnold Preston, an American, E. Barry, Rhina Dhin, a wealthy Burmese merchant, H. Collins; Marcus Marks, manager Jandak Hotel, R. Bruce; Inspector Brand, of the Mandalay Police, W. S. Mew, Cecil Colby, an American tourist, N. Deans; Maisie Colby, his sister, Mavis M'Farlane; Angele Mendoza, a Creole, Mavis M'Farlane. Act I. Scene 1: Evening—the lounge of the Jandak Hotel, Mandalay. Scene 2: After dinner. Scene 3: Fifteen minutes later. Scene 4: In less than two minutes. Scene 5: The lounge of the Jandak Hotel, Mandalay. Overture and incidental music by the Studio Orchestra. Part II.—Studio Programme. 9.0: Wee-end road information for motorists, officially supplied by the Royal Automobile Club of Queensland. 9.15: The Studio Orchestra (Conductor, A. R. Featherstone)—Overture, "Comedy-Drama" (Tobani). 9.23: Ben Cloirec (baritone). "Playlida" (Fisher). "The Condemna Shore" (Fisher). 9.30: Frank Warwick (pianist)—In a ten minutes recital, including: "Rigaudon" (Godowsky). "Songs of the Hunter" (Grovez). "White Poem" (Grovez). "Punch and Judy Show" (Gosson). 9.0: Neil Douglas - Graham (elocutionist)—"The Artist's Secret." "Butterflies." 9.48: H. Jackson (cornetist)—"Una" (Hartman), accompanied by the Studio Orchestra. 9.50: The Studio Orchestra—March, "Magnificent" (Orosby). 10.0: "The Daily Mail" news. "The Courier" news, weather news. Close down.

5CL

MORNING SESSION

11.0: G.P.O. chimes. 11.1: Instrumental and vocal Interlude—Station Quartet. 11.8: Denis Sheard, tenor. 11.15: "Economist." Kitchen craft and menu talk. 11.30: Station Quartet. 12 noon: G.P.O. chimes. 12.1; Denis Sheard, tenor. 12.6: Station Quartet. 12.15: General news service. 12.35: British official wireless news. 12.40: Hilda Hammond, soprano. 12.46: Geoff. Goldsworthy, cellist—selected numbers. 12.82: South Australian railway information; S. C. Ward and Co.'s Stock Exchange information; meteorological information. 1.0: G.P.O. chimes. 1.1: Lizette Foglia, violinist. 1.5: E. J. Winnall, basso. 1.11: Station Quartet. 1.20: Hilda Hammond, soprano. 1.28: Tom King, pianist. 1.30: E. J. Winnall, basso. 1.36: Station Quartet. 1.44: Hilda Hammond, soprano. 1.50: Station Quartet. 1.57: Meteorological information. 2.0: G.P.O. chimes, and close down.

AFTERNOON SESSION

3.0: G.P.O. chimes. 3.1: Rev. G. E. Hale, B.A. 3.15: Jean Finlay, pianist. 3.20: Bernard Manning, bass-baritone. 3.26: The Cotton Pickers—banjo and guitar solos. 3.34: Dorothy Back, soprano. 3.40: Fred Brown, cornetist, and Joe Hardy, cornetist. 3.46: Bernard Manning, bass-baritone—selections from his repertoire. 3.52: The Cotton Pickers—banjo and guitar solos. 4.0: G.P.O. chimes. 4.1: Dorothy Back, soprano. 4.6: Fred Brown, and Joe Hardy, cornet duettists. 4.12: A Sonora recital—The Band of His Majesty's Royal Irish Fusiliers; Sydney Coltham, tenor. The Band of His Majesty's Royal Irish Fusiliers; Sydney Coltham, tenor; Max Darawski, pianist; Frank Webster, tenor; Max Darawski, pianist. 4.55: S. C. Ward and Co.'s Stock Exchange information; Port Lincoln race results. 5.0: G.P.O. chimes and close down.

EVENING SESSION

6.0: G.P.O. chimes. 6.1: Children's nappy moments—birthday greetings, correspondence, songs and stories by "Miss Wireless." 6.30: Interlude of dinner music—E.M.V. recordings. 7.0: G.P.O. chimes. 7.1: S. C. Ward and Co.'s Stock Exchange information. 7.5: General market reports—Dalgety and Co.'s wool and grain report. 7.10: 5CL's sporting service by "Silvius," including a review of to-morrow's Amateur Turf Club and Williamstown meetings. 7.22: Resume on South Australian cricket, by "Willow." 7.35: Leo Thielston—talk on "How to Do the Varsity Drag." 7.45: P. H. Nicholls—Another Month with Shakespeare, "Romeo and Juliet."

NIGHT SESSION

8.0: G.P.O. chimes. 8.1: Station Orchestra—

lection, "The Gondollers" (Sullivan). 8.10: Bernard Manning, bass-baritone—selections from his repertoire. 8.18: William Davey, xylophonist—"The Merry Widow" (Lehar). 8.22: Fred Williamson, tenor—"On with the Motley," "Mavis." 8.28: A. V. Noske, flautist—"The Woodland," "The Brooklet" (German). 8.30: Aileen Newlyn, soprano—"Take Me with You" (Clarke), "La Capinera" (Benedict). 8.38: Pianoforte recital by Hans Bertram—selected pianoforte numbers. 8.54: Bernard Manning, bass-baritone—selections from his repertoire. 9.0: G.P.O. chimes. 9.1: Meteorological information. 9.2: Overseas grain report. 9.3: William Davey, xylophonist—"Nola," (Arndt), "Breeze" (Hanley). 9.9: Fred Williamson, tenor—"Provence," "Your Eyes Have Told Me." 9.15: Station Orchestra—selection, "The Flatterer" (Chaminade), Danse, "Polish Dance" (Wieniawski). 9.25: Don Fraser, comedian—in a humorous interlude. 9.31: Station Orchestra—Oriental, "Caravan" (Joyce). 9.38: Aileen Newlyn, soprano—"Evening" (Schumann), "I Hear a Thrush at Eve" (Cadman). 9.42: William Davey, xylophonist—"Good-night" (Wood), "Dainty Miss" (Banres). 9.48: Fred Williamson, tenor—"Down Our Way" (King-Fewster). 9.54: Station Orchestra—Overture, "Marie Antoinette" (Dubois). 10.0: Don Fraser, comedian, in a humorous interlude. 10.6: Station Orchestra—foxtrot, "Decameron Night" (Benjamin); "Mademoiselle Kiki" (Rawlinson). 10.15: "The Advertiser" general news service; meteorological information; 5CL's sporting service by "Silvius." 10.31: Modern dance numbers by the famous Radi-o-Aces. 11.0: "God Save the King."

6WF

12.30: Tune in. 12.35: Markets, news, and cables. 1.0: Time signal. 1.1: Weather notes, supplied by the Meteorological Bureau of West Australia. 1.3: Music by the Station Orchestra. 2.0: Close down. 3.30: Tune in. 3.35: Afternoon tea concert, relayed from Rosebud Cafe. 4.30: Close down. 6.45: Tune in. 6.48: Bedtime stories for the kiddies by Uncle Duffy. 7.5: Light music by the Station Trio. 7.30: Commercial and general information; station announcements. 7.45: Racing talk by the sporting editor of "Truth" Newspaper Co. 8.0: Time signal. 8.1: Weather bulletin, supplied by the Meteorological Bureau of West Australia. 8.3: Katoomba Duo. 9.0: Late news items, by courtesy of the "Daily News" Newspaper Co.; late weather bulletin; station announcements; ships within range announcement.

7ZL

MID-DAY SESSION.

11.30: Records. 11.34: Weather information. 11.35: Records. 11.55: Tasmanian station's 9 a.m. weather report. 12.0: G.P.O. clock chimes the hour. 12.1: Shipping information. Ships within wireless range; mail notices; housewives' guide. 12.8: Records. 12.11: British official wireless news. 12.20: Records. 12.29: Announcements. 12.33: Records. 12.55: "Mercury" news service. 1.10: Records. 1.30: Close down.

AFTERNOON SESSION.

3.0: G.P.O. Clock chimes the hour. 3.1: Records. 3.4: Special Midlands forecast. 3.5: Records. 4.15: Readings from the "Weekly Courier," "What Energetic Men are Doing," 4.30: Close down.

EARLY EVENING SESSION.

6.15: Records. 6.25: "The Story Lady" will tell a story to the children. 6.40: Records. 7.0: Answers to letters and birthday greetings by "Uncle David." 7.5: Records.

EVENING SESSION.

7.15: A. M. O'Leary will speak on "Cricket Activities." 7.30: A Studio concert by the Discus Ensemble and 7ZL artists. Doris Barker, soprano. 7.37: Lella Read, pianoforte solo. 7.42: Mabel Bailey, contralto. 7.49: Mischa Eiman, violin solo. 7.56: Jean Hibbard, soprano. 8.3: Spencer Shaw, organ solo. 8.10: Doris Barker, soprano. 8.17: Lella Read, pianoforte solo. 8.22: Mabel Bailey, soprano. 8.29: International Concert Orchestra. 8.38: Jean Hibbard, soprano. 8.43: Paul Whiteman and his Orchestra. 8.45: J. M. Counsel, A musical programme by the Old Masters, "The History and Development of Music." 9.30: Miss Charity Wynne will speak on "Rhythm in Dancing." News session. British official wireless news; "Mercury" special Tasmanian news service; railway auction produce sales, held at railway; weather information; Hobart Stock Exchange quotations; market reports from Messrs. Roberts and Co. and Messrs. Wise and Stirling. 10.0: G.P.O. clock chimes the hour. Close down.

Exide

LONG-LIFE BATTERIES

AT

HALF PRICE

TYPE

CZ5

2 volts, 50/100 amp. hours.

16/-

Fully Charged.

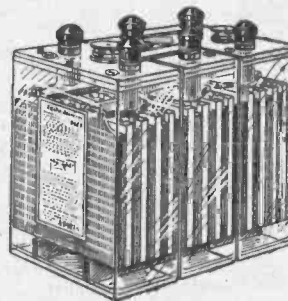

6-volt "CZ" Battery

TYPE

CZ6

2 volts, 60/100 amp. hours.

18/3

Fully Charged.

This offer remains open only so long as our present stocks last. Every battery is in an absolutely new and first class condition, and is sold under the protection of our guarantee.

Be Sure You Don't Miss This Opportunity

GIBSON, BATTLE & CO., LTD.

HUNT & COMMONWEALTH STS.

(Off Wentworth Avenue) SYDNEY 'Phone: M 2771-2-3.

Delco—Remy—Autolite—North East—Owen Dyneto Car Electrical Equipment.

Local Programmes, Saturday, February 9

2FC

EARLY MORNING SESSION.

Announcer: A. S. Cochrane.

7.0: "Big Ben" and announcements. 7.2: Official weather forecast rainfall, river reports, temperatures, astronomical memoranda. 7.7: "Sydney Morning Herald" summary. 7.12: Shipping intelligence, mail services. 7.15: Studio music. 7.25: Investment market; mining sharemarkets, metal quotations, wool sales, breadstuffs markets, inter-State markets, produce markets. 7.40: Studio music. 8.0: "Big Ben," close.

MORNING SESSION.

Announcer: A. S. Cochrane.

10.0: "Big Ben" and announcements. 10.2: Pianoforte reproduction. 10.10: "Sydney Morning Herald" news service. 10.25: Studio music. 10.30: Last-minute sporting information by the 2FC Racing Commissioner. 10.40: Studio music. 10.45: A Gardening Talk by "Redgum" (J. G. Lockley). 11.0: "Big Ben;" A.P.A. and Reuter's cable services 11.5. Close.

MIDDAY AND AFTERNOON SESSIONS.

Announcers: Laurence Halbert. Ewart Chapple.

12.0: "Big Ben" and announcements. 12.2: Stock Exchange information. 12.4: Studio music. 12.10: "Sydney Morning Herald" news service. 12.15: Rugby wireless news. 12.20: Studio music. 12.45: Cricket scores, England v. Ballarat, played at Ballarat. 1.0: "Big Ben;" weather intelligence. 1.3: "Evening News" midday news service 1.20: Studio music; races. During the afternoon events at the Canterbury races will be described by the 2FC Racing Commissioner. Cricket: Cricket results, England v. Ballarat, played at Ballarat, will be given during the intervals. During the intervals from the studio musical items will be given by the Idlers. 4.45: From the studio; complete sporting resume. 5.0: "Big Ben;" close down.

EARLY EVENING SESSION.

Announcer: A. S. Cochrane.

5.40: The chimes of 2FC. 5.45: The children's session, conducted by the "Hello Man;" letters and stories. 6.30: Music and entertainment. 6.40: Weather intelligence, shipping, Stock Exchange. 6.45: Rugby wireless news. 6.50: Sporting news, late news, and studio music. 7.10: The 2FC Dinner Quartette, conducted by Horace Keats—(a) "Serenade" (Chaminade), (b) "Spanish Dance" (Rehfeld), (c) "Three English Dances" (Quilter), (d) "Wonder Eyes" (Fletcher), (e) waltz (Carreno), (f) "Song of the Vagabonds" (Friml).

EVENING SESSION.

Announcer: Laurence Halbert.

Accompanist: Ewart Chapple.

7.40: Pianoforte reproduction.
7.45: Programme announcements.
7.48: Cricket results, England v. Ballarat, played at Ballarat. Popular music.
8.0: From "Bodington," Red Cross Home, Waterfall—Hospital concert party under the direction of Charles Lawrence, in association with R. A. Bartleman, Dorothy Dewar, Arthur Prince, Florence Page.
9.30: From the studio; weather report. Description from the Speedway.
Dance music by the Studio Dance Band, conducted by Cec. Morrisson.
11.30: National Anthem; close down.

INDEX TO LOCAL PROGRAMMES

Friday, February 8—	
2FC, 2BL, 2GB, 2UW	29
Saturday, February 9—	
2FC, 2BL, 2GB, 2UW	32
Sunday, February 10—	
2FC, 2BL	36
Monday, February 11—	
2FC, 2BL, 2GB, 2UW	38
Tuesday, February 12—	
2FC, 2BL, 2GB, 2UW	42
Wednesday, February 13—	
2FC, 2BL, 2GB, 2UW	46
Thursday, February 14—	
2FC, 2BL, 2GB, 2UW	50

2BL

MORNING SESSION

Announcer: A. C. C. Stevens.

8.0: G.P.O. chimes; metropolitan weather report. 8.1: State weather report. 8.2: Studio music. 8.15: G.P.O. chimes; news service from the "Daily Telegraph Pictorial." 8.30: G.P.O. chimes; news service, continued. 8.40: Information; mails; shipping, arrivals, departures and sailings. 8.45: Studio music. 9.15: Half an hour with silent friends. 9.45: Studio music. 10.0: G.P.O. chimes. Close down.

MIDDAY SESSION.

Announcers:

A. C. C. Stevens, J. Knight Barnett.

11.0: G.P.O. clock and chimes; women's session, conducted by Mrs. Cranfield; what's on at the pictures and theatres; novel suggestions to listeners; week-end specials. 11.30: Advertising hints. 11.40: Gardening Talk by City Parks Superintendent. 12.0: G.P.O. clock and chimes; special ocean forecast and weather report. 12.3: Pianoforte reproduction. 12.30: "Sun" news service. 12.40: Studio music. 12.45: Cricket scores. 1.30: "Sun" midday news service. 1.40: Studio music. 1.57: Cricket scores. 2.0: G.P.O. clock and chimes; close down. Note.—Race results will be broadcast.

AFTERNOON SESSION

Announcer: Basil Kirke.

Accompanist: Kathleen Roe.

3.45: G.P.O. clock and chimes; cricket scores, England v. Ballarat, played at Ballarat. 3.46: Pianoforte reproduction. 4.0: G.P.O. clock and chimes; from Romano's, Romano's Cafe Dance Orchestra, under the direction of Bennie Abrahams. 4.10: From the studio—Frank Whitley and Billie Gillies, instrumentalists: (a) "Hawaii, I'm Lonesome for You" (Cunha), (b) "Girl of my Dreams" (Clapp), (c) "That's my Weakness Now" (Green). 4.20: From Romano's—Romano's Cafe Dance Orchestra, under the direction of Bennie Abrahams. 4.30: From the studio—Cricket scores, England v. Ballarat, played at Ballarat. 4.32: Frank Whitley and Billie Gillies, instrumentalists—(a) "Hilo March" (Pale), (b) "Wailana," Drowsy Waters (Alau), (c) "Beautiful Hawaii" (Kallimal). 4.40: From Romano's—Romano's Cafe Dance Orchestra, under the direction of Bennie Abrahams. 4.50: From the studio; "Sun" news service. 4.55: Popular music. 5.0: G.P.O. clock and chimes; popular music. 5.15: Cricket results, England v. Ballarat. 5.17: Popular music. 5.25: Complete sporting and racing resume. 5.37: Features of the evening's programme.

EARLY EVENING SESSION.

Announcer: Basil Kirke.

5.40: Children's session, conducted by Uncle Bas; music and entertainment; letters and stories. 6.30: "Sun" news and late sporting. 6.40: 2BL Dinner Quartette—(a) "Mauresgu" (Coates), (b) "Serenade," Mileuka (Blocks), (c) "Siegmond's Love Song" (Wagner), (d) "March of the Tin Soldiers" (Fierne), (e) "Orientale" (Cul), (f) "Melodie in D" (Faure), (g) "Divertissement" (Delibes). 7.10: Cricket scores, England v. Ballarat, played at Ballarat. 7.12: Australian Mercantile, Land, and Finance Co.'s report; weather report and forecast by courtesy of Government Meteorologist; Producers' Distributing Society's fruit and vegetable market report; grain and fodder report ("Sun"); dairy produce report ("Sun"). 7.25: Mr. Pim and Miss Pam in advertising talks and nonsense. 7.55: Programme and other announcements.

EVENING SESSION.

Announcer: J. Knight Barnett.

Accompanist: G. Vern Barnett.

8.0: G.P.O. clock and chimes.
Topical chorus.
8.3: Ye Merri Trio.
8.15: Harrison White, banjoist.
8.22: Harry Croot, popular numbers—
(a) "Sonny Boy" (Jolson)
(b) "Because my Baby Don't Mean Maybe" (Donaldson).
8.29: Popular programme.
9.45: Weather report.
9.46: Ye Merri Trio.
9.56: Harrison White, banjoist.
10.3: Harry Croot, popular numbers—
(a) "For Ever More" (Burnett).
(b) "Sweet Ukulele Maid" (Connelly).
10.10: Ye Merri Trio.
10.20: From Romano's—Romano's Cafe Dance Orchestra, under the direction of Bennie Abrahams.
10.30: From the studio; weather report.
10.32: From Romano's—Romano's Cafe Dance Orchestra, under the direction of Bennie Abrahams.
10.57: From the studio; to-morrow's programme.
10.59: From Romano's—Romano's Cafe Dance Orchestra, under the direction of Bennie Abrahams.
11.30: National Anthem; close down.
During intervals between dance music "Sun" news will be broadcast.

2GB

5.30 p.m.: Children's session by Uncle George. 7.15: Music from studio. 7.20: Dance programme. 8.0: Request evening. 9.0: Grown-up bedtime stories. 10.0: Close down.

2UW

5.30 p.m.: Bed-time Stories, conducted by Uncle Jack. 6.30: Close down. 7.0 to 9.59: Musical programme. 10.0: Close down.

2GB

Sunday, February 10

10.15 a.m.: Organ music from St. Alban's Church, Redfern. 10.30: Morning service from St. Alban's Church. 12 noon: Close down. 5.30 p.m.: Children's session by Uncle George. 7.0: Lecture by the Rt. Rev. C. W. Leadbeater. 8.0: Music from the studio. 8.15: Sacred concert from Adyar Hall; songs by Miss Maesmore Morris. 8.22: Songs by Mr. J. Lou Walters. 8.29: Violin solos by Mr. Cecil Berry. 8.38: Songs by Miss Elsie Brown. 8.45: Songs by Miss Maesmore Morris; 8.52: Pianoforte solos by Miss Ada Brook. 9.0: Songs by Mr. J. Lou Walters. 9.7: Violin solos by Mr. Cecil Berry. 9.15: Songs by Miss Elsie Brown. 9.22: Pianoforte solos by Miss Ada Brook. 9.30: Close down.

YOUR RADIO DEALER WILL NOW SELL YOU

A B405 FOR 15¢

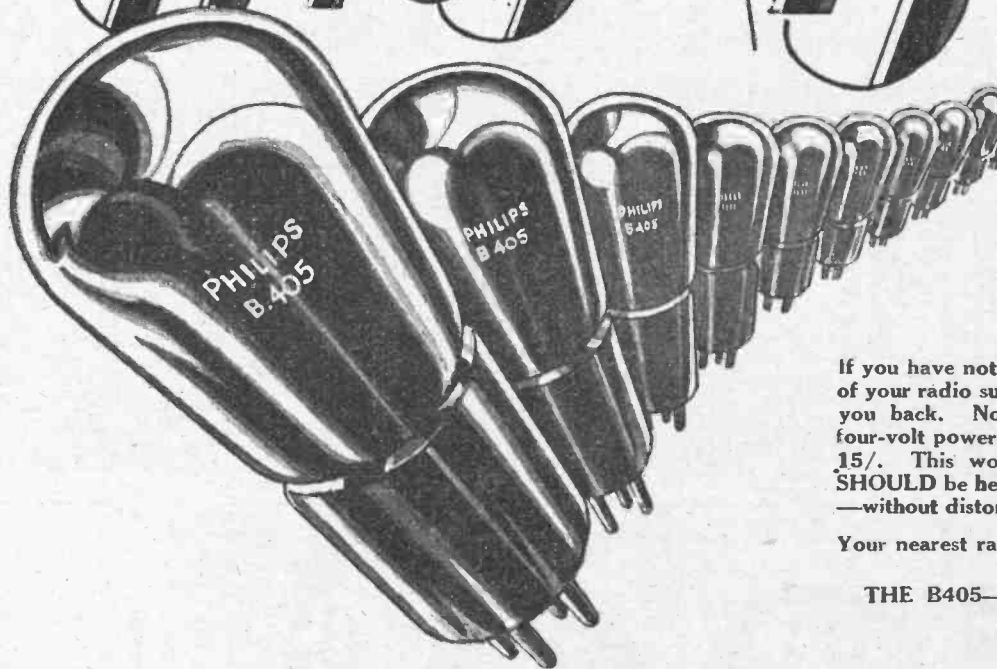

**THE B405 IS THE
POWER VALVE
FOR YOUR RADIO**

If you have not a Power Valve in the last stage socket of your radio surely only the extra cost must have held you back. Now, however, the mightiest of Philips four-volt power valves, the B405, has been reduced to 15¢. This wonder tube will give you music as it SHOULD be heard, for it is designed to handle volume—without distortion—without effort.

Your nearest radio dealer sells Philips Valves.

**THE B405—THE TUBE WITH THE SHEER
SLOPE OF 2.4**

PHILIPS

Interstate Programmes, Saturday,

3LO

EARLY MORNING SESSION.

7.15 to 8.15: See Friday.

MORNING SESSION.

Announcer: C. J. O'Connor. Accompanist: Mabel Nelson. 11.0: The Station Orchestra, overture "William Tell" (Rossini). 11.10: John Byrne, bass, "Two Japanese Love Songs". 11.17: Eric Welch will speak on to-day's races at Williamstown. 11.27: The Station Orchestra. "Petite Suite de Concert" (Coleridge Taylor). 11.34: Courtney Ford, humorist, "I'm Clever" (Windsor). "Arabella Blinks" (Macey). 11.41: Bertha Jorgensen, violin, "Prairie Flower" (MacMillan). 11.48: The Station Orchestra, "Fantasie Heidenbruch" (Wagner). 12.0: Mid-day news session.

MID-DAY SESSION.

Announcer: C. J. O'Connor. Accompanist: Mabel Nelson. 12.20: The Station Orchestra. 12.30: Jack Lumsdaine, the "Radio Bascia". 12.37: Tasma Tierman, cello. 12.42: Stock Exchange information. 12.45: The Station Orchestra. 1.0: Gertrude Gray, mezzo-soprano. 1.7: Meteorological information; weather forecast for Victoria, New South Wales, South Australia, and Tasmania; ocean forecasts; river reports; rainfall. 1.15: Jack Lumsdaine, whispering baritone. 1.22: The Station Orchestra. 1.30: Gertrude Gray, mezzo-soprano. 1.37: The Station Orchestra. 1.45: Close down.

AFTERNOON SESSION.

1.58: Description of Summer Hurdle. 2 miles. Williamstown races, by Eric Welch. 2.5: Sonora recital, from the studio. 2.15: Description of Pennant cricket match, St. Kilda v. Melbourne at M.C.C., by Rod McGregor. 2.33: Description of F. O. Orr Stakes, 1 mile, Williamstown. 2.40: Description of Pennant cricket match, St. Kilda v. Melbourne, at M.C.C. 2.47: Description of Electric Handicap, 3/4 furlongs, Williamstown races. 3.15: Description of Pennant cricket match, St. Kilda v. Melbourne, at M.C.C. 3.43: Description of Wyvatham Handicap, 1 mile 3 furlongs, Williamstown races. 3.50: Description of Pennant cricket match, St. Kilda v. Melbourne, at M.C.C. 4.0: Sonora recital from the studio. 4.13: Description of Marine Handicap, 6 furlongs, Williamstown races. 4.20: Description of Pennant cricket match, St. Kilda v. Melbourne, at M.C.C. 4.48: Description of February Welter, 1 mile, Williamstown races. 4.55: Description of Pennant cricket match, St. Kilda v. Melbourne, at M.C.C. "Herald" news service. During the afternoon progress scores of the cricket matches in England and Iarnat, will be broadcast as they come to hand. 5.25: Close down.

EVENING SESSION.

5.50: Sporting results. 6.0: Answers to letters and birthday greetings by "Little Miss Kookaburra." 6.25: Musical interlude. 6.30: Captain Donald MacLean will tell you some more pirate stories. 6.45: "Little Miss Kookaburra" sings extracts from "The Cricket on the Hearth," "The Song of the Kettle," and "Kitty Slowboy and the Baby," by Charles Dickens.

NIGHT SESSION.

Announcer: John Stuart. Accompanist: Mabel Nelson. 7.5: Stock Exchange information. 7.15: Market reports (see Friday). 7.20: News session. 7.43: Birthday greetings. 7.45: "The Valley and the Hill" (Quilter). 8.10: Dr. J. A. Leach will speak on "Whiplirds". 8.0: A maker of history. 8.1: The Station Orchestra, overture, "Jean de Paris" (Boieldieu). 8.10: Gertrude Gray, mezzo-soprano, "The Sunny Garden." "The Valley and the Hill" (Quilter). 8.17: The Station Quartet, "Sally in Our Alley" (Pochon). "Scottish Dances" (Pochon). "Minuet" (Bocherini-Pochon). 8.27: "The Sundowners" Radio Revue Co. in a sketch specially written and produced for radio by J. Harcourt-Bailey. "A Black Outlook." A delightful half-hour of up-to-date nigger minstrelsy, during which the following numbers will be rendered: "The Ovine Back to Dixie." "Chloe" (Moret). "I Miss You, Liza" (Crosby). "Suzanne" (Brazier). "I Got a Home" (Brown). "Nigger Nonsense," original arrangement. "Blackest Man I Know" (Grey). 8.57: The song feature of the week. 9.0: The Station Orchestra, "Adagio and Allegro." No. 1. Symphonon" (Schubert). 9.10: Perry Code, trumpet. "Parted." 9.15: Eric Welch will describe to-night's events at the Stadium. 9.30: The Station Orchestra, fantasia, "The Selfish Giant" (Cotter). 9.37: Jack Lumsdaine, whispering baritone, "Modern Melodist." 9.41: The Station Orchestra, "Deuxieme Petite Suite" (Michell). 9.50: Gertrude Gray, mezzo-soprano, "At Sunrise" (Ronald). "Spring's a Lovable Lady" (Eliott). 9.57: The Station Orchestra, selection, "Sometime." 10.5: Eric Welch will again describe to-night's events at the Stadium. 10.20: The Station Orchestra, selection, "Le Forze del Destina" (Verdi). 10.30: Courtney Ford, humorist, "Improve Your Appearance" (Martin). "The Uninstructed Delegate." 10.35: Jack Lumsdaine, whispering baritone, selected. 10.42: Late sporting. 10.45: The Radi-o-Aces, "Old Man Sunshine" (Dixon). "My Dream Sweetheart" (Hall). "Quest Who's in Town" (Razey). "That Stolen Melody" (Fisher). "Tenors" (Gibbert). "Japanese Mammy" (Donaldson). "There's a Rickety Rickety Shack" (Turk). "That's What You Mean to Me" (Davis). "Lazy Feet," piano solo (Masman). "Just Like a Melody Out of the Sky" (Donaldson). "Beloved" (Kahn). "Because My Baby Don't Mean May Be Now" (Donaldson). "I Love to Dunk a Hunk of Sponge-cake" (Castill). "Ramona" (Wayne). 11.0: God Save the King.

3AR

Announcer: C. J. O'Connor. 10.0 to 10.59: See Friday. 11.0: A Gramophone Recital of World Famous Music. 11.50: British Official Wireless news. Announcements Messrs. John M'Namara and Co. Pty. Ltd., report on to-day's Newmarket fat cattle sale, direct from the yards. 12.0: Close down.

AFTERNOON SESSION.

Announcer: C. J. O'Connor. 3.0: Johnston's Studio Boys. 3.15: Gramophone records. 3.27: Johnston's Studio Boys. 3.34: Gramophone Records. 3.40: Johnston's Studio Boys. 3.50: Gramophone Records. 4.2: Announcements. 4.5: Johnston's Studio Boys. 4.20: Gramophone records. 4.32: Johnston's Studio Boys. 4.39: Gramophone recital. 4.45: Johnston's Studio Boys. 4.55: Announcements. 5.0: Close down.

EVENING SESSION.

Announcer: J. Stuart. 6.0: A Bravura of Beautiful Ballads and Orchestral Chef d'Ouvrre. 7.15: John M'Namara and Co., Pty. Ltd., auctioneers, Melbourne, report on to-day's Newmarket cattle sale. 7.25: Gramophone recital continued. 8.0: Results of cricket match, Ballarat v. Victoria, at Ballarat. All sporting results. Announcements.

NIGHT SESSION.

Announcer: J. Stuart. Accompanist: Reg. Brown. 8.30: Brunswick City Band, selection, "The Knight Errant" (Trussell). 8.45: John Byrne, bass, "In Sympathy." "The Bellinger" 8.52: Brunswick City Band, march, "Namu" (Richards). 8.57: Diana Belmont, soprano, "Summer Stars" (Lehmann). "Rose Leaves" (Lehman). 9.4: Brunswick City Band, fantasia, "John Peel" (Greenwood). One Act. Play, "The Evidence," produced by Dulcie Hall. Caste: Matthew Pringle. Played by Digby Marriott. A man of about 36 years of age, bald and looks older than his years. Agatha Fringle, his wife, played by Dulcie Hall. Stranger, played by Andrew Howard. Police Officer, played by Tony Marshall. Time, 11 p.m. Scene: A sitting room in a flat showily furnished. 9.29: Brunswick City Band, waltz, "Fond Memories" (Round). Selected. 9.41: Diana Belmont, soprano, Request Items. 8.57: Victor Stephenson, "Waltz in E Major" (Brahms), "Rhapsody in G Minor" (Brahms), "Gavotte in A Major" (Glick-Brahms), "Prelude in B Flat Minor" (Chopin), "Prelude in A Major" (Chopin), "Study in C Sharp Minor" (Chopin). 10.3: Brunswick City Band, selection, "Pride of Ireland" (Round). 10.13: John selected. 10.20: "Age" news service, exclusive to 3AR. Result of cricket match, Ballarat v. England, at Ballarat. Announcements. God Save the King.

4QG

EARLY MORNING SESSION.

Announcer: J. Tyson. 7.43: Time signals. 7.45: News service. 8.0: Music electric records. 8.15: News service. 8.30: Close down.

AFTERNOON SESSION.

Race meeting. The race meeting will be described direct from the course. Transmission will commence with the start of the first race. Between races music from the studio will be relayed. 5.0: Close down.

EARLY EVENING SESSION.

6.30: Bedtime stories conducted by "Uncle Ben." 7.15: To-day's race results in brief. 7.20: General sporting notes. 7.30: Sailing notes by Mr. Fred Smith.

NIGHT SESSION.

Announcer: H. Humphreys. 8.0: Overture by the Savoy Orchestra. 8.5: Annie Adams (soprano)—"My Message" (d'Hardelot). 8.9: The Rio Grand Serenades—five minutes' Hawaiian music. 8.14: Kezzy (the entertainer). 8.20: Edda Woolmer, at the studio organ. 8.25: C. T. Birckbeck, tenor, "When the Great Red Dawn is Shining" (Sharp). 8.30: From the Savoy Theatre, orchestral music. 8.35: Annie Adams (soprano), "I Wonder if Love is a Dream" (Poster). 8.40: The Rio Grand Serenades, five minutes' Hawaiian music. 8.45: C. T. Birckbeck (tenor), "Lorraine" (Sanderson). 8.50: From the Speedway, results of motor cycle races. 9.0: Metropolitan weather forecast. 9.1: A Wurliizer organ record. 9.5: The Rio Grand Serenades, more Hawaiian music. 9.10: Harry Humphreys, in a character sketch. 9.20: From the Speedway, motor cycle races. 9.30: From Lennon's Ballroom, dance music. 10.0: "The Daily Mail" news. "The Courier" news, weather news. Close down.

5CL

AFTERNOON SESSION.

12.0: G.P.O. chimes. 12.1: Last-minute selections of Victorian races by Mr. Eric Welch, of 3LO, Melbourne. 12.3: Probable riders and starters for Cheltenham races. 12.15: General news service, and British official wireless news. 12.30: Sonora recital. 12.45: From Cheltenham Park Racecourse, positions and riders of Aldridge Stakes, first division. 1.0: Studio music. 1.45: A Sonora recital of Aldridge Stakes, first division. 1.5: Close down. 1.30: Positions and riders of Aldridge Stakes, second division. 1.35: Five minutes' with Parlophone artists. 1.40: Running description of Aldridge Stakes, second division. 1.45: A Sonora recital of H.M.V. recordings. 2.5: Positions and riders of M. Eba Hurdle Race. 2.10: Musical numbers. H.M.V. recordings. 2.20: Running description of M. Eba Hurdle Race. 2.25: Sonora recital.

Single Range and
Three Range
Instruments



RADIO
METERS

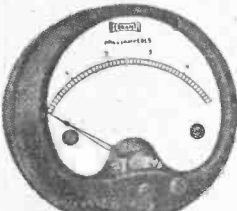

Single Reading, 0-150 m/a. £1/17/-.

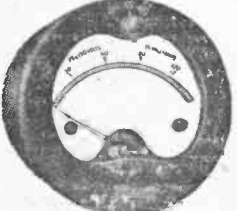

Three Reading, 10.50 and 250 Volts, 1,000 ohms per volt, £3/10/6.

PANEL TYPE
[Flush and Projecting]
and PORTABLE TYPE

Get your Ferranti Radio Meter now, because Ferranti Radio Meters are necessary to any Valve Receiver if true reproduction of Broadcast and other Radio transmissions is to be obtained.

Obtainable from every Radio Dealer in Australia.

R2.

February 9

H.M.V. recordings. 2.45: Positions and riders of Wilgena Two-year-old Race. 2.50: Musical interlude. 3.0: Description of Wilgena Two-year-old, by Mr. Arnold Treloar. 3.4: Resume of Victorian race results. 3.5: Sonora recital. Parlophone recordings. 3.25: Positions and riders, Bungaree Cup. 3.30: Ten minutes with Parlophone celebrity artists. 3.40: Running description of Bungaree Cup, by Mr. Arnold Treloar. 3.45: Parlophone recordings. 4.0: Resume of inter-State and S.A. sporting. 4.5: Positions and riders of Benson Welter. 4.10: An interlude on "The Sonora" (Parlophone recordings). 4.20: Running description of Benson Welter, by Mr. Arnold Treloar. 4.25: Instrumental numbers on "The Sonora" (Parlophone recordings). 4.45: Positions and riders of Kidman Stakes. 4.50: Resume of afternoon's sporting. 5.0: Running description of Kidman Stakes, by Mr. Arnold Treloar. 5.10: Close down.

EVENING SESSION.

6.0: G.P.O. chimes. 6.1: Resume of late sporting results. 6.8: Children's happy moments. Birthday greetings, correspondence, songs and stories by "The Wattle Lady." 6.40: An interlude of dinner music (Parlophone recordings). 7.0: G.P.O. chimes. 7.1: S. C. Ward and Co.'s Stock Exchange information. 7.8: International cricket scores, England v. Ballarat. 7.10: Rev. G. E. Hale, B.A., talk on "Shakespeare's Soliloquys." 7.25: Resume of South Australian cricket, by "Willow." 7.35: O. G. Riley, talk on "Items of Interest." 7.45: 5CL's sporting service, including cricket scores, and late race results.

NIGHT SESSION.

8.0: G.P.O. chimes. 8.1: Solomon Sisters, instrumentalists, "Prelude in O Sharp Minor" (Rachmaninoff), "De Zweifel" (Glinka). 8.7: Bernard Manning, bass-baritone, selections from his repertoire. 8.13: Seth Smith, banjolist, "Sympathy Waltz" (Bibo). "Romping Rossie" (Rossiter). 8.19: Will Runge, humorist, in selected humor. 8.29: Solomon Sisters, instrumentalists, "Let Me Gaze" (Gounod), "Intermezzo" from "Cavalleria Rusticana," "Three Miniatures" (Bridg), 8.39: Linda Wald, soprano, "Oh, Didn't It Rain" (Burliegh), "The Charm of Spring" (Clarke). 8.48: Jean Finlay, pianiste, "Gavotte" (Brahms). 8.48: Bernard Manning, bass-baritone, selections from his repertoire. 9.4: From Wayville Speedway, description of the motor-cycle contests. 9.26: From studio. Linda Wald, soprano, "Music When Soft Voices Die" (Besby). "When I'm a Grown-up Lady" (White). 9.28: Solomon Sister, instrumentalists, "Three Fours" (Taylor), "Melodie" (Moszkowski). 9.30: Will Runge, humorist, in a humorous interlude. 9.46: Seth Smith, banjolist, "Darkies Dream" (Lansing), "Blaine Waltz" (Folack). 9.52: Bernard Manning, bass-baritone, selections from his repertoire. 9.55: Solomon Sisters, instrumentalists, "Finale of Trio No. 1" (Haydn), "Romance" (Reissiger), "Simple Avou" (Thome), 10.0: From Wayville Speedway, a description of the final speed events. 10.15: From the studio. 5CL's sporting service. 10.30: Modern dance numbers by the famous Radi-o-Oces. 11.0: God Save the King.

6WF

12.0: Tune in. 12.5: Musical programme from the studio, with pianoforte solos by Miss Audrey Dean. 12.43: General information; cables, news, etc. 1.0: Time signal. 1.1: Weather bulletin, supplied by the Meteorological Bureau of West Australia. 1.3: Close down. 2.15: Tune in. 2.30: Sporting session, with musical numbers from the studio. 5.20: Close down. 6.45: Tune in. 6.48: Auntie Amy will talk to the children. 7.12: Sports news. 7.30: Commercial and general information. 7.45: Music from the studio. 8.0: Time signal. 8.1: First weather bulletin, supplied by the Meteorological Bureau of West Australia. 8.3: Including vocal and instrumental items from the studio. 9.0: Late news items, by courtesy of the "Daily News" Newspaper Co., ships within range announcement; late weather bulletin; station announcements. 10.30: Close down. 104.5 metre transmission: Simultaneous broadcast on 104.5 metres of programme given on 1250 metres, commencing at 6.45 p.m.

7ZL

AFTERNOON SESSION.

3.0: G.P.O. clock chimes the hour. 3.1: Records. 3.4: Weather information. 3.5: Records. 3.10: Running description of electric Handicap, 5½ furlongs, run at Williamstown Racecourse, Williamstown, Melbourne, Victoria. 3.15: Transmission from the T.C.A. Ground, cricket match, Sandy Bay v. New Town, described by A. M. O'Leary. 3.45: Running description of Wynden Handicap, one mile and three furlongs. 3.50: Cricket match, Sandy Bay v. New Town. 4.20: Running description of Marine Handicap, six furlongs. 4.25: Cricket match, Sandy Bay v. New Town. 4.50: Running description of February Welter, one mile. 4.55: All sporting results to hand. 5.0: Close down.

EARLY EVENING SESSION.

6.0: All sporting results to hand. 6.15: Records. 6.30: "Uncle David" will entertain the wee folk. 7.0: Answers to letters and birthday greetings by "Uncle David." 7.5: Request numbers for the children. 7.15: News session.

EVENING SESSION.

7.30: Mrs. J. J. Wignall (Mayress of Hobart) will speak on "Civic Spirit." 8.0: G.P.O. clock chimes the hour. 8.6: Selections by the Melody Masters. 8.30: Transmission from the Continental, Macquarie Street, Hobart. Theo Ptpkin and his Continental Orchestra. 10.20: From the studio, news session. 10.30: Close down.

HOW TO CHOOSE YOUR "EVER-READY" RADIO "B" BATTERY

EFFICIENCY OF SERVICE and ECONOMY IN RUNNING COSTS are obtained only by choosing the right size and type of "EVER-READY" H.T. "B" Battery, together with an "EVER-READY" Bias (No. 126C) Battery. The result—a perfect combination of QUALITY QUANTITY, and LONG SERVICE.

Get yours to-day from any radio dealer.

Type of Set.	Type of Ever-Ready Battery.	Total Voltage.	Ever-Ready "C" Battery.
1 Valve	One W.P. 31½-Volt or One W.P. 42-Volt	18 to 42	—
2 Valves	One W.P. 63-Volt or Two W.P. 42-Volt	63 to 84	No. 126
3 Valves	Two W.P. 42-Volt or Two H.D. 45-Volt	84 to 90	No. 126
4 and 5 Valves	Two H.D. 45-Volt or Two S.S. 45-Volt	90	No. 126
4, 5, or more Valves or Power Valves..	Two or Three S.S. 45-Volt	90 to 135	One or more No. 126 or one W.P. 31½

There's an interesting folder in colors about these great batteries, with much useful information for radio enthusiasts. Write us for your copy to-day!

WHOLESALE DISTRIBUTORS:
THE EVER-READY CO. (Gt. Britain) LTD.,
163 Pitt Street, Sydney.

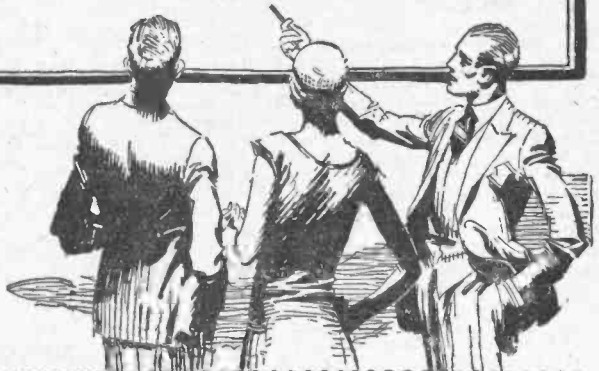

W.E.I.O

EVER-READY RADIO BATTERIES

SAFETY FIRST — UTILITY ALWAYS

LOOK FOR THE TRADE MARK

Local Programmes, Sunday, February 10

2FC

MORNING SESSION

Announcer: A. S. Cochrane.

- 10.0: "Big Ben," and announcements.
- 10.2: Studio music.
- 10.15: News service.
- 10.30: Studio music.
- 11.0: Morning service, broadcast from St Mark's, Darling Point. Preacher: Rev Canon E. Howard Lea.
- 12.15 approx.: Close down.

AFTERNOON SESSION

Announcer: C. R. Hall

- 2.30: Programme announcements.
- 2.32: The Cheer Up Society, conducted by Uncle Frank.
- 3.0: From the Lyceum Hall, Pleasant Sunday Afternoon, arranged by Central Methodist Mission.
- Doxology.
- 3.1: Prayer.
- 3.5: Programme outline.
- 3.6: Baritone solo, Mr. Garnet Thompson
- 3.10: Recitation, Mr. Robert Turner.
- 3.17: Contralto solo, Miss Florence Smith
- 3.22: Tenor solo, Mr. J. M. Ewen.
- Offertory.
- Organ solo, Miss C. Bardsley, L.T.C.L.
- 3.40: Topical address, Mr. E. L. Sanderson, M.L.A.
- Doxology.
- Benediction.
- 4.30: From the Studio—
- Organ and vocal recital by Mr. and Mrs T. F. Faulkner.
- Organ solos: (a) "A Perfect Day" (Mendelssohn)
- (b) "Ancante" (Bach)
- Contralto solos "Abide With Me" (Liddle).
- (d) "A Perfect Day" (Bourne)
- (e) "Coming Home" (Casper)
- 4.48: Studio music
- 5.0: Close down.

EVENING SESSION

Announcer: Laurence Albert

Accompanist: Kathleen Roe.

- 6.0: "Big Ben," and programme announcements.
- 6.3: A Talk by Francis Jackson "The Menin Gate."
- 6.20: Programme arranged by the British Music Society's Quartette—
- (a) "Old Black Joe" (Old Negro)
- (b) "Angel Gabriel" (Spiritual)
- (c) "Deep River" (Pochon)
- (d) "Serenade" (Moskowsky)
- (e) "Song of Volga Boatman" (Pochon)
- (f) "Rondo" (Mozart)
- 6.45: Organ recital, from St. Street Congregational Church.
- 8.30: From the Studio—programme arranged by the British Music Society's Quartette—
- (a) "Molto Lento" (Rubenscan)
- (b) "Promenade" (Moussorgsky)
- (c) "Serenade" (Moussorgsky)
- 8.45: Eileen Starr, soprano.
- 8.52: British Society's Quartette—
- (a) "Traumerel" (Schumann)
- (b) "Hungarian Dance" (Brahms)
- (c) Selected.
- 9.2: Susan Emnis, contralto.
- 9.9: British Music Society's Quartette—Selected.
- 9.19: Eileen Starr, soprano.
- 9.26: British Music Society's Quartette—Selected.
- 9.36: Susan Emnis, contralto.
- 9.43: British Music Society's Quartette—Selected.
- 9.53: Programme announcements
- 10.0: Recital of selected records
- 10.30: National Anthem.
- Close down.

2BL

MORNING SESSION

Announcer: A. C. C. Stevens.

11: G.P.O. clock and chimes. Service

broadcast from Burton Street Baptist Church
12.15: From the Studio, "Sun" news service.
12.30: Studio music.

2.0: G.P.O. clock and chimes; close down.

AFTERNOON SESSION

Announcer: J. Knight Barnett.

3.0: G.P.O. clock and chimes; record recital.

3.30: From the Manly Band Rotunda, Manly Beach.

5.0: G.P.O. clock and chimes; close down.

EVENING SESSION

Announcer: J. Knight Barnett.

Accompanist: G. Vern Barnett.

6.0: Children's Session, conducted by Uncle Peter.

7.0: From St. Jude's Church of England, Bells of St. Jude's.

7.10: Organ music.

7.15: Hymn 19. "The Radiant Morn has Passed Away."

Prayers.

Psalm 53.

Lessons.

Magnificat.

Nunc Dimittis.

Creed.

Prayers.

Anthem.

Prayers—Notices.

Hymn 172. "Praise to the Holies in the Highest."

Sermon by Canon Cakebread.

Hymn 62. "Alleluia, Song of Sweetness."

Benediction.

Closing Organ Voluntary.

8.30: From the Manly Band Rotunda, Manly Beach.

9.30: From the Studio.

Stanley Catlett, tenor

9.37: Gerald Walenn, violinist.

9.44: Stanley Catlett, tenor.

9.51: Gerald Walenn, violinist.

9.58: Programme announcements

10.0: National Anthem

Close down.

SA Y WHEN!!!

You can't have TOO much of a GOOD thing, says the Radio Fan who purchases his parts from
PRICE'S

Electron Wire, the wonder aerial, 100ft. carton	2 0
Miniature S.P.D.T. Panel Mtg. Switches	0 9
Miniature D.P.D.T. Panel Mtg. Switches	1 0
Tefag Adjustable Diaphragm. 4000 Ohm Phones	12 6
Terraphon Lightweight 8000 Ohm Phones	12 6
Beede 0-50 Pocket Volt-meter	3 6
Beede Accumulator Check Meters	3 0
Attractive Panel Mtg. Meter, 0-6 and 0-120 combined	13 9
Panel Mtg. Amp-meter, 0-3 amps. Tone Control	7 6
Centralab Special 30 Ohm Rheostat, usually 7/-	6 9
A Special Bakelite Vernier Dial, the A.S.L.	3 6
	6 0

QUALITY PARTS FOR THE "MARCO FOUR"	
	s. d.
Bakelite Panel, 18 x 6	4 9
Ruseboard, 17 x 9	2 0
Sangamo .002, .0001, .0005	7 3
3 A.S.L. Vernier Dials	18 0
2 Pilot .0005 S.L.F.	28 6
1 Pilot .00025 S.L.F.	11 3
2 Pilot 30 Ohm Rheostats	5 6
2 Pilot Transformers	20 0
1 Filament Bellows	3 0
1 Pilot B.C. Jack	1 3
1 Push Pull Switch	1 9
4 U.X. Sockets and Terminals	5 0
1 Sentinel Marec Kit	5 6
1 Sangamo Condenser and Leak	4 0
1 10 Terminal Strip	3 10
4 Philips Matched Valves	55 6
	£8 15 1

£8/8/- THE OUTFIT.

Carborundum Super Crystal Detector	8 8
Ediswan 45-amp. actual 2-volt Glass Accumulators	18 6
Copper Adjustable Earth Clips, with nut and bolt	0 3
Plugs and Sockets for short wave coil adaptors, per pair	0 3 1/2
.00025 Variable Condensers (reaction)	3 6
Celastrite Flex. Wiring Wire, in 25ft. cartons	3 0
Block 4mf. 7/6, 2mf. 4/-, and 1mf. Record Bell Ringing Transformers for Eliminators	7 6
Pilot 30 Henry 85 m.a. Chokes, for Eliminators	17 6

COMPLETE PRICE-LIST FOR THE ASKING

ALL COUNTRY ORDERS POST FREE EXCEPT BATTERIES

PRICE'S RADIO SERVICE

Wingello House, Angel Place, Sydney. B4146

"Where you are always on a good thing."

Interstate Programmes, Sunday, February 10

3LO

Announcer: John Stuart. 10.30 a.m.: Bells from St. Paul's Cathedral. 10.45: Express train information; British official wireless news from Rugby; news from yesterday's papers. 11.0: Morning service from Scots' Church, Collins Street, Melbourne. 12.15: Close down.

AFTERNOON SESSION.

Announcer: John Stuart. 2.0: Sonora recital of the world's most famous records. 3.0: Pleasant Sunday afternoon service, Central Mission, Wesley Church; chairman, Rev. J. H. Cain. 4.30: Close down.

EVENING SESSION.

Announcer: John Stuart. 5.45: Shipping information. 5.47: Answers to letters and birthday greetings by "Join the Piper's Son." 6.25: "Brother Bill" will speak on "Looking Backward and Forward." 6.45: Adult birthday greetings and programme announcements. 6.47: Bells from St. Paul's Cathedral.

NIGHT SESSION.

Announcer: John Stuart. Accompanist: Mabel Nelson. 7.0: Evening service from Wesley Church, Lonsdale Street, Melbourne, conducted by Dr. S. J. Hoban and Rev. C. Irving Benson. 8.30: Malvern Tramways Band, "Semiramide" (Rossini). 8.42: William Bossence, baritone, "Lord God of Abraham" from "The Messiah." 8.49: Raymond Lambert, piano, "Concert Study" (K. Jongen), "Campanella" (Liszt). 8.59: Malvern Tramways Band, "Ravenswood" (Rimmer). 9.4: Jean Hambleton, contralto, "The Maiden's Vow," "The White Flower" (Louis Lavater). 9.11: Edouard Lambert, violin, "Fantasie de Concert," for violin (Rimsky-Korsakoff). 9.21: William Bossence, baritone, "A Blackbird Singing," "Nocturne" (Michael Head). 9.28: Malvern Tramways Band, "Europe United" (Zehle). 9.33: Raymond and Edouard Lambert, "Sonata for Violin and Piano" (G. Groves). 9.40: Jean Hambleton, contralto, "In Haven," "Where Corals Lie" (Eigar); 9.47: Malvern Tramways Band, "Little Drummer" (Rimmer). 9.52: "Argus" news service. Announcements. 10.0: Close down.

4QG

MORNING SESSION.

11.0: The complete morning service will be relayed from St. Andrew's Presbyterian Church, Creek Street. 12.30: Close down.

AFTERNOON SESSION.

The Federal Band. The concert by the Brisbane Federal Band will be relayed from the Botanic Gardens. 3.15: From the Botanic Gardens, Federal Band concert. 4.30: Close down.

EARLY EVENING SESSION.

Children's Session. 8.30: From the studio, a session for little listeners. Greetings and replies to letters.

NIGHT SESSION.

Presbyterian Church. The complete evening service will be relayed from St. Andrew's Presbyterian Church, Creek Street. 7.0: From St. Andrew's, children's service. 7.30: Evening service. At the conclusion of the church service, the concert by the Brisbane Municipal Concert Band will be relayed from Wickham Park. 9.30: Close down.

5CL

MORNING SESSION.

10.45: Carillon of bells from Adelaide Town Hall. 11.0: G.P.O. chimes. 11.1: Divine service from St. Peter's Cathedral. 12.15: British official wireless news. 12.20: Close down.

AFTERNOON SESSION.

3.0: G.P.O. chimes. 3.1: A Pleasant Sunday Afternoon Service from Maughan Methodist Church, Franklin Street, City. 4.0: G.P.O. chimes and close down.

EVENING SESSION.

6.0: G.P.O. chimes. 6.1: S.A. railway information. 6.3: Birthday greetings, correspondence, songs and stories by "Miss Wireless." 8.30: "The Bird Lady" and "The Junior Songster" will entertain the children. 7.0: G.P.O. chimes. 7.1: A religious service from Parkside Baptist Church.

NIGHT SESSION.

8.25: S.A. Railways Band. March, "National Emblem" (Bagley). Overture, "Jolly Robbers" (Suppe). 8.38: Linda Wald (soprano). "O That it were So" (Bridge). "The Tryst" (Sibelius). 8.46: Lewis Jones (violinist). "Berceuse" (Faure). "Caprice Viennois" (Kreiskler). 8.52: Reg. Harris (tenor).

"Take a Pair of Sparkling Eyes" (Sullivan). "Macushla" (MacMurrough). 8.58: S.A. Railways Band. Waltz, "Die Hydropten" (Gungl). 9.4: Linda Wald (soprano). "Virgin Slumber Song," "Ave Maria" (Du Bois). 9.10: S.A. Railways Band, selection, "Tolanthe" (Sullivan). 9.20: Lewis Jones (violinist). "Cantilene" (Schafer). "Reve d'Enfant" (Ysaeye). 9.26: Reg. Harris (tenor). "I Seek for Thee in Every Flower," "Because" (d'Hardelot). 9.32: S.A. Railways Band. March, "BB and OP" (Hume). 9.45: P. H. Nicholls. Talk on "Bunhill Fields." 9.59: Meteorological information. 10.0: God Save the King.

6WF

10.25: Tune in. 10.30: Special half-hour for the enthusiastic listener-in. 11.0: Morning service, relayed from St. Mary's Roman Catholic Cathedral. 12.45: Close down. 2.40: Tune in. 2.45: Grand sacred concert; Haydn's oratorio, "The Creation," by Perth and Railway Philharmonic Society, accompanied by full orchestra, relayed from Theatre Royal, Perth; assisted by Miss Gwladys Edwards (soprano), Mr. Rhys Francis (tenor), and Mr. O. G. Haywood (bass). 4.30: Close down. 7.0: Tune in. 7.5: Bed-time stories for the kiddies. 7.30: Evening service, relayed from the Trinity Church. 8.45: A relayed programme from the Government Gardens; item by the Perth City Band, conducted by Mr. L. Price. 10.5: Close down. 10.5 metre transmission: Simultaneous broadcast on 104.5 metres of programme given on 1250 metres, commencing at 7 p.m.

7ZL

MORNING SESSION.

10.45: Transmission from Trinity Church, Hobart. 11.0: Transmission from Memorial Congregational Church, Brisbane Street, Hobart. 12.30: Close down.

AFTERNOON SESSION.

A band concert by the Municipal Band (L. Barnett, conductor). 4.30: Close down.

EARLY EVENING SESSION.

6.15: Chorus singing (conductor, Trevor M. Morris, of Children's Special Service Mission). 6.45: Bertha Southey Brammall will read a poem to the wee folk—"Fairy Horses," "Told in Bed."

EVENING SESSION.

7.0: Transmission from Chalmers' Methodist Church, Bathurst Street, Hobart. 8.25: A programme of sacred and classical music, arranged by J. M. Counsel. 9.40: News session. 9.50: Close down.

FIRE!! FIRE!!!

Your Chance to Secure
Radio Bargains at your own Price!

As a result of the recent FIRE, all goods must be sold, regardless of cost --- GLASSWARE, CROCKERY, WIRELESS SETS, TORCHES, BATTERIES, VALVES, ETC.

Note the Address:

LATIMERS RADIO BAZAAR

281 GEORGE STREET,
SYDNEY

Interstate Programmes, Monday, February 11

2FC

EARLY MORNING SESSION.

Announcer: A. S. Cochrane.

7.0: "Big Ben," and announcements. 7.2: Official weather forecast; rainfall; river reports; temperatures; astronomical memoranda. 7.7: "Sydney Morning Herald" summary. 7.12: Shipping intelligence; mail services. 7.15: Studio music. 7.25: Investment market; mining share markets; metal quotations; wool sales; breadstuffs markets; inter-State markets; produce markets. 7.40: Studio music. 8.0: "Big Ben." Close down.

MORNING SESSION.

Announcer: A. S. Cochrane.

10.0: "Big Ben," and announcements. 10.2: Pianoforte selection. 10.10: "Sydney Morning Herald" news service. 10.25: Studio music. 10.30: A Talk, by the 2FC Racing Commissioner. 10.45: A Talk on "Home Cooking and Recipes," by Miss Ruth Furst. 11.0: "Big Ben"; A.P.A. and Reuter's cable services. 11.5: Close down.

MIDDAY SESSION.

Announcer: A. S. Cochrane.

12.0: "Big Ben," and announcements. 12.1: Stock Exchange, first call. 12.3: Official weather forecast; rainfall. 12.5: Studio music. 12.10: Summary of news, "Sydney Morning Herald." 12.15: Rugby wireless news. 12.18: A reading. 12.30: Studio music. 12.45: Cricket scores, N.S.W. v. Tasmania, played at Hobart. 12.48: Studio music. 1.0: "Big Ben," weather intelligence, 1.3: "Evening News" mid-day news service; Producers' Distributing Society's report. 1.20: Studio music. 1.28: Stock Exchange, second call. 1.30: Popular studio music. 1.57: Cricket scores. 2.0: "Big Ben." Close down.

AFTERNOON SESSION.

Announcer: Laurence Halbert.

Accompanist: Ewart Chapple.

3.50: Programme announcements. 2.32: Educational session for the schools; short musical recital; a reading. 3.0: "Big Ben"; pianoforte reproduction. 3.15: Popular music. 3.37: Enid D'Arcy, soprano, (a) "April Song" (Newton), (b) "Dearest, I Love the Morning" (Wood). 3.44: Cricket results, N.S.W. v. Victoria. 3.45: A reading. 4.0: "Big Ben"; Molly James, pianist. 4.8: Popular music. 4.18: Enid D'Arcy, soprano, (a) "The Charm of Spring" (Clarke), (b) "I Opened My Window" (Nicholl). 4.25: Studio music. 4.35: Molly James, pianist. 4.45: Stock Exchange, third call. 4.47: Popular music. 5.0: Close down.

EARLY EVENING SESSION.

Announcer: A. S. Cochrane.

5.40: The chimes of 2FC. 5.45: The Children's Session, conducted by the "Hello Man"; letters and stories; music and entertainment. 6.30: Daigley's market reports (wool, wheat and stock). 6.40: Fruit and vegetable markets. 6.43: Stock Exchange information. 6.45: Weather and shipping news. 6.48: Rugby wireless news. 6.50: Late sporting news. 7.0: "Big Ben"; late news service. 7.10: The 2FC Dinner Quartette, conducted by Horace Keats, (a) "A Little Dream Nest" (Nicholls), (b) "Gavotte Moderne" (Severne), (c) "The Fair Maid of Perth" (Bizet), (d) "Everywhere" (Cawey), (e) "A Hillside Melody" (Phillips). (f) "Jeannine" (Shilkret).

EVENING SESSION.

Announcer: Laurence Halbert.

Accompanist: Ewart Chapple.

7.40: Pianoforte reproduction. 7.45: Programme announcements. 7.48: Cricket results, N.S.W. v. Tasmania; popular music.

8.0: "Big Ben"; from the Haymarket Theatre, the Haymarket Theatre Orchestra, conducted by Stanley Porter.

8.20: From the studio—The Ashfield Choral Society Male Choir—(a) "Tell Her I Love Her So" (Faye), (b) "In Absence" (Euck).

8.30: Light Music Four—(a) Selection, "The Marriage of Figaro" (Mozart), (b) "Noël, Noël!" (Beigel).

8.45: Clarice Coles, contralto—(a) "My Ships" (Barratt), (b) "Vale" (Russell), (c) "O Western Wind" (Brahe).

8.52: The Light Music Four—Selection "Nadeshda" (Goring-Thomas).

9.2: Weather report.

9.3: Tales of a Traveller, told by Rev. F. H. Rayward.

9.18: The Light Music Four—(a) Overture, "Giovanna D'arco" (Verdi), (b) "Serenade and Bee's Wedding" (Mendelssohn). 9.30: The Ashfield Choral Society Male Choir—(a) "Pussy's in the Well" (Herbert), (b) "Lend Your Ear, Pretty Maid" (M'Lellan), (c) "True Till Death" (Gatty).

9.40: From the Haymarket Theatre, The Haymarket Theatre Orchestra, conducted by Stanley Porter.

10.0: "Big Ben"; Clarice Coles, contralto—(a) "Ships that Pass in the Night" (Stephenson), (b) "Jerusalem" (Parry), (c) "My Prayer" (Squire).

10.7: The Light Music Four—(a) "Les Preludes" (Liszt).

10.17: The Ashfield Choral Society Male Choir—(a) "Creation's Hymn" (Beethoven), (b) "The Soldier's Farewell" (Kunkel), (c) "Drink to Me Only" (Old English).

10.27: To-morrow's programme.

10.30: National Anthem. Close down.

2BL

MORNING SESSION.

Announcer: A. C. C. Stevens.

8.0: G.P.O. clock and chimes; metropolitan weather report. 8.1: State weather report. 8.2: Studio music. 8.15: G.P.O. chimes; news from the "Daily Telegraph Pictorial." 8.30: G.P.O. chimes. News service continued. 8.40: Information, mails, shipping, arrivals, departures, and sailings. 8.45: Studio music. 9.15: Half an hour with silent friends. 9.45: Studio music. 10.0: G.P.O. chimes; close down.

MIDDAY SESSION.

Announcer: J. Knight Barnett.

11.0: G.P.O. clock and chimes; 2BL Women's Sports Association Session, conducted by Gwen Varley. 11.30: Advertising hints. 11.40: Women's Session, conducted by Mrs. Cranfield. 12.0: G.P.O. clock and chimes. Special ocean forecast and weather report. 12.3: Studio music. 12.30: Shipping and mails. 12.35: Market reports. 12.48: "Sun" midday news service. 1.0: Studio music. 1.30: Talk to children and special entertainment for children in hospital. 1.57: Cricket scores. 2.0: G.P.O. clock and chimes; close down. Note.—Race results will be broadcast by courtesy of "Sun" newspapers.

AFTERNOON SESSION.

Announcer: J. Knight Barnett.

Accompanist: Kathleen Roe.

3.45: G.P.O. clock and chimes. Pianoforte reproduction. 4.0: From Romano's, Romano's Cafe Dance Orchestra, conducted by Bennie Abrahams. 4.10: From the Studio, Captain Aarons will commence a series of personality talks, "Sir John Vanbrugh" (Irene Duncan, soprano) (a) "Forest Echoes" (Phillips), (b) "You" (Harrhy). 4.32: "Sun" news service. 4.40: From Romano's, Romano's Cafe Dance Orchestra, conducted by Bennie Abrahams. 4.50: From the Studio, Irene Duncan, soprano (a) "Love Nest Just for Two" (Lohr), (b) "Persian Fable" (Rohde). 4.57: "Sun" news service. 5.0: Our serial story. 5.10: Pianoforte reproduction.



The Rev. F. H. Rayward who is scheduled to broadcast a talk on "Tales of a Traveller" from 2FC at 9.3 tonight. Mr. Rayward has traveled extensively and should have many interesting experiences to recount.

5.20: Popular music. 5.34: Racing resume. 5.37: Features of the evening's programme.

EARLY EVENING SESSION.

Announcers: J. Knight Barnett, Basil Kirke.

5.40: Children's Session, conducted by Uncle Peter. Music and Entertainment. Letters and stories. 6.30: "Sun" news and late sporting. 6.40: 2BL Dinner Quartet. (a) "Intermezzo Francaise" (Hosmer) (b) Valse "Gina" (Ralt), (c) "Four Fancies" (Somerville), (d) "If You were in My Garden" (Bengon), (e) "Laughing Eyes" (Finck), (f) "Londonderry Air" (arr. Kreisler). 7.10: Australian Mercantile Land and Finance Co.'s report; weather report and forecast by courtesy of Govt. Meteorologist; Producers' Distributing Society's Fruit and Vegetable Report. Grain and Fodder Report ("Sun"). Dairy Produce Report ("Sun"). 7.25: Mr. Pim and Miss Pam in advertising talks and nonsense. 7.55: Programme and other announcements.

EVENING SESSION.

Announcer: Basil Kirke.

Accompanist: G. Vern Barnett.

8.0: G.P.O. Chimes. Topical chorus. 8.3: From the King's Cross Theatre, The King's Cross Theatre Orchestra, conducted by E. J. Roberts.

8.20: From the Studio, Robert Gilbert, baritone (a) "My Desire" (Cadman), (b) "A Banjo Song" (Hornor).

8.27: Foster and Finlay, Instrumentalists. 8.35: Iverna Kyle, soprano (a) "The Adorable Outcast" (Hayes), (b) "Mavourneen" (Richards).

8.42: The Savoyans' Dance Band.

8.54: Charles Lawrence, Entertainer.

9.1: Weather report.

9.2: Saxophone Solos by George Ellis.

9.9: Robert Gilbert, baritone, (a) "Moon Dream Shore" (Lockhart), (b) "Friendships" (Lohr).

9.16: Cello solo by Basil Grey.

9.23: The Savoyans' Dance Band.

9.35: Iverna Kyle, soprano, (a) "I Thank the Moon" (Anthony), (b) "Rosette" (Lombardo), (c) "What Do We Care" (Revel).

9.42: Foster and Finlay, Instrumentalists.

9.52: Charles Lawrence, Entertainer.

10.2: The Savoyans' Dance Band.

10.12: From the King's Cross Theatre, The King's Cross Theatre Orchestra, conducted by E. J. Roberts.

10.30: From the Studio, Late weather.

10.31: The Savoyans' Dance Band.

10.57: To-morrow's programme.

10.59: The Savoyans' Dance Band.

11.30: National Anthem. Close down.

2GB

10 a.m.: Music. 10.10: Happiness talk by A. E. Bennett. 10.20: Music. 10.30: Women's session by Miss Helen J. Beegling. 11.30: Close down. 2.0 p.m.: Music. 2.5: Women's radio service, by Mrs. Dorothy Jordan. 2.50: Music. 3.15: Close down. 5.30: Children's session by Uncle George. 7.0: Stock and market reports by New Zealand Loan and Mercantile Agency, Ltd. 7.15: Music. 8.0: Songs by Miss Lorraine Linecy. 8.10: Pianoforte solos by Miss Belle Young. 8.20: A humorous interlude by Mr. Jack Win and Mr. Heath Burdock. 8.25: Songs by Mr. Leon Novello. 8.35: Instrumental music. 8.45: Songs by Miss Ethel Jones. 8.55: A humorous interlude. 9.0: Weather report. 9.3: Address by F. Houston, B.A. 9.15: Songs by Miss Lorraine Linecy. 9.25: Pianoforte solos by Miss Belle Young. 9.35: Songs by Mr. Leon Novello. 9.45: Instrumental music. 9.55: A humorous interlude by Mr. Jack Win and Mr. Heath Burdock. 10.0: Songs by Miss Ethel Jones. 10.10: Orchestral music. 10.30: Close down.

2UW

MID-DAY SESSION.

12.30: Music. 1.0: G.P.O. clock and chimes; music. 2.30: Close down. 4.30: Musical programme.

EVENING SESSION.

5.30: Children's Hour, conducted by Uncle Jack. 6.30: Close down. 7.0: G.P.O. clock and chimes; music. 8.0: To-day's Anniversary; music. 9.0: G.P.O. clock and chimes. Comments on Foreign Affairs, by Mr. J. M. Prentice. 9.10: Music and request numbers. 10.0: Close down.

**OUT OF THE FUTURE
IT CAME**

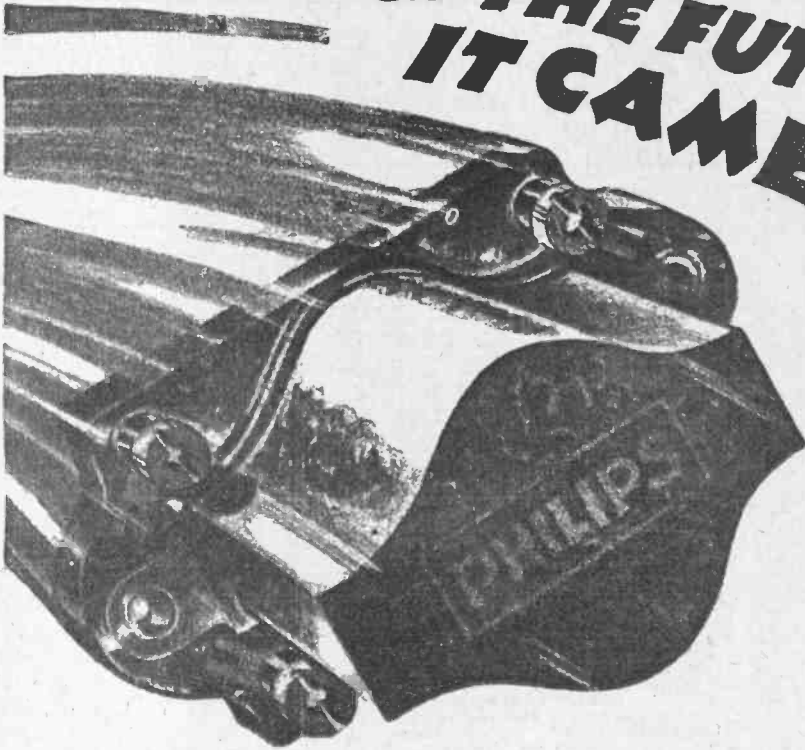

—A CREATION FROM PHILIPS LABORATORIES

Not of the present, but distinctly of to-morrow is the Philips Audio Transformer. Its features are as varied as they are unique.

- (1) *A pure silver primary—non-corrosive.*
- (2) *A nickel secondary.*
- (3) *A special alloy core—impossible to saturate even when using the largest of Power Valves.*
- (4) *Compact—efficiently compact.*
- (5) *Completely shielded.*
- (6) *Transforms ALL frequencies equally from 200 to 10,000 cycles.*

This transformer, used with the correct "Miniwatts" (a Power Tube for the last stage, of course), and a Philips Loudspeaker, will give you music that lives again in all its glory.

27/6

PHILIPS
RADIO APPARATUS

Interstate Programmes, Monday, February 11

3LO

EARLY MORNING SESSION.

7.15 to 8.15: See Friday.

MORNING SESSION

Announcer: John Stuart. 11.0: 3LO'S Different Dainties for the Daily Dinner. To-day's Radio Recipe: Fricassee of Chicken. 11.5: Olga Parker: What some famous Poets have written for Children. "Long-fellow—Part II." 11.20: Musical Interlude. 11.25: Under the auspices of the Workers' Educational Association, E. J. Ingram will speak on "Child Endowment." 11.40: Musical interlude. 11.45: Under the auspices of the Boy Scouts' Association S. Sanders will speak on "How Mothers could assist the Scout Leaders." 12.0: Midday News Session. 12.20: Community Singing, transmitted from the King's Theatre, Russell Street, Melbourne. Conductor: G. MacKay. The Huxham Serenade Quartet. 12.40: Stock Exchange information. 12.43: Community Singing recorded. 1.45: Meteorological information; weather forecast for Victoria, South Australia, Tasmania, and New South Wales; ocean forecast; river reports; rainfall. 1.55: Close down.

AFTERNOON SESSION.

Announcer: John Stuart. Accompanist: Mabel Nelson. 2.15: The Strad Trio (Cecil Parkes, violin; May Broderick, piano; and Frank Johnstone, cello). 2.45: Jovan Massanoff, piano. 3.0: Melbourne, has much pleasure in introducing this noted Russian tenor in his first "appearance" in broadcasting. 2.50: May Broderick, piano. 2.57: Cecil Parkes, violin, and May Broderick, piano. 3.0: Diana Belmont, contralto. 3.11: The Strad Trio. 3.22: Captain Donald MacLean will continue his series of Pirate Stories. 3.40: The Station Orchestra. 3.50: Reverend Frank Gorman and Sadie McDonald, baritone and violinist—their first appearance in broadcasting. 4.5: The Station Orchestra. 4.12: Jovan Massanoff, tenor. 4.19: The Station Orchestra. 4.25: Diana Belmont, contralto. 4.32: The Station Orchestra. 4.40: Courtney Ford, humorist. 4.50: The Station Orchestra. 5.0: News session. 5.15: Close down. During the afternoon progress scores of the cricket match, England v. Ballarat, will be broadcast as they come to hand.

EVENING SESSION.

8.0: Answers to letters and birthday greetings. 6.25: Musical interlude. 6.30: Captain Donald MacLean will tell some more "Pirate" stories.

NIGHT SESSION.

7.5: Stock Exchange information. 7.15: Market reports (see Friday). 7.30: News session. 7.43: Birthday greetings. 7.45: Out of the Past. 7.46: Under the auspices of the Department of Agriculture, P. de Castella, viticulturist, will speak on "Table Grapes." 8.0: A Maker of History. 8.1: The Station Orchestra, overture, "Orpheus in the Underworld." 8.2: Out of the Past. 8.3: "In Autumn" (Franz), "The Philanderer" (Lohr), 8.17: The Station Orchestra, suite, "Summer Days" (Coates). 8.24: Gertrude Gray, mezzo-soprano. "The Blind Ploughman" (Clemens), "I Love the Moon" (Paul Rubens). 8.31: Victor Stephenson, piano, "Valse Caprice" (Frank Bridge), "To a Water Lily" (MacDowell), "Humoresque" (York Bowen). "Reveries" (Strauss), "Cadenza" (G. Major), (Dohnanyi). 8.46: Rev. Frank Gorman and Sadie McDonald, baritone and violinist: "Pale Moon," "Side by Side," "Patter," "Killarney." 9.0: Description of the races at the Melbourne 2,000 foot-running carnival at the Motordrome. 9.15: Wesley Church Choir, under the direction of Mr. G. James, transmitted from the Wesley Church: "Distracted with care and anguish" (Händel), "O, Righteous They" unaccompanied (Tschalkovsky), "Glorv to God" (Noble). 9.25: The Station Orchestra, overture, "Precioso" (Weber). 9.32: Huxham's Serenades. 9.52: The Station Orchestra, "Romance" (Fopper). 9.57: Jovan Massanoff, tenor, "La Julie" from the opera, "La Julie" (Halévy). 10.0: Description of the races at the Melbourne 2,000 foot-running carnival at the Motordrome. 10.15: Wesley Church Choir: "I Will lay Me Down" unaccompanied (Martin), "Glad-glending Light" (Martin). 10.25: "Argus" news service. Eric Welch's selections for to-morrow's charity race meeting at Moonee Valley. 10.35: The Station Orchestra, "The Blue Eyes" (Stephen Jones). 10.45: Gertrude Gray, mezzo soprano, "Lackaday" (Crampton), "When Thy Blue Eyes" (Lassus). 10.53: The Radi-o-Aces: "I Just Jog Along" (Rose), "Hi-Cap" (Go), "Right with You" (Berlin), "Mississippi Mud" (Harris), "Tin Pan Parade" (Whiting), "Day Dreams" (Hallam), "Jeannine" (Gilbert), "Dream Home" (Fox), "Mother, I Still have You" (Jolson), "The Dawn" (Donaldson), "Get Out and Get Under the Moon" (Tobin), "Sleepy Baby" (Kahn), "The Frune Song" (Crumit), "Sincerely I Do" (Davis), "Sally Rose" (Friend). Good-night waltz, good-night chorus. 11.40: God Save the King.

3AR

Announcer: Maurice Dudley. 10.0 to 10.59: See Friday.

MORNING MUSICAL SESSION.

Announcer: Maurice Dudley. 11.0: A Recital of Popular English Ballads and Orchestral Gems. 12.20: British Official Wireless news. 12.30: Close down.

EVENING SESSION.

Announcer: Frank Hatherley. 8.0: A Bravura of Beautiful Ballads and the Works of the Master Musicians. 7.0: "Age" news service. Results of cricket from Ballarat. 7.10: Gramophone records continued.

NIGHT SESSION.

Announcer: Frank Hatherley. Accompanist: Reg. Brown. 8.0: E. C. H. Taylor, "School Life and

School Sport." 8.15: "Mark the High Notes" (Shakespeare). 8.30: Ned Tyrrell's Radi-o-Aces: "Chiquita" (Wayne), "Last Night I Dreamed You Kissed Me" (Kahn), "Tin Pan Parade" (Gillespie), 8.40: Courtney Ford, humorist, "The Old Bassoon." 8.43: Ned Tyrrell's Radi-o-Aces: "Little Log Cabin of Dreams" (Harley), "Who" (Donnan), "The Sweet Mystery of Life" (Herbert). 8.53: Harold Webb, baritone, "King Duncan's Daughter" (Allitt). 8.56: Ned Tyrrell's Radi-o-Aces: "To-day, To-morrow, for Ever" (Harley), "Down Home Rag" (Sweetman), "We'll Have a New Home in the Morning" (Buck). 9.3: Courtney Ford, humorist, "Beautiful Hump" (Fox), "Oh, What a Nose" (Forman). 9.9: Ned Tyrrell's Radi-o-Aces: "In a Bamboo Garden" (Donaldson), "Anything You Say" (Donaldson), "That Melody of Love" (Allans). 9.19: Harold Webb, baritone, "Maire, my Girl" (Aitken). 9.23: Ned Tyrrell's Radi-o-Aces: Constantinople (Carlton), "Don't Cry" (Kahn), "Hum and Strum" (Meryers). 9.33: Courtney Ford, humorist, "Fifty Million Frenchmen" (Fisher), "Hey Diddle Diddle." 9.36: Ned Tyrrell's Radi-o-Aces: "Jazz Master, Piano Solo" (Mayer), "In My Bouquet of Memories" (Lewis), "Fancies" (Nichols). 9.46: Harold Webb, baritone, "Sea Fever" (Irland). 9.49: Ned Tyrrell's Radi-o-Aces: "Rose of Monterey" (Guy), "Red Head" (Ermine), "Belmontine" (Gilbert). 9.57: Courtney Ford, humorist, "Oh, What a Nose" (Forman). 10.3: Ned Tyrrell's Radi-o-Aces: "Dream Home" (Fox), "I'm Sorry, Sally" (Kahn), "When You Know Me" (Bellam), 10.13: Harold Webb, baritone, "Trees" (Donashah). 10.15: Ned Tyrrell's Radi-o-Aces: "Talk Me To-night" (Little), "Let a Smile be Your Umbrella" (Fair), "Back in Your Own Back Yard" (Jolson). 10.20: News session. God Save the King.

4QC

EARLY MORNING SESSION

7.43: Time signals. 7.45: News service. 8.0: Some electric records. 8.15: News service. 8.30: Close down.

MORNING SESSION

11.0: Music. 11.5: Social news. 11.15: Lecturette, "To New Guinea and Back" part 2, by "Traveler." 11.30: Music. 11.35: More social news. 11.45: From the Wintergarden Theatre, Wurliizer organ. 12.0 noon: Close down.

MID-DAY SESSION

1.0: Market reports and weather information. 1.28: Lunch-hour music. 2.0: Close down.

AFTERNOON SESSION.

3.0: A programme of electrically reproduced records. 3.30: Mail train running times. 4.15: This afternoon's news. 4.30: Close down.

EARLY EVENING SESSION.

8.0: Mail train running times; mail information; shipping news. 8.5: Dinner music. 8.25: Commercial announcements. 9.0: Time stories, conducted by "The Sandman." 7.0: News in brief. 7.5: Stock Exchange news. 7.6: Metal quotations. 7.7: Market report. 7.25: Fenwick's stock report. 7.30: Weather information. 7.40: Announcements. 7.43: Standard time signals. 7.45: Lecturette, "The Children's Music Corner," conducted by "The Music Man."

NIGHT SESSION.

Queensland Woollen Mills. The first portion of to-night's transmission will comprise descriptions of the Queensland Woollen Mills at Ipswich and of the manufacture of the various classes of cloth. The sheep and wool industry is of paramount importance to the State, and the mills, which have been established at Ipswich, at a cost of many thousands of pounds, represent a very serious attempt to build up a secondary industry in the wool trade in Australia. The machinery they contain and the manner in which the wool is handled from the time it is received in the stores at Ipswich until the finest quality of worsted and other materials are produced, are known to comparatively few people. Microphones will be installed in various parts of the mills, and interesting descriptions of the various phases of treatment which the wool undergoes will be broadcast. The intricate and almost human machinery which is used for the weaving of cloth will also be described. The broadcast will be entirely upon educational lines, and as such should interest quite a number of listeners. 8.0: From the Woollen Mills, Ipswich. A description of cloth manufacture. Studio programme. 9.30: From the studio, Metropolitan weather forecast. George Walker (cornetist), "Russia" (Hartmann). Winnie Dunoon (soprano), "Song for Spring" (Russell). Aeolian Vocalion record. A Wurliizer organ selection. Another Wurliizer organ record. Daily "Time" news. "The Courier" news; weather news. Close down.

5CL

MORNING SESSION.

11.0: G.P.O. chimes. Musical interlude on the Sopora. Coldstream Guards Band. Joseph Hislop, tenor. Interlude with Schubert. Covent Garden Orchestra. Alma Gluck, soprano. Maid Powell, violin. John McCormack, tenor. Paderewski, pianist. Robert Radford, bass. Coldstream Guards Band. 12.0: G.P.O. chimes. 12.1: An interlude by the Coldstream Guards Band. 12.15: "Advertiser" general news service. 12.35: British official wireless news.

12.40: Ten minutes of selected "cello music. 12.52: S.R. Sharpe, cellist; W. H. Squire, cellist. 12.57: B.A. railway information. Stock Exchange information. S. C. Ward and Co. Meteorological information. 1.0: G.P.O. chimes. 1.1: Jean Finlay, pianist. 1.5: Florence Rendall, soprano. 1.11: Eric McLaughlin, violinist. 1.17: Sonora; a lunch-hour recital (H.M.V. recordings). 1.46: Florence Rendall, soprano. 1.52: Eric McLaughlin, violinist. 1.58: Meteorological information. 2.0: G.P.O. chimes and close down.

AFTERNOON SESSION.

3.0: G.P.O. chimes. 3.1: Station Quartet. 3.10: Bernard Manning, bass-baritone. 3.16: Don Parrnell, comedian. 3.25: Station Quartet. 3.30: Victoria Wilson, soprano. 3.38: Vern Rogers, cornetist. 3.40: Bernard Manning, bass-baritone. 3.46: Station Quartet. 3.56: Norah Shirley. 4.2: Tom King, pianist. 4.8: Don Parrnell, comedian. 4.14: Station Quartet. 4.20: Victoria Wilson, soprano. 4.27: Geoff Goldworthy, cellist. 4.32: Norah Shirley. 4.38: Miss N. Moore. 4.57: S. C. Ward and Co's Stock Exchange information. 5.0: G.P.O. chimes and close down.

EVENING SESSION.

6.0: G.P.O. chimes. 6.1: Birthday greetings, correspondence; songs and stories by "Aunt Peggy." 6.30: An interlude of dinner music. 7.0: G.P.O. chimes. 7.1: S. C. Ward and Co's Stock Exchange information. 7.5: General markets reports. 7.10: Extracts from bulletin supplied by the Minister for Markets and Migration. 7.30: The 5CL Twinkler Boys' Club; entertainment by "The Twinkler" (Mr. F. J. Mills).

NIGHT SESSION.

8.0: G.P.O. chimes. 8.1: William Davey, xylophonist, "Manna's Gone Young" (Jeannine) (Shillars). 8.6: Bernard Manning, bass-baritone, selections from his repertoire. 8.12: William Runge, comedian, selected humor. 8.20: Lewis Jones, violinist, "Arlecchino" (Pecolesi). 8.26: Victoria Wilson, soprano, "Tiptoe" (Carew), "Two Brown Eyes" (Grieg). 8.32: Pianoforte recital by Hans Bertram. 8.52: Lyric Male Quartet, "Story of the Tack" (Parks), "Absent Faces" (Davey). 9.0: G.P.O. chimes. 9.3: Meteorological information. 9.2: Overseas grain report. 9.3: The Cotton Pickers (banjo and guitar entertainers), "Sounds from the Sunny South" 9.9: Phyllis Hopf, soprano, "The Mad Scene" from "Thomas." 9.15: William Davey, xylophonist, "Dainty Miss" (Barnes), "Good-night" (Wood). 9.21: William Runge, humorist, selected humor. 9.31: Lewis Jones, violinist, "Valse Triplet" (Scott). 9.37: Bernard Manning, bass-baritone, selections from his repertoire. 9.43: The Cotton Pickers, instrumental entertainers, negro melodies. 9.49: Lyric Male Quartet, "At Sweet Sixteen," "Silent Night" (Thomas). 9.55: Victoria Wilson, soprano, "Love and Sleep" (Hart), "There is a Lady" (Warloch). 10.1: William Davey, xylophonist, four hammer novelties. 10.6: Bernard Manning, bass-baritone, selections from his repertoire. 10.12: Phyllis Hopf, soprano, "Charming Bird" (David), "Lullaby" (Brahms). 10.15: The Advertiser' general news service. Meteorological information. 10.30: Modern dance numbers by the famous Radi-o-Aces. 11.0: God Save the King.

6WF

7.30: Tune in. 12.35: Markets, news, cables, etc. 1.0: Time signal. 1.1: Weather bulletin, supplied by the Meteorological Bureau of West Australia. 1.3: Panatrop: hour relayed from Messrs. Mustgrove's, Ltd., Lyell House, Perth. 2.0: Close down. Tune in. 3.35: Musical programme, relayed from the Carleton Cafe; vocal selections from the studio. 4.30: Close down. 6.45: Tune in. 6.48: Bedtime programme, relayed from the Lyell House, Perth. Music by the Station Instrumental Trio. 7.30: Commercial and general information. 7.48: Talk by Lieut.-Col. Le Souef, Director, Zoological Gardens, Perth, on "Poison Plants of Australia." 8.0: Time signal. 8.1: First weather report, supplied by the Meteorological Bureau of West Australia. 8.3: R.S.L. Band, conducted by Mr. Mellor, will render the following: "The Marchers and Stripes" (Dacre), "On the Rivers" (Finlay), "Sunday Parade" (Lynn Kings), "Picardy" (Finlay), "The Old Regiment" (Thomas). 9.0: Late news items, by courtesy of the "Daily News" Newspaper Co.; station announcements, by the Lyell House, Perth. 9.15: Range announcement. 10.30: Close down. 10.45 metre transmission: Simultaneous broadcast on 104.5 metres of programme given on 1250 metres, commencing at 6.45 p.m.

7ZL

11.30 to 1.30: See Friday.

AFTERNOON SESSION.

3.0: G.P.O. clock chimes the hour. 3.1: His Master's Voice in moments merry and musical. 3.4: Weather information. 3.5: His Master's Voice in moments merry and musical. 3.15: An all star programme by the Discus Ensemble, with rangey Trio, violin and piano; Charles Hamp, baritone; Jack Courtney, organ solo on the Compton Theatre organ. Sir Harry Lauder, baritone; guitar duet; guitar novelty trio; Ewan Williams, tenor; Jeanette Gerrard, piano accordion solo. 4.15: "Aunt Edna" will speak on "Summery Sales." 4.30: Close down.

EARLY EVENING SESSION.

6.15: Records. 6.30: Little Sheila Carroll will recite for the children, "The Tempest," "The World." 6.48: Records. 7.0: Answers to letters and birthday greetings by "Uncle David." 7.8: Request numbers for the little ones. 7.15: News session.

EVENING SESSION.

7.30: Geo. Collis (Tasmania's champion wrestler) will speak on "Physical Culture," under the auspices of the Radio Research Club. 7.45: Trevor Watkins will speak on "Oscillation." 8.0: G.P.O. clock chimes the hour. 8.6: Transmission from the Prince of Wales' Theatre, Macquarie Street; Ted McCann and his Orchestra. 9.50: News session. 10.0: G.P.O. clock chimes the hour. 10.1: Close down.

3AR

Sunday, February 10.

Announcer: Frank Hatherley. 10.45: Morning Service from St. Paul's Cathedral, Melbourne. Quinquagesima Sunday. Matins and Choral Litany. 12.15: British Official Wireless news. 12.20: Close down.

AFTERNOON SESSION.

Announcer: Frank Hatherley. 3.0: A Gramophone Recital of the works of the Master Musicians. Tudor Davies, tenor. Edward Isaacs, pianoforte. Walter Glynn, tenor. Vocal Trio, Nellie Walker, Sydney Coltham, E. Halland. Band of the Goldstream Guards. Sydney Coltham and Peter Dawson. Ignaz Friedman, piano. Harold Williams, baritone. British Guards' Band. Evan Williams, tenor. Organ Solo by Foster. Alfred O'Shea, tenor. 4.30: Close down.

EVENING SESSION.

Announcer: Frank Hatherley. 5.0: "Brer Rabbit." Stories for the Children. 5.30: Close down.

NIGHT SESSION.

Announcer: Frank Hatherley. Accompanist: Vera Howe. 7.0: A Bravura of Beautiful Ballads, including "The Bonnie, Bonnie Banks of Loch Lomond," "On the Banks of Allan Water," "Allen au Bois" (Snow Maiden), "Song of the Shepherd Lehi," "Annie Laurie," "Callie Herrin," "Lullaby My Sweet Little Baby," "Sing We at Pleasure," "The Arrow and the Song," "Oft in the Silly Night." 8.0: The Strad Trio, Cecil Parkes, violin; May Broderick, piano; Frank Johnston, cello. Trios, Op. 15, F Major (Rubinstein). Con moto Moderato, Moderato, Finale. 8.18: John Byrne, bass, "It is a Wondrous Thing" (Liszt), "Old Doctor Maginn" (Lohr). 8.25: Stephanie Deste in a Special Programme. A Recital of the works of Australian Poets. "Sea Grief" (Dowell O'Reilly), "The Shearer's Wife" (Louis Mason), "When I Was Six" (Zora Cross), "The Grey Company" (Jess Mackey), "A Maori Haaka" 8.45: Cecil Parkes, violin, "Ave Maria" (Schubert), "Menuet" (Mozart), "Zephyrs" (Hubay). 8.55: Bessie Banks, soprano, "Songs my Mother Taught Me" (Dvorak), "My Desire" (Gardam). Interlude. 9.2: A. S. Kenyon, Ethnology of the Australian Aborigine, "Death and Burial." 9.17: May Broderick, piano, "Romance" (Sibelius), "Arabesque No. 1" (Debussy). 9.24: John Byrne, bass, "Now Gently Here" (Schumann), "The Ten Grenadiers" (Schumann). 9.31: The Strad Trio, "Songs Without Words," No. 19 (Mendelssohn), "Gavotte" (Sosseo), "Prelude" (Caesar Cul), "Rondo" (Mozart). 9.42: Bessie Banks, soprano, "Two Bergerettes." 9.49: News. Announcements. God Save the King.

IGRANIC RADIO PARTS

Igranic "LOKVANE" Condensers

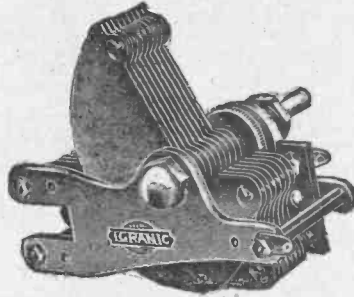

The H.F. Choke.

The "Lokvane" is a high quality condenser, possessing several new Igranic features. By reason of the special mounting of the vanes, they are locked, ensuring rigidity and perfect electrical contact between them.

This condenser can be used in any circuit demanding the very highest quality instruments.

PRICES—

.00015 mfd.	12/9
.0003 mfd.	14/3
.0005 mfd.	15/9

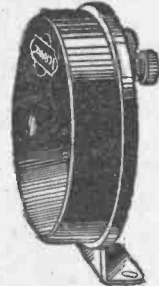

Price 7/6

The Igranic H.F. Choke.

Whenever a H.F. Choke is required, either to obtain good reaction effects or as a bar to H.F. currents, the Igranic instrument can effectively be used. It has a high inductance, and is effective on wave lengths up to 3000 metres, whilst its self-capacity is so low that it gives equally good results on the lowest broadcasting wave-lengths.

The Igranic Universal High Resistance.

An essential part of every experimenter's equipment. It can be used in every case except where appreciably large current has to be carried. The Igranic Universal High Resistance is totally enclosed and protected.

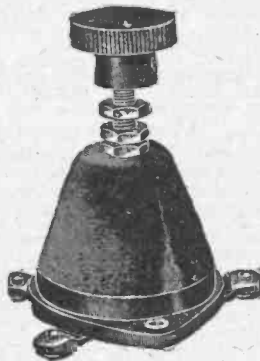

Model A-O-1 meg., with control knob. Price, 8/3.

NOYES BROS.

(SYDNEY), LTD.

(MELBOURNE) PTY., LTD.

Write for Pamphlet I.W.W.

Sydney: 115 Clarence Street.

Melbourne: 495 Bourke Street.

Newcastle: 11 Watt Street.

Adelaide: 119 Pirie Street.

Brisbane: Perry House, Elizabeth St.

Hobart: 36 Argyle Street.

Launceston: 59 George Street.

Perth: J. R. W. Gardam & Co.

Reliable Fixed Condensers

for your electric sets where reliability is essential.

TESTED 700, 1000, 1500, 2000, 4000 volts.

All leading wholesalers stock them.

Manufacturers' Representatives

H. HECHT & CO.

181 Clarence St., Sydney
WHOLESALE ONLY.

(Also at Melbourne.)

Phone MA2892

Local Programmes, Tuesday, February 12

2FC

EARLY MORNING SESSION.

Announcer: A. S. Cochrane.

7.0: "Big Ben" and announcements. 7.2: Official weather forecast; rainfall; river reports; temperatures; astronomical memoranda. 7.7: "Sydney Morning Herald" summary. 7.12: Shipping intelligence; mail services. 7.15: Studio music. 7.25: Investment market; mining share markets; metal quotations; wool sales; breadstuffs markets; inter-State markets; produce markets. 7.40: Studio music. 8.0: "Big Ben." Close down.

MORNING SESSION.

Announcer: A. S. Cochrane.

10.0: "Big Ben" and announcements. 10.2: Pianoforte reproduction. 10.10: "Sydney Morning Herald" news service. 10.25: Studio music. 10.30: Last minute sporting information by the 2FC Racing Commissioner. 10.40: Studio music. 10.50: Pianoforte reproduction. 11.0: "Big Ben." A.P.A. and Reuter's cable services. 11.5: Close down.

MID-DAY SESSION.

Announcer: A. S. Cochrane.

Note: Race results will be given from Gosford.

12.0: "Big Ben" and announcements. 12.1: Stock Exchange, first call. 12.3: Official weather forecast; rainfall. 12.5: Studio music. 12.10: Summary of news: "Sydney Morning Herald." 12.15: Rugby wireless news. 12.18: A reading. 12.30: Studio music. 1.0: "Big Ben"; weather intelligence. 1.3: "Evening News" mid-day news service. Producers' Distributing Society's report. 1.20: Studio music. 1.28: Stock Exchange, second call. 1.30: Studio music. 2.0: "Big Ben." Close down.

AFTERNOON SESSION.

Announcer: Laurence Halbert.
Accompanist: Ewart Chapple.

2.30: Programme announcements. 2.32: Educational session for the schools. Short musical session. A reading. 3.0: "Big Ben." Pianoforte reproduction. 3.15: Popular music. 3.37: Esther Herford, soprano. Two Seal songs (a) "Mother Seals Lullaby" (Lehmann) (b) "You Mustn't Swim Till You're Six Weeks Old" (Lehmann). 3.44: A reading. 4.0: "Big Ben." Phillipa Alston, contralto. (a) "Prelude" (Ronald). (b) "Down in the Forest" (Ronald). 4.7: Popular music. 4.17: Esther Herford, soprano. (a) "The Garden Wind" (Fenner). (b) "Little Lady of the Moon" (Coates). 4.24: Popular music. 4.38: Phillipa Alston, contralto. (a) "Isle of Innes-free" (Penniquick). (b) "Elegie" (Massenet). 4.45: Stock Exchange, third call. 4.47: Popular music. 5.0: Close down.

EARLY EVENING SESSION.

Announcer: A. S. Cochrane.

5.40: The chimes of 2FC. 5.45: The Children's session, conducted by the "Hello Man," assisted by Aunt Eily. Letters and stories. Music and entertainment. 6.30: Dairy's market reports (wool, wheat, and stock). 6.40: Fruit and vegetable markets. 6.43: Stock Exchange information. 6.45: Weather and shipping news. 6.48: Rugby wireless news. 6.50: Late sporting news. 7.0: "Big Ben." Late news service. 7.10: The 2FC Dinner Quartette, conducted by Horace Keats. (a) "Valse in E Minor" (Chopin). (b) "To the Spring" (Grieg). (c) "Solveig's Song" (Grieg). (d) Suite, "The Rebel Maid" (Phillips). (e) "Someday, Somewhere" (Rapee). (f) "Romance" (Sibelius).

EVENING SESSION.

Announcer: Laurence Halbert.
Accompanist: Ewart Chapple.

7.40: Pianoforte reproduction.
7.45: Programme announcements.
7.48: Popular music.
8.0: "Big Ben." Salvation Army Congress Band—
(a) March, "The Red Shield" (Goffin).
(b) Cornet Solo, "Largo" (Handel).
Bandsman T. Smith.
Euphonium solo, "Entreaty," Bandsman H. Hanna.
8.15: The Mellow Fellows.

8.22: Pianoforte solos by Maurice Arlen.
8.32: Gwen Hastings, soprano.
8.39: Salvation Army Congress Band—
(a) Selection, "Gems from Great Masters, No. 6" (arr. M'Anally).
8.51: A talk by Freda Sternberg—"A Trip to Palm Island in a Sugar Boat."
9.6: Weather report.
9.7: Carlton Fay, pianoforte solos.
9.14: Bryson Taylor, tenor.
9.21: Salvation Army Congress Band—
(a) Selection, "Gems from the Messiah" (Handel).
(b) March, "The Valor Crown" (Herd).
9.38: The Mellow Fellows.
9.46: Carlton Fay, pianoforte solos.
9.53: Wilfrid Thomas, basso.
10.0: Salvation Army Congress Band—
Selected.
10.15: Gwen Hastings, soprano.
10.22: Studio Dance Band.
10.32: Late weather.
10.33: Studio Dance Band.
10.57: To-morrow's programme.
10.59: Studio Dance Band.
11.30: National Anthem. Close down.

2BL

Announcer: A. C. C. Stevens.

MORNING SESSION.

8 a.m.: G.P.O. chimes; metropolitan weather report. 8.1: State weather report. 8.2: Studio music. 8.15: G.P.O. chimes; news service from the "Daily Telegraph Pictorial." 8.30: G.P.O. chimes; news service continued. 8.40: Information, mails, shipping, arrivals, departures, and sailings. 8.45: Studio music. 9.15: Half an hour with silent friends. 9.45: Studio music. 10.0: G.P.O. chimes; close down.

MIDDAY SESSION.

Announcer: J. Knight Barnett.

Note.—Race results will be given at regular intervals by courtesy of the "Sun" news-papers. 11.0: G.P.O. chimes; 2BL Women's Sports Association Session, conducted by Miss Gwen Varley. 11.30: Advertising Hints. 11.40: Women's Session, conducted by Mrs. Cranfield. 12.0: G.P.O. chimes; special ocean forecast and weather report. 12.3: Pianoforte reproduction. 12.30: Shipping and mails. 12.35: Market reports. 12.48: "Sun" midday news service. 1.0: Studio music. 1.30: Talk to children and special entertainment for children in hospital. 1.57: Cricket scores. 2.0: G.P.O. chimes; close down. Note.—Race results from Gosford.

AFTERNOON SESSION.

Announcer: J. Knight Barnett.

Accompanist: Kathleen Roe.

3.45: G.P.O. clock and chimes; pianoforte reproduction. 4.0: From Romano's, Romano's Cafe Dance Orchestra, conducted by Bennie Abrahams. 4.10: From the Studio: A reading. 4.25: Mab Fotheringhame, soprano. (a) "Don't Hurry" (Sanderson); (b) "Daddy's Sweetheart" (Lehmann). 4.32: "Sun" news service. 4.40: From Romano's, Romano's Cafe Dance Orchestra, conducted by Bennie Abrahams. 4.50: From the Studio, Thelma Houston, contralto. 4.57: "Sun" news service. 5.0: G.P.O. clock and chimes; our serial story. 5.10: Mab Fotheringhame, soprano (a) "I Couldn't, Could I" (Roedel); (b) "A Tiny Lil' Tot" (Morrison). 5.17: Thelma Houston, contralto. 5.24: Popular music. 5.32: Poultry report. 5.34: Racing resume. 5.37: Features of the evening's programme.

EARLY EVENING SESSION.

Announcer: Basil Kirke.

5.40: Children's Session, conducted by Uncle Bas. Music and entertainment. Letters and stories. 6.30: "Sun" news and late sporting. 6.40: 2BL Dinner Quartet. (a) Waltz "Der Rosenkavalier" (Strauss). (b) "Mississippi Mud" (Barris). (c) "Romeo and Juliet" (Gounod). (d) "Sizilietta" (Non Blon). (e) "Reverie" (Macdowell). (f) "Pansies" (Nicholls). 7.10: Australian Mercantile Land and Finance Co.'s Report. Weather report and forecast by courtesy of Govt. Meteorologist. Producers' Distributing Society's Fruit and Vegetable Market Report. Grain and Fodder Report ("Sun"). Dairy Produce

Report ("Sun"). 7.25: Mr. Pim and Miss Pam in Advertising talks and nonsense. 7.55: Programme and other announcements.

EVENING SESSION.

Announcer: Basil Kirke.

Accompanist: G. Vern Barnett.

8.0: G.P.O. Chimes; Topical Chorus.
8.2: The Music Makers, "Robert le Diable" (Meyerbeer).
8.12: From the Rose Bay Wintergarden Theatre, The Rose Bay Orchestra, conducted by Lionel Hart.
8.30: From the Studio, Camille Alder, soprano. (a) "Into the Dawn" (Smith). (b) "Fairy Shopping" (Day).
8.37: From the Sydney University Carillon Rectal. Hon. Carillonist, J. G. Fletcher. (a) "L'Adieu" (Beethoven). (b) "The Merry Feast" (Schumann). (c) Songs (a) "All Through the Night" (b) "Believe Me If All Those Endearing Young Charms" (c) "The Lomonderry Air" (d) "The Last Rose of Summer".
8.52: From the Studio, Linda Hartge, contralto. (a) "A Summer Night" (Thomas). (b) "The Way Home" (Liddle).
8.59: The Music Makers. (a) "Allegro in Waltz Form" (Walenn) (b) Phantasy, "The Three Bears" (Coates).
9.11: Talk by S. H. Bowden, Week by Week.
9.26: The Music Makers. (a) "Reminiscences of Schubert," (b) "The Florida Spiritual" (Foulds), (c) "Le Forgeron" (Longo).
9.41: Camille Alder, soprano. (a) "A Desert Love Song" (Bennett). (b) "You—Your Eyes, Your Hair" (Thompson).
9.48: The Music Makers. (a) Suite "The Green Lanes of England" (Clutsam), (b) "Canzone d'amore" (Lowitz).
10.0: G.P.O. chimes. Linda Hartge, contralto. (a) "There's a Song Down Ev'ry Roadway" (Wood). (b) "Still Unexpress" (Jacobs-Bond).
10.7: From the Rose Bay Wintergarden Theatre, The Rose Bay Orchestra, conducted by Lionel Hart.
10.27: From the Studio, To-morrow's programme.
10.30: National Anthem; close down.

2GB

10 a.m.: Music. 10.10: Happiness talk by A. E. Bennett. 10.20: Music. 10.30: Women's session by Miss Helen J. Beegling. 11.30: Close down. 2.0 p.m.: Music. 2.5: Women's radio service, by Mrs. Dorothy Jordan. 2.50: Close down. 3.15: Close down. 5.30: Children's session by Uncle George. 7.0: Stock and market reports by New Zealand Loan and Mercantile Agency, Ltd. 7.15: Music. 7.30: Talk from the Radio Service Dept. by Mr. Stan Crittenden. 8.0: Violin solos by Mr. Lionel Hargreaves. 8.10: Songs by Mr. Breffni Rorke. 8.20: A humorous interlude by Mr. Jack Win and Mr. Heath Burdock. 8.25: Instrumental music. 8.35: Songs by Miss Ethel Hawley. 8.45: A humorous interlude by Mr. Jack Win and Mr. Heath Burdock. 8.50: Songs by Mr. Norman Williams. 9.0: Weather report. 9.3: Address by Mr. W. Heyting. 9.15: Violin solos by Mr. Cecil Berry. 9.25: Songs by Mr. Breffni Rorke. 9.35: Instrumental music. 9.45: A humorous interlude by Mr. Jack Win and Mr. Heath Burdock. 9.50: Songs by Miss Ethel Hawley. 10.0: Orchestral music. 10.30: Close down.

2UW

MID-DAY SESSION.

12.30: Music. 1.0: G.P.O. clock and chimes; music. 2.30: Close down. 4.30: Musical programme.

EVENING SESSION.

5.30: Children's Hour, conducted by Uncle Jack. 6.30: Close down. 7.0: G.P.O. clock and chimes; music. 8.0: To-day's Anniversary; music. 8.15: Paramount Film Talk, by Miss E. Baumberg. 8.25: Music. 9.0: G.P.O. clock and chimes. Comments on Foreign Affairs, by Mr. J. M. Prentice. 9.10: Music and request numbers. 10.0: Close down.



Now Fifty Dollars Less

«\$10 in our Australian Money»

S EVEN or eight months ago we made an important announcement. The Radio Corporation of America had achieved an all-electric 6-valve Receiver at a price less than half the cost of their previous A.C. operated set. The response was immediate. Literally hundreds purchased within the first few weeks.

Now we are glad to announce that R.C.A. has cabled an important reduction in price. The new price of R.C.A.'s 6-valve A.C. Receiver, together with Model 100A Loud-speaker, is now only £65.

Go to-day and hear it. Everyone on the electricity supply will want this light-socket-operated 6-valve Receiver. No more "dimming" batteries and "fading" reception. Here's power—unfailing power—volume—tremendous amplification—clear, rich tone. And all at a cost to operate no more than that of a small, sixty-watt electric lamp! Just plug in. Snap a switch. Turn a single dial for your station—another for your volume. Here is Radio that is both simpler and greater. It brings new tone, too—tone that ranges from the deep harmonies of a cathedral organ to the trilling of a flute. Hear it to-day—at any of the best radio dealers.



RCA Light Socket RADIO

Complete with
Model 100a Loudspeaker
New Price £65

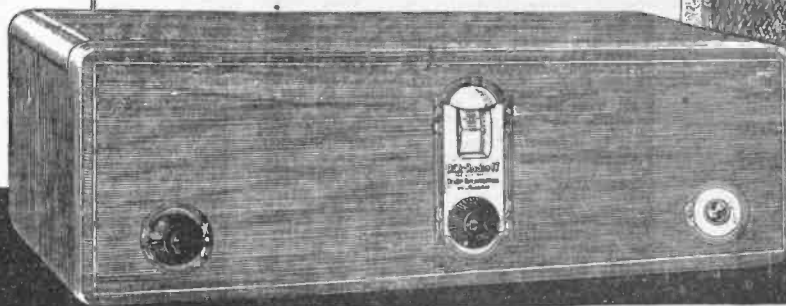

Obtainable at any of the best Radio Dealers

AUSTRALIAN

CANBERRA,
Civic Centre.

GENERAL

Australian General

SYDNEY, 93-95 Clarence Street,



ELECTRIC

Electric Company, Ltd.

NEWCASTLE, 53 King Street.

ALBURY,
611 Dean Street.

Interstate Programmes, Tuesday,

3LO

EARLY MORNING SESSION

7.15 a.m.: Morning melodies. 7.20: Morning exercises to music. 7.30: Stock reports; market reports; general news; shipping; sporting information; Stock Exchange information. 8.0: Melbourne Observatory time signal. 8.1: Morning melodies. 8.15: Close down.

MORNING SESSION

Announcer: John Stuart. 10.0: Eric Welch will speak on to-day's races at Moonee Valley. 11.0: 3LO's Different Dainties for the Daily Dinner—to-day's radio recipe, Eton Cake. 11.5: Miss E. Noble will speak on "Gas Cookery." 11.20: Musical interlude. 11.25: Mrs. Dorothy Silk will speak on "Home-crafts." 11.40: Musical interlude. 11.45: J. Howlett Ross will speak on "Women Poets of Australia—Part II." 12.0 noon: Midday News Session (see Friday). 12.20: The Station Orchestra. 12.30: John Byrne, bass. 12.37: Stock Exchange information. 12.40: The Station Orchestra. 12.45: Gertrude Gray, mezzo-soprano. 12.52: The Station Orchestra. 1.0: Rev. Frank Gorman, baritone, and Sadie McDonald, violin. 1.15: Meteorological information; weather forecast for Victoria, South Australia, New South Wales, and Tasmania; ocean forecasts; river reports; rainfall. 1.22: The Station Orchestra. 1.27: John Byrne, bass. 1.34: Percy Code, trumpet. 1.38: Gertrude Gray, mezzo-soprano. 1.45: Close down.

AFTERNOON SESSION

Announcer: John Stuart. Accompanist: Mabel Nelson. 1.58: Description of the Trial Hurdle, 2 miles, Moonee Valley Charity race meeting, by Eric Welch. 2.5: The Radi-o-Aces. 2.8: The Radi-o-Aces, tenor. 2.21: The Radi-o-Aces. 2.28: Description of the Two-year-old Handicap, 5 1/2 furlongs, Moonee Valley Charity race meeting. 2.35: Courtney Ford, humorist. 2.32: The Radi-o-Aces. 2.51: Diana Belmont, contralto. 2.58: Description of the Highweight Handicap, 7 furlongs, Moonee Valley Charity race meeting. 3.5: The Radi-o-Aces. 3.14: Hugh Eckham's Serenaders—The Quartet, Rena Miller, Chas. McFee (saxophone), the Quartet, Les Richmond (piano), the Quartet. 3.34: The Radi-o-Aces. 3.38: Description of the Hospital Handicap, 1 1/4 mile, Moonee Valley Charity meeting. 4.5: Blanche Bell, soprano. 4.32: The Radi-o-Aces. 4.1: Courtney Ford, humorist. 4.8: The Radi-o-Aces. 4.18: Description of the Trial Mile, 1 mile, Moonee Valley Charity race meeting. 4.25: Diana Belmont, contralto. 4.32: The Radi-o-Aces. 4.1: Blanche Bell, soprano. 4.48: Description of the Carlton Handicap, 6 furlongs, Moonee Valley Charity race meeting. 4.55: The Radi-o-Aces. 5.0: News service; Stock Exchange information. 5.10: Close down.

EVENING SESSION

8.0: Answers to letters and birthday greetings. 8.20: Musical interlude. 9.30: "The Old Curiosity Shop"—"Dick Swiveller and the Marchioness."

NIGHT SESSION

Announcer: C. J. O'Connor. Accompanist: Mabel Nelson. 7.0: Stock Exchange information. 7.15: Market reports. 7.30: News session. 7.43: Birthday greetings. 7.45: Out of the way. 7.46: Under the auspices of the University Extension Board. 8.0: Programme announcements. 8.1: Metropolitan Fire Brigade Band—march, "The President"; overture "Victoria Cross." 8.10: Jovan Massanoff, tenor—"Dreams of Long Ago" (Caruso). "My Little Irish Outrage" (Sumner). 8.11: Metropolitan Fire Brigade Band—march, "The Forthcoming Track and Field Games." 8.24: Diana Belmont, contralto—My Heart is Weary" (Goring Thomas). 8.31: Mabel Nelson, soprano—"Flirtation in a Chinese Garden" (Abram Shasins). "Rush Hour in Hongkong" (Friedmann). 8.41: Rev. Frank Gorman and Sadie McDonald, baritone and violinists—"Old Pal, Old Gal" (Jerome). "Andantino" (Lemanz). "The Merry Gadshook" (Ernest Ball). 8.55: The story of the opera "Carmen," under the direction of William G. James. 9.30: The Metropolitan Fire Brigade Band—grand selection, "The Master Singers." 9.40: Jovan Massanoff, tenor—"Gladia na Looten, Russian Folk Song (J. Strunoff). "Memories of a Song" (Nicholls). 9.47: Metropolitan Fire Brigade Band—waltz, "Flowers of Spring." 9.54: Courtney Ford, humorist—"Toorooladdy" (Tellew). "Papering the Parlor" (Weston). 10.4: Metropolitan Fire Brigade Band—gavotte, "Hypatia." 10.11: Diana Belmont, contralto—"Fred Bands" (Sanderson). "The Curtain Falls" (d'Hardelet). 10.28: Huxham's Serenaders—the Quartet, "High Up on a Hilltop"; Madoline Knight (contralto), "Moonlight on the Danube"; interlude, trombone solo, Courtney Ford, humorist, "Farmyard"; Rena Miller (bass), "If Winter Comes"; interlude, cornet solo; the Quartet, "Spring's Awakening." 10.46: The Radi-o-Aces—"The Dance of the Blue Danube" (Fisher). "It Goes Like This" (Gees), "Roses of Yesterday" (Berlin). "Forever More" (Bennett), "Nebraska" (Bennett), "That's My Weakness Now" (Steph). "Get Out and Get under the Moon" (Toobal). "In a Goodly Garden" (Donaldson). "Anything You Say" (Donaldson). "Good-night Waltz" (Bibo). "Good-night Song." 11.40: "God Save the King."

3AR

Announcer: Maurice Dudley. 10 to 10.59: See Friday.

MORNING MUSICAL SESSION.

Announcer: Maurice Dudley. 11.0: Sweet Solace on the Seraphine. 12.20: British Official Wireless news. 12.30: Close down.

EVENING SESSION.

Announcer: Frank Hatherley. 6.0: A Special Recital of Gramophone request items. 7.0: "Age" news service; selections for Geelong races on Wednesday. 7.18: Gramophone recital continued.

NIGHT SESSION.

Announcer: Frank Hatherley. Accompanist: Reg. Browne. 8.0: Mme. Seward. 8.15: A. W. Jackson, "Gold". 8.30: The Station Orchestra, overture, "Alphonso and Estrella" (Schubert). 8.45: Gertrude Gray, mezzo, "Bird Lullaby" (Sanderson). "The Early Morning" (Peel). 8.52: Station String Quartet, "Andante from Symphonie in D" (Mozart). 9.2: John Byrne, bass, "Had a Horse" (Korbay). "Long Ago" (Korbay). 9.9: Vida Lugg, pianoforte recital, "Shepherds, Key" (Percy Grainger), "Shepherd's Fennel Dance" (Dardier), Allegro-Scherzo, from Pastoral Sonata (Beethoven). 9.22: Victor Baxter, tenor, "Life and Death" (Coleridge Taylor), "By the Waters of Minnetonka" (Lieurance). 9.30: The Station Orchestra, "Harvest Time" (Haydn-Wood), "My Native Heath" (Arthur Wood). 9.45: Gertrude Gray, mezzo, "The Blind Ploughman" (Clarke). "The First Primrose" (Grieg). 9.52: Bertha Jorgensen, violin, "Shepherd's Dance" (German). "Pastoral Dance," selected. 10.0: John Byrne, bass, see Thy Horse's Poising Mane" (Korbay). "The Roadside Fire" (Vaughan Williams). "I Have Sung of Pastures, of Fields, of Chieftains" (Virgili's Epitaph). 10.7: The Station Orchestra, "Pastoral Symphony" (Beethoven). 10.12: Victor Baxter, "Les Rameux," 8he Palms (Faure). 10.19: The Station Orchestra, "Pastoral from L'Arliesienne Suite" (Bizet). God Save the King.

4QG

EARLY MORNING SESSION.

7.43: Time signals. 7.45: News service. 8.0: Some electric records. 8.15: News service. 8.30: Close down.

MORNING SESSION.

11.0: Music. 11.5: Social news. 11.15: Lecture, talk on "Home Crafts," by Mrs. R. I. Reid. 11.30: Music. 11.35: More social news. 11.45: Music. 12.0 noon: Close.

MID-DAY SESSION.

1.0: Market reports and weather information. 1.20: From the Wintergarden Theatre, Wurlitzer organ. 2.0: Close down.

AFTERNOON SESSION.

3.0: A programme of electrically reproduced records. 3.30: Mail train running times. 4.15: This afternoon's news. 4.30: Close down.

EARLY EVENING SESSION.

6.0: Mail train running times, mail information, shipping news. 6.5: Some electrically reproduced records. 6.25: Commercial announcements. 6.30: Bed-time stories conducted by Uncle Ben. 7.0: News in brief. 7.5: Stock Exchange news. 7.8: Metal quotations. 7.7: Market reports. 7.25: Fenwick's stock report. 7.30: Weather information. 7.40: Announcements. 7.45: Standard time signals. 7.45: Lullaby, talk on "Photography," by Mr. F. L. South (manager, Kodak, Ltd.).

NIGHT SESSION.

A programme arranged by Mr. Erich John. 8.0: From the studio, Group 1, Grand opera. Instrumental quartette, "Evening Star" (from "Tannhauser," Wagner). Double quartette, "O Balmy Night" (from "Don Pasquale," Donizetti). Mildred Bell (contralto), "Cannonette" (from "Carmen," Bizet). W. W. Crisp (tenor), "Donna Mobile" (from "Rigoletto," Verdi). Double quartette, "Hymn of the Fishermen's Children" (from "Zampa," Herold). Instrumental, "Minuet" (Paderewski). 8.20: Group 2. Songs of China and Japan. Double quartette, "Feast of the Lanterns" (Bliss). Mrs. R. Bell (soprano), "The Girl of Japan" (Philip). Double quartette, "Songs of the Bells" (Bantock). Instrumental quartette, "In a Japanese Tea Garden" (Grieg). Stanley Tamblin (bass-baritone), "In the Palace" (Bantock). Double quartette, "In the Temple" (Bantock). Instrumental quartette, "Japanese Intermezzo" (Chapuis). 8.40: Group 3. Sacred. W. W. Crisp (tenor) and Stanley Tamblin (bass-baritone). Vocal duet, "Crucifix" (Gaura). Mildred Bell (contralto), "Like as the Heart Desires" (Allitsen). Double quartette, "Abide With Me" (arr. by Erich John). Instrumental quartette, "Andante Religioso" (Thome). 9.0: Metropolitan weather forecast. Group 4. Classical. Mrs. R. Bell (soprano) and Mildred Bell (contralto), "How Lovely is the Face" (Handel). Double quartette, "In Silent Night" (Ehrlich). Tony Ryan (bass), "I Will Not Grieve" (Schumann). Instrumental quartette, "Anitra's Dance" (from "Peer Gynt" suite, Grieg). 9.20: Group 5. Miscellaneous. Male quartette, "Three Little Ditties" (arr. by Erich John). (1) "All On a Sunday" (Ehrlich). (2) "When Jack Proposed." (3) "And That Was All." Mildred Bell (contralto), "A Little Girl's Lament" (Beringer). Jack Lord (tenor), "Song of the Bold Little Boy" (Beringer). Instrumental quartette, "The Garden" (Chaminade). 9.40: Group 6. Light opera. Mrs. R. Bell (soprano), "Love Me Now" (from "Madame Pompadour," Fall). W. W. Crisp and Jack Ford (tenors), "Poaching" (from "The Dairy Maid," Rutland). Mrs. R. Bell (soprano), Mildred Bell and Audrey Bell (contraltos), vocal trio "Just a Lulling Ring" (from "Lilac Time," Schubert). Instrumental quartette, "Dance Grottesque" (Leigh). 10.0: "The Daily Bulletin." "The Courier" news; weather news; "Queenslander" bi-weekly news service.

5CL

MORNING SESSION.

11.0: G.P.O. chronicle. 11.1: "Economist," kitchen craft and menu talk. 11.30: Columbia recordings. 11.45: Maggie Tulliver, a story of Old Rome, "The Psyche," by Hans Anderson. *12.0: C.F.O. times. 1.1: Sonora, organ recital by W. Webber on organ of Ch. Church, Westminster Bridge Road, London. 12.15: "Advertiser" general news service. 12.35: British official wireless news. 12.40: Grand opera, selections from well-known operas by Columbia artists. 12.52: S.A. railways information. 12.53: S. C. Ward and Co.'s Stock Ex-

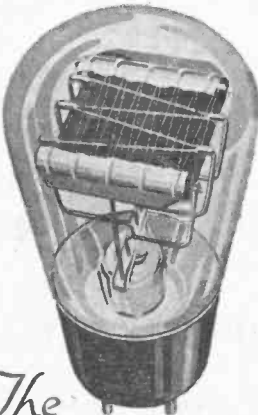

The COST PER HOUR OF GOOD RADIO RECEPTION

It all depends on the valves you use. Most of them look the same from the outside—it's the inside that counts. Mullard valves—the only valves containing the wonderful P.M. Filament—ensure the finest reception of which your set is capable at the lowest maintenance cost. It stands to reason—they cost no more to buy, they consume only .075 amps, their gigantic emission surface gives maximum power and purity, and they last for years. Every radio dealer in Australia stocks Mullard Master Valves—the all-British valve with the wonderful P.M. Filament.

Mullard

THE MASTER VALVE

D

February 12

change information. 12.58: Meteorological information. 1.0: G.P.O. chimes. 1.1: Sonora, a lunch-hour recital of selected Columbia records. 1.28: Gwen Moss. 1.34: Howard Bauerochse and Geo. Cowley. 1.40: Jean Finlay, pianiste. 1.46: Gwen Moss, violinist. 1.52: George Cowley, baritone. 1.58: Meteorological information. 2.0: G.P.O. chimes and close down.

AFTERNOON SESSION.

3.0: G.P.O. chimes. 3.1: Rev. G. E. Hale will speak on "Stoop to Conquer." 3.15: From Regent Theatre. 4.10: From studio, Victoria M. Wilson, soprano. 4.16: Fred Brown, cornetist. 4.22: Bernard Manning, bass-baritone. 4.28: Harry Hutchins, violinist. 4.34: Victoria M. Wilson, soprano. 4.40: Fred Brown, cornetist. 4.46: Bernard Manning, bass-baritone. 4.50: Harry Hutchins, violinist. 4.57: S. C. Ward and Co.'s Stock Exchange information. 5.0: G.P.O. chimes and close down.

EVENING SESSION.

6.0: G.P.O. chimes. 6.1: Birthday greetings, correspondence; songs and stories. 6.30: Sonora, inter-luncheon of dinner music. 7.0: G.P.O. chimes. 7.1: S. C. Ward and Co.'s Stock Exchange information. 7.5: General market reports. 7.10: 5CL's sporting service, by "Silvius." 7.22: Miss Laurie M'Leod, talk on "The Art of Dancing." 7.40: Dr. Herbert Basedow, an Australian talk.

NIGHT SESSION.

8.0: G.P.O. chimes. 8.1: Station Orchestra, overture, "Rosamund" (Schubert). 8.8: Victoria M. Wilson, soprano, "The Flower Song" (Gounod), "Hark My Triangle" (Dvorak). 8.14: A. V. Noske, hautist, "Valse Byaux" (De Lorenzo). 8.20: Don Fraser, comedian, in droll moments. 8.26: Station Orchestra, "Bon Vivant" (Zamocnik). 8.32: Bernard Manning, bass-baritone, selections from his repertoire. 8.38: Dramatic play, "Convict Mogg." Characters: Merchang, Athol Lykke; boy, Harold Clay; detective, William Harris; crook. 9.0: G.P.O. chimes. 9.1: Meteorological information. 9.2: Overseas grain report. 9.3: Station Orchestra, selection, "Mary" (Hirsch). 9.10: Howard Bauerochse, tenor, "Comfort Ye" (Handel); air, "Every Valley" (Handel). 9.16: Geoff Goldsworthy, cellist, selected solo. 9.22: Don Fraser, comedian, in selected comedy. 9.28: Station Orchestra, "First Movement of Concerto," by Grieg, for piano and orchestra. 9.36: Victoria M. Wilson, soprano, "Porgi Amor" (Mozart), "Autumn Thoughts" (Grieg). 9.42: Vern Rogers, cornetist, selected solo. 9.48: Bernard Manning, bass-baritone, selections from his repertoire. 9.51: Station Orchestra, suite "Hyde Park" (Jalawiez). 10.0: G.P.O. chimes. 10.1: Howard Bauerochse, tenor, "Ah Moon of My Delight" (Lehmann), "Jock the Fiddler" (Martin). 10.6: Station Orchestra, "Moonlight Silhouettes" (Lodge); novelties, "Rosemary" (Reynard). 10.15: "Advertiser" news service; 5CL's sporting service, by "Silvius"; meteorological information. 10.30: On with the dance music by Radi-o-Aces. 11.0: God Save the King.

6WF

12.30: Tune in. 12.35: Markets, news, and cables. 1.0: Time signal. 1.1: Weather bulletin. 1.3: Lunch hour programme, by the Studio Orchestra; and vocal selections. 2.0: Close down. 3.30: Tune in. 3.35: Musical programme, including pianoforte solos by Miss Audrey Dean. 4.30: Close down. 6.45: Tune in. 6.48: Bedtime stories for the kiddies. 7.5: Light music by the Station Instrumental Trio. 7.30: Commercial and general information. 7.45: Talk by Mr. Bathgate. 8.0: Time signal. 8.1: Weather report, supplied by the Meteorological Bureau of West Australia. 8.3: Vocal and instrumental items from the studio. 9.0: Late news items, by courtesy of the "Daily News" Newspaper Co.'s late weather bulletin; ships within range announcement station announcements. 10.30: Close down. 104.5 metre transmission: Simultaneous broadcast on 104.5 metres of programme given on 1250 metres, commencing at 6.45 p.m.

7ZL

AFTERNOON SESSION.

3.0: Running description of Hightweight Handicap, seven furlongs, run at Moonee Valley Racecourse, Victoria. 3.5: Musical selections. 3.30: Running description of Hospital Handicap, one mile and a quarter. 3.35: Musical selections. 4.15: Running description of Trial Handicap, one mile. 4.20: Musical selections. 4.50: Running description of Carlton Handicap, six furlongs. 6.45: All sporting results to hand. 5.0: Close down.

EARLY EVENING SESSION.

6.15: Musical selections. 6.25: Doreen Eisey will play for the children—"Jeannine, I Dream of Liliac Time" (Shikret), "How Sweet the Moonlight Sleeps" (Devoe). 6.50: "The Story Lady" will tell a story to the wee folk. 6.45: Answers to letters and birthday greetings by "Uncle David." 7.5: Musical selections. 7.15: News Session.

EVENING SESSION.

7.30: Hon. A. W. Loone, will speak on "The History of the North-eastern Coast of Tasmania." 7.45: W. E. Fuller will speak "Literary Lapses and Library Lists." 8.0: G.P.O. clock chimes the hour. 8.6: A programme by the Ritz Band and Monsieur Sonora—Ritz Band, two fox-trots, waltz. 8.15: Joseph Hislop, tenor. 8.22: Ritz Band, Yale, fox-trot. 8.29: Malcolm M'Eachern, bass. 8.36: Ritz Band, waltz, fox-trot. 8.45: Alfred O'Shea, tenor. 8.52: Ritz Band, fox-trot, Yale. 8.59: James Melton, tenor; Evan Williams, tenor. 9.8: Ritz Band, fox-trot, waltz, Yale. 9.15: Guitar Novelty Trio, a slow Huhu, with incidental singing. 9.22: Ritz Band, two fox-trots, waltz. 9.29: Rachel Morton, contralto. 9.32: Ritz Band, fox-trot, Yale. 9.38: Harry Dearth, bass. 10.0: G.P.O. clock chimes the hour. Close down.

"Farmer's Three"

Worth all of £17/10/- and more!

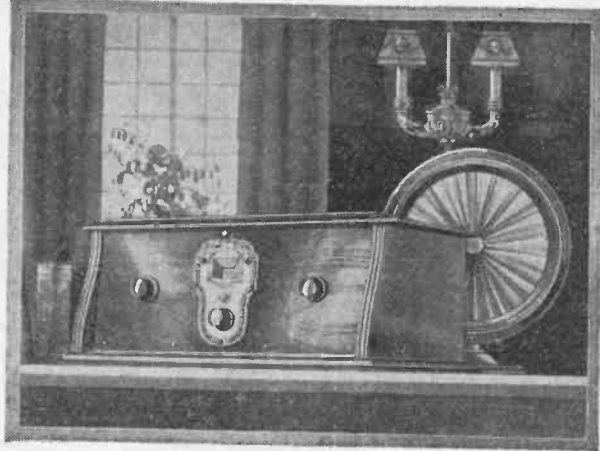

Doesn't it all come round to this?

You know Radio's no longer a novelty. And if it's going to be a successful source of entertainment in the home, your receiver must be a good one; yet, of course, moderately priced. Well, that's just what "Farmer's Three" is, a reliable "Home" Set—priced and worth every penny of £17/10/0

As far as fine tuning is concerned, you've never controlled a set more responsive, more clearly selective. You've rarely heard a more beautifully realistic tone. Its upkeep is comparatively negligible. All accessories, with "Sonachorde" loud speaker, are included. The set is installed free in City and Suburbs. In technical design "Farmer's Three" represents a definite advance on sets of its type. If you know anything at all about wireless you'll realise this when you hear it. Come and do so *without obligation* in Farmer's—

Wireless Department, First Floor, Market Street

FARMER'S

PITT, MARKET AND GEORGE STREETS, SYDNEY

Local Programmes, Wednesday, February 13

2FC

EARLY MORNING SESSION.

Announcer: A. S. Cochrane.

7.0: "Big Ben" and announcements. 7.2: Official weather forecast; rainfall, river reports; temperatures; astronomical memoranda. 7.7: "Sydney Morning Herald" summary. 7.12: Shipping intelligence; mail services; 7.15: Studio music. 7.25: Investment market; mining share markets; metal quotations; wool sales; breadstuffs markets, inter-State markets; produce markets. 7.40: Studio music. 8.0: "Big Ben." Close down

MORNING SESSION.

Announcer: A. S. Cochrane.

10.0: "Big Ben" and announcements. 10.3: Pianoforte reproduction. 10.10: "Sydney Morning Herald" news service. 10.25: Studio music. 10.45: A talk on "Home Cooking and Recipes" by Miss Ruth Furst. 11.0: "Big Ben." A.P.A. and Reuter's cable services. 11.5: Close down.

MID-DAY SESSION.

Announcer: A. S. Cochrane.

12.0: "Big Ben" and announcements. 12.1: Stock Exchange, first call. 12.3: Official weather forecast; rainfall. 12.5: Studio music. 1.30: Stock Exchange, second call. 1.32: Weather forecast. 1.34: "Evening News" mid-day news service. Producers' Distributing Society's report. 1.42: Rugby wireless news. 1.45: Studio music. 2.0: "Big Ben." Close down. Note: Race results will be broadcast as received from Ascot.

AFTERNOON SESSION.

Announcer: Laurence Halbert.

Accompanist: Ewart Chapple.

2.30: Programme announcements. 2.32: Record recital. 3.0: "Big Ben." Pianoforte reproduction. 3.15: Popular music. 3.38: Ruby Lesley, soprano—(a) "The Jewel of Asia" (Phillip). (b) "Philosophy" (Emmell). 3.45: A reading. 4.0: "Big Ben." Beatrice Kendrick, contralto—(a) "Hindoo Song" (Bernberg). (b) "Arrow and the Song" (Balfe). 4.7: Studio music. 4.17: Ruby Lesley, soprano—(a) "June Music" (Trent). (b) "Roses of Picardy" (Wood). 4.24: Popular music. 4.38: Beatrice Kendrick, contralto—(a) "The Birds Go North Again" (Willeby). (b) "Three Fishers Went Sailing" (Hullah). 4.45: Stock Exchange, third call. 4.47: Popular music. 5.0: Close down.

EARLY EVENING SESSION.

Announcer: A. S. Cochrane.

5.40: The chimes of 2FC. 5.45: The children's session, conducted by the "Hello Man," assisted by Uncle Ted and "Sandy." Letters and stories. Music and entertainment. 6.30: A chat about the Cheer-up Society, by Uncle Frank. 6.35: Dalgely's market reports (wool, wheat, and stock). 6.40: Fruit and vegetable markets. 6.43: Stock Exchange information. 6.45: Weather and shipping news. 6.48: Rugby wireless news. 6.50: Late sporting news. 7.0: "Big Ben." Late news service. 7.10: The 2FC Dinner Quartette, conducted by Horace Keats. (a) "Sefira" (Slade). (b) "I Can't Do Without You" (Berlin). (c) "Melodie" (Moskowsky). (d) "Phi-Phi" (Cristine). (e) "My Desire" (Cadman). (f) "I Just Roll Along" (de Rose). (g) "Nocturne in E Flat" (Chopin).

EVENING SESSION.

Announcer: Laurence Halbert.

Accompanist: Ewart Chapple.

7.40: Pianoforte reproduction. 7.45: Programme announcements. 7.48: Popular music. 8.0: "Big Ben." Classic programme arranged by Alexander Sverjensky. Piano soli, Alexander Sverjensky—(a) "Nocturne in F Sharp Minor" (Chopin). (b) "The Swan" (Palkren). (c) "Prelude" (Pachulsky). (d) "Evening Harmonies" (Pachulsky). 8.15: Baritone songs, Mr. Lathlean—(a) "Maria's Cradle Song" (Reger). (b) "False Phyllis" (Old English Song). (c) "Easter Hymn" (arr. by Bridge). (d) "Captain Stratton Sancy" (Warlock).

"The Silver Fox." To be produced from 2BL by the H. W. Varna Co., to-night, is by Cosma Hamilton and was originally produced in New York. It deals with a wife who discovered she had married unwisely, and then, without anger or jury, concentrated her whole effort in freeing her husband from an unuitable marriage, ensuring, also, that he should not be a sufferer thereby. Thus this made it possible for him to ally his life and interests happily to another woman, and at the same time enabled the wife to satisfactorily pair off with a worthy man, who had wished to make her his wife many years earlier.

8.30: Violin soli, A. Podinovski—

(a) "Ballade and Polonaise" (Vieuxtemps).

(b) "Meditation" from "Thais" (Massenet).

(c) "Serenade" (Pergament).

8.45: Piano soli, Alexander Sverjensky—

(a) "Melodie" (Gluck-Sgambati).

(b) "Etude" (Liszt).

8.55: Weather report.

8.56: A talk by C. R. Hall, "Out and About Iraq and Persia"—"A Nation Afoot."

9.10: Second half of the classic programme arranged by Alexander Sverjensky. Trio, Messrs. Podinovski, Van der Klei, and Sverjensky. "Trio, E Major" (Mozart).

9.30: Soprano songs, Gwen Selva—

Group of French songs.

9.45: 'Cello soli, J. Van der Klei—

(a) "Kol Nidrei" (Bruck).

(b) "Liebesleid" (Kreisler).

10.0: Duets, Gwen Selva and C. Lathlean—

from the Grand Operas.

10.15: A talk by W. F. Kay—"Stage Reminiscences."

10.28: To-morrow's programme.

10.30: National Anthem. Close down.

2BL

MORNING SESSION.

Announcer: A. C. O. Stevens.

8.0: G.P.O. chimes; metropolitan weather report.

8.1: State weather report.

8.2: Studio music.

8.5: G.P.O. chimes; news from the "Daily Telegraph Pictorial."

8.30: G.P.O. chimes; news service continued.

8.40: Information, mails, shipping, arrivals, departures, and sailings.

8.45: Studio music.

9.15: Half an hour with silent friends.

9.45: Studio music.

10.0: G.P.O. chimes; close down.

MIDDAY SESSION.

Announcer: J. Knight Barnett.

11.0: G.P.O. clock and chimes; 2BL Women's Sports Association Session, conducted by Miss Gwen Varley.

11.30: Advertising hints.

11.40: Women's Session, conducted by Mrs. Cranfield.

12.0: G.P.O. clock and chimes. Special ocean forecast and weather report.

12.3: Pianoforte reproduction.

12.30: Shipping and mails.

12.35: Market reports.

12.48: "Sun" midday news service.

1.0: Studio music.

1.30: Talk to children and special entertainment for children in hospital.

2.0: G.P.O. clock and chimes. Close down. Note.—Race results from Ascot.

AFTERNOON SESSION.

Announcer: J. Knight Barnett.

Accompanist: Kathleen Roe.

3.45: G.P.O. clock and chimes. Pianoforte reproduction.

4.0: G.P.O. clock and chimes. From Romano's, Romano's Cafe Dance Orchestra, conducted by Bennie Abrahams.

4.10: From the Studio: Talk by Basil Kirke, "Arts and Crafts of the Melanesians."

4.25: Popular music. 4.33: H. C. Gilson, tenor.

4.40: From Romano's, Romano's Cafe Dance Orchestra, conducted by Bennie Abrahams.

4.50: From the Studio, Ida Horwood, mezzo soprano. (a) "Sink Red Sun" (Del Riego).

(b) "When Song is Sweet" (Sans-Souci).

4.57: "Sun" news service. 5.0: Our Serial Story. 5.10: Ida Horwood, mezzo soprano. (a) "Now Sleeps the Crimson Petal" (Quilter). (b) "My Prayer" (Squire). 5.17: H. C. Gilson, tenor. 5.24: Popular music. 5.34: Racing resume. 5.37: Features of the evening's programme.

EARLY EVENING SESSION.

Announcers: J. Knight Barnett, Basil Kirke.

5.40: Children's Session, conducted by Uncle Peter. Music and Entertainment.

Letters and Stories. 6.30: "Sun" news and late sporting.

6.40: 2BL Dinner Quartet. (a) Valse "Nadia" (Delibes). (b) "Nocturne" (Widow).

(c) "The Quaker Girl" (Monckton). (d) "One Hour" (Longstaffe). (e) "My Wild Irish Rose" (Olcott). (f) "The Tin-Pan Parade" (Whiting).

7.10: Australian Mercantile Land and Finance Co.'s Report. Weather report and forecast, by courtesy of Govt. Meteorologist. Producers' Distributing Society's Fruit and Vegetable Market Report. Grain and Fodder Report ("Sun"). Dairy Produce Report ("Sun").

7.25: Mr. Plim and Miss Pam in Advertising talks and nonsense. 7.55: Programme and other announcements.

EVENING SESSION.

Announcer: Basil Kirke.

Accompanist: G. Vern Barnett.

8.0: G.P.O. clock and chimes. Topical chorus.

8.2: Studio production by the H. W. Varna Co. the "Silver Fox." Cast:

Edward Quilter H. W. Varna

Helen, his wife Meg. Service,

Frankie Turner Gwen Lascelles

Major Stanley William Huml

Captain Belgrave J. J. Tallor

Scene: "Quilter's House, London."

Act 1.—An afternoon in September.

Act 2.—The same, next evening.

Act 3.—The same, a year later.

9.2: The Savoyans' Dance Band.

9.14: Valerie Sims, popular vocalist.

9.21: The Savoyans' Dance Band.

9.32: Talk on general sporting, by Claude Corbett.

9.47: Zylphone solo by Lisle Lea.

9.54: Valerie Sims, popular vocalist.

10.1: Euphonium solo by Andrew Madden.

10.8: The Savoyans' Dance Band.

10.18: Late weather and announcements.

10.28: The Savoyans' Dance Band.

10.57: To-morrow's programme.

10.59: The Savoyans' Dance Band.

11.30: National Anthem. Close down.

2GB

10 a.m.: Music. 10.10: Happiness talk by A. E. Bennett. 10.20: Music. 10.30: Women's session by Miss Helen J. Beegling. 11.30: Close down. 2.0 p.m.: Music. 2.5: Women's radio service, by Mrs. Dorothy Jordan. 2.50: Music. 3.15: Close down. 5.30: Children's session by Uncle George. 7.0: Stock and market reports by New Zealand Loan and Mercantile Agency, Ltd. 7.15: Music. 7.30: Short talk by Miss Beegling. 8.0: Vocal duets by Miss Elsie Brown and Miss Eva Croft. 8.10: Pianoforte solos by Miss Ada Brook. 8.20: A humorous interlude by Mr. Jack Win and Mr. Heath Burdock. 8.25: Instrumental music. 8.35: Mr. Tommy Clyde, Scottish comedian. 8.45: Clement Hosking Vocal Quartette. 9.0: Weather report. 9.3: Address by Mr. Warner. 9.15: Instrumental music. 9.25: Songs by Mr. Clement Hosking. 9.35: A humorous interlude by Mr. Jack Win and Mr. Heath Burdock. 9.45: Clement Hosking Vocal Quartette. 9.55: Instrumental music. 10.0: Mr. Tommy Clyde, Scottish comedian. 10.10: Orchestral items. 10.30: Close down.

2UW

MID-DAY SESSION.

12.30: Music. 1.0: G.P.O. clock and chimes; music. 2.30: Close down. 4.30: Musical programme.

EVENING SESSION.

5.30: Children's Hour, conducted by Uncle Jack. 6.30: Close down. 7.0: G.P.O. clock and chimes; music. 8.0: To-day's Anniversary; music. 9.0: G.P.O. clock and chimes. Comments on Foreign Affairs, by Mr. J. M. Prentice. 9.10: Music and request numbers. 10.0: Close down.

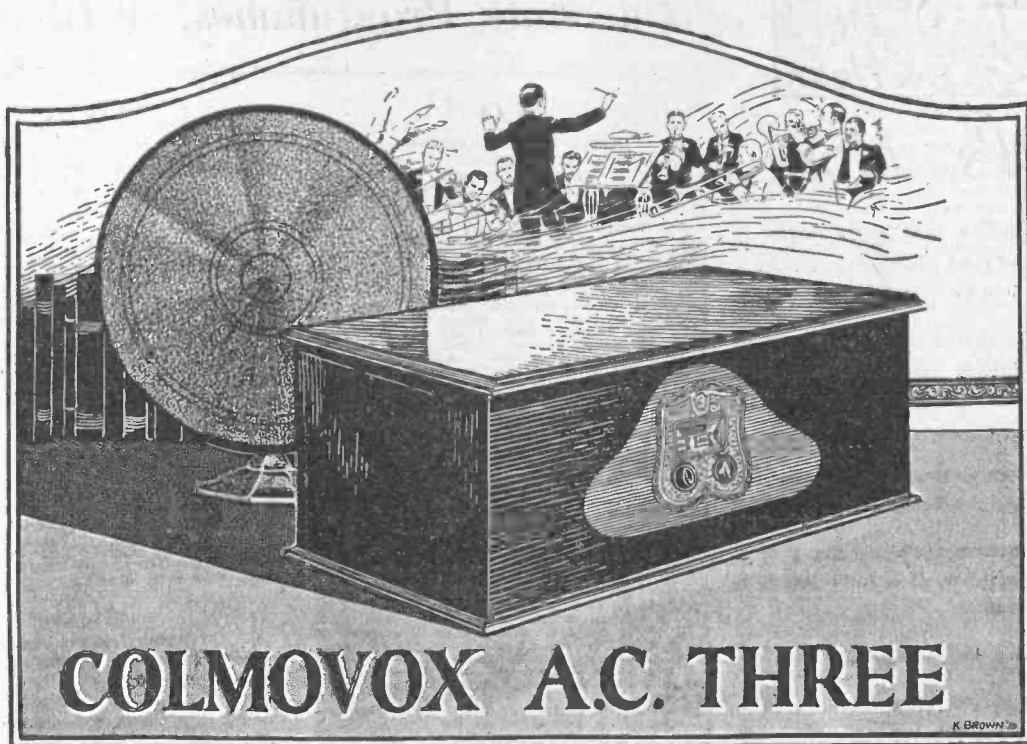

“COLMOVOK” RECEIVERS

Practically the oldest Receiver manufacturers in New South Wales! “Colmovox” Receivers have stood the test of time and are still in demand from those who buy recommended goods. “Colmovox” Receivers are guaranteed for twelve Months, and are built to suit Australian conditions, being selective to a high degree, giving good, faithful reproduction, and they are moderately priced.

Our new Model AC3 Batteryless Receiver is the latest addition to our large range of Receivers, and intending purchasers should see this wonderful Receiver before they buy elsewhere.

	Cash Price.			Deposit.			Weekly.	
	£	s.	d.	£	s.	d.	s.	d.
“Colmovox” All-Electric Three	29	0	0	5	0	0	9	8
“Colmovox” All-Electric Five	48	10	0	11	0	0	15	11
“Colmovox” Three-valve Receiver	17	10	0	3	0	0	6	2
“Colmovox” Four-valve Receiver	28	0	0	4	0	0	9	8
“Colmovox” Five-valve Receiver	33	10	0	6	0	0	11	8
“Colmovox” One-valve Receiver	5	10	0	0	10	0	5	0
“Colmovox” Crystal Receiver	3	10	0	0	7	0	3	6

ALL SETS ARE COMPLETE WITH LOUD SPEAKER, BATTERIES, ETC. AND INSTALLED FREE OF CHARGE

Demonstrations given in your own home without any obligation.

Colville-Moore Wireless Supplies Ltd.,

10 ROWE STREET (Next Hotel Australia) SYDNEY.

'Phone B2261

'Phone B2261



Bill's Nose

If Bill's nose were a penny magnet it couldn't collect more pins than, as a respiratory organ, it collects trouble.

It is a constant attraction to adenoids, indigestion, cynical women, colds, police fines, and caustic comments from prohibitionists.

They gravitate to it with the sure instinct of small insects to a woolly dog.

As is a luscious apple, hanging over a fence to a small boy, so is Bill's nose to a tempted providence.

It can't keep its hands off!

Large, red, shaped like a moon in its last quarter, it bears boldly the imprint of hoary fists, hob-nailed boots, and children's loving hands.

Even in wartime days, a sniper's bullet found its careless way through the tip of the fiery blob. The bullet was meant, no doubt, for the rosy ribbon on some brave fellow's chest.

Now much water (?) has passed beneath that bridge?

In the ripeness of middle age, Bill's nose hangs above a drooping crescent of moustaches, like a Dutch cheese in an undertaker's window.

All that is left for Bill is to join the Ku Klux Klan.

Fortified behind a kindly pillow-slip he feels he could really enjoy life.

Meanwhile, he clings to his Acme Eliminator.

"Nothing," says Bill, "gives you such a feeling of calm confidence as owning a real live socket power for your radio set, that is both unobtrusive and trouble-proof."

Nothing—that is, except a Grecian profile or a bottle of . . . orange crush!

The New System radio folk, at 280 Castle-reagh Street, sold Bill his Eliminator, but they cannot help his nose.

Interstate Programmes, Wednesday,

3LO

EARLY MORNING SESSION.

7.15 to 8.15 a.m.: See Friday..

MORNING SESSION.

Announcer: John Stuart. 11.0: 3LO's Different Dainties for the Daily Dinner. To-day's Radio Recipe: Cottage Pudding. 11.5: Miss I. D. Beavan will speak on "Home-made Confectionery." 11.20: Musical Interlude. 11.25: Mrs. M. Callaway March. "Color in Decoration." 11.40: Musical Interlude. 11.45: Mrs. Clarence Weber, Physical Culture Expert, "Physical Culture for Women." 12.0: Melbourne Observatory Time Signal. Stock Exchange Information. 12.1: British Official Wireless news from Rugby. Reuter's and the Australian Press Association cables. "Argus" news service. 12.15: Newmarket stock sale. Cattle sale report—bullocks and calves—by the Associated Stock and Station Agents, Bourke Street, Melbourne. 12.20: The Radi-o-Aces. 12.30: Courtney Ford, humorist. 12.37: Stock Exchange information. 12.40: The Radi-o-Aces. 12.45: Diana Belmont, contralto. 12.58: The Radi-o-Aces. 1.5: Meteorological information. Weather forecast for Victoria, South Australia, Tasmania, and New South Wales. Ocean forecasts. River reports. 1.15: Courtney Ford, humorist. 1.19: The Radi-o-Aces. 1.23: Diana Belmont, contralto. 1.30: Speeches from the Rotary Club luncheon, transmitted from the Freemasons' Hall, Collins Street, Melbourne. 2.0: Close down.

AFTERNOON SESSION.

Announcer: John Stuart. Accompanist: Mabel Nelson. 2.13: Description of the Novice Handicap, five furlongs, Geelong races, by Eric Welch. 2.20: The Station Orchestra. 2.30: John Byrne, bass. 2.37: Tsama Tierman, cello. 2.43: Description of the Jumper Flat Races, 1 mile 2 furlongs 192 yards, at Geelong races. 2.50: The Station Orchestra. 3.0: Rev. Frank Gorman and Sadie McDonald. 3.14: Description of the Drysdale Plate, six furlongs, Geelong races. 3.21: The Station Orchestra. 3.30: Diana Belmont, contralto. 3.37: The Station Orchestra. 3.43: Description of the February Handicap, about one mile, Geelong races. 3.50: Hugh Huxham's Serenader Quartet. 4.10: The Station Orchestra. 4.18: Description of the Drysdale Purse, five furlongs, Geelong races. 4.25: John Byrne, bass. 4.32: The Station Orchestra. 4.38: Diana Belmont, contralto. 4.43: Description of the Welter Handicap, seven furlongs, Geelong races. 4.50: The Station Orchestra. 5.10: News service. Stock Exchange Information. 5.10: Close down.

EVENING SESSION.

Announcer: Maurice Dudley. 6.0: Answers to Letters and Birthday Greetings by "Mary Mary." 8.25: Musical Interlude. 8.30: "Mary Mary" will tell you two lovely fairy tales, "Tom Tit Tot" and "The Golden Snuff Box."

NIGHT SESSION.

Announcer: C. O'Connell. Accompanist: Mabel Nelson. 7.5: Stock Exchange information. 7.15: Market reports. 7.30: News service. 7.43: Birthday greetings. 7.45: Out of the Past. 7.46: Under the auspices of the Department of Agriculture, E. W. Davey, chief orchards supervisor, will speak on "Stocks for Fruit Trees." 8.0: Maker of History. 8.10: The Station Orchestra, selection, "The Arcadians." 8.20: Gertrude Gray, mezzo soprano, "Arcady is ever Young" (The Arcadians). 8.24: The Station Orchestra, selection, "The Merry Widow." Part I. (Lehar). 8.29: Huxham's Serenader Quartet, musical numbers from Act I, "Merry Widow." 8.36: The Station Orchestra, selection, "Merry Widow." Part II. 8.41: Huxham's Serenader Quartet, Musical numbers from Act II, "Merry Widow." 8.48: John Stuart, comedian, "I'll be the same." 8.52: The Station Orchestra, selection, "Maid of the Mountains." 9.2: Gertrude Gray, mezzo-soprano, "The Heart's Desire" (The Street Singer). 9.6: The Station Orchestra, selection, "Rose Marie." 9.16: John Stuart, comedian, "Women Haven't Any Mercy on a Man" (Kissing Time). 9.20: The Station Orchestra, "The Desert Song" (Romberg). 9.30: Captain Donald MacLean will continue his series of "Pirate" stories to-morrow. 10.27: Rev. Frank Gorman and Sadie McDonald, "Barcarolle" (Offenbach). "Bylo." Patter, "Just a Memory" (Henderson). 10.43: The Radi-o-Aces: "Forever More" (Burnett), "Nebraska" (Revel), "Monna Lisa" (Wayside), "I Love to Dunk a Hunk of Spongecake" (Castell), "Beaus my Baby Don't Mean Maybe Now" (Donaldson), "Beloved" (Kalm), "Just Like a Melody out of the Sky" (Donaldson), "Topsy Feet", piano solo (Masman), "That's What You Mean to Me" (Trotter), "There's a Ricketty Racketty Shack" (Turk), "Japanese Mammy" (Donaldson), "Lenora" (Gilbert). 11.40: God Save the King.

3AR

Announcer: Maurice Dudley. 10.0 to 10.59: See Friday.

MORNING MUSICAL SESSION.

Announcer: Maurice Dudley. 11.0: Sweet solos on the Seraphina. 12.20: British Official Wireless news; announcements. 12.30: Close down.

EVENING SESSION.

Announcer: Frank Hatherley. 6.0: A Bravura of Beautiful Ballads and Orchestral Chef d'Ouvre. 7.10: "Herald" news service. Announcements. 7.15: Gramophone recital continued.

NIGHT SESSION.

Announcer: Frank Hatherley. Accompanist: Reg. Browne. 8.0: Under the auspices of the Boy Scouts' Association, W. D. Kennedy will speak on "What is a Scout?" 8.15: J. Howlett Ross will speak on "Will Longstaff's picture, "The Ghosts of Menin Gate." 8.30: Brunswick City Band, overture, "Fair Maid of Perth" (Volte), march characteristic, "Pat in America" (Eden). 8.45: Jovan Massanoff, tenor, "Dear Heart" (Mattel), "Doreen" (Oscar Allen). 8.50: Brunswick City Band, fantasia, "Musical Fragments." 9.2: John Byrne, bass, "Scots wha hae," "Rolling Down to Rio" (German). 9.3: Brunswick City Band, cornet solo, "Eileen Annamah," characteristic piece, "Parade of the Tin Soldiers" (Jessel). 9.19: Courtney Ford, humorist, "Timothy Kelly" (Grant), "Trip" (Weston). 9.26: Thelma Ready, banjo, "I Got a Robe" (Negro Spiritus), "The Old Log Cabin in the Dell." 9.33: Jovan Massanoff, tenor, "Glada na loolthe" (Strunoff), "Memories of a Song" (Nichols). 9.40: Brunswick City Band, fantasia, "The Old Rustic Brandy" (Mallinson). 9.50: John Byrne, bass, "Speeding Along" (Mallinson), "Eureka" (Mallinson). 9.57: Thelma Ready, banjo, "Leavin' on a Cloud" (Reddick), "A Little Bit of Honey" (Carter). 10.0: Courtney Ford, humorist, "In the Mood" (Robey), "A Funny Game" (Mills). 10.11: Brunswick City Band, march, "The Cross of Honor" (Ramer), Selected. 10.20: News service; announcements. God Save the King.

4QG

EARLY MORNING SESSION.

7.43: Time signals. 7.45: News service. 8.0: Some electric records. 8.15: News service. 8.30: Close down.

MORNING SESSION.

11.0: Music. 11.5: Social news. 11.15: A talk on "Artistic Uses of Sealing Wax and Crepe Paper" by "Dunse." 11.30: Mental quotations of Liza. 1.20: From the Wintergarden Theatre, Wurlitzer organ.

MID-DAY SESSION.

1.0: Market reports and weather information. Dinner music. 1.15: From the Postal Institute, Orchestra. 2.0: Close down.

AFTERNOON SESSION.

3.0: A programme of electrically reproduced records. 3.30: Mail train running times. 4.15: This afternoon's news. 4.30: Close down.

EARLY EVENING SESSION.

Announcers: R. Wight and H. Humphreys. 6.5: Wurlitzer organ. Mail train running times; mail information; shipping news. 6.25: Commercial announcements. 6.30: Bedtime stories conducted by "Little Miss Brisbane." 7.0: News in brief. 7.5: Stock Exchange news. 7.6: Mental quotations. 7.7: Market reports. 7.25: Fenwick's stock report. 7.30: Weather information. 7.40: Announcements. 7.43: Standard time signals. 7.45: Lecture arranged by the Queensland Agricultural High School and College.

NIGHT SESSION.

A dance night. 8.0: Alf. Featherstone and his orchestra. Fox trot, "The Doll Dance" (Brown). Fox trot, "At Sundown" (Donaldson). 8.10: The Albert Trio, ten minutes' fun. 8.20: Alf. Featherstone and his orchestra. Fox trot, "Speedy Boy" (Greer). Fox trot, "Golden Gate" (Jobson). 8.30: Etta Monte (soubrette), "Me and My Shadow" (Jobson). "Plenty of Sunshine" (de Sylva). 8.40: Alf. Featherstone and his orchestra. Jazz-waltz, "Was It a Dream?" (Coslow). 8.45: Hugh Herald (tenor), "A Dream" (Bartlett), "On With the Motley" (Leonard). 8.55: Metropolitan weather forecast. Movements of lighthouse steamers. 9.0: Alf. Featherstone and his orchestra. Fox trot, "I've Got a Yes Girl" (souvenir). Fox trot, "Sentimental Silly" (Souvenir). 9.10: "The Moonlight" (soprano), "A Little Pink Rose" (Jacobs-Bond). "I Dream That I Was the Wind" (Phillips). 9.20: Alf. Featherstone and his orchestra. Fox trot, "Maybe Till Baby Foot" (Stamper). Fox trot, "Plenty of Sunshine" (de Sylva). 9.30: The Albert Trio, Ten Minutes' Fun. 9.40: Alf. Featherstone and his orchestra. Jazz-waltz, "Chiquiti" (Wynne). 9.45: Lillian Corrigan (harpist), "The Hip that Once." "A Lullaby" (Thomas). 9.55: "The Daily Mail" news. "The Courier" news; weather news. 10.15: Alf. Featherstone and his orchestra. Three-quarters of an hour's dance music. 11.0: Close down.

6WF

12.30: Tune in. 12.35: Market; news, etc. 1.0: Time signal. 1.1: Weather bulletin, supplied by the Meteorological Bureau of West Australia. 1.3: Music. 1.12: Hygiene. 1.15: "The Wintreson" by Hobbs of London. 1.30: Close down. 3.30: Tune in. 3.35: Musical programme, relayed from the Rosebud Cafe; vocal numbers from the studio. 4.30: Close down. 6.45: Tune in. 6.48: Bedtime stories for the kiddies by Uncle Duffy. 7.5: Light music by the Station Trio. 7.30: Commercial and general information.

February 13

7.45: Talk by Lieut.-Col. Le Souef, Director of the Zoological Gardens, South Perth, on "Animals." 8.0: Time signal. 8.1: Weather bulletin, supplied by the Meteorological Bureau of West Australia. 9.0: Late news items, by courtesy of the "Daily News" Newspaper Co.; ships within range announcement; station announcements; late weather bulletin. 10.30: Close down. 104.5 metre transmission: Simultaneous broadcast on 104.5 metres programme given on 1350 metres, commencing at 6.45 p.m.

7ZL

MID-DAY SESSION.
11.30 to 1.30: See Friday. 2.0: Running description of Novice Handicap, five furlongs, run at Geelong Racecourse, Geelong, Victoria. 2.5: Close down. 2.45: Running description of Jumpers' Flat, one mile two furlongs and 192 yards, run at Geelong Racecourse, Geelong, Victoria. 2.50: Close down.

AFTERNOON SESSION.
3.15: Running description of Drysdale Plate, six furlongs, run at Geelong Racecourse, Geelong, Victoria. 3.20: Selections. 3.45: Running description of February Handicap, one mile. 3.50: Selections. 4.20: Running description of Drysdale Purse, five furlongs. 4.25: Selections. 4.50: Running description of Welter Handicap, seven furlongs. 4.55: All sporting results to hand. 5.0: Close down.

EARLY EVENING SESSION.
6.10: Geelong race results. 6.15: Selections. 6.30: Bertha Southey Brammall will tell a Tasmanian fairy tale to the wee folk. 6.40: Little Teddy Richardson will sing to the children. 6.45: Request numbers for the little ones. 7.0: Answers to letters and birthday greetings by Bertha Southey Brammall. 7.5: His Master's Voice in moments merry and musical. 7.15: News session.

EVENING SESSION.
7.30: Geo. Nation will give a talk on "This month's Calendar." 7.45: J. M. Counsel will speak on "European Affairs." 8.0: G.P.O. clock chimes the hour. 8.6: On February 13, 1813, B. Wagner was born. A Wagner concert, arranged by Paton's Music Warehouse, Hobart. 9.45: News session. 10.0: G.P.O. clock chimes the hour. Close down.

The Bells! Three Bells!

A COUNTRY correspondent writes to thank the announcer who pit on "Big Ben" without anything else coming through at the same time. "If you people were left in the country for a while, you would realise the feeling of companionable 'nearness' which the ringing of the old bell gives one first thing in the morning. Figuratively, it is a happy morning 'handshake' from the City to the Country." For people who get up at four in the morning, it may be all right to listen to a handshake at seven or eight o'clock; but with city people the "handshake" which pulls them away from comfortable pillows needs a little accompanying music to clear the shadows away and take the bad taste out of their mouths. To speak figuratively.

Cats!

FROM a letter to Captain Stephens. "Do you like cats, Mr. Stephens? If you do, I will send you a photo. of our cats. We had three beauties, and one died leaving us two—a big grey one and a black one."

W. FURNESS,
1st Floor, Furness Chambers,
KING'S CROSS, DARLINGHURST.
Shields, Coils, and all Component Parts as used in the Tested 1928 Solodyne. Coils are guaranteed to proper specification.
Shields assembled if desired.
Terms may be arranged.

TRANSFORMERS.
Built up to a specification and wound, lamination iron cut to any size from stock. Prices and estimates on application.
O'DONNELL, GRIFFIN, & CO., LTD.,
53 Druitt Street, Sydney.
'Phones: M 2991 (3 lines).



Magnavox Dynamic Power Speakers differ from other speakers both in principle of operation and construction. Made under exclusive Magnavox patents covering principles which are acknowledged by leaders in radio science as the only type of speaker construction capable of flawless radio reproduction. This new Magnavox Dynamic realism has caused a furore everywhere . . . a low whisper . . . pure and clear . . . or a glorious cascade of volume . . . without the slightest distortion

The Incomparable

MAGNAVOX

DYNAMIC

Power Speakers

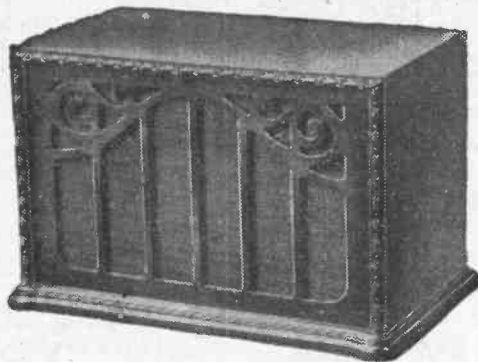

"BEVERLEY" JUNIOR MODEL

Fitted with Unit to work from Accumulator or Trickle Charger **£10**

Ask the nearest Radio Dealer for a demonstration, or hear it in our modern Audition Rooms.

DISTRIBUTORS:—

Mick Simmons Ltd.

Headquarters: 720V, Haymarket, Sydney.

Local Programmes, Thursday, February 14

2FC

EARLY MORNING SESSION.

Announcer: A. S. Cochrane.

7.0: "Big Ben" and announcements. 7.2: Official weather forecast, rainfall, river reports, temperatures, astronomical memoranda. 7.7: "Sydney Morning Herald" summary. 7.12: Shipping intelligence; mail services. 7.15: Studio music. 7.25: Investment market; mining sharemarkets; metal quotations; wool sales; breadstuffs markets; Inter-State markets; produce markets. 7.40: Studio music. 8.0: "Big Ben." Close down.

MORNING SESSION.

Announcer: A. S. Cochrane.

10.0: "Big Ben" and announcements. 10.2: Piano-forte selection. 10.10: "Sydney Morning Herald" news service. 10.25: Studio music. 10.30: Last minute sporting information by the 2FC Racing Commissioner. 10.40: Studio music. 11.0: "Big Ben." A.P.A. and Reuter's cable services. 11.5: Close down.

MIDDAY SESSION.

Announcer: A. S. Cochrane.

12.0: "Big Ben" and announcements. 12.1: Stock Exchange, first call. 12.3: Official weather forecast; rainfall. 12.5: Studio music. 12.10: Summary of news, "Sydney Morning Herald." 12.15: Rugby wireless news. 12.18: A Dickens' reading by A. S. Cochrane. 12.30: Studio music. 1.0: "Big Ben"; weather intelligence. 1.3: "Evening News" midday news service; Producers' Distributing Society's report. 1.20: Studio music. 1.28: Stock Exchange, second call. 1.50: Last minute sporting information by the 2FC Racing Commissioner. 2.0: "Big Ben." Close down.

AFTERNOON SESSION.

Announcer: Laurence Halbert.
Accompanist: Ewart Chapple.

2.30: Programme announcements. 2.32: Educational session for the schools; short musical recital; a reading. 3.0: "Big Ben"; piano-forte reproduction. 3.15: Popular music. 3.38: Ann Luciano, soprano. 3.45: A reading. 4.0: "Big Ben"; Carlos Fakola, novelty pianist. 4.7: Popular music. 4.17: Ann Luciano, soprano. 4.24: Studio music. 4.38: Carlos Fakola, novelty pianist. 4.45: Stock Exchange, third call. 5.0: Close down.

EARLY EVENING SESSION.

Announcer: A. S. Cochrane.

5.40: The chimes of 2FC. 5.45: The children's session, conducted by the "Hello Man"; letters and stories; music and entertainment. 6.30: Dalgety's market reports (wool, wheat, and stock). 6.40: Fruit and vegetable markets. 6.43: Stock Exchange information. 6.45: Weather and shipping news. 6.48: Rugby wireless news. 6.50: Late sporting news. 7.0: "Big Ben." Late news service. 7.10: The 2FC Dinner Quartette, conducted by Horace Keats—(a) "Marche Turque" (Ellenberg), (b) "Mexican Serenade" (Terese), (c) "Miss Springtime" (Kalman), (d) "It Goes Like This" (Friend), (e) "High Up on the Hill Top" (Whiting).

EVENING SESSION.

Announcer: Laurence Halbert.
Accompanist: Ewart Chapple.

7.40: Piano-forte reproduction.
7.45: Programme announcements.
7.48: Popular music.
8.0: From the Capitol Theatre, the Capitol Unit entertainment.
8.21: To-night's competition.
8.36: Madame Vera Tasma, soprano.
8.43: Piano-forte solos by Professor Von Hoffmann.
8.55: Weather report.
8.56: Vignettes of Humanity by a Story Teller.
9.11: Virginia Bassetti, contralto, Song Cycle—Old English (arr. Coleman).
(a) "Pack Clouds Away."
(b) "Love Me or Not."
(c) "Love in Thy Youth."
9.18: Programme announcements.
9.20: From the Capitol Theatre, stage presentation.

9.38: From the studio, Madame Vera Tasma, soprano.

9.45: Professor Von Hoffmann, piano-forte solos.

9.57: Virginia Bassetti, soprano—(a) "Om-bra Mai Fu" (Handel), (b) "Lullaby" (Scott).
10.4: From the Hotel Australia, Cec. Morrison's Dance Band.

10.14: From the studio, Jill Valentine in popular melodies.

10.21: From the Hotel Australia, Cec. Morrison's Dance Band.

10.31: From the studio, late weather.

10.32: Jill Valentine in popular melodies.

10.38: From the Hotel Australia, Cec. Morrison's Dance Band.

10.57: From the studio, to-morrow's programme.

10.59: From the Hotel Australia, Cec. Morrison's Dance Band.

11.30: National Anthem. Close down.

2BL

MORNING SESSION.

Announcer: A. C. C. Stevens.

8.0: G.P.O. Chimes. Metropolitan weather report. 8.1: State weather report. 8.2: Studio music. 8.15: G.P.O. chimes. News from the "Daily Telegraph Pictorial." 8.30: G.P.O. chimes. News service continued. 8.40: Information, mails, shipping, arrivals, departures, and sailings. 8.45: Studio music. 9.15: Half an hour with silent friends. 9.45: Studio music. 10.0: G.P.O. chimes. Close down.

MIDDAY SESSION.

Announcer: J. Knight Barnett.

11.0: G.P.O. clock and chimes. 2BL Women's Sports Association session, conducted by Miss Gwen Varley. 11.30: Advertising hints. 11.40: Women's session, conducted by Mrs. Cranfield. 12.0: G.P.O. clock and chimes. Special ocean forecast and weather report. 12.3: Piano-forte reproduction. 12.30: Shipping and mails. 12.35: Market reports. 12.48: "Sun" midday news service. 1.0: Studio music. 1.30: Talk to children and special entertainment for children in hospital. 2.0: G.P.O. clock and chimes. Close down.

AFTERNOON SESSION.

Announcer: J. Knight Barnett.

Accompanist: Kathleen Roe.

3.45: G.P.O. clock and chimes. Piano-forte reproduction. 4.0: G.P.O. clock and chimes. From Romano's, Romano's Cafe Dance Orchestra, conducted by Bennie Abrahams. 4.10: A reading. 4.25: From the studio, Marcus Burkitt, pianist—(a) "Impromptu in A Flat" (Schubert), by request; (b) "Evening Song" (Schumann). 4.33: "Sun" news service. 4.40: From Romano's, Romano's Cafe Dance Orchestra, conducted by Bennie Abrahams. 4.50: From the studio, Marcus Burkitt, pianist—(a) "Nocturne in C Minor" (Chopin), (b) "Gavotte in F" (Burkitt), by request. 5.0: Our serial story. 5.10: Piano-forte reproduction. 5.24: Popular music. 5.37: Features of the evening's programme.

EARLY EVENING SESSION.

Announcer: Basil Kirke.

5.40: Children's session, conducted by Uncle Bas. Music and entertainment. Letters and stories. 6.30: "Sun" news and late sporting. 6.40: 2BL Dinner Quartette—(a) "Minuet" (Bocherini), (b) "Lynstrata" (Lincke), (c) "A Lover in Damascus" (Woodforde-Finden), (d) "My Blackbirds are Bluebirds Now" (Friend), (e) "Love's Last Day" (Banatsky), (f) "The Magic Flute" (Mozart). 7.10: Australian Mercantile Land and Finance Co.'s report. Weather report and forecast, by courtesy of Government Meteorologist. Producers' Distributing Society's fruit and vegetable market report. Grain and fodder report ("Sun"). Dairy produce report ("Sun"). 7.25: Mr. Pim and Miss Pam in advertising talks and nonsense. 7.55: Programme and other announcements.

EVENING PROGRAMME.

Announcer: Basil Kirke.

Accompanist: G. Vern Barnett.

8.0: G.P.O. clock and chimes. Topical chorus.
8.2: Marrickville Salvation Army Band—

(a) Grand March, "Departed Heroes" (Coles), (b) Fantasia, "Songs of Britain" (Marshall).

8.16: George Trail, baritone—(a) "Friend" (Davies), (b) "Tom Brown" (Squire).

8.23: The Two Sad Sunbeams in seven minutes of sorrow.

8.30: Jeanette Ethelstone, soprano—(a) "My Message" (D'Hardelot), (b) "Japanese Love Song" (Brahe), (c) "I Love You Truly" (Bond).

8.37: Edward Gregory, saxophonist—(a) "Saxarella" (Wiedoeff), (b) "Basheva" (Gurewicz).

8.44: Robert Mylchreest, tenor—(a) "The Crown" (Bee), (b) "Tired Hands" (Sander-son).

8.51: Lloyd Davies, violinist—(a) "Slavonic Dance" (Kreisler), (b) "Lullaby" (Bridge), (c) "Schon Rosmarin" (Kreisler).

8.58: Weather report.

9.0: Ethel Daw, contralto.

9.7: Marrickville Salvation Army Band—(a) Selection, "The Fortress" (Vanderkam), (b) Air Varié, "Silver Threads" (Twitchin). Soloist: Harold Orr.

9.22: George Trail, baritone—(a) "Oberon in Fairyland" (Slater), (b) "Be Brave and Smile" (Pepper).

9.29: The Two Sad Sunbeams in a further seven minutes of sorrow.

9.36: Jeanette Ethelstone, soprano. Russian classics—(a) "My Native Land" (Gretchni-noff), (b) "The Wounded Birch" (Gretchni-noff), (c) "The Rose Has Charmed the Nightingale" (Korsakoff).

9.43: Edward Gregory, saxophonist—(a) "Rose Elegante" (Johnston), (b) "Velma" (Rosebrook).

9.50: Robert Mylchreest, tenor—(a) "Guess You Know" (Brahe), (b) "Flower of the Desert" (Lohr).

9.57: Lloyd Davies, violinist—(a) "Berceuse" (Faure), (b) "Minuet" (Bach).

10.4: Ethel Daw, contralto.

10.11: Marrickville Salvation Army Band—(a) "Alas Those Chimes" (Wallace), (b) selection, "Banner of Liberty" (arr. Goldsmith), (c) march, "The Conflict" (Coles).
10.30: National Anthem. Close down.

2GB

10 a.m.: Music. 10.10: Happiness talk by A. E. Bennett. 10.20: Music. 10.30: Women's session by Miss Helen J. Beegling. 11.30: Close down. 2.0 p.m.: Music. 2.5: Women's radio service, by Mrs. Dorothy Jordan. 2.50: Music. 3.0: Talk by G. H. Chappell. 3.15: Close down. 5.30: Children's session by Uncle George. 7.0: Stock and market report by New Zealand Loan and Mercantile Agency, Ltd. 7.15: Music. 7.30: Short talk by Mrs. Jordan. 8.0: Songs by Miss Dorothy Stacey. 8.10: Instrumental music. 8.20: A humorous interlude by Mr. Jack Win and Mr. Heath Burdock. 8.25: Songs by Mr. C. E. Cooke. 8.35: Instrumental music. 8.45: Songs by Madame Bennett North. 8.55: A humorous interlude by Mr. Jack Win and Mr. Heath Burdock. 9.0: Weather report. 9.3: Address by Mr. Heyting. 9.15: Songs by Miss Dorothy Stacey. 9.25: Instrumental music. 9.35: Songs by Mr. C. E. Cooke. 9.45: A humorous interlude by Mr. Jack Win and Mr. Heath Burdock. 9.50: Songs by Madame Bennett North. 10.0: Orchestral items. 10.30: Close down.

2UW

MID-DAY SESSION.

12.30: Music. 1.0: G.P.O. clock and chimes; music. 2.30: Close down. 4.30: Musical programme.

EVENING SESSION.

5.30: Children's Hour, conducted by Uncle Jack. 5.30: Close down. 7.0: G.P.O. clock and chimes; music. 8.0: To-day's Anniversary; music. 8.15: Gardening Talk, by Mr. S. H. Hunt. 8.30: Music. 9.0: G.P.O. clock and chimes. Comments on Foreign Affairs by Mr. J. M. Prentice. 9.10: Music and request numbers. 10.0: Close down.

BURGESS "SUPER B" BATTERIES

NOTE THESE SPECIAL FEATURES:

LARGER CELLS
HIGHER GRADE AND MORE REFINED MATERIALS
IMPROVED SCIENTIFIC CHANGES IN ELECTRICAL AND
MECHANICAL CONSTRUCTION
GREATER CAPACITY
LONGER SHELF LIFE

Plus these Standard Burgess Features

Paste Electrolyte	Individual Cell Wrapper
Inner Seal, Cementing Cells into Solid Block	Paraffined Black and White Container
Moisture-Proof Insulating Cell Partitions	Moisture-Proof Inner Container Individually Selected Cells
Double Top Seal	55 Scientific Tests—Electrical Chemical, Mechanical, and Physical
One-Piece, Drawn, Seamless Zinc Can	

CLIMAXED BY

Chrome

Chrome is a preservative that prevents the waste of battery power. It is an exclusive patented feature of Burgess Batteries. It is responsible for these batteries giving more hours of service than any other batteries made.

NEW SYSTEM TELEPHONES PTY. LTD.,
280 Castlereagh St., 181-3 King St., Charles St.,
Sydney. Melbourne. Adelaide.
Queensland: Canada Cycle & Motor Agency
(Q.) Ltd.,
Creek and Adelaide Streets, Brisbane.



Interstate Programmes, Thurs., Feb. 14

WE ADMIT

That cheaper sets than "Resco" can be purchased—but

WE CLAIM

That no set in Sydney—regardless of price—uses a better quality of material than that used in "Resco" sets.

For This Reason—

"Resco" sets are backed by an unconditional guarantee for twelve months.

We specialise in modernising your old set. All remodelled sets are also covered by our guarantee.

Consult us on your RADIO PROBLEMS. We take a personal interest in them.

The Resco Radio Supply Company,

38A PITT ST. (Near Quay), SYDNEY.

'Phone, B1817.

3LO

EARLY MORNING SESSION. 7.15 to 8.15: See Friday.

MORNING SESSION. Announcer: John Stuart. 11.0: 3LO's Different Dainties for the Daily Dinner. To-day's Radio Recipe: Peach Delight. 11.3: Matron Moreland will speak on "Mothercraft." 11.20: Musical Interlude. 11.25: S. W. Hecker, Superintendent and Secretary of the Royal Victorian Institute for the Blind, will speak on "The Housewife and the Institute." 11.40: Musical Interlude. 11.45: Mrs. Austin Gatehouse, president of the Ladies' Golf Union of Victoria, will speak on "Golf for Women." 12.0: Mid-day news session. 12.20: Community Singing. Old-time choruses, transmitted from the King's Theatre, Melbourne. Conductor: Frank Hatherley. 12.40: Stock Exchange Information. 12.43: Community Singing resumed. R. Frank Gorman, baritone, and Sadie McDonald, violinist, in old-time melodies. 1.45: Meteorological information. Weather forecast for Victoria, New South Wales, South Australia, and Tasmania. Ocean forecasts. River reports: Rainfall. 1.52: Close down.

AFTERNOON SESSION.

Announcer: John Stuart. Accompanist: Mabel Nelson. 2.15: The Strad Trio. 2.25: Jovan Massanoff, tenor. 2.35: Cecil Barker, violin. 2.48: Gertrude Gray, mezzo-soprano. 2.55: May Broderick, piano. 3.3: The Strad Trio. 3.12: Rev. Wm. Bottomley, chorist. 3.27: The Station Quartet. 3.57: The Station Orchestra. 4.1: The Serenade Quartet. 4.20: The Station Orchestra. 4.30: News session. 4.45: Evenson, transmitted from St. Paul's Cathedral, Melbourne. 5.30: Acceptances and barrier positions for V.A.C. races at Caulfield on Saturday, 16th. 5.35: Close down.

EVENING SESSION.

6.0: Answers to letters and birthday greetings by "Bobby Bluegum." 6.25: Description of races at Caulfield. "Bobby Bluegum." Songs and Stories for the Little Ones.

NIGHT SESSION.

Announcer: C. O'Connell. Accompanist: Mabel Nelson. 7.5: Stock Exchange information. 7.15: Market reports. 7.30: News session. 7.53: Birthday greetings. 7.45: Out of the Past. 7.46: Gertrude Augarde, now appearing in "Figs." at the New Comedy Theatre, will speak from her dressing room at the Theatre, by permission J. C. Williamson, Ltd. 8.0: A Maker of History. 8.1: Rod McGregor will speak on "Cricket." 8.15: The Radi-o-Aces: "Top Town Artillery" (Carlton). "Because My Baby Don't Mean Mayne Now" (Donaldson). "Wabaly Walk" (Green). 8.24: Jovan Massanoff, tenor. "The Flower" from "Lilac Time" (Schubert). 8.27: The Radi-o-Aces: "The Desert Song" (Romberg). "One Alone" (Romberg). "Alabama Stamp" (Oreger). 8.36: Courtney Ford, humorist. "The Artist" (Scott). 8.39: The Radi-o-Aces: "Gypsy" (Gilbert). "Jo Anne" (Ward). "Get Out and into the Moon" (Tobias). 8.48: Gertrude Gray, mezzo-soprano. "I Love the Moon" (Rubens). 8.51: The Radi-o-Aces: "That's My Weakness Now" (Step). "Nebraska" (Slak). "Forever Mine" (Burnett). 9.0: Description of races at Melbourne. Thousand foot-running carnival at Motordrome. 9.15: The Radi-o-Aces: "Roses of Yesterday" (Berlin). "It Goes Like This" (Caesar). "Just Keep Singing Song" (Sisell). 9.24: John Byrne, bass. "Old Doctor MacGinn" (Lohr). 9.27: The Radi-o-Aces: "Minnetonka" (Wallace). "The Dance of the Blue Danube" (Fisher). "In the Woolshed She Said She Would" (Johnson). 9.36: Gertrude Gray, mezzo-soprano. "The Cuckoo Clock" (Grainger). 9.39: The Radi-o-Aces: "Constantinople" (Carlton). "Japan" (Klenner). "Dream House" (Fox). 9.48: Jovan Massanoff, tenor. "Just a Cottage Small" (Hartley). 9.51: The Radi-o-Aces: "My Blackbirds are Blue Birds Now" (Friend). "I Can't Do Without You" (Trent). "I Just Roll Along" (Trent). 10.0: Description of races at Melbourne. Thousand foot-running carnival at Motordrome. 10.15: (Plataneus news service. British Official Wireless news from Rugby. Meteorological information. Announcements. Sporting notes by "Olympus." 10.25: The Radi-o-Aces: "Oh, Ya Ya" (Erich). "There ought to be a Law Against That" (Friend). "Hot Ivories" (Snastra). 10.34: Courtney Ford, humorist. "The Ideal" (Scott). 10.37: The Radi-o-Aces: "Chiquita" (Wayne). "Just Like a Description of the Sky" (Donaldson). "You Are Wonderful" (Ash). 10.46: Gertrude Gray, mezzo-soprano. "Arietta" (Cyril Scott). 10.49: The Radi-o-Aces: "Avalon Town" (Brown). "Paradise" (Zamcnic). "Annama Cake" (Bernard). 11.0: The Radi-o-Aces: "Where the Cot-Cot-Cotton Grows" (Klien). "Tokio" (Condon). "You're a Real Sweetheart" (Friend). "Under the Burma Moon" (Davis). "Colombo" (Nichols). "High Up on a Hilltop" (Boer). "D'Yea" (Plataneus). "My Inspiration is You" (Nichols). "Dawning" (Silver). "Ready for the River" (Moret). 11.30: God Save the King.

3AR

Announcer: Maurice Dudley. 10 to 10.59 a.m.

MORNING MUSICAL SESSION. Announcer: Maurice Dudley. 11.0: A Recital of Popular Ballads and Orchestral Gems. 12.20: British Official Wireless News. 12.30: Close down.

EVENING SESSION.

Announcer: Frank Hatherley. 6.0: A Bravura of Beautiful Ballads and a Recital of the Works of the Master Musicians. 7.0: "Age" news service. Acceptances of barrier positions for Caulfield races on Saturday. 7.15: Gramophone recital continued.

NIGHT SESSION.

Announcer: Frank Hatherley. Accompanist: Reg. Browne. 8.0: J. H. Hissett Ross. "St Valentine's Day a forgotten festival. 8.15: Under the auspices of the Nurserymen and Seedsmen's Association. E. Wiseman will speak on "Growing Ranunculus for Winter Flowers." 8.30: The Station Orchestra. "Fidelio" (Beethoven). 8.40: Diana Belmont, con-

tralto. "The Virgin's Slumber Song" (Max Reger). "A Wayside Flower" (D'Harelto). 8.47: Programme arranged by J. Sulton Crow, transmission from The Auburn Methodist Church. J. Sulton Crow, organ. "Oferleire in E Flat" (Dulst). Stella Dredge, soprano. Selected. J. Sulton Crow. "Andante" (Bastiste). Stella Dredge, soprano. "Lullaby" (Cyril Scott). J. Sulton Crow, organ. Fantasia on tune "Fatherland" (Was-Crow). Stella Dredge, soprano. "Aris Oh Sun" (Deay). J. Sulton Crow, organ. "Evensong" (Easthorpe Martin). From the Studio. One Act Play. Saint Valentine's Day (Marjorie M'Leod). Produced by Winifred Moverley. Castle Mrs. Lacey. Marjorie M'Leod; her grandson, J. Alexander Browne; Edith (his fiancee), Winifred Moverley. Scene: A summer house in a park. 9.33: Quartet, Hugh Huxham. "Walk as much as you can," "Love rules the world." Interlude, Guildford Bishop. "Aris Oh Sun" (Deay). J. Sulton Crow, organ. Humorous quartet. "Fussey in the Wall" Due. Hugh and Edith Huxham. "That's What I Think of You" (Interlude). Dorothy Huxburgh, viola. "Capriello" (Haydn) quartet. "Castelano" 9.53: The Station Orchestra. selection. "Clovertown" (Haydn Wood). 10.3: Diana Belmont, contralto. "Mention when soft voices die" (Besley). "Obstinatton" (Fontanelles). 10: The Station Orchestra, selection. "La Navarraise" 10.20: News session. News service. Announcements. God Save the King.

4QG

EARLY MORNING SESSION.

7.43: Time signals. 7.45: News service. 8.0: Some electric records. 8.15: News service. 8.30: Close down.

MORNING SESSION.

11.0: Music. 11.5: Social news. 11.15: Gardening talk by "Tecoma." 11.30: Music. 11.35: More social news. 12.0 noon: Close down.

MID-DAY SESSION.

1.0: Market reports and weather information. 1.15: A lunch-hour address. 2.0: Close down.

AFTERNOON SESSION.

3.0: A programme of electrically reproduced records. 3.30: Mail train running times. 4.0: Afternoon news. 4.30: Close down.

EARLY EVENING SESSION.

6.0: Mail train running times; mail information; shipping news. 6.5: Description of races at Caulfield reproduced records. 6.25: Commercial announcements. 6.30: Bedtime stories conducted by "The Sunbeam." 7.0: News in brief. 7.5: Stock Exchange news. 7.0: Metal quotations. 7.7: Market reports. 7.25: Fenwick's clock report. 7.30: Weather information. 7.40: Announcements. 7.43: Standard time signals. 7.45: Lecturette, "On the Wallaby: Rural Reminiscences" No. 4, by Mr. J. F. F. Reid. ("Queensland Agricultural Journal").

NIGHT SESSION.

A classical programme by the Richmond Party. 8.0: Instrumental trio. "Valse" (Tschakowsky). Hilda Hamilton (mezzo-soprano). "Dove Song" (Mozart). Ottilie Cloake (cellist), selected. Max Aronsten (baritone). "The King's Minstrel" (Pinsuti). "My Dreams" (Tosti). Jack Ellis (pianist). "Polonaise in E" (List). Hilda Hamilton (mezzo-soprano) and Max Aronsten (baritone), vocal duet, selected. Ottilie Cloake (cellist) selected. Max Aronsten (baritone). "Bitterness of Love" (Dunn). "Can't Remember" (Gostley). "The Carpet" (Sanderson). Hilda Hamilton (mezzo-soprano). "Langley Fair" (Martin). "Fair Song" (Evered) (Coates). Jack Ellis (pianist). "Rush Hour in Hongkong" (Chasins). Hilda Hamilton (mezzo-soprano) and Max Aronsten (baritone). "In the Garden of My Heart" (Ernest Bell). Instrumental Trio. "Scherzo" (Arensky). Jack Ellis (accompanist). 9.0: Metropolitan weather forecast. Part II, Annerley Choral Society. 9.0: From the studio. A programme by Annerley Choral Society. "Song of May" (M'Burney). "The Mighty Deep" (Jude). Annerley Choral Society. "The Le Shore (Coleridge Taylor). Mesdames Corbett and Muller, vocal duet. "Down the Vale" (Moir). Annerley Choral Society. "He That Hath a Pleasant Face" (Hutton). "The Bells" (Wheeler). Nina Dudley (contralto). "A Song of Life" (Del Rago). E. Tait (pianist), selected. Annerley Choral Society. "O Lovely May" (German). Miss Noden (soprano). "Evered of My Delight" (Phillips). Annerley Choral Society. "O Gladsome Light" (Sullivan). Mrs. Corbett (mezzo-soprano). "Bill as the Night" (Bohm). Annerley Choral Society. "Spring Song" (Pinsuti). T. L. Muller (bass). "Bedouin Love Song" (Pinsuti). Annerley Choral Society. "In This Hour of Softened Splendor" (Pinsuti). 10.0: "The Daily Mail" news. "The Courier" news; weather news. Close down.

7ZL

EVENING SESSION.

7.30: Alderman J. J. Wignall (Mayor of Hobart) will speak on "Literature for Tasmanian Light-houses," and "Discarded Toys for the Wee Folk." 7.45: J. B. Read (Champion) will speak on "Tasmania as a Tourist Resort." 8.0: G.P.O. clock chimes the hour. 8.6: Selections. 8.15: A programme of popular and classical music by the Discus Ensemble. Ketybey's Orchestral Orchestra. 8.22: Alma Cluck, soprano. 8.28: Mischka Elman, violin solo. 8.35: John Bonnee, the boy soprano. 8.42: W. H. Squire, cello solo. 8.49: Philadelphia Symphony Orchestra. 8.57: John M' Cormack, tenor. 9.0: Vivian des Villes, baritone. "Shakespeare's Hamlet." A first discourse: "Was Hamlet Mad?" 9.20: John M' Cormack, tenor. 9.23: Ketybey's Orchestral Orchestra. 9.30: Denis Noble, baritone. 9.37: Jas. Compton, cornet solo. 9.44: Peter Dawson, piano. 9.50: Selections. 10.0: G.P.O. clock chimes the hour. Close down.

The WIRELESS WEEKLY

RADIO INFORMATION

Under the direction of

Ray Allsop

and

Don B. Knock

(Associate Technical Editors)

Service

Correspondence Answered

only through

these

Columns

(See Coupon Below)

J.W.S. (Petersham).—"I am having trouble with a rectifier which I have been forming for the trickle charger recently described in "W.W." I am using a 15 watt lamp in series with the primary."

Answer: Details on forming rectifiers will be found in "Proving Radio," part 1. Try using a 10 watt lamp in series with one of the primary leads.

M.W. (Ultimeo).—"My aerial is too short, and as I do not get enough volume, I desire to make it longer. However, my only way of doing this is to carry the aerial all round in a triangle. Will this be O.K.?"

Answer: Quite O.K., but not so satisfactory as the straight aerial. Suggest you use three wires running parallel, spaced 6ft. apart, rather than the triangular arrangement.

J.W.E. (Campse).—"I have wired up a Browning Drake receiver from the enclosed diagram. The receiver will not bring in inter-State stations. It will work with just as well as four. The first valve can be removed with no detriment. Tuning is broad."

Answer: It seems the receiver is not neutralised. The fact that the R.F. valve can be removed is quite O.K. Any slight adjustment of the controls may be made, which will boost signals up. If this adjustment is great, neutralisation is incorrect, and must be gone through again. If neutralisation cannot be obtained, reverse the connections to the R.F. primary, and try again. If neutralisation cannot be obtained either way, it may be an indication that the capacity of the neutralising condenser is too great or too small. In either case, the correct value must be substituted. I think you will find your neutralising condenser is rather small. Use one of 13 plates, and try neutralising with this.

J.F.K. (Bondi).—"I have read of many ways of neutralising the Browning Drake. Some writers suggest placing one of the filament terminals on a piece of blotting paper and replacing the valve, whilst others say the rheostat should merely be turned out. There are several other conflicting methods. Which is correct? Why are these deviations made?"

Answer: The correct method has been explained in these columns for "J.W.E. (Campse)." The method of using some substance on one of the filament prongs of the valve is used when the R.F. valve is not controlled by a rheostat. If a filament ballast is used, this may be removed with the same result as turning out the rheostat, or insulating the filament prong. Methods of neutralisation vary very slightly with some receivers, but this is mostly a matter of number of valves, and condenser capacity.

W.H.J. (Victoria).—"Would you kindly oblige by inserting a request in your Radio Information Service columns for a copy of "W.W." containing the Marco Four receiver? I would be willing to pay for same if any of your readers will forward price and address to W. H. Jackson, Post Office, Murrumbidgee, Victoria."

Answer: Your letter was written before last issue of the "Weekly" was published, and you will, therefore, have a pleasant surprise ere you read this, as the Marco Four article was re-published last issue, in compliance with many requests.

H.E. (West Ryde).—"Which set would you advise me to build—the Screen Grid Browning Drake or the Screen Grid Marco Four, which is, I understand, to be published shortly—i.e., next week?"

Answer: The Marco is the better receiver, in the writer's opinion, though opinions differ. Personally, I have tried both receivers, and got better results from the Marco. However, the Screen Grid Marco has not yet been published. In queries we referred to the original Marco article. I am, however, preparing a Screen Grid Marco—which will appear in good time. If you are bustin' for a circuit, send a stamped addressed envelope. Replies to queries are not usually made by post, but as your case is important we shall be pleased to help you this time.

P.H.T. (Glenorie).—"I am enclosing circuit of my crystal set, which does not give enough volume on 2BL and is also insensitive. What do you suggest?"

Answer: The circuit is of a very elementary type, and your best plan would be to build another crystal receiver. Here are particulars of one that is very cheap to make—gives excellent volume, and is knife-like in sensitivity. Connect the aerial terminal to the first turn of a 50-turn coil (31n-former), and also to one side of the crystal. The other side of the crystal to connect to one side of the 'phones, and the other side of the 'phones to the other end of the coil, and also to the earth terminal. Now, in the centre of this coil, wind another 15 turns (24-gauge) D.C.C. wire may be used throughout), and connect the first turn to the fixed plates of .0005 variable condenser, and the last turn of the coil to the moving plates. You will find it an excellent crystal receiver. Let us know if you would like a diagram.

Mr. J. M. Sheppard (73 William Street, Sydney) writes: "I tuned in a 'phone station on my R.C.A. short-wave receiver at full loud speaker strength somewhere between 15 and 18 metres, at 9.50 p.m., 24/1/29, playing gramophone records, one of which I recognised as 'The Whistler and His Dog.' Would any reader who poked up this transmission let me know, through these columns, if he heard the call sign, as I was obliged to leave my receiver before the station gave it out. I might mention here I have never missed getting a copy of your interesting paper for the last 18 months, and have built a number of receivers from your diagrams."

Answer: Thanks for your kind remarks. Probably Bandaeng, Java.

D.J.L. (Toronto).—"Would you kindly let me know if it is too late to join the 'Wireless Institute'? If not, would you let me have the address of saue?"

Answer: The address is 5 Elizabeth Street. The admission fee is £2/2.

W.F.M. (Harden).—"Would nonecomb coils be suitable for 'The Countryman's One-valve' ('Wireless Weekly,' 25/1/29)? What gauge wire do you recommend for the 'Loveless' aerial? Would one Amphon Carboncol be suitable as an 'A' battery on a one valve set—and on the Marco Four?"

Answer: Nonecomb coils may be used in "The Countryman's One Valve." Use 18-gauge wire for the aerial, spaced 1/8 own diameter for each turn. Re Carboncol depends on type of valve used. If Re Carboncol is used with a Phillips, Radiotron, Osram, Mullard, or other 4-volt valve this will be O.K. You would require a Carboncol with greater ampereage for the Marco Four. Thanks for your kind remarks.

A.C.W. (Bassendean).—"Are 2ME and 3ME still on 28.5 metres and 32 metres respectively? Wnen do these stations broadcast?"

Answer: See the List of World's Broadcasting Stations on Long and Short Waves. Times of transmission vary. 2ME usually transmits on Monday, from 4.30 a.m. to 6 a.m. Sydney time. 3ME is from 4.30 a.m. and 6.30 a.m. Sydney time. This information is contained in the list of broadcasting stations.

N.D.E. (Summer Hill).—"Please give me a complete list of the hours a.m. and p.m. corresponding with the four figure method—starting from midnight."

Answer: Midnight is 2400 (i.e., 24 hours no tens of minutes, and no units of minutes); 1 a.m. is 0100; 2 a.m., 0200; 3 a.m., 0300; 4 a.m., 0400; 5 a.m., 0500; 6 a.m., 0600; 7 a.m., 0700; 8 a.m., 0800; 9 a.m., 0900; 10 a.m., 1000; 11 a.m., 1100; noon, 1200; 1 p.m., 1300; 2 p.m., 1400; 3 p.m., 1500; 4 p.m., 1600; 5 p.m., 1700; 6 p.m., 1800; 7 p.m., 1900; 8 p.m., 2000; 9 p.m., 2100; 10 p.m., 2200; 11 p.m., 2300; midnight, 2400. Minutes are shown in the last two figures in place of noughts. For instance, 9.35 would be 0935.

H.B. (Earlwood).—"Being anxious to obtain loud-speaker strength on one valve, I intend building 'The Countryman's One Valve.' Will the characteristics of the valve mentioned hereunder be suitable?"

Answer: No; use a Radiotron 169, a Phillips 4-volt, or any of the 4-volt detector valves. A Phillips 4-volt (Carlton).—"I built a 'B' eliminator described in 'Wireless Weekly,' and found the H.T. was passing through my filaments."

Answer: Place a 1 mfd. condenser in series with the earth lead, and make couplings between the primary and secondary coils, inductive instead of magnetic.

W.W. (Randwick).—"I have a Marco Four, which is giving excellent results, but I suffer interference from trams, which run right past my house. There is a grating noise."

Answer: Build the interference eliminator, and try a counterpoise instead of an earth. See that your aerial is running at right angles to the tram cables, which carry something like 33,000 volts.

D.O. (Young).—"Will you please tell me if the enclosed is shellac or some brand of size?"

Answer: Shellac—poor quality. (2) "How would it be prepared for use?" Answer: For shellac varnish dissolve the flakes in methylated spirit, in quantities depending on the thickness of varnish required. Keep well corked, as the methylated spirit is soon absorbed into the air. Ezywark is good.

(3) "I have a six valve A.W.A. Radiola superhet. Can I use the short-wave adaptor described in queries with this receiver?"

Answer: Yes, if you remove the R.F. valves and the oscillator.

C.C.J. (Randwick).—"Will 'The Countryman's One Valve' suit my locality?"

Answer: Yes. (2) "I have all the necessary parts on hand; also a .00025 variable condenser. Can this be used in any way?" Answer: Yes, it can be placed across the reaction coil (try reversing the connections if results are poor), or it can be used in the aerial lead to help selectivity. The first method will give you control over regeneration.

R.C.W. (Belmore).—"What causes a continuous squeal in speaker when connected to wires 46ft. long from the set? Everything is O.K. when the 5ft. extension cable is used."

Answer: A matter of resistance. Use thicker connecting wires, such as electric light twin flex. O.K., with thin wire for some sets, where the added resistance is an advantage.

J.E. (Gungah).—"As you offered to give names of firms who could supply anything mentioned in 'Proving Radio' articles, I would be obliged if you would tell me where I could obtain in commercial quantities zinc oxide, zinc chloride, and oxide of manganese."

Answer: Messrs. Selby, Bulletin Place, Sydney, and Burroughs, Wellcome, Sussex Street, Sydney. If unable to obtain here, try Elliott Bros., Sydney; Parke, Davis; Australian Drug Stores. Mr. C. V. Hoek, 29 Blairgowrie Street, Dulwich Hill, desires to get in touch with you.

T.J. (Bondi).—"I have recently acquired a five-valve set. My desire is now to make a one or two valve set. Having no knowledge of wireless, I am afraid to dismantle this set, for I may ruin it, and I don't quite understand a circuit diagram. What would you advise?"

Answer: Leave your five-valve set intact, and purchase parts for the one or two valve receiver you require. They will not cost much. The same battery and valves as used in your present receiver can be used in the one or two valve. There is no need to follow the circuit diagram. "Wireless Weekly" supplies a back-of-panel wiring diagram, which is easily followed. Try the Countryman's One Valve.

QUERY COUPON

If you are in difficulties about reception or set-construction, let us know, and we will endeavor to set you right. Make your queries brief to the point, and, where possible, show lay-out and wiring design. Under no circumstances will answers to queries be made by letter or by telephone. All answers will appear in the columns of the "Radio Information Service," WIRELESS WEEKLY. Please answer the accompanying queries in your earliest convenience. I enclose this coupon in order to indicate that I am a bona-fide reader.

The Radio Information Service, WIRELESS WEEKLY. Please answer the accompanying queries in your earliest convenience. I enclose this coupon in order to indicate that I am a bona-fide reader.

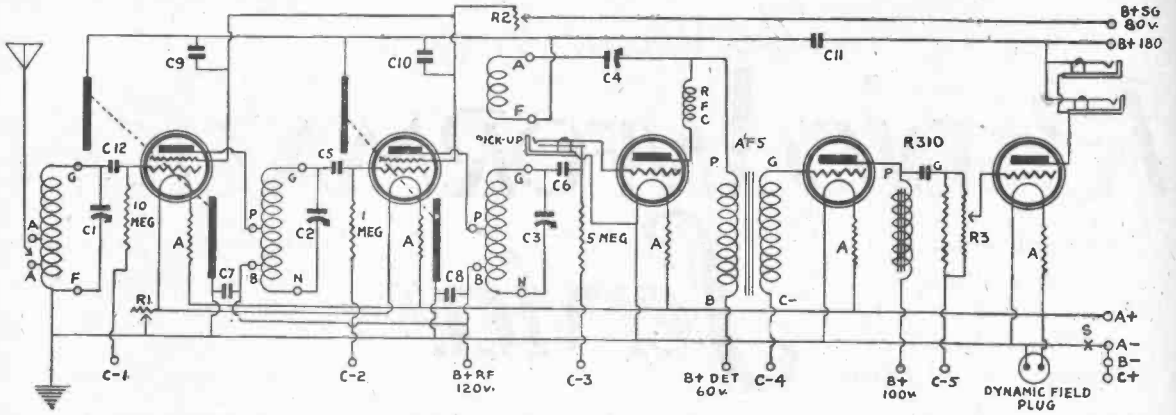

The circuit diagram of the Marnock de Luxe screen-grid five valve receiver, to be described in full in the next issue of "Wireless Weekly." This receiver is the outcome of many months' experimentation, and is the latest word in receiver construction. Do not miss the next issue.

S.J.L. (Sydney).—"I have a Swain's Simpler Three, and wish to build the S.W. adaptor described in "W.W." January 4, by the Query Answerer. (1) Re the R.F. choke, does 1/2 in. core mean an iron core? Answer: Yes. (2) I use a home-built "B" eliminator and cannot use the earth connection. How shall I connect the earth of the adaptor?"

Answer: It will be O.K. to attach the earth lead in the usual manner with the adaptor, because the coupling is inductive. You can use an earth lead on your set if you place a 1 mfd. condenser in the earth lead.

(3) "Is the Vernier dial necessary?"

Answer: Yes, otherwise you will find it practically impossible to tune in a station correctly. Tuning is very fine on a short wave set. Thanks for your kind remarks.

W.H.O.N. (STANMORE).—"I desire to submit a few questions in respect of the Perfection Five Valve described in last year's 'Radio.' The set employs two stages of R.F., one stage detector, and two audios. The coils are Radiok's Circloid. I have built this set, and may state that it fully justifies its title 'Perfection.' I find local stations come in excellently, but I cannot get Inter-State at all. I substituted three controls instead of the one dial tuning, described in 'Radio.' I am using Philips valves throughout, so I did not include rheostats in this set. I may add that I think the new 'Wireless Weekly' a go-ahead journal, and well worth the few pence charged.

Answer: Though rheostats are not absolutely necessary, it would be advisable to use filament ballasts. I think the trouble lies in the fact that you are using three-control instead of one. Adjust all dials to the same reading, approximately. It

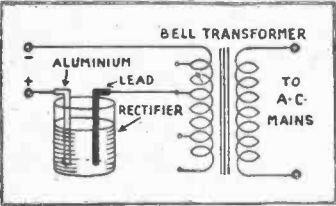

The 240-volt A.C. mains can be stepped down to 6 volts D.C. for ringing the house bell, and a variety of other services.

is more difficult to tune three dials than one. I think you will find (when you get used to the tuning a little) that the Inter-State stations are there all right.

H.S. (HURSTVILLE).—"Could you let me know through your wireless paper if there is a wireless set that will pick up England direct without any relays? What circuit would be employed?"

Answer: Any good short-wave receiver. The Go-Getter, the All-Empire, and others. Would you like us to publish a circuit for you?

L.D. (DROMOYNE).—"Proving Radio" you have described an apparatus for use of the power or electric light mains. (1) Is this a battery, charger or an 'A' eliminator?"

Answer: Neither, but it can be used for both purposes. There will be a slight hum if used as an 'A' eliminator. It will not charge batteries direct, but may be used as a Trickle Charger.

(2) "If the former, how long approximately would it take to charge a 60 amp hour 6 volt accumulator?"

Answer: As the amperage is very low, it would take a considerable time, perhaps three or four days, or even more.

(3) "If it is an eliminator, can it be used as a battery charger?"

Answer: This was answered above.

(4) "I have some spare Osclim lamps, but no spare filament lamps. Would the Osclims do as resistances in the circuit whilst 'forming the rectifier'?"

Answer: Yes, but keep an eye on those Osclims, as they can be used in later experiments with oscillation effect.

(5) I have only changed over to your paper since

the beginning of the New Year, but I'm satisfied already that this is one resolution that is not likely to be broken."

Answer: We're pleased to hear it!

J.N. (Gunnedah).—"I am writing to let you know that I am having trouble with my machine. I have had it ten years, and in the last ten weeks something has gone wrong. I have bought new batteries, but it makes no difference. Other people who have sets similar to my own are getting good results."

Answer: The makers are always ready to assist you. Why not send the set to A.M.A.? They will. I am sure, be pleased to tell you what is wrong. Unfortunately, you give me no idea as to where the trouble lies—whether it is in volume, sensitivity, selectivity, distortion, or anything else. Mr. Marcus J. Oliver, who lives near you, may be able to help. Advise you to do the right thing first, i.e., see the makers of the set. In any case, you must remember that the set is very, very old, indeed, considering that radio has not been in Australia for much more than ten years. Your set is decidedly out of date. Why not place your old set as a deposit on a new one?

A.W.O. (Leichhardt).—"I have a three-valve Reinartz receiver, and would like to know which aerial, high or low, would be best for Inter-State reception. Please give me details of a good all-round aerial for reception of an Inter-State station."

Answer: Your best plan would be to add a stage of R.F. to the receiver, making it into a Marco Four. You would have a much better chance of Inter-State reception then. The most ideal type of aerial would be short, fairly high (up to 60ft), at right angles to power mains, etc., and would be of the single-wire inverted L type. You will also find that there is one good spot for the aerial (for all aeriels have a directional effect), and you should (if room is available) manoeuvre your aerial to find the best direction.

J.G.K. (North Sydney).—"Why is it that, in spite of the fact that 2FC and 2BL are using the same power, 2FC is received at twice the volume of 2BL on my crystal set? I have always noticed this—on other sets, too. 2BL is always the worse station."

Answer: You are, in the first place, nearer to 2FC's transmitting aerial than you are to 2BL's transmitter. Further, you may suffer some interference (on an insective crystal set) from 2GB.

Disgusted (Newcastle).—"How can I overcome interference from a Nizer refrigerator? Who are the proper authorities to deal with this kind of nuisance? What are the particulars of construction of underground aeriels that are at times recommended to avoid interference?"

Answer: Build the Interference Eliminator, published in these columns on January 4, 1923. The

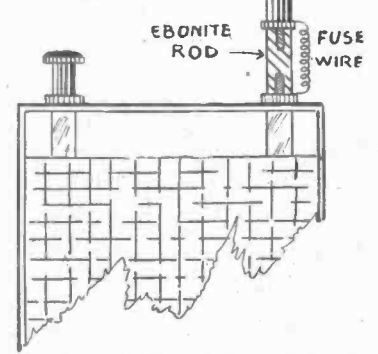

A simple accumulator fuse will protect your valves and batteries. The drawing shows how the fuse should be mounted on the accumulator.

local council may be able to help, but at present the subject has not caused enough annoyance for concern. There may be a leak somewhere in the refrigerator. Shielding your coils may help. Particulars of underground aeriels, in fuller detail than could possibly be given here, were published in "W.W." a week or two back.

C.J. (Kogarah).—"I am thinking of building the Harkness Reflex receiver, and would like to know if I could use a .00035 condenser instead of the .0005. If so, what alterations would be necessary?"

Answer: Add ten more turns to the coil.

W.R.M. (Glen Innes).—"I wish to make a Carbon-cell to replace my six-volt accumulator. Since reading of the one described in 'Proving Radio' I have been wondering if you could give me details as to the size of the carbon, zinc, size of jar, and amount of sal-ammoniac and water to use. Approximately how long would a battery of this type last in a four-valve receiver using the set, say, three hours a night?"

Answer: The diagram published in the article shows that the original was built in an ordinary drinking glass. However, since you desire to use the battery on your receiver, one with a bigger ampere-hour capacity would be necessary. Therefore, I would suggest that you use a jam jar for container. The sal-ammoniac solution should be poured in until the jar holds little more than two-thirds. The size of the zinc rod should be the same size as the carbon rod, and the only size available when the writer carried out his experiments was 9/16 in. long by 1/16 in. diameter (B.G.E.). Cannot tell you how long the battery would last on your receiver, because (1) the ampere-hour capacity is very small, and varies with size of components used; (2) you do not mention the type of valves in use. In any case, several of the batteries would be needed in series and in parallel in order to give the correct voltage and amperage. The larger the cells the greater will the amperage be, though the voltage will not go beyond 2. Have noted your remarks re postal address.

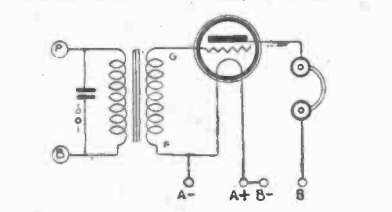

Add this one-valve amplifier to your crystal or one-valve set. It will give you ten times the volume you are at present receiving.

P.F.C. (Ashfield).—"When I first procured my set I could get gradual volume from a whistler to loud-speaker strength, but now I have to turn the knob on an inch before anything happens; then it is too loud. If I turn the knob back a fraction everything disappears."

Answer: A breakdown in the volume control. Use a Bradleymohm or Centralab resistance—0 to 500,000 ohms.

GENERAL.—Has any reader a spare copy of "W.W." containing the Filadine One Valve? The inquirer is Mr. L. W. Mackenzie, Smithtown, Macleay River. (Published November 11, 1922.)

E.J.L. (Kilcoy).—"The above reader would be gratified if you would send him a copy of your one-valve Filadine circuit."

G.H.H. (Strathfield).—"I have an Extraordinary One Valve, and would like to increase the volume. When I turn the rheostat up more the set breaks into oscillation. I am using a Philips A415 valve, with 42 volts 'B' battery. Would an increase in the 'B' battery supply increase the volume? If so, how many more volts would be necessary? I have been a consistent reader of your 'Weekly' for the last 18 months, and have got many useful hints out of your 'Radio Information Service.'"

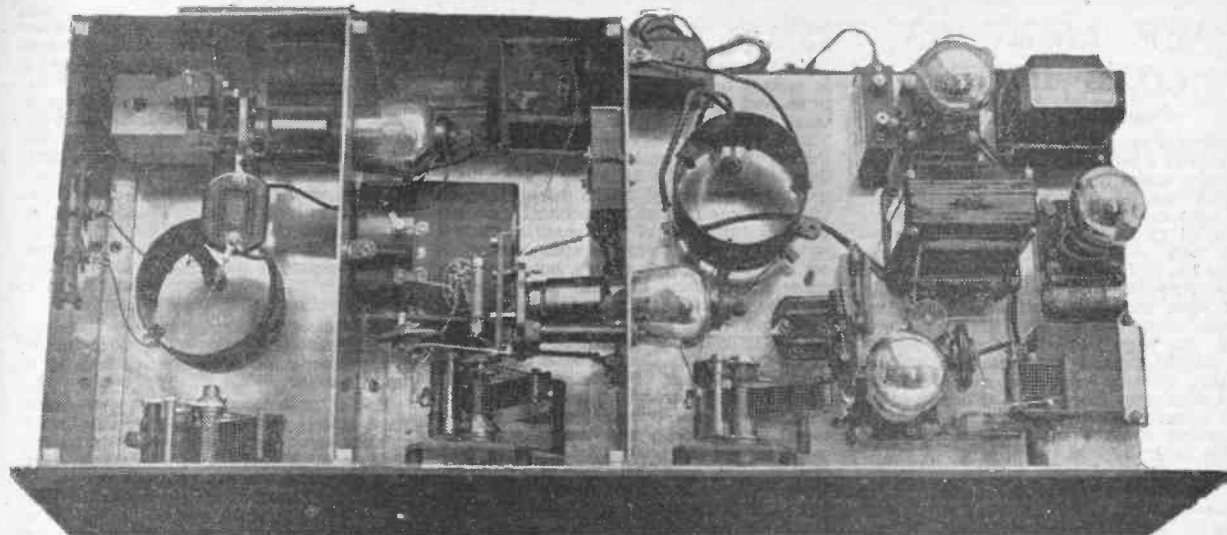

A plan view of the Marroch screen-grid five valve receiver, to be described in the next issue—one of the best of the 1929 new model receivers.

Answer: It will be necessary to add a one-valve amplifier. The circuit is published in these columns. Do not use more than 30 volts on the detector. When using an amplifier, you will probably find that 20 volts is quite enough for the detector.

C.H.O. (Unanberra).—"What is the average life of a Burgess 'C' battery in a three-valve receiver, using six-volt valves and accumulator?"

Answer: Approximately 12 months.
 (2) "What are the correct valves to use in a three-valve Reinartz with a six-volt accumulator? I prefer Philips. What power valve should be used? Which is the power valve socket?"

Answer: Detector (first socket, from left to right), A615; first audio (second or centre valve), A609; power valve (last socket), B605.

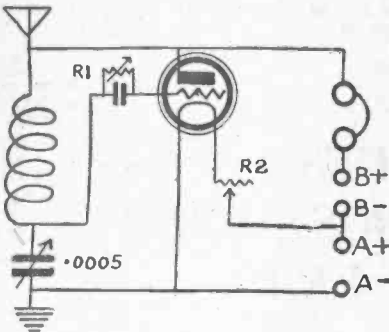

This circuit shows a simple one-valve receiver. Coil consists of 50 turns 24-gauge wire on a three-inch former. Grid leak 0-10 variable. Grid condenser, 00025 MFD. Rheostat (R2), 30 ohms.

A.R. (Dulwich Hill).—(1) "What are the QRA's of KEL, KTN and JAN?"
 Answer: KEL—San Bolinas, California, U.S.A. Cannot place KTN, which is (according to the call sign) an American station. JAN is situated at Tokio, Japan.

(2) "Where could I procure a complete list of amateur transmitters?"
 Answer: The A.W.A. Handbook for 1928.

(3) "What other radio club is near my district besides 'Croydon'?"
 Answer: The Proving Radio Club, c/o Mr. C. Y. Hook, 29 Blairgowrie Street, Dulwich Hill. This is in your own district.

R.C.T.H. (Coomb).—Please send me your address. A kind reader has forwarded us a copy of "Wireless Weekly," August 12, 1927, which you require.

W.D. (Rockdale).—Please forward me your address. A lady reader has kindly sent us the copy of "Radio" (June 15, 1928) for which you were inquiring.

V.C. (Leura).—Thanks very much for the two copies forwarded on behalf of our readers. We are much obliged.

A.M.A. (Lane Cove).—"Please explain, in very simple language, the action of a wave-trap."
 Answer: Stated simply, the theory is this: A broadcasting station sends out two waves, i.e., an ether wave and a ground wave, in the same manner that an electric cable carries negative and positive current. The wave-trap resembles the first part of an ordinary receiver. The aerial carries the movements of current down through the primary coil, and instead of being picked up by induction in the secondary coil, these movements in current (termed radio-frequency oscillations), are earthed. As the

other wave from the station is also a ground wave, we might roughly say that the undesired station has been 'shorted,' thus allowing us to tune in another station without interference.

J.E.G. (South Lismore).—"Some time ago I built the Marco Four, and found it a wonderful receiver for winter reception, but it weakened down in summer. I decided to wire the coils the same as shown in the article, 'The One Control Marco,' and then wired them together as shown in the Universal Four. This was much better, and I think it will improve again when I fit the 1 mfd. condensers in. However, I have struck trouble somewhere. I used a special power valve, and increased the voltage, but, instead of improved results, I lost power. What might be the trouble? Where can I get glass tubes suitable for a wet 'B' battery? I have found the 'Marco' very cheap to run. Also, I am very pleased indeed with your 'Proving Radio.' Just what we mugs want. Might call you by air some day!"

Answer: The coil system seems to be out of order. Perhaps the special detector valve is not suitable. Try an A615 or a 201A. Glad you like "Proving Radio." Mr. C. Y. Hook, 29 Blairgowrie Street, Dulwich Hill, is forming a "Proving Radio" Club. Why not join it? You can get glass tubes from Selby's, Bulletin Place, Sydney.

Mr. L. Hellyer, Sydney, writes:—"I shall be pleased if you will insert in your query columns a notice to readers that I have received a reply to my request for 'W.W.' for June 29, 1928. No doubt by the time this goes to press, I shall have received several more replies. If so, the numbers will be returned with postage. Thanking you for your kind service."
 Answer: Glad you were fixed up, Mr. Hellyer. Thanks for your consideration.

A.F. (Haberfield).—"I shall be pleased if you will advise me as to the most efficient circuit for a three-valve set making provision for an additional stage at any time."
 Answer: The Reinartz Three, which can be made into a Marco Four by the addition of an R.F. stage.

F.G.H. (Wagga).—"Will you please published a circuit of the Marco Four, and give details of winding my own coils?"

Answer: The article appears in this—or may be, next week's issue.

J.L. (Bodalla).—"I have made up five Peridyne sets for friends. Each has been perfect, no trouble. Last two used 30 ohm rheo. Instead of Bradleystats, and I find control far better with them—and I have used only the Molebdynite fixed crystal. This has given every satisfaction and absolutely no trouble. Am going on with the Screen Grid Peridyne now, and intend to try the above crystal in place of carborundum suggested. Do you think it will stand up to this work?"

Answer: Yes, quite O.K.
 G.E.R. (Coogee).—"I was a constant reader of 'Radio' and was very sorry when circulation of

that paper was discontinued, but I have started to be a regular subscriber to 'W.W.' and I am finding it very satisfactory. Being interested in short-waves, I built the 'Go-Getter' published in 'Radio' some time ago, and up to now have had a great deal of success with it considering my situation at Coogee. I have tuned in the following international stations, BSW, RNF, ANE, VPD, POC, PCL, together with 109 Australian and New Zealand on telephone only—for I can't read Morse yet. You have published in 'W.W.' several times a list of in-

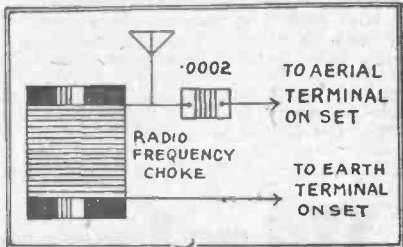

The remedy for local electrical interference is a counterpoise and an interference eliminator. Wind 100 turns of 24-gauge wire on a three-inch former.

ternational short-wave stations with the times of broadcast in form of G.M.T. I find difficulty in converting G.M.T. into Sydney time. I would be much obliged if you could tell me, per columns of "W.W." how to convert these times from one to the other.

Answer: Sydney time is approximately ten hours ahead of Greenwich Mean Time. Thus, if it is noon in London, it will be approximately ten hours earlier in Sydney, i.e., 10 p.m. I am not sure whether or not you refer to the four-figure method, so in case, I'll explain this. The first two figures represent the hour of the day, and the last two figures represent the minutes. Thus 1100 is 11 a.m. There are twenty-four hours only in the system—and 1 p.m. would therefore be shown 1300. 1 a.m. is 0100, 2 a.m. 0200, 3 a.m. 0300, 4 a.m. 0400, etc., 10 a.m. is 1000, 11 a.m. is 1100, noon is 1200, 1 p.m. is 1300, 2 p.m. is 1400, midnight is 2400. 11.35 would be shown 1135 if it was in the morning (a.m.) whereas 11.35 p.m. would be shown 2335. In any case, the lists now published in our paper are reverted to Sydney Mean Time, so there are no calculations for you to make.

R.L.G. (Alstonville).—"Re the Ultimix Three. I have constructed this set, with all parts as specified, and have had excellent results. Would the addition of another stage of audio to this receiver improve its capabilities as to daylight reception? I am 300 miles from Sydney. At present I receive these stations at fair headphone strength. Congratulations on the new 'Wireless Weekly.' What combination of valves, transformers, would be required?"

Answer: The set might be too unstable if you were to add another audio stage, and reproduction would be distorted, and mixed with howls and squeals. Suggest you add a Radio Frequency Booster Unit, which is in effect another R.F. stage.

J.H. (Abermain).—"I wish to know does daylight reception from Melbourne come through to Sydney by telegraph, or by telephone, such as test matches and races, or is it relayed from 2FC or 2BL?"
 Answer: Daylight reception refers to direct reception of the Melbourne station in the same way that you hear 2FC. Daylight reception does not include reception of a distant station through a relay. Telegraphy is a system of signalling, and telephony is not sent by telegraph. The telephone is used when re-broadcasts take place. The telephone is then called a land-line.

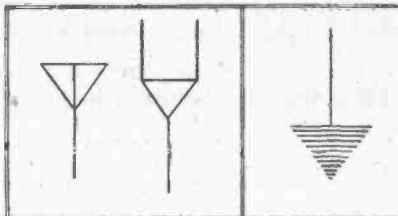

Simple Simon asks for simple symbols. This diagram shows the earth symbol, and the two signs that are used to denote the aerial.

NEW LIGHT ON CONE ACTION

(Continued from Page 27.)

piston in a gas engine; in other words, that it acted as a very rapid air pump, generating standing waves in the air. For this action, a stiff, non-stretching and non-vibrating but light material is desired. Paper does not fulfil all of these requirements. Good results have been attained with paper cones under 7in. in diameter, when their edges were pulled outward by an elastic tension member, and when they were actuated by a long stroke (over 1-32in., and preferably over 1in.) But even under this form of mounting and drive paper is not perfectly adapted because there is some wave motion set up, thus destroying overtones; furthermore, the high power required to obtain the necessary amplitude shatters and loosens the fibre of the paper, causing breakdown.

Other studies of many surfaces in present use indicate that the motion is anything but a piston action. To make clear what takes place it should be understood that a body of matter can set up air waves by at least five different motions or combinations of them:—

- (1) Increase and decrease in length.
- (2) Increase and decrease in width.
- (3) Increase and decrease in thickness.
- (4) Flexural waves moving lengthwise.
- (5) Flexural waves moving sidewise or circularly.

Now, when a thin material is so shaped that it can be actuated from one point, the exact motion which takes place is determined by a large number of factors. Observation shows that any or all of the varied motions can take place in the same cone or surface generator at different frequencies. For instance, in a small cone at low frequencies, trough-like waves from the apex outward are formed. The ends of these troughs tend to

become sine curves. Now, the sum of the sines must be greater than the circle from which they are formed. Hence, properly to execute this motion, a cone must be able to expand and contract its diameter, or, to speak more correctly, to change its angle. This, plain paper cannot do; consequently, the low frequency notes from paper cones are dull or flat. As the frequency is raised, the number of peripheral trough waves increases until, at some frequency dependent upon the physical constants of the cone, a flexural wave, progressing from the apex outward, is set up inside of each trough, but of reverse phase in adjoining troughs. This demands that the material be able to bend with small resistance. Thin paper may readily do this but in so doing, it usually makes a noise of its own. As the frequency is further raised, the number of these outward rolling waves in each trough increases, and the amplitude of the trough decreases until it seems to disappear, and then the flexural waves reverse and become the same phase all around. The cone then generates only circular rolling waves outward from the apex, like those produced by dropping a stone into a pond of water, since these are very small with relation to the thickness of the cone. Properly to execute this motion, the cone must increase and decrease in length from the apex to the edge. This, also, paper cannot do unless excessive power is applied. Now it happens that the electrical combinations used in sets and amplifiers do give excessive power in high frequencies to which a paper cone responds, and thus the high frequency response seems ample or even exaggerated. Nevertheless, the paper cannot respond to the weak high frequency overtones which give music its beauty.

This information has, of course, been obtained in the laboratory by precision methods. The author witnessed a simple and ingenious experiment which enabled him to see successively all the motions in a special cone. The cone was actuated by a phono-

graph record of known keynote or frequency, and the observations were made by microscopic examination of a single gold-dust speck fastened near the periphery of the cone. Several frequency motions could be seen. (Keynote equals 426 Int. A—visible frequencies equal 106, 142, 213, 426, 852, 1278, 1704, and, to some extent, thirds and fifths of these. Light frequency is 425.) The speck could be seen at different frequencies moving parallel with the rim. This showed expansion and contraction of the rim, and reciprocity on a radial line showed increase and decrease in the radius. By changing the angle of observation, rolling waves in both directions could also be seen.

Aural demonstrations were also made, and the difference in quality of reproduction over a paper cone could be detected even by an untrained ear.

The manufacturers of these special cones have always asserted, and laboratory investigation establishes the fact, that "edge control" of such cones is not necessary. Furthermore, their claims regarding the curved line form of these cones are shown to be correct. By curving the lines of the cones outwardly instead of using the straight line of paper cones, new and better results are obtained. This curve is such that a narrow angle is obtained at the apex which will withstand high power, and the angle increases at such a rate that internal reflections are avoided. This shape not only dispenses with the need of "edge control" of the cone, but also enables more power to be handled and better reproduction to be obtained.

The physical constants of the material are quite different from paper, and the best results can be obtained by determining the correct characteristics for a given speaker in the laboratory. This is particularly true of the curved type of surface, because, in this type, the shape of the curve is a function of the driving unit, and the space available.

Wireless Weekly

52 ISSUES
DELIVERED POST FREE
FOR ONE YEAR

13/-

"WIRELESS WEEKLY" gives you the complete broadcasting programmes from every important station in Australia a week in advance in addition to topical news and articles and a technical constructive article by a qualified radio man.

SUBSCRIPTION FORM

To the Editor, "Wireless Weekly," 51 Castlereagh Street, Sydney.

Please forward "Wireless Weekly" for a period of
for which I enclose for

(Add Exchange to Country Cheques.)

NAME

ADDRESS

Subscription Rates: 12 months (52 issues), 13/- post free; 6 months (26 issues), 6/6 post free.

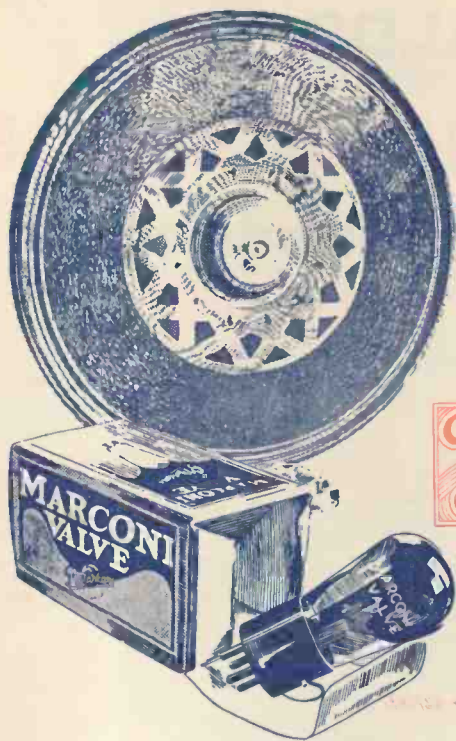

The New Marconi Valves and Speakers

THE proved efficiency of the new Marconi valves and speakers is the result of years of careful research by the engineers of the Marconi Company, England.

Three years intensified research in loud speaker production introduces the ultimate in cone loud speakers—the new Marconi cone—This new loud speaker meets every exacting condition, bringing an entirely new conception of broadcast entertainment.

The new Marconi valves, available in two, four and six volt series, are noted for their economy of operation with regard to both "A" and "B" batteries. They ensure a maximum of undistorted signal strength with a minimum of current.

Adjustment of the new Marconi Cone Loud Speaker is at the front. The cone is protected at the back by a metal bracket

Price . . . £5

The New Marconi Valves are packed on scientific principles. Risk of breakage during transit is obviated.

Obtainable all Radio Dealers

MARCONI VALVES & SPEAKERS

"as famous as the name they bear"



Amalgamated  Wireless
(Australasia) Ltd.

February 1— HERALDS Price Reductions in the Cone Models

AMPLION CONE SPEAKERS BRITISH and BEST



Chippendale Mahogany. Model AC9 (Senior). Old Price £9/10.
New Price £7/10/-



Junior Bronze Hang-
ing Cone. Model AC 2 (Junior)
Old Price £4/10/-
New Price £2/15/-



Jacobean Oak. Model AC7 (Senior). Old Price £7/15/-
New Price £6/17/6



Junior Bronze Open
Cone. Model AC1.
Old Price £4/10/-
New Price £3/17/6



Senior Silver Open
Cone. Model AC3.
Old Price £6/0/0.
New Price £4/17/6

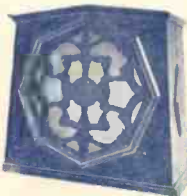

Dark Oak (Senior). Model AC5. Old Price £7/10/-
New Price £6/10/-

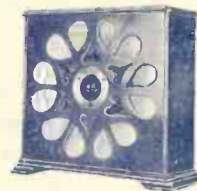

Junior Cabinet. Model AC4. Oak. Old Price £5/5/-
New Price £4/7/6
Mahogany. Old Price £5/10/-
New Price £4/12/6

Whether you already have a Speaker or are thinking about getting one, the unprecedented value as represented by the new Amplion prices, will attract you. Throughout the world Amplion is the recognised standard, giving reproduction of the finest quality yet attained.

AMPLION

(A/sia) Ltd.

Bradbury House, 53-55 York St.,
SYDNEY

COUPON:

Please mail me illustrated literature describing Amplion Cone Speakers, etc.

Name

Address

State