

WIRELESS WEEKLY

Broadcast Programmes a Week in advance

VOLUME 9

Registered at the G.P.O., Sydney, for
transmission by post as a Newspaper.

NUMBER 20



Friday, March 11, 1927.

Price Threepence

UDISCO Receivers

that supply every demand

Perfection of tone, reproduction from all Stations, local and Interstate, without interference, on the Loud Speaker. Economy in price, sturdiness in manufacture, and handsome appearance.

Both the Sets here shown are most simple to operate, and will bring in Queensland, Victoria and other Interstate Stations on either Loop Aerial, Indoor Aerial or ordinary Aerial with the greatest of ease. Any Station can be eliminated with the fraction of a turn of the Dial. The volume from each Set can be made far greater than is needed for any ordinary purpose.

UDISCO B.T. COUNTERPHASE SIX—made up on the famous Bremer Tully Circuit, which is world-renowned as being one of the most selective and satisfactory circuits ever produced during the past two years, is sold as shown, with Cabinet and Stand of Polished Maple for £57/10/-
Or without the Battery Stand . £50/-/-



The Udisco B.T. Counterphase, 6-Valve Tuned Radio Frequency Receiver

Complete with Quam or Amplion Speaker and the very best of equipment £82/10/-

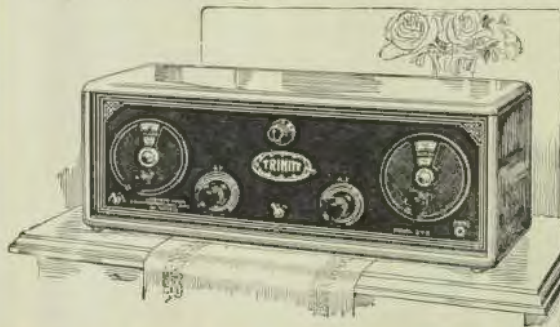

THE PILOT 5-VALVE TRINITY SET. The sturdiest and simplest 5-Valve Set on the market to-day. Splendid tone, great volume, and a real distance getter.

Price, as shown £20/-/-

And with all Accessories required to give really good reproduction £35/-/-

United Distributors Limited

WHOLESALE ONLY:

72 Clarence Street, Sydney.

343 Queen St.,
BRISBANE

27 Chesser St.,
ADELAIDE

26 Queen St.,
PERTH

Cr. Jervois Quay & Harris St.,
WELLINGTON, N.Z.

66 Charles St.,
LAUNCESTON, Tas.

AWA Radio Guide 1927 Edition

The Editor of "The Wireless Weekly"



in the Mar. 4th Issue writes

"One Hundred and Seventy Six pages of some of the best and most useful matter we have yet seen compiled in book form—that is the best concentrated opinion we can give of the "A.W.A. Radio Guide" 1927 edition issued by Amalgamated Wireless (A/sia) Ltd."

" The Technical portion of the book is exceptionally well written "

Summed up briefly, the matter contained in the "A.W.A. Radio Guide 1927" is just as interesting as the front cover is attractive. "IT IS BY FAR THE BEST PRODUCTION OF ITS KIND THAT WE HAVE YET SEEN"

Price 1/- Postage 5^d. Extra

Send for your copy today!

At all Radio Dealers, at NSW Bookstalls and at

Amalgamated Wireless

(Australasia Ltd.)

97 Clarence St., Sydney

167-9 Queen St., Melbourne

King & King Chrs,
Queen St., Brisbane



Lowest Prices in RADIO History!

THERE are no extravagant claims made for Harringtons Sale---it is a *Genuine Sale* at which not only are prices reduced to the absolute minimum consistent with business, but, to effect a rapid clearance, various lines are priced at startling low figures

End-of-Sale Opportunities offer startling bargains!

Sample Sets are offered at Genuine Clearing Prices:

Four only, 4-valve sets (bare) £4
Complete £11

Six only, 4-valve sets (bare) £8/10/-
Complete £17 10/-

One 5-valve set (bare) - - £13

One 1 valve set (bare). - - £4

Accumulators

6 volt 33 amp - - - £2/5/-

Other types and capacities are also drastically reduced.

Boys' Wireless Books - 1/-

Make it an important point to visit Harringtons Radio Basement--- especially before these End-of-sale opportunities go.

Take advantage NOW of these sweeping reductions

MELBOURNE:
286 Collins Street,

BRISBANE:
93 Queen Street,

ADELAIDE:
10 Rundle Street,

NEWCASTLE:
81-86 Hunter Street

Harringtons LTD

Gradually Built on Public Confidence since 1889
386 GEORGE STREET :: SYDNEY

KATOOMBA:
Katoomba Street,

NEW ZEALAND:
Wellington:
40-42 Willis Street,

Auckland:
140 Queen Street,

WIRELESS WEEKLY

VOL. 9, No. 20.

FRIDAY, MARCH 11, 1927.

Service

THE adjudicator in a 4QG broadcast debate between one side advocating radio as a utility as against radio as an entertainment, decided that radio was a utility. The decision, of course, may have been made purely on the grounds of controversial skill, and it is significant that the debate took place immediately following the devastating Cairns cyclone, when radio saved many lives by directing relief parties issuing warnings, and calls for assistance, but there must have been more in the argument than that.

When we say that broadcasting is essentially an entertainment, we use the word in its restricted sense, as applied to the transmissions of the large stations depending on the support of the enthusiast for their maintenance. The word radio embraces more than that, and it is quite wrong to regard radio as essentially an entertainment.

Radio is communication, and as such it is of far more value to civilization than as an amusement or an entertainment. We overlook this because broadcasting, coming directly in contact with us, has seized upon our imaginations, and is, therefore, uppermost in our thoughts. We forget the utility value of radio as the cheapest, quickest, and least expensive means of conveying messages

across the sea and land. Broadcasting owes its early development to the fact that it was destined to be a popular entertainment, and that there was money and fame in it for those who seized the opportunity. Radio as a service offered the same inducements, but only at the end of long and tedious experimentation. No doubt the future development of wireless will not be in the direction of broadcasting as an entertainment, but in its application as a means of communication by voice and sight.

The utility value of broadcasting (using the word in its restricted sense) has not yet been fully exploited. We have not gone further than press news, market reports, flood warnings, and storm forecasts. There is only one broadcasting station in Australia which aims at service, making a business of the broadcasting of S.O.S. calls for missing property. A few attempts have been made to assist education by radio, but these have met with failure at the hands of unimaginative government officers. There are other phases of broadcasting service as yet untried, perhaps unthought of, which will find their place as we progress, but at present we conclude that broadcasting is essentially an entertainment, although radio as a whole is of most value to the world as a utility.



Between You And Me And The Microphone

Conducted by Jack Plugge



ON FRIDAY, FEBRUARY 25, a cricket team from I.O. scored a victory over a team selected from the Federal Government House Staff. The scores were 51 and 48. The Governor General, Lord Stonehaven, congratulated I.O.'s captain, Mr. Todd Collins, upon his team's victory.

MISS EILEEN HARPER, winner of the I.O. Perfect Girl Competition, was fortunate in being at Rotorua during the visit of the Duke and Duchess of York to the New Zealand hot springs district. Miss Harper and her chaperone were given a special vantage point from which to view the arrival of the Royal Party, and called the information to I.O. that "The Duchess was delighted."

OFFICIALLY OPENING IYA, Christchurch, the second broadcasting station of New Zealand, the Dominion Postmaster General (Hon. W. Newbould) said that there were only 4,500 licenses when he opened the Auckland station IYA six months ago. To-day there were 16,000. On a population basis, this represented an approximate increase of from 1 in 200 to 1 in 80.

PASSENGERS on board the Atlantic liner "Leviathan" can now avail themselves of a commercial wireless telephone service to any city in the United States while the vessel is within 2000 miles of New York. Conversation is also possible with other ships. The charge for the new service is £1 per 1000 miles for a three-minute conversation. Considerable reductions will be made shortly.



The Philistine (switching off): "Wicked the way this classical stuff is supplanting jazz—what!"

DURING a flute solo from IYA recently, reports a listener, a local bowler acted as an almost perfect accompanist for several bars. He thinks this should be barred.

Bahl

A DEBATE arranged by the Queensland Union of Debating Societies was recently broadcast from 4QG. The subject was: "Does the future of broadcasting depend upon its development as an amusement or a utility?" The adjudicator in making his summary decided in favor of the development of broadcasting as a utility.

THE BRITISH House of Commons and the Australian House of Representatives will play a radio chess match on the occasion of the opening of Canberra next May. For the longer-range match, Amalgamated Wireless and the British Post Office will transmit the messages without toll. As Canberra is ten hours ahead of London in time, many moves may be made the day before they are made.

Shades of Alice!

WHAT WOULD OUR PARENTS have thought of a box which, attached to a piece of wire thrown over the curtain rod, reproduced the voices of entertainments from hundreds of miles away? Such is a common occurrence now.

"CALLING" proved to be the most popular song in Mr. Jack Lumsdaine's competition held at 2FC recently. The winners were: First, Miss F. Tucker, Lakemba; second, Miss K. Foskett, Willoughby; third, Mrs. E. McKay, Newtown; fourth, G. Macaulay, Annandale.

ONE SUNDAY NIGHT recently police authorities informed 4QG that a patient was dangerously ill in the General Hospital and requested the Station to broadcast a message hoping to locate the sick man's brother who was living in the Oakey district. The message was announced by the engineer, and a few minutes later a call came from a garage in Oakey to say that the brother had received the message and was leaving for Brisbane.

A RADIO listener at Lakemba has written to 2FC asking that the G.P.O. clock chimes be broadcast more often. He explains that listeners in his neighborhood set their watches and clocks each night before going to bed, taking the time from the radio set. As a matter of fact, both the Sydney stations tune in G.P.O. every hour, and occasionally work in the quarter and half hour chimes as well.

World Explorers Always Select Burgess.

PLAYS that can be AIRED

What type of play do you enjoy most over the radio? The writer's answer to this question is the result of five years' experience writing and producing broadcast plays

By SCOTT ALEXANDER

If it is almost five years since I entered into radio work as an artist and a producer of radio comedies, and in that time I have studied the broadcast drama from every conceivable angle. Since my experience has been gained while working in front of the microphone, I am able to speak with some authority on this aspect of broadcasting.

The reader can hardly understand what five years practical work before the microphone means to an actor; he cannot know the thousand tiny experiments and tests which must be undergone in the endeavor for perfection. To the actor the microphone is a twin brother to the microscope, and functions for the ear in much the same way as the microscope functions for the eye. It can magnify a sigh into a cyclone, or make audible sounds that otherwise would not reach the ear.

You, who take such pride in your personal appearance, imagine yourself subjected to the scrutiny of a hundred thousand pairs of eyes through a gigantic microscope. You will then have some idea of the position of the radio actor, whose voice is his pride and his livelihood, when all the tiny faults and blemishes of his voice, magnified a hundred fold by the microphone, are heard by a hundred thousand people.

Although the microphone is a highly sensitive instrument, it possesses no soul; it offers no sympathy to the radio artist; it hears all he has to say, then casts it in a loud voice over the ether, to the furthestmost

limits of the earth. If he shouts, his tones will reverberate unsatisfactorily, if he whispers, it will whisper. If his emotions are not correctly tuned, it will denounce his work. It will show no mercy. There is no response, the artist is never whipped into his stride by the microphone, it does not tell him what his hearers think. It does not reflect the moods, passions, or magnetism of the audience which lies behind this mystic instrument. Yet it is a strange fact that nearly every actor possesses an extraordinary sense, a sense that is vital to his own work, the sense of feeling how his own work is going, the peculiar knowledge of success or failure. While the audience is still invisible, yet he knows when his work over the air is meeting with a response in the hearts—nay, the very souls—of his hearers, or is ingloriously failing.

I have had many difficulties to overcome, the greatest of all, in the use of the vocal organs. I found that in radio, too many voices sounded alike, and confused the listeners, since they had no means of seeing the lips of the person speaking. It was a very difficult problem and took me three years to overcome it. I tried many actors in many parts, without obtaining the results I required. I grappled with the question, but couldn't put my finger on the cause until I listened to

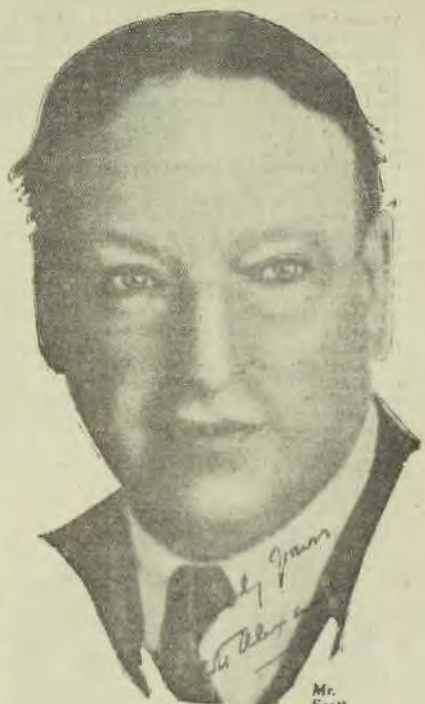

Mr.
Scott
Alexander

others. The similarity of voices killed the whole presentation. I at last remedied this by engaging artists solely for the quality of their voices, light, deep, musical, querulous, harsh, emotional, and the results were quickly apparent. I got characterization without visibility.

This was my first achievement. Later I discovered that it was easily possible for one artist to play two or more characters, by adopting a different note in the voice. I developed my own work along these lines, and built up a fabric that has proved most successful to me. I assumed several different personalities by adopting different voices, toning them with quaint dialects. I used the deeper notes in my voice for old men, and the top notes for garrulous old women.

After considerable study I brought the results to a final issue, when I played seven distinct characters in the first serial mystery play which I produced for 2FC, called "The Green

Diamond Mystery." Only a few of my keenest listeners were aware of my achievement, which I accepted as a great tribute to my development of personality in the voice. It was very hard work. I had to dissect and examine the personality of each character, and the class of voice that would go with it to make it distinctive. Then came the long conversations between three or more characters, and the sudden change required for each. I soon found a way to guide me (but this I must keep a secret for the present), and I can now manage these changes with the greatest confidence and ease. I am still studying, as I feel that I have only just cleared the surface of the subject, the gold still remains deeper beneath the soil.

The selection of plays for airing needs care. Ordinary plays, which make their appeal to the eye, spectacular plays, or the classic tragedies are nearly always a failure to the listener. Too much is left to the imagination, the action is lacking

and the most vital business of the play is eliminated, with the result that the presentation is incomplete, and it becomes a blur. As an instance, take any of Shakespeare's plays and read them. The word music is unsurpassed, and the stage directions are of the simplest, though they convey the action, without which the plays would be unrepresentable.

Take the last scene from Hamlet during the duel.

Laertes says: Have at you now, Hamlet wounds Hamlet; then, in scuffling, they change rapiers, and Hamlet wounds Laertes.)

King: Part them, they are incensed. Hamlet: Nay, come again.

(Queen falls.)
Later, the queen says: "I am poisoned," and the business simply states "she dies." Almost immediately following this Laertes falls, after which Hamlet discovers that the rapier was poisoned and the instructions are: "Hamlet stabs King," and after being told to "follow his routing," the King dies, after which Laertes dies, then Hamlet, after telling his friend Horatio that the potent poison quite overpowers his spirit, dies also.

The instructions are imperative to the play. Together they are the vital stage business, that marks the movement and action without which the story would be unphased. What you see at the theatre is what you hear when listening in. The action is missing, and that is why tragedy fails. The same fate is meted out to comedy, where the comic business, the expression on the quiet comedian's face or the comic action (which requires no words to help it), fails ingloriously over the air.

To broadcast the last scene from Hamlet successfully would necessitate a re-editing of the act, for the listeners would have to be told how and where Laertes and Hamlet changed swords. How they fought, and fell. How the Queen mother drank from the poisoned cup and died. How, in anger, Hamlet stabbed the villainous King and sent him unrepentant to his grave,

and then died in his friend's arms. This is impossible, so the plays are unrepresentable and fail.

Plays transmitted from theatres during their actual performance are difficult to follow. You hear a snort of laughter or a wild roar of applause, but you don't know the cause. You cannot see the stage business. Often the transmission, too, lacks evenness, through the actors being too far from the microphone. To my mind, these presentations will one day be eliminated, and only plays that can be "put over" satisfactorily, will be given from the studio, where a competent set of trained radio artists, directed by an efficient radio producer, will provide the public with just what they want.

Looking at this question from the listener's point, I quite understand why plays have not yet gripped them, as they should. There sits Mr. Listened, in his comfy arm chair, surrounded by his family, amusing themselves in direct ways, while the loud speaker (very often much too loud) is shrieking forth the night programmes. There sits Peter-familias staring round the room, with his mind only half occupied, as he tries to get to grips with the play that is being aired. If it is not crisp, if it does not possess an immediate punch, if he is unable to concentrate (owing to the noise in the room), what does he do? He simply switches off and gets in touch with another station, where a jazz band is tearing up the latest ball-room dance. He then lies back in his chair, and dilates on the impossibility of successful radio plays to his restless family.

Restlessness is the worst enemy of the radio. We live in an age of restlessness, and most of the people suffering from that complaint have radio sets. They must be considered and a programme provided for them that will prove soothing and restful. Then we have the child. The young child and the old child, they are the backbone of radio supporters. If the radio artist does not make good with the younger set, he is doomed to failure.

The writer of radio plays finds himself hedged round by all kinds of strange entanglements. He must not be too subtle, nor too outspoken, nor too clever (cleverness that gives itself away is criminal folly). High-brow radio work is senseless, for it demands too much concentration, and makes too small an appeal. So my rule is just simplicity. A plot easy to follow, yet interesting, with a surprise that is unexpected and delightful at the finish. Or a quarrel, for listeners love a row. I have seen quite a crowd of "Noisy Parkers" standing outside a house, listening to a quarrel, which

(Continued on Page 8.)

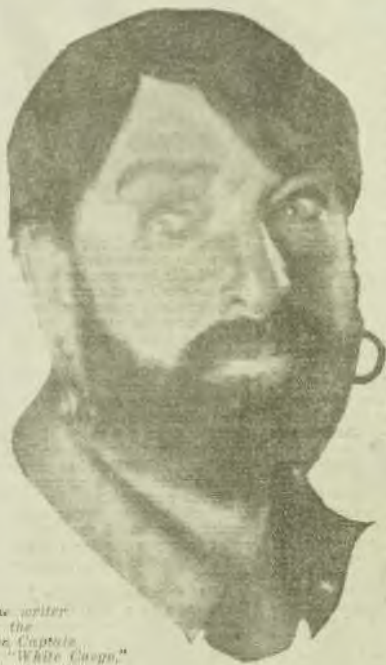

The writer as the *Sue Captain* in "White Cargo," an admirably portrayed character

Radio Helped Me to Recover

The large public hospitals are not the only institutions benefiting by radio. This is the inside story of the part radio is playing in many small hospitals throughout Australia as told by a patient.



LYING here in bed, the hours hang heavily, despite the view from the window, the pile of books and magazines, and a frequent contemplation of one's damaged countenance in a hand mirror, kindly supplied by a sympathetic but not too admiring nurse.

Half an hour's scrutiny of the view from the Bull Pass Lookout may send even the hardened Globa trotter into rapture, but if one were sentenced to gaze at the same scenery hour after hour, day after day, for weeks on end, the old saying about "When you are on the heights looking down, the view is different" gains a fresh significance. Just so with this view from my window—it takes in a beautiful wooded headland, some square miles of blue water, and, out through Sydney heads, the white caps as they go racing past. All very wonderful during the first couple of days, with the big steamers passing in and out to break the monotony, but rapidly losing its interest as various features become more familiar, and, having become familiar, become monotonous.

It is so also with the books and magazines. Reading to be really enjoyed, should be sandwiched in between one's other activities, but, like everything else, a surfeit of it produces extreme boredom, and one finds oneself yawning even over Zane Grey, Philip Gibbs, P. C. Wren, and those other "best authors" whose novels are universally acclaimed.

Inaction is a curse, but there are various forms of it, some of them more bearable than others. A rest by any other name may be just as sweet, but one hospital is just like another—except that some have wireless and some haven't.

About the time I commenced taking

an interest in things, I became aware of their novelty. Over in the corner stood a tall wardrobe with a full length mirror carefully turned away so that I couldn't see myself; in another corner was a chest of drawers; out the window were the scenic effects referred to before and through the wide open doorway I could see a picture hung on the wall, depicting a battle royal between two medieval Japanese warriors. One of them stood with spear poised ready for a thrust; the other one was in the act of taking a flying leap with the intention of looping his opponent's head off. A faint smell of ether crept into my nostrils and I learned that it came from the operating theatre just across the way—subsequently also I found that by gently manœuvring the ward-

robe mirror I could watch the reflected view of the nurse getting it ready for operations. This was very interesting to me, because I went in there myself. The glimpses of the theatre were but fleeting, however, because when anything really interesting occurred, the door was shut—and kept shut.

It was the picture that got on my nerves first. Subconsciously, I found myself figuring out what would happen if that fellow completed his leap—then I reckoned up the distance he was from the ground—the total distance of the leap. All these things kept my mind busy until unconsciously I had familiarised every tiny detail of the picture. Every time I looked out that door I saw it staring at me, hard and unyielding. I longed for the opportunity of scoring across the surface with a large hair brush dripping with red paint. Actually, of course, the picture was a work of art probably worth a great deal, but the sick mind is fretful and continued dwelling upon one particular subject is apt to cause what a wireless man would call "distortion." Turning to the window for comfort, I found the view entrancing, to my eyes, long accustomed to the stern lines of a tall building opposite my place of business in the city.

The flat surface of the blue water, the same trees and the red roofed house on the headland gradually became dull and uninteresting—so also



Fairlight private hospital, Manly, where the writer was confined for some weeks suffering from a fractured jaw, and lacerations and abrasions in the face and body—the result of a motor car accident.

did the wardrobe and the chest of drawers. Now and again a white-robed nurse stole in, took my temperature, asked how I felt, and then departed—anon she came in and performed the mysterious and painful operation known as "dressing." These brief visits, however, were akin to the oases in the desert, and it wasn't long before I knew exactly when they occurred. The occasional flink of a bell somewhere down below intrigued me for a time, but I soon learned to associate it with the various duties which occur in a hospital.

All these things may seem trivial—even childish—but the sudden reaction from hard work to absolute inactivity can scarcely be appreciated except by those who have unexpectedly found themselves in hospital.

One of the nurses drew my attention to a small bell-push hung on the bed-rail above my head, and it was while reaching gingerly up for this that I discovered that there were also a pair of headphones. Lifting these off I put one to my ear and heard a voice singing, and by and by someone announced "2FC calling—so and so will ring from the tea room."

Well, that banished the monotony for me—I listened in for hours, hanging on to every note, to every word, that came through. There was one particular humorist who set me cackling and giggling just like the kiddies whom he happened to be entertaining in the children's ward at the Royal South Sydney Hospital—I refer to Rex Garland and his inimitable officer Jerry.

I found that the broadcasting took me completely out of myself—I forgot my little worries and troubles, my damaged face, and took the most intense interest in everything that came through on those headphones.

Later, when I was allowed to walk about, I discovered the extraordinary extent to which wireless was made use of in that hospital. There were twenty beds, and each one had its pair of headphones, the whole linked up to a three valve receiver operated by the nurses.

In one room, a little fellow recovering from pneumonia and painfully thin lay there with the headphones clamped to his ears, quite obviously oblivious to himself and his surroundings. This little chap spoke learnedly of Uncle George, telling me scraps of what that genial personage had said to so and so. I asked him how he liked the wireless, whereat he answered "It's fine." In another room a young man who had undergone an operation only the day before listened in with eyes closed.

In few instances did I find the headphones hanging up unused—the sick, the weary—young and old—all turned to broadcasting for comfort. I wondered if those announcers and artists



MR. J. S. BURTWISTLE.

INTRODUCING Mr. J. S. Burtwistle, just recently appointed outdoor Sales Representative for the Clyde Batteries. An old hand in the battery business, he is a native of Brisbane, where he was born 33 years ago. He commenced his business career with the Canada Cycle and Motor Agency in 1913, working up through the various Departments to an executive position.

at the broadcasting studio could have any idea of the joy they were giving these people.

There is, of course, a psychological aspect to this broadcasting business as it relates to sick people. A doctor told me he regarded the wireless as a most important adjunct to a hospital.

"You see," he said, "it takes the patients' minds completely off their worries—makes them forget themselves, and you couldn't have a better thing to help you in the treatment of sickness." This doctor was most enthusiastic. Other doctors expressed their opinions in various ways—"A fine thing," "A great help," etc.

A well-known nerve specialist unhesitatingly endorsed radio broadcasting—in mental cases, or with patients of a highly strung nature, it proved soothing and restful.

A matron, long familiar with the hospital wireless, was loud in her praise. Moving round constantly among the patients, she had ample opportunities of studying the effects of broadcasting. Nurses, too, had much to say in favor of broadcasting.

These opinions, coupled with my own experience, gave me quite a new conception of this wonderful thing. It seemed to me that, if broadcasting were used purely for the benefit of the sick and suffering and not as a means of public entertainment, then it would still be justified.

Plays that can be Aired

(Continued from Page 6.)

is going on behind drawn blinds. How they love it? The rattle of the pots and kettles or the rump and haucers, as they are being hurled through the air—the' unseem—gives a piquancy to the scene. That is why I love a quarrel scene over the air. I can feel the listeners, revelling in it. It's so true to life— isn't it?

The play to be aired must be human, easily understood, bright, cheery, homely, and free from salacious matter. The radio play must have a universal appeal if it is to be acceptable.

The work is a perpetual joy to me. I grow more and more enthusiastic about it every day. It is the great business of the future and whatever I do towards making it a success I will be proud of having done, no matter how trivial my share may be. After all, what greater pleasure can an artist have than in the knowledge that he is bringing a smile of happiness into the homes of thousands of people—many of whom are far away at the very back of beyond, who live remote lives, working hard for the future welfare of this wonderful country, who after a hard day's toil sit round the table and listen to my work. Each little joke that wins a smile from them makes their drab lives less weary, and keeps them in touch with the great city, which lies so far beyond the horizon, and if I make those people happy, during the brief moments that I'm endeavoring to entertain them, why I'm not wasting my time, am I?

THERE WERE 998 transmitting and 124,456 receiving stations in operation in Canada at the end of 1926. Of the transmitters, fifty-five were commercial broadcasters, sixteen amateur broadcasters, 252 commercial ships, twenty-eight government ships, eight direction-finding stations and six beacons, the two latter groups serving as navigational aids distributed on the coasts and the lake shores.

WHILE LICENSES are required and fees are collected, even from the listeners, they amount to only a dollar a year and are usually paid without argument. Broadcasters are required to pay 50 dollars for commercial licenses, and 10 dollars for amateur sending stations. Revenues for the past year aggregated 436,185, being 45,610 more than during the preceding year. The increase from licenses alone was over 45,000.

How to use Reaction in Radio Receivers

THE use of reaction or regeneration in a radio receiver requires a good deal of knowledge in order that it may not be over used. If improperly applied reaction will cause distortion of the signals; it will cause the receiver, in certain circumstances, to radiate and cause annoying interference to other receivers in the locality. Both of these troubles should be carefully avoided by all listeners in their common interest.

The first trouble, distortion, prevents the listener obtaining the benefit of the programme, and undoes all the work of the broadcasting staff who use every endeavour to make the transmission of the first order.

Reaction correctly applied, and used with a certain amount of knowledge, is a distinct aid in the picking up of distant stations. One of the oldest applications of reaction is that embodied in the three coil, or two coil feed back circuit. In these circuits the plate energy of the detector valve is fed back through a "tickler" coil to the pick up or aerial coil or in the case of the three coil circuit the feed back is made to the secondary or grid coil.

Immediately the plate circuit is coupled to the grid circuit the valve will begin to generate oscillations, and as the whole circuit is coupled to the aerial circuit the receiver sends out a "carrier wave" and acts as a small transmitter. There is no real way to overcome radiation caused in this way, but if the aerial coil is as loosely coupled as possible to the grid coil the effect will be minimised.

If the tickler coil is coupled too closely to the grid coil the strength of oscillations will be very much increased, and in addition the signals will be badly distorted, due to the violent oscillation within the circuit.

For good reception the tickler coil should not be used if the signals can be tuned in without its aid—reproduction will then be faithful. To tune in long distance stations the tickler coil should be coupled and the carrier of the desired station tuned in, and then the tickler coil slowly uncoupled until the speech or music is clearly heard. In a circuit of this description it will be found that should the movement of the reaction coil be course of adjustment, the fine control of the detector filament will greatly assist in reducing the oscillation to a point which will clear up reception.

Reaction to any of the coils which are coupled to the aerial is a practice

Extracts from a talk delivered at 3LO

By H. K. LOVE

(President Victorian Section Wireless Institute.)

which should be used as little as possible. There are circuits which have been designed of recent years which employ reaction but in such a form that it can be very easily controlled, and which do not permit radiation from the aerial system. The methods of application of the regeneration in these circuits are such that it can be used to advantage without any of the disadvantages common to the two or three coil circuits.

Most of the receivers sold up till about a year ago employed a third or tickler coil to couple the plate or secondary energy of the valve back to the primary or grid circuit.

In my opinion the use of a moving coil for this work is out of date. Reaction may be effected by conductive, inductive or capacitive means; of these methods the most convenient is the capacitive. In this case a small variable or throttle condenser is used to feed the energy back through a fixed tickler coil. The condenser is placed

in series with the tickler coil and the plate of the valve. When the condenser is at minimum value there is not sufficient bypass capacity to allow the high frequency to pass through the condenser and the coil. As the value of the condenser capacity is increased by turning the plates "in," the path for the high frequency energy is made easier and when the condenser is full "in" the maximum amount of energy is allowed to flow through the condenser and coil.

If the condenser is very small the amount of reaction can be easily controlled by the operator and can, by reducing the condenser value, be entirely throttled. This method does not, however, do away with the problem of radiation from the aerial system. It is necessary to install in front of the detector valve a radio frequency amplifier which, if kept adjusted in a stable condition by the correct use of a "c" battery, will form an effective block to any high frequency oscillations which may result from the use of reaction in the detector circuit.

A radio frequency amplifying valve will show a strong tendency to oscillate unless its grid is correctly biased with a "C" battery. Should this amplifier be allowed to oscillate it will radiate energy from the aerial system which is often direct coupled to it. The points to be noted, then, in the effective use of reaction, are:—

1. To prevent radiation use a radio frequency amplifying valve before the detector.
2. Make certain that the radio valve cannot oscillate.
3. To prevent distortion due to uncontrolled oscillation, use the condenser control method which allows a vernier adjustment of the degree of reaction.

This method will not alter the wave length of the circuit when the condenser is altered, whereas the moving coil method alters the tuning every time the tickler coil is adjusted.

In building or rebuilding a radio receiver I would suggest that any circuit which does not use the condenser control method of reaction should not be for a moment considered, if the builder requires ease of control, distance reception, and good reproduction. With the use of a circuit of this kind, if the voice or music become the slightest bit "mussy" it can at once be cleared up by throttling the reaction out without altering the tuning at all.



Laurence Broadbent, basso cantante, a new 2FC artist who has been enthusiastically received by listeners-in.

The Safety Valve

A department in which readers are invited to relieve their feelings by commendation or condemnation of broadcasting stations and their programmes. All letters must be addressed to "The Safety Valve," Wireless Weekly, 51 Castlereagh St., Sydney.



CHEERFUL ANNOUNCERS.

Dear Sir,—Here at a distance of from 900 to 2,500 miles from the broadcasting stations, with the intervening static and all the ship and other traffic, and particularly the local spark station just above us, and a local "howler or two" thrown in, the most cheerful thing in the world is the announcer's voice conveying the title, composer and performer of the item following, together with the name of the station, and all in the same moment setting a standard for those who lecture or otherwise address us through the microphone.

Although I have never met an announcer in the flesh, somehow the personality gets over the air, and one feels that he is a likeable chap. For example, 4QG's stands out for clearness of utterance, while I could never feel 2BL's programme had concluded satisfactorily unless I heard his cheerful "Rukky-doo, everybody," followed with a high-pitched "Good-night," which never fails to compensate the listener for the conclusion of the entertainment.

It would help the groucher somewhat if the different broadcasters took a different time each for news or lecture sessions, than the listener could switch over with the certainty of getting entertainment to suit him somewhere. But do not cut out the station or item announcements—fancy writing all night to listen to whom you were listening and then missing it.

Yours, etc.,

A. S. SAMPSON.

Cooktown.

TOO SEVERE.

Dear Sir,—I think Paul Jennings (W.W. 26/2/27) a little too severe in his criticism. I have been in correspondence weekly with all the wireless stations in Australia, and as the outcome of many suggestions, I prepared and forwarded a list of four pages of foolscap of high-class musical subjects. Each station replied very courteously and thanked me for the suggestions, with the remark that they would try to incorporate these masterpieces.

The various licence holders comprise the country bushman, the hotel-

keeper and safe-keeper, the flapper, the wireless youth, the hospital inmate, the serious-minded aged lady and gentleman, student, the dreamer, the dancers, lovers, the evening party, and religionist, ad infinitum, and it appears to me, as a musical expert and wireless enthusiast, that with programmes on the lines of 3LO (Melbourne) none of these people will see the fall of beautiful and classical music in Australia, and I therefore ask Mr. Jennings to recall many of his remarks.

Yours, etc.,

THOMAS J. SWAIN.

Cook's Hill.

FROM THE SHOULDER.

Dear Sir,—When "R.D.W." (W.W. 25/2/27) quotes 2BL's items as "sentimental descriptive tosh" and asks for help for those who have the power to listen "without squinting, to the Prisoner's Song," he is sinking to a rather low level, in that he is abusing something which he is apparently unable to improve on.

His suggestion of splitting the week up is impracticable. Who wishes to listen in for just three nights, if he is unmusical, and four nights if he is musical? If "R.D.W." doesn't like 2BL's programmes, why not tune in to some of the other stations?

Yours, etc.,

J.W.H.

Redhead.

DULY RECORDED.

Dear Sir,—I agree with "V.P." ("Wireless Weekly," 11/2/27) that gramophone records should be cut out of the broadcasting programmes. If I want to hear records I shall buy a gramophone and play it to my heart's content. Why should I pay 27.6 licence fee to hear records, when I bought a wireless to hear the articles and music direct? Let us have plenty of novelties on the air, and good band music, as we heard from 2FC a little while back.

Yours, etc.,

NO RECORDS.

Clarence River.

POOR COUNTRY RECEPTION.

Dear Sir,—For the past few weeks I have been suppressing a grievance against the quality of the transmission from 2BL and 2FC, but now consider that a protest is long overdue. In daylight, these two stations are not bad, but at night they are really impossible to listen to. Their signals, both speech and music, are blurred and distorted beyond recognition.

I have tried these stations on various sets, and am at present operating a "Marvel" Reflex, and in each case reception is as stated above. These are not merely my own observations, but are the experience of every listener-in in this district to whom I have spoken. Apart from the annoyance of being unable to receive stations in our own State, it seems to me a very inequitable arrangement when these stations collect our fees while we have to depend on other States for our service. I get very fine reception from 3LO and 4QG, and both these stations are to be complimented on the excellence of their transmission.

Surely it would not be impossible for the management of the Sydney stations to arrive at some plan which would ensure that country licence-holders would get proper service for their fees. One scheme that appears to be sound and practicable, is to require the companies available, to use, is that the companies appeal directly to country listeners to forward detailed reports on transmission, a request to which all enthusiasts, for their own satisfaction, would be only too ready to respond. From these reports much valuable data must inevitably be obtained, and great improvement in reception for country districts should result.

In the case of districts where reception is found to be uniformly bad, it should not be impossible for the companies to send inspectors to investigate causes and report on local conditions, which may affect reception.

Yours, etc.,

R.W.S.

Kurri Kurri.

[The Editor welcomes reports of day and night reception of 2FC and 2BL in the country districts.]

IT'S ALL IN THE AIR

Coming Features in the Broadcasting Programs

BISHOP OF LONDON will be heard on the air from 2FC on Sunday morning, March 20, from St. Mark's, Church of England, Darling Point, and again in the evening from St. Andrew's Cathedral.

COUNTRY AND CITY church-goers alike will be glad to hear that 3LO Melbourne has made arrangements for the Bishop of London to be broadcast on Sunday afternoon, March 27. Country clergy are installing loud speakers in churches for the occasion.

MR. W. F. KAY will shortly give a series of talks from 2FC under the title of *Immortals of the Sydney Stage*. He is a man whose knowledge of the Sydney Stage is immense, whose personal relationship with the principal characters whom he will describe was an intimate one, and his first talk set down for Saturday, March 12 deals with such names as J. C. Williamson, George Rignold and Alfred Dampier.

PEGGY PEAT, a young Australian actress, who graduated from the "Tivoli Follies," and toured Australia and South Africa in the ballet with the Oscar Asche company, will shortly be heard from 2FC. She has played flapper roles with Ada Reeve, and toured with Wilkie Bard. She recently played lead with Phil Smith's Musical Comedy Co. Miss Peat says: "I find broadcasting very interesting—quite tranquil—after the hustle and bustle of the stage."



Miss Peggy Peat.

THEATRICAL PROGRAMMES: About twenty theatrical acts are at present engaged on the programmes of 3LO. The programmes for Saturday morning, March 12, includes Osborne and Ferryer, Geo. Welch (comedians from Tivoli), Sydney Birchall, Marjorie Vere (from "Pins and Needles"), Huxham's Serenaders, Maggie Foster and Miss Jessie Batchelor.

CAVALLERIA RUSTICANA: Surely there must be a limit somewhere to the excellence of the musical fare provided by 3LO, and we feel this limit was reached when, under the capable baton of Mr. William James, the opera, "Cavalleria Rusticana," was recently broadcast. The soprano role was sustained with perfect understanding and sympathy by Miss Saffo Aron, who was in magnificent voice, and who had the assistance of a finely trained choir of 60 voices. The whole performance was a tribute to the masterly musicianship of Mr. William James, and we look forward to another of these "productions" with the keenest interest.

THE RENOWN'S TOUR: In view of the early arrival of H.M.S. Renown, with the Royal party on board, greater interest is given to the descriptions of the route of the vessel that have been given from 2BL by Mr. J. Holmes. On March 10, a week before the arrival, Mr. Holmes will deliver a special address on "The Tour of the Renown: Its Significance with British Trade."

THE ROYAL VISIT: No stone is being left unturned by 2FC to secure a wonderfully representative programme during the Royal visit. The landing of March 26 will be completely covered. One of the most enterprising radio transmissions yet attempted was on the occasion of the arrival of the American Fleet, when 2FC specially chartered the "Sir Dudley de Chair," and going outside the Heads for five miles, broadcast a complete description of the entire scene in a practically unbroken transmission, which kept on for two hours. Even more elaborate preparations are being made for the Duke's visit, and not one happening of any import will be overlooked. Details are almost complete, and our next issue will give further information.



Miss Jessie Batchelor.

FORTUNATE INDEED is the artist who possesses all the broadcasting qualities necessary for perfect transmission, as does Miss Jessie Batchelor, the popular contralto at 3LO. Her rich velvety voice loses nothing of its sympathetic sweetness in transmission, especially when her contribution to the programme is a melody that calls for artistic interpretation.

IRISH RADIO CONCERT: In celebration of St. Patrick's Day, March 17, a special Irish concert is to be broadcast from 2ML. The programme will be contributed by Miss Amy O'Leary (contralto), Mr. Stanley R. Cottle (tenor), Mr. Dud Osborne (descriptive vocalist), Miss Dorrie Ward (soprano), Mr. W. E. Lewis (baritone), Mr. Bert Warne (comedian), and Mr. Peter Sutherland (humor).

ST. PATRICK'S DAY: There is no day in the year that every broadcasting station gives its service to, as a national day—March 17. 2FC has gladly fallen into line by preparing a programme replete with Irish song and humor. Madame Evelyn Grieg and Madame Vera Tasma are collaborating in preparing a delightful programme in which the old Irish melodies will be sung to accompaniments played on the dulciana, by Madame Evelyn Grieg. She has also made an arrangement of various Irish airs for the piano. Madame Vera Tasma is undoubtedly one of the finest soprano voices heard on the air, and her association with Madame Grieg is always looked forward to by listeners. The humorous side of the programme will be worthily upheld by Mr. Joe Cahill, Miss Nora Hill, Irish soprano, topical cartoon by Mr. Harry Julius, and selections from the Lyceum Orchestra of Irish airs.



Daddy Long-legs and his assistants who are brightening the bedtime-story hours at 2BL.

"I HASTEN TO THANK BLO and acknowledge my appreciation of the great pleasure you afforded us in broadcasting our Queen of Song," writes a correspondent to BLO Melbourne following upon Madame Melba's broadcast concert at Flinders Naval base. "I consider this the pinnacle of your efforts, thus to enable us to hear the magnificent singer with the voice of a girl, and we do admire her graciousness in allowing the thousands of gratified listeners to hear her, many of whom, like myself, had no other opportunity, other than gramophone records."

THEATRE TRANSMISSIONS. Following the act of "The Mikado" from the Theatre Royal, on Wednesday, March 9, "Tell Me More," the new musical comedy from Her Majesty's, will be heard on Friday evening, March 18, featuring Miss Dorothy Lenz. The 1st Act is between 8 and 9.30. Miss Goodie Reeve will interview Miss Lenz in her dressing room, on that evening. From the Studio, a talk on the "Art of Fencing" by that well-known swordsman, Frank Stuart, will be given. Then from the Palace Theatre on Saturday, March 19, the 1st Act of "Hullo Beale" will be put on the air. The 2nd and 3rd Acts have already been broadcast by 2FC, much to the delight of listeners. Mr. Arthur Stigant's humor is excellent, and he is the life and soul of the piece. On the evening of March 19, the 2nd Act of the "Girls of Gottenburg" will be broadcast by the Langley Operatic Society.

UNIQUE AUTOGRAPH HUNTER:

Probably the most unique and persistent autograph hunter in the world, Corporal Williams has arranged to tell his experiences to 2BL listeners. Corporal Williams first achieved fame when as a member of the A.I.F. he succeeded in obtaining the autographs of the most inaccessible "Brass hats." Afterwards he continued his hunt, adding the signatures of King George and Queen Mary and of the Kaiser to his collections. His many strange adventures should form an interesting story.

RADIO SERIAL: Are you listening to the serial farce that Scott Alexander is putting on the air each Tuesday night from 2FC? The laughable blunders committed by "The Man Who Wouldn't Quit" are entertaining in themselves, but when with a little ingenuity the listeners may guess the solution of the "mystery" and win cash prizes, the entertainment becomes more pleasurable. The play commences on Tuesday, March 15, and will run right through for four weeks on the same evening, at the same time, i.e., 9.45 p.m. At the end of the third evening, Mr. Alexander will ask for solutions. The correct answers will be placed in a sealed envelope and locked up by the Broadcasting Manager of 2FC. Then the last instalment will be given, and the listener who came closest to the actual solution of the mystery will be awarded the prizes. So listen in to 2FC on Tuesday night, 15th March, at 9.45, and hear all about it.

SPEECH BY GOVERNOR GENERAL TO BE BROADCAST: The Governor General, Lord Stonehaven, is to unveil a War Memorial at Hunter's Hill on March 20, and arrangements have been made to broadcast his speech by 2BL.

WALTER THORMAN, professional musician at the N.S.W. Conservatorium of Music, is a very cheerful personality, and listeners will be able to hear him in some of his experiences of his recent world tour. It will be remembered how he went with Mr. Cyril Monk and Mr. T. Lobban of the Conservatorium on a trip to England. The other two members of the party came home first, and left him to carry out a jaunt through the Continent. Readers will remember accounts appearing in the evening papers of a well-known Australian who was deliberately floored of a large sum of money, in Germany. 2FC tried to prevail on Mr. Thorman to give some details of this audacious coup, but it appears he prefers it to remain a dark mystery. He is happy, however, to talk to listeners about the brighter side of his tour, on Sunday afternoon, March 13, when he will chat in his entertaining way about his experiences in Singapore and the East.



Jack Lumadine, whose song "Calling" was voted the most popular in a recent 2FC competition.

News and Notes from 3LO, Melbourne

SOMETHING of a record was put up by the Postal Mechanics' Union and their confreres in Railways and Electricians' Union on Saturday, February 26, when they equipped 130 beds at St. Vincent's Hospital with wireless.

This was the first instalment of the big job of putting headphones on 1700 beds in hospitals that do not yet enjoy this benefit. 3LO was associated with "The Herald" in making an appeal for funds to do this work, and £3000 was collected. The men are doing the wiring in their own time on Saturdays and holidays.

About 5 o'clock on Saturday the task was just about completed, and the patients listened to 3LO's evening programme with intense happiness. Just to see their smiles was enough to bring the realisation that such an addition to hospital treatment must have a curative value.

From now on, each Saturday will see a fresh batch of patients with smiling faces, and ears agog for the time signal from the studio, which is to usher in three hours of entertainment.

THE QUESTION HOUR.

A correspondent has written to 3LO from the country, making the suggestion that half an hour a week should be set aside for answering questions. This is a most excellent idea, if only some sort of restriction could be placed on the inquisitiveness of listeners. The questions, I fear, will range through sport to science and no one person could be expected to "mug up" the answers to a thousand questions a week, let alone the difficulty of compressing the answers into the time allowance.

I certainly think that questions relating to a single subject might be answered by an expert. Country people especially would be able to derive a vast amount of information and pleasure from the replies.

The difficulty is that you cannot get any more liquid into a filled bottle, and the regular features at 3LO are so many and varied that it is hard to find time for more, without dropping some that are keenly anticipated each week.

The same correspondent makes another suggestion that can hardly be done, one, indeed, that has already been done. That is, that a microphone should be placed twice a week at a busy intersection in Melbourne, so that the many and varied sounds of a great city on the move may be broadcast to lonely dwellers. What comfort they would derive from this aural demonstration that the city is still carrying on I cannot say. Perhaps it is in this man's mind to train

his horse to street noises, before he subjects him to the strain of actual city traffic. Otherwise it is a pleasure hard to be understood.



Madame Saffo Arnoy, who took the soprano part in the recent production of "Cavalleria Rusticana" at 3LO.

LUCKY MUSICIANS.

The winners of the 3LO Scholarships at the University Conservatorium have been announced. These scholarships are three in number and are worth £32. They are awarded for study in singing, in the use of a stringed instrument, particularly the violin, and in pianoforte.

The scholarship for singing has been awarded to Miss Mary Monica Nugent, of Hastings Road, Auburn. That for the violin goes to Mr. Alfred Arthur Acland, of Rathdown Street, Carlton, and the pianoforte scholarship was won by Mr. George Walter Findlay, of Wheatland Road, Malvern.

Pathetic circumstances mark the good fortune of the two men. One, Mr. Acland, was ill in hospital when the examination was about to be held. Indomitable as he is ambitious, Mr. Acland insisted on getting up to present himself. When the task was finished, he went back to the hospital, where he is still confined to bed with a serious illness.

The other, Mr. Findlay, is stone blind. He received his musical and his ordinary education at the Victorian Institute for the Blind, St. Kilda Road. He is doing his second year for the degree of Mus.Bac., and besides being a fine performer is an original composer. It is eminently satisfactory to think that this generous provision by 3LO for musicians is helping two such deserving rises as these two men, at odds with good health.

MY PROGRAMME.

Major Condon, the managing director of 3LO, is one of those pestilent fellows one can never get ahead of. The other day I met him by chance, and immediately waylaid him. An unusual thing had occurred to me. I had an idea.

"Look here," I began, "why not improve your programmes? There are a number of clever, capable people about who know something of programme work. The thing to do is to enlist them in the service of 3LO by getting them to be entirely responsible for a programme a week—say, the Sunday night session."

He gazed at me pithily, thrust a cigarette at me, borrowed my matches, put them in his pocket and then said: "I've just sent a note to the studio telling them to see me about doing that very thing."

So there I was—forestalled again. Last year I proposed an experiment in telepathy. My idea was to have a psychologist segregated from his kind and asked to think of a certain subject, hard. The thing was to discover how many listeners could accurately say what the subject of his intense thought was, telepathically received.

I thought it was a whale of an idea. So did some one in England, for a few days ago a cable informed the world that Sir Oliver Lodge was conducting precisely this experiment through the British Broadcasting Company.

However, to get back to individual programmes. One night when Miss Renee Kelly was broadcasting from her dressing-room, I wandered in to see her. She was filled with interest in radio at the moment, and said unguardedly that she wished she could have the chance to arrange an entire evening's programme.

"Why not?" I asked, willing to please. "I should think they would be glad to have you." So there's the position. I passed on the idea to Major Condon, who is willing, not only that Miss Kelly should do the job, but that other eminent folk should do the same. So don't be surprised if the Archbishop of Melbourne, Billy Grime, Renee Kelly, Gus Blust, and Myer's Emporium share the next few Sundays between them to provide innocent amusement for Australian listeners.

The great blessing of the movement will be that if the programmes are bad, there will be a definite person to blame, which is a heap of satisfaction.

Melbourne Radio Exhibition Reviewed

Our Melbourne correspondent discusses the trend of radio development as revealed in the Melbourne Exhibition.

ONE sees a good sign of the progress of broadcasting in the wireless exhibition in Melbourne. This public display of receiving equipment has advanced far from the first more or less amateur showings of a few years ago. The amateurs who organised the first exhibitions did a real service for the industry generally. It was only right, however, that the organising and management of the exhibitions should ultimately pass to the active commercial interests engaged in the business.

One can only to think of the quality and arrangement of the exhibits in the first exhibition in 1924 to realise how broadcasting has developed. The receivers then regarded as first class were fine things to look at, but demanded a much greater knowledge of the listener who operated them. There were several dials, and knobs to turn, coils to twist, and terminals on the front of the set for wires to batteries, aerials, etc., and the tuning process generally resulted in the production of weird whistles and gurgles. More often than not these noises were inseparable from the music.

SIMPLIFIED SETS NOW USED.

Now the popular types of sets, in fact, the only sets that are selling well, are very different. The main difference is the simplified method of tuning and operating the sets. Since the change of wavelength of SLO, the use of external, movable coils has not been necessary; it became possible to contain a fixed coil or coils in the set. This alteration, together with the reduction in the number of tuning controls or switches, has enabled a type of set to be developed that is simple in operation.

The number of control dials and knobs has been gradually reduced, and is now fast approaching the ideal of "one control." Some types of sets are now available to listeners, with a so-called "slide control," but there is generally another small knob or turn to adjust. There will be considerable development before the

ideal has been attained whereby it will be necessary only to adjust one switch or control "gadget" in order to tune in the various stations at pleasing volume.

BETTER QUALITY OF REPRODUCTION ALSO OBTAINED.

In addition to more simplified control arrangements, the present day good type of receiver is marked by an improved quality of reproduction. Engineers in various parts of the world have been very busy endeavoring to eliminate the noises and the imperfections from receivers. This research work has resulted in sets being available with greater clarity and faithfulness of reproduction—the "tonal quality" of the receivers has been improved.

Australian manufacturers have not been behind in applying these principles to the assembly of sets, and nowadays it is not a difficult thing to ensure the purchase of a really useful and pleasing set.

DEALERS SHOULD INSTRUCT LISTENERS IN OPERATING SETS.

The primary object of the exhibition is probably to induce more people to take up radio; to convince the doubting prospective listeners

that broadcasting is worth listening to. That is a very laudable and national object, but there is another that exhibitors should not overlook. It is to instruct and advise existing listeners in the operation of their sets.

A great deal of trouble is caused to listeners by the action of persons—including themselves—in so operating or adjusting their sets as to cause interfering whistles to be sent out. This oscillating valve nuisance has been described as a menace. It surely is, and there is no way of eliminating it unless by selling sets that will not oscillate, or by showing owners of oscillating sets how they can improve the quality of their own reproduction, and avoid annoying their neighbours, if they operate their sets correctly. That can be done at the exhibitions, and is a very important duty of exhibitors.

A VERY popular feature of recent SLO programmes has been a lecture on the care of cantos. Dozens of listeners have written expressing their appreciation of Mr. W. Francis' talk. Cantos are popular domestic pets, and there are no many cages in suburban streets as there are wireless aerials.



The Austral Trio, Daisy Richards, violin, Alexander Sverjensky piano, and Jules Van de Klei, cello. A new combination who will broadcast better class music.

Defects that Prove Progress

Another short article by the Chief Engineer of the British Broadcasting Corporation. This time he deals with the small experiments in the transmission of programmes.

By CAPT. P. P. ECKERSLEY

IT is a continuous embarrassment to know how much the Broadcasting stations should experiment upon the public. It is probably far easier to stick to a sameness, to dig in on the line of present achievement, than to go over the top in an attempt to gain fresh ground. There are casualties, expenditure of ammunition, staff work till the small hours of the morning, and then we find, even when we have taken up new positions "according to plan," that their unfamiliarity makes them less tenable. Before we had comfortable dig-outs to protect us from the fire of criticism, formulae by which to answer the letters of those who noticed unfamiliar changes.

New Studios and New Methods.

In our opinion, however, no advances can be made except in terms of actual service. Service spells experience; mock battles never yield the really important knowledge.

At the present moment, new studios, new methods of controlling, and other innovations are occupying us. We have, in consequence, received a certain amount of comment on "the variability of quality." Now, up to a few weeks ago, we played from, practically speaking, one studio. Those who wanted room to rehearse, experiment, give other programmes, sit in a talk and a military band, Sir Harry Lauder and a chamber music quartet with ten-second intervals, agitated considerably against this. Consequently, three new studios were built. Now we are able to have singer and piano in one, while the symphony orchestra is in the other, and waits between items are reduced.

The players may speak their lines in a quiet room while backgrounds are controlled in another studio by a head-phoned individual who hears as much as the listener-in. Now a speaker may be ushered into a (comparatively) hushed study and speak his talk at a desk copped by an omnibrosive microphone.

When Hearing Varies.

If the listener-in, with his own ears, were to walk from studio to studio and hear even the same sort of item in such, he would hear differences, owing to the varying acoustics of each room; and he would not greatly complain, I venture to suggest. If he went to hear the London Symphony Orchestra

at Queen's Hall, the Philharmonic Hall, the Albert Hall and Covent Garden, he would not get the same effect exactly. I suggest in each case the effect would be well worth a visit.

When we relay the Savoy Bands from the Hotel, or an orchestra from an Eastbourne Hotel, the acoustics are different, but mainly pleasing. The point is that there is no criterion as to which is absolutely right—only a very few are given out to detect what they consider perfect, and a certain change is interesting. So with our studios; we cannot hope to do more than the ear; we cannot correct to a dead level the varying acoustics of different rooms. Thus my "apology" for variations in the quality, apart from other causes.

Microphone Experiments.

From time to time, too, we experiment with new forms of microphone. Not until we are assured that the standard is good enough for broadcasting do we venture to put such devices into actual service; only by continued trials and our judgment can we expect to make up our minds.

Then, again, we are always trying to improve the performance of our transmitters, amplifiers, lead-lines, and so forth; so changes—we believe for the better—are constantly in progress. A factor of variability must enter into our calculations; we try, as far as possible, that this variability shall be towards improvement.

Sometimes an actual improvement in theory may seem to a listener to be a retrograde step. Let us take it that a listener has, by certain "correction" circuits, made up for the performance of a frequency band in our transmission. I will not pretend that the performance of our system is such that it gives equal response (as it ought to) from 30 a second to 10,000 a second. (Incidentally, no receiver gives this either.)

Suppose that a correction circuit has been introduced to put in more of those frequencies between 30 and 100; then suppose after a year's work we get new transformers with better performance, then a step towards theoretical perfection has introduced, perhaps, too much bass in certain receivers and the step seems retrograde.

Obstacles to Success.

How easy it would be just to "sit tight" and explain away deficiencies!

How much less criticism, worry and anxiety to continue in the old rut!

A statement of ideals, however, leads me to say that we must go forward; in terms of past experience we must progress and make changes, if we are to increase our facilities to the general public. Until all receivers are moderately selective, do not have to oscillate to achieve a robust signal, do not rely upon special circuits, give faithful quality without undue complication, broadcasting cannot reach finality.

Until we can give to such receivers robust alternative programmes, unhindered by foreign transmissions, until the electrical performance of the transmitters is equal over the audible frequency range, until the microphones, the ether and the loud-speaker form a link which truly substitutes the ear, our jobs on the technical side will not be completed.

We ask always for the listener's co-operation, without which British broadcasting cannot achieve ultimate perfection, nor maintain its pride of place. When it is all over, I suppose somebody will bring television into the range of practical politics. Then it will all start over again. I wonder if it will be as interesting!

RADIO PRIZE-WINNERS: Probably no more practical example of the value of broadcasting has been given than the response to the competition organised by the Women's Section of Broadcasters Limited in connection with the Radio Exhibition at the Town Hall. Entries came from all corners of the State, and their variety is demonstrated by the Exhibition. The following prizes have been awarded:—Preserves, Miss Lutter (Croydon); battle shawl, Miss Fraser (Kew); sponge sandwich, Miss N. Adams (St. Mary's); scones, Mrs. Postill (Oatley); 1, Mrs. Caldwell (Barwood); 2, cake, Mrs. Robertson (Barwood); sweets, Mrs. Kemp (Leighford); wrege paper hat, Mrs. C. D'Arvy (Matsville); 1, Mrs. Postill (Oatley); 2, Miss Postill (Oatley); 3, wrege paper hat, Mrs. M. Cleveland (Roseville); raffia, Mrs. Gay Relf (Manly); lamp shade, Miss McDonald (Peterham); paper flowers, Mrs. Wearne (Cloveley).



The Australian Commonwealth Band, which was broadcast from the "Haymarket" Theatre by Station 2FC. This band has entered into a £10,000 contract to tour Canada.

On Everybody's Wavelength

MR. MAURICE DUDLEY, the 3LO announcer, recently received a request from an announcer in a new studio requesting some practical hints and advice on the art of announcing. Mr. Dudley's obliging reply contained the following hints:—Keep programmes strictly to timetable, speak rather more slowly than usual, be ready to fill in should any item finish before advertised time, have next turn ready before preceding one finishes, vary announcements as much as possible, in order to avoid stereotyped speeches. The correspondent received several pages of advice which should be of great benefit to himself and his listeners.

IN SHARP CONTRAST with the chaotic wave length conditions in the United States, Canada has been most capable in regulating radio by assigning transmitting licences on a sound and simple basis. Each district of the country is given one channel exclusively, there being duplication only between Montreal and Vancouver. There are ten stations sharing one wave length.

UNTIL AMERICAN broadcasters began abusing the gentlemen's agreement to keep off the fourteen Canadian channels, Canada's 67 stations operated entirely without interference. Of course, it could not be expected that the ruthless American ether vandals would regard international agreements worthy of consideration. When an American broadcaster interferes with a Canadian frequency, he injures radio for an entire district.

A VISITOR from New Guinea called at 2BL a few days ago to chat over his experiences. He remarked that in the evenings residents of New Guinea listened to 2BL Sydney, 4QG Brisbane, and 3LO Melbourne. Between 7 and 8 p.m., however, the Australian stations fade away and JOAK (Japan) comes in strongly. About 9.30 JOAK begins to fade and by 10 o'clock he is hardly audible. About this time, however, the Australian stations again come in and continues strongly until the programmes are concluded at midnight.

COMPLAINTS RECEIVED from readers regarding alterations to the broadcasting programmes as printed in "Wireless Weekly" forwarded to 2FC received the following answer:

In some countries of the world the broadcasting companies adhere religiously to the broadcasting programmes drawn up perhaps a month before, but in Australia the practice is to make the programmes an up-to-date as possible by the inclusion of items for which arrangements may have been made at the last minute. 2FC has by this means been enabled to include in recent programmes a number of important items. The Prime Minister's speech from the Wentworth Hotel and Mr. Syd. Smith's talks on the Australian Cricket team were put in the programme at the last minute. The Big Four from the Haymarket Theatre was also a last minute engagement. Other items included in the programme at short notice within the last month were:—Racing from the Speedway Royal, Ernest Truman's Gilbert and Sullivan Recital, Arthur Stigant, principal comedian of the Hullo Healo Co., Alfred O'Shea, Australia's foremost tenor, Ken Duffield, composer of the new play, "Hullo Healo," Civic Reception and Luncheon to the Bishop of London.

"BROADCASTING is improving the national musical taste," says an admirer. "I heard a milkman whistling Bach recently."

A sort of can-tata, perhaps.

HEADLINE in Daily Paper: "Wireless Works." A correspondent wrote the other day to ask us when.



Left, is Mr. A. H. representing the Pilot Electric Manufacturing Co. Inc., Brooklyn, New York. Mr. Freedman is Export Manager of this big Company, and is on a tour of Australia, New Zealand and Japan, consolidating Pilot interests. On the right is Mr. C. W. Sawyer, Senior Sales Representative of United Distributors Ltd.

An Australian Views New York Radio Progress

THE first week in the New Year witnessed two outstanding radio events. First, the opening of the Transatlantic radio telephone system, and, secondly, the descriptive broadcasting of a football match played in California, throughout the length and breadth of the United States.

The official opening to the public of the London-New York system took place on Friday, January 7, but I was fortunate enough to be shown over the station and apparatus during the tests, and had an opportunity of "listening-in" on some of the conversations. The clarity of speech is undoubted, and is comparable with any good phone conversation. It seemed strange to hear the London operator mention the fact that he had just had lunch, when it was still only 9 a.m. by New York time.

The only difficulty so far encountered has arisen from the differences in speech inflection, accent, and the divergent meaning of certain words and phrases. For instance: When the English telephone attendant says, "You're through," she intimates that the line is ready to begin conversation. Here, in America, the phrase has an opposite meaning, for when the party "is through" the conversation is concluded. Certain technical terms also have slightly different meanings, but, no doubt, a common code will soon be observed on this system.

Any person in the United States may speak to anyone, in the United Kingdom, by means of the ordinary house phone, as they would on any other long-distance or "trunk" call. The rate at present is 25 dollars a minute, with a minimum of three minutes.

The other event mentioned was the broadcasting in New York (as well as throughout the States) of a football game played three thousand miles away. Here, again, the time factor gave an added interest. The match was being played at Pasadena, California, in bright sunlight, and listened to by New York citizens during and after a late dinner, darkness having set in some time.

The description of the actual play was very realistic, but to me the interposed description of the sunlight and sunset effects on the snow-capped mountains surrounding Pasadena (considering we were in total darkness) were even more realistic and impressive. One could plainly hear the cheering crowds, occasional re-

The first dispatch from our recently appointed New York correspondent, who will forward regular reports of the latest radio developments in America.

marks, band music, and now and again the whizz of an aeroplane overhead. This was the largest network of stations which has yet attempted to broadcast a simultaneous programme, and it proved most successful.

Perhaps a somewhat similar idea may, with success, be applied in Australia, with, say, two small power stations, one in the north-west and the other in the south-western districts of N.S.W., connected by land line to station 2FC, would materially increase the interest and number of subscribers throughout the country districts. This, however, is only presented as an idea.

During the week, I was a guest at the Radio Manufacturers' Association dinner, held at the Commodore Hotel, New York. Dr. Alfred Goldsmith, Chief Broadcast Engineer of the Radio Corporation of America, was the chief speaker. In their speeches, the Doctor and others stressed the general impression that for the radio trade, 1927 will be a better year than was 1926; and that this year will result in a general improvement in broadcasting programmes.

It is expected, also, that 1927 will see the practical solution of the radio interference problem, through careful legislation by Congress, and the acceptance on the part of the public of the idea underlying Chain Broadcasting, resulting in the supplying of a few worthwhile programmes, as against the unsystemised methods at present prevailing, and producing a repletion of mediocre entertainments. It may be of interest, at this point, to note that Canada has instituted the chain system with success—Montreal and Ottawa being linked once a week, with the inclusion of Toronto in the very near future.

Some of the statistics mentioned were of interest. It was shown that the output of multi-valve sets in 1926 was over 1000 per cent. greater than that of 1923; but that the saturation ratio is still only 24 per cent. For the same years, the increase in the output of valves was 410 per cent., and for loud speakers 318 per cent. Mr. Kent, of the Atwater Kent Com-

pany, stated that his company were turning out 5300 sets per day.

The demand certainly seems to be for simple, thoroughly efficient, and high-grade, multi-valve sets, especially of the five valve and six valve type, which appear to be regarded as more or less standard. It was also stated that the Department of Agriculture is now sending information to farmers through 100 stations, and it is estimated that there are more than 550,000 radio sets on farms. In one State alone, one farm in four is fitted with a radio receiver.

Some interesting predictions were made: Capt. Ranger, of the R.C.A., announced important and marked improvements in picture transmission by radio, and said that the development of photographic transmission is approaching the point where the broadcasting of pictures is bound to be undertaken soon. In general, however, this year is expected to result in the stabilising and improving of radio broadcasting conditions and programmes, rather than be productive of any outstanding and radical changes.

BEETHOVEN IS POPULAR: Station 2FC asked listeners recently if Beethoven was popular on the air. This was in connection with a series of recitals which were being given at the Studio by Madame Evelyn Grieg and Mr. Henri Staell. It was felt that these severely classical evenings were not proving popular with the majority of radio listeners, who, we are led to believe, roam restlessly from one station to the other in search of popular items. The artists were taken into the confidence of 2FC's manager, and the doubt as to the wisdom of carrying on the series was explained to them. They then asked permission to put the matter before the listeners by medium of the microphone and see what they had to say. Even the most enthusiastic lover of better class music on the air would be surprised at the response which came to the station from all quarters. Letters by highly educated people, letters from students—young girls, presumably flappers—and one and all cried aloud that they expected one station at least to cater for the needs of lovers of better music. Station 2FC is still undecided. On the one hand, there are hundreds of letters asking for more Beethoven—on the other, the silent majority. It is an interesting question, and correspondence on the subject is welcomed.

4QG Brisbane Calling, Tune In Here

THE AERIAL OF 4QG, when first erected, shone like strips of polished gold and was a glittering landmark for miles. However, the new copper, when exposed to the corrosive action of air and moisture, soon became oxidised and added to this, the soot and dust which collects on all exposed surfaces in a city soon took all the shine out of the aerials. But this coating on the wires does not stop the wireless waves from leaving the aerials, and, even if the wires were covered with rubber insulation, the strength of broadcast music from 4QG would not be lessened in the slightest.

An excellent demonstration in favor of the power of the spoken word was given quite recently at 4QG. In the bedtime story session recently, "Little Miss Brisbane" told her listeners a story of a little blind girl—how she lost her sight, and yet how happy she was in spite of her affliction, and how sorry she felt for those even worse off than herself. At the conclusion of her talk, "Little Miss Brisbane" asked her listeners would not it be splendid if that little blind girl were actually to speak to them and tell the story in her own words. Then, quite suddenly, the little blind girl was introduced, and spoke to the kiddies herself.

The anticipation of hearing the voice of someone about whom they had been listening could well be imagined, and indeed, judging by the tone of the letters received by "Little Miss Brisbane," the children seemed to derive as much pleasure from the little surprise as from the actual story.

Reports are still coming in to 4QG from all parts of Australia and almost without exception, everyone reports most favorably on the Speedway transmissions. Western Australian listeners are just as enthusiastic as the New South Welshman and Victoria follows with full appreciation. A letter recently reached 4QG from Point Lonsdale, Victoria, which said: "Have been hearing 4QG splendidly lately. Got the motor races last Saturday evening. The transmission was excellent, and the chap announcing was awfully exciting."

This is typical of many letters received at 4QG.

The success of the bedtime story sessions at 4QG may be attributed to their variety. Each session of the bedtime story stuff has a style of its

own for the entertainment of the kiddies. Tiny tots, and children more advanced in years—and even adults too—are all catered for with melody, monologue and myth.

That there is a romantic side to broadcasting was brought home to Mr. Scott MacCallum (Musical Director of 4QG) a few days ago, when he received a letter from a very old friend, resident in Ballarat, Victoria. It was through the instrumentality of wireless that his identity was established to his old friend, a friend who with her daughter, a prominent pianist, had a great influence over the early career of Mr. Scott MacCallum in music. The letter contained some very flattering eulogies of 4QG.

A WELCOME TO THE DUKE AND DUCHESS.

Tune in, Remona; we will remember you!

A happy second greeting to our sea.

*Tune in, Remona, and hear a welcome sung
From 4QG across the southern breeze.*

*To Henry and his Lady fair,
we send*

A greeting our waves that roll and toss,

A greeting and a hope that you will love

Our new Britain north the Southern Cross.

Canberra waits, our city yet to be.

She waits the music of your Royal hand.

To bid her rise and take her rightful place

As sovereign city of our southern land.

As Duke and Duchess, we will watch you pass.

And mile on mile will send its ringing cheer;

But more than this, we hope to meet you both

As man and woman and to count you dear.

So welcome, Royal Henry, Duke of York!

Elizabeth of Glamis, welcome too.

From 4QG for all the sunny south

We send a welcome warm for both of you.

BOOK REVIEW.

CIRCUITS, miscellaneous information, experimental section, call signs and a feast of other interesting matter for both the broadcast listener and the experimenter are contained in the "Daily Telegraph Radio Handbook" which is now for sale at all bookstalls and newsagents.

As set out in the preface the book has been compiled and published in order to explain in simple non-technical language how to obviate the trouble which seems to be inseparable from learning to operate a Wireless Set. This objective has certainly been achieved, and we can thoroughly recommend this Handbook to anybody interested in Radio.

Of particular interest is an article describing how to choose and use a broadcast receiver. This sets out exactly the type of set required for different purposes and contains dozens and dozens of useful hints which will set the intending purchaser on the right track.

Further hints are supplied describing how to get the utmost efficiency out of a broadcast receiver.

There is an article dealing particularly with Aerials which is extremely well written, and which alone is of considerable value. Other articles which help to make this book a success are "Hints on tuning a Regenerative Receiver," "Causes of imperfect reproduction in broadcast receivers," "Notes on the care of Accumulator 'V' Batteries," and a Trouble index, which is very complete. The constructional section deals with many types of receivers from a Selective Crystal Receiver to an excellent type of Four Valve Receiver. Amplifier units and Wave traps are also dealt with in this section.

In the section devoted to miscellaneous information there is much of value, including an article on "Fading" and another article dealing with the methods of soldering, and many pages of well-written matter of great value.

The experimental section contains a list of Australian Amateur Transmitting Stations, and other call signs, a record of which is always handy.

The author, Mr. C. W. Slade, knows his subject, and is to be congratulated upon such an excellent production. The book sells at one shilling and sixpence a copy, and we predict a very large sale for it.

Will advertisers please note that all blocks intended for "Wireless Weekly" should be supplied unmounted. The correct screen for half tone blocks is 85.

BOOK REVIEW.

WE have received from Amplion (Australasia), Ltd., a copy of their publication No. 40, 201, featuring the well-known Amplion Carboncel batteries. This is a booklet of 46 pages, through which are run splendid illustrations of the various types of Carboncel wet and dry batteries, which are now being extensively marketed in Australia by this company. On the front cover appear illustrations of the Carboncel wet battery No. 222 and dry battery No. 505.

Glancing through the pages of this nicely-printed book, we find featured such batteries as No. 222, No. 649, which is a high-tension dry battery; Carboncel No. 270, a small type of high-tension wet battery; and many other types. On page 3 appears a full list of the wet type of Carboncels, featuring the size over all, weight, sal ammoniac charge, internal resistance, normal output, and the capacity in ampere hours.

On page 4 a similar table outlines the features of the various types of Carboncel dry batteries. Full instructions are printed for the use of the wet Carboncels. On page 5 a table showing the volts maintained at varying discharge rates, will prove extremely useful to the user, as the prospective user of this popular type of battery.

The Carboncel high-tension "B" batteries are composed of units made on the air depolariser principle, and page 14 of the booklet contains a great deal of good reading matter concerning these. On page 15 are shown some tables giving comparative tests of Carboncels, as tested by such big concerns as the Metropolitan Railway, London, and the General Post Office, London. Page 15 features a comparison showing the cost of operating the No. 222 Carboncel battery, as against that of the average accumulator, and on this page also appears a table showing the discharge rates and other particulars.

It would be impossible to cover in this brief paragraph the full details contained in this valuable booklet, but, considering the rising popularity of this type of battery, it is needless to say that the book will be a valuable adjunct to the literature of every wireless enthusiast.

A.O.P. COURSE.

The sixteen back copies of "Wireless Weekly," containing the series of articles dealing with the Amateur Operators' Proficiency Course, are now obtainable.

Wanted!

Dealer-Agents Throughout N.S.W.

Several centres are available
for real live Dealer-Agents

Prepare for 1927

By Linking Up with a
Successful Manufacturer
and Sales Organisation



Mingay's Wireless Mfg. Ltd.

Head Office - 60 Castlereagh St.
Factory - - 56 Alma St.

Phones: B 6651; B 6652; Red. 1124

Cut Out That Interference!

Build the Selective Three Valve Receiver as described in this issue.

Here are the Parts as Actually Specified:

| | £ | s. | d. |
|---|---|----|----|
| 1 Radiator Panel, 20 x 8 x 3-16 | 0 | 17 | 3 |
| 1 .0005 Heath Variable Condenser | 1 | 2 | 0 |
| 1 .0005 Heath Variable Vernier | 1 | 5 | 0 |
| 1 .00025 Heath Variable Plain | 0 | 18 | 6 |
| 2 3in. Ajax Dials, each 1/3 | 0 | 2 | 6 |
| 1 30 ohm Rheostat (Centralab) | 0 | 0 | 0 |
| 1 2in. Ajax Dial | 0 | 1 | 0 |
| 1 Double Circuit Jack | 0 | 2 | 2 |
| 1 Single Circuit Jack | 0 | 1 | 7 |
| 3 Radiator No. 2 Sockets, 3/9 | 0 | 11 | 7 |
| 1 Battery Switch (Best) | 0 | 2 | 0 |
| 1 F.M.C. Audio Transformer, 5 to 1 | 0 | 18 | 0 |
| 1 F.M.C. Audio Transformer, 35 to 1 | 0 | 18 | 6 |
| 1 Bradyleak | 0 | 15 | 0 |
| 1 Mesh Grid Condenser, .00025 | 0 | 3 | 0 |
| 1 Radiator Terminal Board, with 7 terminals | 0 | 2 | 0 |
| 5 inches of 3in. Diameter Radiator Tubing | 0 | 4 | 2 |
| 2 Renrade Filament Bulbs, 2/6 | 0 | 7 | 4 |
| 1 Fixed Panel Plug (De Luxe) | 0 | 3 | 0 |
| 1 200 Turn Honeycomb Coil | 0 | 2 | 10 |
| 2 Reactance Coils, 35 and 50 turns | 4 | 12 | 6 |
| 1 Doz. Lengths Square Buswire | 0 | 0 | 10 |
| 3 Lengths Spaghetti, at 1d. | 0 | 0 | 0 |
| Total | £ | 19 | 4 |

The "Crescent" Audio Transformer

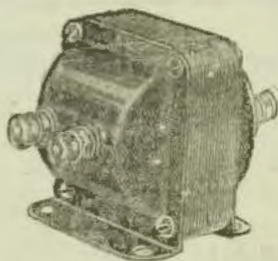

The "Crescent" Audio Transformer.

(The Transformer that does not burn out.)

Delivers pure music and clear speech.

Made in two Ratios: Completely Shielded.

6 to 1, for first stages

3½ to 1, for second stages

13/6

Sold with an Unconditional Guarantee.

"YOURS FOR LOWER PRICES."

We recommend the following goods as alternative choice when building this set:—

| | s. | d. |
|---|----|----|
| Certified Lowloss Condensers: Plain .0005 | 12 | 0 |
| Certified Lowloss Condensers: Vernier .0005 | 15 | 0 |
| Advance S.L.F. Condensers: Plain, .00025 | 9 | 6 |
| Bakelite Panels: 20 x 8 x 1-8. Price | 10 | 0 |
| Precision 10 ohm. Rheostats: A high-grade Article | 3 | 0 |
| Parker Audio UX Sockets: Genuine Bakelite | 2 | 0 |
| Tiffany Buttons: Switches: Push-pull type | 1 | 0 |
| Crescent Audio Transformers: 6 or 34 to 1 | 13 | 6 |
| Wairnet Variable Gridleaks: 4 to 5 megohms | 4 | 3 |
| Ajax Terminal Boards, with 7 terminals | 2 | 3 |
| Honeycomb Coils, "The Apex," 50 turns, 35 turns, etc. | | |

The Last Word in Condenser Design

The "KARAS ORTHOMETRIC" is used by the Set Builder who knows.

There is no better Condenser made.

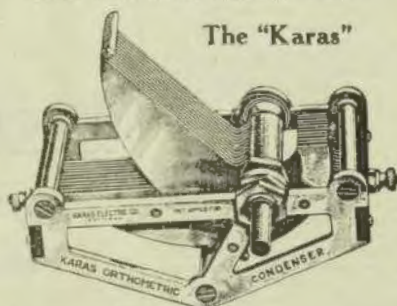

The "Karas"

Wonderful Separation of Stations, Lowest Losses.

Size 11 plates, .00025. Price 32/3

Size, 17 plates, .00037. Price 33/6

Size, 23 plates, .0005. Price 34/9

SEND FOR ONE NOW.

MONEY BACK GUARANTEE: Country Customers!

As you are unable to appreciate the wonderful value we are offering in the above advertisement, any purchases you make from us will be covered by a Money-back Guarantee. That is, if you are not satisfied with the goods, return them, and we will refund in full the amount of purchase.

We Pay Carriage on all orders of 10/- and over, except on Batteries, Speakers, Cabinets, and Value Payable Post Parcels.

The Economic Radio Stores

25 New Royal Arcade, Sydney.

Phone M 3049

Branches:— PARRAMATTA: Corner Church and Macquarie Streets. Phone UW.9601.

NEWCASTLE: 569 Hunter Street West. Phone: New.1622.

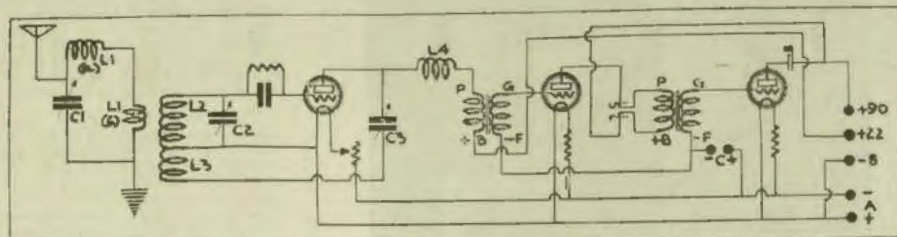

Novel Method of Coupling Provides both Selectivity and Sensitivity in a New 3 Valve Circuit

NUMEROUS requests for something new in three valve sets have prompted us to produce this one. Selectivity is the most desirable feature—combined with easy reaction control—and, of course, the receiver must respond to the wavelengths of all the Australian broadcasting stations, Perth excepted. Keeping these facts in mind, we have designed this receiver which measures up to requirements.

Early listeners remember just how selective was the well-known Cockaday receiver, the receiver which relied on a coupling of one turn of the aerial coil over the grid-coil. This resulted in selective arrangement of distinct advantage, which proved extremely efficient in the Hamil Crystal Receiver, described in these pages on 12/11/26. But in order that no great loss in signal strength results from this weak coupling, the greater portion of the energy is catered for by an aerial coil set at right angles to the grid coil. This aerial coil in this receiver takes the form of a Ronetone coil of 25 or 35 turns and is ideally suited to the purpose.

Let us examine the circuit diagram and discuss it. Aerial coil L1 is split into two portions, (a) the Reactance coil and (b) the coupling portion. The whole is tuned by a .0005 variable condenser C2. L2, C2 is the grid coil, L2 receiving its energy from (b) of L1. The wonderful Reinartz form of reaction is used as may be seen in L3, C3 with choke coil L4. The choke coil L4 is inserted in the circuit in order that the radio frequency energy is fed through the reaction coil L3. This choke may be dispensed with, provided the self capacity of the primary of the first audio transformer sets in this manner. If dispensed with

and a whistle permeates the whole of the broadcasting it is a sure sign that the choke is required.

Further inspection of the circuit shows that the standard transformer coupled audio frequency is employed. This system is by far the most popular of all types and is more or less universally understood. But always remember to employ the 5 to 1 in the first stage and 31 to 1 in the second stage. Never use two 5 to 1 ratio audio transformers in one set, the volume of sound will be rather distorted, and always place the transformers at right angles to one another.

The photographs show the completed receiver. The front panel view shows the condenser dials, rheostat knob, battery switch and jacks. Immediately on the left is the aerial tuning condenser. The rheostat is to the right, whereas the grid or secondary tuning condenser is to the right

again. That small knob right alongside this condenser dial is for the vernier action which is such a good feature of the Heath condenser. And as some sort of vernier action is practically indispensable to this portion of the circuit, this proves ideal. The small dial governs the reaction condenser, which is of .00025 capacity.

The back view shows the disposition of the parts. Immediately in the foreground is the Radison former, on which is wound the secondary and the reaction coils. The transformers and condensers are easily seen. A close up view of the coils is also provided as a guide.

The parts used and the brands are (limited here)—

- 1-Radison or Dilecto Panel, 20in. x 8in. x 3/16in.
- 1-.0005 Heath Variable Condenser.
- 1-.0005 Heath Variable Condenser (with vernier).
- 1-.00025 Heath Variable Condenser (plain).
- 2-3in. Dials.
- 1-2in. Dial or similarly sized Knob.
- 1-30 ohm. Rheostat (Centralab).
- 1-Battery Switch.
- 1-B.M.S. D.C. Jack.
- 1-B.M.S. S.C. Jack.
- 3-Radison No. 2 Sockets.
- 1-F.M.C. Audio Transformer (5 to 1).
- 1-F.M.C. Audio Transformer (31 to 1).
- 1-Bradleybank.
- 1-.00025 Grid Condenser.
- 1-Radion Terminal Board, complete with 7 terminals.
- 5in. of 3in. Diameter Radion Tubing.
- 2-Renrade Filament Ballasts.
- 1-Fixed Coupling Plug.
- 1-Baseboard, 19in. x 9in. x 3/4in.
- 1-200 turn Honeycomb Coil.

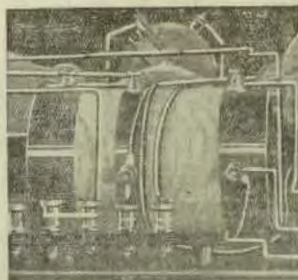

A close-up showing the construction of the coils and their position in relation to the remainder of the set.

Ask for the New 83X Philco Battery.

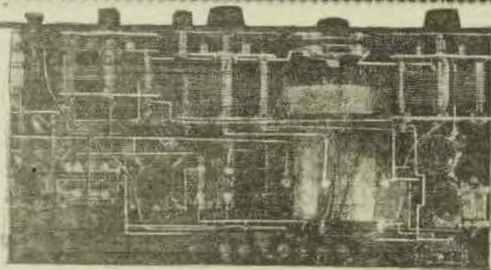

A Back-of-Panel View of the Set.

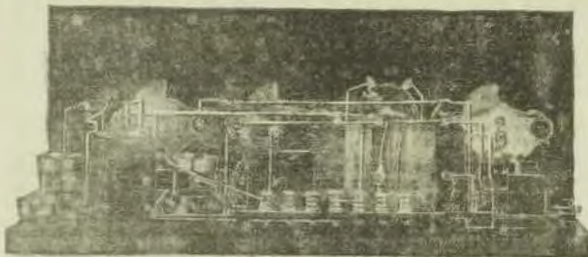

The Base-board Lay-out of the Parts.

the secondary coil from the reaction coil. At each end, but on the other side of the former from the former from the first and third binding posts, drill two holes sufficiently big to allow a wood screw to pass through in order to secure this former to the baseboard.

This leaves binding posts 4 and 5 without any connections whatever up to the present. These binding posts 4 and 5 are required for the connections of the coupling turns from the aerial circuit, so that in actual wiring binding post four is connected to one side of (a) of L1, from thence the coupling turns (b) are taken right around the filament end of L2, thence to binding post 5, which is connected to the ground terminal of the terminal board.

Now lay your panel on a flat surface and mark out in accordance with the panel diagram reproduced elsewhere in this article. Using the template supplied by the condenser manufacturers, mark out the fixing holes for the condensers and then provide three holes at equal distances at the bottom of the panel for attaching the panel to the baseboard. Having done this satisfactorily, mount the panel components and then temporarily place the panel in position along the edge of the baseboard, and plot the location of the baseboard components. This photograph will prove of great assistance in this matter, as also will the back of panel wiring diagram. Note carefully that the (a) portion of L1 is entered for by means of a standard fixed Honeycomb coil coupling plug, mounted on a small portion of panel material and fixed to the baseboard at right angles to the other coils. Immediately in front of this should be fixed a Bradysleak and a grid condenser, in front of this again

- 2 Reaction Coils (one 35 turn, one 50 turn).
- One Dozen Bushbars.
- 3 Lengths of Spaghetto Tubing.
- 8 Small Binding Posts.

All these parts are quality parts and have been specially chosen for this receiver. They may be obtained from any of the advertisers in this paper.

Construction—

The tubing should first be wound with the grid coil and the reaction coil. At a distance of half an inch from one end of the former drill a hole sufficiently big to secure in position a binding post. In line with this along the length of the coil, but two and a quarter inches away, fix another binding post, a third binding post to be attached two and a half inches away still further along in line. Around the circumference of the coil, say about a quarter of the way and in line with the first two binding posts, fix two others. These binding posts are for the connections of the coils, and greatly simplify the wiring.

Now clamp underneath the first binding post you placed in position, the beginning of the wire of the grid coil, which consists of 50 turns of No. 24 gauge D.C.C. wire. Wind this wire, each turn close to its neighbor, and secure under the second binding post in the order of fixing. The reaction

winding consisting of 25 turns of the gauge wire, is now wound on in the space between terminals 3 and 3, the beginning being clamped under terminal 2, which also has the end of the secondary, and the end of the reaction winding is secured under binding post 2. These coils should be so wound that a distance of approximately half an inch should separate

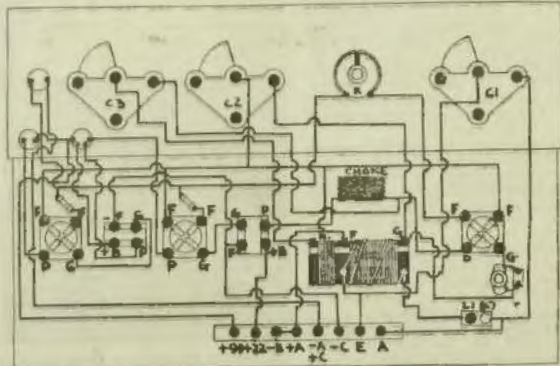

The Wiring Diagram.

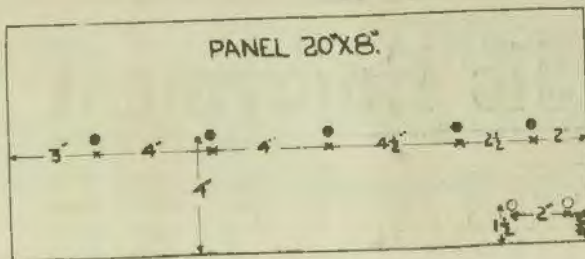

The Panel Wiring Template

is the socket of the first valve, then comes the variable condenser C1. In describing this we are looking from the back. To the left of this Bradley-leak and valve socket V1, space the former containing and reaction coils, with the reaction portion of the winding kept at the left-hand side. Secure to the baseboard by means of a small piece of radium or diletto and two wood screws right in front of this coil and immediately behind the rheostat is the choke coil, consisting of a Honeycomb coil of the order of 200 or 250 turns. This choke coil, of course, will therefore be fixed right between the two 0405 variable condensers. At a distance of approximately one and a half inches away from the reaction end of the former is placed the first audio transformer, to the left again and very close to this transformer will be found room for the second valve socket. Then comes the second audio transformer and third valve socket. As only one rheostat is used in this circuit and this to control the detector valve only, we have chosen filament ballasts as supplying the correct filament current for the two audio valves. Therefore obtain the correct sized filament ballasts for the valves intended to be used and screw them in position on the baseboard alongside and in front of their respective valve sockets. Ample room should be found for the terminal board right at the back of the baseboard.

Having arranged everything nicely in place the receiver may now be wired. The back of panel wiring diagram is of extreme interest at this stage, for those who do not quite understand a circuit diagram. Square busbar was used to wire the receiver photographed, and it looks very neat indeed. Take the wiring step by step and soon this interesting job will be finished. Attention should be paid to the coupling turns from the aerial coil. As explained in the beginning of this article these turns are wound around the filament end of the grid or secondary coil—the filament end being that end near to the reaction coil. These turns should be wound in the same

direction as the secondary coil and may consist of from one to four turns, according to the degree of selectivity required. Try with three turns first and if a certain amount of interference is experienced reduce to two or one perhaps if this suits best. Enclose these coupling turns in a length of varnished cambric spaghetti tubing, 24 gauge being a satisfactory wire.

Check over the wiring carefully before testing, noting that no errors have crept in. See that the B battery wires don't touch the A battery wires—this is important.

Having satisfied yourself that everything is in perfect order, insert the valves in their sockets. There are many different valves to choose from, but don't forget to use the valves which correspond in consumption rate with the filament ballasts. For example, if .96 ampere filament ballasts are used in the set, see that the valves used consume .06 of an amp.—a De Forest DV3 for example. Don't use a DV3 valve with a .25 ampere filament ballast—it won't suit.

However, select the correct valves and hook on the Aerial and Earth and the A and B batteries. The detector valve will function best with a plate voltage of 225 volts to 45 volts, whereas the full 90 volts will feed the audio valves. A C battery of from 2 to 3 volts to be determined by trial will be of immense value in prolong-

ing the life of the B battery. Plug the speaker into the loud speaker jack and tune in firstly the local station. The middle condenser (C2) will be found extremely critical, so remember this. That's why a varner condenser is used. The aerial condenser C1 is governed by the size of Reactance coil inserted into the plug. Either a 25 or 50 turn coil will suit, depending on the length of aerial used. The reaction condenser will act in many respects as a volume control, perhaps this condenser may cause a squeal or two, so be careful to keep just below oscillation point. No difficulty will be experienced in bringing in all the local stations at comfortable loud speaker strength, in fact it will be found that the two main stations of Sydney will yield splendid results on two valves only. To obtain this effect plug the speaker into the first jack, that is the D.C. jack.

Seek Interstate stations by plugging the phones into the D.C. jack and carefully tune. A correct recombination of condensers C1 and C2 will bring in all Interstate stations excepting Perth. Brisbane 4QG will be easily found. Tested at Marrickville on a standard 78 feet aerial 3L0, 4QG, 5CL and 3AR were all heard nicely, the two former stations at remarkably good strength. Later on in the evening the excellent transmission of 2UE kept all out of bed, for this receiver is not raucous; it is, in fact, very clear indeed. An excellent receiver worth well building.

DURING a discussion on inter-Empire radio problems at the Dominion Premiers' Conference it was stated that loud speakers would be installed for the convenience of passengers on the R101, the great new airship. The vessel will be, in reality, an air liner, having a minimum speed of 50 miles an hour, and a cruising range of 4,000 miles at an altitude of 5,000 feet.



The Finished Panel.

Real Radio Enjoyment

Use an EVER-READY B. BATTERY on your set and have Real Radio Enjoyment. The Ever-Ready Radio B. Batteries are manufactured in Australia from the finest materials obtainable. Owing to the exceptional demand, we have new and fresh stocks arriving from the factory almost daily, and all Batteries are tested on a special testing instrument before despatch.

For 1 and 2 Valve Sets.

WP30—30v. 9/6

WP40—40v. 12/6

WP60—60v. 18/-



For 3, 4 or 5 Valve Sets.

XP30—30v. 16/-

XP40—40v. 21/-

XP60—60v. 31/6

Illustration of W.P. 60 B. Battery.

ADD an EVER-READY No. 126 "C." or Bias Battery to your Set. In addition to increasing life of your B. Battery, it will make a wonderful improvement to the purity of Reception 2/9 each
 "Ever-Ready" Standard "A." Battery—1½ Volt 9/-

METERS. For Testing "A." and "B." Batteries.

0-50 Volts 4/9

0-50 Volts—0-50 Amps. 7/6

0-10 Volts—0-35 Amps. 4/9

0-10 Volts—0-150 Volts 10/6

Pocket-type Hy-Dro-Meters—for testing 6 Volt Accumulator 7/6

Wiles Wonderful Wireless and Electrical Stores

Pitt and Goulburn Streets :: SYDNEY

BRANCH: 384 Pitt St., Nr. Goulburn St.

BRANCH: 23 Pitt St., Nr. Circular Quay.

MAIL ORDER DEPARTMENT—60 GOULBURN STREET.

BROADCASTING PROGRAMMES

For the COMING WEEK

Friday, March 11

2FC, SYDNEY

Farmer's Broadcasting Service.

Wave Length, 442 Metres.

EARLY MORNING SESSION.

- 7 a.m.—"Big Ben" and announcements.
 7.5 a.m.—Studio music.
 10 a.m.—Official weather forecast, rainfall, temperatures, astronomical memoranda, shipping intelligence, mail services, commercial news.
 7.25 a.m.—Investment market, mining share market, metal quotations.
 7.35 a.m.—Wool sales, broadstuffs markets, interstate markets, produce markets.
 7.45 a.m.—"Sydney Morning Herald" news service.
 8 a.m.—"Big Ben." Studio music.
 8.15 a.m.—Close down.

MORNING SESSION.

- 9.50 a.m.—Marching music for school children.
 9.40 a.m.—Some popular records.
 9.50 a.m.—Pianoforte reproduction in the "Debussy" Player Piano.
 10 a.m.—"Big Ben" and announcements.
 10.5 a.m.—Late "Sydney Morning Herald" news service.
 10.15 a.m.—Studio music.
 10.45 a.m.—A vocal duet.
 11 a.m.—"Big Ben," Australian Press Association and Reuter's Cable Services.
 11.10 a.m.—Studio music.
 11.15 a.m.—A talk on home cooking and recipes by Miss Ruth First.
 11.30 a.m.—Marching music for school children.
 11.55 a.m.—Close down.

MIDDAY SESSION.

- 12 noon—"Big Ben" and announcements.
 12.10 p.m.—Stock Exchange, (By) call.
 12.5 p.m.—Studio music.
 12.50 p.m.—Rugby Wireless News.
 12.55 p.m.—Miss Kathleen Horn, soprano: "A Little Love Note" (Lobe).
 1 p.m.—"Big Ben" and weather information.
 1.5 p.m.—"Evening News" holiday news service.
 Producers' Distributing Society's report.
 1.25 p.m.—Stock Exchange, second call.
 1.30 p.m.—Marching music for school children.
 1.50 p.m.—Miss Kathleen Horn, soprano: "I Pitch My Lonely Caravan" (Contes).
 1.45 p.m.—Studio music.
 2 p.m.—"Big Ben." Close down.

AFTERNOON SESSION.

- 2.30 p.m.—Programme announcements.
 2.35 p.m.—A pianoforte recital arranged by Miss G. D. Bartoe:
 MISS JOYCE DOUBKÉ:
 (a) "Doctor Graudenz Farnassum" (Debussy).
 (b) "Refrain de Berceuse" (Palmgren).
 MISS PHYLLIS LYNCH:
 "Two Arabesques" (Debussy).
 MISS JOAN HIGGINS:
 (a) "Romance Op. 28" (Schumann).
 (b) "Prophet Bird" (Schubert).
 MISS OLIVE SIMPSON:
 "Three Alouettes" (Lisztovsky).
 2 p.m.—"Big Ben." A studio recital.
 2.10 p.m.—Further items from the Pianoforte Recital arranged by Miss G. D. Bartoe.
 MISS LORNA FORESTH:
 (a) "Leyende" (Albion).
 (b) "Danse de Chabert" (Brahms).
 (c) "Valse Op. 10" (Chopin).
 MISS JESSIE HUXTABLE:
 "La Papillon" (Liszt).
 MISS BETTY HIGGINS:
 "Minuet" (Paderewski).
 2.10 p.m.—Marching music for school children.
 2.20 p.m.—FROM FARMER'S TEA ROOMS:
 Miss Alice Kent, mezzo: "Sweet Lady Moll" (Phillips).
 2.35 p.m.—Studio music.
 2.50 p.m.—Miss Essie D'Arcy, soprano:
 "Butterfly Wings" (Phillips).
 2.55 p.m.—A popular record.
 3 p.m.—FROM FARMER'S TEA ROOMS:
 Miss Jeanette Rooney, contralto.
 3.5 p.m.—A music talk by Mr. Ewart Chappie.
 1.20 p.m.—FROM FARMER'S TEA ROOMS:
 Miss Alice Kent, mezzo:
 "Vainka's Song"
 4.25 p.m.—A popular record.
 4.50 p.m.—Miss Essie D'Arcy, soprano:
 "We'll Know We'll Understand" (Henry).
 4.55 p.m.—A pianoforte reproduction in the "Debussy" Player Piano.
 4.40 p.m.—FROM FARMER'S TEA ROOMS:
 Miss Jeanette Rooney, contralto.
 4.45 p.m.—Stock Exchange, third call.
 4.45 p.m.—Close down.

EARLY EVENING SESSION.

- 5.15 p.m.—The Chorus of 2FC.
 5.30 p.m.—The "Hello Man" talks to the children.
 6.15 p.m.—Songs for the little ones, sung by Miss Neroli Whittle:
 (a) "Time to Rise" (del Rio).
 (b) "I Wonder I Get Up at Night" (Nevin).
 6.30 p.m.—"A Fairy Went A-marketing" (Goodhart).
 6.35 p.m.—A story for the older ones.
 6.40 p.m.—Dinner music from Farmer's Tea Dining Hall. Instrumental and vocal numbers, under the direction of Mr. Horace Keats.

- 10 a.m.—"Big Ben" and announcements.
 10.5 a.m.—Late "Sydney Morning Herald" news service.
 7 p.m.—"Big Ben." Last minute sporting information by the 2FC Racing Commission.
 7.10 p.m.—Dalger's Market Reports (wool, wheat and stock).
 7.15 p.m.—Fruit and vegetable markets.
 7.20 p.m.—Weather and shipping intelligence, stock exchange.
 7.25 p.m.—Late "Evening News" news service.

NIGHT SESSION.

- 7.45 p.m.—Programme announcements.
 7.55 p.m.—Some popular records.
 8 p.m.—FROM THE LYCEUM THEATRE, PITT STREET, SYDNEY.
 Items by the Orchestra.
 8.12 p.m.—FROM THE STUDIO:
 Mr. Powell Phillips, Tenor:
 "Before You Leave" (Wright).
 8.16 p.m.—Mr. J. Wilkinson, Soprano-contralto solo.
 8.20 p.m.—Miss Kitty Elliott, Contralto.
 8.25 p.m.—A talk on Art Education by the well-known Painter, Daryl Rubau.
 8.30 p.m.—Mr. Powell Phillips, Tenor:
 "Who Knows?" (Hall).
 8.40 p.m.—Mr. Herbert Wallon in a few merry moments.
 8.45 p.m.—Mr. Cy Pat, Ukulele Troubadour.
 8.54 p.m.—Miss Marie Sagar, Soprano.
 9 p.m.—Mr. Montgomery Stuart, in a humorous recitation.
 9.1 p.m.—Mr. J. Wilkinson, Soprano-contralto solo.
 9.12 p.m.—Mr. Powell Phillips, Tenor:
 (a) "In an Old-fashioned Town" (Ligeti).
 (b) "Bis de Mo" (Ligeti).
 9.20 p.m.—Mr. Cy Pat, Ukulele Troubadour.
 9.25 p.m.—FROM THE LYCEUM THEATRE, PITT STREET, SYDNEY.
 Orchestral items, and variety act.
 9.35 p.m.—FROM THE STUDIO:
 Miss Kitty Elliott, Songs at the Piano.
 9.45 p.m.—Mr. Montgomery Stuart, Ukulele Troubadour.
 9.50 p.m.—Miss Marie Sagar, Soprano.
 9.55 p.m.—Mr. Herbert Wallon in a few merry moments.
 10.5 a.m.—FROM THE LYCEUM THEATRE, PITT STREET, SYDNEY.
 Items by the Orchestra.
 10.15 p.m.—FROM THE STUDIO:
 Mr. J. Wilkinson, Soprano-contralto.
 10.20 p.m.—Mr. Montgomery Stuart, Ukulele Troubadour.
 10.52 p.m.—Items by the Lyceum Theatre Orchestra.
 10.45 p.m.—FROM THE WENTWORTH CAFE, SYDNEY: The New Westsart Symphonic Dance Orchestra, conducted by Mr. Sydney Simpson.
 10.40 p.m.—Celebrity records from the Studio.
 11 p.m.—"Big Ben." Late news and announcements.
 11.5 p.m.—Items by the Wentworth Symphonic Dance Orchestra, until midnight.
 12 midnight—"Big Ben." National Anthem. Close down.

2GB, SYDNEY

Theosophical Broadcasting Service.
Wave Length, 316 Metres.

Friday.

MORNING SESSION.

- "Chorus Hero," conducted by the "Chorus"
Man.
9.30 a.m.—General Talk by Mr. J. K. Powell.
9.45 a.m.—Music.
10 a.m.—Psychological Class.
10.30 a.m.—Music.
10.45 a.m.—Theosophical Talks for Schools.
10.58 a.m.—Music.
11.30 a.m.—Class closed.

AFTERNOON SESSION.

- 3.30 p.m.—Radio Music.
3.45 p.m.—Critical Topics in Mathematics.
4 p.m.—Music Lesson Continues.
4.15 p.m.—THE CHILDREN'S SESSION,
conducted by Mr. J. K. Powell.
4.45 p.m.—Popular Song Numbers, Vocal,
Gymnastics and Piano.
5.15 p.m.—Psychology.
5.30 p.m.—Announcements.
5.45 p.m.—Instrumental Trio: Maria Handz,
Muriel Lang, and Ada Brook.
6.15 p.m.—Address by THE GINESE WOOD.
6.30 p.m.—Song by Mr. E. B. Butterworth.
6.45 p.m.—An Hour with the 316 Metres
Station: Miss Davies, Maria Handz,
Charles Bank and Muriel Lang.
6.55 a.m.—Announcements.
7.15 p.m.—Musical Monologues.
7.30 p.m.—Instrumental Trio: Maria Handz,
Muriel Lang and Ada Brook.
7.45 a.m.—Musical Monologues.
8.15 p.m.—Songs by Mr. E. B. Butterworth.
8.45 p.m.—"Chorus" Talk.
9.15 p.m.—Grand Thoughts.

2KY, SYDNEY

Trains Hill Broadcasting Station.
Wave Length, 280 Metres.

Friday.

LUNCHBOX HOUR SESSION.

- 12.15 p.m.—There is in the Ticking of the
Clock.
12.45 p.m.—Popular Favorites. "Orpheus"
Gymnastics.
12.55 p.m.—Musical Interlude.
1.10 p.m.—News Items.
1.15 p.m.—Vocal Items.
1.35 p.m.—Recycled Steel Guitar Solos.
1.55 p.m.—Dance Tunes and Melodians.
2.30 p.m.—Linda's Remedy.
2.45 p.m.—Where is the Tonic?
3.15 p.m.—Closing Announcements.

CHILDREN'S HOUR.

- 4.30 a.m.—The Storyman, Mr. Thompson.

EVENING SESSION.

- 7.0 p.m.—Sporting Features: Turf Topics; Re-
view of candidates and their prospects for
tomorrow. Mr. A. Powell.
7.45 p.m.—The morning's sporting events, and
news items.
8.0 p.m.—Talk on Motor Cycle Racing, Mr.
J. S. Hoelzel.
8.15 p.m.—Presenters welcome. Miss Maria
Larochette.
8.20 p.m.—Soprano solo, Miss Edith Walsh.
8.40 p.m.—Soprano, Mr. David Edelstein.
8.50 p.m.—Musical Interlude. (Illustrated
Panel Orchestra; Billy Kovacic, Leader.
(By kind permission of Gen. Irvine).

- 7.4 p.m.—Bertone solo: MR. VAL BLACK.
7.10 p.m.—Sporting Feature: Fanciful description
of Man's Contest from Mr. Banks.
7.45 p.m.—Golf.
8.00 p.m.—Rugby of Eight.
8.30 p.m.—Music from Studio.
10.0 p.m.—Closing Announcements.

3LO, MELBOURNE

Broadcasting Co. of Aust.
Wave Length, 371 Metres.

Friday.

MIDDAY SESSION.

- Announcements. AGNES FORTUNE
Assessment. ALFRED ADORF
"SNAPS AND SNATCHES"
12 noon—Time Signal, British Official Wire-
less news from Rugby, Betsey's and the Aus-
tralian Press Association, Canteen.
12.15 p.m.—Stock Exchange information.
12.30 p.m.—"Argos" and "Herald" news sum-
maries.
12.45 p.m.—"BURNING AND FEUDING."
"Radio Letters."
1.15 p.m.—STUDIO ORCHESTRA.
"The Cabaret Girl" (Jerome Kerviel).
1.30 p.m.—SIDNEY BURCHALL, baritone.
"The Land where the Grass Grows so
Greenly" (Von Tilzer).
"Waltzes for Show" (Abe Olman).
1.45 p.m.—MAGGIE FOSTER, violin.
"La Germaine" (Bella).
"Waltz Festival" (Dobos).
1.45 a.m.—JONES AND KATIE, The West
Herald.
2.00 p.m.—"Hi, Ho, He!"
2.05 p.m.—"Celia, Celia be Fairer than Thou!"
2.15 p.m.—Meteorological Information, Weather
forecasts for Victoria, Tasmania, South
Australia, and New South Wales.
2.25 p.m.—STUDIO ORCHESTRA.
"Auld Acquaintance" (Broadbent).
2.35 p.m.—SIDNEY BURCHALL, baritone.
"Jean" (Burlingame).
"Dances" (Elton Pachel).
2.45 p.m.—STUDIO ORCHESTRA.
Solo, "Dulcians," Part 1, (Hans).
2.50 p.m.—MARIE LE VARGE, contralto.
"L'Amour and Serez"
3.00 p.m.—"Time Night."
3.05 p.m.—Class closed.
Revue of ROOBY BAKER will be given as
this time to hand.

NEW SOUTH WALES "A" AND "B"
CLASS BROADCASTING STATIONS.

- 2P.—Farmer's Broadcasting Station,
I.A.B., Sydney, wavelength 442 metres,
power 5000 watts.
2AB.—Broadcasters' Ltd., Sydney, wave-
length 252 metres, power 5000 watts.
2IC.—Theosophical Broadcasting
Station, Ltd., Sydney, wavelength
316 metres, power 300 watts.
2AY.—Trade and Labor Council, Syd-
ney, wavelength 234 metres, power
1000 watts.
2I.—Gita Sandel, Sydney, wavelength
342 metres, power 300 watts.
2IX.—Gita Sandel, Waucho, wavelength
309 metres, power 300 watts.
2AK.—"Mackay" Bros., Balbrain, wave-
length 273 metres, power 300 watts.
2IR.—Educational Utilitas Supply Co.,
Sydney, wavelength 395 metres,
power 500 watts.
2BE.—Bazely, Electric Co., Sydney,
wavelength 316 metres, 1000 watts.
2BD.—H. A. Douglas, Newcastle, wave-
length 238 metres, 1000 watts.

AFTERNOON SESSION.

- Announcements. AGNES FORTUNE
Assessment. ALFRED ADORF
2.30 p.m.—STUDIO ORCHESTRA.
"Waltzes for Show" (Abe Olman).
2.40 p.m.—AU PAFF of Messrs. Buckley &
Nunn Ltd., will give a Fashion Talk.
2.45 p.m.—STUDIO ORCHESTRA.
"Glimpses in Gipsy" (Broadbent).
2.55 p.m.—MARJORIE VERRÉ, soprano.
"Aria of O' Rio" (Cranke Day).
"What You Think of Me?" (O'Hagan).
3.05 p.m.—HARRY GOULD.
Song, "Now do You Think He's Man?"
"Things are Ought to Know."
"A Story of Two."
"The Admiral's Room," called to pieces.
3.15 p.m.—STUDIO ORCHESTRA.
Soloists, "Red Jinks" (Pratt).
3.30 p.m.—JESSE BATHFORD, contralto.
"Melancholy" (Broadbent).
"To a Mountain" (Gresham).
3.45 p.m.—STUDIO ORCHESTRA.
"Tenderly However" (Thomson).
3.55 p.m.—MARJORIE VERRÉ, soprano.
"A Little Song" (Widener).
"A Birthday" (Coverly).
4.05 p.m.—MRS. M. CALLAWAY SAHODI.
"Art in Modern Life."
4.15 p.m.—"Herald" news summary, Stock Ex-
change information.
4.30 p.m.—Class closed.

EVENING SESSION.

- 7.15 p.m.—CHILDREN'S HOUR. Answers to
letters and recitation recitals.
7.30 p.m.—MOUTH ORGAN BAND, H. COL-
LIER'S CHURCH ORGAN MOUTH ORGAN
ORCHESTRA.
"Harmony."
"Princess's Song."
"Pussy O'Neil" (Children's Request).
7.45 p.m.—"BILLY BUNNY" has a story for
the Day.
7.55 p.m.—MARJORIE VERRÉ, soprano.
Two little songs for the children.
8.10 p.m.—MOUTH ORGAN BAND.
"Hells of St. Mary."
"Madness."
8.24 p.m.—"BILLY BUNNY," Stories.
"Queen Bee."
"The Black Princess."
8.35 p.m.—"Argos" and "Herald" news sum-
maries. Weather forecasts, Shipping news-
papers.
8.45 p.m.—Stock Exchange information.
8.55 p.m.—Fish Market reports by J. R. Her-
vey Ltd.
9.05 p.m.—Silver reports.
9.20 p.m.—Market reports by the Victorian
Producers' Association, Mr. Ltd., Victorian
Biology and Industry, Mining, Hay, Straw
Jobs, Dairy Producers, Poultry and Cattle.
9.30 p.m.—Market reports of Fruit by the
Victorian Producers' Association. Whole-
sale, compiled by the "World World," Ex-
change in 2014. Market prices of Oranges
and Lemons by the Victorian Central Citrus
Association Pty. Ltd.
- Announcements. AGNES FORTUNE
Assessment. MAURICE DUDLEY
"THE SUEB ALL TASTES"
10.15 p.m.—Under the supervision of the Depart-
ment of Agriculture, MR. C. H. P. DAKER,
private Dairy Superintendent.
"Domestic Treatment of Live Stock."
10.30 p.m.—STUDIO ORCHESTRA.
"Soldiers' Chorus" from "Fatah" (Gussard).
"Lullaby" (Archie).
10.45 p.m.—JONES AND KATIE, The West
Herald, are here again for a few more
minutes.
10.55 p.m.—MAGGIE FOSTER, violin.
"Les Trois Rois" (de Berlioz).
"Kilnaring."

4QG, BRISBANE

Queensland Radio Service.

Wave Length, 385 Metres.

Friday

MIDDAY SESSION.

- 7.57 p.m.—HARRY GOULD:
"The Banquet."
"A Story of Two."
- 8.4 p.m.—TRANSMISSION FROM THE
WIRELESS EDUCATION EXHIBITION
BUILDING:
COLLINGWOOD CITIZENS' BAND:
March, "Victrola Serenade."
Novelty March, "Missings."
8.14 p.m.—SIDNEY BURCHALL, baritone:
"Sands of Time" (Clay).
"Ties of the Heart" (Ledy).
8.20 p.m.—COLLINGWOOD CITIZENS'
BAND:
Waltz, "Glimy Love."
- 8.23 p.m.—FROM THE STUDIO:
RUTH HUXHAMA, soprano:
Quartet, "The Galah Gull" (Dunne).
RUTH HUXHAMA, DOLLY HERBERT,
RENN MILLAR and RUTH HUXHAMA,
Solo, "Delicate Shade of Blue" RUTH
HUXHAMA
STUDIO ORCHESTRA:
"Agorian Song" (Kestley).
PAUS SOLO: "The Two Grandees" RENN
MILLAR
Quartet, "Down by the Kosciuszko" (Lea).
THE STRONGMAN QUARTET:
TASMA TIERKAMP, solo:
"A Midsummer Song" (Gibson).
OPERATIC QUARTET:
"Fair Wares Song" (Fisher).
8.23 p.m.—STUDIO ORCHESTRA:
"Spanish Dance" (Rabold).
8.3 p.m.—GARDNER AND FREYER:
"Cockney Comedy Canons."
8.15 p.m.—MARGARET, MR. H. A. WOLFE,
Morning chorus at the "Cavendish" and "Australia"
will speak on Saturdays. 8.25 p.m.—
COLLINGWOOD CITIZENS'
BAND:
Quartet, "Tachibana."
J. BRAYWELL, M. STANLEY, B.
GOLTZ, F. WHITE.
8.25 p.m.—SIDNEY BURCHALL, baritone:
"Selected."
8.41 p.m.—MOANE LUG DOD, baritone:
"Intruder."
"Rose of Walsley."
"Pau Caracation."
"Lullaby."

- 1 p.m.—Market reports, weather information,
"The Daily Mail" news, "The Daily Standard"
news.
2.30 p.m.—From Hotel Carlton: Lunch hour
music played by Hotel Carlton Symphony
Orchestra.
3.15 p.m.—From the Observatory. Standard
time signal.
5 p.m.—Close down.

AFTERNOON SESSION.

- 3.10 p.m.—From Hotel Carlton: Afternoon
Tea Music from the Lounge, Hotel Carlton,
played by Hotel Carlton Symphony Orches-
tra.
4.15 p.m.—"The Telegraph" news.
4.30 p.m.—Close down.

EARLY EVENING SESSION.

- 6 p.m.—Daily Standard news, weather in-
formation, announcements.
6.10 p.m.—Business closed by "The Standard."
7 p.m.—Musical opera, stock reports, Lec-
tures, "Agricultural Journalism," Mr. J.
T. F. Bell (Editor, Queensland Agricultural
Journalist).
8.10 p.m.—Weather news, announcements.
8.30 p.m.—Standard time signal.

NIGHT SESSION.

- 8.45 p.m.—Lecture Session, "The Trend of
Modern Poetry," Mr. G. Altherton Hughes,
I.A.A. State Organizer W.E.A.

LYRIC ENTERTAINERS.

Tonight's programme will be supplied by
the "Lyric Entertainers" and has been
arranged by Mr. J. E. Osprey.

INTERSTATE "A" AND "B" CLASS
BROADCASTING STATIONS.

- 310.—Broadcasting Company of Aus-
tralia, Ltd., Melbourne, wavelength
271 metres, power 1000 watts.
- 467.—Newcastle Radio Service, Bris-
bane, wavelength 326 metres, power
2000 watts.
- 470.—Central Broadcasters' Ltd.,
Adelaide, wavelength 385 metres,
power 1000 watts.
- 472.—Woolman's Farmers, Ltd., Perth,
wavelength 1250 metres, tower 5000
watts.
- 721.—Tasmanian Broadcasters, Ltd.,
Hobart, wavelength 325 metres, 500
watts.
- 742.—Associated Radio Co., Ltd., Mel-
bourne, wavelength 224 metres, power
1000 watts.
- 810.—Ordnance, Business and Technical
College, Melbourne, wavelength 254
metres, power 100 watts.
- 812.—O. J. Nilson & Co., Melbourne,
wavelength 315 metres, power 100
watts.
- 813.—Gold Radio Electric Service, Too-
woodville, Queensland, wavelength 264
metres, power 100 watts.
- 153.—Sport Radio's Broadcasting
Station, Adelaide, wavelength 326
metres, power 1000 watts.
- 153N.—32N Pty., Ltd., Adelaide, wave-
length 315 metres, 500 watts.

- 8 p.m.—Overture, "From Shore to Shore,"
Lyric Orchestra; musical, "Down in a
Flowery Vale" (Festo), Lyric Glee Party;
duet, "Garden of Happiness," Mezzos, Mel-
ville and Belmore; soprano solo, "Hiring's
a Lovable Lady" (Hillard), Mrs. H. Gil-
son; selection, "Selection from Barcarola,"
Lyric Orchestra; part song, "Softly Fall
the Shades of Evening" (Hastings), Lyric
Glee Party; accompaniment, "The Bird on
Nellie's Tail," Miss May Angland; solo
characteristic, "Fragrant, Simplicity, Co-
quetry and Singing," Lyric Orchestra;
duet, "Oh Night on You," Miss D. McDowell
and Mr. J. P. Corwell; baritone solo, "The
Gardener," Mr. R. H. Belmore; song, "Love
is Meant to Make us Glad," from "Morris
Engleme," Lyric Glee Party; one-act,
"Stepping the Scale," Lyric Orchestra.
- 9 p.m.—Metropolitan weather forecast.
Borrows solo, "Selected," Miss Dolly Mc-
Dowell; male quartette, "Plantation Mel-
ody" (Robinson), Lyric Glee Party;
part song, "Go Back to Brass," Lyric
Glee Party; solo, "Valse Bipote," Lyric
Orchestra; soprano solo, "A Little Glimpse
of Sun" (Drummond), Mrs. H. Gilson;
duet, "Hills to Fly," (Hest-Gentry),
Miss May Angland; orchestra—(a) "Quar-
tets from Binicola" (de "Minuit" (Hest-
Gentry), Lyric Orchestra; part song, "The
Sea Bath By Evening," Lyric Glee Party;
bass solo, "The Bandoliers," Mr. J. E. Cor-
well, orchestra, "The Belton Love Song,"
Lyric Orchestra; part song, "Nigh, Nigh,
Nigh," Lyric Glee Party; march, "Moby,"
Lyric Orchestra.
- 10 p.m.—"The Daily Mail" news, weather
news. Close down.

5CL, ADELAIDE

Central Broadcasters, Ltd.

Wave Length, 395 Metres.

Friday

MORNING SESSION.

- 11.30 a.m.—G.P.O. Chimes.
- 12.31 a.m.—Autophone Reproductor rental
- 11.40 a.m.—"Advertiser" news service.
- 11.55 p.m.—G.P.O. Chimes.
- 12 noon.—G.P.O. Chimes.
- 12.1 p.m.—"Advertiser" news service.
- 12.15 p.m.—Autophone Reproductor rental.
- 12.40 p.m.—G.P.O. Chimes.
- 12.45 p.m.—Radio Orchestra: Overture, "Alma
de la," solo, "Dance through the room";
for two, "Dance through the room";
"Dance" (Dance), "Tangos"; solo, "A
Gavotte" selection "Dance Music," solo,
"Gavotte"; Solo, "Tou."
- 2 p.m.—G.P.O. Chimes. Close down.

AFTERNOON SESSION.

- 2 p.m.—G.P.O. Chimes.
- 2.1 p.m.—Relay from the Maple Leaf Cafe—
Orchestra numbers.
- 2.15 p.m.—From the Studio—Autophone Repro-
ductor and G.P.O. Chimes.
- 4 p.m.—G.P.O. Chimes.
- 4.1 p.m.—Relay from the Maple Leaf Cafe—
Orchestra numbers.
- 4.55 p.m.—Radio Orchestra: reports, ground for
formation and other announcements.
- 5 p.m.—G.P.O. Chimes and close down.

EVENING SESSION.

- 6.30 p.m.—G.P.O. Chimes.
- 6.57 p.m.—Autophone Rental and news rental.
- 6.58 p.m.—Radio stories.
- 7.30 p.m.—G.P.O. Chimes.
- 7.40 p.m.—Musical talk by "Mandy."
- 8 p.m.—G.P.O. Chimes.
- 8.15 p.m.—Relay from Maple Leaf Cafe.
- 8.15 p.m.—Solo, Mr. H. Talbot.
- 8.19 p.m.—Relay from Maple Leaf Cafe and
G.P.O. Chimes.

- 9.12 p.m.—MR. H. K. LOVE:
Technical Talk.
- 9.15 p.m.—MORRIS FOSTER, voice:
"Popular Choruses."
- 9.8 p.m.—ETHEL READEY, soprano:
"Carissima" (Festo).
- "At Dawning" (Chorus).
- 10.15 p.m.—British General Wireless news
from Rugby. Announcements.
- 10.25 p.m.—COLLINGWOOD CITIZENS'
BAND:
Duet, "EXCELSIOR."
J. BRAYWELL and B. Reiners.
10.38 p.m.—HARRY GOULD:
"Impersonations."
10.45 p.m.—ETHEL HEANEY, soprano:
"Blitheness of Love" (Dunne).
"I Love the Moon" (Hillard).
10.52 p.m.—"Aries" news service. Weather
forecast.
- 11 p.m.—OUR GREAT THOUGHT:
"To write well is to think well, to see
well and to render well; it is to speak at
once intellect, soul, and taste."—Buffon.
- 11.1 p.m.—JOE ARNOLD and HIS EYECOS.
SYMPHONISTS:
"Drearing of Cattle in the Air."
"Tonight's My Night with Betty."
"Let's Talk about My Dreams."
"I Wish You were Justice of Me."
"Ayers."
"I Wish I had my Old Gal Back Again."
"Sunday."
"Rose-colored Glasses."
"Am I Wasting My Time."
"Calling Me Home."
"The Village Blacksmith Owns the Village
Now."
"By the Sign of a Rose."
"Idolizing."
"In a Little Spanish Town."
"That Damon and Delilah Melody."
- 11.40 p.m.—GOD SAVE THE KING.

8.30 p.m.—Song, Miss Lorraine Gilbert.
 9.34 p.m.—Solo from Messrs. Malvern Eclair & Co.—Orchestral numbers.
 9.43 p.m.—Song, Miss Eileen Coombs.
 9 p.m.—G.P.O. chimes.
 9.1 p.m.—Weather report.
 9.3 p.m.—Dalgety's wheat report.
 9.14 p.m.—Selection, SCL Orchestra.
 9.15 p.m.—Song, Mr. H. Tideman.
 9.19 p.m.—Recitation, Mr. George Whittle.
 9.25 p.m.—Selection, SCL Orchestra.
 9.35 p.m.—Song, Mr. Frank McCabe.
 9.36 p.m.—Carnet solo, Mr. Vera Rogers.
 9.43 p.m.—Song, Miss Lorraine Gilbert.
 9.47 p.m.—Selection, SCL Orchestra.
 9.57 p.m.—Song, Miss Eileen Coombs.
 10 p.m.—G.P.O. chimes.
 10.1 p.m.—Advertiser's news service.
 10.15 p.m.—Selected on SCL Orchestra.
 10.25 p.m.—Song, Mr. H. Tideman.
 10.29 p.m.—Recitation, Mr. George Whittle.
 10.35 p.m.—Song, Mr. Frank McCabe.
 10.39 p.m.—Selection, SCL Orchestra.
 10.49 p.m.—Song, Miss Lorraine Gilbert.
 10.54 p.m.—Recitation, Mr. George Whittle.
 10.57 p.m.—Song, Mr. Frank McCabe.
 11 p.m.—G.P.O. chimes and close down.

6WF, PERTH

Westralian Farmer's.

Wave Length, 1250 Metres.

Friday

12.30 p.m.—Tune in.
 12.35 p.m.—First local news bulletin.
 Market reports.
 Tables.
 1 p.m.—Time signal from Perth Observatory.
 1.4 p.m.—Weather notes supplied by the Meteorological Bureau of Western Australia.
 1.5 p.m.—STUDIO QUINTETTE.
 2 p.m.—Close down.
 2.30 p.m.—Tune in.
 3 p.m.—Musical programme.
 4.20 p.m.—Close down.
 4.30 p.m.—Tune in.
 7.5 a.m.—Musical evening for the kiddies, by Aunt Evelyn and Uncle Henry, Leslie, Perry, Rag and Duffy.
 7.55 p.m.—Stock and share intelligence.
 Market reports.
 Tables.
 8 p.m.—Time signal from Perth Observatory.
 8.1 p.m.—Weather notes supplied by the Meteorological Bureau of Western Australia.
 8.4 p.m.—Talk: "Books of the Month," by Mr. J. I. Fairbairn.
 8.45 p.m.—POPULAR NIGHT.
 Musical programme.
 Items by the Misses Sutton and Fales, of the s.s. Karoola.
 9 p.m.—Talk.
 10 p.m.—Second local news bulletin, supplied by courtesy of "The Daily News" Newspaper Co.
 10.30 p.m.—Close down.

Saturday, March 12

2FC, SYDNEY

EARLY MORNING SESSION.

7.5 a.m.—"Big Ben" and announcements.
 7.55 a.m.—Studio Music.
 8 a.m.—Official weather forecast, rainfall, temperature, astronomical memoranda, shipping intelligence, mail services, commercial news.
 7.25 a.m.—Investment market, mining share market, metal quotations.

7.55 a.m.—Wood sales, breadstuffs markets, infarinate markets, produce markets.
 7.55 a.m.—"Sydney Morning Herald" news service.
 8 a.m.—"Big Ben." Studio music.
 8.15 a.m.—Close down.

MORNING SESSION.

9.30 a.m.—Studio Music.
 9.45 a.m.—Last minute sporting information by the 2FC Racing Commissioners.
 10.15 a.m.—Studio Music.
 10.45 a.m.—A Serial Story.
 11 a.m.—"Big Ben." Australian Press Association and Reuter's Cable Services.
 11.10 a.m.—A popular record.
 11.15 a.m.—A Talk on Gardening, by Ms. G. J. Lockley ("Redgum").
 11.50 a.m.—Close down.

MIDDAY AND AFTERNOON SESSION.

12.55 a.m.—Programme announcements.
 1 p.m.—"Big Ben." Weather intelligence.
 1.30 p.m.—"Evening News" midday news service. Stock Exchange information.
 1.30 p.m.—Studio music.
 NOTE: Between the afternoon race results from Moorfield, Victoria Park and Wauchope will be given, interspersed with items from the Wentworth Symphonic Dance Orchestras and Studio numbers.
 4.30 p.m.—Complete resume of the afternoon sporting events, including cricket, tennis, golf, swimming, yachting and racing.
 5 p.m.—"Big Ben." Close down.

EARLY EVENING SESSION.

6.40 p.m.—"The 'Judo Man'" will talk to the children.
 6.50 p.m.—A talk to the little ones by Mr. G. H. Duff, Secretary of the R.S.P.C.A.
 6.40 p.m.—Dinner music.
 7 p.m.—A complete resume of the day's sporting events.
 7.15 p.m.—"Evening News" late news service.
 7.50 p.m.—Weather intelligence.

NIGHT SESSION.

1.40 p.m.—Programme announcements.
 1.45 p.m.—A Talk on Sculpture by the well-known Australian artist, Miss Theo Cohen, dealing with "Statues, Pictures and Art Generally."
 2 p.m.—"Big Ben." FROM THE RAILWAY AND TRAMWAY INSTITUTE: The first act of the amazing musical farce, "THE BOY," adapted from Pinocchio's play, "The Magistrate," and produced by the Railway and Tramway Institute by arrangement with J. C. Williamson, Ltd.
 2.15 p.m.—FROM THE STUDIO.
 Mr. Herbert Fortescue, Tenor Horn solo.
 9.11 p.m.—Miss Dorothy Dewar, cello.
 9.13 p.m.—Mr. Arthur Prince, banjoist.
 9.15 p.m.—Results direct from the Speedway Royal.
 9.15 p.m.—Mr. Herbert Fortescue, Tenor Horn solo.
 9.20 p.m.—Mr. Arthur Prince, banjoist.
 9.25 p.m.—FROM THE CHATSWOOD TOWN HALL: Musical items from the recent act of "BIG BINKS," produced by the Kurland-Gardie Society, conducted by Mr. Arthur Champion.
 ACT 2. Musical numbers:
 Opening Chorus, "I Want to Give My Order," The Company.
 Solo Dancer, KENNETH FISHER.
 Song, "Home," GWEN SHERWOOD and Chorus.
 Duet, "Chi-Chi," JOYCE FISHER and CLAUDE K. EARLE.
 Duet, "Not Now, but Later," DOROTHY MERRIDITH and STEWART THULOCK.
 Song, "To-night's My Night," BILLY COOK, Chorus and Ballet.
 Solo Dance, JOYCE FISHER.
 Duet, "She Says It with Her Eyes," GWEN SHERWOOD and HAROLD WATCH.

Final, "We're Sorry to Detain You," The Company.

10.25 p.m.—FROM THE WENTWORTH CAFE: The New Westworth Symphonic Dance Orchestra, conducted by Mr. Sydney Simpson.

10.5 p.m.—Miss Dorothy Dewar, cello.
 From the Studio.

10.55 p.m.—Mr. Arthur Prince, banjo solo.
 10.55 p.m.—Late news and announcements.

11 p.m.—"Big Ben." FROM THE WENTWORTH CAFE: The Westworth Symphonic Dance Orchestra.

11.20 p.m.—Celebrity records from the Studio.
 11.30 p.m.—"Big Ben." FROM THE WENTWORTH CAFE: In popular numbers until midnight.

12 midnight—"Big Ben." National Anthem.
 Close down.

2BL, SYDNEY

Broadcaster's Ltd.

Wave Length, 353 Metres.

Saturday.

EARLY MORNING SESSION.

7.15 a.m.—G.P.O. Clock and Chimes.
 7.16 a.m.—Metropolitan weather report.
 7.17 a.m.—Musical programme from the Studio.
 7.23 a.m.—Physical training and health exercises.
 7.30 a.m.—G.P.O. Clock and Chimes.
 7.31 a.m.—Hints on health.
 7.36 a.m.—Physical training and health exercises.
 7.45 a.m.—G.P.O. Clock and Chimes.
 7.46 a.m.—Weather report.
 7.47 a.m.—Broadcaster's special news service.
 8 a.m.—G.P.O. Clock and Chimes; close down.

MORNING SESSION.

8.1 a.m.—G.P.O. Clock and Chimes.
 8.11 a.m.—Weather report and forecast by courtesy of the Govt. Met.
 8.13 a.m.—"Sydney Daily Telegraph" news service.
 11.20 a.m.—Women's Session, conducted by Mrs. Jordan—Social notes.
 11.30 a.m.—Mrs. Jordan replies to correspondents.
 11.40 a.m.—Talk on "Simple Cooking for Children," by Mrs. Jordan.
 12.5 p.m.—Musical programme from the Studio.
 12.15 p.m.—News from the "Sun" Cable Edition.
 12.50 p.m.—G.P.O. Clock and Chimes.
 12.51 p.m.—London metal quotations.
 12.53 p.m.—Boats to sail by wireless.
 12.55 p.m.—Weather report and forecast.
 12.57 p.m.—Shipping information—arrivals and departures.
 12.40 p.m.—Information on Interstate and Overseas Mails.
 12.43 p.m.—News from the "Sun."
 1 p.m.—G.P.O. Clock and Chimes.
 1.1 p.m.—Musical programme from the Studio.
 1.15 p.m.—News from the "Sun."
 1.20 p.m.—G.P.O. Clock and Chimes.
 1.31 p.m.—Musical programme from the Studio.
 1.45 p.m.—Talk on sporting and athletic fixtures for the day; Lacrosse, hockey, golf, bowls, turfing, baseball. During the afternoon sporting information will be broadcast by courtesy of the "Sun" Newspapers, interspersed with musical programme from the Studio.
 4.25 p.m.—Resume of night's programme.
 5 p.m.—G.P.O. Clock and Chimes.
 8.1 p.m.—Resume of day's racing.
 9.4 p.m.—Close down.

EARLY EVENING SESSION.

- 8.46 p.m.—G.P.O. Clock and Chimes.
- 8.48 p.m.—Uncle George and the Kiddies.
- 8.50 p.m.—Musical programme from the Studio.
- 9.16 p.m.—Result of all sporting information, including racing, bowls, tennis, swimming, sailing, athletics, by courtesy of the "Sun".
- 9.20 p.m.—Country news from the "Sun" and results of all sporting and athletic fixtures.
- 9.40 p.m.—Talk on "Patriotic Literature" by Mr. A. G. Stephens.
- 9 p.m.—G.P.O. Clock and Chimes.
- Broadcasters' Topical Chorus.
- 1.3 p.m.—Ivy and Eric Butterfield (steel guitar).
- 8.18 p.m.—Mr. A. T. Garrard (bass).
- 8.21 p.m.—Mr. Reg. Harrison (comedian).
- 8.28 p.m.—Miss Elsie Findlay (soprano).
- 8.37 p.m.—Mr. Leslie Herford (baritone).
- 8.45 p.m.—Miss Mah Fotheringham (soubrette).
- 8.53 p.m.—Resume of following day's programme. Weather report and forecast by courtesy of Mr. C. J. Mares, Govt. Meteorologist.
- 9 p.m.—G.P.O. Clock and Chimes.
- 9.1 p.m.—Announcements.
- 9.16 p.m.—Ivy and Eric Butterfield.
- 9.23 p.m.—Mr. T. Garrard.
- 9.33 p.m.—Mr. Reg. Harrison.
- 9.41 p.m.—Miss Elsie Findlay.
- 9.48 p.m.—Mr. Leslie Herford.
- 9.57 p.m.—Miss Mah Fotheringham.
- 10.4 p.m.—The Ambassadors' Dance Band broadcast from the Ball Room of the Ambassadors. During the intervals between dances news reports by courtesy of the "Sun" will be broadcast.
- 11 midnight.—G.P.O. Clock and Chimes.
- National Anthem.

2KY, SYDNEY

Saturday.

EVENING SESSION.

- 7.15 p.m.—Sporting feature; Complete review of to-day's racing, MR A. E. POWELL.
- 7.50 p.m.—News items and late sporting results.
- 8.0 p.m.—Flanorite solos, MISS ALMA BAUGHEY.
- 8.10 p.m.—Sketch, MISS VJELSKON AND BOB CORBEN.
- 8.30 p.m.—Musical Interlude, Glaciarium Dance Orchestra (Billy Romaine, Leader). (By kind permission of General.)
- 8.6 p.m.—Recital, Mr. BOB CORBEN.
- 9.16 p.m.—Popular Fox-trots.
- 9.30 p.m.—Tenor solos, MR. RAY HAMILTON.
- 9.46 p.m.—Humorous Ords and Ends, MR. HERBERT BEAVER.
- 9.50 p.m.—Dance Music.
- 10.6 p.m.—Closing Announcements.

3LO, MELBOURNE

Saturday.

MORNING SESSION.

- Acrobatist AGNES FORTUNE
- Amusements ALFRED ANDREW
- 11 a.m.—STUDIO ORCHESTRA.
- "Four Fancies" (Reginald Somerville).
- 11.10 a.m.—OSBORNE AND PERRYER.
- Comedy Sketches.
- 11.20 a.m.—WALTER SMITH, Cornet.
- "Arbuckle"an Polka" (Bartmann).
- 11.27 a.m.—MARJORIE VERE, Soprano.
- "The Reason" (Del Rio). Selected.

11.34 a.m.—STUDIO ORCHESTRA:

- "Andalusian Suite" (Bizet).
- 11.44 a.m.—SIDNEY BURCHALL, Baritone.
- "Boor Ballad" (Gower).
- "Ma Little Radio."
- 11.51 a.m.—MAGGIE FETTER, Violin.
- "Wedgefield."
- "Alice Ben Roll."
- 12 noon.—Time signal. British official wireless news from Radio; Reuters and the Australian Press Association cables.
- 12.15 p.m.—Stock Exchange information.
- 12.20 p.m.—"Arms" and "Herald" news service.
- 12.30 p.m.—HURHAM'S SERENADERS.
- Quartet, "How, Sister Sailing" (Alden).
- EDITH WILKRAM, DOLLY BURBURY, RENN MILLAR, HUGH HURHAM.
- Contralto solo, "The Rosary" (Neville).
- DOLLY BURBURY.
- STUDIO ORCHESTRA:
- "The Cingalee" (Dan Godfrey).
- Song, "Sitting in a Corner" EDITH HURHAM.
- Humorous Quartet, "What Story Had" STUDIO ORCHESTRA.
- "Dance of Dwarf and Giant" (Brook).
- (Musical) Quartet, "Cavalieri Rusticana" (Mascagni).
- THE SERENADERS' QUARTET.
- 12.55 p.m.—DOROTHY ROXBURGH, Voice.
- "Reasons" (Pain).
- "Gipsy Lament" (Ryle).
- 3LO, SATURDAY, MARCH 12th 1927.
- 1.2 p.m.—STUDIO ORCHESTRA.
- "Gems from South America" (Schmidt).
- 1.12 p.m.—Meteorological information, weather reports for Victoria, Tasmania, South Australia, and New South Wales.
- 1.22 p.m.—JESSIE PATCHELOR, Contralto.
- "Anxiety Guard" (The "Goodland").
- "That's All" (Drabo).
- 1.30 p.m.—Description of NARONG BURDLE, CAULFIELD RACES, by "Muskie" of the "Sporting Globe."
- 1.35 p.m.—STUDIO ORCHESTRA.
- "Romance" (Kazemoff).
- 1.45 p.m.—GEO. WELCH, Comedian.
- "Nobody Noticed Me."
- 1.52 p.m.—STUDIO ORCHESTRA.
- "From Italy" (Oto Luoney).
- 2 p.m.—Close down.
- 2.30 p.m.—Description of ORRONG TWO YEAR OLD, CAULFIELD RACES, by "Muskie" of the "Sporting Globe."

AFTERNOON SESSION.

- 3.0 p.m.—JOE ARONSON AND HIS SYNO-CYMPHONISTS:
- "Thinking of You."
- "Just a Bird's Eye View."
- 3.5 p.m.—Description of ST KILDA HANDBICAP, CAULFIELD RACES, by "Muskie" of the "Sporting Globe."
- 4.10 p.m.—THE OPTIMISTAL OPENING OF THE NEW CLUB HOUSE of the Aero Club, by HIS EXCELLENCY, the GOVERNOR GENERAL LORD JONATHAN, at the Esplanade Aerodrome, Hulla Road, Esplanade.
- During the afternoon, descriptions will be given of various Aerial Displays.
- 4.40 p.m.—JOE ARONSON AND HIS SYNO-CYMPHONISTS:
- "Just One More Kiss."
- "Reside a Garden Wall."
- "A Night of Love."
- 4.45 p.m.—Description of GORDON STEEPLCHASE, CAULFIELD RACES, by "Muskie" of the "Sporting Globe."
- 4.45 p.m.—JOE ARONSON AND HIS SYNO-CYMPHONISTS:
- "Hello, Hello."
- "Don't Be Angry with Me."
- "There's a Bonanza on the Volga."
- "Tully Tully."
- "I Don't Want Nobody but You."
- "A Cup of Coffee, a Sandwich and You."
- "Ting a Ling Waltz of the Bell."
- "Mary Ann."
- 4.45 p.m.—Description of SOUTH YARRA HANDBICAP, CAULFIELD RACES, by "Muskie" of the "Sporting Globe."
- 4.55 p.m.—JOE ARONSON AND HIS SYNO-CYMPHONISTS:
- "Up to Mountain."
- "Somebody's Lenny."
- "Hi Diddle Diddle."
- "That's Why I Love You."
- "Hi Ho the Merryland."
- "Tingling Waltz."
- "No Foolin'."
- 4.45 p.m.—"Arms" news service—Stock Exchange information, sporting results.
- 4.50 p.m.—Description of THURGA WELTER HANDBICAP, CAULFIELD RACES, by "Muskie" of the "Sporting Globe."
- 5 p.m.—Close down.
- 5LO SATURDAY, MARCH 12th 1927.

EVENING SESSION.

- 8.30 p.m.—Sporting results.
- 8.40 p.m.—"GIBBONS" HOUR. Answers to letters and holiday greetings.
- 8.55 p.m.—MAGNA LEO DUO.
- "Barebona."
- "Hawkerie Medley."
- 8.5 p.m.—Little Miss Kookaburra, little ones! This time the little puppy dog, "Bugs" doesn't like the new warden, and Miss Kookaburra will tell you all about it.
- 9.12 p.m.—OSBORNE AND PERRYER: In fun and frolic.
- 9.22 p.m.—"LITTLE MISS KOOKABURRA"—(A tall one) some news of "Carol of Hollyhock Ballad" (The clown goes in search of a mermaid).
- 9.33 p.m.—"Arms" and "Herald" news service; Weather information, Aerial and all information by the Australian Aerial Services Ltd.
- 9.47 p.m.—Stock Exchange information, overseas shipping.
- 9.52 p.m.—Fish market reports by J. R. Barrett, Ltd.
- 9.55 p.m.—Market reports by the Victorian Producers Co-operative Co. Ltd., Haymarket sheep sales, Puttano and Union, Market prices of Drapery and Lenses by the Victorian Central Circus Association Pty. Ltd., Fruit market reports by the Victorian Wholesale Fruitgrowers' Association, compiled by the "Fruit World," exclusive to 3LO.

NIGHT SESSION.

- Acrobatist AGNES FORTUNE
- Amusements MAURICE DUDLEY
- 11.5 p.m.—MR. J. FOWLER (Railways).
- "The Iron Horse."

NEW ZEALAND STATIONS:

1YA, Auckland, The Radio Broadcasting Co. of New Zealand, Ltd.
Power 500 Watts; Wave-length, 420 Metres. Silent Night, Monday.

2YK, Wellington, The Radio Broadcasting Co. of New Zealand, Ltd.
Power 120 Watts; Wave-length, 295 Metres.

3YA, Christchurch, The Radio Broadcasting Co. of New Zealand, Ltd.
Power 500 Watts; Wave-length, 400 Metres. Silent Night, Thursday.

4YA, Dunedin, The Radio Broadcasting Co. of New Zealand, Ltd.
Power 750 Watts; Wave-length, 380 Metres.

2YM, The Gisborne Radio Co., Gisborne.
Power 50 Watts; Wave-length, 160 Metres.

1.30 p.m.—MR. E. E. PRESCOTT:
"Australian Grasses."

1.45 p.m.—DR. J. A. LEACH:
"Storm-Petrels" or Mother Carey's
Chickens."

6 p.m.—TRANSMISSION FROM THE WIRELESS
EXHIBITION, Exhibition Buildings,
BRUNSWICK CITY BAND:
Overture, "Marches" (Hummert).

8.10 p.m.—HUGHMAN'S BREWMASTERS'
Quartet, "Floating Down the River"
(Wilde).
EDITH HUXHAM, DOLLY BURDETT,
BESS MILLAR and HUGO HUXHAM
Bass solo, "Mountain of Mourne" BESS
MILLAR.

BRUNSWICK CITY BAND:
Process, "Nones" (Nichols).
Humorous Quartet, "The Tale of a Flea."
Humorous Song, "Bury, Oh its quite all-
right" EDITH HUXHAM.
BRUNSWICK CITY BAND:
"Chester Castle" March.
Overture Quartet, "William Tell Overture"
(Rossini), Words by Hans Midler.

8.15 p.m.—FROM THE STUDIO:

Les Gibsons' Sextet:
"Moon River" (Dvorak).
"Humoresque" (Grieg).
Maudlin solo, "Tessie Mae."
8.20 p.m.—VICTORIA WILSON, Soprano:
"The Lass with the Delicate Air" (Arne).
"My Prayer" (Squire).

8.30 p.m.—JONES AND RAINE the Welsh
Hebrews:
Song, "Heads Looking"
Humour Parodie, "Bosley Land."

9 p.m.—MR. E. M. AKIN, one of the
Drama Handicappers:
"How Fair is Obtained."

9 p.m.—VICTORIAN RAILWAYS INST-
RUMENT DRAMA, "THE GREAT
Escape from 'SILVER KING."
CAST OF CHARACTERS:

JAMES ALBERT WATKINS
GUYVER HERALD LAMBLI
TADBY ELAINE TOWNSEND
MRS. GAMMIDGE LOLA MARTIN
THIRIE KARA HAFKENSE
NELLIE ALICE EAST
DENVER G. S. COCKERILL.

9.15 p.m.—BRUNSWICK BAND:

Fantasia "Framo" (Rayner).
9.30 p.m.—HARRY GOULD:
"A Hero or Two."
"A Gossip Knewles."

9.30 p.m.—LEN GIBSON'S NEAPOLITAN
SEXTET:
"Mignorette."
Maudlin solo, "Belton Melody" (Van
Horn).

"Tremors" (Schumann).
10 p.m.—MABIE LE VARRE, Comedienne:
"Thinking of You."
"Wife a Little Bit."

10.10 p.m.—NORMAN BRADSHAW, Tenor:
"Sometimes in Summer" (Hennet).
"Did Not Eat" (Fraser).

10.15 p.m.—BRUNSWICK CITY BAND:
Fantasia "Musical Fragments" (Hummert).

10.25 p.m.—VICTORIA WILSON, Soprano:
"Wailing Song" (Hummert).
"Duffell" (Hill) (Hummert).

10.35 p.m.—British Official wireless news
results.

10.45 p.m.—HARRY GOULD:
Improvizations.

10.50 p.m.—NORMAN BRADSHAW Tenor:
"News in his Forest" (London Round).
"Ma Rose" (Malcot).

10.55 p.m.—OUR GREAT THOUGHT:
"Conversation is the best of character as
well as of cheer" (Hummert).

11 p.m.—ABINSON AND HIS SYMCO-
SYMPHONISTS:
"Smiling Eyes."
"Smuggler's Noddy."
"O Come the Righteous Mountain."
"Frolics."
"Katieka."
"The Rose Tree, The Rose on Me."
"Heardly."
"Then I'll be Happy."
"Twilight Waltz."
"Rising of the Steam."

11.05 p.m.—GOD SAVE THE KING.

4QG, BRISBANE

Saturday.

NO MIDDAY TRANSMISSION.

AFTERNOON SESSION.

2.25 p.m.—Tune in.
3.20 p.m.—A message for little listeners by
"Miss Waratah."
4.30 p.m.—Close down.

EARLY EVENING SESSION.

6.25 p.m.—Tune in.
6.30 p.m.—Children's Feature, Bedtime stories
by "Uncle Sam" and "Circus Jim."
7.15 p.m.—Sporting news.

NIGHT SESSION.

7.30 p.m.—Ending notes by "Tiler."
7.40 p.m.—Announcements.
7.45 p.m.—From the Observers. Standard
time signals.
7.55 p.m.—From the National Speedway. A
description of the motor cycle races.
8 p.m.—From the Gaiety Theatre, Townsville.
Orchestral music.
From the National Speedway. Motor cycle
races.
8.30 p.m.—From Lennon's Ballroom. Dance
music.
10 p.m.—From the Studio. "The Sunday
Mail" news service, weather news.
Close down.

SCL, ADELAIDE

Saturday.

MORNING SESSION.

10.55 a.m.—G.P.O. chimes.
10.31 a.m.—Studio Orchestra: Overture, "Dr.
Ohm's" suite, "Sweetest little rose" and
other "Smiling eyes"; "Midiemidie Kiki"
selection, "Sobit" concert solo, "A round"
"Polonaise militaire"; novelette, "Birds and
butterflies"; Skak, "Fausl".
11.55 a.m.—Station announcements.
12 noon.—G.P.O. chimes and close down.

AFTERNOON SESSION.

3 p.m.—G.P.O. chimes.
3.15 p.m.—From the Radio-Autophone Studio.
Duet and Senora Recital interspersed with
varietal sporting results.
5 p.m.—G.P.O. chimes and close down.

EVENING SESSION.

6.30 p.m.—G.P.O. chimes.
6.31 p.m.—Autophone Reproducer recital.
6.36 p.m.—Bedtime stories.
6.40 p.m.—Sporting results.
6.50 p.m.—Radio Wedding—Broadcast from
Parish of Baptist Church (Miss Doris Hol-
land) by Mr. Herbert Edwards, A.M.U.A.
I.A.B.).
7.05 p.m.—Sporting results continued.
8 p.m.—G.P.O. chimes.
8.12 p.m.—Recital on the Superphonic Senora.
If listeners desire any request (with their
names) give at least 24 hours' notice).
8.20 p.m.—Bass solo, Mr. Erik Wickens.
8.31 p.m.—Maudlin-Guitar solo, Mr. Jack
Lenthall.
8.40 p.m.—Song, Miss Lorna Sidel.
8.42 p.m.—Pianoforte solo, Mrs. Hubert James.
8.44 p.m.—Popular musical number, Miss
Dorothy Meyer.
8.46 p.m.—Song, Mrs. Hubert James.
8.48 p.m.—Maudlin-Guitar solo, Mr. J. Len-
hall.

8 p.m.—G.P.O. chimes.

9.1 p.m.—Superphonic Senora recital.
9.45 p.m.—Bass solo, Mr. Erik Wickens.
9.50 p.m.—Maudlin solo, Mr. J. Lenthall.
9.55 p.m.—Song, Miss Lorna Sidel.
9.58 p.m.—Pianoforte, Mrs. Hubert James.
9.58 p.m.—Popular musical numbers, Miss
Dorothy Meyer.
10.5 p.m.—Song, Mrs. Hubert James.
10.9 p.m.—Maudlin solo, Mr. Jack Lenthall.
10.15 p.m.—Sporting results.
10.30 p.m.—Superphonic Senora recital.
11 p.m.—G.P.O. chimes and close down.

6WF, PERTH

Saturday.

12 noon.—Tune in.
12.5 p.m.—Musical programmes, including
pianoforte selections by Miss Evelyn Williams,
A.R.C.M.
12.57 p.m.—First local news bulletin.
Market reports.
Cables.
3 p.m.—Time signal from Perth Observatory.
11 p.m.—Weather news, supplied by the
Meteorological Bureau of Western Australia.
1.2 p.m.—Close down.
7 p.m.—Tune in.
7.5 p.m.—Eric Leslie will talk to the
Kiddies.
7.28 p.m.—Sports results, supplied by
courtesy of "The Mirror" Newspaper Co.
7.55 p.m.—Stock and share intelligence.
Market reports.
Cables. News, supplied by courtesy of "The
West Australian" Newspaper Co.
8 p.m.—Time signal from Perth Observatory.
8.1 p.m.—Weather news, supplied by the
Meteorological Bureau of Western Australia.
8.5 p.m.—MUSIC AND SONG.
Musical programme.
10 p.m.—Second local news bulletin, supplied
by courtesy of "The Daily News" Newspaper
Co.
10.30 p.m.—Close down.

Sunday, March 13 2FC, SYDNEY

MORNING SESSION.

1935 a.m.—Announcements from the Studio.
11 a.m.—"Big Ben." The morning service
from the Liverpool Hall, arranged by the
Central Methodist Mission, Perth, by
Preacher, Rev. F. H. Rowland.
12.15 p.m.—FROM THE STUDIO:
News service.
12.30 p.m.—Close down.

AFTERNOON SESSION.

2.25 p.m.—Studio announcements.
2.30 p.m.—FROM THE LIVERPOOL CAMP
HEADQUARTERS: A description of the
Consecration and Presentation of the Re-
gimental Colour to the 54th Battalion, Lach-
lan-Macquarie Regiment.
2.45 p.m.—The Regimental Colour is given to
the 54th Battalion, A.M.F., by the ex-
Officers of the 54th Battalion, A.I.F.
2.50 p.m.—The Colour is consecrated by the
Right Rev. George Merrick Long, D.D.,
I.L.D., C.B.E., Bishop of Bathurst, and will
be presented to the Battalion by the Hon-
orary Colonel of the Regiment, Colonel W.
E. H. Colme, C.M.G., A.D.C., Staff Corps.

2BL, SYDNEY

AFTERNOON SESSION.

- 9.30 pm.—Colonel Carr will address the Rev. Talbot.
- During the Ceremony the 54th Battalion Band will play the hymn "King's Reposeful."
- 10.10 p.m.—The Bishop of Bathurst.
- 10.40 p.m.—At the conclusion of the ceremony the Escort to the Colors with King's and Regimental Colors unfurled will turn towards the centre of the Battalion and will be given a general salute. The Escort to the Colors will then march in slow time to its place in the Hon. the Band playing the Regimental March of the 54th Battalion. The Battalion will then march past with the other units of the 5th Australian Infantry Brigade.
- 1.45 p.m.—The 54th Battalion Band under Warrant Officer S. Lewis in Solemnity from the Band Stand in front of Camp Headquarters.
- 6.10 p.m.—FROM THE STUDIO. Mr. Walter Thurman, well-known musician (recently returned from a world tour), will talk of an experience in Singapore and the East.
- 6.40 p.m.—Close down.

EVENING SESSION.

- 6 p.m.—"Big Ben" and programme announcements.
- FROM THE CONGREGATIONAL CHURCH, POT STREET, SYDNEY.
- 6.45 p.m.—An Organ Recital by Miss Lilian Ford, interspersed with vocal numbers.
- 7.10 p.m.—"Big Ben" The Evening Service from the Congregational Church, Pot St., Sydney, Rev. T. K. Rink.
- 8.07 p.m.—Interval.
- 8.35 p.m.—FROM THE BAND ROTUNDA, MARLEY REACH.
- A Concert by the Manly Municipal Band under the baton of Mr. J. Pheasant, Ryeholme, "The Unfinished" (Roussell).
- 9.40 p.m.—Mrs. Fred, "Heils Aelike" (Hess).
- 9.45 p.m.—Clarinnet solo, "Caprice" (Mayerne) Soloist, Bardsman A. Bennett.
- 10.32 p.m.—Selection, "H. Trognies" (Vard).
- 10.55 p.m.—Wells, "At Peace with the World" (Hess).
- 11.15 p.m.—Selection, "The Gipsies" (Linnos).
- 11.35 p.m.—Fox Trot, "Gipsie" (D'Amel).
- 11.47 p.m.—March, "Cross the Rockies" (Morsey).
- 11.57 p.m.—FROM THE STUDIO.
- Miss Virginia Bassett, contralto.
- "Anne's Day" (Hess) (Obligato by Mr. James Hickey).
- 12.04 p.m.—Mr. Richard McCallhead, tenor "Home and Army" (Hess).
- 12.30 p.m.—Mr. Lionel Lawson, violinet "The Cuckoo" (Linnos).
- 12.45 p.m.—"Big Ben"
- Miss Virginia Bassett, contralto.
- (a) "Forn" (FDRK); (b) "Gipsie" by Mr. James Hickey.
- (c) "Nearer my God to Thee" (Cassely).
- 12.55 p.m.—Mr. Richard McCallhead, tenor (a) "The Monk" (Bogrovner); (b) "A Gipsie Country" (Gibson).
- 1.15 p.m.—Mr. Lionel Lawson, violinet.
- 1.24 p.m.—Miss Marjorie Cole, soprano (a) "A Song of Love" (Morosini); (b) "A Lady went a-milking" (Pyle-Webb).
- 1.35 p.m.—Miss Virginia Bassett, contralto "Some Quiet Day" (Hess).
- 1.55 p.m.—Mr. Lionel Lawson, violinet.
- 1.57 p.m.—Miss Marjorie Cole, soprano "Soprano" (Gounod).
- 1.59 p.m.—Mr. Richard McCallhead, tenor "Summer Highland Dore" (Pyle).
- 12.20 p.m.—National Anthem.
- Close down.
- Accompanist—MR. HORACE KRATS

Sunday.

- 10.45 p.m.—Special news service.
- 11.30 a.m.—Service broadcast from St. John's Church of England, Randwick.
- 1.40 p.m.—Stage concert.
- 3.40 p.m.—Bible class conducted by Mr. W. "Gipsie" Bradley, Church.
- 5.15 p.m.—Close down.
- 5.45 p.m.—Children's service conducted by Miss Gwynne.
- 7 p.m.—Service broadcast from Chalmers Place Wesleyan Church.
- 8.30 p.m.—From the Studio.
- Miss Camille Alder (dramatic soprano).
- 8.37 p.m.—Miss Dulcie Hulse (soprano).
- 9.14 p.m.—Mr. Albert Carlisle (tenor).
- 9.21 p.m.—Miss C. C. Robertson (soprano).
- 9.30 p.m.—Resumes of following day's programme.
- 9 p.m.—G.P.C. Club and Chimes.
- Weather report and forecast by courtesy of Mr. C. J. Harris, Gen. Meteorologist.
- 9.45 p.m.—Pianoforte Trio.
- 10.15 p.m.—Mr. Herman Tompkins (tenor).
- 10.20 p.m.—Miss Camille Alder.
- 10.27 p.m.—Pianoforte Trio.
- 10.37 p.m.—Mr. Albert Carlisle.
- 10.44 p.m.—Miss C. C. Robertson.
- 10.52 p.m.—Mr. Herman Tompkins.
- 10 p.m.—G.P.C. Club and Chimes.
- 10.15 p.m.—Pianoforte Trio.
- 10.11 p.m.—Close down.

2GB, SYDNEY

Sunday.

- 10.25 a.m.—Organ music from St. Alban's Church, Redfern.
- 10.35 a.m.—Morning service from St. Alban's United Catholic Church, inner-city, City, 10.30.
- 11 a.m.—Close down.
- 8.45 p.m.—Close.
- 1.15 p.m.—Stage and songs from Adelphi Hall.
- 2.40 p.m.—Piano solo by Vera Brown.
- 2.48 p.m.—Vocal solo, by Mrs. Beattie.
- 2.55 p.m.—Talk by Mr. J. B. Duncanson.
- 8.15 p.m.—Duet for two voices with piano accompaniment. One Seilly Monica Howard. A.S. Brown, solo, by Monica Howard.
- 8.25 p.m.—"Faded" solo, by Monica Howard.
- 8.30 p.m.—Talk.
- 8.50 p.m.—Mr. J. Doug Duncanson.
- 9 p.m.—Close down.

3LO, MELBOURNE

Sunday.

MORNING SESSION.

- 10.30 a.m.—Bells from ST. PAUL'S CATHEDRAL.
- 10.45 a.m.—Service from St. Paul's Cathedral, Official Wireless Service from Sydney.
- 11 a.m.—SERVICE from CENTRAL MISSION, Wesley Church, Doncaster and Dromedary.
- 11.30 a.m.—"Hail Holy, Hail, Thou God Almighty."
- Prayer.
- Hymn, "I Need Thee Every Hour."
- Hail, Sovereign Ruler, Holy Father, ANTHEM.
- Notice and offering.
- Hymn, "Ours Thou'st is above All Others."
- SERMON.
- Hymn, "Hark! My Soul, it is the Lord's."
- Benediction.
- 12.15 p.m.—Close down.

- 11.30 a.m.—PLEASANT SUNDAY AFTERNOON SERVICE from CENTRAL MISSION, WESLEY CHURCH, Chairman, REV. J. H. CAMP.
- Orchestral Selections, (Conductor, Mr. G. M. Williams).
- Hymn, "Forward, Christian Soldiers."
- Prayer, REV. G. LYVING BIRNSON.
- Hymn, "Lead, Kindly Light."
- Solo, "The Holy One" (Adams).
- MISS MADGE AGNEW
- Orchestral Selection.
- Solo, "Glorious."
- MISS MADGE AGNEW
- Notice, Offering and Orchestral Selection.
- ADDRESS: REV. A. W. GUY, NEW BRITAIN.
- "It Was in Panna."
- National Anthem.
- Benediction.
- 4.10 p.m.—Close down.

EVENING SESSION.

- 8.10 p.m.—CHILDREN'S HOUR Music by "THE FIVE PIPERS"
- Hymn, "Vidua of Gold."
- "Lead, Kindly Light."
- 8.35 p.m.—"BILLY BUSHY" will tell more about the "Christmas Carol."
- 9 p.m.—Musical programme by "THE FIVE PIPERS."
- Chorus "Happily Sings the Verse of Evening."
- Solo, "Dear Little Lad with Your Eyes of Blue."
- Duet, "God is Love" (By request).
- Piano Solo, "A Little Mistle."
- Chorus, "The Tune."
- "The Broken Trench" (By request).
- "A Hymn for Australia."
- 8.38 p.m.—"Sisters" by Lovers and Divides Trappings.
- 8.55 p.m.—"BILLY BUSHY" will continue the story of "David's Liberation."
- 9.10 p.m.—Close down.

NIGHT SESSION.

- SERVICE FROM TOMPA'S PRESBYTERIAN CHURCH.
- PRABHAN CITY BAND.
- MARY NUGENT, soprano.
- GEORGE MINDLAY, baritone.
- J. ALEXANDER BROWN, baritone.
- Accompanist—AGNES FORTNEY.
- Assisted—ALFRED ANDREK.
- 6.30 p.m.—Bells from St. Paul's Cathedral.
- 7 p.m.—SERVICE from TOMPA'S PRESBYTERIAN CHURCH, preacher, Rev. John Mackenzie, Organist and Accompanist, MR. JAMES W. HUDSON.
- Organ Voluntary.
- Hymn.
- Invocation.
- Hymn 300 "For All Saints."
- Old Testament Lesson.
- Prayer.
- Hymn 108.
- New Testament Lesson.
- Duet, "Children Play this Love to Church" (Hess).
- MRS. L. ILLIHOORNE and MR. C. HUGHAN.
- Latin Text.
- Hymn 21 "When I Survey the Wondrous Cross."
- Prayers.
- Offering and Anthem: "Ouse This My Cause" (Mozart).
- SERMON.
- Prayer.
- Hymn 300 "O Love God will not Let Me Go."
- Benediction.
- Vesper Hymn.
- Organ Voluntary.
- FROM THE STUDIO.
- 6.45 p.m.—PRABHAN CITY BAND (Conductor, Mr. Derek Cople).
- Selection, "H.M.S. Pinelore" (Gibson).

SCL, ADELAIDE

Sunday.

MORNING SESSION.

11 a.m.—G.P.O. chimps.
11.1 a.m.—Hymn from Parkdale Baptist Church
11.45 p.m.—Close down.

EVENING SESSION

8.30 p.m.—G.P.O. chimps.
8.45 p.m.—Autumn Reproduction recital.
9.10 p.m.—Sunday stories for children.
9.30 p.m.—Relax from St. Bartholomew's Church.
9.40 (approx.)—Instrumental and vocal concert by S.A.R. Band, assisted by Messrs Mita (Rafel), Luoba Pugh and Mr. Fred Williamson.
9.50 p.m.—Time announcements.
10 p.m.—Mr. P. H. Nicholl's address: "The Pathway of the God."
10.30 p.m.—Chimes continued.
10.45 p.m.—G.P.O. chimps. and close down.

11.30 a.m.—A Serial Story.
11.30 a.m.—Marching music for the school children.
11.30 a.m.—Close down.

MIDDAY SESSION.

12 noon—"Big Ben" and programme announcements.
12.10 p.m.—Stock Exchange, first call.
12.6 p.m.—Studio music.
12.30 p.m.—Miss Joyce wireless news.
12.35 p.m.—Kylie Nellie Jaeger, soprano.
1.5 p.m.—"Big Ben". Weather intelligence.
1.5 p.m.—"Evening News" midday news service.
Professors Distributing Society's report.
1.30 p.m.—Studio music.
1.30 p.m.—Marching music for school children.
1.40 p.m.—Miss Cecily Auditt, soprano.
1.45 p.m.—Studio music.
2 p.m.—"Big Ben". Close down.

AFTERNOON SESSION.

2.30 p.m.—Announcements.
2.35 p.m.—A Pianoforte Recital, arranged by Mr. Gordon Lavers:
1. "Fantasia Op. 46" (Chopin), MISS DOROTHY FARLEIGH, L.A.B.
2.45 p.m.—2. "Sonata Op. 27, No. 1" (Beethoven), MISS JOYCE FREW, L.A.B.
3 p.m.—3. "Fantasia 1st Movement, Op. 17" (Schumann), MISS GWEN BOGSON.
2.49 p.m.—Miss Myrtle Gibeman, soprano: "Little Brown Bird" (del Riego).
3.14 p.m.—2. Other items by the pupils of Mr. Gordon Lavers:
4. "Finale from Sonata Pathétique" (Beethoven), MISS VIOLET CIEGWIDEN.
2.19 p.m.—5. "Vocal, 'Mosses when Young'" (Lohmann), MR. GORDON V. LAVERS.
2.24 p.m.—4. "Fareyoure Fields" (Agnew), MISS D. FARLEIGH.
3.20 p.m.—Marching music for school children.
3.40 p.m.—FROM FARMER'S TEA ROOMS: Miss Cecily Auditt, soprano.
3.45 p.m.—Pianoforte solos from the Recital by Mr. Gordon V. Lavers' pupils:
3.45 p.m.—"Serenade" (Rachmannoff), MISS J. FREW.
3.50 p.m.—"Arlesaiseur T. Major" (Debussy), MISS V. CIEGWIDEN.
3.55 p.m.—"Phantasy on the Jennian Cases" (Lavers), MR. GORDON V. LAVERS.
4 p.m.—FROM FARMER'S TEA ROOMS: Miss Muriel Humphries, contralto: "Oh, to be a Gipsy" (Forster).
4.45 p.m.—FROM THE STUDIO: Miss Deborah Lilly: A Talk on Hampton Court Palace, London.
4.50 p.m.—FROM FARMER'S TEA ROOMS: Miss Cecily Auditt, soprano.
4.55 p.m.—Pianoforte solo, "Rhapsody No. 2" (Lavers), MISS GWEN BOGSON.
4.57 p.m.—Miss Myrtle Gibeman, soprano: "Over the Waters Blue" (Clarke).
4.40 p.m.—FROM FARMER'S TEA ROOMS: Miss Muriel Humphries, contralto: "With You Beside Me" (Newton).
4.45 p.m.—Stock Exchange, third call.
4.46 p.m.—Close down.

EARLY EVENING SESSION.

5.45 p.m.—The Chimes of 2FC.
5.50 p.m.—The "Hello Man" talks to the children.
5.55 p.m.—Miss Ethel Athalwood, mezzo, will sing the little ones:
(a) "Little Min-Min" (Peterson).
(b) "Mission-Road" (Peterson).
6.40 p.m.—Dinner music.
7 p.m.—Late sporting news.
7.10 p.m.—Daily's market reports (wood, wheat and stock).
7.15 p.m.—Fruit and Vegetable Markets.
7.20 p.m.—Weather and shipping intelligence.
Stock Exchange information.
7.25 p.m.—Late "Evening News" news service.

GWF, PERTH

Sunday.

10.45 a.m.—Time in.
11 a.m.—Marching service relayed from the Perth Congregational Church, St. George's Terrace, Perth.
12.10 p.m.—Close down.
12.30 p.m.—Time in.
1.30 p.m.—Major Le Sand will give a short talk on Animals of the foot.
1.45 p.m.—B.S.L. Band and Vocal Concert, relayed from the Zoological Gardens, South Perth.
Conductor: Mr. Geo. E. Muller.
2 p.m.—Close down.
2.30 p.m.—Time in.
2.35 p.m.—Children's feature stories.
2.45 p.m.—Evening service, relayed from St. George's Cathedral, Perth.
3.45 p.m.—Perth City Band and Vocal Concert, relayed from the Government Gardens, Perth.
Conductor: Mr. S. A. Halverson.

Monday, March 14

2FC, SYDNEY

EARLY MORNING SESSION

7 a.m.—Studio news and announcements.
7.5 a.m.—"Big Ben" and announcements.
7.55 a.m.—Official weather forecast, rainfall, temperatures, astronomical observations, shipping intelligence, mail services.
8.25 a.m.—Live news, market, mining share market, metal quotations.
8.30 a.m.—Wool sales, breadstuffs markets.
8.35 a.m.—Interests markets, produce markets.
8.45 a.m.—"Settle Morning Herald" news service.
8.50 a.m.—"Big Ben". Studio music.
9.15 a.m.—Close down.

MORNING SESSION

9.30 a.m.—Marching music for school children.
9.45 a.m.—Some popular records.
10 a.m.—"Big Ben" and announcements.
10.5 a.m.—Late "Sydney Morning Herald" news service.
10.15 a.m.—Studio music.
10.45 a.m.—Foot minute sporting information by the SFC Racing Commentator.
11 a.m.—"Big Ben". Australian Press Association and Reuters' Cable Services.
11.10 a.m.—Studio music.

6.40 p.m.—MARY NUGENT, soprano (winner of ILO Exhibition): "Ave de Salome" (Debussy). "Elegie" (Massenet).
6.47 p.m.—GEORGE FINTLAY, pianoforte (winner of ILO Exhibition): "Sonata Op. 27, No. 2 (Moonlight)" (Beethoven). "Adagio" (Scherzetto, Allegretto, Presto sections).
7 p.m.—ALEXANDER BROWNE, baritone, "The Living God" (Elijah) (Mendelssohn).
7.15 p.m.—FRABIAN CITY BAND: March, "Himself" (Himes). "Chorus" "The Hazzers are Telling" (Haydn).
7.30 p.m.—MARY NUGENT, soprano: "Irish Folk Song" (Foster). "Margaret at the Spinning Wheel" (Schubert).
7.35 p.m.—GEORGE FINTLAY, pianoforte: "Gavotte and Minuet" (Debussy). "Romance on F. Scarlatti" (Schumann). "Humoresque" (Debussy).
8.11 p.m.—ALEXANDER BROWNE, baritone: "The Lord is My Light" (Luther). "There is no Death" (O'Hara).
8.15 p.m.—FRABIAN CITY BAND: "March" "Nations" (Himes). "Prelude" (Bachmann).
9.31 p.m.—"Argus" News service. Matrimonial and information. Announcements.
9.40 p.m.—GEO. GRAY, "WHODDY": "Chimes composed of many fruits that reason would not know how to conceive."
10 p.m.—GOD SAVE THE KING.—Bachmann.

4QG, BRISBANE

Sunday.

MORNING SESSION.

CHURCH SERVICE.

The complete Morning service will be relayed from the City Tabernacle Baptist Church.
2.15 p.m.—Devotional Invocation and Lord's Prayer, hymn, hymn "God is Love His Mercy Brightens" (Lassus, Ant. XV, 86—XV), 12 solo, "Sound an Alarm" (Hawley), Children's story, children, hymn 14, "God Bless the Sun, the Smiling Flowers" Announcements, Offertory: Declaration, anthem, "Dear My Prayer" (Mendelssohn); Prayer; hymn 361, "Enter, March the Shining Word" (Lassus, Ant. XVI, 6-7, hymn 365, "O Lord, How Happy Should We Be", Benediction—Greenfield Amen.
10.15 p.m.—Close down.

AFTERNOON SESSION.

BAND CONCERT.

2.15 p.m.—Band concert.
The concert by the Brisbane Eccelesial Band will be relayed from the Botanic Gardens.
4.30 p.m.—Close down.

NIGHT SESSION.

CHURCH SERVICE.

The complete Evening service will be relayed from the City Tabernacle Baptist Church.
8.25 p.m.—Aerial Quartette: "God is a Spirit" (Barnfield, Berlioz), hymn 418, "Praise Me, O Thou Great Jehovah" (Lassus II, Kings XXI: 1-18, Prayer and Lord's Prayer, (sung), announcements, Offertory: Declaration, hymn "The Father's Way" (Gounod); hymn 411, "Christian Love Thy Eye Thou"; sermon, subject: "A Man Who Broke through a Hedge" (Lk. 11. 19-26); hymn XXXIX, 10, hymn 410, "Lead Kindly Light" (Benedict); vespers.

BAND CONCERT.

At the conclusion of the Church Service the Concert by the Brisbane Municipal Band will be relayed from Wynnum Park.
The programme will include: Overture to "Patriotism"; "Waltz" (selected from "11 Transients" (Vardi), solo, "Three Light Pieces" (Fletcher).
9.30 p.m.—Close down.

NIGHT SESSION.

- 7.46 p.m.—Announcements and record of programme.
- 8.15 p.m.—General Hints on Photography by Mr. E. J. Van de Velde.
- 8 p.m.—"Big Ben." FROM THE HAYMARKET THEATRE, GEORGE STREET, SYDNEY: Items by the Operatic Orchestra of 20 members under the baton of Mr. Stanley Porter.
- 8.12 p.m.—FROM THE STUDIO:
Miss Dorothy Ewbank, soprano:
"Micaela's Aria" ("Carmen") (Bislet).
- 8.18 p.m.—Mr. Ellis Price in musical novelties. (First appearance at the Studio):
(a) "I Don't Mind" (Wallace).
(b) "The Clutching Hand" (Crossley).
- 8.24 p.m.—"The Art of Public Speaking," a Talk by the Rev. E. H. Raward.
Subject, "How to Begin."
- 8.28 p.m.—FROM THE BAPTIST HALL, ULTIMO:
Items by the Sydney Harmonic Society conducted by Mr. William Bourne:
(a) Male part-song, "Excelsior" (Baird).
(b) Chorus, "Belongs Alone" (Harris).
(c) Part-song, "Gardens" (Gardiner).
- 8.34 p.m.—FROM THE STUDIO:
Mr. Victor Gouret in musical comedy memories.
- 9 p.m.—"Big Ben."
Miss Dorothy Ewbank, soprano:
(a) "Oh, Press Thy Check" (Jensen).
(b) "Memorising Exercises" (Jensen).
- 9.5 p.m.—FROM THE HAYMARKET THEATRE, GEORGE STREET, SYDNEY:
Vocal Act.
- 9.26 p.m.—FROM THE BAPTIST HALL, ULTIMO: The Sydney Harmonic Choir conducted by Mr. William Bourne:
(a) Solo and chorus, "Queen of the South" (Gardiner) (soloist, Mr. J. Rapp).
(b) Part-song, "Morning" (Ramsay).
(c) Part-song, "Carnovale" (Rossini).
(d) Male chorus, "Peace be Still" (Protheroe).
- 9.56 p.m.—FROM THE STUDIO:
Mr. Ellis Price in musical novelties:
(a) Modern version of "Bluebird."
(b) "Big Jere" (Price).
- 9.53 p.m.—Mr. A. G. Ellis, baritone:
"The Hag" (Clintam).
- 9.47 p.m.—FROM THE HAYMARKET THEATRE, GEORGE STREET, SYDNEY:
Items by the Orchestra under the baton of Mr. Stanley Porter.
- 9.57 p.m.—FROM THE STUDIO:
Miss Dorothy Ewbank, soprano:
- 10 p.m.—"Big Ben." Mr. Victor Gouret in musical comedy memories.
- 10.4 p.m.—Mr. A. G. Ellis, baritone:
"To The Western Wind" (Clintam).
- 10.12 p.m.—FROM THE HAYMARKET THEATRE, GEORGE STREET, SYDNEY:
Items by the Operatic Orchestra. Conductor, Mr. Stanley Porter.
- 10.49 p.m.—FROM THE STUDIO:
Mr. A. G. Ellis, baritone:
(a) "The Elfin King" (Leon).
(b) "Dawn Skies" (Drummond).
- 10.58 p.m.—FROM THE WENTWORTH CAPE, CHURCH HILL, SYDNEY:
Items by the new Wentworth Symphonic Dance Orchestra, under the baton of Mr. Sydney Simpson.
- 10.69 p.m.—FROM THE STUDIO:
Celebrity records.
- 11 p.m.—"Big Ben." Late news and announcements.
- 11.5 p.m.—The new Wentworth Symphonic Dance Orchestra in popular numbers until midnight.
- 12 midnight—"Big Ben," National Anthem.
Close down.

2BL, SYDNEY

Monday.

EARLY MORNING SESSION.

- 7.15 a.m.—G.P.O. Clock and Chimes.
- 7.16 p.m.—Metropolitan weather forecast.
- 7.17 a.m.—Musical programme from the Studio.
- 7.23 a.m.—Physical training and health exercises.
- 7.30 a.m.—G.P.O. Clock and Chimes.
- 7.31 a.m.—Hints on health.
- 7.36 a.m.—Physical training and health exercises.
- 7.45 a.m.—G.P.O. Clock and Chimes.
- 7.46 a.m.—Weather report.
- 7.47 a.m.—Broadcasters' special news service.
- 8 a.m.—G.P.O. Clock and Chimes, close down.

MORNING SESSION.

- 10 a.m.—G.P.O. Clock and Chimes.
- 10.1 a.m.—Weather report.
- 10.3 a.m.—Musical programme from the Studio.
- 10.29 a.m.—News service from the "Daily Telegraph."
- 10.31 a.m.—Musical programme from the Studio.
- 11 a.m.—G.P.O. Clock and Chimes.
- 11.1 a.m.—News from the "Daily Telegraph."
- 11.12 a.m.—Rabbit Market report.
- 11.15 a.m.—Yak Market report.
- 11.19 a.m.—Vegetable Market report.
- 11.21 a.m.—Fruit Market report.
- 11.23 a.m.—London Dairy Farm, Egg, and Poultry Market report.
- 11.28 a.m.—Information re wireless.
- 11.26 a.m.—Shipping information re interstate and Overseas Mails.
- 11.31 a.m.—Shipping information—arrivals and departures.
- 11.58 a.m.—WOMEN'S SESSION.
Talk by Miss G. Varley, Broadcasters' Women's Secy.
- 11.47 a.m.—Serial Notes by Mrs. Jordan (authorities on "Athletes").
- 11.58 a.m.—Mrs. Jordan replies to correspondents.
- 12.5 p.m.—Talk by Mrs. Jordan on "Lenten Pilgrims."

- 12.56 p.m.—G.P.O. Clock and Chimes.
- 12.31 p.m.—Sydney Stock Exchange calls.
- 12.33 p.m.—"Sun" Newspapers news service.
- 12.45 p.m.—Hilliers' Instrumental Quartet: direction, Carl Gustling.
- 1.30 p.m.—G.P.O. Clock and Chimes.
- 1.31 p.m.—Weather report and forecast.
- 1.33 p.m.—Sydney Stock Exchange calls.
- 1.36 p.m.—News from the "Sun."
- 1.45 p.m.—Musical programme from the Studio.
- 2 p.m.—G.P.O. Clock and Chimes, close down.

AFTERNOON SESSION.

- Racing information broadcast by courtesy of the "Sun."
- 2 p.m.—G.P.O. Clock and Chimes.
- 2.1 p.m.—Weather report.
- 2.3 p.m.—Serial notes from the "Sun."
- 2.8 p.m.—News from the "Sun."
- 2.20 p.m.—Musical programme from the Studio.
- 2.30 p.m.—News from the "Sun."
- 2.46 p.m.—Musical programme from the Studio.
- 2.52 p.m.—News from the "Sun."
- 4 p.m.—G.P.O. Clock and Chimes.
- 4.1 p.m.—Musical programme from the Studio.
- 4.15 p.m.—Serial story entitled "The Borrowed Shield."
- 4.26 p.m.—G.P.O. Clock and Chimes.
- 4.31 p.m.—Musical programme from Studio.
- 4.48 p.m.—Producers Distributing Society's Vegetable and Fruit Market report.
- 4.50 p.m.—Shipping information when available.
- 4.52 p.m.—Day's racing resumes on race days.
- 4.55 p.m.—News from the "Sun."
- 4.58 p.m.—Resume of night's programme.
- 5 p.m.—G.P.O. Clock and Chimes, close down.

EARLY EVENING SESSION.

- 8.45 p.m.—G.P.O. Clock and Chimes.
- 8.46 p.m.—Uncle George and the kiddies.
- 8.49 p.m.—Musical programme from the Studio.

SPECIAL COUNTRY SESSION.

- 7 p.m.—G.P.O. Clock and Chimes.
- Australian Mercantile Land and Finance Co's report. Weather report. Producers Distributing Society's Fruit and Vegetable Market report. Stock Exchange report. Grain and Poultry Report ("Sun"). Dairy Produce report ("Sun"). Primary Producers' N'paper Report on London Butter Market.
- 7.15 p.m.—Country news from the "Sun."
Books to read.
- 7.30 p.m.—Talk on "Facilities offered to students by Sydney University" by Mr. Rupert Markham, R.E.
- 7.45 p.m.—Talk on "The Tour of the Republic," by Mr. J. Holmes.

EVENING SESSION.

- 8 p.m.—G.P.O. Clock and Chimes.
- Broadcasters' Topical Broadcast.
- 8.3 p.m.—New Year Band Broadcast from Industrial Hall, Newtown.
- 8.23 p.m.—Mr. Frank Ryan (comedian).
- 8.40 p.m.—Miss Ilesina Stewart (soprano).
- 8.37 p.m.—Mr. Stan Carlin (comedian).
- 8.48 p.m.—Mr. Eric Masters (descriptive haristone).
- 8.52 p.m.—Resume of following day's programme. Weather report and forecast by courtesy of Mr. C. J. Moore, Gurt, Meteorologist.
- 9 p.m.—G.P.O. Clock and Chimes.
- 9.1 p.m.—Neil Grace and Alf Lawrence.
- 9.23 p.m.—Newtown Band.
- 9.41 p.m.—Interval.
- 9.48 a.m.—Mr. Eric Masters.
- 9.54 p.m.—Miss Helena Newark.
- 10.1 p.m.—Mr. Stan Carlin.
- 10.8 p.m.—Mr. Frank Ryan.
- 10.35 p.m.—The Ambassadors' Dance Band broadcast from the Ball Room of the Ambassadors. During the intervals between dances news reports by courtesy of the "Sun" will be broadcast.
- 12 midnight—G.P.O. Clock and Chimes, National Anthem.

2GB, SYDNEY

Monday.

MORNING SESSION.

- Chorus Hour, conducted by the Chorus Men.
- 9.29 a.m.—Music.
- 9.35 a.m.—Psychological Class.
- 10.4 a.m.—Music.
- 10.15 a.m.—Biographical Talks for Schools.
- 10.25 a.m.—Music.
- 10.50 a.m.—Close down.

AFTERNOON SESSION.

- 3.30 p.m.—"Children's Session," conducted by Mr. J. K. Powell.
- 3.15 p.m.—Popular song number, vocal, piano and eremitophone.
- 3.30 p.m.—Chorus Talk to Men.
- 3.50 p.m.—Instrumental Trio: Dan Sealy, Myrielle Lang, Ada Brook.
- 4.5 p.m.—Address by Prof. Ernest Wood.
- 4.15 p.m.—"Cello solos by Myrielle Lang.
- 4.22 p.m.—Songs by Miss Augustine Lee.
- 4.33 p.m.—Instrumental Trio: Dan Sealy, Myrielle Lang, Ada Brook.
- 4.45 p.m.—Topic talk.
- 7 p.m.—Announcements.
- 8.5 p.m.—Talk on "Some Famous German Song Writers," illustrated by songs. Artist: Clement Hosking.
- 9.15 p.m.—Vocal solo by Dan Sealy.
- 9.41 p.m.—Songs by Miss Josephine Lee.
- 9.51 p.m.—"Chorus Talk."
- 10 p.m.—Great Thoughts from Great Minds.

2KY, SYDNEY

Monday.

LUNCHEON HOUR SESSION.

- 12.15 p.m.—Tune in to the Ticking of the Clock.
 12.18 p.m.—Popular Favorites, "Orpheum" Gramophone.
 12.25 p.m.—Musical Interlude.
 12.40 p.m.—News Items.
 1.0 p.m.—Victrola.
 1.10 p.m.—Havillath's Novel Singer Selections.
 1.20 p.m.—Dutton news and meetings.
 1.30 p.m.—Lithols Records.
 1.40 p.m.—Where to go Tonight.
 1.45 p.m.—Closing announcements.

EVENING SESSION.

- 7.30 p.m.—Tune in to the Ticking of the Clock.
 7.40 p.m.—News items.
 7.45 p.m.—Sporting Talk, Mr. A. J. DODD, Sporting Editor Sydney "Sportman" and "Track".
 7.55 p.m.—"Hands Off China" Campaign, Mr. J. GARDIN.
 8.0 p.m.—Pianoforte solo, Mr. EMMÉ DIBBLE, L.I.C.M.
 8.10 p.m.—Victrola solo, Mr. E. HIRRELL.
 8.15 p.m.—Popular numbers, Mr. H.A.C. PRINCE.
 8.20 p.m.—Musical Interlude, introducing later stage numbers.
 8.25 p.m.—Review of Life and Works of the Great Company Sales, Arranged and presented by Mr. J.P.O. J. MANDEL.
 8.35 p.m.—Life of Company.
 8.40 p.m.—The Works of Company.
 8.50 p.m.—Musical Illustrations from the life of company.
 9.0 p.m.—Tune into Mr. RAY HAMILTON.
 9.10 p.m.—Pianoforte solo, Mr. NORMAN A. PULLING.
 9.20 p.m.—Musical Interlude, MAY E. MELODY MAKERS, W. A. M. CULLLEN, Leader.
 9.30 p.m.—Closing announcements.

3LO, MELBOURNE

Monday.

THE STUDIO ORCHESTRA.

- GEORGE WELCH, conductor.
 MAGGIE FOSTER, violin.
 JONES AND RAINE.
 MAURIE LE VAREE, accompanist.
 OWEN H. TRAPPEE, harpist.
 Accompanist: AGNES FORTUNE.
 Announcer: MAURICE DUDLEY.
 12 noon.—Tune Signal, British Official Wireless news from Rugby, Rugby and the Australian Press Association Clubs, Stock Exchange information "Argus" and "Herald" news reviews.
 12.20 p.m.—STUDIO ORCHESTRA.
 Quartette "Barber of Seville" (Hessell).
 12.40 p.m.—GEORGE WELCH, conductor.
 "Comedienne."
 12.45 p.m.—MAGGIE FOSTER, violin.
 "People's Avon" (Thorne).
 Popular Chorus.
 12.55 p.m.—JONES AND RAINE.
 Song, "It's Like to be."
 Song, "If I can't Sing about My Menus."
 1.15 p.m.—STUDIO ORCHESTRA.
 "Suite Melodica" (Prini).
 1.15 p.m.—Meteorological information, Shipping Intelligence, Weather forecast for Victoria, Tasmania, South Australia and New South Wales, Ocean forecast, River reports.
 1.30 p.m.—MARIE LE VAREE, accompanist.
 "Discontented."
 1.35 p.m.—MAGGIE FOSTER, violin.
 "Value Value."
 Popular Chorus.
 1.45 p.m.—STUDIO ORCHESTRA.
 Selection, "Flourishes" (Lefkoff).
 2 p.m.—Close down.

- 1.55 p.m.—OWEN H. TRAPPEE, harpist of the New Music Co., by permission of J. E. Williamson, Ltd.).
 "When My Ship Comes Sailing Home" (Commonwealth National) (Lorenz).

AFTERNOON SESSION.

"AT HOME."

- 2.00 p.m.—STUDIO ORCHESTRA.
 "At Home."
 2.05 p.m.—MRS. DOROTHY SILK, Harpist.
 2.10 p.m.—MISS FLORA PELL, MRS. DOROTHY SILK, HASTINGS AND ADAIR.
 DOROTHY ROXBURGH, violin.
 SIDNEY BURCHELL, bassoon.
 IAN DEVENNEY, flauto.
 WALTER SMITH, cornet.
 Accompanist: AGNES FORTUNE.
 Announcer: MAURICE DUDLEY.
 2.15 p.m.—STUDIO ORCHESTRA.
 Song, "The Fishermen's Lark" (Toselli-Lovely).
 2.20 p.m.—MRS. DOROTHY SILK, Harpist.
 2.25 p.m.—HASTINGS AND ADAIR.
 Song, "Wren's Nest."
 "Patter."
 Chorus Solo, "Till."
 One-Step Solo, "Perfect Day."
 Parodie, "What'll I do."
 2.30 p.m.—DOROTHY ROXBURGH, violin.
 "Berceuse" (Mozart).
 2.35 p.m.—SIDNEY BURCHELL, bassoon.
 Talking to the Moon (Lullie).
 Talk where the "Traffic" flows" (Donaldson).
 2.40 p.m.—STUDIO ORCHESTRA.
 "Monsters" (Hessell).
 2.45 p.m.—IAN DEVENNEY, harpist of the New Music Co., by permission of J. E. Williamson, Ltd.).
 Life and Death (Golding Taylor).
 "I Know a Lovely Garden" (D'Almeida).
 2.50 p.m.—WALTER SMITH, cornet.
 "Waltz" (Mozart).
 2.55 p.m.—SIDNEY BURCHELL, bassoon.
 Let's Sing Happy (Donaldson).
 Thinking of You (Donaldson).
 3.00 p.m.—STUDIO ORCHESTRA.
 A Musical "Hi-See" (Koskoff).
 3.05 p.m.—MISS FLORA PELL, Inspector of Schools, Education Department, Danavon Exchange.
 3.10 p.m.—"Herald" news review, Stock Exchange information.
 3.15 p.m.—Close down.

EVENING SESSION.

- 7.45 p.m.—CHILDREN'S HOUR. ANNA TOY and Hilda's Interlude.
 7.55 p.m.—RUXHAM'S SPERNADEERS.
 Quartet, "The Frog Leaves."
 SPERNADEERS' QUARTETTE.
 Duet, "Gipsiana."
 BERN MILLAR and HIGH BEYHAM.
 8.0 p.m.—"Little Miss Koskoffers" will tell her "Koskoffers" sisters and brothers the story about the dear old lady "Home" by Koskoffers.
 8.10 p.m.—RUXHAM'S SPERNADEERS.
 Humorous Quartet, "The Little Broom."
 8.15 p.m.—"Little Miss Koskoffers" will give another installment of "Out of Hollywood School" as having expedition and "Lullie" (Lullie) (Lullie).
 8.20 p.m.—"Argus" and "Herald" news review, and Stock Exchange information.
 8.25 p.m.—Stock Exchange information, Overseas shipping.
 8.30 p.m.—Fish Market reports by J. E. HOSKELL, Ltd.
 8.35 p.m.—Herald reports.
 8.40 p.m.—Margaret reports by the Victorian Press and Commercial Ltd. Has-Parquet Sheep sales, Painter Green Hay, Oat, Straw, Jute, Dairy Produce, Poultry and Hides.
 8.45 p.m.—Harpist, piano of George and Lenore by the Victorian General Citrus Association Pty. Ltd. Fish Market reports by the Victorian Wholesale Fruit and Vegetable, compiled by the "Fruit World," exclusive to 3LO.
 8.50 p.m.—Harpist, piano of George and Lenore by the Victorian General Citrus Association Pty. Ltd. Fish Market reports by the Victorian Wholesale Fruit and Vegetable, compiled by the "Fruit World," exclusive to 3LO.

NIGHT SESSION.

- 9.00 p.m.—Singer.
 MR. N. E. MCKENNA, LL.B., MR. E. C. H. TAYLOR, MR. F. de CASTILLA, MR. LANCE LE SOUFFE.
 THE STUDIO ORCHESTRA.
 MAGGIE FOSTER, violin.
 OSBORN and PERRYER.
 MOLLY SAFFO ARNAV, soprano.
 WILLIAM JAMES, pianoforte.
 GEORGE FOSTER.
 MR. LAURINE CHORAL UNION, HASTINGS AND ADAIR.
 JOE ARBONSON and HIS SYNCOPIATING CHORUS, SYMPOZYUM.
 Accompanist: AGNES FORTUNE.
 Announcer: MAURICE DUDLEY.
 9.10 p.m.—Order the supper of the Devonian Australia League, MR. N. E. MCKENNA, LL.B., "The Shepherds in Australia."
 9.20 p.m.—MR. E. C. H. TAYLOR, "School Life and Sport."
 9.25 p.m.—Tune the system of the Department of Agriculture, MR. E. C. H. TAYLOR, "Ministrating 'Manning of View' FROM THE SUBURBANE."
 9.30 p.m.—STUDIO ORCHESTRA.
 Selection, "La Boheme" (Puccini).
 9.35 p.m.—OSBORN and PERRYER, in "Originality."
 9.40 p.m.—MAGGIE FOSTER, violin.
 "An' Mees" (Hessell).
 An Old Melody.
 9.45 p.m.—MR. LANCE LE SOUFFE.
 "His Majesty" (Hessell) (Hessell) in Sheep-breeding.
 9.50 p.m.—STUDIO ORCHESTRA.
 "Talks of Hoffman" (Hessell).
 9.55 p.m.—A SPECIAL PROGRAMME ARRANGED BY MR. W. R. JAMES.
 MOLLY SAFFO ARNAV, soprano.
 WILLIAM JAMES, solo pianist.
 (Soloists Four).
 MOLLY SAFFO ARNAV.
 MRS. BERTRUDE HUTTON.
 MR. E. C. H. TAYLOR, MR. F. de CASTILLA, MR. J. ALEXANDER BROWNE.
 Melbourne Choral Union, under direction, WILLIAM JAMES.
 Flauto, Soloist (Hessell) (Hessell) (Hessell).
 Duet from "Aida" (Verdi).
 SAFFO ARNAV and GERTRUDE HUTTON.
 Studio Orchestra.
 "Quintet for Clarinet and Strings" (Mozart).
 Solo with Chorus, "Tale to My Father's" (Koskoffers) (Hessell).
 MR. J. ALEXANDER BROWNE and MELBOURNE CHORAL UNION.
 Flauto solo, "Aberno" (Schubert).
 "Mittens" (Dr. Arno).
 "Tale to My Father's" (Hessell).
 WILLIAM JAMES.
 Aria, "Una Fide Duo" (Mozart) (Hessell) (Hessell).
 SAFFO ARNAV.
 "Tale to My Father's" (Hessell).
 Studio Orchestra.
 "Suite English Folk Songs" (Vaughan Williams).
 Solo with Chorus, "Drinking Song" (Vaughan Williams).
 HURALE WHITE and MELBOURNE CHORAL UNION.
 Aria from "Aida" (Verdi).
 SAFFO ARNAV.
 Piano Solo, "Prelude" (Debussy).
 "The Waterfalls" (MacDowell).
 "Lullaby" (MacDowell).
 Solo from "LUCIA" (Donizetti).
 With CELEBRITY SOUVENIR and MELBOURNE CHORAL UNION.
 10.00 p.m.—HASTINGS AND ADAIR.
 "La, La, La, La."
 "Patter."
 "Harpist, piano of George and Lenore by the Victorian General Citrus Association Pty. Ltd. Fish Market reports by the Victorian Wholesale Fruit and Vegetable, compiled by the "Fruit World," exclusive to 3LO.
 10.10 p.m.—British Official Wireless News from Rugby. Sporting Personalities by "Gipsiana" (Hessell) (Hessell) (Hessell) Secretary, Victorian Athletic Association.

- 10.44 p.m.—STUDIO ORCHESTRA.
"La Vota des Cloches" (Liszt).
10.54 p.m.—"Argus" news service. Weather forecast. Announcements.
11 p.m.—OUR GREAT THOUGHT:
"Sonnet" as one of the ultimate principle and the highest aim of art.—Goethe.
11.1 p.m.—JOE ARONSON AND HIS SYN-
COPATING SYMPHONISTS:
"That Samson and Delilah Melody" (Grey).
"I Wish You were Jealous of Me" (Rowell).
"I'm Talk About My Sweetest" (Hakari).
"Alma Oe" (Waltz) (Arr. Berger).
"Ho, Ho the Merry" (Brown).
"Rose Colored Glasses" (Stamer).
"Am I Wasting My Time" (Hibbs).
"Burgundy" (Malle).
"Dreaming of Castles in the Air" (Ward).
"To-night's My Night with Belg" (Hesler).
"That's Why I Love You" (Hendelton).
"Maidling" (West).
"In a Little Spanish Town" (Wagner).
11.40 p.m.—GOD SAVE THE KING.

4QG, BRISBANE

Monday.

MIDDAY SESSION.

- 1.3 p.m.—Market Reports, Weather Information supplied by the Commonwealth Weather Bureau. News Services supplied by "The Daily Mail" and "The Daily Standard."
1.29 p.m.—From Hotel Carlton: Lunch Music played by Hotel Carlton Symphony Orchestra.
1.58 p.m.—From the Observatory: Standard Time signal.
2.0 p.m.—Close down.

AFTERNOON SESSION.

- 3.00 p.m.—From Hotel Carlton: Afternoon Music, played by Hotel Carlton Symphony Orchestra.
4.15 p.m.—From the Studio: News Service supplied by "The Telegraph."
4.30 p.m.—Close down.

EARLY EVENING SESSION.

- 6.0 p.m.—News Service supplied by the "Daily Standard."
6.30 p.m.—The Children's Session—Stories by "The Sandman."
7.0 p.m.—Market Reports; Stock Reports; Lectures: "Selection of the Bear and Bow," Mr. E. J. Shelton, Instructor in Pig Raising.
7.30 p.m.—Weather News; Announcements.
7.45 p.m.—Standard Time Signal.

NIGHT SESSION.

- 7.45 p.m.—Lecture Session—The Children's Corner—conducted by "The Music Man." A. BERTHOUD and FRIGRA M.M. To-night's programme has been arranged and organised by Mr. Keith Johns. It will comprise a Beethoven programme, and will be given in conjunction with the famous composer's death, which occurred in March, 1827.
8.0 p.m.—A Biographical Sketch of Beethoven, Choral, "Nature's Adoration," vocal and a duet, "Max Song," Mrs. Mildred Bell (contralto), and Mr. Ben. Choire (baritone); instrumental, "Robbins" in G-Major; song, "The Quail," Miss Maye Hatcher (soprano); song, "The Kiss," Mr. Geo. Williamson (tenor), and chorus; pianoforte solo, "Moonlight Sonata," Mr. Ross Morgan; song, "From Goethe's Faust," Mr. Paul Homer (baritone) and chorus; duet, "Pain and Joy of Love," Miss Mabel Malouf (soprano), Mr. Geo. Williamson (tenor); instrumental, "Minuet in G"; "The Master Speaks" an imaginative episode in Beethoven's life, written by Michael Costler.
9.0 p.m.—Metropolitan Weather Forecast. Instrumental, First Movement of Trio Op. 9, No. 3, string trio, song, "Kissed, Thou the Land" (Mignon), Miss Clarice Cox

(contralto); flute solo, "Eccosa'ses" (Scott dances); Mr. R. B. Brock; solo, "What's-his-name's Tour Round the World," Mr. Ben. Choire; and chorus; duet, "Chloe's Warning," Miss Mabel Malouf and Miss Mildred Bell; instrumental, "Finale of Trio Op. 1, No. 2"; song, "New Love and Life," Mr. Jack Lord, (tenor); chorus, "The Spring is Retaining," vocal octette.
10.0 p.m.—From the Studio: "The Daily Mail" News; Weather News; Close Down.

5CL, ADELAIDE

Monday.

MORNING SESSION.

- 11.20 a.m.—G.P.O. chimes.
11.21 a.m.—Autone Reproducer recital.
11.28 a.m.—"Advertiser" news service.
11.55 a.m.—Studio recital.
12 a.m.—G.P.O. chimes.
12.1 p.m.—"Advertiser" news service.
12.16 p.m.—Autone Reproducer recital.
12.29 p.m.—R. Ward and Co.'s Stock Exchange reports, official stationery and station announcements.
12.30 p.m.—G.P.O. chimes.
12.31 p.m.—Studio: Orchestral Overture, "Rhapsody in Allegro" waltz, "There never was a pal like you" for tenor, "Where'd you get those eyes?" novella, "In birdland" violin and "Schindler's Tanquerone" solo-voice, "Little Dutch girl," "Valse des Alouettes" mazurka "La Crazier" vocal, "Musical switch."

- 1 p.m.—G.P.O. chimes and close down.
2 p.m.—G.P.O. chimes.
2.1 p.m.—"Adlon" from the Maple Leaf Cafe—Orchestral numbers.
2.25 p.m.—From the Studio—Autone Reproducer and piano numbers.
2.38 p.m.—G.P.O. chimes.
2.41 p.m.—Belair from the Arcade Cafe—Orchestral numbers.
2.50 p.m.—Stock Exchange reports, general stationery and station announcements.
2.55 p.m.—G.P.O. chimes and close down.

AFTERNOON SESSION.

- 3 p.m.—G.P.O. chimes.
3.1 p.m.—"Adlon" from the Maple Leaf Cafe—Orchestral numbers.
3.25 p.m.—From the Studio—Autone Reproducer and piano numbers.
3.38 p.m.—G.P.O. chimes.
3.41 p.m.—Belair from the Arcade Cafe—Orchestral numbers.
3.50 p.m.—Stock Exchange reports, general stationery and station announcements.
3.55 p.m.—G.P.O. chimes and close down.

EVENING SESSION.

- 6.30 p.m.—G.P.O. chimes.
6.31 p.m.—Autone Reproducer recital.
6.38 p.m.—Bedtime stories.
6.48 p.m.—Market Reports.
7.00 p.m.—Meteor talk by Mr. Van Sonden, of the Vaccuum Oil Co.
8 p.m.—G.P.O. chimes.
8.1 p.m.—Concert by Miss Hilda Wheeler's party.
8.20 p.m.—"Winkler's" original talk.
8.40 p.m.—Miss Hilda Wheeler's Concert Party.
9.0 p.m.—G.P.O. chimes and close down.
9.1 p.m.—Weather report.
9.2 p.m.—Dalgety's wheat report.
9.3 p.m.—Hilda Wheeler's Concert Party.
9.45 p.m.—Physical culture talk by Mr. Noel Hubble, of the Central College of Physical Culture.
9.50 p.m.—Concert party continued.
10 p.m.—G.P.O. chimes.
10.15 p.m.—"Advertiser" news service.
10.25 p.m.—Concert party continued.
11 p.m.—G.P.O. chimes and close down.

6WF, PERTH

Monday.

- 12.30 p.m.—Tune in.
12.35 a.m.—First local news bulletin.
Market reports.
1 p.m.—Time signal from the Perth Observatory.
1.1 p.m.—Weather notes, supplied by the Meteorological Bureau of Western Australia.
1.2 p.m.—STUDIO QUINTETTE.

- 2 p.m.—Close down.
3.30 p.m.—Tune in.
3.35 p.m.—Musical programme.
4 p.m.—STUDIO TRIO.
4.40 p.m.—Close down.
5 p.m.—Tune in.
5.5 p.m.—Children's bedtime stories, by Ursula Henry and Duffly.
5.55 p.m.—Stock and share intelligence.
Market reports.

- Cable News, supplied by courtesy of "The West Australian" Newspaper Co.
6 p.m.—Time signal from Perth Observatory.
6.1 p.m.—Weather notes, supplied by the Meteorological Bureau of Western Australia.
6.2 p.m.—Bee Keeper's Talk, by Mr. C. Wallace, under auspices of the Bee Keeper's Association.
6.18 p.m.—CONCERT NIGHT.

- Musical programme.
6.20 p.m.—Health talk, by Mr. R. S. Hutton, of the Western School of Physical Culture.
10 p.m.—Second local news bulletin, supplied by courtesy of "The Daily News" Newspaper Co.
10.30 p.m.—Close down.

Tuesday, March 15
2FC, SYDNEY

EARLY MORNING SESSION.

- 7 a.m.—"Big Ben" and announcements.
7.15 a.m.—Studio music.
7.25 a.m.—Official weather forecast, rainfall, temperature, astronomical memoranda, shipping intelligence, mail services, commercial news.
7.28 a.m.—Investment market, mining share market, metal quotations.
7.35 a.m.—Wool sales, breadstuffs markets, interstate markets, produce markets.
7.45 a.m.—"Sydney Morning Herald" news service.
8 a.m.—"Big Ben" Studio music.
8.15 a.m.—Close down.

MORNING SESSION.

- 8.20 a.m.—Marching music for school children.
8.30 a.m.—Popular record.
8.45 a.m.—Last minute sporting information by the SFC Racing Commentator.
9 a.m.—"Big Ben" and announcements.
9.05 a.m.—Late "Sydney Morning Herald" news service.
9.15 a.m.—Studio music.
9.25 a.m.—A serial story.
9.31 a.m.—"Big Ben," Australian Press Association and Reuters's Cable Services.
11.10 a.m.—Studio music.
11.15 a.m.—A talk to home cooking and recipes by Miss Ruth Furst.
11.25 a.m.—Marching music for school children.
11.35 a.m.—Close down.

MIDDAY SESSION.

- 12 noon—"Big Ben" and announcements.
12.5 p.m.—Stock Exchange, BFC call.
12.55 p.m.—Studio music.
1.00 p.m.—Rugby wireless news.
1.05 p.m.—Miss Annie Payne, mezzo.
"The Fairy Prince" (Brewer).
1 p.m.—"Big Ben" Weather intelligence.
1.3 p.m.—"Evening News" midday news service.
Producers Distributing Society's report.
1.24 p.m.—Studio music.
1.28 p.m.—Stock Exchange, second call.
1.30 p.m.—Marching music for school children.
1.40 p.m.—Miss Annie Payne, mezzo.
"When the Roses Bloom" (Rushardt).
1.45 p.m.—Studio music.
2 p.m.—"Big Ben" Close down.

Have you changed it Lately?

FEW people realise what a remarkable improvement they can secure in tone quality by occasionally changing the transformers in their sets. Remember that the characteristics of valves and batteries constantly change. There is always some depreciation in your set, and always some variance in the component parts.

Changing valves within your set require efficient transformers, if you are to have harmony and unison of all the elements which affect perfect reception. Most internal receiver noises are not from faulty valves, "B" batteries or loose connections, but are purely the result of unstable transformers.

Try changing the transformers in your set, and when you buy your new transformer be sure it is branded **Emmco**. You are not likely to have to change an **Emmco** transformer for a long time to come.

In a lesser degree the same principle applies to condensers, rheostats and valve sockets. By renewing these occasionally you are assured of better results, especially if you replace with **Emmco**. Just try one of these parts, they are obtainable at all dealers.

Made by

**ELECTRICITY METER MFG. CO.,
LTD., SYDNEY.**

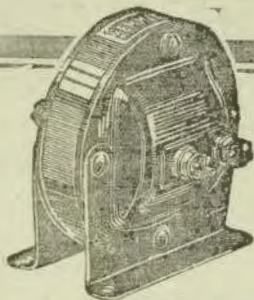

The Emmco
Transformer,
21/-

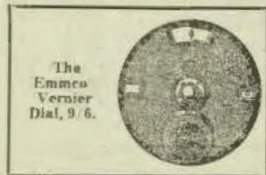

The
Emmco
Vernier
Dial, 9/6.

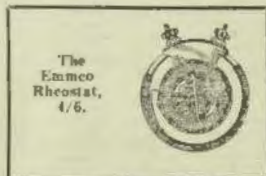

The
Emmco
Rheostat,
4/6.



The
Emmco
Valve
Socket,
4/6.

AFTERNOON SESSION.

- 2.30 p.m.—Announcements.
 2.33 p.m.—Items by the Rhoventyria pupils of Mr. Harry Thomas.
 3 p.m.—"Big Ben," Pianoforte solo.
 3.15 p.m.—Items from the Recital by Mr. Harry Thomas.
 3.20 p.m.—Attracting music for schoolchildren.
 3.40 p.m.—FROM FARMER'S TEA ROOMS:
 Miss Eileen Crowley, soprano:
 "THE GREEN HAT" (McMurry).
 3.45 p.m.—Social activities during the Royal Visit.
 3.50 p.m.—Studio music.
 4 p.m.—FROM FARMER'S TEA ROOMS:
 Miss Beatrice Kendrick, mezzo:
 "Since I have loved Thee" (Johnson).
 4.5 p.m.—A reading.
 4.25 p.m.—FROM FARMER'S TEA ROOMS:
 Miss Eileen Crowley, soprano:
 "The Lass with the Delicate Air" (Arnet).
 4.25 p.m.—Studio music.
 4.50 p.m.—FROM FARMER'S TEA ROOMS:
 Miss Beatrice Kendrick, mezzo:
 "Soft-footed Snow" (begins lib.).
 4.55 p.m.—Stock Exchange, third call.
 4.56 p.m.—Close down.

EARLY EVENING SESSION.

- 8.45 p.m.—The Children of 2FC.
 8.50 p.m.—The "Hello Man" talks to the children, assisted by "Inits" (Corporal Phillips).
 8.49 p.m.—Dinner music.
 7 p.m.—"Big Ben," Late sporting news.
 7.15 p.m.—Daily's market reports (wheat, wheat and stock).
 7.15 p.m.—Fruit and Vegetable Markets.
 7.20 p.m.—Weather and shipping intelligence. Stock Exchange information.
 7.25 p.m.—Late "Evening News" news service.

NIGHT SESSION.

- 7.40 p.m.—Programme announcements.
 7.45 p.m.—Mr. D. Stewart, General Secretary of the Workers' Educational Association, will commence a series of talks on behalf of the Association. His subject to-night is: "Workers' University" STREET, SYDNEY.
 8 p.m.—"Big Ben," FROM THE ROYAL NAVAL HOUSE, MARGARET STREET, SYDNEY:
 Items by the N.S.W. State Military Band.
 8.12 p.m.—Mr. Alfred Cunningham, baritone:
 "Passing By" (Purrell).
 8.18 p.m.—FROM THE ROYAL NAVAL HOUSE, MARGARET STREET, SYDNEY:
 Items by the N.S.W. State Military Band.
 8.25 p.m.—FROM THE STUDIO:
 Bird and Animal Imitations by "Inits" (Corporal Phillips).
 8.35 p.m.—Miss Margaret Grimshaw, mezzo.
 8.40 p.m.—FROM THE ROYAL NAVAL HOUSE, MARGARET STREET, SYDNEY:
 Items by the N.S.W. State Military Band.
 8.45 p.m.—FROM THE STUDIO:
 Mr. Alfred Cunningham, baritone:
 (a) "Lover's Wish" (Anderson).
 (b) "Summer Shies" (Anderson).
 8.52 p.m.—FROM THE ROYAL NAVAL HOUSE:
 Items by the N.S.W. State Military Band.
 9 p.m.—"Big Ben," FROM THE STUDIO:
 Mr. Gordon Rodda, pianist, makes his first appearance:
 "Moto Perpetuo" (Weber).
 9.5 p.m.—Miss Margaret Grimshaw, mezzo.
 9.10 p.m.—FROM THE ROYAL NAVAL HOUSE:
 Items by the N.S.W. State Military Band.
 9.22 p.m.—FROM THE STUDIO:
 Mr. Alfred Cunningham, baritone:
 (a) "The Meeting of the Waters" (Olo Irish).
 (b) "The Minstrel Boy" (Olo Irish).
 9.35 p.m.—FROM THE ROYAL NAVAL HOUSE, MARGARET STREET, SYDNEY:
 The N.S.W. State Military Band.
 9.42 p.m.—FROM THE STUDIO:
 Mr. Gordon Rodda, pianist:
 (a) "Mozart" (Bach).
 (b) "Etude" (Mozowski).

9.50 p.m.—From the Studio and produced for the first time, a radio serial farce in four parts, specially written for this station by Mr. Cordington Ball and produced by Scott Alexander and his Comedy Company. The title of the farce is THE MAN WHO WOULD NOT QUIT" and listeners are asked to endeavour to solve the problem which is presented. On each Tuesday night at this time the story will be taken through different phases and the station will offer £20 each prize to the listener who first gives the correct solution. The farce deals with the guest, who having been invited to stay, outwits his welcome, but his hide is so hard that he cannot accept the hint that he is no longer wanted in the home of his friends, who resort to every possible means to shift him, but without success. He declines to quit, believing that he is indispensable.
 10.20 p.m.—NOTE: By arrangement with the Tivoli Theatre Ltd. the act by the famous Mexican pianist, Don Zeyta, will be broadcast from the Tivoli Theatre, Castlereagh Street, Sydney.
 This time is only approximate.
 10.40 p.m.—FROM THE STUDIO:
 The 1FC Studio Dance Band, conducted by Mr. Eric Pearce, in popular numbers. Vocal choruses by Mr. Len Maurice.
 10.50 p.m.—Mr. Arthur Aab, saxophone solo.
 11 p.m.—"Big Ben," Late news and announcements.
 11.5 p.m.—FROM THE STUDIO:
 The 1FC Dance Band, with the popular baritone, Mr. Len Maurice, in numbers until midnight.
 12 midnight—"Big Ben,"
 National Anthem.
 Close down.

2BL, SYDNEY

Tuesday.

EARLY MORNING SESSION.

- 7.10 a.m.—G.P.O. Clock and Chimes.
 7.16 a.m.—Metropolitan weather forecast.
 7.17 a.m.—Musical programme from the Studios.
 7.23 a.m.—Physical training and health exercises.
 7.30 a.m.—G.P.O. Clock and Chimes.
 7.31 a.m.—Hints on health.
 7.36 a.m.—Physical training and health exercises.
 7.45 a.m.—G.P.O. Clock and Chimes.
 7.46 a.m.—Weather report.
 7.47 a.m.—Broadcasters special news service.
 8 a.m.—G.P.O. Clock and Chimes; close down.

MORNING SESSION.

- 9 a.m.—G.P.O. Clock and Chimes.
 9.1 a.m.—Weather report.
 9.15 a.m.—Report of Lenon Dairy Farm.
 10.20 a.m.—News from the "Daily Telegraph."
 10.26 a.m.—Musical programme from the Studios.
 11 a.m.—G.P.O. Clock and Chimes.
 11.15 a.m.—Report of Lenon Dairy Farm.
 11.15 a.m.—Rabbit Market report.
 11.17 a.m.—Fish Market report.
 11.18 a.m.—Vegetable Market report.
 11.21 a.m.—Fruit Market report.
 11.25 a.m.—Report of Lenon Dairy Farm.
 Egg and Poultry Market report.
 11.28 a.m.—London metal quotations.
 11.30 a.m.—Ships in call by wireless.
 11.31 a.m.—Information re Interstate and Overseas Mail.
 11.33 a.m.—Shipping information—arrivals and departures.
 11.35 a.m.—WOMEN'S SESSION.
 Social Notes by Mrs. Jordan.
 11.55 a.m.—Talk on "Handicraft" by Miss Hoyle.

- 12.20 p.m.—Musical programme from the Studio.
 12.30 p.m.—G.P.O. Clock and Chimes.
 12.31 p.m.—Weather report and forecast.
 12.33 p.m.—"Sun" Newspapers news service.
 12.45 p.m.—Hillier's Instrumental Quartet; direction, Carol Gattling.
 1.30 p.m.—G.P.O. Clock and Chimes.
 1.51 p.m.—Weather report and forecast.
 1.53 p.m.—Sydney Stock Exchange calls.
 1.56 p.m.—News from the "Sun."
 1.58 p.m.—Musical programme from the Studio.
 2 p.m.—G.P.O. Clock and Chimes; close down.

AFTERNOON SESSION.

- Racing information broadcast by courtesy of the "Sun."
 3 p.m.—G.P.O. Clock and Chimes.
 3.1 p.m.—Weather report.
 3.3 p.m.—Social notes from the "Sun."
 3.10 p.m.—News from the "Sun."
 3.15 p.m.—Civil Service Stores Trio; direction, Miss de Convey Beer.
 3.30 p.m.—News from the "Sun."
 3.45 p.m.—Musical programme from the Studio.
 4 p.m.—G.P.O. Clock and Chimes.
 4.1 p.m.—Civil Service Stores Trio.
 4.15 p.m.—Serial story.
 4.30 p.m.—Musical programme from the Studio.
 4.45 p.m.—Producers' Distributing Society's Vegetable and Fruit Market report.
 4.50 p.m.—Shipping information when available.
 4.52 p.m.—Day's racing resume on race days.
 4.54 p.m.—News from the "Sun."
 4.58 p.m.—Resume of night's programme.
 5.15 p.m.—G.P.O. Clock and Chimes; close down.

EARLY EVENING SESSION.

- 8.40 p.m.—G.P.O. Clock and Chimes.
 8.46 p.m.—Uacke Concerts and the kiddies.
 8.49 p.m.—Musical programme from the Studio.

SPECIAL COUNTRY SESSION.

- 7 p.m.—G.P.O. Clock and Chimes.
 Australian Merceotte Land and Finance Co's report.
 Weather report and forecast.
 Stock Exchange reports.
 Producers' Distributing Society's Fruit and Vegetable Market report.
 Dairy Produce report ("Sun").
 Grain and Fodder report.
 7.15 p.m.—Country news from the "S.N."
 7.30 p.m.—Talk on "The Motor Car" by Mr. Robert A. Morris.
 8 p.m.—G.P.O. Clock and Chimes.
 Broadcasters' Topical Chorus.
 8.3 p.m.—Broadcasters' Miniature Orchestra under the direction of Mr. J. Knight Harrell.
 8.15 p.m.—Mr. Albert Jones (tenor).
 8.20 p.m.—Graham and Kingsley (comedy and harmony).
 8.25 p.m.—Mr. Henri Penn (pianist).
 8.45 p.m.—Mr. Robert A. Morris (baritone).
 8.52 p.m.—Mr. Phil Mountain (light comedian).
 9 p.m.—G.P.O. Clock and Chimes.
 Weather report and forecast by courtesy of Mr. C. J. Marcus, Govt. Meteorologist.
 Resume of following day's programme.
 9.5 p.m.—Broadcasters' Miniature Orchestra.
 9.15 p.m.—Miss Gladys Verona (soprano).
 9.35 p.m.—Mr. J. Crosby Brown (clarinet solo).
 9.42 p.m.—Mr. Albert Jones.
 9.49 p.m.—Broadcasters' Miniature Orchestra.
 10 p.m.—G.P.O. Clock and Chimes.
 10.1 p.m.—Mr. Phil Mountain.
 10.8 p.m.—Mr. Robert A. Morris.
 10.15 p.m.—The Ambassadors Dance Band broadcast from the Big Screen of the Ambassadors. During the intervals between dances news reports by courtesy of the "Sun" will be broadcast.
 12 midnight—G.P.O. Clock and Chimes.
 National Anthem.



With the "Trouble-Shooters" of the North Atlantic

ICE-BERGS—towering, ponderous, deadly mountains of ice, drift southward from the ice fields of the Arctic into the traffic lane of trans-Atlantic steamers.

Locating and destroying them is the perilous and never-ending duty of the Coast Guard cutters.

Shell fire and high explosives, however, often fail to blow the bergs from the sea, and warnings are then broadcasted by radio to every ship whose course lies through the danger zone.

Smooth power, unflinching dependability over long periods and under all conditions of service are qualities demanded in the radio batteries used in this dangerous naval service.

The fact that Burgess Batteries meet those requirements recommends them to you for your own receiving set.

WHOLESALE DISTRIBUTORS:

NEW SYSTEM TELEPHONES PTY. LTD.
280 CASTLEREAGH STREET, SYDNEY

25 Queen's Bridge St., MELBOURNE. Charles St., ADELAIDE. Queensland Agents:
Canada Cycle and Motor Agency (Q.), Ltd., Creek and Adelaide Sts., BRISBANE.

Become a Wireless Officer

— and —

Travel the World

Well-paid positions await
YOU at sea and on
shore.

Over 600 of our students
have already become
wireless officers.

20 secured situations in
the last three months.

By our Home Study method
you can be taught in your
own home.

We guarantee to instruct
you until you are
proficient.

Write, Phone or Call

**Marconi School
of Wireless**
99 Clarence Street
SYDNEY

2KY, SYDNEY

Tuesday.

LUNCHEON HOUR SESSION.

- 12.15 p.m.—Tune in to the Ticker of the Clock.
- 12.15 p.m.—Popular Favorites, Orpheus Gramophone.
- 12.35 p.m.—Musical Interlude.
- 12.40 p.m.—News Items.
- 1.0 p.m.—Vocal Items.
- 1.15 p.m.—Haviland steel Guitar selections.
- 1.25 p.m.—Union News and Meetings.
- 1.30 p.m.—Lincoln Records.
- 1.40 p.m.—Where to go Tonight.
- 1.45 p.m.—Closing Announcements.

CHILDREN'S HOUR.

- 4.30 p.m.—CHILDREN'S HOUR. The Storyman MR THOMPSON.

EVENING SESSION.

- 7.0 p.m.—THANE OFF CHINA. Canadian, Mr. J. RYAN (Director Labor Board) and Information Bureau).
- 7.30 p.m.—News Items.
- 7.45 p.m.—Lecturette, Mr. W. McNAMARA.
- 8.0 p.m.—Pianoforte solo, Miss MARY DEAN.
- 8.10 p.m.—Musical Interlude.
- 8.15 p.m.—Tenor solo, Mr. STANLEY RICHLEY.
- 8.25 p.m.—Soprano solo, Miss FRANCIS WRIGHT.
- 8.35 p.m.—Duo, Miss FRANCES WRIGHT and Mr. STANLEY RICHLEY.
- 8.45 p.m.—Monologue, Mr. JAMES STANLEY.
- 8.55 p.m.—Comedette solo, Mr. C. McWILLIAMS.
- 9.10 p.m.—Baritone solo, Mr. ALP. JAMES.
- 9.15 p.m.—Chorus, Tally.
- 9.25 p.m.—Recital of Latest Release of Lincoln Records.
- 9.45 p.m.—Dance Music.
- 10.0 p.m.—Closing Announcements.

3LO, MELBOURNE

Tuesday.

MIDDAY SESSION.

- 12.15 p.m.—STUDIO ORCHESTRA, HASTINGS AND ADAIR.
- GERTRUDE ARMSTRONG.
- C. R. CHUGG, Flute.
- SIBNEY BURCHALL, Baritone.
- WALTER SMITH, Cornet.
- Announcement, MARGIE FORTUNE.
- Announcement, MARGIE DUDLEY.
- 1.0 p.m.—"SET FAIR."
- 1.15 p.m.—Time Signal, British Official Wireless News from Rugby, England and the Australian Press Association. Cables "Argus" and "Herald" News Service; Stock Exchange information.
- 1.30 p.m.—HASTINGS AND ADAIR.
- "Say, Misses, Have You Seen Rosie's Sister?" Patter.
- Comed, "The Say."
- Vocal, "Romantic House."
- Comed, "Mother Mothers."
- 1.45 p.m.—STUDIO ORCHESTRA, Selection "Home and Juliet" (Gounod).
- 1.50 p.m.—GERTRUDE ARMSTRONG, The Girl From Glasgow.
- March, "Highland Wedding."
- Strathmore, "The Grange."
- Recd, "The Diversion."
- 1.55 p.m.—SIBNEY BURCHALL, Baritone, "When Love is True" (Bach).
- "Case the Fiddler" (Wood).
- 1.55 p.m.—C. R. CHUGG, Flute.
- Distant Voice (Lantern).
- "Gipsy Dance" (German).

- 1.12 p.m.—Meteorological Information, Shipping Intelligence, Weather Forecast for Victoria, Tasmania, South Australia, and New South Wales; Ocean Forecast; River Reports.
- 1.55 p.m.—STUDIO ORCHESTRA, Vocal, "The Girl" (Ludlow).
- 1.55 p.m.—GERTRUDE ARMSTRONG, The Girl from Glasgow.
- "Ye Halls and Halls."
- "Cath. Heretic."
- 1.47 p.m.—SIBNEY BURCHALL, Baritone, "Banning" (Münzer).
- "Myself When Young" (Lachner).
- 1.50 p.m.—WALTER SMITH, Cornet, "The Trumpeter" (Dix).
- 1.55 p.m.—STUDIO ORCHESTRA, "Hallel Music" (Lasser).
- 2.0 p.m.—Close Down.

AFTERNOON SESSION.

- Speakers.
- "AU FAIT" and MATHON MORELAND, JOE ARONSON and HIS SYSCO-SYMPHONISTS.
- GRAY WELCH, Comedian.
- JONES and RAINE, Welsh Barrels.
- MARIE LE VAREE, Announcer.
- MARGIE DUDLEY, Announcer.
- AGNES FORTUNE, Pianoforte solo.
- VERY FALTY, Pianoforte solo.
- JOE ARONSON and HIS SYSCO-SYMPHONISTS.
- "Thinking of You" (Ash).
- "Just a Heart for You" (Donatelli).
- "Just One More Kiss" (Dwan).
- 8.10 p.m.—"AU FAIT" of Meats, Hobbies and News, 10.00 will give a Fashion Talk.
- 8.25 p.m.—JOE ARONSON and HIS SYSCO-SYMPHONISTS.
- "Hush a Garden Wall" (Kahn).
- "A Night of Love" (Hart).
- "Hello Aloha" (Hart).
- 8.50 p.m.—ALP. JAMES will do his best to entertain.
- 9.0 p.m.—JOE ARONSON and HIS SYSCO-SYMPHONISTS.
- "Love All Henry Ford" (Hart Dance).
- "Baby Face" (Ash).
- "I Don't Want Nobody But You" (Meyer).
- 9.25 p.m.—JONES and RAINE, The Welsh Barrels.
- Comed, "Married Man."
- Comed, "See Upon a Puff Pat."
- 9.30 p.m.—JOE ARONSON and HIS SYSCO-SYMPHONISTS.
- "Gait Tomorrow" (Vai Almond).
- "Somebody's Lenny" (Dwan).
- 9.35 p.m.—MARIE LE VAREE, Comedian.
- "That's Why I Love You."
- "Some Other Bird Wounded a Tree."
- 9.47 p.m.—JOE ARONSON and HIS SYSCO-SYMPHONISTS.
- "A Cup of Coffee, A Sandwich and You" (Meyer).
- "Ting a Line Waits at the Bell" (Dwan).
- "Long Lost" (Herman).
- "Don't be Awary With Me" (Donatelli).
- "There's a Boatman on the Veiga" (Lenny).
- 9.50 p.m.—MATRON MORELAND, "Infant Welfare."
- 9.55 p.m.—"Herald" News Service, Stock Exchange information.
- 10.0 p.m.—Close Down.

EVENING SESSION.

- 8.10 p.m.—CHILDREN'S HOUR. Answers to letters and Birthday greetings.
- 8.35 p.m.—STUDIO ORCHESTRA, "Parade of the Soldiers" (Jenny).
- 8.5 p.m.—"MARY GUMLEAF" Poem.
- "I Can't Think Why."
- "The Little Person."
- Story for the Blind ones, "Finding Baby's Mother."
- 8.15 p.m.—STUDIO ORCHESTRA, "The Mouse and the Clock" (Whitney).
- 8.25 p.m.—"MARY GUMLEAF," Story for the Blind ones and Girls, "A Talk to the Boys and Girls who Love Books."
- 8.55 p.m.—"Argus" and "Herald" News Service; Weather Synopsis, Shipping Movements.

- 8.47 p.m.—Stock Exchange information.
- 8.52 p.m.—Fish market reports, by J. R. Barrett, Ed.
- 8.55 p.m.—Market reports.
- 8.58 p.m.—Market reports by the Victorian Producers' Co-operative Co., Ltd., Dairy Produce, Potatoes and Onions; Harrogate; Sheep, Cattle, Poultry, Grain; Straw; Hay and Jute.
- 9.0 p.m.—Market prices of Oranges and Lemons by the Victorian Central Citrus Association; Market reports by the Victorian Wholesale Fruitellers' Association, compiled by "The Fruit Week," exclusive to 3LO.

NIGHT SESSION.

- Speakers.
- SIR JAMES BARRETT.
- MR. P. D. PHILLIPS, M.A., LL.B.
- DR. LOUIS HILLS.
- MR. J. C. BOYCE.
- MISS A. M. BERRENS.
- MALVERN TRAMWAYS BAND.
- HUGHAM'S SERENADES.
- JEN GIBSON'S SEXTET.
- OSBORNE and PERRYER.
- REG. WYKHAM and PERRYER PRESTON.
- HASTINGS AND ADAIR.
- MARIE LE VAREE, Comedian.
- JOE ARONSON and HIS SYSCO-SYMPHONISTS.
- Announcement, AGNES FORTUNE.
- Announcement, ALFRED ANDREW.
- 9.15 p.m.—Under the Auspices of the Town Planning Association, SIR JAMES BARRETT, resident of the Town Planning Association, "Town Planning in New Zealand."
- 9.30 p.m.—University Extension Board, Mr. P. D. PHILLIPS, M.A., LL.B., "Social Aspects of Advertising."
- 9.45 p.m.—DR. LOUIS HILLS, Popular Solence.
- "VADEVILLANTIER."
- 9.45 p.m.—MALVERN TRAMWAYS BAND, March, "Gideon" (Fryer).
- Waltz, "Satin" (Cubin).
- 9.45 p.m.—HUGHAM'S SERENADES, Quartette, "The Girl from Glasgow" (Hodson).
- EDITH HUGHAM, DOLLY BIRDETT, HENRY MILLAR, A HUGH HUGHAM, "Vocal."
- DOLLY BIRDETT, "Deuxième de Jockey" (Gardner).
- Humorous Novelty, "Opera v. Bartina."
- THE SERENADE QUARTETTE.
- Margie Foster, "Robert Bonner's" (Kiesler) Quartette (Operatic). "A Max Morning" (Dwan).
- THE SERENADE QUARTETTE.
- 9.50 p.m.—JEN GIBSON'S SEXTETTE, "Promises" (Richmann).
- "Humoresque" (Dwan).
- 9.55 p.m.—OSBORNE and PERRYER, to Radio Hallucination.
- 10.0 p.m.—MALVERN TRAMWAYS BAND, Selection, "Rose Marie" (Pratt and Stegarty).
- 10.10 p.m.—MR. J. C. BOYCE, will speak on Arrangements in the Country for entertaining the men of the "Remount."
- 10.15 p.m.—MALVERN TRAMWAYS BAND, Intermezzo, "La Paloma."
- 10.25 p.m.—REG. WYKHAM and PERRYER PRESTON, Sketch, "The Perfect Pain."
- 10.30 p.m.—HASTINGS AND ADAIR, Comed, "Say It Again," Patter, "Ginger, 'Can You Forget," "Kilnicker's" Christening.
- 10.45 p.m.—MISS A. M. BERRENS, Deputy Chief Commissioner, Girl Guides Association of England, "Guiding."
- 10.50 p.m.—MARIE LE VAREE, Comedian, "A Road with the World With You" "Pale Moon."
- 10.55 p.m.—JEN GIBSON'S SEXTETTE, "Mexican Rose."
- "Hawaiian Love" (Verrier).
- 10.55 p.m.—Dr. Phillips, "Wireless News from Rugby, Arrangements."
- 10.55 p.m.—MALVERN TRAMWAYS BAND, "The Wind" (Haller).
- 10.57 p.m.—MARIE LE VAREE, Comedian, "No Wonder She's a Blushing Bride."

Let Your Battery Save our Purses: Philco.



Look at the plates in the Oldham

—you tell a good Car by its engine
and a good Accumulator by its plates

OLDHAM Accumulators are fitted with plates made under the Oldham Special Activation Process—an exclusive method of obtaining surprising vitality and long life. The Special Activation Process costs more than the ordinary method of plate manufacture, but then—since it means such a greater increase in efficiency—obviously it is a worth-while investment. Remember the difference in cost between an Oldham and an ordinary Accumulator cannot be more than a shilling or two, yet whereas the latter may last only a twelve-month, the Oldham

will last two or three times as long. And whereas the ordinary Accumulator may require to be charged every ten days, the Oldham will probably operate for a fortnight on a charge.

These are the points you should consider when choosing your Accumulator. Get your Dealer to show you an Oldham, compare its stout, well-impregnated plates with those in any other make of Accumulator. Compare their area for area and thickness for thickness. You'll then see why an Oldham lasts longer and gives more hours to the charge.

NOYES BROS. (SYDNEY) LTD.

115 Clarence Street

And at Brisbane, Newcastle, Melbourne, Adelaide,
Hobart and Perth.

Special Activation Process
OLDHAM
ACCUMULATORS



Happy though Married!

An old bachelor once wrote a book about the best way to be happy though married, but the divorce courts were just as full afterwards.

The best way I know is to put in a good wireless set—something polished and pretty. I did, and the result is that my wife has turned life into a dainty sandwich, and there is no matrimonial indigestion as a result.

She begins the day by reducing exercises, following directions by radio. Personally, it seems slightly indelicate to be exercising in a dressing gown before a loud speaker—but I wisely refrain from comment.

Cooking, scrubbing, dusting, bed-making, etc., are all done to music and eleven o'clock tea is spent beside the wireless. The day seems half the length to her and twice as interesting.

In the evening we visit band concerts, theatres, political meetings, the stadium and a motor race—all by wireless.

The only rift in the wireless lute came from foolish economy on my part. I bought a cheap battery, which cracked and ran down. What my wife said about the battery should have given her ten days, without the option, I paid more in mental anguish than the cost of ten first-class batteries.

Finally, I bought the very best dry battery on the market, the good old Burgess, and now my life is a mixture of rose petals and cream.

Which taught me for the N-th time that you cannot satisfy a woman with cheapness. Whether it is a hat or a coat, or a radio battery, she must have the best. You should hear her explaining to our guests when they praise the set—

"We always use the Burgess. Of course, they cost a little more, but the life and purity of reception are remarkable. You could not give us a cheap substitute."

Secretly, I am convinced that my wife believes her only instance of faulty taste was in the choice of a husband. But she has refrained from saying so, since that happy day I brought home the Burgess.

Go thou and do likewise.

- 10.32 p.m.—LEN GIBSON'S SEXTETTE,
"Sleepy Honolulu Moon."
"Oloha-Oo."
10.40 p.m.—"Argos" News Service. Announcements.
10.45 p.m.—JOE AROSSON AND HIS
SYNCO-SYMPHONISTS,
"Baby Face."
"Smile a Little bit."
"At Peace With the World."
11.0 p.m.—OUR GREAT THOUGHT: "Our
grand business is, not to see what lies
dimly at a distance, but to do what lies
clearly at hand."—Thomas Carlyle.
11.1 p.m.—JOE ARONSON AND HIS SYNCO-
SYMPHONISTS,
"At Peace With the World."
"Hi, Diddle Diddle."
"Smiling Eyes."
"Neapolitan Nights."
"I'd Climb the Highest Mountain."
"Precious."
"Kalinka."
"Fire, Fire, Fire, Turn the Hose on Me."
"Any Ice To-day, Lady."
"Tummy a Little Kiss, Will 'Ya' Huh."
"Punchy."
"Indian Love Call."
"Rose Marie."

11.40 p.m.—GOD SAVE THE KING

4QG, BRISBANE

Tuesday.

MIDDAY SESSION.

- 1.0 p.m.—Market Reports: Weather information supplied by the Commonwealth Weather Bureau; News Service supplied by "The Daily Mail" and "The Daily Standard."
1.30 p.m.—From Hotel Carlton: Lunch Music from the Lounge, Hotel Carlton, played by Hotel Carlton Symphony Orchestra.
1.55 p.m.—From the Observatory: Standard Time Signal.
2.0 p.m.—Close Down.

AFTERNOON SESSION.

- 3.30 p.m.—A Programme of Music from the Studio.
4.20 p.m.—"The Telegraph" News Service.
4.30 p.m.—Close Down.

EARLY EVENING SESSION.

- 6.5 p.m.—"Daily Standard" News; Announcements.
6.30 p.m.—The Children's Session—Stories by Uncle Ben and Uncle Jim.
7.0 p.m.—Market Reports; Stock Reports; Lectures on "Irrigation for Sugar Cane and Pineapple Growing in Hawaii," Mr. Jas. Allen.
7.30 p.m.—Weather News; Announcements.
7.45 p.m.—Standard Time Signal.

NIGHT SESSION.

- 7.45 p.m.—Lecture Session—"Photography"—by Mr. F. L. South (Manager Kodak Ltd.).
8.0 p.m.—STUDIO CONCERT. Orchestral, Prelude from "Merchant of Venice" (Rossi), the Regent Symphony Quartette (leader, Miss Phyllis Fitzroy); tenor solo, "The Swain" (Squire); Mr. John Steel; monologue, "A China Tragedy," Miss Foe Todd; organ solo, selected, Mr. Arthur Sharma; soprano solo, "Come Back to Erin," Mrs. Robert Bell; a thought for tonight by Will H. Lister—"Opportunity"; orchestral, "Serenade" (Wilder), the Regent Symphony Quartette; bass solo, "The Alone Charmeth My Sadness" (Gounod), Mr. Stanley Tamblin; ten minutes of humor by Mr. Wally Charleris; fox-trot, "Moonlight on the Gangs" (Myers), the Regent Symphony Quartette; soprano solo, "Autumn" (Mullins), Miss Beatrice Pugh; monologue, "The Dream Ring of the Desert" (Gower), Miss Foe Todd; bass solo, "The Merry Monk" (Evans), Mr. Stanley Tamblin; orchestral, "Fifth Nocturne" (Lyzbach), the Regent

- Symphony Quartette; baritone solo, "Mandelay" (Cobb), Mr. E. B. Astley; fox-trot, "Eyes Were Never Made for Crying" (McNeil), the Regent Symphony Quartette; contralto solo, "Bonsoir, Thy Wife" (de Capone), Mrs. Jean Taylor; orchestral, "Blue Lotus Dance" (from "Pagoda of Flowers"—Woodford-Finden), the Regent Symphony Quartette; tenor solo, "Songs My Mother Taught Me" (Dvorak), Mr. John Steel.
9.15 p.m.—Metropolitan Weather Forecast.
9.20 p.m.—From the Centennial Hall; Dance Music.
10.0 p.m.—The "Daily Mail" News; Weather News. Close Down.

5CL, ADELAIDE

Tuesday.

MORNING SESSION.

- 11.30 a.m.—G.P.O. chimes.
11.51 a.m.—Autonee Reproducer recital.
11.40 a.m.—"Advertiser" news service.
11.55 a.m.—Songs recital.
12 noon.—G.P.O. chimes.
12.1 p.m.—"Advertiser" news service.
12.10 p.m.—Autonee Reproducer recital.
12.30 p.m.—S. C. Ward and Co.'s Stock Exchange reports, official weather synopsis and station announcements.
12.50 p.m.—G.P.O. chimes.
12.51 p.m.—Studio Orchestra: "The Circle's" waltz, "Am I wasting my time on you?" fox trot, "Rose-colored glasses"; waltz, "A garden dance"; concert solo, "At sunset" selection, "The wilderness"; waltz, "A minor"; Ennio, "March of the heroes."
2 p.m.—G.P.C. chimes and close down.

AFTERNOON SESSION.

- 3 p.m.—G.P.O. chimes.
3.1 p.m.—Relay from the Maple Leaf Cafe—Orchestral numbers.
3.45 p.m.—From the Studio—Autonee Reproducer and Songs numbers.
4 p.m.—G.P.O. chimes.
4.1 p.m.—Relay from the Atraxia Cafe—Orchestral numbers.
4.55.—Stock Exchange report, general information and station announcements.
5 p.m.—G.P.O. chimes and close down.

EVENING SESSION.

- 6.30 p.m.—G.P.O. chimes.
6.31 p.m.—Autonee Reproducer recital.
6.35 p.m.—Bed-time stories.
7.20 p.m.—Market reports.
7.40 p.m.—Home beautiful talk by "Dorcas."
8 p.m.—G.P.O. chimes.
8.1 p.m.—From Adelaide Town Hall—Anti-prohibition platform by Mr. Bowdler, Sydney's orator.
8.20 p.m.—Selection, SCL Orchestra.
8.30 p.m.—Song, Mr. Geo. Myers.
8.34 p.m.—Song, Miss M. Wallace.
8.38 p.m.—Gornet solo, Mr. Vern Rogers.
8.42 p.m.—Song, Mr. Arnold Matters.
8.46 p.m.—Selection, SCL Orchestra.
8.58 p.m.—Song, Mrs. L. H. Hill.
9 p.m.—G.P.O. chimes.
9.1 p.m.—Weather report.
9.2 a.m.—Dalcely's wheat report.
9.3 p.m.—Song, Mr. Geo. Myers.
9.7 p.m.—Selection, SCL Orchestra.
9.22 p.m.—Song, Miss M. Wallace.
9.24 p.m.—Violin solo, Miss I. Fogelin.
9.28 p.m.—Song, Mr. Arnold Matters.
9.32 p.m.—Song, Mrs. L. H. Hill.
9.36 p.m.—Selection, SCL Orchestra.
9.40 p.m.—Song, Mr. Geo. Myers.
9.40 p.m.—Pianoforte solo, Mr. Tom Kior.

- 2.48 p.m.—Selection, SCL Orchestra.
2.54 p.m.—Song, Miss M. Wallace.
10 p.m.—G.P.O. chimes.
10.1 p.m.—"Advertiser" news service.
10.15 p.m.—Selection, SCL Orchestra.
10.20 p.m.—Song, Mr. Geo. Myers.
10.22 p.m.—Celli solo, Mr. Ted Williams.
10.33 p.m.—Song, Mr. A. Matter.
10.37 p.m.—Selection, SCL Orchestra.
10.50 p.m.—Song, Mrs. L. H. Hill.
10.54 p.m.—Song, Mr. Geo. Myers.
10.55 p.m.—Station announcements.
11 p.m.—G.P.O. chimes and close down.

6WF, PERTH

Tuesday.

- 12.30 p.m.—Tune in.
12.35 p.m.—First local news-bulletin—Market reports.
Cables.
1 p.m.—Time signal from Perth Observatory.
1.1 p.m.—Weather notes, supplied by the Meteorological Bureau of Western Australia.
1.2 p.m.—STUDIO THIO.
1.30 p.m.—Close down.
1.50 p.m.—Tune in.
2.0 p.m.—Musical programme, including pianoforte selections by MISS EVELYN WILLIS, A.R.C.M.
4 p.m.—STUDIO THIO.
4.45 p.m.—Close down.

NIGHT SESSION.

- 7 p.m.—Tune in.
7.5 p.m.—Stories for Tiny Tots by Auntie Kate.
7.20 p.m.—Uncle Leslie will talk to the Kiddies.
7.35 p.m.—Stock and Share intelligence.
Market reports.
Cables, News supplied by courtesy of "The West Australian" Newspaper Coy.
8 p.m.—Time Signal from Perth Observatory.
8.1 p.m.—Weather Notes supplied by the Meteorological Bureau of Western Australia.
HAND NIGHT—
8.2 p.m.—Concert by the Perth City Band, conducted by MR. W. A. HALLVOESLEN.
10 p.m.—Second local news bulletin, supplied by courtesy of "The Daily News" Newspaper Coy.
10.50 p.m.—Close Down.

Wednes., March 16 2FC, SYDNEY

EARLY MORNING SESSION.

- 7 a.m.—"Big Ben" and announcements.
7.5 a.m.—Studio music.
7.55 a.m.—Official weather forecast, rainfall, temperatures, astronomical memoranda, shipping intelligence, mail services.
7.55 a.m.—Investment market, mining share market, metal quotations.
7.55 a.m.—Wool sales, breadstuffs markets, interstate markets, produce markets.
7.55 a.m.—"Sydney Morning Herald" news service.
8 a.m.—"Big Ben" Studio music.
8.15 a.m.—Close down.

MORNING SESSION.

- 9.30 a.m.—Marching music for school children.
9.40 a.m.—Some popular records.
10 a.m.—"Big Ben" and announcements.
10.5 a.m.—Late "Sydney Morning Herald" news service.

You'll
find-

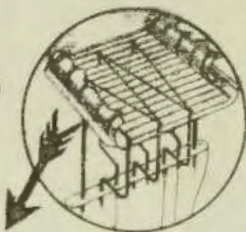

inside the famous B 406

THE NEW WONDER VALVE

a filament

so strong only a deliberate foe can break it.

so tough it can be filed like string even after burning for many hundreds of hours.

so rigidly supported by extended anchorages that all vibration is eliminated, and characteristics remain constant throughout its life.

so long that it gives more than five times the emissive surface of an ordinary filament.

a working temperature

so low that no glow is discernible when working at the correct filament voltage. No previous filament is needed in bringing the Philips filament to white heat.

an economy

so wonderful that three dry cells or two small accumulators will now do the work for which formerly a large 62 volt accumulator was absolutely necessary. The B406 takes only one seventh of the current required by earlier types of valves.

CHARACTERISTICS:

| | |
|-------------------------------|--------|
| Fil. Voltm. | 4 |
| Fil. Amps. | 1 |
| Plate Voltm. | 20-120 |
| Amplification Factor. | A |
| Impedance (ohms) | 13,000 |

Write to:
G.P.O. Box 2703C

Sydney

For complete
VALVE
CATALOG

The B406 is standard equipment on many of the higher grade sets sold in Australia to-day.

ASK YOUR DEALER

PHILIPS
LAMPS AND RADIO

2BL, SYDNEY

Wednesday.

EARLY MORNING SESSION.

- 7.15 a.m.—G.P.O. Clock and Chimes.
- 7.18 a.m.—Meteorological weather forecast.
- 7.17 a.m.—Musical programme from the Studio.
- 7.22 a.m.—Physical training and health exercises.
- 7.25 a.m.—G.P.O. Clock and Chimes.
- 7.31 a.m.—State of health.
- 7.35 a.m.—Physical training and health exercises.
- 7.45 a.m.—G.P.O. Clock and Chimes.
- 7.48 a.m.—Weather report.
- 7.47 a.m.—Broadcasters' special news service.
- 8 a.m.—G.P.O. Clock and Chimes; close down.

MORNING SESSION.

- 11 a.m.—G.P.O. Clock and Chimes.
- 11.1 a.m.—Weather report.
- 11.2 a.m.—Musical programme from the Studio.
- 11.3 a.m.—Sydney "Daily Telegraph" news service.
- 11.15 a.m.—Habbit Market report.
- 11.17 a.m.—Fish Market report.
- 11.19 a.m.—Vegetable Market report.
- 11.21 a.m.—Fruit Market report.
- 11.25 a.m.—London Dairy Farm, Egg and Poultry Market report.
- 11.28 a.m.—London metal quotations.
- 11.30 a.m.—Rifts in call by wireless.
- 11.35 a.m.—Information re Interstate and Overseas Mails.
- 11.42 a.m.—Shipping information—arrivals and departures.
- 11.45 a.m.—Women's Section: Miss Varley, Broadcasters' Women's Sports Authority, will speak on "Swimming."
- 11.48 a.m.—News from the "Sun."
- 11.55 a.m.—Mrs. Jercan reports to correspondents.
- 12 a.m.—Talk on "Musical" by Dr. H. S. Morris.
- 12.10 p.m.—G.P.O. Clock and Chimes.
- 12.21 p.m.—Sydney Stock Exchange calls.
- 12.33 p.m.—News from the "Sun."
- 12.45 p.m.—Musical programme from the Studio.

- 1 p.m.—G.P.O. Clock and Chimes.
- 1.1 p.m.—Flandreau Lecture Recital by Mr. Arnold B. Mott, B.A., broadcast from the Fines Art Gallery, Anthony Hardisty.
- 1.40 p.m.—News from the "Sun."
- 1.50 p.m.—Sydney stock Exchange calls.
- 2 p.m.—G.P.O. Clock and Chimes.
- 2.1 p.m.—Weather report and forecast.
- 2.3 p.m.—Musical notes from the "Sun."
- 2.5 p.m.—Musical programme from the Studio.
- 2.55 p.m.—Racing resumé.
- 3 p.m.—G.P.O. Clock and Chimes.
- 3.25 p.m.—News from the "Sun."
- 3.50 p.m.—Musical programme from Studio.
- 3.45 p.m.—News from the "Sun."
- 4 p.m.—G.P.O. Clock and Chimes.
- 4.1 p.m.—Musical programme from the Studio.
- 4.15 p.m.—Serial story.
- 4.50 p.m.—G.P.O. Clock and Chimes.
- 4.51 p.m.—Musical programme from the Studio.
- 4.55 p.m.—Producers' Distributing Society's Vegetable and Fruit Market report.
- 4.58 p.m.—Shipping information when available.
- 4.52 p.m.—Day's racing resumé.
- 4.55 p.m.—News from the "Sun."
- 4.58 p.m.—Resumé of night's programme.
- 5 p.m.—G.P.O. Clock and Chimes; close down.

EARLY EVENING SESSION.

- 6.45 p.m.—G.P.O. Clock and Chimes.
- 6.48 p.m.—Littie Willie and Daisy Long Legs and entertain the kiddies.
- 6.52 p.m.—Musical programme from Studio.

NIGHT SESSION.

- 7.40 p.m.—Programme announcements.
- 7.46 p.m.—A Tale by the well-known Australian Sculptor, Miss Theo Gosau: Subject, "Types of Beauty."
- 8 a.m.—"Big Ben."
- FROM THE CRYSTAL PALACE THEATRE, GEORGE STREET, SYDNEY: Items by the Orchestra under the baton of Mr. Harry Gratio.
- 8.15 p.m.—FROM THE STUDIO: Mr. Oliver King, the well-known Australian bass, makes his first appearance at the Studio since his return from abroad.
- 8.30 p.m.—Buddy's Brass Band, conductor, Mr. Harry Gratio: (a) March, "Brilliant" (Hamel). (b) Fox Trot, "Oh, the Rivers" (Finlay). (c) Valse, "Calling" (Lizemann).
- 8.45 p.m.—Mr. Arthur Champion, tenor: "Daphne" (Clark).
- 9 p.m.—FROM THE CRYSTAL PALACE THEATRE: Orchestral items.
- 9.30 p.m.—FROM THE STUDIO: Miss Nancy Metcalfe, violin solo.
- 9.45 p.m.—Miss Marie Cooke, soprano: "Come, for It's June" (Foster).
- 9 p.m.—"Big Ben." Buddy's Brass Band, conductor, Mr. Harry Gratio: Selection, "Il Trovatore" (Verdi).
- 9.15 p.m.—Miss Freda Fink, violin solo.
- 9.15 p.m.—Mr. Oliver King, bass.
- 9.31 p.m.—A Talk by Mr. W. F. Jackson on the "Latin quarter of Paris."
- 9.30 p.m.—Buddy's Brass Band, conducted by Mr. Harry Gratio: Cornet Solo, "Lizau" (Hartmann).
- 9.45 p.m.—Miss Marie Cooke, soprano, and Mr. Arthur Champion, tenor: Duet: (a) "The Day is Done" (Lohr). (b) "The Light in Venice" (Lizemann).
- 9.55 p.m.—Buddy's Brass Band, conducted by Mr. Harry Gratio: (a) Fox Trot, "Picardy" (Finlay). (b) March, "Orestes" (Greenwood).
- 10 p.m.—"Big Ben." Miss Freda Fink and Miss Nancy Metcalfe in violin duet.
- 10.5 p.m.—Mr. Robert Turner, entertainer: "Babbages of Babbage" on Literature and Music.
- 10.15 p.m.—Miss Marie Cooke, soprano, and Mr. Arthur Champion, tenor: Duet: (a) "Seven o'clock in the morning" (German). (b) "In Our Boat" (Allison).
- 10.20 p.m.—FROM THE CRYSTAL PALACE THEATRE, GEORGE STREET, SYDNEY: Items by the Orchestra under the baton of Mr. Harry Gratio.
- 10.30 p.m.—Mr. Robert Turner, entertainer: (a) "Any Other Time" (Patterson). (b) "The Pickpocket" (Gouraud).
- 10.45 p.m.—Mr. Arthur Champion, tenor: "Life in a Caravan" (Riesig).
- 10.45 p.m.—FROM THE WESTWORTH CAFE, CHURCH HILL, SYDNEY: The New Westworth Symphonic Dance Orchestra conducted by Mr. Sydney Simpson.
- 10.55 p.m.—FROM THE STUDIO: Miss Marie Cooke, soprano: "The Woodpecker" (Lohmann).
- 10.55 p.m.—Mr. Robert Turner, entertainer: "Pier" (Scott-Gattin).
- 11 p.m.—"Big Ben." Late news and announcements.
- 11.4 a.m.—FROM THE WESTWORTH CAFE: Items by the Westworth Symphonic Dance Orchestra until midnight.
- 12 midnight—"Big Ben." National Anthem. Close down.

- 10.15 a.m.—Studio music.
- 10.45 a.m.—A serial story.
- 11 a.m.—"Big Ben." Australian Press Association and Butler's Guide Service.
- 11.10 a.m.—Studio music.
- 11.15 a.m.—A Talk on Home Cooking and Recipes by Miss Ruth Furst.
- 11.30 a.m.—Marching music for school children.
- 11.35 a.m.—Close down.

MIDDAY SESSION.

- 12 noon.—The "Big Ben" Chimes and programme announcements.
- 12.3 p.m.—Stock Exchange first call.
- 12.3 p.m.—Studio music.
- 12.40 p.m.—Rugby wireless news.
- 12.55 p.m.—Miss Diana Bartz, soprano: "Dancing Days" (Lohmann).
- 1 p.m.—"Big Ben." Weather intelligence.
- 1.1 p.m.—"Evening News" midday news service. Producers' Distributing Society's report.
- 1.20 p.m.—Studio music.
- 1.25 p.m.—Stock Exchange, second call.
- 1.30 p.m.—Marching music for school children.
- 1.40 p.m.—Miss Diana Bartz, soprano: "Bonnie Mary of Argyll" (Neilson).
- 1.45 p.m.—Studio music.
- 2 p.m.—"Big Ben." Close down.

AFTERNOON SESSION.

- 2.30 p.m.—Programme announcements.
- 2.35 p.m.—Vocal items by the pupils of Madame Emily Marlet: "In a quiet tonino" (Cluck), MISS BEGGIE DUBBAL, contralto.
- 2.37 p.m.—"Spring's Awakening," MISS DIANA ROOTH, soprano.
- 2.41 p.m.—"Cupid Fickle Cupid" (German), MISS PHYLLIS HAYNER.
- 2.45 p.m.—A Talk by Mr. S. H. Bowden on Lambeth Palace, London.
- 2.5 p.m.—Further items from the Recital arranged by Madame Emily Marlet: "A Walk in the Wood" (Cluck), MISS KATHLENE BEVERLY, soprano.
- 2.9 p.m.—"The Lament of Iph" (Bantock), MISS FOSSE BRAKEL.
- 3.13 p.m.—"April is a Lady" (Phillips), MISS MARGARET GRIMSHAW, mezzo.
- 3.17 p.m.—"Country Poll" (Halse), MISS BEGGIE DUBBAL, contralto.
- 3.21 p.m.—Some popular tenors.
- 3.30 p.m.—Marching music for school children.
- 3.40 p.m.—FROM FARMER'S TEA ROOMS: Miss Sybil Ashelwood, organ: "Far Away Bells" (Gordon).
- 3.45 p.m.—Studio music.
- 4 p.m.—"Big Ben."
- FROM FARMER'S TEA ROOMS: Miss Olga Brizz, soprano.
- 4.1 p.m.—A recital.
- 4.20 p.m.—FROM FARMER'S TEA ROOMS: Miss Sybil Ashelwood, organ: "Love's Bright Day" (Wood).
- 4.25 p.m.—Studio music.
- 4.45 p.m.—FROM FARMER'S TEA ROOMS: Miss Olga Brizz, soprano.
- 4.48 p.m.—Stock Exchange, third call.
- 4.49 p.m.—Close down.

EARLY EVENING SESSION.

- 6.45 p.m.—The Chimes of 2FC.
- 6.50 p.m.—The "Hillo Man" talks to the children, assisted by Uncle Ned and "Jerry."
- 6.55 p.m.—Dinner notice.
- 7 p.m.—"Big Ben." Late starting news.
- 7.10 p.m.—Inter-Is. market reports (Wool, wheat and stock).
- 7.15 p.m.—Fruit and vegetable markets.
- 7.20 p.m.—Weather and shipping intelligence.
- 7.25 p.m.—Stock Exchange.
- 7.35 p.m.—Late "Evening News" news service.

Satisfaction, not for a year or two, but for a lifetime, is built into every Magnavox Set.

MAGNAVOX

One Dial (5 Valve) Radio

Representing the "ne plus ultra" in Radio, the Magnavox is America's acknowledged leading Broadcast Receiver

To see, to hear, and to operate the MAGNAVOX is a revelation—a new adventure in radio enjoyment.

Its single dial control permits the triple attributes of simple operation, perfected performance and enduring beauty of appearance.



Illustrated here

The "Berkeley" Model

Two toned mahogany highboy cabinet, with built-in

MAGNAVOX Cone Speaker.

Compartments for all Batteries.

Price, complete,

£92

Other Models, complete at

**£75, £65, £51,
£40**

CASH or TERMS

Hear these wonderful Receivers demonstrated in our Special Audition Room or arrangements can be made in your own home.

Profusely illustrated Booklet, free on request.

Mick Simmons Ltd.

"The World's Greatest Sports Store"

Headquarters: HAYMARKET, SYDNEY
And at BRISBANE

SPECIAL COUNTRY SESSION.

3LO, MELBOURNE

Wednesday.

MIDDAY SESSION.

JOE ARONSON AND HIS SYNCOPIATING SYMPHONISTS.

SIDNEY BURCHALL, baritone.
MARIE LE VARRE, contralto.
Accompanists AGNES FORTUNE
Announcer MAURICE DUDLEY
"WATTLE I DO" WHY DANCE OF
"GIRLES"

12 noon. Long signal. British Official Wireless news from Rugby. Router's and the Australian Press Association Cables, Stock Exchange information, "Argus" and "Herald" news service.

12.30 p.m.—JOE ARONSON AND HIS SYNCOPIATING SYMPHONISTS.

"Moonlight on the Ganges."
"That's My Girl."12.45 p.m.—SIDNEY BURCHALL, baritone.
"Free Lance" (D.S.).
"The Windmill."1.15 p.m.—JOE ARONSON AND HIS SYNCOPIATING SYMPHONISTS.
"You Need Someone to Love."
"It Made Me Happy."
"Roses."1.30 p.m.—MARIE LE VARRE, soprano.
"The Windmill" and "Fountain Pen."

1.45 p.m.—JOE ARONSON AND HIS SYNCOPIATING SYMPHONISTS.

"I Want a Pardon for Daddy."
"His Hands—How come Charlie."
"St. Louis Blues."

1.45 p.m.—Metereological information, shipping intelligence. Weather forecast for Victoria, Tasmania, South Australia, and New South Wales. Ocean forecast. River reports.

1.55 p.m.—JOE ARONSON AND HIS SYNCOPIATING SYMPHONISTS.

"How Many Times."
"Magnificent"
"Sad."1.45 p.m.—SIDNEY BURCHALL, baritone.
"Waiting for the Moon" (Lerner).
"Boo, You Rascal!" (Henderson).

1.42 p.m.—JOE ARONSON AND HIS SYNCOPIATING SYMPHONISTS.

"Speech."
"While the Years go Drifting By."
"Swain" (the Piano).1.52 p.m.—MARIE LE VARRE, soprano.
"Henry Burchell."
"I Don't Believe it, but Say it Again."2 p.m.—Close down.
(Results of the Pakoham Races will be given as they come to hand.)

AFTERNOON SESSION.

THE STUDIO ORCHESTRA.
HUGH HUXHAM'S SERENADERS.JONES AND RAINE, comedians.
GEORGE WELCH, comedian.
HASTINGS AND ADAIR.Accompanists AGNES FORTUNE
Announcer MAURICE DUDLEY3 p.m.—STUDIO ORCHESTRA:
"Merchant of Venice Suite," Part I.3.30 p.m.—HUGH HUXHAM'S SERENADERS:
Quartet, "The Sunny Summer-time."EDITH HUXHAM, DOLLY BURDETT,
RENN MILLAR, AND HUGH HUXHAM
Contralto solo: "Less than the Dust."DOLLY BURDETT,
STUDIO ORCHESTRA:
"Merchant of Venice" Suite, Part 2(Close).
Soprano Solo: "Live, Laugh and Love."EDITH HUXHAM,
STUDIO ORCHESTRA:
"In a Rose Garden" (Acciani).Musical Recs. "To Fair Jean" (Huxham).
SERENADERS QUARTETTE.3.40 p.m.—STUDIO ORCHESTRA:
"Melicita" (Rachmaninoff).3.50 p.m.—JONES AND RAINE, The Welsh Bardic:
Song: "Jimmy Law."Human Funnel: "Light Cavalry."
Duet: "I'm Going Away."4 p.m.—STUDIO ORCHESTRA:
"Music Pictures" (John Foulds).4.10 p.m.—GEORGE WELCH, comedians:
"Comicalities."4.17 p.m.—STUDIO ORCHESTRA:
"The Song of the Volga Boatman."
"From India" (Percy).4.30 p.m.—HASTINGS AND ADAIR.
Song, "Garden of Happiness."
Comedy Song: "Beauty.""Shoe Shop."
4.45 p.m.—"Herald" news service, Stock Exchange information, Results of Pakoham and Rochester Races.

5 p.m.—Close down.

EVENING SESSION.

5.45 p.m.—CHILDREN'S HOUR.
Answers to Letters and Birthday greetings.5.55 p.m.—STUDIO ORCHESTRA:
"Baby's Opera," Part I (Byge).

5.8 p.m.—JONES AND RAINE will entertain the children.

5.15 p.m.—STUDIO ORCHESTRA:
"Baby's Opera," Part 2.

5.25 p.m.—Story for the Children by "Bobby Buggins."

5.35 p.m.—"Argus" and "Herald" news service, Weather and Aerial Mail information by The Australian Aerial Services, Ltd.

5.45 p.m.—Stock Exchange information. Over-sea shipping.

5.55 p.m.—Fish Market reports by J. R. Barrett, Ltd.

5.44 p.m.—River reports.

5.42 p.m.—Market reports by the Victorian "Producers' Co-operation Co., Ltd. Hay-market, stock sales, Poultry, Grain, Hay, Cattle, Sheep, Hides, Dairy Products, Potatoes and Onions.

5.5 p.m.—Market reports of Oranges and Lemons by the Victorian Central Citrus Association, Fruit Market reports by the Victorian Wholesale Fruit-growers' Association, compiled by the "Fruit World," exclusive to H.O.

NIGHT SESSION.

Speakers:
MR. R. CROWE, CAPT. PETERS,
THE STUDIO ORCHESTRA.THE IRISH PIPERS,
HUXHAM'S SERENADERS
OSBORNE AND PETER, HASTINGS AND ADAIR,
SIDNEY BURCHALL, baritone.PRESENTATION OF THE 3LO SHIELD.
JOE ARONSON AND HIS SYNCOPIATING SYMPHONISTS.Accompanists ALFRED ANDREW
Announcer ALFRED ANDREW7.15 p.m.—Under the auspices of the Department of Agriculture, MR. R. CROWE, Exports Superintendent,
"Market Comments."7.30 p.m.—OPENING OF THE WIRELESS EXHIBITION at HAMILTON.
"ST. PATRICK."8 p.m.—STUDIO ORCHESTRA:
"The Emerald Isle" (Lange).8.10 p.m.—SIDNEY BURCHALL, baritone:
"Meadow Lark."

"Keep on Keeping On."

8.17 p.m.—IRISH PIPERS:
"The Pewee and the Goat."
"Minstrel Boy."
"Forty Miles."8.27 p.m.—HUGH HUXHAM'S SERENADERS:
Quartets: "Devote God's Deed."EDITH HUXHAM, DOLLY BURDETT,
RENN MILLAR AND HUGH HUXHAM
Bass Solo: "The Sea Road."RENN MILLAR,
TASMA TIERNAN, solo:
"Adagio" (Schubert).

2GB, SYDNEY

Wednesday.

MORNING SESSION.

"Cheerio Hour," conducted by the Cheerio Man.

8.30 a.m.—Music.

9.30 a.m.—Psychological Class.

10.5 a.m.—Music.

10.10 a.m.—Biographical talks for schools.

10.25 a.m.—Music.

10.50 a.m.—Close down.

AFTERNOON SESSION.

3.30 p.m.—Children's Session, conducted by the Cheerio Man.

7.15 p.m.—Popular song number, vocal, piano, and eraphone.

7.30 p.m.—Address: Rt. Rev. G. S. Arundale.

7.45 p.m.—Instrumental Trio: Monica Horder, Marielle Lang, Ada Brook.

8.0 p.m.—Address by Prof. Ernest Wood.

8.15 p.m.—Songs, by Miss Ethel Jones.

8.25 p.m.—Piano solos, by Ada Brook.

8.35 p.m.—2GB Vocal Quartette.
Ethel Jones, Sibyl Bevan, Thos. Hall, Clement Hooking.

8.45 p.m.—Violin solos, by Monica Horder.

8.54 p.m.—Announcements.

9 p.m.—Songs, by Clement Hooking.

9.8 p.m.—Topical Talk. Physical Culture, M. P. Herbert.

9.25 p.m.—Instrumental Trio: Monica Horder, Marielle Lang, Ada Brook.

8.45 p.m.—Vocal Quartette.

9.45 p.m.—Violin solo, by Monica Horder.

9.52 p.m.—Cheerio talk.

10 p.m.—"Great Thoughts from Great Minds."

Here's a Price List of Parts
FOR THE
SCREENED COIL RECEIVER

Issued Recently in "Wireless Weekly."

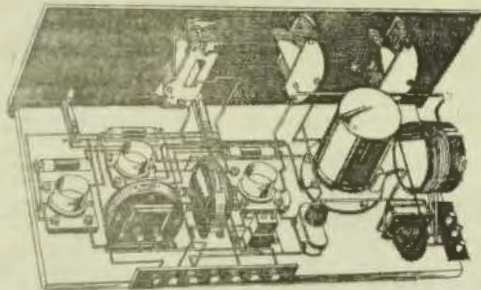

This working model, actually constructed from parts and accessories from David Jones' Radio Department, is now on display there at 22 York Street. See it immediately. It is an excellent example of a selective three-valver, giving unexpected results.

These high grade parts are all obtainable at David Jones' Radio Shop and panels will be drilled free of charge and all advice and assistance given to the construction.

| | | | |
|--|------|--|-----------------------|
| 1-Radioc or Dilecto Panel, 20in. x 7in. x $\frac{1}{2}$ in. or $\frac{3}{4}$ in. $\frac{1}{4}$ th panel . . . | 10/3 | 1-Bradleyeak | 15/- |
| 2-.0005 Emeco B.L.F. Condensers, 15/- each | 30/- | 3-Valve Sockets, 3/- each | 9/- |
| 1-.0003 Pilot Condenser | 10/6 | 3-Emeco Vernier Dials, 9/6 each, 28/6 | |
| 1-D.C. Filament Control Jack | 3/6 | 1-.00025 Grid Condenser | 2/6 |
| 1-S.C. Filament Control Jack | 2/9 | 1-Terminal Board with 7 terminals, 3/6 | |
| 1 to 1 Emeco Audio Transformer, 21/- | | 1-Terminal Board with 3 terminals, 1/6 | |
| 1- $3\frac{1}{2}$ to 1 Emeco Audio Transformer, 21/- | | 1-dozen Busbars | 1/6 |
| 1-Fixed Coupling Plug | 3/- | 6-inches of electric light flex | 4d. |
| 3-Amperites, to suit Valves, 7/6 each, | 22/6 | 1-Battery Clip | 6d. |
| 1-Advance Neutralizing Condenser, 4/6 | | 1-Baseboard, 19-in. x 9-in. x $\frac{1}{2}$ -in. 2/6 | |
| 2-inch length of 3-inch diameter Radioc or Dilecto Tubing, | 2/- | 1-Screened Coil, of split primary type | 14/6 |
| | | 4-oz. No. 30 D.C.C. Wire | 1/9 |
| | | | Total £10/12/1 |

DAVID JONES'

For Service

Radio Dept.: 22 York Street, Sydney.

Narrative, "Songs and Their Authors";
**HUGH AND EDITH HUGHAM AND
 KENN MILLAR.**
 Soprano: "I Don't Know."
EDITH HUGHAM.
ALICE FORTUNE. pianoforte:
 "Dancing Doll" (Fiddler).
 Operatic Quartette:
 "Nelly Laska; My Heart" (Saint Saens);
THE SERRAVALLE QUARTETTE.
8.40 p.m.—STUDIO ORCHESTRA:
 "Two Irish Pictures" (Walton O'Donnell).
9 p.m.—ADMIRAL NAPLES will present the
31.0 SHIELD to the Winner of the Third
 Mile Swimming Race—Footrace Team.
9.15 p.m.—IRISH PIPERS:
 "Reheaters' Jig."
 "Irish Republic."
 "Cathie Taylor."
9.22 p.m.—OSBORNE AND PERRYER:
 "Radio Joke."
9.26 p.m.—MAGGIE FOSTER (violin):
 "Glow" (Fern).
 "Sally Anne; My Heart."
9.30 p.m.—CAPT. PETERS:
 "Boots, who and where."
9.34 p.m.—HASTINGS AND ADAIR:
 Song: "Oh! Miss, Ah! Miss."
 Patter.
 Violin: "Somewhere a Voice is Calling."
 Patter: "When I Lost You."
9.4 p.m.—STUDIO ORCHESTRA:
 "Londonderry Air."
9.44 p.m.—BRITISH Official Wireless (speaking from Bagby). Announcements.
9.54 p.m.—SIDNEY BURCHALL, baritone:
 "Unmistakable of the Road."
 "Last Evening Along."
10.1 p.m.—IRISH PIPERS:
 "Paddy O'Ballory."
 "God Save Ireland."
 "Black Donald."
10.35 p.m.—"Argus" news service. Announce-
 ments. Weather forecast.
10.4 p.m.—STUDIO ORCHESTRA:
 "Piedmont" (Jarvis).
10.5 p.m.—O'H GREAT THOUGHT:
 "Corruption does much, but encouragement
 does more. Encouragement affords comfort
 to the sun after a shower" (Smith).
**11.1 p.m.—HIE ARONSON AND HIS SYN-
 COPATING SYMPHONISTS:**
 "Tinkling" (West).
 "Nobody but You" (O'Hagan).
 "Sweet Hawaiian Sand" (O'Hagan).
 "Dip on the Plane" (Shanley).
 "Lovers and Lorry" (Lavel).
 "Craving for the Moon" (Conroy).
 "There Never was a Pal Like You"
 (O'Hagan).
 "Lancelotti" (Arany).
 "The Me to Your Agony Striver" (Shanley).
 "Just Around the Corner" (Van Tilford).
 "Oh, Miss Hannah" (Deppen).
 "Love Bump" (Bryce).
 "That's Your 'I Love You'" (A.D.).
11.40 p.m.—COD SAYS THE KING.

4QG, BRISBANE

Wednesday.

EARLY MORNING SESSION.
 6.40 a.m.—Physical Culture Session.
 7 a.m.—Close Down.
 MIDDAY SESSION.
 1.10 p.m.—Market Reports; Weather Informa-
 tion supplied by the Commonwealth Weather
 Bureau; News Service supplied by "The
 Daily Mail" and "The Daily Standard."
 1.40 p.m.—From the G.P.O.: Lunch Hour
 Music played by the Postal Institute
 Orchestra (under the leadership of Mrs.
 V.E. Thomas).
 1.55 p.m.—From the Observers: Standard
 Time Signal.
 2 p.m.—Close Down.

AFTERNOON SESSION.
 2.30 p.m.—From Hotel Carlton: Afternoon
 Tea Music from the Lounge, played by
 Hotel Carlton Symphony Orchestra.
 4.15 p.m.—News Service supplied by "The
 Telegraph."
 4.40 p.m.—Close Down.
 EARLY EVENING SESSION.
 6.4 p.m.—"Daily Standard" News; Announce-
 ments.
 6.50 p.m.—The Children's Hour—Stories &
 "Little Miss Brisbane."
 7 p.m.—Market Reports; Stock Reports;
 Lecture: "Common Diseases of Live
 Stock," Mr. K. J. McKeown (Lecturer
 in Animal Husbandry, Queensland Agricul-
 tural High School and College).
 7.40 p.m.—Weather News; Announcements.
 8.45 p.m.—Standard Time Signal.
 NIGHT SESSION.
 7.45 p.m.—Lecture: "Science—A Yacht to
 Meteorite," by Mr. W. J. Donohue.
 CONCERT FROM MR. COOTER.
 The whole of tonight's programme will be re-
 ceived from the 5400, Mr. Cooter.
 8.4 p.m.—From Mr. Cootin: March "By Right
 of Sword" (Lasser); the Studio Orchestra
 (conductor, Mr. A. R. Featherston) cele-
 brate solo, "Liza" (Caldman), Miss Irene
 Featherstone; monologue, "The Voyage of
 Diurect" (Williams), Miss Ethel Alfrey; for-
 ever, "Broken Moon" (Lee & Roberts), the
 Studio Orchestra.
 8.40 p.m.—A short address by His Worship
 the Mayor of Greater Brisbane (Ald W.
 A. Jolly).
 8.45 p.m.—Characteristics: "Devils' Dance"
 (Frank); the Studio Orchestra has solo,
 "Lady Mine" (Lebel), Mr. A. S. Fairly
 male quartette, "An Evening Lullaby"
 (Shaw); the Lyric Male Quartette Party
 speaks solo, "Gammer" (Lynn Williams),
 Miss Jill Manning, intermission, "Dance
 Conquest" (Kahn), the Studio Orchestra.
 9 p.m.—Metropolitan Weather Forecast.
 9.15 p.m.—"I Love That I Hear You
 Singing" (Marshall), Mr. J. J. Ford; mono-
 logue, "Bastion's Moonlight Sonata"
 (Farrill); Miss Elise Allen; contralto solo,
 "Fare's Old Sweet Song" (Mullins); Miss
 Vera Parker; male quartette, "The Calan-
 drock" (Bragato); the Lyric Male Quar-
 tette presents "Cryer Life" (Trinkan);
 the Studio Orchestra; contralto solo, "Lull
 Song of the Blue Bird" (Bates); Miss Irene
 Featherstone; contralto solo, "Valse Vante"
 (Wiedhoff); Mr. C. Hansen (accompanied
 by the Studio Orchestra); a thought be-
 thought by Will H. Lister, "The Power
 to Do"; male quartette, "Peter Zenberg"
 (Kite); the Lyric Male Quartette; soprano
 solo, "April is a Lady" (Phillips); Miss
 Jill Manning; contralto solo, "Jazz Days"
 (Donahue); Miss Park; mixed duet, "Hymn
 of Love," Mr. H. Jackson (accompanied
 by the Studio Orchestra); baritone solo,
 "The Blue Dragon" (Russell); Mr. A. N.
 Kelly; march, "Conspicuous" (Allen); the
 Studio Orchestra.
 10.5 p.m.—"The Daily Mail" News; Weather
 News. Close Down.

5CL, ADELAIDE

Wednesday.
 MORNING SESSION.
 11.30 a.m.—G.P.O. chimes.
 11.31 a.m.—Autone Reproducer number.
 11.40 a.m.—Advertiser's news service.
 11.45 a.m.—Souera number.
 12 noon.—G.P.O. chimes.
 12.1 p.m.—Advertiser's news service.
 12.14 p.m.—Autone Reproducer number.
 12.28 n.m.—S. C. Ward and Co.'s Stock Ex-
 change reports, official weather synopses and
 station announcements.
 12.30 p.m.—G.P.O. chimes.
 12.31 p.m.—Studio Orchestra: Selection,
 "Tim"; fox trot, "To-night's my night with
 baby"; waltz, "Magnificent"; waltz,
 "Cupid's Dream"; cornet solo, "While you're
 away"; selection, "La Sonnambula"; jazz-
 waltz, "The dream lagoon"; Oriental,
 "Chinese lantern dance"; and, "Madam
 Pompadour."
 2 p.m.—G.P.O. chimes and close down.
 AFTERNOON SESSION.
 3 p.m.—G.P.O. chimes.
 3.1 p.m.—Relay from the Maple Leaf Cafe—
 Orchestral numbers.
 3.45 p.m.—From the Studio—Autone Repro-
 ducer and Souera records.
 4 p.m.—G.P.O. chimes.
 4.1 p.m.—Relay from the Arcadia Cafe—
 Orchestral numbers.
 4.35 p.m.—Stock Exchange reports, general in-
 formation and station announcements.
 5 p.m.—G.P.O. chimes and close down.
 EVENING SESSION.
 6.30 p.m.—G.P.O. chimes.
 6.31 p.m.—Autone Reproducer record.
 6.35 p.m.—Fiddling stories.
 7.20 p.m.—Market reports.
 7.30 p.m.—Roy Scott's concert.
 7.50 p.m.—Fiddling's scientific talk.
 8 p.m.—G.P.O. chimes.
 8.1 p.m.—Organ solo (Doris Parkside; Barford
 Church Organist), Miss Owen Coudercy.
 8.10 p.m.—Song, Mr. Fred Williamson.
 8.14 p.m.—Instrumental number, Mr. A. Fry.
 8.18 p.m.—Song, Miss Agnes Wainwright.
 8.22 p.m.—Song, Mr. B. L. Melrose.
 8.26 p.m.—Organ solo, Miss G. Coudercy.
 8.30 p.m.—Song, Mr. W. James.
 8.40 p.m.—Pianoforte solo, Mrs. J. L. Black.
 8.44 p.m.—Song, Mrs. W. James.
 8.48 p.m.—Organ solo, Miss G. Coudercy.
 8.52 p.m.—G.P.O. chimes.
 9.1 p.m.—Weather report.
 9.5 p.m.—Daigert's photo report.
 9.14 p.m.—Song, Mr. F. Williamson.
 9.2 p.m.—Instrumental number, Mr. A. Fry.
 9.12 p.m.—Song, Miss Agnes Wainwright.
 9.20 p.m.—Organ solo, Miss G. Coudercy.
 9.24 p.m.—Song, Mr. B. L. Melrose.
 9.28 p.m.—Instrumental number, Mr. A. Fry.
 9.34 p.m.—Song, Mr. W. James.
 9.38 p.m.—Pianoforte solo, Mrs. J. L. Black.
 9.42 p.m.—Song, Mrs. W. James.
 9.46 p.m.—Organ solo, Miss G. Coudercy.
 9.50 p.m.—Song, Mr. F. Williamson.
 10 p.m.—G.P.O. chimes.
 10.1 p.m.—Advertiser's news service.
 10.13 p.m.—Song, Mrs. W. James.
 10.15 p.m.—Instrumental number, Mr. A. Fry.
 10.23 p.m.—Song, Mr. B. L. Melrose.
 10.27 p.m.—Pianoforte solo, Mrs. J. L. Black.
 10.31 p.m.—Song, Mr. W. James.
 10.35 p.m.—Song, Miss Agnes Wainwright.
 10.43 p.m.—Song, Mr. E. L. Melrose.
 10.47 p.m.—Song, Mrs. W. James.
 10.51 p.m.—Pianoforte solo, Mrs. J. L. Black.
 10.55 p.m.—Song, Miss Agnes Wainwright.
 10.58 p.m.—Station announcements.
 11 p.m.—G.P.O. chimes and close down.

6WQ, PERTH

Wednesday.
 12.30 p.m.—Time in.
 12.35 p.m.—First local news bulletin. Market
 reports. Cable.
 1.1 p.m.—Time Signal from Perth Observers.
 1.1 p.m.—Weather Notes, supplied by the
 Meteorological Bureau of Western Australia.
 1.2 p.m.—STUDIO SEPTETTE:
 2 p.m.—Close down.
 2.50 p.m.—Time in.
 2.55 p.m.—Musical programme.

SLINGSBY and COLES

Limited

Under Central Station.
482 PITT STREET**THE SWEETEST SONG EVER SUNG
CAN ONLY BE HEARD ON
THE SUPERPHONE.**Call and See Our Special 5-Valve
Supersteroidal at £31/19/- complete.
The Famous "BLUE SPOT" PHONES,
the lightest ever made, 15/- pair.
Special Accumulators, 50 Amps Actual
22/- per 2-volt cell; 49 Amps Actual
13/- per 2-volt cell.Large Stock of Hallison's B. Batteries.
Lead on Wire, 2d. per lb.
225. Speaker cords, 4/6 each.
Sets rewired to any circuit.**Warneford & Son****RADIO ENGINEERS****Bring your Radio troubles
to us.**

Is your receiver selective?

If it isn't, let us know. We
will remodel your receiver
along modern lines to pro-
duce maximum efficiency.Local conditions play a big
part in good reception.We will design and build a
receiver to suit.**Rewiring faithfully carried
out at reasonable rates.**Write Box 967, G.G., G.P.O.,
Sydney.

'Phone: Pet. 1045 & X 3149.

**FARMER'S**
Standard 2-Valve Receiver

Complete with Accessories.

A radio receiving set is as good as the service it
gives; good reception, tone, reliability, economy
in upkeep, and other essential attributes. A
crystal set has tone quality, but is limited in
radius; some valve sets are both reliable and
economical. Farmer's Standard two-valve
receiver is reliable and economical, possessing
tone and volume.This set takes less than two hours to instal in
the city or suburbs, and maintenance cost,
including licence, is less than £1 10/- per year.Perfect reception from all local stations is certain,
and Farmer's invite you at any time to see this
set demonstrated, and test the unusual features
of the instrument.**Price £14/10/-****"FROST" HEADPHONES.**Frost Headphones are highly recommended and
greatly used, being reliable and accurate. They
are used constantly by experimenters, who need
a better class of phone, so no better addition could
be made to your receiver. Price 45 -**FARMER'S, SYDNEY**

RADIO DEPARTMENT, GROUND FLOOR.

1 p.m.—STUDIO TRIO:

- 4.30 p.m.—Close down.
 7 p.m.—Time in.
 7.15 p.m.—A plerette for the Kiddies by Uncle Duff, with Aunties Kate and Evelyn and Uncles Henry, Leslie, Perry and Duffy.
 7.35 p.m.—Stock and Share Intelligence.
 Market reports, cables, news supplied by courtesy of "The West Australian" Newspaper Co.
 8 p.m.—Time Signal from Perth Observatory.
 8.1 p.m.—Weather Notes supplied by the Meteorological Bureau of Western Australia.
WITH THE TRIO
 8.5 p.m.—THE STUDIO STRING TRIO.
 Miss Evelyn Willis, A.R.C.M. piano.
 Mr. H. C. Busham, cello.
 Mr. H. T. Newton, violin.
 10 p.m.—Second local news bulletin, supplied by courtesy of "The Daily News" Newspaper Co.
 10.30 p.m.—Close down.

Thursday, March 17

2FC, SYDNEY

EARLY MORNING SESSION.

- 7 a.m.—"Big Ben" and announcements.
 7.15 a.m.—Studio music.
 7.35 a.m.—Official weather forecast, rainfall, temperatures, astronomical memoranda, shipping intelligence, mail services.
 7.55 a.m.—Investment market, mining share market, metal quotations.
 7.55 a.m.—Wool sales, breadstuffs markets, interstate markets, produce markets.
 7.45 a.m.—"Sydney Morning Herald" news service.
 8 a.m.—"Big Ben." Studio music.
 8.15 a.m.—Close down.

MORNING SESSION.

- 8.30 a.m.—Marching music for school children.
 8.40 a.m.—A popular record.
 8.45 a.m.—Last minute sporting information by the FFC Racing Commission.
 9 a.m.—"Big Ben" and announcements.
 9.25 a.m.—Late "Sydney Morning Herald" news service.
 9.15 a.m.—Studio music.
 10.45 a.m.—A serial story.
 11 a.m.—"Big Ben." Australian Press Association and Reuters's Cable Services.
 11.20 a.m.—Studio music.
 11.35 a.m.—A Talk on Home Cooking and Recipes by Miss Ruth Furst.
 11.30 a.m.—Marching music for school children.
 11.55 a.m.—Close down.

MIDDAY SESSION.

- 12 noon—"Big Ben" and announcements.
 12.15 p.m.—Stock Exchange, first call.
 12.30 p.m.—Studio music.
 12.50 p.m.—Rugby wireless news.
 12.55 p.m.—Miss Chris Hawkeford, soprano: "Golden Dancing Days" (Clarke).
 1 p.m.—"Big Ben." Weather intelligence.
 1.15 p.m.—"Evening News" midday news service.
 Producers Distributing Society's report.
 1.30 p.m.—Studio music.
 1.35 p.m.—Stock Exchange, second call.
 1.50 p.m.—Marching music for school children.
 1.40 p.m.—Miss Chris Hawkeford, soprano: "Flourite" (McGeech).
 1.45 p.m.—Studio music.
 1.55 p.m.—Last minute sporting information by the FFC Racing Commission.
 2.10 p.m.—Close down.

AFTERNOON SESSION.

- 2.20 p.m.—Programme announcements.
 2.40 p.m.—A Recital by the Violin Pupils of Mr. Norbert Wentzell.
 3.40 p.m.—Some popular records.
 3 p.m.—"Big Ben."
 Miss Mavis Gail, soprano:
 "I Heard You Go By" (Wood).
 3.5 p.m.—Further violin numbers by Mr. Norbert Wentzell's pupils.
 3.50 p.m.—Marching music for school children.
 3.40 p.m.—FROM FARMER'S TEA ROOMS:
 Miss Aileen Bear, mezzo.
 3.45 p.m.—FROM THE STUDIO.
 Popular records.
 3.55 p.m.—A pianoforte solo.
 4 p.m.—FROM FARMER'S TEA ROOMS:
 Mr. Fred Harman, baritone:
 "Trees" (Kashbach).
 4.5 p.m.—Studio music.
 4.10 p.m.—Miss Mavis Gail, soprano:
 "April is a Lady" (Phillips).
 4.15 p.m.—Pianoforte solo.
 4.50 p.m.—FROM FARMER'S TEA ROOMS:
 Miss Aileen Bear, mezzo.
 4.55 p.m.—Studio music.
 4.45 p.m.—FROM FARMER'S TEA ROOMS:
 Mr. Fred Harman, baritone:
 "My Ship" (Del Riego).
 4.45 p.m.—Stock Exchange, third call.
 4.45 p.m.—Close down.

EARLY EVENING SESSION.

- 5.45 p.m.—The Chimes of 2FC.
 5.50 p.m.—The "Hello Man" talks to the children.
 6.30 p.m.—Irish songs by Miss Nora Hill.
 Irish soprano:
 (a) "The dear little Shamrock" (Cherry).
 (b) "The Leprosman" (Joyce).
 6.35 p.m.—Dinner music.
 7 a.m.—"Big Ben." Last sporting news.
 7.10 p.m.—Dairy's market reports (wool, wheat and stock).
 7.15 p.m.—Fruit and vegetable markets.
 7.20 p.m.—Weather and shipping intelligence.
 Stock Exchange.
 7.25 p.m.—Late "Evening News" news service.

NIGHT SESSION.

- 7.40 p.m.—Programme announcements.
 7.45 p.m.—Hints to listeners by the Technical Editor of "Wireless Weekly."
 8 p.m.—"Big Ben." FROM THE LYCEUM THEATRE, PITT STREET, SYDNEY:
 A Medley of Irish Airs played by the Orchestra.
 8.12 p.m.—FROM THE STUDIO:
 Miss Nora Hill, Irish soprano:
 (a) "I'm the tear and the smile in this eye" (Moore).
 (b) "The Waird of the Green" (Anon).
 8.20 p.m.—The Randwick Municipal Band.
 8.27 p.m.—Mr. Harry Julius, well-known cartoonist, will continue his radio cartoons and comic drawings.
 8.40 p.m.—Madame Evelyn Grieg, pianist, and Madame Vera Tassan, soprano, present an Irish programme:
 (a) Selections of Irish airs arranged and played by Madame Evelyn Grieg on the Dulcians.
 (b) "Believe me if all" (Moore).
 2. "The Minstrel Boy" (Moore).
 4.5 p.m.—(b) Madame Vera Tassan, soprano:
 1. "The Barn that once" (Moore).
 2. "Barney O'Neil" Irish Folk Song).
 9.50 a.m.—(c) Madame Evelyn Grieg, pianoforte solo:
 "Molly on the Shore" (arr. Grainger).
 9.55 p.m.—The Randwick Municipal Band.
 9.8 p.m.—Mr. Joe Cahill, Irish comedian:
 (a) "Mister Dooly on Archie" (Tranter).
 (b) "If I could paint a picture" (Nicholls).
 9.10 p.m.—The Randwick Municipal Band.
 9.30 p.m.—Book Reviews by Mr. Grattan-Smith.
 9.40 p.m.—The Randwick Municipal Band.

- 9.45 p.m.—Mr. Raleigh Pheloung, trombone solo:
 "Chanson Trieste" (Tschalkowsky).
 9.53 p.m.—The Randwick Municipal Band.
 10 p.m.—"Big Ben." Part two of the Irish programme presented by Madame Evelyn Grieg and Madame Vera Tassan:
 (a) Selection of Irish airs including:
 (i) "The dear little Shamrock" (Jackson).
 (ii) "The Last Rose of Summer" (Moore).
 (c) "The Wearin' of the Green."
 (d) Arranged and played by Madame Evelyn Grieg on the Dulcians.
 (e) Soprano solo by Madame Vera Tassan:
 (a) "Change o' Mind" (Currant).
 (b) "Killarney" (Balfe).
 (c) Pianoforte solo by Madame Evelyn Grieg:
 Irish tune from "County Derry" (arr. Grainger).
 10.23 p.m.—FROM THE LYCEUM THEATRE, PITT STREET, SYDNEY:
 Orchestral items.
 10.49 p.m.—FROM THE STUDIO:
 Mr. Joe Cahill, Irish comedian:
 (a) "Hanrahan" (John O'Brien).
 (b) "Casey the Puffer" (Wood).
 10.49 p.m.—The 2FC Dance Band, conducted by Mr. Eric Pearce, and assisted by the popular baritone, Mr. Len Maurice.
 10.54 p.m.—Late news and announcements.
 11 p.m.—"Big Ben." Trombone solo by Mr. Raleigh Pheloung.
 11.3 p.m.—The 2FC Dance Band will play popular numbers until midnight.
 11.55 midnight—"Big Ben."
 National Anthem.
 Close down.

2BL, SYDNEY

Thursday.

EARLY MORNING SESSION.

- 7.10 a.m.—G.P.O. Clock and Chimes.
 7.30 a.m.—Meteorological weather forecast.
 7.47 a.m.—Musical programme from the Studio.
 7.55 a.m.—Physical training and health exercises.
 8 a.m.—G.P.O. Clock and Chimes.
 7.55 a.m.—Hints on health.
 7.50 a.m.—Physical training and health exercises.
 8 a.m.—G.P.O. Clock and Chimes.
 8.45 a.m.—Weather report.
 8.47 a.m.—Broadcasters special news service.
 8 a.m.—G.P.O. Clock and Chimes; close down.

MORNING SESSION.

- 10 a.m.—G.P.O. Clock and Chimes.
 10.1 a.m.—Weather report.
 10.3 a.m.—Musical programme from the Studio.
 10.20 a.m.—News service from the "Daily Telegraph."
 10.35 a.m.—Musical programme from the Studio.
 10.50 a.m.—Ten minutes' talk supplied by the N.B.M.A.
 11 a.m.—G.P.O. Clock and Chimes.
 11.1 p.m.—News from the "Daily Telegraph."
 11.15 a.m.—Bobby Market report.
 11.17 a.m.—Fink Market report.
 11.19 a.m.—Vegetable Market report.
 11.23 a.m.—Fruit Market report.
 11.25 a.m.—London Dairy Farm, Egg and Poultry Market report.
 11.28 a.m.—London metal quotations.
 11.29 a.m.—Ships in call by wireless.
 11.31 a.m.—Information re interstate and Overseas Mails.
 11.40 a.m.—Shipping information—arrivals and departures.
 11.55 a.m.—Women's Session:
 Social notes by Mrs. Jordan.
 11.45 a.m.—Mrs. Jordan replies to correspondents.

Low Loss Parts

Specified and recommended
in this issue of *Wireless
Weekly* for the "Extremely
Selective 3 Valver"

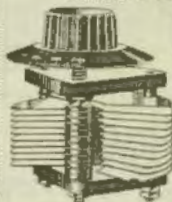

Heath

Non-
Dielectric
and
Strictly
Low Loss
Condensers

| | Plain | Varnish |
|--------|-------|---------|
| .00025 | 18/6 | 23/6 |
| .0005 | 22/- | 25/- |
| .001 | 28/6 | 33/6 |

Not Cheapest—But BEST

REACTONE Low Loss Coils

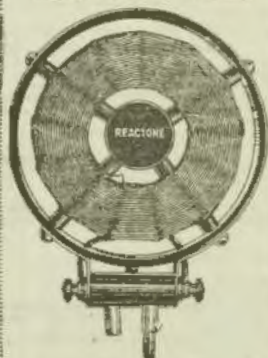

| | 25a | 35a | 50a | 75a |
|----------|-----|-----|-----|-----|
| Framed | 5/6 | 6/- | 6/6 | 7/6 |
| Unframed | 2/9 | 3/3 | 3/6 | 4/6 |

Thousands of sets have been and
thousands more will be improved
by substituting

HEATH LOW LOSS CONDENSERS
And REACTONE LOW LOSS COILS

W. MALING & CO.

30 Market Street :: SYDNEY

A Radio Bargain

3 Valve Set in handsome
cabinet, complete in every
detail, including—

Loud Speaker
Exide Accumulator
84 Volt B Battery
4½ Volt C Battery
Large Valves (the best)
Aerial Gear

A guarantee with every Set

Two Prices:

Price - £16 17 6 Price - £19 17 6

Deposit - 1 14 6 Deposit - 1 18 6

Weekly - 5 9 Weekly - 6 9

We charge no interest for these easy terms.

The easy terms also apply to country
customers.

Take one home to-night!

Radio-W'Less Mfg. Co. Ltd.

317 George Street :: SYDNEY

Telephone: B 5747

11.55 a.m.—Talk on "Photography" by Miss K. Mahoney.
 12.30 p.m.—Musical programme from the Studio.
 12.50 p.m.—G.P.O. Clock and Chimes.
 12.51 p.m.—Sydney Stock Exchange calls.
 12.52 p.m.—"Sun" Newspapers news service.
 12.55 p.m.—Hilary Instrument Quartet; direction, Caryl Castling.
 1.00 p.m.—G.P.O. Clock and Chimes.
 1.31 p.m.—Weather report.
 1.33 p.m.—Sydney Stock Exchange calls.
 1.35 p.m.—News from the "Sun."
 1.45 p.m.—Musical programme from the Studio.
 2 p.m.—G.P.O. Clock and Chimes; close down.

AFTERNOON SESSION.

Racing information broadcast by courtesy of the "Sun."
 3 p.m.—G.P.O. Clock and Chimes.
 3.11 p.m.—Weather report and forecast.
 3.13 p.m.—Social notes from the "Sun."
 3.16 p.m.—News from the "Sun."
 3.16 p.m.—Musical programme from the Studio.
 3.30 p.m.—G.P.O. Clock and Chimes.
 3.31 p.m.—Country Women's Session.
 3.45 p.m.—Musical programme from the Studio.
 4 p.m.—G.P.O. Clock and Chimes.
 4.1 p.m.—News from the "Sun."
 4.15 p.m.—Serial story.
 4.30 p.m.—Musical programme from the Studio.
 4.45 p.m.—Producers Distributing Society's Vegetable and Fruit Market report.
 4.50 p.m.—Shipping information when available.
 4.52 p.m.—Day's racing resume on race days.
 4.55 p.m.—News from the "Sun."
 4.57 p.m.—Resume of night's programme.
 4.58 p.m.—G.P.O. Clock and Chimes; close down.

EARLY EVENING SESSION.

5.45 p.m.—G.P.O. Clock and Chimes.
 5.46 p.m.—Little Willie and Doodle Long Legs will entertain the kiddies.
 6.00 p.m.—Musical programme from the Studio.

SPECIAL COUNTRY SESSION.

7 p.m.—G.P.O. Clock and Chimes.
 Australian Mercantile Land and Finance Co.'s report.
 Weather report and forecast by courtesy of Govt. Meteorologist.
 Stock Exchange reports.
 Producers Distributing Society's Vegetable and Fruit Market report.
 Grains and fodder report ("Sun").
 Dairy Produce report ("Sun").
 7.15 p.m.—Country news from the "Sun."
 SPECIAL PROGRAMME IN HONOR OF

ST. PATRICK'S DAY.

8 p.m.—G.P.O. Clock and Chimes.
 Broadcasters Topical Opera.
 8.5 p.m.—Miss Amy Oettinga (contralto).
 8.10 p.m.—Mr. Stanley R. Cutler (tenor).
 8.17 p.m.—Fashion and Social Notes broadcast from the Ball Room of the Ambassadors.
 8.25 p.m.—Mr. Dud Osborne (descriptive vocalist).
 8.30 p.m.—Miss Dorrie Ward (soprano).
 8.37 p.m.—Mr. W. E. Lewis (baritone).
 8.44 p.m.—Mr. Bert Waring (comedian).
 8.52 p.m.—Mr. Peter Sutherland (bass).
 9 p.m.—G.P.O. Clock and Chimes.
 Resume of following day's programme.
 Weather report and forecast by courtesy of Mr. C. J. Mares, Govt. Meteorologist.
 9.5 p.m.—Duet, Miss Dorrie Ward and Mr. W. E. Lewis.
 9.10 p.m.—Miss Amy Oettinga.
 9.17 p.m.—Fashion and Social Notes from the Ambassadors.
 9.22 p.m.—Mr. Stanley R. Cutler.
 9.29 p.m.—Miss Amy Oettinga.
 9.34 p.m.—Duet, Miss Amy Oettinga and Mr. Peter Sutherland.

9.39 p.m.—Mr. W. E. Lewis.
 9.46 p.m.—Osborne and Waring.
 9.55 p.m.—Miss Dorrie Ward.
 10.6 p.m.—Mr. Peter Sutherland.
 10.10 p.m.—The Ambassadors Dance Band broadcast from the Ball Room of the Ambassadors. During the intervals between dance news reports by courtesy of the "Sun" will be broadcast.
 10 midnight.—G.P.O. Clock and Chimes.
 National Anthem.

3LO, MELBOURNE

Thursday.

MIDDAY SESSION.

"PHILARMONY AND HERIVOL"
 THE STUDIO ORCHESTRA.
 JONES and RAINE.
 MAGGIE FOSTER, violinist.
 GEORGE WELSH, comedian.
 HARTING and ADAIR.
 Announcer..... MAURICE DUDLEY
 Accompanist..... AGNES FORTUNE
 17 noon.—Time signal. British Official Wireless news from Radio Receiving and The Australian Press Association Cables.
 12.18 p.m.—Stock Exchange information.
 12.26 p.m.—"Argus" and "Herald" news services.
 12.30 p.m.—STUDIO ORCHESTRA.
 Introduction..... WALTER SMITH.
 12.45 p.m.—JONES and RAINE will amuse you for a few minutes at the Piano.
 12.54 p.m.—MAGGIE FOSTER, violin solo ("Dance de Spigole" (Dorville).
 "Minuet" (Hector).
 1.2 p.m.—GEORGE WELSH in "Whimsicalities"
 1.35 p.m.—STUDIO ORCHESTRA.
 Introduction..... WALTER SMITH.
 1.15 p.m.—Meteorological information.
 Weather forecast for Victoria, Tasmania, South Australia and New South Wales.
 River reports. Shipping intelligence.
 1.25 p.m.—HASTING FRANCES ADAIR.
 Song, "What do They Mean to Love."
 "I'd Climb the Highest Mountain."
 "Gambol" ("Susan Boy Shyly Sighed").
 "Gambol."
 1.45 p.m.—STUDIO ORCHESTRA.
 "Rose Marie" (Friedl Shokler).
 1.42 p.m.—MAGGIE FOSTER, violin solo.
 "Midnight Bells" (Kreidler).
 "Old Negro Melody."
 1.50 p.m.—STUDIO ORCHESTRA.
 Selection, "Martha" (Plafow).
 2 p.m.—Close down.
 Results of Races at Kyneton and Koroit will be given as they come to hand.

AFTERNOON SESSION.

WE SERENADE
 THE STUDIO ORCHESTRA.
 HUXHAM'S SERENADERS.
 IAN DEVEREUX, baritone.
 WALTER SMITH, cornet.
 ANNOUNCER..... MINS FRANCES FRASER.
 ST. PAUL'S CATHEDRAL EVENING.
 Announcer..... MAURICE DUDLEY
 Accompanist..... AGNES FORTUNE
 4 p.m.—STUDIO ORCHESTRA.
 "Moses" (Old English).
 "Sarabande" (Old German).
 4.10 p.m.—MISS FRANCES FRASER.
 "The Birth of the News."
 4.25 p.m.—STUDIO ORCHESTRA.
 Selection, "Sullivan Song."
 5.35 p.m.—HUGH HUXHAM'S SERENADES.
 Quartet: "Hush-a-bye" (Spencer).
 EDITH HUXHAM, HOLLY BERRYETT.
 RENN MILLAR and HUGH HUXHAM.
 Song "A Little Bit of Cheese."
 EDITH HUXHAM.
 "Cello solo, "Saxophone" (Hanzel).
 TASHA TIERNAN.

Song, "One Fleeting Hour."
 DOLLY HUBBERT.
 Tonic, "Oo Wonder Why."
 THE SERENADE QUARTET.
 Viola, Solo, "Gavotte" (Mozart).
 DOROTHY RUXHUGH.
 Operatic Quartette. Selections from "Coral-aria Rhapsody" (Massenet).
 4 p.m.—STUDIO ORCHESTRA.
 "Ballet Rhapsody" (Ligeti).
 4.10 p.m.—IAN DEVEREUX, baritone, of the "Rose Marie" Company, by permission of J. C. Williamson, Ltd.
 "Lighterina Tom" (Squire).
 "Love's Coronation" (Aylward).
 4.17 p.m.—WALTER SMITH, cornet solo.
 "The Alpine Horn" (Rimsky).
 4.25 p.m.—STUDIO ORCHESTRA.
 "Andante Appassionata" (Brahm).
 4.30 p.m.—"Herald" News services. Stock Exchange information. Accompanist for Minnie Valley Race, Saturday. Results at Koroit and Kyneton and Koroit.
 4.45 p.m.—CHORAL EVENING, transmitted from St. Paul's Cathedral.
 5.10 p.m.—Close down.

EVENING SESSION.

5.40 p.m.—CHILDREN'S HOUR. Answer to letters and holiday greetings.
 5.45 p.m.—MARY GUMBLEAF, Poetess.
 "The Little Lily Next Door."
 "Story for the Little Ones."
 "See, My Land."
 5.55 p.m.—HARTING and ADAIR will entertain the children with songs and violin solo; played on a funny one-stringed violin.
 6.10 p.m.—MARY GUMBLEAF, Stories for the little ones.
 Song, "Jimmy be a Daddy."
 6.25 p.m.—"Argus" and "Herald" news services.
 Weather synopsis.
 Shipping news items.
 6.47 p.m.—Stock Exchange information.
 6.52 p.m.—Foil market reports by J. R. Boxer, Ltd.
 6.55 p.m.—River reports.
 6.58 p.m.—Market reports by the Victorian Producers' Association. Ltd. Hay-market sheep sales. Poultry, grain, straw and hay. Jute, dairy produce, potatoes and onions. Fowl market sales by the Victorian Producers' Association, supplied by the "Fruit World" exclusive to Ltd. Market prices of oranges and lemons, by the Victorian Central Citrus Association Pty. Ltd.

NIGHT SESSION.

"LET'S SYNC OUR TROUBLES."
 Epilogue: Mr. W. P. HORDAN.
 MR. A. W. JACKSON.
 MISS HARRIETT BENNETT.
 MR. J. J. MAHER.
 JOE ARBONSON and HIS SYNCOPATING SYMPHONISTS.
 MARIE LA VAREE, comedienne.
 DINKEY HUBBALL, baritone.
 OSBORNE and PERRYETT.
 FESSIE BACHELOR, contralto.
 Announcer..... ALBERT ANDREW.
 Accompanist..... AGNES FORTUNE.
 10.15 p.m.—Under the auspices of the Health Association of Victoria.
 Mr. W. P. HORDAN, "Oval Hymn."
 10.30 p.m.—MR. A. W. JACKSON, "Gold."
 10.45 p.m.—MISS HARRIETT BENNETT, of "Rose Marie" will speak from her dressing room at His Majesty's Theatre, by permission of J. C. Williamson, Ltd.
 10.50.—JOE ARBONSON and HIS SYNCOPATING SYMPHONISTS.
 "In a Little Garden" (Jude).
 "Thinking of You" (Ash).
 "Perfume of the Poet" (Mazoni).
 11.10 p.m.—MARIE LA VAREE, comedienne.
 "I don't ball laugh, not art."



**"Come on over!
It's coming in great tonight!"**

Much excitement in the family when the New Broadcast Receiving Set picks up broadcast from other States. Who would want to leave Home when the whole world comes singing, playing, talking to your Drawing Room?

The Home of the right Radio Equipment is never dull, never monotonous; and young people deserve all the fun they can get out of Radio, even to the jolly music of a fine orchestra in the next State.

| | |
|----------------------------|----------|
| Two-Valve Colmovox | £16/- |
| Three-Valve Colmovox | £20/10/- |
| Four-Valve Colmovox | £27/- |
| Five-Valve Colmovox | £33/10/- |

The Colmovox line of Radio Receivers has been developed to suit Australian conditions, and fulfils the demand for Radio Receivers of highest quality and lowest price, of highest grade workmanship, and best material.

Each Colmovox Receiving Set represents the best that can be offered.

Come in to-day and let us show you our line of famous Colmovox Receiving Sets. Free advice, and service, too. Let's talk it over.

| | |
|---------------------------------|----------|
| Four-Valve Super Colmovox | £37/10/- |
| Five-Valve Super Colmovox | £49/10/- |
| Six-Valve Super Colmovox | £55/- |

Colmovox Receivers

Are Complete with all Accessories including Loud Speaker, Batteries, Aerial Equipment, etc. Nothing Further Required.

EASY TERMS CAN BE ARRANGED.

SEE US AT STAND 13 RADIO & ELECTRICAL EXHIBITION, TOWN HALL.

Colville Moore Wireless Supplies Ltd.

10 ROWE STREET (Next Hotel Australia), SYDNEY. Phone: B 2261.

8.14 p.m.—JOE ARONSON AND HIS SYNCO-SYMPHONISTS.

"We don't want to get married" (Stereo).
 "Laughing at the ivories" (Werdahl).
 "Bye, Bye Blackbird" (Dixon).

8.24 p.m.—SYDNEY BURCHALL, Baritone.

"Blue Eved Sally" (Robinson).

8.28 p.m.—JOE ARONSON AND HIS SYNCO-SYMPHONISTS.

"I Can't Forget" (Mortien).
 "Hundalorg" (Walker).
 "Where Did You Get Those Eyes" (Donalson).

8.38 p.m.—OSBORN AND PERRYER in Cuckney Camera.

8.40 p.m.—JOE ARONSON AND HIS SYNCO-SYMPHONISTS.

"Six Feet of Papa" (Moll).
 "Sing, Katie, but Leave the Piano Alone" (Tracy).
 "Dreary Hawaii" (Conley).

8.53 p.m.—JESSIE BATCHELOR, Contralto.

"An Unforgotten Song" (Wright).

8.57 p.m.—Description of the 220 yards Breast Stroke Race by the Australian Champion, IVAN STEWART, who will make an attempt to win the 250 Yards Cup stroke for any swimmer who lowers an Australian and New Zealand Championship distance record. The present record is 2 minutes 6 and 4-5ths seconds.

9.17 p.m.—JOE ARONSON AND HIS SYNCO-SYMPHONISTS.

"Back Where the Daffodils Grow" (Donalson).
 "Bonzabunch" (Friend).
 "To-night's my Night with Baby" (Meyer).
 Legends.

9.21 p.m.—MARIE LA VARRE, Comedienne.

"Legends".

9.37 p.m.—JOE ARONSON AND HIS SYNCO-SYMPHONISTS.

"Loneliness and Sorry" (Davis).
 "Cheer, I Love You" (Goodman).
 "I Wish I Saw You Smiling" (Donalson).

9.41 p.m.—SID BURCHALL, Baritone.

"Little Irish Girl" (Lohr).

9.45 p.m.—JOE ARONSON AND HIS SYNCO-SYMPHONISTS.

"Whisper Sh" (Bryan).
 "So Foolish" (Buch).
 "Blue Bonnet" (Bryan).

9.55 p.m.—JESSIE BATCHELOR, Contralto.

"The Moorish Maid" (Parkin).

9.59 p.m.—MR. J. J. MARKS of the "Sporting Globe," will give a talk on "The Lure of the Stawell Gift."

10.0 p.m.—JOE ARONSON AND HIS SYNCO-SYMPHONISTS.

"Schalls is Back Again."
 "Say That You Love Me" (Nichols).
 "She's Everybody's Sweetheart" (Ruse).
 "1918 p.m.—"Argus" and "Horak" News Service. British Official Wireless News from Rugby. Meteorological Information. Sporting notes by "Olympus."

10.13 p.m.—MARIE LA VARRE, Comedienne.

"To-night's My Night With Baby."

10.38 p.m.—JOE ARONSON AND HIS SYNCO-SYMPHONISTS.

"I'll Climb the Highest Mountains" (Brown).
 "Give Me Tender" (Flowerbird).
 "Just a Bird's Eye View" (Kahn).

10.48 p.m.—JESSIE BATCHELOR, Contralto.

"A Cloudless Night" (Bozart).

10.52 p.m.—JOE ARONSON AND HIS SYNCO-SYMPHONISTS.

"Adorable" (Ford).
 "While We Danced Till Dawn" (Lewick).

11.0 p.m.—OUR GREAT THOUGHT. "The unity that wisdom knits not, folly may unknit" (Shakespeare).

11.1 p.m.—JOE ARONSON AND HIS SYNCO-SYMPHONISTS.

"Talking to the Moon" (Basket).
 "The Animal Fair" (La Forrest).
 "At Peace With the World" (Berlin).

11.16 p.m.—SIDNEY BURCHALL, Baritone.

"Along the Windy Way" (Clapham).

11.14 p.m.—JOE ARONSON AND HIS SYNCO-SYMPHONISTS.

"Pearl of Malabar" (Nichols).
 "Somebody's Lonely" (Davis).
 "Alohaa Stony" (Greenster).

11.24 p.m.—SIDNEY BURCHALL, Baritone.

"We Danced Till Dawn" (Isaks).

11.38 p.m.—JOE ARONSON AND HIS SYNCO-SYMPHONISTS.

"Picador" (Nichols).
 "Dianofore" (Barty).
 "I Love My Baby" (Warren).
 "In a Little Spanish Town" (Young).
 "Just a Cottage Small" (Hansen).
 "Frenchie" (Green).

11.40 p.m.—GOD SAVE THE KING.

4QG, BRISBANE

Thursday.

MIDDAY SESSION.

1.0 p.m.—Market Reports: Weather information supplied by the Commonwealth Weather Bureau. News Service supplied by "The Daily Mail" and "The Daily Standard."

1.20 p.m.—Teatime: Carlton Lunch Music from the Lounge, Hotel Carlton, played by Hotel Carlton Symphony Orchestra.

1.50 p.m.—From the Laboratory: Standard Time Signal.

2.0 p.m.—Close Down.

AFTERNOON SESSION.

3.30 p.m.—A Programme of Music from the Studio.

4.15 p.m.—Telegraph News.

4.30 p.m.—Close Down.

EARLY EVENING SESSION.

6.0 p.m.—"Daily Standard" News: Announcements.

6.30 p.m.—Bedtime Stories by "The Sandman."

7.00 p.m.—Close Down.

7.30 p.m.—Weather News: Announcements.

7.45 p.m.—Standard Time Signal.

NIGHT SESSION.

8 1/2 PATRICK'S NIGHT. An Irish Concert will be broadcast from the Studio.

8.0 p.m.—AN ILLUSTRATED. Orchestral, "O'Connell Alice" (Witt), the Gaiety Orchestra leader. Miss Jean Naylor, contralto solo. "Kileen Ailann" (Thomas). Miss Mae King, violin solo. Selection of Irish Airs (No. 1). Miss G. Fink, baritone solo. "Little Irish Girl" (Lohr). Mr. A. N. Falk, choral number, selected. St. Stephen's Cathedral Choir, same Irish humor by Laury: the entertainers; selection, "Dear Little Shamrock" (Greenwald), the Gaiety Orchestra; a short talk. "St. Patrick's Day" (choral number, selected, St. Stephen's Cathedral Choir, soprano solo. "Bushman Macreave" (Gibson and Hall). Miss Nance King, male quartette, Off in the Silly Night, the Lyric Male quartette, Box, Ter, Killarney, My Killarney" (Lynn). The Lyric Male quartette, choral number, "The Mountain of My Love" (Collinson). Mr. J. P. Cornwell, choral number, selected. St. Stephen's Cathedral Choir.

9.0 p.m.—Metropolitan Weather Forecast. Waite, Shamrock (Tobias), the Gaiety Orchestra; contralto solo. "Ave Maria" (Gower). Miss Mae King, violin solo. "Selection of Irish Airs" No. 2. Miss G. Fink, baritone solo. "For the Green" (Lohr), choral number, selected. St. Stephen's Cathedral Choir vocal duet, "The Bower" (Ness). Miss Nance King, soprano solo. "Songs of Ireland" (Dunlop), the Gaiety Orchestra; soprano solo. "Killarney" (Hulife). Miss Nance King, violin quartette, "The Little Shamrock" (Lohr). Lyric Male quartette, choral number, selected. St. Stephen's Cathedral Choir vocal duet, selected. Messrs. J. P. Cornwell and R. J. Robinson, orchestral. "Bite of a Hat" (the Gaiety Orchestra). Irish solo. "Father O'Flaherty" (Mr. J. P. Cornwell, male quartette, "Killarney," the Lyric Male quartette.

10.0 p.m.—From the Studio: "The Daily Mail" News: Weather News. Close Down.

5CL, ADELAIDE

Thursday.

MORNING SESSION.

11.30 a.m.—G.P.O. chimes.

11.31 a.m.—Autosonic Reproducer recital.

11.40 a.m.—"Advertiser" news service.

11.55 a.m.—Sonnet recital.

12 noon—G.P.O. chimes.

12.1 p.m.—"Advertiser" news service.

12.16 p.m.—Autosonic Reproducer recital.

12.20 p.m.—S. C. Ward and Co.'s Stock Exchange, official weather synopsis and station announcements.

12.30 p.m.—G.P.O. chimes.

12.31 p.m.—Studio Orchestra: Overture, "Triumph" waltz. Meet me at twilight" fox trot, "Loneliness and sorry" waltz solo. "Green melody" selections.

"Bird of Paradise" solo. "Dream pictures" Mendelssohn dance. "Change" second-ade finale. "Maid of the mountains".

At intervals of 20 minutes, Tuleucan soldiers' cricket match—Biarquean deactivation by Mr. Alfred Teakoe; match to be played between Licensed Waitresses' Association and L.V.A. travellers.

1.0 p.m.—G.P.O. chimes and close down.

AFTERNOON SESSION.

3.0 p.m.—G.P.O. chimes.

3.1 p.m.—Relay from the Maple Leaf Cafe—Orchestral numbers.

3.15 p.m.—From the Studio—Autosonic Reproducer and Sonora numbers.

4.0 p.m.—G.P.O. chimes.

4.2 p.m.—Relay from the Arcadia Cafe—Orchestral numbers.

4.35 p.m.—Stock Exchange reports, general information and station announcements.

5.0 p.m.—G.P.O. chimes and close down.

EVENING SESSION.

6.30 p.m.—G.P.O. chimes.

6.31 p.m.—Autosonic Reproducer recital.

6.38 p.m.—Bedtime stories.

7.15 p.m.—Health talk, by Mr. A. W. White-terbury.

7.30 p.m.—Market reports.

7.40 p.m.—Poultry talk by Mr. A. M. White-terbury.

8.0 p.m.—G.P.O. chimes.

8.1 p.m.—St. Patrick's Day concert broadcast from Exhibition Building.

8.20 p.m.—Fruit-bottling talk by fruit expert in charge of Fowler's vacuum bottling system.

8.40 p.m.—St. Patrick's Day concert, continued.

10 p.m.—G.P.O. chimes.

10.15 p.m.—"Advertiser" news service.

10.45 p.m.—Supersonic Sonora recital.

11.0 p.m.—G.P.O. chimes and close down.

6WF, PERTH

Thursday.

12.30 p.m.—Tune in.

12.35 p.m.—First local news bulletin.

Market reports.

Cables.

1.00 p.m.—Time signal from Perth Observatory.

1.30 p.m.—Weather notes, supplied by the Meteorological Bureau of Western Australia.

1.5 p.m.—STUDIO QUINTETTE.

2.00 p.m.—Close down.

8.30 p.m.—Tune in.

8.45 p.m.—Musical programme, including pianoforte selections by Miss Evelyn White, A.R.C.M.

The WONDERFUL P.M. FILAMENT

**The unbreakable
Filament which
defies the roughest
handling.**

The mechanical strength of the Mullard P.M. Filament can be gauged by the fact that whereas the ordinary filament will barely support one valve the P.M. Filament will support four.

This difference is due to the special metal core in the P.M. Filament which is so tough that it can be tied in knots after 1000 hours' life. The P.M. Filament is set around 5 strong resilient hooks and is free from tension, sag or danger of displacement during the long life of the valve.

Every feature of the wonderful P.M. Filament has a superiority of its own, and its form is developed at the expense of another. You have the low current consumption of one-tenth compared with the consequent low accumulative charging upkeep cost. Many times greater emission surface than that of an ordinary filament, giving a wide range of power free from microphonic disturbance.

There will be something lacking in your radio reception until you get the valves with the MULLARD WONDERFUL P.M. FILAMENT.

Mullard

THE - MASTER - VALVE

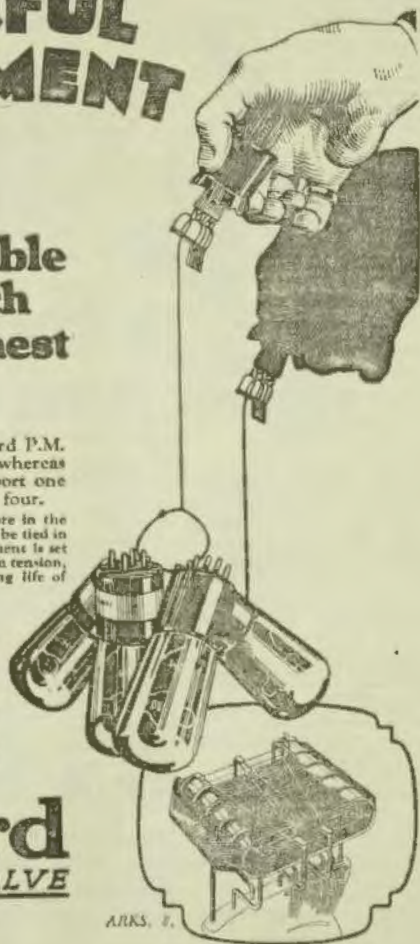

All Mullard Valves are manufactured at Mullard Works, London, England.

OBTAINABLE FROM EVERY RADIO DEALER IN AUSTRALIA.

Advertisement of the MULLARD WIRELESS SERVICE CO. LTD. "MULLARD HOUSE",
Denmark Street, London S.W. 2 England.

Ever-Ready Radio Batteries last longer

The New Ever-Ready No. 126 or A, B, or C Battery

Price 2/9

One of a group of radio batteries. Useful in wireless, lighting, and amplification. Size, 3½ x 4 x 11. Most useful for bells, telephones, burglar alarms, medical coils, etc. With three brass terminals. Voltages 1.5, 3 or 4.5 volts. Useful for all wireless purposes as well as general utility.



The "Standard" "A" Radio Battery.

Price 2/9

The Ever-Ready "Standard" "A" Battery (No. 126), 4.5 volt, specially designed for economical operation at 1, 3, or 4.5 volts, taking 60 amperes at 3 volt. For sets with four or more valves, the most economical service is obtained by using two "Standard" "A" Batteries connected in parallel.



If unobtainable locally, write for address of nearest source of supply to

The Ever-Ready Co. (Gt. Britain) Ltd.

163 Pitt Street ✉ SYDNEY

- 10.45 a.m.—A Gardening Talk by Mr. G. J. Lockley ("Redgum").
- 11.0 a.m.—"Big Ben"; Australian Press Association and Reuter's Cable Services.
- 11.5 a.m.—FROM THE TIVOLI THEATRE, CASTLEREAUGH STREET, SYDNEY—A special matinee performance for the Juvenile Radio Listeners of Sydney, at which the new American comedians—Olson and Johnson—will appear. The "Hello Man," with Uncle Rus and "Gertie," will attend this Matinee.
- 12.45 a.m.—Close Down.

MIDDAY AND AFTERNOON SESSION.

- 12.55 p.m.—Programme announcements.
- 1.0 p.m.—"Big Ben"; Weather Intelligence.
- 1.5 p.m.—"Evening News"; Midday News Service; Stock Exchange Information.
- 1.35 p.m.—Musical items from the studio.
- 1.45 p.m.—Rugby wireless news.
- 1.40 p.m.—Studio music.
- NOTE—Results of the Hawkesbury Racing Club Meeting will be given during the afternoon.
- 2.0 p.m.—FROM THE WENTWORTH CAFE, CHURCH HILL, SYDNEY. Popular numbers by the new Wentworth Symphonistic Dance Orchestra, interspersed with results of cricket, tennis, swimming, yachting, and golf and items from the studio.
- 4.15 p.m.—Complete resume of the afternoon's events and late news.
- 4.30 p.m.—Close down.

EARLY EVENING SESSION.

- 5.45 p.m.—The chim-a of 2PC.
- 5.50 p.m.—The "Hello Man" calls the children.
- 5.55 p.m.—A serial story for the older ones.
- 6.40 p.m.—Dinner music.
- 7.0 p.m.—"Big Ben"; Late sporting news, complete resume of the day's events.
- 7.10 p.m.—"Evening News" late news service.
- 7.30 p.m.—Weather intelligence; Studio music.

NIGHT SESSION.

- 7.40 p.m.—Popular records from the studio—Programme resume.
- 8.0 p.m.—"Big Ben" FROM THE NEW PALACE THEATRE, FITZ STREET, SYDNEY—THE FIRST ACT OF "HULLO HEALO"—the new musical comedy, written by Dion Tiberadge; Music by Kenneth Duffield; Featuring Arthur Slight, Musical Director, Cyril Connelly, ACT ONE—SCENE: General Offices of "Healo" Limited.

MUSICAL NUMBERS.

- Opening Ensemble, "We'll Strike"
Song, "Hullo Healo," Sally Fisher & Chorus
Song, "Lisoparra," Clive McLennan and Chorus
Song, "Lancashire Caravan of Girls," William Ferryman and Chorus
Duet, "Love and Adventure" Adele Crane
Song, "Buttons" Joy Thompson
Finale, "Good-bye London" Full Company
- 8.50 p.m.—FROM THE STUDIO, Mr. Alex. Whitson, baritone, "Pass Evergreen" (Saunderson).
- 8.54 p.m.—Mr. Sydney Smith, Junior, will continue his interesting description of the recent tour of the Australian Cricket Team.
- 9.10 p.m.—Mr. Wally Barnes, comedian—
(a) "Alice's House" ("Barley")
(b) "Back Answers" (Coverdale).
- 9.17 p.m.—Mr. R. P. Kerry, Cornet solo—"The Bower Land" (Cowan).
- 9.24 p.m.—Mr. Alex. Whitson, baritone—
(a) "The Gineby Road" (Edward).
(b) "Friendships" (Loby).

8.30 p.m.—Mr. Wally Haynes, comedian—
 (a) "Goldfish" (Harcroft); (b) request.
 (c) "The More we are Together" (Gonsky).
 9.25 p.m.—Mr. Alex. Whitson, baritone—
 "Casey the Fiddler" (Wood).
 9.45 p.m.—Mr. E. P. Kerry, cornet solo—
 "Zelda" (Cole).
 9.50 p.m.—FROM THE ROCKDALE TOWN
 HALL—The second act of the delightful
 comic opera, "THE GIRLS OF GOTTEN-
 BURGA," produced by the Langia Operatic
 Society by arrangement with J. C. Wil-
 lamson, Ltd.

MUSICAL NUMBERS.

Duet—"The Birds." Miss Ethel Allen and
 Wai Goodmar.
 Trio—"Sprechen Sie Deutsch." Dorothy
 Meredith, Wai Goodman, and W. H.
 Gibson.
 Song—"The Ladies' Post." Ernest Boyd.
 Song—"I Love My Love With an A,"
 Olive Carver.
 Duet—"Two Steps." Olive Carver and W.
 H. Gibson.
 Song—"Colossal." Hilda Smith and Charlie
 Meredith.
 Song—"Berita in the Spring." Dorothy
 Meredith and Cairns.
 Female.
 10.45 p.m.—Late news and announcements.
 10.50 p.m.—Celebrity Review.
 11.0 p.m.—"Big Ben": FROM THE WENT-
 WORTH CAPE, CHURCH HILL, SYDNEY.
 The New Wentworth Symphonic Dance
 Orchestra, conducted by Mr. Sydney Simp-
 son.
 12 midnight—"Big Ben": National Anthem.
 Close Down.

WIRELESS PLAYS.

An interesting performance was the wireless broadcasting of "Uncle Tom's Cabin," on March 11th, from 3.0 Mr. Eardley Turner, the well-known Australian actor, was in charge and specially prepared the manuscript of the play for radio transmission, cutting it down to three-quarters of an hour. With him were associated such well-known character actors as John Forde and Edwin Lester, as well as the favorite, Marie Le Varre.

What an extraordinary thing it is to look back to the days when Harriet Beecher Stowe wrote the immortal classic and to ponder on the changes time has brought. The slaves' freedom must have seemed a miracle to a generation that was accustomed to look on negroes as only part-human, created for toil. Now this story of their torture is still living, and being sent across thousands of miles of ether by the marvellous march of modern science. Nothing in the author's wildest dreams could ever have prepared her for this.

This will be only the first of many plays to be prepared for broadcasting by Mr. Turner.

RADION

BEFORE you build the three valve set described this week get our Catalogue of Panels and parts.

Sets built with Radion have that "Factory" appearance so hard to obtain with any other insulating material.

RADION

The Supreme Insulation

Do Not take substitutes. If your dealer cannot supply you, write direct to us.

Catalogue M on Request Free.

International Radio Co. Ltd.

200 Castlereagh Street, Sydney

91-92 Courtenay Place, Wellington, N.Z.

Queries Answered

A.C.A. (CRENORNE).—I built the "Capacity-Coupled One-Valve" which you described in your paper some time ago, and found it satisfactory in regard to volume and sensitivity, but its capacity is very noticeable in the secondary variable condenser. I would be very pleased if you could give me a remedy for this.

A.: Make carefully that the fixed plates of the condenser are connected to the grid. If this doesn't help it, then insert a copper screen between the back of the panel and the front of the condensers. Cut out holes in this screen to allow the spindle and fixing screws for the condenser sufficient clearance. Don't let them touch the screen, which should be approximately 4 cubes by 4 inches. Connect this screen to earth.

E.L.P. (COLEDALK).—Q.: Please find enclosed a diagram of a super het. Please tell me if it is suitable for Australian conditions. If you could answer this through the columns of this week's "Wireless Weekly" I would be much obliged.

A.: The circuit is quite O.K.

SHORT WAVE (ROZELLE).—Q.: It is my intention to construct a short wave receiver on the circular system, and with this end in view I looked through the back numbers of "Wireless Weekly" till I came to the issue of July 30, 1924, which gave the details of a receiver for "English Phones." In connection with this receiver, I would esteem it a pleasure if you would advise the following matters for the U.K. Would two 5000fm. Eimco S.L.F. Condensers be suitable, and if not what valve should I use?

A.: (1) The 5000mf. condenser are suitable.

Q.: (2) What type of valve would be the best to use. Would dual-diode valves working from a two cell accumulator be suitable?

A.: (2) Use a good detector valve, followed by an amplifying valve. A Mallard P.M.T. (H.P.) for detector, with a P.M.T. (L.F.) for the amplifier, would be a good combination for a 2-cell accumulator.

Q.: (3) What ratio transformer is required?

A.: (3) Either 5, 5 or 6 to 1 ratio.

Q.: (4) Would the efficiency of the receiver be impaired if I were to use double loads where possible instead of human and solder?

A.: (4) Use Eimco, but make sure that the connections are good.

B.J.J. (ROCKDALE).—Q.: Having been a constant reader of "Wireless Weekly" since its inception, and tried many of your circuits, I would like some information re the Marinton, which appeared in your issue of December 4, 1924, Vol. 7, No. 4. I find that on one valve I get all Local Stations, 400 and 201, very strong, but so far have not lugged S.W., but my trouble is this: I have added 2 stages of Audio in the ordinary way, the phono terminals of set 2. He and plate of transformer, I get the Local Stations very clear and loud, in fact,

13/6

**Radio de Forest
AUDIONS**

13/6 **12/-**

24/-

The AUDION YOU WANT is in this group. Special R.F. DL4, Detector DL5, Audio DL7, Dull Emitter DL3.

THE Best
from
INTERNATIONAL RADIO CO., LTD.
200 Castlereagh Street, Sydney
91, 93 COURTENAY PLACE, WELLINGTON, N.Z.

Queries Answered

better than anything I have heard, but when I plug in to the 2 valves after tuning an Intermediate Station on one valve, the Local Station completely drowns any other sound. Can you tell me if there is a circuit for 2 stages of Audio to be added to this, or, if not, could you let me have a 2 valve circuit suitable for Loud Speaker work on Intermediate Stations?

A.: This circuit is not suitable for audio amplification. A suitable receiver is found in this issue.

J.F. (DEE, WHY).—Q.: I have the intention of building the three valve regenerative receiver published by you in the 29th October issue of "Wireless Weekly" last year, and would thank you to let me know either over the air from 2FC or through the query column of "Wireless Weekly" if a Gillman Vanz Looper would be suitable for this set? I am at present operating a three coil regenerative set with two valves and am able to get both 3LD and 4QG with the aid of a wave trap to cut out the local stations and get excellent reception. The variocoupler at present in use has 6 turns on the aerial coil, 50 on the secondary and 40 on the rotor. The wave trap has 10 turns on the aerial, and 50 turns tuned with a 0.005 condenser, the 10 turns aerial being wound over the 50 turns. Should I be able to get the intermediate stations without the wave trap operating the set at Dee Why?

A.: The variocoupler is quite suitable. Use it by all means. I can't advise you definitely on the other matter. Provided everything is properly put together, you should hear intermediate stations. Try for yourself.

J.A.C. (BONDALL, Q.).—Q.: I have made necessarily, Radio Transformer Transformation of two basket coils tied tightly together, tuning the secondary, helping the selectivity of the set. I am now building a modified Super-Het, and want to make the R.F. Transformers. I want one for the "Filter" and one "Long Wave" Transformer. Now those want to be designed to operate on 3000 metres (100 K.C.). Could these be made with the New Groden Former, the secondary wound on the outside former, and the primary on the inside former (which is fixed inside neatly). The whole neatly shielded by the new copper shield. If they could be made thus, would you give me the windings required? I think I should use silk covered wire, not cotton. I should use each primary. What condensers should I use? I read your answers in "Wireless Weekly" each week. Much helpful. I consider.

A.: I wouldn't advise you to make your own super-het kit. It is a difficult and tedious job balancing them up, and very few people make a success of it. Purchase a ready-made kit and go ahead. Glad to hear from you.

G.J.C. (CLARENCE RIVER).—Q.: I own a four-valve "Udico" receiving set. I would like to know if any advantage would be gained by altering same to a Browning-Drake. If so, where might I procure a plan of the Browning-Drake? What are the advantages generally in the Browning-Drake? The last two questions might be answered without respect to my present set, the "Udico."

A.: I cannot advise you on this at all. Firstly, I haven't heard your present receiver, nor do you tell me the results you are getting. If results are satisfactory, why alter your receiver. Still, particulars of a Browning-Drake receiver are published in "Radio," 2-3/27.

Thousands
Of Listeners
Endorse
Our
Statements

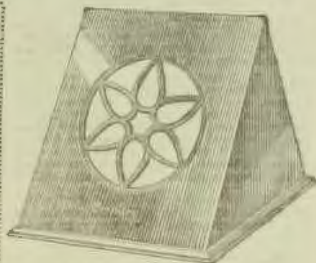

BRANDES

.. AS ..

"The Leading Reproducers"

.. WITH ..

- The Table Talker
£2-5-0
- The Table Cone
£4-0-0
- The Brandola
£5-10-0
- The Ellipticone
£8-0-0



IN THE LEADING PARTS
AT ANY TIME THEATRE

International Radio Co., Ltd.
200 CASTLEREAGH ST. :: SYDNEY

91-93 Courtenay Place, Wellington, N.Z.

All Readers' Queries Answered Here

M.L. (WARATAH). Q: (1) I am thinking of building a Brownings-Drake receiver, and I would like your advice regarding the time and volume of this receiver?

A: (1) I am enclosing a list of Parts which I have at present in my latest Anode receiver, and I would like to know if I would be able to use these parts in a Brownings-Drake receiver, also what other parts would I require? Please find enclosed stamps for (2) and I want you to send me a copy of the "Wireless Weekly" with the wiring of the Brownings-Drake receiver, and oblige.

A: We are posting you a copy of "Radio" 7-9 in which you will find particulars of a Brownings-Drake. Compare your parts.

D.E. (WEST KOGARAH). Q: I wrote a few weeks ago to the building of a four valve Armstrong oscillator as published in your "Wireless Weekly" of 8/9/26, which I duly received. I would esteem it a favor if you will give me an approximation as to the plate voltage required, also the amount of C battery voltage. I might state that I have 60 cells at my disposal from a set of Philips V6 Batteries, also a 3 cell 80 amp. Edison Radio Accumulator?

WANTED FOR PAPUA

Good Mechanic and Electrician, with first-class wireless operator's ticket, two years' engagement, good salary suitable man.

Apply J. MacD. ROYLE,
Chief Engineer, Ormco Oil Limited,
25 George Street.

Tinker Tim's Denial!



I deny it!
All this about different soldering belongs to the old-Wunderflux era.
"But now"
I deny that anyone at all can take a soldering iron or kitchen poker (or perhaps a candle flame) will do for heating; and a little Wunderflux outfit can make a neat, safe soldering joint in a minute.
"Do you have to clean the wire first?"
NO!

Wunderflux is non-poisonous, too. And a Wunderflux mend never corrodes. I'd like you to prove (or yourself) all the praise that's being broadcast about Wunderflux!

Wunderflux Home Soldering Outfit

1/6 AT RADIO DEALERS.

Or Write to Byrne & Ross, Brighton House, Clarence Street, SYDNEY.

A: For a C battery use (1) volts on UV201a Radiotrons. The plate voltage of 50 volts is O.K. for the anode amplifier, and 60 volts for the rectifier.

C.H. (DARLING PT.). Q: Many thanks for your article on "The Construction of an Accumulator B. Battery" which I have followed in every detail, except one, namely, I purchased 100 turns of Helicon wire, 17 mg B, after three 17-megohm coils and if my voltmeter is not in line I have 120 volts. About 10.50 I show down front set and the battery was 180 volts, but had, what? The set I refer to is a Brownings-Drake, also built to your instructions. At first I had all the trouble you said I would have, which, thanks to your instructions, I have overcome. It works perfectly. (1) Like many thousands of others, I enjoy building sets, and having built and operated three successively, I enjoy selling them to places and individuals. It has struck me that since the Neutrodine is a good set and the Brownings-Drake I know is excellent, what would a Brownings-Drake Neutrodine be like. Using either the R.D. or Neutrodine aerial coils, then the two Neutrodine or H.F. transformers, then the Neutrodine, etc., making a six valve set with three stages of R.F. amplification?

Q: (2) I would be very much obliged if you would let me know through your columns if this is worth trying, also any article you may have in one of your other papers giving the rod winding data for Neutrodines, of the Neutrodine?

A: (1) You are very much afraid that this idea, although practicable, would not furnish on a par with your night owl circuit.

A: (2) Primary 6 to 7 turns wound on 2 1/2 in. former (inserted under P.I.) and Sec. 65 turns 1/2 in. former (on at 1/2 in. diameter and

G.H. (HAMILTON). Q: I am only a beginner in wireless construction, and have decided to build the Receiver published in vol. 8, No. 21 of your valuable paper of October 16th 1926. I would be pleased if you could publish this same receiver made into a three valve set, using 600 cells, etc. I am asking this as I do not know how to add or wire on a stage of audio. If you cannot publish this, could you in any way through queries answered if I could obtain from you by send^g the set of some, a back of panel diagram of this set, as a three valve diagram and back panel view are excellent for a new chain constructor. Trusting you can assist me?

A: Kindly look up "Wireless Weekly" of January 7th. This will meet with all your requirements.

K.R.G. (GOLBURN). Q: I would be very thankful to know if any of your many readers have built with success the "Wireless Weekly" 6 Valve Reflex published in your paper of July 22nd 1926. I have built many sets in my day, and got results, but with this one, the circuit I have checked and checked again, my parts have been tested and found O.K. and are of good make. My aerial & earth system is also O.K., and other sets work perfectly for it. Can you tell me something concerning it? I will be very thankful.

A: Together with a few who have struck trouble with this receiver, we have stacks and stacks of letters of appreciation on the grounds of a mistake that has been given. The fact that it met with no success have generally found that their district is not suitable for 6-Valve receivers. We should advise you to make sure that no Power Transformer or H.F. units, etc., are in your district.

B.H. (MOSSMAN). Q: I am desirous of building a portable wireless set, but am hesitating as to which circuit to employ. I shall be greatly pleased if you will inform me: (1) What circuit is the most available for a portable set and how many valves? (2) Would "Neutrodine" be suitable or even advisable in such a circuit?

A: Kindly refer to "Wireless Weekly" of Oct 8 for the most suitable circuit. These valves will suit the purpose admirably.

T.O. (GUMBLE). Q: I have been thinking of having a chance over from the set I am using, but would be pleased to know if the Brownings-Drake case could be screened. Pick up seems to be an interesting subject these days, thanking you for your past favors and wishing W.W. continued success.

A: Screening the R.D. coils will certainly make an improvement.

C.B. (BANGALOW). Q: I have had some difficulty in obtaining the glass tubing to make a Tunable B Battery, as described in "Wireless Weekly" of 11/11/26. I have had you please let me know through "Wireless Weekly" or 2FC, where I can obtain this, and also the actual quantity of zinc necessary to construct a 100-ohm Battery?

A: Glass tubing may be obtained from Selby's, Bullfinch Place, Sydney. An article on this subject will be dealt with in the near future.

T.P.S. (BURWOOD). Q: I wrote you about a condenser case, asking your advice re placing a fixed condenser in the Harkness 6-Valve receiver that I have built according to plan in "Wireless Weekly". I have made a real good job of the set, and am well pleased with it, but if possible, I should like to make it a little more selective, so I sent you the back panel view in a stamped addressed envelope, asking you if you would kindly mark on the diagram just the best place to connect the condenser. I do not know if my letter to you went astray, or what happened, as I have had no reply either by letter or through the Query Columns of the last two copies of "Wireless Weekly". If I am not asking too much of you, kindly advise me on the subject, also what of fixed condenser to be used. Please find stamp for reply. Thanking you for past favors.

A: Your previous letter has evidently gone astray. Insert a fixed condenser in series with the aerial in this fashion. Looking at the fixed condenser, there will be found two plates for connections. Attach one side to the aerial terminal of the set, and connect the lead in from the aerial to the remaining side of the fixed condenser. This condenser may be either 5000 or 6000, or even 6000 p.f.d. Try them.

W.T. (DEFFERN). Q: Would you be kind enough to answer W.S. the following questions—(1) I have a home-made charger (Tanner circuit), would this be suitable for charging "Wireless Weekly" B Accumulator? (2) Would it be necessary to re-charge polarity with this type? (3) Neutrodine Browning

USE PILOT PARTS

PILOT ISOGRAD MOULDED CONDENSERS.

| | s. d. |
|----------------------------|-------|
| .001 | 3 9 |
| .002 | 3 0 |
| .004 | 3 9 |
| .0005 | 2 9 |
| .00025 | 2 9 |
| .00025 with clips | 2 9 |



This fixed Condenser is unique, inasmuch as it has screw holes for mounting by wood screws apart from the usual holes for terminals and connections.

Method of construction adopted completely protects the Condenser from moisture and the pressure of the securing screws does not affect the capacity of the Condenser.

PILOT CONDENSERS.

Straight Line Wavelength.

| |
|-----------------------------|
| No. 5113, 13 plate, £0 11 3 |
| No. 5117, 17 plate, 0 12 0 |
| No. 5123, 23 plate, 0 13 6 |

Straight Line Frequency, Aluminium Plate.

| |
|-----------------------------|
| No. 7113, 13 plate, £0 12 0 |
| No. 7117, 17 plate, 0 13 6 |
| No. 7123, 23 plate, 0 14 3 |

STRAIGHT LINE FREQUENCY BRASS PLATE.

| |
|---|
| No. 8113, 13 plate, £0 14 0 |
| No. 8117, 17 plate, 0 16 9 |
| No. 8123, 23 plate, 0 17 3 |
| No. 8117-2, 17 plate, double Condenser, 1 14 6 |
| No. 8117-3, 17 plate triple Condenser, 2 1 3 |

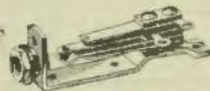
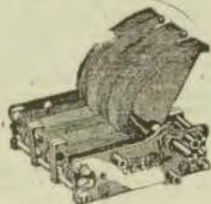

JACKS.

| | |
|--|--------|
| Pilot Single Circuit Jack, No. 1161 | £0 2 3 |
| Pilot Double Circuit Jack, No. 1162 | 0 2 6 |
| Pilot Single Filament Control Jack, No. 1163 | 0 2 9 |
| Pilot Double Filament Control Jack, No. 1164 | 0 2 9 |

The Pilot Kilo-grad vernier dial — calibrated both clockwise and anti-clockwise on the one dial — moulded in pure bakelite — with friction control — absolutely no backlash, and only



No. M.7.

Midget condensers, 7
plate .. 5/9
No. M.7.
Midget condensers, 13
plate .. 7/-

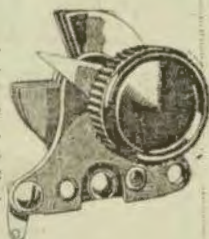

PILOT RHEOSTATS.

| | | | |
|--------------------------------|--------|---------------------------------|-------|
| No. 906, 6 ohm Rheostat | £0 3 9 | No. 930, 30 ohms Rheostat | 0 3 9 |
| No. 910, 10 ohm Rheostat | 0 3 9 | No. 200 ohm Potentiometer | 0 5 6 |
| No. 920, 20 ohm Rheostat | 0 4 9 | No. 400 ohm Potentiometer | 0 6 6 |

United Distributors Limited

WHOLESALE ONLY

72 Clarence Street, SYDNEY

27 Chesser St.,
BRISBANE.

343 Queen St.,
ADELAIDE.

26 Queen St.,
PERTH.

Cr. Jervois Quay & Harris St.,
WELLINGTON, N.Z.

66 Charles St.,
LAUNCESTON, TAS.

At last new shipments have arrived.

The Balkite Trickle Charger

A LONG FELT WANT NOW FILLED

The Balkite Trickle Charger may be connected to any 6 volt radio "A" battery of 30 ampere hour capacity or more and left permanently on charge. This is known as trickle charging. Used in this manner, it automatically keeps the "A" battery always at full charge. It converts your "A" battery into a permanent "A" power unit that operates from the light socket and furnishes full current to the "A" circuit at all times.

With any smaller battery (4 volt or small 6 volt) this charger may be used as an intermittent charger of the usual type. Wherever a low-priced charger is wanted it has no superior. When used in connection with the low-capacity batteries offered by leading manufacturers it makes possible a most

economical installation for sets now using dry cells.

With small batteries this charger can also be used as a trickle charger if a resistance is added to cut down the charging rate to the needs of the set.

When used as a trickle charger, as an added convenience, some owners add a switch, which cuts out the charger during operation. Switches of this type also turn on Balkite "B" when the set is turned on, thus providing an entirely automatic current supply for both circuits.

The Balkite Trickle Charger is 5½ inches long, 2½ inches wide, 5 inches high. It may be put in the usual dry cell compartment. Charging rate, 4 to 5 amperes. Current consumption, 1/10w per hour. Operates from 220-240 AC 50 cycle current.

Only £4 - 7 - 6

The Balkite Trickle Charger



Provides "A" current from the light socket

Sold by Leading Radio Dealers Everywhere

Manufactured by The Fansteel Product Company, Inc., North Chicago
SOLE AUSTRALIAN DISTRIBUTOR:—

O. H. O'BRIEN :: SYDNEY

(LATE O'BRIEN AND NICHOLL)

37-39 PITT ST., SYDNEY.

516 COLLINS ST., MELBOURNE.

Manufacturers
Products Pty. Ltd.
(M.P.)

(H. J. HAPGOOD)

Challis House, Martin Place,
SYDNEY

Tel.: BW 1525



Agents for all Styles of Radio Products,
Including Globe Batteries.

Elec. Motor Mfg. Co. "Eumec."

Wenrad Condensers, Leaks and
Fixed Resistors.

Airame Rhum, Poles, Special Coils
and Loops.

Neutron Crystals, Braided Phones,
Prompt Shipments from Sydney.

We represent 21 Foreign Radio
Manufacturers.

Write for Instant List.

Surplus Stocks sold Interstate.

Radiokes acknowledged
as the World's Best



£2/2/- at all Dealers.

The Browning-Drake is holding most of the world's records—Radiokes is the only genuine Browning-Drake coil kit on the market.

Metropolitan Electric Co. Ltd
27-29 King Street, SYDNEY.



Transform Your Wireless Set...

By Fitting the WORLD'S BEST INTERVAL TRANSFORMER.

NEW BRITISH MADE

FERRANTI

TRANSFORMERS

The "FERRANTI" Interval Transformer, designed to improve loud speaker results, is constructed with full realization of this fundamental—That it is necessary to amplify all waves in accurate proportion in order to get satisfaction from wireless concerts—which many transformers seem to ignore.

OBTAINABLE FROM ALL RADIO DEALERS IN AUSTRALIA.

Dealers please communicate with:

A. BEAL FRITCHETT (Aust.) LTD., Sydney and Melbourne.
WEDRA, LTD., Adelaide. — — — EDGAR V. HUDSON, Brisbane.

TYPE AF3 - 42/6

Impedance
at 100 per cent. 30,000 Ohms.
at 500 per cent. 410,000 Ohms.
No other transformer is available at any price.

TYPE AF4 - 32/

Impedance
at 100 per cent. 12,500 - Ohms.
at 500 per cent. 14,000 - Ohms.
The best transformer at the price.



Registered Trade Mark.

Published by Arthur William West of "Preststone," Lavender Street, Lavender Bay, for the Proprietors, Wireless Newspapers Limited, 51 Castlereagh Street, Sydney, and printed by Macdonald & Co. Ltd., 55a Goodburn Street, Sydney.

The Editor will be glad to receive Technical and Topical Articles of interest to Australian Experimenters. All Manuscripts and Illustrations are sent at the author's risk, and although the greatest care will be taken to return unsuitable matter, it is accompanied by cheque, the Editor cannot accept responsibility for its safe return.

Subscription rates—Twelve months (12 issues), 13/- post free; six months (6 issues), 6/6 post free. Single copies 4d each, or post free. All Subscriptions should be addressed to Wireless Newspapers Ltd., 51 Castlereagh Street, Sydney.

Advertising—Our advertising representatives keep in close touch with advertisers, and he is ready at all times to supply information concerning advertising.

Agents in Great Britain—The Colonial Technical Press Ltd., Dudley House, Southampton Street Strand, W.C.2.

"Wireless Weekly" is fully protected by copyright, and nothing has appeared in it that is not recorded, written or in type, without special permission. The use of our articles or illustrations from them for any purpose whatsoever is never permitted without our written authority.

YOU CAN HAVE "Wireless Weekly"

Delivered POST FREE for One Year for

13/-

Avoid delay or disappointment
by forwarding the following

SUBSCRIPTION FORM

To the Editor, "Wireless Weekly," 51 Castlereagh Street, Sydney.

Please forward "Wireless Weekly" for a period of

..... for which I enclose

..... for
(Add exchange to Country Postage)

Name

Address

Subscription Rates: 12 months (52 issues), 13/- post free; 6 months (26 issues), 6/6 post free.

THE PINNACLE
PORTA
 Reg'd.

SELF CONTAINED RADIO SET

Entertains Everywhere

NO AERIAL

NO EARTH

 N.S.W. Representative:

H. J. Hapgood

Manufacturers' Products Pty. Ltd.

Challis House,

Martin Place :: SYDNEY

"Take Wireless with you"

Whether motoring, holidaying, or visiting, you have always at hand in the wonderful "Porta" a perfect receiving set that will give unlimited pleasure. You can carry it from room to room, out on the verandah, or into the tennis court—and there you have all the wonders and many delights that wireless alone can bring you. TERMS ARRANGED.

£39/10/-

ENTERTAIN WITH THE
"PORTA"

Give pleasure with radio! Use the self-contained Porta—quite the latest idea. Music in a moment—just open the lid. It is the simplest receiver in modern radio. Opening the lid of the compactly made Oak Cabinet is all that is necessary to put the Porta in instant operation. Come and hear the Porta!

OBTAINABLE AT ALL RADIO STORES.

BEWARE OF IMITATIONS.

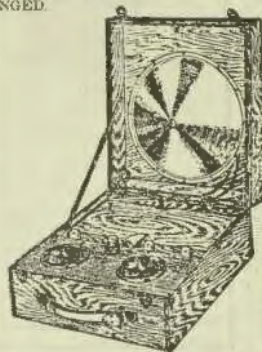

**Enjoy Real
 Broadcasting**

Why put up any longer with tinny reception noises, when they can be completely cut out with a **Maclurcan Tone Purifier**? In this static season, too, static noises may be considerably lessened with one of these easily fitted instruments. Fit one into your set to-day, and get pure undistorted reception.

THE MACLURCAN TONE PURIFIER

21/-

At all Dealers

Manufactured by ELECTRICITY METER MFG. CO. LTD., Sydney, N.S.W.

Price Reduction!

A.W.A. and RADIOTRON VALVES

Amalgamated Wireless (A'sia.) Ltd.

ANNOUNCE

that from March 1, 1927

The following Prices will obtain for the undermentioned Valves :

| | |
|-----------------------|------|
| A.W.A. 101X | 11/- |
| A.W.A. 55 | 11/- |
| A.W.A. 99X | 13/- |
| A.W.A. 99 | 13/- |

GENUINE RADIOTRONS

| | |
|---------------------------|---------|
| UV. and UX. 199 | 13/- |
| UX. 201A | 11/- |
| UX. 120 | 15/- |
| UX. 112 | £1/15/- |
| UX. 200A | £1/10/- |
| UX. 210 | £2/10/- |

AT ALL DEALERS

Amalgamated  **Wireless**
(Australasia) Ltd.

97 Clarence Street, Sydney

167 9 Queen Street, Melbourne

King and King Chambers, Queen Street, Brisbane.

AMPLION



Radiolu
AMPLION

The Natural Tone Loud Speaker

The Famous AMPLION Loud Speakers are
obtainable from all Radio Manufacturers
and Dealers throughout Australasia