

RADIO

IN AUSTRALIA
& NEW ZEALAND

Registered at G.P.O., Sydney, for transmission by post as a newspaper.

VOL. II

FEBRUARY 4, 1925

No. 49



FEB 18 1925

Not to be removed
the Library until the next
Number is received.

By Order of
the Library Committee.

F.19409.

TWO "LOUD-SPEAKERS"

All Sizes and Grades of C.M.A. Wires and Cables carried in stock



ALSO

BARE COPPER

WIRES
CABLES
BARS
RODS
STRIPS



DESIGN APPEARING ON C.M.A. LABELS.



Instrument Wires

Double Cotton Covered
Single Cotton Covered
Double Silk Covered
Single Silk Covered

Enamelled Copper
Wires.



BRITISH INSULATED & HELSBY CABLES, LTD., ENGLAND.

AGENTS:

William Adams & Co. Limited

175 Clarence Street, SYDNEY.

53 King Street, NEWCASTLE.

Edward and Mary Streets, BRISBANE.

RADIO

IN AUSTRALIA
& NEW ZEALAND.
Incorporating Sea, Land and Air.

[Edited by N. H. THOMPSON.]

CONTENTS

Copyright Registered.

Volume II. FEBRUARY 4, 1925 Number 49

	Page.
Radiatorial—	
Reliable Radio	731
Recent Commonwealth Wireless Patents	732
A Novel Switching Arrangement for Detector Amplifier	734
"In Re Wireless —"	736
Our London Letter	737
The Progress of Wireless	738
Talks from 3LO	742
We Leave It to You!	743
Broadcasting and Listening-in	744
Using Earth instead of Aerial	747
The Super-sonic Heterodyne Receiver	748
Broadcasting in America	752
The Experimenters' Corner	754
Denmark Communicates with North America	732
Queries Answered	764
Movements of Marine Wireless Officers	765

Published by

THE WIRELESS PRESS

Gloucester House, 97 CLARENCE ST., Australasia Chambers,
44 Market Street, Melbourne. SYDNEY. Wellington, N.Z.

PRICE, 6d. per Copy.

Subscription Rate: 10/ per annum (26 issues) throughout Australia and New Zealand; Foreign Rate, 12/6 (26 issues).

Obtainable from all Booksellers and News Agents, also the N.S.W. Bookstall Co., Ltd.—all branches.

Canada and U.S.A.:
The Wireless Press Inc.,
326 Broadway,
New York City.

Wholesale Distributing Agents:
GORDON & GOTCH (AUSTRALASIA), LTD.,
Sydney, Melbourne, Adelaide, Brisbane, Launceston, Perth,
Auckland, Wellington, Christchurch, and Dunedin, N.Z.

Great Britain:
The Wireless Press Ltd.,
12-13 Henrietta St.,
London, W.C.2.

FROST-RADIO



FROST
 No. 161, 2,000 ohm 32/6
 No. 171 3,000 ohm 37/6
 Aluminium Type.

FONES
 No. 172, 3,200 ohm 45/-
 Genuine Moulded Bakelite Type.

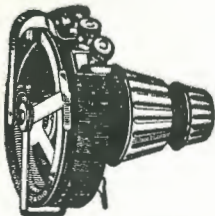

FROST-RADIO
 Tube Control Unit 17/6

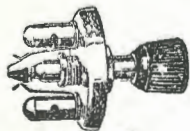

FROST-RADIO
 Push-Pull Battery Switch 4/-

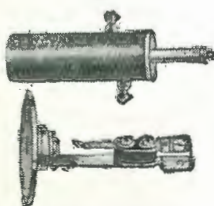

FROST-RADIO
 Plug and Jack.

YOU want dependability above all else in your radio parts and accessories.

FROST-RADIO is guaranteed to give long service and complete satisfaction. This guarantee is not qualified in any way. You are the sole judge of FROST-RADIO quality.

How often have you wished that some manufacturer would offer a complete line of radio parts and accessories? FROST-RADIO does this with FROST FONES, FROST-RADIO Plugs, Jacks, Sockets, Rheostats, Potentiometers, Switches, Adapters, Jac-Boxes, Extension Cords, Tube Control Units and many other products.

On this page are illustrated but a few of the items in this well-known line.

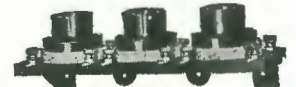

FROST-RADIO
FROST-RADIO
 No. 616-619, Shock Absorber
 for UV199 and UV201... 24/6



FROST-RADIO
 No. 602, Metal Frame Rheostat, 35 ohm 5/6

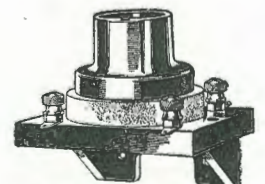

FROST-RADIO
 Bakelite Sockets.
 Sponge rubber cushion, non-microphonic. Standard base or C-299 UV199 type, Panel or Table Mounting 6/3

YOUR DEALER CAN SUPPLY YOU AT THESE PRICES.

Ask him to show you the complete FROST lines.

UNITED DISTRIBUTORS LIMITED

(Wholesale Only).

72 CLARENCE STREET — SYDNEY.

592 BOURKE STREET, MELBOURNE.

And at Adelaide, Perth, Hobart, Brisbane, Wellington.

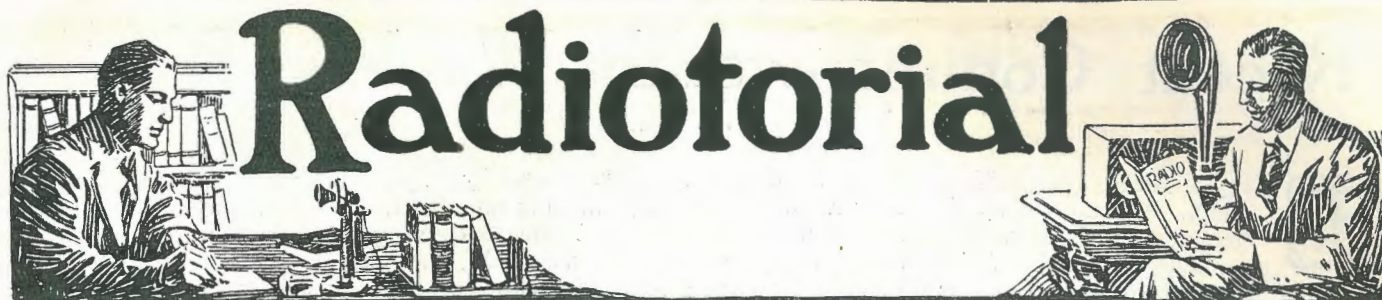

Reliable Radio



VERY innovation that makes an appeal to popular use is more or less subject to early depreciation by some users, and, at the same time, undue appreciation by others. Considering the rapidity with which broadcasting took hold of popular imagination and spread throughout the world, it is only natural that it has been subject to misuse by thousands of people. The boom period that set in in America, England and later in Australia, resulted in many extravagant claims being made as to the advantages that broadcasting would bring to the home. For the time it was overlooked that wireless is a science and that, as a necessity, efficient reception could only be obtained with receivers scientifically designed and manufactured in accordance with well-defined radio engineering practice. The passage of the human voice through the ether without the use of connecting wires, so fascinated thousands, that for

own business, but doing a deal of damage to the trade generally. Every experienced radio engineer is cognizant of the fact that the home-made set incorporates a greater ratio of inefficiency than efficiency—a truth of which the owner is blissfully ignorant. He imagines all sets alike.

THE consequential trade re-action has to be faced by the reliable manufacturers and conscientious dealers. The "get rich quick" merchant has folded his tent and disappeared in the night, to the chagrin of his creditors. Meanwhile, the purchaser has become a more discriminating, and may be a sadder, individual.

THE evolution of wireless sales has, to a large degree, taken this course in America, England and Australia. The remedy adopted in other countries, which will likely be a major factor in the trade, in the near future, in Australia, is to re-educate these disillusioned listeners-in.

SEE "THE SUPER-SONIC HETERODYNE RECEIVER," ON PAGE 748.

a while they were quite happy to listen to distorted reproductions of broadcast transmissions. In fact, the greater the volume the unfortunate instrument would turn out, the greater the wonder and delight of the user.

IT was, therefore, only natural that the time would come for thousands of people to give up their wireless for the reason that it failed to live up to the claims put forward for it. These people would thereafter decry the new medium of entertainment.

THIS condition of affairs is not due alone to the disillusioned user, but in a measure to the "get rich quick" dealer, who having a very small amount of invested capital and able to procure a comparatively large amount of credit, speedily took the opportunity of selling radio parts and sets without any regard for the efficiency of those parts or the ability of the purchasers to use them.

AGAIN, the same thing occurred with other dealers, who, while having the capital, lacked the foresight to see that by selling parts that could not possibly function satisfactorily they were not only harming their

With an efficiently-designed wireless set, incorporating the best components procurable, assembled by experienced radio engineers and laboratory tested, wireless broadcasting can take a place in the most cultured home and render pleasure and amusement equal to, if not better than, the highest class gramophone. Thousands of high-grade sets in use in Australia to-day evidence this opinion.

THE latest reports from abroad, far from showing any decline in the sale of radio apparatus, tell of increased sales; the majority of such sales, however, are of trade-marked sets bearing the stamp of national manufacturers of undoubted reputation.

A MARKED tendency in Australia at the present time is the consistent demand for three and four valve sets capable of covering big distances and reproducing the broadcasting transmissions without a flaw. It cannot be too strongly stressed that the more conscientious the dealer is in supplying only those sets that will give the utmost in performance and service, the more stable and, consequently, the more profitable will the industry become.

Recent Commonwealth Wireless Patents

By G. Apperley.



THE following are abridgements of complete specifications of Wireless patents notified in the official journal of patents as accepted at the Commonwealth's Patents Office, Melbourne, during the month of September, 1924.

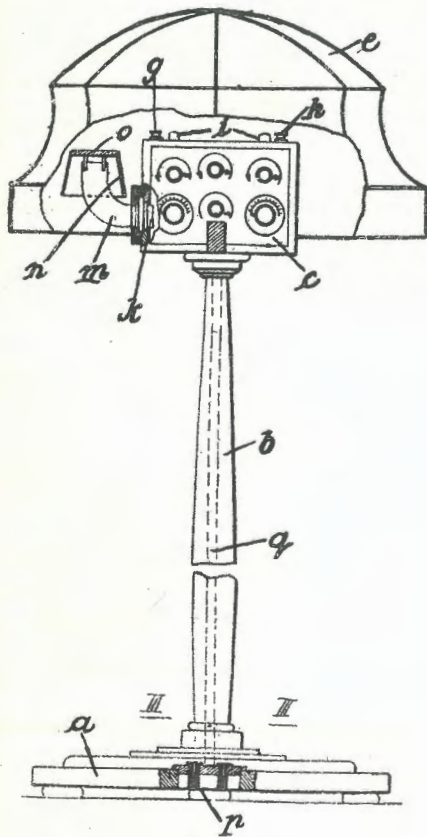

Fig. 1.

No. 17279/24: APPLICANT, KARL THEODOR ELLRICH, GERMANY.

To enhance the aesthetic effect of wireless receiving apparatus on the senses and mood of the hearer, it is concealed together with the loud-speaker reproducer under a suitable lamp shade carried on a pedestal. The invention is illustrated in Fig. 1, where B is a lamp pedestal, on which is mounted a shade (E) concealing the receiving apparatus (C) and reproducer (K). Associated with the reproducer is a sound-arm (M) covered by a sound-deflector (N), which has the shape of a hollow trun-

cated cone closed at its narrow end by a plate (O). The lamp shade is capable of being turned back 90 degrees about the axis of the two arms (D), in order to gain access to the apparatus concealed under the shade. By means of a suitable switch the loud-speaker may be cut out of circuit, the current then being led to the base of the lamp to terminals, to which head-receivers can be connected. Battery terminals are also provided on the lamp base, whilst the lamp wiring is provided in the usual manner through the centre of the upright portion of the device.

spective view of the improved cabinet, one object of which is the arrangement whereby the amplifying apparatus occupies a minimum space, whilst a maximum sound amplification is produced. Another object is to provide a cabinet wherein the closing of the hinged lid puts the apparatus out of service for reception by operating a switch to break the filament current supply to the thermionic valves. The cabinet (5) of veneer wood is constructed with an open end (6) and a hinged cover (8). The body of the cabinet is divided by a shelf (9) into two

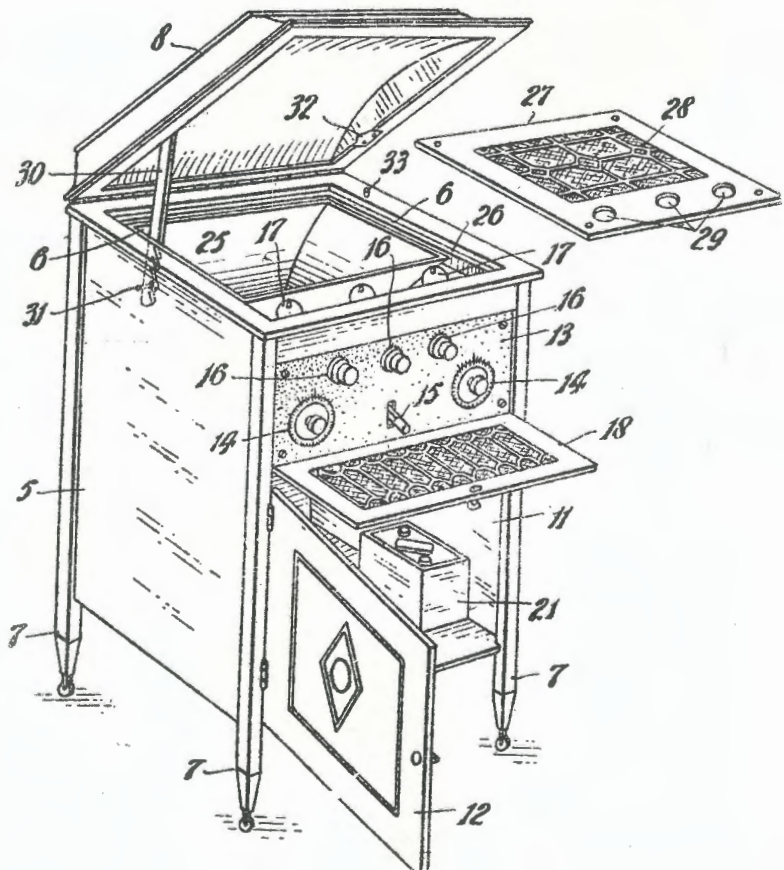

Fig. 2.

No. 14288/23: APPLICANT (ACTUAL INVENTOR), L. D. RUDOLPH, SYDNEY, N.S.W.

For improvements in cabinets for wireless receiving sets such as are employed for the reception of broadcast programmes. Fig. 2 is a per-

compartments (10 and 11), the lower having a hinged swinging door (12). The upper compartment is provided with a front panel of ebonite, upon which is mounted the control handles if the wireless apparatus. When the cabinet is not in

use the control panel may be concealed by the hinged flap (18). The lower compartment is designed to accommodate the low-tension battery (21) and the high-tension battery (22) of the amplifier, and may

by adjusting the lid opening to various angles. Sockets are provided for connecting the aerial and earth wires to the apparatus.

No. 14333/23: APPLICANT, THE CONNECTICUT TELEPHONE & ELECTRIC CO. INC., U.S.A. INVENTOR, H. P. DONLE.

A modified form of vacuum tube, having for its object delicacy in point of responsiveness to weak signal impulses. A highly evacuated tube (5), Fig. 3, preferably of glass, encloses a cathode filament (8) of highly electro positive metal, supported by members (9 and 10) having external terminals (11 and 12). A collector electrode (15), preferably trough-shaped with its concave face adjacent the cathode, is carried by the member (13a) on support (13), having an external terminal (14). The anode (16) is connected to the external terminal (17a) by the connection (17). A typical circuit for use with the device is shown in Fig. 4, in which an external heater (32), which may be embedded in the base of the tube, is provided for supplementing the heat from the filament (8).

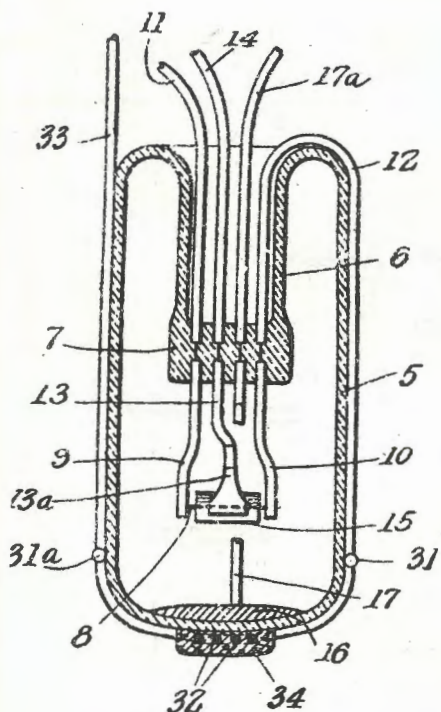

Fig. 3.

be enclosed by means of the door (12). In the same compartment a sound-amplifier (24) is mounted and associated with a wooden horn (25), which extends upwards to be flush with the top of the cabinet. A de-

15475/23: K. H. KINGDON AND I. LANGMUIR, U.S.A.

This invention consists of a method of generating positive ion currents in an electric discharge device independently of ionisation by collision, by bringing into contact with a vapour, consisting of caseium or rubidium (having a lower electron affinity than

or other suitable material contains filaments (2 and 3), the former being used as the ion generating electrode and the latter for the preparation of the film electrode (4) on the inner surface of the glass bulb. Filament (2) may consist of tungsten molybdenum or nickel, and filament (3) preferably of tungsten, although other materials also can be used.

The filaments are connected respectively to suitable lead-in conductors (5-6 and 7-8) sealed into a stem (9). Surrounding the filaments is a cylindrical electrode (10), and conductors (11 and 12) serve to convey current to this and to electrode (4). After evacuation the container and electrodes are freed from gas, and caseium or rubidium may be introduced from a reduction tube containing a mixture of caseium chloride and a reducing agent such as magnesium or calcium. After sufficient material

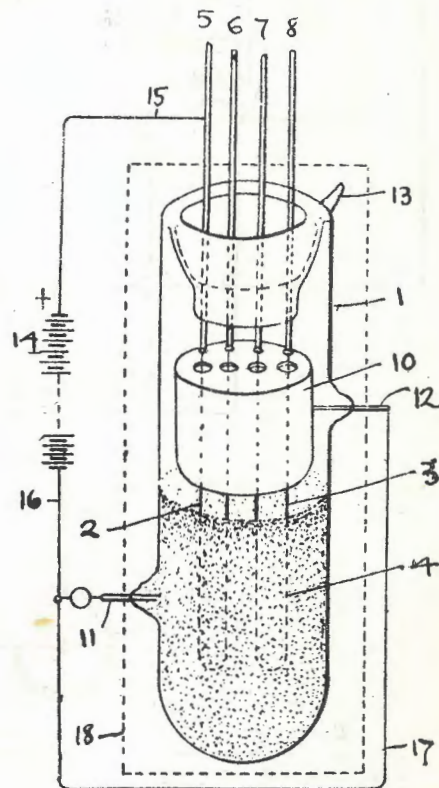

Fig. 5.

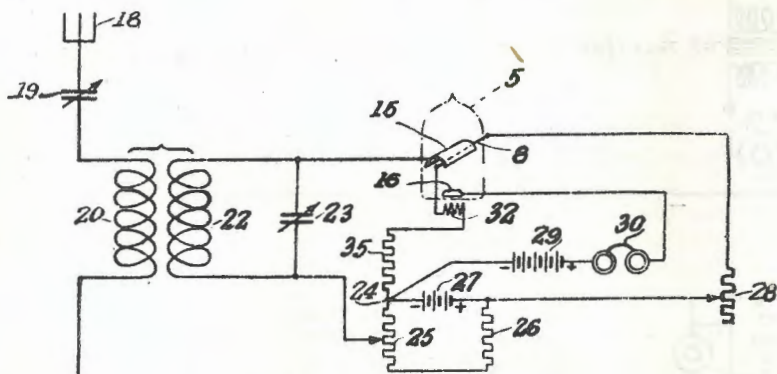

Fig. 4.

tachable cover (27) provided with fine wire gauze is fitted to the upper part of the cabinet, whilst the lid is hinged with a toothed link by means of which the volume of sound from the reproducer may be varied

the electrode), a positively charged electrode of tungsten, which is heated above a critical temperature at which ions are generated.

A sealed container (1), Fig. 5, consisting of refractory glass quartz

has been introduced to serve as a source of vapour, the tube is sealed off at 13. When caseium is used as the actual material and the filament (2) consists of tungsten, the critical (Continued on page 747).

A Novel Switching Arrangement for Detector Amplifiers

(By R. S. Wheeler.)

FOR those living in the vicinity of a spark transmitting station, nothing is more exasperating than, after tuning a multi-valve set to the highest degree of sensitiveness (having bagged a "Yank" amateur,

and with ears strained trying to get his call-sign, or having tuned-in distant telephony), to experience the blasting effect of one and a half kilowatts of damped spark energy suddenly launched into the ether a few miles away.

To minimise this cause of interference, the switching arrangements described in Figs. 1 and 2 were introduced into a panel set. The switch itself is a Federal Anti-Capacity Switch with twelve contacts, and it is sometimes referred to as a four-way,

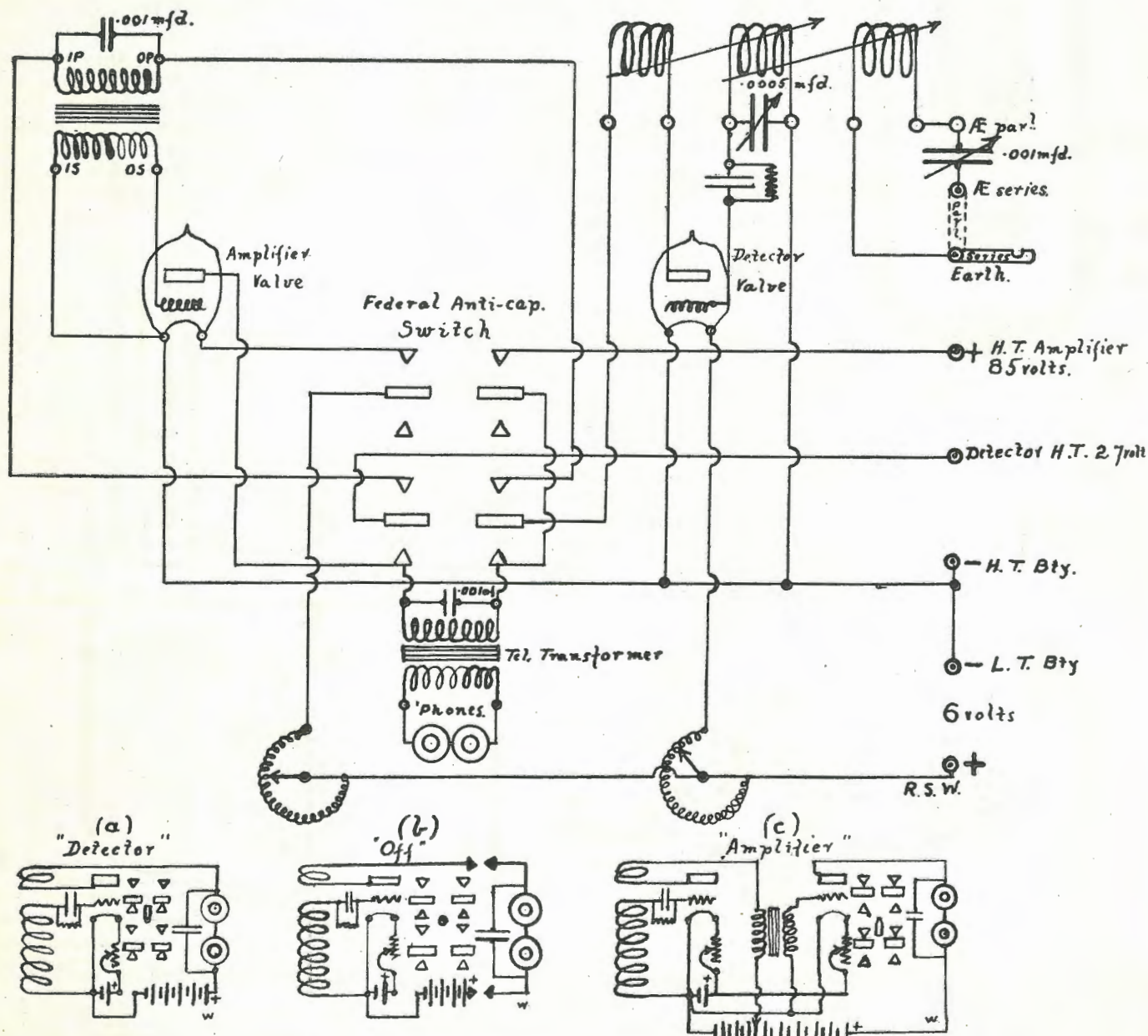

Fig. 1.—Illustrating wiring arrangement of Federal Anti-capacity Switch with twelve contacts:—(a) Schematic with switch at "Detector"; (b) schematic with switch at "Off"; (c) schematic with switch at "Amplifier." Actual position of contacts and lever is also shown within the schematic diagrams.

three-position Federal Anti-Capacity Switch.

With the switch lever in the top position, Fig. 1 (a), the detector only is joined to the telephone or loud-speaker, while the low and high tension current supply is disconnected from the audio-amplifying side of the set. Placing the lever in the mid-way, or "off" position, Fig. 1 (b), disconnects the telephones (or loud-speaker), amplifier low-tension current circuit, and amplifier high tension circuit, cutting off all noise from the operator, besides conserving the amplifier filament current supply. Depressing the lever to the lowest or "amplifier" position, Fig. 1 (c), switches in all batteries, at the same time joining the detector high tension battery through the primary of the first low-frequency transformer, and the telephones and the amplifier high tension battery to the plate of the amplifying valve. This arrangement introduces considerable economy in both high and low tension battery power, because immediately the amplifier is no longer required its low and high tension current supply is instantly switched off.

To avoid alteration of filament rheostat or detector high tension battery adjustments, when changing over from "detector" to "amplifier" (by a sudden depression of the switch lever), the resistance of the primary winding of the first low-frequency transformer winding should be equal to the resistance of the telephones or loud-speaker (unless the latter are worked through a transformer having the same resistance as the first low-frequency transformer primary winding).

This may be done by arranging the telephones in parallel or series, according to their resistance, or by inserting a fixed resistance in series with the telephones or transformer primary, as the case may be. The introduction of the fixed resistance is, however, inefficient and should be avoided if possible. The best plan is to use a telephone transformer having its primary wound to the same resistance as the first audio-frequency transformer primary as shown in Fig. 1. Unless this arrangement is resorted to, switching from detector to amplifier will make re-adjustment of filament control necessary. As this was

found to be rather annoying, the telephone transformer was introduced.

When on D.X work, the unpleasant effect of spark stations can be eliminated by placing the switch in the mid-way position, disconnecting the telephones, and then raising the lever occasionally to the "detector" position, until the spark station has ceased transmitting, when a downward pressure on the lever, switches in the amplifiers. This permits of the operator keeping track of weak signals without having his auditory nerves dulled by the terrific blasts of the baneful spark station.

This switching system was adopted

Capacity twelve-contact switch, while Fig. 3 gives a good idea of the compact panel arrangement on two different sets. The set on the left-hand side of Fig. 3 is a two-stage detector-amplifier wired as shown in Fig. 2 with the anti-capacity switch pressed into the "amplifier" position. The left-hand set is a one-stage detector-amplifier portable set wired as in Fig. 1, and showing the switch lever in the "off" position.

It will be noticed that in Fig. 2 the high tension wiring is so arranged as to allow two separate voltage values to be connected to the plates of the first and second amplifying

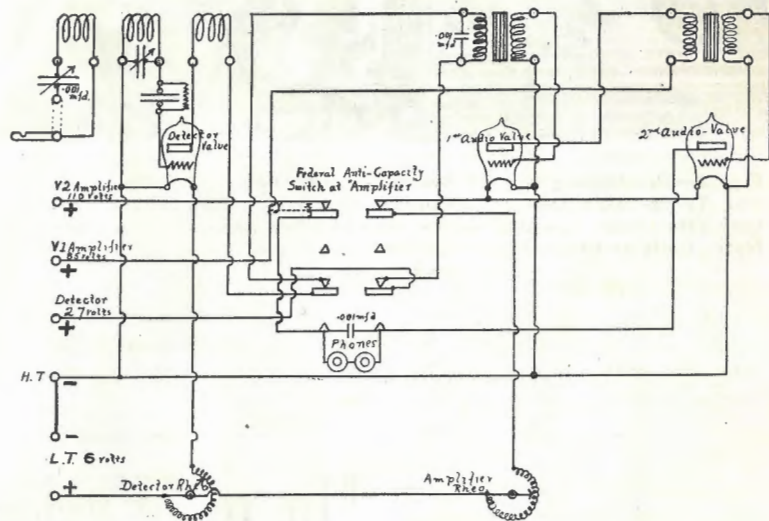

Fig. 2.—Illustrating the wiring arrangement of a four-way, three-position Federal Anti-capacity Switch, showing lever in "Amplifier" position as used with two stages of Audio-amplification.

as the most efficient remedy to combat the spark telegraphy nuisance, and is now becoming quite popular in New Zealand.

Fig. 1 is drawn the reverse way round to the usual standard wiring diagrams in order to facilitate the wiring of the panels, and should be placed in front as a guide while doing this, otherwise the wiring process becomes rather confusing.

Thoroughly test out all circuits before connecting up, because it is very easy to make a wrong connection to the switch soldering tags. An electric soldering iron and resin-core solder can be thoroughly recommended for the job.

Fig. 2 shows a three-valve detector-amplifier wired with a Federal Anti-

valves, as this was found necessary to obtain best results when using audio-frequency transformers of different ratios in conjunction with grid bias cells (not shown). As a matter of fact, 85 volts was tapped off to the first stage valve and 110 volts to the second stage valve when using a loud-speaker, and this ratio was found to give best results as regard volume without distortion. However, if it is desired to apply the same voltage to both amplifying valves, the terminal marked "V1 amplifier" may be omitted from the scheme, and the high tension current supply for both amplifying valves tapped from point X, Fig. 2 (the dotted line XY shows the alternate path to the first audio-valve plate). This will permit of the high tension supply to both

valves being disconnected when the amplifiers are not in use, otherwise there always remains a path from

circuit comes to a dead-end at the plate of the first audio valve, it has the disadvantage of allowing just a

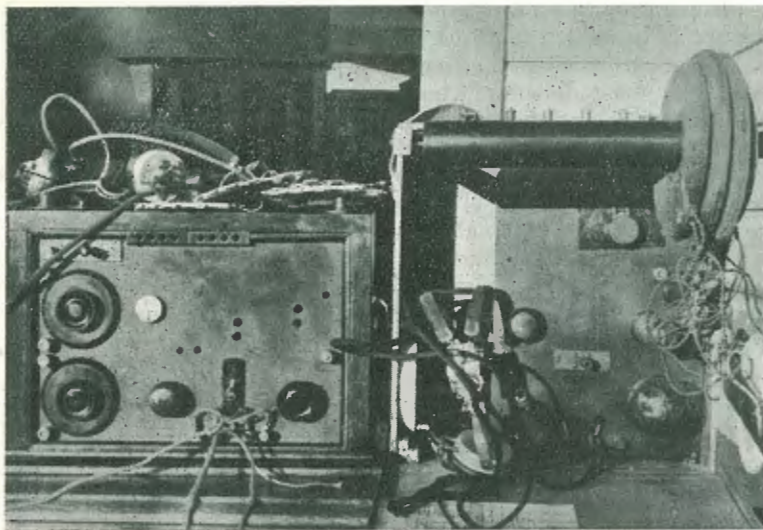

Fig. 3.—Illustrating use of Switch in Two-valve Portable Receiver, and Three-valve Detector-amplifier (on left). The compactness of both sets shows how this switch may be fitted and used to advantage. Note: Coils and holders are removed from Three-valve Set in order to give clear view of panel.

the terminal "V1 amplifier" to the plate of the first valve in any position of the switch lever. Although this

minute leakage should the insulation of the circuit not be exceptionally good.

"THE GREATEST THRILLS."

RECEIPT of two messages within a day or two of each other, one from Australia and the second from New Zealand, brought from Hiram Percy Maxim, President of the A.R.R.L., the comment that the "big radio thrills are in the two-way telegraphic game."

"This appears to be another of the startling things that amateur radio is developing," Mr. Maxim declared. "Imagine what would have been said of me only five years ago if I had predicted that in 1924 private citizens in their homes in New Zealand and Australia would be communicating back and forth with private citizens in the United States, as well as in England and France?"

"The private citizens of the world have it in their power to communicate with one another without leaving their homes. Where is it leading to? May it not be toward broader political views, more international friendships and better understanding? There is a thrill in receiving music broadcast from France, but I believe it is even more awe-inspiring to converse back and forth with an individual whom you have chanced to meet on the air."

"In re Wireless—"

By A. T.

DINNER was over in my suburban "Three times a day," and about one hour later as I sat varying my variable .001, the door "spoke" three times.

In response to my "Come in!" the landlady entered, accompanied by a friend. The introduction followed. "This is Mr. Adonis Adrian Smith—very interested in wireless. Would you be good enough to, etc.?"

The lady, after making the usual comment, "This wireless is a wonderful thing," departed.

I passed A.A. my last Corona and reached my chair—now a witness-box—and plugged in an extra pair of 'phones for Smith (now K.C.).

VIS was straining the "ether" at the time.

Smith, K.C.: "Who is this?"

Witness: "Sydney Wireless Station."

Smith, K.C.: "What's he saying?"

Witness: "He is sending a private message to a ship. I am not allowed to say what it is."

Smith, K.C.: "H'm! Very interesting. What do you need three lights for?"

Witness: "They are—er—slightly different to lights, Mr. Smith. They detect and amplify the signals."

Smith, K.C.: "Wonderful! Wonderful!! This Marconi must be a clever man."

Witness: "Yes (faintly), Mr. Smith."

Smith, K.C.: "What are those things you wear on your ears?"

Witness: "Telephones."

Smith, K.C.: "Why do you turn that black knob? Makes it louder or softer, I suppose?"

Witness: "Because it (sighs)—. Yes! Yes! Mr. Smith."

Smith, K.C.: "How far can you receive?"

Witness mops forehead and points to NPO and a few other high power stations on the world map.

Smith, K.C.: "Marvellous!"

Witness (very faintly): "Yes, Mr. Smith."

Smith, K.C. (leaving 10 p.m., with thanks): "This radio they talk about is another wonderful thing, too. Something like wireless, I believe. One is speech and the other Morse Code or something."

Witness (surviving): "They are both the—Ah, yes, Mr. Smith."

[University men say that to retain the knowledge received at lectures, it is a good idea to instruct somebody else on the same subject. So! If any "ardent ham" is enthusiastic enough to experiment on this circuit, get in touch with me and I will introduce him to Adonis Adrian at the earliest opportunity.—Author.]

Our London Letter

(From our Special Correspondent.)

"INTERNATIONAL RADIO WEEK."

THE event of the month in this country has been the "International Radio Week," which was an ambitious programme arranged to consist of a series of trans-Atlantic tests between Great Britain and America and between the Continent and America. From reports which are now coming in, the week's series of tests have met with quite gratifying results. It

and steady in their strength, owing to the lesser distance, and, taking all things, the results of the week were very gratifying to the British amateur. The only "fly in the ointment" was the unfortunate fact that to receive America well in this country it is necessary to wait up until after midnight, owing to the fact that until this hour there is no continual darkness all the way across the Atlantic.

the month, and formed a great attraction for wireless amateurs. Many improvements were noticeable in wireless component parts, such items being exhibited as square-low condensers, low-loss coils and neutrodyne condensers. An efficient, but simple, new patented type of valve holder, which possesses a desirable anti-capacity quality, and many other components which have hitherto been almost unprocurable to the ordinary amateur, except at prohibitive prices.

The completely made sets do not show much improvement, because there is hardly room for improvement in the appearance, and what improvement there is takes more the form of more modern circuits being used and technical improvements in the component parts.

Radio Rides Behind The Ox In Jersey

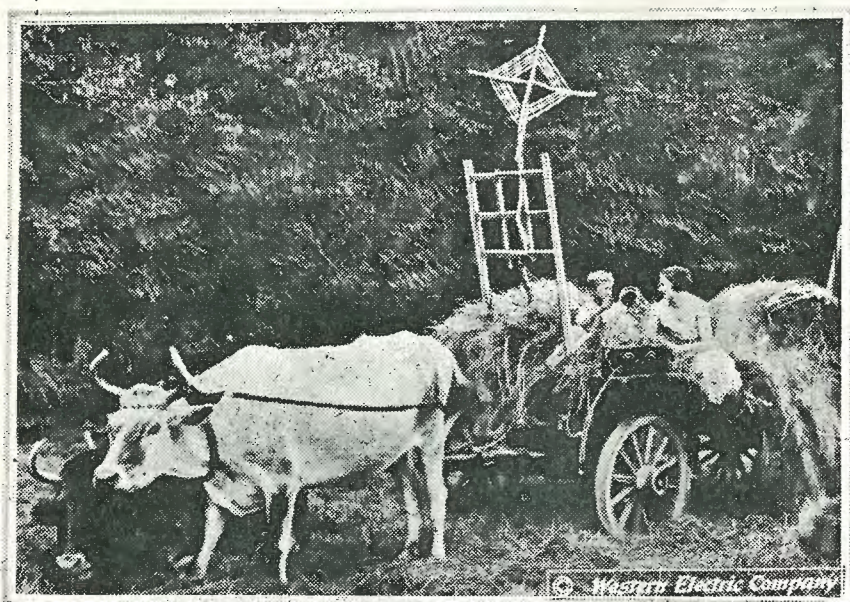

Keeping in touch with the city, the radio headset tells all about politics on the farm of Alfred Reilly, near Butler, New Jersey.

appears that the British broadcasting stations have not been heard very well in America, owing to bad atmospherics over there. The American station heard best on this side of the Atlantic seems to have been KDKA, the broadcasting station at East Pittsburgh, U.S.A. The results were received quite well and the results were relayed through land-lines and then re-broadcasted simultaneously from all the British broadcasting stations. Thus every British amateur, even those with merely crystal sets, were able to hear American broadcasting.

Results received from the Continent were, of course, more satisfactory,

AMATEUR FEATS.

Meanwhile, the purely amateur tests go on apace, with exceedingly surprising results. A British amateur has succeeded, for the first time, in transmitting to the Argentine, where he is reported to have been heard at quite good strength on a small two-valve set. The wavelength used was 100 metres, which rather points to the inference that short waves are equally capable of travelling long distances as long waves.

WIRELESS DEVELOPMENTS.

A large wireless exhibition was held at the White City, London, during

PICTURES BY WIRELESS.

The report that at last pictures have been sent successfully from Great Britain to America by wireless has aroused a certain amount of interest, and opens up a conjecture as to what size this new invention will develop. Pictures by wireless, coupled with wireless telephony, will perfect broadcasting; but perhaps it is rather too soon now to look forward to the time when our broadcasting receiving sets will have white sheets attached on which events are shown as on a screen, while the loud-speaker furnishes voices and sounds exactly synchronised with the visible event. No doubt it will come some day, and it may be two years or twenty, but sooner or later it is bound to come, and we will then be able to watch sporting events in the comfort of our armchairs at home—that is to say, if the sporting events can be carried on without the money which people at present pay to go and see them!

CONDENSERS in series reduce the wave-length, while coils in series increase it.

BY reading a handbook on valves you will get more out of your set.

The Progress of Wireless

Mr. E. T. Fisk Reviews the Position

"THE time will come when Sydney residents, while seated in their homes, will be able, by means of wireless, to see the Melbourne Cup run.

"I am also certain that eventually ships, trams and aircraft, through the same agency, will be driven without crews or their usual staffs."

These two interesting forecasts were made recently by Mr. E. T. Fisk, managing director of the Amalgamated Wireless (Australasia), Ltd., in a comprehensive review of wireless during last year.

Mr. Fisk said that wireless experimenters were convinced that energy would eventually be transmitted in sufficient quantities for power supply. When this was done it would be possible to drive a ship or tram by the use of energy derived from a fixed transmitting station, and supplied without the aid of connecting wires.

Once mechanical control had sufficiently developed one could visualise a "crewless" ship being sent to sea and manipulated over a short range. Successful experiments had actually taken place in America and England. The system by which this could be done would be that vessels would be fitted with specially-arranged selective tuning circuits and other electrical and mechanical selecting devices. Certain combinations would control the steering gear, while others would control the engines for speed and direction. The controlling station on shore would have suitable corresponding transmitting equipment. Those in charge of sending out waves and signals of the right length and code could manipulate the steering gear and engines of the ship at will. Economic considerations would probably preclude a general adoption of this system for commercial purposes, but "crewless" vessels could probably be used to great advantage in warfare. Experimenters were at present engaged upon the perfection of technical details.

Mr. Fisk did not think that Sydney residents could in the near future hope to see the Melbourne Cup run

without going to Melbourne. The accomplishment of a feat, however, enabling them to see it without going was "on the horizon," and he considered it would not be many years before this was possible.

RECENT DEVELOPMENTS.

Mr. Fisk stated that the greatest development of the past 20 years took place last year with the perfection of Marconi's new beam, which brought any two points on the earth's surface into direct communication by means

transmitter. This instrument was so arranged that the beam revolved in the same way as the beam of the lighthouse, but the new wireless revolving beam was so powerful that it penetrated fogs and gave mariners their position at any time and under any circumstances. One transmitter had been erected in the Firth of Forth, and others were being erected in England.

Lifeboats on ships were also being equipped with wireless calling and direction-finding apparatus. The ad-

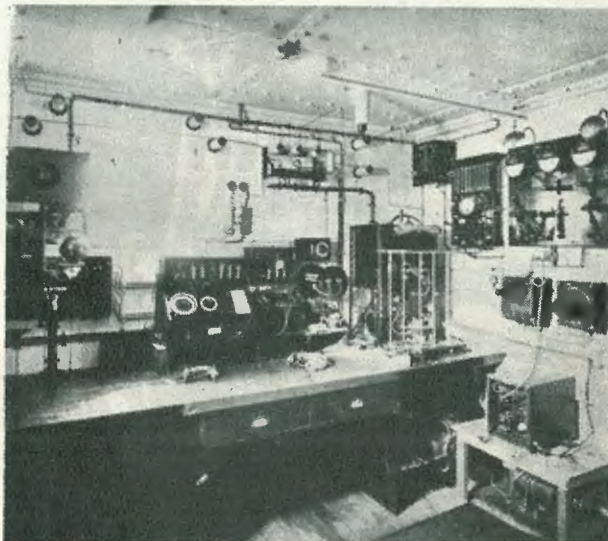

A modern ship's wireless installation.

of energy sent in the direction required, instead of being radiated in all directions.

Great progress had been made during the year in the development of what might be called the "ultra short waves." By use of these, communication between Australia and England and between New Zealand and England had taken place on extremely low power—much less power than would have been expected with the longer waves.

Important developments had taken place in the application of wireless to navigation. There was, for instance, the use of the small Marconi beam

vantage of this would be that in the event of a lifeboat going adrift it would be possible to call for assistance to ships hundreds of miles away, and also to give them particulars of direction to steer by means of the wireless direction-finder.

Another development had been the establishment of a daily newspaper on board Trans-Pacific passenger ships and those plying between Australia and New Zealand. The Orient line had established a daily news service in their ships for the benefit of passengers travelling via the Suez Canal. The latest development, which was only just commencing to be generally

adopted, was the broadcasting from stations on shore of musical programmes and other entertainments to the ships. There were still technical problems to be solved owing to the fact that a ship was of itself a transmitting station. A number of vessels had been equipped for this purpose in the Atlantic, where broadcasting stations were comparatively close on both sides. Dances had actually taken place on ships at sea to music played on shore.

Mention should be made (said Mr. Fisk) of the decision last year of the police to use wireless to assist them in their night patrol and other work. The innovation had been considered a great success, and had proved of great value to the authorities in their work.

During the period under review the low temperature valve, which was particularly useful for "listening-in" purposes, had come into general use. It enabled people to operate receivers in their homes with ordinary dry batteries instead of having to use accumulators.

Another invention which was gaining in popularity was a type of broad-

casting receiver, which could be placed in a room in any position and also carried from room to room. It required no outside aerial or earth connections and received broadcasting over suitable distances.



A phase in the local manufacture of Radio Valves.

THE BEAM STATIONS.

Marconi's success in building a powerful short-wave transmitter, and at the same time concentrating wireless energy into a beam, had revolutionised the methods of world-wide

wireless communication, said Mr. Fisk. His beam transmitter and receiver were no longer in the experimental stage. His company was now prepared to erect stations and to guarantee speed and efficiency far higher than they could guarantee for the high-powered stations. In August the Federal Government made arrangements for the erection of two beam stations in Australia—one to communicate with England and the other with Canada. All the preliminary arrangements had been completed.

The construction of the two beam stations would be commenced within a few weeks, and would probably be in working order before the end of the year.

They would give commercial telegraphic services between here and England and between here and North America at very much cheaper rates than are available at present.

There was a possibility that at a later stage the stations would be used for telephonic communications, enabling direct personal conversations to take place between England and Australia and also in North America.

It was worthy of note that the pre-

A MAN IN BOGGABRI

who possesses a "Burgin" Phone, gets 6 W.F. Perth, W.A., 3 L.O. Melbourne, 2 F.C. and 2 B.L. Sydney, and low-powered New Zealand Stations in loud speaker strength. He is on the instant with the Test Match results, and is looking eagerly forward to Galli-Curci and other big events.

A Broken Hill user says:—"The set works the loud speaker splendidly; couldn't wish for anything better; 3 L.O. Melbourne I receive the strongest; then 2 B.L. and Farmers, and 2 R.J., also 6 W.F. Perth on 'phones, very clear. I am obtaining excellent results, no set could give better."

BURGIN VALVE SETS SPECIALLY REDUCED!

4-Valve Sets from £32.

5-Valve Sets from £40.

Other Sizes Correspondingly
Reduced.

Our Annual Stocktaking, just completed, has shown that during our recent removal to new and larger premises, some of our well-known Burgin Valve Sets were very slightly damaged. These have all been immediately reduced in price, although all are otherwise in PERFECT CONDITION.

During 1925 a wealth of musical gems will be broadcasted—thrilling finishes in Sport; Valuable Business and Topical News will flood into the home if you are equipped to receive it.

This is the greatest opportunity in the history of wireless. The sets we have reduced in price are among the best made, and you enjoy these extraordinary reductions because of slight shop soiling, which is practically unnoticeable. An expert Staff is at your disposal for installation service—so act NOW, and hear the Test Scores at first hand.

Call and see us — or write — to-day.

BURGIN ELECTRIC CO. LTD.

LICENSED WIRELESS MANUFACTURERS AND SUPPLIERS,

340 KENT STREET — — — — SYDNEY.

liminary experiments which were successful had been conducted with only a part of Marconi's new transmitter. The portion of the apparatus which concentrates the energy into a beam was not available. It would be embodied in the complete station, and

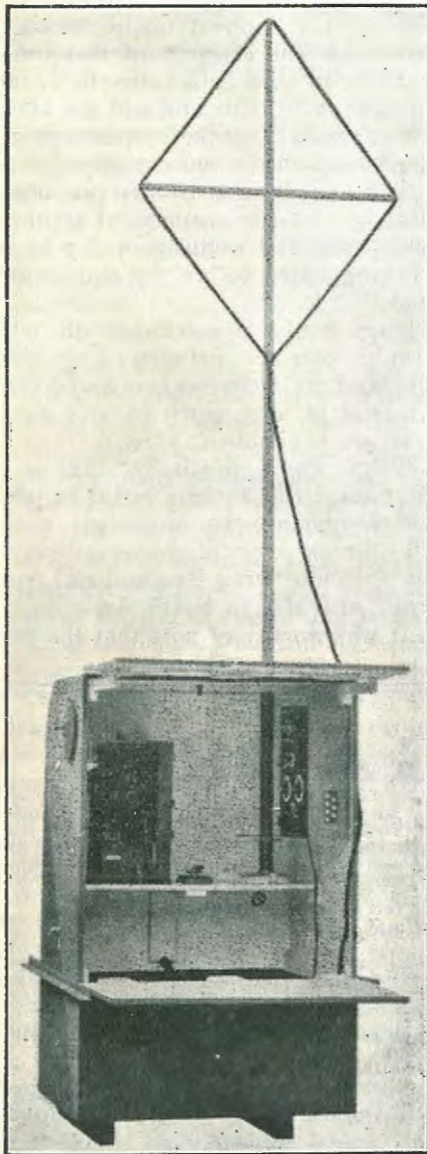

Marconi Wireless Installation for Ship's Life-boat.

would, therefore, give greater results than were obtained during the experimental period.

BROADCASTING STATION FOR QUEENSLAND.

IT is announced by Amalgamated Wireless (Australasia), Limited,

that arrangements have been completed with the Queensland Government for the erection of a 5-k.w. "Class A" broadcasting station at Brisbane. Work will be commenced at an early date, and it is anticipated that the station will be in operation for the coming winter. In many respects it will be a replica of the three broadcasting stations—2FC Sydney, 3LO Melbourne, and 6WF Perth—already constructed by the company. The whole of the transmit-

wireless traders in N.Z. over the delay in the launching of the company that is to maintain a broadcasting service in the Dominion. The syndicate formed by the traders, New Zealand Broadcasters Ltd., reports that it has proceeded as far as is possible, having even appointed the sharebroker; but that final adjustments on the part of the Government are delaying the immediate floating of the company. Until these are concluded, nothing further can be done.

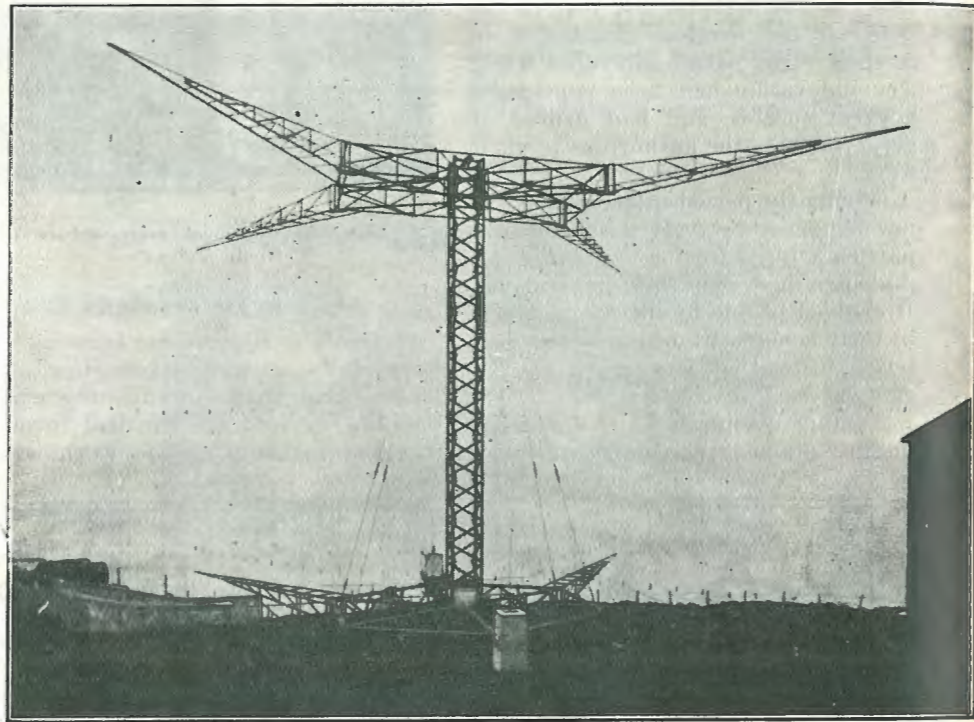

Marconi Wireless Beam Reflector at Inchkeith Island, Firth of Forth.

ting apparatus will be manufactured at the radio-electric works of Amalgamated Wireless (Australasia), Limited, Sydney.

N.Z. BROADCAST SCHEME AWAITS FINAL ADJUSTMENT.

THERE is growing impatience among broadcast listeners and

The scheme, as is generally known, covers the erection of a 500-watt broadcasting station in Auckland, Wellington, Christchurch and Dunedin; and the maintenance of a satisfactory broadcasting service. The service will be controlled by a board of eight members: four representing the radio dealers, three the Government and one the listeners. The capital of the proposed company will total £30,000; of which £10,000 will be authorised, the remaining £20,000 being in the form of debentures. With this sum it is hoped to establish the four 500-watt stations.

TEL.: CITY 4429

Charles D. Maclurcan
CONSULTING RADIO ENGINEER

MACLURCAN & LANE, LTD.
9-13 Brisbane Street, Sydney

SATISFACTION IS CERTAIN WITH United Distributors' Products

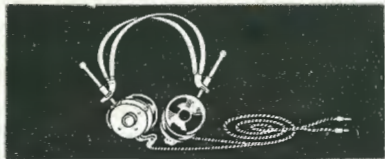

"PICO" HEADPHONES.
Strong, light, durable, fully guaranteed, give you programmes at their best, 25/-

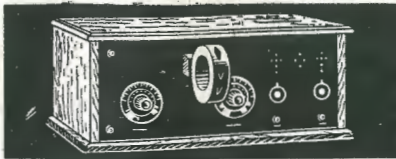

UNITED HOME ASSEMBLY SETS.
One to five Valves, can be put together with a screw-driver and a pair of pliers. Prices 5 to 11 guineas.
New Circuit now available.



SIGNAL AUDIO FREQUENCY TRANSFORMER.
Made in Australia, as good as the most expensive imported 21/-
Why Pay More?



THE "MUSIC MASTER,"
the De Luxe Loud Speaker. Has an amplifying bell of resonant wood £12



RELIANCE Condensers.
Low loss, accurate and reliable. Straight line 22 & 44 plate Vernier.



UNITED BATTERIES.
Made by the Clyde Engineering Co., Ltd. Announcement later.



"SIGNAL" VARIABLE CONDENSERS.
Distance and volume assured. All capacities, plain and vernier.



"ATLAS" LOUD SPEAKERS.
The "Musician of the Air." Clear, mellow, true £7/10/-



UNITED CRYSTALS.
Made and tested in Australia. Price, 1/3. Galena, Midite, Hertzite, Pyrites, Claritone, Zincite. Same mounted 1/9

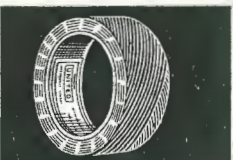

UNITED COILS.
Guaranteed, correct, efficient. True Inductance. Price, 2/- upwards. Mounted and unmounted.

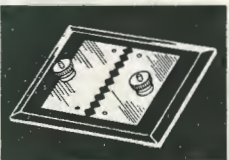

Static Lightning Arrester, 2/6. Required by the Fire Underwriters, accurate.

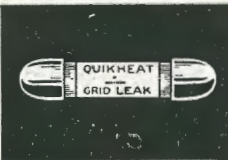

QUICKHEAT GRID LEAKS.
13 different capacities, 100,000 to 10,000, 1/2 meg. to 5 meg.



SIGNAL DIALS.
Best grade. Bushings absolutely true. Inlaid with fast white enamel



FROST FONES.
2,000 ohm, Aluminium type 32/8
3,000 ohm, Aluminium type 37/8
3,200 ohm, Maroon Bakelite type .. 45/-

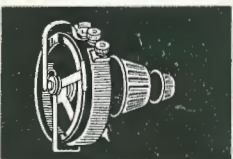

FROST RADIO, 607-610.
Maroon Bakelite Tube Control Unit 17/8
3 Different Capacities.

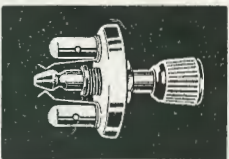

FROST RADIO, No. 608.
Push-Pull Battery Switch 4/-



"FROST" RADIO RHEOSTATS AND POTENTIOMETERS.
Nos. 650-2, Maroon Bakelite, 6 and 35 ohm Rheostats 7/3
Nos. 651-3. Same with Vernier 9/6

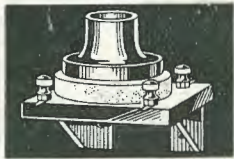

FROST RADIO, No. 617-618. Sponge Base, Shock Absorber Sockets, for 201A and U.V. 199 6/3

YOUR DEALER CAN SUPPLY YOU AT THESE PRICES.

ABOVE ARE ONLY A FEW OF THE GUARANTEED PRODUCTS OF

UNITED DISTRIBUTORS LIMITED

(Wholesale Only)

72 Clarence Street,
SYDNEY.

592 Bourke Street,
MELBOURNE.

27 Chesser Street,
ADELAIDE.

847 Hay Street,
PERTH.

Cr. Jervois Quay & Harris St.,
Wellington.

Talks from 3LO

A Simple Explanation of Wavelength

WE all know that the wireless signals we hear when listening-in arrive at our homes in the form of waves. Now waves must travel through some medium—water, air, etc.—so let us first agree that wire-

less waves travel to us through a medium called ether, and let us assume that the electrical energy in the aerial of the broadcast transmitting station causes a wave to form in the ether which travels at the

speed of light, i.e., 186,000 miles per second, passing outward in every direction and carrying the music to which we listen.

These ether waves have height, called amplitude, and length, called wavelength. We have all heard of wavelength and that 3LO uses a wavelength of 1,720 metres. Why do different stations have different wavelengths? Just a minute, and we shall see. Suppose we have a perfectly round, large dish and fill it with water, and then we take a small pebble and drop it exactly in the centre. Ripples will travel outwards from the centre to the edge of the dish. Now these ripples, assuming the dish is round and the pebble was dropped exactly in the centre, will reach the edge all round at exactly the same instant, that is, they travel at the same speed in all directions. Another thing, the distance between each consecutive ripple will be exactly the same. Now suppose while the ripples were travelling outward we could suddenly freeze the water, then, if we measured the distance from the top of one ripple to the top of the next this would be the wavelength; and if we measured the distance from the top of a ripple to the trough or height, this would be the amplitude.

Suppose the water in the dish is once more calm and we take another pebble, this time we drop it from twice the height and again measure the distance from crest to crest of any two consecutive ripples. We will find that the distance is exactly the same as before, but when we measure the height of a ripple we will find it is greater.

In dropping the pebble from a greater height we caused a larger disturbance in the water and the waves were higher or had greater amplitude, but their length remained the same.

The ether waves which travel out from a broadcast station and carry on their backs the music to which we listen are similar to our water ripples in that they have length and



Betty Ross, well-known interpretative dancer, practices her steps to Radio music.

amplitude. The wavelength is governed by the amount of inductance and capacity in the transmitter circuits and the amplitude is governed by the amount of power at the transmitter.

Returning to our dish of water and the ripples, there is one thing we should have noticed, and that is that while the wavelength remains the same, no matter how far the waves travel, the amplitude does not. It becomes less and less as the waves travel further from their starting point and finally, if the dish were large enough, they might die down and cease to exist. Just so with our wireless waves. the farther we go from the transmitting station the less their amplitude—that is, the farther away we go, the weaker we receive the music.

The power of a broadcast station is expressed in kilowatts or thousands of watts. The watt is the electrical unit of power, and this expresses the station's ability to produce amplitude in the wave it sends out. Now, I think when you read that 3LO employs a wavelength of 1,720 metres and a power of 5 kilowatts, you will understand just what is meant.

KGO HEARD IN THE YUKON.
RESIDENTS of Dawson, Yukon Territory, Alaska, find the long polar days less irksome when radio programmes are received.

H. G. Blackman, acting sheriff of Yukon Territory, has written KGO that he hears programmes even during daylight. He says that it is very encouraging to Dawson radio fans who are looking forward to the time when they will be able to hear radic programmes night and day throughout the year.

We Leave it to You!

Editor *Radio*, Sydney,

Dear Sir,—I have a 5 valve receiver which will not give results. I wired it up as per a diagram I saw in *Weird Wireless*. At first the filaments would not light up. I thought I had connected the wrong battery, so I reversed the connections and the fila-

friend told me to go to an estate agent's office—not a radio shop.

Then I was advised to put a couple of megohms in the grid connection, but I couldn't do that without breaking the valve.

My aerial seems to be alright; do you think it is long enough?

It runs right across the street to a pole in a friend's backyard, but my pole is not high enough for it to clear the top of his roof (which is iron), so portion of the aerial is resting on it. Insulators are fixed at each end, and the lead-down wires connected between the insulators and the bit of wood keeping the two wires apart. I have wound the down wires round a sewer ventilator to keep them from touching the brick chimney.

I have already bought five new valves, which are supposed to work from dry batteries. I emptied the solution out of my accumulator, but the filaments only lit up for a little while and gradually went out again.

I found the B battery should not be connected to the filaments, so hooked it up to the "fones," but every time I connected up I heard a heavy click, so I "shorted" them, as I did not want them to "go bung."

I heard a man in the tram the other morning talking about a brass battery he had put in his set. Will this make an improvement, and do you know where I could get one?

Hoping you will be able to tell me what is wrong with my set, and that I have not asked too many questions, I am, yours sincerely,

SOL. IDIVORY.

AMERICAN BROADCASTING EXPERIMENTS.

MR. E. H. SCOTT, of Chicago, formerly of New Zealand, who is visiting the Dominion, states that the undermentioned American stations will transmit programmes on the following two nights, to see if it is possible to reach Australia and New Zealand:—

January 28: Station WGN, Chicago, on a wave length of 370 metres.

February 4: Station WQJ, Chicago, on a wave length of 448 metres.

February 10: Station WFAA, of Dallas, Texas, on a wave length of 476 metres.

All these stations will start transmitting at 8 a.m. Australian time, and will continue broadcasting for four hours.

ments lighted up well, but suddenly went out, which proved the B battery must have run down.

A friend of mine told me I needed a few more ohms in the valve rheostat, so I asked one or two radio dealers for a couple, but they didn't seem to understand what I wanted. One

"The Theatre, Society and Home"

LIKE WIRELESS IT TOUCHES ALL PARTS OF THE WORLD.

After Reading Please Pass on to a Friend. Larger Circulation Means More Advertisements :: More Advertisements Mean Extra News, Pars, and Home Chatter.

PUBLISHED MONTHLY. SOLD BY ALL BOOKSTALLS.

HEAD OFFICE: 16 BOND STREET, SYDNEY.

Branches: 100 King St., MELBOURNE; 75 Elizabeth St., BRISBANE; 32 Waymouth St., ADELAIDE.

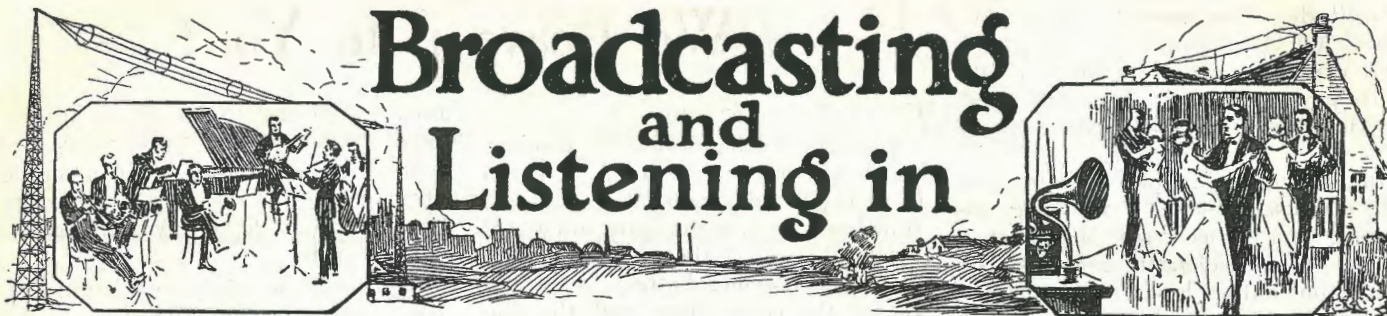

Broadcasting and Listening in

2FC

BROADCASTING TIMES.

Sydney Mean Time
CALL SIGN 2FC, SYDNEY.
Wave Length: 1100 metres.
Power: 5 kilowatts.

Midday Session:

- 12.55 The Chimes of 2FC.
12.58 Time Signals from Farmer's Master Clock.
1.0 Coastal Farmers' Market reports, Stock Exchange information, Weather information, "Sydney Morning Herald" news service, Reuter's and Australian Press Association cables, "Evening News" midday news service.
1.30 Close down.

Educational Session:

- 3.0 The special Education Session, which has been arranged by the N.S.W. Department of Education, will be held on Mondays, Tuesdays, Wednesdays, and Thursdays of each week. Friday, Musical Programme from 8 p.m. to 3.45 p.m.
3.3 The Chimes of 2FC.
3.50 Musical Programme.
Afternoon Stock Exchange information, late Weather information, "Evening News" afternoon news service.
4.0 Close down.

Early Evening Session:

- 6.30 The Chimes of 2FC.
6.33 Children's Hour.
7.10 Dalgety's Market reports (wool, wheat, stock), fruit and vegetable markets, late Stock Exchange information, Weather News, Shippings News, late "Evening News" news service, Reuter's and Australian Press Association cables.
7.20 Close down.

NIGHT SESSION:

- 7.55 The Chimes of 2FC.
8.0 Musical Programme.
The evening entertainment broadcast from Station 2FC is varied and includes Theatrical transmissions from the Theatre Royal, Her Majesty's Theatre, The Criterion Theatre, The Palace Theatre, The Tivoli Theatre, Haymarket Theatre and the Prince Edward Theatre.
Jazz music provided by the Wentworth Orchestra is also broadcast direct, and high-class musical entertainments provided at the Studios of 2FC, in which Sydney's leading artists participate, are also features of the programme.

SATURDAY: Midday, early evening and evening sessions as on week days, afternoon session as follows:—

- 3.15 The Chimes of 2FC.
3.18 to 3.45: Late Sporting information.
3.45 Close down.
SUNDAY: No midday, afternoon or early evening session. Church Services from one of several Churches, commencing at hour appointed for Divine Service, according to the Church, and varied by some Sacred Concert from the Studio of 2FC.
10.0 Close down.

6WF

BROADCASTING TIMES.

Perth Mean Time.
Wave Length: 1250 metres.

Midday Session:

- 12.30 Tune in to gramophone.
12.35 Market Reports of The Westralian Farmers' Limited.
12.38 News Service.
12.42 Weather Reports.
12.44 Gramophone Items.
1.0 Time Signal.
1.1 to Gramophone and Pianola.
1.30
1.31 Close down.

Afternoon Session:

- 3.30 Tune in to Pianola.
3.35 } Special programme, comprising
to Talks, Gramophone, Pianola, Wes-
4.0 } tralian Farmers' Studio Orchestra.
4.1 Close down.

Early Evening Session:

- 7.5 Tune in to Gramophone.
7.10 Bedtime Stories.
7.45 Market Report.
7.57 Weather Report.
8.0 Time Signal.
8.1 News Cables.

EVENING SESSION:

- 8.10 } Entertainment.
to }
— } See list hereunder.
Monday: 8.10, Lecture: 8.45, Wesfarmers' Orchestra.
Tuesday: 8.10, Professional Concert.
Wednesday: 8.10, Theatre or Hall Broadcasting.
Thursday: 8.10, Professional Concert.
Friday: 8.10, Concert Evening and Lecture.
Sunday: 7.20, Church Service.
Saturday: 8.15, Wesfarmers' Studio Orchestra.

SATURDAY:

- Midday Session:**
12.0 Tune in to Gramophone.
12.5 Market Reports of The Westralian Farmers' Ltd.
12.10 News Service.
12.15 Weather Report.
12.16 Gramophone and Pianola.
1.0 Time Signal.
1.1 Close down.
Early Evening Session:
7.5 Tune in to Gramophone.
7.10 Bedtime Stories.
7.45 Market Reports.
7.57 Weather Report.
Evening Session:
8.0 Time Signal.
8.2 News Cables.
8.15 Wesfarmers' Studio Orchestra.

3LO

BROADCASTING TIMES.

Melbourne Mean Time.
Wave Length: 1720 metres.

MONDAY TO FRIDAY:

Midday Session:

- 12.55 Time Signals. "Argus" and "Herald" News Service, Reuter's and the Australian Press Association Cables.

Afternoon Session:

- 3.30 Musical programme.
4.45 "Argus" and "Herald" News Service.

Early Evening Session:

- 6.30 Children's Hour; "Billy Bunny" Stories.
7.0 "Argus" and "Herald" News Service, Reuter's and the Australian Press Association Cables.

Evening Session:

- 8.0 Theatrical Items, Lectures, Vocal and instrumental items.

TUESDAY NIGHT.

- Carlyon's (St. Kilda) Dance Orchestra.

SATURDAY:

Midday Session:

- 12.55 Time Signals, "Argus" and "Herald" News Service, Reuter's and the Australian Press Association Cables.

Afternoon Session:

- 3.15 Musical programme.
4.0 "Herald" News Service. Results of Races and other sporting events broadcasted immediately details received.

Early Evening Session:

- 6.30 Children's Hour; "Billy Bunny" Stories.
7.0 "Argus" and "Herald" News Service, Final Sporting Results.
8.0 Vocal and Instrumental Concerts.

SUNDAY:

Afternoon Session:

- 3.0 Pleasant Sunday Afternoon Services from Wesley Church.

Early Evening Session:

- 6.30 Children's Hour; "Billy Bunny" Stories.
7.0 Church Service.

Evening Session:

- 8.30 Concerts from the Studio.

ONE of the most popular receivers on the market at the present time is the Radiola IV. It is an Australian production, manufactured at the radio-electric works of Amalgamated Wireless (A/sia.) Limited, and their representative states that the sales

Appreciatory letters bearing on the operation of the Radiola IV. are continually being received. A prominent Newcastle professional man has written to the effect that notwithstanding at this time of the year when good reception is not usually obtained, he can bring in 3LO, Melbourne, on his Radiola IV. with an Amplion loud-speaker with fair volume, while his reception of 2FC and 2BL is wonderfully clear, and for clarity, volume and sweetness of tone he has not heard anything equal to this receiver. Before making his purchase this gentleman had during a period of five months listened to and used five different makes of four-valve sets.

in, and they all hope that they may hear another church service from your station next Sunday evening. The baptismal service was very impressive, and caused a marked silence among the prisoners."

2BL

BROADCASTING TIMES.

Sydney Mean Time.

Wave Length: 350 metres.

Midday Session.

12 } Musical Programme, with News
to } Reports supplied by "The
2 p.m. } Guardian."

Afternoon Session.

3 } Musical Programme, with News
to } Reports supplied by "The
5 } Guardian."

Early Evening Session.

7 Nursery Rhymes and Bedtime Stories.
7.45. Pitt, Son & Badgery Stock Exchange Reports.

Night Session.

8 Nightly Concert.

EVENING ENTERTAINMENT.

Monday: "Jazz" night, with vocal items from the Studio.
Tuesday: Classical Studio Concert.
Wednesday: Dance Night.
Thursday: Broadcasters' Popular Concert.
Friday: "Jazz" night, with popular items from the Studio.
Saturday: Popular Concert.
Sunday: Classical and Operatic Concert.

figures for this particular model are increasing daily. This is no doubt largely accounted for by the public demand for the better class of set, which combines efficient reception, radio engineering skill, and cabinet workmanship of the highest standard.

DOES being in gaol have any terrors in this radio age? It would seem from a letter addressed to KGO from some inmates of the Marin County, California, gaol, who signed themselves "The Happy Five," that it does not.

"Being confined to the Marin County gaol," say "The Happy Five," "we believe we are the first on this coast to have radio in our cell. We want to show you our appreciation for the play 'Tweedles,' by Booth Tarkington, which you broadcasted to-night. It was great stuff. We pass many happy hours listening-in."

Farther north, in Spokane, Washington, prisoners in gaol also receive benefits from radio. "We have just been listening to your Sunday evening church service and we enjoyed it very much," writes a prisoner. "There are over one hundred prisoners here in the county gaol listening-

3AR

BROADCASTING TIMES.

Melbourne Mean Time.

Wave-length: 480 metres.

MONDAY TO SATURDAY.

Morning Session:

11.0 Musical Items.
11.45 Weather Report, Stock Exchange Information.
12.0 Time Signal, Close Down.

Afternoon Session:

3.0 Musical Items.
3.30 Weather Report, Afternoon Stock Exchange News.
4.0 Time Signal, Close Down.

EVENING PROGRAMME.

7.0 Children's Corner, by "Uncle Rad."
7.35 Closing Stock Exchange News.
7.45 Weather and latest Market Reports. News Bulletin.
8.0 Vocal and Instrumental Concerts.
10.0 Close down.

SUNDAY.

Afternoon Session:

3 to 4 Musical Items.

EVENING PROGRAMME.

7.0 Children's Corner, by "Uncle Rad."
7.30 Vocal and Instrumental Items (Church Services announced).
9.30 Close down.

YOUR filament should be burned on constant voltage rather than current.

CRYSTAL detectors are good in that they are distortionless.

DO not put valves in the sockets until the rheostats are turned off.

Wireless Receiving Sets Made to Order

I am prepared to make sets of any design, either complete or parts only.

VICTOR MARKS' Radio House

BEAMISH STREET, CAMPSIE.

KFI.

THE old 500-watt equipment of the radio broadcasting station KFI, of Los Angeles, California, owned and operated by Earle C. Anthony Inc., was changed to new 5,000-watt Western Electric equipment in the middle of last December and, consequently, a largely-increased long-distance reception will result.

Under the present law, the station has a license for the use of 1,000-watt transmission and 1,500 for special super-station tests and programmes. Whether additional power will be used depends on conditions of the future.

The new station will enable daytime listeners in the United States to use less amplification for reception. Even before the change KFI programmes have been heard by the Macmillan North Pole Exploration party, and by radio enthusiasts in Honolulu, Samoa, Australia and Japan.

The old studio has been remodelled and will still be used for broadcast purposes. In addition, a large reception hall, with concealed loud-speak-

ers for the entertainment of guests, will be used as an auxiliary broadcast studio for large bands and orchestras. In the furnishing, the old Spanish type will be used, with here and there a dash of Oriental trimmings to liven the atmosphere.

The cost of the new equipment will be approximately £25,000, not including the old equipment, structure or elevators, and the monthly cost will be about £1,500. Remote controls to the five points in the city will be maintained as before. Acting on a toll basis, many commercial and industrial firms will present musical and other programmes.

Tune in on KFI at 469 metres from noon until midnight, Pacific standard time (6 a.m. to 6 p.m. Sydney mean time) and hear the first of the world's super stations.

RECEPTION IN N.Z.

RADIO 6WF is received clearly in N.Z. with detector and two stages of audio. With the same combination 2FC is heard much too loudly for the wearing of telephones, and Melbourne

(3LO) is also very good. In one instance, 2FC was listened to thirty yards from the loud-speaker.

The new radio station at Adelaide has been reported as having been heard faintly on January 1.

Radio 1YA, Auckland, has been supplying good entertainment since the holidays; while 2YM, Gisborne, is a very worthy second. Mrs. Dore, of Wellington, continues to assist with the programmes there, and is rightly termed "The Mother of Broadcasting" in that city. Radio 3AC, Christchurch, is struggling to maintain a broadcasting service against overwhelming odds; the transmission, unfortunately, is not as good as it used to be. Taihape (2AQ) is a station that gets out very strongly at times, and the programmes are generally well worth listening to.

Conditions of listening have, on the whole, been rather uncertain; one night it would seem as if the evil god of X's was taking his Christmas holidays, but the next evening that optimistic wish would "go west" immediately on turning up the filament.

"RADION" within 11° of the North Pole



The biting cold of the frozen north, many degrees below zero, holds no terrors for Radion.

Frozen in the ice for weeks within 11° of the North Pole, the "Zenith" Radio set taken by Dr. MacMillan on his recent expedition provided the famous explorer and his men with the only news obtainable of the outside world.

This set, carefully selected for its adaptability to any climate and condition, was equipped with both Radion panels and parts. Radion once again proved its matchless qualities under the most vigorous test any radio equipment was ever put to.

Radion will prove equally supreme in any climate. It is made expressly for wireless work and far excels any other material in the four main radio essentials, namely:

1. Low Angle Phase Difference
2. Low Dielectric Constant
3. High Resistivity
4. Low Absorption of Moisture

These characteristics result in a clear, satisfactory reception unobtainable by the use of any inferior material. Do not jeopardize all the time and effort you put into the making of your set by using inefficient insulating material. Look for the name Radion on every panel, dial, socket, knob, etc., so that you will be sure you are getting the very best that science has devised.

International Radio Co., Ltd.,
 91-92 Courtenay Pl., Wellington, N. Z.
 200 Castlereagh St., Sydney, N.S.W.

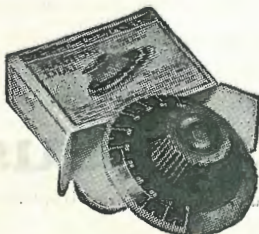

C45

Using Earth instead of Aerial

WHILE the majority of people can put up some sort of an aerial, there are some who cannot and who also cannot afford a multi-valve set that uses a loop aerial. For this class the hookup using a ground connection only is submitted.

The drawing shows the apparatus needed for this set, and is the same as for one using an aerial. It is simplicity in itself, and consists of a coil, variable condenser, valve and accessories. The coil should be about 60 turns, although it will vary with the length of ground connection. The variable condenser is .0005 microfarad capacity, and the audion should be one of the detector valves, although it will work on any of the standard tubes.

The hookup is a little different from the regular one, using aerial and ground connection, and is quite critical as to values and operation.

The ground connection, which is your collector, is connected to the coil, variable condenser and grid condenser. The other side of the coil and condenser is connected to the plate and telephones, the plate and filament circuit being similar to other hookups, although the grid return is not connected to the filament.

This is a unit controlled set, all tuning being done with the variable condenser, which should either be of the vernier type or have a dial that allows vernier adjustments. For your individual location experiment with the connections on the variable condenser, that is, first try rotor plates

to ground and then stator plates. A fixed condenser may also be tried across the telephones, telephones and B battery, or leave it off.

The energy received over this type of set is electrostatic, and not electromagnetic, as in other types of receiving sets using an aerial. As the energy picked up by this type of set is received through the ground, very little atmospherics are heard on it, even during bad radio weather, and there is absolutely no danger even with a local storm raging.

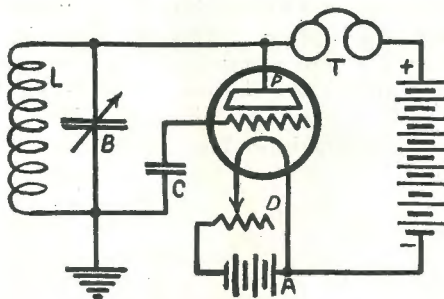

Tuning of this set is very sharp, and you will be able to copy stations even with locals going full blast. For loud speaker operation, audio frequency may be added in the usual manner, and as very little outside noise is heard on this type of set, high audio frequency amplification is permissible, which means that three stages may be used without the usual crashes of atmospherics.

This type of set is really portable when valves that will operate from

dry cells are used, because the batteries may be placed in the same cabinet, and wherever you are the collector may be connected to the ground, or even 20 feet of wire may be thrown on the ground to act as the collecting agency. If you are in a canoe or boat, the wire may be dropped overboard.

L, coil; B, variable condenser; C, grid; P, plate; T, telephones; A, filament battery.

WHEN planning on putting up an aerial, take into account the objects near it as they may interfere with good reception.

DO not let the solution drip off the hydrometer when testing your storage batteries.

RADIOPHONE signals sound better on a crystal than a valve.

JOIN a radio club if you want to get good information on sets.

Recent Patents

(Continued from page 733.)

temperature above which atoms, striking the filament, leave as ions, range from 1000 to 1200 degrees C. Above the critical temperature the ion emission is proportional to the vapour pressure, which may be fixed at different desired values by an external heater such as an oil bar, indicated by the dotted line (18).

— QUALITY IN RADIO APPARATUS —

STROMBERG-CARLSON

Radio Head Set, 2-A	40/-
Loud Speaker, 1-A, with Cord and Plug	£7/10/-
Transformer Audio, 3-A	33/6
Transmitter, 7-L	25/-
Radio Jacks, Plugs, etc.	

JEWELL

Radio Measuring Instruments, built for accuracy and to last. A-B Battery Testers, R. F. Meters, Wave Meters, Valve Tester, Grid Leak Tester, etc.

DURHAM Variable Grid Leak, 2 to 10 Megs., 4/6.

Factory Representatives:

L. P. R. BEAN & CO. LTD., 229 Castlereagh Street, Sydney

Melbourne: H. G. SMALL & CO., 360 P.O. Place. Brisbane: S. H. SMITH, 209 Adelaide Street. Adelaide: CHAS. ATKINS & CO., LTD., 90 Currie Street. Perth: T. MUIR & CO., 99 William Street. Hobart: J. COOPER, 90 Harrington Street.

The Super-sonic Heterodyne Receiver

THE purpose of this article is to briefly explain the theory of "Super-Heterodyne" reception and the construction of an efficient receiver operating on this principle. The great selectivity, high sensitivity and simplicity and stability of operation of this method of reception are three of the principal features which have attracted the interest of Radio enthusiasts in all parts of the world. From an instrument so complicated as to confine its use to laboratories and skilled engineers it has rapidly been developed into a household receiver unequalled in performance and ease of manipulation. To enable readers to clearly understand the function of the different sections of the circuit arrangement, the first portion of the article is devoted to theoretical considerations.

By Geo. Apperley.

THEORY OF HETERODYNE RECEPTION.



LL rectifiers, including the three electrode valve, are disproportionately insensitive to weak signals by reason of the shape of their characteristic curve. This was fully explained in an article published in the last issue of *Radio*. The maximum possible efficiency of reception is, however, obtainable even for the weakest signal by impressing on the rectifier a locally generated E.M.F. of such amplitude as to well cover the bend of its characteristic curve in such manner as to cause it to be added to the E.M.F. due to the incoming signal.

This is diagrammatically shown in Fig. 1 in which A is an average characteristic curve of a rectifying valve. The locally generated E.M.F. is represented by L, whilst that due to the incoming signal is shown by S. The result of adding these two together is shown by R. The rectified current due to the local oscillations is shown by l and this will remain constant as long as the oscillations are maintained. When the signal S is applied, the rectified current is increased by R and remains at this value so long as the signal lasts. For convenience it has been assumed that the incoming signals and the locally generated oscillations are exactly in phase, but in practice this condition is seldom, if ever, obtained, but the illustration will serve to show how rectification can be made more efficient by utilising a maximum portion of the characteristic curve.

It is well-known that aural reception of continuous waves is usually effected by the "heterodyne" or "beat" method in which feeble oscillations generated locally are superimposed on the incoming signals. If

the local oscillations have a frequency differing slightly from that of the incoming signals the two will at one moment be in phase and will, therefore, assist one another and at the next moment will be opposite in phase and will oppose. This is shown in Fig. 2, where S represents the incoming signal oscillations and L the locally generated oscillations. These two combined produce oscillations of

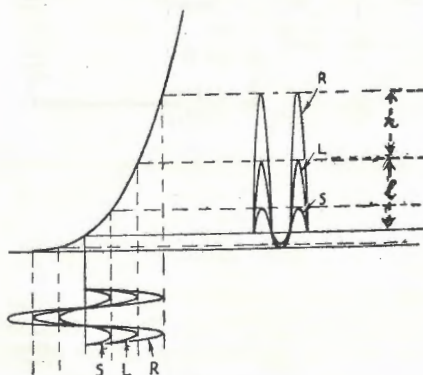

Fig. 1.

a complex frequency as shown by C the amplitude of which constantly changes at a frequency equal to the difference of the frequencies of S and L. These so-called beats when rectified produce a pulsating current P in one direction the pulsations having, of course, the same frequency as the variations of amplitude or envelopes E of the combined oscillations. For the reception of continuous wave signals the locally generated frequency is usually adjusted to produce a beat frequency of about 1000 cycles per second, which is, of course, audible and has been found to be most suitable. If the incoming signal has a wave-length of 600 metres, its frequency will be 500,000 and the locally generated oscillations will therefore have to be set to a frequency of 501,000 or 499,000. Most readers

when listening to broadcast stations have heard the characteristic and annoying whistle of near-by receivers. This is caused by careless neighbours allowing their receiving sets to oscillate and radiate feeble oscillations which heterodyne with the waves sent out by the broadcasting station. As the offender varies the adjustment of his receiver, so does the pitch of the whistle vary, but not only to the extent which is heard but to frequencies well beyond the senses of the human ear.

The method of creating beats for the aural reception of signals is known as Sonic Heterodyne and it will now be understood that by its use the rectifying valve becomes equally sensitive to strong and weak signals.

SUPER-SONIC HETERODYNE RECEPTION.

The above principle may also be used for the production of heterodyne beats having a frequency well above audibility. For instance, if the incoming signal as before has a frequency of 500,000 cycles per second, we may combine with it a locally generated frequency of either a beat frequency of 100,000. This frequency when rectified and passed into a suitable transformer will set up an oscillating current of 100,000 cycles which is, of course, far above the range of audibility corresponding as it does to 3,000 metres wave-length.

This frequency may again be heterodyned to give beats within the range of audibility.

Up to the present we have assumed the incoming oscillations to be of constant amplitude such as are employed for continuous wave telegraph signalling. Let us now analyse the effect when the oscillations received are modulated by speech or other sounds.

A (Figure 3) represents the oscillating energy received from a broadcast station — its amplitude varying in accordance with sounds transmitted. It must be observed that, although the amplitude is varying the frequency remains

E in an associated circuit tuned to 100,000 cycles or 3,000 metres. We have now obtained from an incoming modulated wave of 600 metres an entirely new frequency corresponding to 3,000 metres and varying in amplitude in exactly the same manner and

degree as the original. This new frequency may now be subjected to amplification and rectification in exactly the same manner as a signalling wave. Curve F illustrates the uni-directional impulses obtained after rectification of the new frequency and G the alternating telephone current obtained therefrom through a transformer.

One of the principal advantages of this method of reception is the great selectivity obtainable. This is clearly illustrated by an example. Let the incoming signalling wave, the local generator frequency and the beat or intermediate frequency remain as above. Now, suppose the incoming signal is decreased in wave-length from 600 to 594 metres (about 505,000 cycles). The beat frequency will now be 94,000 cycles, corresponding to a wave-length of about 3,130 metres. Thus only one per cent. change of wave-length of the incoming signal produces over four per cent. change in the intermediate frequency. Usually in practice the intermediate frequency is arranged to be in the neighbourhood of 50,000 cycles (6,000 metres) on account of the greater ease and efficiency at which it can be am-

(Continued on page 750.)

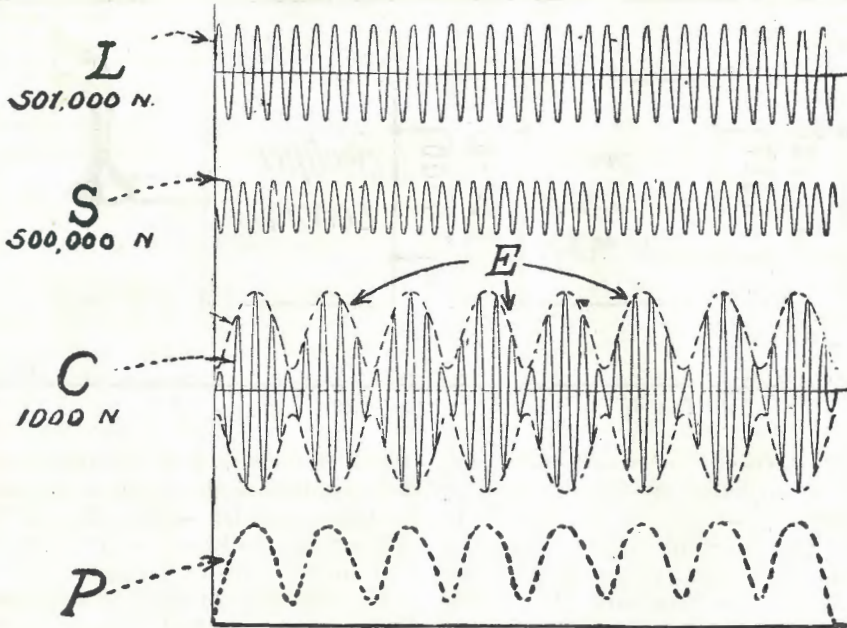

Fig. 2.

constant. If these oscillations are rectified direct we will get in the telephone circuit of the receiver an alternating current, as shown by G, its frequency and amplitude varying in exactly the same manner as the original sound waves at the transmitting station. Corresponding sounds may, therefore, be reproduced in the telephones or loud-speaker. Instead of rectifying direct we may apply locally generated oscillations, B, which will produce beats, C, similar in frequency to the beats shown in Fig. 2 but varying in amplitude in accordance with the incoming signals. We will assume as before that the frequency of A is 500,000, corresponding to a wave-length of 600 metres and B, 600,000, corresponding to a wave-length of 500 metres. The frequency of the resultant beats as shown by C will, therefore, be 100,000 cycles per second, corresponding to a wave-length of 3,000 metres. This is, of course, still radio frequency well above audible limits, so we may therefore rectify the beats and obtain uni-directional pulsating currents as shown by D, which, when passed through the primary winding of a transformer, will set up oscillations

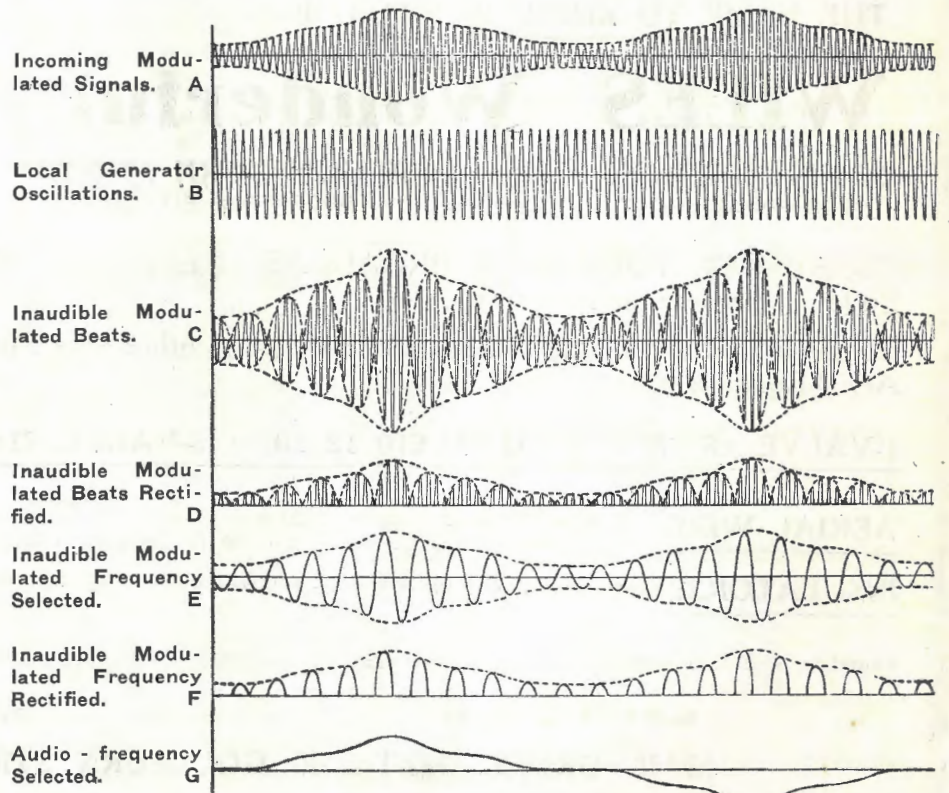

Fig. 3.

plified. Moreover, an increase in selectivity is obtained, for if in the example quoted above the frequency of the locally generated oscillations is increased to correspond to 550 metres, the beat frequency will become equal to about 6,530 metres and a simple

super-heterodyne method, the chief of which is the difficulty of transferring energy from a local generator into a circuit tuned to a widely different frequency. Suppose the incoming signal is 3,000 metres (100,000 cycles) then to produce a beat frequency of 50,000

metres (1,050,000 cycles). Comparing the two cases, we find in the first the local generator must be mistuned 1,000 metres in 3,000 or about 33 per cent. and in the second 14 metres in 300 or, roughly, 5 per cent. The Super-Heterodyne method is,

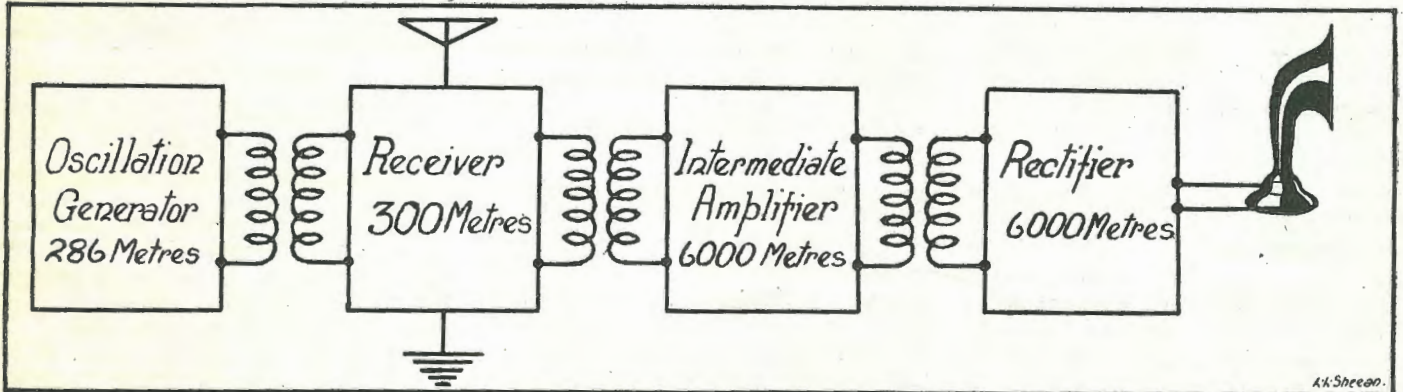

Fig. 4.

calculation will show that a change of one per cent. in the incoming wave under these circumstances will cause a change of something like 15 per cent. in the intermediate frequency.

There are practical considerations which limit the usefulness of the

(6,000 metres) the local oscillator must be adjusted to 2,000 metres (150,000 cycles). If, on the other hand, the incoming signal is 300 metres (1,000,000 cycles) to produce the same beat frequency the local generator must be adjusted to 286

therefore, particularly adaptable to the reception of short waves not only for this reason but also because of the difficulties usually met with in amplification by ordinary methods.

The efficiency of a valve as an amplifier varies inversely as the fre-

THE NAME TO KNOW IN RADIO IS—

WILES Wonderful Wireless

384 PITT STREET
(NEAR GOULBURN ST.)

56-58 GOULBURN STREET
(1 DOOR FROM PITT ST.)

23 PITT STREET
(NEAR CIRCULAR QUAY)

CONSTRUCT YOUR OWN BROADCAST RECEIVING SET. We supply complete Building Instructions with each order.

Complete parts, including Cabinet and accessories other than Headphones, Loud Speaker and Aerial Equipment.

1-VALVE, £6/18/1; 2-VALVE, £10/12/10/-; 3-VALVE, £14/7/1; 4-VALVE, £19/10/-

AERIAL WIRE: $\frac{1}{16}$ Bare Copper, 2/3 100 ft.; $\frac{3}{20}$ Bare Copper, 2/6 100 ft.; $\frac{1}{16}$ "Navy" Non-Corrosive, 2/6 100 ft.; $\frac{3}{20}$ "Navy" Non-Corrosive, 2/9 100 ft.; Heavily Insulated Lead in Wire, 2d., 3d., 4d. yard.

INSULATORS: Best Quality English White Strain, 8d.; Small Shell, 5d., large 8d.; Reel, 4d., Egg, 4d. each.

Complete Stocks of CRYSTALS, HEADPHONES, LOUD SPEAKERS, TRANSFORMERS AND ALL ACCESSORIES.

Send for Price List R5.

Established 20 years.

MAIL ORDER DEPT.: 60 GOULBURN STREET, SYDNEY.

quency of the signals to be amplified, because the self-capacity of the valve provides what might be called a short circuit for some of the energy at the high frequencies. This capacity, however, has little or no effect on the lower frequencies, and it is for this reason that cascade amplification can be carried to a far greater degree on long waves than on short waves.

Fig. 4 illustrates the general layout of the component sections comprising a Super-Heterodyne receiver and in our next issue the construction will be described in detail.

ROSS SEA WHALERS.

THE interesting article which appeared in *Radio*, of December 24, concerning the doings of the *Sir James Clarke Ross* in the Antarctic, has been the means of bringing the Dominion into closer touch with the southern regions, and the request was made by Mr. L. Jensen that reports of reception from the *Clarke Ross* would be very welcome on his return from Antarctica. Quite a number of southern wireless enthusiasts have been successful in picking up Mr. Jensen's messages, and in return, reciprocating the news of the world. Sad to relate one of the first items of importance received from the ship was the news of the death from heart trouble of Captain C. A. Larsen, master. Captain Larsen's wife is a resident of Port Chalmers and messages of sincere sympathy in her bereavement have been received from many persons interested in wireless throughout the Dominion. Following upon the news of the death of the Captain, comes by wireless the message from the *Ross Sea* that the catch for the season has been a good one. It is hoped and believed that the catch will run into something like 20,000 casks of oil and the fleet is expected to be back at Stewart Island in the second week in March. Mr. Jensen further intimates that Australian reports of reception would be exceedingly welcome on his return from his present gloomy but fascinating world.

N.Z. TIME SIGNALS.

TIME signals are regularly sent out by Radio, Wellington, VLW, and are much appreciated by amateurs throughout the Dominion. On Tues-

days and Fridays they commence at 8.29 p.m., and every morning, excepting Saturdays and Sundays at 10.29. The time is sent from the standard mean-time at the Hector Observatory, Wellington, the sending key at the radio station being automatically operated by the observatory clock. The first true time signal commences at 8.30 p.m. and 10.30 a.m. is repeated at the first, second, fourth and fifth minutes thereafter. Each time signal consists of a dash, commencing at the beginning of the minute and lasting one second approximately. In between these automatic time signals, except for fifteen seconds before and after other signals are transmitted by hand. The final time signal is sent at 8.35 p.m. and at 1.35 a.m. The wave-length is 600 metres.

BROADCAST STATION FOR ADELAIDE.

AN "A" class broadcasting license has been granted to Central Broadcasters, Limited, Adelaide.

The general manager of the company is reported to have said, in connection with this matter: "We shall get to work immediately to establish the station and to give the public good programmes. Many of our plans have already been made and we will push ahead as speedily as possible with our arrangements."

It is likely that the station and aerial will be erected outside the city and connected by land-line to the studio proper. The station will commence transmitting on a power of 500 watts, which will be increased to 5,000.

FAMILY USES RADIOPHONE.

PRACTICAL use of the radio telephone for private conversation between individuals has been demonstrated by Donald H. Johnson, of Euclid Beach Park, Cleveland, Ohio. For two years he has employed the radiophone for a daily chat with his father, Dr. William H. Johnson, of Collins, Ohio, about 70 miles distant. These conversations were carried on in broad daylight with the same reliability of a private telephone and, of course, necessitated no toll charges. Both father and son are licensed amateurs, using respectively the calls 8BEI and 8DGS. The younger Johnson declared that the daily chats had never been missed so far. Other members of the family use the microphone and letter-writing is "a thing of the

past." Report and station cards show that the range of these stations is from the Rocky Mountains to the Atlantic Ocean.

A log of atmospheric conditions and resulting radio audibility is kept. This indicates that reception is best during rainstorms, or when the antenna system and counterpoises are wet. Both stations are well known to broadcast listeners and have given effective service in emergencies when wire communication was interrupted.

EDWARD WATERS & SONS

(Established 1859.)

PATENT and TRADE MARK ATTORNEYS,

CATHCART HOUSE,

11-13 Castlereagh St., SYDNEY.

Tel.: B 5937.

(And at Melbourne.)

To Advertisers!

FOR SPEED AND
QUALITY GET
YOUR BLOCKS
MADE AT

BEN JORDAN

LTD.

Macdonell House,
PITT STREET, SYDNEY.

'Phone: City 4030.

QUERIES ANSWERED.
COUPON.

"RADIO
in
Australia & New Zealand."

February 4, 1925.

Broadcasting in America

By Ralph L. Power, D.Sc., of "The Los Angeles Examiner."

WITH the advent of cooler weather, and its attendant clearer reception, radio interest in the Western United States, has taken on renewed activity. KGO, in Oakland, has been having splendid programmes; the dance music particularly being timed to coincide with reception hours in New Zealand, and, in consequence, the Pacific Coast Station of the General Electric Company is daily receiving communications from distant points.

Interesting speakers on lecture programmes recently transmitted from Southern California stations included Annette Kellerman, internationally famous swimmer, and travelogues by Captains Basil Webb and Dudley S. Corlett, formerly of the British Colonial Service.

The Wampus Club, an official organization from "movieland," continues to broadcast its programmes from *The Examiner* on alternate Wednesdays at nine o'clock (American

time). The artists concerned include many well-known people — Elinor Glyn, Bill Desmond, Belle Bennett, Betty Blythe, Priscille Dean, and other stage and screen stars.

Special events galore are claiming the attention of local radio enthusiasts. Athletic games and sports are being broadcasted through portable panels at the stadium. Most football and basket ball matches are being radiocast, either directly from the field or play by play from newspaper plants. The Dempsey fight and the national presidential elections also mean overtime schedules for the larger sending stations.

Los Angeles' newest station is KNX, operated by the *Los Angeles Evening Press* in Hollywood at the Paul G. Hoffman-Studebaker Building. It works on 337 meters with 500 watts power. KNX is on the air hourly from 10 o'clock in the morning until seven at night, with a ten

minute programme of news. Beginning at six o'clock in the evening, a musical programme is broadcast until eleven or later. The station is silent on Sundays, except for a two-hour session at eight in the evening. Listeners should not confuse these calls letters. KNX was formerly used for the California Theatre from a station owned by the Electric Lighting and Supply Company. The station's transmissions were discontinued and the letters given to *The Express*.

Los Angeles has five 500-watt stations at the time of writing—KHJ, *The Times*; KFI, Earle C. Anthony Inc.; KFSG, The Angelus Temple; KJS, the Bible Institute; and KNX, *The Express*.

KFI, of Earle C. Anthony Inc., now has a series of remote control stations, as follows:—*The Examiner*, *The Herald*, the Ambassador Hotel, the Metropolitan Theatre, and the George Birkel Music Company. A new station of 1,000 watts (with a reserve of 4,000 additional) is in operation on the roof of the Packard Motor Car Building. In addition to remote control stations, the Anthony studio also broadcasts its own programmes. The new station, with Western Electric equipment, is on the air continuously from noon until midnight. The additional power enables a fuller schedule of daytime broadcast which hitherto were not entirely successful, particularly in the summer months. The design of the Anthony studio enables an orchestra to assemble in one while a soloist is entertaining in the other, and changes can be made without loss of time. The reception apartment, connected with the studios by plate glass partitions, is splendidly appointed with a cheery grate and homelike furnishings. Already KFI programmes have been heard many times in Australia, Tasmania, and New Zealand. With the new station, of the same power as KGO, far away listeners should have little difficulty in hearing programmes broadcast from the States in late evening time.

With the next news letter from the Pacific Coast of the States winter radio movements will have taken on increased activity.

RADIO

THE GIFT SUPREME.

**"LEVIAPHONE" SENIOR
CRYSTAL SETS.**

They mean hours of exalted joy, not only during Xmas, but throughout the whole year. Guaranteed Braybrook Wave Length (20 mile radius), and complete with one pair of Headphones, aerial wire and insulators. Will carry three pairs of phones. For **£3/3/-**

ASTROPHONE CRYSTAL SETS.

The De Luxe Model is in velvet-lined case, with patent spring lid; the ideal present; just a nice convenient size; will fit in your suit case for the holidays. Fitted with nickel-plated fittings. Guaranteed Braybrook wave length (20-mile radius) without headphones and aerial wire. Accessories, 30/- extra. For **£3/10/-**

Write for Illustrated Catalog. We Stock all Sets and Accessories.

**THE
LEVIATHAN**

PTY., LTD.,
Cr. Swanston and Bourke Sts., MELBOURNE.

AN EXPERIENCE.

3MS (Seymour, Vic.) writes:—The "static" season opened up to a full chorus during the last few weeks. I do not wonder at 2CM having a change and listening to what the wild waves are saying. Speaking of static reminds me of an experience with an "A5" that would have probably clean bowled me, had it got home. I was transmitting a war-warning from a land station at the time, and, as the message was rather long, I had taken the 'phones off my head when suddenly I was surprised to see the table literally covered with a bluish haze. I immediately pulled out the main switch, thinking of fuses and overloads, etc. Then the sentry came to

XN, OT, whilst YY is making his presence felt. 2JM, 2GQ, 2JS, 2HM, 2CH, 2DE, 4SF, 7SF (good note), 3AF, NZ, 4AA, 2AC, 40A are among the most persistent.

DIRECTION - FINDING AT SEA

NAVIGATORS make frequent complaint that the British coasts are very deficient in direction-finding stations, as compared with other coasts, especially those of Canada and North America. But the opinion is gaining ground among shipowners and seamen that, rather than wait for the Government to provide stations which will adequately serve the needs of shipping in British waters, it is a

the shore direction-finding stations, some may have to wait for hours before their turn comes. The danger of such a delay was recently illustrated by the case of a steamer off the North American coast which stranded during the period of waiting. On the other hand, a ship which carries a direction-finder on board is not subject to any such delay. She can, at any time, take a series of bearings off any land wireless station, and also off any other ship whose wireless transmitter may be in operation. Moreover, a navigator feels a greater security in relying upon the accuracy of an instrument which is under his own control than upon one which is in the hands of unknown operators.



Mr. A. R. Finch, Rigger, with the help of several dusky and trustworthy assistants, is here shown putting some finishing touches to an aerial erected in Papua.

the office and asked if all was O.K. He said there were flashes all round the building as a terrific flash of lightning followed by a deafening peal of thunder occurred. The papers next day described the visitation of a thunderbolt close handy. I often think of "what might have been" had I been listening-in instead of transmitting, as previously the static was only a moderate A2-3.

Signals are maintaining their strength; fading is not so prevalent as it used to be. (What do other experimenters find?) The "3" stations come in well, the first few "very loud" and should easily span the two oceans. 3BD, BM, BQ, JH, JU, XF,

more practical and desirable policy to proceed with installation of direction-finding apparatus on shipboard, and to press for the establishment of wireless beacons at suitable points along the coasts.

Even if there were a satisfactory chain of stations along the British shores to supply wireless bearings to all ships that might require them, most navigators would still prefer to have a direction-finder on board. The shore installation has one grave disadvantage which the ship installation eliminates; it can only serve one vessel at a time. It follows that during an extensive fog when many ships require to use the service provided by

DAVID JONES' SALE
REMARKABLE REDUCTIONS
in
WIRELESS

- Headphones tested and guaranteed "D.J. "Special." Usual Price 21/-
Sale Price 19/6
- "Rico" Headphones.
Usual Price 18/6
Sale Price 18/-
- Variable Condensers of standard makes (K.C. Master, United, etc.)
7-Plate. Usual Price 17/6
Sale Price 7/6
- 11-Plate. Usual Price 25/-
Sale Price 10/-
- 13-Plate. Usual Price 25/6
Sale Price 10/-

A Special line for use in Crystal Set for finer tuning.
All less 2/- in the £ for Cash.

DAVID JONES'
For Radio Service,
22 YORK STREET, SYDNEY.

The Experimenters' Corner



A PRIZE of one guinea (£1/1/-) has this issue been awarded to the author of "A Handy Template." The judging was difficult, as the entries were all of a high standard.

A HANDY TEMPLATE.

By V. B.

WHEN buying the component parts of a wireless set it is often a cause

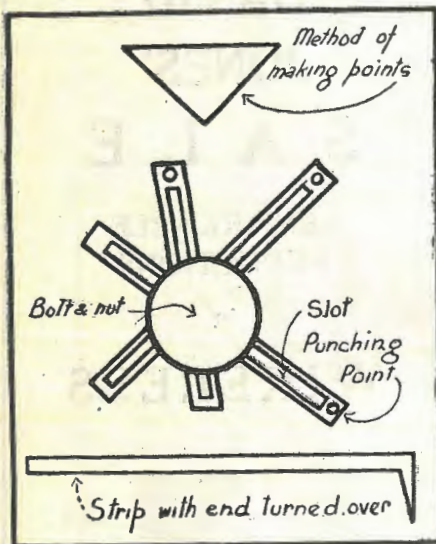

I have found the following template of very great use in such cases:—

The template consists of three metal strips, about 3in. long and $\frac{1}{2}$ -in. in width. Each strip has a slot which starts at one end and terminates about $\frac{1}{4}$ -in. from the other end. This end of each strip is turned down at right angles and sharpened to a point. The three strips are fastened together by a bolt and nut, and the whole thing is completed.

To use the template, adjust it so that the three points show the relative positions for the holes to be drilled. Place the template against the panel and give three light taps with a hammer behind the points.

A USEFUL COIL HOLDER.

By J.N.

FREQUENTLY shunned by the man with limited tools and materials available is the making of an efficient coil stand, with suitable

mountings for basket and honeycomb coils.

The winding of the coils themselves has been thoroughly dealt with in previous issues of *Radio*. Full constructional details are here given of an efficient three-coil stand, in the construction of which few tools are required and which compares favourably in appearance and in performance with bought types representing as they do an outlay much greater. The materials required are:—

One piece of $\frac{1}{2}$ -inch ebonite, $6\frac{1}{2}$ by one inch.

One piece of $\frac{1}{4}$ -inch ebonite, 8 by $1\frac{1}{4}$ inches.

Six standard valve sockets.

Six switch studs.

One foot of flexible wire.

Construction.—The $\frac{1}{2}$ -inch piece of ebonite is first placed in a vice and squared up accurately with file and emery paper. It is then marked off with square and pencil into three sections, each two inches long. Allow $\frac{1}{16}$ -inch space for saw-cuts between each section, and saw into three sec-

of annoyance that a good article is sold without a template.

ALL WIRELESS SETS AND REQUISITES

ARE OBTAINABLE AT — LOWEST PRICES — FROM

SWAINS, 119a and 123 Pitt St., Sydney

A FEW DOORS FROM THE G.P.O.

CRYSTAL RECEIVING SETS, from 25/-. Operative up to 25 miles from Sydney.

ONE-VALVE RECEIVING SETS, from 25/10/-. Operative up to 100 miles from Sydney.

TWO, and UP TO SIX VALVE, from £28, Operative up to 5,000 miles from Sydney.

To INCREASE the EFFICIENCY of YOUR CRYSTAL SET BUY OUR ONE-VALVE AMPLIFIER—Ready to connect up—Price £8; or the TWO-VALVE AMPLIFIER—which will operate a Loud Speaker—Price £9.

— WE SELL —

THE FAMOUS FROST FITTINGS, all makes of 'Phones and Loud Speakers—THE UNITED DISTRIBUTORS, LTD., HOME ASSEMBLY SETS and RADIOVOX SETS — STERLING 4-VALVE and 2-VALVE SETS, Loud Speakers and Phones — GALENA, ZINCITE, BORNITE, MOLYBDENITE, IRON PYRITES, AUSTRALITE CRYSTALS.

ALL THE LATEST BOOKS and MAGAZINES on WIRELESS in Stock.

tions with a tenon or hack-saw. Smooth the sawn ends with emery paper. If the three pieces are placed together in a vice, it is easy to finish them all exactly the same length.

on the top edge, and points X and Y are marked off on it, each $\frac{7}{16}$ -inch from the centre of the line. Holes $\frac{1}{4}$ -inch in diameter are now drilled at X and Y to a depth equal to the length

and bore right through. The two other pieces of ebonite are then drilled similarly.

Two valve sockets may then be fitted into each block and the nuts placed on and tightened up. See Fig. 2, diagram 1. On two of the blocks the projecting screwed portion of the sockets are sawn off flush with hack-saw or file.

Holes must now be drilled in the ends of each block. These are drilled to a depth of $\frac{5}{16}$ -inch at points $\frac{3}{8}$ -inch from the bottom, as shown in Fig. 3, diagram 1. The drill should be tested on a spare piece of ebonite, and the hole should be a very tight fit for one of the switch studs.

To tap these six holes, file four sloping faces on the thread of a spare switch stud, slot the head with a hack-saw and screw it steadily into each of the holes.

Now prepare six screws by slotting the heads of six switch studs, and sawing off the threaded portions to a length of $\frac{1}{2}$ -inch.

The side pieces are now prepared. Divide the $\frac{1}{4}$ -inch ebonite into two pieces, each $4 \times 1\frac{1}{4}$ inches, and round off two corners on each and drill as

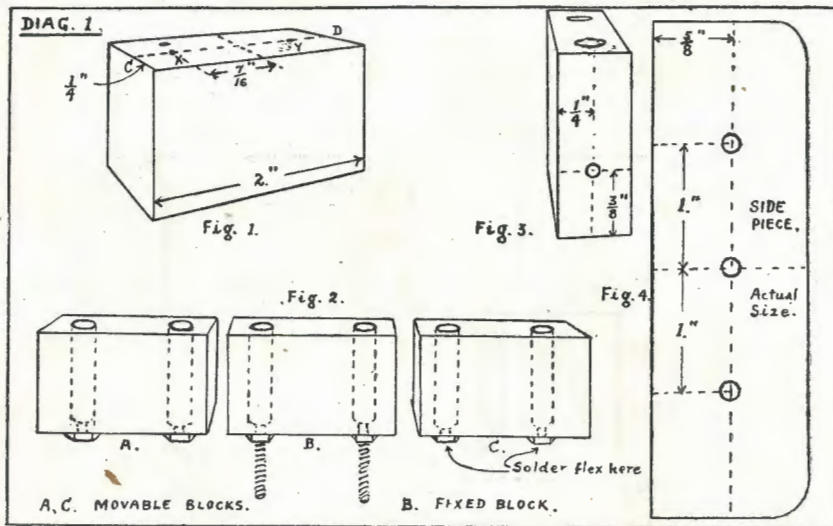

Each piece is then treated as follows:—

(See Fig. 1, diagram 1.)

The line CD is marked centrally

of the barrel portion of a valve socket. Use a valve socket as a depth gauge to ensure accuracy.

Next use a $\frac{1}{8}$ -inch drill or bradawl,

30/- EACH.



D.V. 3
Filament, 3 Volts,
.06 Amp.

Both Types Fit Standard American Socket.



D.V. 2
Filament, 5 Volts,
25 Amp.

MADE BY—



THE MAN WHO INVENTED BROADCASTING.

DE FOREST VALVES

TYPE D.V. 2—Takes 5 Volts at $\frac{1}{4}$ Amp. on Filament 30/- each

Plate Voltages, Detector 18-22 $\frac{1}{2}$ Volts; Plate Voltages, Amplifier 60-150 Volts.

TYPE D.V. 3—Takes 3 Volts at .06 of an Amplification Filament 30/- each

Plate Voltage, 16-22 $\frac{1}{2}$ Volts, Detector; Plate Voltage, 60-120 Volts, used as an Amplifier.

Both Types Fit Standard American Socket.

WHOLESALE ONLY.

INTERNATIONAL RADIO CO. LTD.

200 CASTLEREAGH STREET, SYDNEY, N.S.W.

Phone: MA 1387.

Also at

91-93 COURTENAY PLACE, WELLINGTON, N.Z.

shown (Fig. 4, diagram 1) with holes $\frac{1}{8}$ -inch in diameter.

The coil holder may now be assembled, as shown in diagram 2, Fig. 1. The fixed block (with unshortened valve legs) is held by two of the prepared screws, screwed up tightly.

The screws holding the movable blocks are so adjustable that the blocks may be readily turned about the axis of the screws. The holder is secured to a panel by passing the projecting valve socket shanks of the centre block through two holes in the panel, and screwing on nuts, which also serve for connections to the middle coil.

Connection to the movable holders is obtained by flex soldered to the nuts on the valve sockets and passed through $\frac{1}{8}$ -inch holes on the panel to switch studs screwed into the back of the panel.

Fig. 2, diagram 2, shows how the holder is conveniently adapted for table use, as a separate piece of apparatus. Extension handles of light brass, with handles of ebonite rod are added, as shown in diagram 2. Suitable coil mountings are easily made from piece of ebonite, with valve legs as plugs, spaced $\frac{1}{8}$ -inch apart.

REVERSING REACTION COIL CONNECTIONS.

By R. J. C.

THE most useful idea that I have used on my radio set (1 H.F.—D—2 L.F.) is a method of reversing the connections to the reaction coil. As seen in the accompanying sketch,

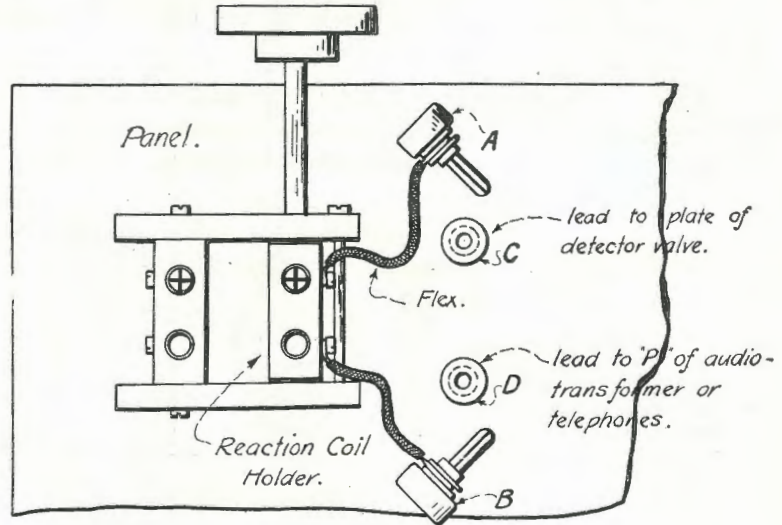
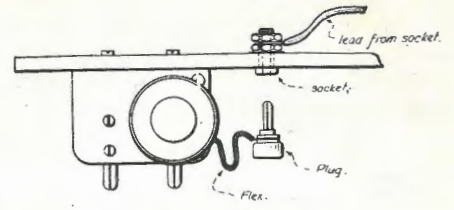

I have a two-coil holder mounted on a vertical panel and the leads from the reaction coil on to the two plugs marked "A" and "B." In the panel

are two sockets marked "C" and "D" which are connected to the plate of the detector valve and "P" of the audio-transformer respectively.

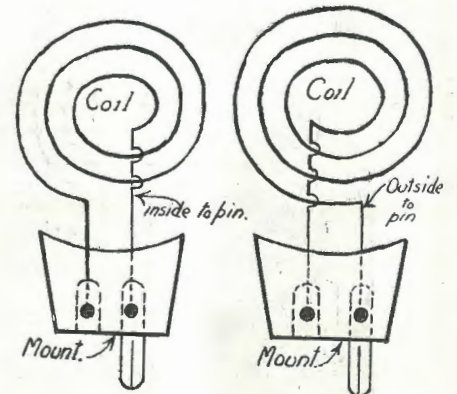
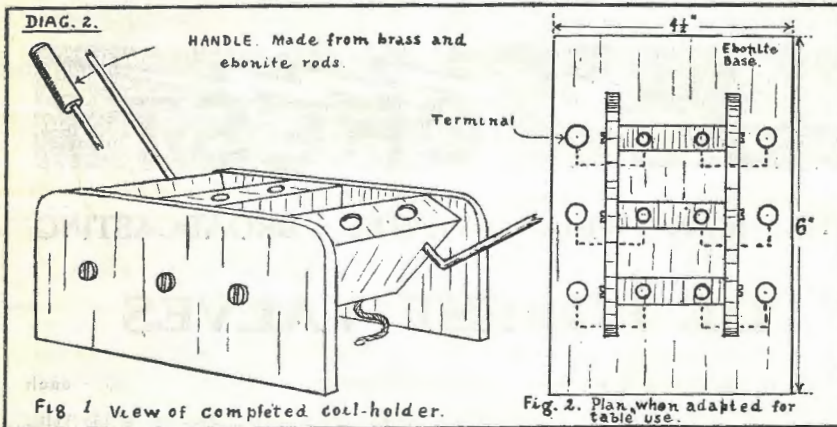

(Continued on page 758.)

WIRELESS PRESS PUBLICATIONS

New and revised Catalogue now available. Send Stamped and addressed envelope for Free Copy to

THE WIRELESS PRESS,

97. Clarence Street, SYDNEY.

44 Market Street, MELBOURNE, VIC.

Australasian Chambers, WELLINGTON, N.Z.

Volume II.

OF

"RADIO"

In Australia and New Zealand"

Handsomely and strongly bound
in cloth and gold, complete

Price - - - 12/6

(Postage, 1/-)

To avoid possible disappoint-
ment, order in advance from

THE WIRELESS PRESS
97 CLARENCE STREET, SYDNEY, N.S.W.

(Continued from page 756.)

Now, "A" may be plugged into "C" and "B" into "D," or "A" into "D" and "B" into "C," thus very simply and efficiently reversing the leads to the reaction coil.

The advantages of this method over, say, a more usual method employing a D.P.D.T. switch are:—

- (1) The very small panel space required;
- (2) its neatness;
- (3) its self-cleaning action;

- (4) its simplicity;
- (5) its cost (1/- approximately);
- (6) extremely simple mounting and wiring.

This idea may be used wherever it is found necessary to reverse any connections in any other part of a circuit.

The times I use it is when the H.F. valve is switched out, and also when using different coils in which the leads may be connected to the coil mount in different ways, as shown in the last diagram.

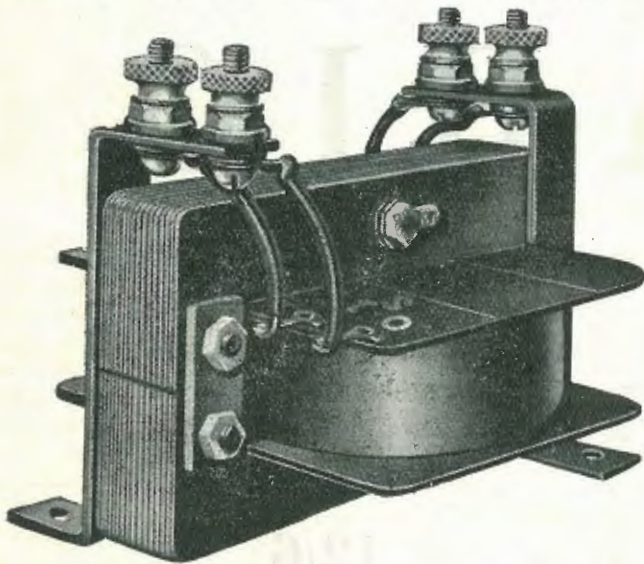

Western Electric Audio Frequency Transformers

THE quality of reception of a radio set is affected directly by the transformer—one of its most important elements.

With the introduction of the Western Electric Audio Frequency Transformer, a long-felt requirement is satisfied. Used with any standard type of valve it affords maximum amplification, with minimum distortion. It embodies the latest findings of radio experts, and ensures the best possible results.

This transformer is of the highest Western Electric standard, simple in design and very strong. The ends of the windings are soldered to nickel-plated thumb terminals. High-grade thin silicon steel plates are used for the core. If your regular radio dealer is unable to supply one, consult

Western Electric Company
(Australia) Ltd.

192-194 CASTLEREAGH STREET, SYDNEY

Telephones : City 336, 355 and 356

And at 588 Bourke Street, Melbourne. Telephones : Central 8336, 8949

R253

AN IMPROVED SWITCHING ARRANGEMENT.

By G. D. I.

AS plugs and jacks usually have lower insulation and higher capacity than D.P.D.T. switches, the latter will probably find more favour now with the experimenters, many of whom are studying low wave—low loss reception.

When attempting DX work with a stage of audio amplification it is desirable to be able to plug the telephones into the detector circuit to see that it is functioning efficiently at any time during reception.

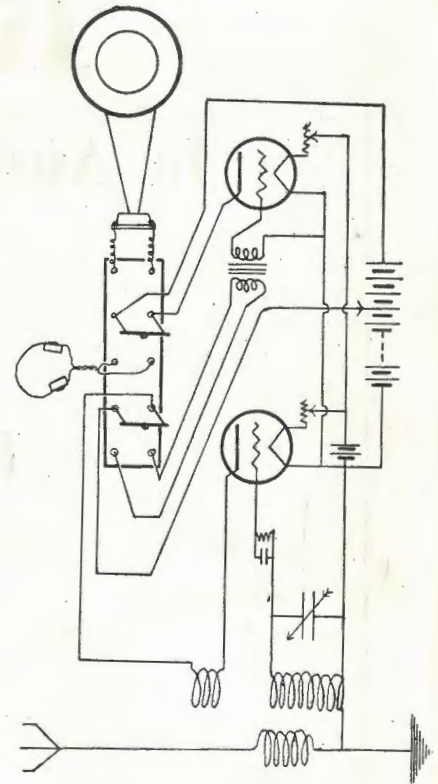

Here is a diagram of two D.P.D.T. switches arranged for use in the above way on a single stage audio frequency amplifier. The diagram is self-explanatory.

The more canny of our readers will note the saving of space on the panel by the omission of one pair of contacts. (Which is an item in these days of soaring Bakelite prices!)

As parts for these switches are readily obtainable it is not worth while, as a rule, going to the trouble of making them.

Can't you get it right?

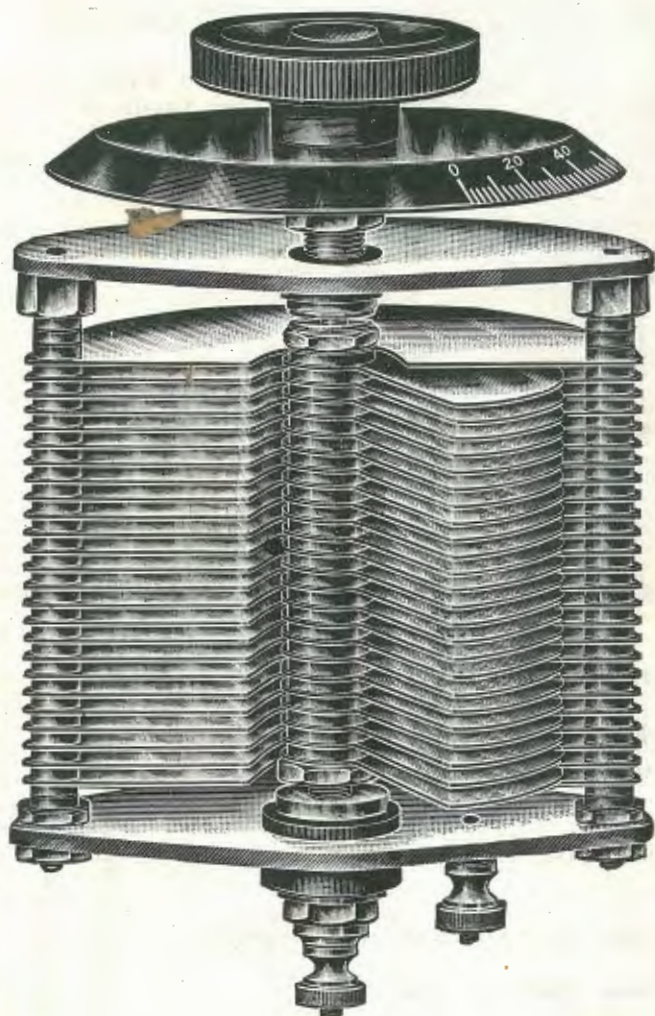

YOU never will while you let unknown products play havoc with your Set. Remember, "Nothing succeeds like success," and a successful career of 25 years is behind *Ormond Products*. Ask your Dealer for

Ormond's No. 2 Condenser

We specialise in turning Brass and Steel Screws and machined parts of all descriptions and accessories.

ORMOND Engineering Co.

199 PENTONVILLE ROAD, KING'S CROSS - - LONDON, ENGLAND

Obtain two sets of movements for D.P.D.T. Switches. See that you get with the parts a template showing exact positions for holes to be drilled in panel. If you have difficulty in obtaining the parts, you may have to buy the complete switches (i.e., mounted on bases).

A very suitable switch is of the Marko make, finished in nickel and mounted on bakelite. The dimensions given on diagram "A" are from the writer's switch constructed from parts of this make.

If the switch is to be used on a specially designed low-loss receiver of the type illustrated on page 606, *Radio*, of 24/12/24, when a stage of audio amplification is added, it would be advisable to mount the switch on a glass panel which any glazier should cut and drill to suit for a reasonable sum.

Similarly, all those who cannot face the job of panel drilling and assembling may couple their switches in this way. In this case, care should be taken to select switches whose knobs are large enough to prevent both being engaged in centre position "X,"

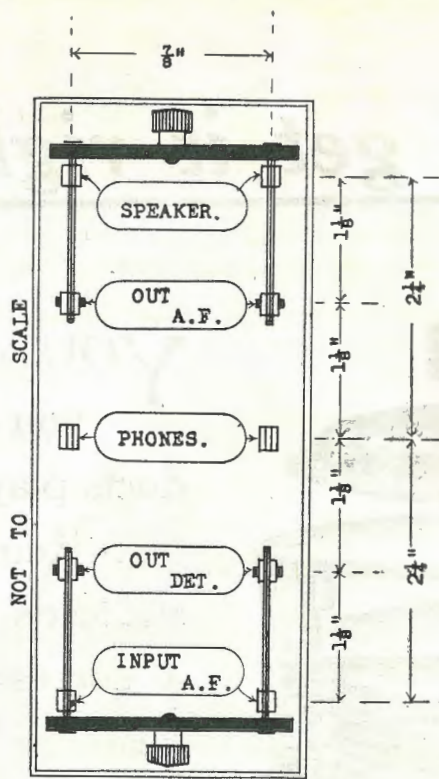

"DIAGRAM" A.

diagram "B," together. If such is allowed it may result in shorting the amplifier "B" battery, and most amateurs would sooner be hanged than shorted!

It will be seen that the first arrangement is a guard against this, is also much neater and professional in appearance, and well worth the extra trouble.

The newly-erected wireless station at Aitutaki, Cook Group, is at present out of action and is likely to remain so for some considerable time. (Post Office Circular.)

EXCESSIVE plate voltages will paralyze your valves.

VALVES are not guaranteed, so do not expect your dealer to replace those burned out.

SOME of the noises in your set may be eliminated by not burning your valve too brightly.

Use a Kilbourne & Clark gang Socket for that new set. You can obtain them in 4, 3 or 2 gang, mounted on Bakelite with polished nickel-plated shells.

These Sockets are absolutely the best you can buy for efficiency, appearance and quality.

They are easy to wire, and they make your set easier to assemble.

Ask your dealer to show them to you.

PACIFIC ELECTRIC Co. Ltd.

(WHOLESALE ONLY)

87 CLARENCE STREET, SYDNEY.

B 5891

SOLE AUSTRALIAN DISTRIBUTORS.

Brandes

The Name to Know in Radio.



*Result of
16 Years'
Experience*

**BRITISH
MADE.**

**PRICE
35/-**

Briefly, our success in perfecting the reception of wireless telephony may be attributed to matching accurately the tones of the two earpieces and ensuring the absolute harmony of one with the other. This means added volume and a clarity of reception unattainable in any other way.

Brandes "Matched Tone" headphones have no peer for long range reception, and are eminently suitable for the enthusiast who desires contact with distant stations. They bring in the weakest signals with consistency.

OBTAINABLE FROM ALL RADIO DEALERS.

Sole Australasian Distributors:

Amalgamated Wireless
(Australasia) Ltd.

97 Clarence Street,
SYDNEY.

Collins Street,
MELBOURNE.

Manufactured in England by Brandes, Limited.

Matched Tone

TRADE MARK

TRADE
ENQUIRIES
INVITED.

Radio Headphones

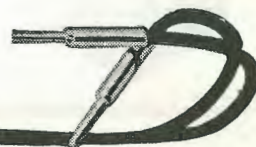

Denmark Communicates with North America

WHILE broadcast listeners have been busily engaged in listening for European stations, the original DX men—amateur radio telegraph operators—have been just as intent in their efforts to communicate with foreign amateurs. Having been the first to show an interest in international radio, they continue to make and break records with unflinching enthusiasm.

Unlike the listening "fans" who turn their dials in the hope of getting a fragment now and then from a faraway musical programme, the amateurs go out for what they think is bigger game—personal communication through the medium of the International Morse code. There is no test period for them as there are now so many foreign operators that they can be picked up every night. The American Radio Relay League is receiving reports of this nature constantly.

For example, the other night D. C. S. Comstock, an amateur radio operator of East Hartford, U.S.A., was tuning in on his set and he heard a strange call which he identified as a Danish station, the first to communicate with this country. Comstock received a message for the A.R.R.L. as follows:—"Greetings from the first Danish amateur across." Hiram Percy Maxim, president of the A.R.R.L., replied through Mr. Comstock with this message: "Sincere congratulations. Hope that we communicate often."

With the addition of Denmark, there are eleven foreign countries whose amateurs have communicated with operators in North America. In many of these countries the development of amateur radio has been inspired by the work of U.S. and Canadian Hams. The list is as follows: England, Australia, New Zealand, France, Italy, Holland, Scotland,

Denmark, Mexico, Argentina and Chile.

HINTS.

TELEPHONES should be connected in series, not in parallel.

WHEN winding coils, do not use a metal form for coils, use cardboard or composition.

IF you want to hear but one station, use loose coupling on your set.

YOUR detector will function best at one particular point on the rheostat. Below that you are not getting enough volume and above it you are shortening the life of your valve.

BY the proper use of tickler coil or plate variometer your detector filament may be burned lower and will last longer.

FOR short waves, a variometer makes a good loading inductance.

A TWO slide receiving set is more selective than one using but one.

Columbia Radio Batteries Are the Best

COLUMBIA Radio Batteries have proven to be the best batteries for radio receiving sets that money can buy. They are made in different styles suitable for every radio equipment and will give more satisfaction than any other make.

Columbia Dry Cell "A"

COLUMBIA Dry Cell "A" Batteries for vacuum tubes of low amperage are made especially for this work. They will withstand the slow steady drain required and give satisfactory results for a much longer period of time than any other similar type of battery.

Columbia Storage "A"

For vacuum tubes of one-half ampere or over, the COLUMBIA "A" Storage Battery is ideal. It is shipped dry and charged and filled when sold, thus assuring a fresh, powerful battery. It is tightly sealed and contained in an attractive mahogany finished box with handles.

Columbia "B"

COLUMBIA "B" Batteries are made in 22½ and 45-volt sizes. They are equipped with Fahnestock Spring Clip Connectors to insure easy, secure connections. They are thoroughly insulated and waterproofed. They are portable, powerful and long lasting.

Columbia "Three"

COLUMBIA "Three" Batteries are designed so that under certain conditions they can be used as an "A," "B" or "C" Battery. They are made of extra large sized cells, and are used as an "A" Battery for light, portable sets using UV-199 tubes; as a "B" Battery for obtaining additional plate voltage; as a "C" Battery for grid biasing.

COLUMBIA Radio Batteries for Every Radio Requirement

NATIONAL CARBON COMPANY, Inc.

30 EAST 42nd STREET, NEW YORK, N. Y., U. S. A.

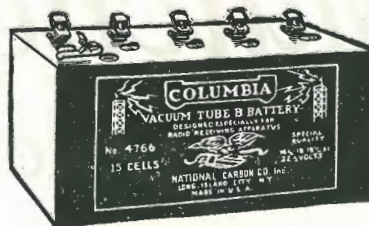

SPECIAL ANNOUNCEMENT

Free Gift Books!

TO COUNTRY, INTERSTATE AND NEW ZEALAND READERS ONLY.

As a result of the phenomenal number of readers who availed themselves of the special Xmas subscription offer published in "RADIO" No. 46, we find the short time allowed did not give our interstate and other distant readers a chance to avail themselves of this splendid offer. We therefore have pleasure in repeating this offer for the benefit of Country, Interstate and New Zealand readers only.

The conditions are that such subscription must be received before February 28, and that the offer is limited to the first one hundred subscribers in each section.

- 1. **Bound Volume, SEA, LAND & AIR, Vols. 2 or 3.**
Ordinary Price 17/6
- 2. **YEAR BOOK OF WIRELESS TELEGRAPHY AND TELEPHONY, 1913-1919 editions (many containing full-size Wireless Map of the World).**
Ordinary Price 15/-
- 3. **HANDBOOK OF TECHNICAL INSTRUCTION FOR WIRELESS TELEGRAPHERS, by Hawkhead & Dowsett (1st Edn.)**
Ordinary Price 7/6

In the event of no copies of one of the above books being available one copy of either of the remaining books will be forwarded.

To ensure receiving the book you like best remit 10/- subscription NOW.

FILL IN THIS FORM.

To "RADIO,"
97 Clarence Street,
SYDNEY, N.S.W.

Dear Sir,—

I enclose herewith 10/- (ten shillings) for twelve months' subscription (twenty-six issues) to RADIO, commencing from the next number; also please send me book No. — (Number of book required.)

Please forward each issue of RADIO to—

Full name

Address

(Special)



Queries Answered



H. E. B. (Charleville). Q.: Recommend an aerial mast consisting of galvanised iron piping about 90 feet high with necessary information how to insulate it from the ground. A.: Try the aerial mast described in *Radio*, No. 43. Although three lengths of 17 feet piping are specified, extra lengths may be used, providing it is well guyed. The mast rests on a white porcelain insulator and the method of erecting is fully described. Q.: Is there any known remedy for eliminating atmospherics? A.: There are many so-called static eliminators, such as the Weagent X, the majority of them, however, reduce signal strength.

F. G. (Townsville). Q.: Advise where four electrode valves may be obtained. A.: Lawrence and Hanson, 33 York Street, Sydney. There are various types, ranging in price from about 27/6 to 37/6.

N. H. C. (Currabubula). Q.: Supply connections for adding a stage of R.F. to the P1 (*Radio*, No. 40) with two stages of audio. A.: Suggest the three-valve receiver (*Radio*, No. 44) comprising one stage radio, detector and one stage of audio amplification, which should give satisfactory results. If necessary, another stage of A.F. may be added by connecting the primary of the second audio transformer in place of the 'phone terminals with secondary connections as in the first stage. Q.: Can an additional stage of audio be added to the P1 and 2 stage audio, and what would be the ratio of the third transformer? A.: It is not usual to employ more than two stages of A.F. amplification. The three-valve receiver recommended with an additional stage of audio should be quite satisfactory for long distance work on 'phones.

G. F. (Randwick). Q.: What type and make of apparatus would you recommend for constructing the two-valve long distance receiver published in *Radio*, No. 45? A.: We cannot recommend any particular make of apparatus. Suggest you use high-grade components throughout to obtain satisfactory results. We refer you to the various firms advertising in this magazine. Q.: Would you suggest any special type of valve for this receiver? A.: Any standard English or American valves. Q.: Could the circuit be improved by any additional apparatus? A.: Particulars of the complete parts required are given in the article. If necessary, a stage of A.F. amplification may be added.

J. F. C. (Red Cliffs). Q.: Using the P1 with 2 stages of audio amplification (*Radio*, No. 40) what is cause of unsatisfactory results? A.: Through an error no connection is shown between the A and B batteries, this should be between the negative of the B and the positive of the A. It is usual to employ a lower ratio transformer for the second stage; about 3½ or 4 to 1 will be satisfactory. Q.: Explain cause of blue flashes jumping across the aerial

to, which is cause of difficulty you have experienced in receiving 2FC.

D. X. BILL (Bundarra). Q.: Using the two-valve long-distance receiver (*Radio*, No. 45) with two stages of A.F. amplification, what is best method of increasing signals on loud-speaker? A.: Suggest two stages of power amplification. Some excellent amplifying circuits for this purpose are given in *The Amateur's Book of Wireless Circuits* by Haynes. Q.: How can body capacity effects be eliminated? A.: Shield your receiver by placing a sheet of tin or copper on the back of the panel and connect to earth. The shield should be of 30 gauge and not touch any of the apparatus. Another method is to use extension handles on condensers and coils.

E. G. W. (Hordern Vale). Q.: What is wave-length of 5CL? A. No record. Q.: Using aerial with a wave-length of 220 metres, what size honeycomb coils are necessary for primary, secondary and reaction for receiving 3AR? A.: Primary, 50; Secondary, 75; and Reaction, 50. Q.: What resistance rheostat should be used for UV199 valves with a four-volt accumulator? A.: 30 ohms.

S. D. (Waverley). Q.: Using two-valve and crystal receiver (circuit submitted) should coils be mounted in a three-coil holder or separated? A.: Mount all the coils separately. Q.: What would be the best method of using tapped coils as shown in diagram for receiving up to 1720 metres? A.: Tapped inductances are not satisfactory for receiving on the wave-length you desire. Use honeycomb coils. Q.: Could 2FC and 3LO be received on the same set of honeycomb coils? A.: You should have no difficulty using .0005 m.f. variable condensers across the anode coils, as shown in your diagram. Q.: Would you advise increasing the voltage of the B battery? A.: Yes, for the UV201A, increase the plate voltage to at least 60 volts. This will greatly improve signal strength. It will be necessary for you to use an insulating condenser of fairly high capacity in series with your B battery and 'phones. One of about .01 m.f. will be satisfactory. A series-parallel switch with your aerial tuning condenser will also be of great advantage.

C. B. C. (Randwick). Q. Using the five-valve receiver (*Radio*, No. 47) should honeycomb coils be mounted in a three-

(Continued on page 766.)

READERS, PLEASE NOTE!

QUERY letters which are accompanied by our coupon and comply with the following directions will receive first preference.

MAKE your letter as brief as possible and write your questions on one side of the paper, one underneath the other. All letters must be signed in full, together with the address of the sender. For publication, the writer's initials will be used or a nom-de-plume, if desired, but on no account will any consideration be given to anonymous communications.

IF requested, answers will be forwarded by post, providing the letter of enquiry contains a stamped, addressed envelope and the coupon to be found elsewhere in this issue.

IT SHOULD BE NOTED THAT IT IS IMPOSSIBLE FOR US TO ANSWER QUESTIONS REGARDING THE APPROXIMATE RANGE OF EXPERIMENTERS' SETS.

and earth connections on the knife switch, although there were no signs of lightning? A.: This is quite a common experience and is caused by electrical discharges in the air not apparent to the naked eye and which often precede a dust storm.

G. J. W. (Dalby, Qld.) submits list of apparatus and asks if it is suitable for the two-valve receiver in *Radio*, No. 45? A.: Yes. Your inter-valve transformer will be suitable for adding a stage of audio amplification for increasing signal strength. You will, of course, require another valve. Replace your vario-coupler with honeycomb coils, as specified in article referred

FOR THE
WIRELESS BOOKSHELF.

**Electrons, Electric
Waves, and Wireless
Telephony**

By
J. A. FLEMING, M.A., D.Sc., F.R.S.

IF YOU WANT A SIMPLE BUT THOROUGH EXPLANATION OF HOW WIRELESS TELEPHONY WORKS AND OF THE PRODUCTION OF ELECTRIC WAVES, YOU CANNOT HAVE A BETTER AUTHORITY THAN THIS BOOK — by Dr. Fleming — THE INVENTOR OF THE THERMIONIC VALVE, WHICH MADE WIRELESS TELEPHONY POSSIBLE.

CONTENTS:

Surface Waves and Wave Production; Waves in Air; The Architecture of Atoms; Electro-magnetic Fields, Forces and Radiation; The Production and Detection of Long Electric Waves; Telephony and Speech Transmission; The Principles of Wireless Telephony.

Only the headings of chapters are given here, space being insufficient for the complete list of contents, which consists of 42 sub-headings.

Price 9/- Postage 6d.

Obtainable from
ALL BOOKSELLERS,

or

THE WIRELESS PRESS,
97 Clarence Street,
SYDNEY.

"Gloucester House,"
44 Market Street,
MELBOURNE.

Australasia Chambers,
WELLINGTON, N.Z.

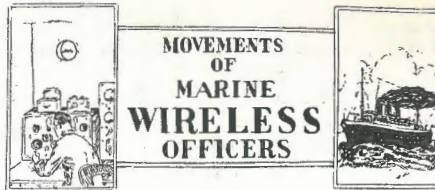

**MOVEMENTS
OF
MARINE
WIRELESS
OFFICERS**

JANUARY.

MR. D. SORAGHEN signed off s.s. *Montoro* as second operator at Sydney, 2nd.
Mr. W. D. Wedgwood signed on s.s. *Montoro* as 2nd operator at Sydney, 2nd.
Mr. W. C. Smith signed off s.s. *Fiona* at Sydney, 2nd.
Mr. J. R. Gilligan relieved Mr. G. H. Hugman on s.s. *Zealandia* at Sydney, 6th.
Mr. W. C. Smith relieved Mr. R. C. V. Humphery on s.s. *Iron Master* at Newcastle, 7th.
Messrs. V. P. Nevins, K. W. Downey and H. J. Edwards signed on s.s. *Dongarra* at Sydney, 7th.
Mr. E. C. Bouel relieved Mr. L. S. Lane on s.s. *Hawraki* at Sydney, 7th.
Mr. G. H. Hugman relieved Mr. F. L. Stevens on s.s. *Levuka* at Sydney, 8th.
Mr. P. C. Gillon signed off s.s. *Suva* at Sydney, 7th.
Mr. S. Hamilton relieved Mr. E. W. Coldwell on s.s. *Echuca* at Sydney, 8th.
Messrs. H. B. Tyler and F. J. Patrick signed on s.s. *Ooma* as third operators at Melbourne, 5th.
Mr. L. C. Farnsworth relieved Mr. J. Carew on s.s. *Loongana* at Melbourne, 6th.
Mr. J. R. Gilligan signed off s.s. *Zealandia* at Sydney, 9th.
Mr. L. N. Callaghan signed off s.s. *Umaroa* at Sydney, 9th.
Messrs. J. H. Bennett, L. E. Ternes and J. W. Jacobs signed off s.s. *Makura* as senior, 2nd and 3rd operators respectively at Sydney, 10th.
Messrs. V. P. Nevins, K. W. Downey and H. J. Edwards signed off s.s. *Dongarra* as senior and third operators respectively at Sydney, 12th.
Mr. G. H. Hugman signed off s.s. *Levuka* at Sydney, 12th.

**THE WIRELESS SOCIETY OF
NEWCASTLE.**

AT the last meeting of the Wireless Society of Newcastle, held at the Society's rooms, Y.M.C.A. Buildings, King Street, Newcastle, Mr. L. T. Swain, the president, gave an instructive lecture on "Low Loss Tuners."

Low loss tuners have only been introduced in Australia recently, and have become very popular among the genuine experimenters, as they are extremely efficient on low wave lengths, as well as being economical, selective, and easy to operate.

A vote of thanks was passed to the lecturer, which was carried by acclamation.

The Society's transmitting set, which has been undergoing reconstruction, is now in complete order, and arrangements are being made for the erection of the new aerial, when the body will again provide those entertainments and experiments which were so popular during last year.

Mention "Radio" when communicating with Advertisers.

HUGHES & CO.

HIGH-CLASS
CIVIL and NAVAL TAILORS

Our civil Suits are perfection in STYLE FIT, DURABILITY and PRICE. TAILOR-MADE on the premises under our own supervision. OUR NAVAL UNIFORMS and GOLD LACE work speak for themselves. CAPS, LACE, BADGES, UNIFORM BUTTONS always in stock. ONE Quality only — THE BEST.

70-72 Erskine Street, SYDNEY
PHONE: City 77.

FOR SERVICE

GREEN & NORTON

(Formerly the Rapid Freight Despatch Co.)
CUSTOMS, SHIPPING &
FORWARDING AGENTS,

Broughton House,
49A King St., SYDNEY.

STERLING PLATING & MFG. CO

(Late Stokes & Sons)
225 CLARENCE ST., SYDNEY.
ELECTRO, SILVER, NICKEL AND BRASS PLATERS.
All kinds of Lacquering, Gilding, Bronzing and Oxidising Done.
Phone: City 6088.

FOR SALE.

SECOND-HAND WIRELESS APPARATUS.
Variable Condensers, Table type, .001 or .0005 . . . 17/6
Telephone Transformers, 150, 1000, 3000 . . . 15/-
Valve Holders for either V24 or QX types . . . 6/-
Receiver Cabinets, Polished Maple . . . 11/6
Filament Rheostats, 6 ohms . . 5/6
Polished Bakelite Panels, drilled 12 x 8 inches . . 3/6
Radio Frequency Transformer, 1100 meters . . . 5/6
Vario Coupler with knob & dial . 15/-
Audio Frequency Transformer, open core type, Ratio 3 to 1 . 10/-
Fixed Condenser, .001 or .00015 . 15/-
Honeycomb Coils, 75 and 115 turns, ¼ inch, width ¼ inch . 1/-
Also quantity of other Wireless Apparatus.

Open for Inspection at 218 Kent St. at 4 p.m. week days; Saturday mornings, 9 till noon. Address all communications to Department "S," 218 Kent Street.

Amalgamated Wireless (Aust.) Ltd., Sydney.

(Continued from page 764.)

coil and single coil holder? A.: The pictorial diagram clearly shows method of mounting the coils. A is used in a single coil holder and should be at right angles to E and B, which are mounted in a two-coil holder. D is mounted in a single coil holder and may also be at right angles or parallel to E and B. Q.: How far apart should they be mounted? A.: A and D should be about 4 to 6 inches from E and B. Q.: What make of dry cell valves would you recommend for this circuit? A.: Any standard English or American such as UV199, DE3, or A.W.A. type. Q.: What should be the voltage of the A, B and C batteries? A.: For UV199 or DE3 type, the A battery should be 4.5 and the B battery, 20 to 80. The correct voltage for the latter will have to be found by experiment. As shown in the pictorial diagram this is 'tapped', the best method would be to adjust each valve independently by using the switching arrangement provided. The C battery is usually a dry cell battery (4½ volts with tappings).

D. E. F. (Glenelg). Q.: At what time and on what wave-length is press transmitted from Sydney and Perth Radio? A.: Sydney, 10.30 p.m. on 1,000 metres I.C.W. and Perth, 1.30 a.m. (Perth time) on about 2,100 metres I.C.W. Q.: Is the beam system of communication with England to be proceeded with shortly, and on what wave-length will transmission and reception be done. A.: Yes. We do not know what wave-length is to be used.

W. S. (Ringwood). Q.: Using the long-distance receiver (*Radio*, No. 45) would adding another stage of R.F. bring in 6WF and possibly KGO? If so, please give diagram of connections. A.: Suggest preferably a stage of A.F. or the three-valve receiver (*Radio*, No. 44).

W. S. H. (Claremont). Q.: Give wiring diagram for adding two stages of R.F. amplification to the P1 with two stages of audio as published (*Radio*, No. 40) with switches for three or five valves. A.: Use the five-valve receiver (*Radio*, No. 47) switches are shown for using any of nine combinations.

W. D. D. (Newcastle). Q.: Advise cause of difficulty in tuning in short wave stations using the three-valve receiver (*Radio*, No. 40), although good signals are received from 2FC after making a few alterations. A.: For receiving on the lower wave-lengths, you will need to have your series-parallel switch in series position, particularly if your aerial is exceptionally large, see *Radio*, No. 41, for correct connections of switch.

T. F. (Warracknabeal). Q.: What time and on what wave-length are S.A., N.Z. and Tasmanian broadcasting stations operating? A.: We have no definite information regarding the regular broadcasting stations in South Australia and Tasmania, except the call letters of the latter are 7ZL. A list of New Zealand broadcasting and amateur stations was published in *Radio*, Nos. 35 and 36, wave-lengths are

given. The best time to receive these stations would be from 6.30 p.m. onwards.

"*Rea*" (Rockhampton). Q.: What type of valves would you recommend using the two-valve receiver (*Radio*, No. 45)? A.: Any standard English or American, either those working from accumulators or dry cells. The latter are referred to as "dull emitters" and are convenient when difficulty is experienced in having accumulators re-charged. Of the former type, a Marconi R as detector and a UV201A as amplifier will be satisfactory, or two UV201A's may be used. Of the dry cell type, either DE3's, UV199's or AWA33's. Be very careful the correct filament and plate voltages are used for the respective valves as specified by the makers. Q.: Using the above valves, what should be the resistance of the rheostats? A.: For those requiring accumulators for filament heating, 6 or 10 ohms and for "dull emitters" 30 ohms.

A. F. D. (Brisbane). Q.: What is cause of noise experienced using four-valve receiver (circuit submitted)? A.: You should use a higher ratio transformer in the first stage, preferably five to one. Three and a half to one is O.K. for the second stage. Try reversing the primary connections. The IS (input secondary) should be connected to the negative of the A battery and the OS to the grid of the valve respectively. The telephone condenser should be shunted across the telephones and be of about .001 m.f. and that across the B battery, one or two mfd. A grid bias battery will be a great advantage. Connections have been given in previous issues. Obtain a copy of *The Amateur's Book of Wireless Circuits* by Haynes.

E. R. (Manly). Q.: Give particulars of tickler coil with loose coupler mentioned on page 617, *Radio*, No. 46. A.: You omitted to give diameters of primary and secondary. The reason you are unable to receive 2BL is due to dead-end losses, your coils apparently being too large for reception on short wave-lengths.

C. E. H. (Tamworth). Q.: Advise cause of unsatisfactory results, using four-valve receiver (circuit submitted). A.: See answer to A.F.D. re transformers, etc., also suggest you obtain copy of book referred to.

E. B. (Armidale) submits two sketches of counterpoise and asks which we consider the best. A.: We presume you intend using the aerials for short wave transmission. That shown in Fig. 1 will form a loop aerial, due to the mutual capacity through the insulators at the top, and as a consequence will have a marked direct effect in the plane of the loop. No. 2 is best for C.Q. working. At the high frequencies employed for short wave transmission the radiation resistance is so high that no appreciable advantage is obtained by employing squirrel cage aerial construction. A single, heavy wire is preferable owing to the fact that its mechanical

swinging can be kept low and the radiated frequency steadier.

N. H. M. (Warialda). Q.: Using the Low-loss Tuner (*Radio*, No. 46), what size should the coils be for receiving on 1750 metres? A.: The type of coils specified are not suitable for reception on the higher wave-lengths. Q.: Could one or two stages of A.F. amplification be added and satisfactory results obtained? A.: Yes, Fig. 8 shows connections to 'phones or primary of intervalve transformer. Use high-grade apparatus throughout.

N. K. W. (St. Kilda). Q.: Using two aerials one 180ft. long and 40ft. high and the other 100ft. long, 35ft. high, what size coils will be required for each aerial for 2BL, KGO, and 6WF? A.: To cover the wave-lengths you require, use preferably the 100ft. aerial, in any case, you will find very little difference in the size of the primary coil. For 2BL use 50, 75 and 50; for KGO, 35, 75 and 50; and for 6WF, 150, 250 and 100. If both aerials are available use the longer.

W. M. (Thornleigh). Q.: What is cause of difficulty in receiving 2BL, using the loose-coupler crystal set described in a previous issue of *Radio*? A.: We presume you refer to the article, "How to Make a Loose Coupler" (*Radio*, No. 37). Your aerial is evidently too large to enable you to get down to the required wave-length. Use an aerial tuning condenser of about .001 m.f. variable and a series-parallel switch, connections of which appeared in *Radio*, Nos. 41 and 47.

A. G. L. (Middle Park). Q.: Which would be preferable, a three-wire aerial 100ft. long, spaced 2ft. 6in., or a two-wire spaced 5ft., the same length? A.: The latter. Q.: Which would you advise, a single slide tuner, or one or two honeycomb coils? A.: For selectivity use the two honeycomb coil combination, and preferably .001 m.f. variable condenser for primary tuning.

G. S. (Newcastle). Q.: Using the P1 circuit, what is cause of unsatisfactory results? A.: Your grid condenser is too high, this should be .0003. Q.: What circuit would you recommend for reception of 3LO on loud-speaker? A.: The P1 with two stages of A.F. amplification (*Radio*, No. 40). You should use a larger secondary coil for 2BL. Replace the 50-turn with a 75. A series-parallel switch will also be an advantage.

H. B. L. (Willoughby). Q.: Would the P1 with two stages of A.F. amplification bring in N.S.W. stations on loud-speaker at Armidale? A.: It is very difficult to give estimates of range. Judging by reports received from experimenters in this district, you should have no difficulty in receiving the local broadcasting stations on loud-speaker and the majority of amateurs.

M. L. (Genmaggie Weir). Q.: Would using a counterpoise improve reception using the P1 circuit? A.: Counterpoise

WIRELESS WIRELESS

The Profession of the Future

THE advent of direct communication between Australia and England, the progress of Broadcasting, and the establishing of Inland Radio, and the growth of the Mercantile Marine in the Pacific means that

*Wireless Operators will be wanted
very soon*

As the time for enrolling is limited
write to-day to

MARCONI SCHOOL OF WIRELESS
97 CLARENCE STREET
SYDNEY

44 MARKET STREET
MELBOURNE

earth is only used for transmitting purposes or where strong induction is being picked up from local power mains. See *Radio*, No. 1.

W. E. H. (Cootamundra). Q.: Advise how to eliminate interference from A.C. mains which is considerably effecting reception of the broadcasting stations. A.: This can be usually overcome by erecting the aerial at right angles to the mains. As you have mains both at right angles and parallel to your aerial this may not assist you, unless you care to go to the trouble of trying the aerial in various positions. This source of interference is often picked up by the earth wire from the receiver, particularly if this is connected to the water pipe in which case it is often worth while to use separate buried earth. A counterpoise earth in many cases is effective and it is possible to dispense entirely with an earth connection. Although signal strength may be slightly reduced if this is done, the inconvenience is compensated for by the freedom from extraneous noises when the receiver has been tuned. Hand capacity effects may be greater, but this can also be overcome as pointed out in previous issues.

A. G. H. (Temora). Q.: Supply names and addresses of the following stations:—2ME, 2LE, 3ME and 3LE. A.: 2ME and 3ME are operated by Amalgamated Wireless, Sydney, and Melbourne respectively. We have no record of 2LE or 3LE.

F. H. (Castlemaine). Q.: Using the Armstrong super-regenerative receiver, how many turns would the vario-coupler require to receive 3LO and 2FC? A.: Vario-couplers are not suitable for reception of the stations you desire, owing to their limited range of wave-lengths. Suggest the two-valve receiver (*Radio*, No. 45). Through a printer's error the condenser C3 is given as 1 mfd., this should be .001. Q.: Using small power valves, what should be the resistance of the rheostat?

A.: Depends upon the type of valve you decide to use. Q.: What should be the value of the battery in the grid circuit? A.: We presume you refer to a grid bias battery, which is usually between 3 and 4½ volts, see *Radio*, No. 41.

G. F. J. (Ingham). Q.: What size honeycomb coils are required to receive 2BL and 2FC using .001 and .0005 condensers in the primary and secondary respectively? A.: For 2BL, primary 50, secondary 75, and reaction 50. For 2FC, 150, 200 and 100 respectively. Without a wiring diagram of your receiver we are unable to advise whether it is satisfactory. Q.: Is aerial 100ft. long, 53ft. high at one end and 27ft. high the other end, satisfactory? A.: Yes. Q.: Would increasing height from 27ft. to about 40ft. be an advantage? A.: Yes, particularly if your down-leads are taken from the lower end. Q.: Can you explain why Morse signals can be received from Townsville radio, using no high tension battery and only filaments burning? A.: You evidently have your battery connections in such a manner that, when the H.T. battery is disconnected there is a potential of about six volts positive on the plate with respect to the filament, enabling strong signals to be rectified. We presume you are using a six-volt A battery.

THREE DEGREES IN THE RADIO FRATERNITY.

THE development of radio in the last three years has contributed to the growth of three distinct radio classes, all of which combine to make one big radio fraternity. The word fraternity is used because an interest in any one of the three phases of citizen radio establishes a common ground for fellowship. Few things make for impromptu conversation and chance acquaintances so much as

a mutual interest, and that factor radio readily furnishes.

The three distinctions intended may be applied to fields other than radio and can be classed generally under the headings—mildly interested, technically inclined and "hobby riders." Translated into radio terms, these distinctions mean the owners of manufactured receiving sets, experimental listeners and the amateurs who not only receive by radio but transmit as well. If you belong to any one of these groups you are a member of the radio fraternity, but your ability to hold your own in conversation with a group of radio fans depends entirely on whether you have taken the first, second or third degree. To be merely the owner of a receiving set, without knowing the first thing about its construction, admits you into the circle. However, you cannot get farther without the ability to converse in terms of "hook-ups."

In order to get the most out of radio, if one seeks more than the ordinary entertainment and educational advantages, it is necessary to go through all of these stages. The amateur game represents the limit that can be reached while maintaining an interest in radio as an avocation. Amateur radio, when one has mastered the code and a certain amount of technical knowledge, admits one to the greatest thrills in radio, the exchange of personal messages over distances limited only by the world itself.

INSURE WITH

The Liverpool and London and Globe Insurance Co. Ltd.

ASSETS EXCEED £20,000,000.

LOWEST RATES.

FIRE — ACCIDENT — MARINE

Head Office for Australasia:
62 PITT STREET, SYDNEY.

W. B. CLARKE, Local Manager for N.S.W.

C. DANVERS, Manager for Australasia.

Melbourne Branch:

415-7 COLLINS STREET.

R. M. EVANS, Local Manager for Victoria.

T. M. DOUGLAS, Assistant Manager for Australasia.

Amplification Without Distortion

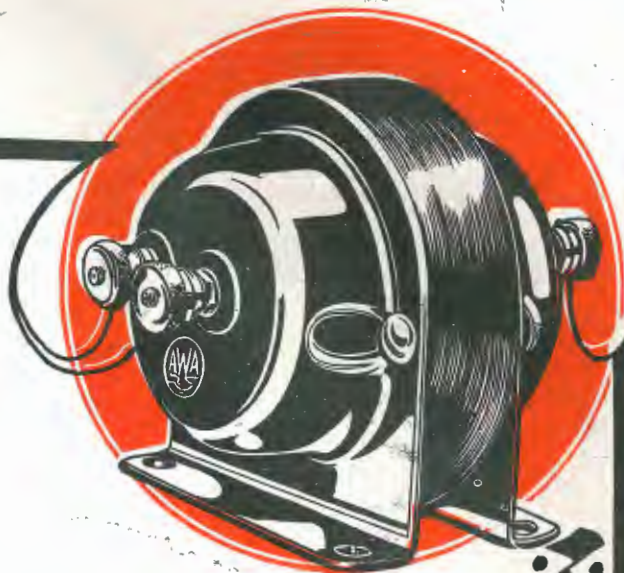

A.W.A. Audio Frequency Transformer

Perfect reception depends upon the efficacy of the transformer to faithfully build up the low frequency oscillations.

Each A.W.A. Transformer is subject to a 1000 volts insulation test between windings and casing, and between the windings themselves; any one not giving infinity reading under this test is rejected. Low self-capacity and the special arrangement of primary and secondary coils, gives uniform amplification over the whole band of useful frequencies.

The closed core eliminates magnetic losses.

A comparatively heavy-gauge wire is used to minimise the possibility of break-down, and there are a sufficient number of turns to bring the natural frequency of the windings above the audibility range, preventing "blasting."

Low-frequency transformers are made in two standard ratios, 5-1 and $3\frac{1}{2}$ -1.

Price, with polished black enamel finish ... 30/-

Price, with polished nickel finish, or oxidised copper finish ... 32/-

At All Radio Dealers.

Amalgamated WORLDWIDE WIRELESS Wireless
(Australasia) Ltd.

97 Clarence Street,
SYDNEY.

Collins Street,
MELBOURNE.

RADIO DEALERS KINDLY WRITE FOR TRADE PRICE LIST.

ITS AN



PRODUCT

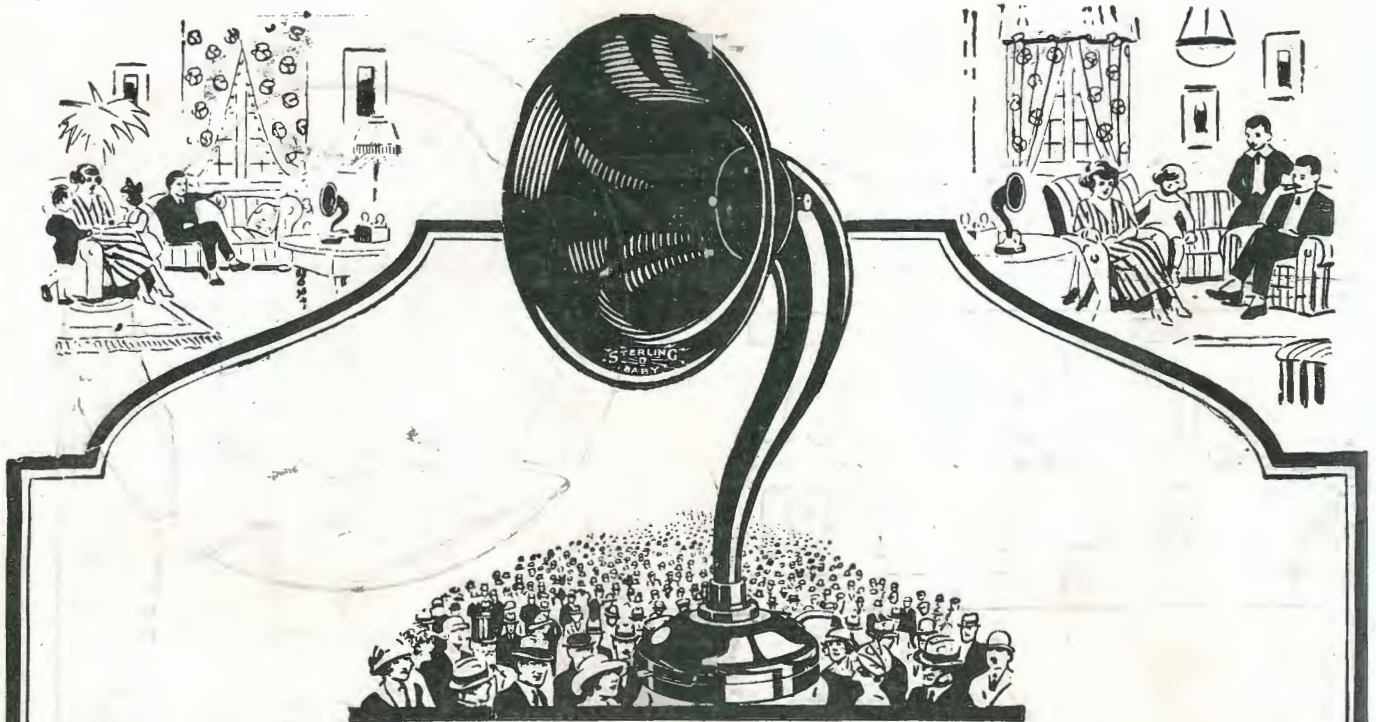

One of the Wonders of Radio

There is no better junior loud speaker made than the Sterling "Baby" or one so popular.

Amazing volume for its size — pure in tone — the Sterling "Baby" sets a standard never bettered, never even equalled. A true Sterling product.

Perfectly made and finished, the "Baby" is a source

of endless entertainment — no distortion — no trouble.

Make any test or comparison you like. The Sterling "Baby" will be your choice — on its merits and its price.

Supplied in black enamel or brown tinted finish (2,000 ohms resistance).

STERLING "BABY"

Loud Speaker

Send for Sterling publication No. 390 B.

TO THE TRADE.

Full particulars of this popular loud speaker, together with information relating to the whole range of Sterling radio apparatus — including Lightweight Headphones, "Dinkie," "Audivox" and "Primax" Loud Speakers, and Crystal and Valve Receiving Sets — will be sent on request.

Advt. of
STERLING TELEPHONE & ELECTRIC CO., LTD.,
 Manufacturers of Telephones and Radio Apparatus, etc.
 210-212, Tottenham Court Rd., London, W.1, England.

Sterling Agents for Australia and New Zealand:-
THE LAWRENCE & HANSON ELECTRIC CO., LTD.,
 Head Office: 33, York Street, Wynyard Square, Sydney.
 Branches: BRISBANE, AUSTRALIA; & WELLINGTON, N.Z.

