

RADIO SCIENCE

Vol. 1.—No. 8.

Registered at the G.P.O., Sydney, for transmission by post as a periodical.

SEPTEMBER, 1948

★ FIVE VALVE DUAL
WAVE RECEIVER

★ AIRPORT APPROACH
CONTROL—PART 2

★ 25w HIGH FIDELITY
807 AMPLIFIER

★ BUILD A THREE-WAY
SPEAKER SYSTEM

★ WORLD WIDE SHORT
WAVE STATION LIST

PRICE

1/-





For high speed relay operation

the MULLARD helium-filled Triode EN31



In the Mullard Gas-filled Triode EN31 the use of helium as a filling medium results in an extremely short de-ionisation time. This factor offers considerable advantages for relay operation in high-speed counter circuits, whilst at the same time serving a vast field of applications in process timers and position control apparatus. Used in time base generation circuits, the EN31 is outstanding, since the short de-ionisation time makes it possible to obtain unusually high-frequency saw-tooth oscillations.

SPECIAL FEATURES OF EN31

MAXIMUM OPERATING FREQUENCY. The short de-ionisation time enables it to be used effectively at frequencies up to 150 kc/s.

PRE-HEATING TIME. The pre-heating time required is sufficiently low to enable the heater to be fed from an indirectly-heated rectifier without the necessity of a time delay switch in the anode circuit.

LOW GRID CURRENT. The low grid current taken by the valve enables it to be operated directly by a photocell.

CONSTRUCTION. The electrode system is of robust construction, and it embodies design features which also contribute to the short de-ionisation time. The valve is capped in an octal base.

VALVE DATA

Max. Operating Frequency	150 kc/s.
Control Ratio	35
Minimum Pre-heating Time	15 secs.
Max. Peak Anode Voltage	1,000 V.
Max. Peak Anode to Grid Voltage	1,500 V.
Valve Voltage Drop	33 V.
Max. Peak Anode Current	750 mA
Max. Mean Anode Current	10 mA
Heater Volts	6.3 V.
Heater Current	1.3 A.

Mullard
THERMIONIC VALVES
& ELECTRON TUBES

MULLARD-AUSTRALIA PTY. LTD.

Head Office: 35-43 CLARENCE STREET, SYDNEY, N.S.W.

DISTRIBUTORS IN ALL STATES

M16-48

F-M, T-V and the Radio Serviceman

In a previous Editorial, the desirability of radio servicemen keeping abreast of modern developments and techniques was stressed, on the assumption that F-M and Television services would be introduced into this country. Since then, a recommendation has been made that T-V stations be erected in each Capital city, and consequently this has once again brought into prominence the question of technical education for the radio serviceman.

At present, the only F-M transmissions operating in Australia are those provided daily by the P.M.G. experimental stations located in Sydney, Melbourne and Adelaide, but the probability of an early participation by commercial transmitters in the 88-108 F-M band to provide an additional service must not be overlooked. It is understood that at least three commercial stations are preparing to open F-M transmissions should these frequencies be made available.

As a result, it would now seem certain that both F-M and Television services will become an integral part of our post-war broadcasting system. When that time arrives, specially trained personnel well versed in the vagaries of installing and maintaining such equipment will be necessary. Unlike the average domestic A-M receiver, both F-M and T-V sets are precision instruments requiring a thorough knowledge of their operation and servicing if the optimum performance is to be realised. This can only be done by trained personnel.

To date, the servicing of radio receivers in this country has followed a fairly simple pattern of development, but the so-called "screw-driver" mechanic will soon, of necessity, disappear from the servicing scene. The future technician, in addition to being entirely familiar with complicated A-M broadcast receivers, must also understand the intricacies of F-M and Television equipment, as well as other electronic devices likely to find their way into the modern home.

For the progressive serviceman, however, who is now willing to expend time and energy in studying these new circuits and their theory of operation there will be a ready and profitable place in the servicing field.

RADIO SCIENCE will assist in this regard by regularly featuring technical articles dealing with these new developments. Thus, our readers will be kept *au fait* with all modern techniques in the radio and electronic fields, both here and overseas.

In This Issue

With the general trend these days towards more realistic audio reproduction, the description of the High Fidelity Amplifier should interest all amplifier enthusiasts. Whilst this was primarily designed for use with the F-M tuner described last month, it is equally suitable for any applications where such high quality performance is essential. Used in conjunction with an adequate speaker system, this amplifier will provide the ultimate in tonal realism.

The popularity of the Five Valve type of receiver is so well-known as to require little comment. The dual wave version featured this month, whilst following generally orthodox lines, will find a ready application by those readers requiring a reliable, low-cost circuit.

SENSATIONAL SCOOP!

Brand new test equipment—made by one of Australia's leading manufacturers—now offered at practically

HALF PRICE

● CATHODE RAY OSCILLOSCOPE

A high-class instrument—designed for laboratory production work—radio servicing, etc.—inbuilt amplifiers with continuous variable gain control on both horizontal and vertical plates—linear time base, having frequency range, from 35 to 40,000 cps—adjustable in nine steps—with switching for coarse control—and a continuous variable control for fine adjustment—operates on 220/260v. AC 50/60 cycles—uses (1) 902 (2) 6J7, (2) 5Y3, (1) 884—finished in black—crackle finish steel case—with carrying handle—metal hood and graduated scale for E.R. tube included—12" x 9 1/2" x 7 3/4"—weighs 20lb. Originally priced £37/10/-. Plus tax.

"HURRY"—"OUR PRICE" **£29/6/8**
Brand new. Not ex-Disposals. Fully guaranteed. (Pamphlets forwarded on request.) (Freight Extra.)

The 'NEW POST WAR CRYSTAL SET'. First release

A midget receiver, uses no batteries—costs nothing to run—ideal for young and old—beautiful plastic cabinet, in choice of three colours, pastel pink, lettuce green and amber—special Hi-gain litz wire coils—dustproof glass enclosed crystal detector—set comes ready to operate with a pair of Brown's Hi-impedance lightweight phones. A real winner, £3/13/6. Post and pack extra 50ft. aerial wire, 3/6 extra.

KITS!

ALL WAVE BATTERY TWO
—complete kit includes all parts, 1T4, 3S4, Btt's etc., 'phones.

(Freight extra) . . . £8/11/6

"MINIVOX" 3 VALVE A.C. KIT

A midget mains kit, uses 6SJ7, 6V6, 6X5. Complete Kit includes Midget Pow.-Trans, Chassis, Valves, Speaker, Cabinet, etc. £9/2/6 (Freight Extra).

"MINIMINOR" 4 VALVE PERSONAL KIT.

A 4-valve Midget Portable. B/cast Super-Het. Uses 1T4, 1S5, 1R5, 3S4, 3in. Rola, Cad.-plated Chassis. Complete Kit includes all parts, plus beautiful shoulder strap carrying Cabinet £12/19/6 (Freight Extra).

"MINIMINOR" 4 VALVE A.C. MIDGET MANTEL KIT.

Kit includes EK32, EBF35, 6V6, 6X5, 3in. Rola Midget P./Trans., choke and all parts, plus attractive Cabinet. (Available in Colours) £13/17/6 (Freight Extra)

"PERSONAL PORTABLE" "SPECIAL"

Another "Lucky" purchase enables us to offer you this exceptional bargain. But hurry, as stocks will not last. This "Special" is a manufacturer's discontinued line. A Five Valve, Personal Portable, Foundation Kit, Custom-made, Cadmium-plated Chassis, All Coils, Tuning Condenser, IF's, Special Vernier Dial, Switch Pot, Knobs, and all Hardware. Complete Kit, less Valves and case, assembled ready to wire. Original Price, £24/17/6.

OUR PRICE 142/-
Beautiful Coloured Leather Cases for the above. Shoulder strap. Built in Aerial, 42/- (Freight Extra).

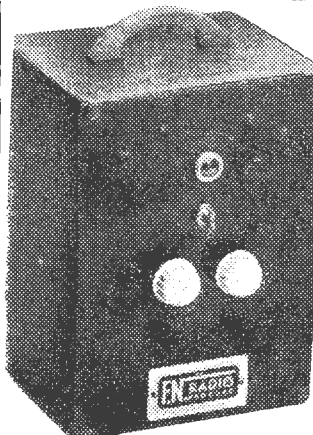

"MIDGET PORTABLE AMPLIFIER"

Only 9" x 6" x 5"—weighs 12lb. Two inputs, 7 watt output. Ideal for steel guitars, small halls, portable work, etc. Wired; ready to operate. Speaker extra £18/7/6 (Freight Extra.)

JUST RELEASED — AMERICAN TYPE—Screw Driver Terminal - Strips—(2) Terminal, 1/3; (3) Terminal, 1/5; (4) Terminal, 1/6; (6) Terminal, 2/1. (Freight Extra.)

"4-VALVE MIDGET AC KIT"
Complete kit includes valves, spk., dial, cabinet, etc., £13/17/6 (Freight Extra.)

"TOOLS"
Box (6) Skt. Wrenches, 1/8" to 3/8" 5/8
Set (7) D/E Spanners, 1/8" to 1" 2/11
4" Shifting Spanners 7/10
6" Electricians' Pliers 6/2
5" Side Cutters 6/6
6 1/2" Side Cutters 7/2
7 1/2" Multigrips 7/6
10" Tin Snips 9/1
(All Plus Postage.)
If not listed here—write for quote.

TUBES.
Thousands of Tubes, if not listed here, write us for Price.

"SPECIALS"

Type 27	6/6
Type 1E7	7/-
Type 1G4	8/6
(Post extra)	
1A5	19/9
1A7	22/10
1G6	20/9
1H4	17/10
1J6	18/10
1L4	20/3
1P5	22/4
1N5	22/4
1Q5	22/10
1S5	20/6
1T4	20/6
2X2	12/9
3S4	20/6
3V4	20/6
5U4	19/3
5V4	19/10
5Y3	14/7
9001	21/-
9002	21/-
9003	21/-
9004	5/-
9006	5/-
VR150	21/-
5BP1	37/6
6AC7	21/-
6AK5	26/-
6AG5	26/-
6B6	18/4
6C4	26/-
6C5	19/3
6F6	17/10
6F8	21/3
6G6	20/9
6H6	19/3
6J5	16/9
6J6	26/-
6K7	20/4
6J7	18/4
6K8	19/10
6L6	21/-
6L7	21/6
6N7	21/7
6R7	20/9
6Q7	19/9
6SA7	19/4
6SH7	19/6
6SJ7	18/4
6SK7	18/4
6SN7	23/6
6SS7	18/9
6SQ7	18/4
6V6	18/10
6X5	20/10
7C7	17/3
12SF7	20/-
12SK7	19/3
12SQ7	18/4
14C5	17/3
14C7	17/3
14S7	17/3
14W7	17/3
80	14/7
807	16/0
837	25/-
5BP1 Skts.,	10/6
Button Skts.,	1/-

Please Add Postage.

BUILD YOUR OWN SIGNAL-TRACER AND SAVE

Kit comes assembled—can be wired in 30 minutes. By self-construction you become fully conversant with the circuit and working, etc.

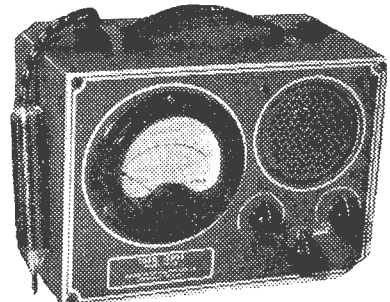

- Comparative intensity of the signal is seen directly on the meter—quality of the signal is heard on the Speaker.
- Simple to operate—uses only one connecting cable, no tuning controls.
- HIGHLY SENSITIVE—uses an improved vacuum-tube volt meter circuit.
- Built-in Hi-gain Amplifier-Alnico Speaker, large, easy to read 4 1/2" meter.
- Tube and capacity resistor net work are built into probe.
- Completely Portable, measures 5 1/2" x 6 1/2" x 9", weighs 8lb.
- Uses standard easy to get Batteries, which are readily accessible to replace. The Kit complete, with all parts, circuit, etc., ready to wire (freight extra), £10/17/6.
- The above kit custom built, fully wired, tested, etc., is also available at (freight extra) £11/17/6.

INSTRUMENT PROBES

Highly polished, metal probes, with polytip and base, ideal for Vtm's S/Tracers, S/Generators, etc. — takes button base type Valves 8/6 (Post extra).

As above, but fitted with tube, resistor-capacity network, cable, etc., 37/6 (Post 6d.).

INSTRUMENT CASES

9 x 6 x 5 1/2 new steel grey crackle finish for Vtm's Oscillators, s/generators, etc., 22/6. (Freight extra.)

Midget FN Reinartz Coil	6/6
Midget FN 150/150V 30MA P/Trans.	20/7
Midget Filter Chokes	8/9
Midget 8MFD Electrocs	3/9
Midget Single Gang Cond's	12/6
Midget Two Gang Cond's	19/3
Midget Three Gang Cond's	25/3
Midget Trimmers	1/1
Midget Off-On Switches	2/9
Midget DP47 Dials with Knobs	7/11
Minivox Chassis	6/6
Miniminor Port Chassis	14/6
Miniminor Mantel Chassis	11/6
Minivox Cabinet in Colours	23/6
Miniminor Mantel Cabinet	25/6
Miniminor Port. Cabinet in Colours	28/10
Volume Controls, any size	3/9
.5 and 1m. Switch Pots	7/6
6.3V Pilot Lamps—U.S.A.	1/3
1 Watt Insulated Resistors	9d.
1 Watt Insulated Resistors	1/-
3W W/W Resistors	1/9
Amphenol Valve Sockets, 4, 5, 6, 7, 8 P	1/-
Rubber Grommets	2d.
Resin Core Solder (Roll)	1/-
Hook-up Wire, any colour, 2d. yard	
New 2000 Ohm Phones	27/6

Postage Extra.

F.N.RADIO,

ELECTRONIC & TELEVISION CO.,

265 Military Rd., Cremorne, N.S.W. 'Phone: XM7063

"Same Day Mail Order Service"
OPEN SATURDAY
SORRY NO C.O.D.

RADIO SCIENCE

FOR THE ADVANCEMENT OF RADIO AND ELECTRONIC KNOWLEDGE.

Vol. 1.—No. 8

::

SEPTEMBER, 1948

EDITORIAL CONTENTS

EDITORIAL	1
AIRPORT APPROACH CONTROL By John G. Downes, B.Sc., A.M.I.E.E.	4
In this second article of the series, the experimental field radar installation at Kingsford Smith Airport, Mascot, is described in detail.	
RADIO SCIENCE QUIZ	8
POWER LINE CARRIER COMMUNICATION	9
A widely used communication system which gives results comparable to those obtainable from a private automatic telephone exchange.	
BRIGHT FLUOROSCOPIC IMAGES	13
Details of new electronic equipment now being developed for increasing the brightness of fluorescent x-ray images.	
INTERNATIONAL RADIO DIGEST	15
Low Cost F-M Receiver; Radar and Raindrops.	
THE DUAL WAVE FIVE	17
A high performance receiver, incorporating a negative feedback tone control, and which is capable of excellent results on both radio and gramophone pickup.	
FOR THE EXPERIMENTER	22
SWEEP-FREQUENCY SIGNAL GENERATOR	23
The basic design features, as well as a step-by-step analysis of the operation by means of the oscilloscope.	
HIGH FIDELITY AMPLIFIER	25
Suitable for use with the F-M Tuner, or any other application where a high quality output is required.	
THREE-WAY SPEAKER SYSTEM	30
A practical design of interest to all experimenters requiring the utmost realism in sound reproduction.	
U.H.F. TECHNIQUES By Harry N. Edwardes, B.Sc., B.E.	33
Part 7—Aerials Radiation and Propagation.	
PICKUP RESONANCE EFFECTS	37
A technical discussion of the mechanical resonance effects which can occur in pickup arms, and interfere with the normal operation of the unit.	
FOR YOUR NOTEBOOK	39
AROUND THE INDUSTRY	40
TRANS TASMAN DIARY	41
ON THE BROADCAST BAND	42
SHORT WAVE LISTENER	43
THE MAILBAG	48

OUR COVER: One of the group of 250ft. steel masts erected at the Commission's stations at Rockbank and Ballan, Victoria. The horizontal boom is 90 feet long. To these booms are attached the cables supporting the multiple arrays of half-wave elements constituting the "Franklin Beam" aerial system used for high speed radio telegraphy on Empire circuits.

Department of Information Photograph. Made available by courtesy of Overseas Telecommunications Commission (Aust.).

Published Monthly by RADIO AND SCIENCE PUBLICATIONS, and printed by Publicity Press (1938) Pty. Ltd., 71-75 Regent St., Sydney.

Address all Correspondence to BOX 5047, G.P.O., SYDNEY.

EDITOR: C. E. Birchmeier (A.M.I.R.E., U.S.A.)

MELBOURNE REPRESENTATIVE: J. Cecil Corboy, 18 Queen Street, Melbourne — Telephone MB 1989.

SUBSCRIPTION RATES:—Single copy, 1/-. Australia, British Empire (except Canada) 12/- per year, 21/- for two years; Canada and U.S.A., \$2.50 for 1 year, \$4.00 for two years. All other countries, 15/- (Aust.) per year. Post free to any address. Foreign remittances should be made by International Money Order or Bank Draft negotiable in Australia.

CONTRIBUTIONS: Articles of a suitable technical nature will be considered by the Editor, and if accepted paid for at current rates. Accepted material is subject to any revision or changes deemed necessary. Contributions will be handled with reasonable care, but this magazine cannot be held responsible for any loss or damage. A stamped addressed envelope should be included for the return of manuscript if unsuitable for publication.

WHOLESALE DISTRIBUTORS: GORDON AND GOTCH (A/SIA.) LTD.

RADAR AIDS TO NAVIGATION

AIRPORT APPROACH CONTROL

By JOHN G. DOWNES, B.Sc., A.M.I.E.E.

In this second article of the series describing the use of radar to control air traffic in the vicinity of airports, the experimental field radar installation at Kingsford Smith Airport, Mascot will be described.

As discussed in the preceding article of this series, it is necessary for the aerial of an airport surveillance radar system to be well removed from obstacles which might obscure the "view" of the aerial, and to be quite close to ground-level, so as to obtain a coverage diagram of the desired shape in the vertical plane. The aerial in the installation at Mascot was accordingly placed at a point on the airfield distant from hangars and other buildings, and was mounted in a pit so that only the aerial proper projected above the surface of the ground. This arrangement may be seen in Fig. 1. Since long leads to and from the aerial are inadmissible at the frequency used (3,000 Mc. approximately), the transmitter and r-f section of the receiver are located in the pit adjacent to the aerial.

Field Equipment.

The apparatus comprising the field radar installation is as follows:—

- (1) Modulator Unit.
- (2) R-F Head.
- (3) Aerial.
- (4) Synchronizer.
- (5) Control Box.
- (6) Indicator.
- (7) Power Supplies.
- (8) Junction Boxes, etc.

These units interconnected as shown in Fig. 2.

The modulator unit initiates the sequence of events in the radar cycle, supplying high-voltage pulses of short

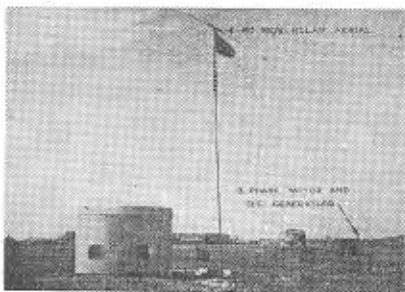

Fig. 1.—The field installation at Kingsford Smith Airport.

duration to the magnetron oscillator in the r-f head. The corresponding bursts of r-f oscillation produced by the magnetron are fed to the antenna.

The modulator unit also gives out pulses synchronised with those above-mentioned, but of much lower voltage. These are fed to the synchronised unit, where they initiate the generation of linear time-base sweep voltages for the cathode-ray tube.

In addition to the magnetron, the r-f head contains the r-f section of the receiver, namely, the crystal converter and the frequency-changing oscillator, and also an electronic transmit-receiver switch. The crystal converter is followed by a 2-stage i-f pre-amplifier, also housed in the r-f head.

The synchronizer unit, in addition to generating tune-box sweep voltages as mentioned earlier, contains the main i-f amplifier, the video-frequency amplifier, automatic frequency-control circuits, and a calibrating-pulse generator, which is used to provide reference points of range on the c-r tube screen.

The indicator is of the *plan position* type (PPI), in which the centre of the tube screen represents the position of the radar and objects *seen* by the radar, cause small, bright areas to appear on the screen in positions corresponding to the range and bearing of the objects. The indicator is coupled electro-mechanically to the aerial so that the orientation of the latter may be followed.

The power supplies for the equipment comprise a 240-volt A.C. motor, two 28-volt D.C. generators, a 400-cycle inverter, and two rectifiers. The inverters and rectifiers are housed in the radar pit and the remaining units some few yards away.

The Control Box controls the power supplies to the equipment and certain other functions it also carries the necessary meters.

We shall now consider these various units in detail.

Modulator.

The modulator is housed in a cylindrical aluminium container about 12in.

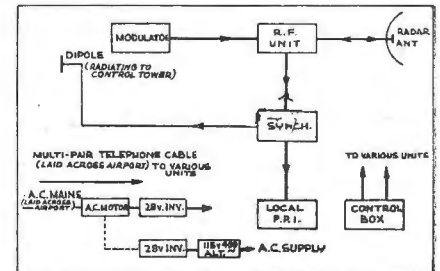

Fig. 2.—Units of the Approach Control Radar, showing intercommunication.

in diameter by 24in. deep, and the unit weighs about 70lb. The circuit of the modulator is shown in Fig. 3, which also illustrates part of the transmitter circuit, and the mode of operation is as follows:—

The 115-volt 400-cycle supply is connected to the voltage-doubling rectifier circuit, at the output of which 4,600 volts D.C. is available. This voltage is applied through a charging choke and diode to a short artificial line, or pulse-forming network. As a result, a surge of current flows into the condensers of the pulse-forming network, and they become charged to a voltage approximately double that of the applied D.C. Having reached this voltage, the condensers would commence to discharge again (i.e., an oscillation would commence), were it not for the charging diode, which prevents a reverse current flow the pulse-forming network consequently remains charged.

Shortly after the charging action is complete, the rotary spark is arranged to gap conduct. This gap consists of four movable electrodes driven round by a 28-volt D.C. motor, and one fixed electrode. When a moving electrode is close to the fixed electrode, the gap breaks down due to the high potential across it; the gap then acts as a switch and connects the pulse-forming network to the primary of the pulse transformer (across which an inductance and a potential divider are permanently connected).

Now the load (i.e., the pulse-transformer primary, etc.) to which the pulse-

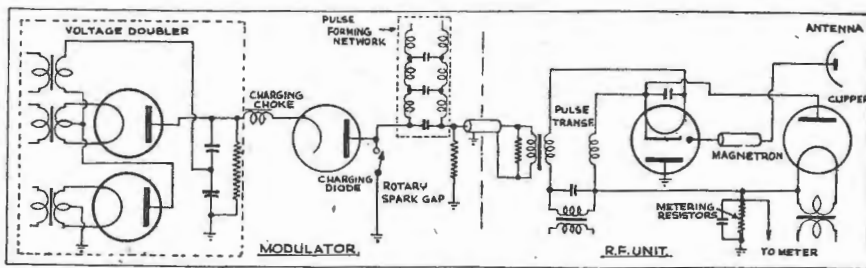

Fig. 3.—Circuit of a modulator unit.

forming network becomes connected is arranged to have a value equal to the characteristic impedance of the artificial line constituting the network. Furthermore, it is a property of a charged line that, when connected to a load of its own characteristic impedance (which may be defined as the impedance of an infinite length of such a line), the energy passes out of the line at a definite rate. This produces a pulse of voltage across the load of magnitude equal to one-half the original D.C. voltage on the line, and of duration equal to twice the time required for a wave to travel the length of the line.

Controlled Pulses

We have therefore a convenient method of producing pulses, the duration of which is readily controlled by pre-adjustment of the length of line. It is general practice to use an artificial line (having lumped-circuit elements) in place of an actual length of line which would necessarily be long and bulky.

Should the line discharge into a load having a value different from the characteristic impedance, there will be some reflection of energy back along the line produced (by repeated reflections), and the result will be that, instead of a single pulse, a series of pulses will be

Thus the modulator circuit causes a high-voltage pulse of short duration, to be applied to the primary of the pulse transformer. The subsequent action will be examined when the transmitter proper is discussed. It may be remarked here, however, that the pulse-forming network is designed to produce a pulse of $1\frac{1}{2}$ micro-second duration, and that the rotary spark gap is driven at a rate such that 750 pulses per second are produced. Further, it will be recalled that a voltage of 4,600 volts D.C. is available at the output of the voltage doubler stage.

By the resonant charging action

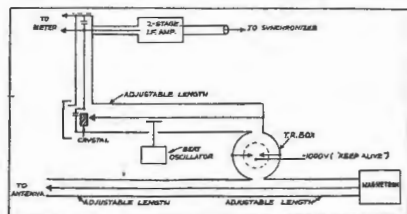

Fig. 4.—Circuit of the R-F unit.

(through the charging choke in series with the capacities of the pulse-forming network), the network is charged to a voltage of about twice this amount, or 9,000 volts. Subsequently, when the line is discharged, a pulse of approximately one-half this voltage, or about 4,000 volts, appears across the load, represented by the pulse-transformer primary (this halving of voltage is analogous to what occurs when a generator of voltage F and internal resistance R is connected to a load, also of resistance R the voltage available across the load is E , and this

$$\frac{E}{2}$$

is the condition for obtaining maximum power from the generator).

The potential divider across the primary of the pulse-transformer is used to provide a low-voltage triggering pulse which initiates the time-base sweeping action on the cathode-ray tube indicator.

R.F. Head.

The various stages contained within this unit have been briefly mentioned earlier. The unit is housed in a cylindrical cast aluminium of approximately the same dimensions as the modulator unit, and the weight is 54lb.

(a) Transmitter.

In discussing the operation of the transmitter, reference is made again to Fig. 3. The 4,000-volt pulse at the primary of the pulse-transformer is stepped-up to a pulse of about 18,000 volts on the secondary side, and the pulse is applied to the cathode of the magnetron oscillator, the anode of which is grounded. The pulse-transformer windings are so polarised that the secondary pulse is negative with respect to earth.

Actually, two secondary windings, providing equal voltages of like polarity, are used, and the magnetron heater circuit, which is common with the cathode, is completed through these secondaries. This technique avoids the need for high-voltage insulation of the magnetron heater transformers.

On application of the high-voltage pulse to the magnetron, electron oscillations of very high frequency are set up. A small pick-up loop in the magnetron

allows pulses of r-f energy to be transferred, via a coaxial line, to the parabolic antenna. The power of the pulse is about 100 kw.

It is found that unless suitable precautions are taken, a train of damped oscillations of voltage appears across the secondary of the pulse transformer subsequent to the main pulse these may give rise to undesirable pulses of radiation. This oscillation is due to the changed load presented by the magnetron after the main pulse is completed (the magnetron current falls and its impedance rises correspondingly) and to the charged conditions in the circuit when the rotary spark gap is extinguished.

To prevent these oscillations causing unwanted radiation, an inductance is shunted across the primary of the pulse transformer. The collapse of the field in this inductance, after the main pulse causes a negative voltage to be superimposed on the oscillations on the primary side of the pulse transformer, the net primary voltage then being negative.

We then get at the secondary an oscillatory voltage which is always positive, and this voltage is clipped off by the clipping diode, leaving the main pulse clean and square. The clipper has no effect during the main pulse, since the secondary voltage then has a high negative value.

(b) T-R Box and Crystal Converter.

It is necessary to provide a means whereby the energy from the magnetron is fed to the aerial without loss and especially without leakage into the crystal of the converter, which would undoubtedly be burnt out by the high momentary burst of energy if such leak-

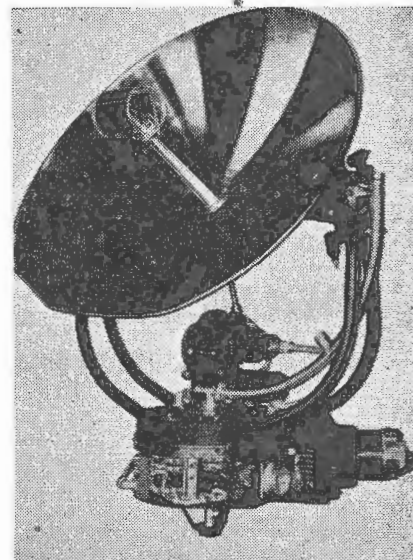

Fig. 5.—View of aerial. In the actual equipment a larger reflector than that shown is used.

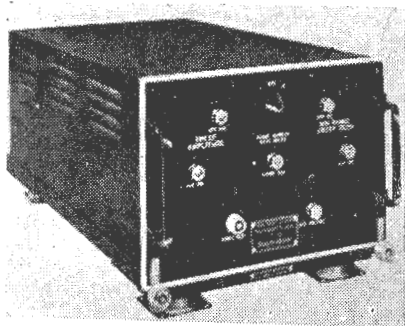

Fig. 6.—View of the Synchroniser unit.

age were appreciable. At the same time it is necessary to ensure that the very small received signal passes from the aerial to the converter without serious attenuation.

These two functions are carried out by an automatic *send-receive* switch, in the form of T-R (Transient-Receive) Box. By reference to Fig. 4, it may be seen that the outer conductor of the main co-axial line between magnetron and aerial opens at one point into the cavity of a T-R box.

When reflected signals are being received by the radar, the energy passes from the aerial along the co-axial line and excites the cavity of the T-R box. The box opens at another point into a second co-axial line leading to the crystal

converter, and the energy in the cavity is transferred to this converter line. The cavity is timed by adjustable metal slugs threaded in its walls, and is resonated so as to transfer maximum received energy to the converter.

The length of co-axial line between the T-R box and the magnetron is adjusted so that the magnetron impedance (in the non-oscillatory, or receiving, condition) is stepped-up to a maximum value. When this is done, negligible received energy passes into the magnetron; practically the whole amount is available to excite the T-R cavity.

During the short period that the magnetron is oscillating, the very large amount of energy present causes a gas tube contained within the T-R cavity to conduct. When this occurs the cavity is effectively short-circuited, and the energy from the magnetron passes along the main co-axial line to the aerial. The short-circuiting of the T-R cavity means that only a very slight amount of R-F energy (insufficient to cause damage reaches the crystal during the *transmit* period.

The gas tube of the T-R box is provided with a *keep alive* electrode, held at a potential of -1,000 volts. The purpose of this electrode is to keep the gas in an ionized state, so that conduction

in the tube will occur very readily when the transmitter pulse commences. By this means the initial sharp peak of energy leaking through to the crystal may be kept below the dangerous level.

As stated earlier, the output of the T-R cavity is coupled by a co-axial line to the crystal converter. The latter is a silicon crystal, mounted in a special holder, and it is effectively in service with the line. Also fed into the line by a small injection electrode passing through the outer conductor of the line is energy from the local beating oscillator. The received and local oscillator signals are thus superimposed at the crystal input, and the difference — or intermediate — frequency component is available at the crystal output.

(c) Local Beating Oscillator.

This oscillator is of the reflex klystron type, which comprises basically a cathode, a resonant cavity connected to two grids, and a reflector or repeller electrode. Adjustment of oscillator frequency is effected by moving one grid relative to the other; this relative movement changes the dimensions of the cavity and hence its resonance frequency. Energy is abstracted from the klystron oscillator by a small loop projecting into the cavity and connected capacitively to the crystal input in the manner already described.

Marconi School of Wireless

CONDUCTED BY AMALGAMATED WIRELESS (AUSTRALASIA) LTD.

For 34 years the leading Radio College in Australia

Courses are available for:

RADAR OPERATORS AND TECHNICIANS, RADIO OPERATORS AND TECHNICIANS, SERVICE MECHANICS, AMATEURS, MORSE TELEGRAPHY

Call, 'phone or write for full particulars

**MARCONI SCHOOL
OF WIRELESS**

47 York Street
SYDNEY

Tel. B0522

163 Queen Street
MELBOURNE

Tel. MU9161

POST THIS NOW!

MARCONI SCHOOL OF WIRELESS

Box 2516, G.P.O., Sydney.

Please send without obligation full details of your courses.

Name.....

Address.....

.....

.....

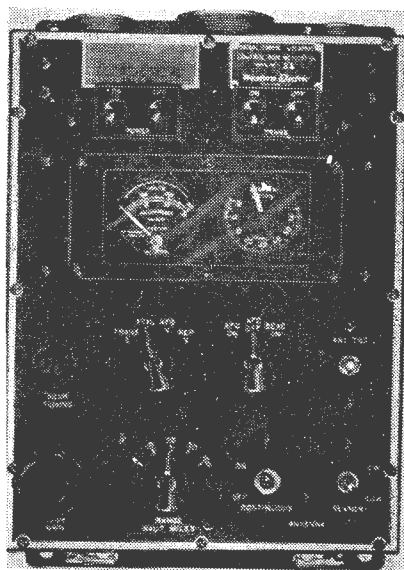

Fig. 7.—View of the control unit.

(d) I.F. Pre-amplifier.

The I.F. output from the crystal converter passes into a co-axial line, which is one-quarter wave-length long at the intermediate frequency (60 Mc.). This line is effectively short-circuited for the I.F. at its far end by a capacity, and is tapped a short distance from that end to provide a 70 ohm. output the line thus acts as an impedance transformer. A D.C. milliammeter connected in shunt with the capacity at the end of the line serves to indicate the mean rectified crystal current, and provides a guide to safe operation of the crystal.

The 70-ohm. output of the I.F. line is connected to a 2-stage I.F. pre-amplifier of gain about 30 db., and bandwidth 6 Mc. The pre-amplifier is designed to have a low inherent noise level, so that the received signal-to-noise ratio is not impaired. The output of the pre-amplifier is at 70 ohm. impedance and is connected by co-axial cable to the main I.F. amplifier contained in the synchronizer unit.

Synchronizer Unit.

As described earlier, this unit houses the main I.F. amplifier, the video amplifier, automatic frequency control circuits, a sweep voltage generator and a range-mark generator. The two last-mentioned circuits are associated with the cathode-ray indicators, and will be dealt with when discussing the display system. The remaining sub-units will be discussed in the present section. A view of the Synchronizer Unit is given in Fig. 6.

The main I.F. amplifier is of four stages, the interstage coupling being partly by transformers and partly by single-tuned circuits. The I.F. is 60 Mc., and the amplifier has a gain of about 85 db.,

with a bandwidth of 5 Mc. The second detector is of a *cathode-follower* type.

The gain control arrangements for the I.F. amplifier are interesting, in that *swept gain* is employed. This means that the gain of the amplifier, commencing at a minimum value at the instant when a pulse is radiated, is automatically increased at a steady rate.

The purpose of this technique is to reduce the *clutter* which would otherwise appear near the centre of the P.P.I. screen, and which is due to strong reflections from objects in the vicinity of the radar. By means of a swept-gain circuit, the gain of the I-F amplifier is kept low at a time when high-intensity reflections are being received, and is gradually increased as weaker reflections, from more distant objects, arrive back at the radar. Such an arrangement makes the display on the C-R screen much clearer and allows the operator to distinguish echoes from aircraft close to the radar which would otherwise be masked by *clutter*.

The swept-gain control circuit is so designed that the I-F amplifier attains maximum gain when echoes from ranges of 15 to 20 miles are being received. The method of obtaining swept gain is to cause the charge on a condenser to commence building up in the usual exponential manner at the instant when a pulse is transmitted from the radar.

The increasing potential on the condenser is transferred via a cathode follower to the anodes of several stages of the I.F. amplifier, so causing the gain of the amplifier to rise steadily from a minimum to a maximum value. This cycle is repeated with the transmission of each pulse from the radar.

In the anode circuit of the second detector is an I.F. transformer supplying a further stage of I.F. amplification. This stage is coupled via low-impedance line to an elevated dipole aerial close to the radar, whence signals are transmitted at 60Mc. across the airfield to the control tower.

Automatic frequency control is incorporated to ensure that the difference between the signal frequency and the local oscillator frequency will be held close to 60 Mc., the nominal intermediate frequency. By this means drifting of either the signal or local oscillator frequencies may be compensated for.

The A.F.C. unit is fed from the output of the crystal converter and consists of an amplifier, followed by a discriminator circuit of the kind fairly widely applied in broadcast receiver practice. The circuit employs both inductive and capacitive coupling between the amplifier stage and the following detector stage, in which two differentially-connected detectors are used.

When the frequency applied to the

discriminator is exactly 60 Mc., the output voltages of the two detectors are equal and opposite, so that the net output is zero. However, if the applied frequency differs from 60 Mc, and has a value of, say, 59 Mc, the output from one detector will rise, while that of the other falls, giving rise to a net voltage of which the polarity is negative. Conversely, a higher frequency, e.g., 61 Mc., will produce a net positive voltage.

The net output voltage from the discriminator, known as the *control voltage*, is fed back to one of the electrodes (actually the repeller) of the klystron local oscillator, and automatically adjusts the frequency of the latter, so that an intermediate frequency very close to 60 Mc. is always obtained.

Video signals from the second detector of the I.F. amplifier are passed to the video amplifier, the output of which is connected to the "local" Plan Position Indicator in the pit on the airfield. This local indicator is used when the radar is being adjusted, and also for monitoring purposes.

The video amplifier comprises a single stage of amplification, a cathode follower, a limiting stage, and an output cathode follower. The limiter allows the gain of the equipment to be adjusted to make weak signals visible without causing very bright "blobs," resulting from strongly received signals, to appear on the C-R screen.

Antenna.

The general form of the antenna is shown in Fig. 5. The parabolic reflector in use, however, is 5ft. in width, being larger than the reflector shown. The radiating element of the antenna consists of a horizontal dipole placed at the focus of the reflector, fed by a co-axial line. Immediately in front of the dipole is a cylindrical shield which reflects energy radiated forward from the dipole back on to the main reflector.

The antenna is driven round at 23 revs. per minute by a 28-volt shunt motor via a gear system. If desired, the continuous rotation can be changed to a slower oscillatory motion of the antenna, when it is desired to search more thoroughly a particular sector of the coverage area.

(Continued on page 48.)

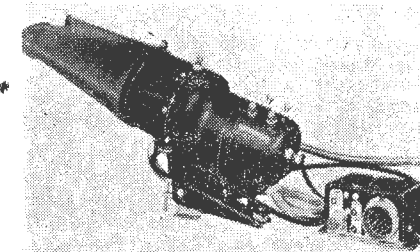

Fig. 8.—View of the Plan Position Indicator.

RADIO SCIENCE

As in previous quizzes, the method of obtaining your score is to take 10 points for each question answered correctly and 5 points if only half right.

As a guide to your ability the scores are:—Beginners, 50% and under; Experimenters and Servicemen, 50 to 75%; Experts 75 to 95%, and Genius over 95%.

Q.1.—To start the quiz off, here is one for the sound expert. The amplitude of a sound wave determines the—

- (a) Pitch of the sound wave.
- (b) Signal-to-noise ratio of received signal.
- (c) Intensity or loudness of the sound.
- (d) Wave-length of the waves.

Q.2.—If you read the words "detector valve", you would know they referred to—

- (a) A special valve used by the PMG Department to detect stations operating off frequency.
- (b) A valve for rectifying the inaudible r-f input into an audio frequency which may be heard in a speaker or headphones.
- (c) The audio output valve in a modern superheterodyne.
- (d) A valve used in certain types of DF equipment to determine direction of incoming signal.

Q.3.—Even if you were able to answer the previous question, you still may not know that a "power detector" is—

- (a) An employee of an electric company who checks meters to see if people are surreptitiously appropriating power.
- (b) An instrument for determining power losses in transmission lines.
- (c) A special detector circuit designed to deliver an output of only 0.00025 volts with a plate voltage of only 5 volts.
- (d) A valve that will not overload with large r-f signals and which delivers considerable power to the output circuit.
- (e) A service instrument for detecting power of radio sets.

Q.4.—The term "push-pull" is one that is frequently seen in technical periodicals. It means—

- (a) A combination receiver and transmitter.

- (b) An amplification system in which two valves work in parallel.
- (c) An accordion-like device which pulls in r-f signals and pushes out a-f signals.
- (d) An amplification system in which the two valves work 180 degrees out of phase.

Q.5.—A variable resistor is—

- (a) A resistor which varies from its rated value.
- (b) Part of the tuning system of a radio receiver which rejects unwanted stations.
- (c) A resistor having one or more sliding contacts for varying the amount of resistance included in the circuit.

Q.6.—Television has been in the news of late, and consequently the following questions are in somewhat of a topical vein. In T-V (television) parlance, a frame really means—

- (a) The border around the C-R tube.
- (b) An innocent person made to appear guilty.
- (c) A form of interference which causes a halo to appear around the object being viewed.
- (d) The receiver cabinet.
- (e) A single complete picture.

Q.7.—Whilst on the subject of television, "video frequency" is another way of saying—

- (a) The second I-F frequency of a special triple detection receiver.
- (b) The frequency that is visible similar to light rays.
- (c) The frequency of the voltage resulting from T-V scanning.

Q.8.—Although the term "thermal agitation" may have several meanings, in radio texts it generally refers to—

- (a) The term used in connection with heat measurement units.
- (b) Free electrons moving around at random continually in any conductor producing tiny electron currents.
- (c) The heat produced in radio valves which is responsible for the blue glow which is emitted in proximity of the various electrodes.
- (d) The heating of i-f transformers to broaden the frequency response.

Q.9.—A "loading coil" is—

- (a) A coil inserted in a circuit to increase the normal inductance.
- (b) Part of a modern machine gun.
- (c) A large coil whose resistance drop is used to supply part of the negative grid bias.
- (d) The small coil in series with the voice coil on a dynamic speaker to assist in eliminating any hum.

Q.10.—With your thoughts directed to coils, here is another question on the subject. A "choke coil" is—

- (a) A coil wound tightly on a valve shield to reduce any stray currents.
- (b) A primitive form of execution.
- (c) A coil used to offer high impedance to an AC current.

Q.11.—Hysteresis is the term applied to—

- (a) Distortion arising from an overloaded detector.
- (b) A mild form of insanity.
- (c) Heat losses in a conductor due to rapid magnetisation and demagnetisation.
- (d) The effect of using too small a capacity in a filter circuit.

Q.12.—The expression "auto-induction" means—

- (a) That the price of motor-cars has been reduced.
- (b) A voltage generated in the same winding which established the magnetic field in the first place.
- (c) A voltage induced in the secondary winding by a primary winding.

Q.13.—A blocking condenser is used to—

- (a) Keep out undesired stations by improving the selectivity.
- (b) Prevent direct current from passing through a circuit.
- (c) Act as a safeguard to prevent the condenser plates from being turned too far.

Q.14.—Syntony is—

- (a) An elaborate composition arranged for a full orchestra.
- (b) The harsh grating tone of a poor speaker system.
- (c) The action which results from a push-pull circuit.
- (d) The condition of two oscillator circuits having the same frequency.

(For answers, see page 47.)

Power-Line Carrier Communication

BY R. C. CHEEK

Westinghouse Electric Corporation

Power-line carrier communication systems have steadily climbed in favour with major electrical utility companies. New equipment, new ways of using the old innovations in the whole field of communications, have brought the systems to a high degree of dependability.

Present-day power-line carrier equipment can provide a communication system that practically duplicates the service obtained from a private automatic-telephone exchange. Its reliability, economy and speed of carrier communication have been of immense value to the power-generating industry, which is clearly indicated from the large number of terminals now in use and under construction.

Power-line carrier communication systems comprise, in essence, receivers and transmitters with their calling devices, and apparatus to couple transmitter and receiver to the power transmission lines. The lines themselves compose the voice-carrying medium. Capacitors of the type shown in Fig. 1, couple the equipment to the power line, as indicated in Fig. 2, generally using a single conductor with ground return. This arrangement offers maximum economy in coupling and in use of by-passing or trap units shown in Fig. 3. For lowest attenuation and noise level, a second conductor of the three-phase line sometimes is employed as a return circuit.

The power-line carrier frequency band, 50 to 150 kc, is dictated by the characteristics of power-transmission lines when they are used as carrier mediums. Short branches along the lines sometimes cause losses because they may approximate an odd quarter wave-length that represents a low impedance at carrier frequency. A line trap inserted in series at the tap point can prevent this. The trap consists of a coil of heavy cable, capable of carrying the full power current of the line tuned to parallel resonance at the carrier frequency. Representative power-line carrier transmitters and receivers are shown in Figs. 4 and 5.

System Combinations

Power-line carrier communication systems can differ in the method of calling, the power supply, or in the modulation system, but any given assembly can be classified as simplex or duplex, depending upon its operation.

A *simplex* system is one in which transmission can proceed from one station only at any given instant. In simplex communication all stations on a channel operate on a single frequency. Transmissions and reception cannot take place simultaneously on the same frequency at one station, because the transmitter in operation blocks the local receiver and may even damage it permanently unless the receiver is de-energized. The simplex system requires means for turning off the receiver during transmission.

Requiring only a single carrier frequency, simplex lends itself readily to applications in extensive carrier-communications involving more than two terminals. It is more economical of space

in the carrier-frequency spectrum since the same frequency is used at all transmitting points. Because crowding of the spectrum is a serious problem on many power systems to-day, this factor alone is often sufficient to justify its application.

A *duplex* system is one in which transmission can take place simultaneously from both stations as in ordinary telephone service. In the usual duplex system, at one station the first of two frequencies is used for transmission, the second for reception. At the other station, the first frequency is used for reception, the second for transmission. The difference between the transmitting and receiving frequencies is held to a

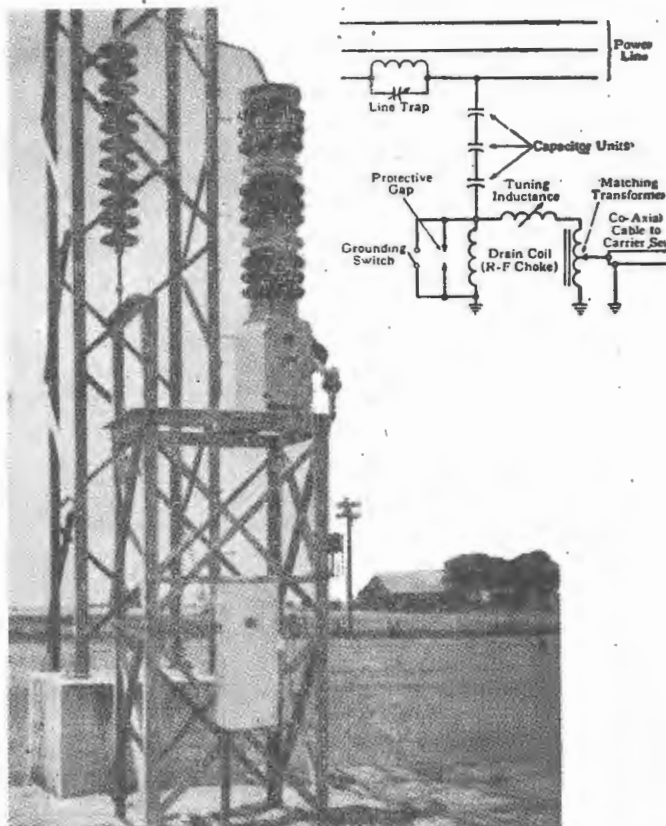

★
Fig. 1.—The carrier wave, containing the voice signals is applied to the power line for transmission through a coupling capacitor. The connections to the power transmission line, simplified are shown in the diagram Fig. 2.

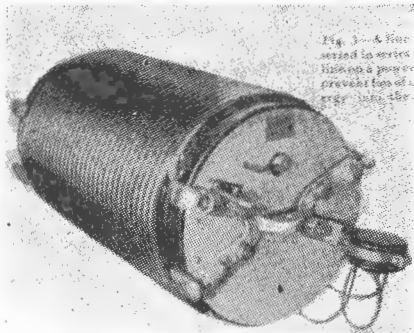

Fig. 3.—A line trap inserted in series with a tap line on a power circuit to prevent loss of carrier energy into the tap line.

Fig. 3.—A line trap is inserted in series with a tap line on a power circuit to prevent loss of carrier energy into the tap line.

minimum of 20 per cent. of the higher of the two frequencies. This prevents local transmitter-receiver interference.

Duplex operation normally is limited to two terminals per channel, unless communication is desired between a central office and several other stations not requiring intercommunication. Its major advantage, and one that in the minds of some users outweighs any disadvantages, is its ability to provide two-way conversation without the switching opera-

tions required by the manual-simplex system.

The Single-Frequency Manual-Simplex System

In the single-frequency manual-simplex system, shown diagrammatically in Fig. 7, "send-receive" switching operations are performed by the speaker using a push-button on the telephone handset. Although provision can be made for complete operation over a two-wire extension, a control circuit separate from the speech circuits generally is required. The need for d-c control circuits, and the fact that a special telephone instrument with a "push-to-talk" button is necessary, precludes any simple method of extending a manual-simplex telephone channel through a conventional private-branch exchange type of board.

The system is used where a simple point-to-point communication channel is needed and where telephone extensions from the carrier equipment are short and few. For routine or emergency communication between system operators accustomed to handling the equipment, the manual-simplex system often is entirely adequate.

The Two-Frequency Duplex System

The basic units of a two-frequency duplex assembly are shown in Fig. 7. Transmitter and receiver operate through the audio-hybrid unit, marking the difference between this system and that of the single-frequency, manual-simplex. The audio-hybrid unit allows transmitter and receiver to operate continuously without switching and using only a conventional two-wire telephone extension.

The assembly shown in Fig. 8 is used



Fig. 4.—Carrier communication transmitter. A beam type oscillator tube in a Colpitts circuit is used to excite six similar tubes in push-pull parallels. Grid bias modulation is employed with a carrier output of 25 watts, adequate for all the usual power-line carrier applications.

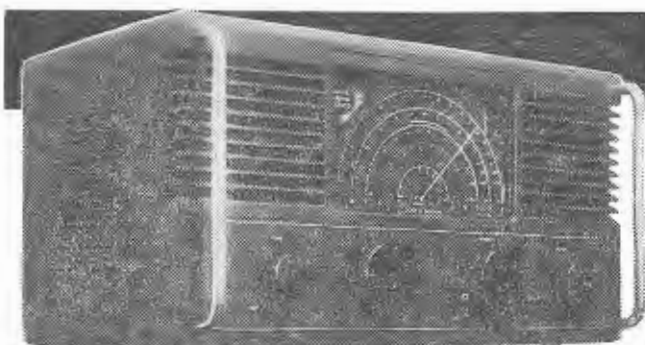

LISTEN on the HIGH SEAS!

This is NEW — the

EDDYSTONE 670 MARINE RECEIVER

Specially designed to eliminate noise from rowdy ship mains

This Receiver has been primarily designed for broadcast reception on board ship, yacht, or launch, and to work on 110 volt D.C. mains. It will, however, work equally well in other locations and on 110/115 volt A.C. and 200/250 A.C. or D.C. mains.

★ ★ ★

GRAMOPHONE PICK-UP: Sockets are provided at the rear of the receiver for connecting a pick-up of the magnetic type.

SPEAKER: A 6½" high flux density unit is fitted internally. Provision is made so that it can be disconnected if desired, when an external speaker is used.

GENERAL CONSTRUCTION: The cabinet is specially reinforced and coated inside to prevent resonance effects. Finished in brown wrinkle with chromium-plated handles.

DIMENSIONS: Overall width 17"; Depth 11"; Height 8¾".

SUPERBLY MADE. CHECK THESE FEATURES

CIRCUIT ARRANGEMENT: The receiver functions on the superheterodyne principle, and has 7 valves with push-pull output.

TUNING RANGE: Four wave-bands are provided. The first two overlap and cover from 10-50 metres and the second two overlap and cover from 110-575 metres.

DIAL: Ranges 1, 2 and 3 are directly calibrated in frequency, and range 4 is calibrated in metres. Additional markings show all Amateur and Broadcast bands.

SENSITIVITY: Sensitivity is of a high order, consistent with a good signal/noise ratio.

SELECTIVITY: Approximately 30 dB attenuation at 10Kc off resonance.

IMAGE RATIO: Image rejection is at least 20 dB at the highest frequency.

AUDIO OUTPUT: Output approaches 1½ watts undistorted, and 3½ watts total. Negative feed-back is also incorporated.

OTHER RECEIVERS AVAILABLE—"640" (Amateur Bands) . . "504" (Prof. & Com.) . . "659" (Domestic)

See about your "670" NOW - contact the Australian Factory Representatives:
KEITH HARRIS & CO. PTY. LTD. - 51 WILLIAM STREET, MELBOURNE C1 - MB 2119

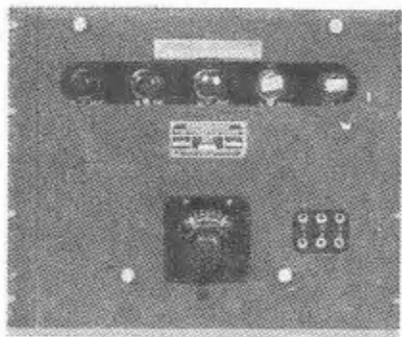

Fig. 5.—In this superheterodyne receiver, a band pass filter feeds into a mixer and two stage i-f amplifier. Two full wave rectifiers are used, one for detection and one for automatic volume control to minimize variations in signal strength caused by changes in channel attenuation, sleet forming on lines, and as compensation for the varying distances separating stations using a single channel.

with telephone extensions that provide d-c paths between carrier equipment and telephone. The hook switch energizes the transmitter through a d-c control circuit when the telephone receiver is lifted. If the extension does not provide a d-c path, the same equipment can be used with the transmitter energized continuously, whether or not conversation is in progress. This may be objectionable because of the possibility of continuous interference with other carrier channels. Alternatively, the assembly can include an element called an audio-relay unit, which functions automatically to energize the transmitter when an audio signal, either voice or ringing tone, reaches the equipment from the telephone line. Time-delay circuits keep the transmitter energized continuously during conversation; they turn off the power at some pre-determined time after the conversation has been completed.

The Multi-Station Duplex System

The multi-station duplex system provides the advantages of duplex communication between any two of a number of stations on a channel. The basic units are shown in Fig. 9.

The transmitter and receiver to be used at a given station, during a conversation, depend upon the point of origin of the call. Designating the two frequencies as F_1 and F_2 , all stations would normally receive on F_1 . A station originating a call would transmit on F_1 . The F_1 transmitter is selected by the calling party by picking up the telephone handset. The closing of the d-c circuit through the hook switch operates a relay, causing the contactor unit to apply audio-amplifier output to the audio terminals of transmitter F_1 . Simultaneously the contactor unit energizes the transmitter and applies the output of receiver F_2 to the audio-hybrid unit. At the called station, reception of the carrier signal

from the calling station on receiver F_1 operates a relay whose contacts open to prevent a transfer (transmitter F_2 to transmitter F_1) being made by the contactor unit when the called party replies. Transmitter F_1 and receiver F_2 at the calling station and transmitter F_2 and receiver F_1 at the called station remain energized throughout. The conversation completed, replacing the receiver at both stations returns conditions to normal, with all stations receiving on F_1 .

The Single-Frequency, Automatic-Simplex System

Single-frequency, automatic-simplex is the most versatile of all the power-line carrier-communication systems. The number of stations on a given channel is not limited to two, as is the case with the usual two-frequency duplex system; it permits a single conversation among several stations on the channel, and it permits operation with two-wire telephone extensions and through PBX boards without requiring balance of a hybrid unit.

Modern automatic-simplex equipment eliminates objections to "send-receive" switching because this function, accomplished automatically, is so rapid and quiet that the user often is unable to detect its occurrence. In up-to-date automatic-simplex equipment, the transfer is made so rapidly that after every slight pause, or even between words, a party speaking can be interrupted.

A typical assembly for automatic-simplex communication is shown in Fig. 10. In addition to the units used in the two-frequency duplex assembly, automatic-simplex operation requires an electronic-transfer unit and a bias-controlled audio-amplifier unit. The latter provides a convenient place to block receiver audio output without disabling the radio-frequency portion. It consists of a single-stage class-A amplifier, with transformer-coupled input and output. Leads are brought out from the grid circuit to a terminal strip so that an

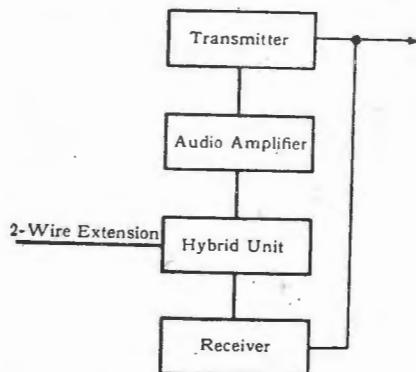

Fig. 7.—The basic units of two-frequency duplex communication assembly. The hybrid unit directs outgoing speech into the transmitter and incoming speech to the telephone circuits.

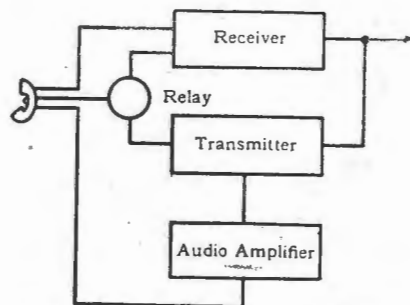

Fig. 6.—The basic units of a manual-simplex carrier communication assembly. The relay removes power from the receiver and applies it to the transmitter when the control button on the handset is operated. The audio amplifier can be omitted.

external negative blocking bias can be applied.

The transmitting audio amplifier in the stand-by condition is unblocked and ready to amplify voice signals from the telephone line. Reception of a carrier signal blocks the amplifier, so that once reception has started, no transmission can occur until the equipment returns to the stand-by condition. On the other hand, if an outgoing voice signal reaches the amplifier from the telephone line with the stand-by condition in effect, it causes the entire receiver to be blocked so that no signal can be received until conditions return to stand-by. The switch from transmit to receive and vice-versa requires that the equipment pass through the stand-by condition in each direction.

The electronic-transfer instrument is the key unit in the automatic-simplex assembly. It switches automatically from stand-by to transmit or receive as required. The unit is normally in the stand-by condition, that is, with no signal being received or transmitted. The transmitter is blocked by voltage 1 (Fig. 11), and the r-f circuits of the receiver are energized to detect the presence of an incoming signal. The bias-controlled amplifier is blocked in the stand-by condition by voltage 2, so that no audio output from the receiver reaches the telephone line. When no carrier signal is being received, the automatic-volume-control circuits of the receiver increase the gain to such an extent that noise on the channel might become annoying if operation of the bias-controlled amplifier were not blocked.

Transfer Unit Operation

The operation of the transfer unit when changing from stand-by to transmit or receive is as follows:—

Transmit.—An audio signal (voltage 3 in Fig. 11) from the telephone line passes through the transmitting audio-frequency amplifier and is applied simultaneously to transmitter and transfer unit. In the latter it is further amplified and then rectified by a diode detector. The

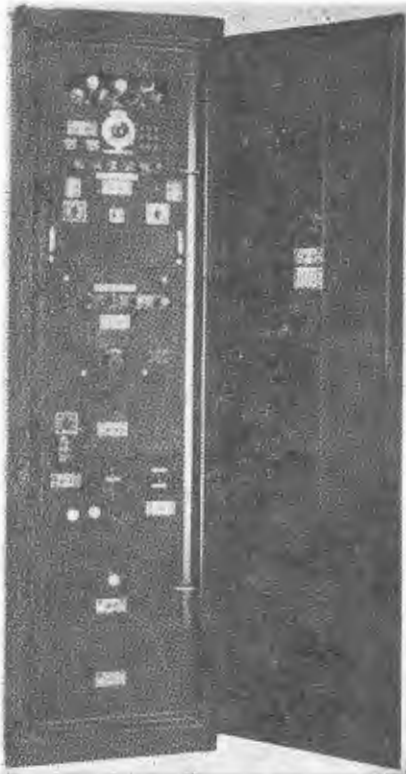

Fig. 8.—Typical two-frequency duplex power-line carrier communication assembly. Units from top to bottom, are transmitter, audio amplifier, panel for test meter unit, super-heterodyne receiver, audio hybrid unit, switch and fuse panel, 640 volt rectifier and 120 volt rectifier.

positive bias so produced is applied to the grid of a small thyratron, which breaks down and begins to rectify a 10-kilocycle internally generated voltage. The negative voltage then appearing across the thyratron load resistor is used to block the radio-frequency circuits of the receiver (voltage 4), and, simultaneously, to stop a second thyratron from rectifying the 10-kilocycle voltage. Extinguishing this second thyratron removes blocking voltage 1 from the transmitter, allowing the audio signal initiating the switching to be transmitted. The entire sequence occurs in 2.5 milliseconds or less, so that not even the first syllable of the outgoing speech is lost.

The disappearance of the audio signal from the telephone line does not instantly return the equipment to stand-by. Resistance-capacitance time-delay circuits with adjustable constants provided in the diode rectifier circuit prevent the actuating bias from disappearing immediately speech ceases. This delay can be adjusted to allow return to stand-by at the end of words, phrases, or sentences, depending upon the preference of the user.

Receive.—The incoming carrier signal (voltage 5 in Fig. 11) is taken from the i-f output stage and applied to an amplifier in the electronic-transfer unit. The

amplified signal is rectified by a diode detector, and the resulting bias causes a thyratron to break down and start rectifying a 10-kilocycle voltage supplied by the transfer-unit oscillator. Current through the load resistor in the thyratron plate circuit produces a negative bias voltage 6, which blocks the transmitting audio amplifier, extinguishes a second thyratron, and removes blocking-bias voltage 2 from the receiving audio amplifier, thus permitting the incoming signal to reach the telephone line. This operation occurs in 2 milliseconds or less. Disappearance of the carrier signal removes the actuating bias furnished by the diode rectifier and causes the opposite sequence of events, returning the equipment to the stand-by condition.

Calling Systems

Several systems to establish a call over a carrier channel are in general use. Among the more important are: code-bell, voice, automatic bell, and dial selective.

Code-bell calling is a system often used on rural telephone party lines, in which all telephones on a given circuit ring. The desired party is indicated by a code of long and short rings. In power-line carrier communications the calling party transmits the code by turning a hand generator, or applies a 60-cycle voltage to the line by means of a push-button on his telephone. A relay in the carrier equipment, actuated by calling voltages between 16 and 60 cycles, operates in accordance with the coded signal to apply 60-cycle modulation to the transmitter. At the other terminal or terminals of the channel, the receiver output energizes a circuit selective to 60-cycle modulation. This circuit operates a relay that applies ringing voltage (either 20 or 60 cycles) to the telephone extensions, causing all telephones to ring in accordance with the coded signal. Code-bell calling can be used either a-c or d-c telephone extensions, and is the most popular system used in power-line carrier work.

In the **voice-calling system**, the call is placed by speaking the desired party's name into the telephone transmitter. Loud-speakers with individual amplifiers at all telephone extensions are disconnected when the receiver is lifted. Where

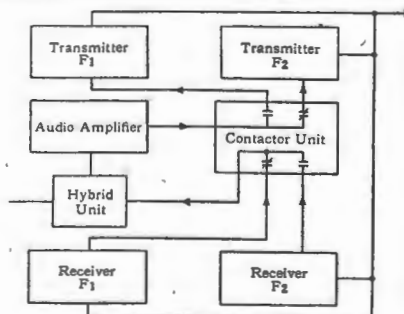

Fig. 9.—Basic units of multi-station duplex communication assembly.

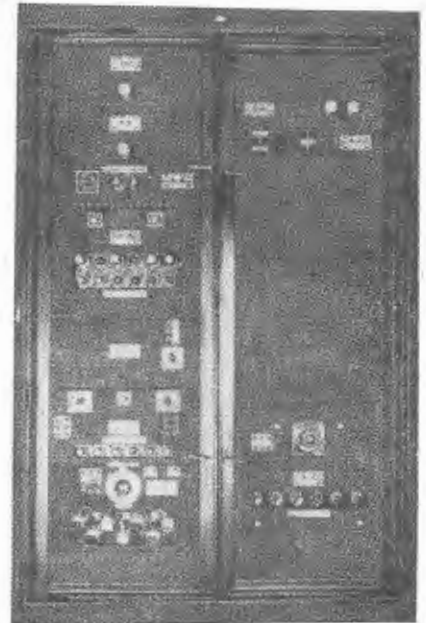

Fig. 10.—A representative assembly of automatic-simplex powerline carrier-communication equipment.

ambient noise level is high, voice calling can be supplemented by a high-frequency tone, transmitted at the option of the calling party by a push-button or key switch. Voice calling can be used with either a-c or d-c lines.

In the **automatic bell-calling system**, the telephones at the opposite terminal are rung automatically when the calling party lifts the handset. The ringing continues for a few seconds and then is cut off. To repeat the ring the calling party must hang up the telephone handset and remove it again, or close the hook switch manually and then release it. Automatic bell-calling systems require d-c telephone extensions, because closure of the d-c circuit through the telephone transmitter initiates application of calling voltage to the carrier equipment. Since this system provides no means of indicating which telephone on an extension should be answered, in general it is used only on point-to-point systems where only one extension is operating at each end of the channel. A carrier channel linking two PBX boards provides an ideal application for the automatic bell-calling system.

In **dial selection**, the desired number is dialed in the conventional dial-telephone manner. Each carrier set includes its own line-selector unit, which receives incoming dial pulses and applies ringing voltage to the wanted extension. Each of these selector units is in itself a complete private automatic-telephone exchange. The automatic-simplex carrier system with selective calling provides nearly every operating feature found on modern dial-

(Continued on page 47.)

BRIGHT FLUOROSCOPIC IMAGES

Details of new electronic equipment now being developed for increasing the brightness of fluorescent x-ray images by a factor of 500.

X-ray research workers stand on the threshold of a development which, if successful, will be out-ranked in importance only by the discovery of x-rays themselves by Roentgen in 1895. It is the means of intensifying the image on an X-ray fluoroscope screen to such a brightness that the physician can read it almost as easily as he does his newspaper.

A vital need exists for greatly brightened fluoroscopic images, in both medical and industrial fields, since the human eye is incapable of distinguishing all but gross evidence that is actually present on the fluoroscopic screen because of the low illumination level of the screen. The conditions that confront the physician in present-day fluoroscopy are even worse than those encountered when trying to find a seat in a theatre after leaving the bright sunshine.

Dark Adaptation Necessary

To see the fluorescent image he has to dark-adapt his eyes for 20 minutes. Even then, with the low brightness available in most difficult cases, such as a large abdominal thickness where the brightness may be as low as .00005 millilamberts, a separation of $\frac{1}{4}$ inch is necessary before contours can be distinguished. Furthermore, this $\frac{1}{4}$ inch figure applies only in measurements where the contour lines separate regions with a contrast of 100 per cent., as in contours between black and white. While this is an extreme case, it compares with 30 millilamberts brightness and .001 inch contour separation as normal conditions for observing X-ray plates. A brightness of .001 millilamberts with a required contour separation of $\frac{1}{32}$ inch is about the centre of the fluoroscopic range.

Now, after four years of intensive study, engineers at Westinghouse Research Laboratories are constructing an X-ray fluoroscope image brightener which is expected to increase considerably the brightness of such images.

A pilot tube has been operated which has produced an amplified image five times brighter than the original X-ray image. With further refinement and the

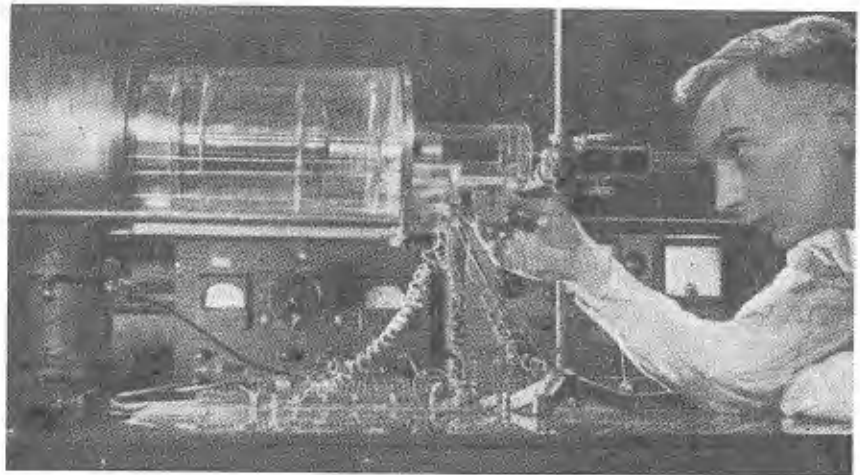

The apparatus used for exploring the principles underlying control and build-up of x-ray produced electron streams.

aid of an optical system of enlargement, the scientists expect to produce a commercially practical tube that can intensify the original X-ray image 500 times.

Amplifier Operation

The new image amplifier increases the brightness of the fluoroscopic image after the X-rays have passed through the patient. This solution to a long-felt need is necessary because the X-ray intensities are already at the patient's tolerance level and is possible because the sensitivity of the physician's eyes are the main limitation to effective fluoroscopy to-day. Fluorescent screens now have a gross efficiency of about 3 per cent., so that even a theoretically perfect screen would be only about 30 times as bright. Thus screen improvement alone cannot achieve the desired brightness gains.

The new tube does its work after the X-rays pass through the subject. These are made to impinge on a fluorescent screen, releasing a stream of light rays. The latter, in turn, strike a photo-electric surface coated on the fluorescent screen. The electrons emitted are accelerated by voltage above 20,000 across the evacuated space within the tube screen at the end, where light rays are produced to form the image.

In the full-scale tube now under construction, the original X-ray image will be reduced at the receiving end by a factor of five, so that if the original image measures five inches across, the final one will be but one inch in diameter. By thus *compressing* the stream of electrons, the final image is additionally intensified by a large factor, because many more high quanta are produced per square inch of fluorescent screen. The final step planned is to enlarge this small image optically, so that the physician reads the results on an image about 5 inches in diameter.

Other Factors Involved

In addition to condensation of the electron screen, two other factors are responsible for the increase in image intensity. First, by accelerating the electrons to very high velocities, considerable additional energy is added to the electron stream before it strikes the fluorescent screen. The greater the energy of the electron stream, the larger the number of light quanta produced and consequently, the more intense the final image.

Secondly, the number of light-producing electrons plays an important role. It is estimated that each X-ray quantum striking the first fluorescent screen is productive of around 2,000 light quanta,

and that about one in 20 of these light quanta is able to shake loose an electron from the photo-electric surface. At the second fluorescent screen, the accelerated electrons may produce from 50 to 100 light quanta per electron, depending upon the voltage.

By increasing the image brightness 500 times, the amplifier tube will permit the physician to perceive structures at present indiscernible. It is mainly the limitations of the human eye that impose restrictions on present-day X-ray fluoroscopy. It has been estimated that an X-ray image taken through an average human abdomen on the best fluorescent screen available is about 30,000 times dimmer than a sheet of white paper viewed under a reading lamp. At this level the eye



The small tube on which image amplification has been successfully achieved.

can barely distinguish objects separated by as much as one-eighth inch.

To achieve even this low sensitivity, the X-ray diagnostician must dark-adapt his eyes, which means sitting in a dark room for times ranging up to 30 minutes, or wearing dark red glasses.

With fluorescent screens as close to the peak of their efficiency, it soon became apparent to workers in the fields that the only solution lay in increasing the energy striking the screen. But the stopper here was that X-ray intensities were about as high as practicable and consequently other methods of achieving desired results had to be evolved. In addition to shorter examinations, such techniques as the use of the wafer grid, stereo-fluoroscopy, and even the televising of fluoroscopic images, may well become practical. All these possibilities are, in addition to the great advantage, that the physician will be able to perceive objects at present indiscernible.

The image amplifying system is just emerging from the research stage. Many months of perfection and design engineering remain to be done before the device is commercially available. The research

Careers in RADIO and TELEVISION

Right now there's the chance of a lifetime for Radio Trained men. Achieve success, independence, and prosperity by getting trained NOW. A.R.C. up-to-the minute result getting training will quickly bring YOU SUCCESS.



We teach you these vital radio subjects:—

- ★Frequency Modulation
 - ★Television
 - ★Facsimile
 - ★Service Engineering
 - ★Amateur Operating, etc., etc.
- ACT NOW!**

Write, 'phone or call TO-DAY. We will send you (without obligating you) a copy of the big free book "Careers in Radio & Television."

**Australian Radio College
Pty. Ltd.**

E.S. & A. Bank Buildings,
Cnr. Broadway & City Road
(opposite Grace Bros.)
SYDNEY. M6391-2

has, however, irrefutably proven the practicality and immense importance of the device.

NEW & USED DISPOSALS EQUIPMENT

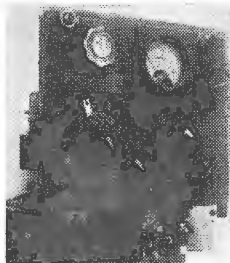

101 TRANSCEIVER UNITS

Transmitter, less valves and meter, 37/6 F.O.R.

R.F. meter for 'above, 10/- extra.

Receiver, less valves, 37/6 F.O.R.

Brass Carrying Case supplied free, if both units are purchased.

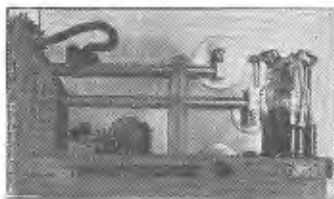

PARALLEL LINE OSCILLATOR

Complete with two CV63 valves. Tunes the 144 mc. band and higher. Lecher bars are silver-plated, 42/6

Postage 2/6 extra

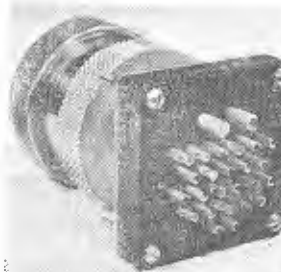

MULTI-PIN PLUG AND SOCKET

26-pin, including 2 large pins for heavy current.

5/6 post free

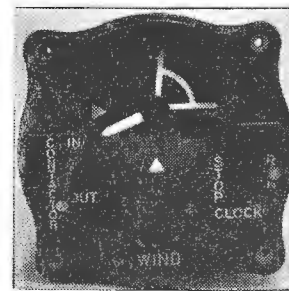

NEW PRECISION TIMER

48-hour jewelled movement, suitable for precision timing over periods of one minute. Ideal for photographic work, electric sign-switching, etc. Price 18/6

Postage 2/- extra.

AVAILABLE ALSO AT:— No. 5 ROYAL ARCADE, SYDNEY

PARAGON RADIO

245 PARRAMATTA ROAD,
HABERFIELD, SYDNEY, N.S.W.

TELEPHONE: UA2145

Address all mail to:
Box 14, P.O. Haberfield, N.S.W.

Please Mention RADIO SCIENCE when Replying to Advertisements.

INTERNATIONAL RADIO DIGEST

A Technical Survey of Latest Overseas Developments

NEW LOW-COST F-M RECEIVER

The receiver was designed to fill the demand for a low cost FM-AM table model receiver. Utilising an unusual circuit arrangement, the design eliminates the necessity for any FM alignment gear, all alignment functions being of an AM nature.

The sensitivity of the receiver is 200 uv for a 50 mw output and is measured as a typical AM set with 23 kc deviation modulated with 400 cycles. In this circuit there is no high frequency switching

involved as the FM converter is used in that capacity only, and is not used when the broadcast band is in operation.

The first FM-IF amplifier becomes the AM converter in the broadcast band position. The FM-IF frequency is 10.7 mc, the demodulator is a 1N34 germanium diode in a reverse polarity half wave rectifier circuit, which operates on FM on the side slope. Audio recovery is obtained on each side slope with no more distortion than found in the typical ac-dc AM receiver. The entire receiver is side tuned for FM operation and all alignment functions are on the centre frequency.

Certain design features which add much to the performance is the element switching in the 12BE6 FM-IF amp., AM conv. When the set is switched to FM the injector grid of this 12BE6 is switched to its screen grid, raising its Gm and increasing the input resistance of this stage, making it a very good amplifier at 10.7 mc. It should be noted that the 12BE6 FM converter stage has an isolated B-floating ground which adds much to eliminate instability and frequency drift to the h-f oscillator.

Courtesy Tele-tech.

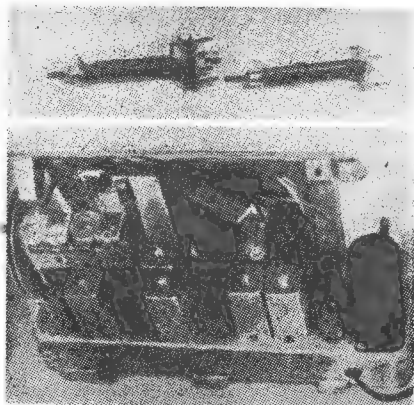

The two 10.7 mc. I.F. transformers used in the circuit are shown in upper photograph. Below is the completed receiver.

HOW NEW PHONOGRAPH RUNS ITSELF ALL DAY

This phonograph can play for more than 14 hours without repeating a selection—and without a hand touching it. In addition, it can turn itself on and off at pre-set intervals any time of the day or night.

A mechanical brain on a track behind a rack holding 100 records (200 sides) goes to the desired disk, lifts it to a turntable, and then plays either or both sides. When finished, the record is returned to its slot, and the player carriage moves to the next selection. Ordinary 10

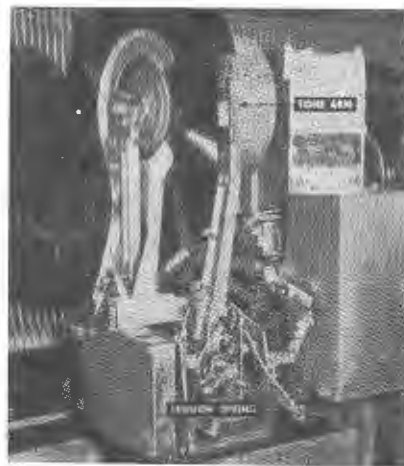

The mechanical brain which selects desired record. and 12 inch records may be intermixed in the rack, and once filed, they need never be touched until replaced.

The industrial model has been designed primarily for factories where it has been found that music boosts morale and reduces fatigue. A whole week's programmes of 15 minute concerts once each hour of an eight-hour day can be laid out in advance. It can also be used in clubs, department stores—even dance halls. Optional extras are an AM-FM radio and an amplifier for remote-speaker outlets that can be also used as a public-address system. Courtesy Popular Science Monthly.

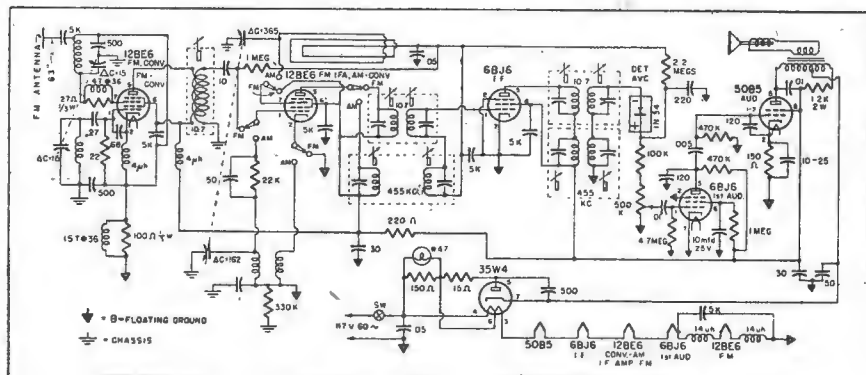

Circuit design and power specification for the FM-AM table model receiver.

RADAR AND RAINDROPS

Nuisance values often pay off in research. Take the case of raindrops during wartime operation of radar sets. As long as wavelengths of three centimetres (the so-called *x*-band) and up were used, no particular difficulties were encountered. But when the new *k*-band of wavelengths (1.25 cm) went into operation during rain, snow or conditions of very high humidity, radar observers noticed a definite drop in the quality and range of echo reception. The dip was attributed to absorption and scattering of the microwave energy by the rain, snow or water vapour.

The Westinghouse Research Laboratories is now attacking this problem with precision instruments for the measurement of microwave scattering. Instead of waiting for a rainy day, artificial raindrops in a range of carefully calculated sizes and fashioned from a mixture of ceramic powder and carbon black to give just the right dielectric constant are being used.

The artificial raindrops are fastened to a background made of special material that absorbs nearly all of the radiation not striking the raindrop. The microwave energy emanates from a horn-shaped transmitter, strikes the raindrop, and is reflected into a receiver placed at various distances and angles from the target. Actual measurement of the amount of scattering from the raindrop is accomplished by means of a neat balancing circuit.

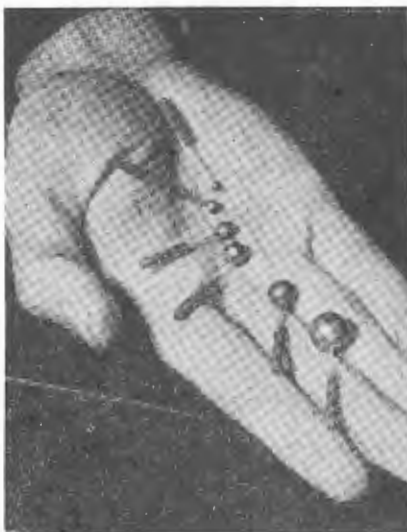

The artificial raindrops used in experiments.

First the transmitter is fired without the raindrop in the field, and the amount of scattering here is balanced with a lower level signal feeding from the transmitter into the balancing circuit. Then the target is placed in the field, causing an increase in scattering that unbalances the circuit. The additional power needed to rebalance the circuit is, of course, the amount of scattering from the raindrop. Amplifiers build up the very weak scattering signal to where it can be read easily from meters.

MICRO-WAVE APPARATUS FOR TRUNK LINES

The Post Master General's Department has placed a Contract with Amalgamated Wireless (Australasia) Ltd., for the supply of micro-wave link apparatus for trunk route working.

This micro-wave equipment is a direct substitute for trunk lines of either the open wire or cable types and acts as the bearer of the many speech or telegraph channels which can be assembled by conventional carrier telephone and telegraph equipment.

Double frequency modulation is employed, the assembled speech channels being made to directly frequency-modulate a sub-carrier which in turn frequency-modulates the final carrier frequency at about 4,000 megacycles. This method of communication employs relatively simple circuits and benefits by the inherent advantages of frequency modulation techniques. Cross talk interference between channels is minimised by the extremely low distortion figures obtained.

A complete system comprises the two terminals and a number of relay installa-

tions. The latter operate unattended and ingenious fault-finding circuits enable technicians at the terminal offices to detect and localise transmission faults which may arise at the relay points. As with other types of micro-wave link equipment, the radio terminals and repeater stations must be strategically situated along the route so that the parabolic aerials can be placed on elevated sites. The distance between stations varies somewhat according to the character of the terrain. For average conditions, the distance of 30 miles between repeater stations is common practice. The equipment utilises a form of diversity reception at each terminal and repeater station which greatly minimises fading effects due to the most commonly occurring causes in this frequency band.

The equipment to be supplied to the P.M.G. will be the same general design as that produced by Radio Corporation of America for Western Union, and is the result of years of research and development now leading to extensive installations in the United States.

5 BAND KIT

FOR YOUR LATEST RIG

consisting of 5 coils:—Aerial, R.F. and Oscillator in the following band.

10 metres	30 mc. to 11 mc.
15 metres	8.25 mc. to 23 mc.
20 metres	16 mc. to 5.5 mc.
40 metres	8 mc. to 3.0 mc.
80 metres	4 mc. to 1.5 mc.
Broadcast	1600 kc. to 550 kc.

SUITABLE FOR:

This coil kit is suitable for use with a Stromberg H. Type condenser and will give a band spread as above. A smaller gang will give less overlap at each end and amateurs may use our type CV49 double spaced condensers for band spreading in conjunction with the H gang.

A six band double sided switch shorting plate, the 2nd side being used to short circuit all unused coils. IT IS NECESSARY to shield between the Aerial, R.F. and Oscillator sections of switch.

SEPARATE COILS

The following padding condensers will be needed:

Colour	Metres	Padders
Nil	B/C Band	R.C.S. Type P21, 5-plate adj.
Green	80	R.C.S. Type P21, 5-plate adj.
Red	40	0015 fixed condenser
Yellow	20	004 fixed condenser
White	15	004 fixed condenser
Blue	10	004 fixed condenser

PRICE:

4/6 each
(b'cast 5/6)

R. C. S.
RADIO PTY. LTD.
174 CANTERBURY ROAD,
CANTERBURY

The Dual-Wave Five

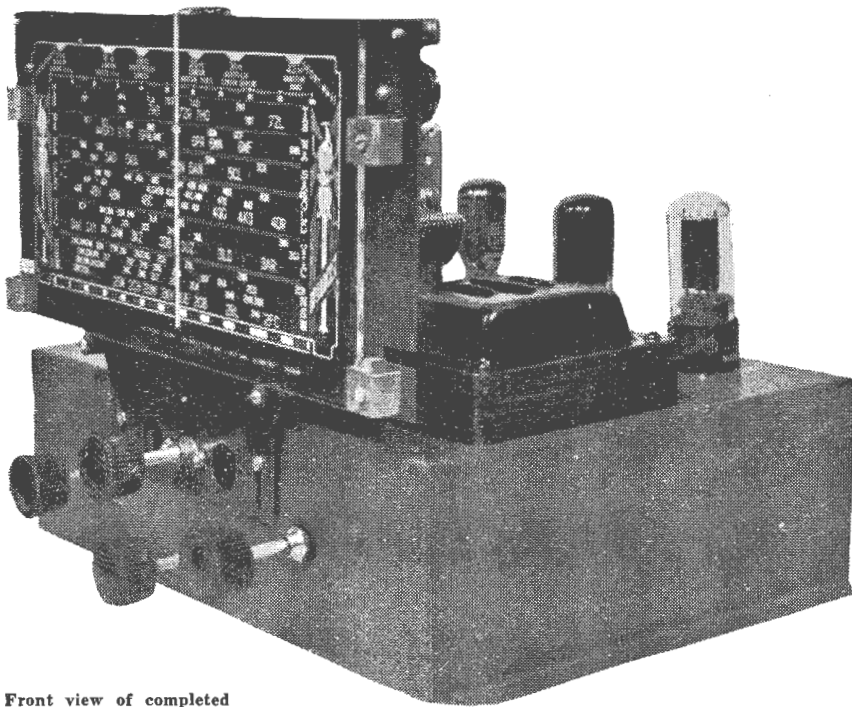

Front view of completed receiver.

***Excellent performance on both Broadcast and Short Wave bands.**

***High gain audio section for use with gramophone pickup.**

***Negative feedback tone control.**

The five valve dual wave type of receiver is probably the most widely used set nowadays, since it is capable of giving excellent results on both broadcast and short wave bands without the necessity of unduly complicated circuits.

Since the description of the Dual Wave Seven in the May issue, there have been many requests from readers, who considered this design too elaborate for their immediate needs, for a circuit of simpler design and layout. With this in mind, the following description of a five valve dual wave receiver designed around modern type valves and components should find a ready appeal among home constructors.

Whilst the present circuit has not been over-simplified it should not present any undue difficulties to either the experienced or novice home set builder, providing reasonable care is taken with the layout and general wiring up. It will be found that this particular receiver is an excellent performer, possessing ample sensi-

tivity on both bands, as well as providing good audio quality with a high power output.

Whilst in some respects it may have been possible to reduce the number of components used, by using common cathode and screen resistors and condensers, it was considered the slight saving effected, somewhat of a false economy, and that more consistent performance and freedom from any circuit instability would result by the inclusion of such extra components. Facilities for adding a gramophone pickup have been included in the design, and to achieve best results with this a high gain audio section utilising an effective form of negative feedback tone control has been incorporated.

Circuit Details

Reference to the schematic diagram will show that for the main part the circuit design is quite conventional and follows modern practice for a receiver of this type. The valves used are: Converter, ECH-35, combined IF amplifier, diode detector and AVC rectifier, EBF-35, audio amplifier, 6SJ7-GT, power output, 6V6-GT and rectifier, 5Y3-GT.

The ECH-35 used in the converter stage, is connected up in a standard manner, and consequently calls for little comment. It will provide consistent operation, especially on the short wave bands, and is now generally considered to be the best all round converter valve. An ECH-33 can also be used in this position with-

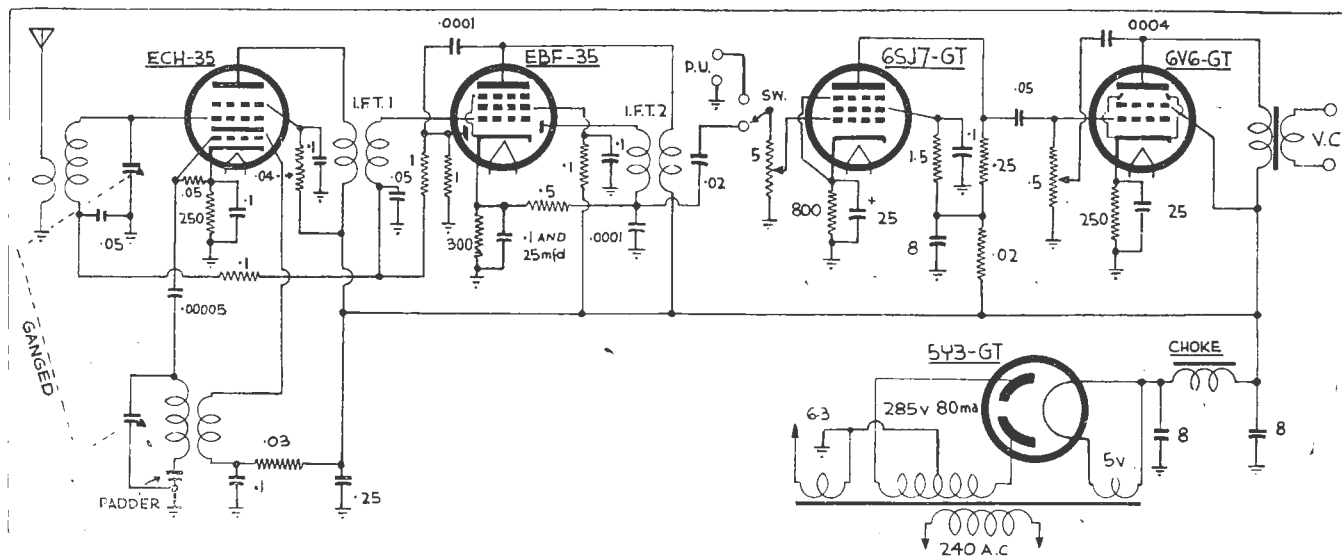

Using the latest type valves, this circuit is capable of excellent results. In effect, it is a high performance tuner and audio amplifier combined, on the one chassis.

out any changes in performance or circuit constants, the only difference being that this latter valve has a slightly lower heater current rating.

The second valve is an EBF-35 and this is used as a combined I-F amplifier, diode detector and AVC amplifier. The high gain pentode section is used as the I-F amplifier, and in conjunction with the two iron core intermediates will provide ample circuit gain, especially on the short wave bands. It will be noted that separate cathode and screen resistors are used in each of these stages, mainly as a precaution against any instability or coupling developing between the stages. The values shown are standard and should be retained for best results.

Use of Diodes

One of the diodes in this valve is used for detection whilst the other provides the AVC control. The AVC circuit used is of the simple series type, and is provided with a small delay voltage. The AVC control is obtained from the plate circuit of the EBF-35 by means of the .0001 mfd feed condenser and the resulting rectified voltage is applied to the I-F amplifier and converter grid circuits through the usual resistor-condenser network.

It is generally preferable to obtain the r-f voltage for the AVC diode from the EBF-35 plate circuit as shown, rather than from the secondary of the i-f transformer, as is frequently the case. With the former connection, any AVC loading on the transformer secondary is eliminated with a consequent improvement in audio response, and at the same time the increased r-f voltage fed to the diode provides improved AVC control.

The detector used is the usual diode detector circuit, with the audio output being obtained from across the .5 meg diode load resistor. It will be noticed that the volume control has been connected in the grid circuit of the first audio amplifier, instead of using it as the diode load resistor—the latter being common practice in many receivers. This arrangement enables easier switching for the gramophone pickup terminals, and in addition decreases the possibility of a noisy volume control developing, as may be the case when it is used as the diode load.

Audio Circuit

The audio circuit is essentially a two stage audio amplifier consisting of a 6SJ7-GT and a 6V6-GT. The 6SJ7-GT is connected as a pentode amplifier, using

a .25 meg load resistor, 1.5 meg screen resistor and an 800 ohm cathode bias resistor. The output from this stage is then taken via a resistance-coupled network to the grid of the 6V6-GT.

The circuit as shown is capable of high audio gain thus providing ample lift for short waves as well as pickup operation. Because of this, it is essential that precautions be taken with this stage to prevent any hum pickup from reaching the grid circuit of the 6SJ7-GT. Consequently all leads to the volume control and pickup switch should be made with shielded wire, making sure the outer metal braid is adequately earthed at several points. In addition the decoupling network consisting of the .02 meg resistor and 8 mfd condenser should be connected in the plate circuit of the 6SJ7-GT.

PARTS LIST

- 1 Chassis, 12 x 7 x 3.
- 1 2-gang "H" tuning condenser.
- 1 Tuning dial to suit gang.
- 1 Dual Wave coil unit.
- 2 455kc. I.F.T.'s.
- 1 Power transformer, 80 ma., 285v. HT, 6.3v. @ 3 amps, 5v. @ 2 amps.
- 1 Filter Choke.

CONDENSERS:

- 2 25 mfd Electrolytic.
- 3 8 mfd Electrolytic.
- 1 .25 mfd Tubular.
- 6 .1 mfd Tubular.
- 3 .05 mfd Tubular.
- 1 .02 mfd Tubular
- 1 .0004 mfd mica.
- 2 .0001 mfd mica.
- 1 .00005 mfd mica.

RESISTORS:

- 1 1.5 meg ½ watt.
- 2 1 meg ½ watt.
- 1 .5 meg ½ watt.
- 1 .25 meg ½ watt.
- 2 .1 meg ½ watt.
- 1 .05 meg ½ watt.
- 1 .04 meg 1 watt.
- 1 .03 meg 1 watt.
- 1 800 ohm 1 watt.
- 1 300 ohm 3 watt wire wound.
- 2 250 ohm 3 watt wire wound.
- 2 .5 meg potentiometer.

VALVES:

- ECH-35, EBF-35, 6SJ7-GT, 6V6-GT, 5Y3-GT.

SUNDRIES:

- 5 octal sockets, 1—4-pin socket, 4 terminals, 1 two-way switch, 5 knobs, hook-up wire, braided wire, nuts and bolts.

To enable the audio section to be switched from RADIO to PICKUP and vice versa, a two way switch is mounted on the rear of the chassis adjacent to the two pickup terminals. One side of this switch is connected to the .02 mfd. coupling condenser, and the other direct to the pickup input terminal. Whilst this arrangement is quite effective for most cases, some may prefer to use a DPDT type switch, and break the screen lead to the EBF-35, when the change is made to PICK-UP. This method will then prevent any possibility of the radio being heard when the pickup is used.

Tone Control Circuit

The output valve is a 6V6-GT, and except for the type of tone control circuit used, this stage calls for little comment. As can be seen the tone control circuit consists of a .5 meg potentiometer connected in the grid circuit, with a .0004 mfd condenser connected from the centre moving arm to the 6V6-GT plate circuit. The circuit works on the basis of negative feedback at one extreme setting attenuating the high frequencies whilst at the other extreme setting the by-passing effect of the condenser stabilises the high frequency response. This is done in the following manner.

When the moving arm of the potentiometer is at the grid end, negative feedback from the plate to the grid circuit takes place via the small condenser. The value of this condenser is such that it passes the higher audio frequencies more easily than the lower frequencies, which means that the feedback factor under these conditions will be high, thus tending to reduce the high frequency response.

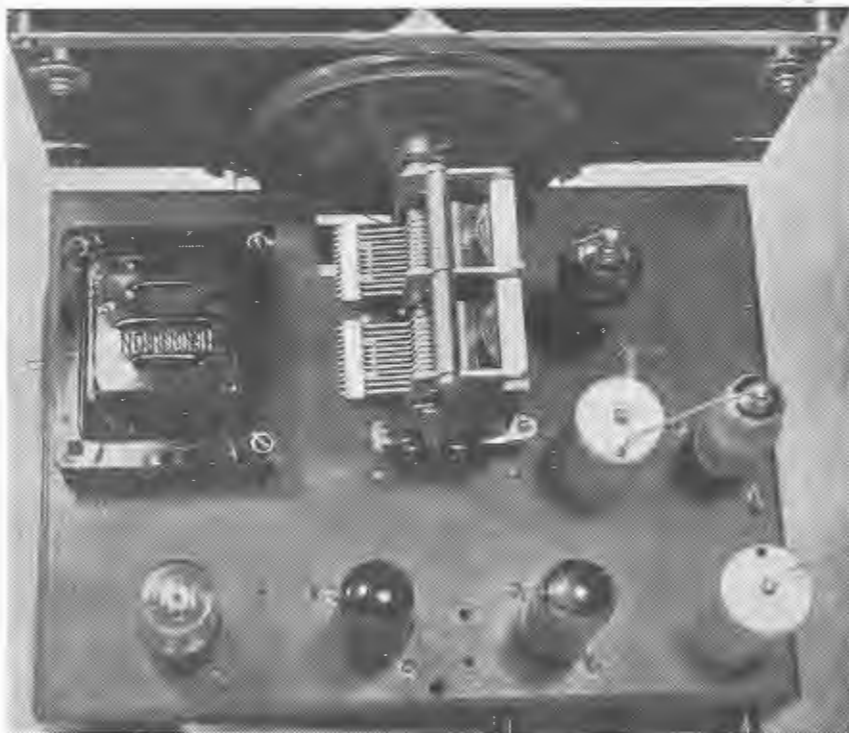

The chassis layout is clearly shown in this photograph.

The net effect of this is to cause a reduction in gain of the high frequencies, making the tone at this setting mostly of a bass nature. As the slider is moved towards the earthed end of the potentiometer, the feedback factor is gradually reduced finally becoming zero at the ground end. Here the condenser connected to the 6V6-GT plate directly by-passes only the very highest frequencies and consequently in this position the response is full treble.

At points in between the two extremes mentioned, it is possible to obtain any desired tonal balance. In use this form of tone control will be found very effective and reliable, and will give a better response than the usual type connected across the output circuit. Altering the value of the feedback condenser will permit a wide variation in results, and different values can be tried here by the constructor to obtain the most desirable tone.

Constructional Details

The various photographs clearly show the positions of the components on the chassis which measures 12 x 7 x 3. The two gang condenser is mounted centrally, and depending on the type of dial used, it may be necessary to raise this slightly from the chassis to provide adequate clearance between the tuning and volume control knobs.

The ECH-35 converter is mounted alongside the gang, with the 1st I-F transformer immediately behind, and the EBF-35 slightly to the left. Then along the back of the chassis is the second I-F, the 6SJ7-GT, the 6V6-GT and the 5Y3-GT rectifier.

All standard components are used, and it will be found these are readily obtainable from most radio dealers. The dual wave unit is just one of the several makes now available, any of which can be used with equal success in this circuit. It will

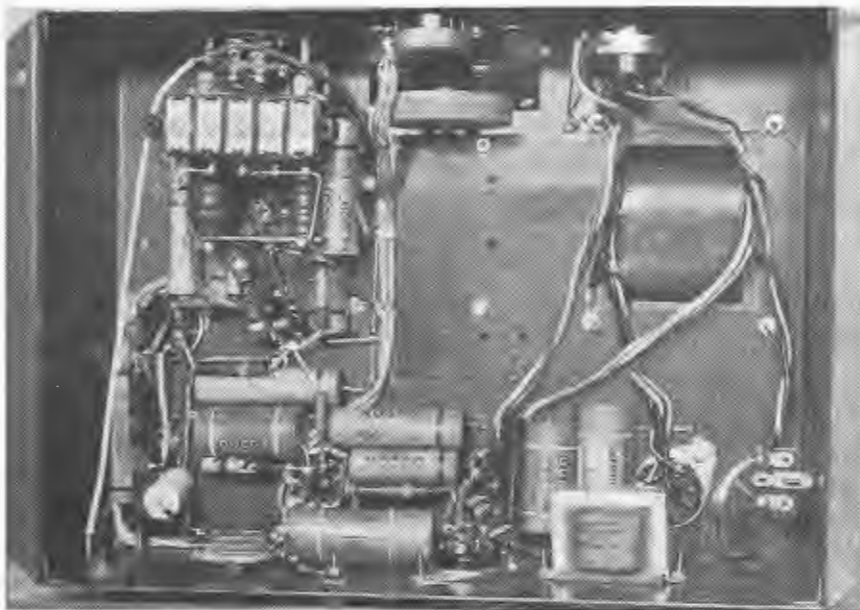

Most of the components are easily recognisable in this underneath chassis view.

Design for quality

- Within the familiar glass bulb of every radio valve, cleanliness and purity of materials rank above all other considerations — a condition achieved only through the application of stringent processes designed to safeguard ultimate performance.
- Chemical analysis, intense heat treatment, protective coating and microscopic examination all combine to ensure that Quality in Radiotron Valves is established in its initial stages of manufacture — that Quality is literally “in built”.



COMPLETE QUALITY CONTROL
AMALGAMATED WIRELESS VALVE COMPANY
PTY. LIMITED
47 YORK STREET, SYDNEY

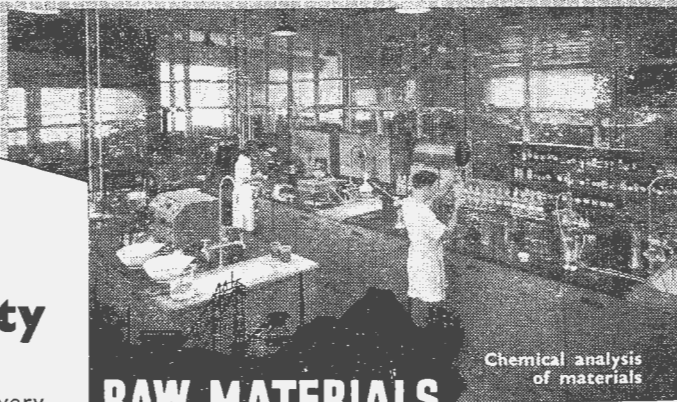

Chemical analysis
of materials

RAW MATERIALS

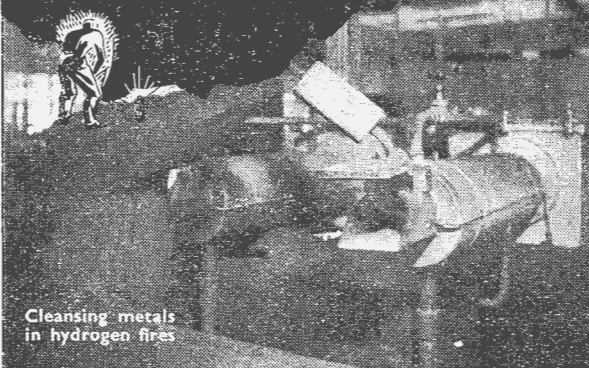

Cleaning metals
in hydrogen fires

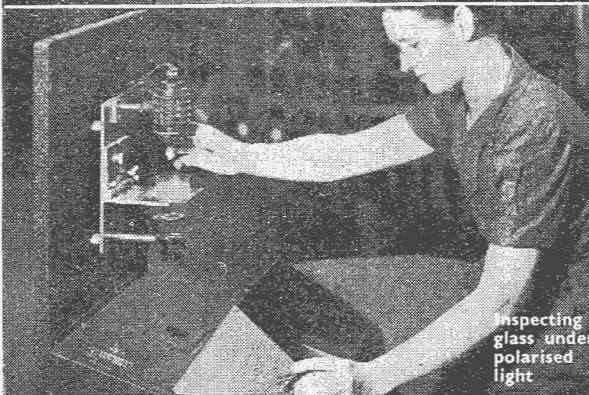

Inspecting
glass under
polarised
light



Protecting bulbs with
carbon lining

be noticed that the dual wave unit is mounted immediately beneath the converter. This enables all leads to be kept extremely short, thus reducing the possibility of instability or circuit interaction.

To ensure good earthing points, lock washers should be fitted to all bolts making sure these cut into the metal chassis. An earth lead then should be connected to several conveniently placed solder lugs, finally connecting to the earth terminal at the rear of the chassis. Such a lead will enable most components to be kept adjacent to their associate circuit, and ensure all earth returns are located conveniently close together for each stage.

Whilst on the subject of earth returns, it is essential to connect the gang wiper earth returns to the chassis. The connection should be made as close as possible to the AVC return, and since it is in effect a part of the tuned circuit, the length of the lead should be kept to a minimum. Unless this is done, the return for the tuned circuits can only be

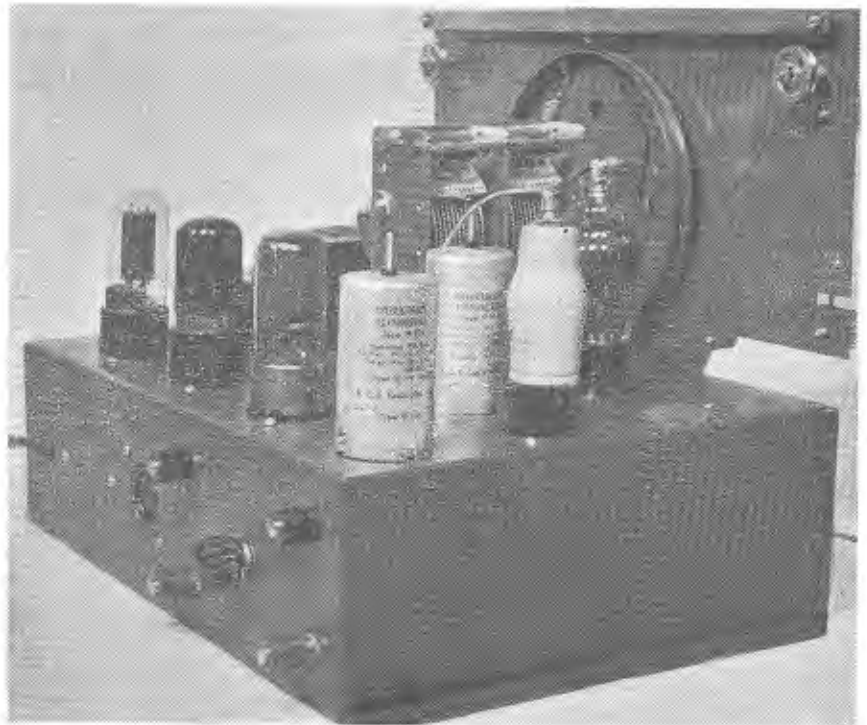

Another view of the receiver. The radio-gramo changeover switch is mounted between the two sets of terminals.

SOCKET CONNECTIONS:

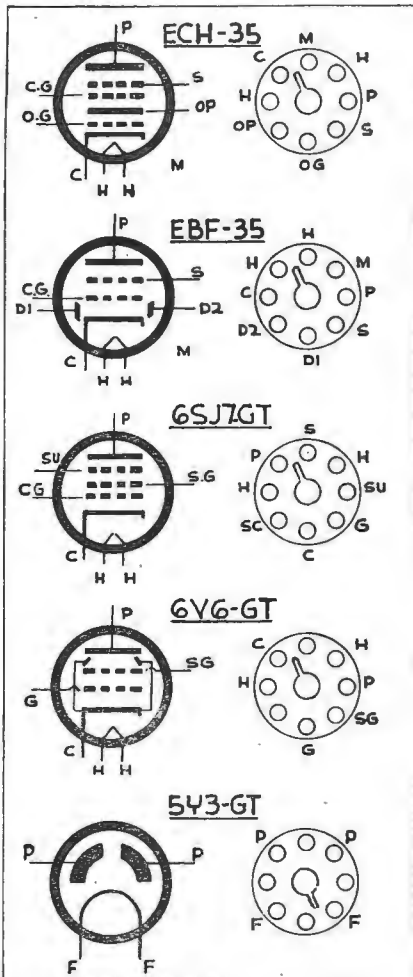

made through the common frame of the tuning condenser and this can lead to undesirable coupling effects, especially on the short wave bands.

The only other point to watch in the construction is the positioning of the aerial lead from the terminal to the coil unit. This lead should be taken direct, and kept well clear of any other circuit wiring. If it is allowed to pass close to the i-f section, feedback may occur, resulting in i-f oscillation developing and possibly causing whistles when tuning in weak stations.

When the set has been wired up, check over all leads for any possible mistakes, especially those to the dual wave coil unit. A wrong connection here may easily result in the non-operation of the receiver.

Alignment Procedure

Then assuming everything is in order, the final step is to align the various tuned circuits. Although the general method of carrying this out has been given in previous issues, the following brief remarks should be of assistance to many.

Since the i-f transformers are generally adjusted to the correct frequency by the manufacturer, these should be left untouched in the initial stages. With the

set switched on, set the broadcast padder and trimmers to approximately the half way position.

Under these conditions, assuming the receiver is functioning correctly, it should be possible to tune in a station, say 2SM, on the high frequency end of the band. By adjusting the oscillator trimmer, position this station until it coincides with the dial marking. At the same peak the aerial trimmer for maximum output.

Next tune in a station at the low frequency end of the band, and adjust the broadcast padder for maximum output. Whilst doing this it will be advantageous to rock the dial slightly, leaving the trimmer set in the position which gives the maximum output. Re-check again at the high frequency end, and if the dials, coil and gang are matched, the stations should be received on the positions indicated on the dial scale.

On the short wave bands, use the oscillator trimmer to position the band in accordance with the dial markings, and then adjust the aerial trimmer for maximum results. In general, it is only necessary to make the high frequency adjustment on short waves, since most units incorporate a fixed padder to ensure correct tracking. In the case of units being used having slug tuned coils, the procedure is generally as outlined, except that the aerial core is adjusted for maximum output on the low frequency end.

FOR THE EXPERIMENTER

By A. H. NICHOLLS, VK2NI

Filament Supply for 12v. Valves.

Much of the equipment now being sold through ex-disposals sources, e.g., SCR522, uses the 12-volt series of valves. A handy power supply for these may be made from a standard power transformer using a 6X5-GT in place of the 5Y3-GT, and connecting the filament windings as shown in the diagram.

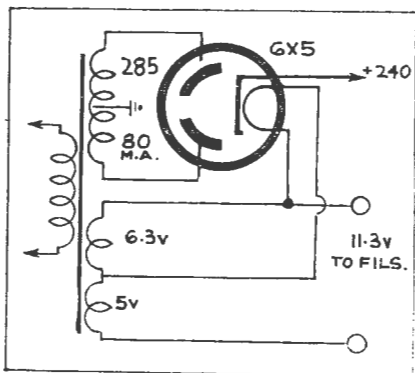

Method of connecting the 6.3v. and 5.0v. windings on a power transformer to give 11.3 volts.

Varying Output Voltage.

Here is a method of reducing the output voltage from a rectifier without resorting to the use of heavy duty series resistors.

The input condenser should be reduced to a value from .25 to 2 ufd, the exact value necessary to give the desired voltage under load, being determined by experiment.

If the hum level rises with this change, the condenser immediately after the choke should be increased in value—up to double the existing value is satisfactory.

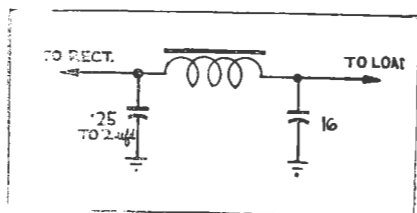

Reducing the input condenser value is a simple method of decreasing output voltage without necessity for series resistor.

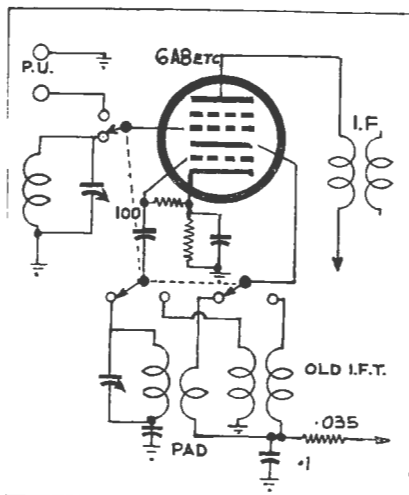

This diagram shows the changes required to play the pickup through the converter stage.

Novel Pickup Input.

By connecting the pickup input in the manner shown, it is possible to utilise all the valves in the receiver. As the pickup is switched into the grid circuit, an old i-f transformer, tuned to the receiver intermediate frequency, is also switched into the mixer circuit to act as an oscillator.

This oscillator generates a signal at the receiver's i-f, which is modulated by the pickup and then amplified through the i f and detected in the normal manner. For best results a pickup with good output should be used.

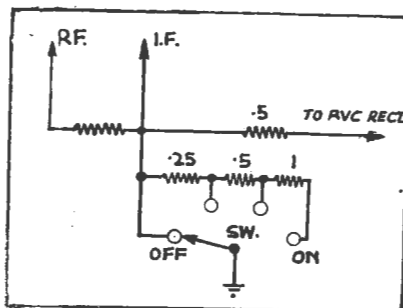

This arrangement permits wide variation of A.V.C. control voltage.

A.V.C. Control.

Frequently it is advantageous when receiving certain types of signals to be able to control the AVC voltage as the normal MAN-AVC switch does not give the desired effect.

The diagram shows a method of wiring in a switch to give Full AVC, intermediate steps and Off.

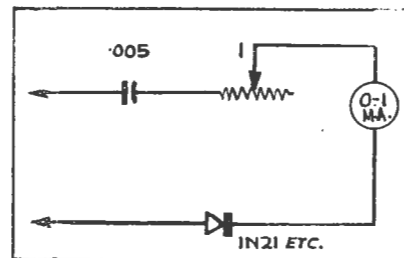

The connections for the useful output meter.

Simple Output Meter.

A handy output meter can be made up from a miniature VHF Germanium diode and a 0-1 ma meter. The necessary connections are shown in the drawing, and the completed unit is small enough to "hang" on the test lead.

though this will not be ganged to the oscillator, but have to be tuned separately, this should cause little inconvenience.

14 Mc. Output from BC459A.

This Command transmitter unit covers 7-9.1 Mc. band, and if required for 14 Mc output, the following changes are necessary. The original condensers C67 and C65 are cut from the coil and substituted with a 75 uufd variable. All

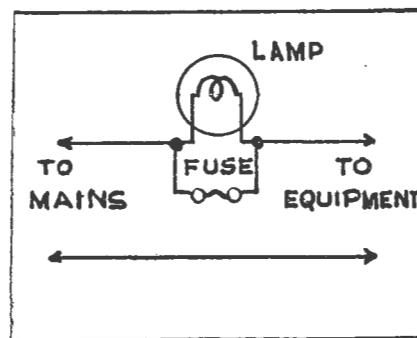

Short Indicator for Bench Use

The circuit indicated provides a ready means of ascertaining whether the device under test has a short circuit or not. If a short circuit is present, the fuse will "blow" and the small bulb will light up.

SUBSCRIBE NOW.

Make sure you receive every copy of "RADIO SCIENCE" by placing a definite order with your newsagent.

If you prefer, subscriptions may be made direct to our office—Box 5047, G.P.O., Sydney.

Subscription Rates at 12/- per year or 21/- for two years post free to any address in the Commonwealth.

Sweep-Frequency Signal Generator

The basic design features of the sweep-frequency signal generator, with a step-by-step analysis of the operation by means of the oscilloscope.

In its simplest form, the sweep-frequency signal generator consists of a frequency-modulated oscillator tuned to the desired frequency. One of the earliest systems of frequency modulating an oscillator employed a motor driven capacitor to swing the frequency of the oscillator back and forth across the centre frequency at a rate dependent upon the speed of the motor.

Use of Reactance Tube

This system has since been superseded by an electronic method of frequency modulating the oscillator with a reactance tube. The reactance modulator consists of a tube connected to the frequency-determining of the oscillator in such a way as to act as a variable inductance or capacity, thereby changing the frequency of the oscillator. A simplified diagram illustrating this system is shown in Fig. 1.

The amount of change or frequency modulation depends primarily upon the amplitude of the audio signal applied to the grid of the reactance tube. Thus, by varying the audio input to the reactance tube, it is possible to control the frequency sweep or band-width of the f-m test signal.

Since it is extremely difficult to design a reactance-tube modulated oscillator which will operate properly over

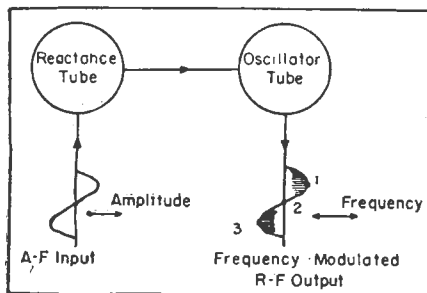

Fig. 1.—Simplified frequency-modulated oscillator. The r-f output of the oscillator is swung back and forth across its centre frequency (2) in accordance with the audio wave shape applied to the reactance tube. The amount of swing or deviation of points 1 and 3 depends upon the amplitude of the a-f voltage applied to the reactance tube.

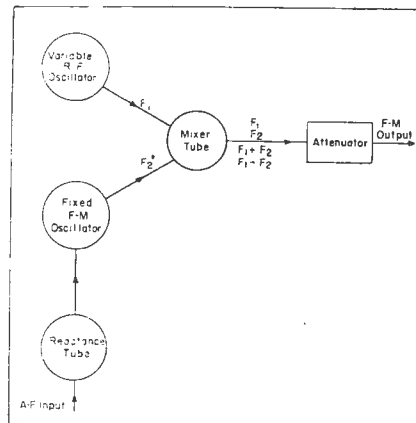

Fig. 2.—How a fixed frequency-modulated signal and a variable unmodulated signal are combined to produce an f-m signal of the desired frequency in one type of sweep frequency signal generator.

the wide range of frequencies encountered in a-m and f-m work, it is common practice to design the frequency-modulated oscillator to work at only two or three fixed frequencies. The frequency modulated signal is then mixed or heterodyned with a variable frequency oscillator to produce the desired output frequency as shown in Figure 2.

The Heterodyning Process.

The combination of two voltages of different frequencies gives rise to beat frequencies equal to the sum and difference of the two frequencies. For example, if two frequencies, F_1 and F_2 , are mixed or combined, the following new frequencies will result: $F_1 + F_2$ and $F_1 - F_2$. If either frequency is modulated, amplitude or frequency, the sum and difference frequencies will retain the modulation component. As an illustration, if a 20 Mc. signal with a frequency deviation of ± 10 kc. is mixed with an unmodulated 30 Mc. signal, the sum of the two frequencies will equal 50 Mc. with a frequency deviation of ± 10 kc.

This phenomena, commonly referred to as *heterodyning*, enables a fixed frequency oscillator of known frequency deviation to control the modulation char-

acteristics of the sum or difference frequency resulting from the combination of a modulated and unmodulated signal. In practice, either the sum or difference may be used to obtain the desired output signal. A typical circuit embodying this principle is illustrated in Fig. 2.

In an oscilloscope the sweep voltage is applied to the horizontal deflection plates of the C.R. tube to swing the electron beam back and forth across the screen of the tube. If a sweep voltage is applied to the reactance tube which frequency modulates the oscillator somewhat the same action will take place, the difference being that we are now swinging the frequency of the oscillator back and forth. If the same sweep voltage is simultaneously applied to the horizontal plates of the oscilloscope and to the f-m oscillator, the two instruments will be in exact synchronisation, disregarding for the moment slight phase-shift effects.

Basis of Visual Alignment

This practice of using the same sweep voltage for both the f-m signal generator and the horizontal plates of the oscilloscope is an extremely important point to remember, because it forms the

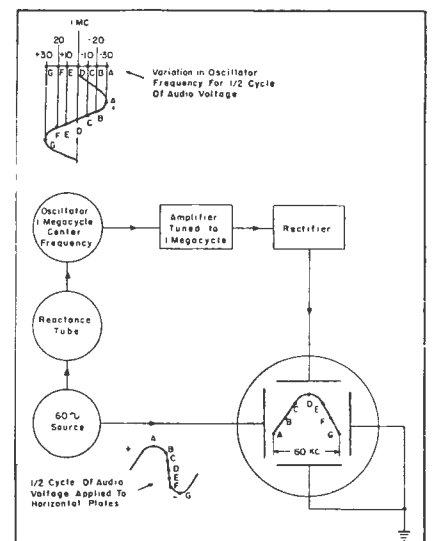

Fig. 3.—Simplified visual alignment circuit.

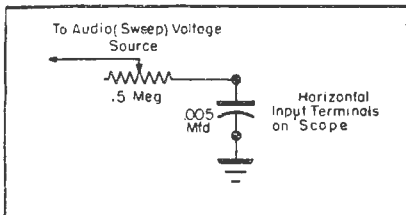

Fig. 4.—Phase shifting network used to eliminate double trace.

basis for practically all visual alignment operations. A simplified visual alignment circuit is shown in Fig. 3.

Here we have a 60-cycle sine wave applied to the horizontal plates of the scope and also to the reactance tube which frequency modulates the oscillator. The f-m oscillator, operating at a centre frequency of 1 Mc, feeds into an amplifier also tuned to 1 Mc. A rectifier demodulates the r-f coming out of the amplifier, and the resultant audio frequency voltage is applied to the vertical plates of the oscilloscope.

Let us assume that the audio input to the reactance tube is adjusted so that the frequency deviation of the oscillator is 30 kc. either side of the 1 Mc. centre frequency or a total deviation of 60 kc. Let us now follow the action which takes place if we simultaneously apply one-half cycle of audio-frequency voltage to the reactance tube and the horizontal plates of the oscilloscope.

At the extreme positive half of the cycle, point A, the reactance tube has swung the frequency of the oscillator 30 kc. lower than the 1 Mc. centre frequency. At the same instant this same positive voltage on the horizontal plates of the oscilloscope pulls the beam to the left of the screen to point A. Since the oscillator is 30 kc. away from the resonant frequency of the amplifier, amplification is very low and relatively little voltage is fed into the rectifier and the vertical plates of the oscilloscope. The vertical plates therefore have very little effect upon the position of the beam.

Trace Movement

Following the audio cycle to point B, we find the reactance tube has shifted the oscillator frequency back toward the centre frequency of 20 kc. away from 1 Mc. At the horizontal plates of the oscilloscope the less positive voltage draws the beam to point B on the screen. Since the oscillator is nearer the resonant frequency of the amplifier, amplification increases, more voltage is applied to the vertical plates, and thus the beam is also drawn upwards.

At point C the oscillator is still closer to the resonant frequency of the ampli-

fier, while at the same time the changing voltage on the horizontal plates deflects the beam further to the right. Amplification in the amplifier increases and the vertical plates exert more pull on the beam, which is thus drawn further upward.

At point D, the oscillator is exactly at the resonant frequency of the amplifier, horizontal deflection moves the beam to the centre and, since amplification is now at a maximum, the vertical plates pull the beam to the top of the pattern.

At points E, F and G, the oscillator swings away from the resonant frequency of the amplifier, while at the same time the horizontal deflection resulting from less positive and now negative voltage, continues to pull the beam right. Amplification decreases, less voltage is applied to the vertical plates, and thus the beam drops as it moves to the right.

On the other half of the cycle the same action occurs in reverse and an almost identical curve is again traced on the screen of the C.R. tube. This second curve may not follow precisely the same path as the first curve because of phase shift effects. This condition can usually be corrected by the addition of a simple phase-shifting network, connected to the horizontal plates. Typical constants and connections are shown in Fig. 4. The potentiometer should be adjusted so that the two curves merge into one.

C-R Screen Traces.

It can be seen from the preceding explanation that the actual response curve of the amplifier is traced on the screen of the c-r tube. It is this feature which makes visual alignment so valuable for f-m work. Peak f-m receiver performance requires that the i-f response curve have a flat-top and steep-sided skirts as illustrated in Fig. 5.

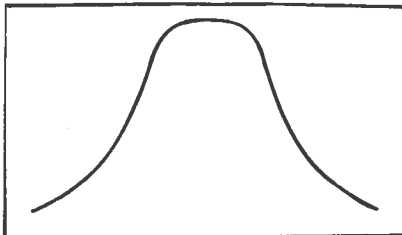

Fig. 5.—Typical over-all response curve of f-m i-f channel.
Reprinted courtesy of "Service."

SUBSCRIBE NOW.

Make sure you receive every copy of "RADIO SCIENCE" by placing a definite order with your newsagent.

If you prefer, subscriptions may be made direct to our office—Box 5047, G.P.O., Sydney.

Subscription Rates at 12/- per year or 21/- for two years post free to any address in the Commonwealth.

SPECIFY THE BEST

"CONNISEUR"

for the finest high range enjoyment, that is only possible from THE perfect crystal type Unit.



The prices are now

TIO 66/-
sapphire tipped.

JIO 60/-
standard needles.

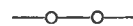

DID YOU RECEIVE OUR FREE BOOKLET?



Watch for this release

The Pick-up For YOU

Unbreakable, guaranteed, true fidelity, and a host of other features.



Write NOW, for all details. They are the finest in this country.

Sole Manufacturers

KELMAN INDUSTRIES

Box 40 — Hawthorn, E.2.
Melbourne — Victoria.

HIGH-FIDELITY AMPLIFIER

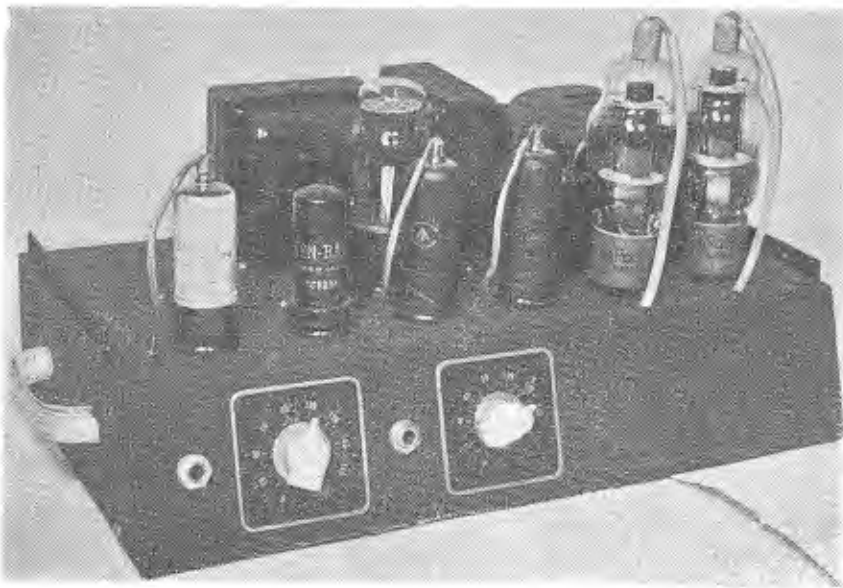

A general view of the amplifier with cover removed.

Full constructional details of an amplifier admirably suitable for use with the F-M Tuner described last month, or any similar application where a high quality output is essential.

The amplifier to be described has been designed primarily with a view to providing a high quality audio outlet for the F.M. tuner detailed in the August issue of "Radio Science," and to allow of the use of one of the low output magnetic pickups which are available on the Australian market at the present time. However, in order to cater for all applications, additions required for the adaptation of the amplifier for public address work have also been shown. The maximum power output using a load impedance of 10,000 ohms from plate to plate of the 807's is 20 watts while the use of a 6,600 ohms load, without any other modification to the circuit, allows an output in the vicinity of 25 watts to be realised.

Compared to the modest output of 4.5 watts for a single 6V6, or 3.5 for a single 6F6, two types of output valves which have been used in thousands of domestic receivers, the power output figures quoted for this amplifier may seem unnecessarily large, especially as the whole unit, tuner and amplifier, is intended for use in the home. To clinch their argument most people would triumphantly assert that even with their single 6V6 or 6F6 they never have the volume control turned up to its maximum extent. This is perfectly

true. The normal listening level in the average lounge-room would be about .25 watt. The softer sounds are much less than this while the louder sounds will represent greater power output.

Dynamic Transmission Range

Due to limitations imposed by the amplitude modulation method of transmission, the ratio between the softest and loudest sounds broadcast is necessarily restricted. The softest sound is set by the transmitter's residual noise level while the loudest sound is governed by the maximum R.F. power which the transmitter can deliver to its radiator. The ratio between the softest and loudest sound is called the dynamic range of the transmission. The ratio between the softest and loudest sound which can be produced by a large symphony orchestra is about 1,000,000 to 1.

By
J. LAWLER
Technical Staff
Australian Radio College

It is not possible for an amplitude modulated transmitter to handle such a wide dynamic range, but it is theoretically possible for an F.M. transmitter to do so. Furthermore, it is not inconceivable that at some time in the future F.M. stations in this country will be providing transmissions of this calibre. At the moment this is not entirely practicable because, assuming that for the time being the local F.M. stations will take either the national or inter-state programme at present being transmitted by existing A.M. stations, the performances are already scaled down in the studio to keep them within the dynamic range permitted by these A.M. transmitters.

However, when a full-scale domestic service is provided here by F.M., one may certainly expect that the wide dynamic range possibilities of the system will be fully exploited. Here then is the need for an amplifier with ample peak power output at low distortion. The need for plenty of reserve power is especially evident when reproducing the transient sounds created by percussion instruments, such as cymbals, drums, etc. Of course, it must not be presumed from the foregoing that an amplifier with ample reserve of power is a requirement peculiar to F.M. receivers. Although particularly desirable in this type such a characteristic is by no means an unnecessary extravagance in A.M. receivers, and record reproducers.

Use of Tetrodes

Some surprise may be occasioned by the use of tetrodes in the output stage, particularly in view of the considerable amount of publicity accorded amplifiers employing push-pull triodes with feedback. First of all, let it be definitely understood that this is not due to any doubts concerning the performance of such triode amplifiers. In fact the writer has used an amplifier of this type em-

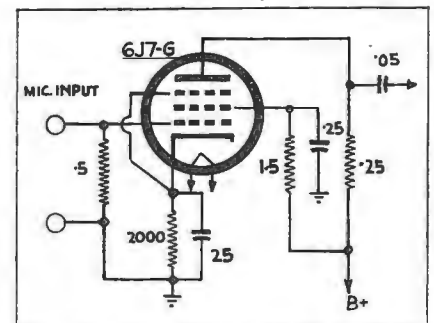

This microphone pre-amplifier stage can be readily added to the main circuit, if required. The output can be connected to either of the input systems. (Fig. 2).

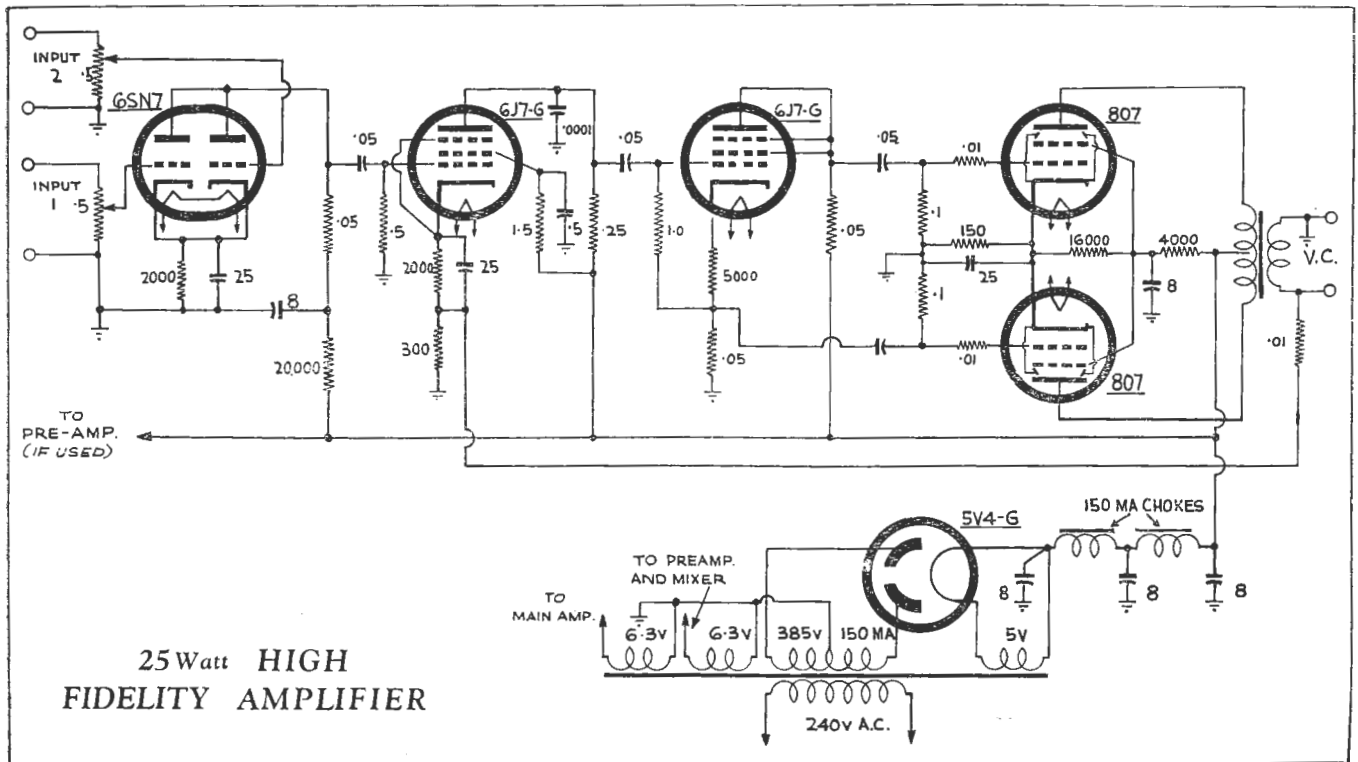

Fig. 1.—Using only standard components and a reliable circuit, the construction should present little difficulty to the home constructor.

playing push-pull triode-connected 807's in the output stage for some months past and can, without reservation, say that the reproduction realised is something out of this world.

The decision to use the 807's as tetrodes was dictated by some slight uneasiness regarding the reliability of the 807 as a triode with 400 volts applied to both plate and screen. Although these fears are probably quite ungrounded they can only be proved so by a rigid life test of the valves concerned under the conditions quoted. While this slight doubt exists, therefore, it was thought better to stick to tetrodes.

Before dealing with the actual construction of the amplifier, brief mention of a few salient points in the design may be helpful. As mentioned earlier, the amplifier is intended for use with the F.M. tuner, or an A.M. tuner for that matter, and for the high quality reproduction of records using either a standard crystal or magnetic pickup or one of the low output high fidelity magnetic types. The circuit diagram shown in Figure 1 is of the basic amplifier and power supply, while Figure 2 illustrates a pentode pre-amplifier unit which may be added to make the equipment suitable for public address applications. The microphone pre-amplifier may be assembled on the same chassis as the main amplifier, since there is ample space for it. In fact, the photographs of the under-chassis wiring and the views of the top

of the chassis actually show the complete equipment using pre-amp. stage.

Glancing back at Figure 1 it will be seen that one side of the output transformer's secondary is earthed, while the other side is connected via a 10,000 ohms resistor into the cathode circuit of one of the 6J7 valves. The combination of the 10,000 ohms and the 300 ohms resistors forms a voltage divider network which ensures that a certain percentage of the output signal is fed back to the second amplifying stage. Naturally, the phasing of the signal which is fed back is quite important. If the proportion of output

signal applied to the cathode circuit of the valve in question is in phase with the signals already there, the effect will be additive and severe oscillation at an audible frequency will take place. If this does happen the remedy is simply to reverse either the primary or secondary connection to the transformer which will result in an out of phase signal being applied to the cathode of the 6J7 and thus allow degenerative feedback instead of regenerative feedback.

A combination of 10,000 ohms and 300 ohms for the feedback voltage divider is correct when a speaker of 8 ohms voice

PARTS LIST

- 1 Amplifier chassis and cover.
- 1 150 ma. Power Transformer, 38v. HT., 6v. filaments.
- 2 150 ma. Filter Chokes.

RESISTORS:

- 2 5 meg.
- 2 1.5 meg.
- 1 1.0 meg.
- 2 .25 meg.
- 2 .1 meg.
- 3 .05 meg.
- 1 .01 meg. 1 watt.
- 2 .01 meg. ½ watt.
- 1 .02 meg. (or .025)
- 3 2000 ohm.
- 1 150 ohm. 3 watt.
- 1 300 ohm.
- 1 5000 ohm.
- 1 16,000 ohm. 20 watt.
- 1 4000 ohm. 20 watt.

- 2 .5 meg. Potentiometers.

CONDENSERS:

- 5 .05 Condensers, 600v.
- 4 25/40v. Electrolytic.
- 1 .5/500v. Tubular.
- 1 .25/600v. Tubular.
- 5 8/525v. Electrolytic.
- 1 .0001 mica.

SUNDRIES:

- 3 valve shields, 5 octal sockets, 3 5-pin sockets, 2 indicator plates, 2 pointer knobs, rubber grommet, 2 jacks, 2 N.P. handles, 3 small grid clips, 2 large grid clips, hookup wire, shielded wire, etc.

VALVES:

- 3—6J7G, 1—6SN7 or 6N7,
- 2—807, 1—5V4G.

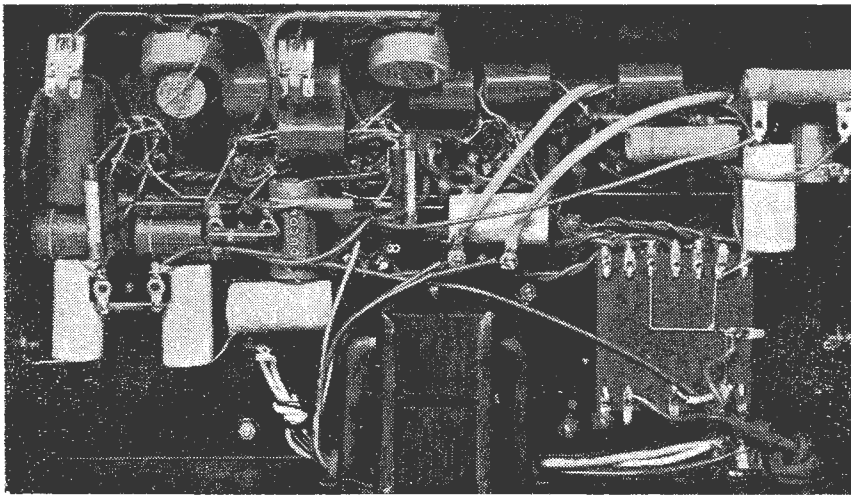

Use this underneath chassis view as a guide to the location of main components.

coil impedance is used. If speakers, having other voice coil impedances are used, then, in order to produce the same degree of negative feedback, it will be necessary to use some value, for the series resistor, other than 10,000 ohms. If the speaker voice coil impedance is higher, then the value of the series resistor will have to be increased, and conversely if the speaker voice coil is of lower impedance than 8 ohms, the value of the series resistor will have to be decreased.

Failure to change the value of the resistor when a higher value of voice coil impedance is used will probably produce no more serious result than a reduction in overall amplifier gain. If, however, the secondary of the output transformer is designed to work into a 500 ohm line, failure to increase the value of the series feedback resistor would then almost certainly result in violent instability. A suitable value to use in this latter case would be about 100,000 ohms. With a 2 ohms speaker a 5,000 ohms resistor would be advisable, while a 12.5 ohms speaker would require that the feedback resistor be about 15,000 ohms.

Further examination of the circuit shown in Figure 1, discloses that the screens of the 807 output valves are fed from a voltage divider connected between B plus and the cathodes of the valves. The values of the two resistors used in the divider, namely, 4,000 ohms and 16,000 ohms, have been chosen so that the voltage between the screens of the 807 valves and earth is approximately 300 volts.

Incidentally, the voltage measured between the plates of these valves and earth should be in the vicinity of 400 volts. 807's in common with most beam tetrodes and pentodes are quite critical in regard to changes in screen grid voltage. Feeding the screen grids of the output valves

from a simple series resistor would result in a serious reduction in maximum undistorted power output because of the poor regulation of the screen supply voltage. The use of the voltage divider method renders the screen grid voltage far less susceptible to fluctuation with varying degrees of power output.

Because the voltage divider is connected between B plus and cathode of the output valves and not between B plus and earth, the cathode bias resistor for the two output valves is rather lower than normal, because part of the voltage drop across it is due to the current flowing through the screen voltage divider.

It will be noted that the screens of the 807's are connected directly to the junction point of the voltage divider and in most cases this will probably be found quite satisfactory. However, if any tendency towards parasitic oscillation is displayed, a cure can generally be effected by placing a 10 ohm non-inductive resistor in series with each screen and connecting between the junction of the two resistors and earth a .01 mfd. mica condenser. This precaution was not found to be necessary with the amplifier described.

It will be observed that the phase-splitting stage is quite conventional. Operating on the well-known split-load principle it employs a 6J7G connected as a triode with equal load resistances in plate and cathode circuits. The reliability of this type of phase-changer more than offsets the disadvantage of its small contribution to the overall gain of the amplifier.

The stage immediately in front of the phase-splitter is again quite conventional, consisting as it does of a 6J7 pentode operating under conditions which provide a stage gain of about 140.

The principal consideration influencing the use of a twin triode valve rather than

one of the more normal single type was that the amplifier thereby became more readily adaptable to P.A. requirements in that smooth mixing of microphone and radio or gramophone input can be very easily obtained. Furthermore, the cost of the twin triode is much the same as a single valve.

Students of design may be inclined to point the finger of scorn at the use of a common plate load for both triode plate circuits. It is acknowledged that such practice is not in line with the very best engineering standards in that each triode is working into a load resistance of lower value than its own internal plate resistance. In spite of this light-hearted flouting of the radio equivalent of Hoyle, we have no qualms about the final result.

The microphone pre-amplifier stage is shown in Figure 2. Here again the arrangement is quite conventional and needs no comment. The power supply is also quite a normal affair using an indirectly heated rectifier coupled to a two-stage condenser input filter. Hum level is so low that at distances greater than about one foot from the speaker, it is completely inaudible.

Bass Correction Circuit

Figure 3 illustrates a rather odd-looking circuit which is simply a frequency discriminating degenerative feedback arrangement. This particular circuit is tied up with the use of one of those high fidelity pickups which we have been mentioning in this discussion at frequent intervals, and in case you are not entirely familiar with the reason for its use, here it is.

All disc gramophone records sold for domestic use are made to have what is termed a constant velocity characteristic from 250 cycles upwards and a constant amplitude characteristic from 250 cycles downwards. The net result of this is that while all musical notes above 250 cycles are recorded in correct proportion, all notes below 250 cycles suffer attenuation at the rate of 6 d.b. per octave.

The circuit shown in Figure 3 will pro-

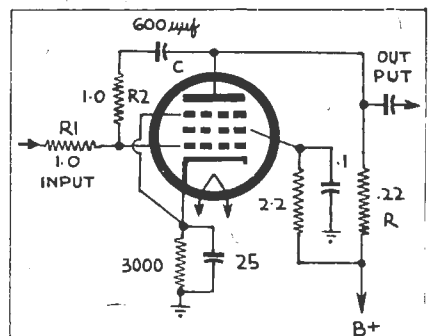

Fig. 3.—The practical bass correction circuit giving the response shown in Fig. 4. Although an EF36 is specified for the original circuit, a 6J7 or 6SJ7-GT will give satisfactory results.

'The Choice of an Amplifier'



is a free booklet written for the public address man and he who seeks the ultimate in sound reproduction.

This booklet gives full technical details of the Electronic Parts range of high class amplifiers which are available either completely built and tested, or in kit form, ready to build yourself.

Send for your copy to-day for prices and technical details of the amplifiers listed below. o

45 Watt Super Power P.A. Amplifier

Designed specially for large outdoor gatherings and factories. Will operate at least six horn type P.A. speakers, or twelve 8in. speakers. In addition to high power, the fidelity of this unit for music is extremely high. (Appearance as illustrated.)

20 Watt All Purpose Fidelity Amplifier

This amplifier originally designed for high fidelity, has also proved most popular for P.A. work, such as outdoor meetings, dances, etc. Will safely handle three horn type P.A. Speakers, or at least six 8in. speakers (Appearance as illustrated.)

13.5 Watt P.A. Vibrator Amplifier

For the country man, or in locations where A.C. power is not available, this 13.5 watter is the answer. Operates from 12 volt batteries, and is suitable for quite large outdoor functions. (Appearance as illustrated.)

4 Watt "Vibravox" Vibrator Amplifier

This small unit is ideal for the country man where home record reproduction is desired. Also highly suitable for amplifying small halls. Fidelity is equally as high as A.C. units of equivalent power output.

4.5 Watt "Vox Minor" Amplifier

The "Vox Minor" is an ideal small amplifier for record reproduction in the home. It is an excellent unit for the experimenter, particularly in view of its very low cost.

15 Watt Ultra High Fidelity Amplifier

For its low cost this, to our knowledge, is the finest high fidelity unit ever produced. Employing push-pull triodes this amplifier is virtually distortion free. Music-lovers will hail it as the amplifier of their dreams. (Appearance as illustrated.)

12 Watt "Vox Major" Amplifier

This amplifier combines compactness and economy with adequate power output. Primarily designed for record reproduction in the home or in a small hall.

10 Watt General Purpose Amplifier

Although suitable for small outdoor functions this amplifier was designed primarily for indoor P.A. work. For those who require an efficient, medium power, low cost amplifier, this 10 watter is the answer. (Appearance as illustrated.)

★ Yes, we can quote you for the kit of parts, or the completely built amplifier described on Page 25 of this issue. It's just the amplifier for your F.M. tuner.

Circuits and building hints supplied with all kits. Prices available upon request.

WHOLESALE DISTRIBUTORS OF EVERYTHING IN RADIO

**ELECTRONIC PARTS
PTY. LTD.**

E. S. and A. Bank Building
BROADWAY, N.S.W.

Phone: MA1661
Telegrams: ELECPARTS SYDNEY

Please Mention RADIO SCIENCE when Replying to Advertisements.

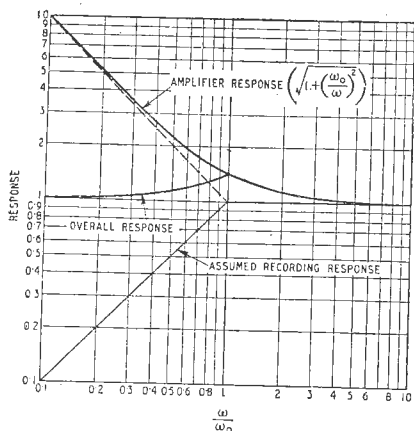

Fig. 4.—Calculated response when feedback is 90 degrees out of phase.

vide the necessary bass correction very nicely when the values indicated are used. The actual frequency characteristic of the circuit is indicated by the accompanying graph. Both the circuit and graph originally appeared in the September, 1947, issue of the English magazine *Wireless World*, by whose courtesy it is reproduced here. In their original article, *Wireless World* stipulated the use of an EF36 valve for the unit. This particular valve has recently been available throughout the trade under its British Army identification, VR56, but in the event of its unavailability, the characteristic of the 6J7G or 6SJ7GT are sufficiently close to allow of their use instead.

Mode of Operation

With R1 equal to R2 this particular circuit has a gain of little more than unity at all frequencies down to 250 cycles. From 250 cycles downwards the gain of the circuit rises steeply because, due to the increasing reactance of the feedback condenser connected between R2 and the plate of the valve, the percentage of output signal sent back to the grid becomes less and less. The resultant characteristic while not absolutely ideal is so close to the desired 6 d.b. per octave boost that the ear will be perfectly satisfied, and that after all is what matters most.

Because of the fact that at 100 cycles the gain of the bass compensating stage is more than 6 d.b. above that at middle frequencies, the unit will be especially susceptible to hum pickup unless the greatest care is taken in decoupling its high tension supply, and adequately shielding the valve. Also for this reason and because the bass boost would not be required on radio, this unit must be placed between the pickup and amplifier. Provided that the precautions mentioned are taken, the bass compensator could be mounted on the main chassis in the event that the microphone pre-amplifier was

not needed because then a vacant valve socket hole would be available.

Constructional Hints

About the actual construction of the amplifier, it is considered little need be said because it is assumed that it will be built by people who have had some experience in this class of work and who are fully aware of all the likely pitfalls. The general layout can be readily seen from the photographs showing both above and below chassis views.

The under chassis photograph indicates a particularly orderly arrangement of components and wiring. The very few unavoidably long leads are at a relatively low A.C. signal voltage in relation to chassis and are not likely to lead to any instability. All small components such as resistors and condensers are supported in the main by their own leads. In the one or two cases where this has not been practicable, small mounting strips have been used.

The output transformer is located under the chassis as can be seen from the below-deck photograph. This will not be possible in all cases because the use of special transformers for feeding a 500 ohm line, or a frequency dividing network, may be rather larger than the one used in the original amplifier and so it may be necessary to mount it on top of the chassis.

It is really just as easy to wire the amplifier in the orderly manner shown, as to stir everything up and wire the components in where they come to rest. Furthermore, the possibility that the amplifier will perform satisfactorily immediately it is switched on its immeasurably greater when care is taken. A final word of warning. Under no circumstances should the plates of the 807 valves be shielded.

When the amplifier is operating at a high level the instantaneous peak potential difference between the 807 plates and earth may rise to several hundred volts, high enough in fact to cause an insulation breakdown between the centre conductor and shielding, thus shorting each end of the output transformer to earth. The resultant heavy current flow through the primary winding would almost certainly destroy it. There is, of course, no fear of this occurring with unshielded leads to the plates of the 807's.

Speaker Systems

Before concluding, a word must be said about the speaker, or speakers, to be used with this amplifier. The equipment is so good that it would be false economy to feed the output of the amplifier into a small light-duty speaker. The best advice we can offer is to use the best speaker which you can afford.

For reasons which are too involved to

explain here, it is not possible for a single speaker of orthodox design, no matter how good, to cover the whole of the audible frequency range. Quite apart from the difficulty in achieving the required frequency coverage, such objectionable effects as inter-modulation distortion become evident when the speaker is operated at a high acoustic level. In high quality reproducing equipment the problem of obtaining full frequency coverage is overcome by employing at least two speakers each designed to handle a limited frequency range with the highest possible efficiency. In some cases, one speaker having a 12-in., or larger, diaphragm handles all frequencies up to about 500 cycles and a second speaker with a small diaphragm of comparatively low mass, which is sometimes horn-loaded, handles all frequencies from 500 cycles up to 12,000 or 15,000 cycles. Other systems allow the large speaker to handle up to about 1,000 or 2,000 cycles, while the smaller speaker takes over from this point.

Self-contained commercial units of the type just mentioned are generally quite expensive. However, it is possible to obtain very satisfactory results by using two ordinary stock speakers, one of the 12-in. type and the other having a 6-in. diaphragm. It is not sufficient to connect the two speakers in parallel to achieve the desired result. While this would have some effect so far as increased frequency range is concerned, it would do nothing to reduce inter-modulated distortion which is caused by modulation of high notes by bass notes. To eliminate this latter effect it is essential that high notes be kept out of the low note speaker and low notes be kept out of the high note speaker.

This is achieved by employing a frequency dividing network consisting of two inductance-capacity filters, one of the low-pass type and the other of the high-pass type. The low-pass filter which is connected between the output of the amplifier and the low-note speaker is designed to pass all frequencies up to the cross-over point. On the other hand, the high-pass filter is connected between the output of the amplifier and the high-note speaker and is designed to pass all frequencies from the cross-over point up to the limit of the speaker's frequency

(Continued on page 47.)

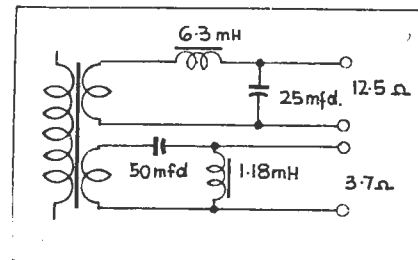

Fig. 5.—The frequency dividing network system, designed to provide a cross over at 500 c.p.s.

THREE-WAY SPEAKER SYSTEM

Of particular interest to the experimenter, this practical design of a three way speaker system should warrant serious consideration as a means of obtaining the utmost realism in sound reproduction.

The wide acceptance of some form of multiple speaker arrangement as a requisite of high-quality reproduction is responsible for a renewal of interest in three-way systems. The extraordinary strides made by dual-speaker systems in the last few years has tended to a state of complacency and has resulted in obscuring somewhat the need for further experiment along these lines, the results attained with the system to be described should warrant serious consideration of the three-way system as a factor in tracking down the elusive will-o'-the-wisp of realism in sound reproduction.

Theoretical discussion is not within the scope of this article other than to point up the desirability of limiting the coverage of single speakers to bandwidths within their capabilities, and utilising as many as are deemed necessary to overcome as much as possible the short-comings of each unit as regards mass, cone break-up, and other inherent deficiencies of design contributing to distortion. In a three-way system, these deficiencies are minimised, in that each unit is called upon to deliver only within a range of about three octaves, a band well within the ability of any speaker of reasonably good quality. Besides permitting the use of a small unit in the upper band and thereby reducing the effects of bass, a separate middle frequency speaker allows the choice of a very low cross-over without the excessive cost of a comparative dual system, and restricts the low frequency speaker to operation within optimum limits.

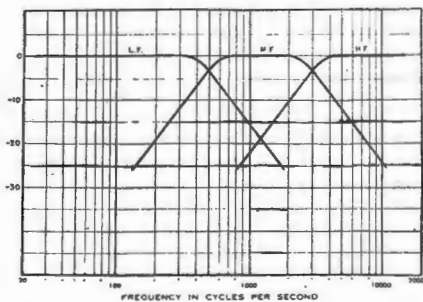
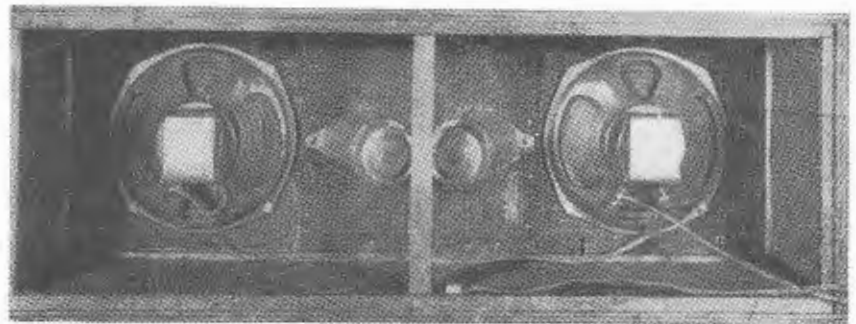

Fig. 2.—Transmission characteristic of the dividing networks shown in Fig. 1.



Arrangement of the speakers on the baffle.

Components.

A three-way system was constructed along the same lines as the conventional two-way system, design data being merely extended to include an additional speaker. The existing reproducer, a 15in. cone in a large cabinet, became the low frequency unit without modification. Eight-inch cones serve in the mid section, two being used to provide sufficient power-handling capacity.

The upper range is adequately taken care of by the dual-horn unit shown in the photograph. It has excellent horizontal and vertical distribution with a manufacturer's rating of 12 watts and response to 15,000 cycles.

Fig. 1 shows the manner in which the filters are arranged to provide the cross-overs. Two series type dividing networks are cascaded to form the low-pass, band-pass, and high-pass transmission characteristic of Fig. 2. Economy and the limitations of the speakers were factors in the choice of cross-over points at 500 and 3,000 cycles.

The cabinet shown in the photograph was constructed to house the upper and middle frequency speakers. No difficulty due to relative positioning was experienced. At 3,000 cycles the distance involved is so small that the units could all be mounted flush and phasing accomplished by observing polarity. The small cabinet, on top of the large baffle, may

be placed to advantage with reference to the low frequency speaker.

Constructional Data.

Flanges for the coil forms were made by cutting discs of one-eighth inch masonite with a circle cutter, the edge of the tool being reversed so that the bevel does not appear on disc. One and one-quarter inch dowel stick in lengths of three-quarters and one and one-quarter inches served as cores. The flanges are glued to the core, being held in place with a small wood screw until the glue is dry, after which the screw is taken out.

Using No. 17 DCE wire, coil specifications are approximately as follows:—

Inductance MH	Winding Space	Turns
5.12	1.25	375
3.2	1.25	315
.85	.75	140
.53	.75	115

Capacitors were assumed to be reasonably accurate and were used to check the coils with the aid of an audio oscillator. It will be noted in the circuit diagram that each pair of inverse reactances are resonant at the cross-over frequency. Connected in series across the output of the oscillator, it was only necessary to alter the inductance until the point of greatest attenuation coincided with the

cross-over frequency. Thus the pairs $L1$ and $C1$, and $L2$ and $C2$, are resonant at 500 cycles; $L3$ and $C3$, and $L4$ and $C4$ resonant at 3,000 cycles. Components were calculated for an R_o of 16 ohms, and in the case of the lower network, the cross-over point was fixed at 497 cycles to arrive at standard capacitor values. This slight shift can be ignored and is only mentioned as a point of information. An eight ohm L pad is connected as shown in the h-f output, the resistor, $R1$ changing the pad impedance to 16 ohms and at the same time reducing the maximum attenuation possible to 6 db.

The small cabinet is of plywood and was constructed with no particular attention to acoustical considerations other than to build it solidly and of ample proportions, and to partially line it with felt. Open mesh grill cloth covers the entire front panel, enhancing the appearance by concealing the speaker openings. On the rear panel is the h-f level control and two jacks for convenient access to speaker leads.

Phasing.

The pairs of speakers in the upper and mid sections were each connected in series and phased separately before connection

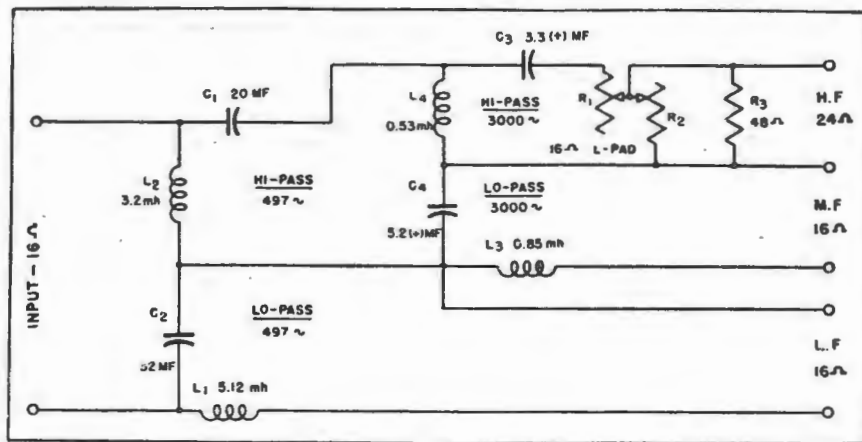

Fig. 1.—Schematic showing circuit of the cross-over networks.

to the outputs of the dividing network. Then, with all speakers in the circuit and the entire system connected to the amplifier, 3,000 cycle response was measured with a microphone and U meter. Maintaining a constant level, the h-f leads were reversed and the two meter readings compared. Maximum indication occurred when the high and mid frequency speakers were correctly phased. As mentioned before, the relative position of the

upper and middle speakers was found to be approximately correct when both are mounted on the front panel in the usual manner.

Using a 500-cycle signal, the same procedure was followed with the low and mid frequency speakers. In addition it was necessary to locate the small cabinet by sliding it backward and forward for maximum response.

Reproduced by courtesy "Audio Engineering".

Kingsley—New Miniature DUAL WAVE COIL UNIT

This New Kingsley Dual Wave Coil Bracket has not merely been reduced in size—it has been thoroughly designed by Kingsley's Research Engineers. It is no mere adoption of existing components, being engineered not only from the electrical but also the mechanical viewpoint.

NO OTHER D/W BRACKET GIVES ALL THESE FEATURES:

- ★ Each unit is core tuned.
- ★ Models for every converter valve.
- ★ Frequency coverage 5.95 megacycles to 18.5 megacycles and 540 to 1650 kC/s.
- ★ Trimmers and cores are readily accessible.
- ★ Coils and wiring well protected.
- ★ Dimensions of unit: 3 ins. wide, 2 ins. deep, 1 1/4 ins. high.
- ★ Ease of wiring into chassis.
- ★ Sturdy construction of unit.

Write for details.

Ask for—Insist on—**DEMAND** Genuine Kingsley Parts from your supplier.

KINGSLEY RADIO PTY. LTD.

380 St. Kilda Road, Melbourne, Victoria — — 'Phones: MX 1159, MX 3653

SLADE'S RADIO PTY. LTD.

Proudly Presents
Australia's First Frequency Modulation Tuner

★
All the advantages
of F-M reception are
yours with this com-
pact 6-valve F-M
tuner.



★
Converts any Radio
Receiver or Ampli-
fier for F-M.

★
Price complete £20-0-0

SLADE F.M. TUNER KIT

Consists of pre-aligned Tuner, two 10.7 mc. I.F. Transformers, one Ratio Detector Coil.

★
As easy to
build as a
Crystal Set.

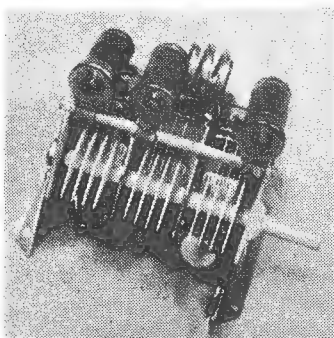

I.F.'s and Ratio Detector Coil

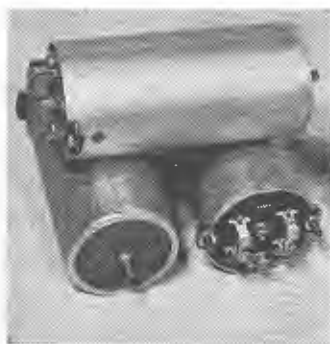

Tuner

★
Frequency
Range
88-108 mc.

★
PRICE, complete with constructional details as described in August issue of RADIO SCIENCE.
£7-18-6 nett

Suitable Amplifiers complete, or Amplifier Chassis and case, now available.

SLADE'S RADIO PTY. LTD.

LANG STREET, CROYDON

— — —
Established 30 years

Tel.: UJ5381; UJ5382

U.H.F. Techniques

By
HARRY N. EDWARDES, B.Sc., B.E.

Having dealt with the generation of U.H.F. energy and its transmission along metallic feeders in previous articles, the mechanism of transmission through the ether is now considered. This involves aerials, radiation and propagation, and forms a very important link in any U.H.F. system.

An aerial is a means of launching electro-magnetic waves in the ether. It can be considered as a coupling between the feeder and the space transmission line.

Propagation involves the behaviour of radio waves in the atmosphere. For any system a study of the propagation properties of the section of ether employed is necessary, both from the point of view of initial design and for correct interpretation of the results obtained. Propagation characteristics are determined by the wave-length, aerial features, terrain and meteorological conditions.

Simple U.H.F. Aerials.

An aerial is an electro-magnetic radiator. It may consist of one or more conductors carrying U.H.F. currents which induce alternating magnetic and electric fields in the ether. This field disturbance is transmitted through the ether as an electro-magnetic wave.

One of the simplest forms of radiator is the half-wave doublet or *dipole*. A dipole can be fed by a two-wire transmission line as in Fig. 1a. A quarter-wave rod (Fig. 1b) is another simple radiator which is easily connected to a co-axial line.

This *spike* type of radiator forms the basis of many aircraft U.H.F. aerials. It

resembles the Marconi aerial used on lower frequencies.

For micro-waves, an open-ended wave guide will radiate well, whilst shaped horns (Fig. 1c) are ideal radiators for applications involving wave guide feeders.

A dielectric wave guide or *polyrod* (Fig. 1d) is a novel form of radiator which has been used in radar aerials.

Combinations of these simple radiators, usually with metallic reflecting sheets, constitute the usual micro-wave aerials.

Directivity.

One of the fundamental properties of an aerial is its *directivity*. By directivity is meant the ability of an aerial to radiate a beam of energy in one or more directions. At low frequencies some directivity is possible with loop aerials, and use of this property is made in radio direction-finders. However, with U.H.F. and particularly micro-wave aerials, nearly all of the energy may be directed into narrow beams.

As the wave-length approaches that of light, micro-wave aerials become more like searchlights. In radar, use is made of these narrow beams for determining accurate bearings of targets. Such beams render plan position and range-height indicators practicable.

For communication purposes, narrow beam aerials can provide privacy and prevent interference between stations on the same frequency.

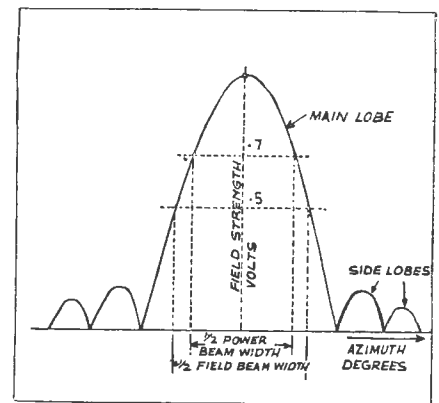

Field pattern plotted on rectangular coordinates. This system is more convenient for narrow beams. Fig. 2.

direction is defined as the ratio of power radiated from the aerial in that direction, to the power radiated by an *isotropic* radiator (i.e., one which radiates equally in all directions; an alternative term is *spherical* radiator).

It may be pointed out that this gain is obtained at the expense of coverage area. A limit to the aerial gain for any system is set by the maximum possible aerial size and the minimum desirable coverage area.

Field Pattern.

The gain of an aerial depends upon the shape of the radiated field strength pattern in space. This three-dimensional pattern is generally a tear-drop shaped surface, representing the relative field strength distribution. (The pattern for an isotropic radiator is a sphere.) It is usually sufficient to consider the sections of this surface by two planes at right angles and to refer to the field patterns in, say, the horizontal and vertical planes. For small angles, rectangular co-ordinates are preferable to the polar system for plotting these patterns (see Fig. 2).

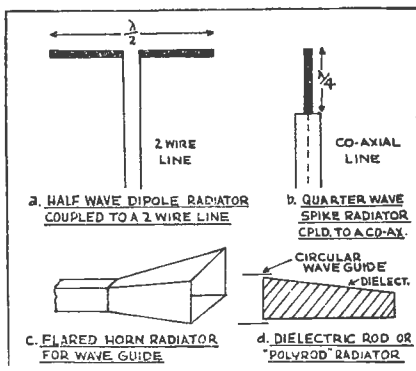
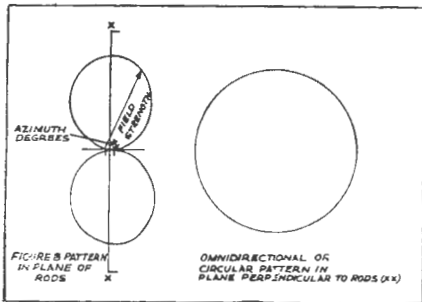

Fig. 1.—Details of some simple U.H.F. aerials.

PART 7. AERIALS, RADIATION AND PROPAGATION

Gain of an Aerial.

As well as providing better *resolution* by means of narrow beams, U.H.F., aerials direct most of the transmitted energy into these beams and thus provide a *gain* in the system. The gain of an aerial in any



Field patterns of a half wave dipole plotted on polar co-ordinates. Fig. 3.

Dipole Patterns.

The polar patterns of a dipole are shown in Fig. 3. for this radiator the maximum gain is 1.63, and there are two maxima of field strength. All the elemental radiators in Fig. 1 have patterns roughly comparable with that of a dipole.

It is convenient to refer to the beam width of an aerial. This is commonly defined as the angle between half-power (or .71 field strength) directions. For a dipole this is 78 degrees.

Side Lobes.

Secondary maxima in the pattern are called *side lobes*. These can have undesirable effects, and the aim in aerial development is to keep them down to a minimum. In radar applications side lobes cause *ghost* echoes on different bearings from the main echo. Side lobes of microwave aerials are usually less than one-tenth of the voltage of the main lobe and therefore contain only one-hundredth of the power.

Aerial Pattern Measurements.

Although aerials may be designed by theory, it is always desirable to check the field patterns experimentally. This may

be done by exploring the transmitted field with a field strength receiver connected to a test aerial. It is more convenient to measure the receiving pattern of the aerial, by noting the variation in field strength received from a fixed transmitting aerial as the aerial under test is rotated. It is necessary to mount the main aerial on a rotatable turntable, a practical proposition for most U.H.F. aerials. The principle of reciprocity, which states that the transmitting pattern is the same as the receiving pattern, is employed. The transmitting aerial must be sufficiently far distant for the wave front reaching the aerial to be plane within about an eight wave-length.

A pattern may be automatically recorded by means of a recording detector meter or by plotting the received signal against angle electronically on a cathode ray oscillograph. These techniques are very useful where a lot of "cut-and-try" work is necessary in developing aerials.

Gain Measurement.

The gain of an aerial is usually measured by the *substitution* method. An aerial of known gain is substituted for the aerial being tested and the relative received signal strengths determined. The sub-standard should have a gain comparable with that of the sample aerial. Dipoles are often used as sub-standards, however, because they have a known gain of 1.63 over an isotropic radiator.

Aerial Impedance.

The impedance of an aerial is an important quantity. For maximum transfer of power it is desirable to have an aerial matched to its feeder. This is usually done through a matching transformer. The technique of impedance measurement and matching was described in the

article on Transmission Lines. Most elemental radiators need little matching. For example, a dipole has an impedance of about 70 ohms resistance.

Radiation Resistance.

The portion of aerial impedance which represents absorption of energy in radiation is termed the *radiation resistance*. The remainder of the resistance represents aerial conductor losses which are usually small. The radiation resistance of an aerial is that resistance which, if it replaced the aerial, would dissipate the same energy as is radiated by the aerial. Expressed in symbols—

$$\text{Radiation resistance } R_r = \frac{P_r}{I_o^2} \text{ ohms.}$$

Where P_r equals radiated power—watts,
 I_o equals current in aerial at the reference point—amps.

Balance to Unbalance Transition.

When a dipole is fed from a co-axial line, it is necessary to provide a balance

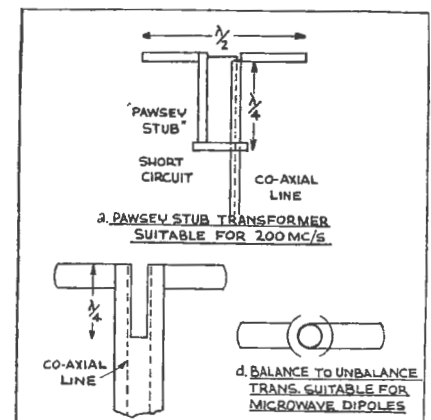

Balance to unbalance transformers for coupling dipoles to co-axial lines at U.H.F. Fig. 4.

The New Midget Three Gang Variable Condenser suitable for 88-108 Mc. FM Band.

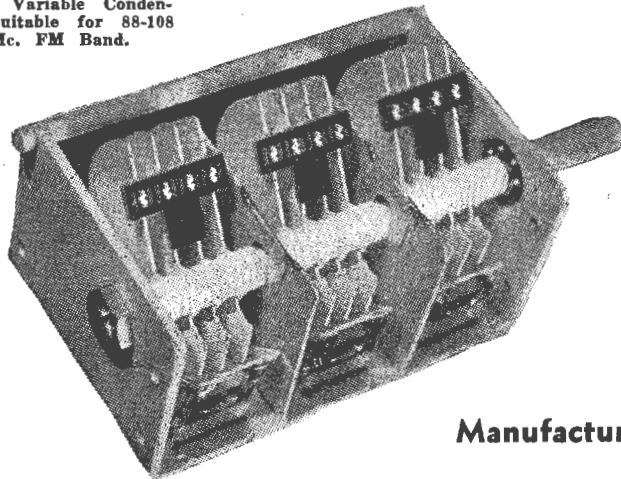

ROBLAN COMPONENTS

Now available to YOU everywhere are ROBLAN midget two and three gang variable condensers, which are of higher quality and lower price than any other manufactured in Australia.

- ★ 9-21 mfd within 2%.
- ★ High Q—admirably suited for V.H.F. equipment.
- ★ Ball bearings ensure long service life.
- ★ Insulation of highest grade imported British bakelite.
- ★ Completely silver plated for low loss and maximum efficiency
- ★ Lowest priced 3 gang on the market.

Manufactured by ROBERTSON & LANSLEY PTY. LTD.
LEICHHARDT, N.S.W.

Trade Enquiries to ELECTRONIC INDUSTRIES

to unbalance transformer to prevent currents flowing down the outside of the co-axial feeder. These currents would cause radiation and loss.

One common and convenient form of transition is the *Pawsey stub* which makes use of a short-circuited quarter-wave two-wire line (see Fig. 4a). The latter provides a high impedance across the centre of the dipole. This has no effect on the dipole impedance, but prevents current flowing down the outside of the feeder. A small matching adjustment is provided by the stub; if necessary some shunt reactance may be added by varying the length slightly from a quarter wavelength. The dipole length is a second matching adjustment; this affects the resistance component of the impedance.

Dipole Arrays.

To attain directivity in the lower U.H.F. region (about $1\frac{1}{2}$ metres), arrays of dipoles are used. These may be either broadside (see Fig. 5) or end fire (the Yagi of Fig. 6 is typical). The field pattern of an array depends upon the phase differences between rays from the different elements; it is a diffraction pattern analogous to that produced by a diffraction grating in optics. Theory shows that the beam width decreases (i.e., the gain increases), with increase in dimensions (in wave-lengths) of the array. The larger the array, however, the greater the number of dipoles, which increases the difficulty of *feeding*. The elements must be arranged in a series parallel combination to maintain an impedance near that of the feeder. A standard Australian 200 Mc/s war-time radar used a 36-element array.

A plane reflector close to an array (usually a quarter wave-length away), produces a uni-directional beam and gives

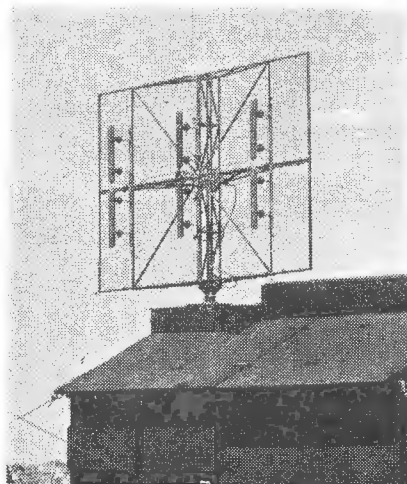

A broad band array type aerial for frequencies from 160 to 190 Mc. It consists of "fat" dipole elements supported by bakelite insulators in front of a mesh reflector. Co-axial cable feed is used. Fig. 5.



Fig. 6.
An eight element Yagi aerial suitable for 180 Mc. Note the folded "fed" dipole with Pawsey stub transformer.

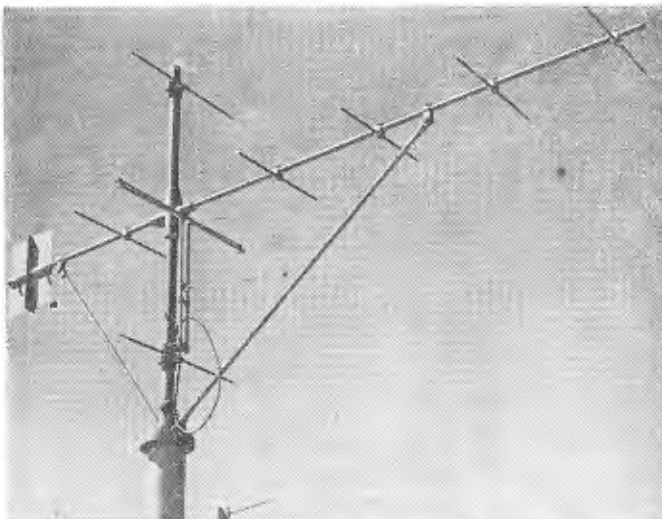

a gain of about 4 to the array. It also has the effect of reducing the impedance if the spacing is less than a quarter wave. The dipoles can be conveniently supported from a reflector by glass or bakelite insulators on metal rods.

Broadbanding.

For operation over a band of frequencies, thick dipole elements are used. The length of these 'fat' elements has to be reduced to maintain the same effective length electrically, a very convenient feature. The impedance is also reduced, so that it is convenient to use several ended half-wave dipoles (which have a much higher impedance than centre-fed ones) in parallel. The array of Fig. 5 is constructed along these lines.

Matching should be kept to a minimum for broad-band aeriels, because of the high frequency selectivity of large correcting or matching impedances.

The Yagi Aerial.

The Yagi aerial (devised by a Japanese of that name), makes use of parasitic elements. Only one dipole is fed; all the other dipoles are excited by induced currents. Parasitic elements longer than a half wave-length act as *reflectors*, whilst those shorter act as *directors*. Plane Yagis usually have one reflector and a number of directors. That depicted in Fig. 6 has reflectors above and below the main plane to narrow the beam in the vertical plane. It will be noted that the driven element is of a folded form. This is to provide a higher input impedance to compensate for the reduction in impedance caused by the parasitics.

Micro-wave Aerials.

To attain very narrow beam widths, a large number of dipoles would be necessary in an array type of aerial. Narrow beams are possible with micro-waves because of the shorter wave-lengths and consequent larger apertures relative to

wave-length. Parabolic reflectors, with suitable sources of *feeds* at their focal points, are more convenient than arrays of dipoles for micro-wave aeriels.

The various types of reflectors in common use are illustrated in Fig. 7. They consist of sections of either paraboloids of revolution or parabolic cylinders. The former can be manufactured by spinning in the smaller sizes (such as those used in aircraft installations). Larger reflectors are built up with wire mesh on a wooden or metal framework. The *orange peel* shape proved convenient for large ground radars.

Parabolic cylinder sections were used in naval radars where "fan" beams (i.e., broad in the vertical plane) were necessary to reduce fading of echoes due to rolling of the ship. These small reflectors were fabricated from sheet metal or cast in aluminium. When the top and bottom of the cylinder were filled with partitions, they were termed *cheese* reflectors.

The requirements of the source or *feed* of a micro-wave paraboloid aerial are a

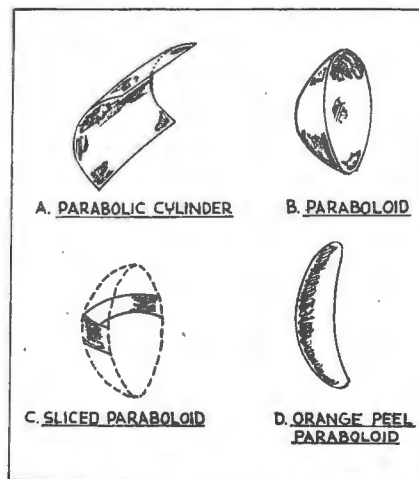

Parabolic reflectors for microwave aeriels. Fig. 7.

spherical wave front and a suitable field strength distribution or illumination across the reflector. These factors affect the beam shape and side lobe characteristics of the aerial.

The half-power beam width of a paraboloid 10 wave-lengths wide, is about 5 degrees. For small angles (less than 10 degrees), the beam width varies inversely as the reflector width.

With narrow strip-like reflectors, it is usual to employ parabolic cylinders with "distributed feeds," such as strings of dipoles or wave-guide slot radiators.

Propagation.

Propagation deals with the properties of waves in the atmosphere. The field pattern of any aerial in practice depends upon the *free space* pattern, the effects of atmospheric refraction, earth and sea reflection, and diffraction due to objects in the transmission path. The contributions from all of these sources may be combined by multiplying together the patterns produced by each phenomenon on an isotropic radiator.

The free space pattern is the relative field strength pattern previously described.

Refraction.

Refraction or bending of the electromagnetic rays occurs in the earth's atmosphere, because they travel through a medium of changing refractive index; the meteorological factors cause the refractive index of the air to decrease with height usually.

The ray paths are approximately circles curving towards the earth, but with a radius of curvature greater than that of the earth. This means that the U.H.F. horizon is greater than the optical horizon. Refraction is covered by using an *effective radius* for the earth, which is greater than the actual radius. This is the radius for which the ray paths become straight lines if the curvature of both rays and earth were reduced.

Charts for drawing aerial coverage diagrams are usually made for an effective radius of 1.3 times the normal figure. (By "coverage" is meant the space locus of all points at which the field strength is the minimum useable value for the particular application.)

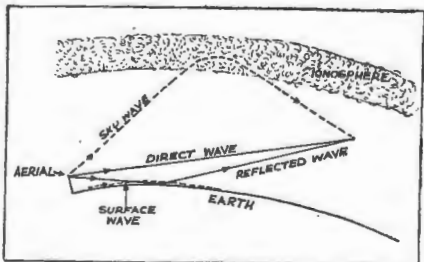

Propagation paths of various components of radiation from an aerial near the earth. At U.H.F. the sky wave is not reflected. Fig. 9.

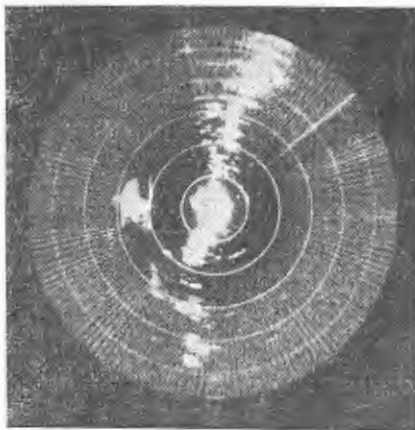

P.P.I. picture from a 25cm. high power radar during super-refraction conditions. The set is located at Sydney and approximate outline of the coast is discernible. Fig. 8 (a).

Super-refraction.

Under certain weather conditions known as *temperature inversions*, anomalous propagation may occur. Extra bending of the rays or super-refraction usually results from such conditions. Consequently, the horizon is extended and abnormally long ranges are possible for U.H.F. equipment.

From the operation of radars during the war, particularly in North-western Australia, much valuable data was obtained on this phenomenon. Fig. 8 illustrates the increased range on permanent echoes with a radar located at Sydney under anomalous propagation conditions, which occur on some days during the summer months.

Trapping.

Under some circumstances *trapping* of waves in ducts occurs. Extremely long ranges have been obtained due to this phenomenon. The propagation in this case is similar to wave-guide propagation.

It is possible for the rays to be curved upwards under anomalous conditions, but this does not occur often in practice.

Reflection.

With an aerial located near the earth's surface, there are several possible paths to any point within the coverage area. These are depicted in Fig. 9. At U.H.F. the sky-wave is not reflected by the ionosphere, and the surface-wave is rapidly attenuated, so that the only effective paths are the direct and reflected ones.

The reflected ray is only effective if the surface is a good reflector for the wave-length involved. The sea is a good reflector even for micro-waves, the efficiency, of course, depending on the "roughness".

Whilst reflections are possible at $1\frac{1}{2}$ meters from rough terrain, they are not obtained with micro-waves. Portions of

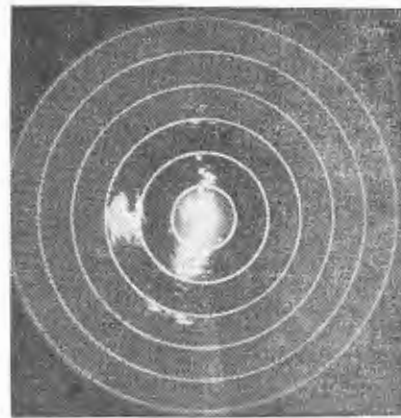

Normal P.P.I. picture of the same radar. Note Blue Mountains echoes to the west and aircraft to the North at about 50 miles. (20 mile range circles). Fig. 8 (b).

buildings could reflect effectively, but micro-waves will not travel far through built-up areas.

Interference.

When reflection occurs from the earth or sea surface, interference between the direct and reflected waves causes a variation in field strength in a vertical direction. Alternate reinforcements and annulments are produced (see Fig. 10). The resulting *lobes* are equally spaced vertically (except for those at very low angles).

The spacing depends upon the aerial height and wave-length. For example, a 3-metre wave-length aerial situated 300ft. above sea-level, has two maxima between sea-level and 20,000ft. at 100 miles. A 10 cm. aerial under the same conditions would have 65 lobes.

If reflection is perfect, the field strength at a maximum is twice the free space figure. Thus the range of a radar set can be improved by reflection. In practice, this advantage is offset by the *gaps* between maxima, where the field falls to zero. Also, reflection even from the sea is not complete, because the curvature of the earth introduces *divergence* or spreading of the beam. Although not serious

(Continued on page 46.)

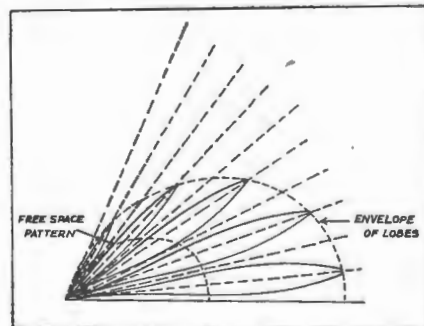

Vertical radiation pattern of a microwave aerial assuming a flat earth. The lobes and gaps are caused by earth reflection interference. Fig. 10.

PICK-UP RESONANCE EFFECTS

The effect of mechanical resonance in a poorly designed pickup may produce undesired mechanical oscillations and impair proper operations of the equipment.

In the multitude of phonographs in use today, both in home receivers and professional phonograph amplifiers, two principal types of pickups are used; the magnetic and crystal. The mechanical design of either type pickup is the most important factor in obtaining good reproduction of the recorded audio frequencies that are cut into the record. Let us consider the basic principles involved in reproducing the original sound from the record.

The phonograph needle, while traveling in the grooves of the record, is moved from side to side or up and down in varying degrees, and in such a manner that the mechanical energy resulting from these motions is changed into electrical energy by the pickup device employed and sent through the audio amplifying system of the unit. In order to obtain good frequency responses from the play-back of the record, this pickup device must have the correct mechanical design.

The primary reason for this is that mechanical systems are exactly the same as electrical systems in that resonance effects exist in both. Since resonance effects are prevalent in mechanical systems, if the mechanical design is poor, the components of the system may produce undesired mechanical oscillation which may impair the proper operation of the equipment.

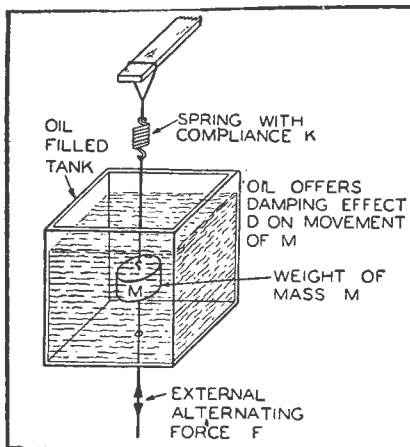

Fig. 1.—A simple mechanical system represented by a spring, a weight immersed in oil, and an external alternating force. This system is equivalent to a series resonant circuit in the electrical system.

In other words, certain features relative to mechanical systems have their exact counterparts in electrical systems. Consequently, any type of mechanical arrangement, no matter how intricate, can be illustrated as an electrical circuit.

Mechanical to Electrical Counterpart.

In an electrical system the four primary features relative to circuit analysis are inductance, capacitance, resistance, and electromotive force. Almost every one is familiar with these electrical circuit characteristics and the relationships among them as given by Ohm's Law and other such fundamental relations.

In mechanical systems the four main properties that are the basic representations of such systems are the mass (weight) of the system, the damping effect or the opposition to movement, the displacement of the system due to some external force, and the external force applied at regular intervals.

A simple mechanical "circuit" is illustrated in Fig. 1. The mass of the system, M , is represented by the weight immersed in oil. The thickness of the oil, which impedes the movement of the weight and is therefore in opposition to this movement, is the damping factor represented by D . The displacement of the system is represented by the stretching of the spring because of the action of some external force, F . The displacement caused by this force, F , is determined by the compliance, K , of the system. The compliance of a system, or in this case of the spring, is the characteristic which determines the degree or extent to which the spring will stretch because of some external force applied to its intervals.

Inductance L in an electrical system is analogous to mass M in a mechanical system. That is, the weight of the mass offers a certain amount of opposition to any change of motion in the mass, and the quantity of inductance offers a certain amount of opposition to change of current flow.

Similarly, the damping factor, D , in the mechanical system is equivalent to resistance R in an electrical system. The reason for this is that damping factor D (due to the viscosity of the oil) reduces the amplitude of the movement of the

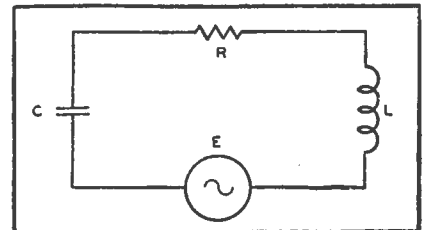

Fig. 2.—This series tuned circuit is the electrical equivalent of the mechanical system in Fig. 1.

mass by absorbing mechanical energy from the system and resistance R reduces the amplitude of the alternating current flow by absorbing electrical energy or power from the electrical system.

Likewise capacitance C is equivalent to compliance K in that there is electrical energy stored in a capacitor which is a determining factor in the amount of current flow, and that mechanical energy is stored in the spring which is a determining element in the amount of displacement of the mass. Finally, the external force, F , acting on the mechanical system is equivalent to the electromotive force, E , of the electrical system since both of these forces start the systems into vibration or oscillation.

Equivalent Electrical Circuit

A typical electrical system analogous to the mechanical system of Fig. 1 is illustrated in Fig. 2. This diagram consists of nothing more than a series resonant circuit containing R , L , C , and an electromotive force, E . From the foregoing discussion it follows that Figs. 1 and 2 are analogous to each other in that R is equivalent to D , L is equivalent to M , C is equivalent to K , and E is equivalent to F .

It is known that the frequency of oscillations in a series resonant circuit is equal

to $\frac{1}{2\pi\sqrt{LC}}$ where L is the inductance

measured in henrys, C is the capacitance measured in farads, and the frequency of oscillations is in cycles per second.

Since M is the equivalent to L , and K equivalent to C , it follows that a resonant frequency also exists in the mechanical

system and is equal to $\frac{1}{2\pi\sqrt{MK}}$. Of

course, the correct units of M and K must be inserted in order to obtain the frequency of oscillations in cycles per second. For the purpose of this article the values of M and K are of no consequence; here the primary purpose of showing that a mechanical system can be represented by an electrical system and that the mechanical system can be represented by an electrical system and that the mechanical system also has resonance effects is of importance to us. In other words, in all the different mechanical arrangements used in today's receivers, a relation exists between the units comprising each arrangement such that mechanical resonance will occur at some specific frequency, such frequency being determined by the aforementioned mechanical units.

Systems Affected

Some of the more common mechanical systems in radio receivers where mechanical resonance may occur are found in phonograph pickup arms, loudspeakers, and recording heads. Mechanical resonance is undesirable because it interferes with the normal operation of the set. That is, the arrangement of the different mechanical parts comprising the system is such that the combined mass, in conjunction with the total compliance, produces mechanical resonance effects that interfere with the operation of the set. Consequently, if improper design and arrangement of the mechanical system of a pickup arm exist, there is the possibility that mechanical resonance may occur within the audio-frequency range and that it will interfere with the reproduction of the audio frequencies (music, speech, etc.) from the record.

Reducing Resonance Effects.

If it is found that the pickup arm produces undesired resonance effects, several methods of correction may be applied. First, if it is desired that only the amplitude or strength of the mechanical resonant frequency be changed (in this case, reduction of the amplitude), all that need be done is to introduce some factor that will damp the amplitude of this resonant frequency. This is equivalent to introducing resistance in a resonant circuit. Therefore, if a damping factor is inserted into the mechanical system, the amplitude of the unwanted mechanical resonant frequency, and not the frequency of oscillations, will be changed (reduced).

However, if the frequency of mechanical oscillations is to be changed, either the mass of the system or the compliance must be changed. This is analogous to the electrical system where either a change in the inductance or capacitance of a resonant circuit will shift its resonant frequency, and this is readily seen from the foregoing equation for the resonant fre-

quency of a series circuit. (If the resistance of a parallel resonant circuit is not too high as compared to the reactance of either the coil or capacitor, the equation for the resonant frequency of a parallel tuned circuit is considered the same as that for the series tuned circuit.)

From the analogous equation for the frequency of mechanical resonance it is found that, if either the mass or compliance is increased, the frequency of oscillations will decrease accordingly; and, on the other hand, if the mass or compliance is decreased, the frequency of oscillations will decrease; and if the product is decreased, the frequency of oscillations will increase.

The methods of changing the parameters M , K , and D to accomplish some means of reducing the effect of the mechanical resonance in phonograph pickup arms are as follows:

1. Introduction of, or removal of, some weight of the system. With this method, great care must be taken in order that the other parameters are not changed.

2. Introduction of, or removal of, some compliance of the system. This is usually accomplished by either tightening or loosening certain springs or wires in the unit such that the movements of the mass will be more or less restrained according to the elasticity of the springs or wires.

3. The most common method of reducing the effect of mechanical resonance is to damp the frequency of oscillations, in other words, the mass and compliance of the system should be kept more or less constant while a damping factor, D , is introduced in the proper place.

One method of introducing a damping factor is to apply a special kind of viscous liquid on various moving parts of the pickup arm. In other pickups the damping may be accomplished by changing the material in the pivots or bearings so that at these points there is dissipa-

tion of the mechanical resonant energy, and the amplitude of the oscillations thus are reduced. Introduction of some material that slows down the ready movement of the system at resonance, such as rubber strips in the correct places, will also help to damp the unwanted oscillation.

When a mechanical system, such as a pickup arm, is changed by the introduction of damping effects, some undesirable factors may be introduced. For example, if a rubber sleeve is placed around a particular piece of wire to damp mechanical oscillations, this also would add some weight to the pickup arm and consequently increase the force of the needle onto the record. That is, the mass of the system would change by becoming heavier and this would mean an increase in the needle pressure on the record. In this respect an additional change in the mechanical arrangement of the pickup arm is necessary to prevent increased needle pressure on the record.

Mechanical Impedance.

From the foregoing analysis of how the effects of mechanical resonance may be reduced, it is readily seen that it is by no means a simple procedure. The design and manufacture of magnetic and crystal pickup devices are indeed a delicate operation. The development and design of such mechanical systems are more readily accomplished from the understanding that most mechanical systems, no matter how complex, can be represented by an equivalent electrical system. The simple case for this was shown with reference to Figs. I and 2 and an explanation of mechanical resonance.

It follows that if resonance in a mechanical system, mechanical impedance must likewise exist, which consists of mechanical reactance and the damping of the system. The mechanical reactance is simply a combination of the reactance due to the mass and the reactance due to the compliance of the system. Whichever has the greater mechanical reactance will be the dominating influence in the total amount of impedance and the actual movement of the mechanical system. In other words, the combination of the mechanical reactance with the damping (i.e. both together being the total effective mechanical impedance) affects the complete system in such a manner that any mechanical movement is retarded according to the magnitude of the mechanical impedance.

Magnetic Pickup.

For the moment, picture a simple magnetic reproducer similar to that used in the phonograph pickups of today's radio receivers. The phonograph needle is in-

(Continued on page 47.)

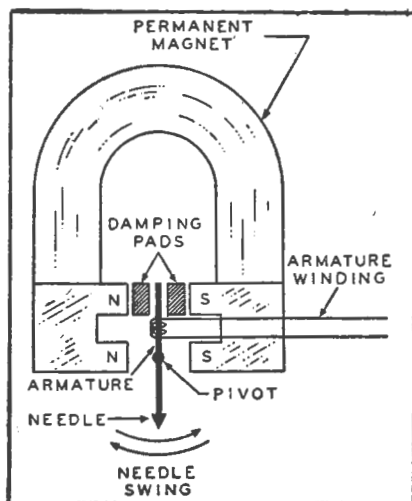

Fig. 3.—Pickup assembly showing damping pads which absorb the strong vibrations of the armature, thereby reducing the effects of mechanical resonance.

For your note book

A page of radio servicing hints and notes of practical value to the radio serviceman and technician.

CHECKING OSCILLATOR CIRCUITS

A frequent cause of trouble in super-heterodyne receivers is the failure of the oscillator circuit. Whilst this fault may be readily diagnosed through the use of a signal generator or a vacuum tube voltmeter, there is a simple method of accomplishing this without the use of any instruments.

The only equipment required is another receiver which is known to be in good operating condition. The two receivers are placed near each other and the set to be tested—let us call it A, is tuned to the low frequency end of the dial, say 600 kc. If the dial of set B (the receiver which is being used as a test instrument) is now set at a point corresponding to the 600 kc. (or the frequency chosen on the other set) plus the intermediate frequency of set A, a whistling note will be produced by the oscillator of set A which will be heard in the speaker of set B. (The whistling note will not be heard in set B unless this set is tuned to a broadcast station and set A is tuned to a frequency lower than this by the amount equal to the IF of set A).

This whistle will then indicate if the oscillator of set A is functioning correctly. This test procedure may be repeated at several points along the dial scale in

order to check the oscillator action at several frequencies. Action of the oscillator cannot be tested at frequencies higher than about 1140 kc. because it will then be out of the range of set B. However it is generally safe to assume that if the oscillator functions on the portion of the scale from 600 to 1140, it will work satisfactorily on the high frequency end of the band.

In practice it is not necessary to know the i-f frequency of the set being tested, since this can be determined by experiment. Since nowadays most Australian receivers have an i-f frequency between 455 and 465 kc. the signal should be received in set B somewhere between 1055-1065 kc., if the dial setting of set A is chosen as 600 kc.

Common Ground.

When a number of leads are to be grounded, a neat job can be made by using a common post consisting of solder lugs mounted in staggered positions on a long bolt grounded to a chassis. The wires are then easily removable one at a time if necessary.

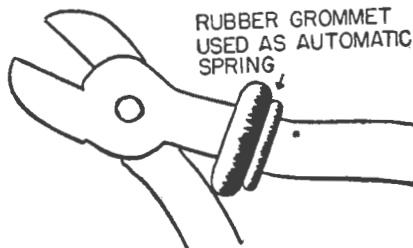

Diagonal Cutting Pliers.

By sliding a large rubber grommet on one of the pliers arms, as shown in the diagram, the grommet will act as an automatic spring. This will open the jaws and keep them open after a cut has been made, thus making it easier to handle the pliers.

Ohmmeter Kink.

Accidental shorting of the test prods of an ohmmeter when not in use, will place a constant drain on the batteries, making frequent replacements necessary. To obviate this trouble, fasten a piece of art gum rubber in one end of the compartment where the prods are stored. Then, when not in use, the tips of the prods are forced into the eraser. This will prevent the tips from shorting as well as keeping them clean thus ensuring better contact.

Faulty Bypass Condensers.

Distortion, loss of volume and squealing in a radio can often be traced to a faulty electrolytic in the cathode of the power output valve. A typical value for this condenser is 25 mfd, 40 volts.

In cases where a receiver suddenly loses volume but can be brought back into operation by banging the cabinet or flicking a light switch in the room, the cathode bypass condenser of the second detector may be leaky. A value often used here is 25 mfd, 40 volts or lower.

In replacing either of these condensers, make sure the positive terminal of the electrolytic condenser is connected to the cathode, and the negative lead to the chassis or other ground.

Wire Stripper

A handy tool for stripping insulation from hookup wire, etc., can be made from a piece of broken hacksaw blade. The jagged broken edge is filed smooth. The toothed edge is used to scrape enamel insulation from wire, whilst the back of the blade is sharpened to a knife like edge and used for cutting rubber insulation. The blade can then be fitted with a small wooden handle or simply taped around with some insulating tape.

Phonograph Needles

Phonograph needles made from ordinary kitchen matches will reduce the pick-up noise usually heard with open-type record players, while providing good reproduction with little loss at high frequencies.

Shorten a dry, softwood match stick to about $\frac{3}{4}$ in. and whittle to a diameter that will fit the pick-up. Then make a perfectly pointed sharp tip. A fibre needle sharpener may be used or the matchstick can be rotated in the chuck of a hand-drill against sandpaper. Re-sharpen after each record for best result.

Around The Industry

V.H.F. TRANSMITTING VALVES

Technical details of two new miniature transmitting valves were recently released by Philips Electrical Industries. These are the QB2.5/250 Tetrode, and the TB2.5/300, both of which are suitable for VHF operation.

The latter valve (TB2.5/300) is a VHF triode for application as HF and LF amplifier, oscillator, or grounded grid amplifier. It will deliver up to 170 watts output at 150 mc and at lower frequencies an output up to 300 watts may be obtained.

Typical ratings are:— Filament 6.3 volts at 5.4 amperes, Anode volts, 2500; Anode dissipation, 135 watts; Anode current, 240 ma; Amplification factor, 26; and Transconductance 3 Ma/V.

For amateur application the anode power available at 150 mc. with 100 volts applied is 80 watts, making it quite suitable for use on the 144 mc band. For commercial Class C telegraphy operation on frequencies as high as 60 mc, the maximum output is 365 watts with 2,500 volts applied to the anode. For Class C anode modulation the rating calls for 2,000 volts maximum on the anode with 180 watts output.

The QB 2.5/250 is a VHF Tetrode which will deliver 220 watts output at 100 mc and up to 325 watts at lower frequencies. Grid drive for maximum out-

put is 5.7 volts. The special zirconium-coated anode shows complete freedom from any secondary emission effects, and consequently the tetrode has the same advantages as a pentode. No neutralisation is necessary at frequencies up to 100 mc if reasonable external screening is used.

Typical ratings of this type are:— Filament, 6.3 volts at 5.4 amperes; anode volts, 3,000 max.; Anode dissipation, 125 watts; Anode current, 240 ma; Screen grid volts, 500; Screen grid current, 50 ma; Mutual Conductance, 1.9 mA/V.

Both valves are of all glass construction, the tetrode measuring approx. 5-in. long by 2½-in. in diameter, and the triode being slightly smaller. They can be mounted vertically, either up or down, but not horizontally, and the base pins are arranged for the large 5 pin socket standard for such valves as the 803, etc. Air cooling is sufficient for normal applications, but when the valves are to be operated at maximum ratings, some degree of forced draught cooling is necessary.

The list prices are: QB 2.5/250 Tetrode



—£11/14/-, plus 2/- duty; TB 2.5/250 Triode—£10/6/-, plus 2/- duty. Sockets are also available at 16 each, plus 2/- duty.

Further particulars, including more detailed operating data can be obtained on application to Philips Electrical Industries, 69-73 Clarence Street, Sydney.

Red Line Transformer Catalogue

Of particular interest to all radio designers, constructors and amateurs, is the recently released transformer catalogue describing the full range of Red Line radio equipment.

This catalogue lists the full specifications of power transformers, chokes and audio transformers as well as giving sufficient technical information to enable the selection of the correct unit for a particular application. In addition, several pages of dimensions and mounting details are included, so that the user can rapidly determine the overall dimensions as well as necessary cut-outs required to adapt the equipment to his particular design.

Readers desirous of obtaining a copy of this useful catalogue should write direct to the manufacturers: Red Line Equipment Pty. Ltd., 2 Coates Lane, Melbourne, Cl, Victoria.

REPLACEMENT FOR TYPE 1603

The Amalgamated Wireless Valve Co. has announced that production of type 1603—the special non-microphonic pre-amplifier valve used in special audio equipment, is to be discontinued.

In place of the 1603, it has been decided to standardise on a specially selected 6J7-G, which passes the same non-microphonic tests as the type 1603, and is electrically its equivalent as regards performance. This valve will be branded 6J7-G/1620 since it is a direct plug in equivalent for the type 1620, although its dimensions are slightly larger.

Amplifiers and other equipment originally equipped with type 1603 and requiring replacements will only need a change of socket from the six pin to the newer octal type. The price of the 6J7-G/1620 will be the same as that for the 1603.

New Red Line Distributor

Advice has been received from Messrs. Red Line Equipment Pty. Ltd. that United Radio Distributors Pty. Ltd., 182 Pitt Street, Sydney, have been appointed a distributor for "Red Line Equipment" in New South Wales.

This firm will carry a wide range of this equipment in stock, and future enquiries in this State should now be direct to the above address.

H. K. LOVE

It is with deep regret that we record the sudden passing of Howard Kingsley Love on July 29th.

As Managing Director of Kingsley Radio Pty. Ltd., and owner-operator of VK3KU, Mr. Love was well-known and highly respected in both radio trade circles and the amateur radio fraternity.

We extend our deepest sympathy to his widow and family in their sad bereavement.



TRANS-TASMAN DIARY

By J. F. FOX

OTAGO CENTENNIAL CELEBRATIONS

This year the province of Otago is celebrating its first centenary. During the early part of 1948, Dunedin, the capital, held many large celebrations which included a monster fireworks display and procession.

The various radio organisations in Otago have contributed to the celebrations by conducting DX contests, an amplifier competition and a special overseas programme.

The Dunedin Branch of the New Zealand Amateur Radio Transmitters held a successful DX contest on the "ham" bands during February and March. The results of this contest appear on this page. The Dunedin Branch of the New Zealand Electronic Institute conducted an amplifier contest as their part in celebrating the centenary. A good number of entries have been received by the Centennial Amplifier Contest Committee and the judging will be carried out in the new 4YA studios in the near future.

On Saturday, March 6th, a two-hour radio programme celebrating the Otago centennial was broadcast from an American Station WFCR, of Reidsville, North Carolina. This programme was arranged by the Otago Branch of the New Zealand DX Club. It had been hoped to have a special programme to be broadcast from 4YA, but this did not eventuate.

CENTENARY DX CONTEST RESULTS

The Otago Centennial International DX Contest which was conducted by the Dunedin Branch of the New Zealand Amateur Radio Transmitters was reported to be a great success. The contest was conducted on the week-ends from February 29th to March 21st, and was open to all licensed transmitting amateurs in any country—mobile marine stations were not eligible.

Phone and c.w. communication was allowed on all of the amateur bands, while a six-figure serial number had to be exchanged by both stations in each contact. A listeners' section was also included, the listener having to show the date, time, band, call of each station heard and the six-figure serial number sent by the station.

In an interview, the Secretary of the Contest Committee, Mr. H. W. Natta (ZL4AR) stated that over 40 entries were received from overseas amateurs, and reports indicated that the contest was enjoyed, with many new contacts being made.

The following are the winners in their respective sections.

Phone Division

Combined Bands: ZL2GX, J. C. White, Patutahi, Gisborne.
10 metre band: ZL4AK, W. L. Shiel, 243 Macandrew Road, Dunedin.
20 metre band: ZL2GX, J. C. White, Patutahi, Gisborne.



The special DX Contest certificate used in conjunction with the Otago Centennial Celebrations. It is attractively printed in red, blue and green on a light buff background.

80 metre band: ZL1LX, W. R. Taylor, Auckland.

C.W. Division

Combined Bands: ZL4GA, A. F. Frame, 10 Gilfillan St., Dunedin.
10 metre band: ZL3HC, C. E. Brittenden, 153 Otupua Road, Timaru.
20 metre band: ZL4GA, A. F. Frame, 10 Gilfillan St., Dunedin.
40 metre band: ZL3LL, J. N. McKin, 1 Chapel St., Timaru.
80 metre band: ZL4DC, J. Robertson, 17 Murray St., Dunedin.

Listeners' Section

M. C. Phillips, P.O. Box 33, Warkworth, Auckland.

The following were awarded consolation prizes for submitting good logs.

20 metre c.w.: ZL2FA, G. B. Butler, 46 Winter St., Gisborne.
10 metre c.w.: ZL2GL, M. T. Gabriel, 239a The Terrace, Wellington.
10 metre phone: ZL4AR, H. W. Natta, 137 Bay View Rd., Dunedin.

OVERSEAS SECTION

Australia:

All Bands: VK2RA, R. Preddle, Rawson Cres., Pymble, N.S.W.
VK4XJ, L. J. Brennan, Williams Rd., Bundaberg, Q'ld.
VK4HZ, J. G. Halyday, Brewery Rd., Gympie, Q'ld.
20 metre c.w.: VK3UM, W. Mitchell, 1946 Malvern Rd., East Malvern, Vic.

R.E.C. IN ACTION

The valuable work carried out by members of the Radio Emergency Corps during floods, earthquakes and on other occasions of emergency have more than once earned the praise of the public.

Recently, the Timaru section co-operated in the search for the missing trawler Margaret, a member of the Timaru fishing fleet. When the trawler was eventually located by aircraft, she was taken in tow by one of the searching launches with the trawler Centaurus as escort.

The section leader of the Timaru corps, Mr. M. O. Johnston, (ZL3JO) operated a station on the Centaurus while Mr. C. E. Brittenden, (ZL3HC) set up a station in the Timaru lighthouse. Contact was maintained throughout by radio telephony on frequencies in the 80 metre band. The service rendered by this section during the search brought such favourable comment from the harbour board officials, fishermen and newspapers, that the Timaru fishermen have decided to establish a base station and to equip all their launches with radio.

It is interesting to note that this section is often called into action, their largest and most successful operation being on the occasion of the Dobson Valley mountaineering tragedy in 1946. Another section of the corps which was recently in action was the Gisborne stations. During the floods in that district the members of this section provided communication for relief organisations.

New Zealand readers are invited to contribute any items concerning radio, broadcasting, DX-ing and amateur radio activities for inclusion in this section. All letters should be forwarded direct to: Mr. J. F. FOX, 41 Bird Street, St. Kilda, Dunedin, S.2. N.Z.

SPECIAL PROGRAMME

A special DX programme which was dedicated to New Zealand DXers was broadcast from Station 2LT Lithgow, New South Wales on Sunday morning, 4th July. The programme which commenced at 12.30 a.m. New Zealand time, lasted 30 minutes and proved to be very enjoyable.

During the programme the Mayor of Lithgow, Alderman W. Black gave a descriptive talk on the town, while the station manager, Mr. S. Emerton described the equipment at 2LT. Reports indicate that the programme was heard throughout the Dominion, though heavy interference was caused by 7HT Hobart. A special verification card has been printed and will be sent to each DXer who reported the station on the special transmission.

ON THE BROADCAST BAND

EUROPEAN AND AMERICAN STATIONS

NEW A.B.C. OUTLET

The increased interference due to electrical storms, etc., which is particularly noticeable on the normal broadcast band during summer months, is amply compensated for by the appearance of many signals which are not generally heard here during the winter. Whilst signals from Asia and the Pacific area are audible almost throughout the year, it is not always possible to hear stations situated in Europe and North America. However, in the case of the latter, it should be mentioned that a few stations are available some evenings between 1500 and 1600kc.

Signals from Europe provide interesting DX during the summer mornings. Among the best signals in the past at our listening post include—Nice, France, 1186kc.; "Radio Sofia", Bulgaria, 850kc.; Rome, Italy, 713 kc., and the B.B.C., 1149kc. (light programme), while several others have been heard at fair level. Listen also particularly for the American Forces network, from Germany, 1249kc. and watch 950kc. for what has been a good signal from Breslau, Germany. This one was heard with Russian programmes last season, at times in parallel with Russian SW stations.

ASIATIC STATION LIST

The following summary of signals likely to be heard from Asia at present, may be considered a supplement to the more detailed accounts of these stations featured in recent issues.

Listen for the following, and other stations operating from the Asiatic continent from approx. 11-11.30 p.m. till around 2-3 a.m.

590kc. JOAK, Tokyo, Japan—a fairly strong signal at most locations with programmes in Japanese.

600kc. KZRC, Cebu City, Philippine Islands—many English announcements from this one.

620kc. "Radio Malaya", Singapore—English language, mainly.

629kc. VUP, Pashawar, India—often a fair signal with mainly Indian native programmes.

650kc. KZRH, Manila, P.I.—another good signal in most locations.

700kc. XPRA, Kuming, China—English at regular periods but otherwise Chinese programmes. Frequency has been changed from 690kc., thus it is clear of interference from 6WF around midnight. ZOH, Colombo, Ceylon, also on this channel, may be heard with weak signals around 1.15 a.m.

710kc. KZFM, Manila.

730kc. VUV, Hyderabad, India.

758kc. VUT, Trichinopoly, India—good signal.

800kc. KZPI, Manila, P.I.—American-type programmes.

810kc. VUC, Calcutta, India—seems to run more English programmes than most Indians.

825kc. HSPJ, Bangkok, Thailand—around midnight.

840kc. ZBW, Hong Kong, China—English used, weak signals.

870kc. WVTR, Tokyo, Japan—American armed forces programmes, good signal, closes 12.5 a.m. after short news.

886kc. VUD, Delhi, India—on till after 3 a.m.

920kc. "Voice of America", from Manila, P.I.—relays programme from U.S.A.; quite good signal.

950kc. KZMB, Manila, P.I.

1000kc. KZOK, Manila, P.I.—programmes in Filipino dialects.

NORTH AMERICAN STATIONS

It is possible at most locations to receive signals, sometimes at quite fair volume, from North America around midnight EST., when they either begin their morning transmission or continue their 24-hour service with the breakfast session. Stations running 24-hour schedules are generally not heard earlier at night as Australians on identical or adjacent channels prevent their being copied.

No doubt KNX, Los Angeles, 1070kc. (best after 6WB closes at 12.30 a.m.), KSL, Salt Lake City, Utah, 1160kc. and KFI, Los Angeles 640kc. will, this season, prove to be among the stronger stations heard. San Francisco stations KPO, 680kc., KGO, 810kc., KFRC, 610kc., KYA, 1260kc. should also make their appearance, plus such stations as: WOAI, San Antonio, Texas, 1200kc., KOA, Denver, Col. 850kc., KIRO, Seattle, 710kc., KECA, Los Angeles, 790kc. and KOB, Albuquerque, New Mexico, 770kc.

As is often the case, one must not take for granted the identity of a station heard on any of these frequencies, as it is quite possible that other Americans on the same channels may be heard, apart from those shown.

By
ROY HALLETT

1022kc. VUW, Lucknow, India.
1050kc. "Radio Saigon", Saigon, French Indo-China.

1086kc. VUL, Lahore, India.
1131kc. Patna, India.
1167kc. "Radio Pakistan"—possibly located at Decca, now in Pakistan territory; English
1231kc. VUB, Bombay, India—weak.
1250kc. KZRC, Cebu.
1280kc. "Radio Malaya", Penang, Malaya.
1355kc. Cuttack, India.
1420kc. VUM, Madras, India—weak.

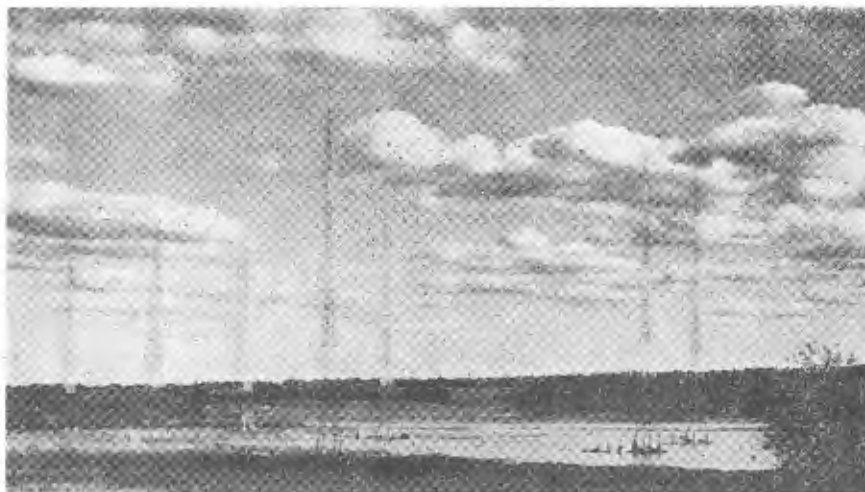

A seven mast aerial system used by one of the large American broadcast stations.

An attractive programme of Choral, Light Orchestral and Band music comprised the latter portion of the 45-minute inaugural programme broadcast on July 29th, to celebrate the opening of the new ABC outlet, 2NB Broken Hill. Speeches by the acting Mayor of Broken Hill, and Mr. J. J. Clark, MHR, followed that by Senator Cameron (Postmaster-General), in which he officially opened the station.

During his speech, Senator Cameron mentioned that there are radio receivers in something like 1,700,000 Australian homes. These are served by a total of 136 medium wave stations (84 National, 102 Commercial), plus 5 National short wave transmitters for the benefit of listeners in the Interior and Islands adjacent to Australia.

PACIFIC SIGNALS

Signals from several centres in the Pacific should be audible during coming weeks. Hawaiians are still good around 2 a.m. at the time of writing, particularly KPOA, 630kc. (which station has just verified our reception by airmail), KULA, 690kc., while KGU, 760kc. and KMVI, 550kc. are also quite fair. KGMB, 590kc. is good level with programmes in Japanese.

From New Zealand, improvements should be noticed as the result of the power increases, frequency changes, etc. to take place on September 1st. The old reliable, 2YA, 570kc. will remain unchanged and with its 60kw and clear channel, should be quite good at night.

UNUSUAL VERIFICATION

A member of the SW League of W.A. has received a verification of his reception of the Sydney Police Radio station VKG, 1700kc. This may indicate that reception reports sent to this station may prove of interest to the operators rather than a nuisance value, as is the case with some authorities operating private communications services.

It is often possible to hear on frequencies between 550 and 1600kc. harmonics of transmitters operating actually outside this band. Listeners in and around Redfern, for example, often hear VKG which operates from that suburb on about 785kc. news 1.30 a.m.



SHORTWAVE LISTENER



SEASONAL FREQUENCY CHANGES

It seems but weeks ago that we wrote of the changing conditions which herald the approach of winter, but now at the advent of spring we must discuss the change from the excellent winter conditions, to the still excellent conditions which are evident at this time of the year. It will, of course, be found that daylight reception on most bands will be affected, and that stations which we are hearing here in the forenoon, will gradually fade out during the warmer months.

However, reception at night will be much improved and many more stations will be heard at fine strength. The emphasis will be on the higher frequencies used for International Short Wave Broadcasting, and it is recommended that readers give their attention to the 13 and 16 metre bands in particular.

Schedules will be modified in the near future, but it is too early at this date to give details of the changes which will take place.

Readers can give us much assistance by providing us with details from their logs each month so that in these columns we can give an accurate cross section of the reception being experienced in all parts of the Commonwealth and in New Zealand. These logs should, of course, be received by us by the 1st of each month for certain inclusion in the earliest issue. Details of verifications received will also be very welcome, station addresses and pertinent facts about the various stations being of interest to many.

BY TED WHITING

READERS' REPORTS

Readers desirous of submitting Short Wave reports for inclusion in these notes, should ensure they reach our Short Wave Correspondent not later than the 1st of each month. Address all letters to:—Mr. Ted Whiting, 16 Loudon Street, Five Dock, N.S.W.

READERS' REPORTS

A fine set of notes is to hand from Mr. A. T. Cushen, Invercargill, N.Z. Very fine reception is experienced in New Zealand and for the benefit of our readers we will mention a few of the stations which will be heard in this country.

A new station, believed to be located in Puerto Rico has been heard on 4785kc. at the opening of transmission at 7 p.m. The "Star Spangled Banner" is played at this time, followed by announcements in Spanish, but as yet strength has been weak and identification has not been possible.

VY3RN, 4945kc. located at Barquisimeto, Venezuela may be heard opening at 8.30 p.m., level is quite good at times.

Radio Malaya, Singapore is heard on 4990 kc., 4895kc. and 4825kc. from 10.30 p.m. until close of transmission at 4 a.m. The transmission on 4895kc is by far the most satisfactory of them all at most locations.

The A.B.C. has recently opened a new transmitter, which has no doubt been heard by most readers. We refer to VLT5 operating on 7280kc. which is heard at fine level from 6.15 p.m. until close, and also to the daytime outlet which can be heard at intervals throughout the day until close at 6 p.m. on 9520kc. The call of this latter station is VLT7.

CR6RA, Radio Luanda, Angola has a further frequency of 8095kc. in operation. The schedule of this station is given as 5.30-7.00 a.m., with an additional transmission on Monday at 2-3.30 a.m.

The station located at Odurman, Anglo Egyptian Soudan which was heard some months ago, has moved to a new channel of 9670kc., but no schedule is available.

KZOK, Manila, Philippine Is. is no longer transmitting on a 24-hour schedule, but is now to be heard from 7.30 a.m. to 2.5 a.m. KZPI also maintains the schedule.

HVJ, Vatican City is heard at fair strength at 8.50 a.m., with closing announcements, on 11685kc.

KKPB, China operates on 12120kc. and is now on an extended schedule which means the station is on the air until 4.5 a.m. News in Chinese is read prior to closing.

TAQ, Ankara, Turkey on 15195kc. has replaced the TAP 9465kc. outlet in the Mailbag transmission on Monday at 6.30 a.m. Reception here is quite good at this time.

☆ ☆ ☆

A very welcome letter from Mr. R. Hallett, Enfield, N.S.W., who is well-known in Broadcast Band DX circles gives details of the Hong Kong stations.

ZBW3 sent our friend a verification for the transmission on 9520kc. which they state is in English from 12.30-2.30 p.m. Sunday. The station closes at 4 p.m. daily to reopen at 8 p.m. when the usual programme is heard until 1 a.m. Relays are taken from the local B.B.C. stations, ZBW and ZEK which carry transmissions in English and Chinese respectively. Regular features are

taken from the General Overseas service of the BBC also, notably the broadcasts of Test Cricket, etc.

Another verification was received from Radio Luxemburg. English transmissions are made from 11.30 p.m.-4 a.m. and 6.15-9 a.m. Monday, and from 2-2.45 a.m. and 7.30-9 a.m., weekdays. The transmitter has a power of 5 Kw and is heard on 15350kc. and on 6090kc. from 2.30-9 a.m.

Mr. Hallett also sends along a card from the "Flying Doctor Service" details of which will be of interest to many. The bases for this service are at Broken Hill, Cloncurry, Alice Springs, Kalgoorlie, Port Hedland, Wyndham.

8SK, Broken Hill, 2020kc., 4130kc., 6690kc. VJL, Cloncurry, 2020kc., 5110kc., 8630kc. 8US, Alice Springs, 1600kc., 5410kc., 8690kc. 8UB, Kalgoorlie, 1600kc., 5360kc., 8750kc. 8SC, Port Hedland, 1600kc., 4030kc., 6960kc. 8SI, Wyndham, 1600kc., 5300kc., 8830kc.

Transmissions are heard frequently from some of these stations when they are in contact with many of the outlying stations, so well-equipped with Pedal Transmitters. The range of these small transmitters is such that in the early morning especially, some of them are audible here.

☆ ☆ ☆

The customary excellent log from Miss Sanderson, Malvern, Vic. is to hand, and despite a bout of illness, many fine stations have been heard down in the southern State.

This reader has received a verification from HLKA, Seoul, Korea. The transmitter there is a 5 Kw Japanese transmitter, Antenna a Half Wave Doublet, and the station operates on 7935kc. from noon-3 p.m., 6.30-11 p.m., 7.30-9.30 a.m. The address of the station is Voice of Korea, 1 Chung Dong, Seoul, Korea.

Verifications have also been received recently from LRM Argentina, Rome for two frequencies, and an interesting verification for the Danish transmitter which was operating on 11800kc.

☆ ☆ ☆

Mr. J. B. Hargreaves, Sydney, gives details of several stations which will be of interest. This listener is one of the many who are working in a poor location, in the heart of the city, where with interference problems, the reception of weak signals is made increasingly difficult, but just the same the stations are heard and at good strength, too.

Radio Rabat, on 11940kc. was heard at 10 a.m. on a Sunday with a session of news in English, the signal was weak but identification was established nevertheless. This station normally is heard in French language transmissions.

A fine signal was heard from KGEA, 9390 kc., with the broadcast of a religious service till close, after the usual announcement at 10.30 p.m.

One which has our correspondent puzzled is heard by him on 11950kc. from some time before 10 p.m. until after 11 p.m. This station is a Spanish-speaking station and was heard with a fine musical programme on several nights. News in Spanish is also heard at 10.30 p.m. We believe that this station would be ZP5 located in Paraguay, but have no definite identification as yet. The station has been heard many times at this hour in the past, however.

LISTEN FOR THESE STATIONS

Signals are coming in well from Canada, as is evident by the following heard during the last month. CKCS, 15320kc. may be tuned at 12.30 p.m. in an instructional broadcast, followed by news in English.

CKNC, 17820kc. with news from the United Nations organisation at 1.30 p.m. CBLX, 15090kc. at 10 p.m. with news, etc., CHLS, 9610kc. at 7.15 p.m., CHOL, 11720kc. at 8.15 p.m., with another broadcast of U.N.O. news.

☆ ☆ ☆

Further outlets of the Singapore transmitters are heard on 6770kc. at 8.30 p.m., with news at 9 p.m., 9690kc. at 9 p.m., 11735 kc. and 15300kc., both heard at 8 p.m.

It is of interest to learn that the BBC are taking the Singapore transmitters over in the near future. The arrangement will be the same as prior to the war, and it is projected to construct at least one new high power transmitter which will carry an improved service and some relays from the BBC.

☆ ☆ ☆

KZPI, Manila, PI., 9500kc. is a good one at 9 p.m., and at around the same time it is easily possible to hear KZRC, 6140kc., KZRH, 9640kc. and KZOK, 9692kc., all at good strength. The "Voice of Manila" on 11890kc. is another heard very well at 7.15 p.m.

☆ ☆ ☆

Best signals from Japan are heard by tuning to JKA, 7285kc. at 7 p.m. and JVV3, 15235kc. at 7 p.m. also. A Western-type programme is heard with the dual news bulletins. WLKS from Tokio on 6105kc. is another good one.

☆ ☆ ☆

Radio Seac, Ceylon, is heard on three frequencies at exceptionally good levels. These are 15120kc., 17730kc. and 9520kc., all heard in the evening and which have been busily engaged recently carrying sporting broadcasts from England.

☆ ☆ ☆

Africa has been just as productive as the other continents in the matter of good signals, Brazzaville being a certainty in any location on 6020kc. at 8 a.m., 9440kc. at 3.30 p.m. and 11970kc. at 3.45 p.m. News is regularly read in English and French.

From across the River Congo, at Leopoldville, we hear OTC, 9767kc. at 9.45 a.m., with a similar service.

FOR COUNTRY READERS

The five valve all battery receiver to be featured in the October issue will have definite interest for all country listeners. Using the latest 1.4v. miniature valves, it includes a special economiser circuit ensuring minimum battery drain.

MAKE SURE OF YOUR COPY NOW!!

Norway's LKQ, 11735kc. at 4.15 p.m. Sunday, with a fine Church Service followed by the good musical programmes heard from the Norge stations.

☆ ☆ ☆

From Paris on 17770kc. at 2.15 p.m., news in French; on 9560kc. at 2 p.m., more news.

HER5, 11715kc. at 5 p.m. with English news is one of the best Swiss stations to be heard on any band, but fine signals are heard, nevertheless, from HEU6, 15315kc. at 12.45 p.m.; the usual news broadcasts are heard in addition to Swiss music, the recordings of which are of a very high standard.

Another Scandanavian is SBP, 11705kc. at 5.45 p.m. in English. The location is Stockholm.

An interesting station is "La Voz de Falange" on 7380kc. at 7.45 a.m. in Spanish, but is easily identified.

☆ ☆ ☆

There are very many stations in operation in China; many of them seem to defy all efforts at identification for months on end, but among those well-known to most readers and heard with regularity are XGOY, 15170kc. at 7 p.m., XMTA, 12217kc., XTPA, 11650kc., XHSR, 5880kc., XGOA, 9730kc., XGOE, 9860kc. and nearby Saigon on 6165 kc. They are all heard during the evening, signals peaking up by 7 p.m.

☆ ☆ ☆

It seems that the stations which interest most readers are those Latin American stations, and while we have experienced better seasons for these stations in past years, we think that conditions in general are on the improve for reception from this area, and in coming years we think that they will be better heard.

HCJB Quito, Ecuador is a good one on 15110kc. at 2.45 p.m., while a further outlet on 9555kc. is heard best at 2 p.m., also in a religious broadcast.

☆ ☆ ☆

Mexico is easily heard on most occasions; XEWW, 9500kc. being an outstanding station from this country. Sunday afternoon is a good time for this one, as on this day the programme is extended till 5 p.m.

XEBT, 9620kc. at 1.30 p.m. fair at most times and XEHH, 11880kc. and XERQ, 9610 kc. are both well received during the course of the afternoon. The programmes of all these stations is in Spanish, with good music and in some cases variety.

☆ ☆ ☆

Cuba is a comparatively small country, but it houses quite a large number of stations, Havana the capital having, we think from memory, some 32 B/c. stations. It is the short wave outlets we are interested in most, however, and from several centres in the country the following are heard: COCX, 9265kc., COKG, 8955kc., COBC, 9370kc., COCO, 9445kc., COCH, 9452kc. All are heard best on Sunday afternoon. Like most South

Americans the programme is extended on that day till at least 4 p.m., and in addition, most are heard quite well at 7 a.m. and better at 10 p.m.-midnight. Actually, most Cubans open at 9 p.m., the best at this time being COKG which at times gives an opening announcement in English.

☆ ☆ ☆

The only Panama station heard is HP5K on 6005kc. at 9.45 p.m., mostly under interference here.

Located at the other end of the Panama Canal at Colon is HOLA, 9505kc., the slogan of "Radio Atlantico" being easily recognised at 9.45 p.m.

☆ ☆ ☆

HI4T, Dominican Republic, 5970kc. at 9 p.m. with news in Spanish has the slogan "La Voz del Yuna". We believe this one verifies.

HI2T, also in Trujillo City is heard on 9727kc. in the afternoon and also weakly at night.

☆ ☆ ☆

From Argentina, LRY, 9455kc. at 9.45 p.m. is a good one, but is in quite a bad spot at times. LRM, 6180kc. a little earlier is well received and LRS2, 11990kc. at 11.45 a.m. may be heard with news and music from the Latin angle. All stations are located at Buenos Aires.

☆ ☆ ☆

CE622, Santiago, Chile, represents that country with a usually good signal on 6220 kc. at opening at 9.30 p.m., when English announcements are made. Verifications are received from this one quite frequently. The usual type of programme is Spanish in origin.

☆ ☆ ☆

Further transmissions are easily tuned from La Paz, Bolivia, CP2, 6110kc.; Sao Paulo, Brazil, ZYB8, 11765kc. and PRL8, 11720kc., the former at 8 a.m. and the latter at 7 p.m.

Uruguay is heard via CXA19 on 11830kc. carrying the world's news in Spanish and is a regular on this frequency at 8.15 a.m. This is possibly one of the best morning stations.

NEW ZEALAND READERS

Ensure you receive every copy of RADIO SCIENCE as soon as it is published by taking out a subscription. This can be made through our local agents, H. Barnes & Co., 4 Boulcott Terrace, Wellington, any branch of Gordon and Gotch Ltd., S.O.S. Radio Ltd., 283 Queen Street, Auckland, C.I., or if you prefer, by writing direct to our office, Box 5047, G.P.O. Sydney.

In each case the rates are the same: 12/- per annum, or 21/- for two years, post free to any address in the Dominion.

WORLD WIDE S.W. STATION LIST

For the benefit of those who have no access to a reliable station list we hope to include each month a list of stations by order of frequency and which, under reasonable conditions, are reliably received in Australia.

Call Sign	Location	Frequency	Schedule	Call Sign	Location	Frequency	Schedule
GSS	London	26550kc.	9-11 p.m.	WRUL	Boston	15350kc.	11.30 p.m.-12.15 a.m.
GSK	London	26100kc.	8-11.15 p.m.	Paris	France	15350kc.	Opens at 1.35 a.m.
GVT	London	21750kc.		Boston	WRUA	15350kc.	1-3 p.m.
KCBF	San Francisco	21740kc.	8 a.m.-2.30 p.m.	VUD	Delhi	15350kc.	Good in evening.
Paris	France	21740kc.		Athens	Greece	15350kc.	8.30-9.30 a.m.
WNRX	New York	21730kc.	Heard at 12.45 a.m. and 8 a.m.	Moscow	Russia	15340kc.	10 p.m., in English.
Singapore	Malaya	21720kc.	7-8.30 p.m.	San Francisco	KNBX	15330kc.	3.30-7 p.m.; 10 a.m.-3 p.m.
GVS	London	21710kc.	9-9.15 p.m.; 2-2.15 a.m.	KCBA	San Francisco	15330kc.	7 p.m.-12.30 a.m.
WLWK	Cincinnati	21690kc.	10 p.m.-5 a.m.	WGEO	Schneectady	15330kc.	1-7.45 p.m.
VLC10	Melbourne	21680kc.	5-5.45 p.m.	OQ2RC	Montreal	15320kc.	3-4.20 a.m.
GVR	London	21675kc.	3.30-6.15 a.m.	CKCS	Leopoldville	15325kc.	1-8 a.m.
WLWS	Cincinnati	21650kc.	10 a.m.-3 p.m.; 9.45 p.m.-7.30 a.m.	VLC4	Shepparton	15320kc.	6.55-9.45 p.m.; 5.45-6.45 p.m.
GRZ	London	21640kc.		VLH5	Melbourne	15320kc.	2.30-3.45 p.m.
KNBA	San Francisco	21630kc.	8.15-11.30 a.m.	OZH2	Copenhagen	15320kc.	11 p.m.-12.45 a.m.
Seac	Ceylon	21620kc.	Heard well in evening.	HEU6	Berne	15315kc.	11.30 a.m.-1.30 p.m.; 7.45-8.15 a.m.; 6.45-7.30 a.m.
KCBA	San Francisco	21610kc.	8 a.m.-2.30 p.m.	GSP	London	15310kc.	9 p.m.-12 a.m.; 3.30-3.45 a.m.
WNRX	New York	21610kc.	Good in forenoon.	HER6	Berne	15305kc.	1-2.20 a.m.
WGEA	Schneectady	21590kc.	Well heard at 10 p.m.	Singapore	Malaya	15300kc.	3.30-4.30 p.m.; 7 a.m.-2.35 p.m.
WCDA	New York	21570kc.	9 a.m.-1 p.m.	VUD11	Delhi	15290kc.	4.30-4.45 p.m.; 5-7 p.m.
WCRC	New York	21570kc.	Good signals at 2.30 a.m.	WRUL	Boston	15290kc.	
Moscow	Russia	21560kc.	News read at 10.45 p.m.	KWID	San Francisco	15290kc.	1.15-4.45 p.m.
GST	London	21550kc.	4-6 p.m.; 12.15-3.15 a.m.; 4-5.45 a.m.	KWIX	San Francisco	15290kc.	8.30-11.15 a.m.
VLB5	Shepparton	21540kc.	Frequent schedules.	WNRE	New York	15280kc.	Opens at 8.30 p.m.
GSJ	London	21530kc.	8-10.15 p.m.	Moscow	Russia	15280kc.	Good signal at 10 p.m.
VUD8	Delhi	21510kc.	1.15-5.30 p.m.	KCBF	San Francisco	15270kc.	4-7.45 a.m.
WOOW	Cincinnati	21500kc.		Moscow	Russia	15270kc.	Good at midnight.
KGEI	San Francisco	21490kc.	11 a.m.-4 p.m.	WCRC	New York	15270kc.	10 a.m.-3 p.m.
PCJ	Hilversum	21480kc.	Evenings.	GSJ	London	15260kc.	3-6 p.m.; 1.15-3.30 a.m.; 4.30-5.15 a.m.; 6.15-7 a.m.
GSH	London	21470kc.	8-10.15 p.m.; 12.15-2.15 a.m.	WLWK	Cincinnati	15250kc.	10 a.m.-3 p.m.; 5.30-7.30 a.m.
KNBA	San Francisco	21470kc.	10 a.m.-3 p.m.	KRHO	Honolulu	15250kc.	11.30 a.m.-2 p.m.; 7 p.m.-1 a.m.
VPO8	Barbadoes	19055kc.	Heard on occasions at 7 a.m.	KNBX	San Francisco	15250kc.	3.30-6.45 p.m.
WNBI	New York	18160kc.	Good level at 10.30 p.m.	WBCS	Boston	15250kc.	8 a.m.-1 p.m.
GRP	London	18130kc.		Paris	France	15240kc.	Opens at 10 p.m.
GVO	London	18080kc.		VLG6	Melbourne	15240kc.	4-4.45 p.m.
GRQ	London	18025kc.	1.30-6.15 a.m.; 4-5.45 p.m.	KNBA	San Francisco	15240kc.	4-6.45 a.m.
KGEX	San Francisco	17880kc.	10 a.m.-3 p.m.	JVW3	Tokio	15235kc.	8.50 a.m.-6.15 p.m.
Moscow	Russia	17860kc.	English transmission, 11 p.m.	KCBA	San Francisco	15230kc.	News at 10 a.m.
KCBF	San Francisco	17850kc.	1.15-6.30 p.m.	VLG6	Melbourne	15230kc.	8.10-9.15 a.m.
KNBI	San Francisco	17850kc.	8.30-11.15 a.m.	VLH5	Melbourne	15230kc.	9.30-6.15 a.m.
Paris	France	17850kc.	English, 8 a.m.; heard midnight.	KNBX	San Francisco	15230kc.	1.15-6.45 p.m.
Brussels	Belgium	17845kc.	5-5.30 p.m.; 9-10.30 p.m.; 2-3 a.m.; 5-7.30 a.m.	Seac	Ceylon	15230kc.	
Moscow	Russia	17840kc.	English, 11 p.m.	Moscow	Russia	15230kc.	
VLC9	Shepparton	17840kc.	1-2 p.m.; 2.30-3.45 p.m.	Tokio	15225kc.	8.50 a.m.-6.15 p.m.	
Radio Eiraan	Ireland	17840kc.	Heard at 4.30 a.m.	JVW	15220kc.	9 p.m.-12.30 a.m.; Sunday, 1.30-3 a.m.; 7-8.30 p.m.	
WCXB	New York	17830kc.	10 p.m.-midnight.	PCJ	Hilversum	15220kc.	
VUD19	Delhi	17830kc.	Reported at 7 a.m.	OLR4	Prague	15220kc.	10-11 a.m.
LLN	Oslo	17825kc.	1.15-5.30 p.m.	WBOS	Boston	15210kc.	11 a.m.-1 p.m.
CKNC	Sackville	17820kc.	10 p.m.-6 a.m., Sunday. Opens 11 p.m. other days.	KGEI	San Francisco	15210kc.	
GSV	London	17810kc.	8 p.m.-5.15 a.m.; 4-8 p.m.	WLWS1	Cincinnati	15200kc.	8 a.m.-4 p.m.; 1.45-5.30 a.m.
WLWO	Cincinnati	17800kc.	9.45 p.m.-7.30 a.m.	VLA6	Melbourne	15200kc.	5-6.15 p.m.; 6.30 p.m.-1 a.m.; Noon-2 p.m.
WLWK	Cincinnati	17800kc.	Good at 11 a.m.	WOOC	New York	15200kc.	Opens at 8.30 p.m.
KRHO	Honolulu	17800kc.	8.30-11.15 a.m.	VLC11	Melbourne	15200kc.	6-7.55 a.m.; 8.10-9.15 a.m.; 4-4.50 p.m.
GSG	London	17790kc.	4-5.45 p.m.; 11.30 p.m.-1.30 a.m.; 9-10.15 p.m.	VLG11	Melbourne	15200kc.	2.30-3.45 p.m.; 12-2 p.m.
HER7	Berne	17784kc.	1-2.30 a.m.	TAQ	Ankara	15195kc.	Closes 9.30 p.m.; Mail Bag, 6.30 a.m.
WNBI	New York	17780kc.	10 a.m.-3 p.m.	OIX4	Lahti	15190kc.	News, 10.35 p.m.
KGEX	San Francisco	17780kc.	3.30-6.45 p.m.	VUD5	Delhi	15190kc.	11.40 a.m.-1 p.m.; 1.15-4.15 p.m.; 5.15-6.15 p.m.; 6.45-11.30 p.m.
WNRX	New York	17780kc.	Good at 10.30 p.m.	CKCX	Winnipeg	15190kc.	11 p.m.-1.45 a.m.; 9.20 a.m.-noon.
PCH2	Holland	17775kc.	1.30-3 a.m.; 5-8.30 p.m.	GSO	London	15180kc.	3-8 p.m.; 8-5.15 a.m.; 5.45-7 a.m.
KROJ	San Francisco	17770kc.	4-5.45 a.m.; 8-10.45 a.m.	XGOY	Chungking	15170kc.	8.30 p.m. to Australia.
KNBA	San Francisco	17770kc.	11.15 a.m.-3 p.m.	TGWA	Guatemala	15170kc.	Closes, 9 a.m.
Moscow	Russia	17770kc.	Good at 10.45 p.m.	Moscow	Russia	15170kc.	News, 10.45 p.m.
Paris	France	17770kc.	Opens at 10 p.m.	LLM	Oslo	15170kc.	10.50 p.m. and 1.45 a.m.
XGRS	Nanking	17765kc.	12.15 p.m., fair.	QUD2AA	Leopoldville	15170kc.	6.30-8.45 p.m.
VUD3	Delhi	17760kc.	5-7 p.m.; 11.40 p.m.-2 a.m.	VUD7	Delhi	15160kc.	12.50-1 p.m.; 1.15-5.30 p.m.; 6.15-7.30 p.m.; 8 p.m.-12.45 a.m.
KWID	San Francisco	17760kc.	10 a.m.-3 p.m.	XEWV	Mexico	15160kc.	Not heard of late.
WRUW	Boston	17750kc.	10.30 p.m.-12.15 a.m.; 9.30-11.15 a.m.	VLB11	Melbourne	15160kc.	7.45-9.15 a.m.
WRUS	Boston	17750kc.		SBT	Stockholm	15155kc.	Heard till 1.30 a.m.
Moscow	Russia	17750kc.	English, 10.45 p.m.	WNBI	New York	15150kc.	10.30 a.m.-2 p.m.
OTC5	Leopoldville	17745kc.	4-8 a.m.	KCBA	San Francisco	15150kc.	1.15-6.45 p.m.
GVQ	London	17750kc.	4-7 p.m.; 11.30 p.m.-12 a.m.; 8-9 a.m.	YDC	Java	15145kc.	8.30 p.m.-1 a.m.
Seac	Ceylon	17730kc.		GSF	London	15140kc.	2-6 p.m.; 10.30 p.m.-3.15 a.m.
GRA	London	17715kc.	6-8 p.m.	WLWL	Cincinnati	15130kc.	12.15-1.15 p.m.
GVP	London	17700kc.	9 p.m.-12 a.m.	VUD11	Delhi	15130kc.	10.15-10.45 p.m.
FZI	Brazzaville	17530kc.	Opens at 7 p.m.	KCBR	San Francisco	15130kc.	10 a.m.-3 p.m.; 7 p.m.-1 a.m.
HVJ	Vatican City	17440kc.		WOOC	Cincinnati	15130kc.	9.45 p.m.-7.30 a.m.
CR6RL	Luanda	15900kc.		Seac	Ceylon	15120kc.	Heard from 8 p.m.
FZI	Brazzaville	15595kc.	News at 10.15 p.m.	GWG	London	15110kc.	8 p.m.-1.15 a.m.; 8-10 a.m.
GRD	London	15450kc.	4-5.45 p.m.	HCJB	Quito	15110kc.	
Moscow	Russia	15450kc.	11.20 p.m.	Moscow	Russia	15110kc.	English, 11 p.m.
GWE	London	15435kc.	2.30-4.45 p.m.	EQB	Teheran	15100kc.	English, 10.15-10.30 p.m.
VPO2	Barbadoes	15425kc.		HVJ	Vatican City	15095kc.	Good at 11.45 p.m.
PZC	Paramaribo	15410kc.	Closes at 12.30 p.m.	CBXL	Montreal	15090kc.	10 p.m.-3 a.m.
Moscow	Russia	15410kc.	10.15-11.15 p.m.	Moscow	Germany	15090kc.	
FGA	Dakar	15390kc.	7.30 a.m., in French.	ETA	Addis Ababa	15074kc.	Heard 1 a.m.; news in English.
Moscow	Russia	15390kc.	English, 10.15-11.15 p.m.	GWG	London	15070kc.	2-6 p.m.; 8 a.m.-1.30 p.m.
Moscow	Russia	15360kc.	Good at 3.45 p.m.	WVW	Washington	15000kc.	Continuous operation.

U.H.F. TECHNIQUES

(Continued from page 36.)

at high angles of incidence, this effect reduces the low angle maxima to about 1.5 times the free space field strength.

Polarisation.

The polarisation or orientation of the electric vector affects the reflecting properties of a wave. The above discussion has assumed a phase change of 180 deg. at reflection and 100 per cent. reflection; this is the case for horizontal polarisation. With vertical polarisation, however, 100 per cent. reflection occurs only at grazing incidence, and reflection falls off rapidly with angle of incidence. The phase change at reflection also varies with angle of incidence.

Changing polarisation is thus a means of gap-filling; it can be achieved with a rotating feed on the aerial.

Diffraction.

Diffraction, another phenomenon familiar in optics, occurs with U.H.F. propagation.

It has already been mentioned in connection with broadside arrays. However, another instance of diffraction is around obstacles in the propagation path, such as buildings or ridges in the terrain. Just as in optical work, objects do not cast sharp shadows, indicating some effective "bending" round corners, the field from a U.H.F. aerial does not cut off sharply behind an obstacle.

The lower the frequency, the more marked is this effect, so that at 1½ metres it is not essential to have a clear line of sight between transmitter and receiver for a communication system to operate.

A diffracting edge causes a reduction in field to half its free space value in the direction of the edge, with a gradual tapering-off behind the obstacle. To the other side of the obstacle the field strength oscillates between maxima and minima, as indicated in Fig. 11. The first maximum is 1.17 times the free space field.

A diffracting edge close to a U.H.F. aerial can cause serious distortion of the coverage pattern. However, for some

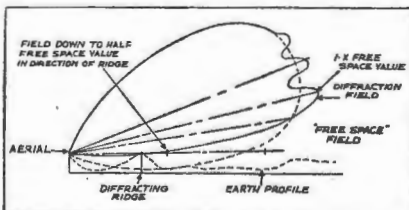

Effect of a nearby ridge on the field pattern of a U.H.F. aerial. Diffraction causes a reduction at low angles with a damped "wriggle" at higher angles. Reflection has been neglected. Fig. 11.

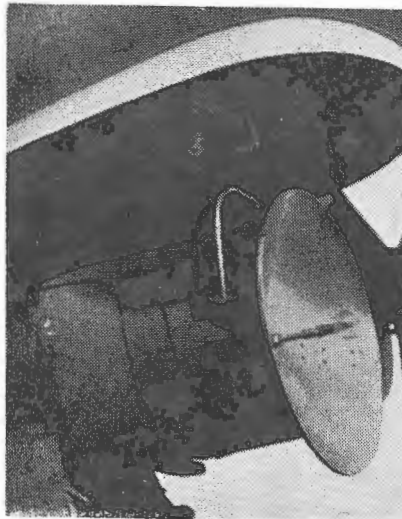

A 10 cm. spinner mounted on an aircraft. This is a dipole fed paraboloid. The whole spinner is normally covered by a blister or "radome", in this case, tear drop shaped.

micro-wave radars screens are purposely placed near the aerial to eliminate or reduce permanent echo clutter.

Effect of Rain.

Rain has little effect on the propagation of U.H.F. waves except in the short micro-wave region. Since extended, heavy rain rarely occurs; attenuation by rain is unimportant at wave-lengths above 3 cm. At 1cm., however, serious absorption takes place in raindrops and moisture to such an extent as to render this wave-length useless for radar.

From the point of view of radar echoes, considerable scattering occurs from raindrops even at 25 cm., so that radar is a useful tool for the meteorologist. Airways control authorities can benefit also.

Search radars employing 25 cm. wave-length can detect rain which might be troublesome to aircraft, the latter being still visible on the P.P.I. presentation amongst the rain echoes.

REFERENCES.

A Text Book of Radar, R.P.L. Staff.
Principles of Radar, M.I.T. Radar School Staff.

QUIZ ANSWERS

- | | |
|--------|--------|
| 1.—c. | 2.—b. |
| 3.—d. | 4.—d. |
| 5.—c. | 6.—e. |
| 7.—c. | 8.—d. |
| 9.—a. | 10.—c. |
| 11.—c. | 12.—b. |
| 13.—b. | 14.—d. |

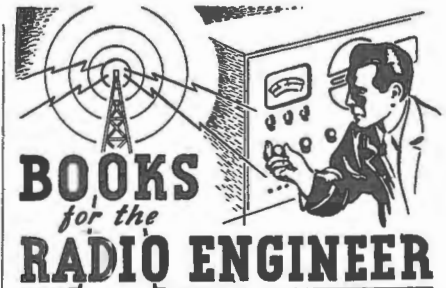

BECK — VELOCITY-MODULATED TUBES. By A. H. W. Beck, B.Sc. (Eng.), A.M.I.E.E. This book gives a general introduction to velocity-modulation tubes and their mode of operation, in such a form as to be readily intelligible to anyone with a reasonably adequate knowledge of pre-1939 radio technique. 180 pages, illustrated. 1948. 23/6 (post 5d.)

BRANS — RADIO VALVE VADE MECUM. 1948. By P. H. Brans. This present edition has now been entirely revised, and is presented in a form in which Designers, Development Engineers and Students will have no difficulty in locating the type of valve (irrespective of make) most suitable for the functions and conditions they have in mind. 7th edition. 270 pages. 25/6 (post 10d.)

KNIGHT — FUNDAMENTALS OF RADAR. By Stephen A. Knight, F.R.S.A. 128 pages, 97 figures. 1947. 15/- (post 6d.)

PIERCE — LORAN. Long Range Navigation. Edited by J. A. Pierce, Research Fellow, Cruft Laboratory, Harvard University, A. A. McKenzie and R. H. Woodward. This book gives a complete account of the design and use of the long-range pulse navigation system known as Loran, both in its original form and as skywave-synchronized Loran. 1st edition. 476 pages, illustrated. 1948. 46/6 (post 10d.)

SMITH — ANTENNA MANUAL. By Woodrow Smith, Radio and Radar Engineer, U.S. Navy. A comprehensive compilation of antenna, transmission line, and propagation data of vital aspects of radio broadcasting and communication. 1st edition. 306 pages, illustrated. 1948. 29/- (post 6d.)

VERY HIGH-FREQUENCY TECHNIQUES. 2 volumes. Compiled by the Staff of the Radio Research Laboratory, Harvard University. A summary of the methods, theories and circuits used by the Radio Research Laboratory that will be of general interest to radio engineers and physicists. 1st edition. 1057 pages, diagrams. 1947. £5/8/6 (post 1/5)

ANGUS & ROBERTSON LTD.

89 CASTLEREAGH ST., SYDNEY

PICKUP RESONANCE EFFECTS

(Continued from page 38.)

serted in its hole and fastened in place. The needle plus the remainder of the magnetic pickup device now function as a complete unit in reproducing the audio variations that are cut into the record.

A diagrammatic view of a typical electromagnetic pickup is illustrated in Fig. 3. The operation of the pickup is such that it converts mechanical energy into electrical energy in this way. As the needle moves from side to side (a lateral movement) in the process of following the groove walls, the armature in turn is forced to vibrate in the magnetic field created by the permanent magnet. The coil wound around the armature moves in accordance with the movement of the armature which in turn varies in agreement with the needle swing. Under the circumstances that the armature follows the needle swings, the flux cutting the armature winding varies in accordance with these needle swings. This sets up a voltage across the terminals of the armature winding, which is connected to an a.f. amplifying system. Since the armature is compelled to vibrate at an audio frequency rate, the voltage at the terminals of the armature coil is an audio frequency voltage which, after amplification, may be delivered to a loud-speaker. The resulting sound is a reproduction of the original sound which was recorded on the groove of the record.

The complete mass of the system consists of all mechanical parts in this pickup, such as the permanent magnet, the armature, the coil, and numerous other parts not necessarily shown in Fig. 3. This mass in conjunction with whatever parts offer compliance to the system are so arranged that at some frequency within the audio range the system will break into mechanical oscillations, and the armature will vibrate vigorously. In other words, the total mass of the system, being electrically equivalent to an inductor and the compliance of the system being electrically equivalent to a capacitor, has a resonant frequency with the audio range.

In an electrical circuit, if the amplitude of the oscillations is desired to be subdued, a resistance would be inserted. This is equivalent to inserting some damping factor in the pickup arm. In order to damp out the strong vibrations caused by mechanical resonance, damping pads are inserted on either side of the armature as seen in Fig. 3. These pads absorb the strong vibrations of the armature and thus reduce the effect of mechanical resonance.

The pickup assembly shown in Fig. 3

only includes those parts necessary to describe its basic operation. In reality it is much more intricate. The method of damping as applied to the typical problem just discussed is only one of the many ways damping is accomplished.

Since the mechanical arrangement of pickups is quite intricate, it is advisable that the serviceman not try to introduce any damping effect. Instead, he should contact the manufacturer of the particular pickup on which he is working.

Courtesy "Successful Servicing"

HIGH FIDELITY AMPLIFIER

(Continued from page 29.)

Figure 4 illustrates a frequency-dividing network designed for a cross-over frequency of 500 cycles per second, and speakers having voice coil impedances of 3.7 ohms and 12.5 ohms respectively. The low-note speaker should be of the 12-in. type, while the high-note speaker may have 6-in. cone. The values of inductance and capacity shown in this circuit are suitable only for the cross-over frequency and speaker impedances quoted. If it is desired to use speakers other than those mentioned, the calculation of the necessary filter constants can be made quite easily with the aid of a frequency-dividing network design chart previously* published in *Radio Science*.

Anyone desirous of using a dividing network of the type illustrated in Figure 4 is strongly advised to have the chokes made up by one of theseveral firms in Sydney, specialising in this type of work. The actual cost would be very small and one would be assured of accuracy. The condensers, incidentally, may be of the electrolytic type. While paper condensers are theoretically correct here, it was found that in practice the electrolytics proved quite satisfactory.

Finally, adequate reproduction of low frequencies demands efficient baffling of the low frequency speaker. For preference this should be of the acoustical labyrinth or vented enclosure type. For those interested, dimensions of a suitable vented enclosure loudspeaker baffle were published in the A.W. Valve Co. technical publication *Radiotronics*, for September-October. The particular number of the issue was 127.

*Speaker Network Design Data, *Radio Science*, February, 1948.

POWER-LINE CARRIER COMMUNICATIONS

(Continued from page 12.)

telephone systems, such as busy signal, a revertive or ring-back signal, local inter-communication, executive right-of-way or preferential service, and a disconnect signal.

Any one of 10 separate extensions at as many different terminals can be chosen by the selector unit. It provides for selection of one line by another at the same station, independent of the carrier channel.

Alternating current at 120 or 240 volts generally has been used for carrier-communication equipment. At locations remote from generating sources, automatically starting motor-generator sets or converters have been used to provide power for the carrier set during emergencies or upon loss of normal d-c supply. This practice still is followed on long-haul channels using relatively high-powered equipment. Equipment capable of operating directly from 125- or 250-volt station batteries has made it possible to provide uninterrupted communication more economically, and without maintenance problems associated with rotating equipment and accompanying control devices.

The Single-Sideband System

Although the carrier-communication assemblies described use the conventional amplitude-modulation system, they can be supplied with the single-sideband system of modulation for channels with high noise level or high attenuation. The single-sideband system offers an advantage in reduced band width, making it possible to operate more channels in a given band of frequencies.

Power-line carrier-communication equipment has progressed rapidly since first developed and offered commercially in 1923. To-day it is firmly established as the prime means of communication for the remote and often isolated areas through which many power-transmission lines are carried.

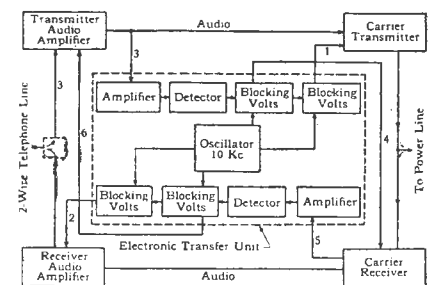

Fig. 11.—Functional diagram of electronic transfer used in automatic simplex communication assembly.

The Mail Bag

L.S.L. (Five Dock, N.S.W.) forwards an interesting letter and offers some suggestions for articles he would like to see published in RADIO SCIENCE.

A.—Thanks for the letter and suggestions, L.S.L. We are pleased to hear you enjoy reading the "Electronics in Industry" articles. These will continue to be published at fairly regular intervals. The idea of the maths. articles has already been suggested by several readers, and this will be given some consideration. In the meantime, however, it is hoped to include a special series dealing with "Electricity and Magnetism" which should prove invaluable to the serious reader, and form a sound basis for some future technical articles we have in mind. The F-M form of transmission does have several advantages over the A-M method, mainly by virtue of the much wider band width used, and the receiver's ability to reject noise impulses. Admittedly, A-M would give the similar frequency response, if used with a wide band pass, but this is impracticable on the present broadcast band, where each station is limited to a bandwidth of 10kc.

I. McL. (Mont Park, Vic.) finds RADIO SCIENCE very interesting, especially the articles dealing with UHF Techniques and Frequency Modulation.

A.—Thanks for the letter, I.McL., and the earlier issues requested have been forwarded along to you. No doubt they will have reached you by this. We note your interest in the UHF and F-M articles, and you may be assured this type of technical information will appear regularly in these pages. We would be pleased to hear your success with the TRF receiver when it is completed, together with any other details you may care to send along. It is hoped that you will soon be over your bout of illness and discharged from hospital.

G.A.K. (Barmera, S.A.) in asking for some back issues writes:—"Allow me to offer you sincere congratulations for your magazine which I think is indeed excellent and I am specially interested in your 'Broadcast Band' notes."

A.—Your interesting letter is appreciated, G.A.K., and we note your remark about the slip in the Quiz. You certainly seem to be obtaining excellent results from the small battery receiver as your list of stations is most impressive. We might mention our 'Broadcast Notes' correspondent, Mr. Hallett, is always pleased to receive listening logs, and if you find time may care to write direct to him at 36 Baker St., Enfield, N.S.W.

R.H.G. (Burrwood, N.S.W.) requires details to modify the Dual Wave Seven to a 5 valve receiver incorporating an RF stage.

A.—As mentioned in the previous reply, it would be possible to amend the circuit to suit your purpose, but at the moment we are

TECHNICAL QUERY SERVICE

Readers are invited to send in any technical problems either dealing with our circuits or of a general nature, and an earnest endeavour will be made to assist you through the medium of these columns. For convenience, keep all letters to the point, with questions set out in a logical order, as space is rather limited.

All technical enquiries will be dealt with in strict rotation and the replies will be published in the first available issue of the magazine. Address all letters to RADIO SCIENCE, Box 5047, G.P.O. SYDNEY, and mark the envelope "Mailbag".

not in a position to supply a complete circuit for these changes. It will be necessary to eliminate the 6SQ7 and 6SJ7 stages completely, and then replace the second 6SK7 with a duo diode pentode type, such as the EBF-35, 6G8G or similar type. The pentode section will then become the i-f amplifier, with the two diodes being used for AVC and detection in the normal manner. The output from the diode load will then be taken to the grid of the 6V6-GT. The lack of audio gain will be particularly noticeable and the results may not be as good as you may anticipate. The only other alternative would be to use the five valve circuit in this issue, adding an RF stage, and once again eliminating the audio stage, to keep within the stipulated five valves. However, this latter circuit may suit you in its present form as the results obtained with it are really excellent. If we can be of further assistance, please do not hesitate to write in again.

K.N.D. (C/-, P.O. Monteagle, N.S.W.) writes in for a copy of RADIO SCIENCE and considers that the magazine sets a very high technical standard.

A.—Your letter is appreciated, and the issue requested has been forwarded. We are pleased to hear you are building up the Miniminor Portable described in the first issue, and think you will be more than pleased with the results. We would be interested of hearing your success with this receiver when it is completed.

G.L. (Balwyn, Vic.) enjoys reading RADIO SCIENCE and would like to see more articles dealing with simple test equipment and small receivers.

A.—Unfortunately, in the limited space available, it is only possible to devote a certain amount of space in each issue to any particular subject. However, you may be assured constructional articles dealing with the topics mentioned will be featured from time to time, as we also realise that the many of our readers. We appreciate your simpler type of equipment is popular with remarks concerning the magazine.

M.F.E. (P.O. Matakawau, N.Z.) in forwarding a subscription mentions he is particularly interested in F-M, and asks some questions regarding the Sydney station.

A.—Thanks for the subscription and appreciative remarks concerning the journal, M.F.E. The August issue has already been forwarded and might mention that copies of the earlier issues are still available should you require these. At the present time, the experimental F-M stations in Sydney, Melbourne and Adelaide are operating on approx. 92 mc., and their transmission in general is taken from the A.B.C. National programme. The August issue of RADIO SCIENCE contained details of a complete 6 valve F-M tuner unit, which should provide interesting reading for you. This unit will cover the 88-108 mc. F-M band.

K.V.M. (West Brunswick, Vic.) requests details of an amplifier suitable for outdoor P.A. work, having about 15 watts output, using 6V6G's.

A.—Sorry, K.V.M., but to date we have not described an amplifier of this type using 6V6G's in the output. However, the large amplifier described in this issue, using 807's should be admirable for the purpose you mention. This will give an output of 20 watts using a 10,000 ohm transformer, or if this is reduced to 6600 ohms, 25 watts will be realised. This has facilities for including a microphone pre-amplifier, and the efficient mixer circuit will enable either microphone or pickup to be used as desired.

AIRPORT APPROACH CONTROL

(Continued from page 7.)

The aerial can also be rotated in the vertical plane, but in the present application is fixed so that the main beam of radiation is at an angle of elevation of 4 degrees from the horizontal.

Associated with the antenna is a system of gears and *Selsyn* motors, which transmit the movement of the antenna to the sweep coils of the Plan Position Indicator. This system will be discussed more fully when the latter unit is described.

Plan Position Indicator.

The details of the indicator will be discussed in the next (final) part of this series of articles, where we should be considering that part of the equipment which is installed in the Control Tower, and in particular the display system used. A general view of the P.P.I. unit is given in Fig. 9.



Audio Equipment

FOR BROADCASTING OR
RECORDING STUDIOS

PICK-UP

TYPE E52211



- Takes standard needles.
- Non - critical electro - magnetic system.
- Permanently adjusted spring-loaded bearings.
- Easy adjustment of needle weight.
- Good frequency response.
- Accurate tracking.
- Standard output impedance, 200 ohms.
- Attractive appearance — fine black crackle and satin finish chrome.
- Australian made — replacement parts available.
- Matches A.W.A. type 1R6938 Equaliser for bass compensation.

AMALGAMATED WIRELESS (AUSTRALASIA) LTD.

AUSTRALIA'S NATIONAL WIRELESS ORGANISATION
47 York St., Sydney

167 Queen St., Melbourne

RED  LINE

PROFESSIONAL EQUIPMENT for the AMATEUR

Featuring Uniformity in Design and Construction.

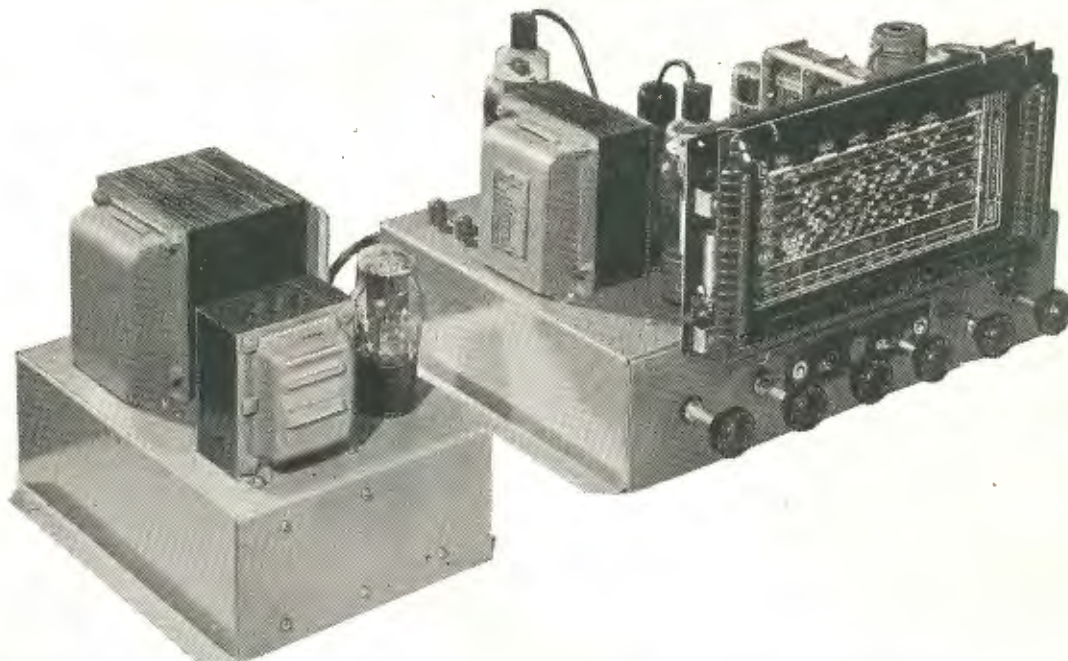

- Power Transformers
- High Tension Plate Transformers
- Low Tension Filament Supplies*
- Output Transformers
- Class B Driver Transformers
- Multi Impedance Modulation Transformers
- Heavy Duty Power Supplies
- Swinging and Smoothing Chokes
- Wide Range Audio Equipment
- Frequency Dividing Networks

*Insulated for High Voltage if required.

SPECIAL EQUIPMENT

We are specialists in the design of transformers and chokes to individual requirements, and it is practically certain that you will not pose a problem of this nature that our very wide experience and manufacturing facilities cannot solve.

Unlike most manufacturers in this field, we operate our own tool room, press shop and laboratory and this close integration of our internal organisation has been of particular benefit to manufacturers using our products.

RED LINE EQUIPMENT PTY. LTD.

Incorporating SWALES & SWANN

Workshops: Cent. 4773
2 Coates Lane, Melbourne

City Office: MU6895 (3 lines)
157 Elizabeth St., Melbourne



Available from
Leading Wholesalers

A GUARANTEE

OF DEPENDABILITY