

RADIO SCIENCE

Vol. 1.—No. 7.

Registered at the G.P.O., Sydney, for transmission by post as a periodical.

AUGUST, 1948

● ADD AN F-M TUNER
TO YOUR RECEIVER

● RADAR-AIRPORT
APPROACH CONTROL

● ELECTRON OSCILLO-
SCOPE-MICROSCOPE

● RECEIVER TUNED
CIRCUITS

● U.H.F. TECHNIQUES-
WAVE GUIDES

PRICE

1/-



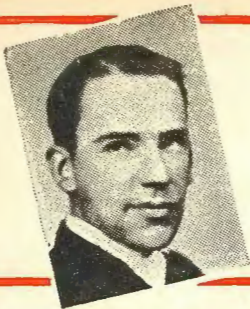

VALVES AND THEIR APPLICATIONS

By M. G. SCROGGIE, B.Sc., M.I.E.E. (Eng.)

No. 3: MULLARD HEPTODE FREQUENCY CHANGER 1R5

THIS is a miniature all-glass single-ended heptode with a filament consumption one twelfth that of a pen-torch bulb. An obvious role for it is in portable receivers, especially of the "personal" calibre.

In this country the triode-hexode is so popular that not everybody may be sure about how to use the heptode, or pentagrid, particularly as there are several different kinds. So here are a few notes on the 1R5.

The prescribed range of H.T. voltage is 45 to 90, but g_2+g_4 (used as the oscillator anode) must be limited to $67\frac{1}{2}$, by a dropping resistor if necessary.

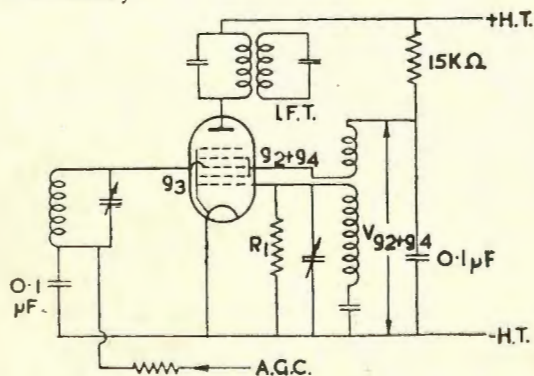

This skeleton circuit diagram is merely to show how the valve should be connected; the details of tuning arrangements can follow conventional lines. An alternative scheme, for making the whole mutual conductance of the valve effective in the oscillator, is to take the +H.T. lead from the I.F. transformer via the oscillator reaction coil instead of direct. Any voltage-dropping resistor must be inserted on the g_2+g_4 side of the reaction coil and shunted by the by-pass capacitor. It is then not available for sharing with the screen of the I.F. valve.

Normally, however, the oscillator section is quite capable of providing sufficient amplitude without help from the I.F. anode. Such help, too, is liable to be varied by A.G.C. bias on g_3 .

The amplitude of oscillation is not at all critical, and there is little to be gained by striving earnestly to keep it at optimum all the time; it is generally more important to economise in H.T. current. The amplitude is measured by a micro-ammeter in series with R_1 . Although $200\mu A$ is recommended, the effective optimum, with $V_{g_2+g_4}=45$ or so, is nearer $100\mu A$, and there is not much loss of signal even at $50\mu A$. Fortunately the optimum increases with $V_{g_2+g_4}$. The less oscillator voltage on g_2+g_4 the better; the reaction coil should be comparatively small.

A.G.C. may be applied to the 1R5; the grid base is roughly one fifth of $V_{g_2+g_4}$. It is important that the g_3 -to-cathode impedance at oscillator frequency should be low, otherwise the action of g_3 may be upset by oscillator voltage from g_2+g_4 . It is true that it can be neutralized out by a few pF from g_1 to g_3 , but there is no need for this complication if the previous condition is fulfilled.



This is the third of a series written by M. G. Scroggie, B.Sc., M.I.E.E., the well-known English Consulting Radio Engineer. Reprints for schools and technical colleges may be obtained free of charge from the address below. Technical Data Sheets on the 1R5 and other valves are also available.

MULLARD-AUSTRALIA
PTY. LIMITED

Head office: 35-43 Clarence St., Sydney

TELEVISION in Australia

The recent recommendation of the special Cabinet sub-committee that, despite cost, television services should be introduced into Australia without delay is indeed welcome news to both technicians and the general public. Apart from its value as a source of entertainment, television will also play an important role in any future defence plans of this country.

Commercial black and white television has been operating in both England and America for some years past, and technically it has proved most successful in all areas served by a transmitter. As most of the technical problems associated with such broadcasts have now been solved, and with the wealth of experience readily obtainable from their overseas associates, it should not be difficult for local manufacturers to make first-class equipment available to the Australian public.

Regarding colour television, this is more or less still in the laboratory stage, and it appears that there will be many years of research ahead before this becomes a commercial possibility. Because of this, it is generally conceded that the future of television in this country can be best ensured by adopting techniques already well-known and proven.

In this way it will be possible at least to make black and white television readily available to the majority of the people in the near future. After this, colour television will be a natural development and will quickly fall into its place in the radio field—much in the same manner as technicolour films have found their place with the black and white counterparts.

From the reports it would appear that some £400,000 will be spent on television equipment, covering the cost of supplying and installing six transmitters and 500 receivers in the six capital cities. It is understood that tenders will shortly be called for the carrying out of this work, which is to be completed within two years.

According to one well-known manufacturer, a home television receiver could be marketed within twelve months after the Federal Government had prescribed the technical operating standards of the proposed system. The price would be in the vicinity of £100—a not unreasonable figure when one takes into account the enormous amount of research necessary before a production model is made, as well as the prospective entertainment value of the receiver. Providing the price range can be kept within reason and comparable to that of the present better-class radio equipment, the manufacturers will be assured of a ready-buying market.

It is understood that the A.B.C. will provide the initial television programmes, but it is to be hoped that commercial interests will be given an opportunity of entering this new field of electronics, thus providing the listening as well as "seeing" public with the best possible entertainment.

In This Issue

With increased interest being shown in peacetime radar uses, the first of the series "Airport Approach Control"—a new Australian development, should prove most informative to all readers.

The main constructional article this month centres around a six valve F-M tuner. Specially designed to cover the 88-108mc. band, this tuner is capable of excellent results when used with a good audio system, and consequently should appeal to all technicians interested in this new form of broadcasting.

SENSATIONAL SCOOP!

Brand new test equipment—made by one of Australia's leading manufacturers—now offered at practically

HALF PRICE

● CATHODE RAY OSCILLOSCOPE

A high-class instrument—designed for laboratory—production work—radio servicing, etc.—inbuilt amplifiers with continuous variable gain control on both horizontal and vertical plates—linear time base, having frequency range, from 35 to 40,000 cps—adjustable in nine steps—with switching for coarse control—and a continuous variable control for fine adjustment—operates on 220/260v. AC 50/60 cycles—uses (1) 902 (2) 6J7, (2) 5Y3, (1) 884—finished in black—crackle finish steel case—with carrying handle—metal hood and graduated scale for E.R. tube included—12" x 9 1/2" x 7 3/4"—weighs 20lb. Originally priced £37/10/-. Plus tax.

£29/6/8

"HURRY"—"OUR PRICE"
Brand new. Not ex-Disposals. Fully guaranteed. (Pamphlets forwarded on request.) (Freight Extra.)

The 'NEW POST-WAR CRYSTAL SET'. First release

A midget receiver, uses no batteries—costs nothing to run—ideal for young and old—beautiful plastic cabinet, in choice of three colours, pastel pink, lettuce green and amber—special Hi-gain litz wire coils—dustproof glass enclosed crystal detector—set comes ready to operate with a pair of Brown's Hi-impedance lightweight phones. A real winner, £3/13/6. Post and pack extra. 50ft. aerial wire. 3/6 extra.

KITS!

ALL WAVE BATTERY TWO
—complete kit includes all parts. IT4, 3S4. Btt's etc., 'phone extra.
(Freight extra) .. £6/19/6

"MINIVOX" 3 VALVE A.C. KIT

A midget mains kit, uses 6SJ7, 6V6, 6X5. Complete Kit includes Midget Pow.-Trans, Chassis, Valves, Speaker, Cabinet, etc £9/2/6
(Freight Extra).

"MINIMINOR" 4 VALVE PERSONAL KIT.

A 4-valve Midget Portable. B/cast Super-Het. Uses IT4, 1S5, 1R5, 3S4, 3in. Rola, Cad-plated Chassis. Complete Kit includes all parts, plus beautiful shoulder strap carrying Cabinet £12/19/6
(Freight Extra).

"MINIMINOR" 4 VALVE A.C. MIDGET MANTEL KIT.

Kit includes EK32, EBF35, 6V6, 6X5, 3in. Rola Midget P./Trans, choke and all parts, plus attractive Cabinet. (Available in Colours) £13/17/6
(Freight Extra)

"PERSONAL PORTABLE" "SPECIAL"

Another "Lucky" purchase enables us to offer you this exceptional bargain. But hurry, as stocks will not last. This "Special" is a manufacturer's discontinued line. A Five Valve, Personal Portable, Foundation Kit, Custom-made, Cadmium-plated Chassis, All Coils, Tuning Condenser, IF's, Special Vernier Dial, Switch Pot, Knobs, and all Hardware. Complete Kit, less Valves and case, assembled ready to wire. Original Price, £24/17/6.

OUR PRICE 142/-
Beautiful Coloured Leather Cases for the above. Shoulder strap. Built in Aerial, 42/-, (Freight Extra).

"FREE TECHNICAL SERVICE" HI-FIDELITY 807 P/P AMPLIFIER

A custom-built unit. Uses all high class components. (1) 6SJ7 pre-amplifier, (2) 6SN7 (2), 807 (1), 5U4G—Red Line Transformers and Chokes. A unit for the discriminating Hi-Fidelity Lover. Complete unit, wired, tested, less Speaker £32/12/7
(Freight Extra)

"FIRST RELEASE" F.N. MIDGET PORTABLE AMPLIFIER

Size only 9in. x 6in. x 5in. Weight 12lb. Full 7 1/2 watt output. Uses 807's—two inputs. Grey or Maroon Crackle Finish Cabinet with Chrome Carrying Handle. Complete unit, wired, tested, etc. Speaker extra. £18/7/6
(Freight Extra)

KIT BUILDERS

We will quote you for any kit that you require. Write and forward details kit required. Should you desire, we will for a small additional charge, custom-build, wire, and check your kit for you. Radio Kits, Amplifiers, Public Address, Intercommunication systems, Communication Receivers, built, modified or repaired.

"TOOLS"

Box Skt. Wrenches, 1-8" to 1" (6) 5/8
Set D/ended Spanners, 1-8" to 3" (7) 2/10
4" Crescent Shifting Spanners 7/10
Electricians' Combination Pliers 6/2
12" Steel Rules (American) 3/2
5" Side Cutters (English) 6/6
6 1/2" Side Cutters 7/2
7 1/2" Multigrips 7/6
10" Tin Snips 9/1

(Postage Extra)
We carry all types, if not LISTED HERE, write for quote

TUBES.
Thousands of Tubes, if not listed here, write us for Price.

"SPECIALS"
Type 27 6/6
Type 1E7 7/-
5BP1 CRT 37/6
(Post extra)
1A3 19/9
1A7 22/10
1G4 19/3
1G6 20/9
1H4 17/10
1J6 18/10
1L4 20/3
1P5 22/4
1N5 22/4
1Q5 22/10
1S5 20/6
1T4 20/6
2X2 12/9
3S4 20/6
3V4 20/6
5U4 19/3
5V4 19/10
5Y3 14/7
9001 21/-
9002 21/-
9003 21/-
9004 5/-
9006 5/-
VR150 21/-
5BP1 37/6
6AC7 21/-
6AK5 26/-
6AG5 26/-
6AG7 27/-
6AU6 21/10
6B6 18/4
6BE6 21/10
6BA6 21/10
6C4 26/-
6C5 19/3
6F6 17/10
6F8 21/3
CG6 20/9
6H6 19/3
6J5 16/9
6J6 26/-
6K7 20/4
6J7 18/4
6K8 19/10
6L6 21/-
6L7 21/6
6N7 21/7
6R7 20/9
6Q7 19/9
6SA7 19/4
6SH7 19/6
6SJ7 18/4
6SK7 18/4
6SN7 23/6
6SS7 18/9
6SQ7 18/4
6V6 18/10
6X5 20/10
7C7 17/3
12SF7 20/-
12SK7 19/3
12BQ7 18/4
14C5 17/3
14C7 17/3
14S7 17/3
14W7 17/3
80 14/7
807 16/6
813 115/-

Please Add Postage.

BUILD YOUR OWN SIGNAL-TRACER

AND SAVE

Kit comes assembled—can be wired in 30 minutes.

By self-construction you become fully conversant with the circuit and working, etc.

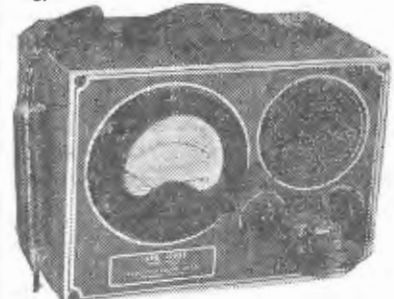

- Comparative intensity of the signal is seen directly on the meter—quality of the signal is heard on the Speaker.
- Simple to operate—uses only one connecting cable, no tuning controls.
- HIGHLY SENSITIVE—uses an improved vacuum-tube volt meter circuit.
- Built-in Hi-gain Amplifier-Alnico Speaker, large, easy to read 4 1/2" meter.
- Tube and capacity resistor net work are built into probe.
- Completely Portable, measures 5 1/2" x 6 1/2" x 9, weighs 8lb.
- Uses standard easy to get Batteries, which are readily accessible to replace. The Kit complete, with all parts, circuit, etc., ready to wire (freight extra), £10/17/6.
- The above kit custom built, fully wired, tested, etc., is also available at (freight extra) £11/17/6.

INSTRUMENT PROBES

Highly polished, metal probes, with polytip and base, ideal for Vtvm's S/Tracers, S/Generators, etc — takes button base type Valves 8/6
(Post extra).

As above, but fitted with tube, resistor-capacity network, cable, etc. 37/6
(Post 6d).

INSTRUMENT CASES

9 x 6 x 5 1/2 new steel grey crackle finish for Vtvm's Oscillators, s/generators, etc., 22/6. (Freight extra).

Midget FN Reinartz Coil 6/6
Midget FN 150/150V 30MA P/Trans. 20/7
Midget Filter Chokes .. 8/9
Midget 8MF'D Electrocs .. 3/9
Midget Single Gang Cond's .. 12/6
Midget Two Gang Cond's .. 19/3
Midget Three Gang Cond's .. 25/3
Midget Trimmers .. 1/1
Midget Off-On Switches .. 2/9
Midget DP47 Dials with Knobs .. 7/11
Minivox Chassis .. 6/6
Minimino Port Chassis .. 14/6
Minimino Mantel Chassis .. 11/6
Minivox Cabinet in Colours .. 23/6
Minimino Mantel Cabinet .. 25/6
Minimino Port. Cabinet in Colours 28/10
Volume Controls, any size .. 3/9
.5 and 1m. Switch Pots .. 7/6
6.3V Pilot Lamps—U.S.A. .. 1/3
1/2 Watt Insulated Resistors .. 9d.
1 Watt Insulated Resistors .. 1/-
3W W/W Resistors .. 1/9
Amphenol Valve Sockets, 4, 5, 6, 7, 8 p .. 1/-
Rubber Grommets .. 2d.
Resin Core Solder (Roll) .. 1/-
Hook-up Wire, any colour 2d. yard
New 2000 Ohm Phones .. 27/6

F.N.RADIO,

ELECTRONIC & TELEVISION CO.,

265 Military Rd., Cremorne, N.S.W. 'Phone: XM7063

"Same Day Mail Order Service"
OPEN SATURDAY

Electronic Oscillograph-Time Microscope

By OTTO ACKERMAN and EDWARD BECK
Westinghouse Electric Coy.

In the study of ultra-high-speed transients, and similar electrical phenomena, that take place in a realm beyond man's ken, a picture is worth many reams of involved computations that are susceptible to errors. The electronic oscillograph provides the portrait from life that tells the history of transients, their rise and fall and—most important—the speed of their passing.

Events sometimes run their course in electric circuits with a swiftness that is far beyond our physical powers of perception. Who can conceive of or describe a millionth of a second? In that time, a point on the earth's equator moves only about 0.02 inch, although the earth's surface is moving at a speed of about 16 miles per minute; yet that time is sufficient for a voltage to rise from zero to a million or more and start events that shut down a transmission line and disrupt important manufacturing processes. Twenty years ago, the lack of an instrument capable of measuring these brief intervals and recording what goes on during them, seriously impeded progress in electrical-equipment development because the exact nature and effect of electric transients was

a closed book. This book was opened by the cathode-ray tube, which years of experience and refinement of design have developed into the present cathode-ray or electronic oscillograph.

The microscope and the electronic oscillograph have much in common. Both make possible the exploration of regions in which the unaided senses are helpless. Based on the early work of Braun and DuFour, and later of Norinder, the oscillograph—like the microscope—has become a widely-used instrument. With it, engineers peer into the realm of micro-time. By the knowledge so acquired, they improve their ability of power-transmission and distribution systems and build better transformers, circuit breakers, lightning arresters, and airplane-ignition

systems. Without it, airplanes would be less powerful and the present high quality of electric service could be accomplished only with the addition of much material and equipment.

An Industrialised Research Instrument

The electronic oscillograph originally was not intended as a commercial device, but as a research tool in the laboratories, where it was needed for exploration of hitherto uncharted fields. The main incentives for its development were: the inability of power-frequency tests to explain the behaviour of insulation of equipment in service; the indispensability of surge testing in the development of lightning arresters; the necessity for learning the characteristics of lightning voltages and currents; and the importance of the voltage-recovery process in circuit-interrupting devices. It is also a great time-saver, for it can be used to analyse circuits, avoiding laborious calculations. It provides answers free from the errors that may enter into the assumptions upon which calculations of this nature are based.

The electric oscillograph (shown in Fig. 1), like the magnetic one, writes on a photographic film. But unlike the moving galvanometer element and mirror system, the writing agent, is not a light beam but a stream of electrons, from which the device takes its name. This feature gives the oscillograph the ability to respond and write quickly, because the electrons are almost weightless and inertia free. The oscillograph, therefore, reacts immediately to electric or magnetic fields and follows faithfully the fastest-known changes.

The production of this nimble electronic pencil requires a source of continuous high voltage applied between two electrodes in a vacuum. The source of the electron stream is a cold cathode (Fig. 2), from which electrons are drawn by the high voltage. They rush towards the anode through which there is a small



★
Fig. 1. — The cathode-ray tube and all necessary components of the electronic oscillograph are entirely enclosed in this metal cubicle. All controls are on the front of the oscillograph.
★

hole. Some of the electrons pass through this hole, which may be regarded as the source of the electron pencil. As a result of the velocity acquired in the high-voltage field, the electrons that pass through the hole in the anode speed on through the deflecting chamber to the photographic film. They tend to disperse, but by means of magnetic fields they can be focussed, as a lens focusses light, to impinge on the film in a fine point. This apparatus for forming the electronic scribe is entirely distinct from any of the measuring circuits and devices, and plays no effective part in the measuring except to provide the recording agent.

To obtain records of maximum clarity, the film is in the evacuated chamber, so that the electron pencil strikes the film directly. Though it is not light, the beam produces a photographic effect somewhat like an X-ray. The electron beam may move across the film with a speed of some 600 miles a second, yet its path is marked by a sharp, distinct trace.

Speed Requirements Determine Recording Choice

Either of two arrangements of film can be used, depending upon the resolving power in micro-seconds desired. Where great detail is not required, or where it is desired to record an appreciable interval of time, such as one cycle of 60-cycle voltage, a film fixed on a rotating drum is used. It can be driven at various speeds up to 7,800 r.p.m. A single rotation of the drum gives a record 18 inches long that, at 7,000 r.p.m., represents a time of 9,000 micro-seconds, or 500 micro-seconds per inch.

For higher recording speeds, i.e., transients lasting only a few micro-seconds or less, the film cannot be moved fast enough. Instead, a fixed film is used, and the electron beam is given a motion across the film at right angles to the deflection produced by the quantity measured. This is accomplished by passing the beam between a pair of timing plates on its way

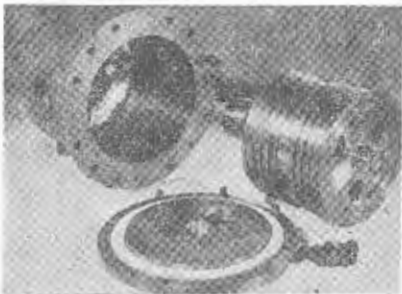

Fig. 3.—These components show the relative simplicity of the little known molecular pump. The electric motor is built in, and drives the grooved cylinder at a speed of nearly 3600 r.p.m.

ELEMENTS OF THE ELECTRONIC OSCILLOGRAPH

For recording high-speed transients on stationary film, the transfer switch (shown at top left of the cathode-ray tube) is closed in the down position connecting the several deflecting electrodes to the timing system shown at the left.

A d-c voltage of three kv is applied to the outer spheres of the double gap, whose spacings are set so that they are just above breakdown at this steady-state condition. The centre sphere is normally at ground potential. Any disturbance in the circuit under test, such as the beginning of the surge to be measured, is transmitted to the centre sphere through resistance or capacitance coupling.

The voltage to be measured is applied at A-A. The fluorescent screen is used to view the resultant trace as it is made. When this screen is turned sideways the photographic film is uncovered.

For phenomena of relatively long duration, film on a rotating drum is used. The movement of the rotating film provides the timing function so the transfer switch is thrown to the left, disconnecting the exposure button, shown below the tube, the electrical timing system. Pressing causes the film to be exposed to the electron beam. This exposure can last for several revolutions; or, if desired, a phototube control limits the exposure to one revolution of the drum.

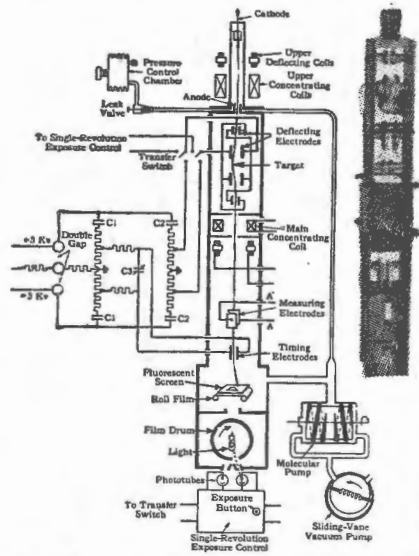

to the film. A uniformly varying timing voltage is applied to these plates, whose field reacts on the stream of electrons and sweeps it across the film. The voltage is obtained by charging a capacitor through a resistance, and the speed of the timing sweep can be adjusted by changing the constants of this capacitor circuit.

In addition to the film, the oscillograph is equipped with a fluorescent screen that serves the same purpose as a ground-glass plate or finder in a camera. The screen can be manipulated from outside the oscillograph, so that visual observation can be made through a window.

Electrostatic Fields Provide Time Component

In addition to a writing agent and a means of producing a time co-ordinate, the oscillograph must have a means of deflecting the pencil at right angles to the timing axis, actuated by the quantity to be measured. Because the electron beam is a current, it can be deflected either by magnetic or electric fields. Magnetic fields drain energy from the circuit under test and introduces appreciable currents in the oscillograph. The electric electrostatic fields used in the electronic oscillograph avoid these undesirable features.

Another pair of deflecting plates is arranged at right angles to the timing plates. When voltage is impressed on these plates, the beam, in passing between them, is deflected in proportion to the magnitude of the voltage. The electron beam is thus controlled in one axis by the voltage representing time, and in an axis normal to the time axis by the voltage representing the transient.

This completes the electronic camera except for one thing, the shutter. If the beam were allowed to impinge on the film while the oscillograph is waiting for application of the voltage to be measured, the film would fog. Because of the high speed required, a mechanical shutter is out of the question. As in the case of the timing sweep, movement of the beam itself is used to initiate the exposure. As shown in Fig. 2, an obstruction, or target, is placed directly in the normal path of the beam. Thus, when the circuits are at rest, the film is completely shielded. Another series of deflecting plates, above and below the target, are so arranged that when they are properly energised, the beam is bent around the target and strikes the film.

To operate the oscillograph, the film is loaded, the vacuum and the electron beam are established. When the transient occurs, the beam is bent around the target by means of suitable circuits, the timing circuit is energised, and the measuring plates deflect the beam as the timing sweep carries it across the film. Thus the record is made. All this requires split-micro-second timing.

Certain accessories are required. In the electronic oscillograph all of these necessary adjuncts and the measuring chamber are incorporated in a self-contained cubicle. These accessories include a two-stage vacuum pumping system, a high-voltage rectifier and its controls, the timing-sweep circuit, a high-frequency oscillator for calibrating the timing sweep, a circuit for calibrating the voltage scale, the shutter circuit and means for actuating it in synchronism with the measured voltage, a potentiometer to adjust the voltage scale within convenient limits, magnetic focussing circuits, and the rotat-

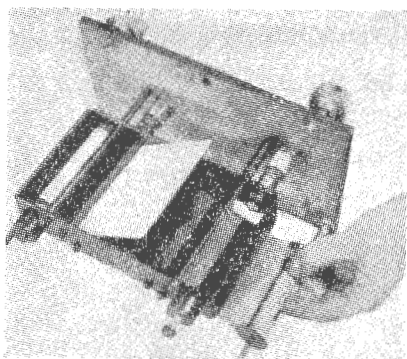

Fig. 4.—This panel assembly that slides from the front of the oscillograph contains the fluorescent screen, here shown as a white plate with cross sections in black, and the roll film holder. The film is loaded here much as in an ordinary camera. Film position is shown by an indicator on the front of the panel.

ing film-drum drive. To place the oscillograph in service requires only that connection be made to the proper power outlets and to the test circuit.

A High-Voltage Cold-Cathode Instrument

The source of the electron stream—the cathode—is an aluminium plug a quarter of an inch in diameter, set into a stainless-steel holder whose edge projects beyond the face of the cathode, thereby

helping shape the electric field. It is supported on a one-inch glass tube that acts as the envelope for the vacuum, and an electrical insulator. The glass tube also performs another function. On its inside wall charges precipitate, which also play an important part in concentrating the beam to assure that a large portion of the electrons pass through the anode hole. A smaller tube would throttle the beam; a wider one would have a diminished focussing effect. The anode is a silver disc in which there is a small aperture. It is fused to a copper plug set in the heavy upper end of the metal deflecting chamber, and is thus adequately cooled by conduction.

A cold cathode and 50,000 volts are used to produce the electron beam in this instrument. A lower cathode voltage would reduce the size and cost of the equipment, as is indicated by the widespread use of sealed-off hot-cathode tubes for related applications. However, experience proves that the high-voltage method used in the electronic oscillograph produces the most precise and easily controlled records, least sensitive to laboratory operating conditions. There are several reasons for this. In impulse laboratories, for example, where millions of volts rise and collapse rapidly, and where surges of many thousands of amperes are released, conductors that are solidly grounded in the usual sense pick

up voltages and may be shocked into oscillation. Magnetic fields permeate space that appears to be well shielded. Spurious voltages may thus appear at the measuring plates and at the cathode that would affect the generation and deflection of the beam. One of the important accomplishments of the electronic oscillograph in impulse testing is the reduction of these outside influences to insignificant values by proper circuit layout shielding and voltage selection. The higher the cathode and deflecting plate voltages, the less the influence of these disturbing factors and the simpler the problems of the technician.

The speed of the electrons in the writing beam, which is a function of the accelerating potential between cathode and anode, is the dominating factor in the calibration of the instrument and in its freedom from disturbances. Just as the course of a high-velocity bullet is less subject to the variable influences of wind and atmosphere, so the high-speed beam is less affected by stray fields. Furthermore, it is desirable to maintain a high ratio between the cathode-to-anode voltage and the voltage on the measuring plates. The reasons for this are as follows: The tangent of the angle to which the beam is deflected by the voltage on the measuring plates is proportional to the measured voltage only if the electron speed is fixed. The electron speed is deter-

Marconi School of Wireless

CONDUCTED BY AMALGAMATED WIRELESS (AUSTRALASIA) LTD.

For 34 years the leading Radio College in Australia

Courses are available for:

RADAR OPERATORS AND TECHNICIANS, RADIO OPERATORS AND TECHNICIANS, SERVICE MECHANICS, AMATEURS, MORSE TELEGRAPHY

Call, 'phone or write for full particulars

MARCONI SCHOOL OF WIRELESS

47 York Street
SYDNEY

Tel. B0522

163 Queen Street
MELBOURNE

Tel. MU9161

POST THIS NOW!

MARCONI SCHOOL OF WIRELESS
Box 2516, G.P.O., Sydney.

Please send without obligation full details of your courses.

Name.....

Address.....

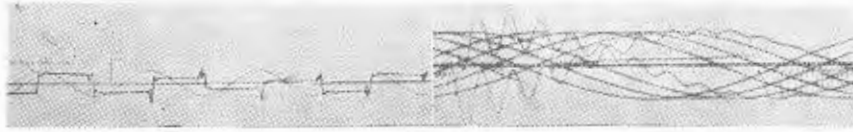

Fig. 5.—An internal-combustion engine ignition-timing oscillogram made on the rotating film drum using the single-revolution exposure mechanism. Actually, this oscillogram shows three exposures, one each to record the ignition trace, timing wave, and zero-reference line.

mined not only by the cathode-to-anode potential, but also by any other electron voltage field in the path of the beam.

The voltages to be measured, which are applied to the deflecting plates, are bound to set up such field components in the path of the electron beam and thereby have an accelerating or retarding effect on the flow of electrons similar to that of a grid in other vacuum tubes. In a device where constant electron speed is essential, it is obvious that the more this effect can be minimised, the better.

The Vacuum and its Control

The two-stage pumping system, a sliding-vane vacuum pump and a molecular pump (Fig. 3), is capable of evacuating the oscillograph to a pressure lower than is needed for its operation. The establishment of the cathode beam requires a low but definite gas pressure, held within narrow limits, in the discharge tube where it originates. In fact, the beam intensity is controlled by this pressure. In order to attain this required pressure, starting from a hard vacuum, a tiny trickle of air is admitted into the oscillograph tube through a delicate leak valve (Fig. 2). The air could be taken directly from the surrounding atmosphere. However, control

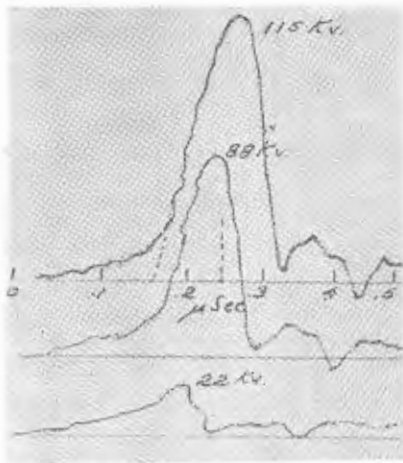

Fig. 7.—An oscillographic record of the puncture of a solid insulation sheet. The first trace shows an outside flashover of the insulation barrier at 115 kv. accomplished within 0.3 microsecond. In the second exposure the barrier punctured at 88 kv. The insulation is pierced at 22 kv. in the next discharge.

Fig. 6.—This record shows details of two half cycles of arcing, the subsequent recovery voltage, and sustained power voltage at the terminals of an arc-interrupting device. Traces of consecutive revolutions can be distinguished even though they are superimposed upon each other.

of the ambient atmospheric pressure affords an excellent means for fine regulation of the air flow through the valve. For this reason, air is fed to the valve from a bellows chamber, whose volume and pressure can be controlled manually to within plus or minus 20 per cent. of atmospheric pressure.

During closely-scheduled testing, the oscillograph body may be opened to the atmosphere several times an hour for re-loading with film. The pumping system can evacuate the instrument to operating pressure within about seven minutes, even though in the chamber there are porous and gas-absorbing materials such as coils, the stator winding of the film-driving motor if used, and the film itself. The water vapour taken up by these materials would interfere with the evacuation, hence provision is made to introduce phosphorus pentoxide, a most effective dehydrator, into the oscillograph below the film holder.

Synchronisation Is Exact

The matter of synchronising the film exposure and the beginning of the time sweep with the phenomenon to be measured is of prime importance. The basic circuits performing this function are shown in Fig. 2. With stationary film (Fig. 4), time sweeps of from one-half to 20,000 micro-seconds are had by the proper selection of resistors and capacitors in the sweep control circuit. For this purpose a number of different resistance and capacity branches are built into the instrument and can be selected by sets of switches. A time axis about three inches in length is thus provided.

If more extended records are desired, the rotating film drum is used. By this, the film is moved under the electron beam, and the timing circuits used with stationary film are inactive. The shutter scheme, described previously, is still used, however, and serves to expose the film for any desired length of time. It can be combined with a photo-electric circuit to start the exposure and cut it off at the end of the film. This is a feature, invented as a result of the inconvenience occasioned by the difficulty in unscrambling intricate traces superimposed on each other because the recording continued for several revolutions of the drum. It pro-

duces a film that is easily read, having but the single trace with no confusing overlapping. Certain traces, simpler in form, are carried through several revolutions of the drum to secure the record of a relatively long-time operation, or a series of operations.

Typical Uses of the Electronic Oscillograph

The various methods of recording transients described above have been developed to meet the requirements of the manifold applications of the electronic oscillograph. Among the principal fields in which the electronic oscillograph is uniquely valuable are the following:—

- (a) The recording of electrical disturbances caused by natural lightning.
- (b) The determination of break-down characteristics and co-ordination of the insulation of all kinds of electric-power equipment.
- (c) The development and testing of lightning protective devices.
- (d) The development and testing of circuit-interrupting devices, principally through the recording of the speed with which such apparatus recovers its insulating properties while opening a circuit.
- (e) Study of all types of electric-spark phenomena such as found in combustion-engine ignition systems.
- (f) The study of voltage surges, traveling waves, and voltage distribution in apparatus of various kinds or combinations of apparatus, such as a complete station equipment.

Examination of the various types of records obtained with the electronic oscillograph illustrates the character of the information obtained through it. Figure 5, for instance, shows the magneto voltage of a combustion engine. Details in the sharply-peaked spark voltages are of interest to the ignition specialist, and even a casual observation discloses that the various cycles are not very uniform

(Continued on page 46.)

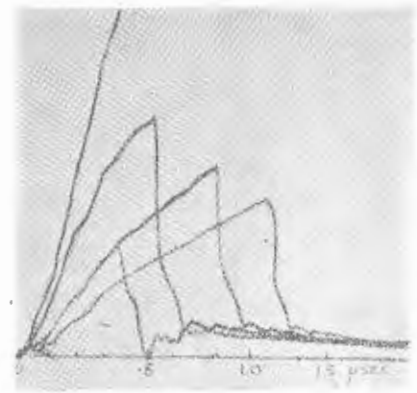
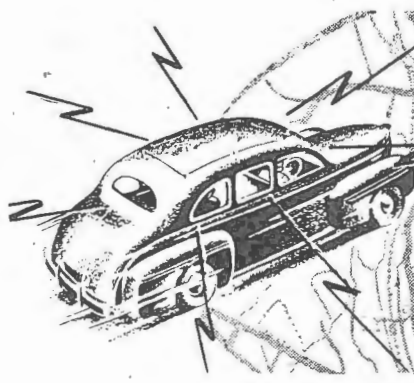

Fig. 8.—Measuring time to spark over on a protective device using four voltage rates rise.



Mobile Radiotelephone Communications

By A. G. BROWN

Engineering Sales Dept., Amalgamated Wireless (A/sia.) Ltd.

In this second article the author discusses various V.H.F. aerials as well as giving details of F-M Mobile equipment.

5.—V.H.F. AERIALS AND TRANSMISSION LINES

Considerable scope in the design of aerial systems is allowed by the small dimensions of the radiating elements; the wave-lengths of the two bands now being licensed in Australia being approximately 4 metres and 2 metres, the lengths of practical quarter-wave elements are approximately 30 inches and 15 inches, respectively. Following American practice, vertical polarisation is employed for mobile communications, being presumably dictated by the need for omnidirectional operation of the vehicle installation.

In planning communication systems, it quickly becomes apparent that each must be given individual consideration, and the radiation pattern or characteristics of the base station aerial should be chosen so

as to give the best coverage. To help in this choice it is desirable that the following general classifications of types should be available:—

- (a) Omni-directional general purpose.
- (b) Directional, general purpose.
- (c) Omni-directional, high gain.
- (d) Broad band.

The first class (a) may be illustrated by the design shown in Fig. 5. This is an R.C.A. ground-plane type 199, in which the vertical active element is an approximate quarter-wave in length, as are also the four horizontal arms constituting the ground plane. The matching stub, which must be provided in order to correctly terminate the transmission line at the aerial, is housed within the base casting.

By the addition of a reflecting element mounted upon a horizontal extension arm, and by suitable readjustment of the active element and matching stub, an aerial of class (b) may be produced as shown in Fig. 6. The polar diagram of radiation in the horizontal plane is heart-shaped, and the power gain in the forward direction is approximately two. Such an aerial may be usefully employed when the base station is located towards one edge of its service area.

The use of a station antenna system which has a gain factor as compared to a standard dipole, is a very desirable practice, since the initial cost is the only cost, yet the effect is that the carrier power of all the transmitters in the network is effectively multiplied by the power gain factor; this follows from the fact that the same aerial is used for both transmission and reception. Some care is needed in the choice of site for such an aerial, because received noise will be multiplied by the same gain factor as the desired signal.

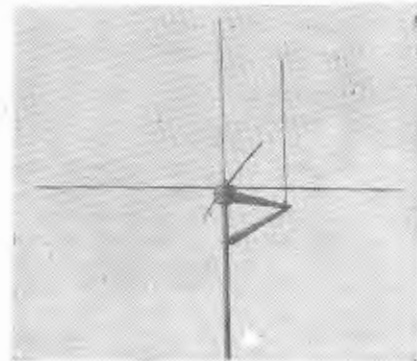

Fig. 6.—Directional Ground-plane aerial for fixed station applications—an extension of the type shown in fig. 5.

Although there are a multitude of high-gain antenna arrays which have been described for the purpose of F.M. broadcasting, they are all horizontally polarised; remarkably little attention has been given to the problem of equivalent omnidirectional designs for vertical polarisation. In Fig. 7 a scale model of a locally-designed high-gain vertical array—coming within class (c)—is illustrated.

The circular structure at the base is an earthed ground plane, and is surmounted by the driven sleeve element. Assembled above the latter are two subsidiary sleeve elements which reinforce radiation in the horizontal plane.

The final classification of broad band aerial structures may be further divided into two sub-classes: (i) aerials which exhibit reasonably constant impedance and radiation characteristics over a relatively narrow band-width, and (ii) aerials which give similar behaviour over a relatively wide band-width. The former may be

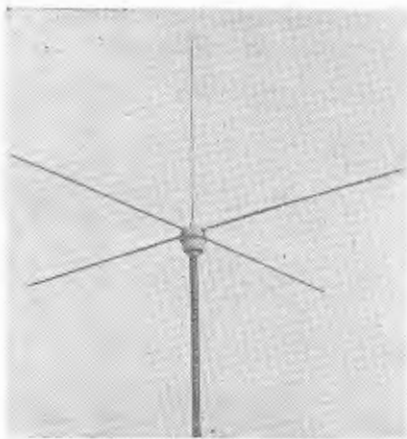

Fig. 5.—Omnidirectional Ground-plane aerial for fixed-station use. The matching stub is contained within the base casting and the feeder cable is passed down the support pipe.

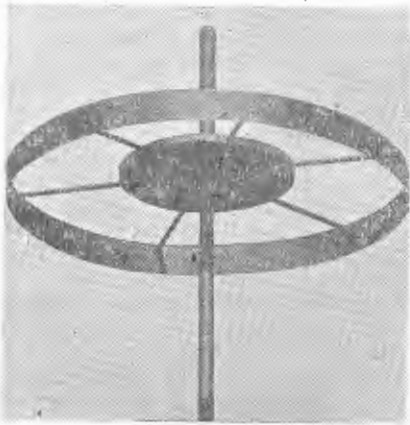

Fig. 8.—Ground-plane aerial giving reasonable constancy of impedance and radiation characteristics over a band width of 7%.

illustrated by Fig. 8, which shows a design suitable for operation over a bandwidth of about 7 per cent., over which band its impedance is such that the standing wave ratio does not exceed 1.5 to 1. Such an aerial, consisting basically of a broadly-resonant vertical radiator and a ground plane assembly, has the advantage that the one design can be used throughout its band without the necessity of individual adjustment to frequency during its manufacture.

Broad Band Aerials

Broad-band aerials for operation over a relatively wide band have one important application. They permit the use of two or possibly three transmissions from the one common aerial; the frequencies being chosen so as to facilitate the design of the channelling filters which must be incorporated at the input to the transmission line to the aerial. The value of such a scheme becomes apparent, when it is considered that the number of really good sites in the Australian capital cities is strictly limited, and that utilisation of such sites is initially expensive on account of their very nature.

For example, in Sydney the arch of the Harbour Bridge would be an excellent but relatively inaccessible site for an F.M. base station, where it would be an economic solution to install one broad-band aerial fed by a low-loss coaxial transmission line terminating at the deck level. At this point the equipment and the filters for two or three services could be located. Fig. 9 shows a type of broad-band aerial, equivalent to a dipole, but effective over a frequency range of more than two-to-one. Such an aerial may be employed for either transmission or reception in the manner described.

Aerials for use on vehicles are most commonly arranged as quarter-wave vertical radiators, using the metal top panel

as the counterpoise or ground plane. In the case of passenger cars, which are reasonably symmetrical in plan, the positioning of the aerial on the centre of the body top produces a fairly uniform polar diagram in the horizontal plane and also has the advantage of giving the best possible effective height. (Systems which operate in the 30-40 megacycle region, wherein the aerial is mounted on the rear bumper, invariably exhibit marked directional effects with best transmission and reception occurring in the forward direction.) In a measurement recently made, it was found that, with an aerial mounted on the car waist-line above the luggage boot, on a frequency of 76 megacycles, there was a 2:1 ratio of field strengths radiated ahead and astern.

Installation Difficulties

One difficulty encountered in the installation of V.H.F. aerials on vehicles is the matter of variation in behaviour of the aerial between types of vehicle. Equipment which may be carried by vehicles of the commercial class further influences the aerial. It is quite possible to adjust aerials to some arbitrary body configuration, and then to install them on a variety of vehicles and obtain results of a sort.

However, it is found that the detuning effects make it impossible to interchange transmitters without re-tuning their output coupling circuits. Accordingly, it has been found necessary in practice to develop impedance measuring apparatus for the purpose of quickly and accurately adjusting vehicle aerials to a standard impedance. To enable this adjustment to be made, the provision of a matching stub line at the aerial base is an essential factor.

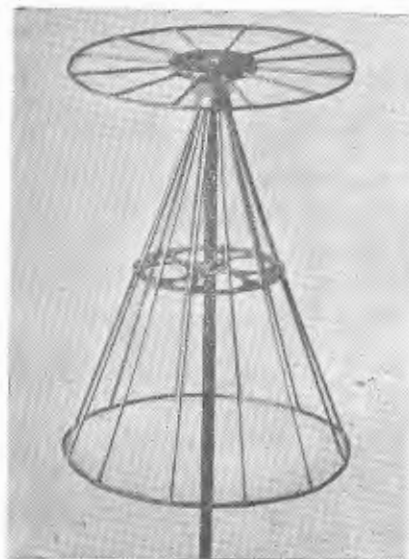

Fig. 9.—Broad-band dipole aerial for operation over a band width exceeding two-to-one.

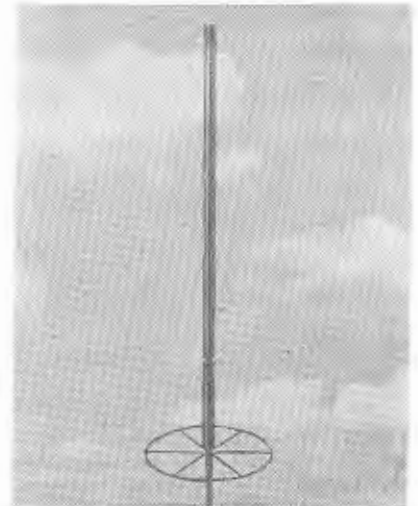

Fig. 7.—A high-gain vertically-polarised array comprising a ground-plane, driven sleeve element, and two parasitic sleeves.

Transmission lines in F.M. V.H.F. systems are invariably of the coaxial type, with polythene dielectric. The main reasons for this choice are the ease of installation and maintenance, suitability of impedances obtainable, and screening from external influences. Open-wire lines which are widely used in broadcasting and H.F. communications are at a disadvantage on all of the four points mentioned.

In order to keep impedance mismatching down to an acceptable figure, it is necessary to pay careful attention to the connectors and other fittings to be used with coaxial cable, more so in the band 150-160 megacycles than in the 70-80 megacycle band. It is good practice to maintain impedance continuity throughout a transmission line and radiating system to such limits that the standing wave voltage ratio does not exceed 1.5:1.

6.—F.M. APPARATUS

In an F.M. mobile communications system, the most interest centres around the design of the actual mobile equipment, and it appears that up to the present time the circuit arrangement of transmitters and receivers has followed set lines. Assembly of the apparatus into two units (transmitter and receiver) is the most common choice, but there are some advantages in adopting a three-unit assembly comprising transmitter, receiver, and separate power unit.

Mobile Transmitter

An F.M. mobile communications transmitter comprises two main parts (three if the power supply is incorporated in the same unit), namely, the R.F. multiplier-output channel, and the A.F.—modulator

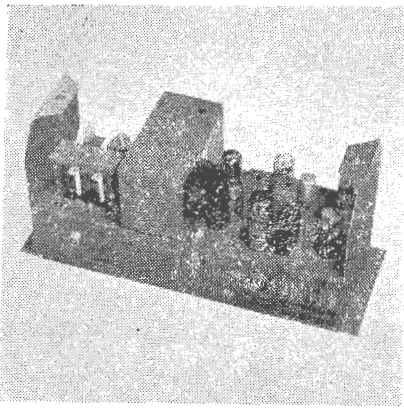

Fig. 11.—Photograph of the mobile F-M transmitter whose block schematic is shown in Fig. 10. The shielding arrangements should be noted.

section. Due to the high frequencies involved, an F.M. transmitter is more complicated than the A.M. counterparts of some years back. Use of crystal oscillators to control the carrier centre frequency is universal, and in the multiplication from the crystal frequency to the output carrier frequency, doubling or tripling stages are arranged in various combinations, with the total multiplication commonly falling between 24 and 48 times. Without the high-level modulator stage, as required in an A.M. transmitter, the overall efficiency is higher, and it is usually increased by operating the output power stage as an amplifier at the carrier frequency (instead of doubling).

This practice entails the use of valves of a type suitable for effective V.H.F. operation, and such valves are characterised by cathodes possessing high-peak emission capability, compact electrode structures, and short-lead low-loss base designs.

The high-level modulator of an A.M. transmitter, assuming 50 per cent. efficiency and a 10-watt carrier, would require about 15 watts plate input power; in an F.M. transmitter this is eliminated and the designer's usual choice is to use this available power to augment the carrier. An average value for the latter is 20 watts, although in the United States designs giving up to 50 watts output have been produced. Some of the available power, however, must be used for the multiplier stages.

Use of Phase Modulator

Frequency modulation is achieved by a phase modulator, and in one form or another this comprises a valve-controlled network interposed between the oscillator and the succeeding multipliers, whereby the instantaneous phase angle of the carrier is advanced or retarded in relation to the centre frequency reference, and in accord-

ance with the input modulation. The phase modulator has no effect upon the stability or accuracy of control of the carrier frequency, and as regards its audio input generally operates as a high-impedance device needing voltage energisation only. The chief design problem in the phase modulator is to obtain a large phase deviation with a low distortion figure, and the limitations of practical modulator circuits are mainly responsible for the use of high multiplication factors after the modulation process.

Practical experience with the wide range of voices encountered, shows that it is desirable to incorporate some automatic control of the modulating voltages applied to the modulator, so that over-deviation may be minimised. A simple peak-clipping circuit would seem adequate for this purpose, but this does not help in respect to obtaining full modulation from a speaker with low speech volume, which occurs just as often as the opposite case.

To obtain the necessary control, it is difficult to use fewer than two valves, but that this is justified has been shown repeatedly by the improvement in consistency of communication, which can be obtained by a control circuit having a compression ratio of 10 and an input range of 20 decibels.

The block schematic diagram of a typical F.M. mobile transmitter is shown in Fig. 10 and the transmitter itself in Fig. 11. It will be noticed that a correction network is inserted before the modulator so that its high-frequency pre-emphasis characteristic may be adjusted.

Mobile Receiver

The F.M. communications receiver is an extension of conventional receiver design practices, but with the major difference centering around the limiter-detector stages. Since the major portion of a typical service area depends upon field strengths less than 5 micro-volts per metre, the main object of the designer is to produce a receiver which will give saturation of the limiter stages with an input carrier signal of 0.5 micro-volt (or less), without sacrificing stability.

With the high sensitivity of a receiver

which will have such performance, the noise factor of the first R.F. stage must be minimised, by choice of valve type, in order that the noise level in the receiver itself shall be as low as possible. The superheterodyne circuit is used without exception, but there is some division of opinion on the merits of single-conversion and double-conversion²⁰. In the latter the incoming signal is heterodyned to a first intermediate frequency of about 20 megacycles, and then again heterodyned to the second intermediate frequency of 2 megacycles, whereat the main amplification and selectivity of the receiver are achieved. In both types of circuit a single crystal is employed to supply the heterodyne voltages to the converter stage, or stages, so that the receiver will be accurately tuned to the corresponding transmitter.

F-M Receiver Schematic

The block schematic diagram of an F.M. receiver is shown in Fig. 12, and it will be seen that the multiplication of the crystal oscillator frequency, the use of two I.F. stages (for high sensitivity), the two limiters and discriminator, are the reasons for such a receiver being more complicated than the conventional A.M. type. Replacement of the discriminator double-diode valve by crystals of the type used in radar is one method now adopted to reduce battery drain and space taken by this circuit. The tuned circuits of the discriminator need to be very stable against temperature and humidity changes and vibration, otherwise their drift away from true tuning will degrade the noise suppression characteristic of the receivers, especially on weak signals.

Due to the extremely constant signal level which the tandem limiters supply to the discriminator, at least for all signal levels greater than that which produces limiter action, no need arises for the type of A.V.C. circuit employed in A.M. receivers, provided that precautions against overdriving of the prior stages on strong signals are incorporated. Although it has not the same character as that of an A.M. receiver, the noise output from an F.M. receiver in the absence of incoming signal is extremely annoying; an effective muting system is accordingly regarded as a neces-

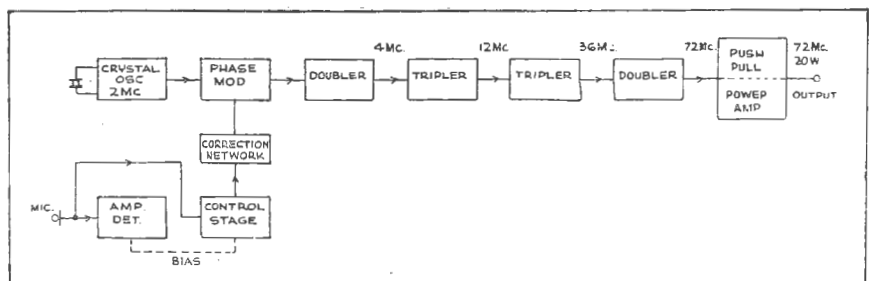

Fig. 10.—Block schematic diagram of an F-M mobile transmitter.

sity. It is fortunate that the operating characteristics of the limiter and discriminator stages permit the arrangement of suitable muting circuits which will completely suppress all output noise in the absence of a carrier, even with high ambient noise levels, while giving reliable operation on carrier signals as weak as 0.5 microvolts.

General Design Trends:

It is interesting to compare the average figures of 16 U.S. designs²¹ with the corresponding figures of an Australian design, as set out below:—

	Av. U.S.	Aust. design
Number of valves in receiver	14	12
Number of valves in transmitter	9	10
	Watts	Watts
Transmitter Power Output	20	20
Transmitting drain (from 6 volt Battery)	37	28
Receiving drain (from 6 volt Battery)	7.7	12

The favourable figure of transmitter battery drain obtained in the local design, which has gained wide acceptance, is due to the use of synchronous vibrators in a highly-efficient circuit in the power supply unit. It may be compared with the values 57 amps and 21 amps, being the highest and lowest figures, respectively quoted for the American products, in which a remarkably diverse variety of valve types are utilised. The less favourable receiver drain and stand-by current is necessitated by the limited choice of tube types available in this country.

Having been originally introduced into service in the 30-40 megacycle range for police networks around 1937, F.M. mobile apparatus is now in extensive use in the United States. With the allocation of new channels by the controlling authority, the Federal Communications Commission, an astounding expansion has recently taken place, especially on the part of taxi-cab fleets, which are operating radio despatching systems under their own control. Also contributing to the expansion are the

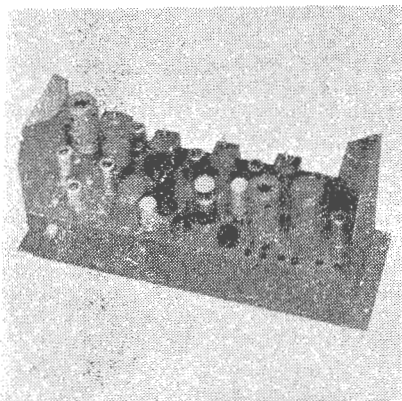

Fig. 13.—Photograph of the F-M receiver whose block schematic is shown in fig. 12.

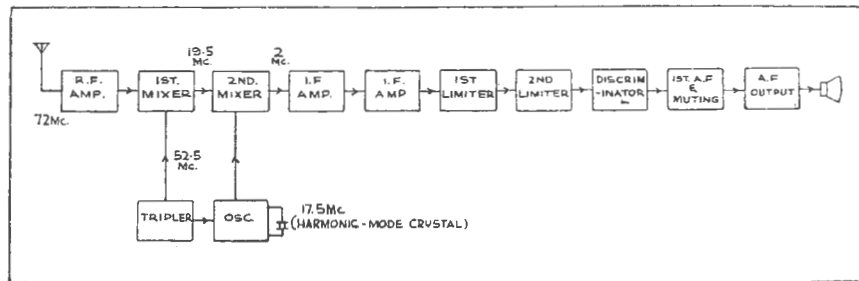

Fig. 12.—Block schematic of an F-M receiver.

mobile subscribers being added to the urban and highway radiotelephone services operated by the telephone administration.

As a result of this market, new trends are plainly indicated in the design of mobile apparatus, the objectives being smaller size and weight and lower battery current drain while receiving. Each improvement in these factors makes it easier to install radio into any of the wide variety of vehicles now on the road.

7.—TYPES OF SYSTEM

As frequently happens when a new field is exploited in telecommunications, developments proceed abreast upon quite different lines, and this appears to be the case in mobile radio. In the United Kingdom a V.H.F. system, using A.M., has been developed²², apparently to meet the specific needs of police radio. In the paper referred to, F.M. is regarded as not being adequate for mobile communication, but this view is difficult to accept when systems having one base station only are considered.

In a typical system there are two general methods of operation: The first is that in which the base station and all mobile stations have the same carrier frequency allotted for both transmission and reception, and the press-to-talk method of operating is used. Having the advantage of simplicity and flexibility, it is by far the most popular system. With the one frequency throughout, vehicles may talk directly to each other under the monitoring supervision of the base station; furthermore, a vehicle on the outskirts of the service area may relay messages to other vehicles beyond range of the main station.

Semi-Duplex

The second system has been termed "semi-duplex" by reason of the fact that the base station works on a duplex basis, transmitting and receiving simultaneously, but the mobile stations retain the press-to-talk method, even though two separate frequencies are used. The latter fact prevents direct working between them, a feature which is favoured by some authorities. In addition to the separation in frequency, the base station receiver and

its aerial are separated from the transmitter by a little distance so as to avoid interaction. The advantage of semi-duplex operation lies in the fact that it permits the mobile stations to break-in on the central station at any time to attract the operator's attention. Under difficult conditions, this feature improves the speed of message handling.

There seems no case on record where the duplex operation of V.H.F. equipment has been carried out commercially in vehicles. In 1946 the author arranged a very simple test in which 43 Mc was used for reception in a car, together with a 20-watt 76 Mc transmitter. Separate aerials were used, as filter designs were not available, and good results were achieved, there being no trace of interference in the receiver when in areas of very weak field strength.

This case is considered to be a fortuitous one and unlikely to be successful in repetition on other combinations of frequencies, or on other designs of apparatus. The working of a highly-sensitive receiver with its inherent number of spurious responses adjacent to a transmitter of at least 10 watts power output, and also possessing a number of sub-carrier frequencies, is a formidable problem, especially when it is considered that each unit is powered by a common battery and that a common aerial would be dictated by practical reasons. It is significant that vehicle duplex operation has not been attempted by the American authorities in their highway service for the public, even although it extends into the 2-wire telephone system.

ACKNOWLEDGMENT

The author is indebted to Amalgamated Wireless (Australasia), Limited, for permission to publish this paper.

REFERENCES:

- Brown & Epstein, "An Ultra-High-Frequency Antenna of Simple Construction", *Communications*, Vol. 20, No. 7, 1940.
- Martin, "High Gain I.F. Amplifier for F.M.", *Bendix Radio Engineer*, Vol. 2, No. 4, 1946.
- Freedman, "Two-way Taxicab Radio Systems", *Communications*, Vol. 27, No. 12, 1947.
- Brinkley, "A Method of Increasing the Range of V.H.F. Communication Systems by Multi-Channel A.M.", *Journ. I.E.E.*, Vol. 93, Part 3, No. 23, 1948.

RADIO SCIENCE

Some of the questions this month are slightly harder than those set in earlier quizzes. However, as a wide range of topics is covered, they should be a good test of your general radio knowledge.

To obtain your score, take 10 points for each question you answer correctly, and 5 points if only half right.

As a guide to your ability, the scores are: Beginners, 50% and under; Experimenters and Servicemen, 50 to 75%; Experts, 75 to 95%; and Genius, over 95%.

Q.1.—As most readers know the decibel is the unit generally employed for the measurement of the ratio of output voltage, current or power to the input voltage, current or power. Now for the question. When dealing with voltages and currents, the number of decibels is found by multiplying the common logarithm of the ratio by:—

- (a) 10.
- (b) 100.
- (c) 20.
- (d) $\frac{1}{2}$.

Q.2.—Although many technical writers are not in agreement on the use of certain radio abbreviations, the following have generally accepted meanings. See how many you can name correctly?

- (a) K; (b) AWG; (c) Y; (d) Cpk;
- (e) Ed; (f) b; (g) ICW; (h) db;
- (i) upo; (j) Ro.

Q.3.—In recent times a great deal of publicity has been given in both the local and overseas press to the new Frequency Modulation system of transmission. Among the advantages claimed for this system is that it will eliminate:—

- (a) All chances of electric shock.
- (b) The necessity for paying a licence fee.
- (c) Static and man-made interference.
- (d) Need for any aerial system.

Q.4.—Radio waves represent only a small section of the total frequency spectrum. They are considered to most nearly resemble:—

- (a) Light waves.
- (b) Heat waves.
- (c) Sound waves.

Q.5.—If the secondary of a power transformer is short circuited, the primary winding will:—

- (a) Draw no current.
- (b) Draw excessive current.
- (c) Will also be short circuited.

Q.6.—Whilst on the subject of transformers, here is another problem. If the two coils of a transformer in operation were free to move around in relation to each other they would:—

- (a) Repel each other.
- (b) Move closer together.
- (c) Spin in opposite directions.
- (d) Remain stationary.

Q.7.—In using components, especially condensers, in alternating current circuits, it is always wise to check on the maximum voltage in the circuit. This maximum value can be readily ascertained by:—

- (a) Multiplying the average value by 0.707.
- (b) Multiplying the effective value by 1.414.
- (c) Multiplying the effective value by 0.707.
- (d) Multiplying the average value by 1.414.

Q.8.—The term "static electricity" is often encountered in an elementary textbook. This is so named because it:—

- (a) Causes the static heard in radio receivers.
- (b) Consists of electrical charges at rest.
- (c) Is the product of standing waves.
- (d) Is induced in the stators of certain electric motors.

Q.9.—Radium, the mysterious element extracted from pitchblende, finds wide application in medical fields. But did you know that this element undergoes a series of transformations over a period of some 1,700 years to finally become:—

- (a) Carbon.
- (b) Amber.
- (c) Lead.
- (d) Gold.

Q.10.—Unless revised from time to time, it is quite easy to forget even the fundamentals of radio. For instance, can you name the basic units in the following list

without having a peep in any textbook:—

- (a) Electrical resistance
- (b) Capacitance.
- (c) Inductance.
- (d) Current.
- (e) Potential difference.
- (f) Power.
- (g) Energy.
- (h) Frequency.
- (i) Magnetomotive force.

Q.11.—Whilst still dealing with fundamentals, how many grids has each of the following valve types:—

- (a) Triode.
- (b) Diode.
- (c) Heptode.
- (d) Tetrode.
- (e) Pentode.

Q.12.—Electrical insulators find ready application in most radio circuits, and these belong to a class of substances known as:—

- (a) Electrolytes.
- (b) Vesicants.
- (c) Eutectics.
- (d) Dielectrics.

Q.13.—Early radio sets employed devices called:—

- (a) Mares tails.
- (b) Catwhiskers.
- (c) Bulls-eyes.
- (d) Crow's feet.

Q.14.—The capacity of a condenser is largely determined by the area of the plates and the dielectric separation. If the distance between two plates is doubled then the capacity of the unit will be:—

- (a) Doubled.
- (b) Halved.
- (c) Only increase slightly.
- (d) Unchanged.

Q.15.—A solenoid is usually defined as a "uniform spiral conductor forming a cylinder around either a straight or curved axis." A property of a solenoid is that it will attract:—

- (a) Lightning.
- (b) Moths and flies.
- (c) Iron.
- (d) Only aluminium.

(Continued on page 48.)

RADAR AIDS TO NAVIGATION

AIRPORT APPROACH CONTROL

By JOHN G. DOWNES, B.Sc., A.M.I.E.E.

The first of a series of articles describing Australian developments which have been taking place since the end of the war in the use of ground radar for controlling aircraft in the vicinity of airports.

As is now well-known, an immense amount of work was done during the war to develop radar devices for use in the air, on the ground and in ships. Early in the war (and in fact, before 1939) these devices operated on relatively low radio-frequencies (between 30 and 200 Mc.). With the advent of that outstanding development, the pulsed magnetron, it became possible to enter an entirely new range of frequencies, the so-called microwave region extending from 1,000 Mc. up to 10,000 Mc. and higher.

This great reduction in wavelength meant that aerial systems could be designed which could, without being unduly bulky, produce narrow beams of radio-frequency energy, only a few degrees in width. Previously, narrow beams of radiation had been obtainable only with aerial systems so large as to be unsuitable for any applications other than to fixed ground installations.

Plan Position Indicator.

Following closely on these techniques there were developed airborne radar equipments with aeriels producing narrow beams of radiation which could scan the terrain over which the aircraft was flying. At the same time there was developed an appropriate technique for displaying the echoes received; this was the so-called *Plan Position Indicator* or *P.P.I.* This type of presentation or display had the appearance of a map drawn on the face of the cathode-ray tube of the radar set, the position of the aircraft being represented by the centre point of the C.R. tube.

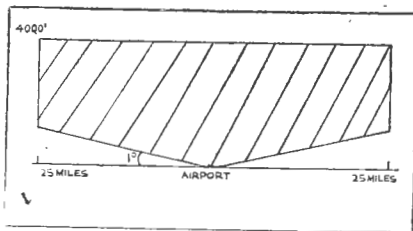

Fig. 1.—Illustrating a vertical cross section of the coverage of an ideal radar for controlling the approach of aircraft to an airport.

If the width of the radiated beam in such a radar system is sufficiently narrow, very good definition may be obtained in the picture on the C-R tube. For example, one of the early applications of airborne microwave radar of this kind was to search for surface vessels. The echoes from such vessels appeared as clearly-defined spots of light, and the bearing and range of such vessels could therefore be measured with accuracy.

Similarly, if the aircraft is flying over a coastline, a sharply-defined line is seen upon the screen. This condition of being able to discriminate sharply between reflecting objects is often described by saying that the *resolution* of the radar set is high. If the radiated beam is broadened, the picture loses definition and the echoes from reflecting objects become blurred and therefore less easy to identify; the resolution is said to be reduced.

Highly satisfactory airborne microwave radars were developed in the later stages of the war; these provided a picture on the C-R tube of sufficient resolution to allow towns, rivers, bridges, etc., to be identified readily. It was equipment of this kind which helped to make possible the precision bombing of objectives in Europe under weather conditions (heavy fog, cloud and the like) which would otherwise have caused a complete cessation of operations. Radar of this kind was also of the greatest help in allowing aircraft to return to their bases safely under similar adverse weather conditions.

Microwave radar has been mentioned in the preceding paragraphs particularly in its application in aircraft. Extensive use of similar techniques was made, however during the war in ground based installations and on ships.

Following on the conclusion of the war, it seemed logical to make use of the high-definition radar techniques mentioned in peacetime developments. Microwave radar has found an important use in marine navigation; experiments are being carried out to determine its usefulness in civil aircraft; and in ground installations it is finding an increasing application for the observation and control of aircraft. It

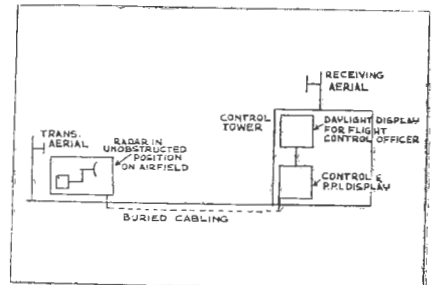

Fig. 2.—This diagram shows the general disposition of the equipment at an airport.

is with this last-mentioned application that we are concerned in the present articles.

Development of such peacetime radar aids has been made very much easier not only because of the immense amount of technical information amassed during the war but also because there is now available a considerable amount of equipment which lends itself quite readily to conversion for civilian needs.

In the present articles it is proposed to discuss in some detail the requirements to be met by a ground radar installation for the surveillance and control of aircraft in the vicinity of a busy airport, and then to describe the form taken by the actual equipment in an experimental installation at Kingsford-Smith Airport, Sydney. Because of the rather extensive form of the complete installation it is intended to deal in this first article principally with the requirements which the radar must meet, leaving the detailed description of the equipment to be discussed subsequently.

The Need for Airport Control Radar.

There are usually within the vicinity of a large airport at any time a number of aircraft which are making preparations to land or which have taken off a short time before. Because by the very nature of these operations these aircraft are in general altering simultaneously their height, position and heading, their movements are much less susceptible to con-

trol than when they are flying *en route*, that is to say, along a definite air route at a given height. In the latter case, by separating in height aircraft of differing speeds or courses, or by ensuring a certain minimum time separation between adjacent aircraft, it is possible to control the flow of aircraft along the route with a high degree of safety.

When, however, aircraft are losing height and are changing course to reach the correct starting point for the final descent to the airstrip, it is by no means so straightforward a matter to ensure that each aircraft is always at a safe separation from all other aircraft within the control area. Of course, one method of control would be to admit only one aircraft to the area at a time, allowing each to land before admitting the next. Such a method would however be so slow as to render it unworkable at a busy airport, and would also lead to major difficulties in regard to the accumulation of aircraft outside the control area.

Flight Control Problems

If the problem of the flight control officer is a difficult one under good weather conditions, it becomes much more so under conditions of poor visibility. One reason for this is that each pilot is no longer able to observe aircraft in his vicinity and hence is unable

of his own initiative to act so as to maintain a safe clearance. The task of ensuring safe separation in bad weather falls almost entirely on the ground controller, and unless his procedure is adequate, the risk of collision is greatly increased.

Secondly, under conditions of bad visibility it is usually necessary for the pilot to make an instrument approach to the airfield, using radio or other navigational equipment. Under present arrangements, such an approach is likely to occupy more time and be more circuitous than an approach under good weather (or so-called *contact*) conditions. Consequently, each aircraft is in the approach area for a longer time and the risk of collision is increased accordingly unless the average rate of entry of aircraft into the area is reduced; a step to be avoided if possible.

We have in the preceding paragraphs not considered recent developments in airborne navigational equipment which, when brought into general use, will enable aircraft in the vicinity of an airport to fly much more closely defined paths than has been possible heretofore. The technical problems associated with such equipment have to a large degree been worked out, and its introduction, together with the development of appropriate flying procedures, should go a long

way towards allowing the ground controller to achieve a safe and expeditious flow of aircraft under all weather conditions. Such equipment is, however, not yet in general use, and it is necessary to see the airport control problem as it exists today.

Despite the difficulties which confront the ground controller it must be emphasised that procedures have in fact been worked out for the handling of large traffic densities at airports. Such procedures involve the *holding* of aircraft within certain areas, vertical *stacking* and the like. These handling procedures have been quite successful up to a point. However, with increasing traffic densities and because of the long delays sometimes incurred with the existing procedures, it is desirable to find new and better methods of handling the flow of aircraft.

Whatever the method in use for the control of aircraft in the area it will clearly be of the utmost benefit to the ground controller if he possesses equipment which enables him to see at a glance the position, height, speed and course of all aircraft within the area under his control. Such equipment will enable him to check that correct approach procedures are being followed to correct any dangerous situations which may arise and to direct, if necessary, any aircraft which

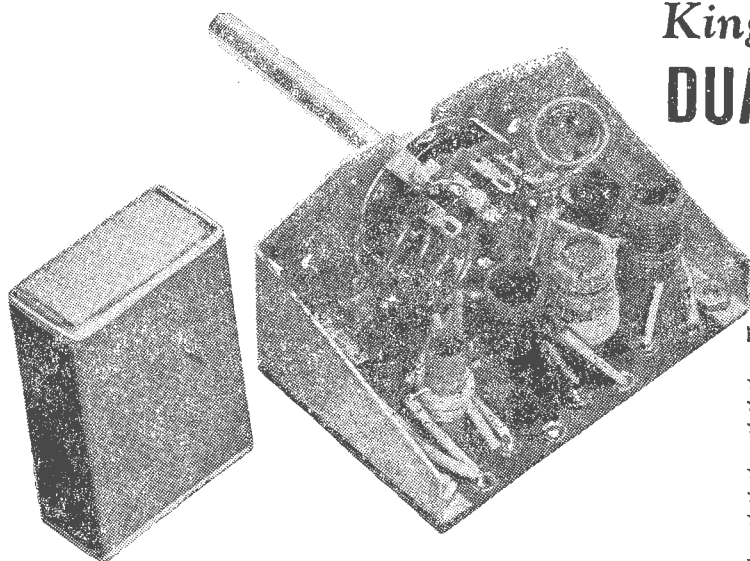

The Kingsley Dual Wave Coil unit is photographed here alongside a match box for size comparison.

Kingsley—New Miniature DUAL WAVE COIL UNIT

This New Kingsley Dual Wave Coil Bracket has not merely been reduced in size—it has been thoroughly designed by Kingsley's Research Engineers. It is no mere adaption of existing components, being engineered not only from the electrical but also the mechanical viewpoint.

NO OTHER D/W BRACKET GIVES ALL THESE FEATURES:

- ★ Each unit is core tuned.
- ★ Models for every converter valve.
- ★ Frequency coverage 5.95 megacycles to 18.5 megacycles and 540 to 1650 kC/s.
- ★ Trimmers and cores are readily accessible.
- ★ Coils and wiring well protected.
- ★ Dimensions of unit: 3 ins. wide, 2 ins. deep, 1¾ ins. high.
- ★ Ease of wiring into chassis.
- ★ Sturdy construction of unit.

Write for details.

Ask for—Insist on—DEMAND Genuine Kingsley Parts from your supplier.

KINGSLEY RADIO PTY. LTD.

380 St. Kilda Road, Melbourne, Victoria

'Phones: MX 1159, MX 3653

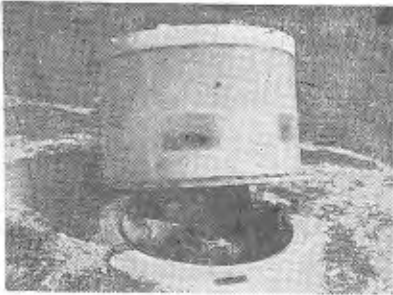

Fig. 3.—Close-up view of the Radome in the raised position.

because of equipment failure or other causes is unable to make the normal approach. The presence of unidentified aircraft in the area can also be detected, and precautions taken.

Technical Features Required in an Airport Control Radar.

We come now to consider the technical requirements to be met by a ground radar for airport control.

1. Required Range of Operation.

This depends on what information is possessed by the ground controller concerning the number and identity of aircraft entering the control area. If complete information in this regard is available to him, his task would be only that of supervising and controlling the movements of identified aircraft, and a range of some 15 miles in all directions from the airport would be sufficient. As an example of a method by which information might be obtained regarding aircraft approaching the area we can consider a long-range radar, covering the airways to a distance of 50 to 100 miles, and relaying information to the airport controller.

If, however, the controller has no precise information as to the number and identity of aircraft approaching the area a radar coverage of some 20 to 25 miles is desirable, so that sufficient time is available to identify the aircraft and prepare to handle them expeditiously.

2. Vertical Coverage.

Aircraft making approach procedures in the vicinity of an airport are not usually at altitudes greater than 4,000 feet, and this is in fact the upper limit allowed at present under conditions of poor visibility. Coverage up to this height should therefore be provided by the airport radar. In certain approach procedures aircraft may fly directly over the airport, and an angular coverage right up to 90 deg. in the vertical plane would appear desirable. This, however, is a difficult technical requirement to meet, and it is considered that in practice a coverage of up to 20 deg. would be suffi-

cient, the gap in coverage then being relatively so small that aircraft would not be out of view for, at worst, more than about one minute.

As far as low-angle coverage is concerned, it is necessary to be able to discern aircraft climbing from and descending to the airport. Such climbs and descents are usually made at an angle of about 1 deg. (this corresponds approximately to a height change of 300 feet per minute). Consequently, a satisfactory figure for the minimum angle of coverage of the radar is 1 deg.

Figure 1 shows diagrammatically the range and vertical coverage which is required of the approach control radar.

3. Display of Information.

3a. Form of Display.

The information which is of most importance to the ground controller is the range and bearing of each aircraft in the area, presented continuously as the aircraft makes the approach procedure. Accordingly, the logical form of display is that of the Plan Position Indicator, on which the control area is represented by a circle of which the centre denotes the position of the ground radar, while bearings and ranges of all aircraft within the area are presented in a direct manner.

To correspond with this presentation, the radar will employ an aerial beam scanning in the horizontal plane.

3b. Height Information.

The problem of height determination by a radar of the kind under consideration is not an easy one, and it seems likely that the height-finding facility will have to be omitted initially, for practical reasons. In order to make accurate height determinations it is necessary to provide an aerial having a beam narrow in the vertical plane; this implies that the vertical dimension of the aerial shall be relatively large. Since the aerial has already been made wide horizontally to achieve the narrowness of beam necessary for precise bearing determination, it is seen that the additional requirement leads to an aerial of quite large size.

Furthermore, height determination requires that the aerial beam shall scan in the vertical plane, additionally to the horizontal scanning required for bearing

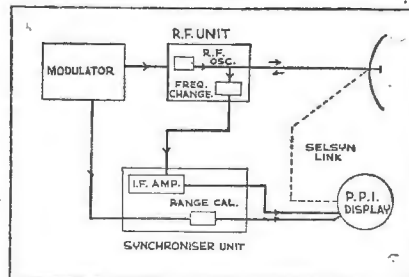

Fig. 5.—Simplified schematic diagram of the basic radar equipment used for approach control.



Fig. 4.—View of radar equipment in pit; the RF unit is at the left control panel, local P.P.I. in centre, and antenna at top.

determination. Apart from the mechanical problems thus introduced, the narrowness of the beam in both horizontal and vertical planes raises difficulties in connection with the scanning speed, which must be great enough to allow a frequent traversing by the beam of the whole region of coverage, to ensure that no aircraft movement is undetected for any appreciable length of time.

It will be clear from the foregoing that the additional facility of height determination by radar is not easily achieved. It remains, however, a desirable goal to aim at. As an interim measure it will probably be necessary to determine height by ensuring that aircraft follow an approach procedure in which height is specified, or by radio communication with individual aircraft. Automatic transmission of height information from the aircraft is also a future possibility.

3c. Daylight Display.

P.P.I. display on the face of the cathode-ray tube is not adequate for the purposes of the ground controller. Firstly, he has many duties to attend to, and therefore cannot be expected to study a C-R screen which must be in a darkened enclosure; the display must be able to be viewed in daylight. Secondly, there is much irrelevant matter on the face of the tube, such as clutter (echoes from nearby objects on the ground) noise, and the like. This extraneous matter is merely confusing and a display is required revealing only essential information, namely, the position and movement of aircraft relative to the airport, together with means for identifying those aircraft.

Thirdly, a C-R screen is in general too small for a display such as is required; some magnification (about 2 or 3 times) is therefore required. Finally, there should be as little time delay as possible between the instant at which the radar receives information and that at which the information is displayed to the controller.

It is clear from the foregoing that a number of specialised requirements have to be met in the link from the P.P.I. screen of the radar C-R tube and the ground controller.

(Continued on page 48.)

INTERNATIONAL RADIO DIGEST

A Technical Survey of Latest Overseas Developments

ELECTRONIC MEMORY TUBE

A memory tube recently developed can remember signals as long as required. It is constructed somewhat similar to an ordinary cathode ray tube, and paints an electronic picture of the signal it is to remember and reads it back whenever desired.

In the new tube there are three electron beams. The writing beam which sprays a pattern of electrical charge corresponding to the signal is controlled by the deflector plates to which the signal is fed. The holding beam sprays electrons evenly all over the target to replace the charges picked up by the reading beam. The reading beam moves over the target in the zigzag pattern used in television. Whenever it runs across a charge left by the writing beam, that charge flows from the target to a near-by metal screen.

The current—or remembered signal—from the pickup screen can be fed to other circuits or devices, such as an ordinary cathode-ray tube. In the case of the cathode-ray tube, its beam is synchronized with the reading beam of the memory tube so that it makes the fluorescent screen of the cathode tube glow every time the reading beam sees a charge on the memory-tube target. Thus the charge

pattern on the memory-tube target appears as a *light* pattern.

Courtesy Popular Science Monthly.

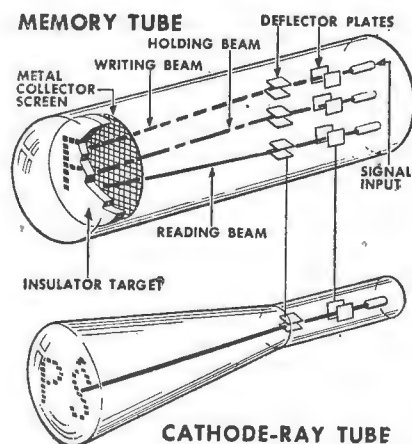

Diagram shows construction of tube and hookup for visual display of signal. The pattern of charge on the insulator target cannot be seen and need not be made visible since it might be fed to any one of many different types of apparatus.

Time Saver For Airline Travellers.

An "electric brain" which would cut the time required to make an airplane seat reservation to a matter of seconds has been announced in U.S.A.

Essentially, the brain consists of a magnetised metal drum which accepts electronic impulses, flashed from other cities, requesting seats. The electric eye scans the nation-wide system of offices when the agent pushes a button, and returns in one-fifth of a second with an accurate yes or no answer.

The device is capable of sorting complete information on seats available on every flight for 30 days. When three or four requests reach the drum almost simultaneously, it stacks them in the order of transmission, then handles them one at a time.



The "remembered" signal can be displayed on the cathode ray tube. In this case the signal originates in an optical pickup device such as facsimile or television equipment.

F-M RECEPTION

Reliable FM Ranges may extend far beyond the horizon according to a Bureau of Standards report. Experimental research undertaken by the Bureau has shown that atmospheric ducts and boundary layers in the lower troposphere both reduce the attenuation of high-frequency radio waves with distance at points beyond the line of sight.

These results are expected to provide a firmer basis for the prediction of the service and interference ranges of FM broadcasting stations; they should also aid in the solution of problems that may occur in connection with other uses of the spectrum above 30 megacycles.

Variations in the density of the atmosphere within a few hundred feet of the ground provide differences of refractive index which can increase the curvature of a radio wave by an amount equal to or greater than the curvature of the earth. Known as ducts, these characteristic changes in the refractive index of the air near the surface of the earth become more and more effective in bending radio waves as frequency increases.

For the overland propagation paths which are usually involved in frequency modulation broadcasting, effective atmospheric ducts are to be expected after the sun sets and the earth begins to cool the atmosphere. Under favourable circumstances this cooling may continue throughout the night with the formation of a duct of great width. The received fields would then be expected to reach their peak values early in the morning before the sun has had opportunity to destroy the duct by warming the earth.

From analysis of the field-intensity data obtained by the Bureau, it appears that external receiving antennas may be used with considerable advantage for reception of FM broadcasts at points far beyond the horizon of the transmitting antenna. The FM fields from stations at large distances may be expected to reach their maximum levels in the early morning hours during the summer months; at these times effective ranges up to several hundred miles may be expected.

Courtesy Radio-Craft.

For the First Time in any Publication!

Build It Yourself —
6 valve F-M Tuner



★ Full constructional details of a 6 valve F-M tuner, for operation in the 88-108 mc. band.

★ A simplified but highly efficient circuit using the latest series of miniature valves specially designed for F-M operation.

★ Pre-tested and pre-aligned coils make this a unit which can be easily duplicated by the average home set constructor.

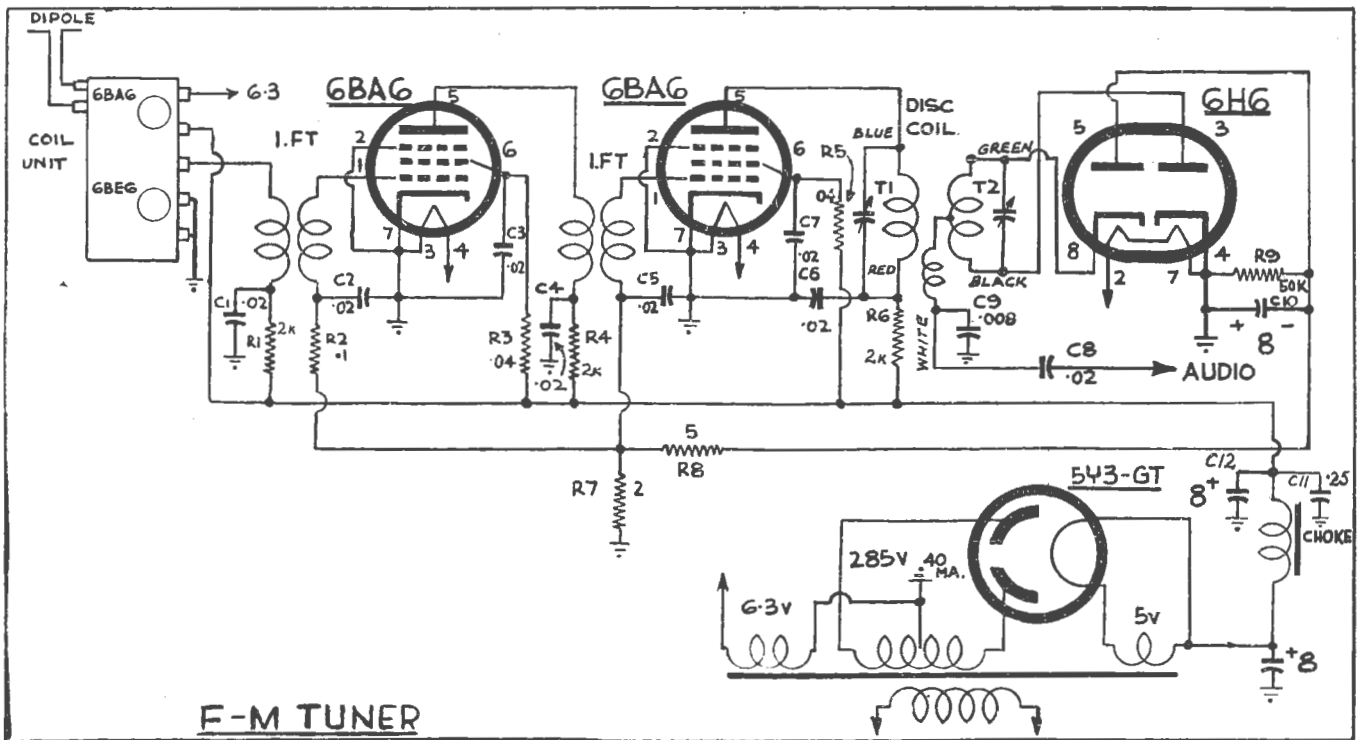

The circuit is quite straightforward and simple to wire up. Note that a simplified form of ratio detector is employed and that a complete de-emphasis network is not required. For alignment the hot lead from the V.T.V.M is connected direct to the white lug of the discriminator coil.

The opening of the 88-108 Mc. band for experimental Frequency Modulation (F-M) transmissions by the P.M.G. Department has brought in many requests for constructional details of suitable equipment for use on this ultra high frequency band. Although at the present time the experimental stations in Sydney and Melbourne are on the air for only limited periods during the day, it is anticipated in the near future that these stations will extend their transmission times to the evening periods—a move that will be undoubtedly appreciated by all interested listeners.

Whilst no definite policy has yet been formulated as to the future status of the F-M bands in this country, such transmissions are gaining wide popularity in many overseas countries. At the present time, there are several hundred F-M stations operating in the U.S.A., with many more proposed or in the course of construction. Engineers in both Canada and England have carried out F-M transmission tests and will shortly have stations operating on a complete programme basis.

In this country the present position is that there is an experimental station operating on approximately 92 Mc. in both Sydney and Melbourne, with proposed stations to be set up in Adelaide and Brisbane. It is understood that the former station is now almost completed and should be in operation in the near future.

Advantages of F-M

As to be expected, there are varying opinions regarding the merits of the F-M system, and whilst it is not possible in the space available to discuss at any length the advantages of this form of broadcasting over the present A-M system, the following points should be of some interest. Among the chief advantages are:

- (1) Elimination of static and similar man-made noises.
- (2) Freedom from fading signals.
- (3) High fidelity reproduction.

In addition, other gains are to be found in the greater efficiency and economy of transmitter operation, in-

creased service area and lower power requirements than would be possible with a comparable A-M transmitter.

It is generally well known that noise impulses, when received by an AM receiver, are amplified and detected along with the desired signal, and even though their intensity may be only 1 per cent. that of the desired signal, the noise can appear quite objectionable to the listener. In the case of the F-M receiver, any noise will be picked and passed through the r-f, converter and i-f stages similar to the A-M receiver, but here the similarity ends. The F-M detector is designed to detect only variations in *frequency* of the applied signal and not changes in *amplitude*. Consequently, any noise variations

PARTS LIST

- 1 Chassis 12 x 6½ x 2.
- 1 Special coil bracket.
- 2 I.F. Transformers 10.7 mc.
- 1 Discriminator coil.
- 1 Tuning dial.
- 1 Power transformer 40m a, 285v HT, 6.3v @ 3 amps, 5v @ 2 amps.
- 1 Filter Choke.
- Resistors:**
 - 1 5 meg ½ watt.
 - 1 2 meg ½ watt.
 - 1 .1 meg ½ watt.
 - 1 .05 meg ½ watt.
 - 2 .04 meg 1 watt.
 - 3 2000 ohms 1 watt.

Condensers:

- 3 8 mfd Electrolytic.
- 1 .25 mfd tubular condenser.
- 8 .02 mfd tubular condensers.
- 1 .008 mfd mica condenser.
- 2 Air trimmers 30 uuf.

Valves:

- 3—6BA6, 1—6BE6, 1—6H6,
- 1—5Y3-GT or 6X5-GT.

Sundries:

- 5 miniature sockets, 1 octal socket,
- 1 power switch, 2 aerial terminals,
- 2 knobs, hook-up wire, shielded wire, rubber grommets, solder lugs, nuts and bolts, etc.

which may be superimposed on the signal are prevented from reaching the output stage of the receiver.

The freedom from fading signals in the F-M system is mainly due to the high frequencies being used. Under these conditions the sky wave component of the transmitted signal is not generally reflected back to earth by the ionosphere, but continues out into space in practically a straight line. The reception therefore depends on the direct wave, and because of this the coverage area is practically constant day and night.

High Fidelity

The final point in favour of the F-M system is its ability to provide the listener with higher fidelity than hitherto obtainable from an A-M receiver. The useful audio frequency range extends from approximately 20 to 15,000 cycles per second, and to achieve high fidelity in reproduction, the broadcasting station should be capable of handling this total range of frequencies. Unless this is done, then the sounds heard by the listener will not be a true reproduction of the original.

Since under the present system A-M stations are assigned to frequency channels only 10 kc. apart, it is apparent that to stay within the stipulated band width all frequencies above 5,000 c.p.s. will have to be attenuated. Naturally, under these conditions, high fidelity transmissions at broadcast frequencies are out of the question.

As against this, 10 kc. limitation, the F-M channels are up to 200 kc. wide, enabling stations to have a 75 kc. maximum frequency swing on either side of their

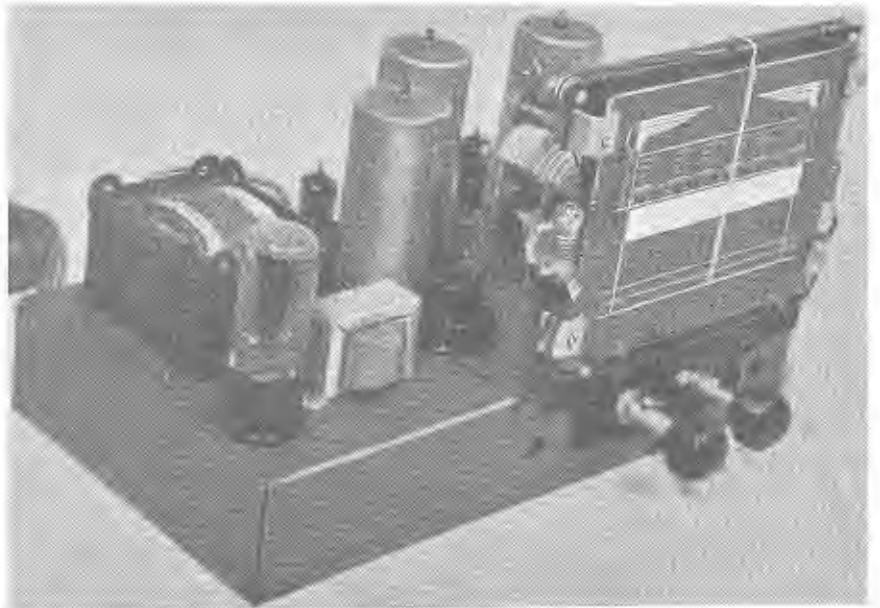

A general view of the completed unit. The controls are: On-off power switch, and tuning.

assigned frequency. This wide channel permits the easy transmission of the full audio range, giving greater brilliance and tonal realism to the reproduced signal.

The increased public interest in this form of broadcasting, and the fact that the modified ex-disposals receiver previously described* is now practically unobtainable, culminated in the decision to present the full constructional details for this simple, but efficient, F-M tuner unit. Under the present arrangements, it is considered that this is a more economical method of tuning-in to this F-M band

than by designing a complete F-M receiver. In most cases the constructor will have a suitable audio end available either on his present receiver or perhaps a high fidelity audio amplifier, which can supply the necessary audio amplification as well as the power supply.

Good Audio Essential

At this juncture it would be wise to stress the fact that the tuner must be used with a good audio end if the worthwhile reception of F-M is to be realised. Such a unit is not a *panacea* for all ills—and if the amplifier is not capable of delivering sufficient power at low distortion, then the reception will be little better than at present being received—except perhaps for a lower noise level.

Since simplicity is generally the keynote of success, the actual construction of this unit has been greatly simplified by the use of a pre-tested and pre-aligned commercial coil unit. This procedure has eliminated the main worry of the home constructor—namely, how to align the tuner when completed, since the special equipment usually associated with F-M alignment is not necessary for the successful operation of this particular unit.

In addition to providing a topic of interest to the home set constructor, this article also makes it possible for the alert Serviceman to build up one of these units and find out about this "F-M" business. In general, the layout and positioning of the components is more critical than the case of an A-M receiver, and in addition

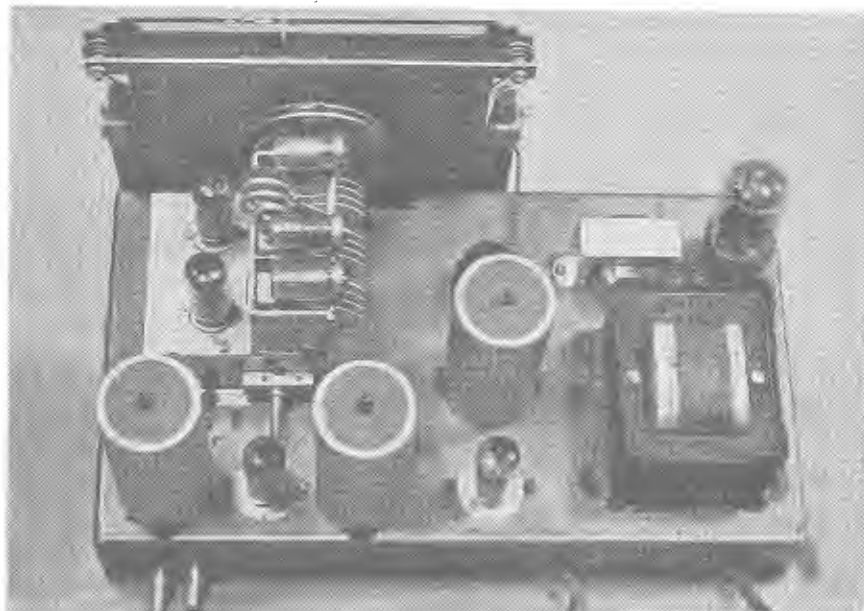

This top chassis photograph shows the location of the various components. For best results this layout should be closely followed.

* See "Convert AR-301/TO F.-M.," Radio Science, March, 1948.

First Again!!

SLADE'S RADIO PTY. LTD.

Proudly Presents
Australia's First Frequency Modulation Tuner

★
All the advantages
of F-M reception are
yours with this com-
pact 6-valve F-M
tuner.



★
Converts any Radio
Receiver or Ampli-
fier for F-M.

★
Price complete £20-0-0

SLADE F.M. TUNER KIT

Consists of pre-aligned Tuner, two 10.7 mc. I.F. Transformers, one Ratio Detec-
tor Coil.

★
As easy to
build as a
Crystal Set.

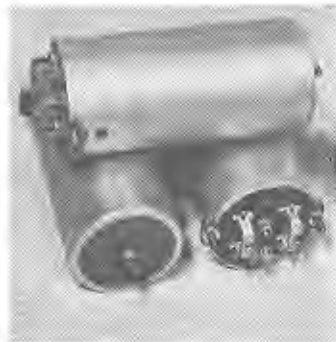

★
I.F.'s and Ratio Detector Coil

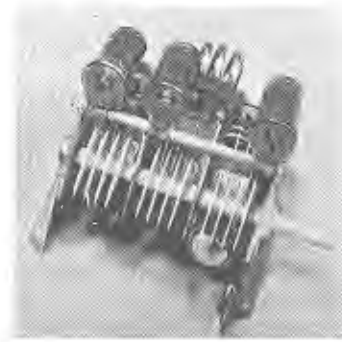

★
Tuner

★
Frequency
Range
88-108 mc.

★
PRICE, complete with constructional details as described in August issue of RADIO SCIENCE.
£7-18-6 nett

SLADE'S RADIO PTY. LTD.

LANG STREET, CROYDON

— — —
Established 30 years

Tel.: UJ5381; UJ5382

the servicing techniques are more complex.

Circuit Details

The circuit has been designed around the latest series of the miniature valves specially designed for use in F-M equipment. It consists of a 6BA6 r-f amplifier, 6BE6-converter, a 6BA6 in each of the I.F. stages, a 6H6 as ratio detector, and a 5Y3-GT rectifier.

The tuning section comes from the manufacturer as a complete unit, and since this is pre-tested and pre-aligned, it calls for little comment. After bolting it into position on the chassis, it is only necessary to make the connections to the lugs provided.

At this stage a word of warning may be necessary. Due to the critical nature of the component position and coil adjustment at these high frequencies, it cannot be stressed too strongly the folly of moving any component, however insignificant it may seem, in the tuning unit. These have been set for correct operation at the factory and consequently any tampering will result in incorrect tracking and possible non-operation. So, do not touch any trimmers, coils or small compensating condensers.

Two i-f stages are used, each employing a 6BA6. These valves are connected up in a standard manner, using separate screen feeds and decoupling in the plate leads for greater stability. The cathodes

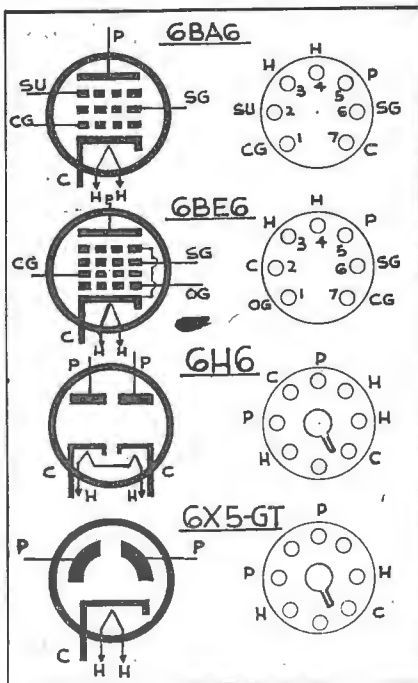

Here are the connections for the various valves, looking at the underneath of the valve socket. In place of the 5Y3-GT, the connections for the alternative 6X5-GT are given.

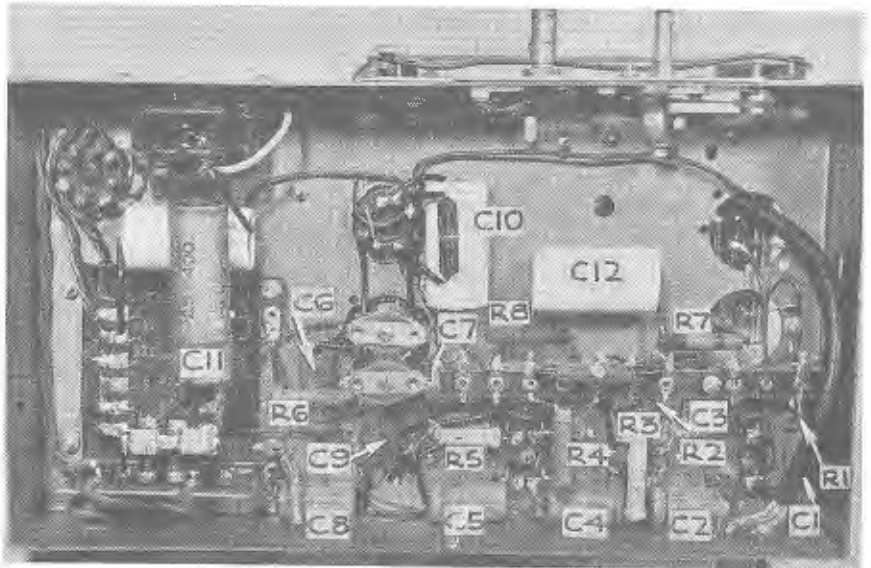

The underneath chassis layout and wiring are clearly shown in this excellent photograph. Care should be taken in positioning the components to ensure all leads are kept short and direct. Note co-axial connection to the aerial coil on the right hand side of the chassis.

are earthed for simplicity, and the necessary negative bias is obtained through the AVC circuit.

The i-f stage is then followed by a ratio detector stage, which, unlike the often-used Foster-Seely limiter discriminator stage, is self-limiting and operates efficiently with a lower input. As a result the ratio detector is able to suppress a-m effects of the incoming F-M signal at a lower level than other detector systems.

Ratio Detector Operation

For those who may not be familiar with the operation of this particular detector circuit, the following description should be of some assistance. The basic circuit of the fundamental ratio detector is shown in the accompanying diagram, and this works on the principle of separating a fixed d-c voltage into two parts.

The condensers C2 and C3 are of equal value and, together with R1 and C4, form the diode load circuit. Since the two diodes are connected in series, they will conduct on the same half-cycles and the rectified current through R1 will cause a negative potential to appear at this resistor. The voltage drop across this resistor depends on the average strength of the applied signal.

At resonance the current will flow around the series circuit and there will be no voltage drop across R1. This means that the voltage ratio across C2 and C3 will be 1:1, that is equal, and consequently there will be no audio voltage developed. As the carrier deviates from resonance on the application of a signal frequency, more voltage will be applied to one diode than the other, and the ratio of the voltages across C2 and C3 will no

longer be equal. It should be realised that the TOTAL voltage across the load circuit has not changed, but simply the ratio of the voltages developed across C2 and C3.

The voltages across C2 and C3 are additive, and their sum is fixed by the constant potential across R1. Therefore, while the ratio of these voltages will vary at an audio rate, their sum will always be constant and equal to the voltage across R1. The potential at the junction of C2 and C3 will consequently vary at an audio rate, and this can be taken off and fed into the audio amplifier.

The constant voltage developed across C4 in the circuit can be considered as a stabilising voltage, in that it stabilises the ratio detector output against any amplitude modulation that may be on the carrier. In this way the rejection of A-M takes place.

As mentioned earlier, the voltage across R1 is proportional to the average strength of the received carrier, and because of this the negative voltage appearing across this resistor serves as an excellent AVC voltage source.

The actual detector used in the tuner is simply a modification of this basic cir-

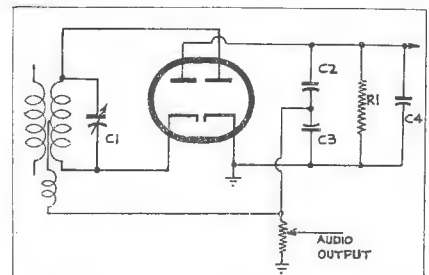

The basic ratio detector circuit.

cuit. Although a comparison of the two circuits will disclose that the two r-f bypass condensers C2 and C3 have now been eliminated, it will be found that the operation is fundamentally the same.

The advantage of this form of detector is that it has no *threshold* effect—that is, it is not dependent on any minimum signal input for efficient operation, and consequently it is generally superseding the older form of limiter-discriminator circuit.

Power Supply

Although a power supply unit has been shown for completeness, in many cases it will be found that the necessary high tension and filament voltages can be taken from the receiver or amplifier being used. The power requirements are 250 volts at 40 ma. and 6.3 volts at 1.5a, and in attaching the unit to a present receiver, these figures must be taken into consideration to prevent overloading the power supply.

To overcome this it may be necessary to include a switching arrangement on the receiver to remove the A-M tuning section when the F-M unit is switched on. However, it is important to ensure the power supply used is well regulated otherwise trouble will be experienced in holding the 6BE6 at the set frequency. On loud signals the variation on total set current is sufficient to upset the applied voltages to the 6BE6, causing a fluttering signal somewhat similar to that heard on certain fading short-wave stations. Because of this some may prefer to add the extra power supply to the tuner unit as shown.

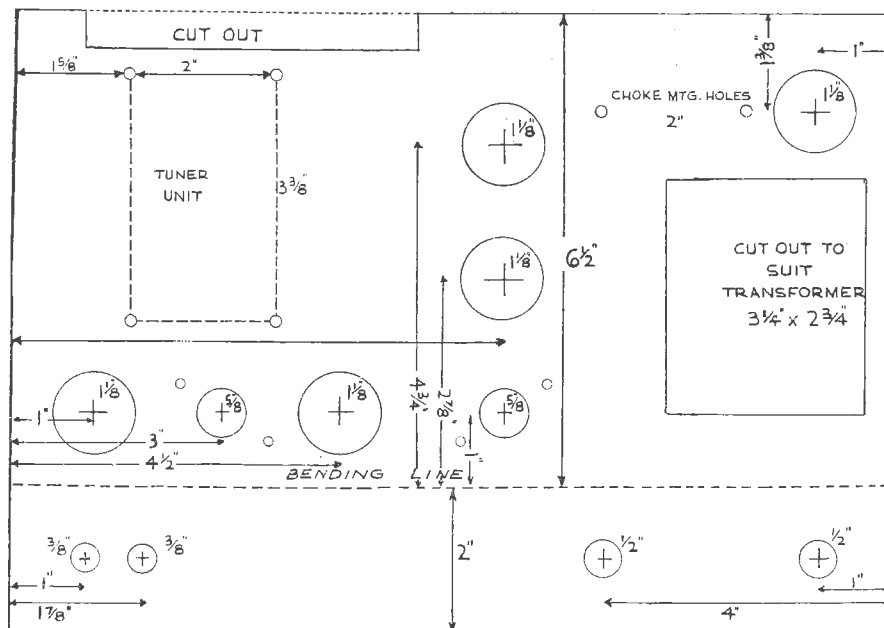

If you intend making your own chassis, this layout will provide all basic measurements.

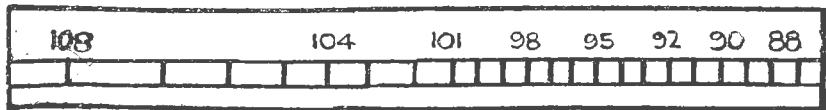

If your dial scale is uncalibrated, this full size layout can be glued in the appropriate position on the glass.

Wiring Up

The completed chassis measures 12 x 6 1/2 x 2, and this can either be bought ready cut or, if desired, you can bend your own, using the accompanying diagram. If you intend making your own chassis, make sure that heavy aluminium is used so as to give a rigid base. This is most important, otherwise any chassis movement could upset the tuning of the receiver.

The layout shown has been chosen for convenience, and as it ensures the shortest possible leads, should be adhered to for best results. Mount the components in the positions indicated—the tuning section on the right-hand side and near the front of the chassis. This is then followed by the first i-f transformer, 6BA6 socket, second i-f transformer, another 6BA6 socket, discriminator transformer, and then the 6H6 detector socket, near the front of the chassis. The power supply is mounted on the rear left side of the chassis, with the filter choke and rectifier immediately in front of it.

With the main components in position, the next step is the wiring-up. This will be simplified by reference to the underneath chassis photograph, as this shows the exact position of many of the resistors and condensers. The eight-lug terminal

strip mounted across the chassis will enable most of these components to be securely soldered, and yet provide short, direct leads to their respective circuit. Make sure all by-pass connections are kept short and direct as possible, and by keeping all plate and grid leads well separated and short, there should be little possibility of any oscillation troubles.

The audio output is taken direct from the discriminator coil, through a 0.02 mfd. condenser, using a shielded cable. If desired, this lead can be terminated at the back of the chassis, using a phonotype jack. The .008 mfd. condenser is inserted to act as the de-emphasis network, and its effect is to attenuate the high note response back to its more natural level.

The two air trimmers used for adjusting the discriminator windings can be seen in the photograph, and these are mounted so that they fit across the lugs from the respective windings, thus ensuring the shortest possible leads.

The connections to the R-F coil unit are simple: The two-terminal strip mounted on the front edge of the unit is for the aerial lead and is connected to the two terminals at the rear of the chassis by means of a short length of co-axial cable. The remaining connections are made to the five-lug strip on the side of the unit. The first lug is 6.3 volts input, second lug to B plus 250 volts, third lug plate of first i-f transformer. The two remaining lugs are connected together and earthed.

Alignment Procedure

After the unit has been wired up and re-checked for any shorts or wiring errors, the next step is to align the various circuits. Since the tuner unit and intermediates are pre-aligned by the manufacturer, it should not be necessary to alter these to any degree. However, once the set is in operation and to compensate for a slightly different wiring layout, some constructors may find it advantageous to peak the circuits for maximum results.

This leaves only the discriminator coil to be aligned in the first instance. This is carried out as follows: Connect two closely-matched resistors—75,000 to 100,000 ohms in value, across R9. Place the common lead of a d-c VTVM or other high-resistance meter at the junction of these

resistors, and the other hot lead at the point indicated in the audio lead. Then adjust the trimmers connected across the windings for a zero reading on the meter. This procedure is done under no signal conditions.

Then, with the set tuned into the station, the i-f slugs can be slightly adjusted for maximum output. At the same time the aerial and r-f trimmers on the coil unit should be peaked for a maximum signal. Under no circumstances should the oscillator trimmer (rear one) be moved, since this is pre-set and sealed at the factory to give the correct oscillator frequency.

F-M TRANSMISSION TIMES

At the present time, Sydney and Melbourne experimental F-M stations are transmitting each day on 92 mc. from approximately 10 a.m. to 10 p.m., Monday to Friday inclusive.

Antenna System

Having completed the tuner, the next step is the construction of a suitable antenna system. To provide adequate signal pick-up and best reception, an outdoor antenna is generally necessary and desirable. An indoor antenna will often provide sufficient signal strength when used near a station, or if the receiver is in a good area. However, it is more prone to pick up electrical interference, and on the whole delivers a much weaker signal to the input terminals of the receiver.

The simplest F-M antenna is a half-wave dipole, consisting of two quarter-wave rods spaced about one inch apart at the centre. For maximum results this should be cut to resonate at the frequency being used: namely, 92 Mc. Since the length of the whole dipole is a half-wavelength at 92 Mc., or 60.3 inches, each quarter-wave rod will be 30.15 inches long. This is constructed from 5/16in. diameter copper rod, and mounted on a piece of 2 x 1 oregon, using small stand-off insulators to hold it in position.

As the transmitted signals are vertically polarised, it is essential that this dipole be mounted in a vertical position to obtain maximum signal pick-up. The whole assembly is then attached to a 12-foot pole orientated in the correct direction and mounted as high as possible. These de-

tails are shown in the small drawing.

Of all the factors contributing to strong signal pick-up, antenna height is among the most important. To-date many tests have proved fairly conclusively that the strength of the signal picked up by the receiving antenna is almost directly proportional to the height of the antenna. That is, doubling the height should almost give a 100 per cent. increase in signal strength—however, there must be a substantial increase in antenna height before any real improvement is noticed.

Lead-in Details

The average simple dipole has an impedance of approximately 75 ohms at the centre at its resonant frequency and consequently the connection to the receiver should be made through a suitable 75-ohm lead—either co-axial or twin lead often being used. The co-axial cable has the advantage of being shielded and not subject to interference pick-up, as is the case with twin lead flat plastic line. The plastic twin lead will usually give very satisfactory results if it is carefully installed and kept away from metal roofs, pipes, etc. To avoid interference pick-up, this flat line is sometimes given a twist of one turn per foot.

The actual location of the receiving antenna can be the subject of some experimentation and for best results should be tried out in several different locations. The main point to bear in mind with any aerial is to keep it away from any masses of metal, such as roofs, pipes, etc., and electric wires.

In Conclusion

In practice the tuning of this receiver will be found little or no more difficult than for a standard superhetrodyne receiver. However, one point to bear in mind is the fact, that by careful tuning, it is possible to hear the station on three different points of the dial.

This is quite normal and should not lead to any difficulties as the correct centre frequency gives a much greater output than either of the two side responses. Also these side responses are easily recognisable as they give rise to a certain amount of noticeable distortion, which disappears as the correct frequency is tuned in.

In the original receiver a standard Efc dial was used, with suitable graduations being drawn up on a piece of white paper and pasted on the glass as shown in the photographs. Although it is anticipated that special dial glasses will soon be made available, a full size drawing of this scale is included for the benefit of readers who may intend using a dial already on hand.

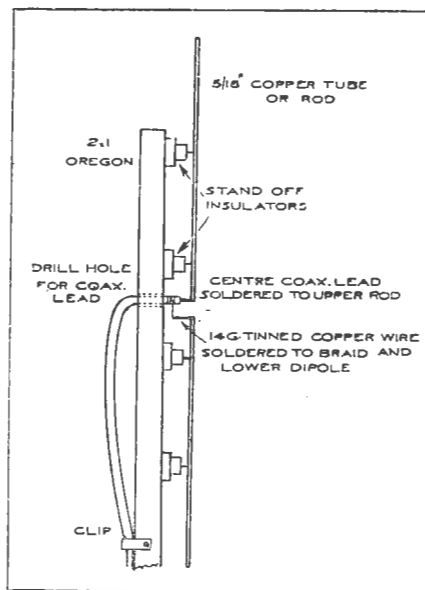

The aerial constructional details are given in this drawing.

In conclusion, it is anticipated that this tuner will create no small amount of interest insofar as it is the first time such a unit has been described by an Australian technical journal. Consequently we would appreciate hearing from all readers building up this unit, and especially request details of results obtained with it.

ARE YOU INTERESTED IN F-M?

If so, the following articles published in previous issues of RADIO SCIENCE should be of interest.

February, 1948.

The ABC of Frequency Modulation.

March, 1948.

Fremodyne F-M Circuit.
Convert the AR301 to F-M.

April, 1948.

F-M Antennas.

May, 1948.

F-M Antenna Transmission Lines.

Limited copies of the above issues are still available and can be obtained by writing direct to the Subscription Department, Box 5047, G.P.O. Sydney. The price in each case is 1/-, post free.

MATCHED TO PERFECTION

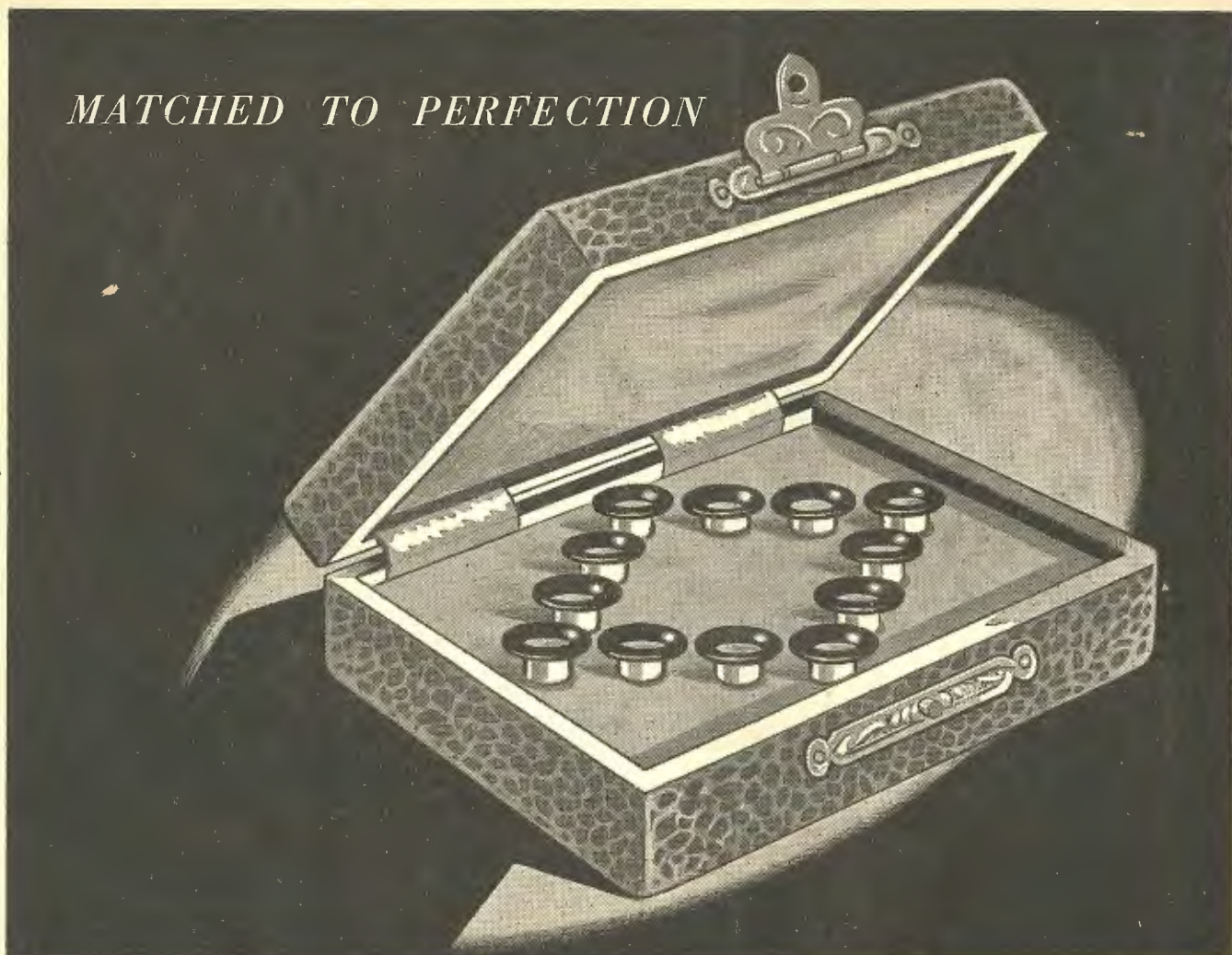

EYELETS WITH THE PRICELESS QUALITY OF ACCURACY

It is natural for us to concentrate on little details: Because we make little things . . . eyelets for all trades . . . and you get the benefit of our many years of specialized concentration. Precision, accuracy and constant uniformity . . . a priceless thing in to-day's manufacturing and merchandising. Quantity production of tiny metal pressings never affect accuracy in Eyelets' products. With Eyelets it is top quality, first class finish, punctual delivery, plus accuracy . . . every

time. New pressings to suit your specific needs . . . specifications as requested . . .

Why not get in touch with us?

EYELETS
PTY.  LTD.

GREEN STREET, WINDSOR, MELBOURNE
Interstate Representatives: C. H. R. JOHNSTON PTY.
LTD., Sydney; F. L. RUNGIE, Adelaide; E. D. WELSH,
Brisbane; C. R. PALMER, Perth.

PATON

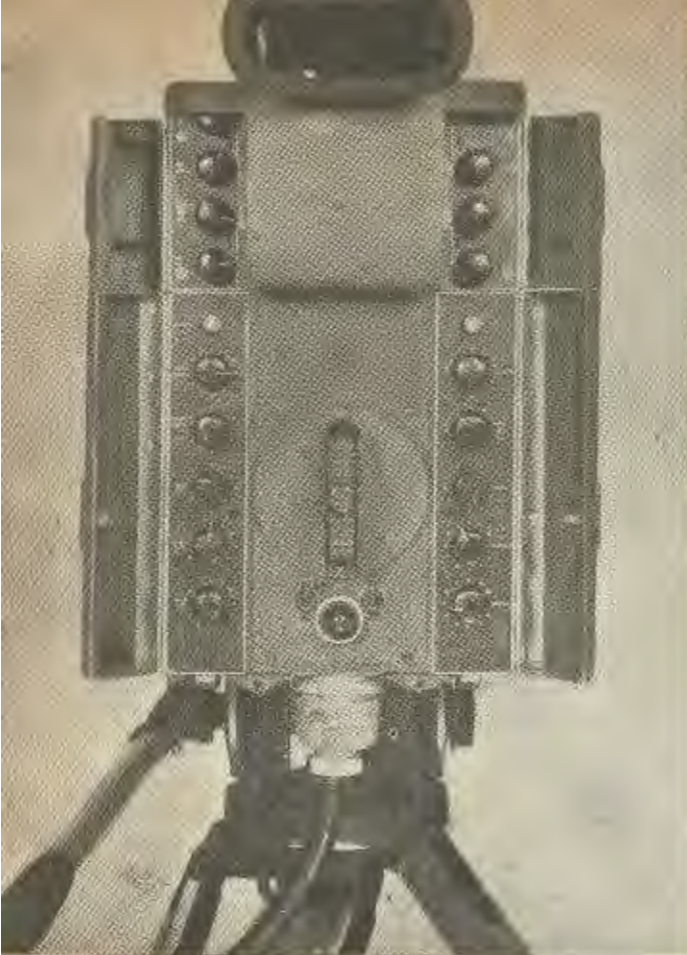

Operating controls at rear of camera.



A top view of the camera with view finder section removed.

Modern TELEVISION Camera

Details of recently developed RCA Equipment used for televising indoor scenes.

RADIO SCIENCE, August, 1948

25

The various lens are mounted on a rotatable turret.

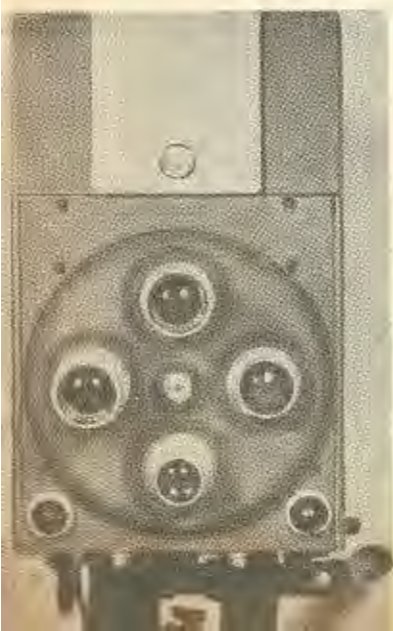

The interior of the camera showing complex nature of circuits.



A general view of the camera.



FOR THE EXPERIMENTER

By A. G. NICHOLLS (VK2NI)

SWITCHLESS INTER-COMM. UNIT

This small inter-comm. can be easily wired up, using standard components, and will find many applications around the home and workshop. In addition to providing satisfactory results over a reasonable distance, it has the added advantage of not requiring a "Talk-Listen" change-over switch.

The usual switching arrangement is replaced by a resistor network which operates in a smaller manner to a "hybrid" coil in a telephone system. The

transformers used in this section of the circuit are ordinary audio transformers.

The potentiometer R1 is of the pre-set type, and adjusted by means of a screwdriver until no audio "howl" or feedback is heard from the speaker. In making this adjustment, ensure that the remote speaker is also connected into the circuit. Once set, this potentiometer should not require adjustment again unless the length of the leads to the speakers, etc., is changed.

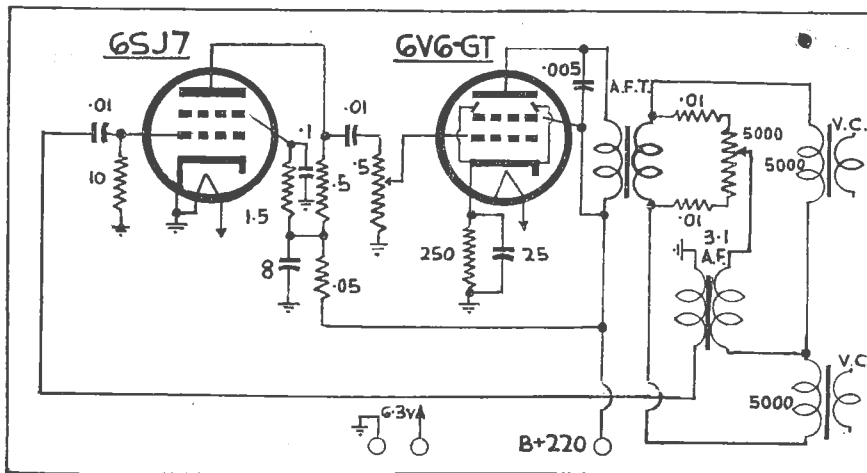

Constructional details of the I.C. unit are given in this circuit.

ONE-VALVE REFLEX RECEIVER

This small receiver requires only a minimum of parts, and yet if used with a good aerial and earth system, is capable of operating a small permag. speaker on the stronger local stations.

All standard components are used, and the circuit employed is of the reflex type. This arrangement enables the one valve to operate simultaneously as an R.F. and A.F. amplifier stage. The valve firstly acts as an R.F. amplifier, and amplifies the incoming signal frequency in the normal manner. The output is then rectified (or detected) in the output circuit by means of the fixed crystal.

This audio signal is then fed back into the grid of the valve by means of the small audio transformer. It is then further amplified by the valve and the output taken via the R.F.C. in the plate circuit to the speaker or the phones.

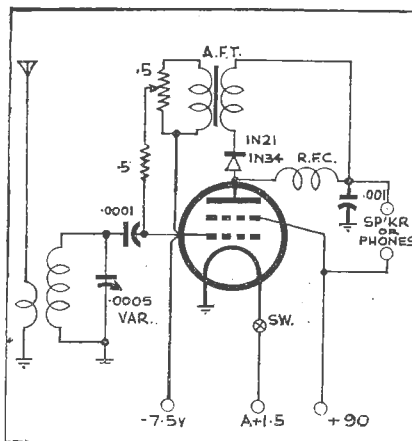

Although designed around a 1C5-GT, any 1.4 volt output valve will operate satisfactorily. The only change necessary is to alter the bias voltage to suit the valve being used.

FREE

and post free is the special technical brochure prepared on the special unbreakable crystal pick-ups, type T10 sapphire needles, type J10 ordinary needles.

These brochures give the most data on a pick-up that has yet been compiled and released from any source. Write today.

These special pick-ups are the finest that are available on the Australian market.

Being of an almost unbreakable construction and carrying a full 12 months' guarantee, they offer many advantages to the

"CONNISEUR"

of pick-ups. Have you heard their utmost fidelity and their true life-like tone?



Write now to the sole manufacturers and distributors for this unique offer.

KELMAN INDUSTRIES

Department RS.

Box 40

Hawthorn, E.2.

MELBOURNE, VICTORIA.

Amateur Radio's Bid For Peace—

K2UN's CHALLENGE TO THE WORLD

By ROTH JONES, VK3BG

Details of the new amateur station K2UN—recently opened and controlled by the United Nations Organisation for the dissemination of peaceful propaganda.

Tucked away behind the glass-panelled doors off the main conference corridor in the United Nations Headquarters, Lake Success, U.S.A., is K2UN, the amateur radio station now being run conjointly by the United Nations Department of Public Information and International Amateur Radio Union—world-governing body of all national societies of licensed amateur radio operators.

Its policy is to spread good-will by wireless. Already operators in many countries, including Australia, have evinced keen interest in the project. All have offered every assistance toward making the plan a success.

Peace Propaganda

The exact type of material to be handled by this station has yet to be determined. However, it is planned to give specific information requested by individual radio operators on the activities of U.N. Primarily, it is a propaganda station which will be used for the preservation of peace and international understanding.



George Bailey calling CQ for the first time from K2UN. Note newspaper representatives at rear. Benjamin Cohen, assistant secretary-general for U.N. Public Information looks on.

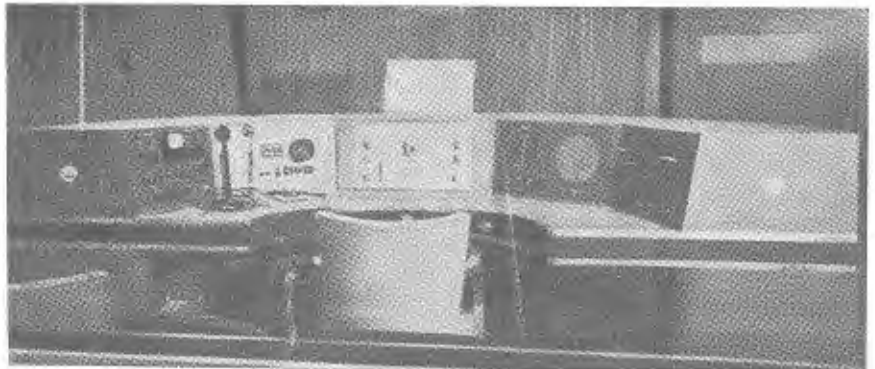

General view of K2UN control table.

The original idea of establishing the station was first suggested by Brig.-General Frank E. Stoner, U.N.'s chief communications engineer. He felt the creation of a high-powered transmitter, operating under the U.N. auspices, would be of value both to amateur radio operators throughout the world and to the Department of Public Information.

The plan was enthusiastically accepted by the International Amateur Radio Union on behalf of its 100,000 members. After technical and other problems were settled, an agreement was signed between both bodies. This specified that the operators could handle only material not otherwise broadcast by international or domestic services.

Periodic Talks

The project now facing the promoters is to arrange periodic talks between experts in the various divisions of the U.N. Secretariat and the specialised agencies and amateur operators who daily practice in similar professional fields. For instance, an expert from the Legal Department of the U.N. might talk to operators who are themselves lawyers. A represen-

tative of the U.N. Food and Agriculture Organisation may talk with a farmer in New Zealand or Canada on mutual problems, while a medical expert from the World Health Organisation, also of the U.N., might chat with a doctor who operates his own amateur station, be it in Sydney, Capetown, or elsewhere.

In the event of international or national emergencies, K2UN will be right on the job. It will play its part in serving the public in such ways as handling traffic and maintaining contact with isolated areas.

Amateur radio is the new hobby at the secretariat. Many members did not know of its existence until they saw K2UN in operation. About 50 members of the staff are already active members of the U.N. Amateur Radio Club. The station is always under the supervision of a licensed radio operator who hopes to train more to gain their "ticket."

The Club is bound by its newly-ratified charter to:—

"Preserve and foster the spirit of fellowship among radio amateurs of the world.

"Promote international awareness of,

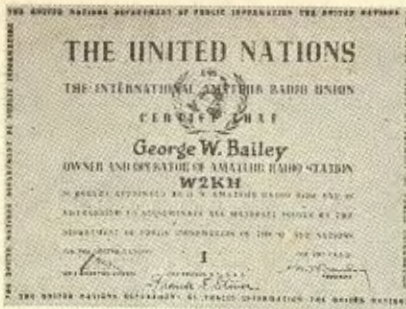

Another of I.A.R.U. President, George W. Bailey's coveted possessions—the first certificate to be awarded by U.N. Amateur Radio Club. The second went to Victor Motto, of Italy, the first station to be worked from K2UN.

and interest in, the U.N. role of building a better world.

"Build prestige for U.N. through radio amateurs."

The station's call letters are symbolic of U.N.'s hospitality and good-will—K2UN standing for "Come to the United Nations." The whole set-up is an amateur radio operator's dream. The receiving position alone makes one feel a trifle jealous. Five separate panels arranged in a neat semi-circle provide: transmitter control, panadaptor to give visual indication of the clearness of the channel,

National HRO receiver, beam direction indicator and built-in speaker and frequency meter. Using an input of 1 kw, two transmitters operate on all bands; one uses 80 and 40-metre bands with doublet antennas, while the other has a rotary beam for 20 and 10 metres. This is controlled from a special panel on the receiving position.

Last month the station made its first appearance on the amateur bands, when George W. Bailey (W2KH), I.A.R.U. President, directed the rotary beam to Europe and spread the word that a special U.N. certificate would be awarded to the first contact.

There was a wild rush, with "half Europe QRM-ing with a vengeance."

From the QRM George picked out IIRM in Como, Italy, and handed the microphone to Benjamin Cohen, Assistant General Secretary for Public Information, who broadcast a congratulatory message in Italian to Victor Motto, IIRM. Contacts then came thick and fast. They are still as thick as ever, and with the many U.N. linguists available, QSO's have resulted with many foreign countries.

U.N. has done its bit. The rest is left to you and I—the radio amateur operators of the world. We must do our best to foster good-will. Surely the 1939-1945 war reminds us bitterly of strife. Amateur radio is the greatest of all hobbies. It is democracy itself.



★
Transmitter control (left) and panadaptor



MODERN CRYSTAL RECEIVER

Details of an easily-constructed receiver employing a Germanium crystal diode and permeability tuned coils.

A 1N34 germanium crystal diode and parts of a permeability-tuned i.f. transformer are used in this efficient crystal set. It is simple to construct and has good volume and selectivity. Unlike most crystal sets, the primary coil instead of the secondary is tuned. The tuned antenna circuit is an important feature of this receiver because it provides a much greater signal strength at the headphones than if the secondary were tuned.

To construct the receiver, take the i.f. transformer apart and unwind the secondary coil until it is about 70 per cent. the size of the primary winding. Remove the iron slug from the secondary core, cut the coil mounting board in two, and mount each part as shown in the drawing. Warm the wax holding the coils to the forms with the heat from the soldering iron (carefully) and move the coils up flush with the ends of the forms.

The wiring is straightforward. One lead of the 1N34 crystal is soldered to one of the secondary coil terminals and

the other lead is fastened directly to the 'phone jack. Make sure that the rotor of the condenser is connected to ground to prevent detuning due to body capacitance.

Selectivity is determined by the position of the iron slug in the primary circuit and by the coupling between the primary and secondary coils. The secondary coil is moved back and forth, to make this adjustment, by turning the wing nut.

Antenna length is not critical, but it is an important part of the receiver and is worth a little extra effort. Maximum signal strength is obtained along its length, so pointing it toward a more distant station will bring in the station. Placing it at right angles to a strong local transmitter permits weak signals to be heard more clearly. With a 50-foot antenna and with a water pipe for a ground, at least 10 stations from 200 to 400 miles away have been clearly heard. An average of three more-distant stations are heard four or five nights a week the year round.

(Courtesy Radio Craft)

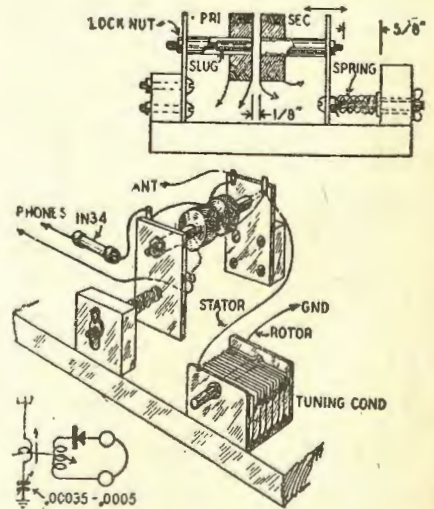

This drawing clearly indicates the method of construction and layout of components.

RECEIVER TUNED CIRCUITS

The property of "parallel resonance" is the underlying *modus operandi* of the tuned circuit. Sound knowledge of this property is essential for the full understanding of tuned-circuit operation and design.

Tuning, as performed in radio reception, consists essentially in setting certain circuits to admit signal voltages of one frequency while excluding those of all other frequencies. Selectivity is a measure of the extent to which this action is achieved. A circuit is said to be selective when it enables the complete rejection of unwanted frequencies, even those which lie quite close to the desired signal. All receiver-tuned circuits should provide selectivity.

The important tuned circuits of a receiver are identical with the basic arrangement shown in Figure 1, consisting of a capacitance connected in parallel with an inductance, or are elaborations of this same arrangement. In order that the circuit may be adjusted, the property of one of its elements is made variable; although it would be entirely possible, though difficult of manipulation, to have both variable. The majority of systems, for numerous reasons of electrical and mechanical practicability, employ a variable condenser rather than an adjustable inductance.

Series and Parallel Circuits

The tuned circuits of a receiver may be operated as series-tuned circuit or parallel-tuned circuit. The characteristics of the series-tuned circuits are essentially the same as those of the parallel-tuned circuit, except that the series-tuned circuit depends on a line current increase for its operation, while the parallel-tuned circuit depends upon a line current decrease for its operation. Therefore, the selectivity of the series-tuned circuit depends primarily on a low-line resistance, while the selectivity of a parallel-tuned circuit depends primarily on a source of high-series resistance.

From a study of the antenna or coup-

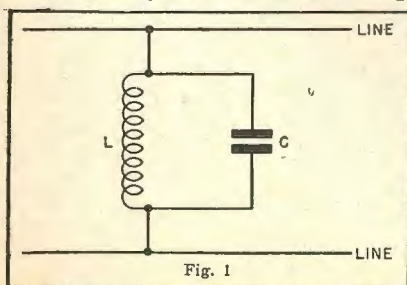

ling transformer of a radio frequency or intermediate frequency stage, it will be noted that the grid circuit is a tuned-series circuit, as the voltage is induced in the coil, and therefore can be considered acting in series with the coil and the condenser. The plate circuit, however, of an i.f. transformer is a parallel-tuned circuit in series with the plate impedance of the tube. Since this plate impedance is fairly high, the parallel circuit gives the maximum voltage gain and selectivity possible.

The property of *parallel resonance*, which is associated with circuits of the type in Figure 1, is the underlying *modus operandi* of the tuned circuit, and an understanding of the principles governing the parallel resonant circuit is essential to a full comprehension of tuned-circuit operation and design.

The Parallel Resonant Circuit

An alternating current views the parallel resonant circuit in Fig. 1 as an inductive reactance in shunt with a capacitive reactance. In flowing down through this combination the current will encounter separate impeding effects in the two legs, the two reactances acting upon it by different amounts, depending upon the frequency of the current alternations and the values of the coil and condenser components.

At some one critical frequency, for any given inductance and capacitance values, the inductive reactance and capacitive reactance will be equal. Because of the nature of the two kinds of reactance, the impeding action of the current will be almost entirely due to the capacitive element at frequencies below this critical frequency and largely to the inductive at frequencies higher. At this critical frequency of *resonance* the two reactances, being equal and of opposite algebraic sign, will neutralise each other, leaving the coil resistance (which is generally negligible in comparison with the coil reactance) as the sole circuit property remaining to impede the passage of current.

Consider three suitable a.c. ammeters—M1, M2, M3—connected in the parallel resonant circuit in the manner illustrated in Fig. 2. When an alternating current (I) is caused to flow into the circuit by action of an impressed e.m.f., its intensity

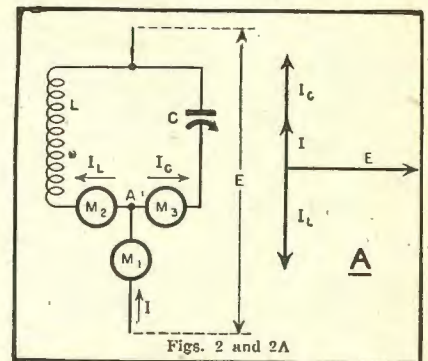

will be indicated by the meter M1. This current, termed the *line current*, will divide at the junction point, A; a portion (I_c , the condenser current) flowing through the capacitive leg of the circuit will actuate M3. And the other (I_L , the coil current) flowing through the inductive leg will actuate M2. The readings of M2 and M3 will be unequal and that of M1 may be less than either of the former.

May be Less than Either of the Former

If then the capacitance of the condenser C is adjusted throughout its range, I_c and I_L will gradually tend to become equal, while at the same time the line current, I, will be growing steadily smaller. Assuming that the capacitance range of C is appropriate, there will be one setting of this condenser at which C and L will have the proper relation to render the circuit resonant at the frequency of the applied voltage. I will fall to a very low value, approaching zero, at resonance, while the large magnitude and near equality of I_c and I_L at that point indicate that the reactive properties of the circuit have very nearly disappeared. Because of the high current in the circuit, the voltage developed across LC will be at its peak.

Beyond resonance, I_c and I_L will again become unequal as the capacitance of the condenser is varied further, the condenser current continuing to move upward; the coil current downward.

Thus, it may be seen that the proper adjustment of L and C at any frequency will result in the appearance of a maxi-

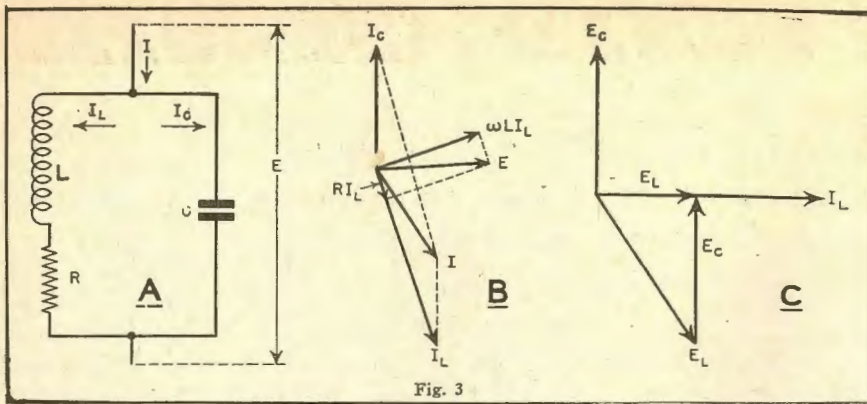

Fig. 3

imum voltage (the resonant voltage) across the combination and minimum current (line current) in the external circuit. And when the circuit is connected to a voltage-operated device, such as to the grid-cathode input of a vacuum tube, voltages of desired frequencies may be selected and applied to the device by *resonating* the circuit. This is the basic function of the receiver-tuned circuit.

The resonant frequency, f , may be determined from the equation.

$$(1) \quad f = \frac{1}{2\pi\sqrt{LC}}$$

From which:

$$(2) \quad L = \frac{1}{4\pi^2 f^2 C}$$

And

$$(3) \quad C = \frac{1}{4\pi^2 f^2 L}$$

f is in cycles per second,
 C in farads, and L in henries.

f in each case is taken to be the resonant frequency.

The above equations hold for both series and parallel circuits.

In the case of pure capacitance in parallel with pure inductance, the simple vector relations of Fig. 2A would apply. Here I_C is leading the applied voltage, E , by 90 deg., while E leads I_L by 90 deg., while E leads I by 90 deg. I , the line current, leads E by 90 deg. when I_C is greater than I_L and lags E by 90 deg. when I_L is greater than I_C . When $I_C = I_L$ (parallel resonance), I is zero.

Inductive reactance equals ωL and capacitive reactance equals $1/\omega C$. Actually, the coil possesses some resistance which appears as a resistance in series with L (see Fig. 3), and while

$$(4) \quad I_C = -X_C E = -\omega C E = -2\pi f C E,$$

$$(5) \quad I_L = E / \sqrt{R^2 + X_L^2} = E / \sqrt{R^2 + (\omega L)^2} \\ = E / \sqrt{R^2 + (2\pi f L)^2}$$

Condenser loss encountered in practice (which appears as a resistance associated with C) has not been considered here.

With respect to phase the line current I (the vector sum of I_C and I_L) is—

$$(6) \quad I = E \sqrt{\left(\omega C - \frac{X_L}{R^2 + X_L^2}\right)^2 + \left(\frac{R}{R^2 + X_L^2}\right)^2}$$

The vector relations of Fig. 3B apply. At resonance, the line current I is at its minimum value (I_r), is in phase with E , and is equal to $ER/R^2 + (X_L)^2$.

The vector diagram of the series circuit is shown in Fig. 3C. It should be noted that this diagram is similar to the diagram for the parallel circuit, except that the voltages replace the currents.

The Nature of C

In Figs. 1, 2 and 3, capacitance associated with the coil in parallel resonant circuits is represented by the condenser component C . Actually, however, C represents not just the capacitance of the condenser, but the *total* capacitances acting in shunt with the coil. And these include (1) the actual condenser capacitance, (2) the distributed capacitance of the coil, and (3) stray shunt capacitance due to wiring and to coil and condenser terminals, all of which act in parallel to resonate the circuit. Wherever C appears in the foregoing formulae, it has the inclusive meaning.

$$(7) \quad C = C_c + C_d + C_s$$

Where:

C = total capacitance resonating the circuit,
 C_c = condenser capacitance,
 C_d = distributed capacitance of the coil, and
 C_s = all stray capacitance due to wiring, etc.

For these reasons, the coil L may be discovered to possess a natural resonant frequency, even with no condenser as such connected across it, because the small distributed and stray capacitances form with it a parallel resonant circuit. It is highly important that these extra capacitances be kept as low as possible if consequential losses are to be avoided in receiver-tuned circuits and full advantage is to be taken of the variable condenser range. Hence

increased turn spacing or lattice winding is resorted to in efficient circuits to reduce distributed coil capacitance.

Tuning Range

From equation (1) it is seen that in any variable condenser-fixed coil parallel resonant circuit the maximum and minimum frequencies at which the circuit may be resonated will be determined by the maximum and minimum capacitances in shunt with the coil. Neglecting distributed and stray properties, these limiting capacitances may be taken as those of the tuning condenser. The wider the capacitance range of the latter, the wider will be the frequency band over which the circuit may be resonated.

Often in practice, the maximum resonant frequency of a tuned circuit is chosen as some multiple of the minimum frequency; the ratio of 2:1 being quite common in applications, although a slightly higher ratio (nearly 3-to-1) is encountered in broadcast tuners. In the case of amateur band-spreading, the band of frequencies covered by the tuned circuits is only a few kilocycles wide, representing a ratio of less than 1.5:1 in some cases.

If it is desired to multiply or divide the resonant frequency of any parallel resonant circuit by any factor, and the fixed inductance value, original frequency, and original capacitance are known, the capacitance of the condenser at the new frequency will be equal to the capacitance at the original frequency divided by the square of the factor.

$$(8) \quad C_2 = \frac{C_1}{n^2}$$

$$(9) \quad f_2 = n f_1$$

Where:

C_1 = capacitance at original frequency,
 C_2 = capacitance at new frequency,
 f_1 = original frequency,
 f_2 = new frequency,
 n = factor by which the original frequency is to be multiplied

Thus, to double the resonant frequency (or to provide a tuning range of 2-to-1), the capacitance must be quartered—the tuning condenser must have a capacitance range of 4:1, or two halves f , C must be quadrupled. Within practical limits, any desired frequency range may be achieved by employing the condenser which gives the proper amount of capacitance variation in conjunction with the inductance capable of resonating at the band-limit frequencies.

Range Extension—Trimmer and Padder

It is obvious from the foregoing that the range of capacitance variation in the condenser will decide the frequency range

of the tuned circuit, and that any extension of the capacitance limits above and/or below their normal positions will correspondingly widen or narrow the band of response.

In order to bring about such changes in the limiting values of C, mechanical alterations would be possible, although hardly practicable, in the tuning condenser by addition or removal of plates. However, such a procedure would involve much labour and would affect both maximum and minimum values very nearly to the same degree, and this is not always desirable when setting a frequency range.

The same results may be accomplished electrically by interposing auxiliary condensers in series or parallel with the main tuning capacitance to operate upon the latter's maximum and minimum capacitances according to the following relations for the parallel connection.

$$(10) \quad C_{\min} = C_{\min_c} + C_a$$

$$C_{\max} = C_{\max_c} + C_a$$

For the series connection:

$$(11) \quad C_{\min} = \frac{1}{\frac{1}{C_{\min_c}} + \frac{1}{C_a}}$$

$$C_{\max} = \frac{1}{\frac{1}{C_{\max_c}} + \frac{1}{C_a}}$$

Where:

- C = resultant minimum or maximum capacitance,
- C_c = condenser capacitance at maximum or minimum as indicated,
- C_a = auxiliary capacitance.

From 10 a variable condenser, having a maximum and minimum capacitance of 100 and 10 mmfd., would have its range altered to cover 35 to 125 mmfd. by connecting a 25 mmfd. auxiliary condenser in

parallel. And if the auxiliary capacitance is 100 mmfd., the resultant capacitance range would become 110 to 200 mmfd. If the auxiliary (trimmer) condenser were variable between these values of 25 and 100 mmfd., then any number of maximum and minimum values (and corresponding widths of band-spreads) could be obtained by properly setting it. By application of relations (1) and (8), various frequency coverages could be determined. It must be remembered, of course, that where C appears in those equations and formulas, it is taken to be the complex term appearing on the right-hand side in (10).

It may be desirable, however, to restrict the maximum capacitance of C without greatly affecting the minimum, in order to achieve a desired frequency range, and in such a case an auxiliary capacitance (padder) is connected in series with C (see Fig. 4), and the relations of (11) apply.

In this series combination, if the tuning condenser C1 has a range of 10-100 mmfd., and the padder C2 a fixed value of 100 mmfd., then the capacitance range of C1 is transformed to 9-50 (equation 11). Note that the tuning condenser maximum

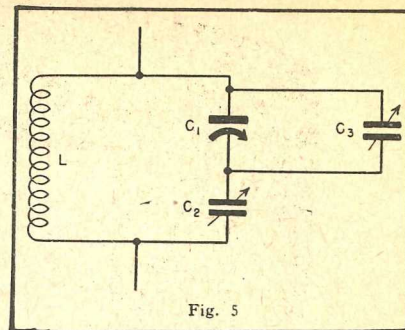
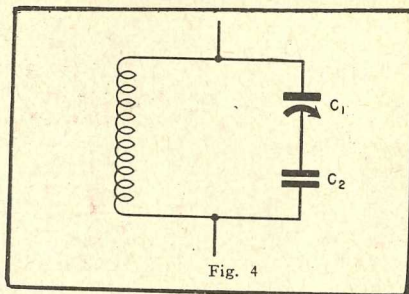

has been altered considerably more than its minimum. If the value of C2 is reduced further to 25 mmfd., and if it is reduced further to 7.1-20 mmfd., the range becomes 7.1-20 mmfd. Note also that as C2 is reduced in capacitance, it has less reducing effect upon the maximum value of C1, while at the same time not altering the C1 minimum tremendously.

The conventional receiver tuned circuit employs the arrangement shown in Fig. 5, with both trimmer (C3) and padder (C2) made variable to achieve any desired amount of band-spread or band-compression. The relations of (10) and (11) are combined to explain the circuit.

In Fig. 5 the total working capacitance in parallel with L, neglecting distributed and stray properties, is—

$$(12) \quad C = \frac{1}{\frac{1}{C_2} + \frac{1}{C_1 + C_3}}$$

and equation (1) becomes:

$$(13) \quad f = \frac{1}{2\pi\sqrt{L \left(\frac{1}{C_2} + \frac{1}{C_1 + C_3} \right)}}$$

The New Midget Three Gang Variable Condenser suitable for 88-108 Mc. FM Band.

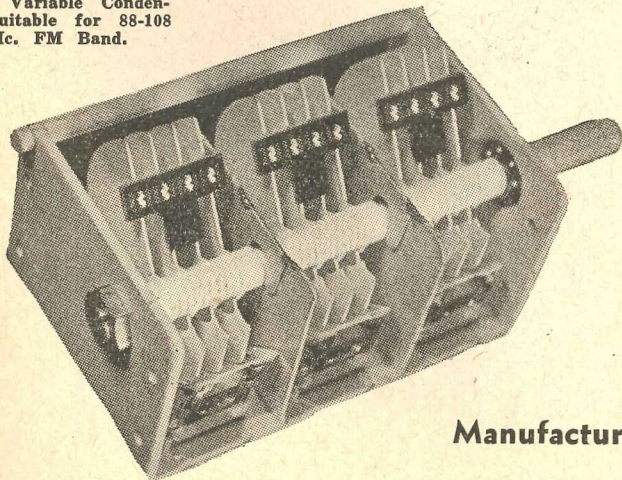

ROBLAN COMPONENTS

Now available to YOU everywhere are ROBLAN midget two and three gang variable condensers, which are of higher quality and lower price than any other manufactured in Australia.

- ★ 9-21 mfd within 2%.
- ★ High Q—admirably suited for V.H.F. equipment.
- ★ Ball bearings ensure long service life.
- ★ Insulation of highest grade imported British bakelite.
- ★ Completely silver plated for low loss and maximum efficiency
- ★ Lowest priced 3 gang on the market.

Manufactured by ROBERTSON & LANSLEY PTY. LTD.
LEICHHARDT, N.S.W.

Trade Enquiries to ELECTRONIC INDUSTRIES



**I WORK
IN THE
'METROPOLIS'**

METROPOLIS "4" The popular Kit Assembly for A.C. use! It's a 4-valve Broadcast model with such quality features as Bakelite Cabinet, Rola Speaker with new Anisotropic Alnico, Aegis permeability Iron-cored B/C Coils and Intermediates, Trimax Power Transformer, etc., and, of course, complete down to the last nut and bolt. The complete price, retail (sometimes slightly variable interstate), Including Sales Tax **£11/17/6**

Plus Valves, £3/12/7

The AEGIS '4' TWINS

**A
'RURAL' LIFE
FOR ME**



RURAL "4" The ideal Kit Assembly for country use. As illustrated, it features attractive mottled Bakelite Cabinet, button Valves for low drain, Aegis iron core I.F.'s J9 and J10 specially designed for Optimum gain, Rola 6" Permag Anisotropic Speaker with Isocore Transformer—highly important for battery sets, Chassis and all metal brackets cadmium-plated, W.S.T. Switch Potentiometer. Price, sometimes slightly variable interstate **£13/13/-** (Plus valves and batteries.)

★ **ATTRACTIVE DISCOUNT
TO AMATEURS AND THE TRADE**

AEGIS MANUFACTURING CO. PTY. LTD.
208 LITTLE LONSDALE STREET, MELBOURNE

DISTRIBUTORS IN ALL STATES

MELBOURNE:
Lawrence & Hanson Electrical Pty. Ltd.
Replacement Parts Pty. Ltd.
Vellis Electrical & Radio Pty. Ltd.
Homecrafts Pty. Ltd.
J. H. Magrath & Co.
John Martin Electrical and Radio Co.

SYDNEY:
John Martin Pty. Ltd.
George Brown & Co. Pty. Ltd.
Fox & Macgillycuddy Ltd.
Australian General Electric Pty. Ltd.
Cook Bros. Pty. Ltd.

ADELAIDE:
George Procter (Factory Representative).
Newton, McLaren Ltd.
A. G. Healing Ltd.
Harris, Scarfe Ltd.
Oliver J. Nilsen & Co. Ltd.
Gerard & Goodman Ltd.
Unbehaun & Johnstone Ltd.

TASMANIA:
Lawrence & Hanson Electrical Pty. Ltd. (Hobart).
Lawrence & Hanson Electrical Pty. Ltd. (Launceston).

BRISBANE:
Chandlers Pty. Ltd.
A. E. Harrold Pty. Ltd.
B. Martin Pty. Ltd.
PERTH:
Nicholsons Ltd.

Please Mention RADIO SCIENCE when Replying to Advertisements.

U.H.F. Techniques

By
HARRY N. EDWARDES, B.Sc., B.E.

Wave guides are hollow pipe transmission lines. They are suitable for use in the micro wave band, their size depending on the wave length employed.

A wave guide has more than twice the power handling capacity of the largest co-axial line that could be used for the same wave-length. This is because of the larger size of wave guide compared with co-axial line for the same wave-length. The losses in wave guides are less for the same reason. Another advantage of wave guides is their convenient mechanical form; there is no inner conductor to be supported, so that joints and elbows are simple.

A wave guide is a single conductor transmission line so that it is not possible to specify voltage and current at any point. The theory has to be based on the concept of electric and magnetic fields. Two conductor transmission lines can also be dealt with by the field theory, and there is identity between the two types of transmission lines in many respects. Thus, from the point of view of impedance measurement and matching, wave guides may be considered equivalent to transmission lines. A wave guide is said to have a characteristic impedance (which may be defined in several ways,

as will be seen later), and any wave guide system has a certain input impedance.

When dealing with systems of pure wave guide components, the absolute value of impedance (in ohms) is not required; all that is necessary is to match one section to another and all impedances are normalised to one particular size of guide. The values of reactances of matching devices are obtained for that particular size of guide rather than in absolute terms (i.e., ohms).

Various Shapes

Wave guides may have different cross sectional shapes, those generally used being rectangular. Circular guides have special applications for rotating joints.

For any shape of guide there are several possible field configurations corresponding to different modes of propagation. These field configurations depend upon the exciting device and whether any mode is propagated depends upon the guide dimensions for any particular frequency. It is usually assumed that other modes are likely to result from irregularities, and steps are taken to prevent them propagating by suitable dimensions of the wave guide or by resorting to special devices.

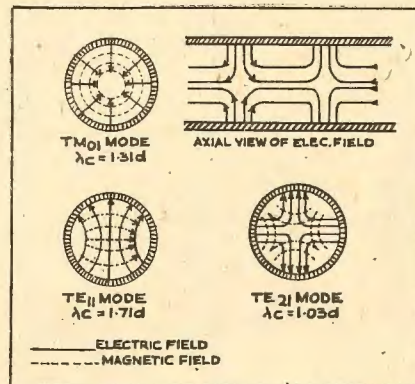

Fig. 2.—Field patterns for circular wave guides.

direction. (See Fig. 1.) This mode is often called the H10 mode because of this axial component of magnetic force. The existence of an axial or longitudinal component of electric or magnetic force distinguishes wave guides from co-axial lines. Maxwell's equations show this to be necessary.

Zig-Zag Propagation

The wave travelling down a wave guide is different from a plane wave because of the field configurations in the guide. However, it may be considered to be composed of two plane waves propagated in zig-zag fashion along the guide (see Fig. 3). This propagation may be compared with the passage of short waves round the world between the Kenelly-Heviade layer and the earth. The fundamental properties of wave guides can be explained on this equivalent plane wave basis.

A radiating source in the centre of the guide will have an infinite series of electrical images in the four walls of the guide. (These are analogous to light images in plane mirrors.)

It can be shown mathematically that the fields resulting from the main and image sources are the same as the fields of two plane waves propagated at equal

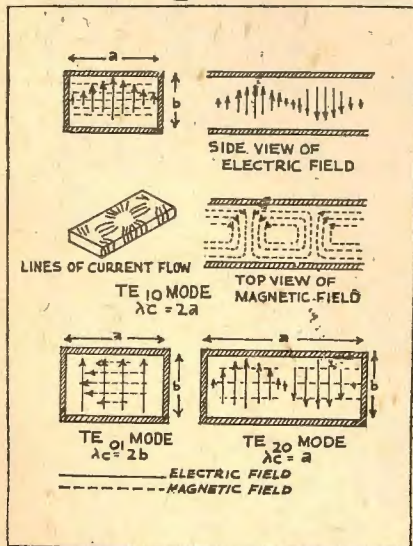

Fig. 1.—Field patterns for rectangular wave guides.

PART 6 WAVE GUIDES

Some of the different field patterns for rectangular and circular guides are shown in Figs. 1 and 2 respectively. Higher modes have more cycles in the field distribution across the guide. These wave guide modes are specified by letters with suffixes, as indicated on the titles.

For example, TE10 stands for a transverse electric wave; i.e., one in which the electric lines of force are all across the guide or transverse, whereas portions of the magnetic lines of force run in an axial

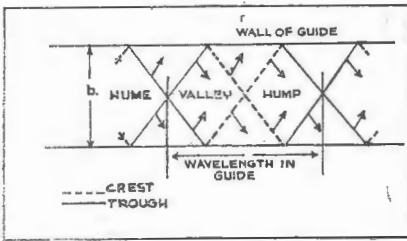

Fig. 3.—Plain wave equivalent.

and opposite angles to the axis of the guide (see Fig. 3) and reflected backwards and forwards between the walls. The angle "x" is given by—

$$\sin x = \frac{a}{l} \text{ where } l = \text{wave-length.}$$

$$2a = a = \text{width of guide.}$$

The angle x increases with the wave-length l, so that when $l = 2a$, x is 90° and the wave is reflected backwards and forwards without moving along the guide. This value of l is called the *critical or cut-off wave-length* (l_c), because the guide will not propagate energy at greater wave-lengths. Some energy flows beyond the cut-off wave-length, but it is attenuated rapidly. An application of a wave guide beyond cut-off is the piston attenuator used in signal generators.

The oblique plane waves travel at the speed of light denoted by C. Thus in time t the wave front advances a distance ct at an angle of x to the axis. The energy, which travels with the plane

waves, thus moves a distance $Ct \cos x$ along the axis of the guide. The quantity $C \cos x$ is called the *group velocity*, and is less than C the velocity in free space. The wave front, however, advances along the axis of the guide, a distance $Ct \sec x$ (see Fig. 3) in time t. $C \sec x$ is called the *phase velocity*, because it is the rate at which the phase or configuration travels along the guide.

This is greater than the speed of light. This may appear paradoxical, but it must be remembered that the energy is associated with the group velocity, not the phase velocity. An example of the phase velocity being greater than the velocity of a wave can be seen in a sea wave meeting a breakwater at an oblique angle. A ripple will appear to move rapidly along the wall as the crest of the wave meets it.

In wave guides the quantities current and voltage are not applicable as for other transmission lines; so that impedance has to be defined in other ways. Since the electric and magnetic fields are analogous to voltage and current, the *wave impedance* is defined as E over H.

Wave Guide Construction.

For radar applications, various standard sizes of wave guide have been adopted. Wave guide is produced commercially overseas by the extrusion process from brass, copper or aluminium, the latter being particularly useful for aircraft in-

stallations. During the war extruded copper wave guide was produced in Australia.

Silver plating is usually employed on 3 cm. wave guide fittings, if not on long runs. One cm. guides are always silver-plated, and often they are made of coil silver to reduce losses.

Wave guides are excited by mounting a suitable source or radiation in the guide. In many cases the wave guide is coupled to a co-axial line. Fig. 4 depicts some typical co-axial to wave guide couplings for the H01 mode. The inner conductor of the co-axial forms an aerial

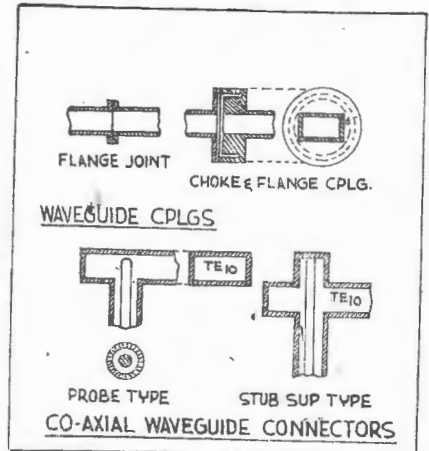
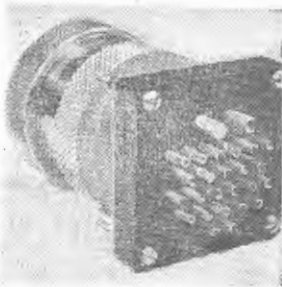

Fig. 4.—Various types of wave guide couplings and connectors.

NEW & USED DISPOSALS EQUIPMENT



MULTI-PIN PLUG AND SOCKET

26-pin, including 2 large pins for heavy current.

5/6 post free

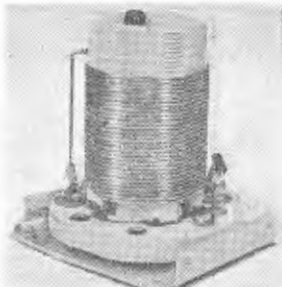

COIL FORMER (ISOLANT)

1½" dia. threaded for 1/16" spacing, American manufacture.

4/- ea. post free



NEW "BIRKO" SOLDERING IRONS

80 watt, operates on 12 or

24 volts 19/6

Postage 2/- extra

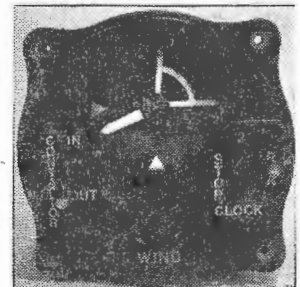

NEW PRECISION TIMER

48-hour jewelled movement, suitable for precision timing over periods of one minute. Ideal for photographic work, electric sign-switching, etc.

Price 18/6

Postage 2/- extra

AVAILABLE ALSO AT:—No. 5 ROYAL ARCADE, SYDNEY

PARAGON RADIO

245 PARRAMATTA ROAD, HABERFIELD, SYDNEY, N.S.W.

TELEPHONE: UA2145

Address all mail to: Box 14, P.O. Haberfield, N.S.W.

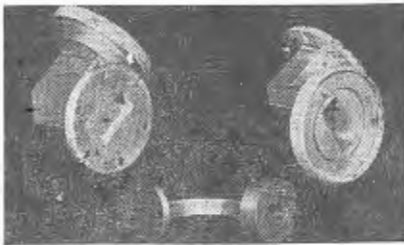

Fig. 5.—Some typical wave guide elbows.

radiating approximately a quarter wave-length from the short-circuited end and sets up the appropriate transverse electric field. For maximum transfer of power, the device must be *matched*. Shunt reactances for matching are provided by the wave guide and co-axial line stubs in the *through* type (Fig. 4), whilst the probe length and wave guide stub provide the adjustment in the other type (Fig. 4). Once the correct setting has been found with adjustable plungers, the coupling design may be *pre-plumbed* (i.e., the stubs are provided with fixed short-circuiting pieces).

Types of Couplings

Connections between sections of wave guide are made by either plain butt flanges or by choke couplings. For 10 cm. work plain flanges are satisfactory, providing good contact is made between surfaces. In practice, it has been found desirable to use carefully-machined and scraped surfaces. This requires fairly heavy bronze castings which are silver-soldered to the wave guide. Wave guides are invariably subject to weathering, so that rubber or cork gaskets are provided in milled grooves in the flanges (see Fig. 4).

At 3 cm. and shorter wave-lengths, it is essential to use choke and flange-type coupling of the type illustrated in Fig. 4, a circular groove or *ditch* a quarter-wave deep in the flange, as indicated, provides the correct impedance relations between the edges of the wave guides to prevent radiation. It is not necessary for the flange and choke to be in contact for electrical continuity. For convenience this type of coupling is often fitted with a screw and union nut coupling device, with locating pins on the flange. The choke coupling allows of movement between two sections of guide, quite a useful feature in wave-guide installations. For negotiating corners, elbows may be used. These may be either curved or mitred type, both of which are illustrated in Fig. 5. The curved bends are more bulky, but cause less mis-match in the feeder and are not so frequency selective. They also have the advantage of reducing the number of joints in the feeder if they are formed by bending long runs of wave guide. Jigs are used for this purpose, the wave guide

being filled with sand or low-melting point metal.

If the inside radius of curvature of the bend is about one guide wave-length or more, the standing ratio is less than 1.03, providing the bending is done carefully.

For confined spaces the mitred bends are essential. These are either fabricated from standard guide or made as castings with coupling flanges included.

Rotating Joints

Micro-wave radar aerials require rotating joints. In wave guide systems this is one of the few applications of circular wave guide. The rectangular wave guide is transformed into circular guide, excited in the TM₀₁ mode. Because of the symmetry of the field in this mode (see Fig. 2), a rotating joint may be made in the circular guide similar to those in co-axial lines. A quarter-wave choke is used at the joint to prevent radiation.

Several types of rotating joints using TE₁₀ to TM₀₁ transformers have been developed, a typical one being shown in Fig. 6. The circular guide stub serves for matching. The resonant ring on the dielectric support is included to suppress the unwanted TE₁₁ mode which would otherwise absorb some of the energy.

Since for 10 cm. the circular guide for such a transformer is about 3½ in. in diameter, a more convenient form of rotating joint is the door-knob transformer type, employing a co-axial line as the rotating coupling element. This is shown diagrammatically in Fig. 6b, while Fig. 7 is a photograph of such a joint. The door-knob transformer was not designed, but "just grew." The power handling capacity of this joint is limited by the co-axial line. It is capable, however, of 600 kw peak power.

In many instances matching devices are necessary in wave guides; aerials and rotating joints invariably need matching for maximum transfer of power and to reduce the maximum electric field across the guide. In experimental work terminations or "infinite lines" need to be accurately matched.

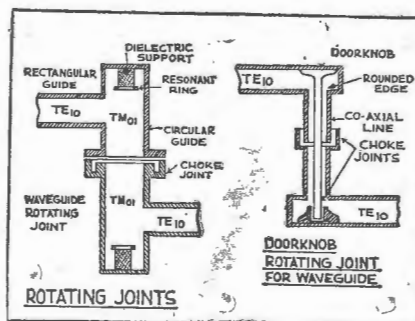

Fig. 6.—The transformer type and door knob transition type rotating joints.

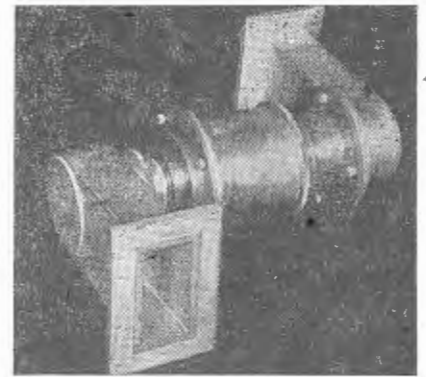

Fig. 7.—Photograph of a door knob rotating joint.

Matching Devices

The simplest form of matching device is a screw inserted through one of the broad walls of the guide. This is effectively a capacitive reactance, the magnitude depending on the depth of penetration. Large screws are more effective and less frequency selective than small ones. If the position of the screw can be varied by moving it along a slot a reasonable range of impedance may be matched. To eliminate the need for a slot and provide for a wide range of adjustment, three screws spaced 1g over 4 apart is the best arrangement. Screw matchers are unsuitable for high powers, because they lower the breakdown voltage of the guide.

Iris diaphragms are the most common form of matching device for aerials and rotating joints. Irises are illustrated in Fig. 8. They consist of thin plates with rectangular holes, fitted into the guide. They may be conveniently placed at a flanged joint and can be made adjustable to some extent. Either inductive or capacitive reactances are available with irises, the former being necessary for high-power applications.

The reactances of irises may be calculated on the basis of an infinitely thin window. It is found, however, that the thickness affects the value somewhat. Quite large mis-matches may be eliminated with irises. In practice, the required position is usually found from impedance measurements and theory, and final adjustment is made by filing the iris down to give minimum standing wave ratio. The breakdown voltage of a wave guide is not reduced appreciably by an inductive iris.

Wave guide stubs with adjustable plungers are often used for matching. An example of this is in the co-axial to wave guide coupling previously described. Plungers are usually of the non-contacting type, making use of quarter-wave chokes, and should have half a wave-length of movement. Stubs are often "T-ed" to the guide for matching and other purposes.

When connected to the narrow edge,

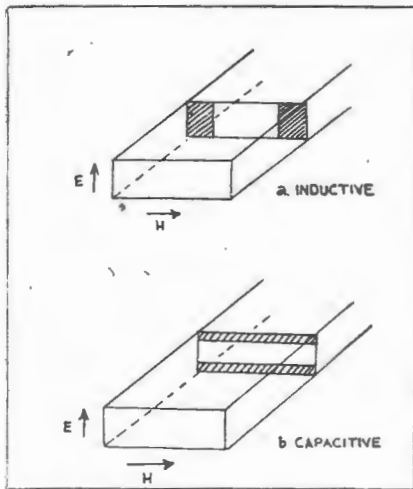

Fig. 8.—Iris diaphragms commonly used as matching device.

the additional impedance is in shunt with the main line, whilst a connection to the broad face represents a series impedance.

At 1 cm. it is common to use circular wave guide stubs, since they are easier to make.

Quarter-wave transformers employing a section of guide of different characteristic impedance are not convenient, but a matching transformer using this principle can be made of one or more dielectric plugs, 1g over 4 long inserted in the guide.

This transformer is obviously unsuitable for high-power work, but is more easily adjustable for experimental work than irises.

Wave Guide Losses

The losses in a wave guide are not increased greatly by corrosion and oxidation. This is because the current flows in the skin of the wave guide material. For a good conductor this is very thin, but for oxides the skin depth is great compared with the oxide coating, because of its low conductivity (skin depth is proportional to the square root of the resistivity). Condensed moisture on the inside surface of wave guides, however, has very drastic effects. Because of the high dielectric constant of water, most of the power flows through the thin film of water and the attenuation is high. For example, at 3 cm. condensed moisture causes a loss of about 1½ db. per metre.

In wave guide installations steps are taken to prevent condensation, either by hermetically sealing or by forcing warm air through the feeder. In ground radar sets, the latter is conveniently achieved by passing the magnetron cooling air into the feeder system, whilst aircraft installations are invariably pressurised (primarily to prevent breakdown at high altitudes, due to pressure) and hence sealed against moisture.

Standing Wave Indicator

Standing wave indicators for wave guides are simpler than those for co-axial lines. A slot may be cut along the centre of the broad face of a rectangular guide without disturbing the field appreciably and without energy radiating. This is because the currents near this portion of the guide flow longitudinally and not laterally (see Fig. 1). There is no inner conductor to support, and the only problem is to provide a suitable carriage and probe. Non-contacting probes with some form of choke coupling are employed at shorter wave-lengths. Figure 9 is an illustration of a 3 cm. standing wave indicator. The two screw stubs on the carriage are matching adjustments to ensure maximum transfer of power from probe to detector. The probe length is kept

(Continued on page 46.)

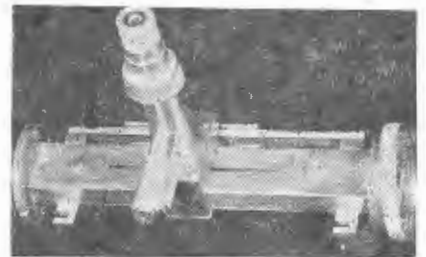

Fig. 9.—A standing wave indicator.

"The York"

FOUNDATION KIT

A boon to the small manufacturer

Comprising:

Cabinet (as illustrated); Chassis; Dial Assembly and Scale; Special Aer-Osc. Coil; Rola 5C Speaker; Rola 6/60 Choke; S/Carlson 2-Gang H. Condenser; Circuit Diagram; Complete Parts List; Simple step-by-step Instructions, "How to build it."

Write, 'phone or call for special price for quantities.

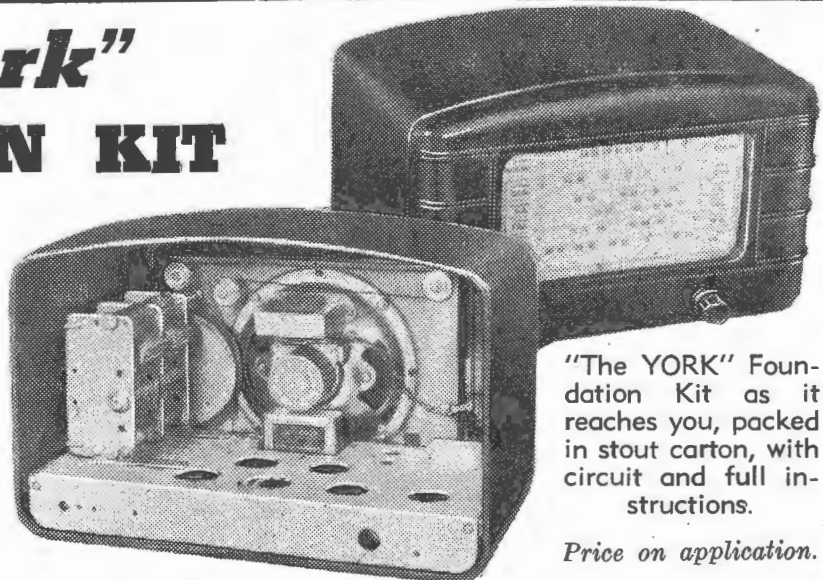

"The YORK" Foundation Kit as it reaches you, packed in stout carton, with circuit and full instructions.

Price on application.

Also supplied as a Kit Set, complete down to the last nut and bolt, including valves and with full instructions that are easy to follow. Build your own set and save pounds. Also, available with Ivory Cabinet.

Price: £15/19/- retail
Attractive discounts to the Trade.



BLOCH & GERBER LTD.

WITH WHICH IS ASSOCIATED

THE WELDON ELECTRIC SUPPLY CO.

46-48 YORK STREET, SYDNEY

TELEGRAMS: "LESAB" SYDNEY

MA6291 (10 LINES)

SERVICE DATA SHEET



MODEL 205

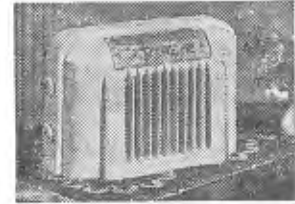

MEASUREMENT SPECIFICATIONS:

I.F. Sensitivity—V1 grid 30 microvolts.

I.F. Sensitivity—V2 grid 2.5 millivolts.

Broadcast Sensitivity—8 microvolts.

Short Wave Sensitivity—55 microvolts.

These figures are related to an audio frequency output of 14 volts measured between the plate of V4 and chassis, through a series condenser of .1 mfd capacity.

ALIGNMENT FREQUENCIES:

1400kc. and 600kc.

455 kc/s. Intermediate Frequency.

CHECK POINT:

1000 kc/s.

POWER SUPPLY:

200-240 volts, 40-50 cycle AC.

LOUDSPEAKER:

6" permag. 5000 ohm transformer.

CIRCUIT: Five valve, dual wave, AC operated superheterodyne, using converter, one stage of I.F. amplification, detector-audio stage, power output stage and H.T. Rectifier.

TUNING RANGE:

Broadcast, 535-1620 kc/s.

Short Wave, 5.9-18.2 mc/s.

VALVES:

V1 Converter 6J8GA.

V2 I.F. Amplifier 6U7-G.

V3 Detector-audio 6B6-G.

V4 Power Output 6V6GT.

V5 Rectifier 6X5GT.

CIRCUIT VOLTAGES:

	Plate	Screen	Osc. Plate	Cathode	Heater
V1	200	*80-90	130	2	6.1
V2	200	*80-90	—	2	6.1
V3	110	—	—	2	6.1
V4	190	200	—	—	6.1
V5	215/215	—	—	200	6.1

*NOTE.—First figure is broadcast operation.

These voltages must be measured to receiver with voltmeter having a resistance of at least 1000 ohms per volt. (Tolerance $\pm 5\%$). Volume control must be turned to maximum.

The voltage drop across choke L5 is 30 volts.

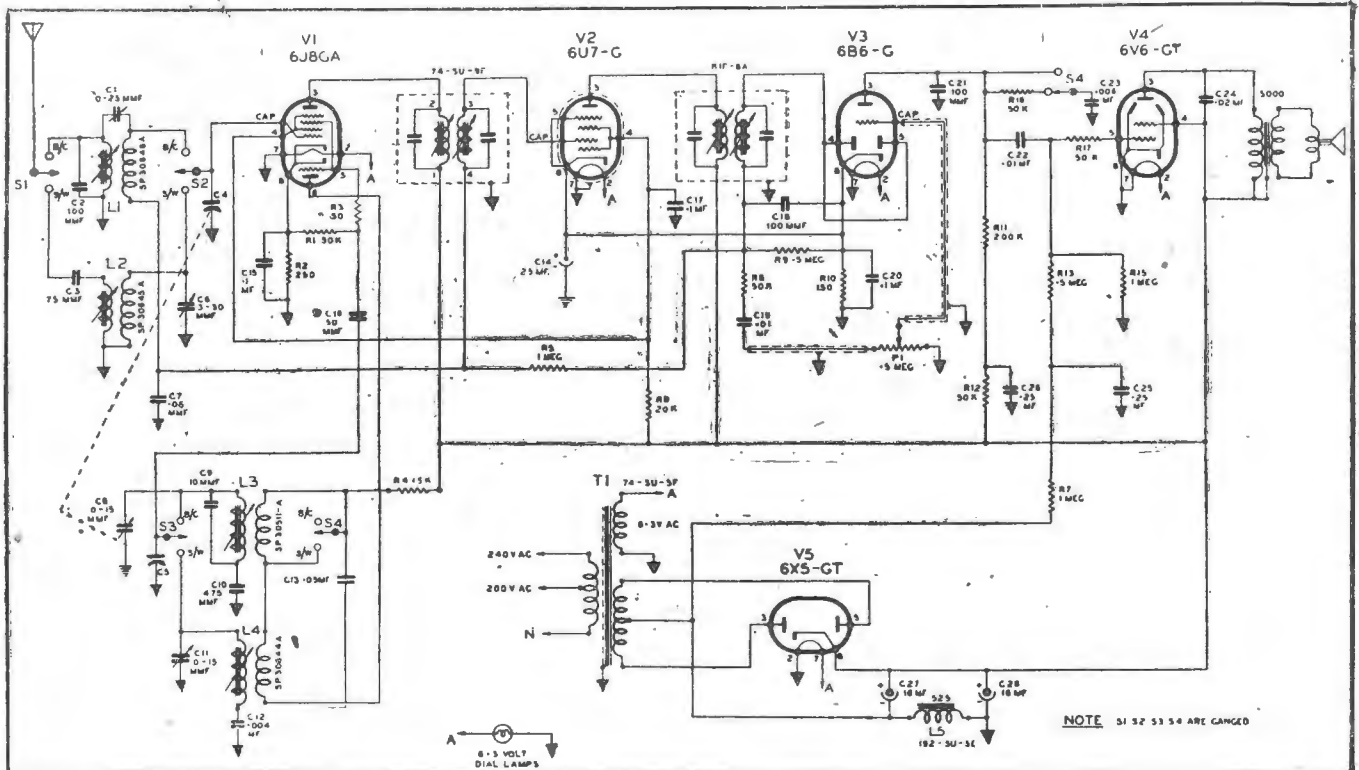

SERVICE DATA SHEET



MODEL 134

MEASUREMENT SPECIFICATIONS:

I.F. Sensitivity—V1 grid 100 microvolts.

I.F. Sensitivity—V2 grid 4 millivolts.
Broadcast Sensitivity—V1 grid 100 microvolts.

These figures are related to an audio frequency output of 14 volts measured between the plate of V4 and chassis, through a series condenser of .1 mfd capacity.

ALIGNMENT FREQUENCIES:

1400kc. and 600kc.
455 kc/s. Intermediate Frequency.

CHECK POINT:

1000 kc/s.

POWER SUPPLY:

"A" Battery 1.5 volt 250 ma.
"B" Battery 67.5 volts, 12 ma.

LOUDSPEAKER:

3" permag. 5000 ohm transformer.

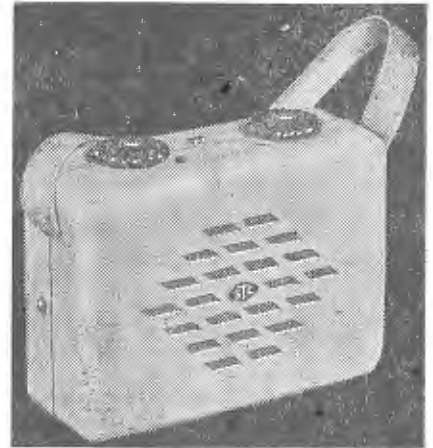

CIRCUIT VOLTAGES:

	Plate	Screen	Osc. Plate	Filament	Grid
V1	60	60	*60	1.4	—
V2	60	60	—	1.4	—
V3	—	—	—	1.4	—
V4	58	60	—	1.4	-8

*NOTE.—Screen of V1 is used as oscillator plate.

These voltages must be measured to receiver with voltmeter having a resistance of at least 1000 ohms per volt. (Tolerance $\pm 5\%$). Volume control must be turned to maximum.

The plate and screen voltages on V3 cannot be accurately measured.

CIRCUIT: Four valve, battery operated, superheterodyne, using converter, one stage of I.F. amplification, detector - audio stage, A.V.C. Low Impedance loop aerial.

TUNING RANGE: 530-1620kc.

VALVES:

- V1 Converter 1R5.
- V2 IF Amplifier 1T4.
- V3 Detector-audio 1S5.
- V4 Power output 3S4.

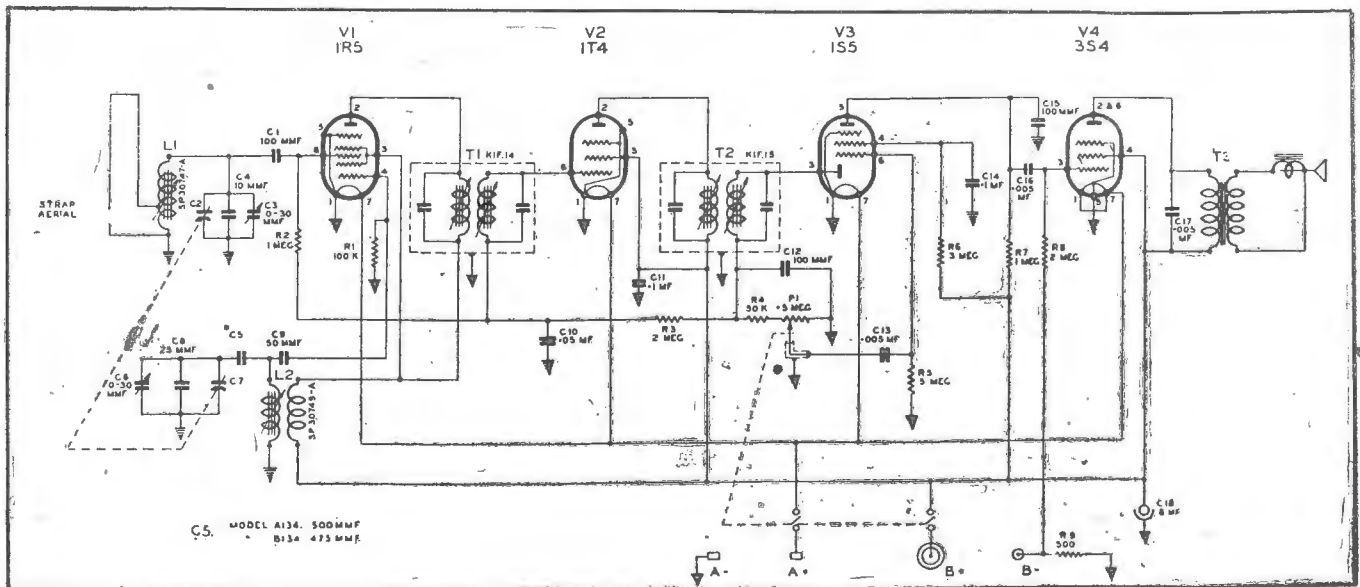

For your note book

A page of radio servicing hints and notes of practical value to the radio serviceman and technician.

NOISY RECEPTION

The cause of noisy reception on either broadcast or short waves is one of the most difficult troubles to diagnose. In general, the sources of these noises can be classified into two categories, and each of these will now be dealt with in turn:—

(a) Noises Originating Within the Receiver Itself

Defective fixed condensers or resistors are a frequent cause of annoyance. Corrosion of soldered joints and oxidation of valve prongs and valve shields also frequently cause noises. Dust collecting in various parts of the receiver chassis can cause a great deal of trouble, both in the way of noises and also in the matter of reducing the set's sensitivity.

Defective condensers or resistors can only be located by means of careful checking one by one. Corrosion of soldered joints can be investigated by gentle pulling on the wires close to the point where they are soldered. It should be noted, however, that this is not an infallible test, sometimes the joint may be *mechanically* secured, while *electrically* bad.

Oxidation of valve prongs and valve shields is a relatively simple matter to check and remedy; simply remove each valve and shield from the set and clean the prongs and shields with a cloth and replace in the set. In the act of replacing, move the valve in and out of the socket several times to wipe the contacts clean.

The same procedure should be followed when cleaning the shields. This simple procedure will frequently perform wonders when the receiver has been used for several months or more.

Dust is one of the greatest enemies of a radio receiver and ideally the set should have a dust cover placed over the chassis at the time of the installation to protect it. If this has not been done, it is a good idea to thoroughly clean the top of

the chassis at least once every six months. Pay particular attention to the removal of dust from valves and valve sockets and from between the movable plates of the main tuning condenser. The easiest way to clean the tuning condenser is by inserting ordinary pipe cleaners between the plates of the condenser sections.

(b) Noises Originating Outside the Receiver

Noises whose source is outside the receiver can be caused by poor joints in the aerial or the ground leads, or by the aerial scraping against another object. Dirt and grime which sometimes collect on the aerial insulators can cause noisy reception also, and it is a good thing to clean the insulators with a little benzine.

An old but effective means of determining whether noise is originating in the receiver or from the aerial system is to tie together the aerial and ground posts on the receiver and turn up the set's volume control. If there is no noise when this is done, it is safe to assume that the noise is originating outside the receiver. If, however, the noise continues, then the trouble is more than likely in the receiver.

Alignment Tool

Many of the iron core i-f transformers which have only a brass rod with a saw cut in the end, frequently stick easily. To prevent spreading or splitting the end when trying to turn with a screwdriver, here is a servicing tip.

Take a 5/16in. insulated rod and drill a hole in the end about $\frac{1}{2}$ or $\frac{3}{4}$ in. deep and just large enough to pass the brass screw of the stubborn slug. Then about a $\frac{1}{4}$ in. from the end of the rod drill a 3/64in. hole at right angles to the rod and passing completely through it.

Through this hole insert a piece of thin spring steel wire and cement it securely in place. It will be found that this tool will permit the most stubborn screw to be turned with ease and without any danger of splitting the screw.

Filter Condenser Test

A quick way to test for leakage in filter condensers is by placing the suspected condenser across the "B" supply voltage to give it a charge. Wait a second and then short the terminals of the condenser together.

If there is a strong spark, it is quite probable that the condenser has very little leakage, and suitable for use in the circuit. In carrying out this test, use well-insulated clips, as the high charge stored in a condenser in good condition can give the unwary a severe shock.

RADIO SERVICEMEN!!

Contributions, preferably of a practical nature, will be accepted for this page. Payment will be made for all items published.

Testing Batteries

In testing the condition of portable and other types of "A," "B" and "C" batteries with an ordinary voltmeter, make sure the check is carried out with the radio receiver connected to the batteries. With the set turned on and operating from the batteries constitutes a load on the batteries, thus enabling a true check of them to be made. Many times with the receiver turned off the batteries will check good, but as soon as the set is turned on and current is drawn, the batteries may shown up very poorly.

Electric Plug Repair

The common habit of pulling electric fixture plugs out of the wall receptacle by the cord frequently results in a short circuit. The wire loosens gradually, eventually shorts and blows the fuses.

To obviate this, tighten up the screws in the plug, then pour in molten sealing wax (obtainable from old tubular condensers) until all wires are covered. This wax will anchor the wire ends securely and double the trouble-free life of the extension cord.

Around The Industry

"YORK" KIT SET AVAILABLE

Latest release for the home set constructor is the "York" kit set now available from Bloch & Gerber.

Housed in an attractive plastic case featuring a large straight line tuning dial, this 4 valve Broadcast mantel receiver is capable of excellent results.

Using a conventional circuit, the valve line up is: 6J8G converter, 6G8G combined I.F. amplifier and detector, 6V6GT output and a 6X5 GT rectifier.

The kit set is supplied complete with all necessary components, together with

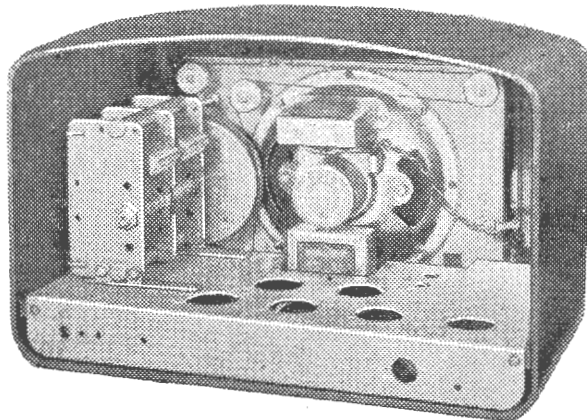

a schematic diagram, building instructions, alignment procedure and retails for £15/19/-. Attractive discounts are given to trade buyers.

All enquiries should be made direct to Bloch & Gerber, 46-48 York Street, Sydney.

Roblan F-M Tuning Condenser

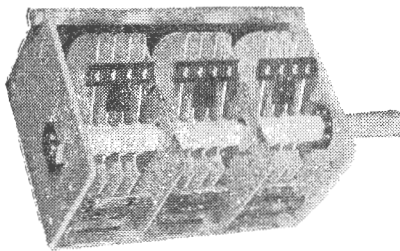

The latest addition to the already well-known range of Roblan miniature radio components is an F-M three-gang tuning condenser. Whilst mainly designed for use in F-M receivers, it is equally suitable for use in any VHF equipment.

Of a particularly robust construction, the unit has a high "Q" factor. To ensure low loss and maximum efficiency, it is completely silver-plated, and the highest grade bakelite is used for insulation purposes. The maximum and minimum capacities (accurate to within 2 per cent.) are 21 and 9 mmfd., respectively, and used in conjunction with suitable coils, will cover the 88-108 mc. FM band.

The condenser is manufactured by Robertson and Lansley, Leichhardt, and supplies are now readily available through most retail stores. All trade enquiries should be made to the local agents: Electronic Industries Imports.

HIGH FIDELITY PICKUP

With greater interest being shown in high fidelity reproduction, the recently released Connoiseur pickup should be of interest to all amplifier enthusiasts. This is a lightweight, moving iron pickup, capable of the highest quality reproduction and which can be readily fitted to any commercial receiver.

Of a distinctive design the unit is smaller than the conventional magnetic unit—a feature which reduces the weight on the needle point to approximately 30 grams. This, in conjunction with the reduction in needle inertia, results in negligible record and needle wear.

The pickup coil is of high impedance—1,300 ohms at 1,000 cps and the correct working load required is 100,000 ohms. The output voltage direct from the pickup terminals is 0.1 volt—sufficient to load a three stage amplifier, whilst in other cases this voltage can be increased to 0.5 volt by the special coupling transformer.

For best results special lightweight



NEW KINGSLEY PRODUCTS

From Kingsley Radio comes details of two interesting products—the Pill-o-phone extension speaker and the special Extension Speaker Adapter.

The Pill-o-phone extension speaker, as the name suggests, is a compact unit specially designed to be slipped-under-the-pillow or other similar position where individual listening is required. It consists of a three-inch Kingsley permag. speaker housed in an attractively moulded ivory plastic cover, and which can be easily attached to any existing receiver. The price of this handy unit is 35/- retail.

To provide the technician as well as the not-so-technical reader with ready means of adding an extension speaker, a special adaptor unit has been developed. This unit requires no soldered connections, but is simply plugged into the output valve socket of the receiver according to the supplied directions. A switch is included and this allows the extension speaker, the receiver speaker, or both, to be operated at will. The price of this adaptor is 22/6 retail.

Both of these units are now readily available from all Kingsley distributors, or further particulars can be obtained by writing direct to Kingsley Radio Pty. Ltd., 380 St. Kilda Road, Melbourne, Victoria.

needles, specially designed for the pickup, should be used, although the H.M.V. Silent Stylus or Columbia 99 are suitable as an alternative.

Using 1,000 c.p.s as the reference level, the frequency response drops off 5 db at 8,500 cycles, whilst at 12,000 c.p.s the cut is 9 db down. From 1,000 c.p.s down to 50 c.p.s, the response is practically constant, and in general it necessitates some form of bass compensation being used.

Further details, as well as technical brochures, may be had on application to J. H. McGrath & Co., 208 Little Lonsdale Street, Melbourne, C.1.

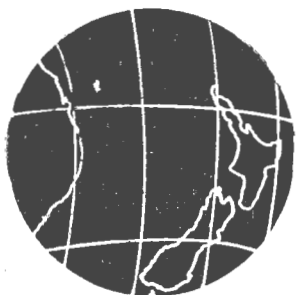

TRANS-TASMAN DIARY

By J. F. FOX

N.Z. STATIONS TO CHANGE FREQUENCY

The operating frequencies (or if you prefer wave-lengths) and the call signs of most New Zealand radio stations will be changed from September 1 next. This announcement was released on June 1 in a joint statement by the Minister-in-Charge of Broadcasting, the Hon. F. Jones, and the Postmaster-General, the Hon. F. Hackett. A similar statement was announced in Australia on the same day.

The planned increases in power of Dominion radio stations to improve reception for country listeners and an endeavour to reduce the interference from Australian stations, has necessitated these alterations. When the change takes place, listeners in the country districts should benefit more than the city listeners, where it is hoped that with the adjustment of frequencies there will be less heterodyne interference on the broadcast band.

In addition to the change of frequencies, there will be several alterations of

call signs. The auxiliary stations in the four main cities are to have the letters YC and YD, while a new series of call signs with the first letter "X" has been chosen. Privately-owned and low-power N.Z.B.S. stations will be effected by this new call allocation.

Big Expenditure Involved

When interviewed, the Minister-in-Charge of Broadcasting, the Hon. F. Jones, stated that an order for approximately £400,000 of equipment for New Zealand stations was coming to hand from Australian radio manufacturers. The shortage of building materials is holding up the expansion of the new stations, but when this is overcome there will be stations at Whangarei, Wanganui, Timaru, Hamilton and Rotorua. A new 10 kw station will be located in the Bay of Plenty area.

The Minister added that the YC stations will take over the former YA transmitters at Auckland, Christchurch and Dunedin. The Greymouth Station 3ZR will shortly have a new kw transmitter, which will be located at Kumara, 15 miles south of Greymouth. 2YN, Nelson, and 2ZA, Palmerston North, will increase power to 2 kw. The four ZB stations will have new transmitters with a power of 10 kw.

Mr. Jones concluded by stating that no decision has been made on what type of programmes the new stations will broadcast.

New Zealand readers are invited to contribute any items concerning radio, broadcasting, DX-ing and amateur radio activities for inclusion in this section. All letters should be forwarded direct to: Mr. J. F. FOX, 41 Bird Street, St. Kilda, Dunedin, S.2. N.Z.

NEW ZEALAND STATION LOG

Call Sign	Location	Present Frequency	Present Frequency from Sept. 1st	Present Power (watts)	Future Power (watts)	Future Call Sign
Auckland District:						
1YA	Auckland	650	750	10000	10000	
1YX	Auckland	880	880	100	10000	1YC
1ZM	Auckland	1250	1250	1000	1000	1YD
1ZB	Auckland	1070	1070	1000	10000	
Wellington District:						
2YA	Wellington	570	570	60000	60000	
2YC	Wellington	840	650	5000	60000	
2YD	Wellington	990	1130	500	500	
2ZB	Wellington	1130	980	1000	10000	
2YH	Napier	750	860	5000	5000	2YZ
2YB	New Plymouth	810	1370	100	100	2XP
2YN	Nelson	920	1340	30	2000	2XN
2ZJ	Gisborne	980	1010	200	200	2XG
2ZM	Gisborne	1180	1180	100	100	2XM
2ZA	Palmerston North	1400	940	1000	2000	
Canterbury District:						
3YA	Christchurch	720	690	10000	10000	
3YL	Christchurch	1200	960	150	10000	3YC
3ZB	Christchurch	1430	1100	1000	10000	
3ZR	Greymouth	940	920	100	10000	3YZ
Otago and Southland Districts:						
4YA	Dunedin	790	780	10000	10000	
4YO	Dunedin	1140	900	150	10000	4YC
4ZB	Dunedin	1310	1040	1000	10000	
4ZD	Dunedin	1010	1430	100	100	4XD
4YZ	Invercargill	680	720	5000	5000	
New Stations of the New Zealand Broadcasting Service:						
1YZ	Rotorua	800 kilocycles				
1XN	Whangarei	970		2000 watts		
1XH	Hamilton	1310		2000		
2XA	Wanganui	1200		2000		
3XC	Timaru	1160		2000		

DX Contest

The 1948 Memorial Cup contest, run by the New Zealand DX Radio Association, is now well under way, and is open to members of the Association who are resident in New Zealand. It is divided into three divisions, broadcast, short-wave broadcast, and amateur phone. In addition to the Memorial Cup, four certificates will be presented to the three section winners and to the holder of the Cup.

ZB Auxiliary Transmitters

Radio enthusiasts who rise early in the morning to tune the dial could not help hearing a New Zealand station transmitting recently on 1460 kc. The station announcing as 3ZB was apparently testing its auxiliary transmitter before beginning the day's programme on 1430 kc.

Most of the ZB stations have a stand-by transmitter, which is used only when the main transmitter breaks down. 4ZB had an auxiliary station on 1360 kc, while Wellington's 2ZB was heard about two years back testing their stand-by station on 980 kc.

However, these days auxiliary transmitters use the same frequency as the main transmitters, and 3ZB auxiliary will probably revert to 1430 kc.

ON THE BROADCAST BAND

STATION FREQUENCY CHANGES

Changes are to be made in frequency of several Australian and all New Zealand stations, with the exception of five. This move on September 1st, will be of interest not only to listeners living near stations affected, but since it marks the use of frequencies off the ends of the existing broadcast band, and not at present employed by Australian Stations, should also attract the interest of all radio owners throughout the Commonwealth.

Under the changes, 4QL Longreach will operate on 540kc. (just below 2CR in frequency) and 2NA Newcastle, is apparently to commence operation on 1,510kc (just above the 2BS and 3AK end of the band).

In addition, frequencies up to 1,560kc. have been assigned to new ABC Regional Stations throughout the Commonwealth in an attempt to improve reception of ABC programmes in areas where, at present, existing stations are not well received.

While the beginning of a gradual ex-

pansion of the normal broadcast band as we know it in this country has been expected for some time, changes on other frequencies will also take place on this date. This is largely as the result of plans set down by the National Broadcasting Service of New Zealand, whereby a great many changes will take place in the Dominion in order to improve reception in country districts, and to avoid interference from Australian stations. An agreement was reached by both countries before any changes on either side of the Tasman were definitely decided upon.

We extend our many thanks to Mr. H. Morris, Christchurch, New Zealand, for information regarding these changes.

By
ROY HALLETT

READERS' REPORTS

Early evening DX is proving quite interesting again this winter, several interesting signals being widely heard, while at favourable locations really surprising volume is available from some trans-Pacific stations.

ZJV Suva, Fiji, 920kc. may be heard frequently here although interference from Australian stations makes logging this one difficult at many centres. Mr. Cushen says he hears this one in N.Z. with news in Hindi-stani, at 5 p.m., relay of ABC news at 7 p.m., local weather at 7.10, closing at 8 o'clock. Try for this one around sunset before Australian stations can interfere with the signals.

We were puzzled when we heard Hindu-stani, or what we thought to be that language, broadcast over ZJV for the first time some years back, but we later learned that this is for the benefit of the many Indians employed in the Fiji Islands. Another evening station heard by Mr. Cushen and others in N.Z. is 2AP Apia, Western Samoa. This one operates on 1420kc. but as it leaves the air fairly early in the evening, it is not likely that it will be heard by many local DXers.

Mr. V. T. Shaw, Townsville, mentions that he is experiencing amazing reception from North American stations. The powerful Mexican XEBG, for example, 1550kc. is regularly heard at comfortable loudspeaker volume around 8 p.m. In the evenings KNX Los Angeles, 1070kc. (a "Midnight American" for most of us) provides tea-time entertainment for him, while KSL Salt Lake City, Utah, 1170kc. is also quite loud at the same time, around 6 p.m. He has heard KNX advertise used cars from a local firm as selling at less than 100 dollars.

DXers are advised to watch for other American stations between 1500 and 1600kc. at night, including XERF, with studios in Del Rio, Texas, U.S.A., transmitting from over the border in Mexico on 1570kc. heard so well by Mr. Norm Harper, Mr. Cushen and others. Try around 9 p.m. for this one.

Also try for KOGT, Orange, Texas, which shares 1600kc. with other Americans, as it is on the air till 6.15 p.m. most nights, later on Sundays with a programme especially for listeners in N.Z. This one should

not be heard easily in this country, but may be worth listening for.

Our latest report from Mr. Norm Harper, in Tooborac, Vic. contains details of signals heard around 1600 kc. and our friend asks whether or not amateur stations operate around this frequency. The stations he hears are in two-way contact with calls like—"Nan Green Roger calling Nan Charlie Roger" etc.

Whilst we have not heard these particular signals they may be any of several groups of stations permitted to conduct two-way communications for various reasons, such as—small vessels (fishing craft, etc.), light-house to shore base, etc. The identity of these stations is usually difficult to determine as such contacts are generally of a private nature.

Mr. Ted Tinning, Kew, Vic. has sent reports recently to several interesting stations, including HLKA, 970kc. (formerly JODK) and is hearing KZRC Cebu, P.I. on 600kc. He is hearing XPRA Kunming, China, on 700kc. in place of its 690kc. channel, and HSPJ Bangkok, Thailand (heard irregularly on its old frequency of 825kc.) is another of the several others reported. He also mentions that Singapore has changed its frequency from 570kc. as reported last month, to a frequency they have been heard on previously, 620kc.

Mr. Stuart Kerr, Maryborough, Vic. has received a letter verifying his reception of XERF, with verifications also from KNX and KFOX (first report for some time from Australia, the station advises) in U.S.A., KZOK Manila, P.I. and others.

Writing from the studios of ZBW, Mr. C. Stansfield advises that English language programmes are presented over ZBW, operating on 845kc., while programmes in Chinese are heard via ZEK, on 640kc. Both stations are on the air till 1 a.m. E.S.T. and operate from studios on the 2nd floor of Hong Kong's Gloucester Buildings. Short-wave station ZBW3 relays many programmes from these stations.

ABC OUTPOSTS

An interesting station not likely to be heard so easily after the September changes in 9PA, operated by the ABC from Port Moresby, New Guinea, on 1250kc. a channel shortly to be occupied by 2DU Dubbo and 7BU Burnie. Many programmes well-known to listeners throughout Australia are re-broadcast over 9PA, its signals being audible at most locations, particularly around 10 p.m. when the channel is clear. Earlier in the evening—from sunset till 8 o'clock—12M Auckland may be tuned on this channel.

Another interesting ABC "outpost" is 5DR Darwin, 1500kc. which is also widely heard at night, generally around 10.30 to 11 p.m., that is, after 2BS closes down, and before 3AK begins its all-night service at 11.30 p.m. week nights. I believe 5DR leaves the air at 11 o'clock, but omitted to check this when last listening to the station.

PROPOSED STATIONS

Some frequencies (with proposed call signs shown where known) allotted national stations to take the air in the near future include:—

- 660kc. Manila, N.S.W. (2NU).
- 720kc. Taree, N.S.W.
- 750kc. Broken Hill, N.S.W. (2NB).
- 750kc. Moora, W.A.
- 800kc. Bega, N.S.W.
- 810kc. Glen Innes, N.S.W.
- 890kc. Cairns, Q'land. (4QY).
- 820kc. Kiama, N.S.W.
- 920kc. Northam, W.A.
- 840kc. Kempsey, N.S.W.
- 1160kc. Mackay, Q'land. (4QA).
- 1160kc. Mt. Gambia, S.A.
- 1520kc. Narooma, N.S.W.
- 1530kc. Tenterfield, N.S.W.; Bendigo, Vic.; Pt. Lincoln, S.A.
- 1540kc. Lithgow, N.S.W.; Gympie, Q'land.; Queenstown, Tas.
- 1550kc. Armidale, N.S.W.
- 1560kc. Canberra, A.C.T.

NEW W.A. STATION

A new commercial broadcasting station has commenced operation from Collie, W.A. Operating on a frequency of 1430kc. with a power of 500 watts. The station took the air on Saturday, 29th May last, and has been assigned the call sign 6CI. Programmes broadcast over this station will be taken generally from 6PR, which station's programmes are relayed also to 6TZ Dardenup, on 1340kc. with 2kw.

6CI has been installed primarily to improve reception of 6PR programmes in the Collie area. Like other W.A. stations, each station in this group share frequencies with stations operating from the Eastern States, this are not heard well in the East till late at night. Most W.A. stations are heard best from around 11.30 p.m. till as late as 2 a.m. E.S.T., ABC stations remaining on the air till that hour—W.A. time, of course, being two hours behind E.S.T.



SHORT WAVE LISTENER



By TED WHITING

TEST CRICKET BROADCASTS

As was the case last month, the main interest at present is in the Test cricket at present being played in England. Many, who rarely listen on the short-wave bands, are finding that excellent reception can be had on these Frequencies, and these broadcasts of the Test matches are by no means any exception.

The well-known voices of John Arlott, Rex Alston, Alan Macgilvray and Arthur Gilligan are being heard with their well-worded descriptions of the events in all parts of the world, Australia being very well served in this respect. The game

may be followed throughout direct from the B.B.C. on 21,470 kc. and 17,810 kc., and at times when reception conditions fall off, especially early in the night, excellent reception is to be had by means of the relay transmitted by Radio SEAC, Ceylon, on 15230 kc, until 11.30 p.m. and on 1170 kc. from 11.30 p.m.-3.30 a.m.

Frequent broadcasts are also made in the General Overseas Service, but these are not a continuous relay. The B.B.C. will no doubt be pleased to hear from listeners to these transmissions, thereby assisting them in the future choice of frequencies.

NEW STATIONS

In the current issue of "Radio Listening Post" the official organ of the Short Wave League of W.A., we glean information regarding quite a few new stations:

Radio Moscow, 15390kc. is heard in English transmission at 10.15-11.15 p.m., with a nice signal.

XOPB, China on 12120kc. is heard in the west at good level at 8 p.m.; similar results being obtained here.

CS2MK operating on 11027kc. has now replaced the transmitter on 11040kc. in the transmission closing at 9 a.m., this one being heard later over there than is the case in the eastern States.

CR7BE, Lourenco Marques, Mozambique on 9175kc. is heard at fair strength at 9 p.m. in their two-hour transmission.

Radio Algiers has again moved, his time to 9570kc.; heard nicely at closing at 9 a.m.

Radio Wien, Vienna has a new frequency of 7240kc., replacing that of 7175kc. which has been used until recently.

CR6RI, Angola, heard only rarely at this location is reported at 4.30-5.30 a.m. on 7165kc.; this one is easily identified and will verify.

OQ2AC, Leopoldville, Belgian Congo on 7195kc. is heard well at 2.30-3.15 a.m. The other outlets of this station are, of course, heard daily with little difficulty.

FK8AA, Noumea, now operating on 6000kc. is heard with the usual signal at 7 p.m.; this one is still suffering from the modulation trouble which has been evident for some months.

HH2S, Port au Prince, Haiti, on 5940kc. is another unusual one reported as heard at 10.00-11.30 p.m. in an English transmission. This service is only intended for local reception and the station staff would no doubt be interested in reception reports from "down under."

SPW, Poland, 11710kc. is on the air from 9.00-10.20 p.m. and is reported also. From Denmark comes the news that the new transmitter which has been under construction for some months is now due to commence operations. From several sources reports are to hand that what is thought to be this station has been heard testing on 21560kc. at 1.40 a.m., and using English recordings and announcements in a Scandinavian tongue. We will be particularly interested in reports on any transmissions heard from this station.

Sofia, Bulgaria, has moved from 9350kc. to 9369kc. and is to be heard with news at 6.15 a.m.; the station closes at 7.30 a.m.

PJC2, Willemstad, Curacao is an infrequently-heard station in this part of the world. The outlet on 2315kc. is now in parallel with the 7250kc. outlet until closing time at 12.30 p.m. An English transmission is radiated at 11 a.m. for 15 minutes, but we hardly think will be heard locally. The former transmitter has been put into use recently (it was formerly an aircraft transmitter) to facilitate reception in adjoining islands.

NEWS FROM AMERICA

News from Mr. K. Boord, Short Wave Editor, Radio News, U.S.A., is very interesting this month. While some of the stations may not be heard here, there is always the possibility that such signals may be heard under freak conditions.

The new Danish transmitters are to use 100Kw and will operate on 4 frequencies between 13.8m and 50m and will operate on a 24-hour schedule with aerials beamed to North America and Greenland; South America, China, Japan and Australia; and in addition, to Danish nationals on the high seas. Danish, English, French and Spanish will be used in the appropriate transmissions.

Located at Elizabethville, Belgian Congo, **OQ2AC** on about 7105kc. has been heard announcing as "Ici Radio Collaise", the schedule appears to be 2.30-3.10 a.m.

The new Finnish transmitter of 100Kw is soon to take the air, located at Pori will commence operations about mid-July with world-wide transmissions; no details of frequencies or schedules yet available.

From Norway, current daily programmes for Norwegians abroad, with some English are radiated on 6185kc., 9610kc. and 11735 kc., using 8Kw on the first two and 100Kw on the latter, at 11a.m.-midnight.

The current schedule for the Swedish stations states that SBU has been replaced by SBT, 15155kc. in transmission at 10-11 a.m. for Swedes abroad. The weekly DX programme is carried at 11-11.15 a.m., Saturday. "Radio Italiana" located at Milan is carrying the North American programme at 10-10.55 a.m., news at the half-hour, on 15120kc. and 11810 kc.

VE9AI, Edmonton, Canada is now only using their assigned frequency of 9540kc.; we suggest that this one may be heard at about midnight.

JVW, 15225kc. and JVW3, 15325kc. Tokio,

have replaced **JVW2, 9505kc and JVW4, 9560kc.** in the Japanese Home Service which is heard at 6 p.m.-midnight.

Radio Nacional, Lisbon, Portugal is now operating on a new channel of 11845kc. at 7-8 a.m.

A new Cable and Wireless outlet is reported from Greece, **SVW, 15905kc.** located at Athens, is heard at 7.45 a.m. in parallel with **SVR, 13670kc.** in contact with American Commercial stations.

Mr. Boord has received a letter from Monte Carlo, Monaco, verifying his reception of the 6035kc. outlet operating on the schedule 4.30-6 p.m., 9-11 p.m., 4-8.15 a.m. In July, a second S.W. outlet will be put into operation using a power of 25Kw in either the 25 or 31 metre band. For those interested, the medium wave outlet will increase power to 120Kw.

Radio Dakar, French Cameroons, is on a new frequency of 15624kc., heard as late as 9 a.m.

LRU, Buenos Aires is now operating on 15280kc. between the hours of 4 a.m. and 8 a.m. Slogan is "Radio El Mundo."

Warsaw has been testing on 11710kc. at 11 p.m., no English in this transmission which at times closes at 10.20 p.m. This station will maintain regular schedules in the near future as Warsaw III.

Current schedules of the Danish Brigade Radio located in Germany on 6225kc. are 10-11 p.m., 1-3 a.m., 5-6 a.m. Transmissions are still experimental.

Bucharest is operating on 9253kc. and 6200kc., with an English transmission at 5-5.30 a.m.

INTERESTING CORRESPONDENT'S LETTER

This month we have some very interesting information forwarded to us by Miss Sanderson, Malvern, Vic. Among the many items which follow we have the Summer Schedule from Hilversum, Holland.

HILVERSUM SUMMER SCHEDULE:

Transmission to Pacific Area and Europe.
8-8.40 p.m., 21480kc., 17775kc., 15220kc., 6020kc.

Transmission to U.S.A., Canada and Australia.

9.30-10.10 p.m., 11730kc., 9590kc., 6020kc.
Transmission to the Pacific Area, Australia and New Zealand.

Tuesday, 6.30-8.00 p.m., 21480kc., 17775kc., 15220kc., 6020kc.

Transmission to Africa and South America.

Sunday and Wednesday, 7-8.30 a.m., 11730 kc., 9590kc., 6020 kc.

XEBT, Mexico

From Mexico comes news of the station XEBT, 9625kc. which with the broadcast outlet on 1220kc. are known as "Estaciones Radiodifusoras Comerciales". The Station Manager, Ing. Andre Duprat states that the short wave transmitter has a power of 10Kw and runs in parallel with the broadcast band station XEB. News is broadcast daily in English at 1.30-1.45 p.m., the remaining programmes being in the local Spanish. For those interested in a verification the address is Estudios Y Oficinas, Calle Buen Tono Num, 6, Mexico, D.F.

"Voice of America" P.I.

A letter received by Miss Sanderson from George H. Chapman, Voice of America, Manila, Philippines is quite interesting. Mr. Chapman, Chief Engineer is interested in any reports from this area and states that the station operates on 11890kc. at a rated carrier output of 50 kilowatts. This energy is fed into Rhombic Antennae so placed as to give the desired coverage.

In addition to the schedule given below this station operates on 15330kc. in a relay of the "United Nations' Programme" beamed to Burma at 5.30 p.m. daily, except Monday.

The 11890kc transmission is heard in the Voice of America programmes from 7 p.m. continuously to 1.05 a.m. and are conducted in English at 7 p.m., Russian at 9 p.m., Korean 9.30 p.m., Chinese 10 p.m., English 11 p.m., Malay 11.15 p.m., Annamese 11.30 p.m., Siamese 11.45 p.m., and finally in English at midnight till close. These programmes are beamed to China, Manchuria, N.E.I., and Burma at the various times.

Colombian Stations

The DX Bulletin includes a list of Colombian stations. We think they will be of interest to our readers.

HJFH, 4875kc., Armenia; HJAB, 4785kc., HJAG, 4905kc., Barranquilla; HJCO, 4955kc., HJCT, 6062kc. and 6200kc., HJC, 11650kc. and 11760kc., HJCP, 6073kc., HJCH, 4895kc., HJCX, 6018kc., HJCD, 6160 kc., HJKE, 4885kc., Bogota; HJGF, 4845kc., HJGB, 4773kc., Bucaramanga; HJAE, 4965 kc., HJAP, 9980kc., Cartagena; HJED, 4825 kc., HJEX, 4865kc., Cali; HJBB, 4815kc., Cucuta; HJFB, 6105kc., Manizales; HJDP, 4885kc., HJDE, 6145kc., HJDX, 4975kc., HJDU, 4805kc., Medellin; HJFA, 6045kc., HJFK, 6097, Pereira; HJDG, 4805kc., Quibdo.

South African Stations

A further page of information received by the same reader came from an eminent S.W. Listener in Mr. M. P. Laubscher, Discovery, Transvaal, South Africa. Any of our readers who follow their hobby through the pages of overseas magazines will know that Mr. Laubscher is one of the most expert among Short Wave listeners and has some very fine reception to his credit. In this letter he details the schedules of stations located in Africa, and we are publishing these, knowing they will be of interest to many of our readers.

Radio Clube de Benguela, Benguela: CR6RB, 9165kc., CR6RF, 7054kc., 9.15-10.00 p.m., 3.30-5.00 a.m. This one verifies with a nice card from Caisca Postal No. 19, Benguela, Angola.

Radio Clube de Huila, Sanda Bandeira: CR6RH, 9235kc., 100 watts, 3-5 a.m.; Sunday from 9.30-10.45 p.m., 3.00-4.30 a.m. Address, Caisca Postal 111, Sa Da Bandeira, Angola.

Radio Diamang, Dundo: CR6RG, 8242kc. Operates from 4-5 a.m., but not heard recently.

READERS' REPORTS

Readers desirous of submitting Short Wave reports for inclusion in these notes, should ensure they reach our Short Wave Correspondent not later than the 1st of each month. Address all letters to:—Mr. Ted Whiting, 16 Loudon Street, Five Dock, N.S.W.

Radio Clube de Huambo, Nova Lisboa: CR6RD, 7152kc., 9.15-10.15 p.m., 4.30-5.30 a.m. Mr. Laubscher states that this one has the strongest signal at his location and should be heard without difficulty in this country.

Estacao Radiodifusora do Lobito, Lobito: CR6AA, 7177kc. using a power of 1Kw., concludes transmission at 5.30 a.m.

Radio Clube de Malange, Malange: 7140kc. drifting occasionally to 7160 kc. and using a power of 50 watts. Schedule: 5-6 p.m., 10.30-11.30 p.m., Sunday. Week-days: 10-10.45 p.m., 5.30-6.30 a.m. Address for reports, Caisca Postal 83, Malange, Angola.

Radio Clube do Mocamedes: CR6RM, 7700 kc., 6-7 a.m.

Radio Clube do Tul de Angola, Lobita: CR6RS, 7058kc., 9-9.30 p.m., 3-4 a.m., 5-7 a.m. This latter schedule is rather doubtful.

Philippines Schedule

Raymond E. Spencer, Programme Manager, Philippine Broadcasting Corporation, Manila in a letter to Miss Sanderson has offered regular schedules for the stations KZPI, 800 kc. and the short wave outlet KZOK, 9500 kc., which operates on a power of 250 watts. We hope to have these schedules in the near future and will be pleased to publish same. Reports, however, can be sent to the above address and will be welcomed.

NEWS OF THE AMATEUR BANDS

Despite the often peculiar conditions on the lower frequency bands these days, much activity is noticed and some very fine contacts are being made, with good level signals at both ends.

Conditions recently on 28 Mc have been very variable, by no means unusual on this band. Although the regular signals are definitely down in level there are quite a few amateurs who are sticking to the bitter end and remain hopeful for the better days in store. Meanwhile, much activity is evident in adjusting beams which will reap its benefit in the warmer weather ahead.

14 mc. Popular

The ever-popular 14 Mc band is productive of good signals, the activity at the week-end seems to be at an all-time high level, as indicated by the amount of hetrodynes on the band. Early morning contacts are at excellent level for the most part, many Europeans being heard and worked by the warmer-blooded members of the amateur fraternity. Local and interstate signals are heard in the forenoon with a few W's still pouring through to some effect. In the afternoon the skip lengthens to bring in the Americans and later, at about 4 p.m., more Europeans are heard, but we find at not so great a level as in the morning. Night reception has fallen off of late, but will improve in coming months when activity on the band will increase.

The usual local and interstate contacts are heard on 7 Mc throughout the day at the same good strength, but at night the band falls to bits as far as local and semi-local contacts are concerned, little DX being heard at any time recently.

Good Signals on 80 m.

Many well-known calls are heard on 80 in the evening, most of those so prominent on 40 having migrated to this band in order to maintain their schedules. The signals on this band have been phenomenal recently, apart from the local and interstate signals, ZL's have been at fine strength and on several nights at about 9 p.m., several W's were heard at very fine strength, and with good readability all through. How long these conditions will continue is a matter of conjecture, but we feel that they will continue for some time to come.

NEW ZEALAND READERS

Ensure you receive every copy of RADIO SCIENCE as soon as it is published by taking out a subscription. This can be made through our local agents, H. Barnes & Co., 4 Boulcott Terrace, Wellington, any branch of Gordon and Gotch Ltd., or if you prefer, by writing direct to our office, Box 5047, G.P.O. Sydney.

In each case the rates are the same: 12/- per annum, or 21/- for two years, post free to any address in the Dominion.

READERS' REPORTS

Fine reports received from Mr. A. T. Cushen, Invercargill, N.Z., in the form of the usual letter and the current issue of DX Bulletin.

HCIAC, "Radiodifusora la Voz de Democracia", Quito, Ecuador is heard in N.Z. at 2.30 p.m. Frequency is 6210 kc.

OAX1B, "radio Piura", Peru on 6190kc. is good listening at 2.30 p.m.

One which has Mr. Cushen puzzled is a station which, after CE622 closes at 2.10 p.m., operates on 6225kc. and plays American recordings. The announcement in a Scandinavian language, possibly Danish, at 3 p.m. mentions the American Forces network, so points to Germany as the location. Mr. Board's letter provides the answer.

OAX5E, "Radio Chinchá", Peru, 6170kc. is heard in N.Z. signing at 2 p.m.; OAX4G, "Radio Lima" signs with "Goodnight Melody" at 2.45 p.m. on 6095kc.

Further Peru stations heard by Mr. Cushen at this time are OAX1A, 6710kc., OAX4V, 5905kc., OAX4Z, 5895kc., OAX4W, 9880kc., all closing at 2.30 p.m.; OAX4M, 6315kc. and OAX6E, 6330kc. signing off at 3 p.m.

Chileans are also heard at this time, among them being CE615, 6150kc., CE622 and CE970, 9720kc., CE1190, 11900kc. heard closing together with "Land of Hope and Glory" at 2 p.m.

HC2AK, 4640kc. heard closing at 3.35 p.m. Sunday, while HC2ET, 4710kc. and HC5HC, 4950kc. are heard in relay as late as 4 p.m.

COCY, 11735kc., after being off the air for some time, returns in a relay of COHI, and signs off at 4.03 p.m.

Radio Baghdad, 7092kc. is heard in Arabic at 11 p.m.-5 a.m., while a further transmitter is operating in Kurdish at 1 a.m.-4 a.m. and in English at 4 a.m.-5 a.m. This latter one is on 7060kc.

Radio Gambia, Bathurst, Gambia closes at 8.30 a.m. on 9530kc., requesting reports on their transmissions.

Rome. Italy has a service at 10.15 p.m. in English on 11810kc. and 15120kc.

A verification in Arabic and English was received from Radio Tabriz. The address is B. Bouchehrpou, Director of the Azerbaijan Dept. of Publications and Propaganda, Tabriz, Iran. The present schedule is 8-9 p.m. on 11960kc., and midnight-4 a.m., on 6090kc. English news at 3.20 a.m., while on Friday a special programme is carried on 11960kc. from 4.30-9 p.m.

Paris is heard in a special broadcast to Brazzaville on 21740kc. from 1.45-2.00 a.m.

Loggings for the month by Miss Sanderson indicate the hours spent at the receiver by this correspondent:

CANADA. CHOL, 11720kc. heard at 11.15 a.m. and again at 7.30 p.m. with music, news and talks; excellent level at the latter time.

CHLS, 9610kc. at 6.45p.m.; CBLX, 15090 kc. at 1 p.m. and at 9.15p.m., fine signal.

CFRX, 6070kc., news and weather reports at from 8.15 p.m. till 11 p.m.; good one.

CKCX, 15190kc. is heard at 10.15 a.m., with a good signal in French.

CHINA. Many Chinese stations are reported this month, among them being XGOY on 15177kc., 7140kc., heard at 8.15 and 10 p.m.; XPSA, 7010kc., at 8.45 p.m.; XMPA, 12220kc., at 7.30 p.m.; XNCR, 6100 kc., 8.30 p.m.; XOPD, 9553kc., at 8 p.m.; XTPA, 11650kc., at 7 p.m.; XHSR, 5880kc., at 9.30 p.m., with English news at 10.45 p.m.; XLRA, 11500kc., at 10.15 p.m.; XMTR, 6105kc., at 10.30 p.m.; XORA, 11690kc., at 9.30 p.m., XNCR, 7520kc., at 10 p.m.; XKPB, 12120kc., with slow speed news in Chinese. All these stations are in local language broadcasts with news frequently given in English and other languages.

SOUTH AMERICAN AND CENTRAL AMERICAN. LRV1, 9545kc., with good musical broadcast and Spanish news at 8 p.m., and LRM (also from the Argentine)

at 9 p.m. on 6180kc., with similar good programme.

CE622, Chile, 6220kc., 9.30 p.m., opens with an announcement in English and requests that reports be sent to P.O. Box 2626, Santiago, Chile. This one is a good signal. CE8AA, 5885kc. also heard at 10.15p.m.; good one.

Dominican Republic stations are heard these days, this country being represented by HI2T, 9727kc. at close at 1.30 p.m., and again at 9 p.m.; HI1Z, 6310kc. at 8.30 p.m., and possibly also at 1.30p.m.; and HIG at 8.45p.m., with the usual CBS relay on 6115 kc. HI1Z also carries this CBS relay.

Cuban stations are coming in nicely at this time of the year. We stress that readers look for these stations, and others from the Central and South Americas which are in our winter, heard at their closing at about 1 p.m. to 2 p.m.

For the night period, COBC, 9370kc. is heard at 8.30 p.m. and also reported at 3 p.m. on Sunday; the slogan of COBC is "Radio Progreso". COKG, 8950kc., at 9 p.m. opens in English with a recording of a composition by Strauss.

Among the Mexican stations the foremost is, of course, XEWW, heard on 9500kc. at 2 p.m. till close at 4 p.m., with very fine programme. Also a fine signal in opening of service at 11 p.m.

XERQ, 9165kc. at 2.30 p.m. is a fine level signal; good music from this one.

XEBT, 9620kc. with news and music at 2.30 p.m. and XEHH, 11880kc. are good signals at the same time. The following gives relays of sporting functions.

Nearby on 9680kc. is XEQQ, with a signal not quite so loud as usual.

PRL8, Radio Nacional, Brazil is operating on 11720kc. to good effect at 8.15 p.m., the programme being in Spanish. ZYBR, 9610kc. is heard at 7 a.m. in a similar service, also at good level.

TGWA, 9760kc. located at Guatemala City carries the N.B.C. relay for the South Americas at 1.45 p.m.; pictorial card from this station.

In the previous years, the stations located in Panama were heard on the 25 metre band at 11 a.m. with an English transmission, but so far this year we have heard no trace of them; the only ones heard and reported are HP5K, 6005kc. at 9.30 p.m., and HP5J on 11695kc. at 9.30 p.m., opening with news in Spanish; signature tune, "Alice Blue Gown".

YV5RM, 4970kc. is the most prominent station at 8.45 p.m. on the 60 metre band; there are many others but by no means the same level. This one is located at Caracas, Venezuela.

CXA3, 6070kc., Uruguay is very strong at 8.30 p.m.; usual Spanish news and music heard from this station.

EUROPEAN STATIONS. European stations, other than the BBC stations are coming in very well indeed, conditions for reception from this area having improved recently.

From Switzerland, HER5, 11715kc. at 1 p.m. in German, news and musical programme, and HER6, 15305kc. in English with Swiss type music at 12.30 p.m. Some very fine recordings are played in this transmission, records we can recommend.

HER5, 11865kc. at 10.45 a.m. is also very good indeed.

Liepzig, 9730kc. at 3 p.m. is very fine, and Frankfurt on 6190kc. at 7 a.m., with news in German is another good one.

SDB2, Stockholm on 10780kc. is heard at 7.30 a.m.; SBP, 11705kc. at 5.15 p.m. can be heard nicely.

The Paris stations are active on 15240kc. at 5.15 p.m. and on 17770kc. at 2.30 p.m. Quite good signals in both cases.

Monte Carlo, 6038kc. at 8 a.m. is a good possibility of a verification; quite a rare country. Moreover, the station will be interested in reception at this distance.

OZG, Copenhagen, Denmark operates on 11805kc. at 4.30 p.m.; not often heard here.

BARGAINS! BARGAINS! LARGEST STOCKS IN AUSTRALIA

★SPEAKERS, 6" dynamic and permag. £1. 2 and 3 gang .0005 variable condensers, 15/- Fixed Resistors, 3/- doz.

★Brand New ENGLISH DON V ARMY TELEPHONES. No technical knowledge required to instal. Used same as P.M.G. phones.

Price £3/19/6
Batteries 5/- set

★CHARGING GENERATORS. 12v. 500 watt. Suitable to use off any farm plant. Ideal as a home lighting plant power supply.

Price £10/10/-

▲TWIN TELEPHONE CABLE 17/6 per 100yd. reel. Suitable for use with Remote Control Unit.

★VALVES VALVES KEEN PRICES

6V6	12/6
1852/6AC7	17/6
EF50	12/6
EA50	6/-
1C7	12/6
1K7	12/6
1M5	10/-
807	12/6

★AERIAL TOWERS. USEFUL TO EXPERIMENTERS. 8ft.

Tubular Steel complete with drive motor and gear box, for 360 degrees rotation, with connections, for two separate circuits. Price £20-0-0

★AERIAL COUPLING UNITS. Contains an 0-300 M/A R.F. Meter 3 Gang .0005 mfd. variable condenser, variometers and resistors. Price 29/6

★METERS METERS METERS

0-500 Micro Amp.	30/-
0-1.5 Amp. R.F. 2" Weston	25/-
0-2 Amp. R.F. 2" Weston	25/-
0-350 M/A R.F.	25/-
0-50 M/A	20/-

Mail orders carefully and promptly carried out.

WALTHAM TRADING CO.

393 Flinders Street
Melbourne. MB2701

ELECTRONIC OSCILLOGRAPH-MICROSCOPE

(Continued from page 7.)

either in wave shape or duration. This has a bearing on engine efficiency. The record was taken on the rotating-drum film, which was exposed for one revolution to register the ignition voltage. Two subsequent exposures provided a zero line, and the 60-cycle wave for timing purposes.

In testing circuit-interrupting devices, film drum records extending over several revolutions are desirable. The various cycles in an arc-interruption process differ sufficiently from one another to be discriminated, even though the traces do overlap. This type of record (Fig. 6) can cover a relatively long-time interval.

At the other end of the time range of the electronic oscillograph are records registering clearly an event taking place in a fraction of a micro-second, such as shown in Fig. 7 and 8. Such records are taken on stationary film. In Fig. 7, several exposures are taken within a short space of the film, the latter being moved a fraction of a frame for each exposure. In Fig. 8 the film was not moved at all between exposures. Four distinctly different traces were anticipated by the operator; therefore, all of the traces were placed on the same time axis which helped in the comparative analysis of the four distinct events depicted on the same frame of oscillographic film.

Timing Consistency

Within 10-8 Seconds

A surprising feature of oscillograms of this type is the consistency with which the oscillograph starts its time sweep with respect to the measured phenomenon. The rise of each surge voltage recorded and the start of the time sweep in the instrument are distinctly separate events

occurring at places remote from each other, coupled only by electrostatic means and involving the breakdown of several sphere gaps. Yet, this timing repeats itself within one-hundredth of a millionth of a second. If there were variations larger than this, they would manifest themselves by a discriminable shift in the starting point of the various wave fronts. The inclination has been to picture such events as random phenomena, in which an appreciable variation might be expected. However, the electronic oscillograph shows an uncanny degree of consistency in timing. This unbelievable astuteness, combined with accuracy and ease of operation, makes this device the essential instrument in the field of analysing ultra-high-speed phenomena.

Figure 8 illustrates how the voltage required to produce a spark-over or puncture depends on the time for which it is applied. The shorter the time of application, the higher is the voltage that the insulation will withstand. This behaviour cannot be detected by 60-cycle tests. The familiar time-lag curves of insulators and gaps are a summary of such oscillographic test data. A curve drawn through the maximum points in Fig. 8 is in effect a time-lag curve. Perhaps the most important contribution of the electronic oscillograph to the power industry has been the determination of these curves. Through them the weakest links in the chain of insulation of a system are disclosed by comparing the time-lag curves of the various types of insulation involved. With such information, co-ordination of insulation can be accomplished and proper protective devices can be selected.

U.H.F. TECHNIQUES

(Continued from page 36.)

small so that the field suffers little disturbance.

The impedance measuring technique is the same as for co-axial lines, except that the guide wave-length is used in calculations. For 1 cm. work a mechanical drive is necessary to provide a fine control for the carriage movement.

Attenuators are often necessary for experimental work. A simple form of wave guide attenuator is provided by a flap of resistive bakelite strip projecting into the guide through a longitudinal slot in the broad wall. This type of attenuator can be made adjustable from 0 up to about 10 db.), and is suitable for low-power use.

Plugs made up of plaster of paris and graphite are used for attenuators at high

powers. Matching is achieved by tapering the plug gradually.

For the measurement of high powers, water calorimeters are employed. These consist of a means of transferring all the power into a quantity of water and measuring the consequent rise in temperature of the water. Generally, the water is passed through a cell in the wave guide continuously, and the rise in temperature is measured with a thermopile and meter.

A matching device ensures full transfer of power. Some of the power goes to heating up the wave guide walls, but this is a negligible loss. Such a device is calibrated by means of an electric heating element operated from an AC or DC source.

Low powers are measured by means of bolometers or thermistors—elements whose

resistance varies with temperatures. The element is mounted in either wave guide or co-axial line and matched, whilst changes in resistance, corresponding to changes in r-f power are measured by means of a DC bridge circuit. Such devices are usually calibrated on DC and are arranged to read power more or less directly.

Wave selectors for tapping-off a small proportion of power flowing in one direction along a feeder can be made for either wave guide or co-axial lines. A wave guide type is depicted in Fig. 10. An auxiliary line is coupled to the side of the main line by two holes spaced a quarter-wave-length apart. The holes provide attenuation because they act as wave guides beyond cut-off. Power travelling in the forward direction (indicated by the arrows) can pass into the connector on the side line. Power travelling in the reverse direction all passes into the termination, because any that flows towards the connector from the hole nearest it is cancelled out by that from the other hole. (This power is a half-wave-length or 180° out of phase, having travelled lg over 4 down the guide and back. With a wave selector the power of a transmitter may be monitored constantly.

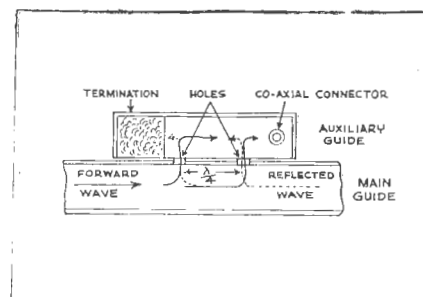

Fig. 10.—Diagram of a wave selector used for tapping off proportion of power in a wave guide.

Centimetre wave-meters are usually made in the form of resonant cylindrical cavities, although co-axial line types are often used as sub-standards. In the co-axial type a variable short-circuited line is excited by a loop loosely coupled in through the outer wall. The plunger is adjusted for resonance, as detected by another coupling loop and crystal detector. The distance between two resonance points is half a wave-length. This type has to be calibrated against a standard. The transition wave meter consists of a cavity with a variable plunger of small diameter. This type also has to be calibrated.

For measuring pulse r-f wave-lengths, a thermistor power meter or vacuum tube voltmeter is used, instead of a crystal detector, because the large voltages involved will invariably damage the crystal before sufficient average power is detected.

The Mail Bag

N.M.P. (Bulakdelah) asks some questions about the recently described "All Wave Battery Two."

A.—This receiver can be used for broadcast reception only by omitting the short wave coils. Whilst the various circuit constants will remain unchanged, the wave change switch will not be required as now the coil leads can be soldered directly into positions shown on the circuit. Not knowing your exact location, it is difficult to advise the reception you would obtain, but this type of receiver used with an efficient aerial and earth system have been known to give excellent results in many outback areas. The heavy tank iron could be used for the chassis providing you have some means for drilling and bending. Due to the difficulties usually encountered working this material, we would suggest you obtain a piece of suitable aluminium as this is much easier to handle. We would be pleased to hear further from you regarding this receiver after you have built it up.

E.J. (Camperdown, Vict.) is interested in battery receivers and asks for details of a four valve vibrator operated receiver that can be operated from a 6.0 volt storage battery.

A.—To date we have not described a set of this type. However, the Caravan Five, detailed in the June issue may suit your purpose. This employs four 1.4 volt miniature battery valves in conjunction with a 6V6-GT output valve, and operates from a storage battery. If you require this issue, it is still available, price 1/-, post free.

W.D. (Forestville, via Chatswood, N.S.W.) sends in several suggestions, and writes: "First of all I would like to congratulate you on the high standard of the magazine, and particularly on the excellent data in the articles on UHF, etc. RADIO SCIENCE is undoubtedly the best Australian radio magazine that I know of, and if its standard improves, which you say it will, it will be one on the world's best."

A.—Thanks for the interesting letter, W.D., and the appreciative remarks about the magazine. A complete index for the year's articles will be made available, but at the moment we doubt if it will be possible to supply binders or covers. At least not until the supply position improves. Glad to hear the Service Data Sheets were of value in your servicing work. It would not be economical to print a few copies of the "Interference" chart, and it would be cheaper from your point of view to buy a second copy of the magazine. Consideration will be given to a similar chart dealing with general servicing faults. It is probable that the 1.4 volt DC supply will be featured in a later issue as well as constructional ideas for the amateur.

TECHNICAL QUERY SERVICE

Readers are invited to send in any technical problems either dealing with our circuits or of a general nature, and an earnest endeavour will be made to assist you through the medium of these columns. For convenience, keep all letters to the point, with questions set out in a logical order, as space is rather limited.

All technical enquiries will be dealt with in strict rotation and the replies will be published in the first available issue of the magazine. Address all letters to RADIO SCIENCE, Box 5047, G.P.O. SYDNEY, and mark the envelope "Mailbag".

L.W.H. (St. Kilda, Melbourne) asks for further particulars of the large HMV receiver mentioned in the International Radio Digest.

A.—Unfortunately, this is the only information we have concerning this particular receiver, and consequently cannot help you with the circuit details and other specifications. Possibly you may have trouble in obtaining the information you require, even from the makers. Your suggestion re the one valve signal generator has been noted, but offhand cannot say when such equipment will be described.

I.B.T. (Caulfield, Vic.) sends in several suggestions for articles and these mainly deal with the topics of acoustics, baffles, speaker systems and electric organs.

A.—In view of the increased interest being shown in high fidelity reproduction, we have been considering publishing some articles dealing with some general audio subjects. These will be published as soon as space in the magazine is available. The copy of the February issue has been forwarded along to you.

D.A.B. (Hobart, Tas.) writes in for some early issues and says:—"I first came across your magazine recently at my newsagent and upon reading it through, found it very interesting and efficient. Its scope is very broad and the nature of the contents should satisfy anyone at all interested in radio."

A.—Many thanks for the letter, D.A.B. and your remarks re the magazine are appreciated. The suggestion for the amplifier has been noted and something along these lines may be featured in an early issue as a logical follow-on to the F-M tuner described in this issue.

A.W.S. (Notts-Well, S.A.) is interested in the Dual Wave Seven circuit and asks on the possibility of using two sets of intermediates in the circuit.

A.—The use of the 175kc. intermediates in conjunction with the 455kc. ones specified would not achieve any better results in this circuit. The 455kc. types usually will give satisfactory results up to approx. 30 mc. above which frequencies it is more usual to incorporate a HIGHER i-f frequency. The use of 175kc. i-f's on the short wave bands would simply lead to image trouble, as this factor becomes more apparent as the incoming signal frequency increases.

R.P. (Dulwich Hill) writes in an interesting letter and includes several suggestions, among which is a request for the description of a car radio.

A.—There are many difficulties to overcome in detailing a set of this type. Firstly to be successful it must be suitable for use with any make of car, which makes the problems of aerial installation as well as necessary shielding a rather complex problem. What may suit one car may be totally unsuitable in another case. However, this idea has been under consideration, and it may be possible to describe a set suitable for most installations in a future issue. As you say, the Caravan Five has its limitations and would hardly be suitable mounted under the dash of a car. Your suggestions re the valve articles are quite sound, and we hope to include these as soon as space is available.

J.B.H. (Sydney) is an ardent short wave listener and forwards some suggestions for improving the present short wave and broadcast band notes.

A.—Many thanks for the letter and suggestions, J.B.H. In a monthly publication it is impossible to obviate the delay between the times the notes are received and to when they are in print. In most cases it will be found that much of the news items given is current for more than any one month, except perhaps for odd station changes. However, we have forwarded your letter along to our S.W. Correspondent, Mr. Ted Whiting, for comment, and no doubt he will write direct to you regarding the points you mention.

L.S.D. (Wagin, W.A.) considers RADIO SCIENCE is the best periodical on the market, but being a serviceman would like to see more articles along the lines of "For Your Notebook", "For the Experimenter" and the "Radio Interference Analysis Chart".

A.—Whilst we have to cater for the needs of a wide range of readers, you will find that servicing articles additional to the present regular features will be included for the benefit of the serviceman. In this regard, the "A-F Amplifier Servicing" article in the July issue should have a particular appeal to you. The copy of the first issue has been forwarded and has no doubt reached you by now.

K.A.B. (Elliston, S.A.) forwards a twelve month subscription and mentions he is particularly interested in battery-operated amplifiers.

A.—Your subscription is appreciated and this has been passed on to the Subscription Dept. for attention. Probably a large amplifier than the one described in the April issue will be featured in a future issue as there has been several requests for this. We doubt whether any articles will be published dealing with the remote operation of equipment for some time yet. Thanks for remarks about the magazine.

B.S.M. (Hampton, Vic.) in writing, refers to a previous reply given in these columns regarding the availability of Geiger-Muller tubes and informs us that these tubes are now being manufactured in Australia, and are available for purchase by the public.

A.—We appreciate your interest in the magazine, and thanks for sending along the information regarding these tubes. This has been noted, and should there be any further enquiries will pass on the information you supplied.

AIRPORT APPROACH CONTROL

(Continued from page 15.)

ANSWERS TO QUIZ

- A.1.—(c) The usual formula is Db equals 20 log E1/E2 in which E1 is the output voltage and E2 the input voltage.
- A.2.—(a) Dielectric constant. (b) American Wire gauge. (c) Admittance. (d) Plate-cathode capacitance. (e) Screen supply voltage. (f) Susceptance (in mhos). (g) Interrupted continuous wave. (h) Decibel. (i) Undistorted power output. (j) Output resistance.
- A.3.—(c) The F-M detector is designed to reject any amplitude modulated signals and since most static etc. is of an A-M character, the system effectively reduces all noise.
- A.4.—(b).
- A.5.—(b).
- A.6.—(a).
- A.7.—(b).
- A.8.—(b).
- A.9.—(c).
- A.10.—(a) Ohms. (b) Farad. (c) Henry. (d) Ampere. (e) Volt. (f) Watt. (g) Joule. (h) Cycles per second. (i) Gilbert.
- A.11.—(a) One. (b) None. (c) Five. (d) Two. (e) Three.
- A.12.—(d).
- A.13.—(b). This is the term applied to the adjustable wire usually found in crystal sets and used to find the most sensitive spot on the crystal.
- A.14.—(b).
- A.15.—(c).

AUDIENCE RADAR

According to a CBS report, the radar principle will soon be used in audience measuring techniques. For each home receiver equipped with a responder attachment, four different kinds of information will be reported:—

- (a) Set "on or off."
- (b) Programme being listened to.
- (c) Family income.
- (d) Set location.

The scheme actually sounds a lot like the IFF radar arrangement used during the recent war. Transponders emitting coded radar pulses triggered off responders. Depending on the code received, the responder answered the original interrogation with a specific piece of information. The new listener checking system was developed by CBS and is to be known as the Instantaneous Audience Measurement Service (IAMS).

SNIFFS GAS LEAKS

An electronic *pistol* which can detect a leak of as little as 1/100 ounce of gas a year has been developed by G.E. engineers.

Air, when drawn into a sampling tube hits a hot anode emitting positive ions. If a halogen gas is present, the anode's ion output rises, and the valves' current output jumps, giving a visible or audible signal. With freon, chloroform, or other gasses containing a halogen—fluorine, chlorine, bromine, or iodine—as a tracer, the pistol can be used to find leaks in tanks or pipes.

4. Emergency Use for Navigation.

It is desirable that the approach control radar be so designed that it can, in case of extreme emergency, be used to guide an aircraft to the vicinity of the landing strip. Such an emergency might be one in which, under conditions of bad visibility, a failure occurred of all instruments which are normally available to assist in making a blind approach.

It would then usually be possible, by observing the position of the aircraft by the radar and by maintaining continuous radio communications to advise the pilot of the movements necessary to bring the aircraft along the final approach path to a position where the runway was visible; the landing could then be carried out as for *contact* (clear weather) conditions. The use of the radar to control the actual landing is not contemplated.

Form of the Approach Control Radar.

We now proceed to consider the way in which the preceding requirements can be met. As a concrete instance, we shall examine the experimental installation at Kingsford-Smith Airport, Mascot.

The radar equipment in this instance is divided into two distinct sections, one being located on the surface of the airport, adjacent to the landing strips, and the second section being housed in the Control Tower. We shall define these as the *field* and *tower* equipments respectively.

The field installation is necessitated by the coverage requirements discussed earlier. It will be recalled that in the vertical plane, coverage between angles of 1 deg. and 20 deg. is a minimum requirement. Now it is a fundamental characteristic of elevated antennas that the radiation produced exhibits a series of maxima and minima in the vertical plane, or in other words, lobes of radiation occur.

At angles corresponding to the minima between the lobes there is little or no radiation, and similarly little or no energy is received. (These lobes are due to the presence of a reflecting surface, the earth, below the aerial.) The presence of the minima mean that there are gaps in the vertical coverage.

The number of lobes or minima present depends on the height of the aerial in *wavelengths* above the ground, increasing directly with height. Since the wavelength used by the radar is of the order of a few centimetres only, it is clear that if the aerial were mounted on the Control Tower its height above the ground would be many wavelengths; there would accordingly be numerous minima in the

vertical radiation diagram, and these gaps in coverage would make such an aerial situation quite unsuitable for the purpose in view.

The aerial must, therefore, be placed very close to the ground. This means, however, that it is very likely to be screened by adjacent buildings. Consequently, in the Mascot installation the aerial was located on the airport some 600 yards from the nearest buildings, and mounted nearly at ground level, the antenna driving gear being placed in a circular pit several feet deep. In order to keep the leads to and from the aerial short the transmitter and high-frequency section of the receiver are also housed in the pit. The pit is covered by a perspex radome. Figure 3 and 4 illustrate the radome and the equipment in the pit.

Of necessity the main control and display apparatus is housed in the Control Tower. The information from the radar is transmitted to the tower by a radio link at 60 Mc. Power and control leads to the radar are run underground from the tower.

Figure 5 is a block schematic diagram of the basic arrangement of the field radar equipment, which will be described in more detail in the following part of the article.

Careers in RADIO and TELEVISION

Right now there's the chance of a lifetime for Radio Trained men. Achieve success, independence, and prosperity by getting trained NOW. A.R.C. up-to-the minute result getting training will quickly bring YOU SUCCESS.

We teach you these vital radio subjects:—

- ★Frequency Modulation
- ★Television
- ★Facsimile
- ★Service Engineering
- ★Amateur Operating, etc., etc.

ACT NOW!

Write, phone or call TO-DAY. We will send you (without obligating you) a copy of the big free book "Careers in Radio & Television."

Australian Radio College Pty. Ltd.

E.S. & A. Bank Buildings,
Cnr. Broadway & City Road
(opposite Grace Bros.)
SYDNEY. M6391-2



For
DEPENDABLE

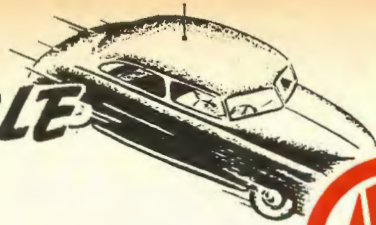

COMMUNICATIONS



**F.M. LEADS
THE WAY...**

These authorities have chosen
A.W.A. F.M. mobile equipment

- ★ *The Brisbane City Council*
- ★ *The Maitland City Council*
- ★ *The Council of the City of
Greater Newcastle*
- ★ *The Blacktown Shire
Council*
- ★ *N.S.W. Road
Transport Dept.*
- ★ *The S.E.C. of Victoria*

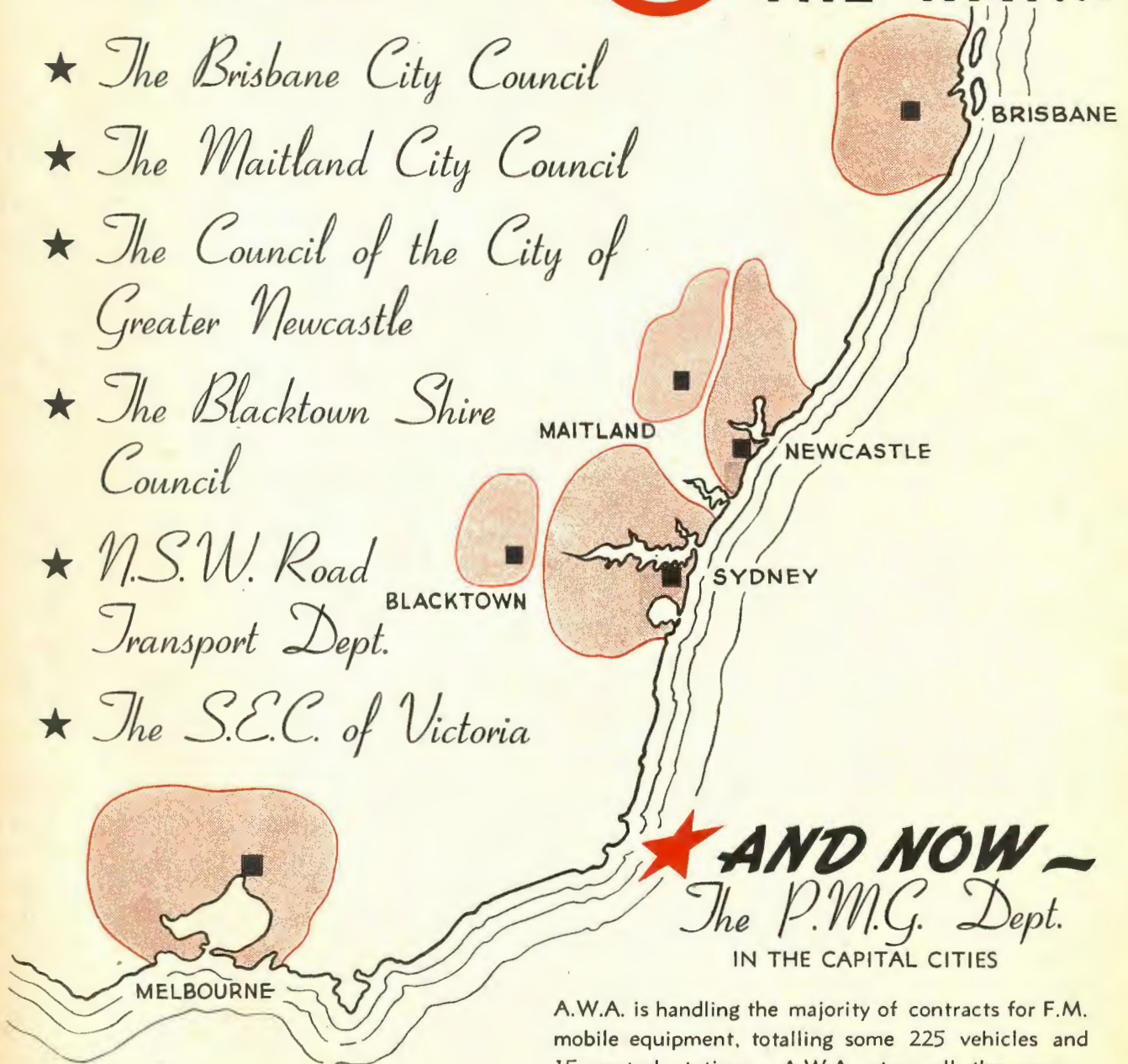

★ **AND NOW -**
The P.M.G. Dept.
IN THE CAPITAL CITIES

A.W.A. is handling the majority of contracts for F.M. mobile equipment, totalling some 225 vehicles and 15 central stations. A.W.A. stays all the way — from engineering planning through installation to maintenance. Enquire from:—

AMALGAMATED WIRELESS (AUSTRALASIA) LTD.

167 QUEEN STREET, MELBOURNE

47 YORK ST., SYDNEY

"I WANT 10,000 GAUSSES"



If this request were made by one of *your* customers, you'd probably look at him surprised. But, if he made it to Rola, he would be greeted as a kindred soul because for years Rola has been selling Gaussses handily packaged in Australia's finest permanent magnet loudspeakers.

In the loudspeaker business, Gaussses spell performance. Loudspeakers with high Gauss magnets produce more acoustic output for a given audio input than those with poor or inefficiently designed magnets. They also possess the valuable quality of instant reaction to rapidly changing audio inputs—the quality which gives that response to musical 'transients' which puts "Zipp" or "Sharpness" into sound reproduction.

Principal ingredients of the modern loudspeaker are Gaussses and the engineering know-how of their application. Both are present to the highest degree in the design of every Rola loudspeaker, each model of which has been tailored for a specific job.

If *you* should be looking for Gaussses, come to us. We'll provide it in a Rola loudspeaker.



Rola Co. (Aust.) Pty. Ltd., The Boulevard, Richmond, Vic., and at 116 Clarence St., Sydney, New South Wales