

The
Queensland

RADIO NEWS



In this Issue
The VICTORY TWO



A MAGAZINE *for the*
SET CONSTRUCTOR &
BROADCAST LISTENER

6

JANUARY 2nd 1929

VOL. IV

No. 12

Start the New Year Right—

WITH

RADIOKES R.F. COIL KITS

AS STANDARD FOR YOUR EVERY CIRCUIT and SET



"RADIOKES" 180 degree Three Circuit Tuner. Ruggedly constructed and reasonably priced at 14/6 ea.

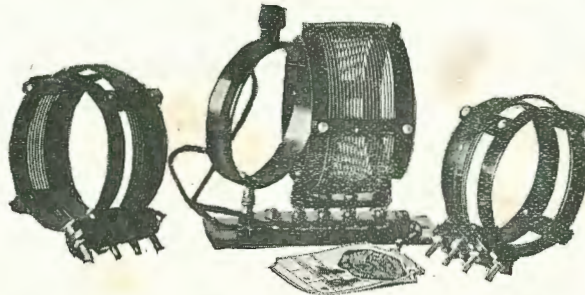

"RADIOKES" Short-Wave Tuner Kit, which covers a wavelength of 15 to 130 metres. Consists of three interchangeable R.F. units, an adjustable Antenna Coil, and base mounting. Price £2/15/ per kit.



"RADIOKES" Bayer Kit. Comprises Antenna Coupler and Three Circuit Tuner. Moderately priced at 25/- per kit.



"RADIOKES" Binocular R.F. Coil Kit. Comprises three low-loss R.F. Transformers. £1/19/6 per kit.

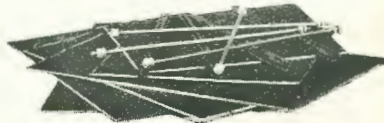

RADIOKES KNOCK DOWN ALUMINIUM SHIELDS 9in. x 5in. x 6in. Ready for use. Bolts and nuts—put together with pliers only. Being extensively used for all shielded circuits.



"RADIOKES" Standard Neutrodyne Kit. Air wound construction. Also Master Neutrodyne Kit on Bakelite. Both types £1/12/6 per kit.



"RADIOKES" R.F. Chokes are considered the world's best. Low capacity, high inductance. Price 8/6 each.

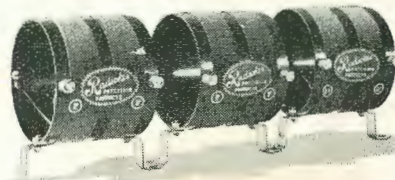

RADIOKES 1928 SCREEN GRID SOLODYNE KIT. Specially designed Astatic Coils on Bakelite. Considered by experts to be the world's best.



"RADIOKES" 1928 Browning-Drake Kit. Latest design. An excellent product, £2 per kit.



"RADIOKES" Reinartz Tuner. Well designed, excellently constructed, and remarkably priced at 10/6 ea.

There is a Radiokes Coil for every Circuit
 Send for the 1929 Booklet Free

Distributed throughout Queensland by:

EDGAR V. HUDSON

("The Leaders in Radio Merchandising.")

51 Charlotte Street, BRISBANE



"RADIOKES" Famous Circloid Kit. Consists of three excellent R.F. units. Price £2/5/ per kit.

At Last!

A Standard Set for City or Country that cuts clean through Local Stations at $\frac{1}{2}$ -mile range

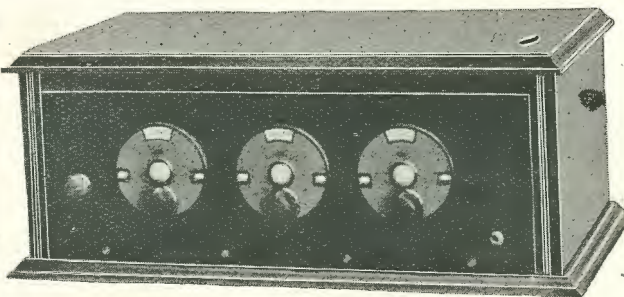

The Pontynen Three

Listening at half-a-mile range of 4QG's aerial, it is impossible to distinguish 4QG from 3LO, 2FC, 2BL—so great is the volume.

Hearing is believing. Arrange a demonstration at your convenience. No obligation incurred. Sold under a **MONEY BACK** Guarantee of satisfaction.

**SELECTIVITY
of a Six!**
**VOLUME
of a Five!**
**SIMPLICITY
of a Crystal Set!**

*Made in Three, Four
and Five Valve Models*

Interstate "A" and "B" class stations received with tremendous volume without a trace of interference from 4QG.

The Pontynen circuit is a marvellous advance. It incorporates the patented Pontynen Filter and the best components procurable.

**Save
Dealers'
Discounts**

£22/10/0

**Buy Direct
from the
Manufacturers**

Sold complete with everything excepting loudspeaker—which may be selected at will.

Let us quote you for remodelling your set to the Pontynen Circuit



**Complete Pontynen Filter Unit and Coils
for home Constructors
Price £3**

**The
Pontynen Radio
Manufacturing Coy.**
Regent St., South Brisbane

(off O'Keefe Street),
(Alight from tramcar at Stone's Corner
Bridge).

Phone: J-3370.

TRANSFORMER RATIOS

Has it ever occurred to you that if we knew how to design a suitable transformer, we should hardly ever require more than one stage of amplification?

In the audio-frequency portion of an amplifier, signals are magnified partly by the valves and partly by the inter-valve transformers, when these are employed. Thus, to take a very simple case, we might have a detector valve coupled by a transformer with a ratio of transformation of two-to-one, to a small power valve working directly into the loudspeaker.

Bulky and Inefficient.

If the magnification due to the detector was 10, and that due to the power valve was 5, the total magnification obtained would be, roughly, $10 \times 5 \times 2 = 100$ times. If the transformer ratio were 5 to 1 instead of 2 to 1, the total magnification would be about 250. Still further amplification would necessitate the addition of another valve.

Now, why could we not use a transformer with a ratio of, say, 50 to 1, and use it for coupling the detector directly to a very big power valve, and thus obtain all the volume we required, even if the original signals were very faint?

To begin with, in order to deal with low notes, a transformer must have a great many turns of wire on its primary winding, to give what is known as high primary inductance. In fact, the more turns the better, providing that the resistance of the winding can be kept from getting too high. If the ratio of transformation were 50 to 1 the secondary winding would then need to have fifty times as many turns.

Even if this was not impossibly expensive and bulky, the very fact of its having so much wire on it would prevent it from reproducing high notes, for the turns would serve as thousands of little condensers which would by-pass the high-note currents instead of allowing them to pass round the winding.

Question of Voltage Drop.

There are other equally serious objections to extremely high ratios of transformation, largely bound up with the somewhat mystical requirements of "impedance matching," but these cannot be dealt with here.

Since all the voltage in the output circuit of a valve is split up between the transformer winding and the valve itself, the voltage spent on the former should be as high, and on the latter as low, as possible. Hence, a valve of high internal resistance, such as a detector valve, will require to be followed by a transformer of much higher primary impedance (i.e., resistance effect) than will a low-resistance power valve. For this reason, a transformer for first-stage working is more difficult to design than one for connection between two power valves.

It is therefore a wise plan, unless transformers of known suitable design are available, to employ resistance or choke coupling in the early stages of an amplifier, and reserve the use of a transformer, preferably of a low transformation ratio, for use before the last power valve.

NEW SCHEDULE FOR PCJJ.

We have just been advised by Philips Lamps (Australasia) Ltd., that PCJJ's schedule has been altered, and will in future be as follows:—

Friday—4 a.m. till 6 a.m. (local time).

Friday—9 a.m. till 1 p.m. (local time).

Saturday—4 a.m. till 6 a.m. (local time).

Saturday—10 a.m. till 4 p.m. (local time).

The wavelength will remain the same—31.4 metres.

INDISPENSIBLE
for 100%
Valve Efficiency

Only Amperite supplies automatically the self-adjusting filament current your valves require. Eliminates hand rheostats. Simplifies wiring. Insist on Amperite. Accept nothing else. Price 5/9 complete with mounting. Sold everywhere. Write for free construction data.



AMPERITE
REG. PAT. OFF.

The "SELF-ADJUSTING" Rheostat

Distributors

EDGAR V. HUDSON

CHARLOTTE STREET, BRISBANE

HENLEY Winding Wires

SCC, DCC, SSC, DSC.

Enamelled, Enamelled SCC.

WHITE & GREEN.

In 4oz., 8oz., 1lb., and larger reels. No. 6 to No. 47

Special Flexible For Radio Work

Also all types of Insulated and bare, and Cables for Aerials.

Insulating Tapes.

Resin Cored Solder.

THE **HENLEY**
Wiring System.

**W. T. Henley's Telegraph
Works Co. Ltd.**

Central: 7044.

59 ELIZABETH ST.



The QUEENSLAND RADIO NEWS

ALFRED T. BARTLETT
Editor



LEIGHTON GIBSON
Technical Editor

WEDNESDAY, JANUARY, 2nd, 1929

Commonwealth Control of Broadcasting

WITH the announcement of the decisions reached by the Wireless Advisory Board, recently published, much comment among broadcasting authorities has been caused. Naturally enough, those whose private interests are centred around the broadcasting companies, are not anxious to hand over the reins of control to the Commonwealth Government, but those of us who view the situation in an impartial light are unanimous in the belief that the new order of Australian broadcasting is going to be of great advantage to the listening public.

In the calling for tenders for the supplying of programmes for all "A" class stations, the Government is evidently aiming to secure greater variety in the entertainments. The successful tenderer will doubtless be an influential theatrical organisation, which must of necessity establish a broadcasting circuit similar to the theatrical circuits in operation throughout the capital cities of Australia. Local talent will then be supplemented by visiting talent, which latter may even include imported artists from overseas.

The existing system of Australian broadcasting has laid a splendid foundation for the industry, but the Government feels that the present system is not capable of directing the future of broadcasting along the comprehensive lines that are now planned. The change will certainly be welcomed in States such as Queensland, where now talent is at a premium and visiting artists are seldom broadcast.

Commonwealth control of broadcasting has already come into force. The Perth station, 6WF, comes under Federal control as from 1st of January, 1929. The existing licenses of 2FC, 2BL, 3LO and 3AR expire towards the middle of this year, whilst those of 4QG and 5CL expire early next year. These licenses are not to be renewed, and the Government has expressed its willingness to take control of these stations immediately, provided the present license holders are prepared to accept compensation to the value of the unexpired portion of their license.

Broadcasting in Australia is about to undergo a revolutionary change, and we are of the opinion that the alteration will be for the betterment of listening conditions and for the advancement of the broadcasting industry in general.

Southern Stations on the Loudspeaker!

The Victory Two

By the TECHNICAL EDITOR

THE Victory Two is intended to fill the widespread need for a very simple receiver that will deliver good loudspeaker volume from the Interstate stations with a minimum of interference from a powerful nearby broadcaster. It fulfils both of these conditions in a very efficient manner, and undoubtedly represents the most powerful two-valve set that can be built at the present time. In several recent issues we have mentioned the wonderful new five-electrode valve or "Penthode," dealing with its application to single-stage audio-frequency amplifiers. This valve, with its abnormally high amplification factor of 100, coupled with a very low output resistance, replaces the usual two-stage transformer-coupled amplifier, and thus may be made to do the work of two ordinary valves. The result is not only a considerable saving in the matter of filament current, but a great simplification of the receiver, eliminating one valve socket and one transformer with their attendant wiring. It is interesting to note, also, that the tone quality thus obtained is very good indeed, and the necessity for some form of output filter between the last valve and the loudspeaker is entirely eliminated.

It is an undoubted fact that the great majority of two-valve receivers are quite unselective, and if the owner wishes to tune in the distant transmissions whilst the "locals" are on the air, he must resort to some type of wavetrap or filter, built as a separate unit and connected between the aerial lead and the aerial terminal of the set. In the Victory Two, this encumbrance has been dispensed with, with the result that the exterior of the set presents a neat and clean-cut appearance, and there are no untidy wires straggling over the table on which the receiver is placed. The panel has been made large enough to accommodate a simple wavetrap of standard design, the tuning dial of which is located on the outside of the panel, where it is in a position convenient to the operator. The only other controls are the main tuning dial, situated at the right-hand end of the panel, the reaction knob in the centre, and the battery switch immediately below it. Rheostats have been entirely dispensed with—a point which certainly does not affect the set's performance, as is sometimes claimed.

Fundamentally, the circuit is the modified Reinartz arrangement that has achieved such wide popularity, its chief features being an inductively-coupled aerial coil, tuned grid input coil, and capacity reaction control. A standard type of Reinartz tuner is utilised, with one small alteration. This alteration is of the utmost importance in obtaining satisfactory volume from distant stations, and will be described in detail under the heading of "Construction." Balanced "anti-microphonic" valve sockets are provided in order to ensure freedom from microphonic interaction effects between the set and loudspeaker—a trouble that can be very annoying if due precautions are not taken, and one which manifests itself in the form of a loud roar immediately the set is switched on. Standard practice is departed from insofar as the radio-frequency choke customarily specified is concerned; none is used in the Victory Two,



FIG. 1.—This back-of-panel photograph shows that exceptional performance often goes hand-in-hand with extreme simplicity. At the right-hand end is the wave-trap, while the single-stage Penthode audio amplifier shows clearly at the extreme left.

No Interference from the Local Station!

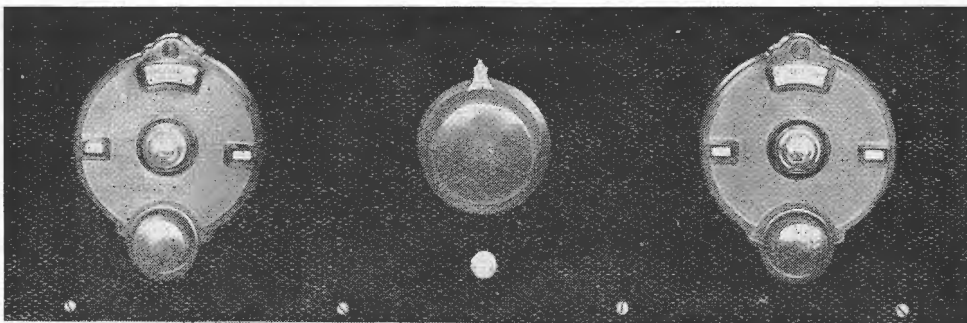

FIG. 2.—Front view of the Victory Two. There are no subsidiary controls on this set—only bare essentials are permitted. The left-hand dial controls the trap condenser, and is not used for tuning purposes. The tuning dial, or station-selector, is at the right, while the reaction knob is located in the centre with the battery switch immediately beneath it.

for the reason that the impedance—or possibly the resistance—of the Philips audio transformer was found to be quite sufficient to prohibit the entry of the radio-frequency component of the detector plate-current into the audio amplifier.

Construction.

In the Victory Two, a bakelite panel is used, because the use of a metallic panel would entail the insulation of the trap condenser from the panel, and, in any case, nothing is to be gained by employing metal here. The panel measures 21 x 7 x 3/16-inch, its edges being filed and sandpapered until a smooth finish is obtained. Nothing, in our opinion, detracts more from the appearance of a receiver than a panel whose edges are marred by saw-marks, and nothing brands the set more unmistakably as a home-made job. A little Brasso, by the way, often works wonders in removing unsightly marks from the polished surface of the panel.

Fig. 5 gives an idea of the location of the holes which must be drilled. In addition to those shown, three small holes are necessary to accommodate the threaded pins for securing the two Emmco De Luxe dials. The positions of these holes can easily be marked from the drilling templates accompanying the dials. After being drilled and cleaned up, the panel is screwed securely to the baseboard, the dimensions of which will be found in the list of parts printed at the end of this article. The three Jackson variable condensers are mounted on the panel, the .00025-mfd. (C2) in the centre, and the two vernier dials, reaction knob and battery switch secured in position. The pictorial diagram (Fig. 4) makes the position of the remaining components clear, but care must be taken that the sockets and transformer are mounted with their terminals in the correct relative positions, so that the various connections will fall in their proper order.

The trap coil (L) calls for some comment. It is made by winding 70 turns of 26-gauge double cotton-covered wire on a 2-inch diameter tube, 3 inches in length,

the actual winding occupying a space of approximately 2 inches. The coil is tapped in the centre, and holes are drilled at each end through which are passed long wood screws for mounting purposes. The coil is elevated a short distance above the baseboard by means of small spacers slipped on the screws.

Now for the Reinartz tuner. The Wetless tuner used is an excellent piece of work, consisting of practically self-supporting windings of green silk-covered wire with bakelite mountings. In common, however, with most factory-built tuners of this type, a small primary (aerial) coil comprising ten turns only is provided, so that the greatest possible selectivity will be obtained. It is well known that a small increase in the number of primary turns results in a considerable gain in volume from distant stations, although a certain amount of selectivity is, of course, sacrificed at the same time. In the Victory Two, the problem of obtaining selectivity in the tuner circuit may be neglected, because of the fact that the built-in wavetrap takes care of this point. Consequently, it was found to be of great benefit to increase the number of primary turns to 17, this being done by winding a small coil of 7 turns haphazardly, the diameter being such that it will fit inside the existing primary coil. It is essential that the additional coil be wound in the same direction as the existing one, and the two connected together in such a way that one

forms in reality a continuation of the other. It will be seen that the "earth" terminal of the tuner now is connected to one end of the extra coil, while the other end of this coil becomes the "earth" terminal in its stead. Notice that the terminal strip of the tuner is shown in the pictorial diagram in a horizontal position, simply for the sake of clarity; actually, it is attached to the tuner in a perpendicular position, with the terminals one under the other.

The pictorial diagram is sufficiently clear to make a detailed description of the wiring unnecessary. Take particular notice of the fact that no battery terminals are furnished, a seven-wire battery cable being fixed

The Secret

THE secret of the Victory Two's splendid performance is the incorporation of a valve of the "Penthode" type in the audio stage, which gives an amplification approximately equal to that of two ordinary "Tetrode" valves. No need to confine yourself to the local station's programme with this receiver; a built-in wavetrap permits reception of the Interstate stations without interference, and the set is one of the simplest we have ever described—both to construct and operate.

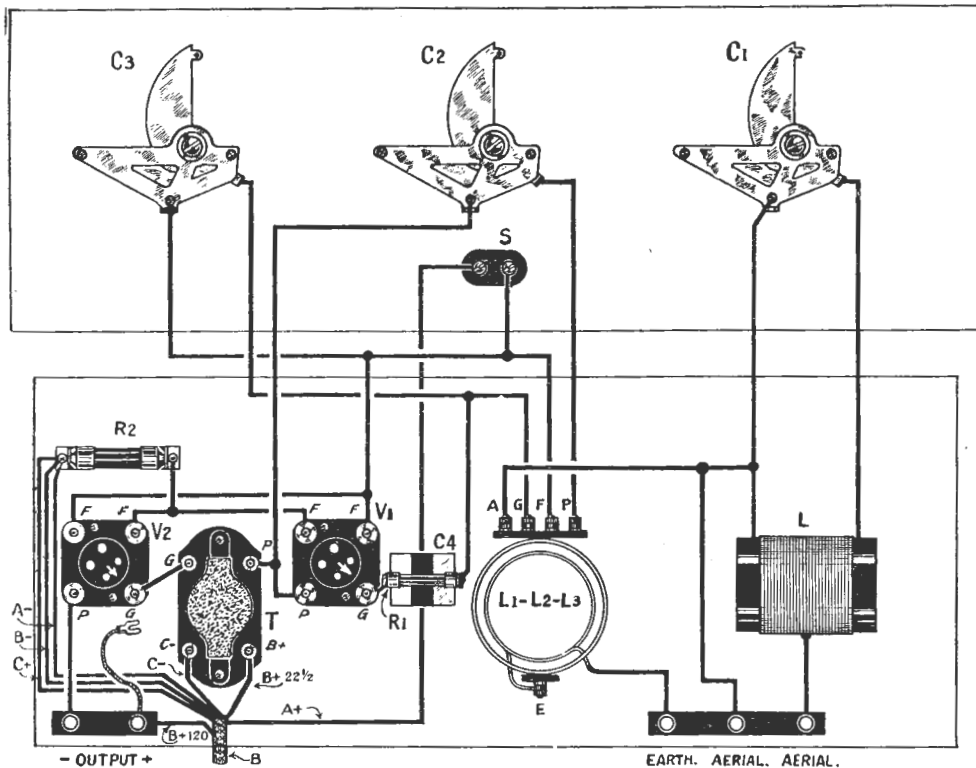

FIG. 3.—The circuit in diagrammatic form. The connections of the alternative aerial terminals are shown, this feature providing a simple means of connecting and disconnecting the wave-trap, as desired.

permanently to the set, each of its wires being connected directly on to its destination. This system not only saves time and money, but makes a better job electrically, since the number of clamped connections—which must always be regarded as a potential source of trouble—has been reduced to a minimum. Two aerial terminals are provided; when the aerial is connected to the right-hand one (looking from the back) the wave-trap is in circuit; when connected to the centre terminal, the trap is cut out of circuit automatically. This system obviates the need for switches of any description, and is a very sound one in practice. To the positive (+) "Output" terminal a flexible lead is joined, in addition to the "+120" battery wire. This is fitted with a lug, and is to be attached to the screen-grid terminal which projects from the side of the Philips B-443 Penthode valve. The wiring is carried out with Chromax insulated wire, which is a solid tinned copper wire with an easily-removed coloured covering. All connections that are not firmly clamped under terminals are soldered.

Operation.

For best results from the Victory Two—and, for that matter, from any receiver incorporating a Penthode valve—a comparatively high voltage must be applied to the plate of the amplifier. This does not mean that the "B" battery consumption of the Victory Two is heavy—far from it. Using a voltage of 120, the total plate current consumption of the set is only 12 milliamperes, a current that can quite economically be supplied by the ordinary heavy-duty "B" batteries. The constructor is left with the choice of using

two 60-volt blocks, or to obtain 135 volts from three 45-volt units. The latter scheme is recommended, as the results are slightly better with the increased voltage.

Either three standard-size 1½-volt dry cells or, preferably, a 4-volt accumulator may be used as an "A" battery. As the total filament current is less than a quarter of an ampere, the accumulator, if one is used, can be of small capacity—say 20 ampere-hours, actual rating. Three 4½-volt, or two 6-volt "C" batteries are required in order to supply the requisite negative grid bias for the audio valve, the current-consumption in this case being practically nil.

Referring to the pictorial diagram, it will be seen that the seven wires comprising the battery cable, which emerges from

the set at the left-hand rear edge of the baseboard, are all marked with indicating letters showing the battery terminals to which they are to be connected. Each wire is, of course, of a different colour, and in our set we used the following system: Red for "A+"; black for "A-"; white for "B-"; purple for "C+"; blue for "C-"; yellow for "B+22½"; green for "B+120." Different makes of battery cable show different colour combinations, and it is, of course, immaterial as to which particular colour-coding system is adopted, as long as the colour which is "A+" in the set goes to "+" on the batteries, and so on.

Just to make the various battery connections quite clear, we will mention that the wire marked "A+" is connected to the positive terminal of the 4-volt "A" battery; the one marked "A-" to the negative terminal of the same battery; "B-" to the negative terminal of the "B" battery; "B+22½" to the 22½-volt point of the same battery; "B+120" to the maximum "B" battery voltage available (120 or 135, as the case may be); "C+" to the positive terminal of the "C" battery; and "C-" to the "-" terminal of the "C" battery (this wire is varied until the point for best operation is determined—a voltage of minus 12 is about right).

The valves are inserted in their sockets—the Philips A-415 in socket V1, and the B-443 in V2—and the flexible connection already referred to is connected to the extra terminal on the latter valve. The aerial is taken to the centre terminal (so that the wave-trap will be cut out), the earth to the terminal so marked, and the loudspeaker to the two "Output" terminals. With the battery switch in the "on" position, the re-

action condenser is turned towards maximum (plates in mesh) until the set oscillates, a condition which will announce itself by a thump, followed by a soft hissing sound. Now the tuning condenser C3 is slowly rotated until the whistle of a station is picked up, when the reaction condenser C2 is retarded (plates turned out of mesh) until oscillation just ceases and the transmission is clear. After that, a slight re-tuning of both these dials will bring the signals up to their maximum point.

Should interference be experienced from the local station—and most likely it will be if the constructor lives within a 10-mile radius—the wavetraps are brought into action by moving the aerial to the outside aerial terminal. Condenser C1, which is the trap condenser, and not a tuning control, is then varied slowly until the interfering station is eliminated or reduced to minimum strength. When that has been done, the distant stations may be tuned in as we have just described. When using a trap of this type, it is often found that the receiver shows a reluctance to oscillate on stations which are **higher** in wavelength than the interfering station. For instance, if the wavetraps are set to eliminate 4QG, some difficulty may be found in tuning-in 2FC and 3AR. This peculiar effect is overcome by a slight adjustment of the wavetraps dial. Should the set still refuse to oscillate on the higher wavelengths, the "B+22½" tapping should

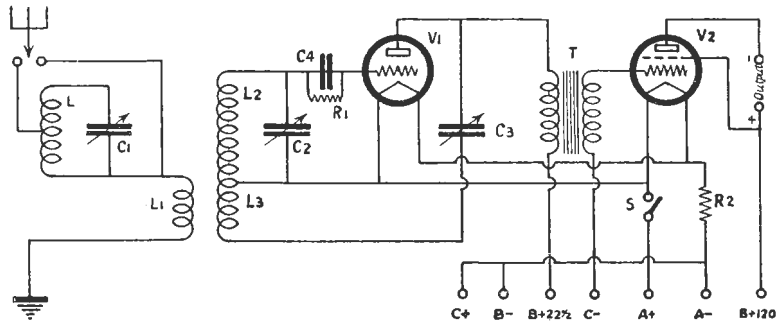

FIG. 4.—The heavy black lines in this pictorial diagram represent the various connecting wires, and the indicating symbols on the components correspond with the list of parts. Note the flexible lead which is to be connected to the extra terminal on the side of the Penthode valve.

be transferred to the 45-volt point of the "B" battery. Be perfectly sure that the additional primary coil is connected correctly; a reversal of this coil will result in very poor reception of the Interstate stations, although it will have little or no effect as far as nearby broadcasters are concerned.

Ordinary Valves Work Well.

Those of our readers who do not feel inclined at the moment to go in for the Penthode valve, can be assured that the Victory Two is well worth building for use with the ordinary type of valve in the audio socket. In fact, the initial tests of the receiver were carried out with this type of valve, and no difficulty was experienced in tuning-in the main Southern stations at fair to good loudspeaker strength while the local station was on the air. Late in the evening, indeed, the volume from 3LO Melbourne was all that could be desired for an average-sized room, and the tone quality was excellent.

The inclusion of the Penthode naturally boosts up the signal strength tremendously, fully bearing out the manufacturers' claim that the use of the B-443 makes a second audio-frequency stage unnecessary. Fortunately, no alterations in the wiring are called for when it is desired to change from one type to the other, with the exception of the flexible screen-grid connection which may be tucked out of the way when the ordinary type of valve is used.

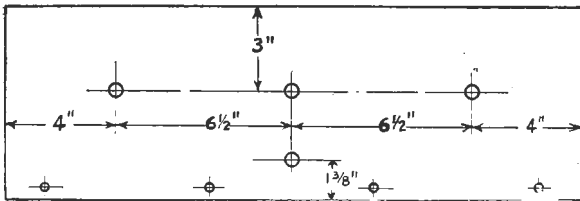

FIG. 5.—How to lay out and drill the bakelite panel. The holes for securing the two dials are not shown, as they may be marked directly from the templates which are always supplied.

Parts for the Victory Two

- 1 Rubber-covered battery cable, 7 wires, B.
- 2 Jackson .0005-mfd. SLF variable condensers, C1, C3.
- 1 Jackson .00025-mfd. variable condenser, C2.
- 1 Wetless .00025-mfd. type B grid condenser with clips, C4.
- 1 Wetless Reinartz tuner, L1, L2, L3.
- 1 Bakelite tube, 3 x 2 inches diameter, L.
- 4 Ounces No. 26 D.C.C. wire, L.
- 1 De Jur 5-megohm grid leak, R1.
- 1 Amperite, type 1A, R2.
- 1 Cutler-Hammer battery switch, S.
- 1 Philips audio transformer, T.

- 2 A.W.A. non-microphonic valve sockets, C1, V2.
- 1 Bakelite panel, 21 x 7 x 3/16-inches.
- 1 Stained wood baseboard, 20 x 8 x 7/8 inches.
- 1 Bakelite terminal strip, 4 x ½ x 1/8-inches.
- 1 Bakelite terminal strip, 2½ x ½ x 1/8-inches.
- 5 Belling-Lee metal terminals: Aerial, Aerial, Earth, Output+, Output-.
- 2 Emmco bakelite de Luxe dials, clockwise, black.
- 1 Large bakelite knob with pointer (for reaction).
- 1 Coil (10 feet) Chromax hook-up wire.

Accessories:

- 1 Philips B-443 Penthode valve.
- 1 Philips A-415 valve.
- 1 4-volt "A" battery.

- 2 60-volt "B" batteries (or 3 45-volt).
- 3 4½-volt "C" batteries (or 2 6-volt).
- Loudspeaker, aerial equipment.





hundreds of thousands of people use

"EVER-READY" RADIO BATTERIES

"EVER-READY" Radio Batteries are made in Australia, and are delivered to you FRESH FROM THE FACTORY. Moisture-proof heavy-gauge zinc containers, high-grade chemicals perfectly balanced, first-class materials and efficient insulation ensure long life and noiseless reception. Warranted to give service NOT EXXCELLED by any other make of battery of equal size and capacity. GET YOURS TO-DAY !

Obtainable from All Good Radio Dealers

Wholesale Distributors for Queensland—

EDISON SWAN ELECTRIC CO. LTD., 156 Creek St., BRISBANE

The ELEMENTS of Radio

The Functions of the Radio Valve Explained in Simple Non-Technical Language

The matter contained in this highly informative article has been compiled from a very interesting and instructive 90-page book entitled "True Radio Reproduction," which we have received from Messrs. Ferranti Ltd., England. Some of the information contained in the book applies mainly to English conditions, and this, of course, has been deleted or suitably adapted to embrace Australian conditions. We have seen no more detailed, and, at the same time, simple, explanation of the fundamental processes involved in the conversion of radio waves into sound waves, and the facts presented no doubt will be read with interest by many of our non-technical readers.—Tech. Ed.



IN a radio set supplying a loudspeaker at least three operations, and in many cases four, are carried out. To understand these operations better it is necessary very briefly to consider what goes on in a broadcasting studio. Sound from a singer, an orchestra, or an instrument impinges on a microphone, where it is converted into electrical vibrations, or, as we usually say, electrical currents, corresponding fairly accurately to the sound vibrations. These are usually known as "audio frequency currents," because they correspond in frequency to sounds which are heard, or are audible. They are magnified by suitable apparatus and super-imposed on a much stronger current whose vibrations are very much more rapid than that of the sound. This process is known as modulation. The stronger current on which the audio-frequency current is super-imposed is usually termed a radio-frequency current through the ether. Every user of a radio set knows it as a carrier wave and has to tune his apparatus to it—that is, to have what is called the same wavelength, or as we are more inclined to say now, "to have the same frequency," as the broadcasting station.

As an example: 4QG Brisbane transmits at present on a wavelength of 385 metres. This corresponds to a carrier current of about 779,000 cycles or vibrations per second, and a more modern form of defining 4QG's carrier wave is to say that it has a frequency of 779 "kilocycles" (779,000 cycles). The modulated carrier wave passes through space, and the aerial receives a very tiny portion of its energy.

The operations in the set can now be clearly understood. The first operation which can be carried out is the magnification or amplification of the tiny energy received in the aerial. This is called "radio frequency amplification," and is carried out in many sets in use in this country.

The second operation is known as "detection," or "rectification." A better term for it is "demodulation," as it is the opposite to the operation in the studio. This is the separation of the audio-frequency currents corresponding to the sound from the carrier

wave. The audio-frequency currents obtained by this process of rectification can be utilised to operate telephones, but are not strong enough to work a loud-speaker.

The third operation is the amplification of the audio-frequency currents obtained by the rectification above mentioned.

The fourth operation is conversion of the amplified signal of the last operation into power and thence into sound.

The Valve.

The component which has made these operations easy is known as the valve. Suitably used, it can amplify radio-frequencies; it can rectify, detect, or demodulate; and it can amplify audio-frequencies. Further, it can supply the energy which is converted into sound by the last component in the radio set, viz., the speaker.

If the valve is to function, it requires three supplies of electrical energy:—

- (1) The low tension ("A" supply) is necessary to heat the filament, thus giving a supply of electrons.
- (2) The high tension ("B" supply) is necessary to draw the electrons across from the filament to the plate of the valve.
- (3) The grid bias ("C" battery) as a means of maintaining the voltage of the grid at the correct mean value.

Until recently the above energy supplies were obtained from batteries or accumulators, but components and apparatus are now available which will allow of the electric light mains being utilised for these supplies. Where the electric light mains are what is known as alternating current it is possible to obtain all three supplies of energy; in the case of direct current mains it is convenient to obtain only the high tension or "B" supply.

The First Operation.

Radio-frequency amplification is necessary where the energy received in the aerial is too small for rectification; that is when a distant or not very powerful transmitting station is tuned in. Until recently this has not been an easy or efficient operation. A

Aerial Efficiency counts!

DO you realise the important part your Aerial plays in Wireless? Efficiency in wireless reception begins with the aerial. Electron Aerial Wire—and Superial (Electron's Super Aerial) are the finest aerial wires obtainable. They are both British Products—used by millions all over the world. Your set will give better results if you use Electron or Superial—the volume will be increased, purity improved, and selectivity made more sensitive, three very important factors.



*Simple to fix—
lasts for Years*



ELECTRON WIRE: Especially good as an indoor aerial, and perfect for outdoor use also. Easily fixed round the picture rail of a room or simply tied to a tree and attaching the other end to the set (in one continuous length); no lead-in tubes being necessary. 100ft. Coil **2/6**



SUPERIAL is specially made for Long Distance Reception. Extra heavy insulation of vulcanised rubber gives perfect protection against leakage—there can be no loss of incoming signals. Wonderful testimonials are received from all over the world. 100ft. (on wooden spool to facilitate unwinding) **4/6**

BRITAIN'S BEST—USED ALL OVER THE WORLD

If unable to obtain—write to the Sole Agents (name and address given below) or to the Proprietors, enclosing remittance.

Sole Distributors for Queensland:
CANADA CYCLE & MOTOR AGENCY LTD.
Cr. Creek and Adelaide Streets,
BRISBANE

Sole Manufacturers:
The NEW LONDON ELECTRON WORKS LIMITED
EAST HAM, LONDON, ENGLAND



valve must have a plate, a grid, and a filament which are of moderately large dimensions. The grid and the plate form the two plates of a tiny condenser. In utilising a valve for radio-frequency amplification two tuned circuits are used; one is connected between the grid and the filament, and the other in some way between the plate and the filament. Both are accurately tuned to the incoming carrier wave. A portion of the magnified energy in the tuned plate circuit is transmitted back by the tiny condenser mentioned above to the grid, and this is usually large enough to set up oscillation unless some other precautions are taken. The first successful way of overcoming this is to use what is known as "neutralisation."

This really consists of feeding back a tiny portion of the energy in the plate circuit of equal value and wholly out of phase with that unavoidably transmitted from the plate to the grid, the two thus neutralising each other. The best form of a set using this is the well-known Neutrodyne arrangement, and provided the neutralisation is accurately carried out, this can give very satisfactory results. The difficulty, however, is that the neutralisation has to be modified whenever valves are changed and often modified when the wavelength of the set is appreciably varied.

Recently, however, a valve has been designed and made in which this plate to grid capacity has been reduced to an exceedingly small figure. This valve is known as the "screen grid valve." It has an additional grid fitted between the ordinary controlling grid and the plate. When this additional grid is connected to a suitable portion of the "B" battery, it reduces the effective capacity of the valve to something like a 200th part of that in the older types. The valve thus becomes a four-electrode valve instead of the well-known three-electrode valve. It has a very high amplification factor, and because of freedom from oscillation a very high degree of amplification can be obtained when the valve is used suitably.

In using this valve, however, certain precautions have to be taken. It is evident that it is no use reducing the capacity of the valve with the consequent reduction of transfer of energy from the plate circuit to the grid circuit unless precautions are taken to prevent a similar transfer of energy by other parts of the set—that is, from the plate coil to the grid coil, or from wires of the plate circuit to those of the grid circuit. This can be done by using a metal screen between the coils and parts of the plate circuit and those of the grid circuit. The best form of screening is to enclose each of these circuits totally in a thin metal box made of aluminium or copper.

The Second Operation.

Before the wireless signal received direct from the aerial (or magnified by the first operation) can be used to operate a speaker or telephones, it must undergo the second operation—rectification or detection. This, as previously explained, is really a separation of the audio-frequency component of the wireless signal which corresponds to music, from the carrier wave component. It can be carried out either by a crystal or by a valve; the latter is preferable because it does not need continual adjustment, and it gives amplification simultaneously. The second operation is necessary because, to use a popular expression, the wireless waves received in the aerial are made up of vibrations so rapid that neither a speaker, telephones, or the ear can respond to them. In the process of

rectification the rapid vibrations of the carrier wave are separated and by-passed, leaving the audio-frequencies or the electrical equivalents of sound waves available for conversion into sound.

How is this desired effect brought about? Any valve which is so adjusted that the output current in the plate is not proportional to the input voltage will give rectification effects. There are two methods which are popular at the present time, viz., cumulative grid rectification and anode bend rectification.

In the former, a condenser of capacity .00025-mfd. is inserted in series with the grid of the valve and between this condenser and the grid a high resistance of 2 megohms is connected from the grid to some point on the filament. The bottom end of the high resistance can be connected to the filament through a dry battery of 1½ volts arranged so as to make the bottom end of this resistance 1½ volts positive. A more common way of carrying this out is to connect the bottom end of the high resistance to 2 volts positive. In the case of a 2-volt valve this would go direct to the positive end of the filament. Where 4-volt or 6-volt valves are used it would be connected to the positive terminal of the first cell from the negative end.

This form of rectification has the great advantage of being very efficient and sensitive to weak signals, and should be used always where the set consists of a detector and two audio-frequency stages, or, in the case of sets used near strong stations, comprising a detector and one audio-frequency stage. When the strength of the signal exceeds a certain value this method can introduce distortion, but if there are two stages of audio-frequency amplification before such a

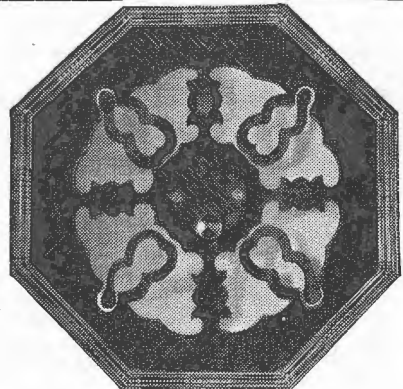

The All 'Brush

**M. P. A. PLAQUE
SPEAKER**

The Diaphragm is Sprung

That's why the M.P.A. will handle so much volume without distortion

Of All Dealers—£2/10/0

Agents for Queensland:

T. H. MARTIN & SON

B. & F. CHAMBERS, ADELAIDE ST., BRISBANE.

Sole Australian Concessionaire:
CHAS. D. MACLURCAN, Pratten Bldg., 26 Jamieson Street, Sydney.

condition is reached the speaker sounds so loud as to be undesirable.

Anode Bend Rectification.

The second method of rectification, viz., anode bend, needs no grid condenser, but the grid is adjusted to be of suitable negative value compared with the filament by means of a grid bias battery. This method should be used when the signal is a strong one, particularly when high-frequency amplification is employed.

Audio-Frequency Amplification.

As explained in the last section, the current obtained, after the detector valve has functioned, is an audio-frequency current, or, as it is often called, a low-frequency current, and represents very closely the sound in the studio. It is usually strong enough to work a pair of telephones, which are sensitive instruments, but is incapable of working a loudspeaker, as the sound energy required for this is enormously greater than that required for a pair of telephones. It is necessary therefore to magnify or amplify this audio-frequency current. In doing so, to avoid distortion the amplification must be carried out in such a manner that the increased signal differs from the original only in being larger. To appreciate what this means, one must recall that sound is caused by a rapid vibration of air particles and the pitch of a note is fixed by the frequency, that is, the number of vibrations per second. Instrumental notes have pitch frequencies from 25 to 3,500 per second, but no note is a simple vibration of one frequency but a combination of vibrations at frequencies which have a simple relation to one another. The lowest, called the fundamental, gives the pitch, while the others, called harmonics, give tone of quality, and cause the sound of one instrument to differ from that of another, although the fundamentals in each case have the same pitch. The frequency of audible harmonics may be as high as 10,000 per second, and thus we may say that musical vibrations have a frequency range from 25 to 10,000 cycles per second.

Therefore the requirements to avoid distortion are:

- (1) That all electrical currents corresponding to notes from 25 to 10,000 cycles shall be amplified equally;
- (2) That the apparatus used shall not introduce notes not in the original broadcast.

A very satisfactory method of audio-frequency amplification is to connect two valves by means of an audio-frequency transformer. Good results can be obtained only if the transformers used are built of the best materials obtainable, carefully tested before during and after assembly.

The Audio-Frequency Transformer.

An audio-frequency transformer consists of two windings on an iron core: one, called the primary winding, is connected in the plate circuit of a valve, and the other, called the secondary, is connected to the grid of the following valve. To function properly the iron core must be of adequate cross section, and, further, there must be a sufficiently large number of turns in the primary winding. This is expressed technically by saying that the primary must have high inductance, so that even for the lowest note considered, the primary "impedance" is high compared with that of the preceding valve. This being so, the voltage of the signal across the primary winding corresponds very closely to the original sound in the studio. The secondary winding, however, is made with more turns

than the primary, so as to increase the signal voltage impressed on the primary. The step-up thus obtained in the case of the best audio-frequency transformers is $3\frac{1}{2}$ times. This figure cannot easily be increased, because the size of a transformer is limited by the price and the space available in receivers. Transformers larger than this are not commercial propositions. It follows, therefore, that having fixed the size of the primary winding as large as permissible the size of the secondary is limited by the space available. But there is in addition a serious defect. As explained later, it is necessary that no current shall flow in the secondary winding, as any such current automatically reduces the inductance of the primary winding. If the secondary winding is increased too far, local currents are set up, usually called "capacity currents," which again have the effect of reducing the primary inductance.

One end of the secondary winding must be connected to the grid of the following valve, and the other end, through a suitable grid bias battery, to the negative end of the filament. The grid bias voltage must be chosen so that the grid never becomes positive even with the stronger signal impressed upon it. Otherwise grid current will flow in the secondary winding, causing a reduction in the primary inductance of the transformer and partial rectification in the a.f. valve, with consequent distortion. Moreover, the grid bias must be adjusted to suit the high tension voltage.



HINTS ON THE USE OF THE PHILIPS PENTHODE TYPE B-443.

(Issued by the Technical Department, Philips Lamps, Limited.)

Type B-443 is a five-electrode valve using new principles for audio amplification. The power-output is phenomenally high when plate-voltage and plate-current are considered. The valve works well at a plate voltage of 90-150 volts.

Owing to the high gain obtained in the valve, it is not necessary in most cases to use a conventional two-stage amplifier, as the energy obtained from the detector valve, after passing through a Philips Type 4003 audio transformer, is quite sufficient, when amplified by the Penthode, to supply a large output. **If two stages are used, care should be taken that the audio input to the Penthode is low.**

The amplifier which precedes the Penthode should be of good design, and if a transformer is used it should be of very good quality. The Penthode transfers power to the loudspeaker, irrespective of frequency; therefore, a high-pitched whistle, which originates in the amplifier and spoils reproduction, but is not otherwise apparent when using a standard valve, may be quite pronounced with Type B-443.

The extra terminal on the valve base should be connected directly to the "B" battery at the same potential as is applied to the plate, otherwise standard connections are used.

BACK NUMBERS OF "O.R.N." WANTED.

A SUBSCRIBER is prepared to give 1/- a copy for the following back numbers of "The Queensland Radio News," in order to complete his volumes. Nos. 3, 4, 6 and 8 of Volume One, and No. 11 of Volume Two. Apply "Back Number," Box 1095N, G.P.O., Brisbane.

Short Wave Activities

More Observations on the Short Wavelengths, culled from the Log of F. W. Nolan



HE general public will more fully realise how truly wonderful short wave radio work is in about four months' time, when it is anticipated anyone will be able to ring up London on the ordinary telephone. The company responsible for this remarkable step, as far as can be gathered from conversations over the air, is Amalgamated Wireless (A'sia) Ltd., of Sydney. This company's station, 2ME, appears to be marking time while awaiting word from the British Postal Department that they are ready to carry on tests. This is all that can be said about the matter at present.

On November 28th, 2ME tested duplex telephony with ANE, Java. 2ME also relayed a London orchestral item. 3ME, Melbourne, relayed 3LO on 32 metres for a week, then went up to 60 metres. At 11.10 p.m. on the 28th, 5SW, Chelmsford, broadcast a record sung by the great Chilliapin. Paris has been testing on a new wavelength; speech only has been used. This station (FL) has been on the air on five different occasions lately.

On the 5th of December, 2ME and ANE held duplex telephony tests. 2ME mentioned that they use an eleven-valve receiver, which I took from the conversation to be a portion of the Beam receiver. Mr. Percy Farmer (who spoke) said that they could do almost as well with a screen grid valve and detector. By the way, we use the good old detector and two audios; anything I can't get on the speaker with this, I usually let slip by.

7DX Hobart and 3GR Bendigo have been doing some two-way phone recently. 7DX comes in well at a steady R8, while 3GR fluctuates slightly between R6 and R8.

From 6 to 7.15 p.m. on December 11th, we heard the following: "Hallo 2ME; this is AGB2, Berlin, calling you."

"Hallo AGB2, this is 2ME Sydney calling you."

2ME: "Your voice is very drummy and hard to follow."

AGB2: "I can't get you too well, either."

2ME: "One moment—is that better?"

AGB2: "Yes, how am I coming in now?"

2ME: "You are much clearer."

At the conclusion, 2ME said they would try and arrange for a speaker of German to be at the station on the 12th at 0730 G.M.T., or 5.30 p.m. Sydney time. As soon as they had finished with the German station, 2ME commenced tests with Suva, Fiji, on telephony. Suva was very clear and twice the strength of 2ME at this particular hour. On the 12th, 2ME and VPD (Suva) were again testing, and AGB2 also linked up with the Sydney station until the German developed trouble and closed down. The Cuban station, PWAA bangs in here on 27 metres. ANE, Java, was overheard saying that the Philips people have constructed a new high-powered short wave broadcast station, which will be in operation shortly on the Holland—

Java service. PHI is the call. AT Java, a "beam" aerial was built pointing northwards, in order to receive U.S.A., but with a negative result. Accordingly, another similar aerial was constructed, this time pointing due south, with the result that signals from the United States are audible over a period of one hour each day.

On the 13th, AGB2 and 2ME were heard on duplex telephony, a German interpreter being located at 2ME. AGB2 speaks a certain amount of English also, and it was amusing to listen to the system adopted by each station when they could not understand one another. The speaker simply whistled the doubtful words in Morse code, so that there could be no possibility of error.

6WF, Perth, is still coming in regularly with very good quality. 5SW gave a bulletin concerning the King's health on December 12th, and played "In a Monastery Garden."

Among the Amateurs.

Static has been giving the amateurs a very uncomfortable time lately, and scathing references to it are heard on all sides. 7DX was the first Australian station heard using the new Australian intermediate—"VK"—which replaces the old "oa". 4PN, not to be outdone, went back at him as "vk—4PN." 7LJ is putting out some fairly good phone, and 7BQ comes in very well. 4RM was busy last time I saw him, removing paint from his short-wave transmitter; the photographer painted it for him! (The "paint" referred to is a whitish substance used by the "Radio News" photographer to deaden the reflections when photographing polished metal panels. No charge is made for the "paint," but the owner has the pleasure of cleaning it off!—Tech. Ed.). He will be on the air soon, and would like reports on his signals. 4NW is rebuilding his station; he has been heard lately in Wales, England, and Germany. 4AB is busy building

FOR SALE

Complete Transmitting and Receiving Station

4PN

3 Transmitters, 4-valve Screen Grid Receiver, all Batteries, Aerials, Meters, Transformers, Rectifiers, etc.

£35 Nett

£5 Deposit—easy Terms to Suit

Apply **RUSSELL ROBERTS**
Tivoli Theatre **BRISBANE**

RADIO TOPICS

by "D.X."

No question of the popularity of the new D.X. Radio Store in Adelaide Street.

This new store has made heavy reduction in prices on all components and sets and, in consequence, they are doing a very excellent trade.

"D.X." is an unusual store. It not only reduces prices, but also gives excellent technical service. Any Radio enthusiast can become a "D.X." member. Membership gives FREE periodical set inspection. Free loan battery service while yours is being charged. Reduced battery charging prices. Special discount on all your Radio purchases and other advantages. The membership fee is 20/- a year. Ask for printed information sheet.

£62/10/- complete. This purchases the Telefunken G—a screen 5 with tremendous punch and range. Call, see and hear this remarkable set.

25/- purchases a Crystal set complete at D.X.

For £16/10/0 you can have a 3 valve set complete. Plenty of punch and cuts out 4QG with ease.

There are a number of standard threes at £12. These cut out Brisbane with a trap. £12 is, of course, for the complete set.

1 Valvers cost 75/-. Twos 120/-. Threes £8. All are excellent value.

£17 complete. 4 valve sets. All Australian A stations, and many smaller stations easily tuned.

45/- purchases the Telefunken Cone—a very fine speaker.

Better make a point of visiting the "D.X." Radio store. You'll certainly be interested



a 250-metre set, in addition to a new 40-metre transmitter which will comply with the new regulations. 4BB has been doing good work on 10 metres; he has been travelling, but is just back again. 4LJ is in Melbourne on holidays (this is written towards the end of December). 4RA and 4CG are still after Yanks. 4CN sticks to his 220-metre phone, and puts out very good stuff. 4MM is back again, and is "just warming up." 4BH is a new "4" at Booval; he has an R.A.C. note, with any amount of punch behind it. 4RG, 4AT, 4GO, and 4WA have been very quiet lately; maybe QRN is the trouble—certainly it has been terrific. Heard old 2HM's daughter the other night asking 5MB what he thought of her code. We think it's very good indeed. 6SA came in at R7 at midnight on the 13th., but is never more than R3. 7DX was the first on 41 metres, and worked our 4CM on December 12th.



A Fine Chance for the Prospective "Ham"!

4PN Selling Out.

By an advertisement appearing on page fifteen of this issue, Russell Roberts, one of the most active amateur transmitters in this State, announces his intention of disposing of his record-breaking station, 4PN, lock, stock and barrel. He is going South at an early date, and rather than dismantle his equipment, pack it up, and lug it along with him, he is prepared to let everything go for a small fraction of the original cost.

Some very fine apparatus is installed at 4PN, and the "ham" or prospective "ham" who is lucky enough to secure it will get a bargain, if ever there was one. This apparatus includes three separate transmitters, a four-valve Screen Grid Receiver, meters, aerial gear, transformers, rectifiers, and sundry equipment.

We wish 4PN every success in his new sphere, and look forward to hearing his well-known fist on the air again under a Second-district call-sign.

Watch for ~

THE Pontynen Three

Complete Constructional Article
in next issue

Full particulars of the remarkable circuit invented by a Brisbane man, giving knife-edge selectivity and the volume of most five-valve sets. Constructed in the "Queensland Radio News" laboratory, and described by the Technical Editor.

Revised List of "Q" SIGNALS

In our issue of September, 1928, we published a list of the existing "Q" signals in response to requests from many readers. We intimated, however, that a new and revised list had been prepared, and that this would come into force on the first day of 1929. The new list is published below, and it will be seen that it bears little resemblance to the old one, the meanings of many of the abbreviations having been altered completely. For this reason, one must forget the old signals, and learn the new list in its entirety.

Signal.	Question.	Answer.
QRA	What is the name of your station?	The name of my station is.....
QRB	At what approximate distance are you from my station?	The approximate distance between our stations is.....nautical miles (or.....kilometres).
QRC	By what private company (or Government administration) are the accounts for charges of your station liquidated?	The accounts for charges of my station are liquidated by the.....private company (or by the government administration of.....).
QRD	Where are you going?	I am going to.....
QRE	What is the nationality of your station?	The nationality of my station is.....
QRF	Where do you come from?	I come from.....
QRG	Will you indicate to me my exact wavelength in metres (or frequency in kilocycles)?	Your exact wavelength is.....metres (or..... kilocycles).
QRH	What is your exact wavelength in metres (frequency in kilocycles)?	My exact wavelength is.....metres (frequencykilocycles).
QRI	Is my tone bad?	Your tone is bad.
QRJ	Are you receiving me badly? Are my signals weak?	I cannot receive you. Your signals are too weak.
QRK	Are you receiving me well? Are my signals good?	I receive you well. Your signals are good.
QRL	Are you busy?	I am busy. Or (I am busy with.....).
QRM	Are you being interfered with?	Please do not interfere.
QRN	Are you troubled by atmospherics?	I am being interfered with.
QRO	Must I increase power?	I am troubled by atmospherics.
QRP	Must I decrease power?	Increase power.
QRQ	Must I send faster?	Decrease power.
QRS	Must I send more slowly?	Send faster (.....words per minute).
QRT	Must I stop sending?	Send more slowly (.....words per minute).
QRU	Have you anything for me?	Stop sending.
QRV	Must I send a series of V's?	I have nothing for you.
QRW	Must I advise.....that you are calling him?	Send a series of V's.
QRX	Must I wait? When will you call me again?	Please advise.....that I am calling him.
QRY	Which is my turn?	Wait until I have finished communicating withI will call you immediately (or at.... o'clock).
QRZ	By whom am I being called?	Your turn is No.....(or according to any other indication).
QSA	What is the strength of my signals (1 to 5)?	You are being called by.....
QSB	Does the strength of my signals vary?	The strength of your signal.....(1 to 5).
QSC	Do my signals disappear entirely at intervals?	The strength of your signals varies.
QSD	Is my keying bad?	Your signals disappear entirely at intervals.
QSE	Are my signals distinct?	Your keying is bad. Your signals are unreadable.
QSF	Is my automatic transmission good?	Your signals run together.
QSG	Must I transmit the telegrams by a series of 5, 10 (or according to any other indication)?	Your automatic transmission fades out.
QSH	Must I send one telegram at a time, repeating it twice?	Transmit the telegrams by a series of 5, 10 (or according to any other indication).
QSI	Must I send the telegrams in alternate order without repetition?	Transmit one telegram at a time, repeating it twice.
QSJ	What is the charge to be collected per word for.....including your internal telegraph charge?	Send the telegrams in alternate order without repetition.
QSK	Must I suspend traffic? At what time will you call me again?	The charge to be collected per word for.....isfrancs, including my internal telegraph charge.
QSL	Can you give me acknowledgment of receipt?	Suspend traffic. I will call you again at..... (o'clock).
		I give you acknowledgement of receipt.

Signal.	Question.	Answer.
QSM	Have you received my acknowledgment of receipt?	I have not received your acknowledgment of receipt.
QSN	Can you receive me now? Must I continue to listen?	I cannot receive you now. Continue to listen.
QSO	Can you communicate with.....directly (or through the intermediary of.....)?	I can communicate with.....directly (or through the intermediary of.....).
QSP	Will you relay to.....free of charge?	I will relay to.....free of charge.
QSQ	Must I send each word or group once only?	Send each word or group once only.
QSR	Has the distress call received from.....been attended to?	The distress call received from.....has been attended to by.....
QSU	Must I send on.....metres (or.....kilocycles) waves of type A1, A2, A3 or B?*	Send on.....metres (or on.....kilocycles), waves of Type A1, A2, A3 or B.*
QSV	Must I shift to the wave of.....metres (or of.....kilocycles), for the balance of our communication, and continue after having sent several V's?	I am listening for you. Shift to wave of.....metres (or of.....kilocycles) for the balance of our communication, and continue after having sent several V's.
QSW	Will you send on.....metres (or on.....kilocycles) waves of type A1, A2, A3 or B?*	I will send on.....metres (or on.....kilocycles) waves of Type A1, A2, A3 or B.*
QSX	Does my wavelength (frequency) vary?	Continue to listen.
QSY	Must I send on the wave of.....metres (or.....kilocycles) without changing the type of wave?	Your wavelength (frequency) varies. Send on the wave of.....metres (or.....kilocycles) without changing the type of wave
QSZ	Must I send each word or group twice?	Send each word or group twice.
QTA	Must I cancel telegram No.....as if it had not been sent?	Cancel telegram No..... as if it had not been sent.
QTB	Do you agree with my word count?	I do not agree with your word count; I shall repeat the first letter of each word and the first figure of each number.
QTC	How many telegrams have you to send?	I have.....telegrams for you or for.....
QTD	Is the word count which I am confirming to you accepted?	The word count which you confirm to me is accepted.
QTE	What is my true bearing? Or— What is my true bearing relative to?	Your true bearing is.....degrees. Or— Your true bearing relative to.....is.....degrees at..... (o'clock).
QTF	Will you give me the position of my station based on the bearings taken by the radio compass stations which you control?	The position of your station based on the bearings taken by the radio compass stations which I control is.....latitude.....longitude.
QTG	Will you transmit your call signal for one minute on a wavelength of.....metres (or.....kilocycles) in order that I may take your radio compass bearings?	I am sending my call signal for one minute on the wavelength of.....metres (or.....kilocycles) in order that you may take my radio compass bearings.
QTH	What is your position in latitude and longitude (or according to any other indication)?	My position is.....latitude.....longitude (or according to any other indication).
QTI	What is your true course?	My true course is.....degrees.
QTJ	What is your speed?	My speed is knots, or.....kilometres per hour.
QTK	What is the true bearing of.....relative to you?	The true bearing of.....relative to me is.....degrees at..... (o'clock).
QTL	Send radio signals to enable me to determine my bearings with respect to the radio beacon?	I am sending radio signals to permit you to determine your bearings with respect to the radio beacon.
QTM	Send radio signals and submarine sound signals to enable me to determine my bearings and my distance.	I am sending radio signals and submarine sound signals to permit you to determine your bearings and your distance.
QTN	Can you take the bearing of my station (or of.....) relative to you?	I cannot take the bearing of your station (or of.....) relative to my station.
QTP	Are you going to enter the dock (or the port)?	I am going to enter the dock (or the port).
QTR	What is the exact time?	The exact time is.....
QTS	What is the true bearing of your station relative to me?	The true bearing of my station relative to you is.....at.....(o'clock).
QTU	What are the hours during which your station is open?	My station is open from.....to.....

* Waves classified as follows, in ART. 4, General Regulations:—A1: Unmodulated continuous waves, varied by telegraphic keying. A2: Continuous waves modulated at audible frequency, with which is combined telegraphic keying. A3: Continuous waves modulated by speech or by music. B: Damped waves.

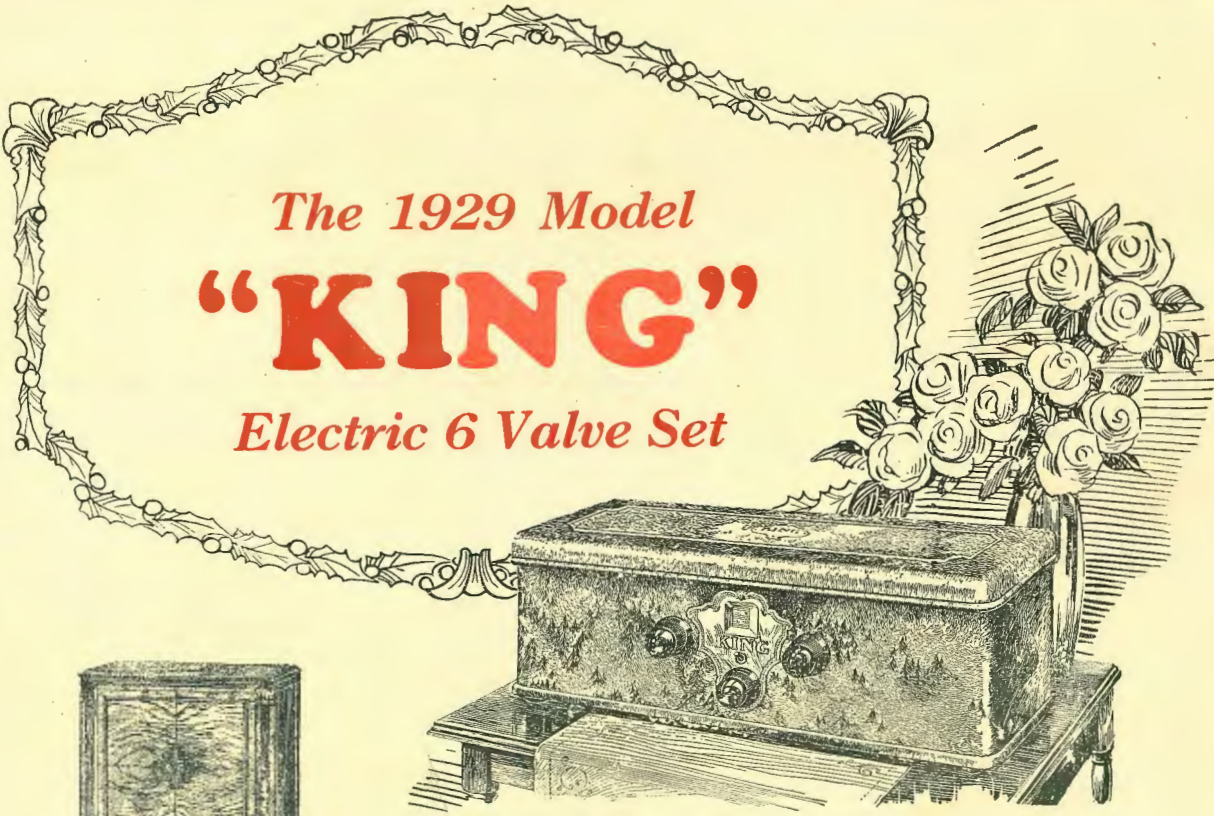

THE GEORGIAN CABINET FOR "KING" RADIO SETS.

This charming Cabinet has been specially designed to accommodate any "KING" Radio Set. It incorporates a built-in tonal chamber of the long air column type, and a high-grade loudspeaker unit.

Complete with "KING" Radio Set and all accessories, the cabinet may be purchased as follows:—

- With Model "G" £55 0 0
- With Model "F" £49 10 0
- With Electric Model £65 0 0

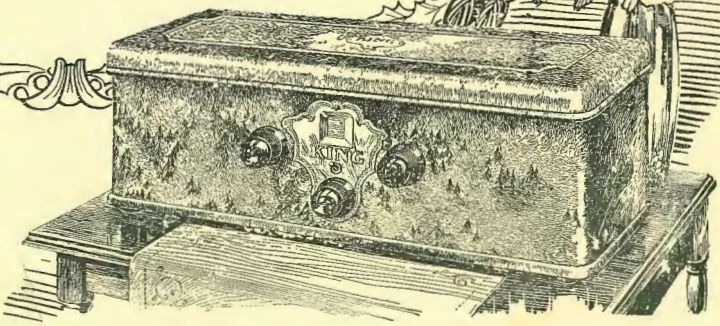

KING in RADIO

If there is someone you know who hasn't a Radio Set, or you haven't a really up-to-date set in your home, why not buy a "KING" RADIO.

Nothing could give greater pleasure. The new 1929 Battery and Electrically-operated models—the very peak of radio perfection—are just out.

They are fully shielded, marvellous distance-getters, and capable of great volume. Control is by a single dial.

MODEL "G"—6-Valve Genuine Neutrodyne built into rich bronze-finished metal case as illustrated above.

PRICE, without accessories **£24**

MODEL "F" is similar to Model "G," but has only five valves.

PRICE, without accessories **£19**

ALL ELECTRIC MODEL—This is complete in itself, the only accessory to be bought being the loudspeaker. In appearance this model is identical with Model "G."

PRICE **£46/6/**

THE AEOLIAN COMPANY [Aust.] Ltd.

436 QUEEN STREET, BRISBANE

Opposite Custom House

264 PITT ST., SYDNEY. N.S.W.; 123 SWANSTON ST., MELBOURNE; and 58 RUNDLE ST., ADELAIDE.

THE AEOLIAN COMPANY (Australia) LTD.
 Please send me details of the 1929 "King" Radio:
 Name
 Address

The
CRAMMOND Super 3 for 1929

Built by Crammond Radio Manufacturing Coy.

Subsidiary to

MELTON & CO., 8 QUEEN STREET, BRISBANE

The Set
 that
 has taken
 Queensland
 by
 Storm.

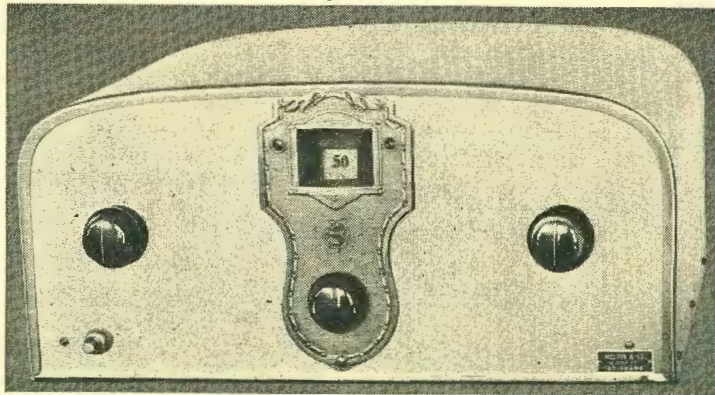

Never before
 such
 Performance
 ADA
 Never before
 such
 Beauty

Read what the Technical Editor of this Paper wrote in the last Issue—

"The Firm's New Shielded Three's performance certainly justifies their action in resorting to shielding . . . The task of testing the Crammond Shielded Three was a most congenial one . . . the receiver was a positive delight to handle, and we know of no set that permits easier tuning . . . it seems to do all that a first-class receiver should do, and a bit more . . . The quality will satisfy the most exacting, and volume is there in plenty. . . . "In conjunction with the set we used the beautiful little Crammond Shielded Wave-trap . . . the resulting selectivity being such, we were

able to tune in 5CL while 4QG was on the air, without interference. . . The reaction control is so smooth we were able to tune from station to station by means of the tuning dial alone, without touching reaction knob. . . The interior of receiver is an excellent piece of work, while the exterior is uncommon and distinctly attractive. . . . our considered opinion is that the Crammond Shielded Three is a receiver the manufacturers have every reason to be proud of. . . and we believe it ranks with the best that can be procured anywhere in the world."

THE CRAMMOND SUPER 3

First Queensland Made All Metal Receiver

Complete with first-grade accessories, including Philips Valves, Amplion Cone Speaker, Columbia High Capacity Batteries.

PRICE
£22/10/0

All sets carry our 12 months' guarantee.

Terms arranged.

Of Solid Brass in Several Finishes—Duco, Oxidised and Nickel, Etc.

**Right at
 North Quay
 BRISBANE**

MELTON & CO.

PHONES: C-3542,
 J-4859, Toowong 2180

WHY is a Radio Soprano Unpopular?

Present Day Radio Equipment Makes Proper Reproduction of Soprano's High Notes Impossible

By JOHN F. RIDER.



NOT so long ago an elderly gentleman whose aristocratic appearance was impaired by a distinct frown, entered a radio store and addressed the clerk as follows: "You sold me a receiver some time ago. I wish you would send some one to my home to fix my set; I hear nothing but screeching sopranos. Here is my address. Thank you."

The above is a concrete illustration of the attitude of the general radio public toward the soprano as a broadcaster. This state of affairs is indeed unfortunate, because the soprano upon the concert stage is one of the most popular, if not the most popular, of artists. But, why is the soprano disliked as a broadcast artist? We, who like the soprano upon the concert stage, do not prefer her over the radio. Our friends, who like the soprano upon the concert stage, do not prefer her over the radio. A survey among radio enthusiasts who consider radio as a medium of musical entertainment and education, shows a general dislike for the radio soprano. Much as we would like to say that she is a delightful radio artist, we cannot in justice to other radio performers speak in the affirmative.

The art of radio reception, marvellously developed as it has been during the past eight years, is not yet ready for the soprano as a broadcasting artist. It is unfortunate, but true. Innumerable enthusiasts who have never had the occasion to listen to a popular art-



The lot of the radio soprano is a hard one. Radio instruments seem to conspire to prevent the successful broadcasting of her voice.

ist upon the concert stage, but who have heard of her reputation and anticipated a delightful rendition of their favourite song, have been sadly disillusioned when she was heard via the air. This statement is made in direct contradiction of the wide acclaim supposedly accorded to some of our famous sopranos upon their radio performance. The heralding of the appearance of a famous soprano at a well-known broadcasting station, immediately creates a favourably biased opinion. The reputation naturally precedes the performance. If the performance is unsatisfactory, as it invariably is to those well versed in musical lore, some excuse is hurriedly found. Seeking an excuse to justify the received performance is in order, so as to reconcile one with the disappointment. That this is done is indeed fortunate for the artist because it means the preservation of her reputation, which justly belongs to her.

The reasons why radio is not yet ready for the soprano are numerous. In the first place, the speech characteristics of woman in general, with respect to aural comprehension, are inferior to those of man. Dr. J.

C. Steinberg, of the Bell Telephone Laboratories, states in "The Bell Laboratories Record," that women are found to talk less distinctly than men. Secondly, the speech characteristics of woman, when changed to electrical impulses, do not blend with the electrical characteristics of our present day radio equipment. Thirdly, the demand for radio equipment to meet their

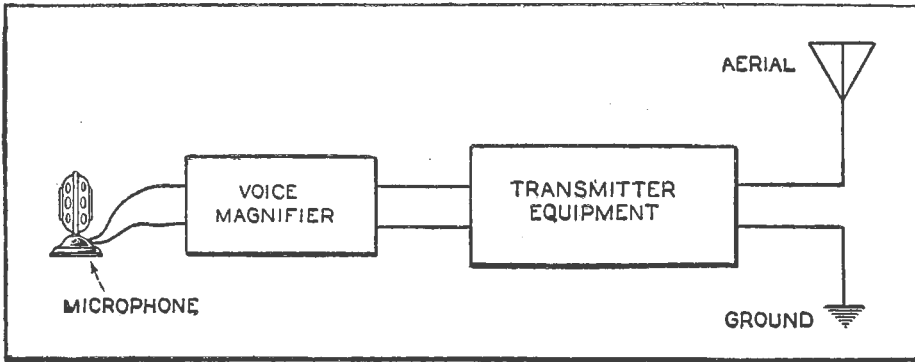

SIMPLIFIED SKETCH OF RADIO TRANSMITTER.
The microphone converts sound waves into electrical vibrations, which are passed to the voice magnifier or amplifier. Here the fundamental and harmonic amplitudes often are changed.

aural fancy has led to design of equipment that impairs the reproduction of a soprano's voice. Therefore, we see that the reasons for the enigma are both physical and electrical.

It may sound strange to hear that man is more readily understood than woman, and that for radio transmission a man's voice is better than a woman's. Nature has so endowed women that they can more easily pronounce such words as "thin" and "fat," such sounds as "th" and "f," but these sounds are most difficult to hear. Dr. K. S. Johnson of the Bell Telephone Laboratories says in his book on telephone transmission circuits, "th, 'f' and 'v' are difficult to hear, regardless of the intensity, and account for over 50 per cent of all the errors occurring in commercial telephone systems. . . ." Our radio equipment is very similar to that used in telephone practice and effects found in telephone practice hold true in radio.

For a basis for determining why the soprano is not a satisfactory broadcasting artist, we must delve somewhat into the physical and the electrical. Speech sounds in general are not simply tones, but on the contrary, are quite complex. Analysis of a tone, complex in nature, shows that what we hear consists of a number of individual tones of varying intensity. That is to say, a complex tone or sound consists of a fundamental tone and a number of harmonics and overtones. In contradistinction to musical instruments such as the pipe organ and the tuning fork—which instruments produce pure tones consisting of just one value of vibrations per second, or frequency—human speech sounds are quite complex and consist of a number of values of vibration per second, or frequencies.

In other words, a certain speech sound may have a fundamental of 300 vibrations per second and a number of harmonics of say 600, 900, and 1500 vibrations, or cycles, per second. The timbre of a sound or its complete tone is governed by the relative amplitudes of the fundamental and its associated harmonics. Decrease or increase the relation of the fundamental and harmonic amplitudes or intensities, and the timbre of the audible sound has been changed. Herein lies the basis for the recognition of the vari-

ous musical instruments or the recognition of a human voice. The preponderance, the absence, the variation in amplitude or intensity, and the number of harmonics present, provide the distinguishing characteristics between musical instruments and the speech of humans.

Upon analysis of the voice range of a soprano, it is found to extend from the "B" just below middle "C" of the piano to the "F" above the second "C" octave above middle "C" on the piano. Interpreted in the number of vibrations per second, the range extends from approximately 240 to 1365. This is the range of fundamental notes within the range of a soprano's voice. Singing a note within this range does not mean that only that note is present, as we hear it. The sound emitted by the singer contains the fundamental and a number of its associated harmonics.

Analysis has shown that the closer the fundamental to the high limits of her voice range, the fewer the harmonics and, conversely, the lower the fundamental within her voice range, the greater the number of harmonics. At all times, however, we must contend with a fundamental and a number of harmonics. The musical value of any tone or note is due to the presence of the harmonics. Remove all the harmonics and the tone has been changed to a sound devoid of all mellowness or sweetness or richness. If the original note is high, such as high "C" sung by a soprano, and all the harmonics are removed or attenuated or diminished, the final sound will be a shrill shriek or whine, entirely unmusical. In fact it is not essential that all the harmonics be removed or diminished. Accentuation or attenuation of some of the harmonics will produce disagreeable effects.

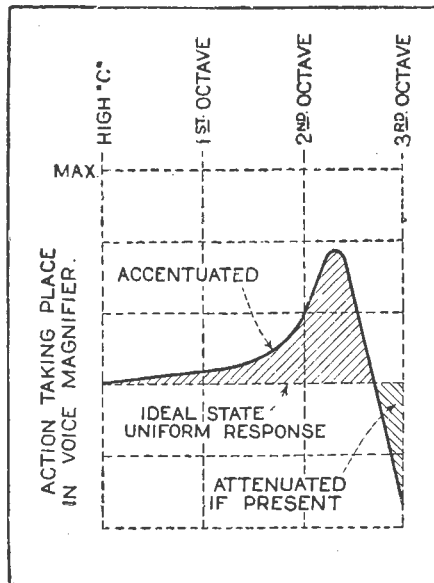

THE AMPLIFIER'S PART

The amplifier or magnifier in the receiver often attenuates or accentuates as shown.

The loss of overtones and harmonics, and the accentuation of some of the harmonics are the reasons for the defeat of the soprano as a radio broadcast artist. Present-day radio instruments are not equipped to transmit and respond faithfully to the overtones and high harmonics of a soprano's voice.

A simple example of this phenomenon in everyday radio reception, is a duet between a tenor and a soprano, or a baritone and a soprano. In both instances, the soprano's voice is lost; the male voice predominates.

A soprano appearing upon the concert stage sings to a listening audience. Her voice is carried through a medium, the air, which does not attenuate or accentuate the frequencies produced by her vocal cords. Distance will diminish intensity, but will not vary the amplitude relation between the fundamental and the harmonic frequencies produced by her vocal chords. The ear of the audience to whom is conveyed directly through the air the relative amplitudes of fundamental and harmonic vibrations, without attenuation or accentuation, hears the sweetness and richness of the soprano voice. With the air as the only transmitting medium, without accentuation or attenuation of harmonics, and with the wide response range of the human ear, the listener hears a delightful performance. The same singer, performing over the radio, sounds disagreeable.

The human ear is both a sensitive and an insensitive organ. It is sensitive in varying degree to pitch, being uniformly sensitive to the normal fundamental ranges of the soprano's voice. On the other hand, the human ear is a poor judge of intensity. With respect to pitch variations, however, we find a variation of approximately .3 per cent. as being perceptible over a soprano's voice range.

We have said that a pure tone is not musical, that the sweetness of a tone is found in the combination between the harmonics and the fundamental. Now let us suppose that a soprano sings high "C." This note is of approximately 1024 vibrations per second, otherwise quoted as having a frequency of 1024 cycles per second. The overtones and harmonics of this note, which give it its timbre, would contain frequencies which would be the second, third, fourth and even higher multiples of 1024 vibrations. For purposes of illustration, let us assume the presence of only two octaves as harmonics. The energy distribution

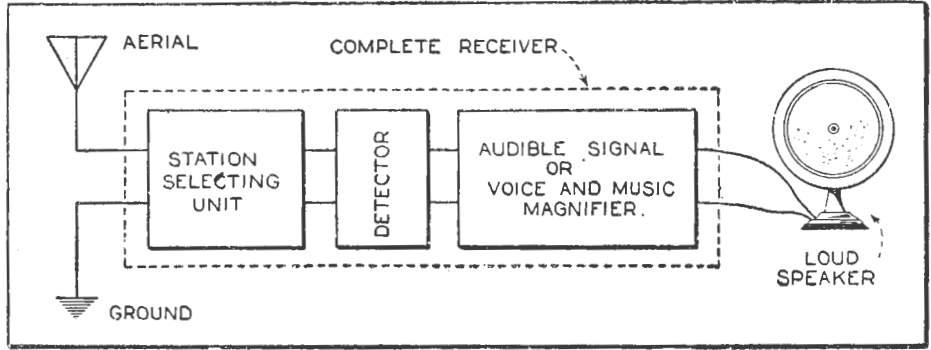

SIMPLIFIED SKETCH OF RADIO RECEIVER.

In the station selector or tuner, relative amplitudes of fundamentals and harmonics often are changed. In the amplifier they are attenuated or accentuated and, in the loudspeaker, high overtones and harmonics are not reproduced. Result—poor reproduction of the soprano's voice.

on the fundamental and the harmonic vibrations has no fixed law, varying with the sound produced, the characteristics of the instruments, and the person producing the sound. In some instances, the fundamental vibration has more energy than the harmonics. In other cases, one of the harmonics may have more energy than the fundamental. This should be remembered for future reference.

Referring again to the high "C" mentioned in the preceding paragraph, the first octave above high "C" would have a frequency of 2048 cycles or vibrations per second; the second octave would have a frequency of 4096 cycles or vibrations per second. The selection of high "C" as an illustration, is based upon a phenomenon most frequently observed. The soprano when singing in a broadcasting station sounds most disagreeable when she attempts to reach the high notes. Mind you, we say that she **sounds** disagreeable. If listened to personally in a concert hall, she would doubtless be a delight to the ear. Over the radio, however, she is poor. The reason for her failure over the air is found in the loss (total) of the above harmonics in the illustration cited or in the accentuation or attenuation of either one of the two harmonics. The final result is a change in the relative amplitudes or intensities of the fundamental and harmonic frequencies. The loss of the above two harmonics when she sings high "C" would result in the loudspeaker reproduction of a shrill, unmusical shriek. Wherever harmonic intensities are faithfully retained, the soprano sounds as well over the air as she does on the stage of a concert hall.

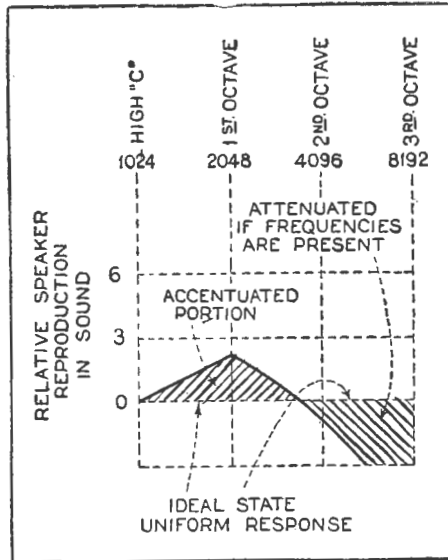

WHAT THE SPEAKER DOES.

Chart showing how the loudspeaker changes the relative amplitudes of fundamental and harmonics by not reproducing uniformly.

The loss of overtones or variations in amplitude of the fundamental and harmonic vibrations is not limited solely to the single note we quoted, but is applicable to all others. Not that they are

THE

FERRANTI

**TRUE EXPONENTIAL
SPEAKER**

The Ferranti Speaker is capable of giving good reproduction from an ordinary set.

It consists of a tone conduit of true exponential shape suitably mounted and connected to a FERRANTI Speaker Unit.

The Unit, which has been carefully designed, has a large and flexible diaphragm capable of good response to a wide range of frequencies. The shape of the sound box in conjunction with the tone conduit is such that there is no objectionable resonance.

The resistance of the Unit is 1300 ohms (approx.), but the resistance of a Speaker is not a reliable guide to its characteristics. The relatively low resistance of this Unit is not due to the smallness of its windings, but to the use of the heavier gauge wire, resulting in immunity from breakdown without any sacrifice in sensitivity.

The terminals are clearly marked and must be connected as indicated. The position of the element with respect to the diaphragm can be varied to give the best results in all circumstances.

When small power valves are used there is no possibility of burning out the Loud Speaker windings or saturating the magnet system.

The best reproduction is obtained when a power valve having an impedance of 8000 ohms or preferably less is used in the last stage.

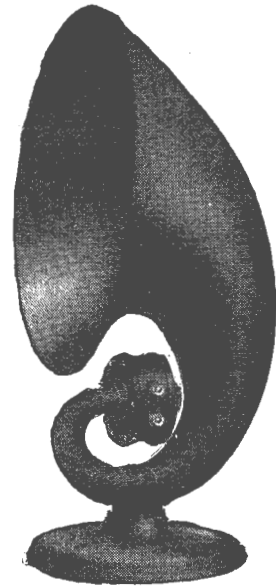

Price £5/5/-

Ask your dealer for a demonstration of the wonderful effect of coupling the atmosphere with the Ferranti Exponential Horn

MADE BY FERRANTI LTD., HOLLINWOOD, LANCASHIRE, ENGLAND

Dealers communicate with:

A. BEAL PRITCHETT (AUST.) LTD.,

SYDNEY AND MELBOURNE.

EDGAR V. HUDSON,
Brisbane.

WEDMA LIMITED,
Adelaide.

GIBBS, BRIGHT & CO.,
Perth.

always lost, but rather that their loss creates the same effect. Faithful reproduction is obtained only when the fundamental and harmonic vibrations and their respective intensity amplitudes are faithfully retained.

If readers will attempt to recall, a radio soprano is not disagreeable to listen to when she is singing notes within the lower half of her voice range. The reason for this is two-fold. First, her voice on these frequencies is richer in harmonics. Secondly, a greater percentage of these harmonics are reproduced with the average radio set, because their frequencies are lower. The greater richness of harmonics compensates somewhat for the partial loss of the high overtones, and even if the voice, as reproduced, does not contain all of the very high overtones and harmonics, the low overtones and harmonics which are present are sufficient to give to the reproduced tone the sweetness and lucidity demanded by the ear of a critical listener.

Unfortunately, however, the beauty of a soprano's voice is found in her ability to sing high notes. Her high notes are of high fundamental and high overtones and harmonics. Present radio equipment is not capable of faithfully retaining these high overtones and harmonics. Consequently a radio soprano's voice, when she sings high notes, will remain disagreeable until the proper changes can be made without destroying the quality of reproduction for other frequencies. These important changes undoubtedly are on the way, but they are not here yet.

Now that we know why a soprano sounds disagreeable, let us see where the loss of overtones and harmonics occurs. An analysis of transmission systems brings to light two significant facts. First, that powerful, well-equipped and scientifically designed broadcasting stations are capable of satisfactorily transmitting a soprano's voice—that is, to such an extent as to permit very satisfactory reproduction if receiving

sets were so designed. It may sound strange, however, to hear that in some countries—notably the United States—the government limitation imposed upon broadcasting stations has an effect upon the satisfactory reception of a soprano's voice. In preceding paragraphs, we considered only two octaves when high "C" is sung. A third octave would be equal to a harmonic frequency of 8192 cycles or vibrations per second. The transmission of this frequency is prohibited by the American Government, since only 5000 cycle sidebands are permitted. An extension of the permissible transmitted sideband to 10,000 cycles would aid materially. At the present time, the broadcasting station would involuntarily be obliged to cut off all frequencies above 5000 cycles in the sidebands.

Hence a change in the timbre of the voice is effected at the broadcasting station. The loss of this third octave may not introduce an appreciable change, but that, in addition to what takes place in the receiver, results in the disagreeable and disparaging statements made about radio sopranos.

The second phase to consider is the other category of broadcasting stations which do not

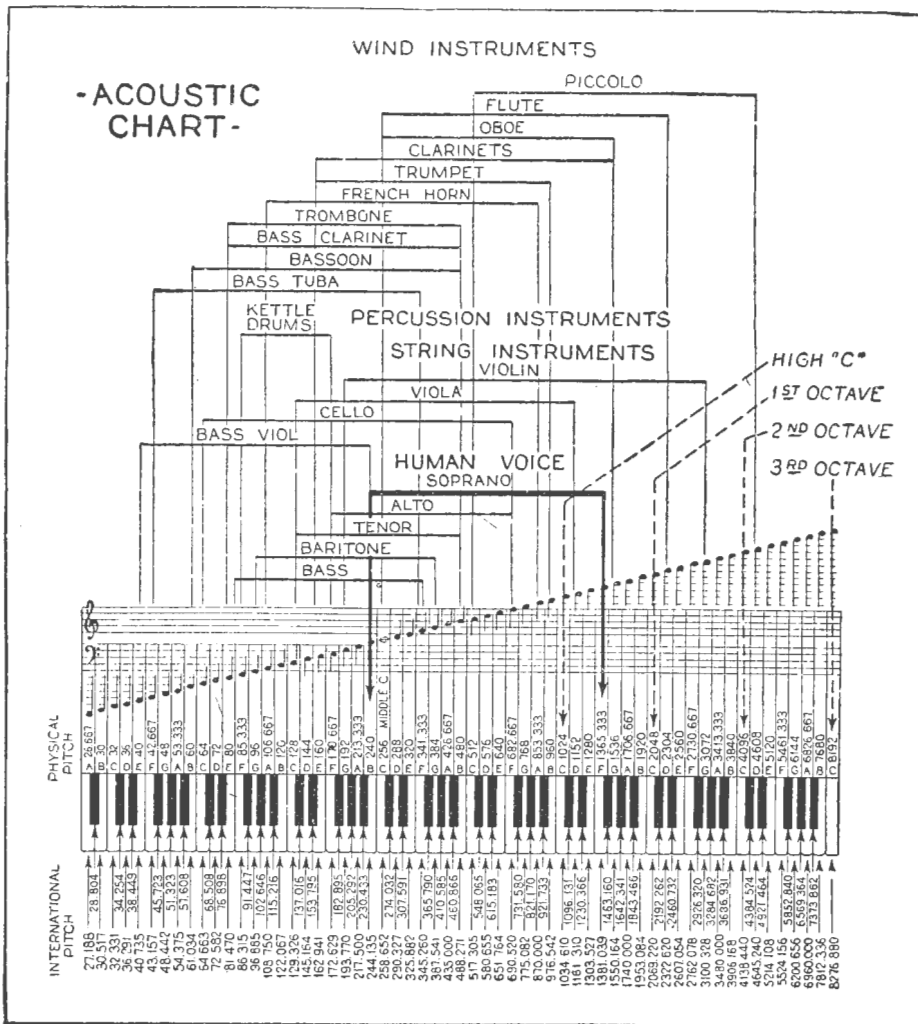

ACUSTIC CHART OF THE PIANO SCALE.

This chart serves to show the sound ranges of various musical instruments, and of the human voice. Here the third octave of high "C" has been added to the regular piano scale at the right.

faithfully transmit a soprano's voice. The difference between the two classes of broadcasting stations is found in the equipment which intensifies the sound waves after they have been picked up by the microphone and converted into electrical impulses. A certain amount of intensity magnification is necessary before the sound wave, now converted into an electrical wave, is propagated from the transmitting station radiating system. During the passage of these electrical impulses through the amplifying or magnifying equipment possessed by the poor and mediocre stations, the relative intensity amplitudes of the fundamental and harmonic vibrations are either attenuated or accentuated with the final result that the electrical impulses transmitted to the receiving set are no longer faithful conversions of the original sound wave emitted by the singer and picked up by the microphone. Were it possible to listen to the signals transmitted from such stations, without recourse to a receiver, we would immediately note the poor response.

The transmitting station is not the only contributor. Let us turn to the receiver. Here we must again convert the electrical impulses to sound waves. The actual process is somewhat complicated, but a description of it is not necessary for comprehension of the points at which a soprano's voice is distorted. The first source of trouble is that portion of the receiver which provides for the satisfactory selection of the station to which one desires to listen. The parts of the receiver, or the complete system of the receiver which gives it this property of station selection, produce an effect equivalent to the limitations of the aural tones which can be passed through the receiver and reproduced by the loudspeaker. This is called sideband suppression. Not that this portion of the receiver curtails the tones which the speaker will reproduce, but rather it limits the overtones and harmonics and the intensity of the overtones and harmonics which can be passed on to the other parts of the receiver and finally through the speaker.

The next factor in the receiver is the system that magnifies the aural tones which have been passed into it from the preceding system. This is the audio amplifier. Here we find that the design of the units comprising this system is the governing factor controlling the attenuation or accentuation of overtone and harmonic vibrations passed through the amplifier. Here we find the system which, if incorrectly designed, would alter the relative intensity amplitudes or values of the fundamental and harmonic vibrations of a soprano's voice. Here we find the system which, by not properly passing or amplifying the two overtones of the illustrated cited above, would greatly contribute to disagreeable reproduction.

Poor reproduction of a soprano's voice in general is greatly attributable to the operating qualities of the

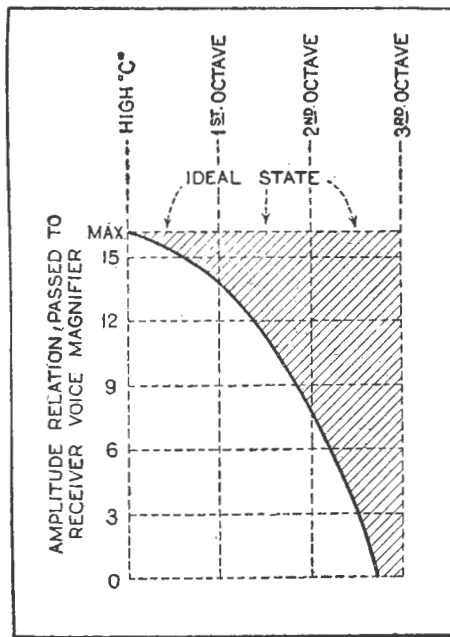

IN STATION SELECTOR.
Tuner reduces intensities of higher octaves.
Curve may be straightened in the future.

audio magnifying or amplifying system. Here we find that some of the units have the property of accentuating some of the vibrations which constitute the harmonics and overtones of a soprano's voice when she sings a high note. In other words, the second octave of the illustration cited might be magnified to an extent 100 per cent or 150 per cent greater than that existing in the original sound wave as produced by the singer. Some audio amplifying systems possess the quality of attenuating or diminishing rather than accentuating or increasing the proportion between the relative amplitudes of the fundamental and harmonic vibrations. The result is the same, namely, distortion of the singer's voice.

In all justice to the designers of radio equipment, we must qualify the preceding discussion of audio amplifiers. Many manufacturers of equipment suitable for use in audio amplifying systems have designed instruments which do not accentuate or attenuate frequencies passed through them and would not affect the soprano's voice in the manner we have

discussed. The majority of receivers, however, do not employ such perfect equipment.

From the amplifier, we proceed to the speaker. Here we find the greatest deficiency of all because the majority of speakers respond very poorly to the harmonics and overtones of high notes sung by sopranos. The speaker is the greatest contributory factor to poor reproduction of the soprano's voice. Assuming perfect transmission and perfect receiving equipment, exclusive of the speaker, the latter in itself would be sufficient to cause disagreeable reproduction by lack of response to the high vibrations found in the overtones and harmonics of high notes sung by sopranos.

The last but by far not the least important contributory cause for poor reproduction of soprano voices, is the general public demand for exceptional reproduction of the vibrations representing the bass portion of the piano scale and the tones produced by such instruments as the bass viol, bass tuba, bassoon, kettle drum, cello, and trombone, and human voices such as the bass, baritone, tenor, and contralto. The presence of the vibrations produced by these instruments and faithful retention of amplitudes, give the richness and depth to musical reproduction and aid in the production of sounds which sound mellow to the human ear.

Unfortunately, the attainment of reproduction of the tones produced by these instruments and by these singers has thus far been carried out at a sacrifice of the higher notes and tones. Receivers have been designed for special cases and the same is true of loudspeakers when operated with certain receivers, with which excellent reproduction of the soprano's voice is possible. On the whole, however, faithful reproduction of a soprano is still impossible with the average receiving set.

Some Illuminating Facts About Transformers

By C. WALTER PALMER

A TRANSFORMER is a device for transferring electrical energy from one alternating-current circuit to another, and for changing the voltage from one value to another. The usual transformer consists of two coils of wire wound on an iron or soft steel "core." The coil through which the current is supplied to the transformer is called the "primary," and the coil from which the electrical power is taken is called the "secondary." The alternating current travelling through the wire in the primary causes the iron core to become magnetised. This produces a varying magnetic field in the core, and because of the movement of this field, a corresponding voltage and electrical current is produced in the secondary by "electromagnetic induction."

It is necessary to use alternating or fluctuating current in a transformer. A steady direct current in the primary winding would magnetise the core and thus produce a magnetic field, but this field would be stationary and it is the **movement** of the field that induces the current in the secondary coil. Alternating current is continually changing, rising to a certain value, then falling to zero, rising in the opposite direction and reversing again. Because of this continually varying action, the magnetic field is also varying, and the form of the voltage induced in the secondary winding corresponds to that of the voltage in the primary. It is not absolutely necessary to have a primary current change its direction periodically, as alternating current does; it is only necessary to have its **value change continually**. A fluctuating direct current in the primary of a transformer will induce a fluctuating current in the secondary.

Turns' Ratio.

The entire purpose of a transformer is to transfer energy from one circuit to another, and, if desired, to change the voltage of the secondary to a different value across that in the primary. The voltage across the secondary of a transformer is proportional to the

ratio of the number of turns in the primary to the number of turns in the secondary. If we have a transformer operating on a 100-volt supply and 500 turns of wire are used in the primary, a secondary containing 100 turns would have approximately one-fifth of the primary voltage, or 20 volts.

There are three general types of transformers. The first has equal primary and secondary winding, and the secondary voltage is the same as that impressed on the primary. The second type has a secondary smaller than the primary, and the secondary voltage is lower than that of the primary; this is a "step-down" transformer. The third type has a larger secondary than primary and the secondary voltage is higher than the primary; this is a "step-up" transformer. The exact value of the voltage in the secondary depends upon the turns' ratio, as explained. See Fig. 1.

There is a slight loss of power in a transformer, for which there are a number of reasons. The windings present a certain resistance to the current, and some of the power is lost in overcoming this resistance. The core also presents a certain amount of heat loss, due to the currents which are set up in its laminations. The wire losses can be reduced by using heavy wire and the losses in the iron can be reduced by using a closed type of core.

Three Types of Cores.

As you will notice in the accompanying illustration, Fig. 2, there are three general types of cores used for transformers. The first is the open-core type, which has the lowest efficiency of the three. The second is the closed-core type, which is used almost exclusively for small transformers. The windings on this type of transformer may be both on one arm of the core, as shown in Fig. 3; or the primary and secondary may be wound on opposite arms, as in Fig. 4. The third type of transformer is the shell type, with a completely closed core. This type of transformer is usually used when large currents are involved.

Fig. 2 also shows an auto-transformer. An auto-transformer contains a single winding, with a tap somewhere along it. In the step-up type, the total winding is used as the secondary and part of the same winding (from one end to the tap) is used for the primary. In a step-down auto-transformer, the tap is placed in such a position that the ratio of the total winding to the section supplies the correct ratio of primary and secondary turns, for the required secondary voltage. The entire

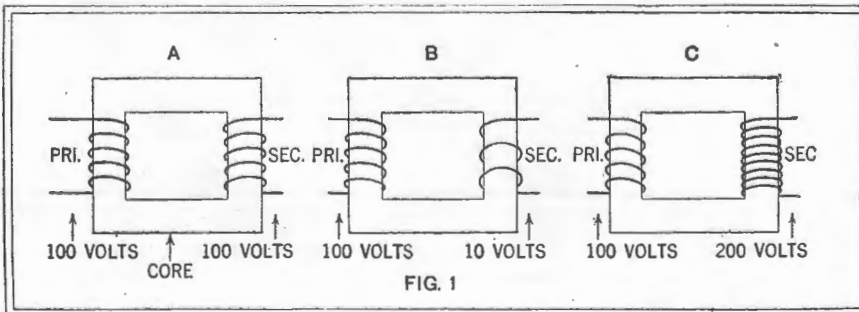

Transformer A is of the 1-1 type; primary and secondary have an equal number of turns, and the secondary voltage is the same as the primary. Transformer B is of the "step-down" type; transformer C, of the "step-up" variety, depending on the "turns ratio."

winding is used as the primary, while the tapped section becomes the secondary. In a step-up transformer the tapped section is the primary and the entire winding the secondary.

Why the Laminations ?

In order to reduce the heat losses in the cores of transformers, they are almost invariably made of very thin sheets of iron, each one insulated electrically from the others. This arrangement prevents large induced currents from being set up in the core. In a closed-core transformer with a solid core, the core can be considered as a single turn secondary which would have a very low voltage but high current-capacity characteristic. Naturally, the current flowing around the closed ring would cause a lot of heat and a corresponding loss of useful current. These currents are called "eddy" currents. In transformers using laminated cores, they are broken up into small sections in each lamination, and since the laminations are insulated, the heat losses are reduced considerably.

An interesting fact about transformers is that when the secondary circuit is opened, very little current flows in the primary. This is due to the fact that the value of the magnetic current set up in the core is gradually increased when no current is drawn from the secondary. This magnetic current reacts on the primary and produces another voltage in the latter which is just opposite to the original current impressed upon this winding. This additional voltage increases in value until it stops all of the current from the supply line, except just enough to produce a magnetic field sufficient to maintain the opposite voltage. Therefore, a transformer connected to a supply line and having its secondary open

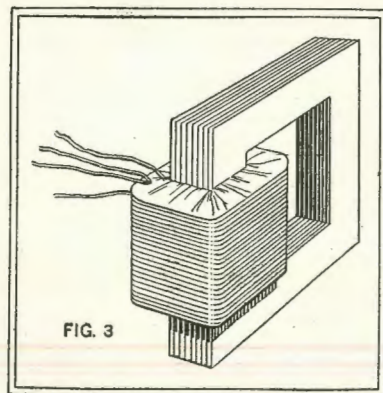

In this model of the closed-core transformer, primary and secondary are wound on one leg of the core.

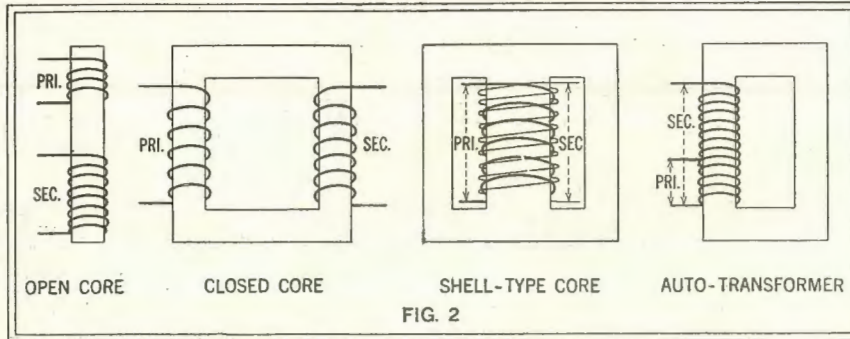

FIG. 2

Above are shown the four general types of transformers. In the auto-transformer, if it is of the step-up kind, all of the single winding is the secondary and part of it the primary. If of the step-down type, the whole winding is the primary and the tapped portion the secondary. In the shell-type transformer, both the primary and secondary are wound on the centre section of the core.

mitting the radio signals from one stage to another.

Power Transformers.

Power transformers are heavily constructed with large cores and heavy wire, since relatively large currents are passed through them. Most commercial transformers are placed in metal boxes and a number of models are sealed in wax or other compounds, to "damp" core vibration. In very large power transformers, the windings and cores are exposed to a current of cold air or they are immersed in oil or water to keep them cool. However, in transformers designed for ordinary radio receiving work, this is not necessary, since the devices are small and excessive heating can be avoided by their natural exposure to the air.

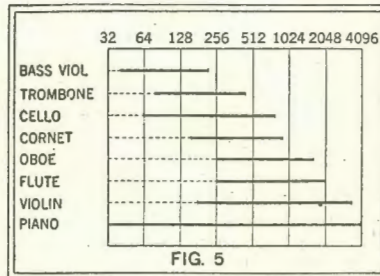

FIG. 5

This chart shows the range of frequencies covered by the common musical instruments.

There are two general types of radio power transformers. The first is of the step-down type, having a much smaller secondary winding than primary. These are used for lighting the filaments of alternating-current valves and the valves used in power-circuits. They are constructed with large cores and heavy windings, so that a large current can be drawn from them.

The second type of power transformer supplies the high voltage required for the plates of the valve in a radio set, and is used in "B" socket-power units. This type of transformer has a secondary winding with a large number of turns of rather thin wire, since only a small amount of current is required. These transformers are

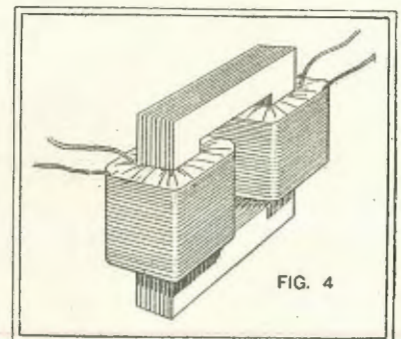
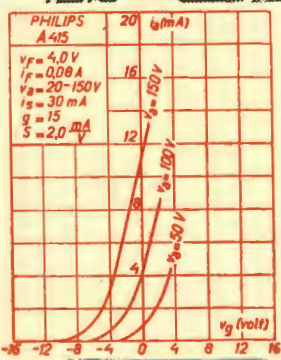
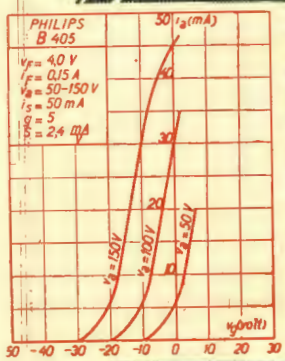
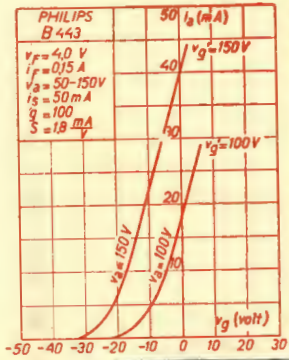

FIG. 4

In this model the primary and secondary are wound on opposite legs of the core.

(Continued on Page 53.)



SLOPE, or as it is often called, Mutual Conductance, indicates just how good a radio valve is. The higher the slope the larger the change in plate current for a given grid voltage.

Look at the slopes of Philips "Miniwatts." Some of them you will see are as high as 2.4 mA/V. Compare their figures with corresponding types of other makers !

PHILIPS

"MINIWATT" VALVES

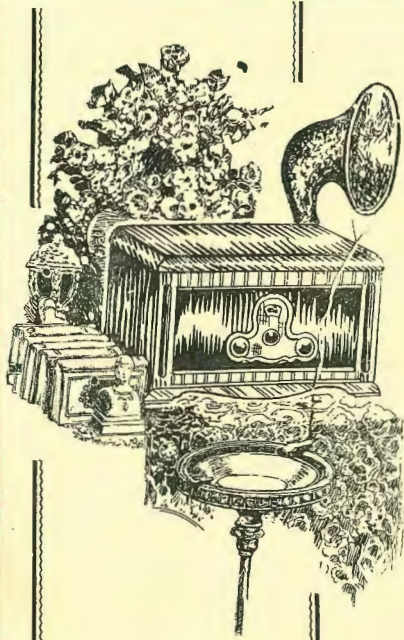

Radio Possesses a New Fascination when You Own **A RADIOLA**

The first time you listen to a RADIOLA you feel that here at last is something decidedly new and different—something enhancing radio with a new fascination.

Never have the clear, full-bodied, resonant, and life-life tones brought in on a RADIOLA been duplicated. Moreover, RADIOLA is highly selective, giving clear reception where interference usually disturbs, has great power and range, the operative simplicity of illuminated single dial control, and such beauty of design and cabinet work that is only found in fine furniture.

Hear a RADIOLA at any authorised RADIOLA Dealers. £ 10 deposit and easy payments will secure you immediate delivery.

Write us for illustrated RADIOLA Booklet—gratis.

RADIOLA Straight Six

A single-control table type Six-valve Receiver—battery operated or all-electric. Cabinet extremely artistic and pleasing in appearance. Complete with first-class equipment, suitable for country use, including a large automobile type storage battery and Amplion AR19 speaker. **PRICE £45**

RADIOLA Screened Six

A Six-valve Single-control Floor Cabinet Receiver, battery operated or all-electric models. All operating mechanism is enclosed in a metal chassis, and cone loudspeaker is built-in. Complete with first-class equipment, suitable for country use, including a large automobile type storage battery. **PRICE £57**

Authorised RADIOLA Dealers Wanted!

In every town, district or centre where RADIOLAS are not already represented, we want dealers of good reput to represent us. If you are anxious to become an authorised RADIOLA Dealer, write and tell us about yourself and business. We will reply to you promptly.

Sole Queensland Distributors

J. B. CHANDLER & CO.

Queensland's Largest Radio Store

45 Adelaide Street, BRISBANE

RADIOLA

Amalgamated WORLDWIDE Wireless
Austrosial Ltd

S.A.S.

AWA "IDEAL" TRANSFORMER

Designed by the research engineers of A.W.A., the special features which make the new A.W.A. IDEAL Transformer outstanding are:—

Increased size of iron core, more copper used in the windings, robust construction, and handsome phosphor bronze enamel finish. It gives flawless realism even to the ear of the trained musician. Obtainable in these ratios:—1-1, 2-1, 3½-1, 5-1, and 9-1.

Price 18/-

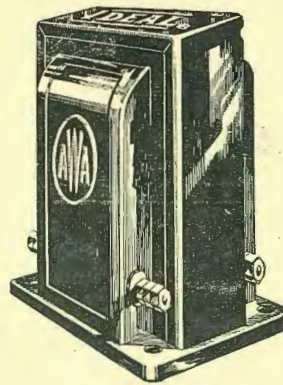

AWA Non-Microphonic Valve Socket

This Australian Socket incorporates the improved spring suspension principle, which fully protects the valve as well as eliminating all microphonic noises. Each terminal is plainly marked and fitted with soldering lugs.

Price 3/6



AWA Logarithmic Condensers

These new condensers meet the demand for a condenser suitable for use either singly or in "gang operation." They have been designed with true logarithmic characteristics which eliminates bunching of stations and makes tuning easy. Rigid construction ensures freedom from all troubles.

.0005 mfd.	PRICE 14/6
.00035 mfd.	PRICE 14/
.00025 mf-l.	PRICE 13/6

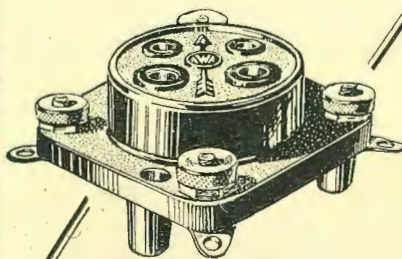

J. B. CHANDLER & CO.

Queensland's Largest Radio Store
Adelaide Street BRISBANE

Here's Value for 1929

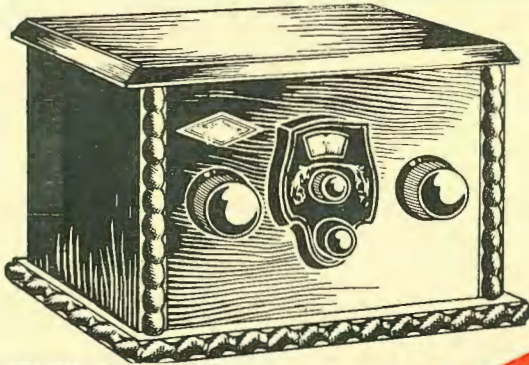

Super Radio "COMPACT" 3 Valve Receiver

Super Radio "Compact" 3 Valve Receiver, complete with "Sterling Dinkie" Speaker and all accessories.

CASH PRICE

£10

CASH PRICE

Where but
TRACKSON'S
could you
expect such
VALUE?



Why pay
more when
these Sets
give the
SAME
RESULTS?

Super Radio "DE LUXE" 3 Valve Receiver

Super Radio "De Luxe" 3 Valve Receiver, complete with "Sterling Dinkie" Speaker and all accessories.

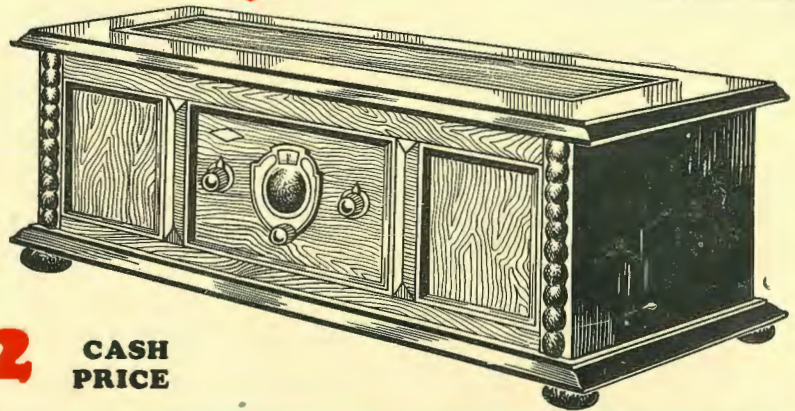

CASH PRICE

£12

CASH PRICE

TRACKSON BROS. LTD.

The Home of Radio Value

157-159 ELIZABETH STREET

Phone Central 6080

BRISBANE

The Transmitting License

By "Q.R.N."

Article No. IV.—Commencing an instructional course covering the theoretical knowledge required.

(All Rights Reserved)



THE first three articles of this series dealt with the conventional Q-signals, the Morse code, and with various aspects of traffic procedure. With this article a commencement is made in the theoretical knowledge required by candidates for the Amateur Operator's Proficiency Certificate.

Such knowledge required covers the general elementary theories of electricity, a good grounding in the behaviour of, and control of, electric current, both direct and alternating, and a sufficient insight into the various phases of radio electrical work. In this issue consideration will be given to some of the various units and terms used by amateur transmitters.

The volt, which is probably the most familiar of all electrical terms, is used to measure electro-motive force, or E.M.F., as it is more commonly called. The existence of this E.M.F. in its turn depends upon a potential difference in the sphere of action of the E.M.F. This potential difference may be defined as the difference of electrical pressure between any two points in an electrical circuit. If there be no measurable difference there is, of course, no E.M.F., and as a natural sequence, no volts to be taken into consideration. Now it is, of course, understandable that different electrical circuits and conductors will differ from each other in terms of their potentials. For the purpose then, of giving ease to calculation dealing with potentials, it is usual to refer to such in terms of their relation to earth potential, regarded as zero. From a consideration of this fact, too, it will be seen that insulation plays an important part. An insulator is any substance or object used to confine an electric current to its destined path, and to prevent such current from leaking away through any neighbouring conductor; and by the use of appropriate insulation the potential difference of any electrical conductor in respect to any other may be preserved. As an example, take the ordinary municipal lighting circuits. The electric light or power lines are usually referred to as 240-volt, or 100-volt, or 5000-volt lines and so on, as the case may be; and all are very carefully insulated with porcelain or glass or other insulators. These lines are carrying electric current which are at a high potential as compared to the potential of the earth (zero). This disparity in potential is measured in volts, and may be, as in the example, 240, 100, or 5000 volts. Any conductor that is directly and electrically connected to earth is at zero potential, hence in speaking of the usual two-line light or power system as 240-volt lines, one means that one of the lines has such a potential difference in respect to the other—for invariably one of the lines is "grounded," that is, at earth potential.

Having dealt with the idea of electrical pressure, or voltage, one naturally turns to its correlatives—amperage and ohmage or resistance. The application of some amount of electrical pressure or voltage to a

conductive circuit has the effect of setting up a state of strain or stress in the conductor. At the instant at which the voltage is applied, the point of application may be regarded as being at a higher potential than the rest of the circuit. So long as this potential difference exists, a current will flow in the direction of the lower potential.

Now the amount of current that will pass along a conductor depends upon two outside conditions; firstly, upon the pressure (i.e., voltage) urging it on; secondly, upon the nature of the path along which it is required to pass, or in electrical terminology, upon the resistance of the conductor. The quantity of current that flows along a conductor is known as the amperage, and is measured in terms of units called amperes. The obstruction offered to the passage of such a current is known as the ohmage or resistance, and is measured in units called ohms.

The relationship between these units—volts, amperes and ohms—is given by an old equation known as Ohm's Law. This was first established by Dr. G. S. Ohm, a renowned German physicist, in a pamphlet published in 1827, and states that, given a constant resistance in an electrical circuit, an increase of voltage will result in a proportionate increase in amperage.

Expressed in terms of an equation, we have—

$$\text{Current equals } \frac{\text{Voltage}}{\text{Resistance}}$$

$$\text{Or more familiarly: } C \text{ equals } \frac{E}{R}$$

(The letter C or I is used to express current, and E to express E.M.F.)

A second form is: $E \text{ equals } CR.$

And a third form is: $R \text{ equals } \frac{E}{C}$

Thus it will be seen that if any two of the factors—voltage, amperage or resistance—are known, the third may be ascertained directly.

Having given the three units their theoretical relationship, one comes to consider their quantitative significance. This, however, is simple, thanks to a prescient agreement between the scientists of early days, and an international ampere is defined as that current produced by a pressure of one international volt in a conductor having a resistance of one international ohm.

Electric currents of varying amperage and at various voltages, are used in radiotelegraphy, chiefly for heating the filaments of the valves in use, and for supplying the plate circuit of such valves. However, a great difference lies between the values of the currents used in the filament and in the plate circuits. The former is always of low voltage—even a big 250-watt transmitting tube has a filament voltage of a

Mullard

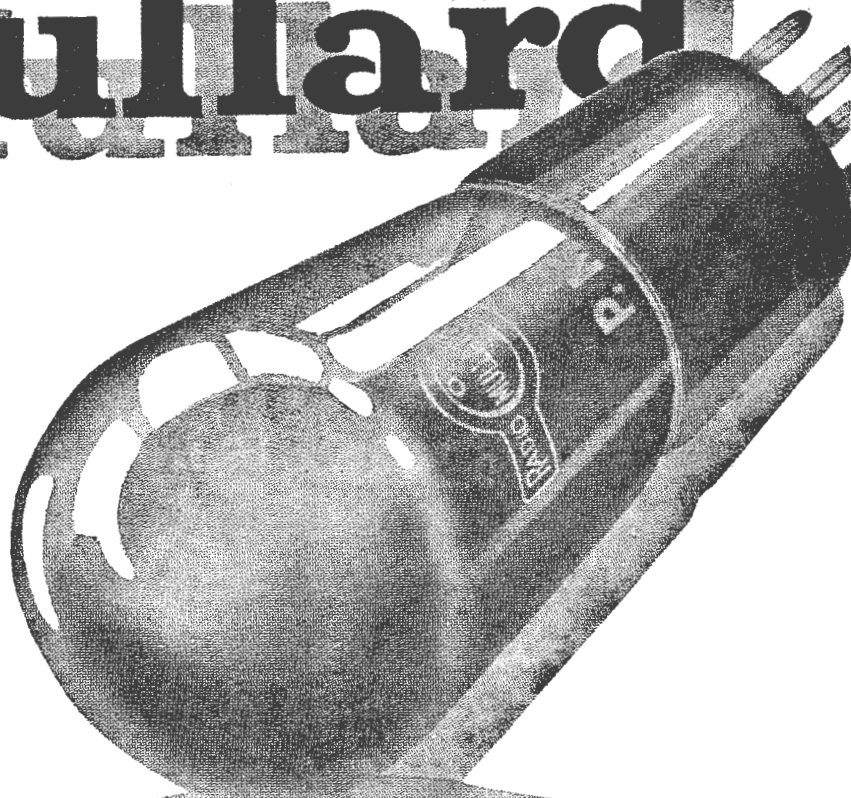

**THE VALVE WITH THE WONDERFUL
MULLARD P. M. FILAMENT**

Gives you the fullest value for your money and improves any radio receiver. Be safe; ask for Mullard P.M. Valves.

Mullard
THE MASTER VALVE

N

mere 12 volts—while the amperage in the filament circuit is always comparatively high. In the case of the plate supply, however, the reverse is the case. Here one finds high voltage, ranging up to thousands of volts, coupled with low amperage usually measuring a few milliamperes.

For filament lighting the average amateur generally uses accumulators or dry cells, though on occasions use is made of such things as step-down transformers working from the alternating current supply, to heat the filaments of transmitting and rectifying tubes. As an accumulator or dry cell only has a voltage ranging from 1 to 2 volts, it is usual to connect several together to increase the available voltage to a suitable value. It is, of course, well known that, to increase the voltage beyond that supplied by one cell, it is necessary to link up further cells in SERIES. The amperage of the battery so made is not thereby increased. The method of doing this is shown in Fig. 1.

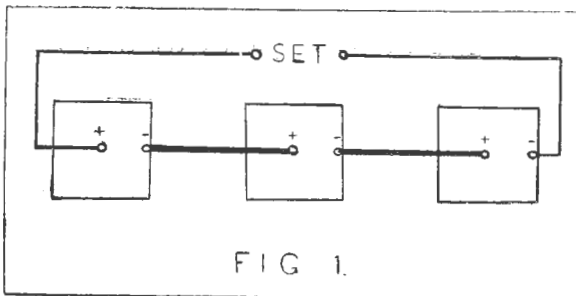

FIG 1.

When, however, it is found necessary to increase the available output of the battery without altering its voltage, additional cells are connected in PARALLEL as shown in Fig. 2.

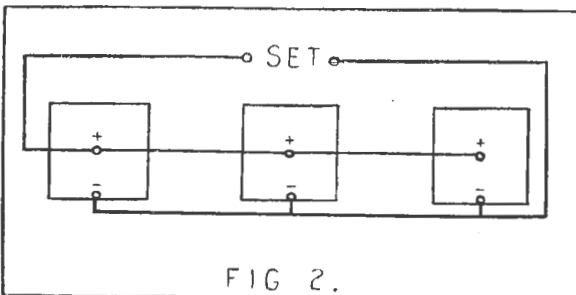

FIG 2.

Thirdly, a combination of these two methods has the effect of increasing both the voltage and the amperage of the battery, the increase in either case being proportional to the number of individual cells connected. A SERIES-PARALLEL arrangement is shown in Fig. 3.

A knowledge of the action and construction of dry cells and accumulators is necessary, but as such is given in most books dealing with electricity, no time will be taken up in this series of articles in giving the matter further consideration.

Resistances.

Every electric circuit has resistance, though for purposes of calculation the resistance of a plain circuit is regarded as negligible. However, it is very often necessary to perform various functions. Thus

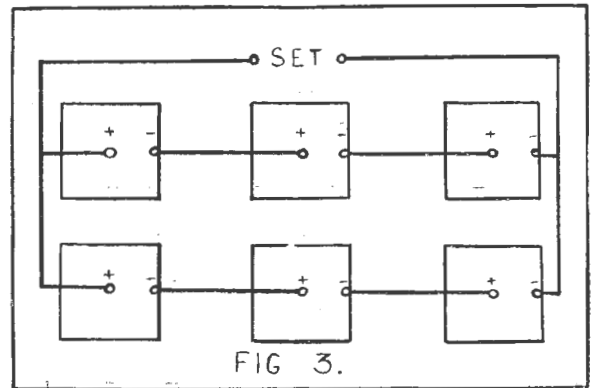

FIG 3.

it is usual to find resistances placed in the filament circuit and in the grid circuit of the usual receiver. When one known resistance is inserted in any given circuit the resultant values of current and voltage are calculable by the formula of Ohm's Law. When more than one resistance is used, however, they must be reduced to one equivalent resistance before further calculation be made.

Resistances in Series.

When two or more resistances are placed in series with each other as in Fig. 4, the equivalent value thereof is simply the sum total of their individual values.

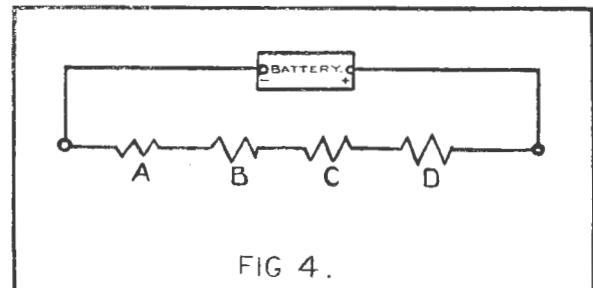

FIG 4.

That is to say, R equals A plus B plus C plus . . . where A, B, C, etc., are the individual resistances; and R is their equivalent expressed as one resistance.

Resistances in Parallel.

If the separate resistances (A, B, C, D, etc.) be connected in parallel (Fig. 5) the equivalent resistance R is given by the formula:—

$$\frac{1}{R} = \frac{1}{A} + \frac{1}{B} + \frac{1}{C} + \frac{1}{D} + \dots$$

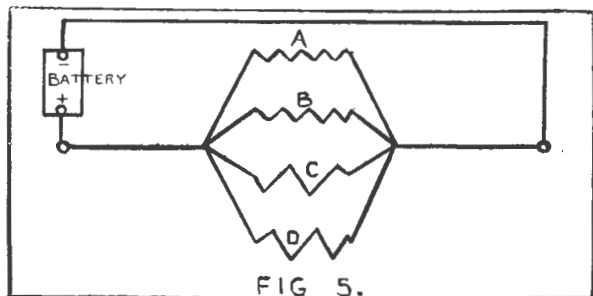

FIG 5.

In this special case of two (only) resistances in parallel this resolves into the following formula:—

$$R = \frac{AB}{A \text{ and } B}$$

Resistances in Series Parallel.

When various resistances are placed in series-parallel as in Fig. 6, it is necessary first to find the equivalent value of each group, and then find the total resistance of the result.

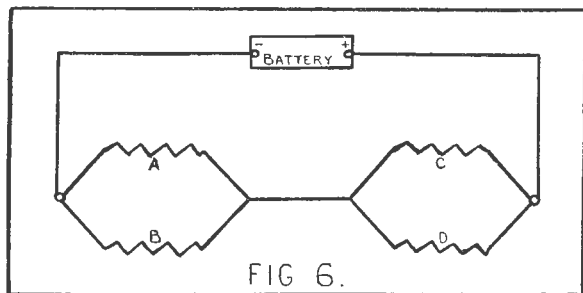

FIG 6.

It should be noted carefully that when resistances are connected in parallel, an equivalent resistance is obtained the value of which is less than any of the individual values of its component members.

Now that we have dealt with resistances in straight circuits, and also with various methods of connecting cells to give increased voltage or amperage, it is time to discuss condensers and capacity.

A condenser, whether of the fixed or the variable type is referred to in terms of its capacity. Now the capacity of a condenser is a measurement in certain fixed units of its power to store up electrostatic energy and the units are known as farads. Any condenser consists essentially of three parts, namely, two conducting surfaces—these may be of any shape and may each or either of them consist of many small individual parts, electrically linked to form one conductor. Thus we have, in the usual variable condenser, two sets of metal surfaces, each consisting of many smaller plates, forming on the one hand the fixed plates, and on the other the moving plates of the condenser. The third essential in any condenser is that the two conducting surfaces referred to shall be separated from each other by an insulating material known as the dielectric. In most variable condensers this dielectric is, of course, air—in most fixed condensers it is either mica sheet or glass, though in many of the fixed condensers used in amateur transmitting circuits, an air dielectric is used, so that when the application of an excessive voltage causes the condenser to flash over—or short-circuit its two sets of plates—the damage done is negligible, and the condenser is fit for further use, whereas such a flash over in a glass or mica dielectric condenser would destroy its value in most cases. There is a type of fixed condenser commonly used in line telegraphy, however, which does not suffer from this defect. This is the self-sealing type, wherein the two conducting surfaces are long sheets of tinfoil separated by a layer of waxed paper. When this insulation breaks down the electric current has a free path from one of the conductors to the other by way of the puncture in the waxed paper. But the passage of this current through the break causes heat to develop at such point. Then the wax on the paper im-

mediately around the puncture melts and flows across the break, restoring the insulation between the two conductors, and thereby repairing the condenser.

Now, to retrace our steps slightly. It was said earlier that the capacity of a condenser was measured in farads. This brings into discussion another unit known as the coulomb. A coulomb is a measure of quantity, and in practice, is the amount of electricity made available in a space of one second by an electric current of one ampere. Thus coulombs are represented figuratively by the product of amperes by seconds. Also it is obvious that when a condenser is incorporated in an electric circuit there will be set up a state of stress or strain between the two plates of such condenser. One plate—this word will be used to denote either of the conducting surfaces—will be charged to a higher potential than the other, and the voltage difference will tend to break down the insulation between the plates, and so form an unimpeded path for the current. Having thus seen that questions of coulombs and volts enter into consideration, the latter to denote the electromotive force across the terminals of the condenser, and the former to measure the total amount of current supplied to one of the plates of the condenser, we may now attempt to define the unit of capacity—the farad.

A farad is the capacity of such condenser as is charged to a potential of one volt by the application of one coulomb of electricity. Think this out, it is not nearly as difficult as it sounds. Symbolically it is

$$\text{represented by the equation } C = \frac{Q}{E}$$

where C is the capacity of the condenser, Q is the charge in coulombs, and E is the applied voltage.

In practice the farad is far too big a unit to be serviceable, and so a smaller unit, the microfarad, or the one-millionth part of the farad is used. Thus in amateur wireless use one finds condensers having capacities of .001 mfd. (usually referred to as two-ohs-one-micro-farads), of .0005 mfd. and so on. However, for short-wave work where capacities as low as .000025 mfd. are common, even the one-millionth part of a farad is too large for convenience, and the micro-micro-farad (mmfd.) is used. This name is somewhat cumbersome, however, and a strong movement is beginning to replace it by the term pico-farad. A pico-farad is equivalent to .000,000,000,001 farad, and a condenser of 250 pico-farads is the same as a condenser of .00025 mfd. The capacity of a condenser depends on, firstly, the area of overlap of the two plates (or sets of plates); secondly, upon the number of such plates; thirdly, on the distance between the plates; and fourthly, on the material used as the dielectric. The mathematical value of this dielectric—or dielectric constant as it is called—varies between unity for air and 81 for pure distilled water, which is of course an insulating material. Mica has a value ranging from 5 to 8, glass from 6 to 8; ebonite from 2 to 3, and shellac from 2 to 4. This means that if an air dielectric fixed condenser were to have the spaces between its plates tightly packed with mica sheet the capacity of the condenser would be increased by from 5 to 8 times the original capacity. This is the reason why such dissimilarity in physical size exists between a mica dielectric fixed condenser and an air dielectric condenser of the same.

In practice condensers may be used singly or in series or parallel with other condensers just as was the case with the resistances dealt with in last article.

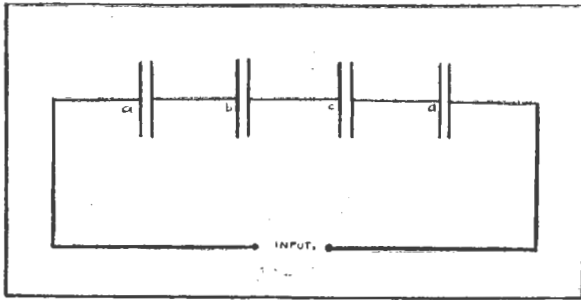

FIG. 7.

When condensers are linked in series, as in Fig. 7, the total capacity of the arrangement is the reciprocal of the sum of the reciprocals of the separate capacities. That is to say, suppose the condensers used had individual capacities of a, b, c, d . . . mfd., then the total capacity (C) of the series arrangement would be

$$\frac{1}{C} = \frac{1}{a} + \frac{1}{b} + \frac{1}{c} + \frac{1}{d}$$

In a similar manner an increase in capacity is given by linking several condensers in parallel as in Fig. 8. In this case the total capacity is simply the sum of the individual capacities of the several condensers.

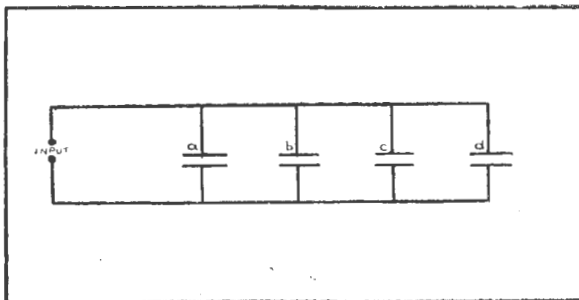
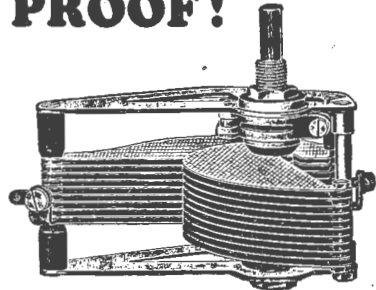

FIG. 8.

The action of condensers in radio circuits is a subject that is not generally understood by amateurs who do not hold their transmitting licenses, and a word here may not be out of place. In a radio set, whether a receiver or a transmitter, there are two types of current. There is the direct current, which is a smooth unidirectional current, as supplied to the plate circuit of the valves. Also there is an alternating current, changing in value many times per second, sometimes flowing in one direction, sometimes in the reverse direction, which is met with in the aerial circuit, say, of a receiver or in the filament circuit of a transmitter. The difference between these currents is shown in Fig. 9 and Fig. 10. Fig. 9 depicts the D.C. or direct current type. In the graph the horizontal value measures time, and the vertical measures voltage. Thus from Fig. 9, when the current is switched on at A it builds up practically instantaneously from zero voltage at A to maximum voltage at B, and then from time B onwards the voltage does not vary, so long as the circuit remains unbroken. But the position as shown in Fig. 10 is very different for alternating current. Here as before the horizontal line measures time, and the vertical voltage. When the alternating current is switched on at A it rapidly builds up to a maximum positive voltage, as at B. Now, however,

CONCLUSIVE PROOF!



J.B. S.L.F.

What influences you more than anything else in the choice of a particular make of component?

EFFICIENCY.

A noteworthy feature of all J.B. Condensers has been their extreme compactness of design. It is important to note that thus it is possible to reduce the amount of metal and insulating material to an absolute minimum. In no other Condenser will such economy of material be found. The dielectric thickness is just right to ensure the maximum of efficiency. Not so close as to produce risk of breakdown; not so wide as to produce losses through use of too much metal. This is only one example of the thought which has been given to every detail of J.B. Variable Condensers. It may be taken, in view of such efficiency, that very sharp tuning and maximum signal strength is positively the result when J.B. Condensers are used.

A close examination of the J.B. Variable Condenser pronounces it equally efficient as an engineering job. That the J.B. is so completely efficient explains why J.B. Condensers are known and used throughout the world. No description or illustration can convey the extraordinary beauty of finish.

Prices J.B. (True Tuning S.L.F.):
 .0005 mfd., 16/6; 100035 mfd., 16/-;
 .00025 mfd., 15/9. For Short Wave
 Receivers, 100015 mfd., 15/9. Write
 for full particulars of Logarithmic
 and Neutralising Models.

JACKSON

CONDENSERS

Dealers communicate with
A. BEAL PRITCHETT (AUST.) LTD.
 SYDNEY AND MELBOURNE
 EDGAR V. HUDSON :: BRISBANE.
 GIBBS, BRIGHT & CO. :: PERTH

Chemically Pure

CLYDE Batteries

CAR
RADIO
HOME LIGHTING



The Clyde Engineering Co. Ltd. BRISBANE BRANCH

115 Albert Street
BRISBANE

Telephone
Central 1425

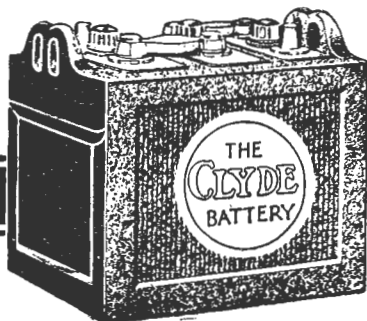

CARS

RADIO

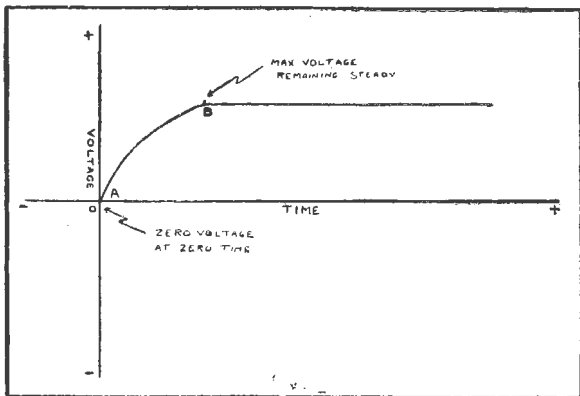

FIG. 9.

it does not remain constant at B voltage, but rapidly falls off to zero again at C, and commences to build up to a maximum negative as at D, and then again falls off to zero at E. This goes on continuously, so long as the circuit is unbroken. The vertical distance from the zero line AE to the points B or D is known as the amplitude, the curve from A to C or from C to E is known as an alternation, either positive or negative, and the complete swing from A to E, following the curve is known as a cycle. When one speaks of 50-cycle current or 500-cycle current, one means that so many complete changes of direction and voltage have taken place in the current lines per second. Thus in these cases the time AE in Fig. 10 represents one-fiftieth or one-five-hundredth part of one second. The number of cycles per second is known as the frequency of the current, and in radioelectric work varies up to a value approaching 300,000,000 cycles. The frequency of a radioelectric impulse transmitted from an aerial on a wavelength of one metre would be a frequency of 300 millions. Similarly, a wavelength of say, 300 metres would impart a frequency of one million cycles per second to the impulse. The frequency of 4QG's signals, on a 385 metre wave, is about 779,220 cycles per second, and the frequency of the signals of any other station may be very closely calculated by dividing 300 million by the wavelength in metres of the station in question.

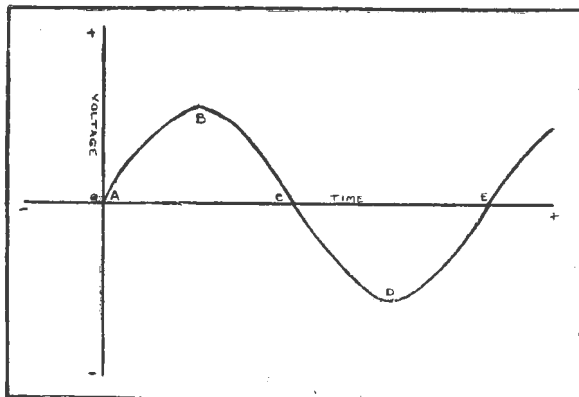

FIG. 10.

Now, having discussed the meaning of cycle and frequency, we may resume our consideration of the

condenser. The opposition to the flow of current that is set up by the insertion of a condenser in the circuit

is given by the formula $R = \frac{1}{2\pi FC}$

Where P is our old friend "Pi" of value 3.14

F is the frequency

C is the capacity of the condenser (in farads).

The term R is known as the reactance of the condenser, and is simply a term to denote resistance to alternating current.

From a consideration of the formula it will be seen that the only variable factor is the frequency. Thus it will be seen that the reactance of a condenser is greatest when the frequency is least. That is to say, a condenser will effectually stop the passage of direct current (frequency zero) or low frequency current, whereas the same condenser will allow high frequencies to pass with ease. This point is of the utmost importance to the transmitting amateur, and should be thoroughly grasped by all who wish to have even a slight knowledge of the working of their sets.



KING ALEXANDER OF JUGOSLAVIA IS AN ENTHUSIASTIC RADIO FAN.

King Alexander of Jugoslavia is an inveterate radio fan. Using a seven-valve set, the King spends practically the whole evening tuning-in. He has already picked up most of the European stations, but complains that reception of Daventry and Paris is poor on his loudspeaker. He is constructing, with the help of an engineer, a small short-wave amateur set which will enable him to receive stations in the United States.

**Clear Reception
is assured
when a C.A.V. supplies
the power!**

The C.A.V. BATTERY is British Built. It is thoroughly constructed, and gives maximum power over the longest period.

Don't waste time with faulty batteries—BUY A C.A.V.—it costs no more.

**C.A.V. "A" & "B" Batteries
BRITISH BUILT**

Queensland Distributors

Barnes Auto Co.

CORNER NORTH QUAY & QUEEN ST.

BRISBANE.



The Condenser

of Precision & Efficiency

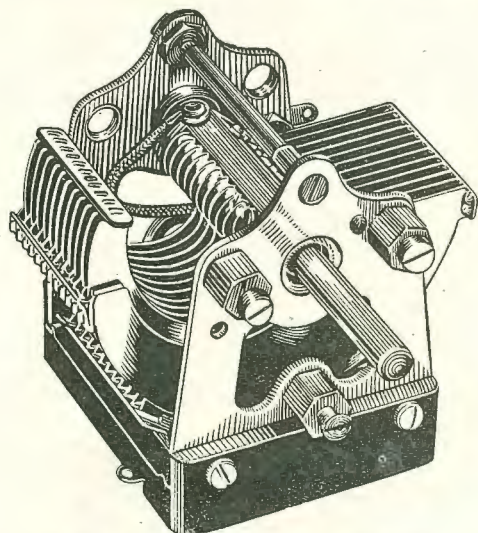

EMMCO SUPER-STRATELYNE CONDENSER

This improved $\frac{1}{2}$ Condenser, with its cast Bakelite base and improved brass frame, gives absolutely correct minimum and maximum capacities.

Perfect insulation, true alignment, easily adjustable brass frame, cut away brass plates in both Stator and Rotor, pig-tailed, and adaptable for either base or panel mounting, adjustable cone bearings.

Unsurpassed
by any imported make

Ample Stocks Available

Super-Stratelyne Condensers

Prices

.0005, 12/6; .00025 and .00035,
12/-; Short Wave, all capacities,
11/6

Simplex Three Gang One Control
Condenser, Two Capacities, .0005 and
.00035, Price £3

Made by **ELECTRICITY METER MFG. CO., LTD.**

Exclusive Factory Representatives:

MANUFACTURERS' PRODUCTS PTY., LTD.

Sydney: 137 Clarence Street.

Melbourne: Sunden Place



Oh!
Jimmy
let's
dance

"Isn't that dance band just wonderful! Listen to that glorious saxophone, it simply thrills me to pieces; Jimmy, let's dance!"
When jazz, such as only the city's star orchestra can play it, comes through your Philips "Baby Grand," you cannot resist the call of the dance.

No wonder, for dance music is not mere syncopation with a Philips Speaker—you hear the *individual* instruments, each sparkling with life as if you stood beside the player.

P.C.J.J. MODEL
£6/10/0

JUNIOR
£5/5/0

BABY GRAND
£3/15/0

PHILIPS
LOUD SPEAKERS

Special Activation Process

OLDHAM

BATTERIES

ALREADY DRY CHARGED—ONLY NECESSARY TO ADD ACID



Supplied
in
20 Volt
Units

Can be
Built
to any
Voltage

1/3 PER VOLT FOR YOUR HIGH TENSION
"B" BATTERY POWER

WRITE FOR ILLUSTRATED PRICE LIST

Noyes Bros. Ltd.
(Sydney)
PERRY HOUSE BRISBANE

What of the Amateur?

What will be the effect of the recently-formulated regulations on the status of the radio amateur? In this article, the subject is reviewed from an impartial angle, and an optimistic note is struck in the forecast of better and more productive days ahead.



As a result of the deliberations of the Washington Congress, which was convened in that city last year, some drastic alterations have been made in the regulations covering the operation of amateur transmitting stations. Few radio amateurs will be optimistic enough to say that the new regulations are in any way favourable to the amateur movement; indeed, there is a strong feeling that the movement will seriously be undermined by the many restrictions imposed in the matter of wavelengths—restrictions that were not unexpected by those who have been in close touch with the short-wave field during the past few years. The amateur must, of course, realise that while he, as a pioneer in the development of the short wavelengths, certainly is entitled to some consideration, it nevertheless is true that such tremendously valuable waves as, for instance, the old "32-metre band" are much too precious to be occupied by the (for the most part) inane chatter that has gone on for some time past. Genuine experimental work undoubtedly will receive every encouragement from the Authorities.

While it would be a great pity to see a waning of the old friendly international spirit that was brought about by trans-world contact between amateurs, we are driven to the thought that perhaps the elimination of the hackneyed "Ur sigs R7, stedi; QRK ?" type of contact will be rather a blessing than otherwise. Perhaps, too, it will result in the undertaking of more serious and worth-while work on the part of those who are qualified to intelligently attempt such work, for there is still much for the amateur to do, and probably there always will be.

As we view the position, the radio amateur of to-day is far too prone to follow the same old beaten track; he builds a short-wave receiver and transmitter, and then proceeds along the entirely worthless course of piling up an imposing list of countries and continents worked. Gene-

rally speaking, the be-all and end-all of his existence is "DX" and still more "DX"—very fascinating, to be sure, but certainly not a pastime that we can expect the powers-that-be to recognise as "research work."

Already we find a very real diminution of the intensely enthusiastic spirit that prevailed in the early days of the "40-metre band"—the hey-days of DX, when every week saw another long-distance, low-power record shattered by simple amateur-built equipment, and every night an invisible link was forged between two far-apart countries. Amateur short-wave transmitters have despatched signals over the longest routes that can be covered on this earth, because of its very "smallness!" Contact has been made with every civilised country on the globe. What, then, remains to be done in this direction?

Improving the efficiency of the short-wave transmitter? Emphatically, no; what of the legion of experimental transmitters of all types owned by powerful commercial concerns, in constant operation day and night, and with competent observers checking every fluctuation in signal intensity? With his limited financial resources, clearly the efforts of the amateur will be wasted here.

We believe that the field of exploration for the amateur is slowly but surely changing; we believe that he will turn ultimately from the transmission of morse signals into the four corners of the earth to the exploration of more clearly defined branches of the art. Television is at our doorstep, and what subject offers greater scope for the amateur than this newest of developments? The concentration of radio waves (probably of very high frequency) in beams by the use of some form of reflector system, the design of short-wave receivers using radio-frequency amplification and with greatly simplified tuning devices are but two of many more specialised departments in which the work of the amateur will be welcomed and is extremely likely to bear fruit.

We believe these changes are coming, and, in our opinion, the sooner the new order of things comes about, the better for the genuine experimenter (who is always a true lover of his chosen hobby) and for radio as a whole. True, the ill-equipped dabbler of to-day will be eliminated because of his very lack of knowledge and suitable apparatus; he may perhaps be permitted to indulge his hobby on some of the less-

valuable wavelengths, but in any case his loss will be no set-back to the cause of the real experimenter, who alone is going to keep the amateur movement alive.

It may be, then, that the influence of the new regulations will be, after all, one productive of good. Let us, at any rate, look forward to the day when we can say: "The amateur is dead—long live the experimenter!"

Electrical Federation Sports Club

At a recent meeting of the Electrical Federation, the members present decided to form a sports club in connection with the federation. The idea of the club is to promote tournaments in golf and other sports, thus bringing the members together and creating a better spirit of goodwill throughout the radio and electrical trade.

The following officers were elected: President, J. B. Chandler; captain and handicapper, H. Maddick; committee, H. Maddick, W. E. Peterman, A. A. Ewing.

The first tournament under the control of the new club was held at the Wynnum Golf Links on 6th December last. After an enjoyable lunch at the club house the "goofers" commenced what proved to be a very keenly contested game. Fred Hoe returned the best card showing a nett score of 72, thus winning the trophy donated by Mr. A. Warburton.

It was certainly Fred's lucky day, as he also won another little competition (popularly known as "two bob in") later on.

Scores:

The scores for the match were as follows:—

	Gross	Hd.'cp.	Nett
Fred Hoe	97	25	72
C. G. Paine	85	10	75
A. A. Ewing	103	25	78
C. A. Fitzgerald	99	17	82
B. S. Goadby	105	23	82
R. Broad	108	25	83
H. Maddick	101	15	86
W. E. Peterman	112	25	87
A. Warburton	113	25	88
P. H. Phillips	118	30	88
R. Jay	119	30	89
J. B. Chandler	127	30	97

A challenge has been issued to the Director of 4QG to form a team representing the station to meet the traders at a golf tournament on some suitable date during February. This challenge has been accepted and should prove to be a very good game, as, leaving out the probability of the Director being a "dark horse," there must be many good golfers among the artists appearing at 4QG. "It is an ill wind that blows nobody any good," as we understand trade has improved with the sporting stores dealing in golf material—and in repairs to broken clubs.



Wooloowin Radio Club 4WN

By the time these notes are read, several vital changes will have taken place in the amateur field; 1929 promises to be the beginning of a new era for the amateur, experimenter and the members of VK-4WN are getting in early with their new 1929 Xmitter. Any reports of reception from listeners would be greatly appreciated.

Mr. J. P. Love has passed the test for the A.O.P.C., and, at the time of writing, is touring the bay, in the good ship "Sweetheart," accompanied by a portable Xmitter using the call XVK-4WN.

Mr. Kenna at present is located at Townsville, having had a very pleasant trip North, keeping skeds with 4JG from Mackay, but not being able to raise contact from Bowen. He is working a 24-hour shift per day, the hours of light being spent on a 100 watt Xmitter, while the silence of night is disturbed by sigs. from his portable Colpitts.

Our leading star—ahem!—4LJ has had a very bad trip South, having contracted a chill on the way down, which put him "non est" for a few days. We have not yet heard the details of the A.R.T.L.'s amalgamation with the W.I.A., but methinks everything has been fixed up O.K., for which we extend our sincere thanks to L.J., who, by the way, is one of the 4WN gang.

Say, OM's, has anyone heard or seen anything of Frank Nolan or Pat Kelly? Come on, fellows—show a light; what with Clyde George popping the question and half the gang being away on extended leave, our hon. sec. sure has to scratch his head in order to get a decent roll call. However, let's start 1929 with a full house. First meeting night is January 10th, gang, so give the YL's the engaged signal for that night and come along.

We take this opportunity of extending our best wishes for 1929 to the Editor and staff of "The Queensland Radio News," the members of the A.R.T.L., and radio amateurs in general. May 1929 be a red letter year in the history of radio.

The New Regulations

Some authentic particulars of the new regulations framed at the recent Washington Conference, and their application to the activities of Australian amateur transmitters.

The following circular letter has been received by all licensed transmitting amateurs in Australia relative to the new radio regulations formulated by the Washington Conference:—

Commonwealth of Australia.
Postmaster-General's Department,
Treasury Gardens, Melbourne, C.2,
8th December, 1928.

Circular to All Licensed Experimenters Authorised to Transmit.

The Wireless Telegraphy Regulations concerning the activities of amateurs have been amended. The principal amendment relates to frequencies (wavelengths) to be used for experimental transmissions. The Postmaster-General has approved of the following frequencies (wavelengths) to be used for that purpose:—

60,000 Kilocycles (5 metres)	to 56,000 Kilocycles (5.25 metres)
30,000 Kilocycles (10 metres)	to 28,000 Kilocycles (10.7 metres)
14,400 Kilocycles (20.8 metres)	to 14,000 Kilocycles (21.4 metres)
7,300 Kilocycles (41 metres)	to 7,000 Kilocycles (42.8 metres)
1,990 Kilocycles (150.8 metres)	to 1,715 Kilocycles (175 metres)
1,715 Kilocycles (175 metres)	to 1,200 Kilocycles (250 metres)

These bands are the only bands available for amateurs at present, and it will probably be found necessary to re-arrange them in about 12 months time, particularly the band 1715-1200 kilocycles.

In allotting these bands, the Department necessarily had to take note of the requirements of commercial and official services, and thus had been unable to grant any further facilities for experimental transmissions.

In this connection, the Department has an obligation under the International Convention to ensure that transmissions by Australian stations will not interfere with stations in other countries.

Transmissions on these wavelengths must be confined to experiments and tests, but the Department has decided to permit the exchange between amateurs of messages relating to the experiments. In no circumstances, however, can messages for a third party be transmitted without the permission of the Department.

In order to avoid interference with other services, particularly on the higher frequencies, experimental licensees will be required to pay special attention to the correct tuning of their transmitters, and will be required to instal approved frequency meters (wavelength meters).

The call signals for experimental stations have been altered to accord with the International Regulations. In consequence, the existing call signals will, in future, be prefixed with the letters "VK."

The new regulations will come into force forthwith, so as to ensure that the conditions are fully effective as from midnight, Greenwich Mean Time on 31/12/1928.

The fees for experimental licenses henceforth will be £1 per annum.

(Sgd.) J. MALONE,
For the Director-General.

A Million Volt Spark

Photograph of a Million-volt spark taken at the works of Ferranti Ltd., Hollinwood, England, whose name is familiar to radio enthusiasts in connection with their audio-frequency transformers, and also their push-pull transformers, now so widely used for gramophone amplification.

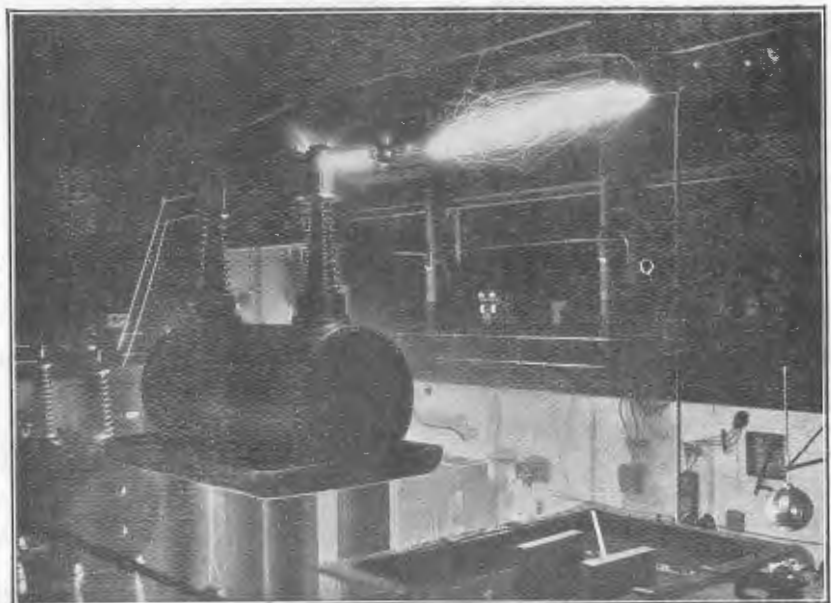

Now—

**MAGNAVOX
DYNAMIC
POWER SPEAKERS**

—for £10!

New Low Prices

*Bring these incomparable Speakers
within the reach of every set owner*



**BEVERLEY JUNIOR
MODEL**
Fitted with Unit to work
from accumulator or
trickle charger,
£10/-/-.



**BELVEDERE (Fire-
screen) MODEL.**
For "A" battery opera-
tion, £11/10/-.
For A.C. power point
operation, £14/10/-.

The enormous output by the Magnavox Company, created by the open preference of set-owners throughout the world for this new Dynamic Speaker, and the adoption exclusively of the Magnavox Power Speaker as built-in by famous makers of fine sets in England and America. . . . these dominant facts alone have brought about the revised Magnavox prices now prevailing throughout Australia.

Magnavox Dynamic Power Speakers differ from other speakers both in principle of operation and construction. Made under exclusive Magnavox patents covering principles which are acknowledged by leaders in radio science as the only type of speaker construction capable of flawless radio reproduction. This new Magnavox Dynamic **realism** has caused a furore everywhere. . . . a low whisper. . . . pure and clear . . . or a glorious cascade of volume . . . without the slightest distortion.

Special Discounts for Dealers

Wholesale and Retail Distributors—

Mick Simmons Ltd

"The Home of Sport and Radio."

Queen Street, BRISBANE

Radio in the Lighthouse Service

An Invaluable Aid to Navigation.

In another part of this issue appears an article dealing with the recent application of the radio-telephone to the Commonwealth Lighthouse Service, and the very important work it is carrying out in connection with maintaining reliable communication between outlying lighthouses and the mainland. In this photograph (reproduced by courtesy of Messrs. Amalgamated Wireless, A'sia., Ltd.), will be seen the type of combined transmitter and receiver which has been specially designed by that company for the purpose.

The outfit consists essentially of a continuous-wave valve oscillator with provision for voice modulation, and a reliable power-supply, this latter being derived from a direct-current generator, driven by a small petrol engine. The consideration of simplicity has been carefully studied throughout, for it will readily be understood that such a set would fail entirely in its purpose if an experienced operator were



needed in constant attendance. Another point worthy of note is the extreme compactness of the outfit—an invaluable feature, as anyone who has ever been inside a lighthouse knows. It goes without saying that the factor of reliability has not been neglected; it is, of course, of paramount importance in such an installation.

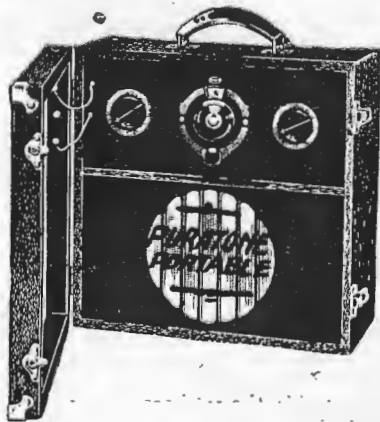

£25

Terms if Desired

E.P.D.

Let us quote you for your

**ELECTRIC LIGHT
INSTALLATION**

4 Valve Portable Receiver

using latest Screen Grid Valve. This wonderful valve is equal to two ordinary valves in amplification on the long waves, and on the short waves is equal to at least three ordinary valves.

COME AND HEAR IT! Works on built-in frame or outside aerial. Receives all stations—short or long waves.

Batteries, loudspeaker, and aerial—all self-contained. We sell, rebuild or repair any make of set.

S. ANDERSON

363 George Street, BRISBANE

Opp. McDonnell and Easts'. Phone: C-4315.



Margaret Street,
Milton, Brisbane,
Friday, 28th Dec., 1928.

(The Editor, "Queensland Radio News.")

Dear Sir,—Through the courtesy of a Japanese friend of mine, I can pass on the following particulars of Japanese radio stations as published in the "Osaka Asahi" (Japan's largest newspaper) on the 19th November, 1928:—

JOAK	at Tokyo	...	10,000 watts	344.9 metres
JOBK	at Osaka	...	10,000 watts	400 metres
JOCK	at Nagoya	...	1,000 watts	370 metres
JODK	at Keijo	...	1,000 watts	366 metres
JOFK	at Hiroshima	...	10,000 watts	353 metres
JOGK	at Kumamoto	...	10,000 watts	379.7 metres
JOHK	at Sendai	...	10,000 watts	389.6 metres
JOIK	at Sapporo	...	10,000 watts	361.1 metres

I can verify two of the stations' wavelengths—JOAK on 344.9 and JOFK on 353 metres—having heard both of these stations on my "Solodyne" at weak speaker strength (good headphone) last night (27th inst) at about 10.40 p.m., just as 2BL closed down.

It may be interesting to some readers to know that our Japanese friends know quite a lot about trans-

mitting pictures by radio, for the "Osaka Asahi," published in November (several issues) contained radio pictures (excellent), transmitted from Tokyo to Osaka—360 miles. These pictures were views of the Japanese Emperor's Coronation.

Trusting this information is of benefit to your many readers,—

Yours truly,

E. J. H. CORNELIUS,



43 Darlington Road,
Miramar, Wellington (N.Z.),
28th November, 1928.

(To the Editor, "Queensland Radio News.")

Dear Sir,—As an old resident of Queensland I have taken a great interest in 4QG, and having been a subscriber to the "Radio News," I thought I would just drop you a line to tell you how much I appreciate your very valuable journal. I might state that it does not always stay in my house, but goes round to more than one of my many friends. But that is not what I am writing to you about. What I wish to know is, if I can procure from your good self a blue print of the set you called "The Globe Trotter Screen Grid Four" for broadcast receiving, which you published in a recent "Q.R.N." If you can supply me with one I would very much appreciate your sending one, letting me know the cost which I will remit on return.

Thanking you in anticipation and wishing 4QG, yourself, and the "Q.R.N." a Merry Christmas and a Happy, Bright and Prosperous New Year.—I am sincerely yours,—

W. WHITELEY.

"Q.R.N." Question Competition

This month we are commencing a novel competition for our readers, for which good prizes are being donated by Messrs Trackson Bros., Ltd. Each month a question relating to some usual trouble experienced with a radio set will be given, the prize being awarded to the sender of the correct or most nearly correct answer:—

As we wish this competition to become popular with our readers, the questions will be kept as simple as possible, so that those with only an elementary knowledge of radio may compete.

The following are the conditions governing the competition:—

- (1) The closing date of the competition will be the 20th of the month in which the question appears.
- (2) Answers must be forwarded to the "Queensland Radio News," box 1095N, G.P.O., Brisbane, the envelope being marked "Question Competition."
- (3) Competitors may send in as many answers as they wish, but each answer must be accompanied by the coupon printed below.
- (4) The prize will consist of an order on Messrs. Trackson Bros., Ltd., for the radio apparatus mentioned each month as the prize.
- (5) The decision of the Technical Editor of the "Queensland Radio News," who will act as judge, will be final.

THIS MONTH'S QUESTION.

A three-valve receiver (detector and two stages of audio-frequency) gave good results until an intermittent crackling sound developed, somewhat similar to static. The noise, however, was audible with both aerial and earth disconnected, which established the fact that the trouble was in the set, batteries or loud-speaker. On the headphones, which were plugged in on only TWO valves, reception was O.K., but when the phones were connected in place of the speaker to THREE valves, the crackling was in evidence. Gradually the noise became greater in intensity and frequency, until it was continuous and prohibited reception. Soon after this, the set became practically "dead." All batteries tested O.K., and the valves likewise. What was the trouble?

PRIZE: One "Ship" Cone Loudspeaker.

COMPETITION COUPON.

This coupon must accompany each answer sent in for the JANUARY Competition.

NAME

ADDRESS

.....

This department is conducted for the benefit of our readers. We cannot answer queries by mail, but if a special diagram is required, we will supply it at a cost of 1/-.

Questions Answered

By the TECHNICAL EDITOR

Questions received before the 20th of the month will be answered in the following month's issue. Queries arriving after this date are deferred until the next issue.

"H.F.," Sunnyside.—"Could you inform me what books are necessary to sit for the Amateur Operator's Proficiency Certificate Examination? (2) With reference to the 'DX Special' short-wave transmitter described in the October 'Radio News,' what spacing should be allowed between turns of coils L1, L2 and L3? (3) What distance apart are these coils placed? (4) What kind of aerial would be found best for use on the 32-metre band?"

Answer.—The most suitable book for your purpose is James' "Wireless Valve Transmitters," obtainable from either Barker's or McLeod's bookstores, Brisbane. This is a standard work which treats the whole subject in a readily-followed manner, and is the one text-book always recommended for intending examinees. (2) The turns are spaced about the same distance apart as the thickness of the wire itself, as is usual in space-wound coils. The exact spacing, however, is immaterial. (3) The distance between the coils is not at all critical, but should be somewhere about three-quarters of an inch. That is the distance between the extreme ends of the coils, of course—not from centre to centre of the end turns. (4) You will see by the matter published elsewhere in this issue that there is no such thing as a "32-metre band." This wavelength has been withdrawn from the amateurs on account of its great value in commercial work, and new wavebands have been allotted. For amateur use, the "Zeppelin" type of Lecher-wire-fed aerial has proved itself eminently satisfactory, and it has the advantage of being quite easy to instal. A rough sketch of an aerial of this type, designed for 40-metre operation, is being mailed to you.

"W.L.R.," Mt. Larcum.—The Philips B-443 Penthode is intended for use in a single-stage audio amplifier, in which it will deliver volume approximately equal to that of a two-stage amplifier using ordinary three-electrode valves. When used in the last stage of a two-stage amplifier, trouble is likely to be encountered in the form of a high-pitched whistle, which may be very hard to eliminate. The same holds true when it is used in the final socket of any multi-valve amplifier, whether it be resistance-, choke- or transformer-coupled, or has a combination of any of these methods of coupling. Personally, I have had remarkable results with this valve, and I think it most probable that you have been unlucky enough to secure a faulty valve. Would suggest that you write to the Philips representative in Queensland—Messrs A. H. Hills, Perry House, Elizabeth Street, Brisbane—who will, I am sure, give you every assistance in solving your difficulty. Do not, on any account, blame the type of valve—faulty specimens creep through with every make.

"A.E.G.," South Bundaberg.—Recently I constructed a one-valve receiver, the circuit diagram of which I have enclosed. I have not yet heard a sound on it. I have tried changing the connections on the coils, but without success. Do you think the range between here and 4QG is too great for the receiver? or isn't the circuit any good? If so, how could I change it, so as to make it into a good, long-range one-valve receiver?"

Answer.—Your circuit should give some results, but the circuit is not a good one, and I would remodel it if I were you. I am sending you a circuit that will give you good long-distance reception. A one-valve receiver in your location should enable you to receiver not only 4QG, but the main Southern station as well—on the headphones, of course, and when conditions are normally good. Let me know how you get on.

"T.R.," Sandgate.—"I have a five-valve Neutrodyne (components mentioned). What I would like to know is whether I could replace my present valves with those of the screen-grid type, and if it would affect the neutralising? Would there be too much volume for the last valve (a PM-4) to handle?"

Answer.—The substitution of screen-grid valves would mean an entirely new layout, and new coils. In fact, it would be best to dismantle the set and build a new one if you intend to use these valves in the r.f. stages. As we have said several times, the use of the screen-grid valves is not just a matter of inserting them in the sockets previously occupied by the old three-electrode valves. Special precautions are necessary in the matter of shielding, and the coils must, in many cases, be designed expressly for the screen-grid valves. I would refer you to the Screen-Grid Solodyne, featured in our October, 1928 issue. This is an excellent example of the best type of screen-grid broadcast receiver, having a circuit very similar to that of the Neutrodyne. With the screen-grid valves, properly used, neutralisation is affected to this extent: it is eliminated entirely! This is one of the great advantages of these valves, when used as r.f. amplifiers; the inherent stability of the circuit is such that no neutralisers, lossers, or any other devices for suppressing oscillation are needed. High plate voltage must be used for best results—not less than 120 volts is recommended. The PM-4 would be rather on the small side for such a powerful receiver; I would advise you to instal a PM-254, which is a small power-valve.



DROP the Technical Editor a line if your set is not "perk-ing" as it should. Be brief and to the point—ten-page epistles strictly prohibited!

"W.A.P.," Mount Morgan.—"Re your query regarding a "B" eliminator: The circuit you enclosed is a very good one, and I don't think you can improve on it. Also, the parts you propose using are O.K. To control the entire output voltage, you should use an Emmco No. 2 Powerstad, which is intended for that purpose. The resistances you show are correct; Emmcostads will be alright here.

Your other diagram is quite in order; personally, I can find nothing to choose between the choke-condenser filter and the 1-to-1 transformer. You will find the former quite satisfactory in practice.

"W.J.W.," Brisbane.—"Please supply a circuit diagram, with all necessary data, for the construction of what you consider to be the latest and best type of crystal receiver employing a carborundum stabilising unit, and capable of giving sufficient volume to operate a small loudspeaker. (2) Would it be advisable to include the device known as a Magnetic Bar amplifier to ensure best results? (3) Would the accompanying circuit be suitable for local conditions and capable of receiving Sydney when 4QG is off the air?"

Answer.—The circuit you have enclosed is as good as anything that I can suggest for this type of detector. Used on a moderately good aerial within, say, five miles of 4QG, you can expect weak to fair speaker reception, depending, of course, on the distance to be covered. (2) I would not use the device mentioned if I were you. (3) I do not think you have much chance of hearing Sydney on the set mentioned. It is barely possible that you may receive them in the middle of winter, late at night, but I would not count on it. The carborundum is not the most sensitive detector by any means, although it is fairly sensitive when used with the local battery and stabilising unit. Its great advantage is the complete stability which such a detector shows, there being no catwhisker to adjust, as in most of the more sensitive types. No doubt you will hear of other people re-

ceiving the South on a crystal set, perhaps with the carborundum detector. You might do the same, but, as I said, don't count on it, or you might be disappointed.

"R.R.," Brisbane.—"As I am going to build the Peridyne receiver described in the August 'Radio News,' I wish to know if it is possible to use the new screen-grid valves, and what alterations would be required?"

Answer.—Yes; it is possible to adapt the Peridyne for the screen-grid valves, and a very powerful receiver is the natural result. So far, we have not described such a set, but constructional details were given in the November issue of our contemporary, "Radio," published in Sydney. I would advise you to write to Messrs. Wireless Newspapers Ltd., 51 Castlereagh St., Sydney, sending 1/- in stamps, and asking them to forward you a copy of this issue.

"A.T.," Ipswich.—"Will you kindly post to the above address a circuit of a Reinartz three-valve set, using a wavetrap in the set. (2) Is it possible to use this set for short-wave work, just by altering the coils? (3) My aerial consists of 7/22 wire. Is this the best, and what length should I use?"

Answer.—I am sending a diagram of the circuit you request. It is exactly similar to the Victory Two, featured in this issue, except that another stage of audio is added, so that ordinary

valves can be used. (2) I would not advise you to attempt this, as such a procedure is seldom satisfactory. It is far preferable to have a separate short-wave receiver, or even a short-wave adapter, which can be used in conjunction with the broadcast set. (3) Use about 80 feet in the aerial proper, and have the lead-in as short as possible. 7/22 is as good as anything.

"T.J.T.," Taringa.—"I have two condensers—Pilot (8 plates) and Advance (11 plates)—that I have used in a short-wave set with good results. Will they be O.K. in the Globe Trotter Screen Grid Four (September issue)? (2) If so, will the other condensers specified by you (fixed and variable) be O.K., or will the values have to be changed? (3) Will the two turns have to be removed from the 8-turn coil? (4) Can the Globe Trotter be used with a 'B' and 'C' eliminator and three Leclanche cells for filament supply?"

Answer.—Yes; use the 8-plate for C1 and the 11-plate for C2. (2) The values will remain unchanged. (3) Yes. (4) The Globe Trotter can be used with an eliminator, but I doubt whether Leclanche cells will give satisfaction for supplying the filaments. It is worth trying, however.

"A.H.S.," Maryborough.—Information mailed to you.

"R.H.W.," Cunnamulla.—Replying to your questions by mail.

4QG's Bedtime Storytellers at Newtown

Successful Entertainment for Children

On a recent evening the combined bedtime stories staff of 4QG entertained a large gathering of children in the Princess Theatre, Newtown. The entertainment formed a part of the week's festivities held to celebrate the opening of Newtown (formerly known as "the Clarence Corner"), and proved to be a wonderful success. As can be seen from the flashlight picture reproduced at the right, the large auditorium was filled to overflowing, and a vast sea of up-turned, smiling faces met the camera's eye. Upwards of 2000 children attended the performance,

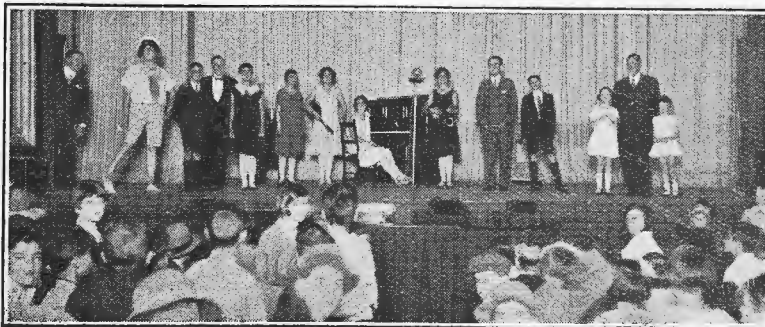
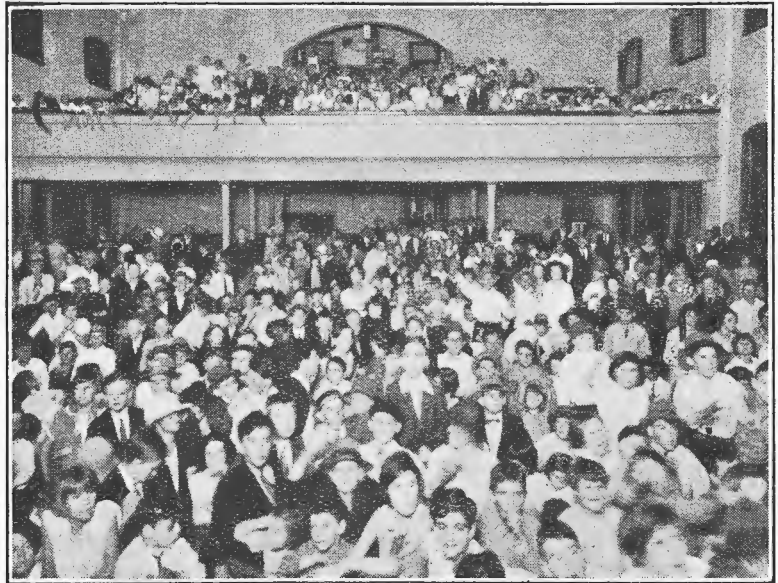

every one of them imbued with the idea of seeing and hearing their friends of radioland in person, and it is safe to say that every one of these 2000 young Queenslanders found the 60-odd minutes occupied by the entertainment far too short for their liking.

The various musical items were greatly appreciated, and each of the bedtime storytellers received a great ovation from the children. Special verses were sung and the Studio Orchestra, under the conductorship of Mr. Alf Featherstone, rendered valuable assistance in the accompanying of the various numbers.

Radio at Lighthouses

Truly has it been said that the usefulness of radio is almost never-ending. It has to its credit a long and honourable record in safeguarding the lives of "those who go down to the sea in ships," and now it enters upon another phase of this invaluable service. As the following article points out, it is of the utmost importance that a light-house should be in constant and reliable communication with the mainland. Using ordinary means, this is often a very difficult and expensive matter to encompass, but once again radio—most versatile of servants—comes to the aid of the engineer.

LO have each lighthouse in communication with the mainland is an important matter to ships, and particularly to vessels not fitted with wireless that have need to communicate with owners or the Navigation Department regarding happenings at sea. Wherever practicable, the lighthouse service has provided some form of telephonic or telegraphic communication to all its manned posts. In a great many cases this has necessitated not only the erection of land lines, but also the laying of short submarine cables. However, in many cases the expense of laying cables, and the fact that the length of cable over which the telephonic conversation may be conducted is limited, have prevented the provision of services to lighthouses, and the keepers of these posts have hitherto been entirely cut off from the remainder of the world. The use of wireless telephony as an effective and relatively cheap means of providing communication service for outlying lighthouses has recently been receiving attention.

The Commonwealth Lighthouse Service is keenly alive to the value of wireless telegraph-telephone equipment, and as a commencement, sets were recently installed at Clifty Island, at Deal Island, and at Wilson's Promontory. As a result, the lighthouses at Clifty Island and Deal Island are in direct wireless telephony communication with Wilson's Promontory, which, in its turn, is in direct touch by means of the ordinary land line telephone with the Head Office of the Commonwealth Lighthouse Service at Melbourne. The distances to Clifty Is. and to Deal Is. from Wilson's Promontory are 17 and 49 miles respectively.

All of the apparatus was supplied by A.W.A., and is of Australian design and manufacture. It is in many respects similar

to the wireless telephone equipment which for some time past has been successfully utilised on trawlers operating between Sydney and the North Coast and the South Coast of New South Wales. The transmitter has a power unit of 250 watts—the current necessary to operate it being produced by a petrol-driven generating plant. This was the first application of telephony to lighthouses in Australia, although at the present time it is extensively utilised in Great Britain. The Victorian lighthouse stations have proved entirely satisfactory in operation, and many reports have been received throughout Australia and Tasmania advising reception at excellent strength.

It is easy to understand the sense of security which radio installations such as these give to the lighthouse-keeper and his family, situated in the lonely wastes of a small rocky island, with only occasional visits from the supply ship to brighten their lives. By means of the radio, they are enabled to keep in constant touch with the mainland, and for them the nerve wracking isolation—heretofore inevitable in such an existence—has lost its terrors.

The transmitter and receiver which have been designed for this class of work are, as far as possible, fool-proof, and they require no especial skill on the part of the operator. The transmitter is tuned by the installing engineers, and, beyond pulling a switch and following simple directions formulated by the manufacturers, the lighthouse-keeper does no "operating," as the word is used in the usual sense.

As far as keeping the equipment in order is concerned, here again the lighthouse-keeper is free from worry. In the first place, there is practically nothing to get out of order; should, however, the unlooked-for happen, the manufacturers maintain a staff of engineers for repair work.

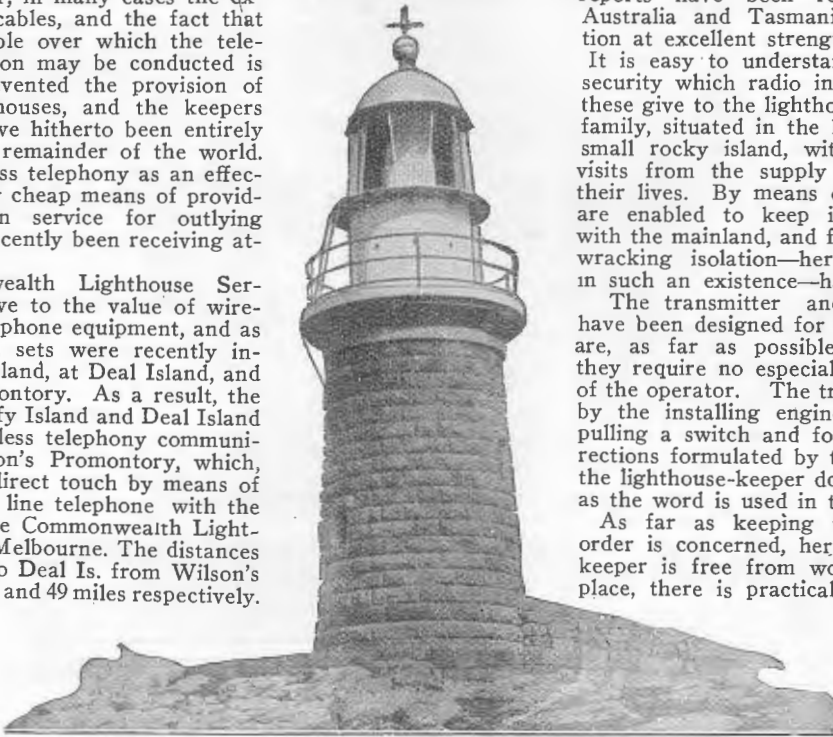

The lighthouse at Clifty Island, situated some 17 miles off the Victorian Coast, in which Amalgamated Wireless (A/sia.) Ltd., have installed radio telephone sets

The 1929 BOOK · O' · FUN

is BRIGHTER and BETTER than ever

COMIC
PICTURES
PUZZLES
ETC.



Every
Child
will
want
a
Copy
for
Xmas
Don't
Disappoint
the
Children



VERSES
STORIES
JOKES



Compiled
by
Uncle Ben
of
4QG
for
His
Little
Radio
Pals

Uncle Ben with Stanley (his young assistant).

ON SALE AT ALL
BOOKSELLERS
AND TOY SHOPS
ORDER EARLY TO
AVOID
DISAPPOINTMENT

2/-

COPY

Send a Postal Note for
2/3 to

The READ PRESS Ltd.
Adeiaide St., BRISBANE

SOME ILLUMINATING FACTS ABOUT TRANSFORMERS.—Continued from Page 28.

wound on either a single secondary winding for a single rectifying element, or with a centre-tapped secondary for the full-wave type of rectifier. The difference between these two systems is that in the half-wave type, only half of the alternating-current cycle is usefully employed. When the current is travelling in the opposite direction, it is not used, but it is merely stopped by the rectifier. This type of transformer and rectifier supplies a fluctuating direct current, and a very efficient filter system must be used to smooth it out into the steady current required for the "B" supply. The other type of rectifier (full-wave) operates on both halves of the cycle, and produces a steadier current which requires less filtering or ironing out.

The Voltage Values.

Transformers for "B" power units are arranged to supply different voltages for the different systems employed. The most common type has a full-wave secondary and supplies about 225 volts in each section, or 450 volts maximum. This transformer is used with the filament type or gaseous-content type rectifying tubes to supply the plate current to the large power valves, as well as to the other valves in the set.

The other common type supplies current at about 500 volts and is of either the half- or full-wave type. This transformer is used with the filament type of rectifier tubes to supply plate current to the 210 and 250 power valves. The current required from the secondaries of these transformers depends upon the type of rectifier tube employed, and the amount of current necessary for the receiver. It usually varies between 60 and 150 milliamperes. This is a rather small current, since a milliampere is one-thousandth of an ampere.

Besides these two general types of transformers and the variations of each type, there are several combination transformers now being sold. These transformers have both large and small secondary windings, so that the filament and plate supply can be obtained from a single unit. A number of these transformers are wound with high-voltage, full-wave windings, and either centre-tapped or untapped windings to supply filament current.

Audio-Frequency Transformers.

The problem of designing good audio-frequency amplifying transformers is very different from that of designing power transformers. In the latter, currents at only one frequency have to be considered, and the windings and core can easily be arranged to give the greatest efficiency at this figure. However, in amplifying transformers, a very wide band of frequencies must be covered with uniform efficiency, so that the signals and music will not be distorted.

By referring to the chart of frequencies covered by common musical instruments, it will be seen that an average broadcast transmission covers a band between 30 and 5000 cycles. An ideal transformer should transfer currents of any frequency in this band equally well.

Transformers for audio-frequency amplifying circuits can be divided into four types; the ordinary step-up, push-pull, auto-transformer and output. The problems involved in each of these types are approximately the same and a general discussion of these problems will be worth while.

The purpose of the transformer used as a coupling device between two valves in an amplifier is to receive the current changes from the preceding valve and deliver them to the following valve with an increase in voltage. However, the comparative voltage changes on the different signals must all be the same, so that natural reproduction will result.

If the primary of the transformer is too small (if it has too low an impedance), the lower-frequencies will pass through without affecting the secondary. The low impedance does not allow the current to magnetise the core or transfer the energy to the secondary, and the low frequencies are by-passed through the primary winding. It has been found that the primary impedance should be two or three times the valve output resistance in order to fully amplify the lower notes.

Obtaining Correct Impedance.

In order to obtain the correct primary impedance, it is better to use a large core rather than increase the number of turns in the primary. If a small core is used, the primary must contain a great number of turns and naturally this also means an unusually large secondary coil in order to get the step-up ratio between the two coils. The use of a very large secondary will also have a bad effect, since it has a tendency to increase the capacity between the turns of wire in the secondary. This value is known as the distributed capacity, and when it is increased, the higher frequencies are by-passed by it and are not properly amplified.

It is generally considered that the larger the core of a transformer, the more uniformly it will tend to amplify both the high and low frequencies. The core must be made of special magnetic material with a high magnetic value, or permeability.

There are two currents flowing through an audio-frequency transformer. The first is the alternating current which constitutes the signal and the other is the direct current of the "B" supply. In a transformer with a small core, these two currents together may be sufficient to saturate the iron. In other words, the core is not large enough to handle all of the magnetic field produced by the primary winding. This condition may cause the production of harmonics of frequencies which do not exist in the original signal, and naturally distortion will result.

It can be seen that there are two opposing values which must be accounted for in designing a distortionless transformer. The first danger is having too low a primary impedance, and the second having too high a secondary capacity. There are several ways of reducing the impedance of the secondary winding so that a sufficiently large primary can be used. One of these methods is to use heavy insulation on the wire, and to space the layers of wire. This reduces the capacity of the winding.

The lowest frequency to which a person's ears will respond is about twenty per second. The highest frequencies used in the average radio musical performance are about five thousand, although the harmonics and overtones reach frequencies higher than ten thousand per second. In order to give perfect reproduction, a transformer would have to respond to all of these frequencies. If only the second harmonic of the notes is reproduced, the tone will seem quite natural, since the higher harmonics do not appear to contribute very much to the naturalness of tone.

Construction.

In the construction of transformers, the secondary winding is usually on the outside and the primary

winding is placed next to the core of the transformer. The cores in practically all the iron-core transformers are made up of a number of thin sheets of transformer iron or steel. In an audio-frequency transformer, these laminations are usually very thin, and care is taken to insulate them from each other.

The push-pull transformer is very much like the straight step-up type, except that the secondary is twice the size of the ordinary type and has a tap in the centre, connected to the "C—" battery, which "biases" the grids of the push-pull power valves. Similarly the "+" power lead is connected to a similar centre-tap on the primary of the push-pull output transformer, or of the output impedance. The auto-transformer contains one long tapped winding, so that part of the winding comprises the primary while the complete coil is used as the secondary.

The output transformer is used to prevent the direct current applied to the plate of the last valve from injuring the loudspeaker winding. It also has another important use in balancing the output resistance of the valve with the impedance of the loudspeaker. In order to get the most undistorted output from a power valve and loudspeaker combination, the loudspeaker should have the same impedance as the plate circuit of the valve. The use of the transformer with the correct primary and secondary impedances will satisfactorily match these circuits when the valve and speaker do not match directly.

It is necessary to use a transformer with a large core so that current in the plate circuit of the valve will not be sufficient to overload the iron magnetically, as explained previously. In the straight output transformer, two windings are used; primary and second-

ary, in 1-to-1 ratio. The primary is sometimes larger than the secondary, since the impedance of the valve is usually higher than that of the speaker. This is especially true of the electrodynamic speakers when a small actuating coil with a very low impedance is used. The push-pull output transformer is constructed like the push-pull amplifying transformer; here the primary is tapped, so that the two valves in the last stage may be coupled properly to the speaker.

—"Radio News" (N.Y.)

In the last issue of the "Radio News," the price of A.W.A. LOGARITHMIC CONDENSERS in J. B. Chandler & Co.'s advertisement was wrongly stated as being 13/- for all standard capacities.

It should have been .0005-mfd., 14/6; .00035-mfd., 14/-; and .00025-mfd., 13/6.

Subscription

6/6

year

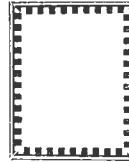

A CROSS in this square denotes that your subscription expires with this issue.

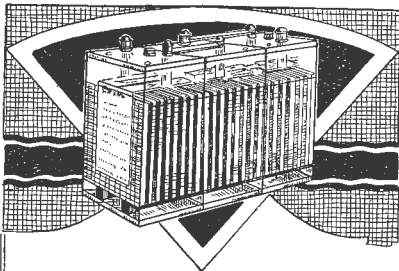

For the Best in Radio Entertainment—

Make sure that the batteries hidden away in the cabinet of your receiving set deliver their power unheard as well as unseen by using EXIDE Wireless Batteries. They

add to the complete efficiency of your receiving equipment — contribute more to your radio entertainment—because they embody every lesson learnt in over 35 years of storage battery manufacture. That's why when you use EXIDE "A," "B," and "C" Batteries you get the most in dependability, longer life, and complete satisfaction. Sold at all Wireless Stores.



**EXIDE BATTERY SERVICE
[Q.] LIMITED**

ADELAIDE STREET — — BRISBANE

Also at Stanley Street, South Brisbane

**Exide
WIRELESS
BATTERY**

S. A. S.

The Wireless Direction Finder



THE object of the Wireless Direction Finder is to enable ships to ascertain the bearing of other wireless stations which are out of sight. Clearly, there are two methods of effecting this. One is to establish direction-finding stations on land, so that they can take bearings of ships and signal such bearings on request; the other is to fit the direction finder in the ship and take bearings of any required wireless station. The first method is of necessity very restricted in its application, and the captain of a ship is asked to rely upon an aid to navigation over which he has no control, and of whose accuracy he has no means of assuring himself. The second method is of very much wider application, as the bearings of any coast station, or of other vessels, can be taken at pleasure, if within range. Further, the captain of the ship has the apparatus and operators under his control, and by regular practice he can assure himself of the reliability of the installation.

The extraordinary accuracy and reliability of the Marconi system of wireless direction finding as an aid to navigation is now universally acknowledged by all the leading authorities on the subject. Periodically modifications are introduced which add something either to the accuracy of the bearings obtained or to the convenience of fitting the equipment on board ship.

Of extreme importance is the latest advance, inasmuch as it substantially reduces the cost to the ship-owner of installing the aerial system on board his vessels. Heretofore the aeriels consisted of two single loops at right angles to each other, supported by four short masts. These large loop aeriels have now been superseded by a small fixed frame aerial which ensures absolute rigidity without the use of any special masts or rigging, at the same time retaining the great advantages of the Marconi system of direction finding, i.e., that of a fixed aerial and a small rotating system. The small deck area of the frame effects a very considerable economy of space, rendering it easy to find a suitable position for it on any sort of ship. The frame is an open teak structure, approximately 8 feet high by 4 feet 6 inches square. All metal fittings are of brass or gunmetal, as it is often convenient to fix the frame near a compass.

Naturally, the distance over which bearings can be taken depends upon the power of the transmitting station and the range obtained in practice when working with ordinary coast and ship stations is of the order of 100 miles.

The Direction Finder is dependent on the exact position of its special aerial loops, which are erected on board ship, and the bearings which the wireless instrument is capable of taking are what are known as relative bearings; that is to say, they refer to the direction of the ship's keel line, and have no connection with north and south. Bearings which are to be used for navigation are almost always required to be either true bearings or magnetic bearings, i.e., they must refer to the direction of the North Pole or to that of magnetic north. In ships which make

use of gyro compasses, a repeater card can be mounted beside the direction finder, and then arrangements can be made so that a true bearing can be obtained by direct observation. Where gyro compasses are not in use it is necessary to observe the exact direction of the ship's head by compass at the moment when the wireless bearing is taken. By means of this information, the wireless bearing, which, as previously stated, is a relative bearing, may be converted into a true bearing by the navigating officers.

The value of the Marine Direction Finder as an aid to navigation has been well proved, and that value is now growing rapidly, especially since the chief maritime countries have commenced erecting special wireless beacon stations. These are small transmitting stations situated at selected points, which operate their transmitting gear for the special purpose that ships fitted with direction finders may be able to take bearings of them.

On many occasions direction finders have contributed materially to the safety of life at sea by guiding vessels to the assistance of others which have been driven out of their reckoning by stress of weather, and which have therefore been unable to state their position correctly. There are certain conditions which will make bearings obtained by a perfectly adjusted direction finder unsatisfactory. (1) Within about half an hour of sunrise or sunset varying and uncertain errors up to as much as five degrees are often encountered. These errors are due to natural causes, and it is impossible to detect their presence or to know in which direction to allow for them. Fortunately, they only exist for brief periods, and an expert operator is aware that the bearings lack their usual sharpness and definition. (2) If the line of bearing touches or approaches the coast line or cuts it at a fine angle, errors are introduced which cannot be foretold or allowed for. Such bearings should be avoided when possible, and in any case they must be regarded as only approximate, and should only be used with due caution.

The Use of a Direction Finder at Long Distances.

It was pointed out above that bearings could be taken of ships or ordinary coast stations at distances up to about 70 miles with a high degree of accuracy. The wireless apparatus is capable of taking bearings with equal accuracy at much greater distances, especially if the transmitting station is powerful, but additional precautions have to be taken when employing such bearings. At long distances a discrepancy is found, due to the fact that the earth is spherical and the chart is flat. This discrepancy, which can be corrected by applying what is known as the "half convergency," is negligible at distances under 70 miles. There are three methods of ascertaining this correction, viz., tables, diagrams, and charts, and all three are supplied with the direction finder instrument, with full particulars as to their use.

Wireless Beacon Stations.

Wireless stations specially designed to send out distinctive wireless signals at regular intervals, enabling

RIGHT: The latest type of Marconi direction-finding receiver designed for ship-board operation. Seven valves are used.

BELOW: The special aerial system used in conjunction with the receiver illustrated at the right. The frame is a permanent fixture and occupies very little space. All metal parts are of gun-metal or brass, so that the loop may be mounted close to the ship's compass without ill-effect.

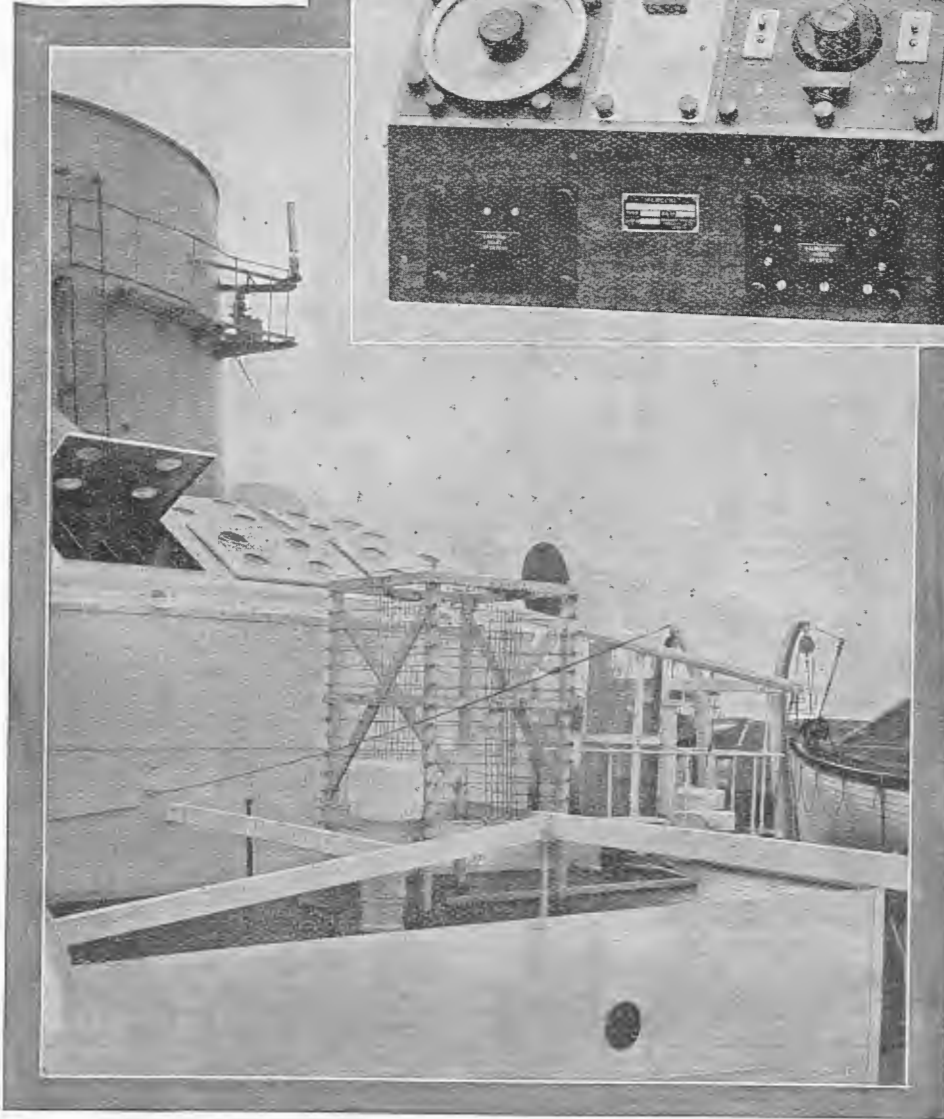
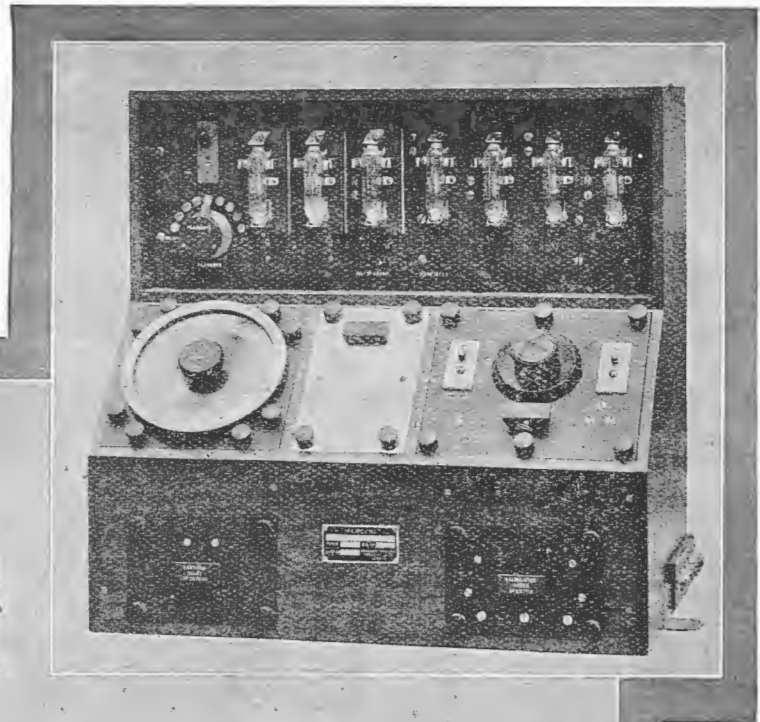

vessels fitted with wireless direction finders to take bearings on those stations and accurately to determine their position, are known as Wireless Beacons. These installations form a valuable addition to the aids to navigation for ensuring the safety of life at sea, and must prove of great assistance to navigators when ships are approaching land, particularly during darkness and in foggy weather. The first wireless beacon station put into regular commission by the British Board of Trade is situated at Round Island, in the Scilly Islands. This set has a power of 500 watts, and is operated on a wavelength of 1000 metres, which is the specified wavelength for wireless beacon stations. Each beacon station has a special call sign, and that at Round Island is the letters GGG in Morse code. The beacon transmitter was designed by the Marconi Company to the specification of the Board of Trade, and the whole equipment is automatically controlled by a master clock for transmitting groups of I.C.W. signals at predetermined intervals.

Every possible precaution has been taken to ensure that the risk of breaking down inherent in automatic operation shall be reduced to a minimum, and all running machinery is duplicated throughout, whilst a spare set of wireless valves is fitted on the main transmitter, with automatic switching arrangements, so that, should a valve burn out, another immediately comes into use, and a suitable warning signal notifies the attendant. The master clock and character machine are also supplied in duplicate, so that any possibility of failure of the apparatus has been obviated as far as practicable.

Until within recent times the use of Direction Finders on board ship has been somewhat hampered by the fact that bearings have had to be obtained from coast stations. The obvious disadvantage of this method is that the coast stations have been installed for the sole object of handling ships' traffic expeditiously, and in consequence have been installed in places where good land-line communications were available. In the majority of cases these sites have not been on the most dangerous points of the coast. It also often happens that, just at the time when a wireless bearing would be most valuable, the nearest coast station has not been transmitting, so that no bearings have been possible. In 1925 the authorities of Trinity House collaborated very cosely with the Marconi Co. in carrying out experimental work with these beacons, with the result that matters have progressed very rapidly since that date. The first beacon set, installed experimentally at Round Island, in the Scilly group, operated for eleven months without a break, and not only proved its value to shipping generally, but incidentally established a record for reliability. When this experimental beacon was dismantled and transferred to The Casquets, prior to the installation of the permanent station, strong protests were raised by the shipping which had become accustomed to take bearings from the Round Island Wireless Beacon—a striking tribute to the usefulness of radio's newest contribution to the safeguarding of life on the high seas.

Description of Wireless Beacon.

The whole of the transmitting circuits are mounted on a panel of robust construction, and there is easy access to all parts. There are four valves, two of which are actually in use, the other two being "stand by" valves. Should either of the two valves in use

burn out, a relay mounted on the panel automatically brings the "stand by" pair into operation, and at the same time a loudspeaker alarm circuit is completed, for warning the attendant that one of the valves has become defective.

The signalling apparatus consists of two main parts: (1) The master control clock, which determines the periods when the beacon is to come into operation, and (2) the character wheel, which actually transmits the call sign of the station. The duplicate master clocks are mounted on a switchboard, which also incorporates a relay operated by the clock for starting up the motor driving the character wheel. The signal for "fair" weather periods consists of the call sign GGG repeated at the rate of fifteen words per minute for 47 seconds, followed by a prolonged dash of 10 seconds' duration and terminated by one repetition of the call sign, the whole transmission taking 60 seconds exactly. This transmission, followed by a silent period of three minutes in each case, is repeated three times, covering a total of nine minutes every half-hour.

In fair weather the cycle is repeated every half-hour. In foggy weather a hand-operated switch is turned to short-circuit the alternator contacts, and the whole signal, consisting of the one-minute transmission and three minutes' silence, is then repeated continuously. The battery supplied is of ample capacity to run the complete station for a period of twelve hours without recharging. A special automatic battery-charging plant is installed, which automatically starts up the engine and proceeds with the charging of the battery, directly the battery discharges itself below a predetermined level. Immediately the voltage of the battery has reached the required level, the engine is automatically switched off. A feature of the charging plant is that the line voltage is kept constant, and the automatic control switchboards are so arranged that at every charge the engines are used alternatively. If one engine fails to start when required, the battery, after a few seconds, is automatically switched to the other engine. Should this fail to start, the plant switches itself off altogether, and rings a bell to warn the lightkeeper.

The range of the station, assuming a normal ship's D/F receiver, is capable of giving accurate bearings up to a range of 70 to 100 miles. Under favourable conditions of atmospherics and the absence of interference this range will, of course, be increased. The first Wireless Beacon in Australasian waters has recently been installed at Cape Maria Van Dieman, at the northern end of New Zealand.

SUBSCRIPTION FORM
"QUEENSLAND RADIO NEWS."
Box 1095N, G.P.O., Brisbane.

Please send me the "Queensland Radio News" for 12 months. I enclose cheque or P.N. for 6/6.

Name

Address



TESTED AND RECOMMENDED

A Department of Investigation, conducted for the benefit of our readers. Every piece of material featured on these pages is subjected to a rigorous and searching test before publication. No remuneration is received for the publication of these paragraphs.

THE PAILLARD ELECTRIC GRAMOPHONE MOTOR.

In these days of electric reproduction of gramophone records, via the medium of the electric pick-up and the radio receiver and loudspeaker, it is only to be expected that electricity will take the place of the old mechanical propulsion motor. The clockwork motor has given splendid service, and no doubt will continue to do so for some years to come, but it has one great drawback which is apparent to even the most enthusiastic gramophone owner. The need for re-winding the spring between the playing of each record is apt to become very irksome, especially, as frequently happens, the gramophone is used to provide music from the world's best orchestras for dancing purposes.

Bearing this in mind, we were particularly interested in the Paillard electric gramophone motor which Messrs Edgar V. Hudson, 53 Charlotte Street, Brisbane, recently sent us to test. This motor is a really beautiful job, and exhibits a care and attention to detail almost worthy of the scientific instrument-maker. Unlike many of the electric gramophone motors at present available, the Paillard motor is not of the induction-disc type. A small universal motor of extremely rugged construction and ample power, wick-lubricated and well ventilated, is used, and is suspended in an adjustable carriage slung by means of heavy springs in a heavy cast grey iron chassis. The motor is coupled by a flat belt to a helical gear train, which in turn drives the tapered vertical spindle carrying the turntable. This turntable is a full 12 inches in diameter, plush-faced, and with nickelled edge. Adjustable cone bearings are used throughout, and all mounting points are insulated with resilient rubber blocks.

A mechanical speed-regulator acts on the centrifugal friction governor in the usual way, the nickelled control knob being fitted with a nicely graduated es-cutechon plate.

A very valuable and unusual feature is that the motor is suitable for operation on any line voltage between 110 and 250, either direct or alternating current, this being made possible by a beautifully constructed and totally enclosed voltage-regulator.

The "on-off" switch is a very cleverly-designed affair, resembling in appearance the orthodox turntable brake fitted to the spring motor. In this case, it is equipped with an automatic stop device, which is tripped by the tone arm at the end of the record, so opening the circuit and stopping the motor. The point at which this trip lever comes into operation is adjustable in order to compensate for the variation between various records and to allow for any slight in-accuracy in mounting. The motor, which measures only $6 \times 4\frac{1}{2} \times 3\frac{1}{2}$ inches overall, is supplied complete with all mounting screws and rubber bushings, so

that it can be installed by the most inexperienced person. Under test in the "Queensland Radio News" laboratory on a 240-volt A.C. line, the Paillard motor worked splendidly. We could detect no variation in speed with changing line pressures, and certainly there was a complete absence of induction or commutation noises in the loudspeaker—a failing that is often attributed to the commutator-type motor. As only the audio-frequency portion of the receiver is in use when the records are reproduced electrically, we cannot see why any such difficulty should be encountered. It was a distinct treat to play record after record without the "drudgery" of re-winding every five minutes or so, and the Paillard motor certainly will appeal to the particular form of laziness with which most gramophone owners are afflicted.

EDISWAN VALVES.

During the month we were given the opportunity of testing two types of the popular Ediswan valves, both of them being of the modern 4-volt, low-consumption type. We obtained very good results with these valves, and have no hesitation in saying that they measure well up to the best of similar types produced by other manufacturers, and that this famous English factory has not lagged behind in the march of progress. In reviewing valves, one can say little beyond mentioning the characteristics as given by the maker, as one valve is very similar to another as far as general design is concerned.

The AR-06 is a general-purpose valve intended primarily for use in the detector and first audio-frequency sockets of the average receiver. The filament consumes 0.06 ampere at a voltage of 2.5 to 3.0. For use as a detector, the plate voltage recommended is 20 to 60; as an amplifier, 20 to 100 volts is advised. The amplification factor is 5, the impedance 14,000 ohms, and the slope 0.35 m.a./V.

Intended for the final stage of an audio amplifier, the PV-410 is a medium-sized power valve having very good characteristics for this class of work. Under test, it demonstrated its ability to handle comparatively large volume without introducing distortion when used with high-grade transformers and a good cone speaker. The filament takes 0.1 ampere at 4.0 volts, and the plate voltage may be increased to 120 volts. The low impedance of 5,500 ohms has been obtained, this being an important point in securing satisfactory matching of impedances between valve and output load. The amplification factor is relatively high for a power valve—5.5—while the slope is 1.0 m.a./V. The use of two AR-06's and one PV-410 in the detector and audio stages of any receiver results in an exceptionally well balanced arrangement, and one that must result in faithful reproduction and adequate volume. We can highly recommend these Ediswan valves to those of our readers who are building sets.

HIGH GRADE PRODUCTS Selling at a LOWER PRICE

GUARANTEED

“WETLESS”

RADIO PRODUCTS

Build the ‘VICTORY TWO’ as described in this Issue

The
Technical Editor
Recommends the

**“Wetless”
Reinartz Tuner**

It is Guaranteed

Price

10/6

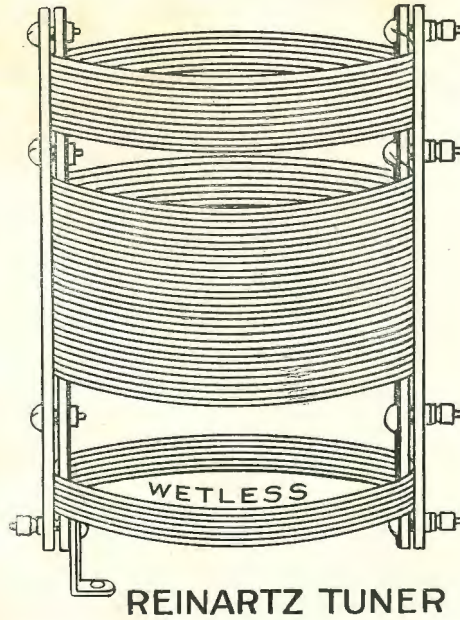

REINARTZ TUNER

The
“Victory Two”
incorporates
a
Wavetrap
thus ensuring
reception
of
Southern
Stations

List of Parts Required for the “Victory Two”

1 Wetless Reinartz Tuner	10/6	1 Battery Switch	2/3
1 Wetless .00025 Variable Condenser	8/6	1 Bakelite Panel, 21 x 7 x 3/16ths	12/6
1 Knob (with pointer) for same	1/-	2 Bakelite Terminal Strips	6d
2 .0005 Variable Condensers (9/- each)	18/-	5 Terminals	1/3
2 Vernier Dials for same (4/- each)	8/-	1 Bakelite Tube, 3 x 2	1/-
1 Wetless Type B Grid Condenser with clips	2/6	4 Ounces No. 20 Gauge DCC Wire	1/-
1 5-meg. Grid Leak	2/-	Hook-up Wire	9d
1 Amperite	5/9		
1 Audio Transformer	9/-		
2 Non-microphonic Sockets (2/6 each)	5/-		
1 Battery Cable (7 wires)	2/9		
		Total	£4/12/3

Accessories

2 Valves (A-415 and B-406)	27/-	1 Dinkie Speaker	15/-
3 1½-Volt “A” Batteries (3/- each)	9/-	Aerial Equipment and Earth Wire	5/-
2 60-Volt “B” Batteries (18/- each)	36/-		
3 4½-Volt “C” Batteries (1/3 each)	3/9	Total	£4/15/9

“Wetless” Products obtainable from all Radio Dealers or from the Distributors :

TRACKSON BROS. LTD.

The Radio and Electrical People

157-159 Elizabeth St., BRISBANE

Manufactured by J. WETLESS, 28 King St., SYDNEY, N.S.W.

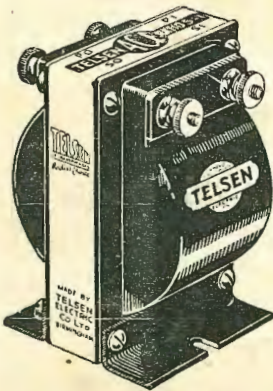

TELSEN ACE TRANSFORMERS 13/6

A smaller model of the Telsen Factory, giving very fair reproduction and entire freedom from breakdown.

Four Representative Lines

From our Most Extensive Stocks

Consistent Sellers for 1928, will be Standard Favourites for 1929



TELSEN RADIOGRAND TRANSFORMERS 21/-

A British component of really high quality at a competitive price; 3-1 and 5-1 ratios. General efficiency unvarying with high or low input values.



CYLDON LOG-MID-LINE CONDENSERS

The finest condenser made without exception. Available all sizes and types, single, double and triple gang.

AVAILABLE FROM RADIO DEALERS THROUGHOUT THE STATE

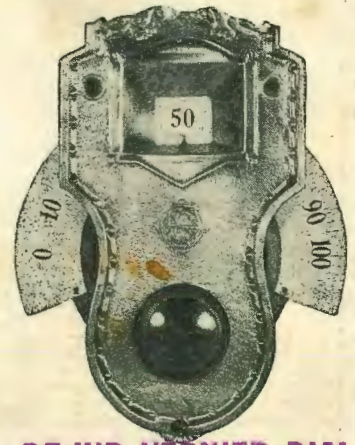

DE-JUR VERNIER DIAL 12/6

Beautiful Gold Recessed Plaque with illuminated dial and handsome bakelite knob. Perfect movement.

51 Charlotte Street Brisbane

EDGAR V. HUDSON

The Leaders in Radio Merchandising

Phone Central, 8622

P.O. Box 522H