

THE AUSTRALASIAN **1/6**

# Radio World

Vol. 15 . . . No. 2 September 18, 1950

Registered in Australia for transmission  
by post as a periodical.

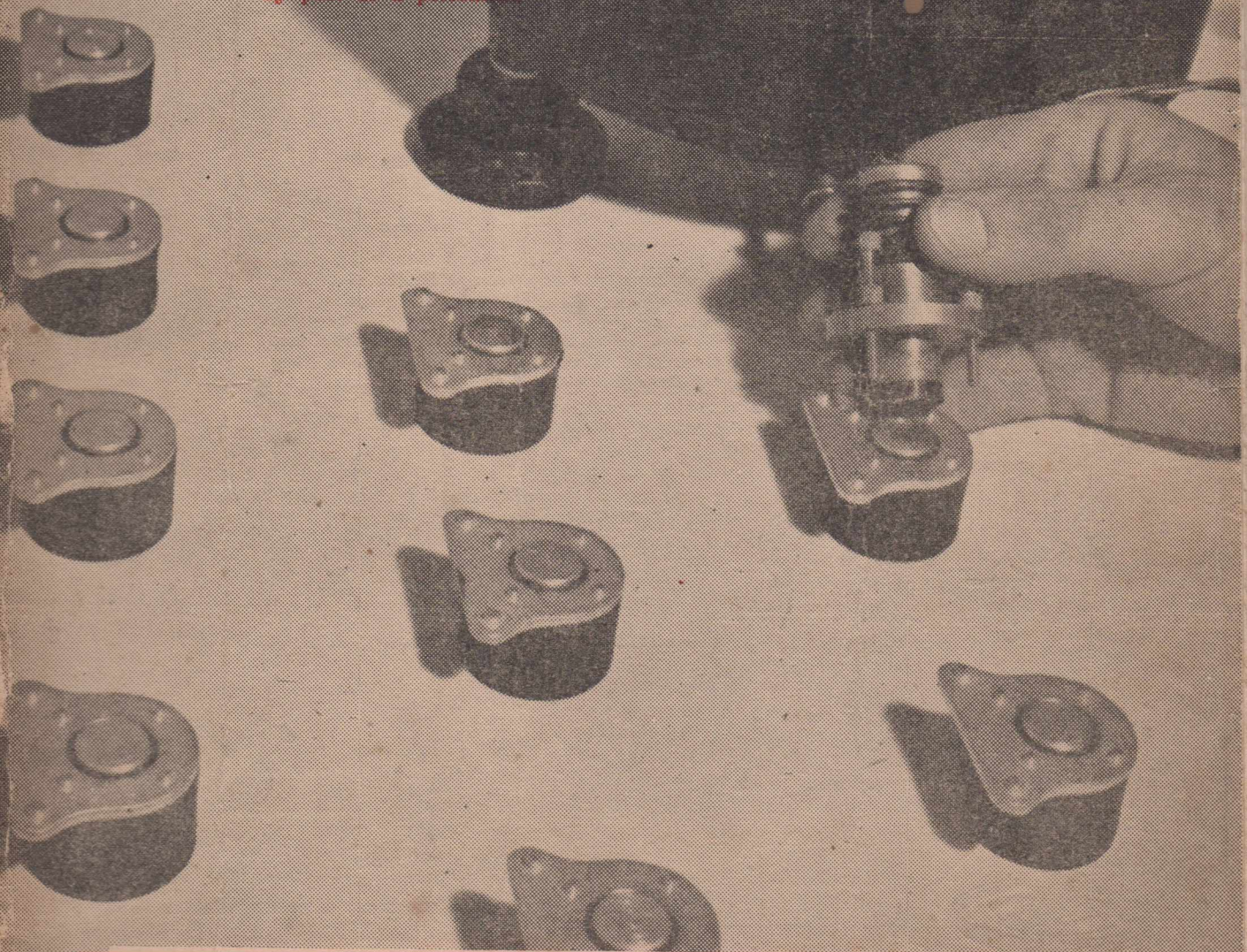

**THE BEST SETS USE ROLA LOUD SPEAKERS**



# RE-PLACING ? Here's why R.C.S. Components will Improve Performance !

## RE-BUILDING ?

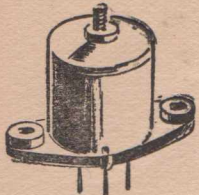

Dual-wave units.

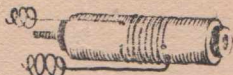

Short-wave Coil.



Trimming condenser.



Midget variable condenser.



Resistors.



Standard broadcast coil.



F.M. Coil.

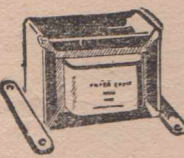

Filament transformer

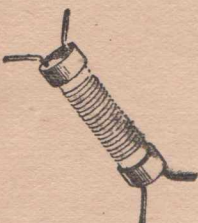

5 band coil.



Loop aerial coll.



Dual wave unit.



Transposition block.



Dial drive drum.



Radio frequency choke.

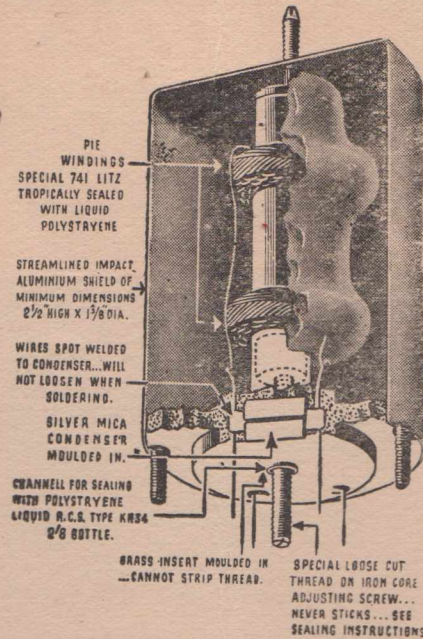

The latest R.C.S. components offer radio technicians and set assemblers the benefit of the very latest development in radio practice and the very latest in the new insulating materials. Outstanding is the latest R.C.S. Intermediate Transformer which has the condensers actually moulded into the Polystyrene base. The condenser is welded to the windings and actually moulded to the Polystyrene base. This is a patented R.C.S. feature and places R.C.S. strides ahead in I.F. design; just as R.C.S. is strides ahead in radio component development. For the best results from your circuit, equip it with R.C.S. components.

R.C.S. LINE FILTER is specially designed to eliminate all background noises which occur by reason of feed back over power mains, electric motors, refrigerators, elevators, sub-stations, high tension wires, irons and plugs. Easy to install. It connects between the radio and the power point.

LINE FILTER Type LF20, 1 amp. . . . . £1/10/0  
 LINE FILTER Type LF24, 2 amp. . . . . £1/18/6



Line filter.

## Specify R.C.S. Components

R.C.S. RADIO PTY. LTD.

174 Canterbury Road, Canterbury, New South Wales



Potentiometer.



Radio Frequency Choke.

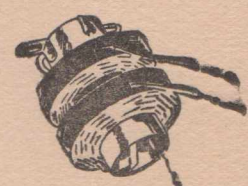

Line filter coil.

If you have difficulty in purchasing R.C.S. components locally, write us and we will advise you of the name of your nearest retailer from whom supplies can be obtained.



# THE AUSTRALASIAN RADIO WORLD

DEVOTED ENTIRELY TO TECHNICAL RADIO

and incorporating

ALL-WAVE ALL-WORLD DX NEWS

Vol. 15

September, 1950

No. 2

Published by the Proprietor:

A. G. HULL  
Box 13, Mornington, Vic.

Short-wave Editor:

L. J. KEAST  
7 Fitzgerald Rd., Ermington, N.S.W.  
Phone: WL 1101.

#### REPRESENTATIVES:

In Queensland: John Bristoe, Box 82,  
Maryborough, Q.

In New Zealand: H. Barnes & Co., 4  
Boulcott Terrace, Wellington.

S.O.S. Radio Ltd., 283 Queen Street,  
Auckland.

In England: Anglo Overseas Press Ltd.,  
Chronicle House, Fleet Street, London,  
W.1.

Distributed throughout the World  
by Gordon & Gotch (A/asia) Ltd.

#### SUBSCRIPTION RATES:

12 Issues	16/-
24 Issues	30/-
To N.Z. and Overseas:	
12 Issues	18/-

POST FREE.

Address for all correspondence:  
AUSTRALASIAN RADIO WORLD  
Box 13, Mornington, Vic.

#### OUR COVER PICTURE . .

Modern Permanent-Magnet Type Loudspeakers have reached their present stage of efficiency only as a result of extensive research by skilled metallurgists and physicists. Our cover picture shows Loudspeaker Magneto being measured in the Rola Laboratory with the aid of a search coil which simulates the magnetic circuit conditions under which the assembly unit will be called on to work.

#### CONTENTS

A Plan for F.M. . . . .	5
World of Radio . . . . .	6
Hi-Fi Parties Crowded . . . . .	7
Modern Commercial Circuits . . . . .	9
Hum in Hi-Fi Amplifiers . . . . .	11
Intermediate Frequency Circuits . . . . .	14
Among Our Readers . . . . .	20
More About the Morse Code . . . . .	21
Amateur Activities . . . . .	23
Going Up . . . . .	25
Short Wave Review . . . . .	28

#### PERSONAL . . .

About four years ago, I started an experiment in de-centralization when I established a combined home and office in what was hoped would be inspirational surroundings. It has now been decided that the experiment was a failure.

Without going into the many minor problems which arose, it finally became evident that I could not handle affairs properly by such remote control. So now I am making tracks back to the "Big Smoke". It is hoped that, by next month's issue, I will be able to advise a city address; in the meantime, the old address is O.K.

In response to a plea for assistance regarding the business side of the publication, I was fortunate enough to receive an offer from an ex-ham, who has a city office and keen sales staff. A working agreement comes into operation for the next issue.

To safeguard the production end was the next problem, and so the latest in high-speed automatic printing presses was ordered from Sweden some months ago and is now on the water. When it arrives I expect to get a working arrangement for its priority operation by an established printer, or else to instal my own complete plant.

The de-centralizing scheme was not all loss. The sojourn in the country was like a grand holiday, from which I now return with renewed vigour and a determination to improve the old Radio World until it is worthy of holding its place as the only magazine in Australia which is devoted exclusively to technical radio.

—A. G. HULL



Containing  
the Circuits  
of All  
Commercial  
Receivers  
Manufactured  
during 1949.

# VOLUME 8

## 1949 RADIO CIRCUITS

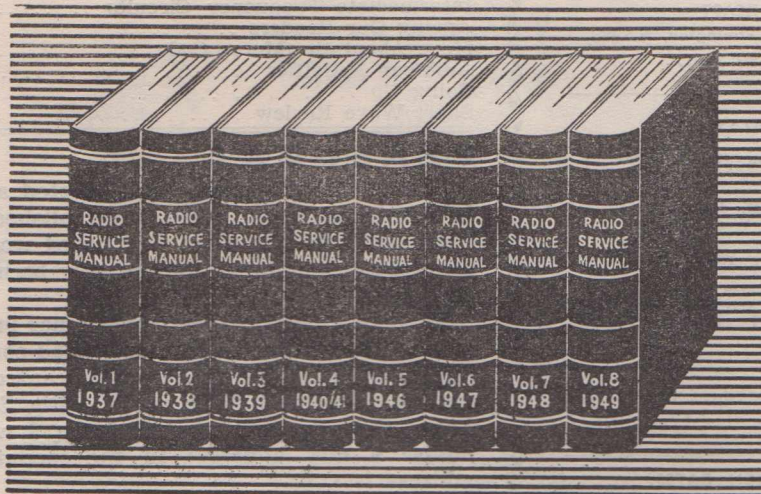

## Australia's Official Radio Service Manual

Volume 8 of the Service Manual is now rolling and should be ready for delivery about the time you see this notice.

Don't delay, send in your order immediately and be sure of getting a copy from the first batch to be received from the printer.

**PRICE: £1 PER VOLUME**

(Postage 9d. Extra)

Obtainable Direct By Speedy Mail Order Service From  
A. G. HULL, BOX 13, MORNINGTON, VICTORIA



# A PLAN FOR F-M

**WHAT** is the future of frequency modulation transmission?

This new development can be of great benefit to all if handled in the right way. So far, it has done nothing but disturb the buying public.

**T**HE radio trade is in the doldrums, and unless something is done to clarify the future there is every chance that things will get worse and worse.

With present broadcasting there is little room left for improvement in modern sets. Those on sale to-day are little better than those which are ten to fifteen-years-old. There is little need for the average person to think about buying a new set.

Irresponsible talk of the coming of television and F-M services has made things even worse and those who feel they need a new set are waiting to see if a combined radio and television set is likely to be available soon. It won't, of course, but the public lives in hope.

There is one solution to the present difficulties; an easy plan which could be put into operation by the radio trade in conjunction with the Wireless Institute and the Broadcasting Control Board. The idea is to introduce F-M transmissions in the same way that radio broadcasting was introduced in the early days of 1922.

Basis of the plan is to allow the issuance of licenses to those who are prepared to carry out experimental F-M broadcasting.

There are three main advantages of F-M. The transmis-

sions can be carried out without interfering with ordinary broadcasting; transmissions can be carried out on the same wave-lengths by stations a hundred miles apart without interfering with each other, and there is ample room for 60 stations to work from any one location without interfering with each other. In other words it becomes possible to have 60 stations working on F-M in Melbourne and 60 more at Bendigo, 60 more at Sale, 60 more at Hamilton and so on, all over the country. Each of these stations can be of low power, cheaply made and easily operated.

It is possible to give an F-M licence to every school, every church, every club and practically every organization in every main country centre, as well as in Melbourne itself. The licences could be of a temporary nature, with an implication that those who make best use of the temporary licences may later receive permanent ones.

Those who can remember the programmes put out on Sunday mornings in the days when amateur stations were allowed to broadcast music on the lower end of the broadcast band will have no trouble in picturing what the amateurs of to-day could do with permits to use the F-M bands in a similar way.

For a start there would not

be a big audience, but it wouldn't be long before the enthusiasts started to build their own F-M sets. Some of them would not be up to the high-fidelity standards possible with F-M, but would at least provide something interesting. At present the factories cannot find it worthwhile to offer F-M sets to the public, but if there were a large number of stations to be heard on F-M, then the demand for sets could be expected.

Drawbacks? Of course, you wouldn't expect the owners of the "goodwill" of present broadcasting stations to be keen about any suggestion which may mean less listeners to the present commercial stations. These owners of such "goodwill" are a mighty powerful bunch, with plenty of influence, so they could be counted upon to put plenty of cold water on the scheme. But otherwise it would be hard to imagine any drawbacks. It wouldn't cost anybody anything if they don't want to put up their own F-M station or hear the F-M broadcasts. It need not interfere in any way with present broadcasting. Those operators of amateur transmitters who frown on the broadcasting of music and any tinges of commercialism can stick to their normal routine on the existing bands.

How does the idea appeal to you?



# Recording Contest

We have been advised by the Sound Recording Institute of Australia that they will be holding another recording contest on Friday, 3rd November, at 8 p.m. in the Radio Theatre, Melbourne Technical School, Bowen Street.

The contest is open to everybody interested in sound recording. Generous prizes will be offered. The winning entrant will be awarded a complete portable disc recording and reproducing machine,

donated by Byer Industries Pty. Ltd.

The contest will be primarily divided into two sections, namely Open and Amateur.

The first-named is open to all comers, and the second is open to Amateurs only. A professional is defined, for the purpose of this contest, as one whose normal occupation includes the operation of Sound Recording Equipment.

Entries may be recorded on disc, tape, wire or film. Where

the entry is other than disc or wire the entrant will be required to provide playback facilities for both the pre-judging and final playings.

In the Open section, the recording shall be entirely the work of the entrant from microphone to recording. Dubbing, if used, shall only be used as an accessory to the main subject matter on the recording.

In the Amateur section, intercepted material may be used for the entire entry.

There shall be two prizes in each section which will be allotted by a panel of judges who will award points for technical merit such as signal-noise ratio, freedom from distortion, frequency range, presentation, etc.

A competitor is eligible to win one prize only in his section, but may receive the popular vote prize in addition.

In order that as many entries may be played in the time available, each entry must be limited to a maximum of five minutes of playing time. For the same reason, any one entrant is limited to a maximum of three recordings.

An Entry Form must be completed for each recording submitted. There is no entry fee. The entrant and his friends are invited to be present at the public audition. Entries must be left at 4 Parliament Place, before FRIDAY, 13th OCTOBER, for preliminary judging.

The Committee reserves the right to accept or reject any recording.

Further details can be had from the Secretary, 4 Parliament Place, Melbourne, C.2.



Precision in design  
and construction

Specialists in design and  
manufacture of Communication  
Equipment, Industrial  
Transformers and Chokes, and  
Fluorescent Lighting Equipment

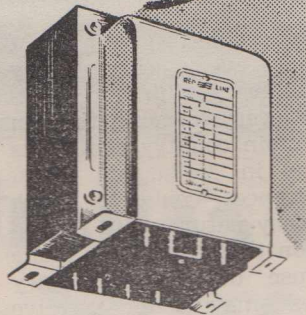

## RED LINE EQUIPMENT PTY. LTD.

City Office: 157 Elizabeth St., Melbourne. MU 6895  
(1 line)  
Workshop: 2 Coates Lane, Melbourne. Central 4773



### DISTRIBUTORS:

S.A.: GERARD & GOODMAN LTD.  
N.S.W.: UNITED RADIO DISTRIBUTORS PTY. LTD  
QLD.: B. MARTIN PTY. LTD.  
VIC.: ALL LEADING WHOLESALERS



# Hi-Fi Parties Crowded

**I**N the July issue we announced a Hi-Fi Party for our readers, inviting all interested in wide-range reproduction to come along to hear the real thing and compare it with restricted range.

**T**HE party, which was made possible by co-operation with the Rola Company, was set down for 3rd August.

Two upsets rather complicated our arrangements. In the first place the estimation of the number of our readers interested in the subject was far too conservative. The rush for reservations bowled us over.

The executives at Rola came to our assistance with clerical help to handle the mail and also by putting on five parties, night after night, in order to handle the hundreds in relays.

Personally, your Editor had an upset of a rather different type. Taking his daughter ice-skating for relaxation on the night before the first party, he finally found that he was not of the same weight, shape or balance as he was thirty years ago. The nett result was a dislocated shoulder, with torn ligaments, and sundry cuts and bruises. By the time the doctors had finished straightening him out next day he was not feeling up to the mark to attend the Hi-Fi party.

Otherwise everything went off swimmingly and all who attended were greatly interested in the demonstration given and also much appreciated the bountiful hospitality of the Rola Company.

Highlights of the show were many. First of all the capabilities of the new Rola wide-range triple-cone speaker were out-

standing. Being made by Rola as an acceptance of the challenge to Australian workers to produce a wide-range speaker to match those made in other parts of the world, the OX model is reasonably flat to 12,000 c.p.s. and proved itself capable of giving true wide-range reproduction. As was shown at the demonstration, the big problem is to get a wide-range source to feed the equipment. A good amplifier, such as the Williamson, when properly stabilised, can handle the wide-range sound, so can the new Rola OX speaker, but there is nothing very wide-range about ordinary gramophone recordings or broadcast programmes.

For the demonstration, the Rola engineers got their wide-range sound from an E.M.I. tape recorder, and from an R.C.A. F-M set which had been checked over and loaned by the P.M.G.'s department.

It was proved that even with a cut-off at 5,000 c.p.s., the wide-range speaker is still much to be preferred to the standard type, but having once heard the true wide-range reproduction a great many of the audience expressed the opinion that they could never rest happy until they could get a good F-M receiver together.

Not all transmissions from the experimental F-M stations in Melbourne and Sydney are wide-range of course, those

coming overland by line have the usual cut-off, and ordinary recorded programmes are of little advantage.

Once in a while, however, the F-M stations transmit live artist shows over special lines from the Town Hall to the transmitter, and these are really something to marvel at.

The F-M transmissions are purely experimental at present, however, and anyone building a special set may find that the transmissions have been abandoned by the time the set is in operation.

Before each session at the demonstrations, Mr. McKenzie, of the Rola Company, gave a short talk on the subject of wide-range reproduction, listener preferences, and so on. A number of those present suggested that Mr. McKenzie should contribute an article on the subject, and it is hoped that this will be ready for publication in the near future. In the meantime we would point out that those who are interested in the subject should study the article which appeared in the issue of October, 1948. Copies of this issue are still available from our Back Dates Department, at 6d. each, post free.

The new Rola wide-range speaker, known as model 12-OX, is similar in general construction to the 12-0, but has

(continued on next page)



**HI-FI PARTY**  
(continued)

three cones, the usual 12in. cone, a small high-note cone attached to it in the middle, and a small internal cone which resembles the dust cap of ordinary speakers, but is actually effective in this new design. The speaker goes into production in about a month's time and will be sold without input transformer at a list price of £5/12/6. The reason for supplying the speaker without input transformer is that the Rola Company is not tooled up for the pi-wound type of transformers which are desir-

able when it is intended to handle frequencies of over 10,000 c.p.s.

At the demonstrations the advantages of wide-range sound were clearly shown and no one could deny that the reproduction of musical instruments is much nearer to realism, with the highest frequencies in force. With a signal obtained from a high-fidelity pick-up on an ordinary commercial recording, however, the surface noise was too strong for many, although quite a few claimed that they had little difficulty in concentrating on the music and thereby avoiding hearing the scratch.

A side light on high fidelity, however, arose when some of the guests got into hots about the desirability of reproducing, for example, the violin with its complete harshness. It seems that recent scientific investigations have proved that the famous violins, such as Stradivarius, when played by masters such as Heifitz, do not have the same degree of high notes as cheap violins played by indifferent artists. In other words, if you want any old violin to sound like a Strad., you want to reproduce it on equipment with restricted frequency range!

There were even those rebels who claimed that they have heard so much "canned" music that they now cannot enjoy live-artist concerts, finding the actual music to be harsh and discordant.

Considerable discussion arose about microphone placement, too. The special demonstration tape which had been prepared by the 3DB orchestra was greatly appreciated, but it would seem that about half a dozen microphones had been scattered among the players, then blended together by a control monitor. To some ears this sounded much better than could be obtained by any single microphone, no matter how placed. To others it sounded more like a hash of different instruments, all brought to the same level of sound and then fed out "en masse."

The amazing response to the invitation to the demonstration has made us think how desirable it is for us to have a real "Radio World Radio Club," so that regular demonstrations of this kind can be held, new products demonstrated by comparison with old and so on. There seems to be endless possibilities and these are being taken into consideration in the present planning for Radio World's future.

Save Money with a . . .

# Subscription!

## Order Yours To-Day

Make sure you get every issue as soon as it is published. Place an order with your news-agent or send direct to us for a subscription.

**IT SAVES YOU MONEY!**

**IT SAVES YOU TIME!**

We guarantee that every subscriber has his copy posted the same day it comes off the press.

<b>RATES</b>	
12 issues . . . . .	16/-
24 Issues . . . . .	30/-
<b>POST FREE</b>	
<b>To N.Z. &amp; Oversea</b>	
12 issues . . . . .	18/-

Enclosed please find remittance for 16/- in payment for an annual subscription to the "Australasian Radio World," commencing with the.....issue.

NAME.....

STREET and NUMBER.....

CITY.....STATE.....

**AUSTRALASIAN RADIO WORLD**

Box 13, Mornington, Victoria.



# Modern Commercial Circuits

**ONCE** upon a time it was thought that radio circuits should be kept secret. In the early days, quite elaborate precautions were taken to safeguard them. Fortunately, those bad old days are gone, and it is now possible to get full details of all the latest commercial circuits in a handy book.

**A** CAREFUL study of the Radio Service Manual, volume 8, which was released last month, reveals several interesting circuit arrangements.

There are a great many circuits of routine types, most of the prominent manufacturers have four and five-valve sets of almost identical circuit design. A most careful examination of these circuits is necessary to find the trifles which make up the differences in performance, if any.

There are also lesser-known circuits of great interest, however.

These are particularly in evidence in the bigger sets, where the individual manufacturers have gone out of their way to try and get something in the way of outstanding performance.

In the Radiola range, the big model 805GZ, whose circuit appears on page 99, shows a pair of 6V6's in push-pull with a floating-paraphase phase splitter of normal type. The use of the 6AU6 type valves in the earlier stages, however, is a little different from the usual run of things.

On page 115, there is a circuit of a receiver with a powerful audio end. It comes from one of the Queensland factories, and is not so well-known

down south. The output valves are a pair of 6L6's, but in the earlier amplifier stages there are three 6SN7's, making six stages in all, as each has a twin set of elements. Just how, and why, these six stages are connected up is a problem over which the keen student of circuits will be able to scratch his curly locks.

Those old-timers who can recall the stir in technical circles which arose when the "Barnes Mystery Circuit" appeared in old "Wireless Weekly" in 1933, will be interested to note that this idea of the earthed grid of one of the push-pull valves has been revived and appears in two places, on page 123 in the Crammond model 607, another set from Brisbane, and on page 141 in the Electro-sound 63P, a model from a Sydney manufacturer. Frankly, I am rather surprised that more has not been seen of this circuit arrangement. It is easily the cheapest form of push-pull operation and capable of giving mightily fine results, judged by any standard.

On page 131 there is the circuit of the little amplifier which is produced by Electro-sound. This is just a straightforward 6J7-6V6 job, but with a clever tone control arrangement which is well worth a few moments study.

Those interested in high-quality reproduction will find much to digest in the circuit of the big HMV Electrogram, model 3000, which is given on page 230. This appears to be an English design. Such things as two separate amplifier valves for bass boost, one for 70 cycles and the other for 105 c.p.s., will give you some idea of the lengths to which the designer has gone in search for pleasing reproduction. Three speakers are used, and the values of the components in the frequency dividing network are given.

Still another powerful set from Brisbane might give the impression that the Queensland manufacturers are devoting attention to a line which is being missed by the rest of Australian designers. This is the Music Masters model A666, circuit of which appears on page 261. A pair of KT61 power valves are used with a novel method of obtaining push-pull by driving one of the grids from the signal which develops by the unbalance across a 300 ohm resistor in the plate supply of the push-pull stage.

About the only southern factory which seems to be interested in push-pull is the Strom-

(continued next page)







# Hum in Hi-Fi Amplifiers

THE usual emphasis in high fidelity equipment is on the high-frequency end of the sound spectrum, but most of the satisfaction—and the headaches—come from the extended and true-to-life bass response.

TO get adequate reproduction of sounds below 50 c.p.s. means the provision of (a) adequate power, (b) a large speaker adequately baffled, and

---

By  
**K. BRADY**  
575 Vulture Street  
East Brisbane, Q'd.

---

(c) complete suppression of the 100 cycle rectifier hum, and any 50-cycle hum picked up from the raw A.C. circuit. This article will concentrate on the thorny problems raised in (c). These problems can be tackled in sections:

(i) smoothing of the rectified plate current;

(ii) preventing the small residual hum voltage in the plate circuit affecting the grid circuits where it would be amplified if induced;

(iii) preventing interaction between the radio frequency and/or intermediate frequency sections of the circuit and the audio section by way of the common power supply circuit, if used;

(iv) the effect of magnetic fields in the chassis due to the power transformer;;

(v) effect of electric fields—particularly high frequency ones from the early stages—on

inductances in the audio circuit; and

(vi) the effect of eddy currents and other loop currents due to unhappy earthing mistakes;

(vii) 50-cycle hum.

This sounds a formidable list; but, if you want hum-free low frequency it must be faced. If you do not want anything lower than that obtainable from an ordinary mantel model set, you have no hum troubles. Let's examine the list.

(i) Two sections of filter, at least, are required, assuming condenser input. Relatively high voltages are required in high fidelity work, so that the first condenser must be reliable. Use a maximum of 6mf. with 1000v. working rating, and you can forget condenser trouble. This should be a paper block of recent manufacture. Pre-war stuff is practically useless. Electrolytics are not good types for reservoir use, and the newest etched-foil jobs are definitely unreliable where the impressed voltage has a strong ripple content. The second and third condensers can be 16mfd. 600v. electrolytics, and the vertical mounting type, mounted above the chassis, do not dry out as quickly as the pigtail type which are usually tucked away from ventilation. Your power

pack will be delivering about 60 watts of high tension and up to the same amount of filament current, while the rectifier tube and chokes will be dissipating about thirty watts as heat. This heat must be allowed for in the design and location of the pack, and of the components used.

Contrary to the usual belief and custom, the inductances need not total more than 30 henries, so that less heat waste occurs, with no lowering of smoothing efficiency, if two 15-henry chokes for a two-stage, or three 10-henry ones for a three-stage filter are used. They must be rated to pass the required current.

That about finishes section (i), and the conclusions can be summarised as:—

Two stages adequate, but three desirable.

6mfd. 1000v. paper condenser recommended for input filter reservoir.

Total inductances need not exceed 30 henry.

Heat dissipation is a big problem, and apart from any other reason (and there are plenty), makes a separate power chassis almost essential.

(ii) Coupling between grid and plate circuits is prevented

(continued on next page)



## HUM

(continued)

by (a) decoupling resistors and by-passing, and (b) by keeping grid and plate circuits well separated. In effect, (a) means that further resistance capacity filter units are added in individual plate leads, tending to act forwards—further decreasing the high tension ripple—and to act backwards, preventing the varying modulated component riding on the plate potential from passing through to the main high tension bus-bars and thence to other circuit points where it isn't wanted. Don't try to increase your plate voltage by modifying

these isolating resistances. You'll be sorry if you do.

(iii) This has been partly covered in (ii), but in practice even elaborate decoupling isn't enough with a superhet, followed by a pre-amplifier or tone control, then a "Williamson" with feedback tacked on to that. Much more rigorous de-coupling is required, and it boils down to a double power pack. With the double set-up, the circuit can be broken into isolated blocks, e.g.:—

- (1) Tuner.
  - (2) Pre-amp.
  - (3) Phase changers and drivers.
  - (4) Push-pull output.
- and the high tension for 1 and

3 taken from a common source "A" with ordinary decoupling still necessary, and blocks 2 and 4 fed from the other source "B".

In this connection, power supply "B", with push-pull output in class "A" as is normal for good quality, will draw a relatively steady 100 odd milliamps and will have good regulation. Power supply "A" will have a drain of about 20 milliamps., and a heavy bleed current would be a good design feature to keep the oscillator circuit happy.

It will pay handsomely to use indirectly-heated rectifiers, and to centre-tap the filament windings of the circuit valves

*Even the TRIMAX factory is Transformed!*



*... Now at a NEW ADDRESS*  
**CHARLES ST., NTH. COBURG MELB. AUST.**



— assuming that indirectly-heated types are used — with a variable rheostat or pot of between 30 and 100 ohm rating. The earthing point of these centre taps is discussed later.

(iv) Magnetic fields induced in a steel chassis by the strong field of the transformer cut the wires of all neighbouring circuits, and induce 100-cycle voltages in them just as though they were part of the transformer winding. The effect is very noticeable in iron-cored inductances, e.g., transformers feeding pick-up to pre-amp., or tone control inductances. This field can be reduced by using non-magnetic metal for the power chassis, and by keeping the power pack as far as possible from the low-level audio circuit. This low-level audio circuit begins at the tuner rectifier. This implies shielded leads from diode output to the pre-amp. or tone control, and further shielded leads from there to the input circuit of the amplifier. It means all-round shielding of the tuner—underneath as well as on top—and a complete boxing in of the low level audio circuits. These shields have to be strongly bonded to earth. The leads should preferably be co-axial cable to prevent losing all the treble you've taken so much trouble to get. Minimum spacings would be (a) between power pack and shielded diode circuit—12 inches. (b) between power pack and low level audio inductions — 2 feet. The low level audio stages are the main trouble. The ripple voltage induced in a 1-volt input circuit, and then amplified with it, is much more of a problem than the same ripple voltage induced in an output voltage of 50 or more volts. Quite considerable liberties can be taken with the location of the output transformer and the loudspeaker, or

even with the filtering of the plate current of the push-pull output stages.

(v) Electric fields are not stopped by ordinary metallic screening and the device known as a Faraday electrostatic shield is fragile and normally too much trouble. The spacings adopted for the magnetic screening will cut out most of the effect of this field.

(vi) To prevent hum pick-up from eddy currents in metal, the earth points should be so arranged that no possibility exists for the chassis to carry out the role of conductor in the valve circuits.

(1) In the power pack, one good method is to earth the transformer electrostatic screen to the metal of the chassis, but to take all other earths to a heavy brass strip isolated from the chassis except at its output end. This earth terminal on the power pack is used, with separate wires, to form the earth connection to the plate circuits of the tuner, pre-amp. and amplifier. There is not so much need to go to so much trouble with the other sections of the circuit, but it is good practice to keep the filament centre-tap resistors on the main power pack and to earth them to the main earthing busbar.

(2) There should be two connections to ground—water tap, etc. One is for the aerial-earth system, and can be the

usual light wire run to a clip on a pipe, but the earth link for the power circuit should be a heavy wire similar to that used in electrical installations, and should be as far as practicable away from the signal earth.

(vii) Fifty cycle ripple voltages are due almost entirely to pick-up from the A.C. filaments. The only feasible way to cut this down is to keep A.C. wiring twisted, and as far as possible from grid wires. Don't forget the grid circuit continues into the valve itself, and raw A.C. leads should not be looped over unscreened audio valves.

### Summary

If you can keep the hum voltages out of the diode - pre-amplifier - phase changer circuit you won't have much hum in the output circuit. Of these, the pre-amp. usually gives most trouble. A circuit allowing a grounded cathode helps considerably to quieten this section, and a cathode-follower, feeding from pre-amp. to amplifier helps also, but coax cable is almost as good and is less trouble.

In conclusion, the low frequencies are worth working for. There is nothing more satisfying in listening than good clear robust low notes. All it needs is the ability to keep on being dissatisfied until your results are good enough.

## SPECIAL BARGAIN OFFER

BACK NUMBERS AVAILABLE

1943—Only December.

1944—Jan., Feb., March, April, May, June, July.

1945—May, June, July, August, September, October.

1946—Feb., June, July, August, Sept., Oct., Nov., Dec.

1947 and 1948—All issues, except September, 1948.

Please send your remittance in 1½d. stamps or postal notes.

Address: Australasian Radio World, Box 13, Mornington, Vic.

PLEASE NOTE: SEPTEMBER, 1948, NOW OUT OF STOCK.



# Intermediate Frequency Circuits

**T**HE heart of the superheterodyne receiver is the intermediate frequency stage. Its efficiency largely controls the overall performance of the set, affecting the gain, selectivity and tone. It is most important for us to fully understand the theory and operation of the i.f. valve and its associated transformers.

In the last part of this series the signal frequency and oscillator circuits of the superheterodyne receiver were discussed. It was pointed out that the output of the frequency changer valve consisted of a number of frequencies—

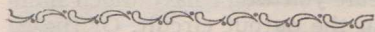

by  
**W. S. LONDEY**  
8A Barkly Street,  
Sale, Victoria

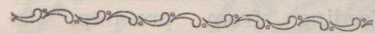

for each signal reaching the frequency changer grid there will be present at the f.c. plate the following frequencies—

- (a) the received frequency;
- (b) the oscillator freq.;
- (c) their sum,
- (d) their difference.

The function of the intermediate frequency system of

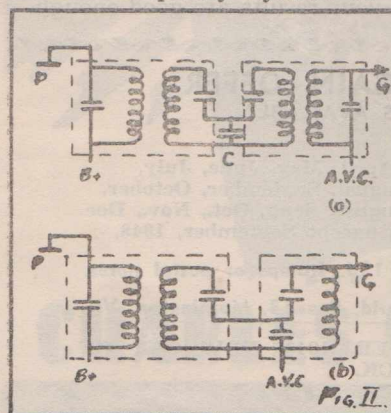

the receiver is to select one of "c" and "d", to amplify it if necessary, and to supply it to the second detector. It must be remembered, however, that there will probably be another station 10 k.c. away from the desired one on either side and that the selectivity of the intermediate frequency tuning circuits must be such that these frequencies do not reach the second detector.

The tuned circuits used for i.f. coupling are, almost without exception, of the double-tuned coupled circuit type, the number used being varied according to the desired selectivity and other factors. Being like a transformer in construction and principle they are called intermediate frequency transformers (i.f.t.).

The simplest intermediate frequency system is one having a single i.f.t. coupling the plate of the freq. changer to the second detector. This is only suited for local reception as the selectivity would not be very good and it would have a further disadvantage in that it would in normal circumstances only supply a small signal to the second detector. The system has been used in some cases and gives some improvement in audio frequency response due to the wider side bands passed.

## The Normal I.F. System

I have classed this as the normal i.f. system because it is the one used on at least 95% of the sets made. It consists of a single i.f. amplifying valve coupled to the converter and second detector

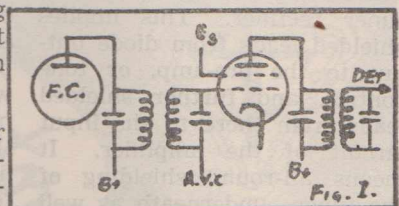

by intermediate frequency transformers. The usual circuit is shown in fig. I which gives the basic circuit only, all voltage supply details being omitted.

Provided cost is to be kept low the single amplifier system gives as much gain as is desirable, in fact special precautions are necessary when valves having a high gain are used, and the selectivity is sufficient for normal requirements.

By suitable coil design the gain and selectivity may be varied within wide limits. Early coils were wound with solid wire and, in consequence had a fairly low "Q", so that a compromise had to be made between gain and selectivity, but modern coils using litz wire allow considerably higher



Q values, allowing both adequate gain and sufficient selectivity to be obtained with two transformers.

Most i.f.t. manufacturers now produce a series of transformers having different L/C ratios giving a variety of gain-selectivity combinations. Owing to the difference in loading between the i.f.t. used to couple the converter and i.f. amplifier and that coupling the i.f. amplifier to the diode detector usually used a different design is used for the two positions.

A typical range is shown below—

No. 1 (for coupling converter and i.f. amp.)

Models A, B, C, D, E.

No. 2 (for coupling i.f. amp. to diode det.)

Models W, X, Y, Z.

Application—

No. 1	No. 2	Gain	Selectivity	Quality
1. A	W . . . . .	Normal	Normal	V. Good
2. A	X . . . . .	Normal	V. Sharp	Fair
3. B	W . . . . .	Good	Average	V. Good
4. B	X . . . . .	Good	Sharp	Good
5. D	Y . . . . .	Normal	Fair	V. Good
6. E	V . . . . .	V. Good	Sharp	Fair

Case 5 is one designated for use in mantel receivers where selectivity is not generally important while the transformers listed in case 6 are specially designed for battery portables where gain must take precedence over quality.

Except in special cases the combination shown in case 1 would be the one selected.

I.f.t. type C is not mentioned in the above list because this transformer is designed to be used in i.f. amplifiers having two amplifier valves and therefore using three i.f.t.s. In this case two type C transformers would be used as intervalve couplings and one type W to couple the second amplifier to the diode detector. Under these conditions the gain would be very good while the

selectivity would be sharp and the quality very good. This arrangement will be dealt with in more detail later.

When some of the late type valves such as the 6BA6 are used as i.f. amplifiers it is necessary to exercise some care in the design of the i.f. transformers to limit the gain and retain the desired selectivity. Too much gain with these valves will lead to instability, owing to the very high mutual conductance of the valves. This result may best be achieved by the use of a high capacity in the i.f. tuned circuits, at the same time keeping the r.f. resistance of the coils low to retain reasonable selectivity. For example it is suggested that the tuning capacity for the i.f. transformers for a 6BA6 stage

be about 200 mmfd. instead of more usual 70 to 100 mmfd. Increased selectivity may be obtained by the use of a band pass arrangement for the first i.f.t. Several different arrangements are possible, two being shown in fig. II. The two circuits are similar, one using two similar i.f. transformers, the two coupled windings forming a band-pass circuit of the same type as that shown in part XII, fig. IIb, as a preselector circuit. The other circuit is simpler and uses only a single winding in the second i.f.t. This would give somewhat less selectivity than the circuit using two complete i.f. transformers but either would be capable of better selectivity than the simple unit. The degree of selectivity may be controlled to some extent with this arrangement by variation of the capacity of the condenser C. Increasing C decreases the coupling and narrows the band passed while a small value of C will, in the limit, give a double hump effect. The usual value of C in this type of circuit is about .005 to .01 mfd. This arrangement can be adjusted to give a comparatively broad top on the selectivity curve and quite steep sides so that the frequency response (audio) is excellent while the adjacent channel rejection is very good.

### Two Stage Intermediate Frequency Amplifiers

Some of the better quality (continued on next page)

be about 200 mmfd. instead of more usual 70 to 100 mmfd.

Increased selectivity may be obtained by the use of a band pass arrangement for the first i.f.t. Several different ar-

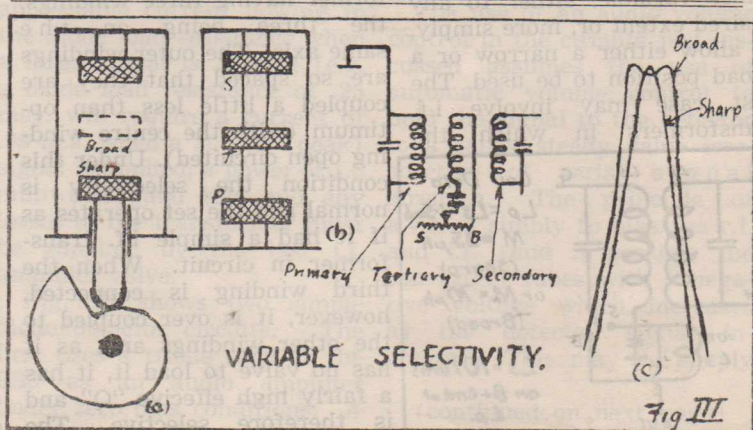



## THEORY

(continued)

radio receivers use two intermediate frequency amplifier valves—usually with a radio frequency amplifier as well. This has several important advantages—the extra amplifier, having a.v.c. applied to it, means that the effectiveness of the a.v.c. is increased, reducing the volume changes with fading; the sensitivity of the i.f. amplifier may be made as high as can be used (this is usually limited by the amplification of the noise which is inherent in the converter stage — it is obvious that no signal weaker than this noise is worth amplifying) and the use of a third set of tuned circuits allows greatly increased selectivity. These last two items would be overdone with normal i.f. transformers, so special ones are used having less gain and a lower selectivity. The use of a greater number of tuned circuits has the effect of improving the selectivity while still allowing a fairly wide band of frequencies to be passed to the detector.

### Variable Selectivity.

Several methods have been used at different times to make the selectivity of the i.f. amplifier variable, either to any desired extent or, more simply, to allow either a narrow or a broad position to be used. The first case may involve i.f. transformers in which the

coupling between the coils may be adjusted by a manual control, or by the use of an absorption trap circuit.

One type of variable coupling transformer consists of a unit in which the primary winding is fixed while the secondary may be moved closer to the primary when desired. When the secondary is furthest away the coupling is somewhat less than optimum and the selectivity is a maximum. As the coil is brought closer the coupling increases until it becomes a greater than optimum and the frequency response curve for the transformer becomes a broad-topped, steep sided one, ideal for wide frequency band reception. This arrangement can be used with two transformers, only the first being adjustable but it is better with a two stage i.f. channel as two transformers out of the three can then be adjusted. Fig IIIa shows the construction of such a transformer. The upper coil is fixed and the lower coil is moved up or down by a rod operated by a cam on a shaft brought out to a control. These transformers should always be set in the sharp position to be adjusted, in fact this rule applies to all variable selectivity circuits.

Another method uses a transformer having three windings, the three being on the same axis. The outer windings are so spaced that they are coupled a little less than optimum (with the centre winding open circuited). Under this condition the selectivity is normal and the set operates as if it had a simple i.f. transformer in circuit. When the third winding is connected, however, it is over coupled to the other windings and, as it has no valve to load it, it has a fairly high effective "Q" and is therefore selective. The effect of the centre winding is

to act as a trap circuit tuned to the intermediate frequency and it reduces the centre of the signal without having much effect on the side bands. If the "Q" of this circuit is made variable, it is possible to control the selectivity within reasonable limits. The simplest way of making the "Q" variable is to introduce some resistance in to the tuned circuit. Fig. IIIc shows the circuit and fig. IIIc shows the effect on the selectivity curve of the receiver.

To give an arrangement which will allow a sharp or broad position to be selected at will, a few turns of wire may be wound round the outside of the first i.f.t. primary and connected in series with the secondary (included in the tuned section). When this coil is included it will greatly increase the coupling so that the coils will be overcoupled to give a double humped selectivity curve. If the first i.f.t. is made like this and a normal type used for the second a fairly broad selectivity curve will be obtained. A simple switch will allow the coupling turns to be switched out or in as desired. Fig. IV shows a typical circuit. Some means of broadening the tuning is advisable when automatic or press button tuning is used for local stations.

### Second Detectors

Almost any type of detector may be used as a second detector in a superheterodyne receiver. Grid leak and condenser detection may be used but is only suitable for a receiver using manual volume control on the early stages as these detectors are liable to distortion with strong signal inputs. A better arrangement from the power handling point of view is to use a sharp cut off tetrode or pentode as a biased detector. This ar-

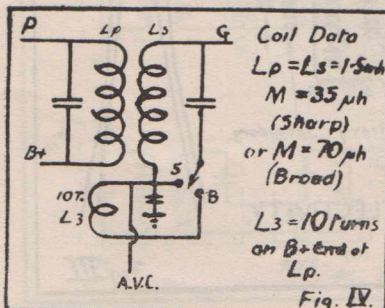



range also requires some form of manual volume control on the preceding stages but will handle a greater range of signal voltages without introducing too much distortion. Fig. V shows a typical circuit (only those parts directly concerned with volume control and detection are shown—the oscillator circuit, power supply, output valve etc. are not shown) using at type 58 (6D6, 6U7) as an i.f. amplifier and a 57 (6C6, 6J7) as a detector.

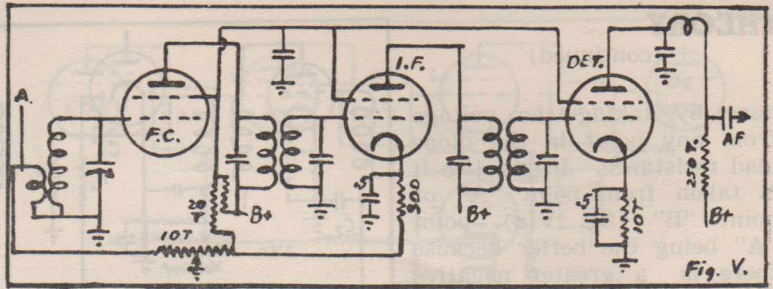

Volume control is by means of the 10,000 ohm potentiometer in the 58 cathode circuit. The 20,000 ohm resistance from the screen serves two purposes, firstly, it ensures a current of about 3 to 4 m.a. through the potentiometer even when the 58 is biased to a low plate current and, secondly, it allows the screen voltage of the valve to rise slightly when the volume control is turned back on a strong signal, reducing the danger of distortion of the modulation envelope. It will be noted that the aerial is connected to one side of the volume control potentiometer so that the input to the frequency changer is reduced by shunting when the volume control approaches the minimum value position. When an r.f. stage is used it would also be connected to the volume control, preferably through a separate 300 ohm minimum bias resistance and the value of the volume control potentiometer may have to be reduced due to the larger current.

### Diode Detectors

By far the most popular detector in use at present is the diode detector for which several advantages may be claimed. —

- (i) A simple detector circuit.
- (ii) Lower distortion than most other types — provided

the associated circuits are properly designed.

(iii) Greater voltage handling capacity — a diode detector will handle voltages in the order of 40 volts peak without any trouble—more than the i.f. amplifier valve is capable of supplying undistorted.

(iv) Gives a simple means of obtaining automatic volume control voltages.

On the debit side is the fact that diode detectors will introduce some distortion when the modulation approaches 100% owing to the fact that the a.f. and d.c. loads are different; the a.f. load impedance being  $\frac{1}{2}$  to  $\frac{2}{3}$  of the d.c. resistance of the diode load resistance. With a high value of grid resistance in the a.f. amplifier following the diode detector this distortion may be kept to a negligible value except for modulation over 90%.

In addition the diode detector requires a certain amount of power because there is an appreciable current flowing in the diode load resistance when a large signal is applied (e.g. a diode load resistance of .25 meg. will require a current of .08 m.a. when a 20 volt (peak) signal is applied, a power of 1.6 milliwatts) and this and any losses in the transformer must be supplied by the last i.f. amplifier valve.

Fig. VI shows two simple diode detector circuits. The first uses a triode such as the 6B6 as an audio amplifier under zero bias conditions. A

10 megohm grid resistance allows some grid bias to appear under operating conditions, but there is a small amount of distortion produced with this connection when the a.f. input to the amplifier is high. The chief advantage of this system is that it allows the cathode of the valve to be earthed directly and therefore eliminates the cathode resistance and its associated condenser. Fig VIIb shows the conventional circuit with cathode resistance for bias. The volume control should be at least 1 meg. An alternative circuit is shown in fig VIIc where the cathode is earthed and the audio valve is biased from a point in the back bias system. In this case the volume control potentiometer is the diode load resistance and a 1 to 2 megohm grid resistance is used.

### Automatic Volume Control (a.v.c.)

The use of an audio volume control in the circuits just discussed assumes the use of automatic volume control to hold the signal to the detector to a fairly steady value irrespective of aerial signal strength. The principle of a.v.c. is simply to bias the r.f. and i.f. (and if possible the converter) tubes with a negative voltage which increases as the detector signal increases. This may be simply

(continued on next page)



## THEORY

(continued)

done by taking the voltage from any point in the diode load resistance. In practice it is taken from point "A" or point "B" (fig. VIa), point "A" being the better because there is a greater negative voltage there, giving more effective a.v.c. action. There is one precaution to be observed in connection with the circuit of fig VIb—under no signal conditions point "A" is positive with respect to the chassis by the voltage developed across the bias resistance (usually 1 to 3 volts) and the cathode bias resistance of the r.f. and i.f. valves must be large enough to cause the cathodes to be positive by this amount as well as the desired standing bias. This does not apply to circuits VIa or VIc.

### Delayed Automatic Volume Control

One disadvantage of the simple automatic volume control discussed above is that the reception of any signal, no matter how small, causes some reduction in receiver sensitivity because it causes a voltage to be developed across the diode load resistance, and therefore some increase in the bias of the controlled valves.

By obtaining the a.v.c. voltages from a separate diode, and arranging that this diode

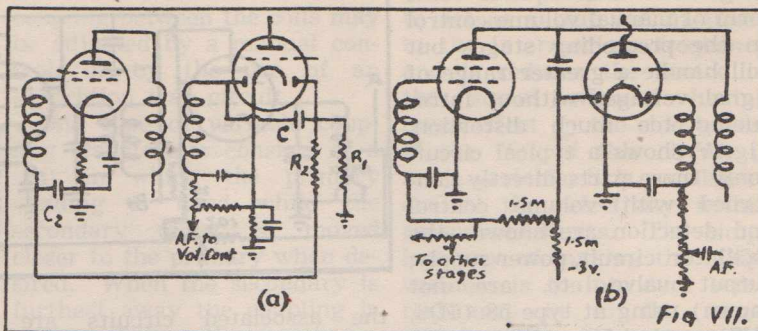

will not operate until some minimum signal strength is reached the receiver will operate at maximum sensitivity up to this point and the a.v.c. will then operate for all signals of greater strength. By using delayed a.v.c. the fact that the cathode of the detector-amplifier valve in fig. VIb is above chassis potential may be turned to advantage as shown in fig. VIIa. The detector diode circuit is the same but the a.v.c. diode is a separate unit which is supplied with r.f. by a condenser C of about 100 mmfd. As the a.v.c. diode is connected through a resistance R1 to chassis then the upper (diode) end of R1 will have an r.f. signal on it, with a mean value of zero. This diode will not conduct until the peak r.f. voltage exceeds the cathode voltage providing the desired delay. As the r.f. peak voltage becomes greater there will be a current flow in R1 so that the average

diode voltage becomes more negative. In other words the average diode voltage will at all times be very slightly less than the peak r.f. voltage and, of course, negative. This voltage is applied to the grid circuits of the controlled valves by the resistance R2 and condenser C2, these being necessary to prevent any audio signals from the diode reaching the grids, and also to provide an easy path for the r.f. in the grid circuit.

Fig. IIIb shows a slightly different arrangement using cathodes connected to chassis and back bias. Although the diodes are shown separate it is not essential and they may be on the cathode of the i.f. or a.f. amplifier valve. In this case the delay voltage is the minimum bias for the i.f. valve (3 volts is usual) and this may be obtained from a resistance in the high tension negative lead. This arrangement is frequently used with the diodes on the i.f. amplifier cathode, the valve being a 6B7S, 6G8G, 6AR7GT, etc. It has the advantage that the audio amplifier may be entirely separate from the r.f. and i.f. sections of the receiver.

Delayed a.v.c. is to be recommended for a number of reasons,—

- i. Improved weak signal sensitivity.
- ii. Improved a.v.c. characteristic.
- iii. Negligible increase in dis-

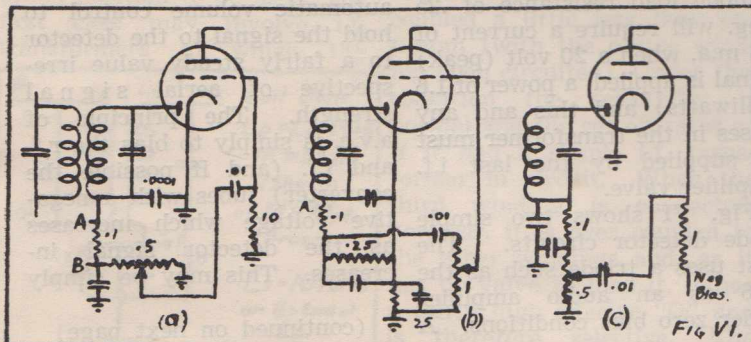



tortion provided that the following precautions are taken—

Condenser C must not exceed 100 mmfd.

Resistances R1 and R2 should be at least 1 megohm each.

The a.v.c. diode is supplied with r.f. direct from the i.f. amplifier plate, not from the other diode.

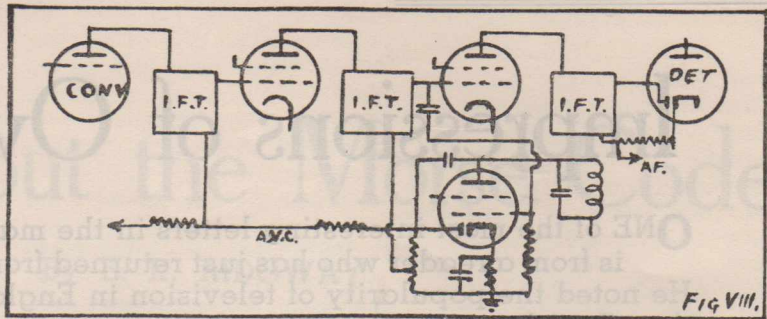

Fig. VIII.

**Separate Channel A.V.C.**

Where expense is not important or where very effective a.v.c. operation is required a separate channel a.v.c. system may be used. This consists of a broad band i.f. amplifier which is used only to amplify a signal for the a.v.c. diode. This amplifier usually takes its signal from a point before the final i.f. amplifier and if it is arranged that the last i.f. valve received more a.v.c. voltage than the a.v.c. amplifier (or if the a.v.c. amplifier is operated at fixed bias) then it is possible to maintain the output of the final i.f. amplifier to the diode at a very steady value. This comes about because the control voltage is taken from a point before the last controlled valve and any fall in signal strength at this point will be partly corrected by the reduction in the a.v.c. bias. This will mean that

there will be less bias on the last i.f. valve so that its increased gain will make up for the remainder of the signal strength change. Fig. VIII shows a block diagram of a typical arrangement. It will be noticed that only part of the a.v.c. bias is applied to the last valve, this is necessary to avoid over-correction.

**Amplified A.V.C.**

There is another method of obtaining improved a.v.c. operation which involves no extra valves or i.f. transformers but which is slightly more complex. It consists of an i.f. amplifier to which is applied delayed a.v.c. The cathode of this valve is connected through a high resistance to a point about 60 volts negative, the value of the resistance being such that point "B" is 3 volts negative under no signal conditions. When a.v.c. is applied to this valve the cathode current will be reduced and the cathode will become more negative. The grids of the other controlled valves are connected through decoupling resistances to the cathode of this valve and thus receive a much greater bias.

Many different circuits may be used, fig IX being a typical example. Amplified a.v.c. may be taken from "A" or "B"; the former being slightly higher in value. The 12,000 ohm resistance or the cathode bias

resistance "R" should be adjusted to give the desired minimum bias to the other controlled valves. Should the controlling valve lose emission the sensitivity of the receiver will fall off as there will be a permanent bias applied to the other valves.

**Infinite Impedance Detector.**

Although the use of a diode detector has been assumed in all the previous discussion, any special form such as the infinite impedance detector mentioned in part XI may be used as the a.v.c. is separate from the detector.

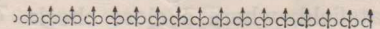

**PICK-UPS FOR MICRO-GROOVE RECORDINGS**

J. H. Magrath & Co. advise that the famous English "Connoisseur" pick-ups are now available with three interchangeable heads for standard and micro-groove recordings. The head with a green spot has a sapphire with a radius of .001in. to suit micro-grooves. The head with a red spot has a sapphire with a radius of .0025in. to suit modern standard recordings. The third head has a yellow spot and a sapphire with a radius of .003in., making it suitable for use with older standard recordings. Frequency range of all heads is claimed to be within plus or minus 2 db. from 25 c.p.s. to 15,000 c.p.s.

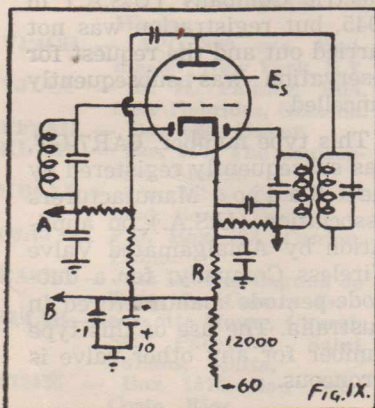

Fig. IX.



# Impressions of Overseas

ONE of the most interesting letters in the mail bag this month is from a reader who has just returned from a trip overseas. He noted the popularity of television in England, the power of the British transmitters and the success of the B.B.C. synchronized transmissions.

"Enclosed please find my subscription for the coming year. Your action in continuing to send "Radio World" during my absence overseas was much appreciated, as I always file it for reference.

Possibly the most outstanding impression I received in the course of a number of visits to various radio organizations, and discussions, with both technical and non-technical people was the very high degree of interest in television.

I was privileged to visit the B.B.C.'s monitoring station at Tatsfield, where a close check is kept on short-wave transmissions throughout the world, and was struck by the fact that all their receivers were of American manufacture. It was explained that the type of receiver which they required simply was not available on the British market, although they hoped in the near future to be able to secure some. It was interesting to note, however, that their precision frequency measuring equipment was all British.

The various "junk shops" are a paradise for experimenters, as also are the retail radio stores, where all sorts of things practically unknown in Australia, are normal stock. For example, ganged potentiometers in two, three or four

gangs in a wide variety of values, Radar gear of various types is a boon to television home constructors, and sufficient parts may be purchased for construction of a television receiver for about £12/10/-.

The signal strength of the various broadcasting stations has to be heard to be believed. Whereas the Australian stations struggle to serve listeners with a very indifferent service over hundreds of miles with something of the order of five to ten kilowatts, the B.B.C. uses, in some cases, 75 or 100 kilowatts. London Regional station at Brookman's Park, which is supposed to serve an area with a radius of about 35 miles, has a power of 75 kilowatts. Admittedly there is no apparent shortage of electricity, but in any case, most of the stations have their own generating sets.

Another method of increasing the signal strength without crowding the band is synchronization of the carriers. In one instance twelve transmitters carrying the same programme are operated on the one frequency. They are not electrically connected, so far as the R.F. end is concerned, relying on accurate frequency control of the oscillators, and I was informed by a B.B.C. engineer that they rarely deviate one

from the other by more than one-fifth of a cycle.

Synchronization is also employed on short-wave transmitters to boost power, in some instances three 100 k.w. stations being synchronized and fed into one aerial system.

C. McI. Janes,  
48 Maitland St.  
Narrabri, N.S.W."

---

## Apparent Duplication of Valve Types

Questions have been asked by those who have noticed type 6AR7-GT listed as a double diode in the A.R.R.L. Handbook and in other overseas publications. The answer is that this type number was reserved by R.M.A. for General Electric Company (U.S.A.) in 1945, but registration was not carried out and the request for reservation was subsequently cancelled.

This type number, 6AR7-GT, was subsequently registered by the Radio Manufacturers Association (U.S.A.) on application by Amalgamated Valve Wireless Company, for a duodiode-pentode manufactured in Australia. The use of this type number for any other valve is erroneous.



# More about the Morse Code

By E. K. RIDGWAY

"Morse code is a SYSTEM of using dots and dashes to represent letters of the alphabet." So says the dictionary. But that is only half the story. There are actually three elements necessary to make morse readable: dot, dash and spaces, with accent on the spaces.

Those of us who learned to use a typewriter were taught very early that a word was completed only AFTER the spacer bar had been used; and we who taught ourselves quite often ran two words together, before finally realising that the space was part of the word, if it was to remain a word. In

~~~~~  
**DX STATION ADDRESSES**

Addresses of DX stations for your notebook this month are:—

- GM2OHN — D. Niven, 31 Glover St., Arbroath, Angus, Scotland.
- GI3GAL — S. H. Foster, 31 Belmont Park, Belfast.
- DL2PD — c/o. 11 Ash Rd., Saltley, Birmingham, 8, Warks.
- VP4CD\* — APO 869, c/o. Postmaster, New York, N.Y.
- YJ1AA — F. H. Palmer, Vila, New Hebrides, Oceania.
- FF8AH — Box 566, Dakar.
- KL7HV — Box 239, The Anchorage, Alaska.
- KB6AJ — c/o. CAA, Canton Island, South Pacific.
- C3AJ — P.O. Box 193, Canton, China.
- EA8BC — Jose Rivera, Laguna de Tenerife, Canary Is.
- ZBIAB—Georgette House, Church St., Paceville, Saint Julians, Malta.
- TI2PZ — Box 1816, San Jose, Costa Rica.

morse, the space is much more important, and has a definite relation to each dot and dash, as well as being used between letters and words.

Now, let us examine the SYSTEM from the point of view of it's design. A dot is not, as a lot of operators will tell us, a mere pin-point. It definitely represents a space of time (and, if indicated by an infinitely thin horizontal line, is actually a short dash). A dash is three times as long as a dot; no longer, no shorter.

The space becomes inherently necessary to separate the dots and/or dashes forming a letter, and in this case is equal in length to a dot. It follows then that the dot becomes the timing unit of the whole set-up; and the length of the dot varies with the speed in "words per minute" (five letters being officially counted as a word). Next comes the space between the letters which is equal to three dots (or one dash) and any variation of that relationship makes for harder copying. The third space type is the one separating words, and is equal to five dots.

This brings us to a most interesting point: Consider a signal being heard by an operator; he does not mentally see dots and dashes, but memorises the sounds at first, until a space occurs. Immediately his brain must substitute the letter, and forget the sounds that represented it to listen for what follows. Note

that the sounds have no meaning except that which is determined by the space. Actually, dots and dashes can be out of proportion somewhat without detracting too much from readability, provided spacing is correct.

To send according to the correct specifications, one would be imitating an automatic machine; but any variation from that standard means that an incorrect technique is being used.

Just as some musicians can attain perfect timing, there are morse operators who can send perfectly; and nothing is more pleasant to copy, or easier either, than perfectly timed morse. Those who cultivate an individual "fist" are merely encouraging defects to creep into the training of their sending muscles, and our advice to you is to do your best to emulate the automatic transmitter. If you attain perfection you will be one of the few, even as perfect musicians are in the minority. Never-the-less, there are many good musicians—so good that they are almost perfect, and likewise many good morse operators.

At this stage, let us advise all beginners to concentrate on receiving. You will learn to pick out the better type of operating, and realise that there is a lot of not-so-good morse on the air. Study the spacing in particular, and the relation of the dash to the dot. Where the dot is too



# CODE

(continued)

short, as is often the case when a semi-automatic key (or "bug") is used, the space between the dot and dash becomes longer than a dot, as the time taken to move the lever to the dash position is more than a dot's duration. This actually splits a letter and makes it seem like two.

Some operators send all letters at high speed, adjusting their words-per-minute by varying the spaces between the letters and words. These chaps often learned to send

before they could receive, and many of them can only receive the same type of sending. All of which may help to explain why many amateurs, after straining every nerve to pass the morse test, throw it away and operate exclusively on telephony (or phone); but seldom does an accomplished morse operator disconnect his key entirely from his transmitter, even if he does use phone.

True, it is not necessary to USE morse to be a 'ham,' though it is an advantage to be able to copy it. "Why then," it has been asked by many, "does the P.M.G.'s de-

partment include it in the exam?" The most general opinion is that it helps to keep out those who know enough theory to pass that part of the exam, by reason of the fact that they may be radio servicemen etc., though not necessarily interested in amateur radio.

That may be so, but there is more to it than that. The mastery of morse is an achievement. It builds up one's self-confidence, and a hobby that can't do that is of no benefit to anyone. Even the indifferent ham has a secret pride in the fact that he did pass the morse test anyway.

## Good Transformers make Good Equipment !

The needs of the discriminating customer are fully catered for by the **A. & R. Company** in that we are manufacturing a wide range of high-class Audio Transformers.

Full and exhausting tests are carried out on every product to ensure that our Transformers are "True to Label" in every detail.

The following are a few of the many popular types selected at random from our range of products:—

| No.       | TYPE                   | FREQ. RANGE | APPLICATION                                                                   | PRICE Inc. Tax |
|-----------|------------------------|-------------|-------------------------------------------------------------------------------|----------------|
| IT 506-6  | Interstage Transformer | Full        | 40,000/100,000 + 18 V.U. P.P.6 J 7's etc./PP Grids . . . . .                  | £3 7 1         |
| IT 574-6  | " "                    | "           | 20,000/5,000 + 24 VU Single 6J7 etc./PP Class A.ABI Grids . . . . .           | £3 7 1         |
| IT 511-10 | Input Transformer      | "           | 50/100,000 + 18VU.Mic or line/single or PP Grids . . . . .                    | £3 3 4         |
| IT 502-10 | " "                    | "           | 600/100,000 + 18 VU.Line to Single or PP Grids . . . . .                      | £3 3 4         |
| IT 568-10 | " "                    | "           | 600/60,000 + 18 VU.Line to Single or PP Grids . . . . .                       | £3 3 4         |
| OT 710-6  | Output to Line         | "           | 20,000/600 + 24 VU. Single triode (6J7, 6C6, etc.) to line . . . . .          | £3 7 1         |
| OT 773-4  | Output Transformer     | "           | 5,000/500 Single 6V6 to line (4.5 watts) . . . . .                            | £1 0 7         |
| OT 780-9  | " "                    | "           | 5,000/500 PP 2A 3's Class A to line (7 watts) . . . . .                       | £2 9 2         |
| OT 798-1  | " "                    | "           | 1,500/500, 280, 167, 125 PP par. 2A 3's/6A 3's Class AB1 (30 watts) . . . . . | £3 9 10        |
| OT 787-9  | " "                    | "           | 10,000/8, 3.7, 2.3 PP 6V 6's Class A to voice coil (10.5 watts) . . . . .     | £2 9 2         |

## A & R Electronic Equipment Co. Pty. Ltd.

378 ST. KILDA ROAD, MELBOURNE, VICTORIA.

Phones: MX 1159, MX 1150



# Amateurs' Activities

Conducted by J. A. HAMPEL (VK5BJ)

WITH the back of winter broken and spring almost here, a young man's fancy turns—to DX! The bands are steadily on the improve again with notable better conditions on 40, as distinct from the rather freakish antics the ino-spherics were giving us a couple of months back. It is once again possible to "roam around Australia" in the evenings so "Clune," 5MA, says. Maybe the 810 in the final running the full quota has something to do with it, too. Anyone wanting information on how to burn up hi-voltage power trannies or r.f. meters can contact Fred on 40 sometime .—.—. 3AGE is in the throes of shack building; with Gordon's clean operating and nice gear, the result should be worth seeing when it's finished. The present rig is a single 807 in the final, with an AR8 taking care of the receiving side. Rumour has it that there are many budding hams in Colac so local QRM will be Gordon's next problem .—.—. 5GY was an early member of the old All Wave DX Club and like most of us went on to getting a ticket after listening for so long. Nobby is busy getting the 288 m.c. gear straightened out in between rag-chewing on 40. Has found that the Hartley oscillator is a better method of frequency control than the Clapp, which was tried a number of times with no success. Two Hartley jobs repose in the GY shack—one as a VFO and the other serving as

a frequency meter to check against the first. (Did I hear someone ask what is a frequency meter?) .—.—. Len, 6LG, at Albany, was still having trouble with his pirate "friend" when last heard in QSO with 5KW who was extending his sympathies to Len. The pirate's latest flout was to work the boys up in Kalgoorlie while Len was waiting down on his frequency for a schedule with them. Harry's sentiments recoiled when the next mail brought a W4 card for a 20 metre contact alleged to have taken place—Harry has never been on 20! .—.—.

In N.S.W. the flood emergency has not yet passed and a listen on the net frequency reveals the great number of stations engaged on the job of maintaining communications ever since the normal channels failed some time back. This work is certainly being officially recognized as evidenced by the recent presentation of a service certificate to VK2KN by the N.S.W. Police Superintendent for the part he played in the 1949 flood emergency work. There is no doubt that this time when the authorities come to reckon up, they will find a great number of Amateurs to thank for their services in the 1950 crisis. It is refreshing to know the recognition that Amateur Radio is receiving by the willingness of the operators and their preparedness for such occasions. The more official credits we have to our ledger now mean,

perhaps, a better balance later when the commercials once more apply for another chunk of an already crowded spectrum. No accurate details of the gear or its operation are to hand as many of the stations it must be realized, are in the flooded area and are now busy restoring their own homes after the waters have passed. We all hope that next year will not see a recurrence of these floods, but it is assuring to know that these stations are ready to go in and provide communications when the usual services fail .—.—. FK8AB has caused some considerable excitement on phone on 40 but the way things are going there will not be many who succeed in working him, the VFO boys giving him little mercy. A suggestion has been advanced to find a cure for this type of selfish operation — put the offending station alone on a completely isolated DX island in the Pacific Ocean with a 10 Watt limit and one crystal to work on .—.—. Talking of single frequencies, the stations in the VK5 Northern Net are heard going strong each Sunday at 0915, SAT. on 7115 k.c. Such is the popularity of this hook-up that it is sometimes difficult to get everybody in before the 5WI broadcast at 1000. 5XR wants to change his call to an A or B call, as he thinks the present one a bad omen when the roll call is done alphabetically .—.—. 5XL has

(continued on next page)



## TRANSMITTING

(continued)

been on QRP for some time now, due to a blown high-tension tranny, a vibrator supply gets Lance on for the Net and other odd times when not tinkering with 6 metres.—.—. A very enjoyable QSO recently was one with 2MM, an old hand who has that love for experimenting, and a knack of making a QSO more than the "hello-goodbye" variety. Bob's latest is what he calls the 2MM

meat-safe—a new ribbon mike with a perforated metal case. Microphone experimenting is right in his line and it was during the QSO that mention was made of the Army type dynamic inserts now on the disposal market, and back came Bob with almost a laboratory report on its characteristics; Bob certainly does things in a thorough way. Always heard with a good signal is VK5, the rig in use is still the same one that was turned off in 1939 and it has been in the shack again since the re-open-

ing. Tubes of the 58 and 59 type are used but Bob doesn't consider them worth changing when such good results are still obtained.—.—. 3AHK has passed along a wealth of material and says that a new club is shortly to start up in Sale, but there will be no fees to pay as everyone has expended so much on disposals. (That being, VK3 — wonder when VK5 will see any disposals gear of any worth). 3AHK has news of their recent outing in the Eastern Zone, and as it was such a success,

---

### FINE EXAMPLE OF A MODERN AMATEUR TRANSMITTER

Towering above his newly-erected home on the Beach Road, Mentone, Victoria, is this fine example of a rotary beam. The station is VK3NZ, owned and operated by R. (Bob) Hall, a long-time subscriber to Australasian Radio World. Bob operates on all bands, and has plenty of effective gear in the "shack", which in this particular case is a main room in the house, adjoining the lounge-room!

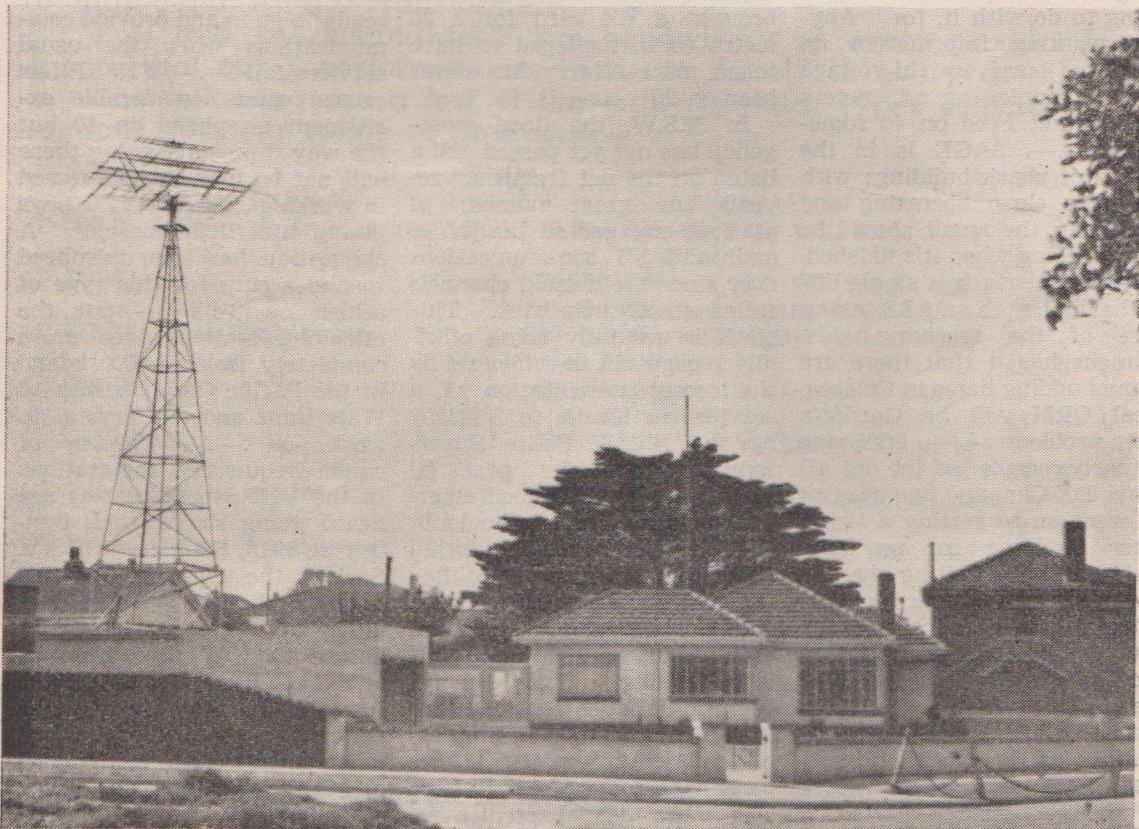



# GOING UP!

THE V.H.F. MAN'S PAGE (By VK5BJ)

THERE isn't much news of the VHF bands at the moment, as apparently even the preparations for the coming summer are just a secret for the present. Some stations are having short haul contacts but nothing out of the ordinary run of distances

has been done. From everywhere though, there are rumours of super rigs ready to be fired up when the Sporadics dot the right thing by the VHF followers.

To prove that line oscillators are still as reliable in these days of 144 m.c. crystal con-

trolled rigs for long distance work, 7MY has installed an RK34 twin triode in a pair of lines to drive a pair of 7193's, these, in turn, will drive a pair of "Micropups" — VT90's, out of disposals radar gear. Also in use at 7MY is an automatic code machine and regular transmissions beamed with a 4 element Lenfo on the mainland are intended. A good nightly path is evident between many distant locations, but signals are very weak. 5BC in Berri continues to work Adelaide nightly but antenna experiments are to the fore at present.

The normal array is a horizontal 4 element, but of late it has been changing almost daily so that it changes from 4-over-4 to a vertical job, then back to a couple of elements and, as sometimes happens, a plain dipole again. From an on the air observation it would appear that the Lenfo is the most popular beam in use with the three and four element parasitic ones not far behind. The Lenfo has, of course, the great saving of not requiring tuning, and should the work be thought worthwhile, more elements can be easily added on to the line at a later date. The moulded 300 ohm ribbon is a dead loss as far as moisture goes, but punching holes in the plastic material doesn't make such a big improvement either, and the best investment at high frequencies are some polythene spacers and wire to con-

## CO-OPERATION APPRECIATED

AS the due date of these notes with the Editor falls at the same time as the writer changing QTH back to Adelaide, some notes may have been omitted but, where possible, any of this will appear in the next month's notes. Would all contributors of amateur news please note the new address for the Amateur Section — Box 1589M, G.P.O., Adelaide, South Australia, and that the deadline for notes to arrive is the seventh of each month, although it would be a big help if they arrived before that date to facilitate preparation. If anything outstanding, such as stop press VHF news happens, send it along as such news can always be found space providing it demands sufficient interest.

This month, besides personal QSO's, my thanks go to VK3AHK, VK5MA, VK5VM (Editor of "Splatter") and others who have personally conveyed news and good wishes for the future of this section of "Australasian Radio World". A glance through the call book reveals a large number of clubs and societies with amateur stations and there are doubt-

less many others without licences so news of these clubs is welcomed for their benefit. By this time, all Zone Stations will have been circularized so that full coverage of the States is expected. It is important that these notes do not become just VK5 notes nor VHF notes but a representative report of activities all over Australia.

Inadvertently, some of the articles prepared for this month have been packed and sent to Adelaide — 150 miles away, so these will have to wait till the next issue! Finally, don't forget the VK-ZL contest at the end of this month. It is usually on such occasions when the rare DX appears on the bands, so take this opportunity to pick off a few new ones for the countries list. Opportunity only knocks once, 'tis said. The week-ends for 'phone and c.w. are as follows—

Sept. 22-24: C.W. Section;  
Sept. 29-Oct 1: Phone Section;  
Oct. 6-8: C.W. Section;  
Oct. 13-15: Phone Section.

See you in the Contest?



Department of  
External Affairs

Antarctic Division

**SUPERVISING  
TECHNICIAN (RADIO-  
RADAR) GRADE I**

Wanted, Supervising Technician (Radio-Radar) Grade I for each of the Scientific Stations at Heard and Macquarie Islands. Salary range £612 to £666 plus special hardship allowance. Clothing, food and amenities provided. Period of stay approximately twelve months. Applicants should possess an appropriate University degree or technical diploma and should have a thorough knowledge of practical electronics. They will be required to service and maintain radio and radar equipment and radiosonde transmitters and receivers, and will also be required to act as senior wireless telegraphists. The appointee to Macquarie Island will be required to operate ionospheric equipment and take an interest in this branch of research. Applicants must be young and healthy and interested in outdoor activities such as walking, ski-ing, mountaineering, etc. Full details on application to the **Officer-in-charge, Antarctic Division, Albert Park Barracks, St. Kilda, S.C.3, Victoria.**

**W/T. OPERATOR**

Wanted, four W/T Operators to staff the radio stations at Heard and Macquarie Islands.

Salary range £552 to £576 plus special hardship allowance. Clothing, food and amenities provided. Period of stay approximately twelve months. Applicants should be fully qualified and must be young, healthy and interested in outdoor activities such as walking, ski-ing, mountaineering, etc. Full details on application to the **Officer-in-charge, Antarctic Division, Albert Park Barracks, St. Kilda, S.C.3, Vic.**

**GOING UP**

(continued)

struct an open wire line. All the stations who previously used the ribbon report better loading of the final since the change to open line. The 1133 transceiver is a popular piece of disposals equipment these days and some chaps are using them as they stand with the 807 operating on 144 m.c. to drive the RK34. The RK34 would be a good buy for VHF if it were not for the high drive requirements.

**AMATEURS**

(continued)

another one is planned for the near future, but next time taking the form of a convention. The stations in this zone have only one grouch—their net frequency is 3650 k.c. on Sunday evenings, but QRM is at times proving too much for an enjoyable zone hook-up. The sooner a full list of all the net frequencies is published the better, so let us have the time and frequency of your particular net for listing in these columns. Besides the WIA list published in the last issue, the following have come to hand:

VK3 Eastern Zone; 3650 k.c. 2000 E.S.T., Sunday night.

VK5 Northern Net; 7115 k.c. 0915 Sundays.

VK5 Murray Net; 7090 k.c. 1100 Sundays. —.

Ex-2AAF, of Parkes, now 5DK, has one of the nicest transmissions yet heard at my receiver. After a visit to his shack which, for the present, is housed in a Men's Club rooms near his home due to BCI, the signal is certainly keeping up the standard of the rig behind it. The most intriguing part of Des's set-up is

the way he sits back over two feet from the mike and fully modulates the rig because there isn't that much audio power available; must be the efficient compressor he has installed. Des has a method of getting through the exams in a hurry; his shack consists of converted railway carriages which still carries some of the past markings on the doors. It's so simple to come in the front door, 2nd class, and arrive at the operating room, 1st class —. Vern, 3YE, has fears of TVI now that announcements are being made in England of increased coverages for the new transmitters. That's just the march of time I suppose, but Tv isn't here yet, so we can rest in peace in our shacks for the time anyway.

**HAM NOTES**

(continued from page 27)

signal rides in on a sideband of one of the broadcasters and is easy to copy, no beat oscillator necessary.

Twenty metres is perhaps erratic, but some good phones are to be heard in the afternoons at times, and a lot of CW too, if you want it. Eighty is generally being used for something, and any band is worth watching during the period of sunspot activity we are going through. The unexpected can happen on any frequency, it seems. Six metres has sprung some pleasant surprises, and with the population there, is on 144 megs. and higher, something is bound to happen for someone. In case you haven't been listening, there are stations who run 'round-the-clock transmissions at times, and any time is the time to scan these bands.



---

# Technical Topics

---

There has been much ado about VT25 tubes recently, on the air and otherwise. Most of the confusion comes perhaps from the different methods of identification used by British and American Defence authorities.

The British VT indicates: Valve-Transmitting; and VR, Valve-Receiving; while in the American system, VT represents Vacuum Tube (both transmitting and receiving) and VR refers to a Voltage Regulator tube, which again is a Voltage Stabiliser (VS) to the British.

The British VT25 is a 25 watt transmitting valve, and the American VT25 appears to be a specialized development of the old UX210.

Often one hears a request for base connections of some obscure type of tube obtained ex disposals. If you have a multimeter with a high ohms scale you can work it out for yourself, without even a socket if need-be.

Stand the tube upside-down, and find two pins which show continuity, but not a short. You most likely have located the heater and application of some voltage will show signs of light unless the tube is of the dull-emitter type, in which case use the half-amp. scale of the meter in series with one leg for a check. If a separate cathode is suspected, find two pins between which conduction can be established, with the ohm-meter on the highest range, in one direction only. (Heater voltage must be applied, of course). Mark the one under the POSITIVE prod as the cathode.

Then with the positive prod still on the cathode (or negative filament, in a directly heated tube) and the ohmmeter on the low-ohms range, the pin giving the highest deflection (other than a short) will be the control grid, unless it happens to be a diode anode. If raising the filament voltage increases the grid current, it should be set above a value where the grid current becomes unaffected by a change in either direction. Generally, the point so established will be somewhere near the one of the standard filament voltages which can be considered to be

the correct one for the tube. Now tie the grid to the cathode, and the next lowest resistance will be to the screen, if there is one, or the plate in a triode. Some positive voltage applied to the screen will enable a reading to be obtained on the plate pin of a beam tube or pentode. While a multigrid converter (triode - heptode, octode etc.) will call for some patience, and imagination perhaps, the method has even been used successfully on cathode ray tubes of the larger types.

Where pins show a short-circuit between them probably they are connected to the same electrode within the tube. Some of the VHF types have four connections to the grid—the grounded grid amplifiers; and others have two cathode connections, and so on.

---

## HAM NOTES By E. K. RIDGWAY

---

**M**OST of us seem to give the forty metre band away after dark for one reason or another. Many theories have been advanced, and I was still wondering which WAS the one when a listen after nine o'clock on the night of 12th August proved them all to be wrong. Every type and quality of phone and as many sorts of voices were heard between the pirate? broadcasters, and a grand variety of CW for every taste in the lower frequency half of the band. Some of the rigs had been collecting dust (or wogs) for months, by the sound of them. It was, of course, the Remembrance Day Contest.

Before the band became so deserted, one ham was heard warning a phone station out of the 7050 portion of the band "before the authorities take away what privileges we have left!" Strange also that just as most of the stickers had

been shifted by the group who had an emergency section outside the band, the P.M.G.'s Department, who withdrew the frequency, suggested the emergency boys move in to 7002 k.c.s with their phone network, and they did just that. Now, some of the CW merchants are trying them out, and they haven't even asked for the channel to be kept clear.

One point which would help is if the emergency phones were all on the same frequency; and it is possible to net within a hundred or so cycles if a heterodyne monitor is used. Crystals can be shifted with an air dielectric trimmer, and the Clapp oscillators should be easy.

But the band isn't dead at night anyway. DX signals of all kinds are coming through most nights, and interstate stations are to be heard at times, too. Often a choice CW  
(continued on page 26)



# The Shortwave Review

Conducted by L. J. KEAST

## NEW STATIONS

### 4 VEH, CAP-HAITIEN—

9.885 m.c. 30.34 met.

This is a new West Indies Station in HAITI. It is a missionary station broadcasting in Spanish and English from 9.40 - 11.50 a.m. It is reported by Ken Boord, of "Radio News".

### YSC, SAN SALVADOR—

6.01 m.c. 49.92 met.

Radio MIL VEINTICINCO is a new station closing around 3.00 p.m.

### HOHM, PANAMA CITY—

6.04 m.c. 49.67 met.

A new Central American station—closes around 3.00 p.m.

## CHANGE OF FREQUENCY

### RADIO KOL—ISRAEL—

9.50 m.c. 31.58 met.

The Voice of Israel is testing on this frequency. (Usually heard on 9 m.c. 33.33 met. May also test on 11.935 m.c. 25.15 met.) (Sweden calling).

### CR7BJ, LOVERENCE MARQUES—

Has been heard recently on 9.67 m.c. 31.02 met.; 9.60 m.c. 31.25 met.; 9.585 m.c. 31.33 met. and 9.787 m.c. 30.66 met. (Sweden Calling).

### RADIO FRANCE, ASIA, SAIGON—

11.83 m.c. 25.36 met.

From June 1st have been on this frequency having moved from 11.84 m.c. at suggestion of Mr. Arthur Cushen. Still suffering a little interference from VLW-3 up to 8.00 p.m.

### HROW, TEGUCIGALPA—

6.025 m.c. 49.81 met.

Radio MONTERA is heard broadcasting from "El Palacio de Radio" from 1.30 - 3.00 p.m. (Sweden Calling).

## RADIO AUSTRALIA

Overseas Service—Australian Broadcasting Commission

To British Isles and Europe—

VLC—

15.20 m.c. 19.74 met.

Monday to Friday 6.00- 9.00 a.m.

Daily 4.55- 6.15 p.m.

Sundays till 9.15 a.m.

Page Twenty-eight

### VLA4—

11.85 m.c. 25.32 met.

Monday to Friday 6.00- 9.00 a.m.

Daily 4.55- 6.15 p.m.

Sundays till 9.15 a.m.

Midnight-2.15 a.m.

### VLA10—

17.84 m.c. 16.82 met.

Daily 4.55-6.15 p.m.

### VLB4—

11.85 m.c. 25.32 met.

Daily, except Saturday 4.55- 6.15 p.m.

## AUSTRALIAN BROADCASTING COMMISSION

### SCHEDULE FROM LYNDHURST TRANSMITTER VLG 10 K/W—

Daily 6.00- 8.00 a.m. VLG-10

11.76 m.c. 25.51 met. To New Guinea

Sundays from 7.00 a.m. VLG-10

11.76 m.c. 25.51 met. To New Guinea

Mondays 8.15-10.30 a.m. VLG-11

15.21 m.c. 19.72 met. To New Guinea

Saturday and Sunday To 3.45 p.m. VLG-11

15.21 m.c. 19.72 met. To New Guinea

Monday-Friday 10.50- 1.30 p.m. VLG-11

15.21 m.c. 19.72 met. To S.W. Asia/

N.W. Australia

Monday-Friday 1.45- 3.45 p.m. VLG-11

15.21 m.c. 19.72 met. To New Guinea

Daily 4.00- 4.40 p.m. VLG-11

15.21 m.c. 19.72 met. To Tahiti

Fridays only 5.00- 5.30 p.m. VLG-11

15.21 m.c. 19.72 met. To Thailand

Daily 5.45- 6.45 p.m. VLG-10

11.76 m.c. 25.51 met. To New Caledonia

Daily 6.59-11.30 p.m. VLG-10

11.76 m.c. 25.51 met. To New Guinea

Saturday only 6.59- Midnight VLG-10

11.76 m.c. 25.51 met. To New Guinea

## NEW ZEALAND

### ZL-4, WELLINGTON—

15.28 m.c. 19.63 met.

"Calling Australia and the Islands"

(Cushen) 4.00- 7.00 p.m.

### ZL-3, WELLINGTON—

11.78 m.c. 25.47 met.

"Calling Australia and the Islands"

(Cushen) 4.00- 7.00 p.m.

Australasian Radio World, September, 1950



## EUROPE

### ARABIA

#### —, DJEDDA—

11.95 m.c. 25.11 met. 3.00- 3.30 p.m.  
Also heard on 11.85 m.c., 11.76 m.c. and  
9.645 m.c.

### AUSTRIA

#### KZCA, SALZBURG—

9.62 m.c. 31.19 met.

Moved to here according to "Sweden  
Calling"

### BULGARIA

#### RADIO SOFIA—

7.67 m.c. 39.11 met.

English Schedule 6.45- 7.00 a.m.  
7.45- 8.00 a.m.

### CZECHOSLOVAKIA

#### OLR3B, PRAGUE—

9.67 m.c. 31.02 met.

Heard around breakfast time

#### OLR3A, PRAGUE—

9.55 m.c. 31.41 met.

Heard around breakfast time

### FRANCE

#### RADIO PARIS—

9.62 m.c. 31.19 met.

Strong signal at 1.00 p.m.

### GREECE

#### AFRB, LARISSA—

6.745 m.c. 44.44 met.

The armed Forces Broadcasting Station  
is now on the Air— 2.30- 4.30 p.m.  
8.00-11.00 p.m.  
2.00- 7.00 a.m.

Verification cards sent for correct re-  
ports (Sweden Calling)

### HUNGARY

#### RADIO BUDAPEST—

11.91 m.c. 25.18 met.

News in English at 7.00 and 9.10 a.m.

9.82 m.c. 30.52 met.

Same as above (Cushen)

Is testing its new 100 kilowatt trans-  
mitter on 11.89 m.c. 25.23 met. around  
1.00 a.m. (Gillett)

### IRAN

#### EQB, TEHERAN—

15.10 m.c. 19.87 met. 5.30- 7.00 a.m.

English at 6.00 a.m. (Sweden Calling)

#### RADIO TEHERAN—

6.155 m.c. 48.74 met. 5.30- 7.00 a.m.

English at 6.00 a.m. (Sweden Calling)

### ITALY

#### ROME RADIO—

17.775 m.c. 16.88 met.

English at 6.15- 6.50 p.m.  
then continues in Italian (R. Gillett)

17.80 m.c. 16.85 met. Same as above

### U.S.S.R.

#### RADIO MOSCOW—

15.18 m.c. 19.76 met.

15.11 m.c. 19.85 met.

11.96 m.c. 25.09 met.

11.82 m.c. 25.38 met.

11.71 m.c. 25.62 met.

9.69 m.c.

Programme to America 9.20-10.30 a.m.

11.00 a.m.-

2.00 p.m.

News at

1.30 p.m.

Moscow hopes to have a new programme  
from 6.00-6.30 a.m. on 17.84 m.c. 16.81  
met., 15.18 m.c., 11.96 m.c. and 11.82  
m.c.

15.44 m.c. 19.42 met.

News in English at 3.00 p.m., also on  
15.16 m.c. 19.79 met.

On 23rd July, Radio Moscow announced  
that, commencing on July 25th, a new  
programme will be presented from  
4.15 a.m. on 15, 19, and 25 met. band.

## CANADIAN BROADCASTING CORPORATION

To Australia and New Zealand—

#### CKLX—

15.09 m.c. 19.88 met. 1.50- 2.20 p.m.

(Commentaries from the U.N.) except  
Sunday and Monday

#### CHOL—

11.72 m.c. 25.60 met. 1.50- 2.20 p.m.

6.40- 8.30 p.m.

#### CKLO—

9.63 m.c. 31.15 met. 6.40- 8.30 p.m.

To Europe—

#### CKCX—

15.19 m.c. 19.75 met. 12.15- 2.00 a.m.

#### CKNC—

17.82 m.c. 16.84 m.c. 12.15- 9.00 a.m.

#### CKCS—

15.32 m.c. 19.58 met. 2.30- 9.00 a.m.

## CENTRAL AMERICA

### GUATEMALA

#### TGWA, GUATEMALA—

15.17 m.c. 19.77 met.

Now heard till 8.30 a.m.

### HONDURAS

#### HROW, TEGUCIGALPA—

6.025 m.c. 49.81 met.

"EL PALACIO DE RADIO"

(Sweden Calling) from 1.30- 3.00 p.m.

(continued on next page)



## SOUTH AMERICA

### ARGENTINA

LRS 2, BUENOS AIRES—

11.97 m.c. 25.07 met.

... "RADIO SPLENDID" is received at good strength at 8.00 a.m. till 11.00 a.m., gives extensive network list at 8.30 a.m. (Cushen).

### BRAZIL

ZYK-3 PERNAMBUCO—

9.565 m.c. 31.36 met. 11.15-11.30 a.m.

Programme in English

### ECUADOR

HCJB, QUITO—

5.995 m.c. 50.04 met.

Daily News in English around 4.00 p.m.

Mondays 7.20- 7.50 a.m.

### NICARAGUA

YNWA MANAGUA—

6.465 m.c. 46.40 met.

"RADIO MUNDIAL"—gives slogan frequently and heard in dance programmes. Signs off at 3.00 p.m.

### PERU

OAX4B, CERRO de PASCO—

6.53 m.c. 46.00 met.

Reported to be signing off at 3.30 p.m. (Sweden Calling)

## AFRICA

### NORTH RHODESIA

ZQP, LUSAKA—

7.22 m.c. 41.55 met. 1.00- 4.30 a.m.

### SOUTHERN RHODESIA

SALISBURY—

4.89 m.c. 61.34 met.

Daily 1.55- 6.00 a.m.

Sundays 3.55- 6.00 a.m.

7.29 m.c. 41.15 met.

### PORTUGUESE EAST AFRICA

CR7BJ, LOURENCO MARQUES—

9.60 m.c. 33.34 met. 2.00- 3.55 a.m.

### FRENCH EQUATORIAL AFRICA

RADIO BRAZZAVILLE—

11.97 m.c. 25.09 met.

News in English at 3.15 p.m.

Talk at 3.30, the news at 3.35.

News in French at 4.00-5.00 p.m.

Closes with "Marseillaise" at 5.15 p.m.

## SCANDINAVIA

### DENMARK

OZH, COPENHAGEN—

15.165 m.c. 19.78 met.

Has a DX Session each Second Tuesday in the programme "Everybody's Programme" 8.20- 8.50 p.m.

(Sweden Calling)

OZF, COPENHAGEN—

9.52 m.c. 31.53 met. 1.00- 1.30 p.m.

Page Thirty

## NORWAY

LLK, OSLO—

11.85 m.c. 25.31 met. 11.00-Midnight  
5.00- 6.00 a.m.

The above times are from Norwegians abroad.

## SWEDEN

SDB-2, STOCKHOLM—

10.78 m.c. 27.81 met.

News in English 11 a.m.; DX Service

11.15 a.m. on Sundays.

## THE EAST

### CHINA

—, PEIPING—

15.065 m.c. 19.91 met.

Good signal at 8.00 p.m.; News in English at 11.30 a.m. (Radio Aust.)

### FORMOSA

BCAP, TAIPEH—

8.99 m.c. 33.37 met.

Said to be on the air from 10.00 p.m.

VOICE OF FREE CHINA, TAIPEH—

15.235 m.c. 19.74 met.

To U.S.A. 1.00- 3.00 p.m.

7.151 m.c. 41.96 met.

Sundays 8.00 p.m.-1.00 a.m.

Week Days 7.00 p.m.-1.00 a.m.

### INDO-CHINA

RADIO FRANCE ASIA, SAIGON—

11.83 m.c.

### INDIA

VUD-7, DELHI—

15.16 m.c. 19.79 met.

Opens at 10.30 a.m. with news in English

### KOREA

—, SEOUL—

7.90 m.c. 37.65 met. 5.00- 7.00 a.m.

11.00 a.m.-

2.00 p.m.

(Gillett)

5.00 p.m.-

12.30 a.m.

—, PYONGYANG—

7.784 m.c. 38.54 met. 5.50- 8.00 a.m.

11.55 a.m.-

1.30 p.m.

4.55-11.00 p.m.

### PHILIPPINES

DZH-7, MANILA—

9.73 m.c. 30.83 met.

Power has now been increased from 300 watts to 3 kilowatts. Report on new signal is requested.

### TAHITI

FZP8, PAPEETE—

12.08 m.c. 24.84 met.

In afternoons—sometimes till 4.30 p.m.

RADIO TAHITI—

9.05 m.c. 33.17 met. 2.15- 3.00 p.m.

(Has moved here from 12.08 m.c.)

Australasian Radio World, September, 1950



## MISCELLANEOUS

### SYRIA

#### RADIO DAMASCUS—

|                         |            |                  |
|-------------------------|------------|------------------|
| 15.09 m.c.              | 19.89 met. |                  |
| Arabic                  |            | 12.40-12.50 a.m. |
| Also on approx. 17 m.c. |            |                  |
| 7.16 m.c.               | 41.86 met. |                  |
| Schedule Daily          |            | 2.00- 8.00 a.m.  |
|                         |            | 2.45- 3.00 p.m.  |
|                         |            | 8.00-11.00 p.m.  |
| Fridays                 |            | 2.45- 6.00 p.m.  |
|                         |            | 7.00-11.00 p.m.  |
| Sundays                 |            | 2.45- 6.00 p.m.  |
|                         |            | 7.30-11.00 p.m.  |

Also on 6.00 m.c. and 12.00 m.c.  
News in English 7.30 a.m.

### MEXICO

#### XEWN, MEXICO CITY—

9.505 m.c. 31.57 met.  
Mr. Cushen tells me is still on this frequency despite reports to the contrary.

### MONACO

#### RADIO MONTE CARLO —

9.785 m.c. 30.66 met.  
Special request session for English listeners on Mondays from 7.30 a.m.

## WEST INDIES

### BARBADOS

#### VPO3, BRIDGETOWN—

11.78 m.c. 25.46 met.  
According to "Sweden Calling" has moved here from 10.605 m.c. 28.28 met. and being heard from 9.18 to 9.45 a.m.

### HAITI

#### 4VEH, CAP-HAITIEN—

9.885 m.c. 30.34 met.  
This is a new station with Missionary broadcasts in Spanish and English from 9. 40-11.50 a.m.  
(Radio News)

## RADIO CEYLON

### B.B.C. PROGRAMMES

Daily Schedule: 6.25 p.m. - 3.05 a.m.  
17.73 m.c. 16.92 met. 6.25 p.m.-Midnight  
15.12 m.c. 19.84 met. 12.15 a.m.- 3.05 a.m.  
21.62 m.c. 13.88 met. 6.25 p.m.- 3.05 a.m.

### BRITISH FAR EASTERN BROADCASTING SERVICE

### B.B.C. PROGRAMMES

Daily Schedule: 7.15 p.m. - 2.30 a.m.  
11.88 m.c. 25.25 met. 7.15 p.m.- 2.30 a.m.  
15.30 m.c. 19.61 met. 7.15 p.m.- 1.30 a.m.  
6.175 m.c. 43.58 met. 7.15 p.m.- 2.30 a.m.

### B.B.C. PROGRAMMES FOR SOUTH-EAST ASIA AND THE FAR EAST

15.07 m.c. 19.91 met.  
To China and Japan 9.00-10.30 p.m.  
To South East Asia 10.30-12.15 a.m.

Australasian Radio World, September, 1950

15.26 m.c. 19.66 met.  
To China and Japan 11.30-Midnight  
21.75 m.c. 13.79 met.  
To South-East Asia 8.30 p.m.-  
12.15 a.m.

17.79 m.c. 16.86 met.  
To Japan, North China,  
N.W. Pacific 5.15 -8.30 p.m.

17.715 m.c. 16.93 met.  
To Japan, North China, 8.30 p.m.-  
N.W. Pacific 12.15 a.m.

15.14 m.c. 19.82 met.  
To Japan, North China, 8.30 p.m.-  
N.W. Pacific 12.15 a.m.

11.75 m.c. 25.53 met.  
To South-East Asia 2.00- 2.30 p.m.

15.26 m.c. 19.66 met.  
To South-East Asia 2.00- 5.30 p.m.

21.47 m.c. 13.97 met.  
To South-East Asia 4.00 p.m.-  
3.15 a.m.

17.81 m.c. 16.84 met.  
To South-East Asia 8.30 p.m.-  
1.15 a.m.

15.26 m.c. 19.66 met.  
To South-East Asia 1.15- 3.15 a.m.

### HUNGARY

RADIO BUDAPEST, 11.91 m.c. 25.18 met.—  
News in English  
Broadcast from 9.10 a.m.

RADIO BUDAPEST, 9.82 m.c. 30.55 met.—  
Daily Programmes in  
German 4.20 a.m.  
Greek 5.30 a.m.  
French 6.00 a.m.  
English Session 7.00- 7.21 a.m.

RADIO BUDAPEST, 6.25 m.c. 48.03 met.—  
Same schedule as in 9.82 m.c. but reception is not as good as above.

### INDIA

VUD-7 DELHI—  
9.62 m.c. 31.19 met. 5.00- 6.00 a.m.

VUD-11 DELHI—  
11.76 m.c. 25.51 met. 5.00- 6.00 a.m.

VUD-3 DELHI—  
11.85 m.c. 25.31 met. 5.00- 6.00 a.m.

VUD-11 DELHI—  
15.29 m.c. 19.62 met. 5.00- 6.00 a.m.

VUM-2 MADRAS—  
9.59 m.c. 31.28 met. 5.00- 7.30 p.m.

7.26 m.c. 41.32 met. 8.30- 9.30 p.m.

11.30 a.m.-  
1.30 p.m.

VUB-2 BOMBAY—  
9.55 m.c. 31.41 met. 5.15- 7.00 p.m.

7.24 m.c. 41.44 met. Noon- 1.30 p.m.  
9.30- 11.45 p.m.



**VUC-2 CALCUTTA—**

7.21 m.c. 41.61 met. 11.30 a.m.-  
1.00 p.m.  
9.30-11.30 p.m.  
9.53 m.c. 31.48 met. 5.00- 7.30 p.m.

**RADIO CEYLON—**

Heard testing on 17.82 m.c. 16.83 met. and  
15.12 m.c. 19.83 met. at 3.15- 3.30 p.m.  
Reports are asked for.

**ISRAEL****RADIO KOL ISRAEL, TEL AVIV—**

9.00 m.c. 33.34 met.  
News in English 5.15 a.m.  
World Zionists  
Broadcasts 7.00- 7.45 a.m.

**INDO-CHINA****RADIO FRANCE-ASIE, SAIGON—**

6.415 m.c. 48.84 met. 8.45- 9.00 p.m.  
11.83 m.c. 25.36 met. 8.45- 9.00 a.m.  
10.30-11.00 a.m.  
7.15- 8.15 p.m.  
8.45- 9.00 p.m.  
Midnight- 2.15 a.m.

**INDONESIA**

(See New Stations)

**ITALY****RADIO ITALIANA—**

15.31 m.c. 19.60 met. )  
11.81 m.c. 25.40 met. ) In parallel  
9.63 m.c. 31.15 met. )

**MEXICO****XEWW, MEXICO—**

9.525 m.c. 31.5 met.:  
"La Voz de la America Latina des de  
Mexico". Formerly on 9.5 m.c. 31.58  
met., now heard here from:  
12.30-12.50 p.m.

**PARAGUAY****ZPA4, ASCUNCION—**

9.74 m.c. 30.89 met.  
Sign off at 1.00 p.m.

**PERSIA****EQB, RADIO TEHERAN—**

15.10 m.c. 19.87 met.  
Heard from 5.30- 7.00 a.m.  
News in French at 5.30 a.m.  
English at 6.00 a.m.  
Russian at 6.30 a.m.

Reports are acknowledged if International  
Reply Coupons are sent with same.

**PHILIPPINES****DZI-3 MANILA—**

6.11 m.c. 49.1 met.  
On air from 7.00 a.m. - 3.00 a.m.

**SIAM****? BANGKOK—**

12.04 m.c. 24.92 met.

This is a new station reported by Miss  
Dorothy Saunders. Heard giving news  
in English at 8.45 and 9.15 p.m.

**SPAIN****RADIO ESPANA INDEPENDIENTE,  
MADRID—**

10.44 m.c. 28.73 met.  
Programmes of 20 minutes duration are  
broadcast at:— 2.30, 3.30, 4.30, 5.30,  
6.00, 6.30, 7.00, 7.30 and 8.00 a.m.

Same can be heard in: 7.37 m.c. 40.68  
met.; 8.091 m.c. 37.08 met.; and 10.24  
m.c.

(Radio Espana Independiente is also  
heard on 8.070 m.c. 37.17 met.; 9.419  
m.c. 31.36 met.; and 10.25 m.c. 29.34  
met.—LJK)

**SWITZERLAND****HEI-3 BERNE—**

7.205 m.c. 41.61 met.  
European Session:  
Daily 3.15- 4.40 p.m.  
Sundays 3.55- 4.40 p.m.

**HER-3 BERNE—**

6.165 m.c. 48.66 met.

**HER-3 BERNE —**

Same as HEI-3

**HER-4, BERNE—**

9.535 m.c. 31.47 met.  
Same remarks apply

**TANGIERS****TANGIER-2—**

11.79 m.c. 25.41 met.  
American Relay Stations  
heard from 6.00- 8.30 a.m.

**TANGIER-1—**

6.06 m.c. 49.5 met. 8.00- 8.30 a.m.

**TURKEY****TAQ, ANKARA—**

15.195 m.c. 19.78 met.  
Broadcast in English—  
Daily 4.45- 5.00 a.m.  
Fridays and Mondays 6.30- 7.00 a.m.

(Turkey is building a new 100 k.w.  
transmitter from which they hope to  
be on the air any day. They have in  
mind a "World Friendship Club and  
Turkish-English Lesson".—LJK)

**U.S.S.R.****RADIO TASHKENT, TURKESTAN—**

6.825 m.c. 43.86 met.  
English Broadcast beamed to South-East  
Asia at Midnight and 2.00 a.m.

**RADIO MOSCOW—**

15.34 m.c. 19.55 met.  
News in English at 11.00 p.m., followed  
by talk, and at 11.15 Home News

Australasian Radio World, September, 1950



# U.S. International Stations

## EAST COAST STATIONS—

| Call Sign | Frequency | Wave Length | On the Air                                                                                                                  |
|-----------|-----------|-------------|-----------------------------------------------------------------------------------------------------------------------------|
| WLWO-1    | 6.08      | 49.34       | 10.00 a.m.- 1.00 p.m.                                                                                                       |
| WGEO-1    | 9.53      | 31.48       | 9.00-10.00 a.m. (Tues.-Sat.)<br>10.00 a.m.-p.m.                                                                             |
| WABC-1    | 9.65      | 31.09       | 6.45- 8.30 a.m.                                                                                                             |
| WRCA-6    | 9.67      | 31.02       | 10.00-10.30 a.m. (Wed.-Sun.)<br>10.30 a.m.-Noon                                                                             |
| WLWO-8    | 9.70      | 30.93       | 10.00 a.m.- 1.00 p.m.                                                                                                       |
| WLWO-7    | 11.71     | 25.62       | 6.30- 8.15 a.m.                                                                                                             |
| WLWO-5    | 11.71     | 25.62       | 10.00 a.m.-Noon (Daily)<br>Noon-1.00 p.m. (Wed.-Sun.)                                                                       |
| WRCA-5    | 11.77     | 25.48       | 6.15- 8.15 a.m.                                                                                                             |
| WRUL-4    | 11.79     | 25.44       | 9.00- 9.45 a.m.                                                                                                             |
| WRUL-1    | 11.79     | 25.44       | Noon-1.00 p.m. (Wed.-Sun.)                                                                                                  |
| WGEO-2    | 11.847    | 25.32       | 6.15- 8.30 a.m.                                                                                                             |
| WRCA-1    | 15.21     | 19.73       | 10.00 a.m.-10.30 p.m. (Wed.-Sun.)<br>10.30 a.m.-Noon                                                                        |
| WLWO-5    | 15.24     | 19.69       | 2.30- 5.30 a.m.                                                                                                             |
|           | 15.25     | 19.68       | 6.30- 8.30 a.m.                                                                                                             |
| WABC-2    | 15.27     | 19.66       | 1.30- 8.15 a.m.<br>8.40- 8.50 a.m.<br>9.30 a.m.- 1.00 p.m. (Thurs.)<br>9.45 a.m.- 1.00 p.m. (Ex. Thurs.)                    |
| WRUL-1    | 15.29     | 19.62       | 9.00- 10.00 a.m.                                                                                                            |
| WRUL-3    | 15.31     | 19.60       | 2.00- 4.00 a.m.<br>6.00- 6.30 a.m.                                                                                          |
| WGEO-1    | 15.33     | 19.57       | 2.00- 8.30 a.m.                                                                                                             |
| WGEO-2    | 15.33     | 19.57       | 9.00- 9.45 a.m. (Tues.-Sat.)                                                                                                |
| WLWO-6    | 15.33     | 19.57       | 10.00 a.m.-Noon<br>Noon- 1.00 p.m. (Tues.-Sat.)                                                                             |
| WLWO-5    | 15.35     | 19.54       | 11.15 p.m.-Midnight                                                                                                         |
| WRUL-1    |           |             | 3.30- 8.15 a.m.                                                                                                             |
| WRUL-2    |           |             | 9.45-10.00 a.m. (Tues.-Sat.)<br>11.00 a.m.-Noon                                                                             |
| WRUL-4    | 17.75     | 16.90       | 1.30- 7.00 a.m.                                                                                                             |
| WRUL-5    | 17.75     | 16.90       | 9.00-10.00 a.m.                                                                                                             |
| WGEO-5    | 17.765    | 16.88       | 2.15- 8.45 a.m.                                                                                                             |
| WRCA-2    | 17.78     | 16.37       | 2.00- 8.15 a.m.<br>9.30 a.m.- 1.00 p.m. (Thurs.)<br>9.45 a.m.- 1.00 p.m. (Ex Thurs.)                                        |
| WLWO-7    | 17.80     | 16.85       | 11.15 p.m.-Midnight                                                                                                         |
| WLWO-2    | 17.80     | 16.85       | 11.00 a.m.-Noon                                                                                                             |
| WABC-3    | 17.83     | 16.82       | 2.00- 8.30 a.m.<br>8.40- 8.50 a.m.<br>9.00-10.00 a.m. (Tues.-Sat.)<br>10.15 a.m.-12.30 p.m. (Tues.-Sat.)<br>10.30 a.m.-Noon |
| WABC-6    | 21.50     | 13.95       | 1.30- 8.15 a.m.                                                                                                             |
| WLWO-3    | 21.52     | 13.93       | 2.00- 8.30 a.m.                                                                                                             |
| WABC-1    | 21.57     | 13.90       | 2.00- 6.30 a.m.<br>9.30 a.m.-Noon (Thurs.)<br>9.45 a.m.-Noon (Except Thurs.)                                                |
| WGEO-2    | 21.59     | 13.89       | 2.00- 6.30 a.m.                                                                                                             |
| WRCA-3    | 21.61     | 13.88       | 2.15- 8.15 a.m.                                                                                                             |
| WLWO-7    | 21.65     | 13.85       | 2.00- 6.15 a.m.                                                                                                             |
| WRCA-6    | 21.73     | 13.81       | 2.15- 8.45 a.m.                                                                                                             |



# Speedy Query Service

Conducted under the personal supervision of  
A. G. HULL

**G.M. (Echuca) is interested to know why, when all circuit diagrams show an earth symbol, he and most of his friends operate their receivers without an earth-wire or connect it to the aerial terminal.**

(A): Originally, as in a crystal or one valve set, the earth wire and, indeed, the earth itself, together with the aerial and lead-in wire, formed part of the tuned circuit.

Removing the earth-wire had the effect of detuning the circuit, as well as reducing the current flowing in it when it was retuned; and perhaps more important, it left the circuit more susceptible to hand capacity," which meant that the operator's hand became part of the tuned circuit. Once tuned, the hand had to be kept on the control knob to "hold" the signal—especially on short waves. These sets were built on wooden baseboards, and later a metal chassis and panel were used to "shield" the circuit from the operator's hand, but an earth wire was still an advantage though it was often connected to a "counterpoise" or second aerial near the ground.

Present receivers, however, contain their own tuned circuits, and, as they have much amplification due to five or six valves, aerial coupling can be reduced to such an extent that it no longer influences the tuning. This fact, along with the superheterodyne circuit, means that the earth is not strictly necessary for operation, and the metal chassis is generally referred to as earth, or the point of earth potential, and can be likened to the

counterpoise.

The earthing of the aerial terminal results in the chassis acting as the aerial, the current flowing "backwards" through the small aerial coil to earth; a workable scheme, but one that is not recommended in the case of an electric set, as a short-circuit from the mains to chassis would burn the aerial coil up, while an earth to the chassis would blow the fuse on the switchboard in such a case, and thus prevent any possibility of fire.

The correct earth connection should be used to comply with insurance regulations.

**J.H. (Albury) want an outside opinion on whether it is good practice to use unfiltered plate supply to a push-pull amplifier. He does not agree with his friend who claims that a push-pull stage is self-filtering as regards plate power.**

(A): We have heard much about such a proposal, and have seen it demonstrated that little, if any, hum results. However, there are two sides to the question. Of course, we presume that a condenser of 8 mfd. or so is used across the rectifier output to act as a reservoir, and preamplifier stages either decoupled or fed through a small filter choke by-passed at the output end with another 8 mfd. condenser.

Now, provided the speaker is not too sensitive at low frequencies, fairly good results can be obtained up to medium volume levels. But, near the peak output point the output may be modulated at both 50 and 100 cycles, by reason of desired point.

the fact that the plate voltage and current are varying at those frequencies, and therefore the power handling capability of the amplifier varies likewise.

It is quite apparent therefore that the saving of the choke and of the extra voltage necessary from the power transformer to overcome its D.C. resistance reduce the efficiency of the output stage to less than it would be when used with a normal filter.

**M.M. (Ararat) is keen to hear the B.B.C. transmissions when conditions are less favourable than usual, and wonders what aerial he could put up.**

(A): Some of the many "beams" as used by amateurs could be tried, but these are generally tuned to a particular frequency band, and thus would have their drawbacks as well as advantages.

The solution to your problem seems to lie in what is termed a "long wire" aerial, and it is just what it is called. Mark out a line in the direction of London from your receiving position, and erect a line of poles, six or eight feet out of the ground, for a distance of five or six hundred feet if possible. Then run a wire along the top, of these, using insulators of course, and connect the far end to a good earth through a small 600 ohm carbon resistor of the insulated type for preference. The near end goes to the receiver aerial terminal.

Such an arrangement will increase the strength of any signal, on any short-wave band, provided the station is located in the general direction of the wire, and will decrease all signals outside an angle of about 20 degrees from the



*The New Name  
of a Well-Tried Product  
always ask for — VEGA!*

**I. F. TRANSFORMERS & COILS**

**STOP PRESS**

*Rely on a...  
'VEGA'  
Product to  
do a better  
job*

**RANGE  
INCLUDES**

- I.F. Transformers:**  
Standard and Miniature.
- Coils — Broadcast:**  
Standard and Miniature.
- Coils — Short Wave:**  
Standard and Miniature.
- Coils — DUAL WAVE:**  
Standard and Miniature.
- Tuning Units, etc.**

**PLEASE NOTE**

**Available at all leading  
DEALERS throughout  
Australia and Tasmania.  
If you have any difficulty  
obtaining supplies, con-  
tact us direct.**

When purchasing your com-  
ponents, always look and make  
sure that your choice bears this

Star

Design



**CRANCH PRODUCTS AND  
TRADING CO.**

**17 Bond Street, Sydney**

Phones: BU 3879, BW 7746.

Telegraphic Code: "CRANLAY," SYDNEY.

**MAIL THIS TO-DAY.**

Please place my name on your mailing list for free issues  
of "VEGA" Technical and Data Sheets.

NAME.....

ADDRESS.....

4R.W.



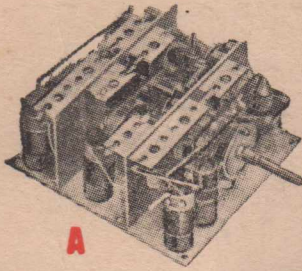

A



A

Aegis Triple Wave Coil Assembly Type K3 covers BC Band (550-1600 kc) and SW Band 13-42 and 40-110 metres.

B

Aegis Vibrator Units for every need 6 $\frac{1}{2}$ in. x 3 $\frac{3}{8}$ in x 5 $\frac{1}{4}$ in.

C

Midget Broadcast coil assembly Unit Type K6 1 $\frac{1}{2}$ in. x 1 $\frac{3}{8}$ in. x 1-5/16in. high.

D

Aegis Loop Aerials M17 or M17A on oval canvas bakelite formers 7 $\frac{1}{2}$ in. x 5in.

E

Aegis Tuning and instrument knobs all sizes and types available.

F

Aegis Intermediates—range of 27 types including 10.7 megs. for FM.

G

Aegis Ceramic Insulator . . . full range of stand off and feed through types.

H

Aegis Broadcast Coils—full range of Standard types plus special windings as requested!

**FROM FIRST TO LAST...**

B

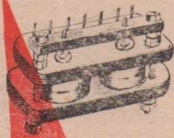

C

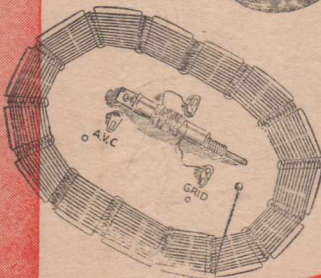
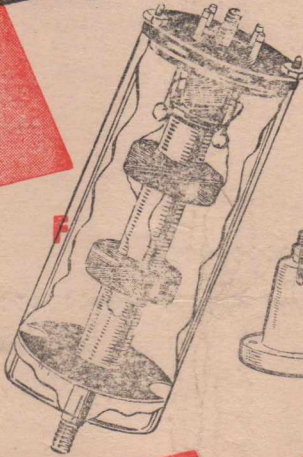
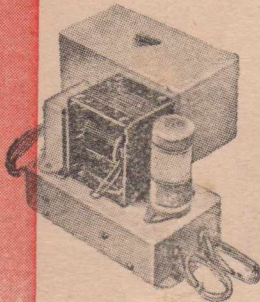

Quality is foremost in Aegis Components . . . Here are some typical examples from the comprehensive Aegis range, each one designed and made to exacting standards from first-grade materials.

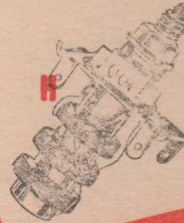

# AEGIS COMPONENTS

MELBOURNE: Lawrence & Hanson Electrical Pty. Ltd.; Replacement Parts Pty. Ltd.; Vealis Electrical and Radio Pty. Ltd.; Homecrafts Pty. Ltd.; J. H. Magrath & Co.; John Martin Electrical and Radio Co.; Warburton Franki Ltd.; A. H. Gibson Elect. Pty. Ltd.; Motor Spares Ltd.; A. G. Healing Ltd.; Hartleys Ltd.; Aust General Elect.; Amalgamated Wireless A/Asia. Ltd.

TASMANIA: Lawrence & Hanson Elect. Pty. Ltd. (Hobart & Launceston); W. & G. Genders Pty. Ltd. (Hobart, Launceston & Burnie); Noyes Bros. Ltd. (Launceston); Homecrafts (Launceston, Hobart & Burnie); Gordon A. W. Wood (Launceston).

ADELAIDE: Geo. Factor (Factory Rep.); Newton, McLaren Ltd.; A. G. Healing Ltd.; Harris, Scarfe Ltd.; Oliver J. Nilsen & Co. Ltd.; Gerard & Goodman Ltd.; Unbehaun & Johnstone Ltd.; Radio Elect. Wholesalers Ltd.; Clarksons Ltd.

PERTH: Nicholsons Ltd.; A. G. Wyle.

SYDNEY: John Martin Pty. Ltd.; Geo. Brown & Co. Pty. Ltd.; Fox & Macgillycuddy Ltd.; Aust. General Elect. Pty. Ltd.; Dominion Factors Pty. Ltd.; Homecrafts Pty. Ltd.; Radio Despatch Service; Davis Radio Co.; Elect. Parts Pty. Ltd.; Lawrence & Hanson Elect. Pty. Ltd. (Syd. & Newcastle); Martin D. Launay Pty. Ltd. (Syd. & Newcastle); Homecrafts (Newcastle); Bloch & Garber; Boyts Radio & Elect.

BRISBANE: Chandlers Pty. Ltd.; B. Martin Pty. Ltd.; A. E. Harrold; Crouch & Connah Pty. Ltd.