

THE AUSTRALASIAN

Registered of the G.P.O. Sydney, for transmission by post as a periodical.

Radio World

1/-

VOL. 11 NO. 2

JULY 15, 1946

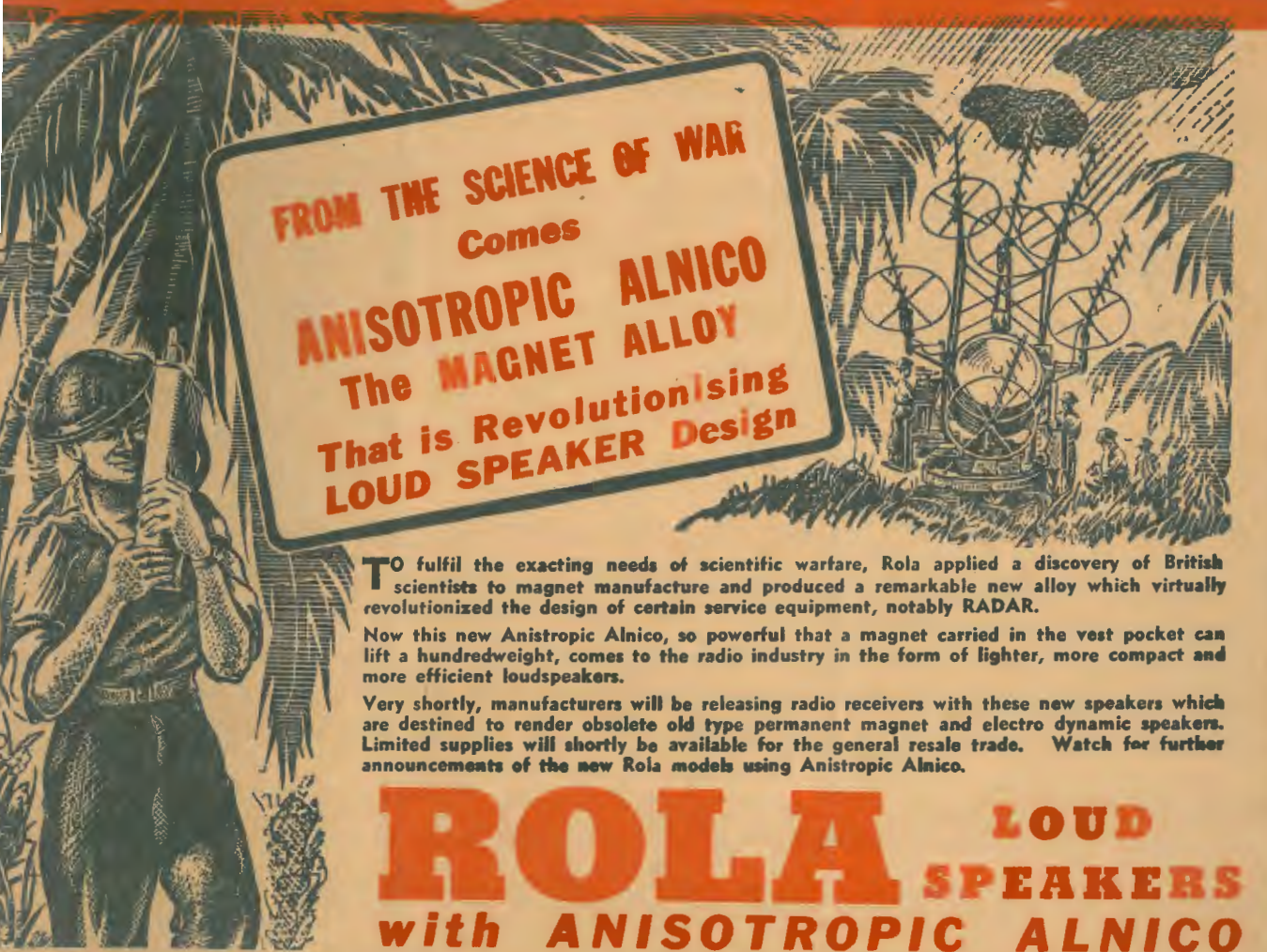

FROM THE SCIENCE OF WAR
Comes
ANISOTROPIC ALNICO
The **MAGNET ALLOY**
That is Revolutionising
LOUD SPEAKER Design

TO fulfil the exacting needs of scientific warfare, Rola applied a discovery of British scientists to magnet manufacture and produced a remarkable new alloy which virtually revolutionized the design of certain service equipment, notably RADAR.

Now this new Anistropic Alnico, so powerful that a magnet carried in the vest pocket can lift a hundredweight, comes to the radio industry in the form of lighter, more compact and more efficient loudspeakers.

Very shortly, manufacturers will be releasing radio receivers with these new speakers which are destined to render obsolete old type permanent magnet and electro dynamic speakers. Limited supplies will shortly be available for the general resale trade. Watch for further announcements of the new Rola models using Anistropic Alnico.

ROLA **LOUD SPEAKERS**
with **ANISOTROPIC ALNICO**

ROLA CO. (AUST.) PTY. LTD., The Boulevard, Richmond, Victoria. 116 Clarence Street, Sydney.



LET US BE PRACTICAL

The future is easy to foretell if you build inferior parts into your radio.

It doesn't take a seer to tell you there is trouble ahead. Any radio is only as good as its weakest part. Plan wisely when you are building your Radio Set—make sure that each part of your equipment is capable of fulfilling its part 100% in the finished circuit.

Be practical and insist on "Crown" parts B/C Coils, S/W Coils, I/F Transformers, Tuning Dials, Padders, Trimmers, etc.

"CROWN" parts are built to rigid standards and are precision tested before they leave the factory; that is your guarantee of quality.

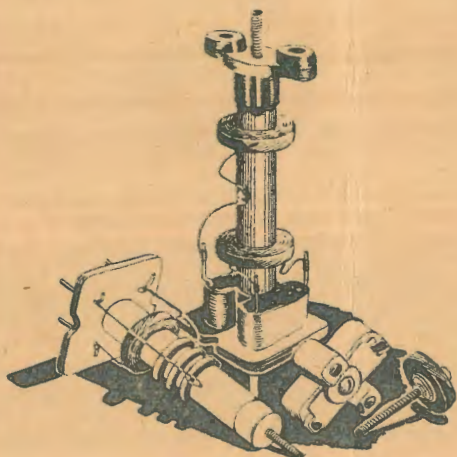

Crown



RADIO PRODUCTS PTY. LTD.

51-53 MURRAY ST.

PYRMONT, SYDNEY. TELEPHONE: MW 2020

THE AUSTRALASIAN RADIO WORLD

Devoted entirely to Technical Radio

and incorporating
ALL-WAVE ALL-WORLD DX NEWS

★ EDITOR
★ PUBLISHER
★ PROPRIETOR—

A. G. HULL

336 Waverley Rd., East Malvern,
Vic.

★ SHORT-WAVE EDITOR—

L. J. KEAST

3 Fitzgerald Road, Ermington,
N.S.W.

★ HAM NOTES By—

D. B. KNOCK (VK2NO)

43 Yanko Av., Waverley, N.S.W.

★ ADVERTISING
REPRESENTATIVE FOR VIC.—

W. J. LEWIS

20 Queen St., Melbourne
Phone: MU 5154

★ ADVERTISING
REPRESENTATIVE FOR N.S.W.—
AMALGAMATED PUBLICATIONS
PTY. LTD.

83 Pitt St., Sydney

Phone: B 1077

★ SUBSCRIPTION RATES—

6 issues 5/3
12 issues 10/6
24 issues £1

Post free to any address in
the world.

Address for all correspondence:
AUSTRALASIAN RADIO WORLD
336 Waverley Rd.
East Malvern, SE5
Victoria

VOL. 11

JULY, 1946

No. 2

CONTENTS

CONSTRUCTIONAL—

The Latest in Direct Coupling	7
"The Spotter"	11
Powerful 8-Valve Circuit	17
An Ideal Single-Ender	21

TECHNICAL—

Advantages of Ferrotune	5
Politics of Ham Radio	15
Servicing A.C. Receivers	20
Estimating Receiver Performance	23
Operating the 807	27
Ham Notes	31

SHORTWAVE REVIEW—

Notes From My Diary	38
Shortwave Stations of the World	39

THE SERVICE PAGES—

Answers	42
---------------	----

EDITORIAL

Many of our readers, in the course of their letters, reveal that they are disappointed at the rate of progress which the radio game is making on its journey from the shadows of war to the sunshine of peace.

Frankly, we disagree with this attitude. Being in a position to know something of the problems of the moment, we feel sure that everybody concerned is doing a good job, and steady progress is being made, even if it is not spectacular.

Some readers seem to think that the heavy income tax is having a crippling effect on initiative; others seem to have an idea that production would be stepped up by manufacturers if they were free from price control.

Possibly these factors are having a slight influence on the trend of affairs, but I feel sure that most of us are fully aware of our obligations and are making a definite effort to give customers the fullest service and attention which is possible under present circumstances.

Taking our own particular case, we realise that our present issues are not yet back to the full size which we were able to publish before the war, but it must be remembered that our production costs are more than double, yet the price of each issue is still the same as pre-war. Likewise, our advertising rates have not been increased, although our printing bill (due partly to increased circulation and partly to increased cost of paper and printing) is more than double what it used to be.

Readers can rest assured that we are keenly on the job and, just as soon as we can, we will publish bigger and better issues.

HEMECRAFTS PTY. LTD.

THE RADIO SPECIALISTS

A Division of Electronic Industries

Distribution in Five States



No Extra Charge for the Milk and Sugar

And there's no extra charge for THE EXTRA SERVICE which HOME CRAFTS extend to their clients.

ARE YOU ON OUR MAILING LIST?

If not send us your Name, Address and Service Licence No. Let HOME CRAFTS keep you up-to-date with the latest information on Stocks, Valve Releases—"B" Batteries, etc.

Write to our nearest Branch—If it's in Radio! Try HOME CRAFTS first.

Head Office: 290 LONSDALE STREET, MELBOURNE.

And at—
100 Clarence Street
Sydney

211 Swanston Street
Melbourne

247 Adelaide Street
Brisbane

307 Sturt Street
Ballarat

132 Moorabool Street
Geelong

Telegraphic Address: "Homecrafts," Each State.

26 Hunter Street
Newcastle

140 Adelaide Street
Brisbane

And at—
Toowoomba, Dalby &
Rockhampton, Qld.

Hobart, Launceston,
and Burnie, Tas.

ADVANTAGES of FERROTUNE

THE expression "Bigger and Better" is one quite generally used about most things; but is not one which can be applied to iron dust used in the composition of adjusting and tuning slugs at radio frequencies.

By

H. K. LOVE

Kingsley Radio Pty. Ltd.
Melbourne

The correct term for iron dust would be more likely to be "Smaller and Better." This term applies very well to the particles which go to make up the dust contained in a core because, within reason, the smaller the particle size the better the "Q" of the completed core.

The average particle size in some good powders is approx. 8 microns in diameter. These particles must be coated with an insulating material so that when they are compacted at high pressure into a solid core, each particle is electrically insulated from its neighbour.

This, briefly, is the story behind the core, or as it is commonly known, the "Iron Slug."

The method of tuning by ferromagnetic material is not new — but for years it's application was limited by the fact that if sufficient iron was introduced into a coil to tune a band as wide as the present medium wave band, the losses in such iron were so great that the coil lost all its goodness, or "Q." On the other hand, if the iron was powdered up and pressed together again, the quality of such powdered iron was such that the "Q" of the coil improved, but there was not sufficient density in the compact to provide tuning over the whole broadcast band.

Powder research, therefore, was directed along the lines of finer particle size, and better insulation to provide "Q" and better quality of iron and alloys to provide permeability.

When this goal was reached — that is, the dog ceased chasing its tail — the Ferrotune became a practicable project.

All this sounds very complicated and it is; but it all adds up to the fact that — the right iron, the right coils and the method of drive provide a tuning unit which is simple in the form it reaches the set builder.

Such unit, known as the Ferrotune, permits the set builder to concentrate on the remainder of the circuit without any worry about lining, padding and dial tracking.

CIRCUIT ARRANGEMENT

The fact that tracking is taken care of in the manufacture of the tuner, is one which shows a distinct advantage to the set builder — the unit is tracked and stays tracked and, in consequence, distortion which may result from imperfect tracking, does not occur.

The tonal qualities, therefore, will depend entirely on the audio circuit used together with speaker and such equipment.

Figure 1, is a simple circuit using a straight out pentode amplifier with a permanent magnet speaker. This circuit is a very satisfactory and simple one to use with the Ferrotune unit. It has the usual limitations in respect to reproduction, but is a good general purpose set up.

DIRECT COUPLED AMPLIFIER

It is well known that audio quality can be much enhanced by the use of push pull circuits and other quite comparatively expensive hook-

(Continued on next page)

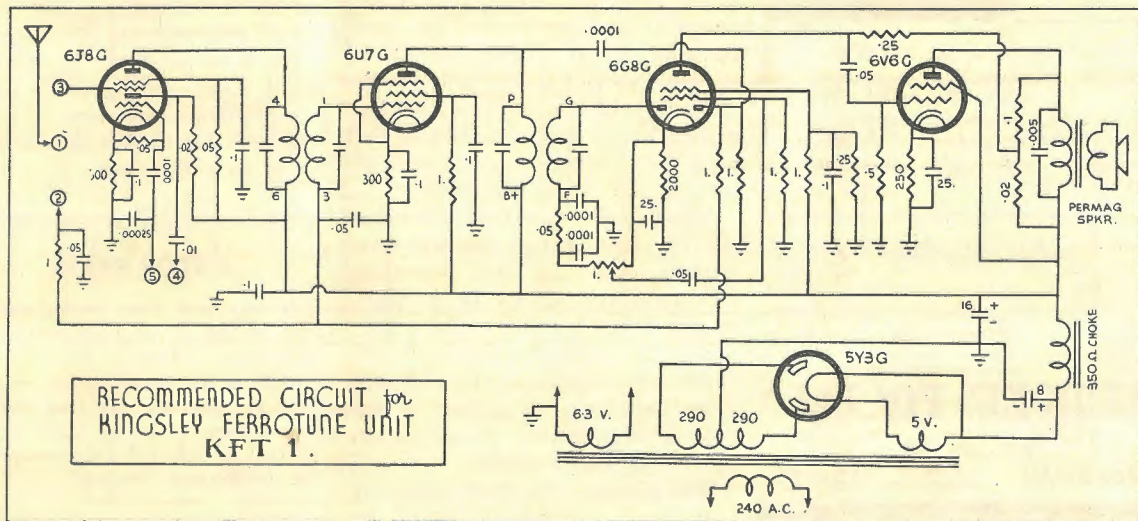

**"THE NAME TO
KNOW IN
RADIO"**

**Radiokes
Radiokes
Radiokes**

Radiokes' Broad-
cast Coils, both
Air Core and Per-
meability types
are now more
freely obtainable.
Features include
rigid Trolital con-
struction. Ask for
Type ACB, Aer,
R.F. or Osc.



RADIOKES D.W. UNITS

Highly selective with exception-
al wide range. To match 'H'
type gang condenser. Incorpor-
ates 4-in-1 padder. Solidly
mounted with coils. Ask for
Type DWU-1.

*Radiokes' precision radio components
have long been recognised in Australia
as being the most outstanding products
of their kind available. It is with
pleasure, therefore, we announce their
return "from active service."*

RADIOKES Pty. Ltd.

P.O. Box 90

BROADWAY - - - SYDNEY

FERROTUNE

(Continued)

ups, but it is not perhaps so well known that a rather unusual circuit known originally as the Loftin White — has, like everything else, undergone simplifications and change. This circuit is perhaps the cheapest method of obtaining quality reproduction.

The circuit employs very simple equipment and completely standard valves. The output tube can be a 6V6 which, it will be noted, is used as a triode, i.e., the plate and screen being connected together and it will be noted on examination of the circuit, that no coupling condensers are used between the plate of the detector and the grid of the output tube. The resistors, as shown in the audio section of the circuit are not the least critical, but the valves should be used as stated. One of the objections to the original direct-coupled circuit, as developed by Loftin and White, was that it had networks of resistors which were difficult to obtain and rather critical as to value — all this presented difficulties to the set builder without instruments to do the checking.

The simplified direct-coupled circuit is easy to build and presents no trouble at all to get under way.

GRAMOPHONE PICK-UP

If it should be desired to use the audio circuit as a record reproducer a crystal pick-up should be used and the circuit slightly modified. It will be found that with these modifications, record reproduction will be a very high quality and the switch and other components will be very well worth while.

The circuit, therefore, provides for the reproduction of broadcast stations tuned by the Ferrotune unit, and reproduced by a high-quality direct-coupled audio amplifier, without the use of critical and expensive components. In addition, if the switching arrangement is employed, high-quality record reproduction is also available.

The photographs shows this unit built from a foundation kit of the

standard Ferrotune type, but modified in the audio section.

FERROTUNE AT HIGH FREQUENCIES

There is no problem in tuning the short wave by means of iron slugs. The technique involved is much the same as for the broadcast frequencies, but the iron core or slug used is of a quite different composition — generally speaking the higher the frequency to be tuned the smaller must be the particle size of the iron dust.

Many versions of iron-tuned high-frequency units will be available in the near future. A combination Ferrotune unit tuning the broadcast and shortwave bands is through its developmental stages and will be going into full production shortly. Another application of this interesting system of tuning is as a shortwave converter to permit the use of a superheterodyne set in conjunction with a converter for good band-spread tuning of the higher frequencies.

THE REINARTZ CIRCUIT

How many of us have from time to time had occasion to put up the little Reinartz circuit?

This, as a rule, involves a Reinartz coil and a single-gang condenser to tune it through the broadcast band.

Ferrotuning has certainly simplified this one — no single gang condenser is needed — the coil, a special one with an iron slug, provides a simple tuner to which an audio stage can be added, making a very compact receiver.

Watch for further details of this set in an early issue.

STOP PRESS

It has just been announced that part of the 20 and 40 metre bands has been returned for ham use. Available for experimental transmitters immediately are the following frequencies: 7,150 to 7,200 Kc., and 14,100 to 14,300 Kc., according to the Melbourne "Argus."

THE LATEST IN DIRECT COUPLING

ABOUT the year 1929 there was a sensation in technical radio circles when direct coupling was brought to the front by two American radio designers, Loftin and White. By an elaborate arrangement of a network of resistors, they evolved a circuit which permitted the plate of the first audio amplifier to be directly connected to the grid of the output valve.

By

A. G. HULL

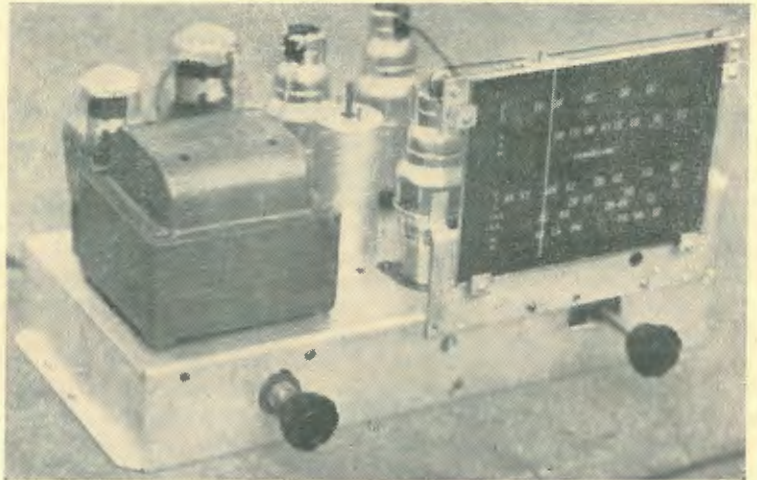

A photograph of the chassis using the latest direct-coupled circuit

The circuit was tricky in many ways, especially to those who were accustomed to the normal voltage distribution of a conventional circuit. The circuit was fairly critical as regards resistance values, and was an awkward one to handle from a servicing point of view, for a faulty resistor in the cathode circuit of the first audio valve could affect the plate current of the output valve and so on.

The circuit was so new and so full of tricks that it lent itself to

endless arguments amongst radio enthusiasts. Some claimed that the output valve would be damaged because it did not have normal bias on its grid until the first audio valve warmed up, and so on. Most of the arguments are still unsettled.

Beyond all argument, however, was the fact that the direct-coupled amplifiers gave quality of reproduction far beyond the normal of that time.

In 1930 a good direct-coupled amplifier, with everything properly adjusted, a Webster pick-up, a Jensen Concert Speaker, and one of the electrically-cut recordings which were introduced about that time, and you had the makings of many an amplifier enthusiast. Most of our readers today are young fellows who may find it hard to realise

(Continued on next page)

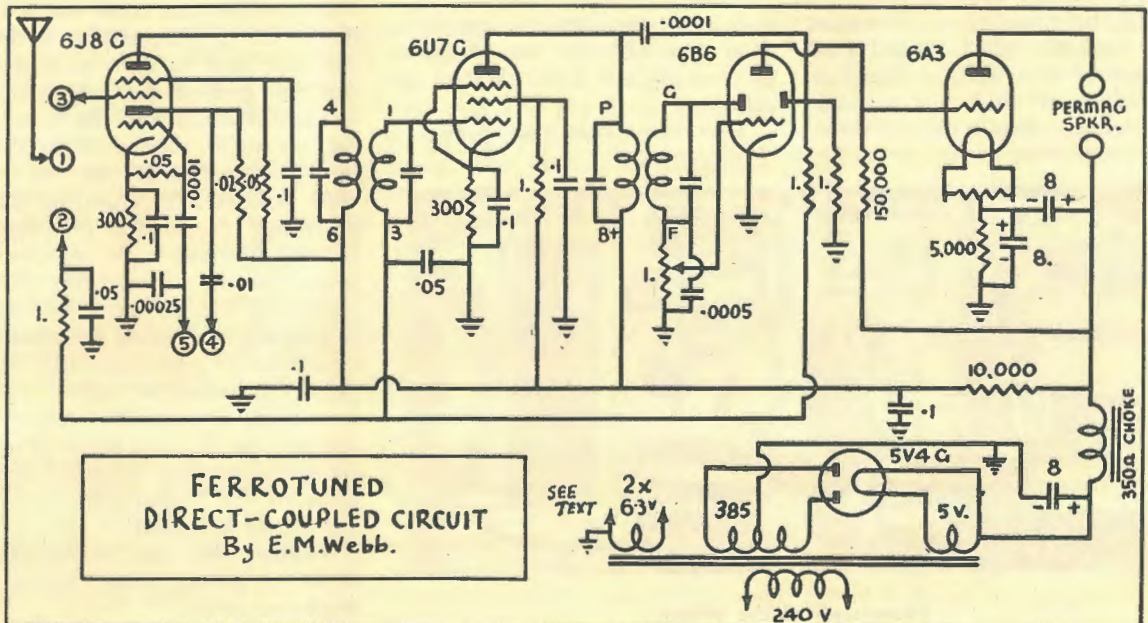

DIRECT-COUPLING

(Continued)

what a thrill we old-timers got from direct-coupling, but you must remember that at that time we had heard little in the way of canned music, except from mechanical gramophones operating from mechanically-recorded discs. Talkies were just being introduced and, of course, they sounded all right, also some of the big £200 "Panatropé" outfits, but it was a big thrill to be able to fill your own home with quality reproduction from comparatively cheap and simple equipment.

For a time the direct-coupled circuits enjoyed intense popularity and many thousands were built, but as time went by they lost out to improved circuits of more conventional design.

The troubles which lead to the downfall of direct-coupled circuits were not those which the theorists had argued about.

Possibly one of the biggest factors was the high voltages inadvertently applied by those whose lack of experience with a.c. operated power supplies let them fall into the error of imagining that a power transformer rated at 475 volts would deliver that voltage after rectification and filtering. Such a factor as the current drain and its effect on voltage was not taken into account by many. Few voltmeters were available which would read voltages of over 150, so that few checked up on their high tension. A misleading characteristic of direct

coupling was that the total high tension drain was only the drain of the output valve, not the total plate current drain of all the valves in the set. This came about by the r.f. and other valves being fed with high tension from the high potential filament circuit of the output valve. So that, in practice, there were often cases where a transformer rated at 475 volts at 100 milliamps was being used on a set with a total current drain of thirty to forty milliamps. The actual high tension voltage was about 575 volts and the sets gave trouble with condenser breakdowns.

Today we can readily understand why, but in those days few condensers were even marked with condenser ratings other than their capacity, whilst others were marked with a test voltage rating of 1500 or 2000 volts, or some such rating which was not worth tuppence when it came to estimating their ability to withstand actual working voltages of up around 500 volts.

Many such things brought about the ultimate downfall of the direct-coupled circuit, and although spasmodic bursts of revival have occurred several times since, it is only amongst a small band of super-enthusiasts that the magic rites of direct-coupling are practiced today.

Which brings us to the point of our story.

A few days ago we stumbled upon one who has not forgotten the lore of the Loftin-White circuit.

This enthusiast has applied a

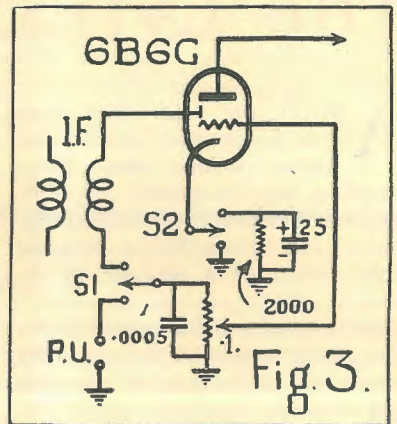

Switching arrangement for gramophone work.

modified circuit of a simplified direct-coupled circuit to the very latest in tuning devices, the Kingsley "Ferrotune" unit. The combination makes a set of the simplest construction, but capable of giving really splendid performance.

We heard this set in operation, and in a few minutes we were so enthusiastic that we had the set on the concrete footpath in next to no time, taking the photographs which you see reproduced on these pages.

We felt that the set would arouse much interest among our readers, so here is a brief description of it.

THE CIRCUIT

If you have not come across the theory of direct-coupling before, you will first have to understand that the grid of the output valve is coupled directly to the plate of the first audio, so that its potential in regard to "earth" may be 160 volts positive. Therefore, in order to arrange proper bias it is essential for this grid to be negative in respect of the filament or cathode circuit of the output valve. This is achieved by keeping the filament circuit at a potential still more positive in respect to "earth," thereby making it positive in respect to the grid; or, in other words to have the grid potential negative in respect to the filament, as required for proper operation.

Perhaps this can be explained better by giving voltage figures in respect to earth.

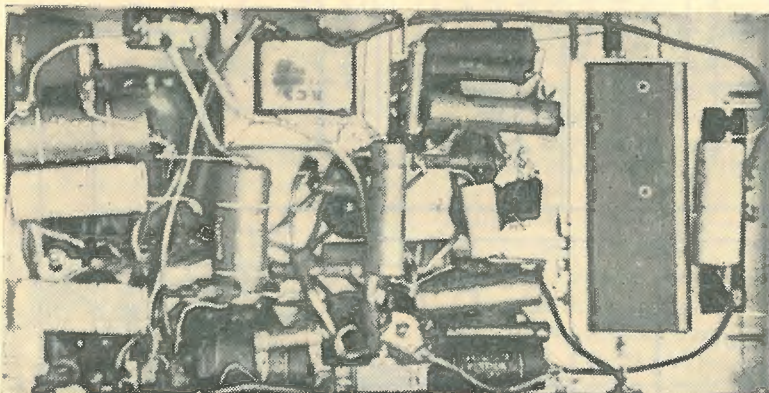

Photograph of the Wiring

For example, the high tension may be 450 volts, and this is applied to the plate of the output valve. The filament circuit is kept at 200 volts to give correct plate to filament voltage of 250 as specified by the makers. The grid of the output valve and the plate of first audio are kept at 160 volts by the voltage drop in the plate feed resistor of 150,000 ohms. Comparing this 160 on the grid with the 200 on the filament, we see that we have the correct bias of 40 volts negative.

These voltages are all for the amplifier in its static condition, of course, without signal input; and they are the surest way of checking up on the proper operation of any direct-coupler.

Many direct-coupling enthusiasts fit a plate current meter for the output valve as a permanent fixture, but that should not be necessary with this set which is not at all critical on account of several self-balancing factors which come into play in practice.

Looking at the circuit you will notice that the high tension is too high for the plates of the r.f. valves, so a series resistor of 10,000 ohms is used in the supply lines for the r.f. stages, suitably bypassed with a .1 mfd. tubular condenser.

It will also be noticed how simple the audio end becomes with so few resistors and practically nothing in the way of condensers. The 6B6 detector is operated with diode biasing, which means that on an extra strong signal it can be choked up, but before this stage is reached the power output is ample for all normal household requirements.

Automatic voltage control is kept entirely separate from the audio by using the second diode plate of the 6B6 and feeding it with r.f. from the plate circuit of the i.f. amplifier.

Dealing with the condensers used, it should be noted that the main bias resistor has a voltage drop across it of about 200 volts, so a condenser of 8 mfd. capacity and a voltage rating of 525 volts

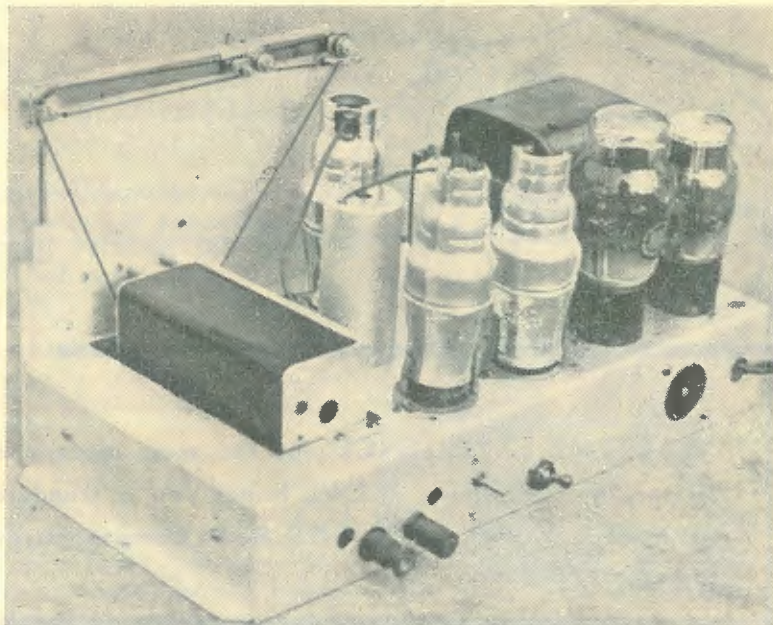

Rear view of the chassis.

is used to be on the safe side. An ordinary 25 mfd. 25 volt electrolytic would be quite useless as a bias by-pass in this particular circuit.

Also to be noted is the way the two filter condensers are connected. The first goes to B negative in the usual way, but the second runs to the filament circuit of the output valve.

THE OUTPUT VALVE

In the actual set which we heard in operation the output valve was a 2A3 triode, but we have been assured that the set works equally well with a 6V6G if the plate and screen are tied together to form a triode. The cathode then becomes equivalent to the lament centre-tapping of the 2A3. Which brings up another point worth noting. It is desirable to have a power transformer with three filament windings: one for the rectifier, one for the output valve and the third for the r.f. valves and first audio. Unless separate filament windings are available there is going to be a potential difference between heater and cathode of a couple of hundred volts, and this is not recommended by the valve manufacturers. So be on the safe side and use a transformer with separate filament

winding for the output valve, tying it to the cathode if using a 6V6G.

It is not recommended that the 6V6G be used as a beam power valve, as under those operating conditions the matter of bias becomes too critical. The 2A3 (or its 6.3 volt equivalent, the 6A3) is to be recommended because its bias can be varied from about 30 to 70 volts without seriously affecting its ability to perform.

The rectifier can be any of the ordinary types such as 80 or 5Y3G, but there are points in favour of using the 5V4G, an indirectly-heated rectifier which is gaining favour with amplifier enthusiasts on account of its good regulation and ability to stand up to overloads.

FOR GRAMO WORK

As described, the circuit is suitable for use only as a radio set, and not as a gramophone amplifier. The excellence of the quality of reproduction, however, makes it highly probable that those who build it will want to use a pick-up. Figure 3 shows how the necessary bias resistor and by-pass is added, with a double-throw double-pole switch which is arranged to change from radio to gramo at a flick of the little finger.

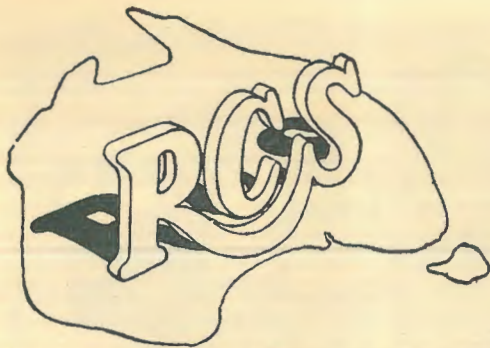

NOW Better than Ever!

WARTIME EXPERIENCE plus the most modern equipment in the new R.C.S. Factory at Canterbury, N.S.W., brings you a standard of excellence never before achieved in Australia. Yes, R.C.S. Radio Components are now even better than ever!

R.C.S. R.F. CHOKES

R.C.S. R.F. Chokes are wound in progressive pies to an approved design giving stable operation with small self-capacity effects. Fully impregnated and finished with robust mounting pigtails, they are available in either 3, 4, 5, or 6 pies construction, giving inductance values of 1.7, 2.5, 4.0 and 7.0 M.H. respectively.

All at one price 4/6



STAR

	Max. Cap. MMFD.	Min. Cap. MMFD.	Plates	Price
CV34	10	3	2	4 0
CV35	15	3	3	4 3
CV36	25	3.5	4	4 6
CV37	35	4	5	4 9
CV38	50	4	7	5 3
CV39	70	5	9	5 10
CV40	100	6	14	6 6
			M/C	
CV41	10	3	2	7 3
CV42	15	3	3	7 9
CV43	25	3.5	4	8 4
CV44	35	4	5	9 0
CV45	50	4	7	9 6
CV46	70	5	9	10 0
CV47	100	6	14	11 3

Miracle-Plastic TROLITUL

This semi-transparent, lightweight moulded insulating plastic is exclusive to R.C.S. Trolitul is used wherever possible in R.C.S. quality parts, sealing wires and connections into one solid damp-proof whole, guaranteeing longer life and maximum efficiency.

R.C.S. MIDGET VARIABLE CONDENSERS

Miracle-plastic Trolitul is used exclusively in the manufacture of R.C.S. midget Variable Condensers. Available in a very wide range of capacities, with and without back bearing plates, these units may be effectively "ganged" is required for receiver or transmitter application. Accurately built on precision jigs, R.C.S. "Midgets" exhibit maximum electrical stability under all conditions.

R.C.S. I.F.

TRANSFORMERS

For short wave enthusiasts R.C.S. now have available I.F. Transformers tuned to a frequency of 1600 Kc/s and featuring full permeability tuning. Careful engineering has resulted in a design giving adequate gain and selectivity in conjunction with stabilised gain. Radio-plastic Trolitul is used in a tropic-proofed construction, ensuring consistent performance under conditions of high humidity.



R.C.S.

RADIO PTY. LTD.

174 Canterbury Road, CANTERBURY

"THE SPOTTER"

Absorption Type Wave-Meter

Here are constructional details of an indispensably handy little gadget for the amateur transmitting station. If you are lining up tuned circuits at multiplied harmonic relation, this piece of equipment is a "Must" among your test gear.

ARE you one of those slightly worried individuals wrestling with a 3 or 4 stage exciter unit for 50 mC/s — or even 28 mC/s? Doubt may be present about just what harmonic you are hitting in that "tripler", or "quadrupler" stage, because things don't check

around £50 each in our money. The man who owned one was a veritable "standards Lab" among his fellows.

With the development of H.F. radio, thanks to *amateurs*, methods of generating and measuring R.F. changed profoundly and, above all, amateurs found their shoes pinching. They were presented with relatively narrow frequency bands and told to keep inside them — or else! No longer was the absorption meter good enough — or anywhere *near* the requirement, for checking to close frequency limits, as now called for. Valve frequency meters and accurately calibrated Signal Generators became the order of things. Quartz crystals took over frequency control — in most cases, but there were, and are, lots of variable frequency oscillator type transmitters. The commercial versions have accurately pre-calibrated V.F.O. control with hair-line adjustments, but even so, are not infallible. A check must be made against proper *standards* to be sure. The amateur station using V.F.O. needs to be much more certain of his oscillator control — he *must*

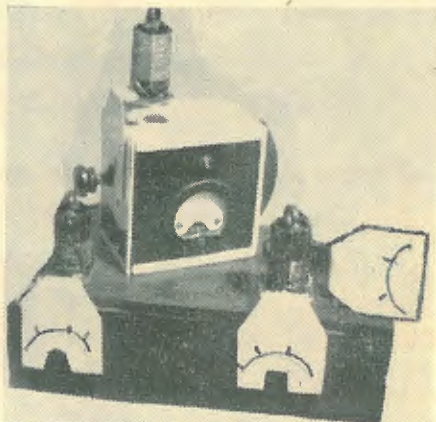

A photograph of the wave-meter.

By
DON KNOCK
VK2NO

right — output is not at the wanted frequency! Here then, is a direct answer to such problems, in the form of a modern version of the wrongly "despised" absorption "wavemeter" — a smart little sentry-box that keeps its eye on harmonic output and tells you at once whether or not the R.F. energising your neon lamp or other "tell-tale" — is friend or foe! In the earlier days of this amateur radio era — the period B.C. — before Crystals (QUARTZ variety) hams were not really frequency conscious. Reason was — they didn't need to be! They had the whole world (below 200 metres) to play around in — and "wavelengths" were vast areas of dial space leading heaven knew where! A transmitter for any "wavelength" was a hit or miss affair so far as accuracy of measurement was concerned — nobody cared much about a few odd "metres" here or there, and the absorption wavemeter was King in its own right. I can show you advertisements in QST's of 1926 vintage, for General Radio absorption meters, massive affairs, costing

be within band limits. A sub-standard of some kind is necessary, but as with those early ham stations — he cannot hope to get away with the use of an absorption meter for *exact* frequency determination, but with his oscillator frequency known from an established standard such as quartz crystal — he can make lots of use of the absorption meter from that point on.

THE "SPOTTER" IS USEFUL FOR

THESE FUNCTIONS

- (1) To check *roughly*, the fundamental frequency of an oscillating circuit.
- (2) The presence and the relationship of harmonics.
- (3) The approximate frequency of parasitic oscillations.
- (4) The neutralisation of an R.F. amplifier.
- (5) Field strength measurements.
- (6) The presence of R.F. in undesired places, such as in power wiring.

It will do all these things, in the form described here, with the coils detailed, from 1500 Kc/s. to around 70 mC/s. *inclusive*, with overlapping of ranges.

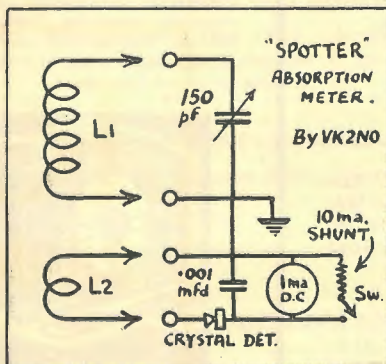

The Circuit Diagram.

(Continued on page 13)



Miss Jones
has clever
fingers . .

Here she is at work assembling meters, a delicate and painstaking job. Just one of the many skilled Australian men and women who after a magnificent war job at "University" are now turning out ever increasing numbers of fine electrical and radio indicating equipment for general needs.



*The name to trust in
Radio and Electrical
Test Equipment.*

DISTRIBUTORS:

- N.S.W.** : All leading Distributors
Queensland : Homecrafts ; J. B. Chandler Pty. Ltd. ;
 A. E. Harrold
Victoria : Vealls Electrical & Radio Pty. Ltd. ; Hart-
 leys Ltd. ; Replacement Parts Pty. Ltd. ;
 Victorian Agent, J. H. Magrath Pty. Ltd.
Sth. Aust. : Radio Wholesalers Ltd. ; Gerard & Good-
 man Ltd.
W. Aust. : Atkins (W.A.) Ltd.
Tasmania : W. & G. Genders Pty. Ltd.
New Zealand : Allum Electrical Company Ltd.

RADIO EQUIPMENT PTY. LTD.

375 KENT STREET, SYDNEY, N.S.W.

Telephones : M6391-2. Telegrams : "Raquip," Sydney

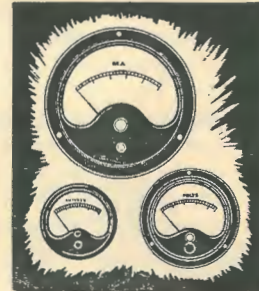

University meters include volt-
meters, ammeters, milliameters,
micro-ammeters, etc. Sizes 2",
3", 4" and 5".

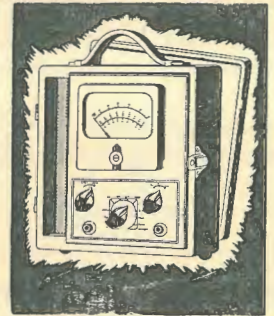

University M.V.A. all-purpose
Multimeter (bench or portable)
giving complete AC/DC meas-
urements together with output
meter ranges.

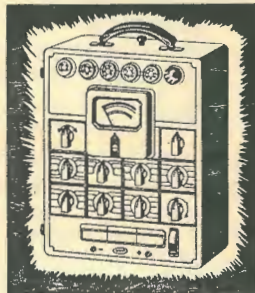

University Supertester is an
extremely versatile Valve and
Circuit Tester featuring an
extraordinary valve and conden-
ser roller test chart.

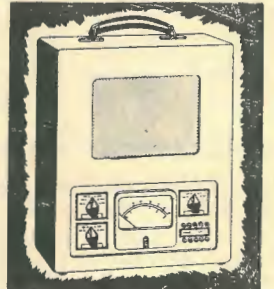

"University" Universal Speaker
and Output Meters make set
testing quick and easy. No
power connections required, just
plug in to any type speaker
socket.

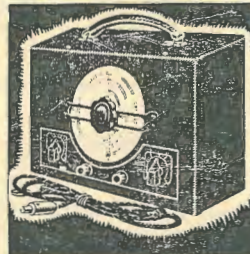

A new "University" five band
oscillator for the alignment of
all types of radio receivers.

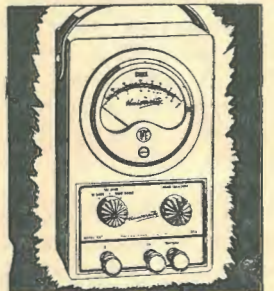

"University" Earthing Resist-
ance Tester is much sought
after by maintenance electri-
cians, and is typical of Uni-
versity's industrial test gear.

Fully illustrated literature available upon request.

ABSORPTION METER

(Continued)

CIRCUIT AND CONSTRUCTIONAL DETAILS

The circuit diagram shows that the instrument is nothing more than a resonant circuit, made up of coil L1 and the .00015 mfd. tuning condenser, with an inductively coupled resonance indicating circuit. This is comprised of the pick-up coil, L2; the crystal detector, the 0-1 D.C. milliammeter, and the .001 mfd. by-pass condenser. A shunt is provided for reading up to 10 milliamperes where a higher range may be required. Calibration charts and a nuisance at any time, so following commercial practice in U.S.A. each coil has its own calibration scale. As the illustration of the meter and coil shows, each scale is fastened to its coil, and goes automatically into position when the coil is plugged into the socket. The latter is a 4 pin ceramic valve socket mounted on top of the instrument case. Measurement of this depends upon the physical size of the milliammeter and the variable condenser — a handy size being 5 x 4 x 3 inches. The box can be made up from sheet aluminium or plywood. Plywood and bakelite were used in constructing the meter illustrated. The variable condenser happens to be the gear-driven oscillator tuning unit from the transmitter of a wrecked ex-Army 101 set, and it was used because of the vernier action. Obviously, a plain condenser averaging around .00015 mfd., with a knob control, will do. Another scheme is the use of a direct drive planetary control. Because of the individual calibration scales, use of an old type front-panel vernier dial is not practical, although this could be done by making the meter case much larger. Incidentally, some of the ex-Service equipment boxes around the Disposals dealers for a shilling or two have obvious uses such as this. Each coil is wound on a 4 pin valve base with extension tubing secured thereto for the lower frequency ranges. The scale is fixed to a piece of aluminium, folded over and bolt-

ed underneath the valve base (clear of the pins). The front portion is bent at right angles so that when the coil is plugged into the socket, the card scale projects downward and rests adjacent to the pointer on the knob or condenser drive. The idea of this can be seen from the illustration. There may be a hitch in your plans for building up gadgets of this nature where crystal detectors are used as rectifiers, for the reason that these once very popular items are scarce — at least, in the "fixed" cartridge types. The American amateur has access to ex-Radar "germanium" rectifiers — no bigger than $\frac{1}{4}$ -watt resistor, but so far I haven't seen any on the Australian market. I did see, however, a rather bulky fixed type in a large Sydney "hardware" store, and such a "detector" would serve the purpose. The "Spotter" described here uses one of those 1928 vintage carborundum cartridges,

which had lain undisturbed among my "museum pieces" through the years.

CALIBRATION

The amateur possessing a tuned R.F. regenerative detector type of calibrated receiver, has on hand the immediate means of calibrating his "spotter" over much of the range. The job is easy enough — holding the meter near enough to the detector coil (with the detector just oscillating) and noting the defined limit where the meter adjustment absorbs energy and pulls the detector out of oscillation. With a Superhet oscillator it is a different story. Remember that the oscillator frequency differs from the Signal by the I.F. If, for example, your signal is known to be on 28,000 Kc/s. and your I.F. is 1600 Kc/s., oscillator frequency will be 29,600 Kc/s., and that frequency is the

(Continued on next page)

SAVE MONEY WITH A SUBSCRIPTION!



Order Yours To-Day

Make sure you get every issue as soon as it is published. Place an order with your newsagent or send direct to us for a subscription.

IT SAVES YOU TIME!

IT SAVES YOU MONEY!

We guarantee that every subscriber has his copy posted the same day it comes off the press.

RATES

- * 6 issues 5/3
- * 12 issues 10/6
- * 24 issues 20/-

POST FREE

Enclosed please find remittance for 10/6 in payment for an annual subscription to the "Australasian Radio World," commencing with the issue.

NAME.....

STREET and NUMBER.....

CITY..... STATE.....

AUSTRALASIAN RADIO WORLD

336 Waverley Road
East Malvern, SE5
Victoria

ABSORPTION METER

(Continued)

one to be marked on the meter scale. You must know, of course, which side of the incoming signal the oscillator is on. Usually it is on the high frequency side of the signal by the I.F. difference.

Where difficulty is had in getting coupling to an inaccessible oscillator, link-coupling can be resorted to. Wrap a few turns of wire round the top end of the "spotter" coil and extend one end near to the stator plate of the oscillator tuning condenser. In doing all this, it is enough, for purely amateur needs, to mark the band limits on the scales, although these will be relatively close together in some cases.

Calibration of "spot" points is an easy matter where the experimenter has a number of quartz crystals of known frequency, and a test oscillating set-up. Here is where some of those "Jap" crystals can be put to work!

FOR TRANSMITTERS

Good indications can be expected

a foot or so distant from a 50 or 100 watt transmitter. Care is thus needed to avoid overloading the meter or burning up the crystal. The shunt comes in useful here, and it is best to start in with it

"in," and to switch it "out" only when the meter shows a low reading. In any case, the looser the coupling between transmitter and

(Continued on page 41)

COIL SPECIFICATIONS

Details given here are intended as a fairly reliable guide, assuming the use of a variable condenser of 150 P.F. If a larger capacity is used, a less number of coils could be provided to overlap the entire

range. Larger than 350 PF (.00035 mfd.) is not recommended, because of inclusion of the highest frequency coil extending to 70 mC/s.

Approx. Freq. Range	Turns on L1.	Wire Size	Winding Length	Approx. Turns on L2
1.5 to 4.5 mC/s.	60	24 enam.	Close-wound	10
3.0 to 9 mC/s.	24	24 enam.	One inch	5
6.0 to 18 mC/s.	12	18 enam.	One inch	3
12.0 to 36 mC/s.	6	18 enam.	One inch	2
24.0 to 70 mC/s.	2	18 enam.	One inch	1

These are based on an outside diameter of 1½ inches. In each case the pick-up coil, L, is close-wound

next to the "earth" end of L1, and is of 26 gauge enamelled wire.

MAXWELLS RADIO

48 ELIZABETH STREET, MELBOURNE

Cent. 4913

FEATURE A FEW OUTSTANDING BARGAINS

Ceramic Octal Sockets	1/9
B. Batteries, H.D., 180-Volt	10/-
Single and Three-Gang Condensers for S.W. From	3/6
Single Gang Condensers, Standard Capacity for Broadcast	12/11
Relays, suitable for Low Capacity Work	8/11

8 AND 10 INCH ROLA SPEAKERS IN STOCK

Extensive Range of All Radio Equipment for the Amateur and Experimenter

Special Allowances to the Trade

Mail Orders Promptly Forwarded

MAXWELLS RADIO

48 ELIZABETH STREET, MELBOURNE

Cent. 4913

POLITICS OF HAM RADIO

GOODNESS only knows why it should be, but the whole history of "ham" radio in Australia seems to have been clouded by brawling among those who should co-operate for the benefit of the game.

The policy of "Australasian Radio World" has always been to do everything possible to further the interests of "ham" radio, but

By

A. G. HULL

never to interfere in the political situation of the various Clubs.

Equal opportunity has always been extended to every club to publicise its activities and build up its membership.

Following this policy I did not hesitate to devote considerable space in the June issue to the launching of the Experimental Radio Society of New South Wales.

By doing so, however, I find that I have become embroiled in "ham" politics and have incurred the displeasure of certain V.I.P.'s (Very Important Persons) of the W.I.A.

Acting on the assumption that I may as well be hung for a sheep as for a lamb, I'm going to make the most of the occasion and let off a few personal opinions, even if they still further displease these V.I.P.'s.

REGULATIONS

Before going further I feel that some personal explanation may be desirable, an explanation which I would have hesitated to make if it were not for the favourable way in which my readers accepted the May issue, with its "Personal" angle. That issue has given me greater courage to approach readers in a more personal way.

I hate regulations as such.

I know that certain rules of con-

duct must be laid down to guide people into the right paths, but all my life I have encountered endless examples of the horrors of repression.

I have seen the tragedies of children brought up by stern parents, who have suddenly found themselves grown up, but with little sense of responsibility. I believe that children should be trained to accept responsibility when they are young and timid, so that as they grow to strength, so they develop their sense of responsibility.

As a typical example, let us consider car driving. In the United States many schools include car driving with the routine lessons. Starting at about 14 years of age a child naturally feels anything but reckless, consequently he starts to drive steadily. As he grows he develops judgment and proper feeling of responsibility. There is then nothing of the style of "Whoopee, now I'm 18 I can get a licence, so step on the gas."

Likewise, a lad who is prevented by regulations from owning a pea-

rifle will squirm under this form of restraint until the calendar indicates that he is "old enough" and then out he goes with a packet of ammunition and shoots at everything he can see.

My theory is that the lad should be taken at an early age, while he is still prepared to accept advice from his elders, taught the uses and dangers of a rifle and encouraged to care for one, and accept the responsibility of owning it. I'll bet anyone that such a course of training will do more to prevent shooting accidents than all the regulations that long-winded professional politicians and would-be dictators can cook up to keep themselves in their snug jobs.

Which brings me to the point. *I think that the regulation recently introduced to make it impossible for a lad to hold a transmitting licence is one which fairly stinks.*

If a lad has the technical knowledge to pass the examination and the applied concentration to learn

(Continued on page 30)



W9JLR. A well-known American 20-metre amateur radiophone station.

THE MAGIC OF FERROTUNE

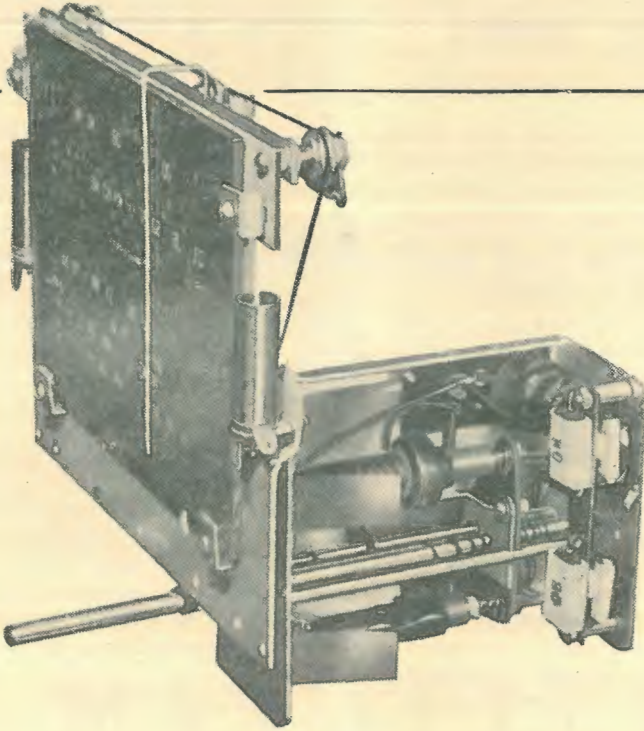

This is the "FERROTUNE" ferromagnetic gangless tuning unit. It covers the broadcast band and includes padding and trimming, tuning mechanism, etc.

WITH the FERROTUNE gangless ferromagnetic tuning unit it is possible to have the optimum of inductance and capacity for every frequency on the broadcast band.

This major contribution is due to KINGSLEY RADIO'S development of the iron-dust core.

Flatness and distortion through inductance flooding is completely avoided and the highest quality reproduction assured.

This is the magic of FERROTUNE, one of the most advanced of modern radio developments.

So when you get going on that superhet specify the FERROTUNE gangless tuning unit . . . ask also for KINGSLEY PERMACLAD coils and I.F.'s, iron-core tuned and designed to give greater gain, selectivity, and "Q."

Ask your radio dealer for

F E R R O T U N E
 FERRO-MAGNETIC IRON-CORE COILS, I.F.'s AND,
 GANGLESS TUNING UNITS

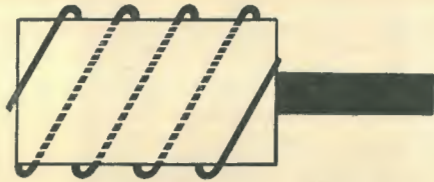

KINGSLEY RADIO

K I N G S L E Y R A D I O P T Y . L T D .

380 St. Kilda Road, Melbourne, Victoria . Phones: MX 1159, MX 3653

POWERFUL 8-VALVE CIRCUIT

IN the radio game there comes a time when every theorist can do well for himself by listening to a receiver instead of watching its patterns on an oscillograph. Laboratory work has its place in the scheme of things and doubtless all major improvements in the art can be traced back to the development lab., but the ear is always the final judge.

To explain what I am driving at by citing an example I might go back to the Amplifier Championship of 1934, which was won by an amplifier using a poor-quality audio choke, a driving stage which did not appear to be properly biased and a pair of pentodes in the output stage. From a glance at the circuit you would get an immediate impression that its tonal quality would be awful. Yet the amplifier won that Amplifier Championship in no uncertain way.

Another case was when a radio dealer once approached with a circuit in his hand showing a pair of 6L6 beam power valves, driven through a class B audio transformer

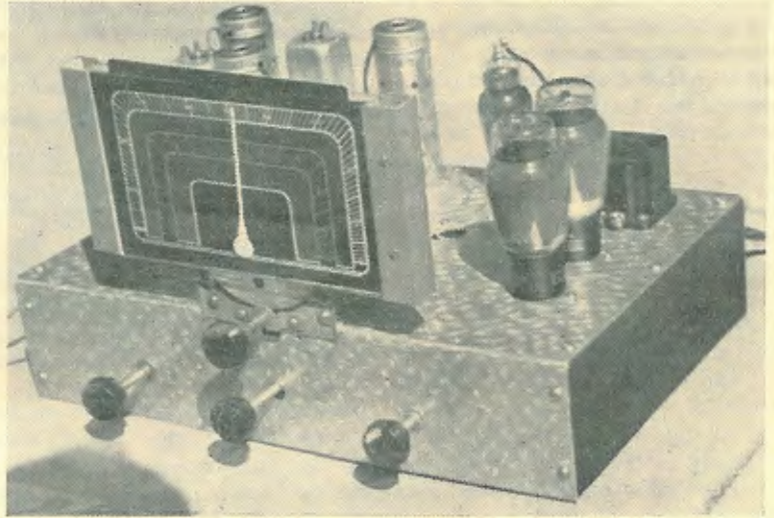

A photograph of the receiver chassis. The power supply is a separate unit.

designed for use in a battery set. From theoretical considerations it would not appear that this circuit could give good reproduction, but in practice it did so, and just the sort of powerful output which appeals to those "men in the street" who have no technical knowledge,

and an ear accustomed to the usual boom-boom of a pentode with a tone control set at maximum. To that type of person the set-up of a pair of beam power valves with a class B audio transformer sounds good.

(Continued on next page)

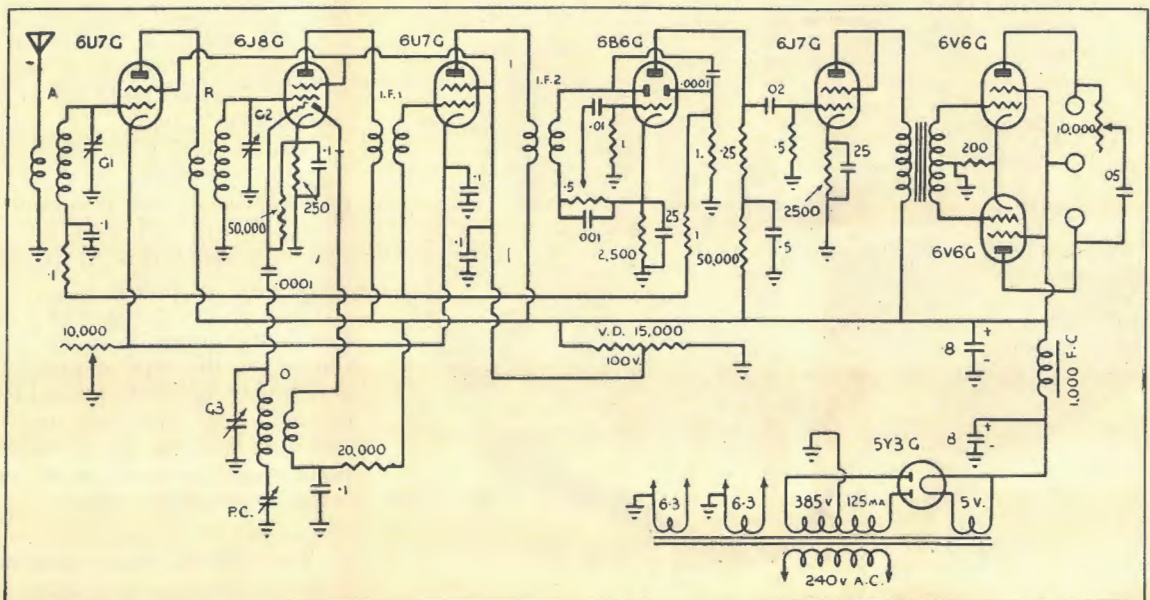

8-VALVER

(Continued)

For a theoretical explanation I would say that the use of an audio transformer with low resistance in the secondary windings allows a fair amount of overloading of the output valve before the distortion sounds too terrible, and that although class B is supposed to give a heavy percentage of distortion at low volumes, this amount of distortion is still not enough to sound bad to anyone who is accustomed to ordinary "commercial" tone.

Using an audio transformer with a step-down ratio makes it necessary to have plenty of audio gain in the earlier stages, but this is easily achieved.

Looking around recently for a nice job to keep a lad out of mischief for a few hours, I picked over the junk lying around and unearthed enough bits to make up a powerful receiver. The job turned out so well and gives such excellent tone and punch that I feel justified in featuring it as a circuit well worth remembering by those who want something to give impressive performance.

In the original set the output valves were a pair of early 6L6G type, which had been lying around for some time. I think that I laid them aside a while back because they seemed to be especially adept at introducing parasitic trouble into any amplifier in which they were used. But in this circuit, with its low-resistance grid circuit, they do not appear to be inclined that way at all.

The tuning end is a dual-wave box which has been around for several years. I think it came originally from Magraths, and might have been either Brittanic or Aegis brand, but this is not a material factor, as probably any similar type of box in any of the other popular brands would give similar results.

For lay-out the power transformer and choke, complete with rectifier valve is kept on a separate chassis. The tuning unit and audio amplifier is then embodied on a base which is plugged into the power unit, connection being made with a built-up six-wire cable and a suitable six-pin plug. This arrangement is an ideal one, as it allows the power transformer to be placed so that it does not cause

hum trouble by induction into the audio transformer.

With regard to the connecting cable there is one point worth stressing. The valve socket should be fitted into the base of the power unit, and the plug to the cable feeding into the tuner unit. If this is done the job will be safe, for with the plug removed from the socket there will be no exposed high tension. If the socket is fitted to the tuner unit and the plug to the wires from the power unit, you have a most dangerous set-up, as with the plug pulled from the socket there will be plenty of high tension fully exposed and quite likely to give someone an unpleasant surprise!

THE SPEAKER

As the job is capable of delivering lots of power, you will need a good solid speaker, nothing less than a Rola K12, and for preference a G12. An electro-dynamic can be used with a field coil rated at 1,000 or 1,200 ohms, or a permag can be used if the field indicated in the circuit is replaced with a suitable heavy-duty filter choke.

THE AUDIO TRANSFORMER

As mentioned in the preamble, the audio transformer is of the class B type, having a step-down ratio. These transformers are available in a number of brands, having been designed for use in battery-operated receivers using the 19 type class B twin triode.

Even if the transformer is a shrimpy little thing, and possibly anything but a flat frequency response, it will still serve the purpose and sound O.K. if you turn the volume up plenty.

There is no reason why a real super-duper class B audio transformer of the type designed for the driving of 6L6G's should not be used, except that these are scarce and dear, and the improvement in performance may not be so much better as you might expect.

THE POWER TRANSFORMER

A heavy power transformer will be required, one rated at 385 volts

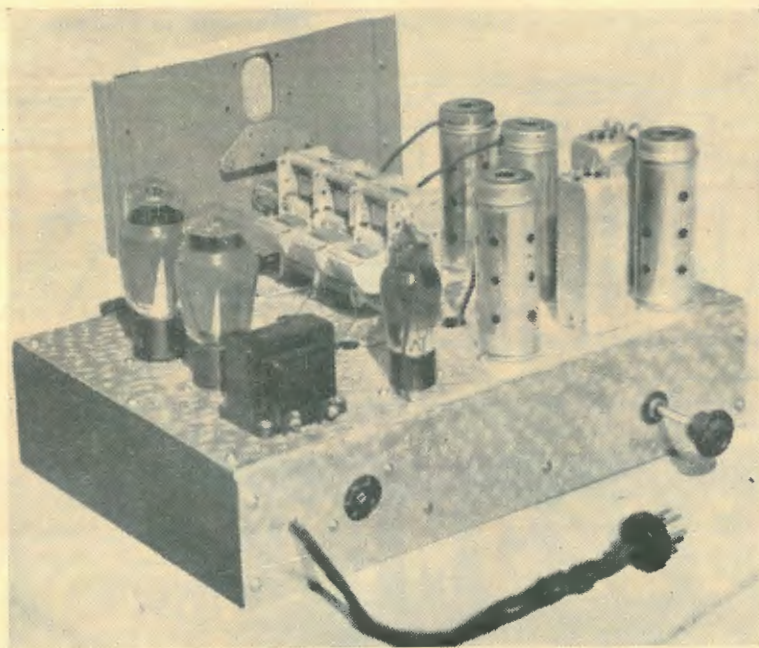

Rear view of the chassis, showing the sensitivity control and cable and plug for the power unit.

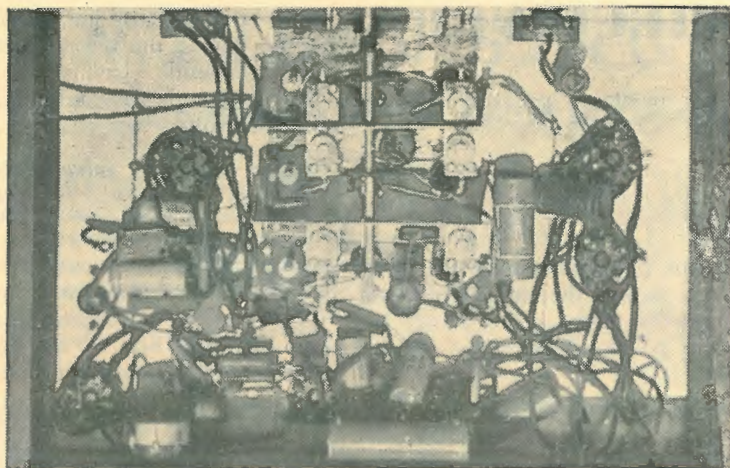

Underside view, showing the wiring and the mounting of the coil box.

at 150 milliamps being just nice if you are going to use an electro-dynamic speaker with a field of 1,000 or 1,250 ohms. If a permag is to be used, the high tension rating should be down about 300 volts. If such a transformer is not available, however, you can use a 385 type and then make some provision for dropping the voltage for the r.f. valves and the screen of the output valves.

Speaking of the power transformer, there is another point worth some care. This is in regard to the filament winding ratings. If a pair of 6L6G valves are used they will need a filament supply of 6.3 volts at 1.8 amperes, which is quite a considerable wattage.

Ordinary valves such as the 6U7G take only one-third the heater current of a 6L6, so that the other five valves of the tuning unit will take as much current as the two output valves. In a nutshell, you want two 6.3 volt filament windings on the power transformer, each rated to supply 2 amperes.

ALTERNATIVE OUTPUT VALVES

As mentioned previously, the original set was built up with a pair of old 6L6G in the output, but our circuit shows 6V6G, these being now more readily available than the 6L6. No changes are necessary, even the main bias resistor being suitable for the 6L6

as well as the 6V6, although actually it slightly over-biases the latter, rather an advantage than otherwise.

The 807 type transmitting valves can also be used in this circuit, but require 5-pin valve sockets, the plate leads coming out of the top cap. By using 807's it is possible to get even greater power output still, if a high tension of up to 600 is applied to the plates and suitable arrangements made to break it down to 275 for the screens and the r.f. valves.

Another possible alternative is the use of the fine Philips' EL3GN, which is extremely sensitive yet rugged. We haven't actually tried these valves in a circuit of this type, but we would expect them to be entirely suitable.

THE SENSITIVITY CONTROL

It will be noticed in the circuit diagram that we have used an old trick of ours to get maximum performance with stability.

With modern high-gain i.f. transformers there is always a chance of instability. It is becoming quite common practice to arrange some form of neutralising in the i.f. stage in order to get stability. Another way is to use a 10,000 ohm potentiometer in the manner shown. This potentiometer then controls the bias on the r.f. and i.f. valves. Its control can be brought out to the rear of the chassis, and after the set is installed and the normal aerial connected, can be advanced right up to the point where the set is just on the point of going into complete oscillation. Needless to add, this gives the maximum possible gain, yet complete stability.

CHASSIS FINISH

From the photographs you will notice that the chassis is an aluminium one with a finish of a kind which was once popular for the dashboard of racing cars. It is done by using a small piece of fine sandpaper under the thumb and putting in the whirls as required. This is quite a simple dodge, the work not as hard as you might expect, and the finish quite attractive.

FITTING FEEDBACK

It is a simple matter to fit inverse feedback to a circuit of this type. All that is required is a half or 1 megohm resistor fitted from the plate of one of the output valves to the plate of the 6B6G. Just which plate can be correctly discovered by fitting the feedback resistor while the set is in operation and noting whether the gain is cut back, as it should be with the feedback in correct phase.

NEXT MONTH:

THE 1946 REINARTZ

featuring FERROTUNING

ORDER YOUR COPY NOW!

SERVICING A.C. RECEIVERS

IN the servicing of radio receivers, it is most important to adopt a logical method of approach in locating the fault. A general method is to proceed from the output stage, back through the i.f. amplifier, and thence to the converter and oscillator, and finally to the r.f. and aerial stages.

Most repairmen have individual methods which they prefer to use, and the suggestions made here are to assist in locating faults in a minimum of time. The series of steps given below apply when the receiver has completely failed, and no output can be obtained.

1.—*Check to see whether power is reaching the receiver.*

This is indicated by pilot lights, valve heaters, or by power transformer hum (hum may not be audible in all cases).

2.—*Check for obvious faults, such as a valve heater not being alight, or the rectifier valve plates running red hot.*

The plates of the rectifier valve becoming excessively hot indicates a short circuit or serious overload in the high tension circuit. This fault is most often due to a faulty electrolytic condenser, and is best checked, having first switched off the receiver, by measuring the resistance of the high tension line in the receiver to ground, to see if a short circuit is indicated. It is usually best to commence at the filament connection to the rectifier, and if a short circuit or low resistance is shown to earth, disconnect the high tension lead to the first electrolytic condenser; it can then immediately be ascertained whether the rectifier socket or filament supply is causing the trouble. The next step is to disconnect the first electrolytic condenser and if a short circuit is still shown, to continue along the H.T. supply line eliminating the wiring sections and each of the components, step by step until the cause of the short circuit

or low resistance path to earth is found.

3.—*Can any sound be heard when the volume control is at Maximum?*

If not, place a finger on the grid of the second detector valve and see whether there is any noise. If there is no sound, move the power



From

A.W. VALVE CO. PTY. LTD.



valve around in its socket, and if no click is heard in the loud speaker check the speaker windings and leads for continuity. If a fairly loud click is heard, try shorting the grid of the power valve, momentarily, to ground, when a click should again be heard. At the same time it is convenient to check the bias voltage on the power valve; also to check whether any positive d.c. voltage is directly measurable across the grid resistor of the power valve. If a positive voltage can be measured on the grid, it is usually due to a faulty coupling condenser between the second detector plate and the grid of the output valve. Next try shorting the plate of the second detector valve momentarily to earth or to B+, when there should be a loud click; if not, the grid condenser should be checked for open circuit. If a loud clicking is heard, the next step is to short circuit from cathode to grid of the second detector valve, and there should again be a loud clicking sound; if not the second detector valve may be faulty.

4.—*Is the transformer abnormally hot, normal temperature, or cool?*

If abnormally hot there is evidence of a short circuit; if cool, there may be an open circuit.

5.—*Is the speaker field abnormally hot?*

If it is abnormally hot, the fault may be due to the second electrolytic condenser having broken down; this can be checked by measuring the voltage across it.

6.—*Is the power valve envelope excessively hot, normal or cool?*

If it is excessively hot there is probably either a serious decrease in grid bias voltage or a gassy valve, or possibly parasitic oscillation. The grid bias of the power valve should be checked by a volt meter between cathode and earth in the case of a cathode-bias resistor, or between cathode and the bottom end of the grid return in the case of other bias arrangements.

If the bias voltage is correct, the next step is to measure the plate current of the power valve. If this is abnormally high the grid resistor should be short-circuited and the change in plate current noted. If this is more than about 2mA. the valve is suffering from gas or grid emission. Gas is usually visible as a blue glow between the plate and the cathode, but it may not be visible in valves in which the envelope is obscured. If the glow is only slight, it may not be possible to distinguish whether the fault is through gas or grid emission.

7.—*If there is no sound after replacing the second detector valve by a good valve:*

Check for voltages across the load resistor from cathode to earth and from cathode to grid.

8.—*If the audio amplifier is O.K. it is then necessary to proceed to the earlier stages.*

This necessitates the use of a modulated oscillator which should be applied in turn to the i.f. grid, converter-grid, r.f. grid and aerial terminal.

On the i.f. grid it would be necessary to step up the output of the modulated oscillator to maximum, at a frequency equal to the i.f. of the receiver. When the oscillator is applied to the grid of the converter, the receiver should be checked first at i.f., and then at

(Continued on page 42)

AN IDEAL SINGLE-ENDER

Amplifier Circuit With Elaborate Tone Control

HERE is my idea for the ideal single-ender for record production which you may find interesting. The main features of the circuit can be readily summarised as under:

(a) Scratch filter: not really necessary, but was wired in the

By

R. H. BARKER

26 Logan Street, Canterbury, E.7
Victoria

original circuit before the tone controls were fitted, and left there for convenience when final wiring was completed.

(b) Pick-up output frequency level compensation control — designed to level frequency response curve between 50 to 8000 c.p.s. The value of components only obtainable by experiment or manufac-

turers' recommendation. (The latter, used in this instance, the pu being a Rothermel Brush type now available locally.)

(c) Bass boost: designed to lift 6 db's per octave below 250 c/s. and suitable only for pick-ups requiring to work into a $\frac{1}{2}$ -meg. load (*n* most crystal types). This filter to work in conjunction with the results obtained by the use of (b) above. Needless to say the circuit is not recommended for normal radio operation.

(d) Tone Control Circuits: a straight copy of Radiotronics' Circuit No. A506 to which due acknowledgment is made. No comment is necessary, the arrangement being of the standard voltage Divider variety.

(e) Power Unit: Main feature is the adaption of standard 385Va side brannies for use in circuits employing Permag speakers, by means of a V. Divider, and the specifica-

tion of Filter Chokes at their "ratings under load," so necessary these days with 30 hy chokes of dubious value being readily available. The ones used in the hook-up, by the way, were made by Swales some years ago, and are still first class, just as good, in fact, as his present day Red Line Equipment, which stands alone in the transformer field (N.S.W. and Vic. anyway) in my opinion.

VICTORIAN AMPLIFIER CHAMPIONSHIP

The Victorian Amplifier Championship will be held towards the end of November. Entries close September 23, with the Hon. Sec., A. Canty, 100 Allison Road, Elsternwick.

Rules are scheduled to appear in next month's issue.

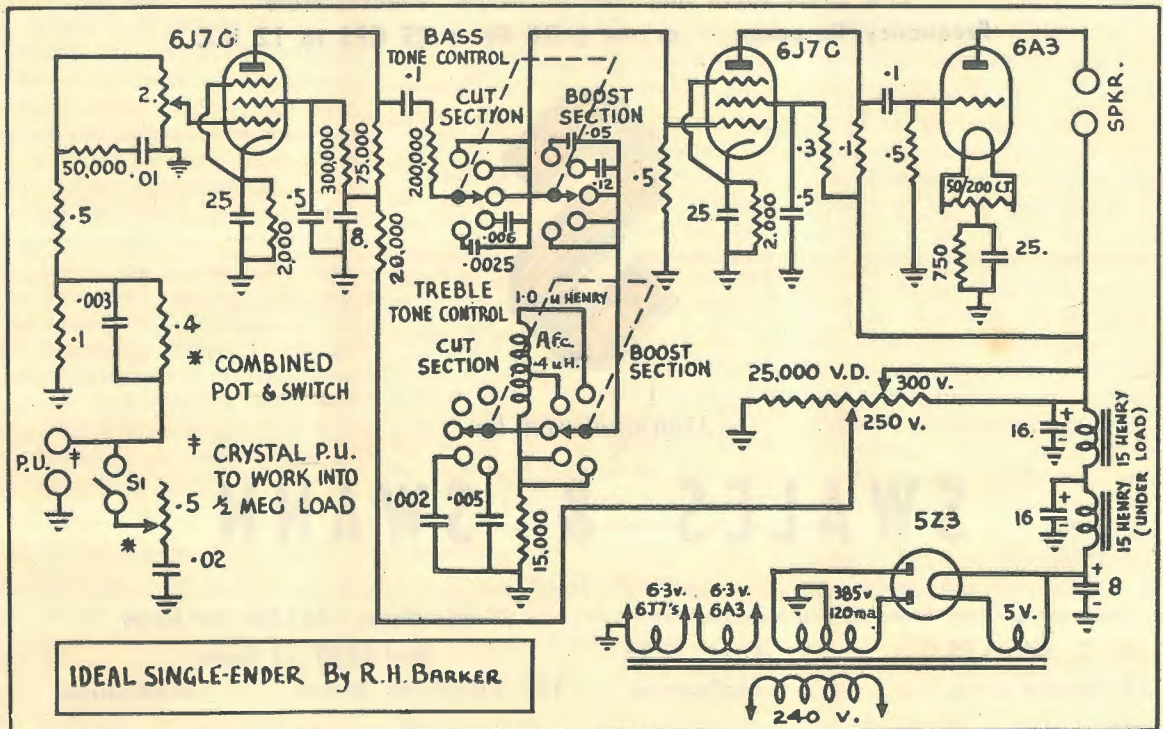

IDEAL SINGLE-ENDER By R.H.BARKER

RED



LINE

TRANSFORMERS and CHOKES of QUALITY and DISTINCTION

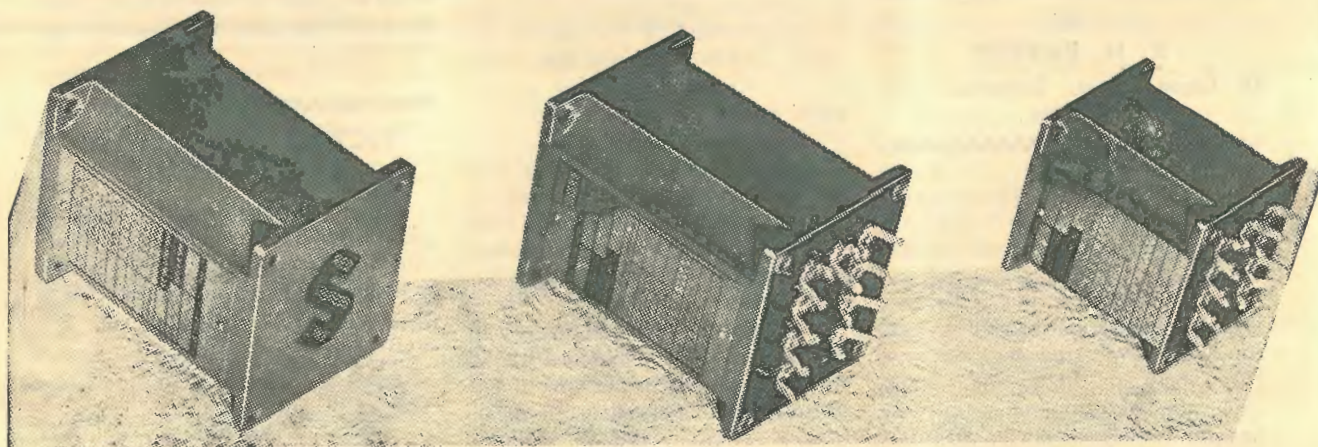

Low Level Input and Output Audio Transformers
Frequency Response + or - $\frac{1}{2}$ DB From 25 CPS to 12 K.C.



Manufactured by

SWALES & SWANN

ENQUIRIES

Technical Service, Wholesale and Manufacturers:

A. T. SWALES,
2 Cootes Lane,

Cent. 4773
Melbourne.

Trade Sales: **ALLEN SWANN,**

MU 6895 (3 lines)
157 Elizabeth Street, Melbourne.

Estimating Receiver Performance

HOW, failing the possession of a few hundred pounds worth of laboratory apparatus, are we to decide whether a receiver suffering from no very obvious defect is really in first-class order in all respects? And, having done so, can we determine whether the limitations imposed by its original design can be tolerated?

There are, unfortunately, no completely satisfying answers to

By

N. A. PARKER

A.M.I.R.E.

(The Broadcaster—W.A.)

such questions. But, by putting prejudice aside and cultivating our critical faculties, it is possible to form a useful opinion by carrying out the aural tests to be described in this article.

Starting in the usual — and apparently illogical — manner, at the output end of the set, it is necessary to determine whether volume is sufficient when receiving the local station. Failing any standard of comparison, it is none too easy to do so by direct means. But if the output and rectifying valves have lost emission (a primary cause of poor volume) it is probable that other valves are in the same case; in a "straight" receiver difficulty in provoking self-oscillation at all wave-lengths by operation of the reaction condenser is a proof that this is so. In a superhet, failure of the oscillator to do its job over part (usually the upper part) of one or both wave-bands conveys similar information.

SIGNAL FREQUENCY CIRCUITS

Partial failure of an HF or IF valve is not at all easy to detect without making measurements either of the valve itself or of the overall sensitivity of the set. It may, however, be suspected as a

possible cause in a case where the sensitivity of a set turns out to be disappointing. There are usually no other symptoms of a worn-out valve in this position in the set. A check can be made as in all cases where a valve is suspected, by replacing the doubtful valve temporarily with one known to be sound.

However expensive and multi-valve the set may be, whatever may be its prowess in receiving distant stations, there is no getting away from the fact that for much of its time it will be used for listening to the local station. The most important test of all must, therefore, be to make sure that the reproduction of the local station programme is good enough, for if it is not, no amount of other virtues in the set will compensate for this one failing. But before settling down to study the fidelity of the reproduction it is quite essential, if we are to be fair to the set, to make absolutely certain that tuning and other adjustments are set to the best possible advantage.

If the set is the "straight" three-valve type, consisting of HF stage, detector, and output valve, it must be remembered that quality can very easily be spoilt by overloading the detector. A set of this type usually has, in effect, two volume controls; one is a means of adjusting reaction, while the other usually varies the bias on the variable-mu HF stage. For the local station the reaction must be turned back as far as it will go, and the bias control must be turned up only just enough to give the required volume. Turning it up too far may not cause the signals to become too loud, but may very easily cause overloading, and consequent distortion, at the detector.

In a straight set the tuning will probably be rather flat with the controls set just as suggested, so that the exact position of the tuning-dial will be of little consequence from the point of view of quality.

In a superheterodyne, on the other hand, tuning will be very much sharper, and to obtain a true impression of the reproduction given by the set it will be necessary to adjust the dial to a setting exactly in the centre of the small range over which the signal is heard. If tuning is slightly offset from this point reproduction will be shrill; the point of exact tune is that where shrillness is most completely absent.

If the set is a fairly modern one, fitted with A.V.C., the manual volume control should be set to give reproduction at a level safely short of that at which there becomes evident distortion due to over-loading the output valve. In the case of an older superhet, with a manual volume control operating on stages preceding the detector, the precaution against detector overload mentioned in connection with the straight set must again receive attention. In either type of set the "tone-control," if one is fitted, should be turned to "maximum brilliance."

STANDARD OF QUALITY

In listening to the set, now adjusted for the maximum fidelity of which it is normally capable, to decide whether the quality of reproduction is up to the standard we require, it is not enough to absorb just a general impression. In any set design there will be practically no distortion in the strictest and most literal sense. That is, the loud speaker should not noticeably emit any sounds not present in the original performance before the microphone. But many sounds, clearly enough audible to anyone present in the studio may fail to reach the listener, while others, present but not obtrusive in the original performance, may be magnified far beyond their true proportion.

Faults of this kind do not always strike the uncritical listener

(Continued on next page)

PERFORMANCE

(Continued)

at once, but unless the ear becomes atrophied, they are apt to attract continually increasing attention as time goes on. In such a test as this it is therefore well to listen for them deliberately. First, the bass.

There is no reason (save, perhaps, lack of power) why the bass should not be present in any fairly modern set with a moving coil speaker. Often, indeed, there is too much. Attentive listening will show whether it is a resonance that turns every low note, no matter what its true pitch may be, into a thud that owes its character to the loud speaker instead of the instrument in the studio.

It is only fair to add that one must not be too critical in this direction. If, on attentive listening,

the bass reproduction seems to be, if not the truth, at least an acceptable substitute for it, the set has passed its test.

TESTS FOR HIGH-NOTE RESPONSE

Now let us transfer our attention to the high notes, the point being to see whether they are present in sufficient quantity. In listening to speech the sibilants should be clean and crisp; "such" should not be rendered as "shush." A more stringent test, passed by many straight sets but by a minority only of superheterodynes, is to tune in a powerful foreign station (accurate tuning; no reaction) and see whether speech in an unfamiliar language can be followed. The language chosen should be one of which we know a little, but in which we are not completely at home. If listening gives the impression that it would not be difficult to write down as from dictation, every word spok-

en, even though the meaning may be quite obscure, then the set is giving really first-class reproduction. But if only a word here and there can be caught, and the rest seems unintelligible jabber, we may at once be sure that the reproduction of high notes leaves much to be desired. That speech in English should be entirely intelligible is no test at all; one unconsciously guesses a half-heard word.

This test depends on the fact that the consonants, upon which speech relies for its intelligibility, consist very largely of sounds of high frequency, and can only be correctly reproduced by a set that has a good response to high notes. Music, except for those who are very familiar with instruments of an orchestra, shows up a defect of high notes much less readily, and so is much less suitable as a test.

It is only fair to say that there are few sets that would emerge as

**A
B
A
C**

**AUSTRALIA'S
BEST
AMPLIFIER
COMPONENTS**

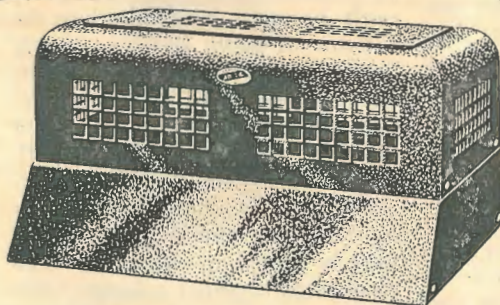

VERSATILITY

in

**CUSTOM-
BUILT
SHEET-
METAL**

Illustrating one of
our advanced designs
any type
custom-built to your
own specifications.

MANUFACTURED BY

TRIMAX TRANSFORMERS

29-35 FLEMINGTON ROAD,
NTH. MELBOURNE, VIC.
(Division of Cliff & Bunting
Pty. Ltd.)

perfect from a really stringent application of the test just described, and to add that any set giving such unusually good reproduction as that suggested would inevitably be of very poor selectivity compared with the average superheterodyne. Each owner of a set must decide for himself whether the degree of

seek for a station which, with careful tuning, can barely be persuaded to give a full-strength signal in the speaker. If the background noise accompanying such a station is only trifling, it is probable that a more sensitive set would bring in more stations of programme value.

standard. A straight set must be expected to tune rather flatly unless reaction is applied; with its aid, it is reasonable to expect that the louder of a pair of stations on adjacent channels should, in most cases, be receivable clear of its neighbour. But the skill with which the user handles the controls is really a much larger factor in selectivity than the design of the set (but the number of tuned circuits counts). In a superheterodyne the selectivity is built in, and does not depend in any way on the user's skill in tuning.

AMPLIFIER ENTHUSIASTS!

In next month's issue we hope to give away a free STROBOSCOPE to tell you when your records are revolving correctly.

intelligibility achieved by the set he is testing is high enough for his requirements. On the whole, it will be found that straight sets give better quality of reproduction than superheterodynes, for the latter are practically always designed to give the rather high selectivity that the public has come to associate with the name "superhet."

In many sharply tuned sets a very considerable increase indeed in the high-note response can be had by slight mistuning. If the set under examination seems to require it, this expedient can be tried while receiving the local station. If we are willing to accept the small extra

Having formed our opinions of the set in the matter of quality of reproduction, we have to extend our tests to its other qualities. Is it sensitive enough? In many cases this can be settled in a few seconds by finding a setting of the tuning dial at which no station is heard. If, with the volume control at maximum, there is heard a greater amount of background noise than would be tolerated when listening to a programme, the set will bring in any station which, at the place where it is being tested, is louder than the background noise. One would never use greater sensitivity than this. Alternatively, one may

But there still remains the probability that the set under test may provide a sufficiently satisfying supply of foreign programmes; no one but the prospective purchaser can decide that point.

In the question of selectivity it is even more difficult to set up any

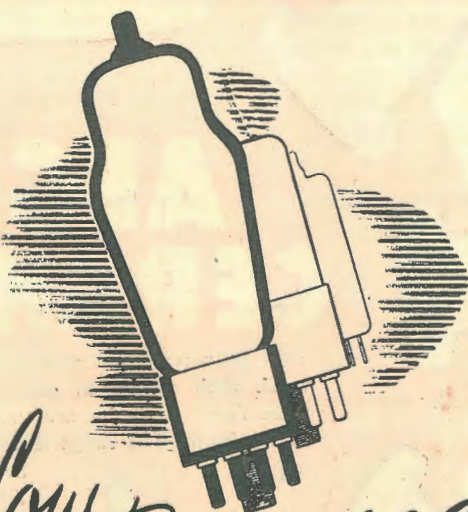

Now Released!

Keep in touch with your Local Dealer for further releases of type ranges.

BRIMAR
VALVES
British Made

A PRODUCT OF
Standard Telephones and Cables Limited

Headquarters for Amateur Equipment

TYPE S14

Retail Price **5/-**



TYPE S13

Retail Price **4/9**



TYPE FT 4

Retail Price **6/9**



AEGIS CERAMICS

Vital little pieces of equipment which proved worth their weight in gold to the Services, these Aegis Ceramics are available right now to the Home! The range is complete . . . and every one is typical Aegis quality . . .

TYPE S12

Retail Price **2/6**



TYPE FT 2

Retail Price **4/7**



TYPE S12A

Retail Price **2/9**



TYPE FT 1

Retail Price **3/9**



TYPE GT 2

Retail Price **8/3**



TYPE BH 2

Retail Price **5/10**



Attractive Discount to Licensed Amateurs

J. H. MAGRATH & CO.

DISTRIBUTORS OF AEGIS COMPONENTS

208 LT. LONSDALE ST., MELBOURNE

OPERATING THE 807

ALTHOUGH the 807 is one of our most popular low-priced transmitting tubes, it is probably the source of more trouble than all other types put together, except perhaps the poorly-screened 6L6. This situation arises not so much as a fault of the tube, but in the way it is handled. Treated properly, it can be a pleasure to operate, but if it isn't given consideration, it will get even with you by putting parasitic signals all over the band (and outside, too) not to mention putting the bite on your pocketbook for replacements.

By

DONALD MIX

Reprinted from "Q.S.T."

One of the chief reasons for its reputation as a bad actor among those who have had sad experiences with this and other r.f. beam tubes is the one which makes it so desirable — namely, high power sensitivity. For efficient operation at full power, the manufacturers recommend a driving power of one-quarter watt, but appreciable output can be obtained with much less excitation. The considerable advantage over a triode of equivalent output rating, which may require as much as five watts, is readily appreciated. However, a very low excitation requirement means that a very small amount of feedback will cause self-oscillation. For this reason the input and output circuits must be much better isolated, if trouble is to be avoided, than in the case of a triode whose power sensitivity is much lower.

Satisfactory reduction in coupling between the two circuits at the operating frequency is not difficult if it is done correctly. Metal construction which provides shielding and a means of obtaining a good common ground connection is al-

most a necessity. Since the portion of the grid lead which passes through the glass seal and the base of the tube is not shielded, an external shield should be provided to eliminate the capacity between this wire and place-circuit components which may be placed nearby. If the chassis is 3 inches or more in depth, the socket may be lowered on brackets so that only the top portion of the tube protrudes above the chassis, which then provides an effective shield. If the socket is to be mounted on the chassis, it should be sub-mounted so that the grid terminal is underneath and the lower portion of the tube should be enclosed in a cylindrical shield extending from the chassis up to the level of the bottom in-

ternal ceramic washer. A long looping plate lead should be avoided, elevating the tank condenser, if necessary, to permit a short plate lead. If the lead must be long for some reason, it should be kept well spaced from the bottom portion of the tube.

It is preferable, particularly at frequencies above 14 Mc., to place the driver plate-circuit components, or those for the grid tank circuit if link coupling is used, below the chassis, keeping the plate tank coil and condenser above. If parallel plate feed is used, the r.f. choke and blocking condenser also should be above the chassis. When plug-in coils are used it is usually not

(Continued on next page)

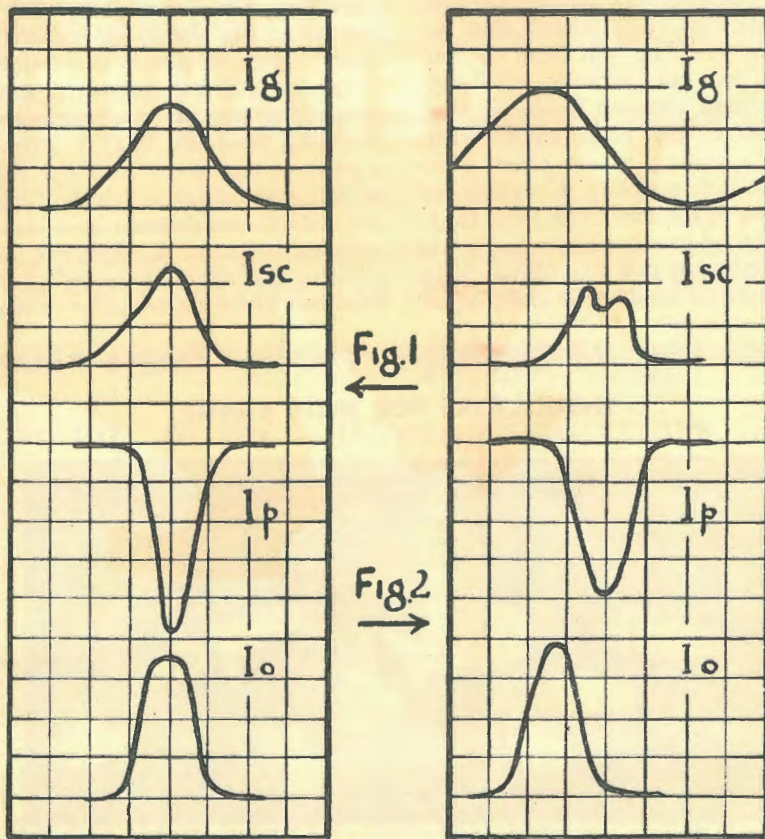

TANK CAPACITANCE

(Continued)

feasible to place the grid tank coil underneath the chassis, although the layout may permit the grid tuning condenser to be placed there. If space is available, plenty of room should be left between the two tank circuits. In any case, the grid and plate coils should be placed with their axes at right angles.

THE TANK CIRCUIT

Unfortunately the tank circuits formed by the coils and condensers are not the only ones present. Leads, r.f. chokes and by-pass condensers can combine to form circuits which will cause oscillation all too readily at frequencies considerably removed from the operating frequency. R.F. chokes may combine with by-pass condensers to form a low-frequency t.p.t.g. oscillator circuit, but since the 807 screening is very effective at these frequencies it is seldom that sufficient coupling will occur to cause this type of parasitic oscillation. The most common trouble is oscillation in the v.h.f. region where the screening is not effective because the coupling is usually external to the tube. The leads to the screen by-pass condenser and to the cathode by-pass condenser also should be as short as possible. At

high frequencies it is sometimes possible to avoid trouble by substituting mica by-pass condensers of smaller capacitance for the usual 0.01- μ fd paper condensers. If oscillation persists, one way to suppress it which has been found effective is to place a 50-ohm, 1-watt resistor between the screen terminal of the tube socket and the by-pass condenser, the voltage being fed in at the by-pass condenser end. This alone, or in combination with a v.h.f. choke in series with the grid, is usually sufficient to suppress any tendency toward instability. Depending upon the length of the leads determining the frequency, the proper size of the choke may vary somewhat above or below 10 turns of No. 1 wire wound on a $\frac{1}{4}$ -inch diameter. A few turns either one way or the other may make considerable difference.

Beam tubes are much less tolerant than triodes in the matter of excitation. The manufacturer's recommendations should be followed closely both in regard to biasing voltage or grid-leak resistance, and screen voltage or screen-voltage-dropping resistance. Fig. 1 shows a group of tuning characteristics for an 807 amplifier in which the various voltages and currents have been adjusted properly. A slight rise in grid current occurs at the point of minimum plate current. The screen

current also shows a very slight rise at the same point. Maximum output is coincidental with minimum plate current.

If the tube is under-excited, the curves do not look so pretty, as will be noted from Fig. 2. Here the grid-current curve shows a hump on the low-capacitance side of minimum plate current and a decrease on the high-capacitance side, in respect to the grid current at the point of minimum plate current. The screen current shows a slight irregularity also on the low-capacity side. Probably the most annoying characteristic is that maximum output occurs not at plate-current minimum but at a point on the low-capacitance side of minimum where the input runs higher. The plate-current dip no longer is an indication of maximum output.

While some increase in power output is possible by running the grid current in excess of the recommended value if the tube is heavily loaded, it is not recommended, because grid and screen dissipation increase rapidly — often with disastrous results to the tube.

OFF-RESONANCE CURRENT

Beam tetrodes differ considerably from triodes in the matter of off-resonance plate current. When using a triode whose rated loaded plate current is 100 ma., it is not uncommon to have plate currents of 150 to 200 ma. when the plate circuit is tuned off resonance. On the other hand, the off-resonance plate current of a beam tube may be only a few milliamperes higher than the rated load value. However, the output does not flatten off with the beam tube as it does with the triode when the loaded plate-current value approaches the off-resonance value. In fact, it is possible to load the tetrode to the point where no noticeable dip is obtained without encountering this flattening off of output.

Our experience with beam tubes has been that they will not stand up under the relatively terrific temporary overloads which a triode of equivalent power rating will withstand when the plate circuit is de-

INSULATORS FOR HAM RADIO

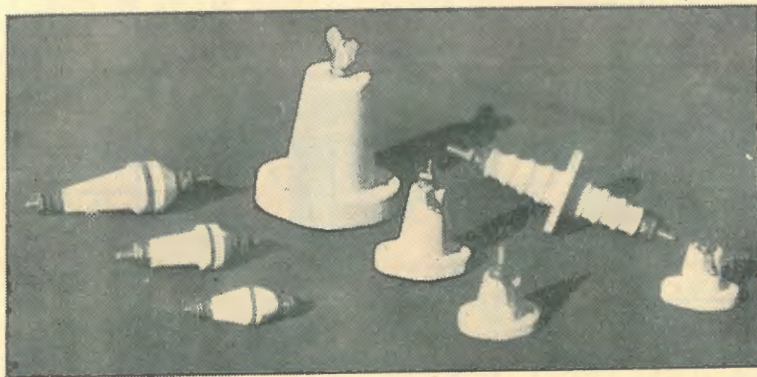

J. H. Magrath & Co., of 208 Little Lonsdale Street, Melbourne, have stocks of insulators for ham radio use. Here is a photograph of some samples from their wide range.

tuned, especially with the grid current above normal. Several 807's which were tried started to disintegrate rapidly when the plate current was tuned off resonance while the grid current was about twice the recommended value. This means a grid current was about twice the recommended value. This means a grid current of only 6 ma. instead of 3 ma., a value which is easily obtained if a close check is not kept on the driver adjustment. In some cases the grid current reversed, causing a \$1.95 display of fireworks before the high-voltage switch could be pulled.

Increasing screen voltage over the manufacturer's recommendations seldom results in increased output. In fact, the tendency is for the screen and plate power both to increase while the output may actually decrease after the optimum value of screen voltage has been reached.

So far as efficiency and tuning characteristics are concerned, it seems to make little difference whether the bias and screen voltages are obtained from fixed sources, from a grid-leak and voltage-dropping resistor, or from a combination of the two, so long as the rated grid current is used. If, in the case of the 807, an extra 50 volts is available from the plate-voltage supply, cathode-resistor biasing may be used with identical results.

Beam tetrodes of the 807 size and smaller make good frequency multipliers, but tube life is quite apt to be short unless suitable precautions are taken. For efficient operation both bias and excitation should be increased. However, there seems to be little point in going beyond twice the normal values for either doubling or tripling at least. The point to be watched is that of keeping the plate and screen dissi-

pation within the ratings. This may mean a considerable reduction in output from the values used when the tube is operating as a straight amplifier, since the efficiency of a doubler or tripler seldom exceeds 40 per cent or so. With the higher grid current, added precaution is necessary, of course, when it comes to detuning of the plate circuit to avoid damage to the tube.

For phone work the tetrode may not be so well suited as an output amplifier, since the screen as well as the plate must be modulated. Unless a special modulation transformer with a dual secondary is available, this means that a fair amount of audio power must be thrown away in the screen circuit. However, since audio power usually comes cheaper than power at r.f., this may not be considered too much of a disadvantage, although it must be taken into consideration.

HAMS!

Keep Abreast of the latest overseas developments.

Subscribe now to any of the following magazines.

Q.S.T.	20/-	WIRELESS WORLD	25/-
C.Q.	22/-	WIRELESS ENGINEER	42/-
RADIO	25/-	ELECTRONIC ENGINEERING	33/-
RADIO CRAFT	22/-	ELECTRONICS	56/-
RADIO NEWS	32/-	F. M. TELEVISION	32/-
SERVICE	24/-	COMMUNICATIONS	24/-

Orders are now being registered for the 1946 editions of A.R.R.L. and Radio Handbooks

SEND YOUR ORDER NOW TO—

TECHNICAL BOOK & MAGAZINE CO.

297 - 299 SWANSTON STREET, MELBOURNE

(Opposite Old Melbourne Hospital)

'Phone: Central 2041

POLITICS

(Continued from page 15)

the morse code, he has every right to operate a ham station.

I feel sure that the W.I.A. has lost many friends by not making an effective protest against this latest rotten piece of out-dated psychology.

What annoys me still more about this particular subject is that one of those V.I.P.'s, who is the very man who should be doing everything possible for the encouragement of the growing youth, makes no secret of the fact that he supports the attitude of the P.M.G. and agrees that "children should be seen, but not heard.

Another unhappy feature of repressive regulations is their habit of breeding people of a dictative nature.

Such a person may be of the highest integrity, capable and ener-

getic, but unfortunately blind to the fact that he suffers from the inferiority complex which repression breeds. Maybe in his young days he was not allowed to give expression to his personality; now that he is grown up he delights to "wield a big stick," with confidence almost amounting to impudence and not the slightest doubt that his own point of view is the only point of view. Not that that is bad.

Provided they are surrounded by co-workers of a tolerant and understanding nature, such people can do lots of good work and cannot easily be deviated from their good intentions.

It is for this attitude of tolerance that I call on all radio enthusiasts to be broadminded enough to overlook the minor problems, but to bring their full strength to bear on the V.I.P.'s to make them realise that if they "wield a big stick"

it should be with a view to getting better treatment and encouragement for "ham" radio, not the suppression of publicity for worthy Radio Clubs.

I have every reason to believe as true the position in regard to the Wireless Institute, as summed by VK6MU in an article in the May issue of "Wavetrap," a little journal published by the Subiaco Radio Society in West Australia. He says, "(the W.I.A.) should ask itself why half the amateurs of Australia have at one time or another been members, but now neither subscribe to its actions nor its finance."

I feel sure that the only worthwhile policy for the W.I.A. is to drop all pretence of appeasement, stand up on its hind legs and fight for better conditions for ham radio, greater freedom, and give every encouragement to all and sundry to fill the ham ranks, even if it does mean QRM!

And Now . . .

POLYSTYRENE CEMENTS

WITH THE SAME UNQUALIFIED ELECTRICAL PROPERTIES OF
ETHOLEX POLYSTYRENE SHEETS AND RODS.

"STYLON" Liquid Polystyrene, for cementing Polystyrene units together.

"STYLON G.P." for joining Polystyrene to glass, plastics, ceramics, metal, rubber, etc. A general purpose insulating cement.

IN 3-OUNCE CONTAINERS, WITH INSTRUCTIONS FOR USE

3/- each (plus tax) Post free.

ETHOLEX PLASTICS

108 CHAPEL STREET, WINDSOR, MELBOURNE, AUSTRALIA

CALLING CQ!

By Don Knock, VK2NO

REMEMBER how popular the American mag "Radio" was pre-war? One could always find lots of interesting "Ham" topics, technical and otherwise, in those pages. Came the war and the "DX demise," and with Pearl Harbour, amateur radio in U.S.A. went to war alongside those already fending off Hitler and Co. Proprietors of "Radio" made a change and the mag., as a 100 per cent. "Ham" publication, died in its tracks.

"Radio" is still very much in existence—as a professional radio engineering monthly, an excellent job in its own sphere.

Recently a new American magazine appeared, obviously backed by the same amateur-minded engineers and editors responsible for pre-war "Radio." This is known simply as "C.Q." and each issue is better than its predecessor.

I wonder how many people calling themselves "old-timers" can recall another magazine with the same title? In Australia there was in existence the "N.S.W. Radio Transmitters League" in 1927-29, and it had an official organ—a very snappy little mag.; "C.Q." was the title, it being published and, with unparalleled generosity, donated and mailed free by the Australian Head Office of the Philips organisation. Only privilege the Co. asked — and naturally nobody kicked — was a centre-spread advertising Philips Valves. Editor was John Bristow, then the Philips advertising chief—and he worked like a Trojan on that mag. But, believe it or not, there were dissentients; those who, with crass ignorance, averred that to have a manufacturer associated with the official organ smacked of "commercialism." Eventually the Co. closed down on their offer, an inevitable result. Ever hear of "looking a gift horse in the

mouth"? Well, *that* was such a horse! All of which is by the way.

The "CQ" I get from U.S.A. each month is like "QST," something I don't want to miss. The "beam" boys have been well catered for in recent issues with full details for close-spaced 28 mC/s arrays, etc. "C.Q." is worth a sub., and I suggest that if you have the idea in mind, you get in touch with the Australian agents, Technical Book and Magazine Co., 297-299 Swanston St., Melbourne; attention, Mr. Floyd.

* * *

A few "Hams" have queried apparent lack of selectivity when using 1600 kC/s I.F.'s in their RX's, as suggested in my "VK2NO V6." Let me clarify things. With air-cored and probably over-coupled I.F.T.'s there *will* be an increase in band-width, to say nothing of more than one resonant peak. But, with a properly engineered I.F.T., using powdered iron cores such as the "Aegis" or "Permaclad" makes, far better results can be expected than with the home-doctored variety. I don't mean to infer that some practical "Hams" *cannot* turn out their own on iron slugs just as one would wish, but many would no doubt make a botch of it. Better to buy the 100 per cent. article if it is available—it wasn't when I described that receiver. 1600 kC/s for the "Ham" RX has an outstanding virtue—that images are off the dial. Against that, I have actually had one or two individuals tell me that with 465 kC/s, they prefer to have signals appearing in

America's Alternative To "TEN"

During March, 1946, American amateurs were authorised to use a band additional to 28-30 mc/s in the range 27.185-27.455 mc/s. This the W's promptly dubbed the "eleven metre" band. It is a region shared with industrial equipment of the R.F. heating varieties, but despite that fearsome outlook, "QST" says that so far there has been very little QRM. Those who use the new band are enthusiastic about its superiority over "Ten;" to my mind a logical outcome of using an even *slightly* lower frequency than "Ten."

No doubt because of the possibil-

ity of lots of QRM from industrial R.F. plants, the Federal Communications Commission has authorised the use of I.C.W. (tone modulation) on "eleven;" also "duplex" telephony. One possibility is that of cross-band DX working, and there seems to be no reason why W's should not reply on their new band to overseas stations calling on "Ten."

VK's who are bored by "condx" on "Ten" might try a "CQ W eleven" call or two, listening for replies between 27.1 and 27.4 mc/s.

—D.B.K.

(Continued on next page)

HAM NOTES

(Continued)

two spots—they are not likely to miss stations calling them! What's the use!

* * *

Don't get the idea that Disposals dealers are bursting with an intense desire just to help out the shallow-pocketed "Ham" by selling "surplus" at knock-out prices. They are in business to make cash, which after all is the modus operandi of this crazy world. But "black marketing" seems to have sullied the atmosphere in some instances. Bob Meadows (VK2ARM) tells me of an experience in a radio shop professing to serve the Sydney amateur. He arrived coincidentally with the unloading of a large batch of ex-

Army wavemeters. Asking the price, he was informed that "they would have sold for 30/-, but as the dealer had been kept waiting for their consignment, they would now be £6." Bob opined that the price was high, and the retort was that there are plenty of mugs who will pay it." Two weeks later, VK2ARM called again, hoping that the outlook might be more reasonable. Result—the price had been raised to £15. My comment is to this effect: if you suspect blatant profiteering of this kind, have a look elsewhere. I happen to know that at the time VK2ARM had this experience, identical gear was selling, in full working order, for £2/10/- each at another dealer's, who really *is* a good friend to the amateur, and has been in business for nearly two decades.

HAM CHATTER

The pathway to success is paved with good intentions! Frequently, whilst quizzing around the dial on "Ten," I hear hopefuls talking glibly of what they are going to do on "Six," and even higher frequencies. So many think that it's just a matter of pruning coils and the old receiver will perform like a veteran on "Six." They seem to forget the struggle they may have had to coax sigs. from "Ten" in the first place.

It is necessary to emphasise that long ago I came to the conclusion that for anything about 60 mc/s either "Acorn," or miniature type valves, are required. The latter are almost an unknown quantity in Australia — unless a few survived the wanton destruction of lease-lend decrees, but "Acorns" can be bought fairly plentifully. They are not cheap, but are a good investment for the keen V-H-F man. If you are considering 166-170 mc/s — then you *must* use valves of these types. For 50-54 mc/s standard valves perform quite well — but even so, a receiver on "Six" with V-H-F valves in the front end will run rings around the other kind.

Talking of "miniatures" — I did see some weeks ago, a few useful types in a Disposal dealer's windows in Sydney, but I imagine they weren't there for long. 1600 kc/s. I.F.T.'s seem to have been in demand—so many people are making up the "VK2NO V Six" receiver. Although, as I pointed out before, there are such I.F.T.'s in the ex-Army 108 MK2 transceivers, don't forget you can buy brand new transformers in Aegis or R.C.S. makes also.

You hams who read "QST" and other American magazines may have noticed the advent of 300 ohm P.V.C. insulated flexible feeder cable — just the thing for feeding close-spaced arrays using a folded dipole for the driven element. If you look around your local hardware stores you may see modern "lamp-cord flex" consisting

RETURN OF HAM BANDS

What are the prospects of restoration of the full amateur frequency channels? Nobody seems to know, and if anybody *does* know, they give a first rate imitation of the proverbial oyster! All that *is* known, according to those ostensibly at the helm of VK affairs, is that promises were made by the P.M.G.'s Wireless Branch that the bands *will* be returned some day. The delay is reaching the irksome stage, but is not through any fault of the P.M.G.

The characteristic scarlet trappings still encircle Service affairs, and he who would dare sever them might find himself ignominiously in Civvy St., where life, involving the garnering of the wherewithal by one's own, instead of Taxpayers' efforts, is a stern affair rather than a prolonged picnic. Even "QST" which has maintained an indulgent outlook toward frequency needs as claimed by the Services, exhibits a somewhat different tone — thus, "It is pretty disgusting to listen in on 14 mc/s and be able to hear the amateurs of practically every country on earth except the Allies, enjoying the current quite grand performance of this band. You, of

course, wonder how this can be. Answer is that most of this operation is in countries that either have had small stake in this war, or have small continuing obligations in the present picture — so they feel free to cut their hams loose, while the Allied countries still have the military establishments, and the bases, and the millions of men overseas. While we feel that the military are collaborating with us as well as the system permits, we agree with you that these matters move with appalling slowness, and that there are probably many circuits being maintained for which there is not true justification."

That picture is no doubt true of the situation affecting all Allied countries — and this is one of them. Rumours abound, but get no further than that stage, and they become even more unreliable as a result of enquiries from W's on "Ten" about the latest position in U.S.A. Making due allowance for *necessary* delay — it's the unnecessary part of it all that gripes hams who now wonder just who *did* win the war — the fighting soldier or the red tape merchants!

BRASS FOR ARRAYS

of two parallel conductors sheathed side by side in P.V.C. material (in various colours). My guess is the R.F. impedance falls around 150 to 250 ohms. That impedance will be a bad mismatch for the ordinary dipole — but just what the doctor ordered for the folded variety.

* * *

Popular secretary of the Experimental Radio Society of N.S.W., Reg. Anthony (formerly VK2AEC) has acquired a change of call sign. Recently, old-timer Ray Conrad (VK2TR) ex-engineer Lieut. R.A.-N.V.R., left N.S.W. for Tasmania, and by mutual suggestion the R.I.'s Dept. agreed to the proposal that Reg take over Ray's old call sign. Ere long, a new VK7 call will be heard with Ray Conrad behind it.

* * *

Re-allocation of many two-letter call signs has taken place throughout Australia, and in some cases the new owners will have a reputation to live up to. There is a suggestion that calls previously held by amateurs who died in their country's service should not be re-issued; a laudable scheme and well worthy of consideration by the authorities. A memorial "roll of honour" is also something that those concerned with amateur "politics" should give a thought to.

Noticed an anomalous par in a publication about "W.I.A. and

A GOOD TIP

A few amateur acquaintances have expressed disappointment to me at not being able to get a copy of "A.R.W." on the bookstalls recently. I'm not surprised. Two days after the 10th birthday issue hit the bookstalls, there wasn't a copy to be had anywhere. Our editor-publisher, Mr. A. G. Hull, who was in Sydney on business — found *himself* in the position of not being able to buy a copy here. It speaks volumes for the popularity of "A.R.W.", and I have a comment to make: Why not be *certain* of your copy by sending your subscription to the address quoted on the fly-leaf of this issue?

—D.B.K.

Ran into a good idea for construction of V.H.F. antenna arrays. Whilst discussing the practical features of a 50 mc/s ground plate antenna with a Ham colleague, the non-availability of dural tube (at a reasonable price) cropped up; also the fact that brass tube is on the heavy side — in weight and price. His suggestion that channel section light gauge brass might serve nicely for the quarter wave radiator and radials prompted enquiries. We didn't locate square channel, but ran across a supply of section brass in 10 feet lengths, and therein lies a useful alternative to Tubing. The R.F. surface path is quite large on such material, as a little thought will show. And talk-

ing further of the G-P antenna conclusive tests at my own station quite forcibly demonstrated the superiority of this over other aerials. I've switched from co-axials to J's and all others and all observers vote a 4R increase in gain from the G-P. Which is just what I would expect from a well-matched low angle radiator. These comparisons, by the way, are against various types of half-wave radiators with no parasitic elements — in others, just plain antennas. Obviously a special high gain beam with 8 or 16 half-waves in phase can be expected to out-perform any single radiator. The G-P scores in that is a good *all-round* system — needing no "beaming."

Loyalty." Points outlined therein are sound — with reference made to "remarks we've heard passed in criticism of the W.I.A., etc." It is assumed that the writer, in quoting the W.I.A., refers to the *New South Wales Division*, and not the W.I.A. in its entirety?

* * *

I've been long enough in the amateur radio world here and overseas (my own W.I.A. experiences date from 1926) to know that those who undertake the political side of amateur affairs, seldom receive appreciation or gratitude for their efforts. It *should* be the duty of every VK to support the W.I.A. and if in the case of any Division, support is lacking or criticism rife, then that Division should seek the reason inside its own structure.

* * *

Recently I have heard references to the Experimental Radio Society of N.S.W. as a "break away" group from W.I.A. — N.S.W. Division. Nonsense! This "new" club is a continuance of the old Lakemba Club — under its new title, with new blood — lots of enthusiasm, and, most important of all — a friendly atmosphere. A future issue of "A.R.W." will tell the

full history of the old Lakemba Club — and the birth of the present Society.

* * *

Noticed an ad. in a publication quoting Dural tubing for "rotaries" which in itself is a good thing. But the price of 30/- for 16 feet of the material seems to be well above the ceiling, considering that a few weeks ago a supply was available to Sydney hams at 2/- per lb. weight. One ham tried also to do

(Continued on next page)

CONGRESSIONAL MENTION FOR ROSS HULL

According to the Congressional Record (U.S.A.), Congressman Jennings Randolph recently made a statement in the House of Representatives, in which he made mention of the many factors which had helped the United States war effort. Dealing with radar-controlled missiles he mentioned that valuable work in this direction had been done by Dr. Walter Good, Chester Lanzo, Clinton De Soto, and the late Ross Hull.

HAM NOTES

(Continued)

business with a Government source of supply, but came up against a similar form of extortion. Originally quoted 6/- per pound — (I saw the typed quotation) for $\frac{3}{4}$ -in. Dural tube, 40 per cent was tacked on to the figure for some mythical and undefined reason. This ham — and others — is making out with galvanised conduit for his requirements, and no wonder!

* * *

Take a tip from an old hand, if you ever see Philips' "B" eliminators going at a reasonable figure, they are a good spec for a quiet, humless, well regulated H.T. supply for small ham receivers. Two such eliminators used in series make up a nice 250 volt unit handing out about 40 milliamps, and if you like to use Voltage Regulator tubes in conjunction, you have a very handy and trouble-free H.T. unit.

* * *

Oft-times two or three hams get into a round-the-circle QSO, especially on "six metres" and discussion may be of absorbing interest. Little opportunity may occur to

"look over the band" for other stations, with the result that somebody anxiously awaiting the chance to break-in on the QSO feels akin to being "on the outside looking in." I've had many a setback thus, but can always find something else to do as an alternative. After finishing a technical discussion with two "6 metre" stalwarts recently, I heard another station referring pointedly to "people who are cliquey, and never call CQ." Evidently the complaining station just isn't listening when others *do* call CQ, but the point I wish to emphasise is that the amateur (experimental) bands are not the place to air imaginary grievances. There is an antidote for people who imagine that access to a microphone gives the right to "slate" the other fellow over the air.

* * *

I recall, some years ago, photographs in Bill Conklin's U.H.F. notes in "Radio" (U.S.A.), of storm damage to 56 mc/s beam arrays — with towers split and broken, lying crazily across roof-tops and gardens. Memory was refreshed quite forcibly when I arose on the

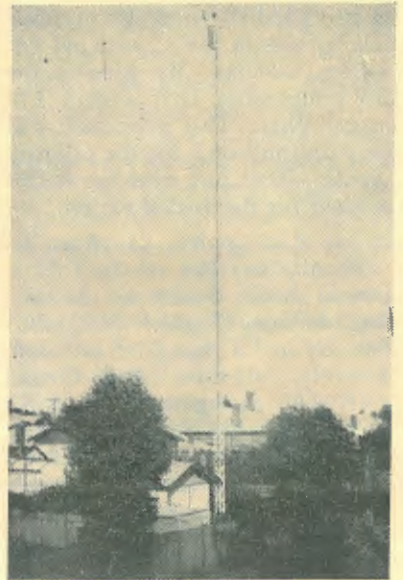

CONFIDENCE!

VK3ZU, Prospect, S.A., tests out his antenna mast after erection. This mast was in use in prewar days.

morning of June 6, 1946, to find the general aspect of my own station looking like a Japanese outfit after a "doing over" by Super-Forts. The gale that blew, with icy rain, over Sydney all night, decided to take with it my 50 mc/s rotary ground-plane array. Snapped guy wires were responsible; the result being a tangle of bent piping, and twisted co-axial line. Only consolation is that — anyway, the system was to be *taken* down for alterations — cold comfort! It's all in this amateur game anyway — moral: *build* better!

From Victoria, Elgar Treharne (VK3AFQ) tells of good "round-table" QSO's with VK's 3NW, 3YJ, and 3HK, on "Six." Sounds akin to VK2's conception of the band, which is "the hospitality band." Assuredly, less "jargon" is indulged in than on "Ten", and experimental technicalities hold pride of place in discussions.

VK3NW is migrating to the next band — 166 mc/s with a concentric grid 800 oscillator. VK3AFQ reports that "Ten" has been so poor that construction of a "YAGI" array for that band has been deferred. Plans now are for

CAMP HAPPY--WITH A DIFFERENCE

They say that one swallow does not make a spring, but one letter of appreciation coming from a service man sometimes says more, because it is friendly and spontaneous, than all the formal notes of appreciation from military authorities and patriotic bodies.

Mr. Jack Burgesson, of Sandringham, Victoria, and formerly a member of the R.A.A.F. is one man who realises that everyone, even electrical firms, appreciates courtesy and encouragement. On his return from service in the Islands he sat down and wrote to Philips:

"I would like to compliment your firm," he writes, "on the faultless operation of your Model 1225M, 25-watt Amplifier, which I had the pleasure of operating in the South West Pacific Area, with

extreme temperatures and humidity."

Mr. Burgesson goes on to say that during the 20 months his R.A.A.F. unit was up North the amplifier operated on an average of from five to six hours daily. The complete unit, he explains, consisted of the Amplifier, two exponential horns, pick-up, turntable and microphone. "It was purchased for the sole purpose of keeping up the morale of the men, and it certainly did all that, thanks to Philips."

Not only Philips, but all electrical manufacturers share the pleasure that a letter like this brings. The whole trade is happy to feel that the entertainment value of their production contributed so much to the well-being of the lads who helped write "Accounts Closed" across the Pacific campaigns.

a beam on "Six." VK3MJ has extended his "skeds" for Westralia, which is not a bad idea; it being latish in the afternoons when VK6's peak on "Ten" in Eastern Australia. That station everybody hears (and works) on Ten, VK-5NR, at Katherine, Northern Territory, is ex-VK3NR, and is now doing some intensive listening on "Six." The more the merrier.

* * *

Did you ever hear the great VK2— say loudly that he has no use for QSL cards, and he wishes that SWL's in particular would leave him in peace? This outlook has not yet recurred, for the reason that we haven't been long enough on the post-war air, but in pre-1939 days it was much in evidence.

Personally I welcomed SWL reports and never failed to answer them — on one condition. The reporter *must* include postage to cover the cost of a reply. Otherwise, an active station can be saddled with a formidable mailing cost. Those who don't know what I refer to will know full well after a year's phone operation on "20." The pre-war "20 metre" phone man was flooded with thousands of "D.E." SWL cards (those zealous people in Europe who were Nazi radiomen as well as "amateurs") to say nothing of quantities of reports from the many "Dx Listening Posts" and SWL clubs throughout the world. Some of the reports I received during my pre-war 20 metre phone activities were excellent and complete in every detail. They must have taken hours to compile. Others were more brief, but often took the form of expensive and elaborate cards which could show "hams" a thing or two about QSL card design. Finally, some reports were obviously the result of enthusiasm from a minor — saying, in effect, "Heard you working VK2XYZ — please QSL." Average "ham" receiving such a report is apt to toss it aside, muttering darkly the while. Here is where I ask for tolerance (a virtue sadly lacking in



Only yesterday! This "shot" was taken during the war at an Australian Army Inspection test room at a large radio factory. It shows final checking in progress on "Wireless Set 22," a conspicuously successful field radio equipment as used by the A.I.F.

this world) that pathetic "report" may have come from some school-boy delighted to have received *anything* on a simple receiver he has made up from "bits and pieces." He may also have spent the last penny of a week's pocket money on the stamp, and if he is ignored — what of his feelings? Or don't you care? A penny stamp for a reply won't hurt the "ham," and the boy's pleasure can be visualised. Too many "hams" who don't know the first thing about the amateur spirit have their noses in the air. I heard of one fellow the other day, loudly stating that no amateur should be permitted on the air with phone "unless he has an oscilloscope to check modulation, etc." This "amateur" is in a commercial position where his employer makes such test gear available for the asking. If he had to make — or *buy* one, he would "pipe down!" The *youthful* ham cannot afford expensive test gear, but he can easily make a modulation *monitor*. Atti-

tudes such as this, and the spurned QSL, are not the correct approach to the younger generation of radio amateurs, which includes SWL's also. Each SWL is a potential "ham!"

—D.B.K.

* * *

Logged In New Zealand

Despite the fact that the "10-metre" band frequently goes "wide open" for ZL signals, it is not always easy for the VK to attract the attention of his colleagues across the Tasman. Reason, I imagine, is that after a ZL calls CQ, his dial may be likely to show a preponderance of Americans answering that call, with only a few Australians in between.

There have been occasions when I have wanted particularly to "raise" a New Zealander and have called repeatedly without success.

(Continued on next page)

HAM NOTES

(Continued)

These instances merely illustrate vagaries of "Ten" that prompt a wish for return to *reliability* of such communication as typified in "80" and "40." New Zealand listeners are logging a lot of Australians on "Ten," and a comprehensive list comes from observer J. Lunn (ZL419) of Duncan Street, Dunedin. The calls listed were

heard between 24th March and 28th April, 1946, and are all C.W. (telegraphy).

VK2's: 2AIH, 2AZ, 2NG, 2NY, 2YL, 2RA.

VK3's: 3AB, 3BC, 3CP, 3EQ, 3IW, 3KJ, 3KK, 3OP, 3MN, 3VC, 3VD, 3VM, 3VV, 3TM, 3YP, 3ZU, 3WC, 3YT, 3YN, 3RW, 3CX.

VK4's: 4EL, 4ES, 4UL, 4PY, 4KS; and VK5BC.

Australians called by American and New Zealand amateurs on C.W. during the above period were, as the calls were logged by Mr. Lunn:

Station Called	Station Calling
VK6PJ	ZL4CK
VK3CX	ZL4AR
VK4EJ	W7FNK
VK3KR	W7FNK
VK5FM	W6AGG
VK2AIU	ZL4CK
VK3HT	WPPA
VK2RA	W6AGG
VK5HN	W6WY
VK4SA	W6AM

CLUB DOINGS

GLADESVILLE AND DISTRICT EXPERIMENTAL RADIO CLUB (N.S.W.)

This small but enthusiastic radio club had its inception in 1938 when VK's 2NP and 2EW made the first move in getting local enthusiasts together. In those days there were 9 transmitting members: VK's 2NP, 2EW, 2AHR, 2AHK, 2AMO, 2KJ, 2ADQ, 2XH, and 2AEX, with 10 receiving personnel, most of whom have since obtained their amateur "ticket."

A transmitting licence was obtained and the call sign VK2ADY was allocated. QSO's were mainly on the old "Five Metre" (56 mc/s) band, between the Club rooms and the members' personal stations. Advent of war halted activity but it was decided not to disband, but to go into recess. Majority of members joined the fighting Services. When VP-Day loomed ahead, some of the prime movers met, with the result that the Club was again in full swing by the time licences were being re-issued. The call sign VK2ADY was again granted and a Club station will shortly be in action.

Meetings are held every Thursday night at the rear of the private residence, corner Sunnyside St. and Victoria Rd., Gladesville, New South Wales, with President S. Walters, Hon. Sec., C. Fryar and Treasurer N. Franks.

EXPERIMENTAL RADIO SOCIETY OF NEW SOUTH WALES

(INCORPORATING LAKEMBA RADIO CLUB) *Melody Hall, George St., Burwood*

Fourth annual meeting was held on May 9, 1946, at 8 p.m., when the President welcomed visitors, included among whom was VK3-AFQ, Elgar Treharne. Five members of the Gladesville (N.S.W.) Club were present, headed by their Secretary, Chas. Fryar (VK2NP).

A feature was the welcome re-appearance of seven old members, and the following new members were enrolled:

VK's 2DP, 2AGL, 2AMZ, 2EQ and Mr. J. Carter.

Main business of this meeting was the election of officers for the ensuing twelve months. These are:

President: Mr. J. C. Warren, VK2QX.

Vice-President: Mr. C. Luckman, VK2JT.

Hon. Secretary: Mr. R. Anthony, VK2TR.

Treasurer: Mr. H. Ackling, VK2PX.

Publicity Officer: Mr. T. O'Donnell, VK2OD.

Managing, Technical and Social Committees were formed. Mr. Treharne (VK3AFQ) appealed for more activity on 6 metres and supported his remarks by quoting official ionosphere data. He referred also to the tests now being conducted at week-ends with New Zealand amateurs.

The above loggings are a clear indication that the "phone" boys haven't really got the monopoly on "Ten"—that C.W. is well in the picture.

Mr. Lunn reports that N.Z. amateurs are holding a convention in Wellington on Labour Day week-end, October 26-28, 1946. Fourth District, Otago Branch of N.Z.A.R.T., held a farewell smoko for G. C. Mulholland, ZL4DC, who left for England, where he will re-appear permanently with a G-call.

A large number of applicants sat for a recent amateur radio examination on 6/3/46—and by now many new call signs may have appeared on "80." Despite the fact that ZL's are (for some incomprehensible reason) banned from working overseas on "80," reports from Australian SWL's or "Hams" are always welcome. It is anticipated that the ban may be removed at any time.

Most active New Zealand amateurs using "Ten" in Dunedin are:

ZL's: 4FK, 4CK, 4AR—on C.W.

4DA, 4BB, 4BN, and 4FK—on 'phone.

Mr. Lunn would appreciate a published list in "A.R.W." of ZL's heard in Australia on "Ten", so if any of our industrious listeners will supply the information, I shall be pleased to pass it on in "Calling C.Q."

—DON—VK2NO.

VK "SIX METER" SCHEDULES AND NOTES

HERE are those who prefer to take the "next band" seriously enough to further its utility by using appropriate equipment, and others who misguidedly make half-hearted attempts in the form of modulated oscillators and "squegger" receivers. Those in the latter category will be the ultimate losers, because stations equipped with superhet receivers, even of broad-band characteristics, pass over a wildly dithering carrier of T5 variety that careers madly about when modulation is applied. Also, the super-regen receiver, unless of the less-aggressively-noisy kind, is likely to miss out on signals of average strength, and is not readily applicable for straight C.W. reception. In other words, to "get places" on "Six," equipment compatible with practice at 28 mC/s and lower frequencies is not merely desirable, but quite imperative. AS yet, VK's haven't been long enough on the (post-war) air to work wonders; consequently, most activity is centred on the "top-band"—28 to 29 mC/s. But there are those who prefer the unusual, even if the unusual is inspired by a desire to get away from the increasingly stereotyped form of QSO now so obviously permeating the atmosphere of "Ten."

Interstation QRM is, doubtless, another reason why other pastures to graze in may be desirable. The attraction of "DX" is certainly the big magnet that keeps most VK's on "Ten" and the same force will prove irresistible when the popular bands are made available.

Each to his own liking—amateur radio will always be primarily individualistic, which is as it *should* be.

Interest in "Six metres" is, despite counter attractions, on the increase, slowly but surely, although of necessity activity is confined to capital cities and adjacent areas. Among the Victorians, most consistent user of "Six" is VK-3MJ, D. J. Medley, who uses 50 watts input on 51 mC/s. The transmitter comprises an EL3NG Tritet

crystal oscillator at 6.375 mC/s by an 807 doubler driving a 100th with output at 25.5 mC/s, followed by an 807 doubler driving a 100th final amplifier. Modulator uses 6L6G's and the aerial is a horizontally polarised four element beam; co-axial-fed. Receiver uses 954 R.F., 954 mixer, 955 oscillator, two 1852 I.F. stages at 5.5 mC/s, 6J7 detector, 6J5 B.F.O., and 6V6G audio output. This station is operated to schedule every Sunday from 1100-1200 E.S.T., with direction for New Zealand, and from 1500-1600 E.S.T. with direction for Western Australia. It is known that at least four observers are listening in New Zealand, and two in Westralia. Transmissions consist of a carrier modulated by 1000-cycle tone, interrupted frequently for announcements on phone and I.C.W.

In Sydney, the writer's station, VK2NO, operates at week-ends with different procedure. Transmitter incorporates the exciter unit described in June, 1946, "A.R.W.," followed by a final amplifier using two Philips TB1/50E's (similar to 800's) running at 80 watts. Times of transmission are from 1100-1300 hours, and 1400 to 1600 hours, E.S.T., by automatically keying the carrier, on 50.4 mC/s. A motor driven arrangement sends "CQ SIX DE VK2NO" and, in order to provide a penetrating signal for possible DX observations, tone modulation at 400 cycles is included on the keyed carrier. Listening is done at 30-minute intervals or oftener, with occasional telephony announcements. Antenna is a vertical ground-plane type, backed by a parasitic reflector, and, at the times specified may be "aimed" in different directions. Receiver at present is a converter with 955 mixer and 955 oscillator, plus EF50 I.F. stage at 21 mC/s into a Philips type R163 communication receiver. The schedules outlined for VK3MJ and VK2NO are, of course, concerned solely with possible DX results and it stands to reason that both stations are operated normally for telephony (or

C.W.) communication in their respective areas, mainly at night-time.

VK3's known to be "on the air" with stable transmissions and receivers other than "squeggers" on "Six" are VK's 3MJ, 3JD, 3NW, 3GG, 3LS, 3YJ, 3AFQ, 3XA and 3BW. 3MJ says "there are about a dozen others using various forms of horrible 'squeggers' and super-regens." Furthest DX in the VK3 district is VK3BW at Port Arlington (32 miles).

In Sydney area, conditions are much the same, with the exception of consistent "DX" with VK2LZ (Wentworth Falls, Blue Mountains—70 miles). Stations in VK2 district (Sydney) using crystal control regularly using the band are: VK's 2NP, 2LS, 2ZN, 2CP, 2AEX. VK2WJ will be using auto C.W. for DX tests in the near future. Stations preparing gear for the band are VK's 2EM, 2CL and 2AZ, and others have been heard (on "Ten") referring to plans for "Six." One station from which good results are expected is VK2CI of Merewether (Newcastle, N.S.W.). Owner-operator Gordon Kempton was a keen 56 mC/s man in pre-war days, and is certain to provide a useful contact for many VK2's. Of doing in other States, I can only guess, but an enthusiast who writes of future plans is R. H. Atkinson, VK6WZ, of Geraldton, W.A. Frank Lambert, of VK6FL, is also a likely user of the band. 6WZ has been hearing most of the Australian aircraft beacons around 35 mC/s very strongly, and is enthusiastic about the possibility of 50 mC/s signals crossing the continent.

Information about V.H.F. activities in all States would be appreciated, and will be collated and detailed in "Calling CQ." V.H.F. listener reports will also be welcome, but readers are asked to keep these to 50-54 mC/s for preference. Address your notes on V.H.F. doings to the writer, direct to VK2NO, at the address indicated on the title page of "A.R.W."

—Don B. Knock.

Shortwave Review

CONDUCTED BY

L. J. KEAST

NOTES FROM DIARY—

PACIFIC SERVICE

For the benefit of newcomers to these pages, remember the BBC in the Pacific Service at 3.05 p.m. on Sundays give programme summary and wave-length details.

And here is an item for those fortunates that can listen in during the afternoon: Commencing on Tuesday, July 9, at 3.30 p.m., first episode of thirteen in the radio adaptation of Charles Dicken's "Dombey and Son" by Leslie Grey and Philip Wade, produced by John Richmond, with Ralph Truman as Mr. Dombey, Elaine MacNamara as Florence Dombey. The cast also includes Philip Wade, Richard Attenborough, a young English actor who scored a hit on the London stage in "Brighton Rock", and also appeared in Noel Coward's film "In Which We Serve," and in the radio version of the famous film "The Way to the Stars."

RUSSIAN BROADCASTS

When the BBC initiated a short while ago its new transmissions in Russian, it brought the number of foreign languages in which it broadcasts to Europe up to a total of twenty-four.

THE CRAFT OF DRY-STONE WALLING

My work takes me up and down the coast of New South Wales, and I never tire of the delightful scenery offered in every mile along the South Coast. One thing that has often intrigued me is the miles of Dry-Stone Walling, and mentioning this to a pal of mine, imagining my surprise on opening up a copy of "London Calling" that had arrived during my last trip to find an article by H. R. Jukes on this very subject. The contributor says, "There is one feature of the dales country in the north of England which always both attracts and puzzles visitors — the thousands of miles of dry-stone walling running up the hillsides, crossing the moors,

bordering the fields. These walls have a long history, of course — some of them go back to mediaeval times; others not so far. They are clever pieces of craftsmanship. They are all built, without mortar, from undressed stone gathered from adjacent land, or immediately underneath it. Most of them are six feet high or more, and they have stood up year after year to the fiercest weather these islands ever get. They are covered with snow every winter for days — sometimes weeks — on end; beaten by the savage eighty-mile-an-hour gales which sweep across the moors from the north, with hail, rain and sleet — everything, I think, except cyclones."

Well, I have not seen snow around Kiama, but most of the other elements I have encountered, so as our Yankee cousins would say, "I guess and calculate" the walls were built by good old British stock.

WOODEN IT?

Charles McCarthy says, "Tattooing is like being vaccinated in Technicolor."

KINGS CROSSITES NOTE

Jack Haley, star of NBC's "Village Store," likes to tell the story about the radio actor who found a vacant apartment but had to qualify by denying he had any pets, children, threw parties or made any noise. When the landlord was ready to accept him as a tenant, the honest thespian broke down and confessed, "But I forgot to tell you. I own a fountain pen that scratches a little!"

SAYS WHO?

Dr. Gaden writes: "Hams have taken up the lion's share of my attention, but I have heard one or two items that will interest you. Heard KRHO give the new skeds, so I took a few notes and am after their NEW card which I am told is the goods. Did you hear SEAC,

Ceylon, on 17.77 megs. testing with the ABC from 11.30 till noon? . . . splendid reception.

On May 30 was tuned to 17.77 towards 4 p.m. expecting to hear KCBR do its sign-off, but KWIX was the call and did NOT close. Never can tell who the Yank is going to be, can you?

About best catch is WLWS on 21.65 mc at 11 p.m. For a wonder he gave the frequency. (This is the service to North Africa from 9.45 p.m.—4 a.m.—L.J.K.). But the signal is weak. WBOS has about reached same heights as WLWS on 19 metre band at night . . . Until now WBOS has never been a really top notcher there.

Got a couple of high class 80 metre Yanks the other night from 8.30 p.m. Both W4 stations in Tennessee.

The three 'Frisco stations at night on 25 metre band are splendid . . . not yet got quite who is who . . . two Far East and one AFRS programmes. The 11.73 mc has ruined a Latin there, in fact, two Latins close together are now swamped."

Another DX-er shortly to take unto himself a bride is Phil Byard of Launceston; but he, apparently, like Arthur Cushen, does not intend to give up listening, although he is fearful of the interference he will get from power lines and trams that run very very close to the proposed "love nest."

Leo Edell is hearing Radio Djok-jakarta on approximately 9.425 mc, and call sounds something like RRR; terrific morse makes listening difficult at 10 p.m.

Another Easterner, which he thinks is a new Chinese, call sign XJCC, Shanghai, is heard around 9 p.m. on approximately 9.555mc. This one is badly qrm'd by KGEI.

Mr. W. Wright, of South Plympton, South Australia, says: "I have
(Continued on page 40)

Shortwave Station Information

"RADIO AUSTRALIA"

OVERSEAS SHORTWAVE SERVICE OF DEPARTMENT OF INFORMATION

Here is a list I have compiled in order of times which will afford a quick check up of the calibrations of your receiver.

7.15—9.00 a.m.: VLA-6 Shepparton 15.2 mc, 19.74m.: Forces programme to Pacific, Japan and Asia.
9.00—9.30 a.m.: VLA-6 Shepparton, 15.2 mc, 19.74m.: To Asia in Japanese.
9.40—11.50 a.m.: VLC-9 Shepparton, 17.84 mc, 16.82m.: To North America (East) and Canada.
Noon—2.00 p.m.: VLG-6 Lyndhurst, 15.23 mc, 19.69m.: Forces programme to Pacific.
VLC-4 Shepparton, 15.32mc, 19.59m.: Japan and Asia.
VLA-6 Shepparton, 15.2mc, 19.74m.:
3.00—3.45 p.m.: VLG-3 Lyndhurst, 11.71mc, 25.62m.: To Nth America (West).
VLC-4 Shepparton, 15.32mc, 19.59m.:
4.00—4.45 p.m.: VLG-3 Lyndhurst, 11.71mc, 25.62m.: To Tahiti in French.
5.00—6.15 p.m.: VLA-4 Shepparton, 11.77mc, 25.49m.: To British Isles.
5.00—6.00 p.m.: VLG Lyndhurst, 9.58mc, 31.32m.: To British Isles.
5.30—6.14 p.m. VLC-11 Shepparton, 15.21mc, 19.72m.: To Northern Asia in Japanese.
6.15—6.53 p.m.: VLG-10 Lyndhurst, 11.76mc, 25.51m.: To New Caledonia in French.
6.35—10.00 p.m.: VLA-6 Shepparton, 15.2mc, 19.74m.: Forces programme to Pacific, Japan and Asia.
6.58—8.00 p.m.: VLG-10 Lyndhurst, 11.76mc, 25.51m.: To Forces in Pacific, Japan and Asia.
8.00—10.00 p.m.: VLG-10 Lyndhurst, 11.76mc, 25.51m.: To Asia in Chinese, Japanese, English, Dutch and Malay.
10.00—11.00 p.m.: VLG-10 Lyndhurst, 11.76mc, 25.51m.: To Asia and Forces.
VLA-6 Shepparton, 15.2mc, 19.74m.:
10.00—11.15 p.m.: VLC-5 Shepparton, 9.54mc, 31.45m.: To North America (East) and Canada.
11.00—11.35 p.m.: VLG-10 Lyndhurst, 11.76mc, 25.51m.: To Indo-China in French.
VLA-6 Shepparton 15.2mc, 19.74m.:
11.35—Midnight: VLG-10 Lyndhurst, 11.76mc, 25.51m.: To Siam in Siamese.
VLA-6 Shepparton, 15.2mc, 19.74m.:
VLC-6 Shepparton, 9.615mc, 31.2m.:
Midnight—12.29 a.m.: VLA-6 Shepparton, 15.2mc, 19.74m.: To Pacific and India.
Midnight—12.50 a.m.: VLC-6 Shepparton, 9.615mc, 31.2m.:
12.15—1.00 a.m. VLG Lyndhurst, 9.58mc, 31.32m.:
1.00—2.00 a.m.: VLA-3 Shepparton 9.69mc, 30.99m.: To British Isles
1.00—1.45 a.m.: VLC-8 Shepparton 7.28mc, 41.21m.:
1.00—1.45 a.m.: VLG Lyndhurst, 9.58mc, 31.32m.:
2.00—3.00 a.m.: VLG-4 Lyndhurst 11.84mc, 25.35m.: To North America (West).
VLC-6 Shepparton 9.615mc, 31.2.:
Lyndhurst Transmitter VLG (10 KW).
Shepparton Transmitter VLC (50 KW).
Shepparton Transmitter VLA (100 KW).

SAN FRANCISCO TRANSMITTERS ARMED FORCES RADIO SERVICE

These frequencies came into operation on June 1, and should obtain for quite a while, I would say.—L.J.K.

KNBA	17.78mc,	16.87m	3.45 pm—	6.45 pm
KNBX	15.34mc	19.56m	2.45 am—	6.30 am
KNBX	17.78mc	16.87m	7.00 am—	8.00 am
KNBX	15.25mc	19.67m	1.45 pm—	3.00 pm
KCBA	15.24mc	19.68m	4.00 pm—	6.45 pm
KCBF	17.85mc	16.81m	4.00 pm—	6.45 pm
KCBR	15.33mc	19.57m	2.15 pm—	6.45 pm
KGEI	9.53mc	31.48m	7.00 pm—	1.15 am
KGEI	15.13mc	19.85m	8.00 am—	10.45 am
KGEI	15.13mc	19.83m	11.00 am—	3.00 pm
KGEX	11.73mc	25.58m	1.00 pm—	3.00 am
KGEX	15.21mc	19.72m	7.00 am—	12.45 pm
KWID	11.90mc	25.21m	5.00 pm—	9.30 pm
KWID	15.29mc	19.62m	1.15 pm—	3.45 pm
KWIX	11.89mc	25.23m	5.00 pm—	4.00 am
KWIX	17.77mc	16.88m	11.15 am—	4.45 pm

BBC LONDON

Night reception doubtful, but here are a few reliable day-time transmitters beamed in a direction favourable to Australia:

GVQ, 17.73mc, 16.92m.: 3.15—9.00 a.m.
GWE, 15.435mc, 19.44m.: 3.15—5.30 a.m.
GSO, 15.18mc, 19.76m.: 7.00—9.00 a.m.
GVX, 11.93mc, 25.15m.: 8.15 a.m.—7.00 p.m.
GSD, 11.75mc, 25.53m.: 7.15 a.m.—7.00 p.m.
GWG, 15.11mc, 19.85m.: 2.00 p.m.—1.15 a.m.
GRP, 17.87mc, 16.79m.: 2.00 p.m.—7.00 p.m.

SHORTWAVE STATIONS OF THE WORLD

Carried over from June Issue

AFN, 15.10mc, 19.86m.: Tokyo.
— 15.10mc, 19.86m.: Luxembourg.
2RO-12, 15.10mc, 19.86m.: Rome.
Paris, 15.095mc, 19.87m.: Paris.
HVJ, 15.095mc, 19.87m.: Vatican City.
HCJB, 15.095mc, 19.87m.: Quito.
CKNX, 15.09mc, 19.89m.: Sackville.
VIG, 15.08mc, 19.89m.: Port Moresby.
GWC, 15.07mc, 19.91m.: London.
2RO-21, 15.06mc, 19.92m.: Rome.
— 15.05mc, 19.93m.: Free Spain.
Macao, 15.045mc, 19.93m.: Macao.
— 15.04mc, 19.95m.: Moscow.
WVW, 15.00mc, 20.00 m.: Washington.
15.00 mc,—10.00 m.c. will be listed in August issue.

ULTIMATE

Champion Radio

Sole Australian Concessionaires:

GEORGE BROWN & CO. PTY. LTD.
267 Clarence Street, Sydney

Victorian Distributors: J. H. MAGRATH PTY. LTD., 208 Little Lonsdale Street
Melbourne

The Ultimate factory has made the changeover from wartime production. Designs for the new models are now completed and production is about to commence.

These models should be available soon — they will be worth waiting for. Watch for further announcements.

SERVICE: Servicing of all kinds of radio sets, amplifiers and Rola speakers will continue to be available.

SAYS WHO?

(Continued from page 38)

not been doing quite so much DX-ing lately, but instead have been working hard on a one valve converter for the 10 metre "ham" band. In adjusting the coils I have landed on just about every frequency except the one I want. The other night I "stumbled" on The Adelaide Electric Supply Co. Ltd.'s transmitter VJA7. Not knowing its frequency I rang the Company and was informed that VJA7 operates on 31.1 mc. When a breakdown in supply is reported the nearest service car is called and answers on 31.2 mc."

And from the Shaky Isles comes word from Arthur Cushen, who expects to take his bride into their new home in a few days now. Evidently Arthur is determined to continue with his DX-ing, as he says he has erected a new 450 feet beverage for broadcast reception and hopes to do something big in the short wave antennae field. Among his latest verifications is Radio Italiana, Via Arsenale 21 Turin, heard

MAJOR RADIO & ELECTRICAL CO.

189 GLENFERRIE ROAD,
MALVERN VIC.

U 9354 — WM 1814

Chassis — Steel Cabinets —
Racks

Finished in black or grey crackle to specifications. Write to us, enclosing sizes, and a quote will be forwarded.

Major Power Transformers Wound to required Voltages

100 M.A. up to 600 Volts	29/6
150 M.A. up to 600 Volts	35/-
200 M.A. up to 1500 Volts	67/6
250 M.A. up to 1500 Volts	77/6
Filament Transformers	25/-

Major Ceramics

2-inch Ceramic Coil Former	5/-
1-inch Stand-off Insulators	2/-

Other sizes available. Write for free particulars.

A 33-1/3% discount is allowed to Amateurs on all Major Ceramics.

on 11.81 mc at good strength at 6 a.m. and good on 9.63 mc, but suffers from interference from GWO—the former being interfered with by another BBC, GWH. Schedule is: 9.63 mc (50,000 watts) 3—4.10 p.m.; 8—9 p.m.; 4—9 a.m., and on 11.81 mc (10,000 watts) 4—8 a.m.

Rex Gillett has some very nice verifications to his credit in the mail just received: XDY, Chapultepec, Mexico, 30.25m, saying his was the first report received from Australia. Power is 8 k.w. with antennae directed to South America. XDA is also operated from the same source on 20.65m.

Another first came from British Forces Network, Hamburg, 41.15 m. Power 50 k.w. Armed Forces Network on 49.34m, in a verification, mentioned their S/W transmitter is located in Munich and broadcasts all programmes from AFN-Frankfurt. Power is 50 k.w. and address, A.P.O., 757 U.S. Army.

Kuala Lumpur verified for 48.70 m., by stating they use a 1 k.w. R.C.A. transmitter in conjunction with a quarter wave delta matched dipole and is beamed S.S.E. to N.N.W. Signature tune is the Knightsbridge March. Power may shortly be increased to 7 k.w.

Miss Sanderson, of Malvern, Victoria, writes: "Conditions last month were quite good and reception in daylight hours was very consistent, but I cannot say the same for at present the noise level is very high, and listening is somewhat difficult. Some evenings the noise persists and I just give up in disgust; then on others the noise clears and the programmes are heard without interruption.

During the time of the full moon I always have good results with the Cuban stations. Veries have been coming along quite well, and a letter and programme schedule from Switzerland arrived. A card from The Near East Arab Broadcasting Service and a letter from 1st Lieut. W. Werner, from Balik-

papan, rounded off a nice list. I was given a call from Radio Saigon on June 9 in their session "Answering Listeners' Letters." This was in answer to a report sent them last January."

1946 VICTORIAN AMPLIFIER CHAMPIONSHIP

Conducted by Aust. DX Radio Club in conjunction with "The Listener In"

RULES

- (1) Entrance fee to be 2/6 and to accompany each entry.
- (2) The Social Committee of the A.DX.R.C. reserve the right to accept or reject any application.
- (3) The A.DX.R.C. reserve the right to publish or use any circuit used in this competition.
- (4) Four competent judges shall be selected to adjudicate at this competition.
- (5) The Judges' decisions shall be final and legally binding.
- (6) Entries must be in the hands of the Hon. Secretary and Treasurer on or before September 23, 1946.

GRADES

- (1) Open to all-comers, including commercially built amplifiers. No restrictions to power output used.
- (2) Open to all amateurs, with a limit of 20 watts power output, but excluding all commercially built amplifiers.
- (3) A single ended grade, using standard radio valves, which is open to amateurs only.
- (4) Open exclusively to active members of the A.DX.R.C.

The Social Committee of the A.DX.R.C. define an amateur to be (a) Any entrant under the age of 21 years.

(b) Or any entrant 21 years or over, not connected with the radio trade whatsoever.

The Grand Final to be held in the Melbourne Town Hall on approximately November 20 1946. All entries to be addressed to the Hon. Secretary and Treasurer, A. Canty, 100 Allison Road, Elsternwick, S.4., Melbourne, Vic.

UNUSUAL SCIENTIFIC INSTRUMENT RECORDED ATOM BOMB TEST

SO much depended on the atom bomb that when the scientists and military authorities gathered at the Bikini atoll in the Pacific recently, the world held its breath.

The audience at this gigantic spectacle of havoc did do more than study the explosion and its aftermath. They recorded the radiant energy and particles which were released when the atoms were shattered. The instrument chosen to register these effects is called the Geiger-Counter, one of the many new industrial X-ray devices being manufactured by Philips in U.S.A.

A recent issue of the well-known American magazine "Life," devotes several pages to this "classical scientific instrument." The magazine's simplified explanation tells us that the "heart of the counter is the Geiger tube, a glass envelope containing two essential parts and an inert gas. The parts are a wire and a metal cylinder . . . which have a delicate electrical balance between them. When a single ray or particle enters, the balance is upset and the tube sends out an electrical impulse. Some Geiger tubes count 100,000 particles a second."

The counter was invented in 1908 by a German named Hans Geiger for pure research in the atom, but since then it has become much more versatile. In addition to atomic particles it counts cosmic rays, gamma rays, X-rays and ultraviolet, all radiated by an atomic explosion."

Already the Geiger-Counter has a wide field of application as a research instrument and as an industrial tool. For example, it is used for analysing the chemical combination of crystalline and certain amorphous materials, pigments, welding rod fluxing materials, soaps, fibres, powder metallurgy, chemical process control, solid solution studies, and in other branches of chemistry and metallurgy.

STOP PRESS VK's GET PORTION OF DX BANDS

As from July 1, 1946, Australian amateurs are permitted to use a very thin slice of "Forty", and a half portion of "Twenty." This is partially in common with the rest of the United Nations, there having been drawn up, according to RS-GB, an agreement wherein all amateurs get their HF bands simultaneously.

As this is written, July 3, 1946, we have seen nothing in writing direct from the P.M.G. — at least, in Sydney — but a W.I.A. bulletin has been issued locally. This "opens" "Forty" to the extent of 7150 to 7200 K/cs. — a mere thin slice of 50 K/cs —!

"Twenty" is somewhat better off with half the band — 14,100 to 14,200 K/cs. The rub, perhaps pro tem, is that overseas amateurs, G's, ZL's, W's, etc., are more sensibly and leniently treated. *They* get most of the band widths—*some* get restoration of the whole pre-war allocations. Even if this *is* an interim arrangement, we fail to see why Australians should be, in Cinderella-like fashion, restricted in any measure not compatible with any Allied inter-service agreement. Because portion of the bands are made available is no reason for individual assumption of a chip on the shoulder attitude. Even if any personal "efforts" *had* been instrumental in getting a toe-hold on the DX bands, there can be no occasion for undue jubilation at a few crumbs from the table. This concession for July 1 was scheduled 6 months ago; was arranged by the Committee of Service officers appointed to confer on the subject at that time . . . and has nothing to do with any pressure from amateur sources. Cuts in the allocations were mooted and decided upon by that committee, but nobody could have expected in the outside world that "Forty" would be in for such drastic treatment . . . even temporarily. As it is . . . the VK can rejoice that at least he has a foot in the door of his old bands. Nevertheless, we cannot overlook a sense

of feeling that he has been rather shabbily treated by the gold braid, pips and wings . . . despite his sterling war service.

—D.B.K.

ABSORPTION METER

(Continued from page 14)

the "spotter", the better. Harmonic identification becomes easy once you have this instrument with enough reference points to check from. Any operating "tank" circuit to which the "Spotter" can be coupled will show the frequencies present as it is tuned through its range. Neutralisation of amplifiers becomes much more of a certainty with this form of indicator than the usual "pea-lamp and loop," and for such work a link-coupling is a decided help. If a small pick-up aerial is fitted to the top of L1, the "Spotter" can be used as a field-meter in the immediate vicinity of a radiating aerial.

Don't, however, expect readings hundreds of yards distant — a *micro*-ammeter is necessary for that. Feeder lines can be tested for standing-waves and the presence of R.F. is detectable in power lines, guy wires, etc. There are lots of uses for the "Spotter" around the experimental station — the one described is a valued accessory at my own station.

Finally, if you are short of 1 m.a. meters, and hesitate to allocate your spare one, a switch to cut the meter in your "Spotter" out of circuit, and an external pair of terminals, will permit the use of the meter for other purposes. Remember, though, this gadget *spots* frequencies — it doesn't measure close tolerances.

DIRECT-COUPLER

(Continued)

As shown, the circuit provides for diode-biasing of the second detector, giving best tonal quality, but having a characteristic that it will block up on extra strong signals. Before this occurs the set will give ample volume for home use. If desired, however, it is simple matter to arrange fixed detector bias in the normal way.

Speedy Query Service

(Conducted under the personal supervision of A. G. Hull)

G.S. (Aspendale) and others.

A.—There was an omission in the article on loud-speaker baffling by Mutton in the May issue. It was not made clear that the sizes shown on the diagram were for a vented enclosure baffle for a 15-inch speaker. Other dimensions for various speaker combinations are as follows: for a 12-inch speaker (or two 8-inch speakers) 12 x 22 x 31. For a 15-inch speaker (or two 10-inch speakers) the sizes are as given on the diagram on page 31 of the May issue. For an 18-inch speaker (or two 12-inch speakers) the sizes can be 14 x 27 x 35. In all cases the size of the vent can be as given on the diagram or of flatter shape, size 16 x 4-ins.

* * *

T.L.K. (Morrington) is worried about needle scratch with a new high-fidelity amplifier which he has just finished.

BARGAINS in Used Components

Single Gangs (mostly .0005 Pilot type)	2/6 ea.
Two Gangs. Assorted	3/6 ea.
Three Gangs. Assorted	4/6 ea.
Four Gangs. Assorted	5/- ea.
Audio Transformers—All ratios	2/- ea.
Audio Chokes—Some centre-tapped	2/- ea.
Vibrators (mostly Electronic 800 type)	1/6 ea.
I.F. Transformers (460 and 175 Kc.)	1/- ea.
Coils. Assorted on 1½" formers	3d. ea.
Speakers. 8-in. Permags—damaged cones, 6/- 4/-, 2/- ea.	
Cones. New, for Amplion 8" speakers	12/6 ea.

Freight Extra

HARVEY IVERS MANNING ST., TAREE N.S.W.

Full laboratory radio service available at three branches, TAREE (phone 137), GLOUCESTER (phone 152), & PORT MACQUARIE (phone 162)

FULL LISTS ON APPLICATION

A.—The better the high-note response of the amplifier the truer will be the reproduction of scratch. With good recordings and proper pick-up alignment the scratch should not be too pronounced and the ear should soon develop the knack of listening to the music and not the scratch. If, however, you really want to cut out the scratch it will be necessary to also cut some of the high-note response, such as with a condenser across the speaker, which is the crude way. A better way is to build up a special filter which will cut only the scratch frequencies and a small band of frequencies on each side, but this is not easy to design or build, and calls for a lot of individual experimenting with the actual amplifier with which it is used.

AIR MAIL POSTAGE

Many readers appear to have the wrong idea about air mail postage. The rate is 5d. per half ounce, plus ½d. war tax (at the moment of writing). This rate applies to periodicals as well as letters, and our issues weigh from 3 to 5 ozs. This means that the air mail postage on them is about 2/6½ to 4/2½ per issue. We mention this because many seem to be disappointed when they write for a back number and enclose a 5½d. air mail stamp.

W.L. (Sandringham) wants us to publish lists of licensed amateur stations.

A.—So far the lists have not been issued by the P.M.G.'s department, but as soon as they are available we hope to be able to publish the lists in full. It seems as though the lists may be issued within a matter of a few weeks.

* * *

P.B.A. (Allentown) has a broken-down vibrator unit which he proposes to return to the United States for repair.

A.—This would be a bit of a problem on account of present regulations. You would need to get an export permit, also an import licence for its return, and you would need to make special arrangements to obtain the necessary dollar exchange to pay

for the repairs. You would also need to have the unit despatched under customs supervision, as otherwise you would be billed up with customs duty on the unit when it was returned, whereas otherwise you will need to pay customs duty on the repairs only. It isn't by any means impossible to get over the hurdles, but we would think it would mean a couple of days time at the Customs House.

SERVICING

(Continued from page 20)

r.f.; the modulated oscillator output being adjusted to a suitable value in each case. Finally, the overall performance of the receiver should be checked from the aerial circuit.

By this means the fault may be traced from the audio frequency end of the set and the faulty stage located. The fault itself will be required to be discovered through measuring the voltages on the stage and replacing any suspected valve or component by one known to be good.

GENERAL COMMENTS

Some receivers have muting switches which may be left in the muted condition, consequently causing no reception. Wave-change switches (if any) should be changed from one range to another to see whether the trouble is on one range only. The tuning should be adjusted from one end to the other on each waveband, as the set may oscillate only at one end of a band. The tone control should be left in the "treble" position in case the condenser has broken down. The volume control should be left at "maximum" during testing.

FOR SALE

High-fidelity 7-valve 12-watt Public Address System, complete with pick-up, turntable, and large impedance-matching transformer, in self-contained cabinet. This outfit is brand new. Price £25.

For further particulars apply to:

LANCE S. HARRISON

Yengarie P.O., Maryborough,
Queensland



THE COUNTERSIGN OF DEPENDABILITY IN ANY ELECTRONIC EQUIPMENT

**HERE IS A RADICALLY IMPROVED
VERSION OF THE EIMAC
MULTI-UNIT 304TL TRIODE**

NEW NON-EMITTING GRIDS

NEW LOW-TEMPERATURE PLATES

The Eimac Multi-Unit triode 3-300A2 pictured above is a radically improved version of the original 304TL which has been establishing outstanding performance records for a number of years in both civilian and military equipment.

The use of Eimac developed, non-emitting grids, contributes greatly to its already high stability, efficiency and long life, and the new type plates enable it to operate at much lower temperatures.

One of its outstanding characteristics is its ability to handle high current at relatively low voltages. For example: as a class-C amplifier the Eimac 3-300A2 will handle 1200 watts plate input with only 2000 volts on the plate. Under these conditions, the valve will deliver a power output of 900 watts, with a driving power of only 36 watts. The chart at right shows driving power requirements vs. power output. The symbols P_p indicate plate dissipation. Further information will be promptly supplied without cost or obligation.

NEW TYPE
NUMBER
3-300A2

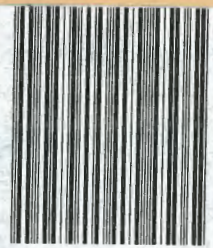

3 1508 01153401 8

ELECTRICAL CHARACTERISTICS

Filament:	Thoriated tungsten	
Voltage	5.0 or 10.0	volts
Current	25.0 or 12.5	amperes
Amplification Factor (Average)	12	
Direct Interelectrode Capacitances (Average)		
Grid-Plate	9.1	uuf
Grid-Filament	8.5	uuf
Plate-Filament	0.6	uuf
Transconductance ($I_b=1.0$ amp., $E_b=3000$, $e_c=-200$)	16,700 umhos	

FOLLOW THE LEADERS TO



EITEL-McCULLOUGH, INC., 1176 San Mateo Ave., San Bruno, Calif.

Plants located at: San Bruno, Calif., and Salt Lake City, Utah

Export Agents: Frazer and Hansen, 301 Clay St., San Francisco 11, Calif., U.S.A.

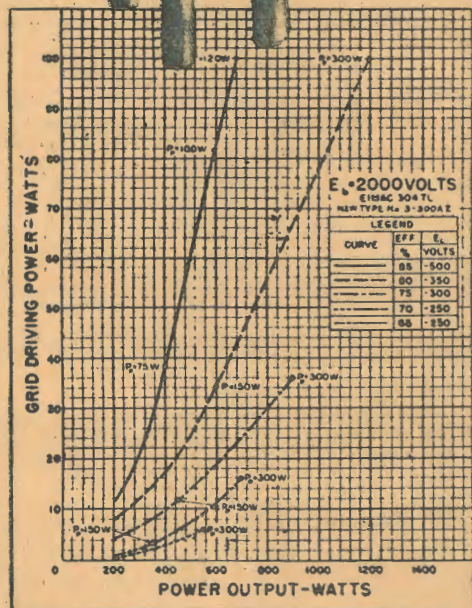

MORE THAN A QUARTER MILLION NEW RADIOS NEEDED YEARLY

...and not enough men to make them

Pre-war production figures reached 280,000 per year but civilian set manufacture virtually ceased DURING the war, so imagine the huge leeway to be made up!



RADIO needs YOU—Now is the time to act!

Every major set manufacturer is short of trained men and that goes for every other branch of the industry. Electronics and the civil adaptation of Radar are now being developed with great speed, but the cry is for more and more skilled men!

We are entering now a Radio age, an Age which has a place for YOU. Radio, a young industry which has made remarkable progress in the past few years, wants trained men urgently to fill vital positions. If you want security, prosperity, and a recognised status in the community, start training NOW.

TRAIN AT HOME, OR AT OUR BENCHES

A.R.C. offers ambitious men a sound proven course in Radio Engineering. Sound because it is the result of many years' successful operation, proven because hundreds of ex-students owe their present success to the College. You can learn with equal facility at home (by means of our correspondence course)

EARN GOOD MONEY WHILST LEARNING

You don't have to wait a year, or even six months, before you are ready to begin "cashing in." We will show you how to earn extra money almost from the word "go." Many students make £4, and up to £8, per week in their spare time whilst studying.

PREVIOUS KNOWLEDGE UNNECESSARY

You don't need a knowledge of Radio or Electricity—we'll give you all you need of both, in a simple, practical manner, that makes learning easy, presented, too, in such a way that you remember what you're taught and how to put that knowledge to practical use.

COSTS LITTLE

Think of this—for a few pence per day—actually less than many fellows spend on tobacco—you can prepare yourself for a man-sized job in Radio NOW.

NOW IS THE TIME TO ACT!

Send in today for my free book, "Careers In Radio and Television." It's a book no man can afford to miss! It shows you the steps you can take to get into Radio immediately!

RADIO IS STILL A NEW INDUSTRY GROWING FAST!



£8,000,000 was estimated prewar sales of radio receivers and parts. The next few years should see these figures doubled.

Pre-war Radio Set output reached an estimated 280,000. All records are expected to be broken in near future.

Even a 25 per cent. increase in set sales will mean openings for perhaps 1,000 more Radio dealers—Over 130 Australian Radio Stations employ a vast number of skilled personnel—a team of specialists which would probably be tripled with the advent of F.M. transmission.

GET THIS BIG FREE BOOK NOW!

To Mr. L. B. GRAHAM, Principal, Australian Radio College, Pty. Ltd., Broadway, Sydney. Phone M 6391-2.

Dear Sir,—I am interested in Radio. Please send me, without obligation on my part, the free book, "Careers in Radio and Television."

NAME

ADDRESS

AUSTRALIAN RADIO COLLEGE PTY. LTD.

Cnr. Broadway and City
Roads, Sydney.
Phones: M 6391, M 6392

