

# Radio World

1/-

JUL 10 ..... NO. 2

JULY 15 ..... 1945

## An Important Message to Buyers of Resale Rola Loud Speakers

To make the most efficient use of available materials and manpower, and to ensure you of maximum service, Rola has instituted these changes in sales policy:

1. The standardisation of the following speaker models: G12, K12, K10, K8, F5B, K5, G12 PM, 12/42, 10/42, 8/20, 6/12, 5/7 (or 5/9, whichever is available), 10/20 and 8/42 can be supplied to special order.
2. The limitation of fields and transformers to popular types.
3. The reference of all orders for resale Rola speakers and parts to distributors and wholesalers.

In these difficult times Rola is making every effort to keep the trade supplied with replacement speakers, and your co-operation along the lines indicated above will greatly facilitate the smooth distribution of supplies throughout the trade.



Listen regularly to the Rola News-reel, Sundays, 7.15 - 7.45 p.m., E.A.S.T., from 3XY, 2UE, 5AD-PI-MU-SE.

# ROLA

THE  
WORLD'S  
FINEST

# LOUD SPEAKERS

*W. Jones*

When civilian production is resumed, make sure that the radio set you sell is equipped with Rola Loudspeakers.

# Components by "CROWN"

CROWN components literally have everything . . . long life, rigidity, dependability, precision and appearance. That is why the various Fighting and Essential Services use Crown Components whenever they possibly can in all Radio Communication Equipment.

The exacting specifications demanded and so faithfully met by Crown are a tribute to their skilled workmanship, the result of years of manufacturing experience. The skill and experience of this organisation is at the disposal of those seeking better Radio Components.

CROWN are now manufacturing vital radio components for all branches of the Fighting Services. They are, nevertheless, assiduously planning for pre-eminence in post-war production.

*CROWN Components  
are accurate and dependable.*

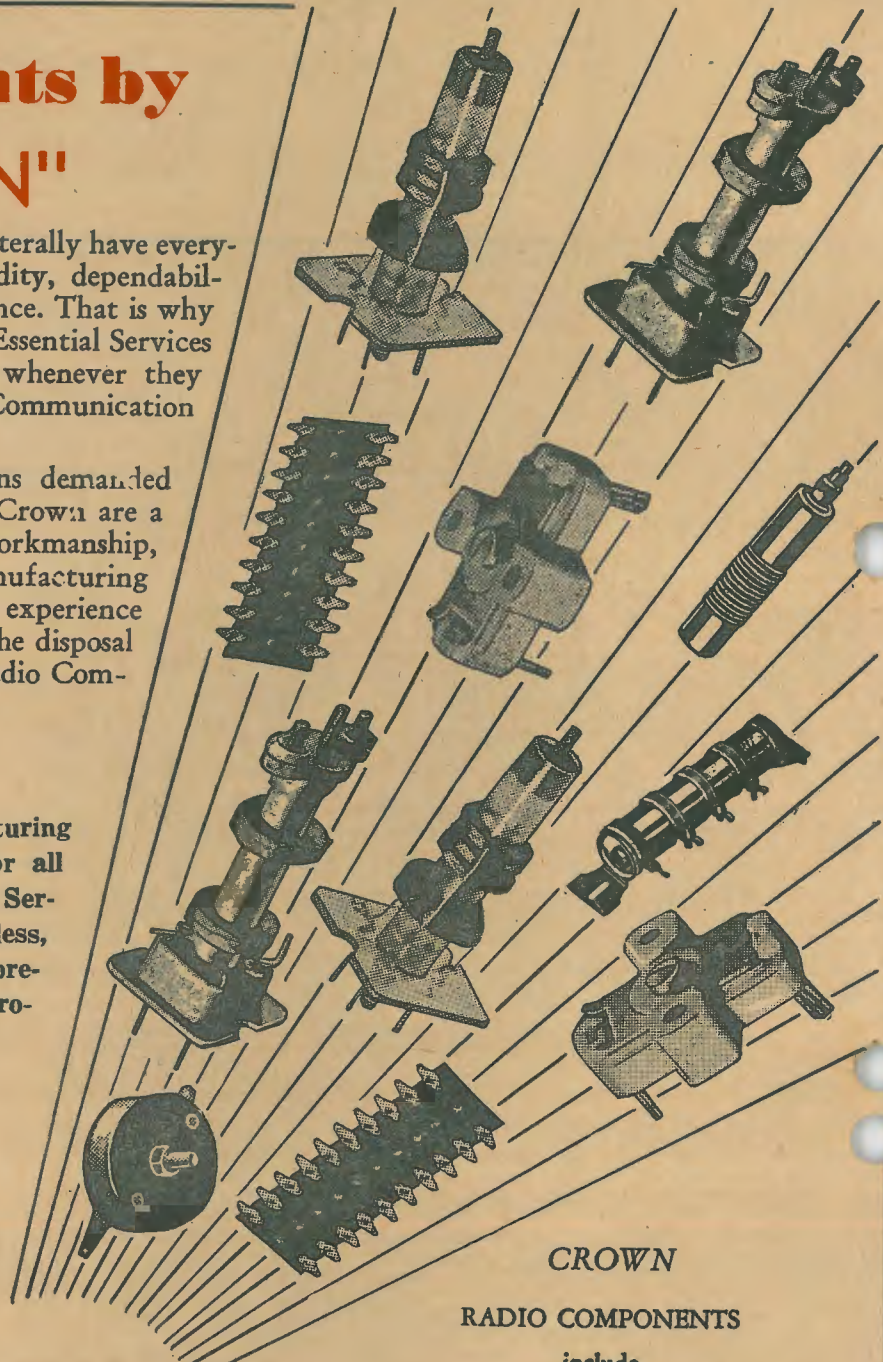

CROWN

RADIO COMPONENTS

include

TUNING COILS  
B/C & S/W COILS  
PADDERS  
TRIMMERS

I.F. TRANSFORMERS  
TUNING DIALS  
VOLTAGE DIVIDERS  
W/W RESISTORS

*Crown*   
**RADIO PRODUCTS PTY. LTD.**

51-53 MURRAY STREET PYRMONT — SYDNEY Telephone 44 92622 (a Livec)

# THE AUSTRALASIAN RADIO WORLD

*Devoted entirely to Technical Radio*

and incorporating  
**ALL-WAVE ALL-WORLD DX NEWS**

Vol. 10

JULY 1945

No. 2

## CONTENTS

CONSTRUCTIONAL—	
Wide Range Resistance and Capacity Meter .....	9
Tone Compensation Amplifier .....	20
TECHNICAL—	
Radio in America .....	5
Theory of Oscillation .....	17
Power Supply Filters .....	24
Straede's Amplifier Contest .....	24
A Short Course in Radio Fundamentals .....	26
Latest Technical Notes from New York .....	29
SHORTWAVE REVIEW—	
Notes From My Diary .....	30
New Stations .....	31
Loggings .....	32
The Service Pages .....	34

## EDITORIAL

The Wireless Institute of Australia has issued a "white paper" in the form of a list of draft proposals for post-war experimental radio.

The suggestion is made that there should be three types of amateur licences. The new licensee is to pass the usual type of examination and is then allowed to operate a power of 50 watts on morse code for the first six months. If all goes well he is then allowed to operate telephony, still on 50 watts for another six months. Having operated for twelve months without falling foul of any trouble, the ham is then allowed to step up to a "B" licence, which allows him to use 100 watts of power.

After operating under "B" class conditions for six months, and passing a test in Higher Radio Technology and Electrical Theory and morse code at 16 words per minute, the amateur operator will then qualify for a licence to operate an "A" class station at 250 watts of power.

Many other matters are covered, such as minimum ages for class "C" at 16 years and class "B" at 18 years, but the above outline gives a fair idea of the plan.

To us the scheme seems sound, except for that one sore point of ours, the morse code test. In both England and America there appears to be a trend to abandon the code test as having little use. War experience has shown that morse code communication is slow, unsatisfactory and generally considered quite out-of-date.

To some people the code comes easily, to others it means hundreds and hundreds of hours wasted in "swotting," ending in sad disappointment to the nervous candidate when he makes a few errors at the examination.

A. G. HULL.

★ PROPRIETOR —  
A. G. HULL

★ Manager —  
DUDLEY L. WALTER

★ Secretary —  
Miss E. M. VINCENT

★ Short-wave Editor —  
L. J. KEAST

For all Correspondence

★ City Office —  
243 Elizabeth St., Sydney  
Phone: MA 2325

★ Office Hours —  
Weekdays: 10 a.m.-5 p.m.  
Saturdays: 10 a.m.-12 noon

★ Editorial Office —  
117 Reservoir Street, Sydney

★ Victorian Advertising  
Representative —  
W. J. LEWIS,  
20 Queen Street  
Melbourne, C1  
Phone: MU 5154

★ Subscription Rates —  
6 issues ..... 5/3  
12 issues ..... 10/6  
24 issues ..... £1  
Post free to any address.

★ Service Departments —  
Back Numbers, 1/- ea. post free  
Reply-by-mail Queries, 1/- each

READY FOR  
TO-MORROWS'

RADIO!

*Designed in keeping with the latest trends in factory construction, the new R.C.S. Factory, 174 Canterbury Road, Canterbury, has now commenced production.*

RCS



Precision-built  
Radio Parts and  
Components . . .

In the modern factory illustrated above will continue to be manufactured the complete range of R.C.S. components so long and so favourably known to the radio trade and to amateur constructors.

Every new and improved technique of production has been incorporated in the precision machines installed. Although at present last-minute additions prevent public inspection of the factory, Mr. Ron Bell, Managing Director R.C.S. Pty. Ltd., will later announce the throwing-open of the factory to inspection by interested radio people.

*In the meantime write for the leaflet shown at left, illustrating the complete range of R.C.S. radio precision components.  
R.C.S. RADIO PTY. LTD., 174 Canterbury Road, Canterbury.*

# RADIO IN AMERICA

**A** FEW weeks ago I returned from America . . . It happened to be the fourth time I have landed on the shores of Australia. I never cease to be astounded at this marvellous country—every visit abroad convinces me that Australia is the best white man's country in the world.

By

**A. G. WARNER**

**Managing Director**

**Electronic Industries Ltd.**

**Melbourne**

in America than in the cities of Australia. Large buildings and flats with lifts and many other electrical appliances create a considerable amount of man-made static and the introduction of frequency modulation perhaps would be justified in America for that purpose only. In Australia, however, the average listener is not bothered much with static and therefore its introduction on that count would not, in my opinion, be justified.

The tone of frequency modulated receivers is excellent, and better

than that of our present amplitude modulation broadcasting receivers, provided, however, that the receiver throughout the radio stages, its detection stages, its audio amplification and its loud-speaker equipment is extremely good. In other words, frequency modulation delivers undistorted reception to the aerial of the receiver, but the receiver itself must be built throughout in such a way as to create no distortion itself over a large band. This can only be done at considerable expense and

(Continued on next page)

I am also continuously surprised at the little appreciation which the Australian public has for their country and their politics. I think the only cure for this—perhaps an impossible one—is that everybody should be forced to live in some other country for a short time.

I tried, during my visit to America, to talk to engineers and sales managers and to inventors employed in radio selling, manufacturing and developmental institutes. I tried to find out the direction in which Australia should tend to go in the post-war period in respect to broadcasting, frequency modulation and television.

I am satisfied that our present method of amplitude modulation broadcasting is as good, fundamentally, as anything which is likely to be developed in the near future.

I endeavoured to discover the answer to the question: Should we have frequency modulation in Australia? It might be desirable on three counts:

1. Because it reduces static;
2. Because it is capable of improving tone; and
3. Because it would provide more broadcasting channels.

Dealing with static in America, the static caused by weather is greater than in Australia and, in particular, static made by man is very much greater in the large cities



The skyscrapers of New York present a problem to television and high-fidelity reception, also to the window cleaner shown on the job in this snap taken by A. G. Hull.

**“THE  
NAME  
TO  
KNOW  
IN  
RADIO”**

*Radiokes  
Radiokes  
Radiokes*



**RADIOKES Pty. Ltd.**

P.O. Box 90  
BROADWAY - - - SYDNEY

**AMERICA**

(Continued)

receivers built to the necessary specification would be too expensive for the average listener.

In the United States, frequency modulation became a popular public requirement but at a low price, and consequently the industry prostituted frequency modulation by selling receivers which were capable of receiving frequency modulation reception but which gave no better tone in the ultimate than a good ordinary broadcast receiver because cost outweighed quality.

I think it should be borne in mind that, to the average person, the average Australian broadcast receiver today gives good tone and a slight increase in the quality of that tone is not perceptible to the person who is not musically educated.

**Frequency Modulation**

In simple language, frequency modulation—to obtain its full benefits in tone—will be expensive and the results not generally saleable.

The third count on which frequency modulation might be desirable is the possible increase in the number of broadcasting stations. At the present time the number of broadcasting stations per head of population is about equal to the number of broadcasting stations per head of population in the United States, so that we are reasonably well served at present. There may be good arguments as to why we should have some more broadcasting stations, but I would like to add a warning that if you permit a larger number of broadcasting stations to be erected, then the number of listeners, per station, will be smaller; the advertising value per station will be correspondingly smaller; and the sponsors of commercial programmes will not, therefore, be able to afford their present expenditure in individual programmes, under which circumstances, the general public appreciation of radio would be reduced.

There are, of course, disadvantages in the frequency modulation method of broadcasting. The range over which the signals can be received is small—not over fifty miles. The broadcasting stations for frequency modulated broadcasting signals—because they have an almost

visual range on the frequencies used—are subject to distortion due to hills, buildings, etc. In general, the additional cost of equipping new broadcasting stations, providing separate programmes with only the smallest benefit to the public, does not commend frequency modulation for broadcasting in Australia.

**Television**

I first saw television in 1928. During the last eighteen years it has, of course, improved, although it still has its troubles.

I think it is important to bear in mind that television has always been capable, since 1928, of being used for entertainment purposes, even if the pictures would have been subject to imperfections. It has not been technical impossibilities which have prevented Australia from enjoying television before this date. Why, then, have we not had television in Australia before? It appears that television transmission and recording is very expensive. The equipment for the transmitting station and the position of the station all tend towards high capital cost. There is, in addition, great difficulty in obtaining suitable programmes. It appears that there should be some new technique developed in the entertainment field for the purpose of television. The picture is still rather small—the largest I saw being about 10ins. x 5ins. Under these circumstances, a complete view such as one gets in talking pictures is not possible with any clarity, and there is the difficulty that small figures, hardly discernible on such a small screen, have very loud voices through the loud-speaker, which creates some element of unreality.

It is necessary, therefore, that the action should take place in what one might describe as close-up views and for this reason: Boxing does television well because the television recording apparatus can be spotted on to the boxers as they move around the ring, and this is one of the most popular forms of television entertainment. I believe that the people in the entertainment field will, in due course, develop a technique which will be entertaining, and I only mention this because it is necessary to understand that the mere adaptation of present forms of entertainment such as talking pictures is not ideal.

It will be necessary to employ

high-class actors, and this is costly and, at the present time, they can only be obtained from the motion picture industry, which has them under contract. Obviously the motion picture industry is not going to release their best programmes over television until such time as they have obtained the cream of the income through their normal channels and thereby recovered the bulk of their cost.

### Outdoor Aerials

For technical reasons it is difficult to receive more than two sta-

tions satisfactorily in a city such as New York. There are difficulties in erecting an aerial in such a position and facing in the necessary direction to get a perfect picture from more than two stations. There is considerable trouble from electrical interference—man-made. The tubes used for screening the picture do not enjoy a long life.

During the war, there has been a tremendous development and experience in the use of frequencies similar to those that will probably be used for television, and when peace arrives and the engineers of

England and America use this technique in the improvement and cheapening of television practice, I believe there will be a marked improvement.

Although the Americans and British have, at the present time, standardised frequencies and methods in their own countries, particularly the number of lines per picture and the number of pictures per second, I feel that these standards will be changed. Under these circumstances, and having regard to all the difficulties, I do not believe that we should, as an industry, push for the immediate equipment of television stations in Australia.

### Broadcasting To Stay

I believe that frequency modulation will have its greatest value in Australia as a channel for the reception of sound. Its disadvantages in regard to distance, etc., will be equal to that of the visual channel, and therefore it will not have the same disadvantage as against the amplitude modulation broadcasting methods. In addition, if the voice channel is used on a frequency modulation system on a frequency outside our present broadcasting range, we shall not have the attendant disadvantage of restricting our present band now used for amplitude broadcasting purposes.

### Television Problems

Television entertainment is quite different from broadcasting entertainment. To enjoy it, all lights have to be turned out and one has to sit prepared either to watch the programme continuously or to give it up altogether. It is not possible to play cards or read and partly enjoy it as it is with broadcasting. Consequently I cannot envisage these expensive programmes being put over continuously all day in the hope that somebody will not be at work and will be prepared to sit down, darken the room and enjoy the programme in an uninterrupted fashion. Television is not a substitute for broadcasting, nor is broadcasting a substitute for television, their only relation being that they both use electronic devices in the technique under which they are operating.



In 1936, A. G. Hull toured the world, investigating television. Here he is shown broadcasting over an American network, relayed by W2XAF and re-broadcast in Australia. Our Mr. Hull pointed out the problems of television, losing popularity in certain circles on that account, but his attitude has since been fully justified.

—Photo by the late Ross A. Hull.

# Your move next TO AEGIS

**QUALITY  
RADIO  
PARTS**

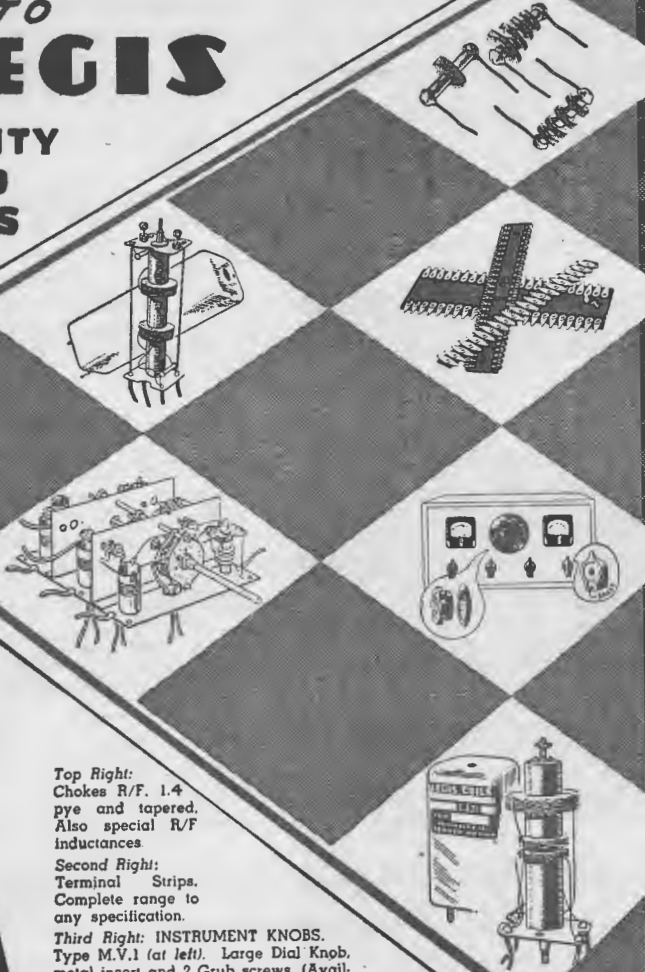

Illustrated above.

**Top left:**  
Transformers 1.F.  
Freq. 455 and 175  
K.C. or as specified

**Lower left:**  
Dual-Wave Kits with  
or without R/F. Stage  
Broadcast and S/W  
Bands to order.

**Top Right:**  
Chokes R/F. 1.4  
pye and tapered.  
Also special R/F  
inductances

**Second Right:**  
Terminal Strips.  
Complete range to  
any specification.

**Third Right: INSTRUMENT KNOBS.**  
Type M.V.1 (at left). Large Dial Knob,  
metal insert and 2 Grub screws. (Avail-  
able with or without flange).

Type M.V.2 (at right). Pointer with  
special brass insert and screw thread.  
**Lower Right: Coils** (all types). Broadcast  
Coils, Aer., Osc and R/F; also short wave

# AEGIS

## MANUFACTURING COMPANY

A Division of

J. H. MAGRATH PTY. LTD.

208 L. LONSDALE ST., MELB.

Wholesale Distributors for Aegis:

VIC. { HOWARD ELECTRICAL & RADIO P./L.  
REPLACEMENT PARTS PTY. LTD.  
LAWRENCE & HANSON ELECTRICAL P.L.

N.S.W. { RADIO EQUIPMENT P./L.  
DAVIS RADIO CO.  
GEO. BROWN PTY. LTD.

## B.B.C. SAVIOUR OF HOLLAND'S MENTALITY

"Nobody outside Holland can realise what the honest B.B.C. news meant to our people," said Christian Geudeker, editor of an illegal newsagency which operated in a private home in Amsterdam. "We call Stuart Hibbert, Alvar Liddell, and others 'the men who saved Holland's mentality.' There's a widespread desire to erect a memorial as a token of Holland's gratitude to them."

### Underground Papers

The newsagency organised by Geudeker was one of the most important assets of the underground press in Holland. It fed 50 underground papers throughout the country, and had its own secret telephone and teleprinter lines. Geudeker was formerly a noted sports editor, known in Netherlands sporting circles as "Kick."

When the Nazis took over the daily newspaper, for which he had worked, Geudeker soon became an active resister by hiding Jews in his house. His newsagency helped underground leaders by circulating quickly to the Netherlands population by means of the illegal Press, important information regarding German plans for deporting compulsory labour, etc. The newsagency obtained this information by tapping German telephone lines.

### Radios From R.A.F.

B.B.C. news, heard over a pocket-size radio dropped by the R.A.F., was also circulated. When it became impossible to use the telephone and teleprinter, the agency's distributing task became most difficult, but scores of women and girls solved the problem by acting as despatch riders, and covering from 50 to 100 miles on bicycles without tyres. As it was dangerous to carry lists, the riders had to learn the addresses by heart.

When asked by the Netherlands Press Agency "Aneta" correspondent, van Beers, which news sources he considered had been most useful, Geudeker replied: "Those straight from the horse's mouth," meaning those gathered by tapping German phone lines. "But the B.B.C. news broadcast proved the most valuable," he added.



# A WIDE-RANGE

# RESISTANCE AND CAPACITY METER

**T**HIS article describes a simple adaptor unit which, when used in conjunction with the balanced linear V.T.V.M. described in the April issue of the Australian Radio World, permits a very wide range of resistance and capacity measurements to be made. If components are properly selected, with values correct to 1/5 per cent, it is possible to make measurements to 1 per cent accuracy over the greater part of the measuring range, while with less accurate components, an error proportionate to the degree of accuracy of the components may be anticipated.

### V.T.V.M. Permits Wide Ranges

A vacuum tube voltmeter of high input resistance can be readily extended to make an ohmmeter capable of covering from zero to several

thousand megohms resistance, and several commercial instruments have been marketed which employ this principle. Due to the limitations of V.T.V.M. calibration, the degree of precision falls short of that provided by a simple ohmmeter. These are usually intended to provide measurements of insulation resistances, such as condenser leaks where absolute accuracy is not essential.

and an accuracy comparable with that of a better grade ohmmeter may be obtained. This is because changes in voltmeter sensitivity can be compensated completely in the zero ohms adjustment and there is no other source of calibration error.

### Use As An Insulation Checker

In the instrument to be described, quite good readings are obtained with resistance as high as 200 megohms, using a test pressure of 250 volts. Thus the instrument fulfills the same function as a 250-volt megger and may be used as an insulation checker, besides covering on the lower ranges all values of components ever encountered in radio work.

Since the A.C. section of the V.T.V.M. is also linear, except at

(Continued on next page)

By  
**Squadron Leader**  
**H. W. HOLDAWAY**  
**R.A.A.F.**  
East Sale, Vic.

However, with a V.T.V.M. of linear calibration, the only restriction on accuracy is the limit to which the meter scale can be read,

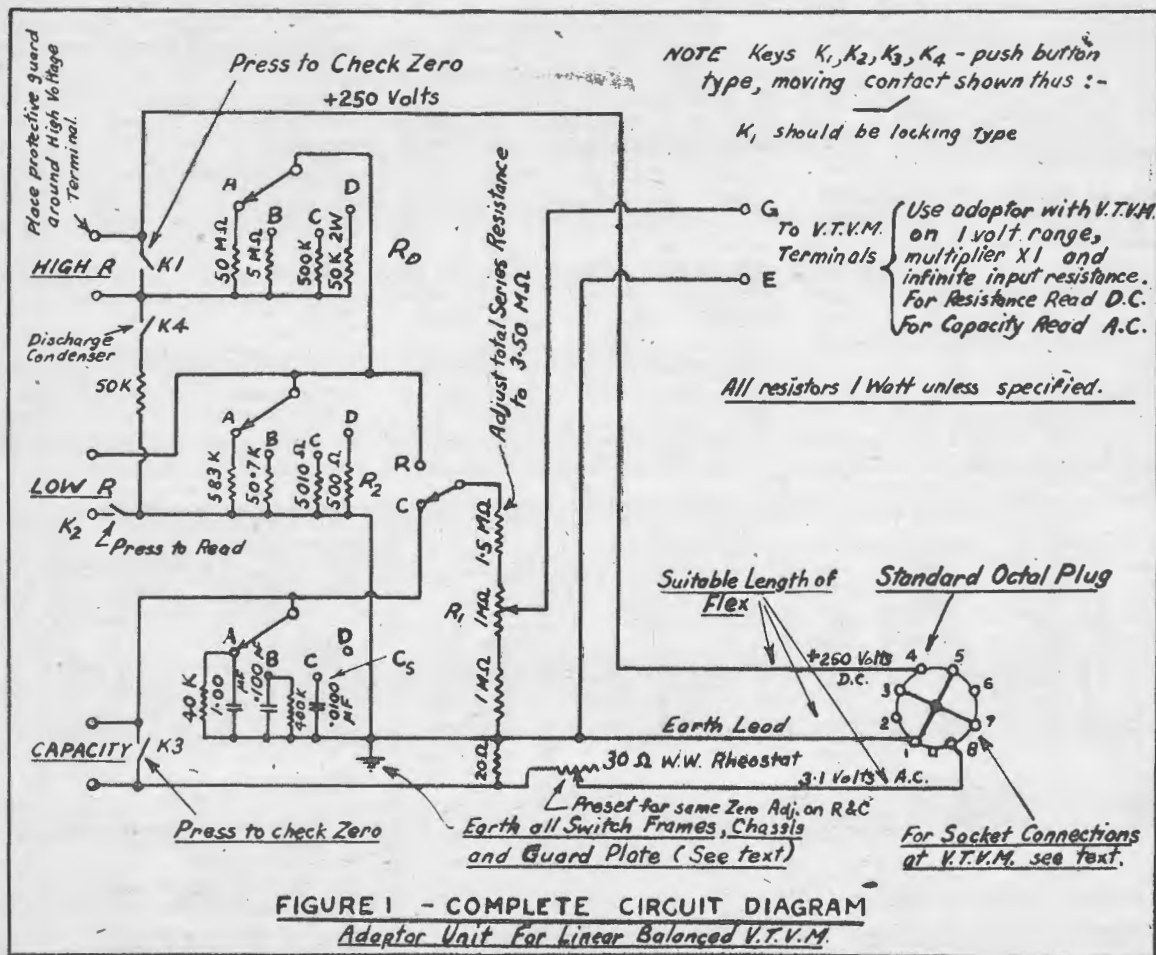

# CAPACITY METER

(Continued)

very small scale readings, it is possible to use this property for the measurement of capacities also over a very wide range.

## Ranges Covered

The ranges covered by this instrument are as follows:

Resistance: 0-200 megohms at 1% accuracy, and reasonable indications at 5000 megohms.

Capacitance: 100 picofarads to 5 microfarads at 1% accuracy, with readable indication at 20 picofarads and 50 microfarads.

## Low Capacity Range

On the low capacity range, stray wiring capacity may become comparable with the capacity being measured. Proper attention should be paid to the wiring to limit this effect as much as possible. The method of applying a correction for this will be described in the section dealing with stray capacity effects. Whilst the low capacity range cannot be as accurate as the high capacity section (due to waveform and frequency errors), it will be found very useful for checking small condensers for open circuits, and for checking the matching of gang condensers, etc.

## Tests on Electrolytic Condensers

Tests on capacity of electrolytic condensers cannot be made with the adaptor, but a leakage test (which automatically indicates open circuits if present) may be made and is sufficient for all normal purposes.

In testing high voltage type electrolytic condensers (that is, 350 to 2525 volts), the "HIGH R" terminals

should be used, whilst in the case of low voltage (12 to 40 P.V.) types, the condensers should be connected to the "LOW R" terminals. Damage would occur to the latter type if tested on the "HIGH R" terminals, whilst the test voltage would be inadequate to properly test the high voltage type if connected to the "LOW R" terminals. Range "D" should be used for all tests on electrolytics. Terminals should be labelled Pos. and Neg. to prevent damage in testing such condensers.

When electrolyte condensers are used to bypass resistors, the leakage resistance should be at least 20 times the value of the bypassed resistance.

## The Circuit

The complete circuit diagram of the adaptor is shown in Fig. 1, and the basic circuit elements for high resistance, low resistance and capacity measurements in Figs. 2, 3 and 4, respectively. The function of the circuit can be best studied by examining Figs. 2, 3 and 4, and subsequently relating these to Fig. 1.

## Resistance Measurements

In Fig. 2, V is a test voltage, Rx the resistance to be measured, R1 a potentiometer resistance. The function of R2 is concerned mainly with low resistance measurements, and its purpose is to adjust the resistance between point B and earth to a suitable standard value. The resistor Rd is used to drop the test voltage to a value suitable for application to the V.T.V.M. The combination of Rd, R1 and R2 forms a standard resistance against which the resistance Rx is compared. When the key K1 is depressed, the full test voltage is applied across this resistor network, and enables

a zero ohms adjustment to be made on the potentiometer R1, for full scale (i.e., 1 volt) meter reading.

The resistors R1 and R2 in parallel have a value R given by the expression—

$$R = \frac{R_1 R_2}{R_1 + R_2}$$

By choosing appropriate values of R2, R may be adjusted to suitable values for each of the ranges A, B, C and D, whilst R1 itself is unaltered.

The resistances RD and R in series constitute the resistance standard Rs, given by—

$$R_s = R_D + R$$

The accuracy of resistance measurements is directly related to the accuracy of Rs, and errors in the value of Rs will introduce proportionate errors in the values of all measured resistors. Fig. 1 gives the correct values of all components which go to make up Rs. R also should have the correct value as shown (and hence RD also) because this will ensure the zero position being the same on all ranges, and also because the accuracy of resistance measurements on the "LOW R" position is directly related to the accuracy of R.

Marked values of commercial resistors are not sufficiently accurate for the purpose, and series or parallel combinations should be built up to the required values, using a bridge or bridge-megger. Alternatively resistors which are accurate within the required limits may be purchased at somewhat extra cost. The I.R.C. type of metallised resistor is quite stable in value under normal conditions

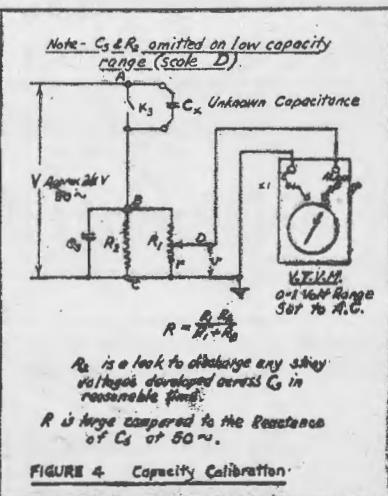
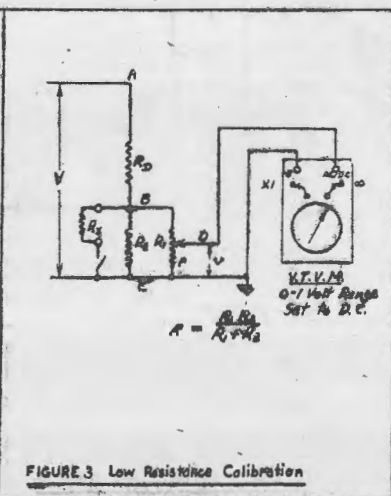
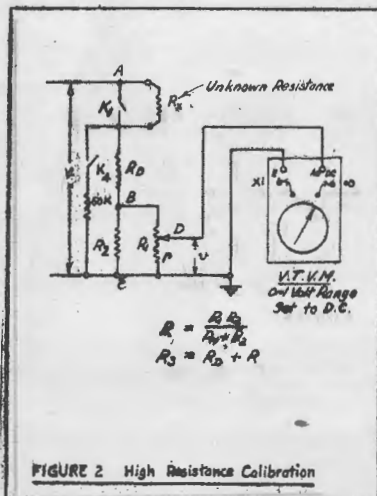

and will be found to be the most suitable type for the purpose:

### "HIGH R" Calibration

Turning again to Fig. 2, when Rx is in circuit the voltage appearing across BC is given by the expression—

$$\frac{VR}{Rs + Rx}$$

The voltage applied to the V.T.V.M. is (r/R<sub>1</sub>) times this value, i.e.,

$$V = \frac{VRr}{(Rs + Rx)R_1}$$

When Rx is shorted out by depressing the key K<sub>1</sub>, the voltage reading becomes unity, so that—

$$1 = \frac{VRr}{Rs R_1}$$

(since Rx becomes zero)

It follows that—

$$V = \frac{Rs}{Rs + Rx + Rd + R}$$

where V is the test reading, after the instrument has been adjusted to read one volt on zero ohms.

Since RD and R are known values and so also is Rs, it is quite a simple matter to calibrate the meter scale or prepare a calibration chart. It is only a matter of choosing suitable values of Rx and calibrating the corresponding readings v.

### "LOW R" Calibration

The basic circuit for measurement of low resistance is shown in Fig. 3. The key K<sub>1</sub> (Fig. 2) is made so that it can be locked in the closed position, thus connecting RD direct to the high tension supply. The circuit is adjusted for full scale reading on the V.T.V.M. with the key K<sub>2</sub> open. When K<sub>2</sub> is closed, thus placing Rx in parallel with the resistance R, a reading v is obtained.

The resistance between B and ground becomes—

$$\frac{Rx R'}{Rx + R}$$

and thus the voltage produced at B is equal to—

$$V \frac{Rx R}{(Rx + R) \left\{ RD + \frac{Rx R}{Rx + R} \right\}}$$

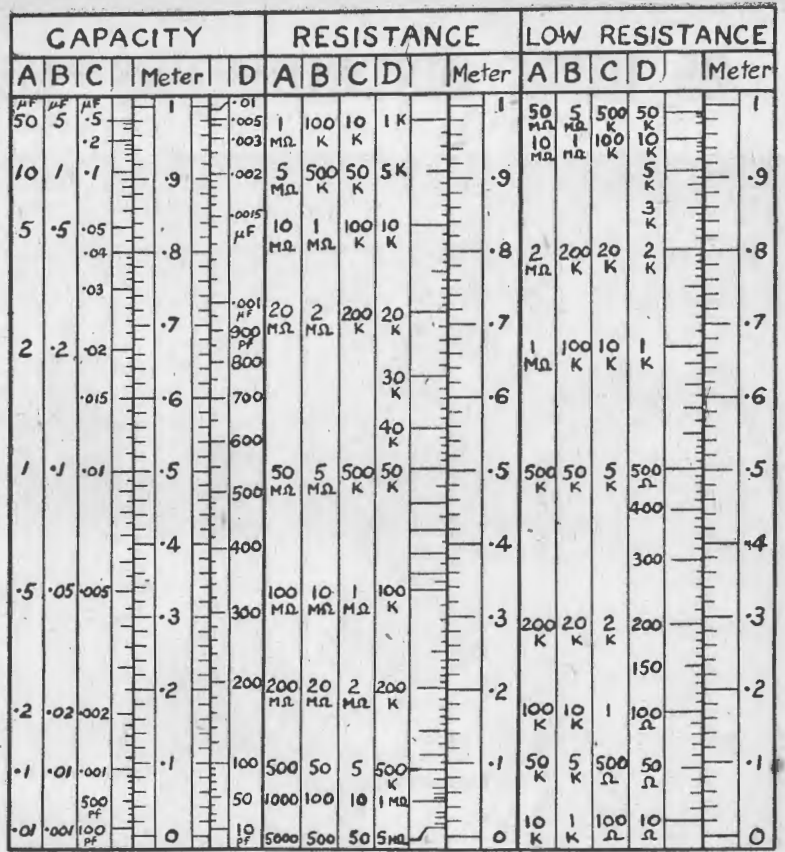

FIGURE 5 Calibration Chart

$$= \frac{VR}{RD \left\{ 1 + \frac{R}{Rx} \right\} + R}$$

The voltage v at the V.T.V.M. input is (r/R<sub>1</sub>) times this, thus—

$$v = \frac{VrR}{R_1 \left[ RD \left( 1 + \frac{R}{Rx} \right) + R \right]}$$

when Rx is infinite, corresponding to K<sub>2</sub> open circuited, v is equal to 1 while—

$$\frac{R}{Rx} = 0$$

thus—

$$1 = \frac{VrR}{R_1(RD + R)}$$

It follows that—

$$v = \frac{RD + R}{RD \left( 1 + \frac{R}{Rx} \right) + R} = \frac{R}{RD + R} + \frac{R}{RD + R} \frac{R}{Rx}$$

### Capacity Calibration

The capacitance check is just as simple to carry out as the High R measurement, and is almost as simple to understand. A simplified circuit diagram is given in Fig. 4.

Cs is a standard condenser, against which the unknown capacitance Cx is compared. The potentiometer R1 serves merely to make zero adjustments. It would be

(Continued on page 13)

# 25 KEEN DISTRIBUTORS "MEAN BUSINESS"

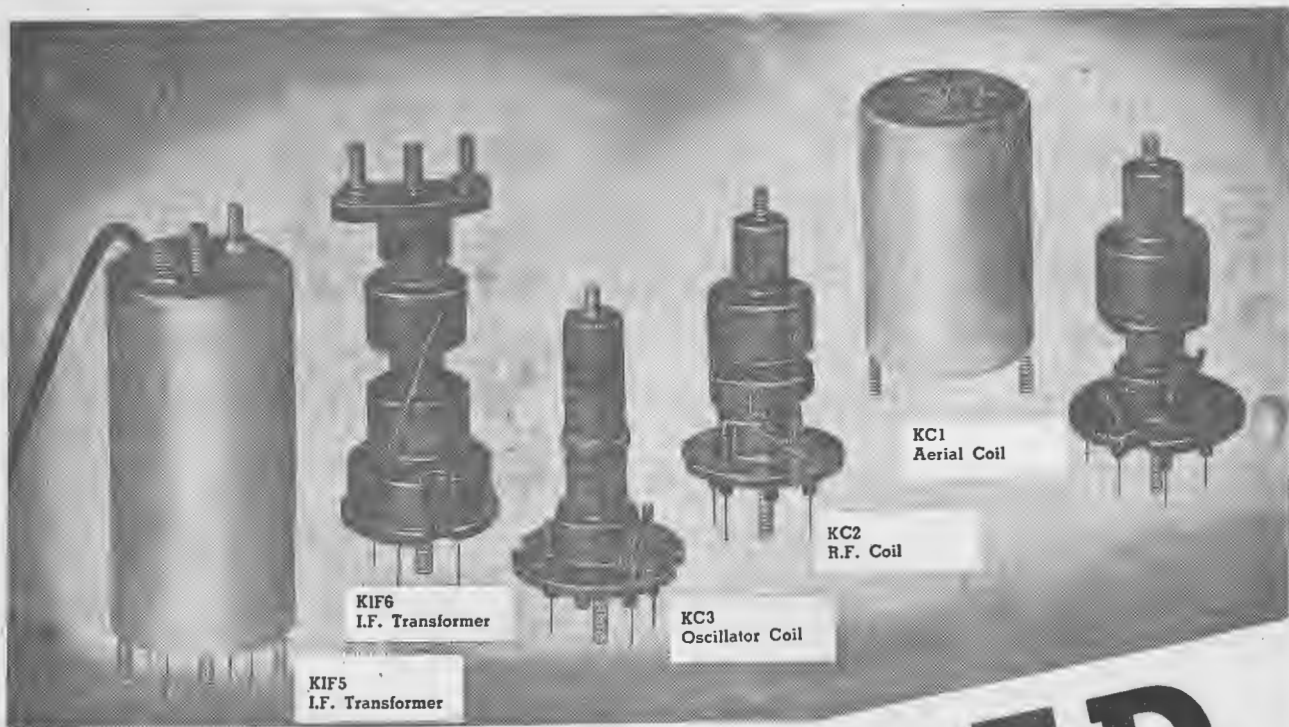

# PERMACLAD

Obviously our "Permaclad" Defence commitments come first, but we are doing all that is humanly possible to assist Radio Servicemen with essential replacement components.

Precision built  
"Permaclad" Coils  
and I.F. Units.

Incorporating   
DUST CORES

**NEW SOUTH WALES:**  
John Martin Pty. Ltd.  
Homecrafts Pty. Ltd.  
Bloch & Gerber Ltd.  
Lawrence & Hanson  
Elec. Pty. Ltd.  
Martin de Launay  
Pty. Ltd.  
Fox & MacGilly-  
cuddy Ltd.  
Electrical Service Co.,  
Newcastle.

**TASMANIA:**  
W. & G. Genders Pty.  
Ltd., Launceston,  
Hobart, Burnie.

**VICTORIA:**  
A. J. Veall Pty. Ltd.  
Homecrafts Pty. Ltd.  
Healings Pty. Ltd.  
Hartleys Pty. Ltd.  
**WEST AUSTRALIA:**  
Atkins (W.A.) Ltd.  
Carlyle & Co.

**QUEENSLAND:**  
E. H. Cantelin  
A. E. Harrold  
Homecrafts Pty. Ltd.  
Trackson Bros. Pty.  
Ltd.

**SOUTH AUSTRALIA:**  
A. M. Ralph  
Gerard & Goodman  
Ltd.  
A. G. Healing Ltd.  
Radio Wholesalers  
Ltd.  
Motor Parts & Ser-  
vice

## KINGSLEY RADIO PTY. LTD.

225 Trafalgar Street, PETERSHAM, N.S.W. LM 4466  
380 St. Kilda Road, MELBOURNE, VIC. MX 1159

# CAPACITY METER

(Continued from page 11)

feasible to omit  $C_s$  and compare  $C_x$  directly against  $R$ . However, the disadvantage of this method is that it depends for its accuracy upon correct frequency and true sine waveform of the applied A.C. voltage. On range D, the lowest capacity range, this method has been applied since greater sensitivity is provided.

The more satisfactory method, adopted on scales A, B, and C, is to make  $R$  so large in comparison with the reactance of  $C_s$  that its effect may be neglected. ( $R$  consists of the resistances  $R_1$  and  $R_2$  in parallel.) On scale C,  $R_1$  only is used, but on scales A and B,  $R_2$  is employed as a leak so that stray voltages picked up on  $C_s$  may be discharged in a reasonable time.

The potentiometer  $R_1$  is adjusted to give full scale reading with the unknown condenser  $C_x$  shorted out by the key  $K_3$ . When  $C_x$  is placed in circuit the voltage reading falls to the value  $v$ .

Where—

$$v = \frac{(r) \left( \frac{1}{C_s} \right)}{(R_1)} V$$

$$\left[ \frac{1}{C_x} \right] + \left[ \frac{1}{C_s} \right]$$

$$= \frac{rCxV}{R_1(C_s + C_x)}$$

When  $C_x$  is shorted out, the voltage  $V$  is applied direct to  $R_1$  and the reading 1 volt is obtained.

Thus—

$$1 = \frac{(r)}{(R_1)} V$$

It follows that—

$$v = \frac{Cx}{C_s + C_x}$$

Thus, if the value of the standard condenser is fixed and known, the readings  $v$  may be readily evaluated for a series of selected values of the unknown capacitance  $C_x$ . Since the value of  $R_1$  is limited to  $3\frac{1}{2}$  megohms, the lowest practical value of  $C_s$  is .01 microfarad, this being the value used on scale C. For scales A and B, the values of  $C_s$  used are 1 and .1 microfarads, respectively.

### Low Capacity Range (Scale D)

The circuit in this case is the same as that for scale C except that  $C_s$  is not in circuit, while  $R_2$  does not appear in the circuit.

The unknown capacitance  $C_x$  is compared directly with  $R_1$ , which thus should be made up to have the correct value of total series resistance. The calibration charts have been made up on the basis of  $R_1 = 3\frac{1}{2}$  megohms. To minimise unwanted stray capacity effects, care should be taken in wiring to make this short and reasonably rigid with adequate spacing from all grounded components.

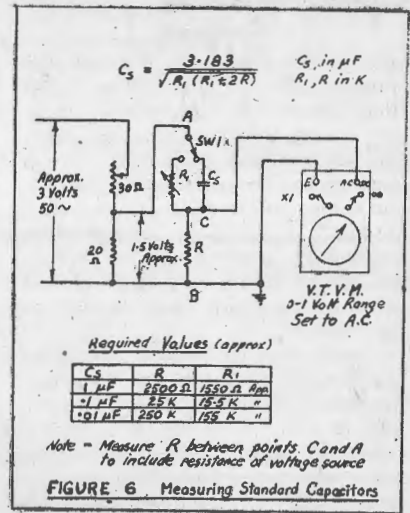

By similar reasoning to that already given, it can be shown that in this case—

$$v = \sqrt{\frac{R_1^2 C_1^2}{\left[ R_1^2 C_1^2 \right] + \left[ \frac{10^{12}}{4\pi^2 f^2} \right]}}$$

where  $R_1$  is in megohms and  $C_1$  is in picofarads.

For a frequency of 50 cycles, this expression reduces to—

$$v = \sqrt{\frac{(R_1^2 C_1^2) \times 10^{-7}}{(R_1^2 C_1^2) \times 10^{-7} + 1.013}}$$

### Calibration Chart

The calibration chart, Fig. 5, has been prepared from the formulae given above. If desired, the meter face itself could be calibrated in Indian ink for scales C and D in capacitance and scale D for High R and Low R. Quite a neat job can be made of it if the meter face is first very lightly swabbed with a rag moistened in alcohol, and a few trial runs are made before actually applying the ink to the meter face.

Successive ranges go in multiples of 10, so that no other scales than the above need be shown. Even so, there is a likelihood of cluttering up the meter face with scales, and the preferred arrangement is to mount the calibration chart (Fig. 5) on the panel of the adaptor unit.

### Preparation of Standard Condensers

The accuracy of capacitance tests depends upon the accuracy of the

(Continued on next page)

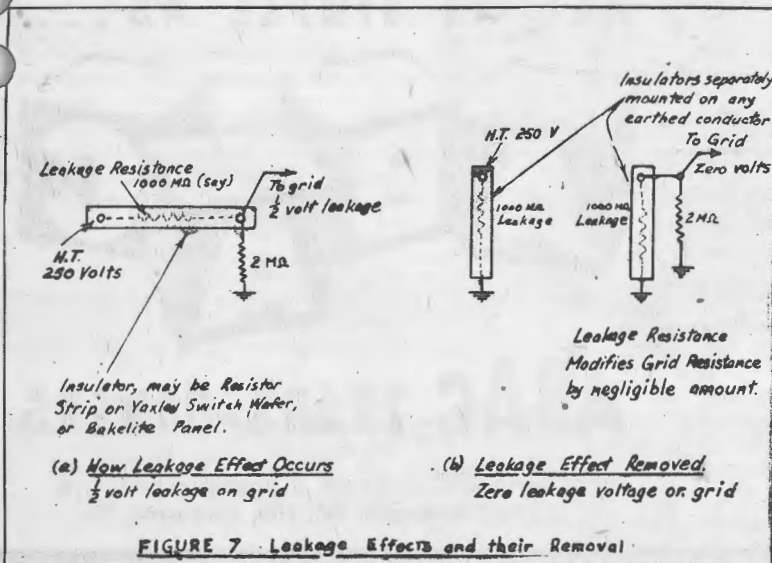

## CAPACITY METER

(Continued)

standard condensers Cs used for ranges A, B and C. It will be found that paper-type condensers generally nearer the marked values, than are the moulded mica type. If one has access to a capacity bridge, condensers of the desired value may be easily made up or, if preferred, condensers selected to be within, say,  $\frac{1}{2}\%$  or better, may be purchased at somewhat higher cost direct from the makers.

An alternative method of checking the values of the standard condensers is described below. Generally it will be better to select a condenser slightly below the correct value and make this up to the correct value by adding a smaller capacitance in parallel. If a few condensers are available it will usually be found possible to obtain suitable combinations, or perhaps even one that is just right.

The circuit for condenser checking is given in Fig. 6. The V.T.V.M. is used on the 1 volt range with the multiplier selector on x1 and the

input resistance selector on infinity. The resistor R should have roughly the same reactance as the condenser under test at 50 cycles per second. Thus 2500 ohms is about right to measure 1 microfarad. The value of R as used should be accurately known in each case.

The applied voltage is adjusted to approximately 1.5 volts at 50 cycles per second. The V.T.V.M. reading is noted when Cs is in circuit. On switching R<sub>1</sub> into circuit instead of Cs, the voltage reading should be brought to the same value by adjusting R<sub>1</sub>. A check reading should be obtained on Cs just in case the supply voltage has changed.

The reading being the same in each case, the total impedance is the same in both cases. Therefore—

$$R + R_1 \sqrt{R^2 + \frac{1}{(2\pi f C_s)^2}}$$
from which the formula for 50 cycles is obtained,

$$C = \frac{3.183}{\sqrt{R_1(R_1 + 2R)}} \text{ microfarads at 50 cycles/sec.}$$

In this circuit C is in the microfarads and R and R<sub>1</sub> are measured in thousands of ohms.

Suitable values of R and R<sub>1</sub> are shown in the table on Fig. 6. R and R<sub>1</sub> should be measured on a suitable bridge if this is available. If the resistance measuring section has been made up of accurately determined components, R and R<sub>1</sub> could be carefully measured on scales C, B and A, respectively, of the low resistance section, with an expected accuracy a little better than 1%.

### Leakage Tests on Condensers

With the larger condensers, an excessive time is taken to change up through several megohms resistance, and this would take an unduly long time. This may be overcome by the key K4 (Fig. 1), which, when depressed, enables the condenser to be changed up to the test voltage through a 50K resistor. The insulation reading is subsequently with K4 open.

### Elimination of Leakage Effects

In the high resistance grid circuits of the V.T.V.M., leakage from high voltage points can produce undesir-

# Transformer Problems

ARE AS SIMPLE AS ...



## ABAC TRANSFORMERS

—a product of TRIMAX TRANSFORMERS  
DIVISION OF CLIFF & BUNTING PTY. LTD.  
29-35 Flemington Rd., Nth. Melbourne, Vic.

Victory will transform our transformer supply position, but, until then, we regret we can meet only Defence requirements of these well-known ABAC lines ...

- Air-cooled power transformers up to 2KVA.
- Small-size current transformers for rectifier instruments.
- Audio and carrier frequency transformers on silicon steel or nickel alloy cores.
- 11, 16 and 31 point switches.
- Custom-built sheet metal.

able effects. Such effects could be obtained, for example, if high voltage points are connected to a common resistor strip mounting (or possibly a Yaxley switch wafer), together with grid circuit elements. Such effects can be overcome completely by mounting high voltage points and grid circuit points on separate insulated supports, the latter being mounted individually on the earthed chassis or metalwork.

Referring to Fig. 7, it is seen that the resistor strip has a resistance of 1000 megohms and, due to the leakage current of  $\frac{1}{2}$  microamp, a voltage of approximately half a volt (or half full-scale deflection) can be obtained at the grid circuit. If the high voltage point and grid lead are mounted on separate insulated terminals, the effect is removed. Similar effects are possible when applied voltage is A.C. in character and may be accentuated by capacity coupling between the A.C. voltage point and the grid circuit. Generally, the greater the resistance in the grid circuit the greater is the possibility of unwanted leaks or pickup unless special precautions are taken. The wiring of the V.T.V.M. itself should be checked to make sure that no arrangement such as in Fig. 7a is present.

In the adaptor circuit, it will be seen that the various terminals are characterised by various potentials as follows:

High R: One terminal at H.T. pos. One terminal at grid potential, except when under test.

Low R: Both terminals at grid potential.

Capacity: One terminal at grid potential. One terminal at A.C. voltage.

If circuit is connected up exactly as shown in Fig. 1, it will be seen that all switch contacts are at grid potential and if the switch frame is earthed, no leakage effects can be produced here.

One method of bringing out the terminals is to use an earthed metal panel as a guard plate and separately bush all insulators as well as earthing all switch frames.

An alternative method is to mount terminals on a sectionalised bakelite panel, the latter being mounted on an earthed guard plate. Actually it is only necessary to keep terminals at grid potential away from terminals of A.C. or H.T. voltage. The

latter may be mounted on a common strip, without any ill effects or they can be separated if preferred. The separate panels carry the different terminals and leakage currents which could upset the operation of the equipment are carried harmlessly to earth by the guard plate.

A suitable layout using this arrangement is shown in Fig. 8.

#### Modifications to the V.T.V.M.

A few modifications only are required to make the V.T.V.M. suitable for use with the adaptor. A standard octal socket should be mounted at any convenient position on the voltmeter chassis, and is used to supply test voltages to the adaptor unit. Leads from each side of  
(Continued on next page)

**IRC RHEOSTATS**

IRC ALL METAL RHEOSTATS are made in 25-watt and 50-watt sizes. Though small in physical dimensions, the unique all metal construction of these Rheostats results in operating temperatures being reduced to almost half that obtained with the conventional types of rheostats. In addition, it permits operation of the Rheostat at full load in any portion of the Rheostat down to 25% of full rotation, without exceeding the normal temperature rise by more than 30 C.

Sole Agents for Australia:

**Wm. J. McLELLAN & CO.**  
BRADBURY HOUSE, 55 YORK ST., SYDNEY • PHONE BW2385

# CAPACITY METER

(Continued)

the 6.3-volt (centre tap earthed) filament winding are taken out to pins 2 and 8. Pins 1, 3, 5 and 7 are earthed. Pin 4 is connected to the pos. 250-volt point and pin 6 to the -50-volt point.

The octal type socket and plug connection is used so that another type of adaptor unit (to be described in the final article of this series) may be employed. This unit requires 6.3 volts A.C., + 250 volts earth and, - 50 volts leads.

In connecting the 6.3-volt winding to the outlet socket, make sure that the 2½-ohm resistor in series with the 6F8G filament is **not** connected in series with the leads to pins 2 and 8. These should connect direct to the 6.3-volt transformer winding or the 6B6G filament pins, whichever is most convenient.

## Accuracy Limitations of the Equipment

Assuming all components are of the correct value, this instrument (in common with all simple ohmmeters) will introduce errors due to inability of an observer to read more accurately than, say, 1/10th of a minor scale division (i.e., .002 of a volt for 1 volt full scale). The effect of this is most pronounced at the ends of the scale where the calibration marks are cramped. Thus it is desirable, wherever possible, to select a range such that the value being measured gives a reading between 1/5th and 4/5ths of the full scale. The errors introduced at various scale readings are shown clearly in Fig. 9, where it will be seen how rapidly errors increase outside the above range limits.

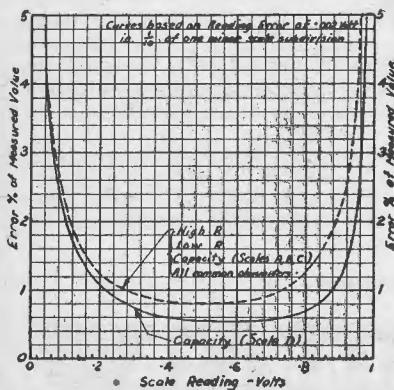

FIGURE 9 Ohmmeter Errors

## Setting Up the Equipment

The V.T.V.M. should always be used on the 1-volt range with multiplier x1 and input resistance set to infinity. The V.T.V.M. zero should be checked before using the adaptor and then the method of adjustment on individual readings follows the normal method used with any ohmmeter.

When the adaptor is first constructed, the 30 ohm wirewound rheostat should be set so that the same position of the zero adjust potentiometer R<sub>1</sub> is applicable both to resistance and capacitance measurements. After this rheostat has been set it needs no further adjustment.

## Stray Capacity Effect

When using scale D to measure low capacities, it will be realised that the instrument measures the combined capacity of the unknown C<sub>x</sub> and the stray capacity C<sup>s</sup>. The latter should be subtracted from all readings to obtain the true value of C<sub>x</sub>. To determine C<sup>s</sup> obtain two .0001 microfarad condensers and take a reading of each on the adaptor and V.T.V.M. If C<sub>x1</sub> and C<sub>x2</sub> are the true values, the instrument will read—

$$C_{x1} + C^s$$

and

$$C_{x2} + C^s$$

If now the two condensers are connected together, the combined capacity will be C<sub>x1</sub> + C<sub>x2</sub>, but the instrument will read C<sub>x1</sub> + C<sub>x2</sub> + C<sup>s</sup>. If this reading is subtracted from the apparent capacity of the combination, which is—

$$(C_{x1} + C^s) + (C_{x2} + C^s) - (C_{x1} + C_{x2} + C^s) = C^s$$

the result will give the value of C<sup>s</sup>.

A value in the vicinity of 30 pf. was obtained by the writer. On applying this correction, consistent results were obtained with different condenser combinations in parallel. The actual value will depend upon the layout and wiring of the unit as constructed.

It will be seen that in measuring small condensers, the leads should be kept small and well spaced, preferably connecting the condenser directly between the capacity meas-

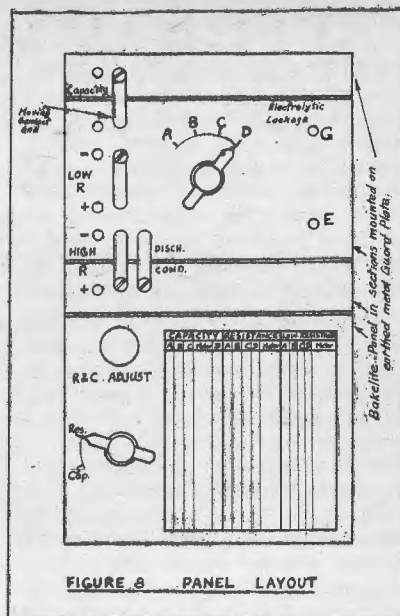

FIGURE 8 PANEL LAYOUT

uring terminals, since the capacity between the wires will be included in the circuit.

## Conclusion

This instrument has been checked on resistances and condensers of various types, and within the accuracy limitations (Fig. 9), it agrees with readings taken on a bridge.

Careful measurements of components is essential if the full potentialities are to be realised. However, if approximate indications only are required, 5% tolerance components could be used. In this case the zero adjustment will need re-setting on each position of the range switch.

A third and final article in this series will describe two simple voltmeter probes which, used as adaptors with the linear V.T.V.M., make possible the extension of A.C. voltage readings to radio frequencies. If a 954 acorn pentode is available, the frequency range may be extended to cover from 50 cycles to 30 megacycles. Voltage ranges covered are 0-1, 0-10 and 0-100 volts with a linear scale over the whole range.

Readings are peak reading compared with the average reading A.C. section of the linear V.T.V.M. already described.



# THEORY OF OSCILLATION

THE radio valve operated as an oscillator is an integral part of modern radio communication. It is the primary stage of valve transmitters; it provides a frequency for the mixer stage of a superhet and, as a B.F.O., makes C.W. signals audible. A similar principle is involved in the reaction receiver. Many oscillator circuits have been evolved but all must observe certain similar conditions.

## Damping

Oscillations once set up in a resonant circuit would continue indefinitely if it were not for circuit losses which are said to "damp" the oscillations, if the condenser in Fig. 1(a) were charged and then allowed to discharge through the inductance damped oscillations similar to that in Fig. 1(b) will be produced and can be seen that the amplitude of each proceeding cycle diminishes until all the energy has been expended in overcoming circuit losses. This may be likened to a pendulum to which no more energy is applied after the initial impulse, each swing becomes less until it finally returns to its position of rest, the energy being expended in overcoming such things as air resistance. We all know that in a pendulum clock there is a device that applies energy, or a "kick" at the right instant to compensate for the losses, thus each swing of the pendulum will be of the same magnitude. If the switch in Fig. 1(a) were closed at the instant the energy from the battery assists that of the oscillatory circuit, the "kick" would be provided; thus the circuit losses would be compensated for and a series of undamped oscillations, similar to Fig. 1(c), could be generated continuously. The difficulties associated with such an instrument would be immense if it were not for the amplifying properties of the thermionic valve practically any of which is capable of generating undamped oscillations in a suitable circuit.

Enough energy is fed back from the output circuit of the valve into the resonant input circuit, so it will assist the oscillations and is of such magnitude to compensate for the circuit losses; thus oscillations will

be maintained. The losses of the resonant circuit are considerably less than the A.C. energy in the output circuit, so it is only necessary to feedback a small portion of it; the rest may be used for whatever purpose it is required. As this device supplies its own exciting voltage, it is known as a "self-excited oscillator," and, when correctly operating, converts direct current into an alternating current, the frequency of which is determined by the circuit constants.

## Coupling Factors

The efficiency of the output or plate circuit of an oscillating valve is the ratio of the A.C. output to the D.C. input and, like most devices, it is desirable to obtain maximum efficiency, and with this object in view the feedback or exciting voltage must have the correct magnitude and phase. The magnitude of the voltage is adjusted by varying the degree of coupling between the anode and grid circuits which should be arranged as to supply only sufficient energy to overcome the circuit losses. The anode load

of this circuit consists of a parallel connected inductance - capacity resonant circuit, in which state, acts as a pure resistance, so the voltage developed across it will be 180 degrees out of phase with the grid voltage. It is obvious that the voltage returned from the output circuit to the grid circuit must undergo a phase shift to assist the oscillatory currents. This is usually carried out in the coupling between the two circuits and is known as "positive feedback."

The action of a simple oscillator as shown in Fig. 2(a) will now be considered. A resonant circuit LC is connected across the input (grid and cathode) of an amplifying triode valve. To L is inductively coupled the feedback winding. The current flow will be considered in this operation, i.e., from positive to negative as opposed to the electron flow.

When the anode current is switched on—position 1, Fig. 2(b)—the valve becomes conductive and

(Continued on next page)

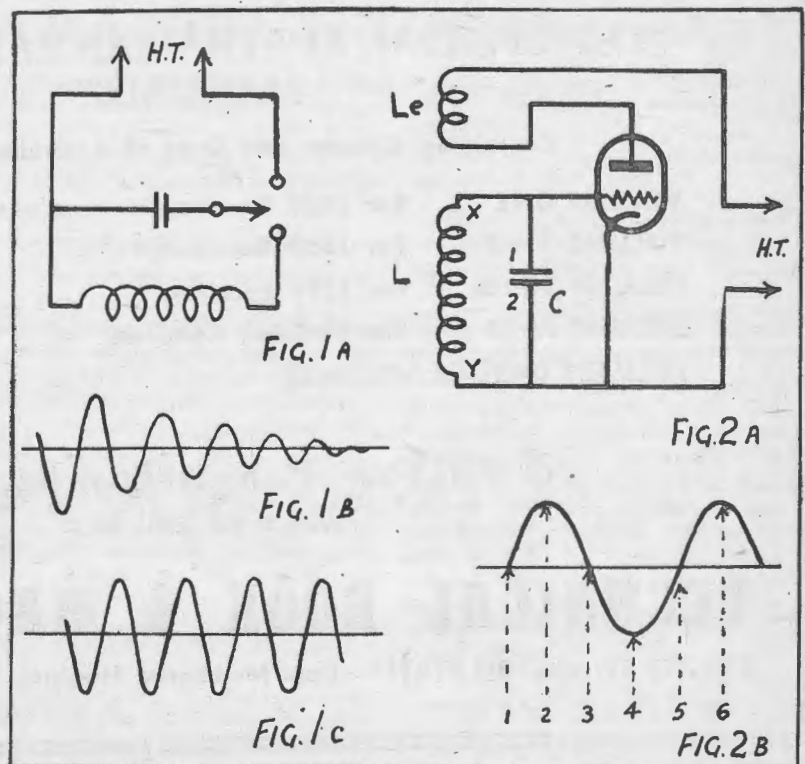

## OSCILLATION

(Continued)

there will be a current surge through the feedback winding,  $L_e$ , the inductance of which will oppose this current, so it will be of an increasing nature, which will induce an EMF across  $L$ . The two inductances are so wound that end X will be positive and Y negative. This will cause the grid to become positive with respect to the cathode increasing the anode current, which causes an increasing current through  $L_e$  and by the same action as before, increasing the positive potential of the grid. This would continue indefinitely if it were not for the fact that a point is reached on the valve characteristic where an increase in the grid potential will not produce an increase in anode current and when this point is reached the current through  $L_e$  will cease to vary—position 2, Fig. 2 (b). However, condenser C has become charged during the operation—plate 1 positive, plate 2 negative

—and will now discharge through  $L$ ; so the potential across the condenser will be reduced, making the grid less positive, causing a decreasing current through the valve, and a consequent one through  $L_e$ , which will then induce an EMF in  $L$  with an opposite polarity to that first induced—X negative, Y positive—which will assist the discharge of the condenser, and when discharged—position 3, Fig. 2(b)—the action of  $L$  will take over and still continue to increase the negative charge on the grid and will continue to do so until the grid is so negative that the valve becomes non-conductive and once again the current through  $L_e$  will not be varying—position 4, Fig. 2 (b)—and there will be no induced current in  $L$ , so the condenser, which once again has become charged, now in the opposite direction—plate 1 negative, 2 positive—will discharge through  $L$ . Thus the negative charge applied to the grid by plate 1 will decrease and the valve will once more be conductive, and the in-

creasing current flowing through  $L_e$  will induce an EMF in  $L$  in a direction as when the anode current was first switched on, thus assisting the discharge of C, when discharged—position 5, Fig. 2(b)—a complete undamped cycle will have been produced and the action of  $L_e$  and  $L$  will once again take over and make the grid more positive—position 6, Fig. 2(b). This action will continue to produce undamped oscillations as long as suitable conditions exist.

The explanation just given does not claim to be a comprehensive one, as several other factors should be taken into consideration but have been ignored for the sake of simplicity.

### Biasing Systems

Normally thermionic valve oscillators are operated similarly to class C amplifiers and the grid is biased to two or three times cut-off value. To obtain this bias, either a battery, grid-leak or a combination of both may be used. If a battery is used it may be necessary to provide

Stocks Are Now Available of the Full Set of

## “THE OFFICIAL AUSTRALIAN RADIO SERVICE MANUALS”

Containing Circuits and Data of Australian Receivers

VOLUME ONE	For 1937 Receivers	.....	15/-	9d.	postage
VOLUME TWO	For 1938 Receivers	.....	15/-	9d.	..
VOLUME THREE	For 1939 Receivers	.....	15/-	9d.	..
VOLUME FOUR	For 1940/41 Receivers	.....	15/-	9d.	..
FULL SET OF FOUR VOLUMES		.....	£3	2/-	..

For All Your Technical Book Requirements  
Write or call to

# TECHNICAL BOOK & MAGAZINE CO.

279-299 SWANSTON STREET (Opp. Melbourne Hospital)

MELBOURNE

a means to start the circuit oscillating, as the grid is so negative no anode current will flow. This may be done by shorting the bias battery for an instant. Another disadvantage of this system is that if the anode H.T. is altered it becomes necessary to alter the grid bias.

### Automatic Bias

Grid-leak bias, or, as it is sometimes known, automatic grid bias, as shown in Fig. 3(a), when suitably designed will automatically provide the required bias and is self adjusting if the anode H.T. is altered, such as when it is desired to increase the power output from the valve.

As the valve is operating in class C, it will be driven positive for a small portion of each cycle—Fig. 3(b)—and when in this condition it will attract a few electrons to its surface which will flow through the external circuit back to the cathode, which is equivalent to a current flow from the cathode to the grid via the external circuit and will charge the condenser  $C_x$  and will continue to do so until the charge is accumulating in the condenser just as fast as it is leaking away through the resistance  $R$ . So a steady negative bias is applied to the grid.

### Capacity Factors

The resistance  $R$  must not be too large, for if it is it will produce a bias that is so negative oscillations will stop. Also, if the condenser is too large in capacity, oscillations will periodically cease and is due to "blocking," which means that the bias voltage developed by the resistance will charge the condenser faster than it can discharge through the resistance. Thus, when the condenser is charged it will cause the grid to become sufficiently negative to prevent the circuit oscillating. When the condenser has the potential reduced across its plates sufficiently, by discharging through the resistance, a consequent reduction in negative bias will follow, and the circuit will again oscillate. Reducing the capacity should not be overdone, as it will then offer an impedance to the oscillatory currents.

If something should occur in the anode circuit to stop the oscillations when using automatic grid bias, a bias voltage will not be developed and the valve will be in a condition of full H.T. and no grid bias which more than likely will

destroy the valve owing to the overheating of the anode.

### Efficiency

Maximum power will be supplied to the anode load when the load resistance is equal to the anode resistance of the valve as in an amplifier. If the anode current and anode voltage waves of the oscillator are equal to the steady values of the anode current and voltage the power supplied to the load is:

$$P = EI$$

2

where  $P$  is the power in watts,  $E$  is the steady anode EMF in volts and  $I$  is the steady anode current in amps.

As we are aware, the total power supplied by the H.T. is  $EI$ , so it is obvious that half the power is dissipated in the valve and the other half is delivered to the load in the form of oscillations. These calculations only hold true if the anode current and voltage waves have a sine wave envelope.

The theoretical side of a simple oscillator has now been considered and at a later issue some practical circuits will be considered with their adjustments and applications.

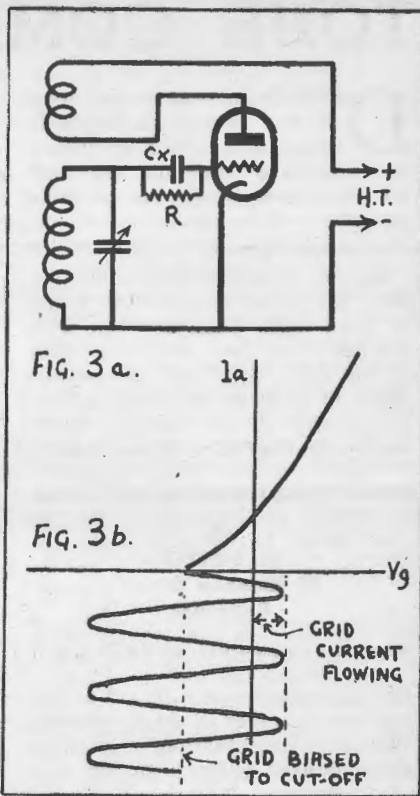

## AN ECHO FROM THE PAST

Those who know about walkie-talkies will find considerable amusement in the following extracts from a book entitled "Radio Telegraphy," by C. C. F. Mockton, published in London in 1908.

### "PORTABLE STATIONS"

"The liability of the field telegraph being cut in time of war has led to considerable experimenting of the army authorities of the leading powers to obtain a portable and reliable telegraph station suitable of working over a distance of a few miles.

"The Marconi System. The Marconi Company make three standard sets. The smallest, complete with tent, packing case and saddles, 425 lbs. for mule transport, and is suitable for a range of 15 miles over land.

"The next size weighs 550 lbs., to be carried in a two-wheel cart, and covers 21 miles. These stations can be erected in five minutes by

six men and one non-commissioned officer. Two masts are required, which for the smaller range are 15 feet and 25 feet and for the other are each 30 feet high."

(Here some fine spirited person had torn out a page. It then continues with the third set.)

"The ordinary distance of signalling is from 15 to 20 miles, but when the wind is sufficiently high, kites may be used, increasing the distance to about 30 miles. An auto-transformer is used to couple the closed circuit to the aerial. The length of the spark is 4 to 5 millimetres, and the wavelength 364 metres. For receiving, the electrolytic detector is used, and waves 5% different from the principal can be shut out. It can be carried in a cart on four mules or over very rough ground by ten men. A station takes 15 minutes to erect with five men."

—Submitted by Charles Aston.

# TONE COMPENSATION AMPLIFIER

**D**URING the past several years it has become increasingly clear that a flat frequency response does not represent the ideal characteristic for an audio amplifier which terminates in an acoustic device.

Certain characteristics of the human ear cause reproduced sound to seem more realistic when both the high and low frequency ends of the audio spectrum are boosted about 15 or 20 db above the middle frequencies at low volume. These same characteristics often require

By  
**H. SMITH**  
85 Rainbow Street  
Randwick

the audio spectrum to be cut at one end or the other at high volumes. The actual accentuation, or attenuation, desired varies with the type of programme material being reproduced.

In this amplifier an attempt has been made to fulfil this need by providing a maximum of control over frequency response. Before using any frequency discrimination in an amplifier it is first necessary that it be inherently stable, and that the frequency response be absolutely flat, with an output of at least 10 watts.

Examination of the various circuits available showed that the A.W.A. 503 circuit had the desired characteristics and, together with certain modifications, was incorporated in the final design.

## Degenerative Feedback

Although the response curve of the A503 is quite satisfactory, it was decided to see what improvements could be affected by using feedback. The first method consisted simply of removing the cathode by-pass condenser of the 6J7G driver: this was an improvement, but not sufficient for our purpose. Feedback was then tried from the secondary of the output transformer to the cathode of the 6J7G driver; it was found possible to use about

10 db of feedback with this circuit, with a reduction of hum, valve noises and distortions by an amount that would be expected with this amount of feedback. Frequency response was found to be substantially flat from 20 to 18,000 cycles, being down about 3 db at 16 cycles. Feedback was left variable, so that it could be removed if so desired, proving particularly useful when using a fairly low output microphone, as the extra gain without feedback can be quite useful.

When using any large amount of feedback the input voltage required was much too high, making it necessary to use an additional stage of audio amplification. Various valves, both triode and pentode, were tried and the best results were obtained with a pentode with limited current feedback obtained by omitting the cathode by-pass condenser.

## Power Supply

A 250 m.a. power transformer is specified in the A503 circuit. Being practically unprocurable, two transformers were used, a 150 m.a. for the 2A3 plate supply, and a 100 m.a. for the remainder of the amplifier, field coils and tuner, if one is used. A 5V4 rectifier with choke input is used for the plate supply of the 2A3 valves, actual voltages measured at the plates worked out at 330 v., no signal dropping to 310 v. with full output. These voltages are a little on the high side, but the valves do not show any signs of distress. A 5Y3 with condenser input was used with the 100 m.a. transformer. Voltages being 360 v. at the rectifier, with the voltage drop across the back bias resistor at approximately 100 v., it leaves 260 v. for the drivers. Incidentally, there is no variation in the bias voltage between no signal and full output. A two stage filter is necessary with this power supply, hum being much too high with a single stage.

## Tone Compensation

Various types of compensation were tried with varying results. From the data compiled it soon became obvious that to obtain the necessary range of control bass and treble boost and cut with a minimum of 18 db. each way was essen-

tial. Additional requirements for successful tone compensation are:

(1) There should be no apparent change in volume at middle frequencies when boost or cut is applied.

(2) The boost must be sufficient to cause an obvious change in volume at the end being boosted.

(3) It must not introduce any distortion or harmonic distortion, because it will be accentuated by the boost.

Boosting of any particular frequencies in the audio spectrum may be accomplished in two ways: either by holding the frequencies not requiring boost steady and amplifying the frequencies to be boosted, or by holding the frequencies to be boosted steady and attenuating the other frequencies. Either method usually requires an additional stage of amplification, although the latter can be used without an additional stage, if there is a large reserve of gain in the amplifier, the final result would, however, be the same.

When using frequency discrimination circuits, it is most important to study the A.C. loading on the input source, or on the valves concerned. If the loading is not favourable the valve won't be able to deliver its normal output voltage without severe distortion. Both methods of boost are used in this amplifier, the first being used for treble and the latter for bass boost. In earlier experiments, both bass and treble boost were incorporated in the same valve, but for reasons which will be detailed later, it was decided to use a separate valve for treble boost, thus requiring an additional two valves for the compensation stage. 6J7G's were chosen for this stage, omitting the bypass condensers, as before, with low plate and screen dropping resistors, so that they were operating with lowest possible distortion.

## Bass Boost

For bass boost it was decided to attenuate all frequencies and then provide some means of restoring the low frequencies as required. This was accomplished by shunting a voltage divider consisting of a 200,000 ohm resistor and a 15,000 ohm



## AMPLIFIER

(Continued)

a central position half way between boost and cut. Adjust the volume controls until the signal is at medium strength. By running through the various controls it will be realised that they are most efficient and that when any boost or cut is applied the effect is most noticeable at whichever end of the audio spectrum it is applied, and also when boost is applied it is noticeably free from distortion.

When using treble boost it is necessary to use the treble attenuation control to cut the high frequencies on this valve slightly, otherwise a noticeable peak will appear and spoil the effect of the treble boost at the very high frequencies.

One point that must be watched with particular care is the volume level of the amplifier when boost is used. Unless this is low, or medium at most, when full boost is used,

the output valves will overload and distortion will result. This will be made clearer when it is pointed out that with  $\frac{1}{4}$  watt of output, which is good volume for an average sized room, if a boost of 20 db. is used we get a power ratio of 100 or, in other words, an output of 25 watts! So be very careful when using boost.

### Speakers

Things being what they are, the speakers that were on hand had to be used, not that they don't give a good quality, because they do! But the full output cannot be used. These speakers are a 12E22 and a K10 and they work very well together. The matter of energisation for the 12E22 was overcome by using a 7500-ohm field from B+ to the centre tap of the transformer, applying the full 360 volts of high tension, giving just over 17 watts in the field. The K10 is supplied from B+ to earth and has about 8 watts in the field. Baffling for the 12E22 consists of a loading horn and the output at low frequencies is full and free from resonance. The

low frequencies are kept out of the K10 by using a filter so that it won't overload at these frequencies when boost is used. It is mounted on a small flat baffle, which is adequate as it only handles the highs.

The output transformers and both speaker transformers were wound by hand, that is, all except the primary winding of the output transformer, which happens to be the secondary winding of a power transformer. An interesting fact came to light while working on these transformers and that is that the K10 is more sensitive than the 12E22, which necessitated an unequal distribution of power between them. It was proportioned by applying two-thirds to the 12E22 and one-third to the K10, resulting in a good balance between them.

### Construction Hints:

Where possible the power supply should be mounted on a separate chassis. If this is not practicable, as in my own case, special precautions must be taken with layout,

INVENTIONS WANTED  
SUGGESTIONS WANTED  
IMPROVEMENTS WANTED

# NOW

ARMY INVENTIONS DIRECTORATE  
WILL PROVIDE FINANCE AND  
SECURE TECHNICAL ASSISTANCE TO  
DEVELOP EVERY SOUND ACCEPTABLE  
SUBMISSION FOR HELPING THE  
NATIONAL WAR EFFORT.

## ARMY INVENTIONS DIRECTORATE

Melbourne  
Sydney  
Adelaide  
Brisbane  
Perth  
Newcastle  
Hobart

31 Spring Street  
117 Pitt Street  
232 North Terrace  
289 Queen Street  
Gledden Building, Hay Street  
Aero Club, Broadmeadow  
94 Melville Street

Telephone MU 9611  
" BW 3871  
" Cent. 8127  
" B 6662  
" B 7763  
" Ham. 919  
" Hobart 3985

earthing and shielding. The layout must be such that the input stages are as far away from transformers and chokes as possible and also the stages must follow one another in the order shown in the diagram. This is most essential, otherwise, with the high gain used, especially with no feedback, hum will prove extremely troublesome. Personally, I tackled the job in the following manner—it may be of interest to the readers, not only in this but in other high-gain amplifiers. I started by wiring the job just as I would any other amplifier except that I used shielded two-core cable for all filament wiring, earthing the centre tap of the filament to make sure the shielding would be effective. When the completed amplifier was turned on, hum was found to be exceptionally high, with no feedback and all controls full on. Valve noise was also fairly high, although it was not so very noticeable until the hum had been cured. By earthing the grid of the 6J7G nearest the phase changer, the hum disappeared entirely, proving that it was coming from the preceding stages. Working towards the input and earthing the grid of the next 6J7G, there was a small amount of hum apparent. Proving a bit obstinate, it was finally cured by returning all earth returns for this stage to a point insulated from earth. A piece of hookup wire was soldered to this point and, with the grid still earthed, taking care not to get between the bare end and earth (being allergic to "bites") it was earthed at various points on the chassis until one was found where the hum disappeared, then earthing the stage at this point permanently.

This procedure was followed with each of the other stages in turn, eliminating nearly all the hum. It was still too high to be termed absolutely quiet, so I went hunting once more. This time it was tracked down to the first volume control and was finally set right by attaching a flexible lead on the earth terminal of the pot. and prodding around until the hum disappeared. Incidentally, full boost on treble and bass was used during this process. Without feedback, the amplifier now has a hum content that is inaudible three feet from the speaker. With 5db of feedback or more it is absolutely quiet with your ear right in the speaker.

### Alternative:

When building this amplifier the usual tolerances are all that are required in the way of resistors and condensers. Apart from these tolerances, do not change any of the resistor or condenser values if you want to duplicate the results outlined. If you do change them, do not blame the designer if results are not up to expectations. The two 10,000-ohm resistors in the plate and cathode of the phase changer are not critical but they must be matched for best results.

In the matter of valves, any of the usual alternatives could be expected to give similar results. The rectifier for the plates of the 2A3's should for preference be a 5V4 or its equivalent, the 83V. However, a 5Y3G could be pressed into service here with a slight reduction in output. With a 5Y3G the voltages on the plates are 310 volts no signal and 265 volts at full output. There are one or two alterations permissible in the compensation stage. If it is found that the single control for bass boost and cut is awkward, then each of the condensers can be shunted with its own .5 meg. pot., allowing two controls for this instead of one. I also reduced the .5 meg. pot. for the treble attenuation control to .05 meg., so that even with this control full off there is still a slight attenuation of the highs on this valve, for reasons outlined previously. It is important that the .25 mfd. blocking condenser in the bass boost stage be the best obtainable, preferably a 600 volt working type. If there is the slightest suggestion of leakage across this condenser the bass boost and cut controls will be very noisy in operation.

I am inclined to think that this amplifier would be a bit of a problem if it were entered in an amplifier contest. It is obvious from results in previous contests that individual tastes vary considerably when it comes to the matter of what constitutes the ultimate in tone from an amplifier. This being so, who is going to adjust the compensation controls? If it is left to the contestant he will naturally adjust them to whatever he thinks gives best results. However, the judges may have other ideas on the matter. So to be fair all round, per-

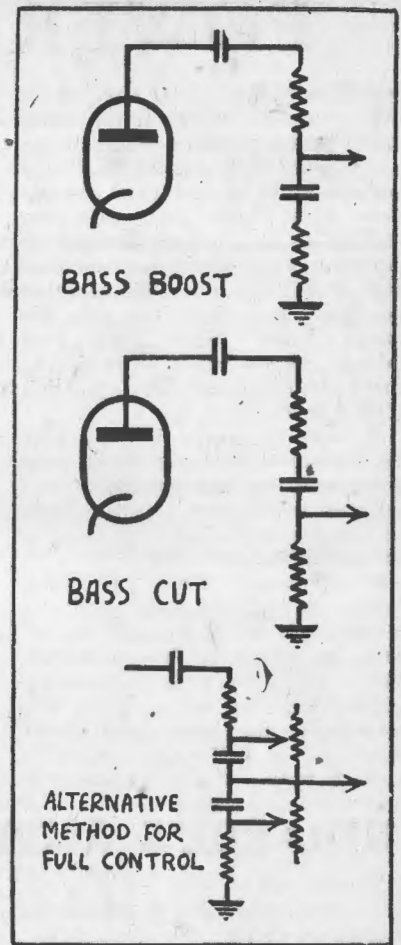

haps one of the judges would be very obliging and come up and adjust the controls for him. Then, again, the judges all have different tastes, so it might be better if all the judges got into a huddle round the amplifier and adjusted the controls until it satisfied a majority of them, thus ensuring a win for the amplifier(?). Of course, complications would be bound to set in if the audience were voting too, because obviously they cannot all come on to the rostrum and adjust the controls. In any case, the pots. would be worn out, not to mention the nerves of a lot of people, by the time the judges and the audience, too, had satisfied themselves. So I think the best thing to do is to leave it at home. Then he will not have the worry of finding out about it.

Quite seriously though, it is a peculiar thing that all the amplifiers

(Continued on page 34)

# POWER SUPPLY FILTERS

THE object of a filter is to remove an unwanted component from a wanted one; thus, when a mixture of sand and stones is applied to a suitable sieve it will offer very little opposition to the flow of the sand, at the same time preventing the passage of the stones. If the mesh of the sieve were "open" enough, the small stones would also pass through; so the result is dependent on the degree of the filtering action of the sieve.

In radio it is very desirable that the high-tension supply is of pure direct current, and when batteries are used as a source of this supply, no filtering is necessary, as there is but one component—the direct current component. When alternating current is available it is usual, for reasons of economy and convenience, to utilise it in conjunction with a rectifier for the high-tension supply, but the output from this rectifier is far from pure direct current. If a half-wave rectifier is used, a pulse of direct current is

only obtained every cycle, and with a full-wave rectifier two pulses per cycle. This pulsating voltage may be split up into a steady voltage, together with an alternating one which has a frequency equal to the number of pulses in the output of the rectifier per second; there are also other frequencies present, but are so small that they may be neglected. It is the purpose of the filter to pass the steady direct current but block the alternating component of the rectifier output.

## Condenser Input Filter

As the name of this system implies, a condenser is connected across the output of the rectifier; following this is a choke connected in series in either the positive or negative lead and across the output of this choke is fitted another condenser.

Now, consider what happens when a half sine wave of voltage is applied by the rectifier to the first condenser—as the voltage is increasing so the condenser will charge, but

when the voltage is decreasing the condenser will discharge through the choke into the load until it is renewed by the next half-cycle, and the sooner this arrives the steadier will be the voltage developed across this condenser, which is another reason why full-wave rectification is more desirable than the half-wave system. It is obvious that this condenser acts as a reservoir, storing up when the voltage is increasing and discharging when the voltage is decreasing or the valve non-conductive. The main purpose of this condenser is to reduce the variations in the voltage applied across it, so causing a more constant input to the choke.

It is the characteristic of the choke (inductance) to oppose any change in the current flowing through it, so there is practically no opposition to the direct current but is an impedance to the alternating component. The alternating component that does pass through the choke is applied to the load which usually has a resistance in the vicinity of 5,000 to 10,000 ohms, while the second condenser, which is connected in parallel with the load, will have a much lower impedance to this component and the greater portion will pass through the condenser causing a voltage drop, which is applied to the load, and it is this that appears as "hum" in the loud-speaker of a receiver. If this hum is too great, it may be almost eliminated by connecting another filter of the type just described in series with it. The direct current component will also be applied across the second condenser, which will offer to it a very high resistance, much higher than the load through which the current will therefore pass. This condenser in the output of the filter acts as a reservoir for the additional current surges that are required when the receiver is reproducing low audio frequencies which may not be drawn from the power supply, as the choke will oppose such sudden changes in current.

This type of filter is only used in conjunction with low power rectifiers such as used in amplifiers and radio receivers for the input condenser places a load on the rectifier immediately it is switched on and

## STRAEDE'S AMPLIFIER CONTEST

Results are to hand for the amplifier contest conducted recently in Melbourne by the well-known radio-chemist, J. W. Straede. The most outstanding feature, at a glance, appears to be the way in which triode output valves won every place in the section judged by public approval, whilst every place in the technical section went to amplifiers using pentodes. It is hard to say just what this result infers, but it might be taken as indicating that technicians do not understand public taste.

First prize in the section judged by the audience went to Mrs. McLean, who used an amplifier with push-pull 2A3 resistance-coupled paraphase of comparatively standard design, but with an elaborate filter to the "Trutan" crystal pick-up cartridge to give a solid bass boost and a sharp cut-off at 6,000 cycles. Twin speakers were used, both Rola brand, a G12 permagnetic for the lows and a 10/42 for the highs.

First prize in the section judged by technicians and on technical features went to an amplifier entered

by Mr. J. Woodward, using a pair of EL8NG pentodes in the output, again with a twin-triode as a paraphase phase-changer with resistance-capacity coupling. Inverse feedback was used, but only to a small degree. Again a Rola speaker was used—this time a permag 10/42 single speaker in a bass-reflex vented baffle.

Results:

### Audience Approval Section:

- 1st, Mrs. McLean.
- 2nd, Mr. McLean.
- 3rd, Mr. Keogh.

### Technical Section:

- 1st, Mr. Woodward.
- 2nd, Tie between Mr. Rees and Mr. Kerr.
- 3rd, Mr. Barnett.

The "Radio Times" prize of £10 for a small amplifier was divided between Mr. Foreman and Mr. Barnett.

A Novice Prize was won by Mr. Sellars.

Prizes for the best home-made pick-up and for the best portable baffle went to Messrs. Hutchinson and McOrist, respectively.



draws very large peak currents from the rectifier which may adversely affect the emitting properties of the filament. It has the advantage the average voltage output is greatly increased by its inclusion.

#### Choke Input Filter

With this filter the output of the rectifier is fed directly into the choke and it is the property of inductance to oppose any change in the current passing through it by generating a back E.M.F. As before, the output of the rectifier may be regarded as a steady direct current component together with an alternating one. The D.C. component will flow through the choke and the load but the series circuit, consisting of the choke and load resistance, will present a high impedance to the alternating component. The condenser in the output of this filter performs the same task as the condenser in the same position in the condenser input filter.

As the rectifier is feeding directly into a choke its output will not appear as half sine wave pulses, but will vary slightly around the average as the back E.M.F. of the choke will oppose both the rise and fall; this means that the current passing through the rectifying valve varies within comparatively small limits and is not called upon to deliver current surges.

This type of filter is unsuitable for use with the half-wave rectifier, as it requires for effective operation an E.M.F. applied at all times, which is not obtainable with this type of rectifier when used with a single-phase supply. The filtering action of this type is not as good as the condenser input and it is possible that a second filter may have to be connected in series to obtain adequate smoothing.

Despite these disadvantages, the choke input filter is now always used with high-powered equipment owing to its good regulation, efficiency and high output.

#### Design Considerations

The filter used in low-power equipment, such as receivers and amplifiers, is invariably what is sometimes known as the "brute force" filter for its cut-off frequency is considerably higher than the output of the rectifier, the reason for this being that the small saving effected by the reduction in the components does not justify the extra trouble incurred.

The power supply of a receiver usually consists of a type 80 valve rectifier, or its equivalent, followed by a condenser input filter. The condensers are of the electrolytic type usually with a capacity of about 8 micro-farads; these are expensive to construct and their peak voltage rating is more than sufficient for this type of power supply. The chokes are wound on laminated cores of stallo and have an inductance of around 30 henries; care should be exercised to see that it is capable of carrying the full high-tension current without overloading. In commercially-built receivers the electro-dynamic speaker is generally used; this requires an exciting current for the field magnet and it has been found satisfactory

in most cases to utilise this as the filter choke, thus performing a dual operation. When a two-section filter is used to give greater "hum" attenuation, the centre condenser should have twice the capacity of the input or output condenser.

In filters where high voltages are being handled, the greatest problem is the production of suitable condensers, and care is taken in the design of these filters so the cut-off frequency will be very close to the frequency it is desired to filter.

Unfortunately, electrolytic condensers cannot be constructed that will stand a peak voltage of more than about 600, and it would not be particularly economical to con-

(Continued on page 34)



NOW - ON SERVICE  
SOON - AT YOUR  
SERVICE

**BRIMAR**  
VALVES  
*British Made*

A PRODUCT OF  
*Standard Telephones and Cables Limited*

# A SHORT COURSE IN RADIO

## PART 6 . . . RECEIVER CIRCUITS

**F**IG. 58 shows a circuit of a simple crystal set. "L" and "C1" comprise a simple tuned circuit, with a crystal and pair of headphones connected in series across it. When a modulated radio frequency signal as represented in Fig. 59(a) is applied to the tuned circuit, it is tuned to resonance by the variable condenser "C1."

The action of the crystal on the signal now becomes apparent. During one set of half cycles of the alternating current, the resistance of the crystal is very low, so that current is able to flow through it easily, but with the half cycles flowing in the opposite direction, the crystal resistance is high, and very little current is passed. The result is depicted in Fig. 59(b), which shows the rectified pulsating current.

These pulses of fluctuations of current are far too rapid to actuate a phone diaphragm. When a station is broadcasting on a wavelength of 500 metres, they are occurring at the rate of 600,000 times a second, and no diaphragm could be

made that would respond to this speed.

The effect, however, is that each successive wave-train actuates the diaphragm, and its motion follows more or less faithfully the shape of the envelope of the rectified carrier current, as illustrated by Fig. 59 (c) Since this envelope is the same shape as the waveform of the sound impressed on the microphone at the broadcasting studio, it follows that the movement of the headphone diaphragm sets up similar sound waves that are heard by the person listening in.

The volume and quality of the received signal is often improved by connecting a fixed condenser "C2" across the headphones. When a signal impulse flows through the headphones "C2" becomes charged. During the next half cycle no current flows through the detector, but "C2" commences to discharge through the headphones, the discharge current flowing in the same direction as that of the impulse which charged the condenser. This action assists considerably in keeping the diaphragm in position until the next impulse comes along. There is, then, during each wave-train a more continuous attraction on the headphone diaphragm, with improved reproduction, since the diaphragm then follows more closely the envelope of the rectified signal current.

However, often it will be found that there is sufficient capacity existing in the headphone windings and cord to provide this effect without the necessity for adding further capacity.

Once widely popular, crystal detectors are little used nowadays, having been supplemented almost entirely by the valve detector.

### Diode Detector

The closest valve equivalent to the crystal is the diode, consisting essentially of two elements, a filament (or cathode) and plate. With a signal applied to the anode, the filament-to-anode electron flow will be stimulated on the positive half-

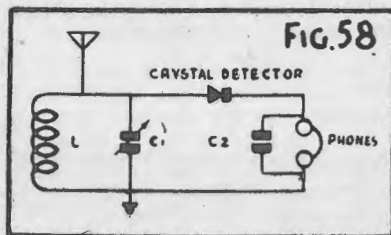

cycles and repressed on the negative, as illustrated in Fig. 2.

### Triode Power Detector

Another type of detector that found wide favour in the days of the early A.C. receivers is the power, or "C" bias detector. More sensitive than the diode, it is appreciably less so than the leaky grid detector, though it has the important advantage over the latter of being able to handle a far more powerful signal without overloading.

The action of a triode power detector is similar to that of the triode when used as an audio amplifier with the important exception that, instead of working on the straight portion of the plate current grid volts characteristic curve, the valve is biased back so that the operating point falls on the bottom bend.

This is illustrated in Fig. 60, the valve being biased so that the operating point is set at "B." When a signal is applied as shown, the maximum swing to the right takes the point to "D." The grid bias is decreased, and hence the plate current increased by an amount represented by "CD."

The next swing, to the left this time, takes the operating point to

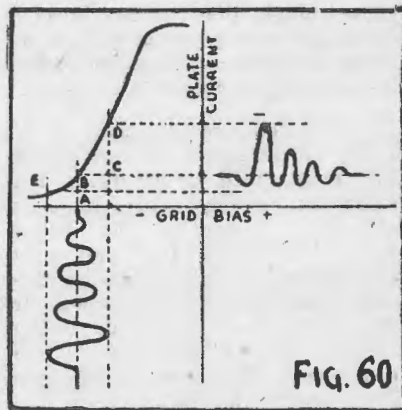
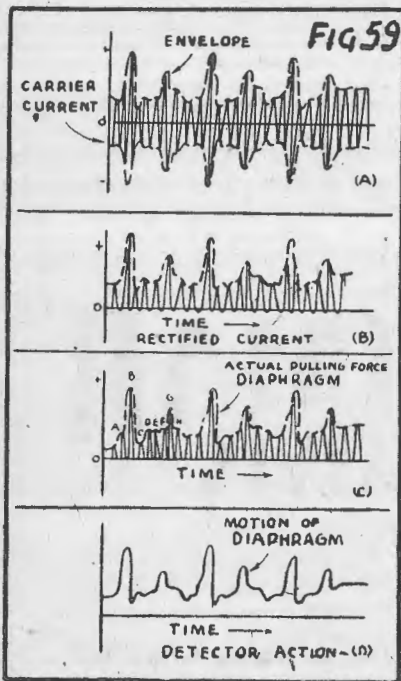



(Continued)

freely through it.

## Power Grid Detector

The power grid detector is an adaptation of the leaky grid detector to allow bigger inputs without distortion. So that power can be developed, the plate voltage is increased to 150 or 200 volts, while the capacity of the grid condenser is reduced to .0001 mfd. A typical value of grid leak for this purpose is .25 megohm.

For sensitivity and power handling capability, this type of detector can be regarded as a compromise between the "C" bias and leaky grid types.

## Regenerative Detector

As we know "C2" in Fig. 61 is inserted to by-pass the unwanted radio frequency currents appearing in the plate circuit. However, this R.F. energy can, by using the modified circuit arrangement shown in Fig. 63, be put to a particularly useful purpose, by feeding it back into the grid current for re-amplification.

This regeneration (or reaction), as this effect is called, results in a tremendous increase in sensitivity, as well as an appreciable improvement in selectivity. The great increase in sensitivity means that enormous distances can be successfully covered with small receivers.

In fact, while a station 50 miles away might perhaps not be heard on a one-valve set without regeneration with it, stations hundreds of miles away can be brought in at good headphone strength.

To enable this to be done successfully, however, it is necessary to provide an efficient means for controlling the amount of R.F. fed back from the plate to the grid circuit, for, if the feedback passes a certain limit, the valve will commence oscillating, which largely nullifies the enormous benefit of regeneration. What is required, then, is a control that enables the highest possible amplification to be obtained without the detector breaking into oscillation.

There are many different modifications of regenerative detector

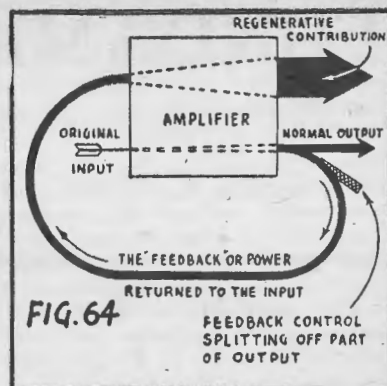

FIG. 64

tuned circuit from the aerial via the primary winding "L1" is in the form of a high frequency alternating voltage. When applied to the detector grid, this results in corresponding variations in the plate current. The latter flows through "L3" (which is known as the tickler, reaction, or regeneration winding), and in so doing induces into "L2," by virtue of the inductive coupling existing between the windings, an identical but greatly enlarged replica of the original signal applied to the grid.

The regenerative effect, if kept under control to prevent the detector from breaking into oscillation, results in very great amplification. The process is indicated in diagrammatic form in Fig. 64.

Some of the methods that have been developed for introducing and controlling regeneration will now be discussed. From the above it is obvious that the essential requirements of a satisfactory regeneration system are smoothness and simplicity of operation. Freedom from hand capacity is also necessary.

The swinging coil method of obtaining and controlling regeneration is rather difficult to handle, and is not easy to get the really fine degree of coupling necessary for best results. Also, varying the coupling between the two windings results in an alteration to the effective inductance of the grid winding, which means that with every adjustment of the reaction control the tuning is upset—only to a very slight degree, it is true, but sufficient to prove annoying.

Fig. 65 shows another type of reaction; the reaction winding is on the same former as the main tuning

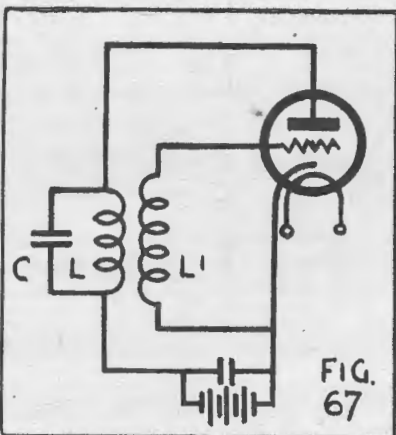

FIG. 67

circuits, but fundamentally they all work on the same principle—the feeding back of energy for re-amplification from one part of the circuit (generally the plate circuit) to the grid circuit.

The method of regeneration illustrated in Fig. 63 is known as the "swinging coil" type. Universally popular in the early days of radio, it fell into disfavour some years ago, mainly because of several serious drawbacks.

The third winding "L3," shown connected in the plate circuit, is the reaction or feedback winding; it inductively coupled to the latter by virtue of its proximity.

The amount of coupling existing between the two windings is controlled in variometer fashion.

The signal applied across the

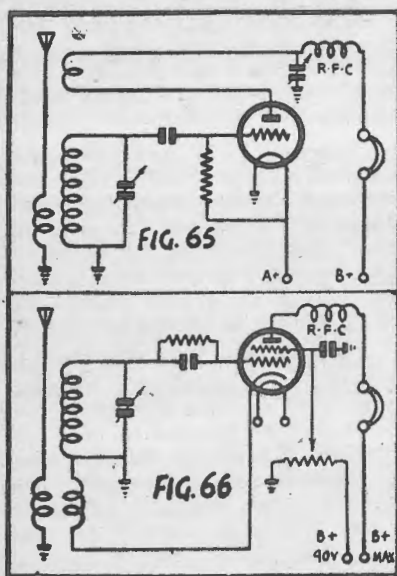

# Latest Technical Notes from New York

By Cable—Courtesy U.S. Office of War Information

The American Telephone and Telegraph Co. has filed application with the U.S. Federal Communications Commission for authority to construct seven relay stations between New York and Boston. The company plans to determine in practical operation the relative efficiency and economy of radio relay for transmission of long-distance telephone messages and of sound and

television programmes compared with transmission over wires and cables and the recently developed coaxial cable.

Between New York and Boston, terminals both atop high buildings, relay stations will be built about thirty miles apart. The terminal sites were chosen for their elevation because microwaves do not travel much farther than the horizon and

because in this way transmitting and receiving antennas are well above intervening obstructions.

Experiments are planned in three parts of the radio frequency spectrum, near 2,000, 4,000 and 12,000 megacycles. It has been proposed to use eight channels, each twenty megacycles wide, in each of these parts of the spectrum and to use the channels to provide two simultaneous transmissions in each direction, with different frequencies in adjacent relay sections. If the experiments prove successful, similar systems will be laid out throughout the United States and spur connections will be made to nearby cities as the demand grows for them after the war.

## FUNDAMENTALS

(Continued)

inductance but separated from it by about  $\frac{1}{8}$ -inch, the amount of feedback depending on the coupling between the two coils, but may be varied, within limits, by the reaction condenser, whose rotor plates are earthed, which helps greatly to reduce hand capacity. When correctly adjusted, this system is quite smooth in operation and is often used in one or two valve sets.

The electron coupled method of regeneration, illustrated in Fig. 66, is now widely used. The feedback winding is included in the cathode instead of the plate circuit, regeneration being controlled by a variation of screen voltage. The valve shown is an indirectly-heated type, though electron-coupled regeneration is easily obtainable with battery type valves as well.

The main advantage of the electron-coupled regeneration is high stability and minimum detuning of the received signal, and if a good quality potentiometer is used, smooth and quiet operation.

### The Superheterodyne Receiver

We are now going to examine the circuit of a standard modern broadcast receiver of the superheterodyne type fitted with a stage of R.F. amplification and automatic volume control (A.V.C.) and see how it operates.

As a valve oscillator is used in this type of receiver it is first necessary to discover how this operates.

### Valve Oscillator

The circuit of a simple oscillator is shown in Fig. 67. CL is a closed oscillatory circuit connected in the plate circuit of a triode valve; to L is magnetically coupled the feedback winding L1, which is connected between the grid and cathode of the valve.

We have seen that if LC were set in oscillation, the oscillations would soon die down owing to losses and if the oscillations are to continue it is necessary to apply suitable energy to the circuit at the right moment to make up for these losses, and that an alternator may be used for this purpose, which is fairly practicable at lower radio frequencies. The difficulties increase with the frequency; so another method, the valve oscillator, was devised. We know that when the grid is sufficiently negative, plate current will not flow and, when positive, it will flow. When the circuit LC is oscillating, it will induce a current into L1 which is so arranged that the grid will become positive at the instant when a "kick" of energy from the battery would assist the oscillatory current during each cycle. As soon as this part of the cycle is complete, the current induced in L1 will change and cause the grid to become negative, making the valve non-conductive, for, if this did not happen, energy would be supplied to the oscillatory circuit that would oppose the oscillation.

(Part 7 of this series will appear in next month's issue.)

\* \* \*

A new method of laying communication wire, based on a specially-designed coil and dispenser, enables the U.S. Signal Corps to lay its wires by airplane and ground vehicles or even by bazookas and rifle grenades without the use of reels. The dispenser is about one foot in diameter and six inches long. It weighs 25lb. and contains about 3,300 feet of wire. Communication may be maintained during the laying process, regardless of the mode of transportation employed. Two or more dispensers may be connected in tandem when it is necessary to lay more than one coil of wire without stopping to make a splice.

A container with a capacity of eight wire dispensers has been designed for the Army Air Forces so that planes can lay a continuous five-mile circuit. Two containers can be mounted on a plane, one under each wing, to balance the ship and to lay two circuits at once.

The adaptability of the method may reduce the requirements for wire-laying equipment and eliminate the maintenance of certain mechanical parts. The laying out of wire by plane over mountain peaks, deep valleys or dense forests will simplify greatly the operations of communications troops. In forests or jungle the wire can be laid over the tops of trees or inaccessible undergrowth.

# Shortwave Review

CONDUCTED BY

L. J. KEAST

## NOTES FROM MY DIARY

I think most listeners to the East Coast of America transmissions concede that the Crosley Corporation for the most part of listening hours offers the best reception here. The following particulars taken from an article in "Radio-Craft" will be of great interest to readers of these columns. The three stations, WLWL, WLWR and WLWS, more powerful than any others in their class, are located in Bethany, Ohio, 20 miles from Cincinnati. They commenced last October as The Voice of America, and the programmes are handled by the Office of War Information and the Co-ordinator of Inter-American Affairs in their New York studios and are sent over telephone lines to the Bethany transmitters. In this way the Crosley Corporation is relieved of all responsibility as to the contents of the programmes. The maintenance of the transmitters, antennas and other equipment is the responsibility of the Broadcasting Division of the Crosley Corporation through the authority of the Office of War Information and the Co-ordinator of Inter-American Affairs. The new transmitters will operate on a power of 250,000 watts eventually. Power outputs of 200 kilowatts have already been reached. Credit for design and construction goes to Crosley's chief engineer, J. R. Rockwell, called "Tinkerboy" by some of his associates from his ability to con-

trive from material at hand any unobtainable equipment, from precision measuring apparatus to guy-wire clamps. Twenty-four rhombic antennas, each 165 feet in the air, are arranged in a circle over nearly a square mile of land. Eight hundred masts are required to hold this system aloft, and with it a signal can be put into practically any corner of the globe.

To put the rhombics into circuit when and as required, the station has the most complex antenna switch-gear ever constructed anywhere. Mounted on a forest of 20-foot poles are 216 switches, which can be manually operated from the ground, to make any desired connection between the six transmitters and the 24 antennas.

Several have asked for some particulars on the Guam transmitters. The following, as far as I know, is the complete list to date:

KU5Q, 17.83mc, 16.83m, heard around 7.45 a.m.; 15.92mc, 18.84m, 8.45 a.m.; 15.60mc, 19.23m, 4 p.m.; 13.39mc, 22.40m, 6.30 a.m., 11.30 p.m.

KUIG, 10.51mc, 28.55m, heard around 8.30 p.m.

KU5Q, 9.67mc, 31.02m, heard around 7.30 p.m.; 9.32mc, 32.25m, irregularly; 9.287mc, 32.30m, 8 p.m.; 9.26mc, 32.39m, 8.45 p.m.; 7.40mc, 40.52m, 10.50 p.m.

On 20th June, heard Bing Crosby putting over a special programme, saluting WVTX, the new Signal Corps station on Iwo Jima. I do

not, so far, know frequency but suspect it is a medium-wave transmitter.

Don't forget the shortest day has passed, so get out after those delightful dytime signals. London and Europe can be heard at midday almost like a local. And if you prefer the Californian stations, well, you have a fine choice all morning, all afternoon and all evening. Even then, several, as will be seen by the list appearing elsewhere in this issue, are still on after midnight.

## SAYS WHO?

"WGEX is verifying again. Received card, a new one, giving present schedule: 11.90mc, 9-11 p.m.; 17.88mc, 11.15 p.m.-3.15 a.m.; 11.90mc, 3.30-6 a.m.; 7.00mc, 6.15 a.m.-5 p.m."—Cushen.

Sorry to hear "Duffy's Tavern" is to be cut out of the A.F.R.S. programme, but trust it is only for a short while. Always get a great kick out of Archie, and his logic is delightful. One little bit heard a couple of weeks ago: "You can lead a camel to water, but if you make him drink through a straw, you break his back."—L.J.K.

"Thanks for information re LRY-1. So Belgrano is the word; was a little puzzled, mainly over the first letter, thinking it might have been B, D, or perhaps T. A

# ULTIMATE

*Champion Radio*

Sole Australian Concessionaires:

**GEORGE BROWN & CO. PTY. LTD.**  
267 Clarence Street, Sydney

Victorian Distributors: J. H. MAGRATH PTY. LTD., 208 Little Lonsdale Street  
Melbourne

As the Ultimate factory is engaged in vital war production, the supply of Ultimate commercial receivers cannot be maintained at present. SERVICE: Ultimate owners are assured of continuity of service. Our laboratory is situated at 267 Clarence Street, Sydney. Servicing of all brands of radio sets amplifiers, as well as Rola Speakers is also undertaken at our laboratories.

splendid signal; is going well after 11 p.m. So far no letter call has been heard or not so far as I can hear or make out. Would like their address."—Gaden.

"Crosley sent me their usual very polite letter, veries for WLWS, 7832.5kc, and WLWR, 9.75mc. Told me that I had veries for all their other frequencies; think I have verified every spot they have ever used since first sending them a report just on 10 years ago—never had a card."—Gaden.

"Veries this month more of the average type on shortwave—ZOJ, Colombo, 15.275mc; WGEX, 9.55 mc; WLWS, 18.022mc; KGEX, 15.21 mc; KNBX, 7.575mc; and KGEI, 5.09mc. My total veries for shortwave are now 434."—Cushen. (That is a very nice record, Arthur, and shows the advantage of sending in reports immediately. Both KNBX and KGEI are now on new frequencies and doubtless reports have gone to USA ere this, so that brings the 500 mark a little nearer. Mr. Cushen says he has 76 countries verified on shortwave and 21 on broadcast, his cards numbering 353. Well, that is a record anyone could be proud of and is a nice reward for the many hours spent at the receiver.—L.J.K.)

Paris, on 11.705mc, broadcasts to Tahiti from 2-2.45 p.m.—Cushen.

"Some splendid reception by day from Great Britain; Pacific Service great. Can still hear 16 and 19 metre bands at night, but not as good as they might be."—Gaden.

"One of the WRU-ites is on about 5985mc; Music from America session at 9.30 a.m. Very weak."—Gaden. (Yes, the station is WRUA and, according to my records, the schedule is 9.30 a.m. till 1.30 p.m., but reception here is hopeless. By the way, you struck the frequency exactly. The programme is beamed to Europe. For the benefit of our readers who prefer wavelength, it is 50.12 metres.—L.J.K.)

The Crosley Corporation have drawn my attention to an error that

crept into the February issue of ARW. WLWS is on 7,832.5kc, and not 7,805 as shown. (This, of course, was corrected in March issue—L.J.K.) They also state WLWV and WLWQ are not for shortwave. Elsewhere in this issue I have listed the latest schedules of the Crosley stations.—L.J.K.

"What a wonderful show these Yanks are putting up for us; maybe we will miss them when the war is over."—Gaden. (Yes, apart from the fun there always is in hunting for new stations or in trying to tune-in a weak sister a little better than "the other night," there are very few stations other than the Yanks putting over worthwhile-listening-to programmes.—L.J.K.

"Mystery. Heard soon after 1.00 p.m. just a shade lower wavelength than KGEX but a bit higher than Paris on 19.68m. Very weak. Think lingo is French. Not been able to hear him 'on the hour.' CHTA? Same spot yesterday at 4 p.m. heard 'God Save the King.' Not necessarily the same station, of course, closed then. CHTA? Today (18th June), not a whisper near 4 p.m."—Gaden.

"Three new countries verified last week, bringing my verified log to 27 countries. Latest veries are from TAP; ABSIE, on 49.42m; Leopoldville, for their 16.88m outlet; HEI-2, 47.28m; "Army Test Transmission," 38.27m; JCJC, 41.55, and a bunch from The Crosley Corporation."—Gillett. Nice bag, Rex.

## NEW STATIONS

### VLG-10, Melbourne, 11.76mc, 25.52m:

This is the new call-sign for the station on this frequency from 6.10-9.45 p.m. From 6.10-6.55 in French to New Caledonia; 7.00-8.15, in English—news from 7.45 at dictation speed; 8.15-8.30, in Chinese; 8.30-8.50, in English; 8.50-9.15, in Malay; 9.15-9.45 in Dutch.

### CKRX, Winnipeg, 11.72mc, 25.60m:

Arthur Cushen sends along these particulars: This is the old CJRO now operating with the new call of CKRX. They are heard to 3 p.m. week days and till 4 p.m. on Sundays. Only call given is that of the broadcast band, CKRC. CKRX uses 2,000 watts and is operated by Transcanada Communications Ltd., who also operate several broadcast stations. They have usual recorded dance programmes and have five minutes' news before signing. Signal is only fair, with severe interference from WRUL and GVV. Signs with "God Save the King."

### KCBB, San Francisco, 9.70mc, 30.93m:

This is a new outlet for The Colombia Broadcasting System, Los Angeles. First heard announcement on Tuesday, 19th June, but believe opened on Monday 18th. Is directed "To the peoples of the Pacific and Far East" from 7 p.m. Signal from opening and until 11.00 p.m. is excellent and, as a great amount of English is used, should be a popular station in Australia.—L.J.K.

### Paris, 9.535mc, 31.46m:

Rex Gillett reports this new spot for Paris. Says he heard them at 6.15 a.m. in relay with 31.38 and 31.51m. Signal on 31.46 m is spott by SBU, Stockholm. Paris is heard again in the afternoon at 3.40.

**Radio Luxembourg, 6.020mc, 49.83m:** Another from the same reporter. Was heard calling Hamburg on this announced frequency at 7.20 a.m. On closing, announced that programme was not a broadcast but a special programme.

### LRV-1, Buenos Aires, 6.09mc, 49.25m:

This is the frequency used by LRV-1, late of 9.688mc, 30.96m. Announces as "Radio Belgrano" and opens at 8.45 p.m. First heard on this frequency at

9.10 on Tuesday, 19th June. Very loud signal. From 9.30 plays a lot of American records, with English, but studio announcements by male and female are in Spanish. Is still there at 11 o'clock, but noise and particularly morse, make it unpleasant at that hour at my listening-post.—L.J.K. (Call will sound like LRE, but don't forget Y in Spanish is pronounced EE, as in Keen.)

### IMPORTANT B.B.C. CHANGES

GRS, 7065kc, has moved to 7075kc, 42.40 m; GWG, 15,060kc, has moved to 15,110kc, 19.85m; GVV, 11,780kc, has moved to 11,770kc, 25.49m; and what seems like a NEW B.B.C. transmitter is on 9.675mc, 31.01m, opening at 4 p.m. with "Ici Londres B.B.C." Programme continues in French till 4.15, when, after . . . several times on a new kind of drum, present news in English. Splendid signal. Understand from Arthur Cushen they also open at 4 a.m.

### CHANGES IN AUSTRALIAN S.W. STATIONS

VLG-3, Melbourne, 11.71mc, 25.62m: Has replaced VLG-6 from 1-2 p.m. (Mondays to Saturdays) and 1-2.30 p.m. (Sundays). The above is the Overseas Service to the Australian Forces.

VLG-4, Melbourne, 11.84mc, 25.34m: Has replaced VLG-9 from 10 p.m.-midnight.

VLR-3, Melbourne, 11.88mc, 25.25m: Has replaced VLR-8 from 6-10 a.m. Mondays to Saturdays and from 6.45 a.m. till 12.40 p.m. on Sundays.

### MIDNIGHT WITH THE CROW-EATERS

From midnight on Saturday, 4th August, ADELAIDE TIME, corresponding to 12.30 a.m. Sunday in sunny New South Wales, 5KA Adelaide will broadcast a special DX programme for one hour. Correct reports received will be acknowledged with a special DX card. The wavelength of the station is 250 metres, 1200 kilocycles, and the power 500 watts.

# The MONTH'S LOGGINGS

ALL TIMES ARE EASTERN AUSTRALIAN STANDARD TIME

Pressure a space only permits of unusual Loggings or alterations in schedules or frequencies.

Readers will show a grateful consideration for others if they will notify me of any alterations. Please send reports to L. J. Keast, 23 Honiton Avenue W., Carlingford. Urgent reports, 'phone Epping 2511.

## OCEANIA

**Australia**  
**VLC-4**, Shepparton 15.315mc, 19.59m  
 Has a most objectionable "echo" effect very often from opening at 3.10 p.m. in programme to North America.—L.J.K.

**Guam**  
**KU5G**, Guam ..... 15.92mc, 18.84m  
 Spoils Paris (15.93mc) in a.m.—like it better on 17.83mc (Gaden). Heard calling KD-18 at 8.45 a.m. (Gillett).

**KU5E**, Guam ..... 13.39mc, 22.40m  
 Heard at 11.30 p.m. calling KD-18—good signal (Gillett, Young).

**Okinawa**  
 ..... 10.64mc, 28.20m  
 Heard irregularly during the night with special broadcasts.

**Philippines**  
**PY-6**, Manila ..... 10.74mc, 27.93m  
 Heard around 11 p.m. (Young).

**WVLC**, Luzon ..... 9.03mc, 33.23m  
 Has been good level at 10.30 p.m. when contacting KEZ and R.C.A. (Gillett).

## AFRICA

**Egypt**  
**JCJC**, Cairo ..... 7.22mc, 41.55m  
 Signal has improved—closes at 6 a.m. (Gillett).

**JCKW**, Cairo ..... 7.195mc, 41.70m  
 This is the call given during transmission closing at 6 a.m. (Gillett).

**French Equatorial Africa**  
**FZI**, Brazzaville ..... 11.97mc, 25.06m  
 Only heard in afternoons, lately—good signal (Gaden). Opens at 3 p.m. with news in French (Cushen).

**Senegal**  
**Radio Dakar**, Dakar ..... 7.21mc, 41.61m  
 Fair signal at 6 a.m. (Cushen).

## THE EAST

**China**  
**XGOY**, Chungking ..... 9.805mc, 30.58m  
 News at 9.30 p.m. daily, but at 10.15 p.m. on Saturdays (Cushen).

**India**  
**VUD-5**, Delhi ..... 17.83mc, 16.83m  
 Splendid signal at 1.30 and 4.30 p.m. (Gaden). (Hear, hear, here, too.—L.J.K.)

**ZOJ**, Colombo ..... 15.275mc, 19.64m  
 Out on its own from 1 p.m.—news at 2.30 p.m. (Gaden). Has made some changes—news in English is now on at 8.30 and 10.30 p.m. (Cushen).

## GREAT BRITAIN

**BBC, London** (See important alterations in frequencies under "New Stations.")  
**GSE** ..... 11.86mc, 25.29m  
 Very good at midday (Gaden). (Closes at 12.15 p.m.—L.J.K.)

**GSN** ..... 11.82mc, 25.38m  
 Carries African Service, now from 4-7 a.m. (Cushen).

**GWH** ..... 11.80mc, 25.42m  
 Very fair at 8.15 a.m. with news in English through ABSIE (Cushen).

**GVV** ..... 11.70mc, 25.64m  
 Wonderful at midday (Gaden). (Grand opportunity to improve your Spanish from 11.30 a.m.—1.45 p.m.—L.J.K.)

**GRY** ..... 9.60mc, 31.25m  
 Delightful signal from 2 p.m. in special programme for the British Forces in the

Pacific.—L.J.K.

**ABSIE**  
**GVV** ..... 11.73mc, 25.58m  
 and

**GRB** ..... 6.01mc, 49.92m  
 News at 5.30 and 7.45 a.m. (Cushen).  
 New schedule is 1.30-8 a.m.

## CENTRAL AMERICA

**Costa Rica**  
**TIPG**, San Jose ..... 9.62mc, 31.19m  
 Has had some good days, from lunch time (Gaden).

**Guatemala**  
**TGWA**, Guatemala ..... 9.785mc, 30.66m  
 Heard here right on top of RNB's spot (Gaden). Heard at fairly good strength prior to Leopoldville opening at 2.45 p.m. (Gillett). Good signal here (Invercargill, N.Z.). Heard till sign-off at 4 p.m. over Mexican and Leopoldville (Cushen). (Call-letters of the Mexican, Arthur, please.—L.J.K.)

**TGWA**, Guatemala ..... 9.76mc, 30.74m  
 Fair signal in afternoon (Gaden).

**TGWB**, Guatemala ..... 6.465mc, 46.40m  
 Good till 4 p.m. Sundays (Cushen).

**TGQA**, Quezaltenango ..... 6.405mc, 46.84m  
 Heard till 4 p.m. Sundays—poor signal (Cushen).

**Nicaragua**  
**YNDS**, Managua ..... 6.76mc, 44.28m  
 Fair and improving at 1.30 p.m. (Cushen).

**Panama**  
**HP5G**, Panama ..... 11.78mc, 25.47m  
 Heard at midday and at night—never very strong (Gaden). Best Panama station—closes 2 p.m. (Cushen).  
**HP5B**, Panama ..... 6.03mc, 49.73m

"Radio Mirimar"—good signal at 2 p.m. (Cushen).  
**HP5K**, Panama ..... 6.005mc, 49.95m  
 Fair at 1 p.m. (Cushen).

## SOUTH AMERICA

**Brazil**  
**ZYB-8**, Sao Paulo ..... 11.765mc, 25.50m  
 Good, but some interference from KCBA. News in Spanish at noon (Cushen).  
**PRL-8**, Rio de Janeiro ..... 11.72mc, 25.60m  
 Now heard closing at 6.30 a.m. instead of 6.10 (Gillett).

**PRL-7**, Rio de Janeiro ..... 9.72mc, 30.86m  
 Can often be heard from 7 a.m. Fair but never in same class as PRL-8 (11.72mc) (Gaden).

**ZYC-8**, Rio de Janeiro ..... 9.61mc, 31.22m  
 Heard closing just after 2 p.m. (Gaden, Cushen).

**Chile**  
**CE1180**, Santiago ..... 11.995mc, 25.01m  
 Heard at 8 a.m. and closing at 2 p.m., when signal is best (Gaden).

**CE970**, Valparaiso ..... 9.728mc, 30.83m  
 Heard after 10 a.m.—very weakly (Gaden).

**Ecuador**  
**HCJB**, Quito ..... 12.445mc, 24.08m  
 Best of the three transmitters in morning and at night (Gaden).

**HCJB**, Quito ..... 9.958mc, 30.12m  
 On occasions is a better signal than 24.08m at night (Gillett).

**HC2AK**, Guayaquil ..... 9.42mc, 31.82m  
 A very regular customer, now; lunch time is quite fair volume on some days. Think it closes at 2 p.m. or so (Gaden). Heard closing at 2.03 p.m. (Gillett). Fine signal at 1 p.m. clear of GRI; has CBS programme till 1.45, then relay of Big Ben and BBC Spanish programme, signing at 2.03 (Cushen).

**HC2ET**, Quito ..... 9.19mc, 32.64m  
 Heard now and again, not as good as formerly, a.m., p.m. and night (Gaden).

**HCJB**, Quito ..... 6.28mc, 47.77m  
 Heard closing at 1.30 p.m. but poor (Cushen).

**Peru**  
**OAX4T**, Lima ..... 11.80mc, 25.42m  
 "Radio Nacional del Peru" has moved

## SCHEDULE OF CROSLY S.W. STATIONS, CINCINNATI

For Latin-Americas. WLWK—WLWO—WLWS and WLWS-2 (\*)

	kc	met.
8.45 p.m.-10.15 p.m.	WLWK 11,710	25.62
8.00 a.m.-10.15 a.m.	15,250	19.67
10.30 a.m.- 3.15 p.m.	6,080	49.34
8.00 a.m.- 8.45 a.m.	WLWO 17,800	16.85
9.00 a.m.- 3.15 p.m.	9,590	31.30
8.45 p.m.-10.30 p.m.	WLWS 6,370	47.10
	* 7,832.5	38.30
10.45 p.m.-12.15 a.m.	WLWS 15,200	19.73
	* 18,180	16.50
1.45 a.m.- 5.30 a.m.	WLWS 15,200	19.73
	* 18,180	16.50
8.00 a.m.-10.15 a.m.	WLWS 15,200	19.73
	* 11,710	25.62
10.30 a.m.-12.30 p.m.	*	
	* 11,710	25.62

For Europe. WLWO and WLWK

10.30 p.m.- 5.45 a.m.	WLWO 15,250	19.67
6.00 a.m.- 7.45 p.m.	9,590	31.30
10.30 p.m.- 7.30 a.m.	WLWK 11,710	25.62

For Europe and Africa. WLWL-1—WLWL-2—WLWR-1

8.30 p.m.-10.15 p.m.	1	17,955	16.70	E.
	2	15,230	19.70	N.A.
11.00 p.m.-11.45 p.m.		17,955	16.70	E.
		15,230	19.70	N.A.
midnight - 1.45 a.m.		17,955	16.70	S.A.
		15,230	19.70	N.A.
2.00 a.m.- 3.30 a.m.		17,955	16.70	S.A.
		15,230	19.70	C.A.
3.45 a.m.- 5.45 a.m.		17,955	16.70	E.
		15,230	19.70	N.A.
6.00 a.m.- 6.45 a.m.		9,700	30.93	E.
		15,230	19.70	N.A.
7.00 a.m.- 9.00 a.m.		9,700	30.93	E.
		7,575	39.60	N.A.
9.15 a.m.- 1.00 p.m.		9,897.5	30.31	N.A.
		7,575	39.60	N.A.
9.00 p.m.- 1.00 p.m.	WLWR-1	9,750	30.77	E.

E—Europe; N.A.—North Africa; S.A.—South Africa; C.A.—Central Africa.



from 9562kc to here. Heard at 2 p.m. at fair strength (Cushen).

**OAX5C**, Ica ..... 9.50mc, 31.58m  
Could not find it at all the other day (Gaden). (I think it is now on 9.54mc, 31.45m.—L.J.K.)

**OAX4Z**, Lima ..... 5.895mc, 50.90m  
Best South American heard. Good from noon till sign off at 2.30 with organ (Cushen). (Not at my place, Arthur. Difference in time is in your favour.—L.J.K.)

**U.S.A.**

**San Francisco unless otherwise mentioned.**

**KCBF** ..... 17.85mc, 16.81m  
Very good early until five minutes' spell for change of antennae at 10.25 a.m.; after that it's a mere shadow of its earlier performance (Gaden). Fair at 11 a.m. (Young).

**KROJ** ..... 17.77mc, 16.88m  
Fair on opening at 8 a.m. in Alaskan Beam, but better at 10.30 till closing at 10.45. On Mondays opens at 9 a.m.—L.J.K.

**KROJ** ..... 17.76mc, 16.89m  
Opens well at 11 a.m. (Young).

**KGT-9**, Los Angeles ..... 15.585mc, 19.27m  
Fair at 3 p.m. (Young). Nice signal in afternoon (Gaden).

**KNBX** ..... 15.34mc, 19.56m  
Certainly very fine especially towards closing, but not better than KNBI, 15.15 mc (Gaden).

**KNBI** ..... 15.15mc, 19.81m  
Beautiful signal 3-4.45 p.m.—L.J.K.

**KGEI** ..... 15.13mc, 19.83m  
Just about as good as KNBX (Gaden).

**KRCQ** ..... 15.12mc, 19.84m  
See "New Stations."

**KLL**, Bolinas ..... 13.72mc, 21.87m  
Heard at 1 p.m. (Young).

**KNBA** ..... 13.05mc, 22.97m  
Excellent from 3 p.m.; much better than anything on the 25-metre band at that time (Gaden). (Yes, from opening at 3 till closing at 4.45 is splendid—also very good again from 5-6.45 p.m.—L.J.K.)

**KCBF** ..... 11.77mc, 25.49m  
Good on opening at 5 p.m. (Cushen).

**KCBR**, Los Angeles ..... 9.70mc, 30.93m  
Very good signal at night (Gaden).

**KNBI** ..... 9.49mc, 31.61m  
Good at 10 p.m. (Young).

**KJE-8**, Los Angeles ..... 9.39mc, 31.95m  
Often at good volume contacting PY-6, Manila, about 10.30 p.m. (Gillett).

**KNBX** ..... 7.80mc, 38.43m  
Very good at 8 p.m. (Young).

**Other than 'Frisco**

**WLWL**, Cincinnati ..... 11.81mc, 25.40m  
As good as any at 9.30 a.m. (Gaden).

**WOOW**, New York ..... 11.87mc, 25.27m  
Splendid till closing at 9.15 a.m. (Gaden).

**WOOW**, New York ..... 11.145mc, 26.92m  
Very good at 9.30 a.m. (Gaden).

**WLWL-1**, Cincinnati ..... 9.8975mc, 30.31m  
Good at 9.30 a.m. (Gaden).

**WNRA**, New York ..... 9.85mc, 30.44m  
Very good at 9.30 a.m. (Gaden).

**WLWR-1**, Cincinnati ..... 9.75mc, 30.77m  
Good signal at 9.30 a.m.—L.J.K.

**WLWO**, Cincinnati ..... 9.59mc, 31.30m  
Poor in comparison with WGE0 in a.m. (Gaden).

**WGE0**, New York ..... 9.53mc, 31.48m  
Very fine in a.m. (Gaden).

**WOOC**, New York ..... 7.82mc, 38.36m  
Very nice at 9.30 a.m. (Edel).

**WBOS**, Boston ..... 7.805mc, 38.43m  
Only a fair signal at 9.30 a.m. (Edel).

**WEST INDIES**

**COCY**, Havana ..... 11.737mc, 25.56m  
Fair at 4 p.m., interference from WRUL-GVV (Cushen).

**COGK**, Havana ..... 8.995mc, 33.33m  
"Radio Grand Electric"—good till signing at 2 p.m. Morse about sometimes (Cushen).

**COCC**, Havana ..... 8.83mc, 33.98m  
Heard before breakfast, near 3 p.m. and at night (Gaden).

**COCD**, Havana ..... 6.13mc, 48.94m  
Heard this one Saturday—closing at 2 p.m. with a march (Cushen).

**'FRISCO AS I SEE IT**

This list has been compiled from my own observations and air-mail material that has reached me. It is believed correct at time of compilation.

All Times are Eastern Australian Standard

Call sign	Freq. (m.c.)	Wavelength	Time on the Air
<b>KNBX</b>	21.61	13.88	Idle.
<b>KCBF</b>	17.85	16.81	<b>7 a.m.-1.45 p.m.</b>
<b>KRHO</b>	17.80	16.85	9-4.55 p.m.
<b>KROU</b>	17.78	16.87	6-8 a.m.
<b>KNBA</b>	17.78	16.87	11.20 a.m.-2.45 p.m.
<b>KROJ</b>	s 17.77	16.88	4-5.45 a.m.; 6-7.45 a.m. (8.45 a.m. Mondays); 8-10.45 a.m. (from 9 a.m. Mondays).
<b>KROJ</b>	s 17.76	16.89	11 a.m.-1.45 p.m.
<b>KWIX</b>	17.76	16.89	<b>Midnight-6 a.m.</b>
<b>KWID</b>	17.76	16.89	<b>6-10.30 a.m.</b>
<b>KNBX</b>	s 15.24	19.56	<b>1 a.m.-3.05 p.m.</b>
<b>KWIX</b>	s 15.29	19.62	6.25-8.25 a.m.
<b>KCBA</b>	15.27	19.65	
<b>KNBI</b>	c 15.24	19.68	6-11.05 a.m.
<b>KGEX</b>	15.21	19.72	7.15 a.m.-1.15 p.m.
<b>KROJ</b>	s 15.19	19.75	Idle at present.
<b>KNBI</b>	15.15	19.81	3-4.45 p.m.
<b>KNBI</b>	15.15	19.81	11.20 a.m.-2.45 p.m.
<b>KGEX</b>	15.13	19.83	<b>1-7 a.m.</b>
<b>KGEI</b>	s 15.13	18.83	<b>7 a.m.-3.05 p.m.</b>
<b>KRCQ</b>	15.12	19.84	2-5 a.m.
<b>KRCA</b>	15.12	19.84	9 a.m.-3 p.m.
<b>KNBA</b>	13.05	22.98	6-11.05 a.m.; 3-4.45 p.m.
<b>KNBA</b>	13.05	22.98	5-6.45 p.m.
<b>KWIX</b>	n 11.89	25.23	9.45 a.m.-1.45 p.m.
<b>KWID</b>	11.87	25.27	2.15-3 p.m.
<b>KGEX</b>	11.79	25.44	5-7.45 p.m.
<b>KCBA</b>	11.77	25.49	<b>7 a.m.-1.45 p.m.; 2-4 p.m.</b>
<b>KCBF</b>	s 11.77	25.49	5-6.45 p.m.
<b>KROJ</b>	11.74	25.55	5-6.45 p.m.; 2-3.45 a.m.
<b>KGEI</b>	11.73	25.58	3.20-6.45 p.m.
<b>KRCA</b>	11.14	26.92	5 p.m.-1.15 a.m.; 1.30-5 a.m.
<b>KWV</b>	10.84	27.68	5-11 p.m.
<b>KES-3</b>	10.62	28.25	9 a.m.-3 p.m.
<b>KROJ</b>	9.89	30.31	2-4.45 p.m.
<b>KWIX</b>	9.85	30.44	5.30-6.30 p.m.; 7-8.45 p.m.
<b>KROU</b>	s 9.85	30.44	
<b>KCBA</b>	9.75	30.77	5-6.45 p.m.
<b>KCBF</b>	9.75	30.77	<b>2-4 p.m.; 7 p.m.-3 a.m.</b>
<b>KCBR</b>	n 9.70	30.93	7 p.m.-12.40 a.m.
<b>KNBC</b>	s 9.70	30.93	
<b>KNBI</b>	9.70	30.93	5-6.45 p.m.
<b>KRHO</b>	n 9.65	31.09	2-5 a.m.
<b>KWID</b>	9.57	31.35	<b>10.45 a.m.-2 p.m.;</b> 5.45-6.45 p.m.
<b>KGEI</b>	9.55	31.41	7 p.m.-2 a.m.; 2.30-4 a.m.
<b>KNBI</b>	9.49	31.61	7 p.m.-1.15 a.m.
<b>KES-2</b>	8.93	33.58	7 p.m.-12.45 a.m.
<b>KNBX</b>	cs 7.805	38.43	5 p.m.-1.15 a.m.; 1.30-2 a.m.
<b>KNBA</b>	7.57	39.60	7 p.m.-3 a.m.
<b>KNBA</b>	7.565	39.66	7 p.m.-12.45 a.m.
<b>KNBX</b>	7.56	39.66	Idle.
<b>KGEX</b>	7.25	41.38	8 p.m.-12.45 a.m.
<b>KGEI</b>	7.25	41.38	Idle.
<b>KWIX</b>	7.23	41.49	9 p.m.-11.45 p.m.
<b>KCBA</b>	6.17	48.62	Idle.
<b>KRHO</b>	s *6.12	49.02	5.15 p.m.-1.15 a.m.
<b>KROJ</b>	6.105	49.18	7-11 p.m.

Station times in bold faced type are beamed to Latin Americas by United Network.

\* Situated in Honolulu.

The following symbols will show alterations to June list: n—new station; f—change of frequency; s—schedule; c—call sign.

L. J. KEAST,  
Carlingford.

**HH3W**, Port-au-Prince ..... 10.13mc, 29.62m  
Heard weakly at 1 p.m. Morse is not so bad as at night (Gaden). Signs at 1 p.m. (Cushen). News from C.B.S. at 10 p.m. (Gillett).

**HHBM**, Port-au-Prince ..... 9.65mc, 31.06m  
Only heard at night—not nearly as good a signal as HH3W, but\* less of Mr. Morse (Gaden). Has been logged at about 10.15 p.m. with programme of popular music. Fades out by 11.10. Station can be identified by the slogan M.B.C. (Magloire Broadcasting Circuit) (Gillett).

**U.S.S.R.**

**Moscow unless otherwise mentioned.**

..... 12.235mc, 24.55m  
Musical programme heard about 10.20 p.m., also on 24.65m (Gillett).

**Haiti** ..... 12.08mc, 24.83m

Heard one morning about 12.30 a.m. during time of the Conference in Moscow when the governing of Germany was mapped out (Gillett).

..... 8.05mc, 37.27m  
Heard at fair strength around 6 a.m. (Young).

..... 7.56mc, 39.68m  
Good at 7 a.m. (Young).

..... 7.50mc, 40.01m  
Good at 8.30 a.m. (Young).

..... 6.98mc, 42.98m  
Fair at 8.30 a.m. (Young).

**MISCELLANEOUS**

**Canada**

**CHTA**, Sackville ..... 15.22mc, 19.71m  
Fair at 4.45 a.m. with news (Cushen).

Uses French between 9.30 and 9.45 p.m., followed by German (Gillett). Fair at night (Gaden).

# Speedy Query Service

Conducted under the personal supervision of A. G. Hull

**F.A. (Derrinallum) asks whether we are still accepting subscriptions.**

A.—Yes, we still accept subscriptions. The rate is 10/6 for twelve issues, post free to any address in the world. We are not running the coupon these days on account of a shortage of paper, but you can just drop a short letter to us at 243 Elizabeth Street, Sydney, and we will look after you all right. Issues are posted in Sydney about the 15th day of each month.

**"Shorts" (Cremorne) enquires about Mr. Keast.**

A.—You can write to Mr. Keast at 21 Honiton Avenue West, Carlingford, and I am sure that he will be interested. His address has been given several times, but apparently you have missed it. Of course, a letter addressed to Mr. Keast care of this office will reach him eventually, but for prompt attention we suggest that you write direct.

**D.P. (Essendon) has a contribution ready.**

A.—Generally speaking, we like to publish the full name and address of every contributor, as it is often helpful for readers who want further information. In many cases it is quite hopeless for our normal query service

---

## AMPLIFIER

(Continued from page 23)

which have won contests over the last several years have been quite straightforward, with no compensation at all. Some of the amplifiers entered must have had compensation applied. So perhaps the foregoing remarks are not quite as facetious as they seem. Either that or the compensation was not applied properly in the amplifier. However, that is a problem which will remain unsolved, so no good purpose is served in pondering on the pros and cons here and causing a lot of argument that will not lead to any solution. Personally, I still think that a compensated amplifier is necessary for the very best results.

to attempt to handle the questions arising from an article written by someone who specialises in his own particular subject. We would be a trifle shaky about accepting and publishing the article if you are not prepared to put your name to it.

**G.P. (Darlinghurst) submits a crazy "push-pull" circuit which he claims will work, but he wants a technical explanation of how it works.**

A.—Sorry to disappoint, but we can't offer any sound reason why the circuit should work. In fact, we feel positive that you are in error in claiming that it does. How have you gone about proving that both output valves are giving their full power correctly out of phase? Any push-pull amplifier will still give some sound when you pull out one of the output valves, but that doesn't prove that the amplifier is pulling and pushing with only one valve left in operation. There are lots of tricks that can be played by using the coupling effects of a common bias resistor and a common output transformer, but don't let them fool you if you are in search of true push-pull.

**C.R. (St. Kilda) enquires about payment for articles published.**

A.—We are always pleased to pay for articles used. Payment usually ranges around between two to five guineas according to merit, but we have up to ten guineas waiting for anything really good. Some of our contributors, however, do not seek payment, writing simply because they are keen radio enthusiasts willing to share their knowledge. To make the matter quite clear, your best plan is to attach an invoice to each article submitted. Then when we send an article to the printer we can detach the invoice and send it to the accountant for payment. In all cases we expect the contributor to submit an account for payment.

**C.F. (Bendigo) wants a further explanation of the term "dielectric constant."**

A.—Suppose you have two condenser plates of a certain size at a certain spacing and you have a cer-

tain capacity when the spacing is filled with air. Replace the air with a sheet of mica and you will have about seven times greater capacity. That is because the mica has a dielectric constant of about seven. Use paper instead of mica and the capacity will be about double the original capacity with air. That is because the dielectric constant of paper is about two.

The size of a paper dielectric condenser of any given capacity will depend primarily on the thickness of the paper used to space the two foils, but also on the dielectric constant of the material used as impregnant for the paper. In this respect the smallest condensers use a chlorinated naphthalene impregnant, such as "Halowax," with a dielectric constant of about four, as against about two for petroleum jelly.

**R.S.H. (Tamworth) enquires about an article he submitted some time ago.**

A.—Sorry not to have acknowledged your letter, but we are right up against it for time. When it comes to Manpower, we don't have any priority, so that we feel happy if we get the issues out on time, even if it means that we can't manage normal courtesy in other directions. Your article is in hand, but needs a photo to brighten it up. If you don't believe there is a war on, just go in and ask for a packet of bromide paper! We will hold the article further unless you have any special reason for wanting it returned, as it is sure to come in handy sooner or later.

---

## FILTERS

(Continued from page 25)

nect enough of these units in series to withstand, say, 6,000 volts. So, in high voltage filters it is necessary to make use of the paper dielectric condensers.

For use with these high voltages, chokes with large inductances are cheaper to construct than large-capacity condensers; it is therefore usual for condensers to have a capacity of about 1 or 2 microfarads which at even this low capacity are of bulky dimensions. The low capacity of the condenser means that the choke must have a large inductance to compensate for this small capacity.



**THERMEX** meets the demand for high frequency equipment for pre-heating of plastic preforms. Preforms are placed on this drawer which slides into unit shown below.



THERMEX MODEL 2-P

*Of course it uses Eimac valves*

This compact Thermex unit measures 28 inches by 28 inches, stands 47 inches high, and weighs only 614 pounds. It is a practical and flexible piece of equipment with built-in heating cabinet and removable 12 inch by 15 inch drawer-electrode.

Being completely automatic, there is nothing to do but plug this Thermex in and load and unload the preform drawer. No dials, no tuning, not even a button to push. Closing the preform drawer all the way in, turns on the high frequency power and timer. At the end of the prescribed time, which may be anywhere from 5 to 10 seconds up to 2 minutes, the red indicating light goes out, the operator removes the tray and unloads the preforms into the mold cavities.

The Thermex Model No. 2-P, which is illustrated, operates at a frequency of 25 to 30 megacycles using 230 volt 60 cycle single phase current. It has an output in excess of 3400 BTUs per hour, and it uses a pair of Eimac 450-TH valves. The use of electronic heating has increased production for many plastic manufacturers who

have been leaders in utilizing the science of electronics.

The Thermex Division of the Girdler Corporation of Louisville, Ky., is a leader in supplying equipment for this and other industrial applications. It's natural that Eimac valves are used, since these valves are first choice of leading electronic engineers throughout the world.

Follow the leaders to



EITEL-McCULLOUGH, Inc.

985 San Mateo Avenue, San Bruno, California

Plants located at: San Bruno, California and Salt Lake City, Utah

Expert Agents: Frazer & Hansen, 301 Clay St., San Francisco 11, California, U. S. A.



Eimac has received 7 ARMY-NAVY "E" AWARDS for production efficiency • San Bruno 5, Salt Lake City 2

TO-DAY

# LET THE PRESENT DECIDE YOUR FUTURE NOW!

Whatever job you are engaged upon at the present time, whether it is in the Forces, or in the Factory, or in any of the many essential Services, keep the Future well before you. Remember, the war won't last forever and the Peace must find you prepared to take your place in the post-war world where competition will be very keen. Radio is a young industry which has shown remarkable progress in the past few years. The future possibilities of Radio are unlimited, and they spell security and prosperity for a man who is trained.

## YOU CAN START RIGHT AWAY

Right now openings in Radio are greater than the number of men available to fill them. Here are three good reasons, moreover, why A.R.C. Radio Training must interest you so vitally. 1. You will enter today's most progressive industry. 2. You will be pulling your weight in the war effort. 3. You will have a splendid career ahead of you when the war is over.

## COSTS LITTLE

Think of this—for a few pence per day—actually less than many fellows spend on tobacco—you can prepare yourself for a mon-sized job in Radio NOW.

## TRAIN AT HOME, IN CAMP, OR AT OUR BENCHES

A.R.C. offers ambitious men a sound, proven course in Radio Engineering. Sound because it is the result of many years' successful operation; proven, because hundreds of ex-students owe their present success to the college. You can learn with equal facility at home, or even in camp with your unit (by means of our correspondence course), whilst the modern equipped College workshops are available to night students.

## PREVIOUS KNOWLEDGE UNNECESSARY

You don't need a knowledge of Radio or Electricity—we'll give you all you need of both, in a simple, practical manner that makes learning easy; presented, too, in such a way that you remember what you're taught and speedily gain the opportunity to PRACTICALLY use your knowledge. A.R.C. Training fully covers Radio Servicemen's Licensing requirements for technical knowledge.

## HERE'S PROOF

"I'm blessing the day I started with A.R.C. Already I've earned enough to cover all expenditures, including: (1) Course paid for; (2) Two meters, value pre-war. £26; (3) Four Radios to learn on and experiment on, plus a fair amount of stock, value roughly £15—and, best of all, worth more than all.—A DECENT FUTURE."  
—H.B., Western Australia.

"Just a letter of appreciation and thanks for what your radio course has done for me. Since obtaining my Certificate in December I have serviced 145 receivers, and I am proud to say that not one of them had me beat, thanks to your wonderful course and advice."  
—D.H., Home Hill, Q'ld.

## SEND FOR THIS BOOK

First thing to do if you want to secure vital Radio facts is to send for "Careers in Radio and Television," a lavishly illustrated book published by the College and available to approved enquirers. Send coupon for your FREE COPY NOW!



# AUSTRALIAN RADIO COLLEGE PTY. LTD.

Cnr. BROADWAY & CITY ROAD  
SYDNEY - Phone M6391-M6392

To Mr. L. B. GRAHAM, Principal,  
Australian Radio College Pty. Ltd.  
Broadway Sydney. Phone, M 6391-2  
Dear Sir,—I am interested in Radio. Please send me, without obligation on my part, the free book, "Careers in Radio and Television."  
NAME \_\_\_\_\_  
ADDRESS \_\_\_\_\_  
A.R.W.5



Radio is now being used to save vital spraying materials in industry. The spraying of radio valves is now controlled by a new radio device. The conveyor belt carries unpainted valves in front of two special spray guns, and then into the baking oven. A control in the form of an electronic switch makes certain that the guns spray each valve completely, but withhold the spray if certain valves are missing from their sockets on the conveyor belt. Truly a marvellous device which can be used by those interested in many forms of spraying.