

**THE
AUSTRALASIAN**

PRICE, 1/-

Radio World

VOL. 4 NO. 9

FEBRUARY 1, 1940

Registered at the G.P.O.,
Sydney, for transmission
by post as a periodical

● "WORLD CRUISER" A.C.
COMMUNICATIONS EIGHT

● 1940 COMPANIONETTE :
MIDGET 3-watt AMPLIFIER

● NEW A.C. BATTERY
PORTABLE REVIEWED

● LATEST OVERSEAS S.W.
AND B.C. BAND DX NEWS



A corner of the Awatea's radio cabin. —Photo courtesy A.W.A.

Oscillator v. Signal Generator



Regarding the principle involved, there is little fundamental difference between an Oscillator and a Signal Generator, yet prices range from approximately £40 to £150 and over—WHY?

Because the instrument selling in the latter price class is invariably a PRECISION INSTRUMENT and—as precision is NECESSARY in commercial radio design and production—it is usual to PAY THE PRICE.

Precision is also very necessary for good service work.

It was with the object of giving the serviceman the maximum of efficiency and precision at a PRICE WITHIN REASON that the "PALEC" G SERIES SERVICE OSCILLATORS were progressively evolved. That a GOOD OSCILLATOR is a VITALLY IMPORTANT TOOL is now universally recognised. NOTE OUR SPECIFICATIONS—better still, VISIT US, and see a stock model demonstrated. We claim the following "HIGH PRICED" features:—

Frequency Accuracy of HALF OF ONE PER CENT. on a direct reading dial; incorporation of a LOW IMPEDANCE 4-step PAD TYPE attenuator; reliability of REPEAT HEADINGS even over a period of years; unusually LOW LEAKAGE level; SINE WAVE Modulation at a mean value of 30 per cent.; incorporation of a compensated R.F. stage for maximum STABILITY, AMPLITUDE LEVEL and minimum FREQUENCY MODULATION; six fundamental bands from 160 k.c. to 24 megacycles; full range external Dummy Antenna.

OSCILLATOR MODELS AND PRICES.

Model GA, A.C. operated	£11 15 0
Model GAO, A.C. operated, with built-in Output Meter	£15 15 0
Model GAV, A.C.-Vibrator, dual operation from power supply or 6-volt accumulator	£13 15 0
Model GAVO, A.C.-Vibrator, with built-in Output Meter	£17 15 0
Model GB, Battery operated	£11 15 0
Model GBO, Battery operated, with built-in Output Meter	£15 15 0



PALEC MODEL V.C.T. COMPLETE VALVE AND CIRCUIT TESTER.

Now in its third year and more popular than ever, the Palec Model VCT continues to supply the demand for a complete Valve and Circuit Tester in one compact unit.

Dozens of letters (on hand) from all States attest the reliability and efficiency of this versatile instrument.

The Model VCT, together with the new Palec Service Oscillator, can be aptly described as the serviceman's right and left hand, respectively. They enable every rational test and adjustment to be made on a receiver, from the aerial coil right through to the speaker voice coil—in other words, with just these two instruments a serviceman is well, if not fully equipped.



PALEC VACUUM TUBE VOLT-METER.

This new unit is an ideal instrument for either service, design or laboratory work. The circuit follows closely a design popularised by a world famous manufacturer of instruments and employs a 955 acorn tube as a diode rectifier in conjunction with a degenerative amplifier.

Features include:—Ranges, 0-2.5; 10-50 Volts A.C.; 3.5 uuf. total input capacitance; 5 megohm impedance at 50 cps.; scale accuracy of $\pm 3\%$ over the frequency range 50 cps. to 50 megacycles; low power factor through the use of mycalex insulation; Lineregulation; A.C. operation. PRICE, £13/15/-.

SPECIFICATIONS:—Tests all valves for MERIT and LEAKAGE; ELECTROLYTIC CONDENSERS; PAPER AND MICA CONDENSERS; FOUR RANGES of current, 1-10-50-250 m.a. D.C.; D.C. VOLTS, 10-50-250-1000V.; A.C. and OUTPUT VOLTS, 10-50-1000V.; a special LOW OHMS range from 0.1 of an ohm (ten ohms half scale), with three other ranges to 1 megohm.

Model "VCT" for straight A.C. operation; price, £15/10/-. Country Model "VCT" (dual operation) works with equal efficiency on either the A.C. line or a 6-volt accumulator; price, £17/17/-.

- ALL INSTRUMENTS PLUS SALES TAX.
- PRICES SUBJECT TO ALTERATION WITHOUT NOTICE.
- SEND FOR OUR ILLUSTRATED CATALOGUE.



PATON

ELECTRICAL PTY. LTD.

90 VICTORIA ST., ASHFIELD, SYDNEY

Telephones: UA 1960-1982

LEADING DISTRIBUTORS ALL STATES



BUILD THE "RADIO WORLD"—

ALL-WAVE SERVICE OSCILLATOR

using the CALSTAN ALL-WAVE OSCILLATOR FOUNDATION KIT

AS SPECIFIED BY THE DESIGNER.

MAIN FEATURES INCLUDE :

- Continuous coverage from 150 k.c. to 30 m.c. in five bands.
- Coils, band switch and attenuator are wired and sealed in a compact steel case, modulation choke and condenser gang being mounted externally.
- ONLY FOUR COLOUR-CODED LEADS to connect Foundation Unit into circuit.
- Band coverage is accurately pre-adjusted to track with five-band direct-reading scale.
- Electron-coupled r.f. oscillator circuit ensures high frequency stability.



The Calstan All-wave Oscillator Foundation Kit Comprises—

1 special Calstan all-wave oscillator foundation kit, comprising ready-drilled steel crackle-finished cabinet, 7½" x 6½" x 10," all-wave oscillator unit (comprising five-band coil assembly and attenuator mounted in steel box, with modulation choke and condenser gang bolted in position), tuning knob and celluloid indicator, scale for front of cabinet printed on heavy art paper. PRICES: £7/17/6 Complete Kit; £4/17/6 Foundation Kit. Coil Kit only, including gang condenser and cover, £3/7/6.

NEW ECONOMY TYPE CALSTAN OUTPUT METER

(As illustrated on the right)

... is now available for the indication of the output of receivers when used in conjunction with the "RADIO WORLD" Service Oscillator. For further information, prices, etc., ring, write, or call—



SLADE'S RADIO PTY. LTD.

LANG STREET, CROYDON, N.S.W. 'Phones: UJ 5381, UJ 5382.

Australia's Largest Manufacturers of Radio Servicing and Measuring Instruments . . . who during the past five years have manufactured over 20,000 Moving Coil Meters . . . this experience has enabled our artisans to produce meters and test equipment equal to the World's best.

Ask your distributor for a complete list of prices and types.

DISTRIBUTORS: N.S.W.: Radio Equipment Pty. Ltd., Martin de Launay Ltd., Bloch & Gerber Ltd., United Radio Distributors, John Martin Ltd., Murdoch's Ltd., Brice's Radio Service, Electric Service Co., Newcastle. QUEENSLAND: Chandlers Pty. Ltd. SOUTH AUSTRALIA: Radio Wholesalers Ltd., Adelaide. WEST AUSTRALIA: Norman J. Burnell & Co. 13 Queen Street, Perth. VICTORIA: Australian General Electric Ltd., Melbourne; Arthur J. Veall Pty. Ltd., Melbourne; Hartleys Ltd., Flinders Street, Melbourne. TASMANIA: Oatlands Garage, Oatlands. NEW ZEALAND: New Zealand Electrical Co. Stocks also available from Turnbull and Jones, all branches.

A SPECIAL KIT

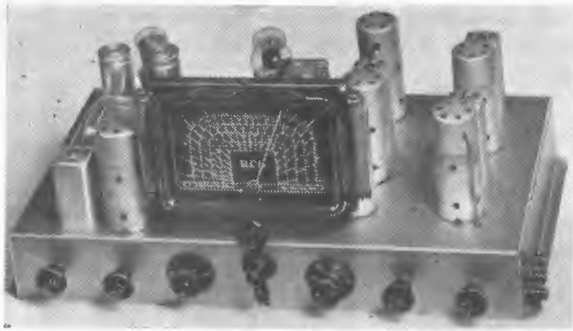

for the "WORLD CRUISER COMMUNICATIONS EIGHT"

Don't take risks in building this magnificent receiver by using parts of doubtful quality. Those supplied in our kit of parts are guaranteed to be exact duplicates of those selected by the Technical Editor for the original model, and by using them you will ensure getting the same outstanding performance.

WRITE NOW FOR DETAILS OF OUR LOW-COST HIGH-QUALITY KIT OF PARTS.

THE "1940 COMPANIONETTE THREE."

1940 version of a widely-popular kit, this little receiver gives an amazing performance out of all proportion to its low cost. QUOTATIONS SENT POST-FREE BY RETURN MAIL.

"RADIO WORLD" SERVICE OSCILLATOR.

The all-wave service oscillator described in last month's issue will cut service costs per set and increase profits. Our low-cost kit of parts can be assembled in two hours . . . success is guaranteed, full assembly instructions supplied with each kit.

WRITE NOW FOR OUR NETT TRADE PRICE. NO OBLIGATION.

FOR LIGHTNING SERVICE AND LOW PRICES . . . TRY US!

You deserve to be sore all over if you continue getting your radio and electrical supplies from firms which deal you out High Prices and Slow Service.

Say to yourself, firmly: "My next order goes to Martin de Launay's!" It'll be one of the best business decisions you have ever made. We promise you that! We promise you a lightning service, careful packing, tip-top quality and keen prices.

Moreover, we promise to keep our promise, no matter whether YOUR order is big or small.

The next move is yours!



The Australasian RADIO WORLD

Incorporating the ALL-WAVE ALL-WORLD DX NEWS

Managing Editor:
A. EARL READ, B.Sc.

Vol. 4. FEBRUARY, 1940. No. 9.

CONTENTS:

New A.C.-Battery "Duo" Portable	3
Book Reviews	4
1940 Companionette Three	5
Modulated Oscillators	9
Midget Three-Watt Amplifier	11
World-Cruiser Communications Eight	13
The Story of R.C.S. Radio (3)	27
What's New In Radio	29
Long Horn Public Address Speakers	31
Shortwave Review	33

The "Australasian Radio World" is published monthly by Read Publications. Editorial Offices: 117 Reservoir Street, Sydney, N.S.W. Telephone FL 2842. Cable address: "Repress," Sydney. Advertisers please note that copy should reach office of publication by 14th of month preceding that specified for insertion.

Subscription rates: 1/- per copy, 10/6 per year (12 issues), post free to Australia and New Zealand.

This cabinet, measuring only 13½" x 9¾" x 5½" and covered in smart airway canvas, houses four Breville portables—the Models 156 and 157 four and five-valve receivers for battery operation only, and the Models 168 and 169 five and six-valve "Duo" receivers for a.c. and battery operation. A test report on the Model 169 appears below.



New A.C. - Battery "Duo" Portable

Latest Breville release has built in a.c. power supply ★ Gives remarkable performance during tests.

THE introduction of the 1.4-volt valves some eighteen months ago removed every practical objection to portable radios that had previously prevented them from becoming widely popular. The very high overall efficiency and modest "A" and "B" current requirements of these valves made possible the design of light, compact and entirely self-contained receivers that could be carried anywhere, and that would give full loud speaker reception day or night, in almost any location.

To-day almost every receiver manufacturer in Australia is marketing one or more 1.4-volt portables, which are available in about every conceivable design and valve arrangement. While most models are designed for battery operation only, there are some for which external a.c. power units are available, and several with built-in a.c. power supplies.

Two Breville "Duo" Models.

Prominent among manufacturers of the last-named type of receiver is Breville Radio Pty. Ltd., of 67-75

Missenden Road, Camperdown, N.S.W., who recently added to their already extensive range of portables the "Duo Five" (Model 168) and "Duo Six" (Model 169). These are five and six-valve models, respectively (including rectifier) designed to give dual-purpose operation from either self-contained batteries, or the a.c. mains (220, 240 or 260 volts).

Last month one of the "Duo Sixes" was supplied to "Radio World" for test, and it has proved itself a remarkable little receiver.

Constructional Details.

It is housed in a cabinet similar to that illustrated above, measuring approximately 13½" long x 9¾" high x 5½" deep, and finished in attractive grey-toned airway canvas with multi-coloured stripe. Weight of the receiver is 20 pounds, complete with batteries.

Both the dial and the three controls are recessed into the front of the cabinet. The back of the latter is held into place with two screws, which also act as terminals for external aerial

and earth connections. However, the efficiency of the built-in tuned loop aerial is so high that it provides more than ample pick-up under almost any conditions.

Inside the cabinet is a horizontal shelf on which the chassis rests, an Eveready Type PR8 "A" unit being located alongside it. The compartment underneath the shelf houses the two Eveready type PR45-volt "B" batteries and the power cord.

The steel chassis, which measures only 10¼" x 5" x 1¾", accommodates the five valves, dial, i.f. transformers, 5" Rola speaker, the three-gang condenser and power transformer.

Provision For Headphones.

There are three controls in front of the cabinet, these being (left to right) tuning, battery/a.c. switch, and combination on/off switch and volume control. A refinement that many users will appreciate is the provision that is made for headphone operation, the necessary sockets being located in a small recess in the left-hand end of the cabinet. This feature will be (Continued on page 40).

TECHNICAL

BOOKS



	Price	Postage
1940 Radio Amateur Handbook	10/-	9d.
Radiotran Designers' Handbook	3/-	4d.
Radio Laboratory Handbook, Scroggie. (This book should definitely be in the possession of every experimenter, engineer and set-builder. It is published by the Wireless World)	13/6	6d.
Radio Physics Course, Ghirardi	30/-	1/3
Modern Radio Servicing, Ghirardi	30/-	1/3
Principles and Practice of Radio Servicing, Hicks	24/-	9d.
Radio Manual, Sterling	42/-	1/3
Vibrator Manual and Professional Serviceman's Auto Radio Guide	2/6	3d.
Servicing by Signal Tracing, Rider	16/-	9d.
Amplification and Distribution of Sound, by Greenlees	17/6	8d.
Handbook of Technical Instruction for Wireless Telegraphists, Dowsett	34/-	1/-
Wireless Direction Finding, Keen	42/-	1/3
Radio Craft Library—		
Home Recording	4/6	3d.
Practical Public Address	4/6	3d.
Breaking Into Radio Servicing	4/6	3d.
The Cathode-Ray Oscilloscope	4/6	3d.
Servicing with Set Analyzers	4/6	3d.
Short-wave Beginners' Book	2/-	3d.
Short-wave Hook-ups	4/6	3d.
Short-wave Radio Quiz Book	2/3	3d.
Cathode Modulation, by Jones	9/6	4d.
The A.R.R.L. Antenna Book	4/6	4d.
R.C.A. Receiving Tube Manual	2/-	4d.
Technical Manual	3/9	6d.
Cathode-Ray Tubes and Allied Types	2/-	3d.

McGILL'S AGENCY

183-5 Elizabeth Street
Melbourne

(Send for our free Catalogue of Technical Books and Magazines on all subjects).

Book Reviews

The Radio Amateur's Handbook: 1940 Edition.

Despite the handicap of war, the amateur transmitter with a keen interest in the experimental side of radio is not likely to throw everything to the winds. Although experimental activities in the way of actual transmission from his amateur station are necessarily suspended, he will in his mind's eye, cherish the day in the unknown future when he will be able to get back on the air and continue inter-communication with fellow radio amateurs far and wide.

Perhaps from the chaos of this war-stricken world, the time may come when sane governments will make available every possible facility for wider instead of narrower frequency channels for amateur communication, with the object of promoting better understanding between men in the world to come. Despite war, the science of radio doesn't stand still, and while at this stage much of its application is along the lines of offence and defence, the interests of the experimenter are still unhampered in yet neutral America.

From that country comes the seventeenth edition of "The Radio Amateur's Handbook," published by the A.R.R.L. at the offices of "QST," Hartford, Connecticut. This 1940 edition is, if that is possible, bigger and better than preceding issues, containing 575 pages of profusely illustrated and diagrammed radio developmental material covering the subject from A to Z.

It is natural that with most Australian amateurs turning their capabilities to the serious business of war communications in one or other of the services, touch with the latest developments in the past few months is likely to be casual. This latest A.R.R.L. Handbook is just the volume to breach the gap and to keep one fully up-to-date. It would be impossible here to detail all the sections of this new edition, and it is sufficient to say that every possible phase of radio reception and transmission is fully covered, from fundamentals to the intricacies of ultra-high-frequency and micro-wave practice of these times.

There are many new ideas in transmitter construction, and the receiver side alone is of particular interest, this being in Australia, one aspect of amateur radio on which much work can be done in preparation for the future.

(Continued on page 40).

Important

The "Australasian Radio World" is about to launch a vigorous policy of improvement and expansion.

The first announcement in this direction is that, as from the next issue, the editorial chair will be occupied by—

A. G. Hull



Mr. Hull, who has been associated with "Wireless Weekly" for the past ten years, originally as technical editor and latterly as editor of both "Wireless Weekly" and "Radio and Hobbies," is recognised as Australia's foremost technical journalist. His wide experience should ensure that "The Australasian Radio World" will maintain its position as the radio-technical authority.



WATCH NEXT MONTH'S ISSUE;
ORDER YOUR COPY NOW!

The "1940 Companionette" is housed in a wooden cabinet covered in airway canvas and measuring approximately 15" x 7" x 8." While designed primarily to bring in locals at full speaker volume, excellent interstate reception is easily possible with this little receiver.



1940 Companionette Three

Full four-valve performance from three valves is given by this a.c. t.r.f. receiver, which employs a 6F7 as combined pentode r.f. amplifier and triode detector driving a high-gain 6AG6G output pentode. Automatic regeneration is an attractive feature.

THE "1940 Companionette" is a new version of one of the most successful little receivers ever featured in "Radio World."

Originally described in the March, 1937, issue, a revised version appeared in the May, 1939, issue. Hundreds of these sets have been built up by

readers throughout Australia, some excellent performance reports being received. Actually the original model is still being built, as this extract from a letter recently received from Mr. M. H. Hughes, a reader in Parkes, N.S.W., shows:—

"After going through some back

numbers of 'Radio World,' I decided wish to report on the reception this little t.r.f. set has produced, with to build the 'Companionette Three' advertised in the March, 1937, issue. I only approximately 14 feet of inside aerial and no earth.

"Tested at 7.30 p.m., the following stations were brought in besides the local, 2PK:—N.S.W.: 2GZ, 2WG, 2CO, 2CR, 2BL and 2FC. Victoria: 3LO and 3AR. South Australia: 5CK and 5CL. All were picked up at good volume. I have a five-valve superhet on hand, and it has been out-classed by the 'Companionette Three' for selectivity."

Other readers using outside aerial and earth systems in fair locations have reported logging up to thirty stations in Australia and New Zealand, all at good speaker strength and excellent tone.

The circuit of the "1940 Companionette," together with under-socket connections of the 6F7 and 6AG6G.

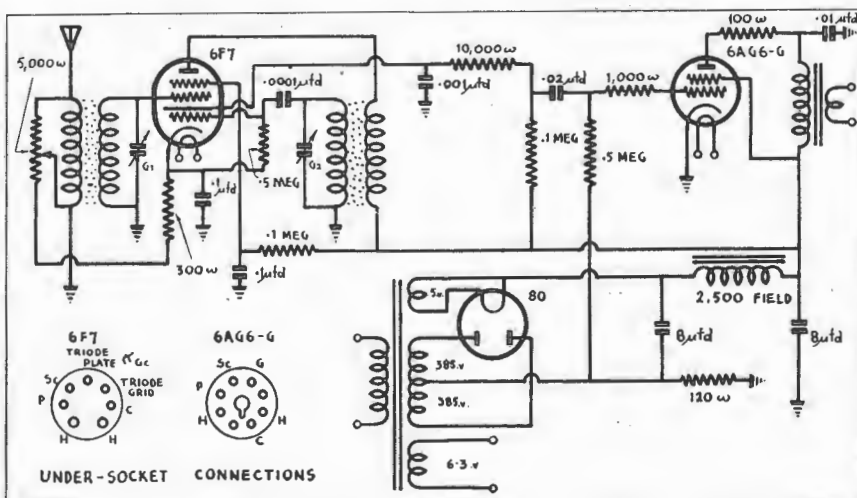

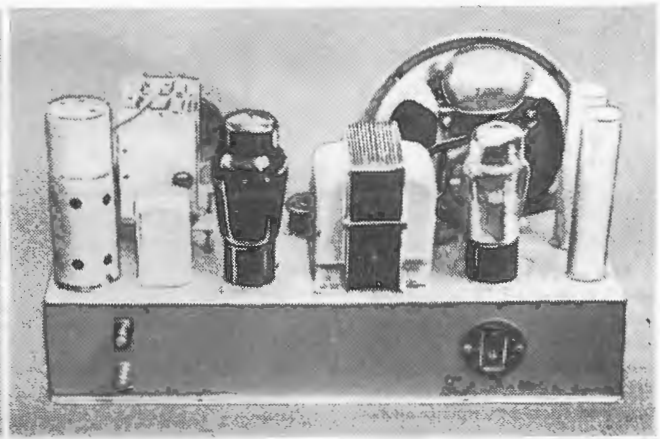
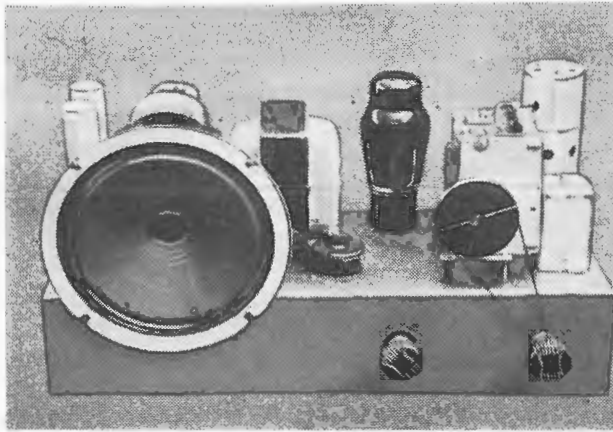

Two views of the completed chassis. Note the method of mounting the speaker so that it projects beyond the front wall. The rear view on the right shows the roomy layout adopted, the chassis having been designed in accordance with the latest trend in mantel receivers.

Is Actually A "Four."

The secret of this exceptional performance lies in the use of the 6F7 triode pentode, which really comprises two separate valves in the one glass envelope, only the cathode being common to both.

The fact that the 6F7 is a double valve does not detract in the least from the efficiency of its component sections. In other words, the overall gain it gives is exactly the same as if separate valves were used. Thus in the "1940 Companionette," there are really four valves—a pentode r.f. amplifier, triode detector, output pentode and rectifier.

Steep Slope Output Pentode.

The output pentode chosen is the now well-known Brimar 6AG6G, a valve that is ideal for a small receiver of this type, as it has exceptionally high sensitivity. A signal input of only 2 volts r.m.s. will fully load it to deliver over four watts of output.

The rectifier used is a 5Y3G, the modern octal equivalent of the 80.

In the "1940 Companionette" the circuit as used for last year's model has been retained without alteration, but the layout has been completely rearranged and a larger and more attractive dial used. As well, the cabinet is covered in the latest airway canvas that in conjunction with the Reedtex material used for the speaker grille, ensures a very attractive appearance.

New Dial, Chassis And Cabinet.

The dial is the new Efco midget cord drive type. Fitted with a green and gold celluloid scale and brown escutcheon, it is very simple to fit, and has a particularly smooth drive

once the tension has been adjusted correctly.

The chassis for the "1940 Companionette," which measures 15" x 6½" x 3," is of 18-gauge steel, finished in battleship grey duco. The original was supplied by Acorn Pressed Metal Pty. Ltd., of 1 Marshall St., Surry Hills.

The cabinet, which was supplied by Western Manufacturing Co. to the Editor's specifications, measures 15½" long x 7¼" deep x 8" high.

How The Circuit Works.

The circuit shown on page 5 will be found very simple to follow. The signal picked up by the aerial is applied in the usual way via the first tuned circuit to the grid of the 6F7 pentode section. After amplification it appears in the plate circuit and is transferred from the primary to the

grid winding of the detector coil.

The triode section of the 6F7 is connected as a leaky grid detector, which in turn is resistance capacity coupled to the 6AG6G output pentode.

Back-Bias For Output Pentode.

The bias required for the latter valve with a plate and screen voltage of 250 volts is -6 volts. As shown by the circuit, back bias has been employed by connecting a 120-ohm resistor between earth and the centre tap of the high voltage secondary on the power transformer, the 6AG6G grid resistor being returned to the centre tap.

The total "B" current taken by the set flows from earth (i.e., chassis), back through this resistor to the high voltage centre tap. It is the voltage drop across this resistor, in this case amounting to 6 volts, which comprises

"1940 Companionette Three."

List Of Parts.

- 1 special cabinet covered in airway canvas (Western).
- 1 steel chassis, stamped and drilled to specifications (Acorn).
- 1 power transformer, 385 c.t., 385, 60 m.a., 6.3v., 2 amp., 5 v., 2 amp. (Radiokes).
- 1 small 7-pin wafer socket.
- 1 octal wafer socket.
- 1 4-pin wafer socket.
- 2 air-cored coils, 1 aerial, 1 r.f. (R.C.S., Radiokes).
- 1 2-gang condenser (Stromberg-Carlson).
- 1 5,000 ohm volume control (R.C.S., Radiokes).
- 2 terminals, 1 red, 1 black.
- 2 control knobs.
- 1 rubber grommet.
- 1 midget dial and escutcheon (Efco).
- 1 power socket and plug.
- 2 8 mfd. wet electrolytics (T.C.C.).
- FIXED RESISTORS:**
- 2 .5 meg. 1-watt carbon (I.R.C.).
- 2 .1 meg. 1-watt carbon (I.R.C.).

- 1 10,000 ohm 1-watt carbon (I.R.C.).
- 1 1,000 ohm 1-watt carbon (I.R.C.).
- 1 300 ohm 1-watt carbon (I.R.C.).
- 1 150 ohm wirewound (I.R.C.).
- 1 100 ohm wirewound (I.R.C.).

FIXED MICA CONDENSERS:

- 1 .0001 mfd. (T.C.C.).
- 1 .001 mfd. (T.C.C.).

FIXED PAPER CONDENSERS:

- 1 .02 mfd. (Ducon).
- 1 .01 mfd. (Ducon).
- 2 .1 mfd. (Ducon).

SPEAKER:

- 1 dynamic speaker, to match single 6AG6G, 2,500 ohm field (Rola F5B, Amplion).

VALVES:

- 1 6F7, 1 6AG6G, 1 5Y3G.

MISCELLANEOUS:

- 2 doz. 3/8" nuts and bolts; 4 yards push-back (solid and flexible); 1 6ft. length power flex and plug; 1 doz. solder tags; 1 yard 4 mm. spaghetti; 1 resistor strip; insulating washers for electrolytic; 1 6.3v. dial light; 1 grid clip.

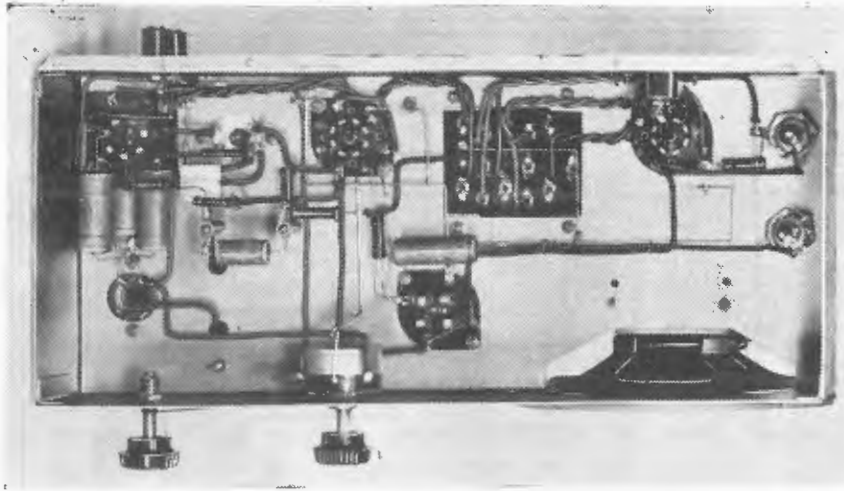

This under-chassis view shows the extreme simplicity of the wiring, only a handful of pigtail components being required for the job.

the negative bias applied to the output pentode.

How Volume Is Controlled.

A simple and well-tried method of controlling volume, that is also very effective, has been incorporated. It consists of a 5,000 ohm potentiometer connected in series with the 6F7 300-bias resistor between the aerial end of the r.f. primary and the 6F7 cathode, the moving arm being taken to earth.

This provides a double control in that both the 6F7 bias and the signal input voltage are both controlled simultaneously. With the moving arm of the potentiometer at the earth end, the 6F7 bias is at minimum and the r.f. signal input is at maximum, which is the condition for greatest volume. With the moving arm at the other end of the resistance, the 6F7 bias is at maximum, giving minimum gain, while the r.f. signal input is shorted to earth. Intermediate positions of the volume control provide corresponding control of volume.

A fixed tone control, consisting of a .01 mfd. fixed condenser connected from the plate of the 6AG6G to earth, provides very well-balanced tone, obviating the need for a variable control. However, by trying slightly smaller and larger values of condensers than that shown, builders can vary the tone to suit their own tastes.

Automatic Regeneration Included.

The automatic regeneration feature introduced with such success in last year's model has been retained in the latest version. In the first "Companionette" to be described, manually-controlled regeneration was incorpor-

ated. However, this possesses the serious disadvantage that in a receiver intended for ordinary domestic use, persons not accustomed to handling critical controls find regeneration very difficult to adjust properly. At the same time, in a set of this type a certain amount of regeneration is a very desirable feature, as it makes an immense improvement to both sensitivity and selectivity.

In last year's model this problem was overcome by employing a special type of automatic feedback, designed to give the greatest boosting effect to signals at the low frequency end of the band, where the sensitivity of the average t.r.f. receiver falls off badly. Once the correct amount of feedback has been adjusted, its operation is entirely automatic, the nett effect being to give even, high sensitivity over the entire band. As well, selectivity is greatly improved.

In practice, the set should be completely assembled and tested to ensure that everything is working perfectly. Feed-back can then be introduced as follows: The bottom end of the detector grid winding is detached from earth, and to this lug is then soldered a length of cotton-covered or enamel wire—26 d.s.c. or enamel will do, though the gauge is not particularly important.

This lead is then taken over to the base of the aerial coil former, and at the point where the wire passes over the hole in the centre of the latter, some half-a-dozen turns are wound around a pencil. These are inserted up inside the aerial coil former, and then the remaining free end of the wire is connected to chassis.

DESIGNER'S HANDBOOK

Invaluable Reference

Fresh from the printing presses, the latest edition of the Radiotron Designer's Handbook (1940) places this already widely-known publication in the category of established text-books on radio design. In a handy octavo size, it comprises no less than 352 pages—its eight sections being dealt with in 40 chapters. Profusely illustrated throughout, over 300 diagrams of circuits, graphs and instruments, exhaustively deal with this continually progressing science. With special attention to radio conditions and requirements in Australasia, its contents are as modern as to-day and it is an indispensable adjunct to every radio engineer's and technician's library.

A detailed cross reference in alphabetical order does away with laborious searching and the comprehensive nature of this volume is indicated in the following summary of its contents:—

PART I.—A.F. Amplifiers, Power Amplifiers, Relation between Output and Speaker, Biasing, Bypassing, Decoupling, Fidelity, Distortion, Negative Feedback, Miller Effect, Audio Amplifier Design, Tone Compensator and Control, Volume Expansion and Compression, Recording, Pick-ups, Microphones, Microphone Amplifiers, A.F. Mixing Systems, Decibels, Neppers, Volume Units and Phons.

PART II.—R.F. Amplifiers, Frequency Conversion, Tuned Circuits, Calculation of Inductance, Low-Loss Inductances, I.F. Amplifiers, Detection, A.V.C., Automatic Frequency Control, Frequency Drift, Reflex Amplifiers.

PART III.—Rectification, Filtering and Hum.

PART IV.—Voltage Dividers, Dropping Resistors, Transformers, Iron-Core Inductances, Voltage and Current Regulators, Tuning Indicators.

PART V.—Receiver Tests and Measurements, Valve Testing, Valve Voltmeters, Measuring Instruments.

PART VI.—Valve Constants, Graphical Representation of Valve Characteristics.

PART VIII.—Resistance, Capacitance, Inductance, Vectors, Complex Algebra, Simple Trigonometry, Units.

PART VIII.—Tables, Charts and sundry Data.

The Radiotron Designer's Handbook is obtainable from Booksellers and Stationers at 3/- per copy in Australia (posted 4d. extra). Copies may also be purchased direct from:—

AMALGAMATED WIRELESS VALVE CO. PTY. LTD.

47 York Street, Sydney.
G.P.O. Box 2516 BB.

This sketch shows the complete under-chassis wiring, and if studied in conjunction with the under-chassis photograph will enable inexperienced set-builders to complete the assembly successfully.

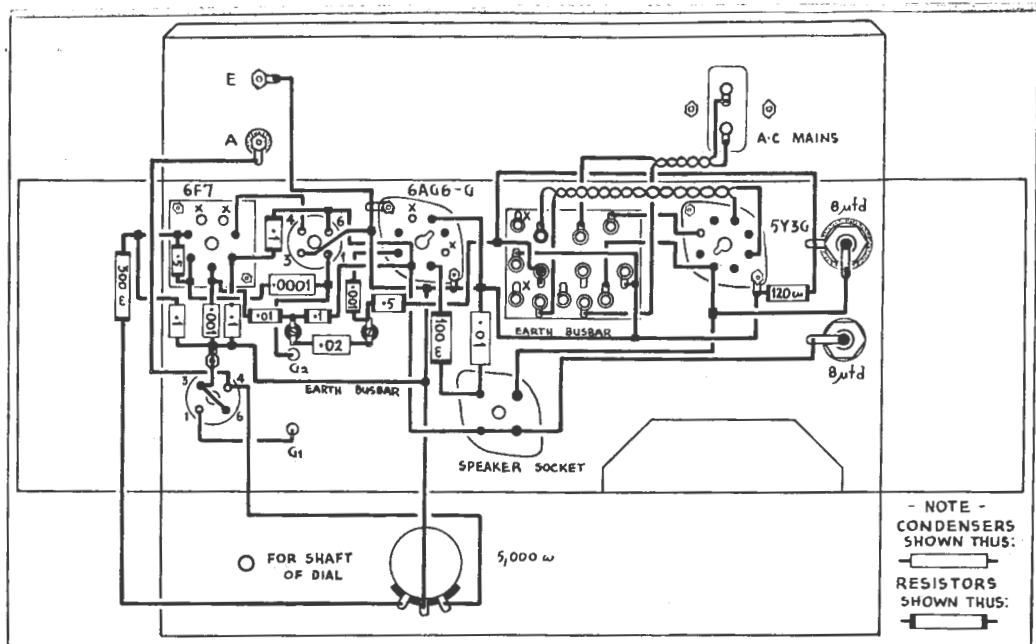

It will then be found that regeneration is available. If there is "squealing" on stations, then there is too much, and the number of turns on the winding will need to be reduced. In the set described, three turns inserted well up inside the former were ample to produce the desired result. Incidentally, if no regenerative effect at all results, the direction of the feed-back winding should be reversed.

Air-cored coils are specified in the list of parts, but undoubtedly readers with iron-cored types on hand will want to use them. However, if iron-cored coils are used, the reaction winding cannot be inserted inside the former, as this is not hollow as with the air-cored type. A simple way out of this difficulty is to drill two small holes in the base of the former, through which the reaction winding can be taken. Thus instead of this winding being inside the former, two or three turns are put on outside, below the grid winding.

The Construction Outlined.

The parts to mount first of all comprise the three valve sockets, power socket and aerial and earth terminals. The power transformer can be bolted in place and the heater wiring put in. To do this run a pair of leads from the 6.3-volt winding on the power transformer to the heater lugs of the 6F7. A further pair of leads is run from these lugs to the corresponding lugs on the socket of the 6AG6G. The centre tap of the 6.3-volt winding is then earthed.

To complete the rectifier socket

wiring, a pair of leads is run from the 5-volt winding on the power transformer to the filament lugs on the rectifier socket. A further pair is taken from the two 385-volt lugs to the plates of the rectifier.

The remainder of the components, with the exception of the dial and speaker, can next be mounted. These comprise the condenser gang, aerial and r.f. coils, electrolytics, and volume control. Before the condenser gang is mounted, a 6" lead should be soldered to the fixed plate lug underneath each section of the gang. These leads pass through the chassis and are connected to the appropriate lugs on the coils.

A point that should be noted here is that the 8 mfd. electrolytic filter condenser on the input side of the smoothing filter must be insulated from the chassis; otherwise the bias resistor will be shorted out.

Next, commencing with the aerial terminal, wire the aerial coil, pentode section of the 6F7, detector coil, triode section of the 6F7, and so on until the wiring is completed. Before the set is switched on, however, the entire assembly and wiring should be carefully checked to ensure there are no mistakes.

Lastly, the dial and speaker can be bolted in position and the control knobs fitted. The set is now ready to be switched on.

Aligning And Operating The "Companionette."

After the wiring has been thoroughly checked by reference to the

circuit and under-chassis wiring diagrams, the valves can be plugged in, aerial and earth connected and the power switched on. While doing this, carefully watch the rectifier for any signs of sparking or of a blue glow, either of which denotes a serious overload due to a short circuit somewhere. If either occurs, switch off immediately and re-check the wiring.

With the set operating correctly, it can be aligned before it is mounted in the cabinet. To do this, set both trimmers on top of the gang a couple of turns or so out, and tune in a station somewhere near the centre of the band. Next, carefully adjust the aerial trimmer for loudest response.

With the set operating satisfactorily, automatic reaction can be added, as described last month. The amount of feedback required is adjusted by varying the coupling between the feedback winding and the grid winding of the aerial coil. This adjustment should be made while the set is tuned in to the highest wavelength station it is desired to receive. Adjust the coupling on this station until a "swish" is heard as the station is tuned in. Because the amount of feedback gradually decreases as the capacity of the condenser gang is decreased, this means that the set will not break into oscillation at any part of the band.

While the fitting of automatic reaction as described is optional, it is well worthwhile including, as it makes a striking improvement to both gain and selectivity.

(Continued on page 39)

This A. W. A. signal generator (type 2R3911), which will supply modulated or unmodulated signals at any frequency between 90 kilocycles and 27 megacycles per second, is designed to give a very high order of accuracy.

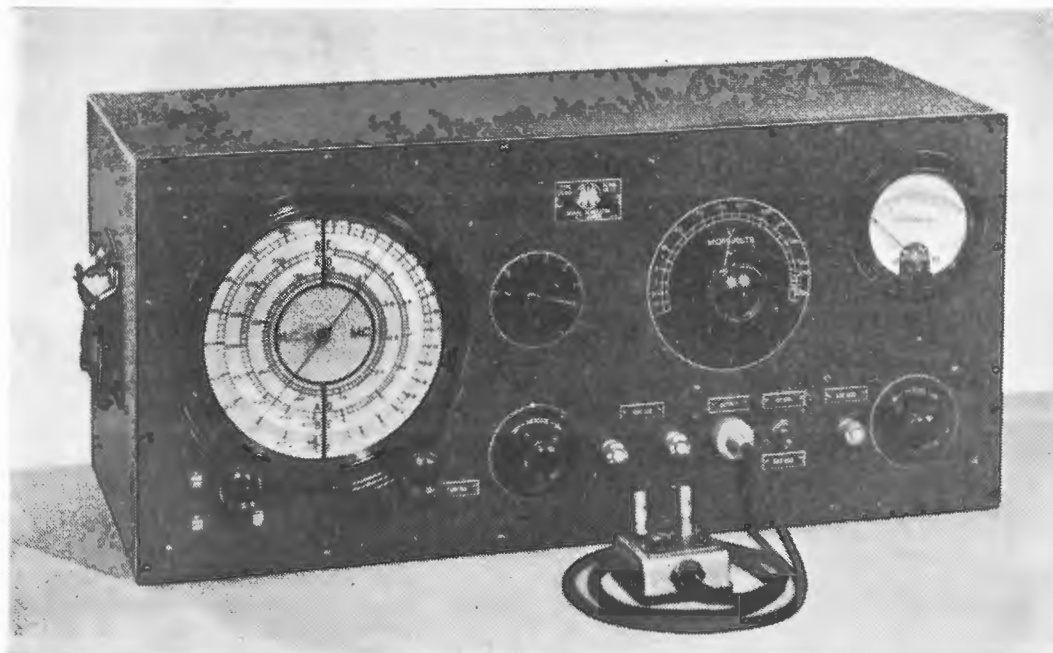

Aligning Receivers

In this instalment from the Radiotron Lecture Service series, continued from last month's issue, the correct procedure for aligning superhets and tuned radio frequency receivers is outlined in detail. The design and application of multi-vibrators are also discussed.

ON the broadcast and short-wave bands sufficient reference points may usually be found by heterodyning the oscillator against stations of known frequency, and listening for zero beat in a receiver. Some care has to be exercised particularly on the short-wave band to avoid confusion due to harmonics from the service oscillator and "second spot" tuning effects in the receiver.

On the 465 k.c.'s i.f. band a more indirect method must be adopted. The approximate dial setting for 465 k.c.'s may readily be found by feeding

the output of the oscillator through the i.f. channel of a receiver known to be aligned at or near this frequency. Once having determined the approximate setting, accurate calibration may be carried out with the aid of the second harmonics.

If, for example, the receiver is tuned to a station on 930 k.c.'s, and the oscillator output lead brought close to the aerial terminal, a beat note will be heard as the oscillator is tuned through 465 k.c.'s. Similarly with the fundamental on 460 k.c.'s the second harmonic will fall on 920 k.c.'s.

By repeating this process it should be possible to draw an accurate calibration curve for the whole band.

Calibration of the 175 k.c.'s i.f. band is also possible by similar means, but greater care must be exercised in discriminating between the various harmonics.

Aligning Receivers.

The alignment of superheterodyne receivers is a fairly standardised procedure and does not involve any great difficulties provided certain precautions are taken. Final alignment should only be carried out after all voltages have been adjusted, and should preferably be the last operation on a chassis. It is not good practice to carefully align a receiver and then to disturb the wiring or subject the chassis and components to undue stresses.

As a general rule, the input voltage from the modulated oscillator should be kept small and alignment carried out with the gain control (or controls) of the receiver in the maxi-

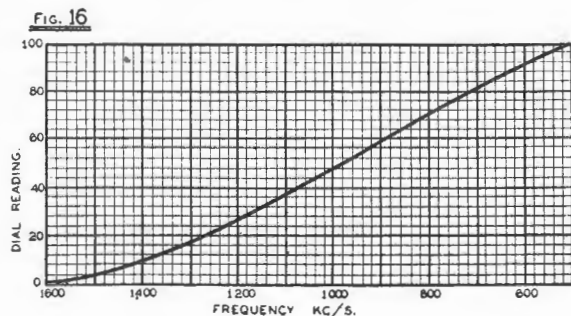

A typical oscillator calibration curve, in which dial readings are plotted against frequencies in k.c.'s.

imum position. The use of small input voltages is particularly important when dealing with a receiver equipped with a.v.c., since at higher signal inputs the a.v.c. becomes fully operative and changes in output level are greatly reduced by its action. Furthermore, the r.f. and i.f. amplifying valves have a certain input capacitance, which is effectively in parallel with the tuned grid circuit and varies with the gain of the stage. If the tuned circuits are aligned with a large input signal, errors may occur on weak signals where the valves are operating under relatively higher gain conditions.

Some form of output meter (such as that incorporated in the Radiotron Volt-Ohm-Milliammeter) is almost essential when aligning receivers, as it is then possible to observe variations in output voltage which could not be detected by ear. If no output meter is available, the power output should be kept to a low level, at which the ear is more sensitive to small variations in volume.

Aligning The I.F. Transformers.

To align the i.f. transformers, the output of the modulated oscillator must be fed into the signal grid of the frequency changer. For exact measurements of sensitivity, the normal grid cap should be removed and the D.C. return made through the output circuit of the modulated oscillator to the chassis, or to some appropriate point when the normal grid return is to a source of negative bias.

This is not always convenient and for purposes of alignment the normal grid cap may be left in position and the oscillator output connected between grid and chassis. A condenser of 0.001 mfd. capacitance connected in series with the "hot" lead will prevent any initial bias being "shorted out" by the modulated oscillator.

Unless there is a definite reason, it is not advisable to alter the intermediate frequency of an existing receiver. Many manufacturers do not adhere rigidly to 465 k.c.'s and prefer to use some slightly different frequency.

(Continued on page 39)

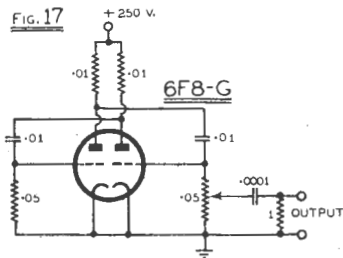

Unnecessary alteration of the i.f. in such receivers may lead to trouble with "joeys" and will upset dial tracking. The frequency of the modulated oscillator should be adjusted for greatest output from the receiver and then, without alteration of the frequency the settings of the individual trimmers should be checked. With new receivers this does not hold, and the i.f. transformers may be aligned to the intermediate-frequency for which the coil kit is designed.

In cases where the i.f. transformers have not been aligned, it may be necessary to adjust the second transformer (by feeding the signal to the grid of the i.f. amplifying valve) before any signal can be obtained from the frequency changer.

Tuning Circuits.

Alignment of the tuning circuits presents little difficulty in the case of receivers in which the dial is marked only in terms of an arbitrary scale. The procedure usually adopted is then as follows:—

The stations on the high-frequency end of the band are set to a satisfactory position by means of the os-

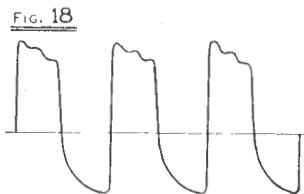

illator trimmer. Reducing the capacitance of this trimmer will shift the stations towards the centre of the dial scale, while increasing it will have the opposite effect. The modulated oscillator is set to 1400 k.c.'s and the output lead connected to the aerial terminal in place of the aerial. The signal is carefully tuned in and the aerial and r.f. trimmers adjusted for maximum output. The modulated oscillator is now set to 600 k.c.'s and, with the receiver tuned to this frequency the padding condenser is adjusted to give maximum output, the gang being "rocked" to allow for alteration in oscillator frequency. The optimum adjustment is that when any variation in the padder setting causes a falling off in output, no matter which way the gang condenser is turned. Having adjusted the padder, it is necessary to re-check the aerial and r.f. trimmers at 1400 k.c.'s.

Unless definitely necessary, the setting of the oscillator trimmer in

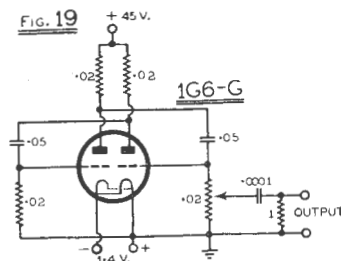

a receiver should not be altered, since any alteration is likely to be very disconcerting to a client who has carefully memorised the positions of the various stations on the dial. It is usually sufficient to check the adjustment of aerial and r.f. trimmers and of the padding condenser.

Calibrated Dials.

When the receiver dial is calibrated with station names, or in terms of frequency and/or wavelength, the same general procedure should be followed, aligning first the trimmers and then the padding condenser.

With the padding condenser adjusted, the receiver is tuned to a station at the low-frequency end of the band (e.g., 2FC or 3AR on 610 and 620 k.c.'s, respectively) and the dial pointer set to its calibrated position. A local station on about 1300 k.c.'s is then brought to its calibrated position by means of the oscillator trimmer. The aerial and r.f. trimmers must then be readjusted, using the modulated oscillator. Then, providing the dial is calibrated to the particular gang condenser and coil kit used, the remaining stations should fall near their calibrated positions.

The general rule therefore is to set the dial pointer by the low-frequency stations and adjust the positions of the high-frequency stations to coincide with their dial calibrations by means of the trimmers.

This rule also holds in receivers where the tuned circuits are aligned inductively by means of variable iron cores. The process may be rather more tedious, however, since the adjustments on the high- and low-frequency ends of the band are less independent.

As previously stated, the output impedance characteristics of the modulated oscillator may differ considerably from those of the average aerial, and may influence the setting of the aerial trimmer. This trimmer should accordingly be re-checked on a weak station (located at the high-frequency end of the band) with the normal aerial connected. If the re-

(Continued on page 39)

A general view of the completed amplifier, which is built on a steel chassis measuring only 7¼" x 5½" x 2½."

A Midget 3-Watt Amplifier

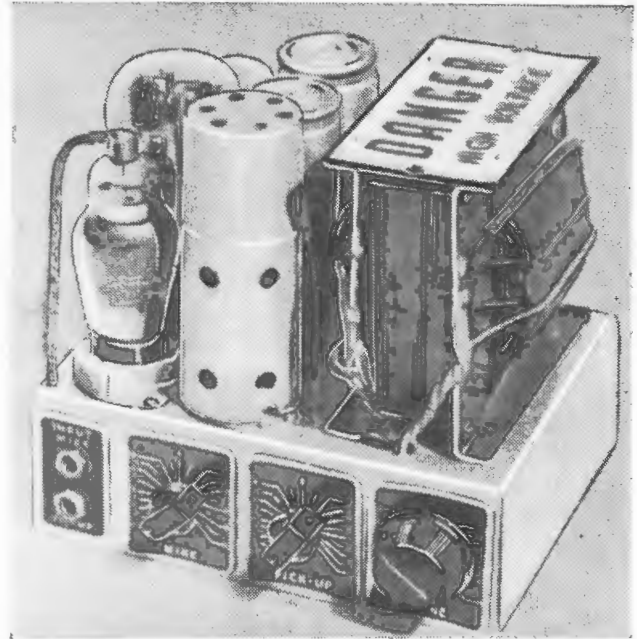

Built from "junk-box" parts at next to no cost, this midget amplifier nevertheless delivers ample power for a small dance hall, with excellent quality of reproduction.

By L. WILSON

THIS amplifier was designed originally to provide dance music in a small local hall, and has been used in that capacity regularly for the past six months.

The finished job had to be compact and cheap, so, with economy as a byword, I commenced going through the junk-box. I unearthed an old power transformer, two electrolytics, a

couple of old 'phone jacks, four sockets, a few old resistors and condensers, etc., three knobs and four old valves—comprising a very old 80, a 2A5, 58 and 57.

With these in front of me, I experimented with a few circuits, eventually selecting the one shown here. Two input channels are provided for microphone and pick-up. The micro-

phone used is the one described in the June, 1939, issue of "Radio World." The tone control is optional, but its advantages make it well worth while.

About The Layout.

An idea of the layout can be obtained from the photograph, while elsewhere appears a list of the parts needed.

The 18-gauge steel chassis measures 7¼" x 5½" x 2½". If desired, the completed job could be housed in a ventilated steel case measuring only 7¼" x 5½" x 7½".

The shielded valve nearest the power transformer is the 57. On the left-hand side of the chassis in the front is the 58, with the 80 behind it, almost hiding the 2A5.

This layout should be adhered to as close as possible so that compactness can be combined with short leads, etc. (In the photograph the shield has been removed from the 58 to obtain a better view of the valves behind).

The fader system shown in the circuit is suitable only when the mike and pick-up are to be used separately.

Midget Amplifier.

List Of Parts.

- | | |
|---|---|
| <p>1 aluminium or steel chassis 7¼" x 5½" x 2½" (Acorn).</p> <p>1 power transformer, 385v. C.T. 385v. 60 m.a., 2.5v., 2a., 2.5v. 3a.; 5 v. 2a.</p> <p>3 6-pin and 2 4-pin wafer sockets.</p> <p>2 500,000 ohm potentiometers (I.R.C.).</p> <p>1 10,000 ohm potentiometer (R.C.S., Radiokes).</p> <p>2 'phone jacks.</p> <p>2 valve shields.</p> <p>3 knobs.</p> <p>1 indicator plates.</p> <p>2 valve caps.</p> <p>2 Dalton spring terminals.</p> <p>FIXED RESISTORS:</p> <p>1 1.5 megohm 1-watt carbon (I.R.C.).</p> <p>1 .25 megohm 1-watt carbon (I.R.C.).</p> <p>2 .25 megohm 1-watt carbon (I.R.C.).</p> <p>1 .1 megohm 1-watt carbon (I.R.C.).</p> | <p>1 2,500 ohm 1-watt carbon (I.R.C.).</p> <p>1 1,000 ohm 1-watt carbon (I.R.C.).</p> <p>1 450 ohm 1-watt carbon (I.R.C.).</p> <p>FIXED CONDENSERS:</p> <p>1 .01 mfd. tubular (Ducon).</p> <p>1 .02 mfd. tubular (Ducon).</p> <p>1 .05 mfd. tubular (Ducon).</p> <p>4 .1 mfd. tubular (Ducon).</p> <p>1 .5 mfd. tubular (Ducon).</p> <p>1 25 mfd. tubular (Ducon).</p> <p>2 8 mfd. wet electrolytics (T.C.C., Ducon).</p> <p>VALVES:</p> <p>1 57, 1 58, 1 2A5, 1 80.</p> <p>SPEAKER:</p> <p>1 8," 10" or 12" speaker to match single output pentode, 2,500 ohm field (Rola, Amplion).</p> <p>MISCELLANEOUS:</p> <p>2 doz. 3/8" x 1/2" nuts and bolts, hook-up wire, shielded braid, 1 yard tinned copper wire, 2 yards power flex and plug.</p> |
|---|---|

3 Great Engineering Features

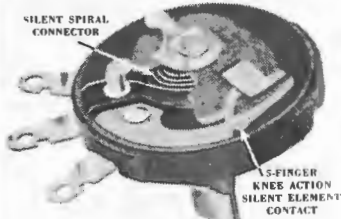

Make **IRC**

CONTROLS Permanently QUIET

All pioneered and perfected by IRC . . . All three available *only* in IRC Type CS Volume Controls . . . and at ordinary control prices.



NO SLIDE . . . NO FRICTION

Metal-to-metal, sliding contact between rotor arm and end terminal is "out." Noise hasn't a chance. The IRC Silent Spiral (positive contact) Connector sees to that.



THE GLIDING ELEMENT RIDER

Instead of a single "rough-riding" contact to element, five separate spring-like contacts give a cushioned "knee-action" effect. Contactor acts independently; each tracks smoothly in perfect unison; each is plated, rounded, smoothed to avoid abrasion and wear.



SMOOTH AS GLASS . . .

The ideal surface for noise-free contact is supplied by the famous IRC Metallized type resistance element permanently bonded to a moisture-proof bakelite base. You can actually *feel* the difference as the 5-Finger Knee Action Contactor is rotated across this element.

Standard Types 4/6
Switch Types 5/6

Sole Agents for Australia:

Wm. J. McLELLAN & Co.
55 YORK STREET :: SYDNEY

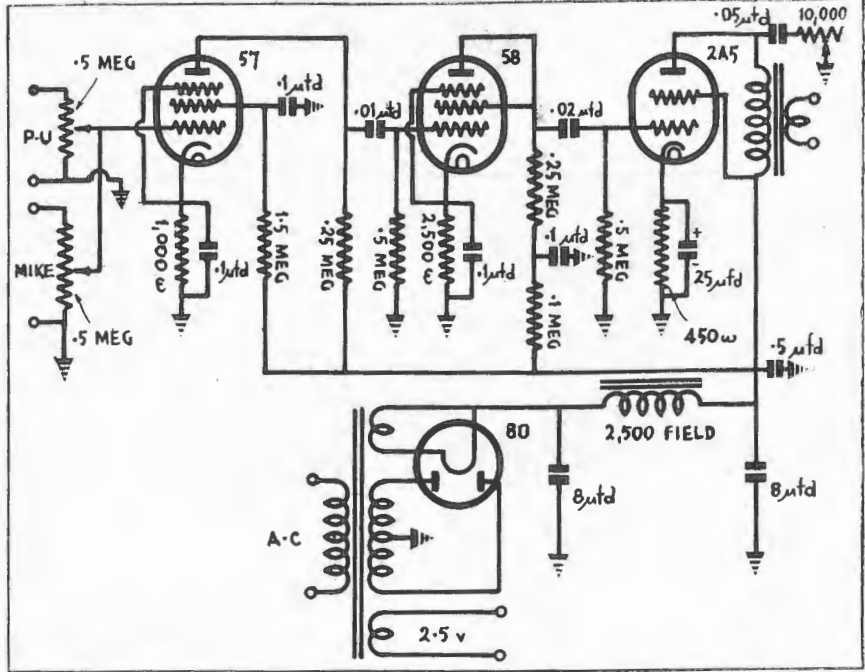

Circuit of the midget amplifier, which uses a 57 first audio stage followed by a triode-connected 58 driving a 2A5.

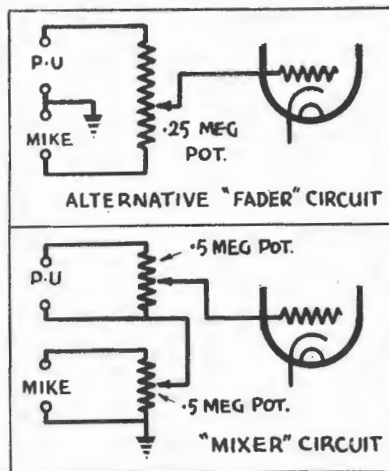

Alternative fader and mixer circuits are shown in an accompanying diagram.

The hall where the amplifier is used accommodates between 60 and 70 people, and I have found the output, which is approximately three watts, to be ample for these crowds. The speaker should be well baffled (for a 12" speaker the baffle should be at least 4 feet square).

Battery Switches From Old Volume Controls.

Old volume controls that are of no more use as such through having be-

come noisy in operation can be given a new lease of life, as efficient rotary filament or dial light switches for battery sets can be made from them, with very little alteration.

With the type shown in the diagram, take out the pile of little discs which make up the resistance (this can be done with the point of a pen-knife). Then place a fibre washer, about the same diameter as the discs, on one end of the disc channel for insulation and replace as many of the discs as possible, so as to hold the pile tightly in position. The moving arm of the volume control may require bending a little, so that it reaches further over the surface of the fixed contact point. The switch will make good contact as it is self-cleaning.

In order to ensure rigid economy when used as a dial light switch, a piece of rubber may be held in position by means of a split rivet through the case, between the base of the moving arm and the side of the case to act as a spring, so that the control knob must be held in the "on" position while in use. No doubt other types of old volume controls could also be adapted for use as switches.—H. W. Ungers (ex-VK2UJ), Alcottown).

The completed "World-Cruiser" is a de luxe receiver that is ideal for DX work on all bands. It is particularly easy to handle, the five-band directly-calibrated dial making station location a simple matter.

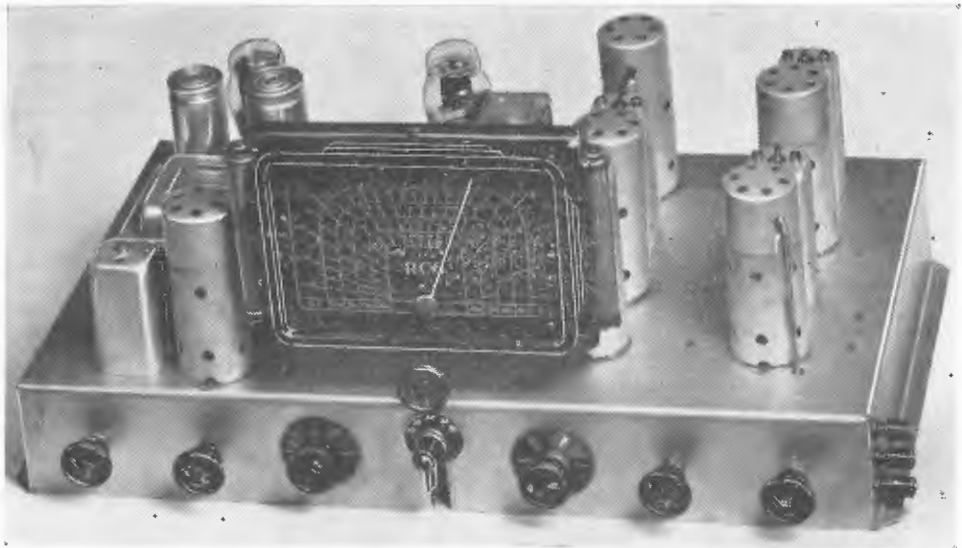

World-Cruiser Communications 8

Uses sensational new R.C.S. five-band 9.8 to 550-metre coil unit ★ Latest permeability tuned i.f.'s ★ Special directly-calibrated dial ★ Built-in b.f.o. unit ★ Tremendous sensitivity, knife-edge selectivity, and perfect tracking with ample overlap on all bands.

DURING the past few years several dozen communication type superhets have been described in various Australian radio magazines, but the "World-Cruiser Communications Eight" is the first to be featured using a switch-type coil assembly in place of plug-in coils. Its construction has been made possible by the release by R.C.S. Radio of a five-band coil unit that is the result of some months of intensive developmental work in the R.C.S. design laboratory.

The design of a coil unit of this type offers many problems, among the most important factors being tracking, band coverage, gain, selectivity, and the maintenance of optimum oscillator grid current over all bands. In the R.C.S. type DW30 kit, all these are above criticism, and, as a result, the performance of the completed receiver is outstanding, and compares more than favourably with expensive American designs.

Many Attractive Features.

The main requirements of a receiver of this type are a high degree of selectivity, high usable sensitivity (i.e., minimum noise level) and good

frequency stability. All are provided by the "World-Cruiser." There is an ample reserve of gain, while selectivity is such that the set will cut through severe QRM to bring in the transmission required.

Actually the "World-Cruiser" is a delight to handle, its performance leaving nothing to be desired even by the most critical of DX fans. The sense of strain felt after an hour or two of DX chasing on smaller receivers, with the "World-Cruiser" gives place to a feeling of "it is there if you want it," the only requirement being to find the correct dial setting and allow the receiver to do the rest.

Three-Stage Five-Band Assembly.

The coil unit around which the "World-Cruiser Communications Eight" was designed is a three-stage five-band assembly comprising aerial, r.f. and oscillator sections, with 10, 20, 40, 80 and broadcast coils in each. It is built up around a three-section five-band wavechange switch with silver-plated contacts, designed specially for the



Indifferent TONE QUALITY

mars
radio enjoyment

The brilliance and tone fidelity of to-day's radio programmes may be completely marred by worn-out valves.

Studio realism, broadcast by modern stations, can be reproduced in your home only when the valves in your radio function efficiently.

To secure the full pleasure of listening,

Re-valve with



RADIOTRON VALVES

Sealed for your protection

Specify . . . RADIOTRONS
for the "World-Cruiser
Communications Eight"
described in this issue.

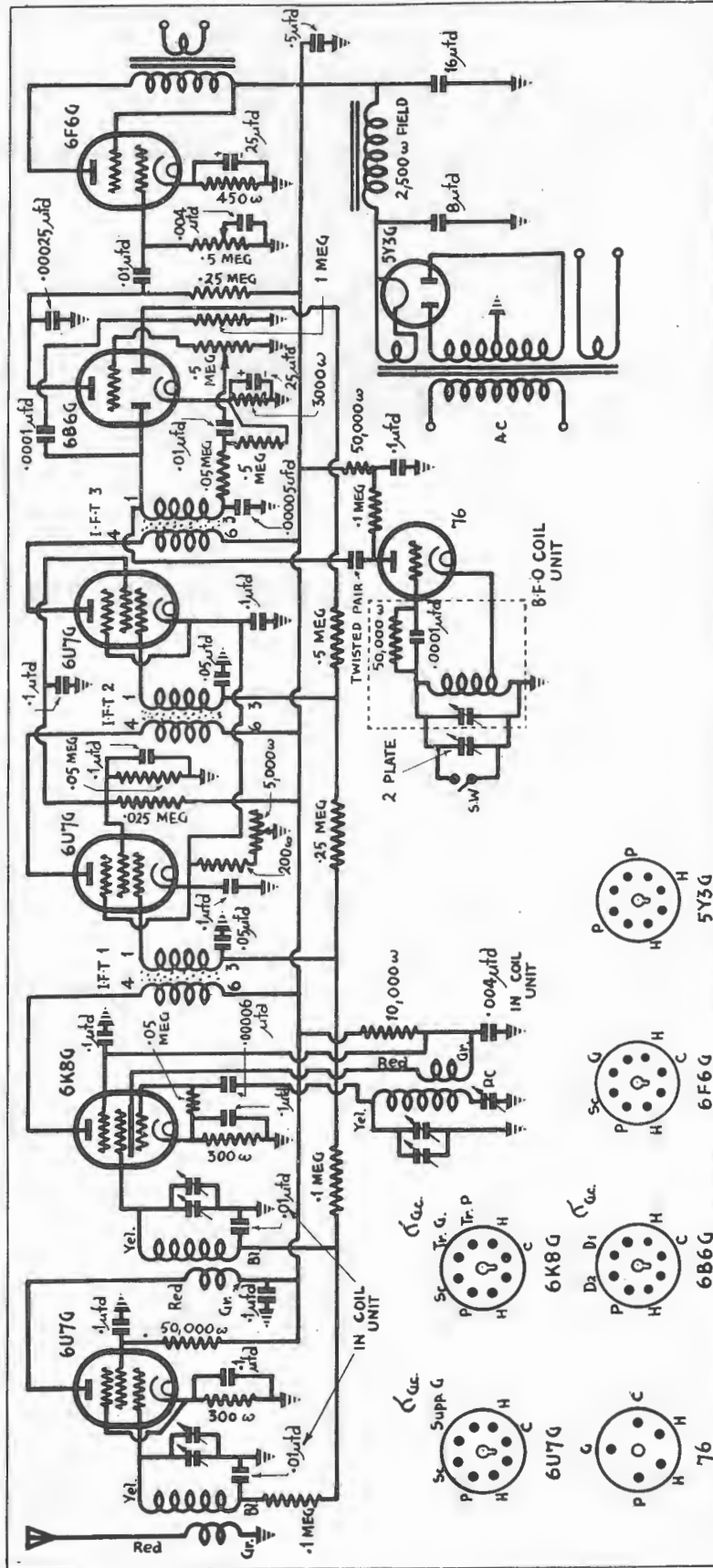

Circuit of the "World-Cruiser Communications Eight," which, except for the 76 beat frequency oscillator, uses octal-based "G" type valves throughout. All constants are shown, together with valve under-socket connections.

job. An important feature is that provision is made on each section for shorting out all unused grid windings.

Partitions of cadmium-plated steel provide very effective shielding between each section. As well, when bolted in position underneath the chassis, the unit is held rigidly in place, ensuring freedom from frequency drift.

The one objective in the design of the coil unit has obviously been to maintain highest possible efficiency throughout. For example, the fifteen coils—three sets of five—are all wound on Trolitul formers, while Trolitul air dielectric trimmers are used.

Particular attention has also been paid to the coverage of each band to ensure the most favourable possible L/C ratio. Band coverage is as follows:—

Band	Coverage
10 metres	30 m.c. to 11 m.c.
20 "	16 " " 5.5 "
40 "	8 " " 3.25 "
80 "	4 " " 1500 k.c.
B.C.	1600 " 550 k.c.

The ample overlap that has been provided is apparent from the figures quoted above.

Alignment Is Simple.

The coil unit is particularly simple to align, because no padding is required on the highest frequency band, while fixed padding is provided on the next two. On the two lowest frequency bands variable padding is incorporated, and to obtain perfect alignment all that is necessary here is to adjust the padder on each band to give correct tracking with the calibrated dial. The tuning condenser specified is a Stromberg-Carlson "H" type, with three 35 mmfd. midget variables paralleled across it for vernier tuning and to spread the "ham" bands.

Exceptionally High-Gain I.F.'s.

The receiver illustrated incorporates a two-stage i.f. amplifier using three permeability-tuned iron-cored i.f. transformers. A striking feature of these is the enormous gain it is possible to obtain from them, with complete stability. For example, the measured sensitivity of the i.f. channel in the "World-Cruiser Communications Eight" is 6 microvolts, but despite this exceptionally high gain there is not the slightest trace of instability present.

Fractional microvolt sensitivity is given by the receiver on all bands except around ten metres, where the sensitivity is a trifle over 1 microvolt. This means that there will always be a tremendous reserve of power available if required, though it will be

WHEREVER YOU GO

THIS SUMMER...

Take a 1.4 Volt Portables!

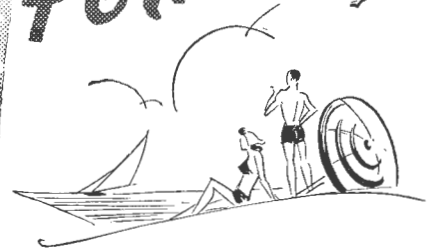

CAMPING — motoring — yachting — picnicking — wherever you go, whatever you do outdoors this summer, TAKE A 1.4 VOLT PORTABLE RADIO ALONG! The perfect outdoor companion for sunny days, it brings you fun and music wherever you happen to be—at the click of a switch. Light, compact, requiring no earth or aerial, you can carry and use it anywhere — and being entirely self-contained (powered with dependable Eveready Dry Batteries) there is no accumulator to recharge, no outside plug or power point to bother about. Ask your radio dealer to demonstrate one of the latest models.



P38A-1222

Equipped with

EVEREADY

RADIO BATTERIES

EVEREADY (AUST.) PTY. LTD., SYDNEY, N.S.W.

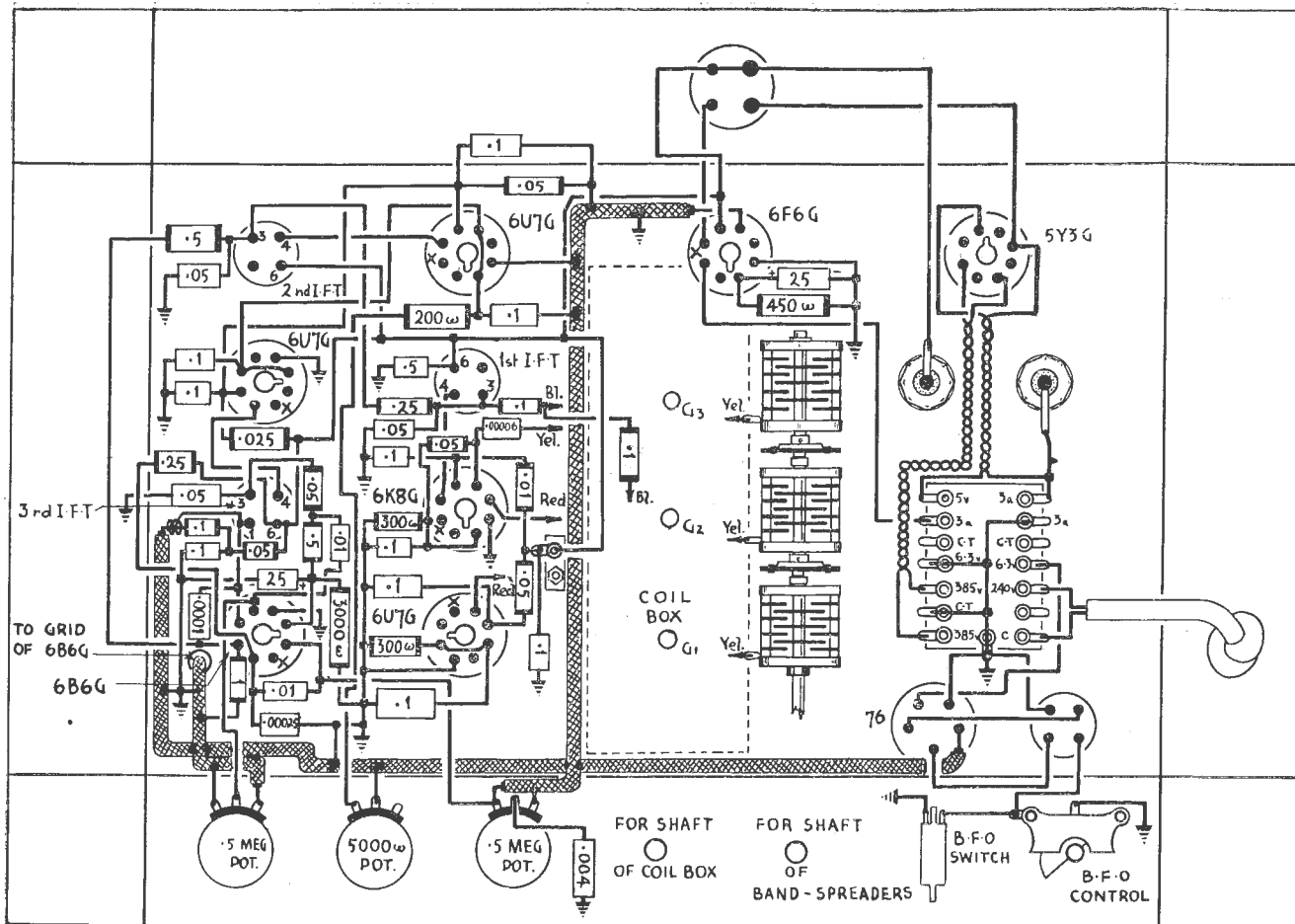

When the receiver is being built, the wiring should first be completed to the stage shown above. Lastly, the coil unit should be bolted in place and wired in accordance with the sketch shown elsewhere.

found that it is rarely, if ever, necessary to operate the receiver "full out."

Directly-Calibrated Dial.

The special dial developed by R.C.S. Radio for use with the coil unit is directly calibrated on all five bands, the scale being etched into the glass. The dial itself has a particularly smooth friction type drive which is fully adjustable, thus obviating all chance of slipping.

The beat frequency oscillator is a 76, an R.C.S. b.f.o. unit being used with it. The special tapped coil required, with mica condenser across it, and the 50,000 ohm grid leak and .0001 mfd. grid condenser are all enclosed in the can as indicated by the dotted line on the circuit diagram. A variable 2-plate midget condenser provides a variable pitch control, while the single-pole/single-throw switch across it enables the beat frequency oscillator to be cut in and out of circuit at will.

Well-Planned Layout.

The layout of the "World-Cruiser" was decided upon after careful consideration of all factors involved, and should not be altered in any way. A particularly important point is that the beat frequency oscillator is located well away from all r.f. and i.f. circuits, to obviate any possibility of unwanted coupling.

Circuit Follows Latest Trends.

The circuit of the "World-Cruiser" is standard throughout, but at the same time is in accordance with latest trends in communications receivers.

The valve line up is as follows:— A 6U7G tuned r.f. stage provides tuned image suppression and ensures a very favourable signal-to-noise ratio. It is followed by a 6K8G mixer. The oscillator section of the coil unit was designed around this valve, and no other type can be used here. Over all bands the grid current of the 6K8G is maintained within the rated limits, even down on 10 metres.

Next follows a two-stage i.f. amplifier using a pair of 6U7G's, the cathodes of these being tied together and returned to earth via a 200-ohm bias resistor and 5,000 ohm potentiometer, which acts as the i.f. sensitivity control. The second detector is a 6B6G, one diode being used for half-wave detection and the other to provide a.v.c., which is applied to the four preceding valves. The triode section of the 6B6G acts as audio driver, driving a 6F6G output pentode. The beat frequency oscillator is a 76, and the rectifier, a 5Y3G.

The seven controls along the front wall of the chassis shown in the view above are (left to right) b.f.o. note control, b.f.o. switch, bandspread control, band switch, tone control, i.f. sensitivity control and gain control.

Assembly Is Straight-Forward.

Until now the construction of a receiver of this type has generally been regarded, and rightly so, as a

(Continued on page 25)

World Shortwave Stations

Below are listed the principal shortwave stations of the world, the majority of which are audible in Australia and/or New Zealand at the present time. The latest available schedules are given in Australian Eastern Standard Time.

The addresses of the stations which were listed in the October, 1939, issue, are not repeated; readers should refer to the issue mentioned. In the case of new stations full addresses are given.

Compiled by ALAN H. GRAHAM.

Call	K.C.	Metres	Location.	Schedule, etc.
W4XA	26150	11.47	Nashville, Tenn., U.S.A.	Daily 2-4 a.m.; 8.30 a.m.-2 p.m.
W9XJL	26100	11.49	Superior, Wis., U.S.A.	Addr: Head of the Lakes Broadcasting Co. Daily 1-11 a.m.
W8XNU	25950	11.56	Cincinnati, Ohio, U.S.A.	Daily 10 p.m.-4 p.m.
W9XPD	25900	11.58	St. Louis, Mo., U.S.A.	Addr.: St. Louis Post-Dispatch. Daily—exact schedule unknown.
WCBX	21570	13.91	New York City, U.S.A.	Daily 11 p.m.-3.30 a.m.
GST	21550	13.92	Daventry, England.	Daily 8.40 p.m.-12.15 a.m.
WPIT	21540	13.93	Pittsburgh, Pa., U.S.A.	Daily 8.30 p.m.-midnight.
GSJ	21530	13.93	Daventry, England.	Daily 8.40-11.45 p.m.
2RO-16	21510	13.94	Rome, Italy.	Daily 12.05-12.55 a.m.
GSH	21470	13.97	Daventry, England.	Daily 8.40-11.45 p.m.
DJS	21450	13.98	Berlin, Germany.	Not in use at present.
DJH	17845	16.81	Berlin, Germany.	Daily 5.30 p.m.-12.30 a.m.
WCBX	17830	16.83	New York City, U.S.A.	Not in use at present.
2RO-8	17820	16.84	Rome, Italy.	Daily 8 a.m.-noon; 9-10.25 p.m.
GSV	17810	16.84	Daventry, England.	Daily 8.40-10 p.m.; midnight-2.30 a.m.
OIH	17800	16.85	Lahti, Finland.	Addr.: Finnish Broadcasting Co., Helsinki. Daily 7 p.m.-midnight.
GSG	17790	16.86	Daventry, England.	Daily 8.40-11.45 p.m.
WNBI	17780	16.87	Bound Brook, N.J., U.S.A.	Daily midnight-11 a.m.
PHI-2	17770	16.88	Huizen, Holland.	Daily except Sunday, 10.40 p.m.-midnight; Sundays, 9.40 p.m.-1.05 a.m.
TPB-3	17765	16.88	Paris, France.	Daily 7 p.m.-midnight.
DJE	17760	16.89	Berlin, Germany.	Daily 5.30-8.50 p.m.; 9-11 p.m.
RV-96	15400	19.47	Moscow, U.S.S.R.	Daily 7-10 p.m.; irregular at other times.
HAS-3	15370	19.52	Budapest, Hungary.	Sunday midnight-Monday 1 a.m.
DIR	15340	19.56	Berlin, Germany.	Daily 3.05 p.m.-2 a.m.
WGEA	15330	19.57	Schenectady, N.Y., U.S.A.	Daily 2.15-9 a.m.
KGEI	15330	19.57	San Francisco, Calif., U.S.A.	Daily 9.30 a.m.-2.15 p.m.
GSP	15310	19.60	Daventry, England.	Daily 4.35-6.30 a.m.; 5-8 p.m.
YDB	15310	19.60	Bandoeng, Java, D.E.I.	Addr.: N.I.R.O.M. Daily 1.30-5 p.m.
2RO-6	15300	19.61	Rome, Italy.	Daily 1-8.55 a.m.; 10.30 a.m.-12.30 p.m.; 7.10-7.55 p.m.
VUD-3	15290	19.62	Delhi, India.	Daily noon-2 p.m.; 4.30-6.30 p.m.
DJQ	15280	19.63	Berlin, Germany.	Daily 3.05 p.m.-2 a.m.; also 2.10-3.25 a.m. on Mondays.
WCAB	15270	19.64	Philadelphia, Pa., U.S.A.	Addr.: C.B.S., 485 Madison Avenue, New York City. Daily 3 or 3.30-8.15 a.m.
WCBX	15270	19.64	New York City, U.S.A.	Daily 4-6.30 a.m.
GSI	15260	19.66	Daventry, England.	Daily 3-4.30 a.m.; 3.57-8 p.m.
TPA-2	15245	19.68	Paris, France.	Daily 7 p.m.-midnight.
2RO-14	15230	19.70	Rome, Italy.	Daily 1-3.15 a.m.; 3.40-8.30 a.m.; 8.30-11.10 p.m.
OLR5A	15230	19.70	Prague, Bohemia.	Daily 10.55 a.m.-1.20 p.m.; 7.55-11.15 p.m.
PCJ-2	15220	19.71	Huizen, Holland.	Daily, except Sunday, 10.40 p.m.-12.10 a.m.; Sundays, 9.25 p.m.-12.45 a.m.
CSW-4	15215	19.71	Lisbon, Portugal.	Daily 2-3 a.m.
WPIT	15210	19.72	Pittsburgh, Pa., U.S.A.	Daily midnight-5 a.m.
DJB	15200	19.74	Berlin, Germany.	Daily 11 p.m.-midnight; also 2.10-3.25 a.m. on Mondays.
XGOX	15190	19.75	Szechwan Province, China.	Irregular; usually around 7-8 p.m.
OIE	15190	19.75	Lahti, Finland.	Address: Finnish Broadcasting Co., Helsinki. Daily midnight-8 a.m.
GSO	15180	19.76	Daventry, England.	Exact hours of transmission not known; heard early morning and evening.
RV-96	15180	19.76	Moscow, U.S.S.R.	Daily 3.45-6.45 p.m.; 7-10 p.m.
TGWA	15170	19.77	Guatemala City, Guatemala.	Mondays 3.45-8.15 a.m.; also on alternate Sundays till 5.15 p.m.
LKV	15166	19.77	Oslo, Norway.	Daily 9.40 p.m.-5 a.m.
JZK	15160	19.79	Tokyo, Japan.	Daily 7.30-8.30 a.m.; 11 a.m.-noon.
SBT	15155	19.79	Motala, Sweden.	Address: Direction Generale des Telegraphes Suede, Stockholm. Daily 4-7.15 a.m.; Sundays from 5.55 p.m.
YDC	15150	19.80	Bandoeng, Java, D.E.I.	Daily 9-10.30 a.m.; 7.30 p.m.-1.30 a.m.

Call	K.C.	Metres	Location.	Schedule, etc.
GSF	15140	19.82	Daventry, England.	Daily 6.50-9 a.m.; 6.30-8 p.m.; 11.55 p.m.-2.30 a.m.
WRUW	15130	19.83	Boston, Mass., U.S.A.	Address: University Club. Daily 5.30-8 a.m.
TPB-6	15130	19.83	Paris, France.	Daily 3-6 p.m.
HVJ	15120	19.84	Vatican City, Italy.	Exact schedule unknown; heard from 11.30 p.m. on Tuesdays; and 1.30-1.45 a.m. daily.
DJL	15110	19.85	Berlin, Germany.	Daily 1.40-7.25 a.m.; 3.05-5 p.m.
2RO-12	15100	19.87	Rome, Italy.	Daily 3.15-8.30 a.m.; 8.30-11.10 p.m.
RKI	15983	19.89	Moscow, U.S.S.R.	Daily 10 a.m.-12.15 p.m.; and irregular at other times.
KQH	14920	20.11	Kahuku, Hawaii.	Relays to U.S.A.; Saturdays noon-1 p.m., 5-5.30 p.m.; Sundays 2-2.30 p.m.
HBJ	14535	20.64	Geneva, Switzerland.	Address: Radio Nations. Heard 6.30 p.m. Sundays.
KKZ	13690	21.91	Bolinas, Calif., U.S.A.	Special relays to Hawaii; Sunday afternoons.
HIIN	12486	24.03	Trujillo City, D.R.	Daily 8.10 a.m.-1.10 p.m.; 9.40 p.m.- 1.40 a.m.
HCJB	12460	24.08	Quito, Ecuador.	Daily 1-2 p.m.; 10-11.15 p.m.
RNE	12000	25.00	Moscow, U.S.S.R.	Daily 2-7 a.m.; 3.45-6.45 p.m.; Mondays 1-2 a.m.; Mondays, Tuesdays 7-8 a.m.; Wednesdays, 9.30-10 p.m.; Sundays 9-10 p.m.
Warsaw	11990	25.02	Warsaw, Poland.	Daily 7 p.m.-midnight.
CB-1180	11970	25.06	Santiago, Chile.	Daily 10 a.m.-2 p.m.
KKQ	11950	25.10	Bolinas, Calif., U.S.A.	Special relays to Hawaii; irregular afternoons.
CD-1190	11910	25.19	Valdivia, Chile.	Daily 1-4 a.m.; 6-9 a.m.; 10 a.m.-2 or 2.30 p.m.
XGOY	11900	25.21	Szechwan Province, China.	Daily 5-9.30 a.m.; 8.30 p.m.-1.30 a.m.
TPB-11	11885	25.24	Paris, France.	Daily 12.15-7.15 a.m.; 3-6 p.m.
TPB-12	11885	25.24	Paris, France.	Daily 9-11.15 a.m.; 11.30 a.m.-2 p.m.
VLR-3	11880	25.25	Lyndhurst, Australia.	Daily 6.30 a.m.-5.15 p.m.
WPIT	11870	25.26	Pittsburgh, Pa., U.S.A.	Daily 5 a.m.-2 p.m.
VLQ-2	11870	25.26	Sydney, Australia.	Daily 5.30-6.30 p.m.
GSE	11860	25.29	Daventry, England.	Daily 9.22 a.m.-12.15 p.m.; 6.30-8 p.m.

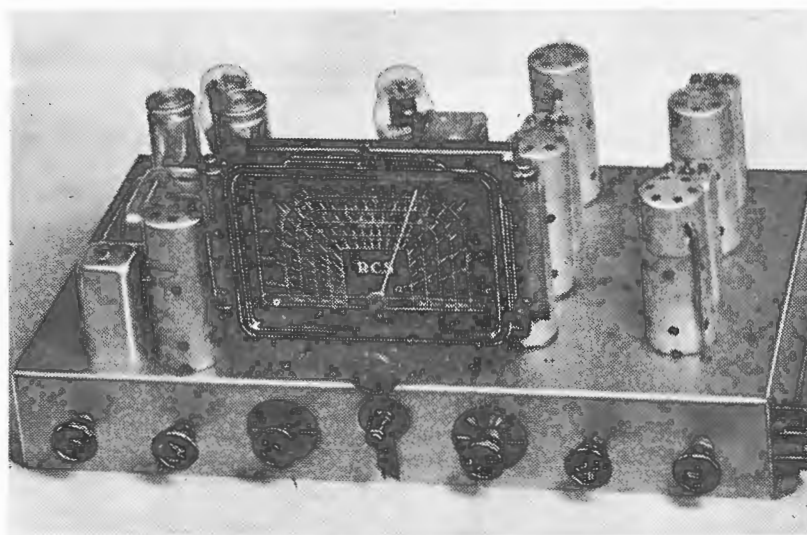

"WORLD-CRUISER COMMUNICATIONS EIGHT."

Use the R.C.S. Foundation Kit Type K124 £13/13/9

Comprising—

- 1 x DA2 5-band dial 22/6d.
- 2 x IF131 permeability I.F.'s 13/9d. each
- 1 x IF132 permeability I.F.'s 13/9d. each
- 1 x DW30 5-band coil unit £10/10/-

Write for our special complete kit of part quotes.

R.C.S. NEW PRICE LIST. POST FREE.
SEND TO-DAY FOR A COPY.

HYDRA METAL CASED BLOCK CONDENSERS.

.25 mfd.	500V. Test 6d. each.	4/- doz.
.5 mfd.	500V. Test 9d. each.	6/- doz.
.5 mfd.	700V. Test 9d. each.	6/- doz.
3 x .5 mfd.	700V. Test 1/6 each.	12/- doz.
2 x .1 mfd.	2000V. Test 9d. each.	6/- doz.

A.W.A. SHORT WAVE AERIAL KITS—Improve the reception of overseas radio by installing one of the latest A.W.A. Aerial Kits 47/6d. each.

VEALLS

490 Elizabeth Street, 168 and 243 Swanston Street, Melbourne;
299 Chapel Street, Prahran; 5 Riversdale Road, Camberwell; 99
Puckle Street, Moonee Ponds.

All letters to BOX 2135T, G.P.O., MELBOURNE.

Telegrams: "ARTVEALL," MELBOURNE."

Call	K.C.	Metres	Location.	Schedule, etc.
DJP	11855	25.31	Berlin, Germany.	Not in use at present.
XMHA	11850	25.32	Shanghai, China.	Daily 8 p.m.-1.30 a.m.
WCBX	11830	25.36	New York City, U.S.A.	Daily 7-9 a.m.; 9.30 a.m.-1 p.m.
VLW-3	11830	25.36	Perth, Australia.	Daily 3.30-4.30 p.m.
2RO-4	11810	25.40	Rome, Italy.	Daily 1-6 a.m.; 9 a.m.-noon; 7.10 p.m.-midnight.
DJZ	11801	25.42	Berlin, Germany	Not used at present.
COGF	11800	25.42	Matanzas, Cuba.	Daily 4-5 a.m.; 7-8 a.m.; 9 a.m.-3 p.m.
JZJ	11800	25.42	Tokyo, Japan.	Daily 7.30-8.30 a.m.; 3-4.30 p.m.; 10 p.m.-12.30 a.m.
WRUL	11790	25.45	Boston, Mass., U.S.A.	Heard in early mornings; schedule unknown.
Saigon	11780	25.47	Saigon, French Indo-China.	Daily 8.45-11.30 p.m.
MTCY	11775	25.48	Hsinking, Manchukuo.	Address: 601 Daido-Taigai, Hsinking. Daily 7-7.50 a.m.
DJD	11770	25.49	Berlin, Germany.	Daily 1.40-7.25 a.m.; 7.50 a.m.-1.50 p.m.
2RO-15	11760	25.51	Rome, Italy.	Daily 1-3.15 a.m.
GSD	11750	25.53	Daventry, England.	Daily 2.52-6.30 a.m.; 6.50-9 a.m.; 12.37-3.20 p.m.; 3.57-6.15 p.m.
LKQ	11735	25.57	Oslo, Norway.	Address: Norsk Rikskringkasting Storingstgaten 28. Daily 2-5 a.m.; 5-9.40 p.m.
WRUW	11730	25.58	Boston, Mass., U.S.A.	Schedule uncertain; heard till 8 a.m.
CJRX	11720	25.60	Winnipeg, Canada.	Daily 9 p.m.-3 p.m.; Sundays till 7 p.m.
JVW-3	11720	25.60	Tokyo, Japan.	Daily 4.50-10.40 p.m.
TPA-4	11715	25.61	Paris, France.	Daily 9-11.15 a.m.; 12.30-3 p.m.; 3-6 p.m.
JLG-3	11705	25.63	Tokyo, Japan.	Daily 5-7 a.m.; and at night from 7 p.m.
SBP	11705	25.63	Motala, Sweden.	Daily 4-7.15 a.m.; 11 a.m.-noon on Thursday and Saturday.
HP5A	11700	25.65	Panama City, Panama.	Daily 2.45-4 a.m.; 9 a.m.-1 p.m.; 10-11.30 p.m.
CB-1170	11700	25.65	Santiago, Chile.	Daily 1.5 a.m.; 6.30 a.m.-2 p.m.
IQY	11676	25.70	Rome, Italy.	Daily 3.07-3.56 a.m.; 4.50-5.30 a.m.; 8.20-8.40 p.m.
XGOK	11650	25.75	Canton, China.	Daily till 11.35 p.m.
HBO	11402	26.31	Geneva, Switzerland.	Schedule unknown; heard 6.30 p.m. Sundays. Address, see HBJ, 14535kc.
CSW-6	11040	27.17	Lisbon, Portugal.	Daily 3.45-6.30 a.m.
PLP	11000	27.27	Bandoeng, Java, D.E.I.	Relays YDC; daily 9-10.30 a.m.; 7.30 p.m.-1.30 a.m.
EAJ-43	10360	28.96	Santa Cruz de Tenerife, Canary Is.	Address: Box 225 Daily 5.30-7 a.m.; 7.30-10 a.m.; 10.45-11.45 a.m.; noon-1 p.m.
ORK	10330	29.04	Ruyssede, Belgium.	Address: Radio Ruyssede, West Flanders. Daily 4.30-6 a.m.
PMN	10260	29.24	Bandoeng, Java, D.E.I.	Relays YDC; as PLP, 11000kc.

"WHEREVER SOUND MUST
FILL GREAT SPACES"



Type P.S.25

The Most Efficient Speaker
on the Market To-day!

WRITE NOW for Publica-
tion No. 90A, telling how
YOU can get REAL P.A.
results more economically!

This six-foot Exponential Horn Speaker of true logarithmic design offers users of P.A. Equipment the greatest possible efficiency, far in advance of cone units driving into short horns. Steps up your P.A. efficiency by more than 300%! The Horn is unique, being the first of its type made of extra heavy gauge sheet aluminium, the granular construction offering far greater strength than heavier castings. The P.S.6 Permag. driving unit weighs 7½ lbs. and has a non-metallic diaphragm spec-

ially impregnated against moisture absorp-
tion. The mechanical strength is many times that of a metal diaphragm and there is no risk of hardening or crystallisation leading to fractures. The unit is permanently trouble-free and will carry steady loads up to 10 watts, delivering acoustic power through the P.S.25 Horn 300% to 400% greater than ordinary types. The permanent magnet is of Alnico alloy with the high flux of 12,000 lines per sq. cm. Full data and Prices on Application—ask for P.A. Publication No. 90.

AMPLION

PUBLIC ADDRESS SPEAKERS

AMPLION (A'sia) Pty. Ltd., 382 Kent Street, SYDNEY

R.C.S. Announce their latest release . . . 5 BAND COIL UNIT

R.C.S. DUAL WAVE UNITS

Type DW24, as illustrated, consists of Aerial, R.F. and Oscillator Coils, Wave Change Switch, the necessary B/C and S/W Trimmers and Padder mounted on a rigid steel base, wired up ready to assemble in a set utilising 465 k.c. and an R.F. Stage. The bands are S/W 16 to 50 metres, and B/C 1500 to 550 k.c.

Retail Price
DW24 for A.C. operation . . . £3 7 6
DW25 for Battery operation . . . £3 7 6

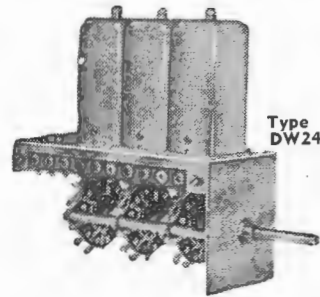

Type DW24

Type DW29, as illustrated, consists of Aerial and Oscillator Coils, Wave Change Switch, the necessary B/C and S/W Trimmers and Padder mounted together, wired up ready to assemble into a set utilising 465 k.c., the bands being S/W 16 to 50 metres, and B/C 1500 to 550 k.c.

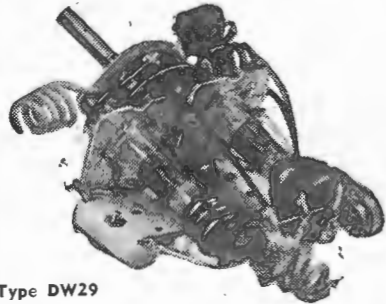

Type DW29

R.C.S. Type DW29 Dual Wave Unit. Retail Price £1 7 6

R.C.S. TROLITUL BROADCAST COILS

These coils are available in both Air Core and Permeability tuned types. The latter are adjusted to ensure maximum efficiency in our laboratories.

Air Core.
Cat. No. Retail Price
E282. Aerial . . . 6/6
E283. R.F. . . . 6/6
E284. Osc. . . . 6/6

Permeability.
E279. Aerial . . . 8/6
E280. R.F. . . . 8/6
E281. Osc. . . . 8/6

Type E284

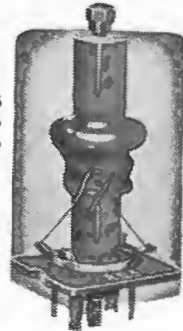

R.C.S. TROLITUL TUNING COILS

The new R.C.S. Trolitul Tuning Coils, as listed and illustrated, provide the highest Q coils yet produced. They are wound on and supported by a combined Trolitul former and base, thus lending themselves to an accuracy and precision hitherto unobtainable, resulting in a higher standard of efficiency than has been available before. All R.C.S. Trolitul Coils are suitable for standard type valves.



Type G17

R.C.S. TROLITUL DUAL-WAVE COILS

These coils have the B/C and S/W Trimmers incorporated. The Oscillator coil also contains the S/W Padder. S/W 16 to 50 metres, B/C 1500 to 550 k.c.

Cat. No. Retail Price
G19. Aerial Air Core . . . 14/-
G20. R.F. Air Core 14/-
B21. Osc. Air Core 14/-

R.C.S. TROLITUL INTERMEDIATE TRANSFORMERS

The new R.C.S. Trolitul I.F.'s are extremely stable, due to new methods of construction made possible by the use of Trolitul formers and base. No loose wires to shift and alter frequency. Positively the best I.F.'s yet produced.

Cat. No. Retail Price
Air Core, 465 k.c.
IF107. 1st I.F. . . 7/6
IF108. 2nd I.F. . . 7/6
Iron Core, 465 k.c.
IF109. 1st I.F. . . 11/-
IF110. 2nd I.F. . . 11/-
Air Core, 175 k.c.
IE68. 1st I.F. . . 7/6
IE69. 2nd I.F. . . 7/6



Type IF107

R.C.S. TROLITUL SHORTWAVE COILS

These coils are the latest product of our factory, and the former, after being moulded from Trolitul, is grooved in a lathe, thus keeping the winding accurately spaced and providing perfect tracking. The four lugs are moulded, two in each end, as illustrated, so that the coil will fit snugly across the two-bank wave change switch. They may be had in five bands, as listed.

Metres	Aerial	R.F.	Osc.	Retail Price
10	H68	H69	H70	2/10
20	H71	H72	H73	2/10
40	H74	H75	H76	2/10
80	H77	H78	H79	2/10
B/C	H80	H81	H82	2/10



Type H71

Just what you have been waiting for—WE HAVE IT!

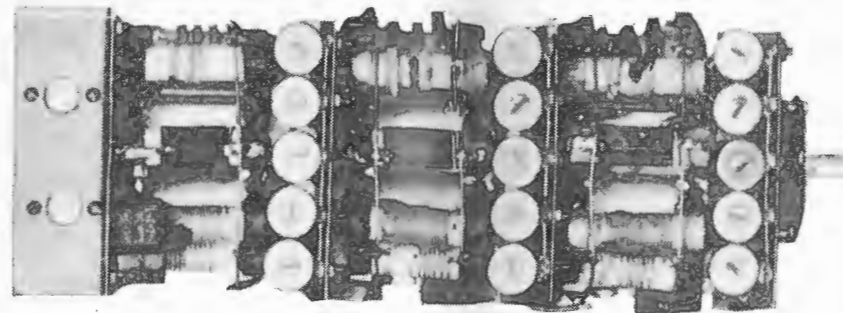

Type DW30 5-band Coil Unit for Communication Receivers.

Continuous coverage from 9.8 to 550 metres is provided by means of a special five-bank three-section silver-plated contact wave-change switch. The 15 coils are wound on Trolitul and the air dielectric trimmers are also Trolitul. The Trolitul padders are incorporated and a band selector plate is provided. With a standard tuning condenser there is a 33 1/3% overlap of bands. A small gang will provide Ham bands only—band spread. For the "World-Cruiser Communications Eight" described in this issue, specify Kit Type K124, comprising—

1 DA2 5-band Communications Dial	£1 2 6
2 IF131 Permeability Intermediates	£1 7 6
1 IF132 Permeability Intermediate	£0 13 9
1 DW30 5-band Coil Unit	£10 10 0

Foundation Kit Type K124 £13 13 9

R.C.S. PERMEABILITY INTERMEDIATE TRANSFORMERS

The new R.C.S. Permeability Tuned Trolitul Former Intermediates are the most dependable and efficient intermediates it is possible to produce. Wherever optimum results are desired these I.F.'s should be used. We supply and recommend them for the "World-Cruiser Communications Eight."

PERM. TUNED 465 K.C.
Standard when 2 I.F.'s are used.

Type	Price
IF130. 1st I.F.	13/9
IF132. 2nd I.F.	13/9

When 3 I.F.'s are used.

IF131. 1st I.F.	13/9
IF131. 2nd I.F.	13/9
IF132. 3rd I.F.	13/9

For Push-Button Kits.
IF113. 1st I.F. 13/9
IF114. 2nd I.F. 13/9



Type 131

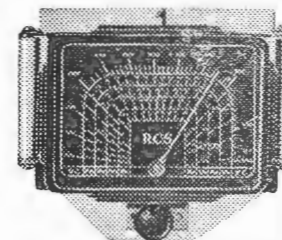

Type DA2

NEW R.C.S. DIAL

The new R.C.S. Communications Dial was designed simultaneously with the 5-band coil unit, consequently the dial tracks with the coils and the H-type condenser.
DA2 Communications Dial 22/6
DA1 B/C Dial ("F" condenser) 22/6

COIL KIT FOR THE "1940 COMPANIONETTE THREE"—K126 13/-

OBTAINABLE FROM YOUR LOCAL DEALER OR WRITE DIRECT TO

R.C.S. RADIO

PTY. LTD.

50 GLEBE ST.,
GLEBE, N.S.W.

Phone: MW 2405.

R.C.S. TROLITUL MIDGET CONDENSERS

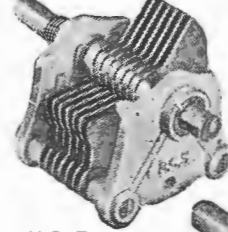

M.C. Type

R.C.S. Midget Condensers are made in two types, using Trolitul supports, thus guaranteeing practically no loss.

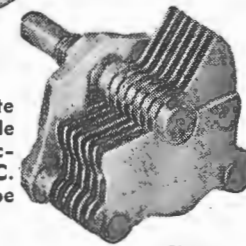

Star Type

The 14-plate equals old style 23-plate capacity. The M.C. type may be ganged.

STAR AND M.C. MIDGETS

Max. Min. Cap. mmfd.	STAR Cat. No.	Retail Price	M.C. Cat. No.	Retail Price
10 3 2	CV34	3/6	CV41	6/9
15 3 3	CV35	3/9	CV42	7/3
25 3.5 4	CV36	4/-	CV43	7/10
35 4 5	CV37	4/3	CV44	8/6
50 4 7	CV38	4/9	CV45	9/-
70 5 9	CV39	5/4	CV46	9/6
100 6 14	CV40	5/11	CV47	10/3

R.C.S. AUDIO TRANSFORMERS AND CHOKES.

Long experience in the production of highly efficient transformers, combined with extensive research into raw materials and design, has resulted in the production of an audio transformer of excellent performance and complete reliability.



TB6—"B" Class

Cat. No.	Retail Price
TA1 Audio Choke Bakelite Case	18/6
TM1 Modulation Transformer—Power	30/-
TB4 Single Input "A" Class Bakelite Case	20/-
TB5 Push Pull "A" Class Bakelite Case	21/-
TB6 Input "B" Class Bakelite Case	18/6
TB35 "A" Class High Fidelity Steel case	67/6
TB36 "B" Class Input High Fidelity Steel Case	67/6
TB37 "AB" Class Bakelite	28/6

NEW R.C.S. DIALS

For some time we have felt that we should provide dials for use with coils of our manufacture, thus assuring perfect tracking. The dial illustrated is the result of considerable thought and engineering experimentation in our laboratory. Both types are single glass Dual Wave dials, the type DA2 having been designed especially for use with our Five Band Communications Receiver coil kit, and the "H" type condenser. Type DA1 is a standard Dual Wave dial for use with R.C.S. Coils and the "F" type condenser.

R.C.S. RADIO FREQUENCY CHOKES



TROLITUL TAPERED PIE WOUND R.F. CHOKES.

These chokes are wound on a Trolitul former, the lugs and mounting screw being moulded into the former. The windings are spaced pieces, tapering to the top. Owing to its very high insulation and construction, this choke is ideal for short-wave receivers. They are made in the following sizes:—

R.F. Chokes, Pie Wound-Trolitul Pies M.H.	Price
RF82 3 1.7	4/6
RF83 4 2.5	4/6
RF84 5 4.0	4/6
RF85 6 7.0	4/6

STANDARD R.F. CHOKES

RF81 and RF86 are single pie wound on a solid Trolitul core, which has the necessary solder lugs moulded in. The design of this choke eliminates the need of bakelite side discs. RF26 Choke is for vibrator work. RF15 for filtering from the mains.

R.F. CHOKES—STANDARD
RF86—Cotton H.C. 1/-
RF81—Silk H.C. 1/9
RF26—Vibrator Low Tension Choke 4/3
RF15—Line Filter 2.3 M.H., .75 amp (2 chokes 1 former) 11/-

R.C.S. POTENTIOMETERS AND RHEOSTATS

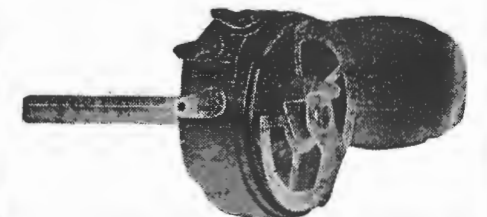

The R.C.S. Volume Controls are the result of improved and new methods of manufacture, together with alterations in design and final testing. Noiseless, they are constructed so as to cut off all volume.

Cat. No.	Retail Price
6 ohm Rheostat	5/-
10 " "	5/-
20 " "	5/-
30 " "	5/-
400 " Potentiom.	5/-
1000 " "	5/-
2500 " "	5/-
5000 " "	5/-
10000 " "	5/-
15000 " "	6/6
20000 " "	6/9

DA1. Standard D/W Dial, Retail Price, 22/6



Type DA1

Call	K.C.	Metres	Location.	Schedule, etc.
PSH	10220	29.35	Rio de Janeiro, Brazil.	Tuesday, 11-11.30 a.m.; Saturday, 10-10.30 p.m.; other days, 9-10 a.m.
JDY	9920	30.24	Dairen, Manchukuo.	Daily 10-11 p.m.
EAQ	9855	30.45	Madrid, Spain.	Schedule irregular at present; 6.30-8 a.m. and at other times.
IRF	9830	30.52	Rome, Italy.	Daily 3-3.25 a.m.; 3.40-4 a.m.; 4.50-5.30 a.m.; 9 a.m.-noon; 8.20-8.40 p.m.
COCM	9805	30.60	Habana, Cuba.	Daily 11 p.m.-4 p.m.
ZRO	9752	30.77	Durban, South Africa.	Address: South African Broadcasting Corporation, Box 4559, Johannesburg. Heard best midnight-3.30 a.m. session.
CSW-7	9735	30.82	Lisbon, Portugal.	Daily 7-11 a.m.
CB-970	9730	30.83	Valparaiso, Chile.	Relays CB-76; daily 9.30 a.m.-2.30 or 3.15 p.m.; also from 9.30 p.m.
JIE-2	9695	30.95	Tyureki, Taiwan.	Relays JFAK from 11 p.m.
ZHP	9690	30.96	Singapore, Malaya.	Sundays 8.40 p.m.-12.40 a.m.; Wednesdays 3.40-4.40 p.m.; Monday-Friday 7.40 p.m.-12.40 a.m.; Saturday 3.25-4.40 p.m., 7.40 p.m.-12.40 a.m.
GRX	9690	30.96	Daventry, England.	Daily 6.50-9 a.m.; 9.22 a.m.-12.15 p.m.; 3.57-8 p.m.; 8.40-11.45 p.m.
TGWA	9685	30.96	Guatemala City, Guatemala.	Daily 10.30 a.m.-3.15 p.m.; later on Sunday afternoons.
XEWQ	9680	30.99	Mexico City, Mexico.	Daily midnight-3.45 p.m.; till 4 p.m. on Sundays.
Paris	9680	30.99	Paris, France.	Testing; afternoons as TPA4
DJX	9675	31.01	Berlin, Germany.	Daily 1.40-7.25 a.m.
WRCA	9670	31.03	Bound Brook, N.J., U.S.A.	Daily 9 a.m.-4 p.m.
2RO-9	9665	31.04	Rome, Italy.	Daily 3.20 a.m.-noon.
KZRH	9660	31.06	Manila, P.I.	"The Voice of the Philippines"; daily 8 p.m.-midnight.
JLT-2	9645	31.10	Tokyo, Japan.	Daily from 3.15 a.m.
JFO	9636	31.13	Taihoku, Taiwan.	Daily 12.05-1.30 a.m.
2RO-3	9635	31.13	Rome, Italy.	Daily 3.07 a.m.-noon; 4-5.30 p.m.
TIPG	9620	31.19	San Jose, Costa Rica.	Daily 10 p.m.-2.30 p.m.
VLQ	9615	31.20	Sydney, Australia.	Daily 1.30-2.30 a.m.; 5-7 p.m.; 9.30-11 p.m.; 11.15-11.45 p.m.
ZRL	9606	31.23	Klipheuvall, S. Africa.	Address as ZRO, 9752kc. Heard midnight-2.45 a.m. session.
DXB	9605	31.23	Berlin, Germany.	Daily 5-5.30 a.m.; 7-7.40 a.m.; 7.50 a.m.-1.50 p.m.
RAN	9600	31.25	Moscow, U.S.S.R.	Daily except Monday 9 a.m.-1 p.m.; Monday 9-10 a.m.; 12.15-1 p.m.
CB-960	9600	31.25	Santiago, Chile.	Daily 10 pm.-7.30 a.m.; 10 a.m.-3 p.m.
HP5J	9590	31.28	Panama City, Panama.	Daily 9 a.m.-1.30 p.m.; from 10 p.m.
VUD-2	9590	31.28	Delhi, India.	Daily 1-3 p.m.; 5-7.15 p.m.; 10.30 p.m.-4 a.m.
PCJ	9590	31.28	Huizen, Holland.	Monday and Wednesday 5-6.35 a.m.
WCAB	9590	31.28	Philadelphia, Pa., U.S.A.	Tuesday, Friday, Sunday 9.30 a.m.-5 p.m.; Thursday noon-5 p.m.
GSC	9580	31.32	Daventry, England.	Daily 2.52-4.30 a.m.; 6.50-9 a.m.; 9.22 a.m.-12.15 p.m.; 12.37-3 30 p.m.; 3.57-4.45 p.m.
VLR	9580	31.32	Lyndhurst, Australia.	Daily 5.30 p.m.-midnight.
KZRM	9570	31.35	Manila, P.I.	Daily 7.30-9 a.m.; 7 p.m.-1.30 a.m.
WBOS	9570	31.35	Boston, Mass., U.S.A.	Daily 9 p.m.-5 p.m.; Sundays from 10 p.m.

RADIOKES — FIRST WITH THE NEW RELEASE.

Use Radiokes 5-band Coil Unit for the "Communications Eight" if you want the BEST results!

1 5-band communications dial	£1 2 6
2 permeability intermediates	£1 7 0
1 permeability intermediate	13 9
1 5-band coil unit	£10 10 0
	£13 13 9

R.C.S.

We are Factory Representatives for R.C.S. Radio Products. Also power transformers and W.W. resistors. Write to us for catalogue. Use the coupon below!

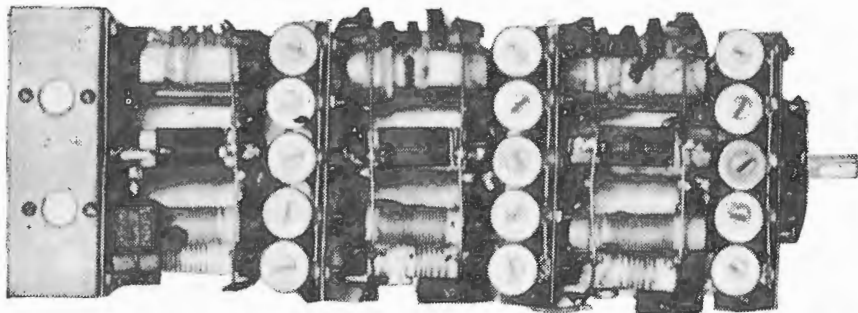

5-band coil unit above now available in tri-wave.

RADIO SUPPLIERS PTY. LTD.

WINGELLO HOUSE, ANGEL PLACE, SYDNEY. 'PHONE: B 4586, B 4557.

Please send details of the following lines.....

Name

Address

Call	K.C.	Metres	Location.	Schedule, etc.
VLW-2	9560	31.38	Perth, Australia.	Testing early a.m.
XGAP	9560	31.38	Peking, China.	Heard after midnight.
DJA	9560	31.38	Berlin, Germany.	Daily 7.50-11 a.m.; 11 a.m.-1.50 p.m.; 3.05-5 p.m.
WGEA	9550	31.41	Schenectady, N.Y., U.S.A.	Daily 8.15-11.15 a.m.
YDB	9550	31.41	Bandoeng, Java, D.E.I.	Daily 7.30 p.m.-1.30 a.m.
DJN	9540	31.45	Berlin, Germany.	Daily 3-7 a.m.; 3.05 p.m.-2 a.m.
JZI	9535	31.46	Tokyo, Japan.	Daily 5-7 a.m.; 10 p.m.-12.30 a.m.
KGEI	9530	31.48	San Francisco, Calif., U.S.A.	Daily 3-6 pm.; 10 p.m.-1 a.m.
WGEO	9530	31.48	Schenectady, N.Y., U.S.A.	Daily 6 a.m.-2.45 p.m.
ZBW-3	9526	31.49	Hong Kong.	Daily 7 p.m.-1 a.m.
RV-96	9520	31.51	Moscow, U.S.S.R.	Daily midnight-7 a.m.; 7-10 p.m.; Sundays 8-9 a.m.
YUA	9507	31.56	Belgrade, Yugo-Slavia.	Daily 3-9 a.m.
GSB	9510	31.55	Daventry, England.	Daily 4.45-6.30 a.m.; 6.50-9 a.m.; 9.22 a.m.-12.15 p.m.; 12.37-3.30 p.m.; 3.57-6.15 p.m.; midnight-2.30 a.m.
XEWW	9503	31.57	Mexico City, Mexico.	Daily midnight-2 a.m.; 3-5 p.m.
KZIB	9497	31.59	Manila, P.I.	Daily 7 p.m.-midnight.
KEI	9490	31.61	Bolinas, Calif., U.S.A.	Relays to Hawaii late afternoons.
TAP	9465	31.70	Ankara, Turkey.	Daily 2-7.30 a.m.; week days 8.30-10 p.m.; Saturday 9.30-11.30 p.m.; Sunday 8.30-10.30 p.m.
COCH	9437	31.80	Habana, Cuba.	Daily 11 p.m.-3 p.m.
COBC	9360	32.04	Habana, Cuba.	Daily 10 p.m.-3 p.m.
OAX4J	9340	32.12	Lima, Peru.	Daily 4-6 a.m.; 8 a.m.-4 p.m.
XTC	9295	32.28	Shanghai, China.	Daily 11 p.m.-midnight.
COBX	9200	32.61	Habana, Cuba.	Daily 11 p.m.-2.30 p.m.
COBZ	9030	33.32	Habana, Cuba.	Daily 10.45 p.m.-midnight.
COCQ	8830	33.98	Habana, Cuba.	Daily 8.45 p.m.-midnight; 2-3 p.m.
HS8PJ	7960	37.56	Bangkok, Thailand.	Irregular 11 p.m.-1 a.m.
JIE	7295	41.13	Tyureki, Taiwan.	Relays JFAK from 11 p.m.
JLG	7285	41.19	Tokyo, Japan.	Irregular; heard around 6 a.m.
TPB-11	7280	41.21	Paris, France.	Daily 12.15-7.15 a.m.
JVW	7257	41.34	Tokyo, Japan.	Daily 5-7 a.m.
GSW	7230	41.53	Daventry, England.	Daily 3.57-8 p.m.; and early a.m.
YDX	7220	41.55	Medan, Sumatra, D.E.I.	Daily 1.30-5 p.m.; 7.30 p.m.-midnight.
XPSA	7000	42.80	Kweiyang, China.	Daily 9 p.m.-11.45 a.m.
XOJD	6880	43.60	Hankow, China.	Daily 9-11.30 p.m.
PMH	6720	44.64	Bandoeng, Java, D.E.I.	Daily 7.30 p.m.-2 or 2.30 a.m.
TGWB	6490	46.20	Guatemala City, Guatemala.	Daily 3.45-6.45 a.m.; 10.30 a.m.-3.15 p.m.; 10.45 p.m.-midnight. Later on Sunday afternoons.
COHI	6460	46.44	Santa Clara, Cuba.	Daily from 9.55 p.m.
COCQ	6360	47.17	Habana, Cuba.	Testing new frequency; 10 p.m.
IAC	6355	47.20	Rome, Italy.	Daily 6-6.35 a.m.
COCW	6324	47.40	Habana, Cuba.	Daily 9.55 p.m.-3 p.m.
TG-2	6190	48.47	Guatemala City, Guatemala.	Tues.-Sat. 9 a.m.-2 p.m.; Sun. 9 a.m.-6 p.m.; 10 p.m.-2 a.m.; Monday 6-11 a.m.
HVJ	6190	48.47	Vatican City, Italy.	Daily 5-6.30 a.m.
TILS	6165	48.66	San José, Costa Rica.	Daily from 10 p.m.
WPIT	6140	48.86	Pittsburgh, Pa., U.S.A.	Daily 2-3 p.m.
KZRF/ KZEG	6140	48.86	Manila, P.I.	Daily 8 p.m.-midnight.
XEXA	6133	48.90	Mexico City, Mexico.	Daily 10.30 p.m.-midnight.
VLW	6130	48.94	Perth, Australia.	Testing at 9 p.m.
MTCY	6125	48.98	Hsinking, Manchukuo.	Address: 601 Daido-Taigai, Hsinking. Daily 11.30 p.m.-1.30 a.m.
FK8AA	6122	49.00	Noumea New Caledonia.	Irreg. 5.30-7 p.m.
WCBX	6120	49.01	New York City, U.S.A.	Daily 3-5 p.m.
GSL	6110	49.10	Daventry, England.	Daily 9.22 a.m.-12.15 p.m.; 12.37-3.30 p.m.
KZRH	6110	49.10	Manila, P.I.	Daily 8 p.m.-midnight.
YUA	6100	49.18	Belgrade, Yugo-Slavia.	Daily 3-9.30 a.m.
ZAA	6085	49.30	Tirana, Albania.	Daily 3.20-7 a.m.
VQ7LO	6083	49.31	Nairobi, Kenya.	Tuesday-Saturday 2.15-5.15 a.m.; Sunday 2.15-6.15 a.m.; Monday 1.45-4.45 a.m.
ZHJ	6080	49.34	Penang, Malaya.	Daily 9.40-11.40 p.m.
OAX4Z	6077	49.35	Lima, Peru.	Daily except Monday 10 a.m.-4.30 p.m.
YDD	6060	49.50	Bandoeng, Java, D.E.I.	Daily 8.30 p.m.-1 a.m.
WLWO	6060	49.50	Cincinnati, Ohio, U.S.A.	Daily from 8.45 p.m.; closes at 2 or 5 p.m.
GSA	6060	49.50	Daventry, England.	Daily 3.57-8 p.m.; 6.30-9 a.m.
WDJM	6040	49.67	Miami Beach, Fla., U.S.A.	Daily 1-4 p.m.
KZIB	6040	49.67	Manila, P.I.	Daily 7 p.m.-midnight.
RV-96	6030	49.75	Moscow, U.S.S.R.	Daily midnight-7 a.m.

Call	K.C.	Metres	Location.	Schedule, etc.
DJC	6020	49.83	Berlin, Germany.	Daily 2.30-7.25 a.m.
XYZ	6007	49.94	Rangoon, Burma.	Daily 9.30 p.m.-1 a.m.
ZRH	6007	49.94	Roberts, Heights, South Africa.	Daily 12.30-6.30 a.m.
HP5K	6005	49.96	Colon, Panama.	Daily 10 p.m.-midnight.
ZNB	5900	50.85	Mafeking, British Bechuanaland.	Daily except Monday 4-5.30 a.m.
PMY	5145	58.31	Bandoeng, Java, D.E.I.	Daily 8.30 p.m.-2 a.m.
VUD-18	4960	60.48	Delhi, India.	Daily 10.30 p.m.-3.35 a.m.
VUM-2	4920	60.98	Madras, India.	Daily 9.30 p.m.-3.10 a.m.
VUB-2	4880	61.48	Bombay, India.	Daily 10.30 p.m.-3.30 a.m.
VUC-2	4840	61.98	Calcutta, India.	Daily 9.30-3 a.m.
YDE-2	4810	62.37	Solo, Java, D.E.I.	Daily 7.30 p.m.-1 a.m.
RV-15	4273	70.19	Khabarovsk, U.S.S.R.	Daily 4 p.m.-1 a.m.

For the Best Results - - -

JONMAR COMPLETE KITSET

For the "WORLD CRUISER COMMUNICATIONS EIGHT,"
"1940 COMPANIONETTE THREE," "MIDGET AMPLIFIER"

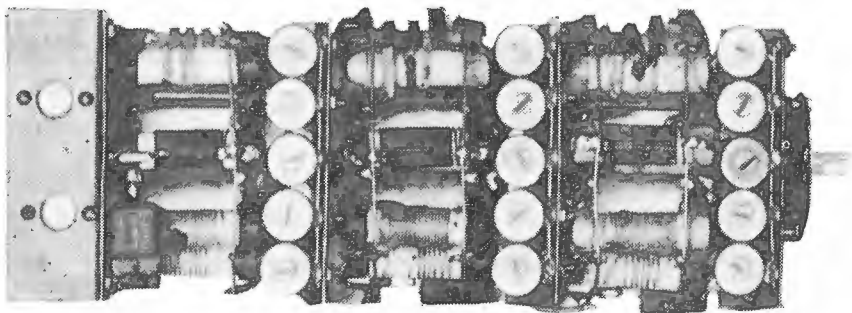

Five-Band Coil Unit as illustrated, and as recommended by the Technical Editor, included in Jonmar Kitset for "Communications Eight." Save time and money—avoid misfit components—complete to the last solder lug—no disappointments with a complete Jonmar Kitset. Post the coupon below for details!

RAYMART

CRAFT A CREED

Most efficient and complete range of shortwave gear in Australia, designed and constructed for complete efficiency.

Rola

"The World's Finest Sound Reproducers" set new high standards in fidelity of reception.

Please send prices and details of the "Jonmar" Kitset for the.....

.....featured in this issue.

Name

Address

Telegrams: "JONMAR," Sydney.

Telephone: BW 3109 (2 lines).



116-118 CLARENCE STREET, SYDNEY.

Simple 'Phone Jack Substitute.

A simple substitute for a double circuit 'phone jack is shown in the accompanying sketch. The cost of material for this job amounts to nil, as three strips of brass 1/2" wide are to be found in almost every amateur's junk box.

First of all take two strips of fairly heavy brass 2 1/2" long and 1/2" wide and bend to the shape shown in the sketch (see "A" and "B"). Now take a piece of springy brass about 7" long and bend to the shape of "C" in sketch.

Contacts "A" and "B" can now be bolted to the side of the cabinet, leaving 1/4" space between contact points. Now mount arm "C" in such a pos-

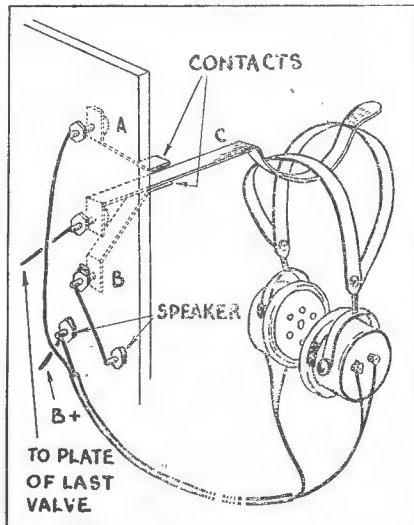

ition that it normally touches contact "A." A good idea is to place a solder lug under each of the mounting bolts; this makes the soldering of these leads much simpler.

Having completed that, join the leads up as shown in the sketch and the job is finished. When the 'phones are hung on the springy brass hook it will engage contact "B," bringing the speaker into the circuit. With the 'phones off the hook, the arm "C" will spring back into position and engage contact "A."

"World-Cruiser Communications Eight."

(Continued from page 16)

job for experienced set-builders. However, the well-spaced layout of the "World-Cruiser," combined with the fact that the R.C.S. coil assembly is supplied fully colour coded, making it a simple matter to connect it in circuit, means that anyone who feels confident of completing a standard 4/5 dual-wave receiver satisfactorily, can be assured of building the "World-Cruiser" successfully.

The complete under-chassis wiring is given in a sketch accompanying this article, while an additional sketch of the coil unit shows the colour coding and the method of wiring it into the receiver, the various leads being coloured correspondingly in both diagrams.

The Construction Outlined.

It will be noted from the list of parts that all the components used in the "World-Cruiser" are standard, and are available anywhere.

In building the set, the first parts to mount are the power transformer, valve, speaker and power sockets, and aerial and earth terminals. (Note that a doublet aerial can be used with this receiver if desired).

Next, the heater wiring for the first seven-valves in the receiver should be put in. Then the 5Y3G rectifier socket should be wired, the 8 and 16 mfd. wet electrolytics mounted, and the wiring of the smoothing filter completed. From this point onward the assembly and wiring are proceeded with systematically. Commencing at the r.f. valve socket and working through to the output pentode, complete everything as far as possible before the coil unit and three band-spread condensers underneath the chassis are mounted.

A particularly important point is that all earth returns should be short and direct, and should be soldered to lugs spot-welded to the steel chassis. (Four of these can be seen in a row directly behind the i.f. gain control in the under-chassis view). As well, all pig-tail components such as resistors and condensers should be located as closely as possible to the appropriate valve socket and i.f. transformer lugs.

Before mounting the type "H" gang condenser, a length of copper braid should be soldered to each wiper. Each of these passes down through a hole in the chassis, and is earthed. This is a particularly important point, and should not be overlooked.

In addition to the coloured leads

shown in the coil and wiring sketches, there are three yellow leads underneath the unit, one coming from each section. These pass up through the chassis and connect to the fixed plates lugs of the gang.

A point that should be noted is in regard to the coupling arrangement between the beat frequency oscillator unit and the second detector. As the wiring diagram shows, a shielded lead is run around the chassis from the

plate of the 76 to a point near the third i.f. transformer. Several turns of flex wrapped round this lead, and with the free end soldered to terminal 1 of "I.F.T.3," ensure ample coupling.

The two-plate midget condenser controls the b.f.o. note, and it will be found that when weak signals are very close to one another, a slight change in beat note will often make the desired signal stand out from the interference.

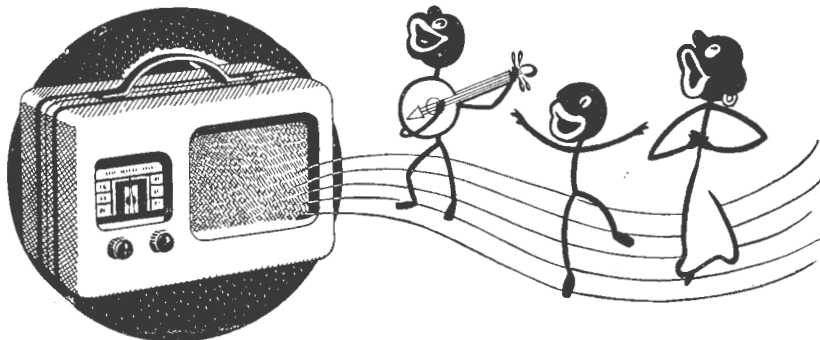

Rola

Loud Speakers Alone Have All Three Essentials To Make Your Portable A Success

- Richness and purity of tone.
- High efficiency at all volume levels.
- Compactness, lightness and all-time dependability.

Rola 5- and 6-inch permanent magnet models are the very speakers for your portable set. Special magnets, moulded polyfibrous diaphragms, special transformers, patented dustproofing and acoustic filter all combine to give these speakers vast superiority in their group. Their abnormally high efficiency makes them ideal for use in conjunction with the special 1.4-volt valves and light portable batteries with which they were designed to work. Little wonder that the manufacturers of Australia's best portable sets have made heavy demands upon the Rola factory for supplies of these amazing little speakers.

See your distributor immediately and order the speakers that will give your portable radio set the professional touch, for the new 5-4 model is now available.

5-4 The lightest permanent magnet speaker available in Australia **25/-**

Write for Specification Sheets and Full Price List.

ROLA COMPANY (Aust.) PTY. LTD.

The Boulevard, Richmond, E.1, Vic.

116 Clarence St., SYDNEY, N.S.W.

New Zealand representative:

SWAN ELECTRIC COMPANY, LTD., High Street, Auckland.



**RADIO VALVES
MAY LOOK ALIKE**

but.

Radiotrons stand out in popularity with radio owners and broadcasting engineers as the most dependable and best known radio valve.

Re-value with

**RADIOTRON
VALVES**

★ SEALED FOR
YOUR PROTECTION



Advt. of Amalgamated Wireless Valve Co. Pty. Ltd.



To Destroy
"TONE BOGEY"
Re-value with
RADIOTRONS

The valves in the sealed cartons

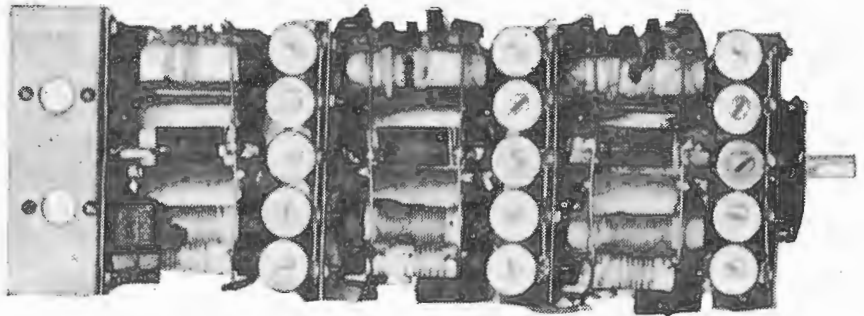

The R.C.S. type DW30 five-band coil assembly used in the "World-Cruiser."

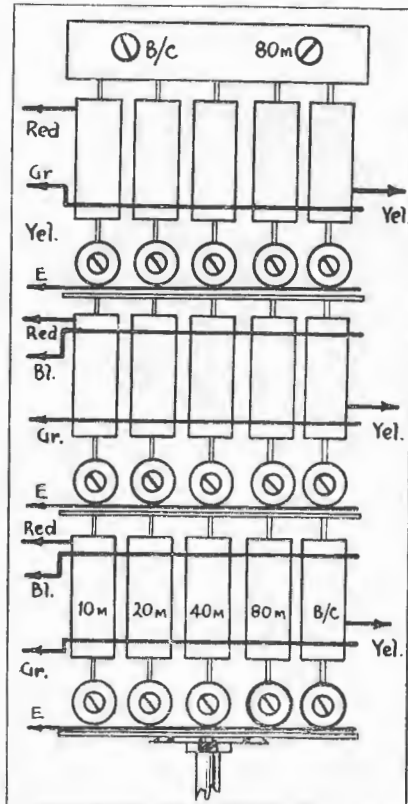

After the assembly and wiring have been completely and thoroughly checked, the dial can be mounted, valves plugged in and the control knobs and valve shields fitted. Next, plug in the speaker and connect the aerial and earth leads. Then turn the waveband indicator to broadcast and switch on. At the same time watch the rectifier closely for any signs of flashes or of a blue glow, either of which denote serious overload due to an error in wiring. If, however, the valves light up and a faint hum is heard coming from the speaker, then the two gain controls can be rotated

(Continued on page 28)

This sketch of the coil unit shows the colour-coded leads, which are marked correspondingly on the wiring diagram. The three yellow leads on the right of the unit connect to the three bandspreaders. Three additional yellow leads will be found underneath the unit. These pass up through the chassis to the three sections of the condenser gang.

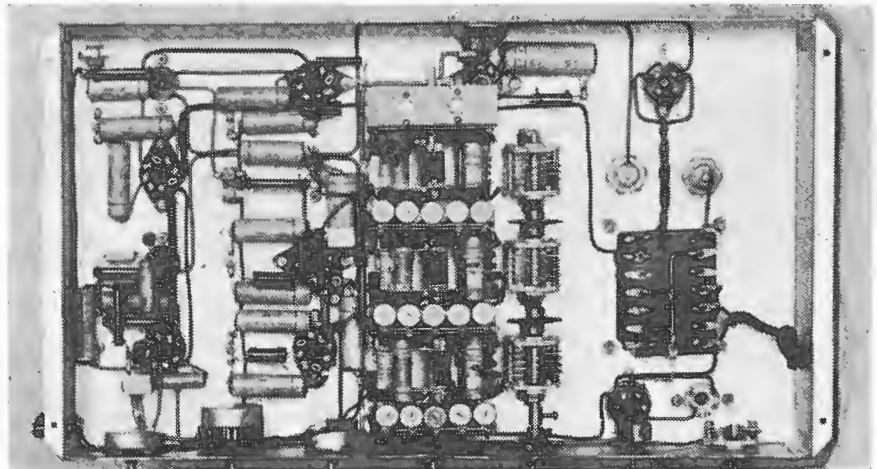

This photo shows how the completed receiver should appear from underneath.

The Australasian Radio World, February 1, 1940.

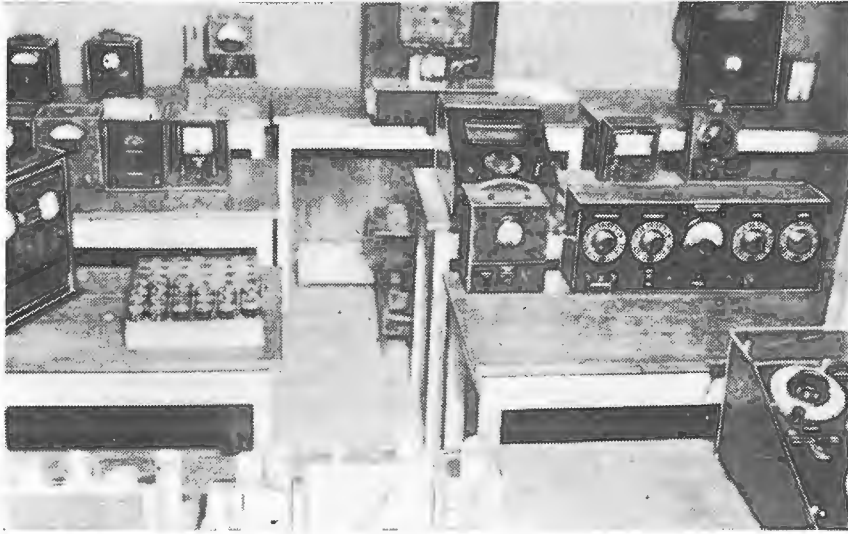

The views on this page show a few of the dozens of instruments of all types in the lavishly-equipped R.C.S. design laboratory.

The Story Of R.C.S. Radio (3)

This month's instalment stresses the importance of design in component manufacture, and describes the several thousand pounds' worth of equipment in the R. C. S. design laboratory.

IN the manufacture of radio components, design is of course of vital importance. Many of the parts manufactured by R.C.S. Radio are produced in hundreds of thousands, and slipshod design in a single line could prove very costly, both as regards wastage of raw material and loss of goodwill among purchasers.

For this reason the company has built up over a period of years what must be one of the finest design laboratories in the Commonwealth. In all, several thousands of pounds have been spent on a wide variety of equipment, the cost of individual instruments ranging from tens to hundreds of pounds.

Notwithstanding the dozens of varied radio lines that are manufactured by the company, there is an instrument to take care of every possible phase in the design of each. In all, there are over fifty instruments, details of the more important of them being given below.

General Radio Signal Generators: There are three models of these world-famous precision instruments in the R.C.S. laboratory—Models 601, 600A and 605A. They supply modulated and unmodulated voltages up to 1 volt at frequencies from 50 k.c. to 50 m.c.

Boonton "Q" Meter: Another world-famous instrument—used for measur-

ing "Q" values of all r.f. components as well as inductance, capacity, etc. Range is from 50 k.c. to 50 m.c.; accuracy within $\pm 1.5\%$.

Cathode Ray Oscilloscope: This instrument is used mainly for fidelity measurements on audio transformers in conjunction with a General Radio beat frequency oscillator. Is also used for general circuit analysis.

Matching Oscillator — Beat Frequency Type: Coils are checked

on this instrument by comparing them with a standard coil. The first section of the tester is a pre-set oscillator, which will automatically measure the coupling between primary and secondary windings of coils, and also indicate phasing of windings. The output of this oscillator beats with a variable oscillator and the resultant beat is fed through an audio channel into an output meter. By this means coils may be matched with an accur-

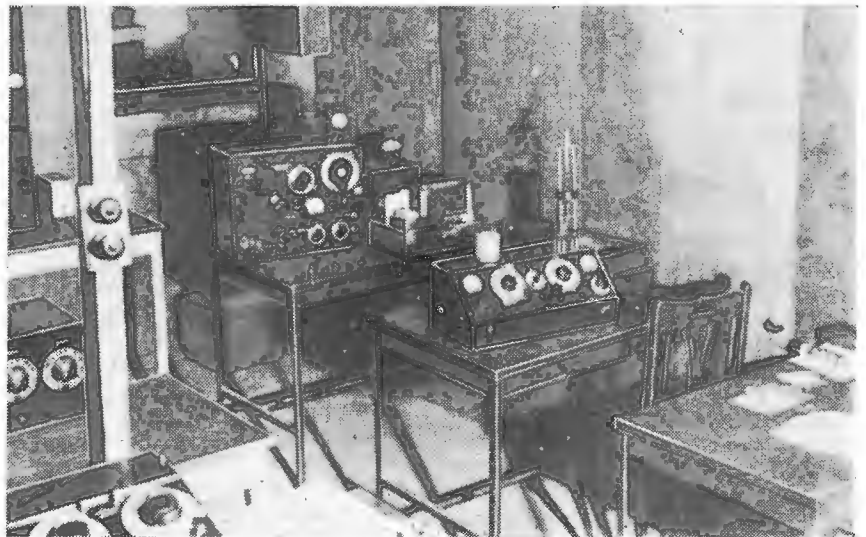

acy of perhaps 10 cycles + or -.

Intermediate Frequency Transformer Tester: This instrument utilizes a frequency-modulated oscillator and oscilloscope in conjunction with an output meter. The intermediates are plugged into a standard i.f. channel, and a direct measure of gain can be ascertained. The oscilloscope shows a comparative selectivity curve.

Vibrator Tester: This instrument has two receivers with a sensitivity of under 1 microvolt, using dummy aeri-als. One receiver uses directly-heated and the other, indirectly-heated valves. Input voltages of 2-32 volts can be switched to the input terminals. Measurements recorded are input voltage, input current and output voltage under fixed loads.

Weston Output Meter: This is used in conjunction with the generator for plotting sensitivity and selectivity curves and for taking a.v.c. measurements, etc.

Wheatstone Bridge: Measures resistance to 10,000 ohms. Indicates percentage error + or - 10%.

Resistance Checker: This is a bridge type instrument, providing indication of percentage error + or - 10% against fixed values.

Coil Checker: Measures coupling and phasing of primary and secondary of coils.

Matching "Q" Meter: This instrument is a switched frequency all-wave "Q" meter giving a comparative reading of "Q" of coils against a standard.

Flash Tester: Supplies test voltages up to 3,000 volts a.c. for breakdown and leakage testing.

Flash Tester: Similar to preceding type, but only has a maximum of 600 volts a.c.

Potentiometer Checker: Comprises a high-speed meter which measures resistance of potentiometer and shows up any open circuits or "jumps" during rotation.

Comparative Resistance Tester. Voltage dividers and resistors may be checked against standard with this instrument.

Matching Oscillator, T.P.T.G. Type: Used for auxiliary checking of coils, etc.

Multimeter, B.S.1 Rating: Measures a.c./d.c. voltage, current, ohms, and can be used as a valve tester in conjunction with suitable test voltages.

Inductance Capacity Bridge: This instrument will measure accurately capacity up to .01 mfd. and inductance to 100 henries.

(To be continued next month).

"World Cruiser Communications Eight."

LIST OF PARTS.

- 1 5-band 9.8 to 550-metre coil unit, type DW30 with band indicator (R.C.S.).
 - 3 permeability tuned iron-cored i.f. transformers, 2 type IF131, 1 type IF132 (R.C.S.).
 - 1 beat frequency oscillator coil unit, type F96 (R.C.S.).
 - 1 5-band directly calibrated dial and escutcheon, type DA2 (R.C.S.).
 - 1 3-gang condenser (Stromberg-Carlson type H).
 - 7 octal, 1 5-pin, 1 4-pin valve sockets.
 - 6 valve shields.
 - 1 16-gauge steel chassis, 20" x 12" x 3" (Acorn).
 - 3 terminals (2 red, 1 black).
 - 3 35 mmfd. double spaced midget variables for ganging (R.C.S., Raymart).
 - 1 2-plate midget variable (R.C.S., Raymart).
 - 1 power transformer, 385 volts, centre tap, 385v.; 100 mills, 5v. 3c., 6.3v. 3a., 6.3v. 2a. (Radiokes).
 - 1 5,000 ohm potentiometer (R.C.S.).
 - 2 .5 megohm potentiometers (I.R.C.).
 - 1 rotary type on/off switch.
 - 2 2" 0-100 degree indicator plates (Raymart).
- FIXED CONDENSERS:**
- 1 .00006 mfd. mica (T.C.C.).
 - 1 .00005 mfd. mica (T.C.C.).
 - 1 .00025 mfd. mica (T.C.C.).
 - 1 .0001 mfd. mica (T.C.C.).
 - 2 .004 mfd. mica (T.C.C.).

- 2 .01 mfd. tubular (Ducon).
- 2 .05 mfd. tubular (Ducon).
- 10 .1 mfd. tubular (Ducon).
- 1 .5 mfd. tubular (Ducon).
- 2 25 mfd. dry electrolytics, 25v. working (T.C.C., Ducon).
- 1 8 mfd. wet electrolytic, 500v. working (T.C.C., Ducon).
- 1 16 mfd. wet electrolytic, 500v. working (T.C.C., Ducon).

FIXED RESISTORS:

- 1 200 ohm 1-watt carbon (I.R.C.).
- 2 300 ohm 1-watt carbon (I.R.C.).
- 1 450 ohm 1-watt carbon (I.R.C.).
- 1 3,000 ohm 1-watt carbon (I.R.C.).
- 1 10,000 ohm 1-watt carbon (I.R.C.).
- 1 25,000 ohm 1-watt carbon (I.R.C.).
- 5 50,000 ohm 1-watt carbon (I.R.C.).
- 3 100,000 ohm 1-watt carbon (I.R.C.).
- 2 .25 megohm 1-watt carbon (I.R.C.).
- 2 .5 megohm 1-watt carbon (I.R.C.).
- 1 1 megohm 1-watt carbon (I.R.C.).

VALVES:

- 3 6U7G, 1 6K8G, 1 6B6G, 1 76, 1 6F6G, 1 5Y3G.

SPEAKER:

- 1 8", 10" or 12" speaker, 2,500 ohm field, input transformer to match single 6F6G (Rola, Amplion).

MISCELLANEOUS:

- 7 knobs; 1 indicator knob; 5 grid clips; 4 6.3v. dial lights; 2 couplers for ganging band spreaders; length of power cable and plug; length of tinned copper braid for shielding; solid and flexible push-back; nuts and bolts; solder tags; spacers; 16ga. tinned copper wire.

"World-Cruiser Communications Eight."

(Continued from page 26).

almost full on, and the tuning control rotated.

To check the broadcast alignment, tune in a station on approximately 1400 k.c. and adjust aerial and r.f. broadcast trimmers for best response. Next, swing over to a station of known frequency near the other end of the dial and adjust the broadcast padder until the transmission comes in at the correct dial setting.

This process is repeated for the 80-metre band, which is the only other band provided with a variable padder. With the other three bands, stations on known frequencies are tuned in, and the oscillator trimmer adjusted if necessary in each case to bring the station in at the correct dial setting. Finally, the aerial and r.f. trimmers are "touched up" at the high frequency end in each case, and the alignment is complete.

While adjustments are being made the volume should be kept well down both to prevent the a.v.c. from coming into action and to enable slight changes in volume to be noted more readily.

While alignment by ear is quite satisfactory for all ordinary purposes, the use of a reliable service oscillator is strongly recommended to ensure maximum performance.

OUTPUT METER FOR "RADIO WORLD" SERVICE OSCILLATOR.

Full Description Next Month.

In next month's issue of "Radio World" full constructional details will appear of the output meter illustrated below. It was designed as a companion instrument to the "Radio World" Service Oscillator described last month, and builders of the latter will find it invaluable, for while alignment of receivers by ear using a service oscillator is fairly accurate, to obtain maximum possible gain from tuned circuits, the use of an output meter is essential.

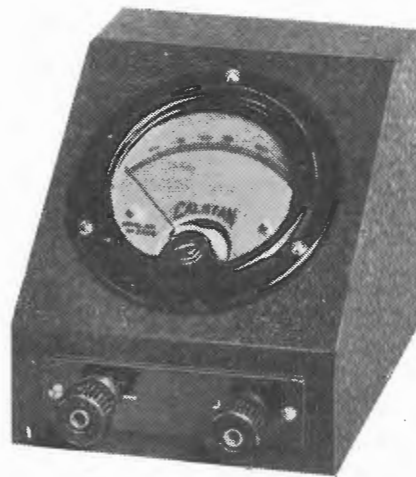

What's New In Radio

1940 R.C.S. Catalogue: New Factory Representative.

R.C.S. Radio Pty. Ltd. announce that their new 1940 catalogue is now ready for distribution. Printed on high-grade paper and well-illustrated throughout, it contains complete details of the dozens of up-to-date lines marketed under the R.C.S. brand. Readers can obtain copies free from any R.C.S. distributor, or direct from R.C.S. Radio Pty. Ltd., 50 Glebe St., Glebe.

The introduction of Trolitul a year ago has been a very large contributing factor to the heavy increase in business enjoyed by R.C.S. Radio during the past twelve months. This has necessitated increasing store facilities so that a stock of every line produced can be built up, from which immediate deliveries can be made.

New Factory Representative Appointed.

Also the sales organisation is being augmented by the appointment of Mr. R. K. Stokes as a factory representative. This appointment does not affect the existing selling organisation, and Mr. F. E. Wodell, Sales Manager, will continue to do his usual round of the trade.

★

Rola Still Receiving Fire-Damaged Speakers.

When the disastrous bushfires swept Victoria months ago, Rola offered to repair free of charge all speakers damaged in the fires. Shortly after the offer was made speakers damaged in various ways came to hand from all parts of the devastated areas.

Even after the fires had become a matter of history, speakers continued to arrive, and only last week a claim was made from Woods Point. The owner, whose home had been destroyed, brought in an old rusted speaker which had apparently been lying in debris throughout the winter. After Rola had verified the authenticity of the claim, the old irreparable speaker was replaced with one of a new, modern type.

★

In Latest "Radiotronics."

Attenuation due to the grid coupling condenser in a resistance

A monthly review of latest releases in sets, kit-sets and components

capacity coupled stage is the subject of an analysis contained in "Radiotronics" No. 101, issued by A.W. Valve Co. Pty. Ltd.

Further articles deal with a filter for bass boosting in pick-up reproduction (necessitated by attenuation deliberately introduced during the recording process), and the use of 1.4-volt valves in battery/a.c. receivers. In the latter article it is suggested that a Radiotron 5Y3G rectifier is capable of giving a d.c. output current of 125 m.a., which is sufficient for a filament current of .1 amp. together with a "B" supply current not exceeding 25 m.a. Most 1.4-volt valve receivers do not require such a high

"B" current supply, and the 5Y3G is thus ample for the purpose.

Main characteristics are also given of the Radiotron 1Q5GT (a 1.4-volt beam power amplifier), the 3Q5GT (a battery beam power amplifier which may be arranged with the filaments either in parallel—1.4-volt .1 amp.—or in series—2.8 volt .05 amp.), the 6AG7 video beam power tetrode (a heater-cathode type metal valve intended for use primarily in the output stage of the video amplifier of television receivers.

Tentative characteristics and ratings are also given of Radiotron transmitting valves, types 811, 812, 893, 899 and 828.

New 5" & 7" Amplions

Entirely New Design Incorporates Many Striking Features

LAST month three sample speakers from the 1940 Amplion range were received from Messrs. Amplion (Australasia) Pty. Ltd., 382 Kent St., Sydney. These comprise the 5E7 and 7E12 electro dynamics, and a 7P14 permanent magnet model.

Features Of New Speakers.

Main features of these new types can be summarised as follows:—

- (1) New housing design, giving increased effective cone area.
- (2) Excellent power-handling capacity and fidelity of reproduction.
- (3) Projection welded construction.
- (4) Adjustable, concentric centring device.
- (5) Completely dust-proofed air gap assembly.
- (6) Impregnated and insulated transformers.

The new models are novel in appearance, constructional methods having been completely revised, giving an outstandingly different type of speaker. The housing departs from the usual circular shape to advantage, the four corner projections with mounting holes, as shown in the accompanying photographs, being provided for mounting purposes. This enables the actual rim of the cone (neglecting the corrugations) to be reduced in width to barely an $\frac{1}{8}$ " with the nett result that the effective cone area is kept large despite the small overall dimensions of the unit. For example, the effective diameter of the new 5" cone is 4," representing an increase of a radiating surface of 30% over earlier Amplion models.

On the 7" model also this new type of housing gives a corresponding increase in the sound radiating area.



Left: The new Amplion 7" electro magnet type 7E12 model.

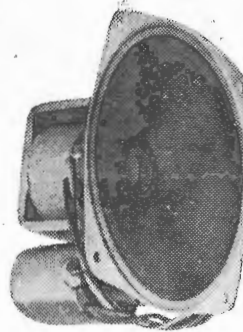

Right: The latest Amplion 5" electro magnet speaker type 5E7.

In the 5E7, the cone assembly is robust enough to handle comfortably the power output from small receivers, though at the same time sensitivity has been kept high, with particularly good tonal balance. In both this model and the 7" 7E12, the cone has been scientifically shaded and treated to retain good high-frequency response, and at the same time to extend bass response to a degree unobtainable in earlier models.

In both 5- and 7-inch speakers the metal parts are projection welded. Thus the housing, pole-plate, yoke and centering ring form a permanent welded unit of rugged durable construction. This welded unit is then used as a central basis for providing accurate alignment between the holes in the pole-plate and yoke, so that when the pole is assembled, it automatically drops centrally in the air gap. Consequently, micrometer tolerances can be achieved so that the efficiency of the magnetic circuit is excellent. The high flux density and total energy in the gap naturally provide high sensitivity, coupled with high-class transient response.

Details Of Suspension.

The corrugated suspension is specially designed for the maximum axial motion so necessary for high-quality reproduction, and simultaneously it prevents any radial motion which might endanger the voice coil or cause unpleasant rattles at high power output. Moreover, the corrugated suspension is attached to a metal support which can be adjusted in position simply by loosening two 4BA screws, so that any service

troubles are reduced to a minimum should the cone ever need re-centring. The corrugated suspensions of the 5" and 7" are similar, but each has been designed to give optimum results in its particular application.

In the 7" models, complete dust-proofing has been achieved by wool felt washers.

New Hermetically-Sealed Transformer.

A new transformer known as the Type XA has been developed for both 5" and 7" models. A midget transformer designed for highest possible efficiency, the windings and core are



Illustrated above is the Amplion type 8E12 electro magnet speaker.

hermetically sealed with humidity-proof compound in a steel casing. All transformers are heat-wax treated with a special process for a period of 36 hours before sealing. One side of the primary winding is electrically connected to the stack, which is in turn insulated from the can, so that

the possibility of electrolysis and possible breakdown is removed.

Since the impedance at 400 cycles of both the 5- and 7-inch speakers is 3 ohms, the same series of "XA" transformers can be used for either speaker.

Connections To Speakers.

(a) The 5" speaker is supplied with short leads from the audio transformer and the field coil.

(b) The 7" speakers can be supplied with either—

- (1) Short leads.
- (2) Cable and plugs.
- (3) Five-point terminal block with cover.
- (4) Five-pin socket and plug.

A tabulated set of important details concerning the loud-speakers of both sizes and types is given below.



Radio Suppliers Pty. Ltd. Now Factory Reprs. for R.C.S.

Information is to hand that Radio Suppliers Pty. Ltd. (managing director, R. K. Stokes), known as sole agents for Radiokes Precision Products, will also be sharing the factory representation of the extensive range of R.C.S. Radio Pty. Ltd. products.

The radio trade is assured that, in order to render the best possible service, arrangements have been made to have available at all times comprehensive stocks of the lines handled.

Radio Suppliers Pty. Ltd. are also factory representatives for the manufacturers of a well-known line of power transformers and wirewound carbon-coated resistors. Of special interest to the dealer is a new dual-wave 4/5 mantel receiver, incorporating the well-known DAU-1 Unit, and which can be retailed at a reasonable price and yet show a generous margin of profit. The set can be purchased in one of three ways:—(1) Completed receiver; (2) wired-up chassis; (3) coil unit and I.F.'s.

Reverting to radio components, the lines handled will include:—Trolitul coil units with and without R.F. stage; Trolitul coil units covering all latest circuits; Trolitul permeability I.F.'s; Trolitul permeability b'cast

(Continued on page 32)

Model	Type	Weight, lbs.	Voice Coil, D.C.		Magnet Wght. ozs.	Wght. of Field Coil, ozs.		Field Excitation			Power Undistorted	Output Maximum
			Resistance Ohms	Impedance, 400 c./s.		Min. Wts.	Nor. Wts.	Max. Wts.				
5E7	5" Electro.	2	2.3	3.0	—	7	2	4	6	3	5	
5P8	5" Permag.	2	2.3	3.0	8	—	—	—	—	2	4	
7E12	7" Electro.	3	2.3	3.0	—	12	6	8	10	8	12	
7P14	7" Permag.	3	2.3	3.0	14	—	—	—	—	6	10	



The Amplion P.S.
25 p.a. speaker horn.

Long Horn Public Address Speakers

Maximum sound coverage from a given output power is ensured by the use of a correctly designed p.a. horn, which provides full air loading for the vibrating speaker diaphragm.

By Norman Head, Engineer, Amplion (A'sia) Pty. Ltd.

THE purpose of speakers, with or without horns, in public address work is efficiently and faithfully to translate the electrical or audio frequency currents flowing in the amplifier output into sound pressure variations of the free air covering an audience.

The degree of efficiency of the speaker is a measure of the A.F. wattage output of the amplifier in relation to the sound propagation. The speaker diaphragm, whether conical or in any other simple or complex shape, is the medium of translation. Two conditions of action may be considered; a comparatively large area cone may by its movement directly instigate compression and rarefaction of the air, resulting in variation of air pressure and sound waves. Or a much smaller diaphragm may, through an acoustic transformer and finally through a horn, produce the same effect.

The large area cone, even if coupled to a small horn, must effect large amplitudes with considerable expenditure of power. The small diaphragm coupled to a correctly-designed horn will have much smaller amplitudes, with correspondingly more economical power input to achieve similar acoustic outputs.

The explanation lies in the efficient coupling of the vibrating medium to the air. In the cone unit, the ratio at high frequencies is proportional to the cone amplitude only, and a small horn allows only comparatively small increase; at lower frequencies this is further complicated by the baffle

action or the ability of the baffle, whether horn or straight board, to minimise the effect of back pressure. This is the effect of the cancellation of the front pressure by the back-of-cone rarefaction.

The horn acts like a transformer in matching the low pressure of the great air space surrounding the audience to the pressure at the face of the moving element.

To be efficient at all frequencies the horn design must comply with certain definite characteristics, horns may be of various shapes, but to cover the widest frequency variation without undue attenuation at either end, the logarithmic or exponential horn is the logical choice. In this horn the throat resistance or loading factor is more constant over a wider range and has a sharper cut-off.

To be efficient at the lower frequencies the horn must have a certain expansion rate along its axis and must have a large flare area; at higher frequencies these constants are smaller, and a horn correctly loaded for low frequencies will automatically be correctly loaded for the "highs." For instance, a horn with a cut-off of 128 c./s. will double in radius every 12" along the axis and should have a mouth radius of about 36" to be effective. The final flare dimensions are important and cannot be ignored or varied if efficiency or mouth reflections are to be avoided, irrespective of the throat.

Provided the expansion rate is correctly proportioned and adhered to, the longer the horn, especially travel-

ling back from the minimum flare dimensions, the more efficient it is and the greater the effective amplification of sound due to the loading.

Another factor in the efficiency and fidelity of the speaker and horn is the acoustic transformer at the throat. This is the ratio of the area of the diaphragm to the throat, and in units in common use is between 3 and 4 to 1; so that the diaphragm is 3 or 4 times the area of the throat.

For fidelity characteristics, and in this respect also the large cone or cone-horn unit is inferior to the small diaphragm, the phase relationship of the various frequencies generated reaching the throat is important. This is the relation of the distance between extremes of the diaphragm and the throat orifice, to the wavelength of the sound. Its effect is more noticeable at high frequencies, and shows to a disadvantage in large-area cones.

It is possible to have 10 watts of high frequencies from a large cone, which, full of phase distortion, is less intelligible than 2 watts without phase distortion from a long-horn speaker.

Economics And Efficiency.

Actually cheaper in its own cost is the cone-horn type speaker, for it simply uses a radio-type dynamic speaker coupled to a short horn with low efficiency. To obtain large power outputs, large inputs are required. If an efficient long-horn and unit were used, equivalent output would be obtained with perhaps one-quarter or one-fifth of the power input.

With a long horn unit capable of 10 watts input, the output would be so

The NEWEST ELECTRICALLY WELDED

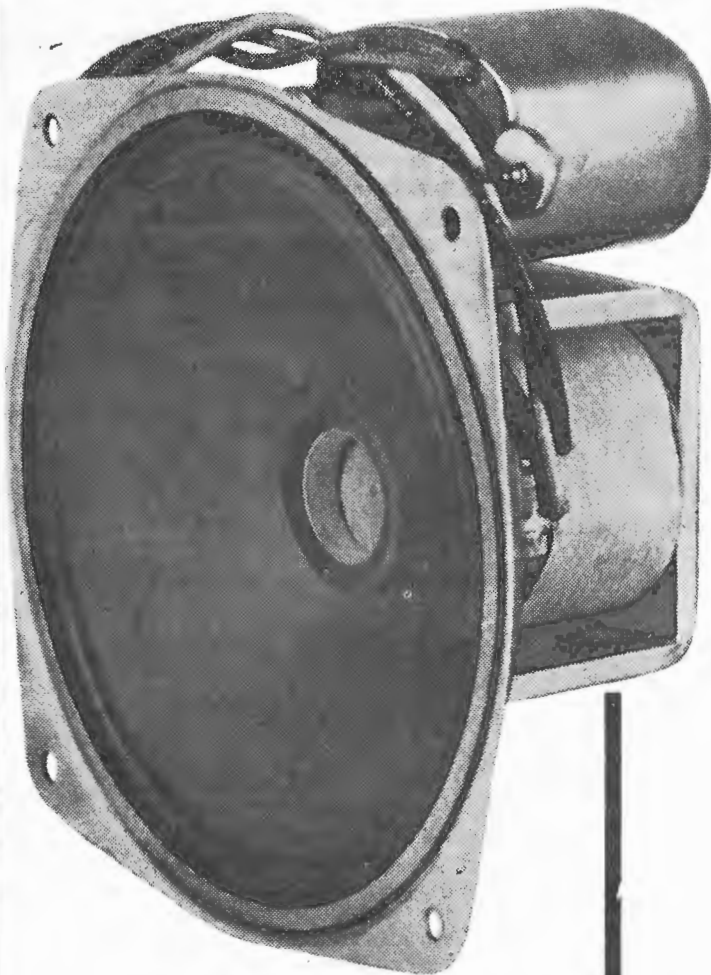

AMPLION

New 5" type shown above has 30% larger cone area than any other, sealed insulated core transformer, larger field, higher output and frequency response equalled by none!

Type 5E7 Electro..... 28/6
Type 5P8 Perm. 31/6

New 7" Amplion supersedes all 6½" and 8" speakers. High fidelity, oversize field, 8" size cone, insulated transformer, 8-12 watts output!

Type 7E12 Electro. 31/-
Type 7P14 Perm. 40/6

WRITE NOW FOR NEW AMPLION SPEAKER DATA
(PUBLICATION 88.C), POST FREE.

AMPLION (A'sia) Pty. Ltd.
382 Kent, Street, Sydney

great that several cone-horns would be required to duplicate it because of their limits of operation. Therefore the efficiency of the long horn unit compensates for its greater initial cost, and actually costs less for the same acoustic power coverage. And the economics extend further in that an amplifier of much smaller output is required.

The Amplion P.S.25 speaker is a 72" exponential horn of careful design coupled to a unit which, properly loaded as it is in this horn, is capable of handling inputs of 10 watts without distress or distortion. And the 10 watts input is comparable with more than three times the power put into cones or cone-horns. That is the efficiency factor.

For example, amplification was required for community singing concerts held weekly in the Sydney Town Hall, an auditorium of 3,500 people. When Amplion P.S.25 speaker; replaced the previously used cone-horn types, the power necessary to cover the audience adequately was reduced from more than 30 watts to less than 10 watts. Four P.S.25 units were used in the installation, each working at a lower level than 2.5 watts each.

Small amplifiers driven from batteries in police cars with the same speaker unit (P.S.6) have extraordinary penetration power above street noises, with extremely low power input.

The P.S.25 long horn speaker is a sound projector as opposed to the cone-horn sound diffuser.

Because a long horn speaker may be more costly in initial expense, it does not mean that it is actually dearer. By the increase of efficiency, the requirements of fewer units and the decreased cost of amplifier design and more economical amplifier power consumption, an actual saving can be effected, and, further, the fidelity of the speaker is superior.

What's New In Radio. (Continued from page 30)

coils; Trolital permeability s'wave coils; Trolital iron core I.F.'s; Trolital air core I.F.'s; Trolital trimmers and padders; 60 m.a. power transformers; 2,500, 5,000 and 10,000-ohm wire-wound volume controls; audio transformers; R.F. chokes; voltage dividers; dials; power chokes, etc.

All products handled by Radio Suppliers Pty. Ltd. are covered by available price lists and leaflets, and buyers would be well advised to cover their season's requirements now and take advantage of present ruling prices.

Shortwave Review

CONDUCTED BY
ALAN H. GRAHAM

Additional New Stations Listed ★ Night Reception Still Excels ★ UHF and Amateur Bands Disappointing ★ Full List of Month's Loggings.

Review of Conditions.

The tendencies in reception conditions outlined in these columns last month have become more pronounced—with early morning reception fair, and night reception exceptionally good—whilst during the day conditions are very poor indeed.

Easily outstanding at present are the 25 and 31-metre bands. In many years' experience of shortwave reception we have never heard anything to equal the present level of 25-metre signals during the night and very early morning session.

New Stations.

As in previous months, we are able to list a number of new stations. The attention of readers is drawn to the following:—COHI; COCQ, on a new frequency; XEWQ; the new Australian stations, VLQ and VLQ-2; the South African station at Durban on 25.49m.; KZRB; HS8PJ, on 37.56m.; a new Warsaw station on 25.02m.; and a new German station on the 41-metre band.

PCJ Discontinue Tuesday Afternoon Session.

Amongst shortwave listeners there will be a feeling of deep regret at the news that the very popular session broadcast by PCJ for Australian and New Zealand listeners has been discontinued. An announcement to session, probably the most entertaining on the air, has always attracted this effect was heard at the end of December. This Tuesday afternoon considerable interest, and the announcer, Bob Wybrands, was a popular personality.

Acknowledgments.

We wish to acknowledge reports from the following:—Messrs. Bantow (Edithvale, Vic.), Neill (Queensland), Chapman and Taylor (N.S.W.), Johns and Cushen (N.Z.), all "Radio World" Observers. And also from Mr. O. G. Washfold (Camberwell, Vic.) and Mr. Goucher (South Yarra, Vic.), AW-257DX and AW536DX, respectively, of the AWAWDXC.

★

Latest Station Changes and Schedules.

Colombian Republic.

In addition to the new station on 9740kc., HJFK, another Colombian transmitter, located in Bogota, is now

Turkey.

The latest information from Ankara reveals that TAQ is now off the air. The present schedule for TAP is:—Week-days, 8.30 to 10 p.m.; 2 to 7.30 a.m.; Saturdays, 9.30 to 11.30 p.m.; 2 to 7.30 a.m.; Sundays, 8.30 to 10.30 p.m.; 2 to 7.30 a.m.

United States

WLWO will soon place in use its new 100kw. transmitter. Using a special rhombic beam antenna, programmes in Spanish and Portuguese will be directed to eastern South America. Transmissions will be on 49, 31, 25, 19, 16 and 13 metres. (Universalite).

Venezuela.

The Government of Venezuela will shortly place on the air a new 30kw. transmitter, which will operate with the following calls:—On 6172kc., 48.6m., as YVKF; on 9640kc., 31.12m., as YVSC; on 11725kc., 25.59m., as

operating on 9710kc., 30.9m., with the call HJCF. (Universalite).

Cuba.

Some confusion has been caused by recent changes of frequency amongst Cuban stations. The new station at Santa Clara COHI, operates on 6460 kc., 44.64m., and carries the same programme as CMCF, COCH and CMKQ.

In addition, COCH is being reported on a new frequency of 6500kc., 46.15m. Listeners should exercise care in logging these two stations, as they may easily be confused.

COCQ is also testing on another frequency, 6360kc., 47.17m., and, in addition, is reported from some quarters as being on 6425kc., but we have no confirmation of this.

ALL-WAVE ALL-WORLD DX CLUB

Application for Membership



The Secretary,
All-Wave All-World DX Club,
117 Reservoir Street,
Sydney, N.S.W.

Dear Sir,

*I am very interested in dxing, and am keen to join your Club.
The details you require are given below:*

Name.....

Address.....

[Please print
both plainly.].....

My set is a.....

[Give make or type,
number of valves,
and state whether
battery or mains
operated.].....

*I enclose herewith the Life Membership fee of 3/6 [Postal Notes
or Money Order], for which I will receive, post free, a Club badge and
a Membership Certificate showing my Official Club Number.*

(Signed).....

[Note: Readers who do not want to mutilate their copies of the "Radio World" by
cutting out this form can write out the details required.]

YVOR; and on 15315kc., 19.59m., as YVPP.



Ultra-High-Frequency Notes.

Conditions Poor.

During the past two months U.H.F. conditions in our locality have been very poor; a complete absence of police band signals; very little on the 10-metre amateur band; and only an occasional good day on 11 metres. Police Bands.

We have recently received a verification of our report to the Glendale, California, police department on their 33940kc., 8.8m., signals. The Superintendent of Communications, Mr. C. Wasmansdorff (W6LFL) was kind enough to forward a recent F.C.C. list of American police calls and frequencies, which has already greatly assisted us in identifying a number of stations heard some time ago.

The full list of police transmitters heard at the end of last year is:—KQBR, Alameda; WQIE, Newark; and WQKB, Evansville, on 30700kc.; KQBV, Los Angeles County, on 31900 kc.; WRBH, Cleveland; KQAN, Fort Worth; KQBH, Kansas City (Kansas); WQMA, Miami Beach; WQKW, Canton; WQNO, Elgin; WQIC, McKeesport; KQAO, Long Beach; KQBW, St. Joseph; and KQBF, National City, on 33100kc.; KQCI, Glendale; and WPDS, St. Paul, on 33940kc.

11-Metre Loggings.

W8XNU, 25950kc., 11.56m., Cincinnati: Most consistent of the stations now heard on this band, though seldom very strong; best around 8 a.m.

W4XA, 26150kc., 11.47m., Nashville: Very erratic now; heard sometimes in early morning.

W9XPD, 25900kc., 11.58m., St. Louis: Seldom heard now; when logged, very weak, and hard to copy.

W9XJL, 26100kc., 11.49m., Superior: Only heard on rare occasions; very weak.



Amateur Bands Review.

Listeners who concentrate on the amateur bands are now finding it difficult to maintain reasonable logs, as conditions have fallen off considerably on both 10 and 20 metres. Very few stations are listed this month in the Calls Heard section.

CALLS HEARD.

(Reports to hand from Messrs. Chapman, Taylor, Cushen and Johns).

10 Metres.

United States: W- 3CBT, 3GRL, 3HUM, 4ETV, 4GDR, 5EEL, 5HDK, 5ILU, 6ABF, 6AKH, 6ITH, 6LES,

6MIW, 6MUO, 6NPF, 6NHN, 6PHF, 6POZ, 6PRB, 6RLF, 6PEV, 6ONQ, 8GU, 9CFQ, 9DRQ, 9GIQ, 9QI.

Philippine Is.: KAIME.

Hawaii: K6- OJI, MVA, PUL, RRM. 20 Metres.

South America: LU- 1HI, 5AN (Argentine); OA4R (Peru); CE- 3AC, 3AG, 3CG, 3CZ, 3CK, 4AC (Chile); HC1FG (Ecuador).

Africa: EK1AF (Tangier International Zone).

Pacific: KB6- ILT, OCL (Guam); K6- MVA, QHU, BNR, MBE, NYD (Hawaii).

The East: KA- 1AF, 1ME, 1BH (Philippines); XU- 1B, 8LA, 7HB, 8AZ, 8RB, 8ZA (China); J- 2NG, 2XA (Japan); PK- 4KS, 4MM, 5KF (D.E.I.).



This Month's Loggings.

Stations not listed in last month's issue are indicated by an asterisk (*).

All times are Australian Eastern Standard.

SOUTH AMERICA.

Peru.

OAX4J, 9340kc., 32.12m., Lima: Becoming more difficult to log, but still heard at times around 7 a.m., and on Sundays between 3 and 4 p.m.

OAX4Z, 6077kc., 49.37m., Lima: Still being heard in N.Z., though not audible in our locality, nor reported by any Australian listeners.

Chile.

*CD-1190, 11910kc., 25.19m., Valdivia: Still being heard, best reports being from N.Z. Closes at either 2 or 2.30 p.m.

*CB-1170, 11700kc., 25.64m., Santiago: Heard fairly well on a few occasions, either early morning or before closing at 2 p.m. (Johns).

*CB-970, 9740kc., 30.8m., Valparaiso: Very erratic, but might be heard before closing just after 3 p.m.

CB-960, 9600kc., 31.25m., Santiago: Most consistent of the Chilean stations. Not very good at night, but quite good on Sunday afternoons till 3.30 p.m.

Argentine.

*LRX, 9660kc., 31.06m., Buenos Aires: Not heard here lately, but reported from N.Z., with good signal at 10.30 p.m. (Johns).

Ecuador.

HCJB, 12460kc., 24.08m., Quito: Heard fairly well lately from 10.30 p.m.; also reported from N.Z. with weak signal around 1 p.m. (Chapman, Cushen).

Colombian Republic.

HJFK, 9740kc., 30.8m., Pereira: Opens nightly with good signal at 10 p.m.

CENTRAL AMERICA AND WEST INDIES.

Costa Rica.

TIPG, 9615kc., 31.21m., San Jose: Widely reported, opening at 10 p.m. One of best night stations on 31m. (Cushen).

TILS, 6165kc., 48.66m., San Jose: Becoming difficult to log, but still heard weakly at 10 p.m. (Cushen).

Cuba.

COGF, 11800kc., 25.42m., Matanzas: Fairly good signal around 7 a.m. on some mornings.

COCM, 9805kc., 30.6m., Habana: Heard weakly from 11 p.m. Varies in frequency, as was heard on 9850kc. for some time.

COCH, 9437kc., 31.8m., Habana: Much better signal at present; heard from 10 p.m.; also at times in early morning.

COBC, 9350kc., 32.08m., Habana: Quite a good signal now, usually opens just before 10 p.m. (Washfold).

COCQ, 8850kc., 33.9m., Habana: Still heard regularly on this frequency; usually opens at 9.55 p.m., but sometimes an hour earlier. See also 6360kc. (Washfold).

*COCO, 8700kc., 34.5m., Habana: New frequency for this station which was previously on 6010kc. Heard from 10 p.m.

*COHI, 6460kc., 46.44m., Sta. Clara: New station, opening nightly at 9.55 p.m. (Goucher).

*COCQ, 6360kc., 47.17m., Habana: Once again on a new frequency, COCQ has been heard testing on a few occasions. (Johns).

*COCW, 6330kc., 47.4m., Habana: Heard with good signal at night, opening at 9.55 p.m. (Washfold).

Panama.

HP5A, 11700kc., 25.64m., Panama City: Fair signal at night; best 10 to 10.30 p.m. (Chapman).

HP5J, 9590kc., 31.28m., Panama City: From 10 p.m. Also reported on 9610kc., 31.22m., and may stay permanently on this new frequency to avoid QRM.

Guatemala.

TGWA, 15170kc., 19.78m., Guatemala City: Heard at good strength on Sunday afternoons, sometimes for whole programme, and sometimes till 5.15 p.m., when change is made to 9685kc. (Washfold, Goucher, Cushen).

TGWA, 9685kc., 30.96m., Guatemala City: Heard best on Sunday afternoons, though not as good as formerly (Goucher).

TGWB, 6486kc., 46.25m., Guatemala City: Best on Sunday afternoons, with same programme as TGWA.

TG-2, 6195kc., 48.4m., Guatemala City: Good signal on Sunday afternoons in N.Z., but rather weak elsewhere. (Cushen, Johns).

Dominican Republic.

HI1N, 12486kc., 24.03m., Trujillo City: From 9.40 p.m. with weak signal.

*HI1N, 6243kc., 48.06m., Trujillo City: Heard weakly with same programme as 24m. transmitter.

NORTH AMERICA.

Mexico.

*XEWG, 9680kc., 30.99m., Mexico City: New station heard during afternoons till just before 4 p.m. with English announcement. (Goucher).

XEWW, 9503kc., 31.57m., Mexico City: Consistent afternoon around 3 p.m.; also audible at times after midnight. (Cushen, Goucher).

*XEXA, 6133kc., 48.9m., Mexico City: Reported from N.Z., with good signal from 2-3 p.m. in English hour. (Johns).

Canada.

*CJRX, 11720kc., 25.6m., Winnipeg: Difficult to log, but best time is on Sunday afternoons when station is on till 7 p.m.

United States.

WCBX, 21570kc., 13.91m., New York City: Opens at 11 p.m., but heard best after midnight.

*WCBX, 17830kc., 16.83m., New York City: Reported at good strength in early a.m. from Queensland. (Neill).

WNBI, 17780kc., 16.87m., Bound Brook: Good signal in early mornings; very weak now in forenoon. (Neill, Chapman, Goucher).

WGEA, 15330kc., 19.56m., Schenectady: Good early morning signal. (Neill, Chapman, Goucher, Johns).

KGEI, 15330kc., 19.56m., San Francisco: Weaker now, but still heard around 2 p.m. (Neill, Johns, Washfold).

WCAB, 15270kc., 19.65m., Philadelphia: Quite good strength in early morning.

WCBX, 15270kc., 19.65m., New York City: Good signal in early mornings, closing 6.30 a.m. (Chapman).

WRUL, 15250kc., 19.67m., Boston: Sometimes used in place of WRUW, 15130kc. (Chapman).

WPIT, 15210kc., 19.72m., Pittsburgh: Quite good signal from midnight till 5 a.m. (Neill, Cushen).

WRUW, 15130kc., 19.83m., Boston: Good, clear signal, closing 8 a.m. (Chapman, Goucher).

KKZ, 13690kc., 21.91m., Bolinas: Special relays to Hawaii.

KKQ, 11950kc., 25.1m., Bolinas: Also used for special relays, around 3 p.m.

WPIT, 11870kc., 25.26m., Pittsburgh: Nice signal in early morning, best from 7 a.m. (Chapman, Goucher).

WCBX, 11830kc., 25.36m., New York City: From 7 a.m., with fine, steady signal; one of best morning stations. (Goucher, Chapman).

WRUL, 11790kc., 25.45m., Boston:

Early morning station with good signal at 6 a.m. (Chapman).

WRUW, 11730kc., 25.58m., Boston: Good signal from 7 a.m. (Neill, Washfold, Goucher, Chapman).

WRCA, 9670kc., 31.03m., Bound Brook: Heard till 4 p.m. closing. Fair signal; very strong in N.Z. (Johns).

WCAB, 9590kc., 31.28m., Philadelphia: Another afternoon station, till 5 p.m. (Washfold, Goucher).

WBOS, 9570kc., 31.35m., Boston: Another afternoon American, closing at 5 p.m.

WGEA, 9550kc., 31.41m., Schenectady: Heard weakly some mornings around 9 a.m. (Bantow).

WGEO, 9530kc., 31.48m., Schenectady: Quite strong signal from 6 a.m. till nearly 9 a.m. (Chapman, Goucher).

KGEI, 9530kc., 31.48m., Schenectady: Heard in afternoons from 4-6 p.m.; also from 10 p.m., though interfered with by JZI in some locations at this time. (Chapman, Goucher).

*KEI, 9490kc., 31.61m., Bolinas: Another relay station for Hawaiian programmes.

*KEE (?), approx. 37m.: American relay station reported from N.Z. by Mr. Johns. Heard at good strength on Sunday afternoons closing at 3.45 p.m.

WCBX, 6120kc., 49m., New York City: Reported from N.Z. with good

signal in 3-5 p.m. session. (Cushen).

WLWO, 6060kc., 49.5m., Cincinnati: Only weakly here at present; but fine signal reported in N.Z. at 5 p.m. (Cushen).

WDJM (and not WBKM, as given last month), 6040kc., 49.67m., Miami Beach: Reported from N.Z.; excellent signals on Sundays from 3.30-4 p.m. (Johns).

WRUL, 6040kc., 49.67m., Boston: Occasionally heard with special test transmission.

AFRICA.

Canary Is.

EAJ-43, 10360kc., 28.96m., Tenerife: Heard at times in early a.m., just before 6 a.m. (Neill).

Kenya.

VQ7LO, 6083kc., 49.31m., Nairobi: Still heard in early mornings, 5 a.m., though hardly as good as previously. (Chapman).

Bechuanaland.

ZNB, 5900kc., 50.85m., Mafeking: Still heard in the early mornings, closing 5.30 a.m.

South Africa.

*Durban, 11770kc., 25.49m.: New station, call unknown, heard around 2 a.m. relaying ZRO on 9752kc.

ZRO, 9752kc., 30.77m., Durban: Easily logged just before closing at 2.15 a.m.

Have Your "RADIO WORLD" Posted To You Direct

Readers who want to take the "Radio World" on a subscription basis and have their copies posted to them direct each month are invited to complete the coupon below (annual sub., 10/6). New readers are advised that all back numbers in Volumes 1, 2 and 3 are still available, price 9d., post free, for all copies up to and including the December, 1938, issue, and 1/-, post free, for subsequent numbers.

Enclosed please find remittance for 10/6 in payment for an annual subscription to the "Australasian Radio World," commencing with the.....issue.

Name

Street and No.

City State.....

Country

THE AUSTRALASIAN RADIO WORLD
117 Reservoir Street, Sydney.

Note:— N.Z. Subscribers should remit by Money Order.

ZRL, 9606kc., 31.23m., Klipheuvall: Heard fairly well at same time as ZRO.

AUSTRALIA.

VLR-3, 11880kc., 25.25m., Lyndhurst: Used from 6.30 a.m. till 5.15 p.m. (Washfold, Chapman, Johns).

*VLQ-2, 11870kc., 25.26m., Sydney: New Australian national shortwave station. Transmits to Europe 5.30-6.30 p.m. (Washfold, Cushen, Johns).

VLW-3, 11830kc., 25.36m., Perth: Heard testing; also used for national shortwave service to Africa, 3.30-4.30 p.m. (Washfold, Bantow, Chapman).

*VLQ, 9615kc., 31.2m., Sydney: Used for transmissions to Europe and America. (Washfold, Cushen).

VLR, 9580kc., 31.32m., Lyndhurst: Used at night.

*VLW-2, 9560kc., 31.38m., Perth: Testing in early a.m. (Washfold).

VLW, 6130kc., 48.94m., Perth: Testing from 9 p.m.

THE EAST.

Philippine Is.

*KZRB, 11840kc., 25.34m., Manila: New station heard testing one night after 8 p.m. Not on regular schedule.

KZRH, 9660kc., 31.06m., Manila: This new frequency for the "Voice of the Philippines" is reported from all parts of Australasia at good strength. (Washfold, Bantow, Goucher, Cushen, Johns).

KZRM, 9570kc., 31.35m., Manila: Good strong signal every night. (Johns, Neill, Washfold, Bantow, Chapman, Goucher).

KZIB, 9500kc., 31.58m., Manila: Another good station at night. (Neill, Washfold, Bantow, Goucher).

KZEG/KZRF, 6140kc., 48.86m., Manila: Very strong signal every night. Uses both calls, though KZRF. (Washfold, Bantow, Chapman).

KZRH, 6100kc., 49.18m., Manila: Fairly good signal. (Neill).

KZIB, 6040kc., 49.67m., Manila: Good signal nightly. (Washfold).

Japan.

JZK, 15160kc., 19.79m., Tokyo: Fairly strong in early mornings around 7 a.m.; also heard 11 a.m. (Chapman, Goucher).

JVH, 14600kc., 20.55m., Tokyo: Reported from N.Z.

JZJ, 11800kc., 25.42m., Tokyo: Heard in early mornings, and from 10 p.m. (Neill, Chapman, Goucher).

JVW-3, 11720kc., 25.6m., Tokyo: Good signal nightly. (Washfold, Bantow, Goucher, Cushen).

JLG-3, 11705kc., 25.63m., Tokyo: Also heard at night.

*JLT-2, 9645kc., 31.1m., Tokyo: Good signals from this station in early mornings till 6.30 a.m. (Neill).

JZI, 9535kc., 31.47m., Tokyo: From 10 p.m. nightly; badly interferes with KGEI in some localities. (Chapman, Goucher, Johns).

*JLG, 7285kc., 41.1m., Tokyo: Seems to be used irregularly; sometimes at good strength early morning or at night.

JVW, 7257kc., 41.34m., Tokyo: Used with JZI in 5-7 a.m. session (Chapman, Johns).

*JLT, 6190kc., 48.47m., Tokyo: Heard here occasionally; and often reported from N.Z.

JZI, 9535kc., 31.47m., Tokyo: From 10 p.m. nightly; badly interferes with KGEI in some localities. (Chapman, Goucher, Johns).

*JLG, 7285kc., 41.1m., Tokyo: Seems to be used irregularly; sometimes at good strength early morning or at night.

JVW, 7257kc., 41.34m., Tokyo: Used with JZI in 5-7 a.m. session. (Chapman, Johns).

*JLT, 6190kc., 48.47m., Tokyo: Heard here occasionally, and often reported from N.Z.

Hong Kong.

ZBW-3, 9525kc., 31.49m., Hong Kong: Good signal nightly. (Washfold, Bantow).

India.

VUD-3, 15290kc., 19.62m., Delhi: Heard in early afternoons till 2 p.m. and also 4.30-6.30 p.m. (Johns, Goucher).

VUD-2, 9590kc., 31.28m., Delhi: Fine signals from 10.30 p.m., opening with news in English. (Washfold, Bantow, Goucher, Johns).

VUD-18, 4960kc., 60.48m., Delhi: Fairly strong from 10.30 p.m.

VUM-2, 4920kc., 60.98m., Madras: Weak. (Chapman).

VUB-2, 4880kc., 61.48m., Bombay: Fair. (Chapman).

VUC-2, 4840kc., 61.98m., Calcutta: Fair. (Chapman).

Malaya.

ZHP, 9690kc., 30.96m., Singapore: Still a good signal, but QRM is sometimes troublesome. (Washfold, Chapman, Goucher, Johns).

ZHJ, 6080kc., 49.3m., Penang: Not so good now, but still to be heard. (Washfold).

French Indo-China.

Radio Saigon, 11780kc., 25.47m., Saigon: Exceptionally strong signal nightly. English session is now from 8.45 to 9.15 p.m. (Neill, Washfold, Bantow, Chapman, Johns, Goucher).

*A new station on approx. 11850kc., 25.32m., heard around 9 p.m. nightly, is thought to be located in Indo-China, but few details are available at time of writing.

China.

XGOX, 15190kc., 19.75m., location uncertain: Strong signal at night around 7 p.m. Often used in special transmissions to U.S.A., Hawaii, etc. (Washfold, Chapman, Goucher).

XGOY, 11900kc., 25.21m., location unknown: Just fair in the morning, but very strong at night. (Bantow, Chapman, Goucher, Johns).

XMHA, 11855kc., 25.3m., Shanghai: Remains a fairly good signal at night. (Washfold, Chapman, Goucher).

*XGOK, 11650kc., 25.75m., Canton: Note change of frequency from 11820 kc. Fairly strong. News at 11.15 p.m.

*XGAP, 9560kc., 31.38m., Peking: Reported from N.Z., and sometimes audible here around 1 a.m.

*XTC, 7000kc., 42.8m., Kweiyang: One of strong regulars at night. (Washfold).

XOJD, 6880kc., 43.6m., Hankow: Never very loud, but usually audible after 9 p.m.

Dutch East Indies.

YDB, 15310kc., 19.6m., Bandoeng: Heard during afternoon, around 4 p.m., at fair strength. (Washfold).

YDC, 15150kc., 19.8m., Bandoeng: Good signal at night; also at times from 9 a.m. (Goucher, Washfold Bantow).

PLP, 11000kc., 27.27m., Bandoeng: Relays YDC; good signals at night. (Washfold, Chapman, Goucher).

PMN, 10260kc., 29.24m., Bandoeng: Also a NIROM relay station; fairly strong at night. (Washfold, Chapman, Goucher).

YDB, 9550kc., 31.41m., Bandoeng: Nice steady signal from this station around midnight. (Goucher).

YDX, 7220kc., 41.55m., Medan: Mainly native programmes; fair signal.

PMH, 6720kc., 44.64m., Bandoeng: Native programmes at good strength; very reliable. (Washfold, Goucher).

YDD, 6045kc., 49.63m., Bandoeng: Not very good, but audible on most nights. (Washfold, Chapman).

*PMY, 5145kc., 58.31m., Bandoeng: Fair signal above high noise level.

Manchukuo.

*JDY, 9920kc., 30.24m., Dairen: Again being heard from 10 to 11 p.m. (Washfold).

MTCY, 11775kc., 25.48m., Hsinking: From 7 a.m. with fair signal. (Chapman, Goucher, Cushen).

MTCY, 6125kc., 48.98m., Hsinking:

From 11.30 p.m.; no English used. (Neill).

Thailand.

HS6PJ, 19020kc., 15.77m., Bangkok: Used on Monday nights in December, but replaced, temporarily at least, by 7960kc., transmitter.

HS8PJ, 9510kc., 31.55m., Bangkok: Replaced recently by 7960kc. transmitter.

***HS8PJ**, 7960kc., 37.56m., Bangkok: New station, replacing transmitters on 15 and 31m. Heard at good strength. (Goucher, Cushen, Neill).

Taiwan.

JIE-2, 9695kc., 30.95m., Tyureki: Weak signal after midnight.

JFO, 9635kc., 31.13m., Taihoku: Seldom very loud; reported from Queensland at 1.30 a.m. (Neill).

JIE, 7295kc., 41.13m., Tyureki: Transmits at same time as **JIE-2**; fair signal at midnight. (Cushen).

Burma.

XYZ, 6007kc., 49.94m., Rangoon: Just fair after midnight. (Chapman, Neill).

EUROPE.

Portugal.

***CSW-4**, 15215kc., 19.71m., Lisbon: Fine signal from 2-3 a.m.

CSW-6, 11040kc., 27.17m., Lisbon: Good steady signal from 3.45-6.30 a.m. (Chapman).

CSW-7, 9740kc., 30.8m., Lisbon: From 7 a.m. with steady and regular signal. (Goucher).

Sweden.

SBT, 15155kc., 19.8m., Motala: Heard best on Sunday nights, after 7 p.m. (opening at 6 p.m.). (Johns).

SBP, 11705kc., 25.63m., Motala: Heard till 7.15 a.m. with fair signal. (Neill).

Holland.

PHI-2, 17770kc., 16.88m., Huizen: Seldom very loud, but heard most nights; best on Sundays from 9.40 p.m. (Neill, Bantow, Goucher).

PCJ-2, 15220kc., 19.71m., Huizen: Tuesday afternoon session now off the air, but can still be heard quite well around 11 p.m. (Neill, Washfold, Goucher, Cushen).

PCJ, 9590kc., 31.28m., Huizen: Good signal in early mornings, Mondays and Wednesdays. (Chapman).

Poland.

***Warsaw**, 11990kc., 25.02m.: New German station heard from 7 p.m. till midnight. German seems only language used.

Turkey.

TAP, 9465kc., 31.7m., Ankara: Another regular morning station at good

strength; also around 10 p.m. at week-ends. (Goucher).

Lithuania.

LYR, 9285kc., 32.34m., Kaunas: Reported from N.Z. between 4.30 and 5.15 p.m. (Johns). Still heard with fair signal till 6 a.m.

Belgium.

ORK, 10330kc., 29.04m., Ruysselede: (Chapman).

Spain.

EAQ, 9860kc., 30.43m., Madrid: Does not seem to have regular schedule; heard as early as 3.10 a.m. and also irregularly at 7 a.m. (Neill). Switzerland.

DX Club Requirements.

All-Wave All-World DX Club members are advised that the following DX requirements are obtainable from Club headquarters, 117 Reservoir St., Sydney.

REPORT FORMS.— Save time and make sure of supplying all the information required by using these official forms, which identify you with an established DX organisation.

Price . . . 1/6 for 50, post free.

NOTEPAPER.— Headed Club notepaper for members' correspondence is also available.

Price, 1/6 for 50 sheets, post free.

DX CLUB STICKERS.— Enlarged two-colour replicas of the Club badge, in the form of gummed stickers, designed for attaching to envelopes, QSL cards, etc. Price, 5 dozen for 1/6, post free.

DX CLUB LOG SHEETS.— Designed by the Shortwave Editor, these headed and ruled log sheets are indispensable to dxers who wish to keep a simply-prepared and accurate list of loggings. Price, 3 dozen for 1/6, post free.

HBO, 11402kc., 26.32m., Geneva: Heard on Sunday afternoons around 6.30 or 7 p.m. (Chapman).

***HBJ**, 14535kc., 20.64m., Geneva: Same programme as **HBO**.

Yugo-Slavia.

YUC, 9505kc., 31.56m., Belgrade: Good early morning station. (Neill, Chapman).

***YUA**, 6100kc., 49.18m., Belgrade: Not heard in our locality recently, but reported from Queensland in early morning. (Neill).

Albania.

ZAA, 6085kc., 49.3m., Tirana: At fair strength from 3.20-7 a.m.

Hungary.

***HAS-3**, 15370kc., 19.52m., Budapest: Only on the air from midnight on Sundays, with English announcements. (Goucher).

Vatican City.

HVJ, 15120kc., 19.84m.: Very strong on Tuesday nights from 11.30 p.m. (Goucher).

***HVJ**, 6190kc., 48.47m.: Good signal on Sunday mornings, opening 5.30 a.m.

Norway.

LKV, 15170kc., 19.78m., Oslo: Still heard in the very early morning, 1-2 a.m.; reported at 4.20 a.m. with English session from Queensland. (Neill).

***LKQ**, 11735kc., 25.57m., Oslo: Best on Sunday nights around 8.45 p.m. with church service. (Johns).

Finland.

***OIH**, 17800kc., 16.85m., Lahti: Heard weakly some nights till Davenport opens at 8.40 p.m.

Bohemia.

***OLR5A**, 15230kc., 19.7m., Prague: Heard weakly on several occasions in 7 p.m.-midnight session.

Italy.

2RO-15, 11760kc., 25.51m., Rome: Latest EIAR transmitter on the air. Heard as early as 9 p.m., but much louder at 1 a.m. (Chapman).

***2RO-14**, 15230kc., 19.7m., Rome: Heard irregularly in early morning or at night (with **2RO-15**). (Chapman). Also logged: **2RO-3**, 9635kc., 31.13m.; **2RO-4**, 11810kc., 25.4m.; **2RO-6**, 15300kc., 19.61m.; **2RO-8**, 17820kc., 16.84m.; **2RO-9**, 9667kc., 31.03m.; and **IRF**, 9830kc., 30.52m. (Washfold, Neill, Bantow, Chapman, Johns, Cushen).

France.

***TPB-11**, 7280kc., 41.21m., Paris: Heard fairly well lately around 6 a.m., closing 7.15 a.m. Also reported at 6 p.m. (Johns, Cushen).

Also logged: **TPB-3**, 17765kc., 16.88m. (note change of frequency); **TPA-2**, 15245kc., 19.68m.; **TPB-6**, 15130kc., 19.83m.; **TPB-11**, 11885kc., 25.24m.; **TPA-4**, 11715kc., 25.61m.; and new station on 9680kc., 30.99m. (Washfold, Neill, Chapman, Johns, Cushen).

U.S.S.R.

Stations logged: **RV-96**, 15400kc., 19.47m.; **RV-96**, 15180kc., 19.76m.; **RKI**, 15083kc., 19.89m.; **RNE**, 1200 kc., 25m.; **RAN**, 9600kc., 31.25m.;

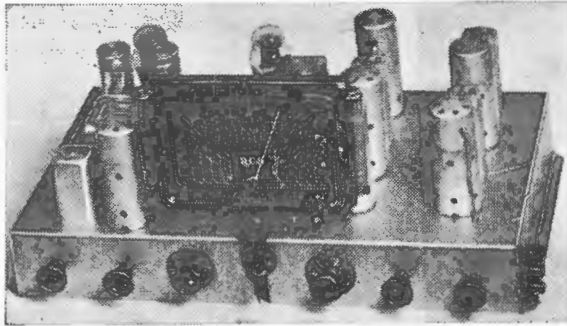

We Guarantee Results !

The five-band "World-Cruiser Communications Eight" is easily the finest receiver of its type yet described in any Australian magazine. We will assemble and air-test your model for you . . . AND WILL GUARANTEE TO DUPLICATE THE MAGNIFICENT RESULTS GIVEN BY THE "RADIO WORLD" LABORATORY MODEL.

WRITE NOW FOR OUR QUOTATION.

Want a Receiver Built, Lined up . . or Serviced ?

If so, we are fully equipped to handle the job for you. For years we have specialised in building to private orders all types of receivers (A.C., D.C., A.C./D.C., vibrator, battery, dual-wave, all-wave or short-wave), amplifiers of all types (P.A. systems a speciality), auto and portable radios. Sets built to individual requirements, or we will design to suit any conditions.

"Little Wanderer" Portable Radio

City, beach or bush . . . anywhere, at any time, a flick of a switch will bring you a wealth of radio entertainment from this sensational new 1.4-volt portable radio.

MAIN FEATURES INCLUDE:

- Powerful five-valve superhet circuit (using 1.4-volt valves) specially developed to give maximum in performance with minimum running costs.
- Six-inch Rola P.M. speaker with high-sensitivity magnet ensures ample volume with superb tone.
- Litz-wound iron-cored coils and i.f. transformers give exceptionally high sensitivity.
- New improved a.v.c. system, station-calibrated dial, non-directional lid aerial, with provision for attaching outside aerial.

PRECISION RADIO

L. T. MARTIN, M. Inst. R.E. (Aust.)
20 CARRINGTON ST. NORTH,
STRATHFIELD, SYDNEY.

'Phone

UM 7858

RV-96, 9520kc., 31.51m.; and RV-15, 4273kc., 70.21m. (Washfold).

England.

Stations logged: GSA, 6050kc., 49.59m.; GSB, 9510kc., 31.55m.; GSC, 9580kc., 31.32m.; GSD, 11750kc., 25.53 m.; GSE, 11860kc., 25.29m.; GSF, 15140kc., 19.82m.; GSG, 17790kc., 16.86m.; GSH, 21470kc., 13.97m.; GSI, 15260kc., 19.66m.; GSJ, 21530kc., 13.93m.; GSO, 15180kc., 19.76m.; GSP, 15310kc., 19.6m.; GST, 21550kc., 13.92 m.; GSV, 17810kc., 16.85m.; GSW, 7230kc., 41.49m.; and GRX, 9690kc., 30.96m. (Washfold, Bantow, Goucher, Chapman, Neill, Johns, Cushen).

Germany.

*A new German station operating on approx. 41.6m. is reported from N.Z. by Mr. Johns. Heard at 5.30 p.m. with strong signals.

Stop-Press Notes.

A report just received from Observer W. H. Pepin, of Maylands, West Australia, lists the following stations:—

HS7PJ, 37.65m., is now the regular channel for the Bangkok station. It is heard nightly from 11 p.m.- 1 a.m., except on Mondays, when HS6PJ, on 15.77m., is used.

Other Eastern stations logged:— VUB-2, on 31 metres, and the four Indian transmitters on 60-61 metres; XGOX and XGOY; JZK and JZJ; YDC, YDB, on 19.6 and 31m.; YDX; PMH, PLP and PMN; KZRM, KZIB and KZRH, all on 31 metres. Lower frequency stations also include YDL-2, on 62 metres; YDA, on 98 metres; and RV-15.

Europeans heard include the majority of the Daventry and Berlin transmitters now on the air; also Paris, on a number of frequencies, including the 41.2 metre transmitter; and RNE, RAN and RV-59 on 50 metres.

The new Australian stations are listed:—VLW, VLW-2, VLW-3, VLQ and VLQ-2.

Amateur loggings on 20 metres are:—W- 3, 4, 5, 6, 8, 9; XU-8AM, 1B, 1A; J2NF; K6- CMC, BNR, MVA; PK, 1MF, 1OG; KA- 1AF, 1LB, 1FM, 1AG, 1BH, 1JM, 1AR, 1MN, 1CW, 1SM, 1OZ, 4LH.

Modulated Oscillators.

(Continued from page 10)

ceiver is fitted with a sensitive tuning indicator this operation is greatly simplified.

Short Wave Bands.

On the short wave bands, the shortcomings of service oscillators in regard to output impedance and attenuation are usually severe, and satisfactory alignment in the normal manner may be very difficult. Under such conditions, it is advisable to align the tuning circuits with the normal aerial connected, and the output lead of the oscillator twisted around it. As before, no higher input voltage should be used than is necessary to give a satisfactory reading on the output meter.

In the majority of receivers the padding condenser is of fixed capacitance and adjustment cannot readily be made for tracking. Should "dead spots" occur in the band, it may be necessary to effect a compromise in the setting of the trimmers so that more even sensitivity will be obtained across the band. Such a measure should not, however, be necessary in a well-designed receiver.

If the padding condenser is of fixed capacitance, the only means of setting the dial calibration is by means of the oscillator trimmer at the high-frequency end of each band. Care must be exercised to discriminate between the signal and the "image" which may be very prominent in small receivers. (The occurrence of "images" or "second spots" was discussed at greater length in Lecture 1).

Another effect which must be appreciated is the "crossing-over" effect. In the majority of receivers the oscillator is tuned to a frequency higher than the signal frequency, the oscillator coil being slightly smaller than the aerial and r.f. coils. If, however, the range of the trimming condensers is great, it is sometimes possible at the high-frequency end of the band to tune the local oscillator to a frequency lower than that of the signal frequency circuits. Under these conditions, as the receiver is tuned across the band, the resonant frequency of the aerial and r.f. circuits decreases more rapidly than that of the oscillator circuit and a point of cross-over occurs beyond which the oscillator frequency is above the signal frequency. At the point of cross-over, i.e., where the two frequencies are equal, instability is likely to be experienced.

The reverse process can also take place when the oscillator is operated at a frequency lower than the signal input frequency.

Multivibrators.

The multivibrator is a form of oscillator which, in addition to the usual fundamental frequency, produces also a large number of equally-spaced harmonics. For this reason and also for the fact that it is simple to design and construct and hence relatively inexpensive, it is extremely useful in service work. The usual form of multivibrator oscillator consists of a two-stage resistance-coupled amplifier, in which the output voltage of the second valve is fed back through a resistive capacitive network to the grid of the first valve. The fundamental frequency and hence the spacing of the harmonics is determined by the time constant of the coupling condensers and resistors. A multivibrator may be designed having a fundamental frequency of approximately 500c/s, and producing harmonics spaced every 500 c/s to approximately 20 m.c.'s (15 m.).

The high-frequency harmonics may be picked up by a normal radio receiver, but are too close to be individually separated, and constitute a continuous signal across the whole of each wave-band. After rectification, the audio-frequency components consist of the fundamental 500 cycle tons together with its audible harmonics.

Fig. 17 shows the circuit of a practical multivibrator oscillator using the twin-triode type 6F8G. Connected as shown, the circuit produces a waveform similar to that shown in Fig. 18. The amplitude of the harmonics steadily decreases with increase of frequency, although from an experimental oscillator sufficient output voltage could still be obtained at 12.5 metres to align a sensitive receiver.

The output voltage may be varied by means of the 0.05 megohm potentiometer in the output circuit, but complete attenuation can only be accomplished if the whole assembly is effectively shielded. The same general precautions are necessary as outlined in connection with modulated oscillators.

Fig. 19 shows an alternative design using type 1G6G, operating entirely from dry batteries. The battery drain is very low, being 100 m.a. for the filament and approximately 3 m.a. for the plate supply.

The output on all bands is less than that given by the a.c. version, but is useful up to approximately 15 m.c.'s (20 m.) above which the output falls off rapidly.

Application Of Multivibrator.

As will readily be appreciated, such an instrument cannot be calibrated in terms of frequency, and consequently cannot be used for aligning i.f. transformers or calibrating dials in terms of frequency. It is, however, extremely useful for aligning the tuned circuits, especially on the short wave bands.

Having once set the oscillator trimmer to a satisfactory position (at the high-frequency end of the band), the output lead of the multivibrator may be connected to, or brought near the aerial terminal of the receiver, and the signal frequency circuits then aligned for maximum output in the speaker.

The receiver may then be tuned to the low-frequency end of the band, and the padder adjusted for maximum output. It is unnecessary to rock the gang condenser, since with the multivibrator in operation, there is always a signal present, no matter to what frequency the receiver happens to be tuned. After adjusting the padder, the aerial and r.f. trimmers should be re-checked at the high frequency end of the band.

Another important advantage in the use of a multivibrator is that it is possible to check, quickly and easily, each wave-band in a receiver for dead spots or variations in sensitivity by the simple expedient of listening to the output from the multivibrator, as the receiver is tuned across each band. The output from rising frequency, but does not vary the multivibrator falls gradually with rising frequency, but does not vary greatly from point to point.

"1940 Companionette Three."

(Continued from page 8)

Short Aerial Is Best In City Locations.

The "Companionette" is highly sensitive, so that in metropolitan areas only a few feet of aerial wire are needed to give more than ample volume from all locals—in fact, in such locations a short aerial is definitely advisable. In country locations, however, with a good outside aerial and an effective earth, excellent interstate reception can be expected.

New A.C.-Battery Portable.

(Continued from page 3).

particularly appreciated by those who are hard of hearing, or by hospital patients, etc.

The valve line-up of the Model 169 is as follows: 1N5G r.f. amplifier, 1A7G mixer, 1N5G i.f. amplifier, 1H5G diode second detector and triode driver, 1Q5G beam output tetrode and a 5Y3G rectifier in the a.c. power unit.

The circuit used incorporates several ingenious features, apart from standard refinements such as full automatic volume control and automatic bias. The intermediate frequency chosen is 252 k.c., giving extremely high gain and excellent selectivity, with a minimum of undesirable reaction with the built-in loop aerial. Sensitivity of the receiver operating on the loop is better than .5 microvolt per metre, which explains its remarkable distance-getting powers.

Fool-proof A.C. Operation.

On the a.c. side the Model 169 has been skilfully engineered to give reliable, hum-free operation, the circuit arrangement being designed to safeguard both receiver and valves against damage under all conditions. Actually the receiver can be switched to battery operation without damage while it is still connected to the mains.

The power transformer, with a tapped primary to match 220, 240 or 260-volt mains, operates in conjunction with a 5Y3G rectifier to deliver an unsmoothed output of approximately 110 m.a. at 110 volts. This is used for both "A" and "B" supplies, in the following way:—

When the receiver is switched over to a.c. operation, a 4 x 2 position switch throws the valve filaments into a series-parallel arrangement drawing .1 ampere at 4.2 volts. A 1000-ohm voltage dropping resistor is connected in series with this network, the whole being across the unsmoothed rectifier output. Thus, of the 110 mills. at 110 volts available, 100 mills. are used for "A" supply, leaving 10 mills. at 110 volts (unsmoothed) for the "B" and automatic bias supplies. Wirewound resistors and high capacity electrolytic condensers provide very complete smoothing of both supplies, reproduction on a.c. being entirely hum-free.

An Excellent Performer.

During a period of a fortnight the receiver was tested under a wide variety of conditions, with consistently excellent results. Sensitivity is exceptionally high, so much so that in none of the many test locations visited was there the slightest need for an external aerial and earth.

In all locations in and around Sydney at least fifteen stations could be

played at full volume at any time during the day, while at night thirty or forty local and inter-state loggings were common. Aroud 10.15 p.m. any night the New Zealand YA's, together with several Japanese stations, were logged.

For the tests mentioned above, the set was carried around to different locations in a Flying Standard roadster. Car-owners will be interested to know that the Model 169 could be played at full volume during these trips with negligible noise from the motor, which incidentally is not fitted with suppressors of any kind.

Thus this new Breville release, which is both light and compact, makes the ideal all-purpose receiver. In the home, on picnics, at week-enders, in the car . . . it can be played anywhere, at any time.

Complete Data Free On Request.

Further details of both Breville "Duo" models, and of other standard type battery portables made by the company, are available free on request from Breville Radio Pty. Ltd., 67-73 Missenden Road, Camperdown, N.S.W.

Book Reviews.

(Continued from page 4)

The chapter dealing with modulation equipment is one providing a wealth of material for the public address amplifier enthusiast, for any of the modulators described can be applied for that purpose. The latter section of this Handbook is devoted to the latest applications of u.h.f. equipment, covering oscillators, transmitters, receivers and aerial equipment for frequencies from 56 m.c. to 112 m.c. and higher.

The laboratory man will find much to occupy him in the chapter dealing with instruments for checking frequency and modulation, audio and r.f. signal generators, D.C., A.C. and r.f. voltmeters and oscilloscopes.

Apart from the primary interest of experimental radio, the 1940 edition of The Radio Amateur's Handbook contains such a wealth of practical and theoretical information that it is of great value to the professional radio engineer, and should be handy in every radio laboratory.

(Our copy from McGill's Newsagency, 183-5 Elizabeth St., Melbourne, price 10/8 posted).



Radiotron Designer's Handbook.

About six years ago Amalgamated Wireless Valve Company furnished a valuable aid to the radio engineer in publishing the first edition of the

Radiotron Designer's Handbook. Now comes the third edition, and of this it is no exaggeration to say that it is a veritable paradise of information for the radio engineer. It is much larger than the first two editions, containing a total of 352 pages, with more than 300 diagrams and charts.

It is evident at first glance that the editor, Mr. F. Langford Smith, B.Sc., B.E. M.I.R.E. (U.S.A. and Australia), A.M.I.E.E., A.M.I.E. (Aust.), set out with the primary object of making this a compilation of material of the utmost possible value that could be included in the space available.

The chapters deal with A.F. voltage amplifiers of all types, A.F. power amplifiers, power output and speaker relationship, biasing, by-passing and decoupling, fidelity and distortion, negative feedback, Miller effect, audio amplifier design, tone compensation and tone control, volume expansion and compression, recording, pick-ups, microphones and amplifiers, A.F. mixing systems, decibels, R.F. amplifiers, frequency conversion, tuned circuits and inductance calculations, I.F. amplifiers, detection, A.V.C., A.F.C., reflex amplifiers, rectification, receiver components, formulae, logarithms, measuring instruments and much other data.

Contrary to expectation, this Handbook, which contains a great deal more informative data for the professional radio engineer than any foreign Manual we have seen, is no expensive purchase, the price being 3/- (postage 4d.).

It is now available from McGill's Newsagency, Melbourne, and other bookstalls throughout the Commonwealth, or from Amalgamated Wireless Valve Company Pty. Ltd., at 47 York Street, Sydney.

42-Foot Aerial Pole.

The greater part of my spare time lately has been spent on my new 42ft. pole. I am using 22 feet of 4" x 3" of oregon and 22 feet of 2" x 3" of same wood, with two cross beams at top of 4" x 3". The base comprises two pieces of 5" x 2" hardwood sunk into the ironstone for 12," and a 4' square cement block built up around it to 6" above the level of the lawn. The eight main guy wires are of No. 12 steel wire, insulators being placed every 6ft. The four wires from top of the cross-beams and to base are of 14-gauge wire. They are plans for my new pole.—R. Sutherland (AW458DX), Balgowlah, N.S.W.



ANOTHER WORLDS RECORD!

**"QUEEN MARY"
USING BRIMAR VALVES
BREAKS ALL RECORDS
FOR MARINE RADIO
TRAFFIC!**

**INSIST ON BRIMAR VALVES
FOR YOUR "WORLD CRUISER"
COMMUNICATIONS EIGHT.**

The safety of the £6,000,000 liner "Queen Mary" and its thousands of passengers depends on the reliability and efficiency of BRIMAR valves. Brimar Valves are also specified for the "World Cruiser Communications Eight" described in this month's issue of "Radio World." Ensure peak performance and unequalled dependability by insisting on BRIMAR.

1940 COMPANIONETTE 3

The following Brimar valves are specified for the "1940 Companionette Three" described in this issue:—Brimar 6F7, combined r.f. pentode and triode detector; Brimar 6AG6G, high-gain output pentode, and Brimar 5Y3G, full-wave rectifier.

MIDGET AMPLIFIER

For the "Midget Amplifier" described this month, insist on Brimar Valves as specified. Types required comprise Brimar 57 first audio stage; Brimar type 58 second audio stage; Brimar type 2A5 output pentode; and Brimar type 80 rectifier.

THERE IS A COMPLETE RANGE OF BRIMAR VALVES TO SUIT EVERY RECEIVER DESIGNED IN AUSTRALIA, FROM THE EARLIEST TO THE LATEST MODELS.

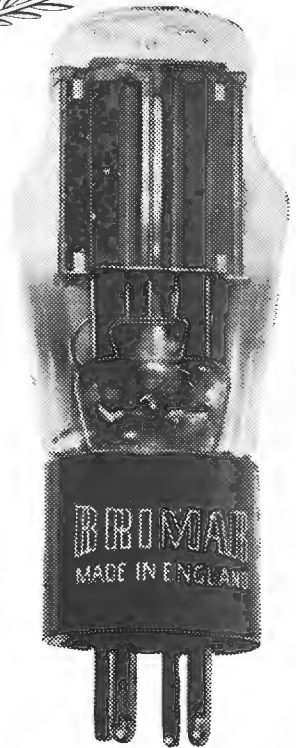

**BRIMAR
VALVES**

BRIMAR DISTRIBUTORS LISTED BELOW:

N.S.W.: Standard Telephones & Cables Pty. Ltd., 258-274 Botany Road, Alexandria. QUEENSLAND: Trackson Bros. Pty. Ltd., 157-9 Elizabeth Street, Brisbane. SOUTH AUSTRALIA: Radio Wholesalers Ltd., 31 Rundle Street, Adelaide. WESTERN AUSTRALIA: M. J. Bateman Ltd., 12 Milliga Street, Perth. VICTORIA: Noyes Bros. (Melb.) Ltd. 597-603 Lonsdale Street, Melbourne. TASMANIA: W. & G. Genders Pty. Ltd., 69 Liverpool Street, Hobart; 53 Cameron Street, Launceston; also at Burnie. NEW ZEALAND: Standard Telephones & Cables Pty. Ltd., P.O. Box 638, Wellington; P.O. Box 983, Christchurch.

EVERY BRIMAR VALVE IS 10 TIMES TESTED.

Ng 621.38703 AUS

NATIONAL LIBRARY OF AUSTRALIA
7 MAR 2012
D2000

DELTA APPLIANCE TESTER



COMPLETE TESTS FOR
IRONS, TOASTERS, FANS,
GRILLERS, VACUUM
CLEANERS, ETC.

Never before has the Electrical Trade received such consideration with respect to their testing needs—with the DELTA APPLIANCE TESTER the practical electrician can make tests of various kinds which require the rapid and accurate measurement of wattage, voltage and current. He can test Electric Irons, Toasters, Grillers, Vacuum Cleaners, Fans, Refrigeration and Washing Machine Motors, etc., for both efficiency and leakage to frame.

The Appliance Tester is very simple to operate and many applications will no doubt present themselves to the user whereby the sale of, or repairs to, appliances will quickly follow its installation.

IN ADDITION, THE APPLIANCE TESTER CAN BE USED AS—

- WATTMETER, Ranges—
0-25-100-250-1000-2500.
- AMMETER, Ranges—
0-0.1-0.5-1.25-5-12.5.
- VOLTMETER, Ranges—
0-125-250.

Self-contained Neon Leakage Indicator and Continuity Tester. Independent Neon Continuity Tester.

WEIGHT: 10 LBS.

PRICE: £10/10/-
(Complete with Accessories)

Measurements: 9" wide, 8" deep, 7" high.

Sole Australian Agents:—

W. G. WATSON & CO. PTY. LTD.
279 CLARENCE STREET, SYDNEY.
BRANCHES ALL STATES.