

**THE
AUSTRALASIAN**

Registered at the G.P.O.,
Sydney, for transmission
by post as a periodical.

1/-

VOL. 11 NO. 11

APRIL 15, 1947

Radio World



**Medical and Biological Ap-
plications of Electronics**



**Reflex Circuits which are
Stable and Efficient**



**New Series of Feature Art-
icles on Radio Technique**



**Short-Wave Reception Review
News of Latest "Ham" Doings**

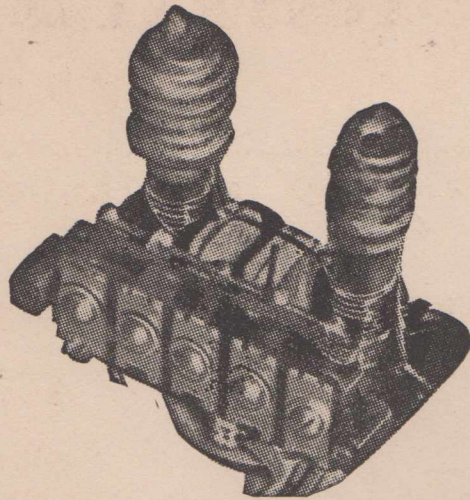

D.C. 2A. TUNING UNITS

B/C AND S/W (RANGE 13 TO 42 METRES)

This unit has a constructional convenience which is ideal for compact chassis layout. Compare it against any other make—you'll see what we mean. Overall dimensions, $3\frac{1}{4}$ ins. long, 3 ins. wide, $2\frac{1}{8}$ ins. deep. Fitted with coloured leads to aid assembly. Coils are impregnated to withstand humid conditions. Each unit is set tested before leaving the factory. Ample factory stock available. Contact your local dealer or write us direct. Retail price 36/-.

Crown 

RADIO PRODUCTS PTY. LTD.

51-53 MURRAY ST.
PYRMONT, SYDNEY. TELEPHONE: MW 2628

THE AUSTRALASIAN RADIO WORLD

Devoted entirely to Technical Radio

and incorporating
ALL-WAVE ALL-WORLD DX NEWS

★ EDITOR
★ PUBLISHER
★ PROPRIETOR—
A. G. HULL
Balcombe St., Mornington,
Vic.

★ SHORT-WAVE EDITOR—
L. J. KEAST
6 Fitzgerald Road, Ermington,
N.S.W. Phone: WL1101

★ HAM NOTES By—
D. B. KNOCK (VK2NO)
43 Yanko Av., Waverley, N.S.W.

★ ADVERTISING
REPRESENTATIVE FOR VIC.—
W. J. LEWIS
20 Queen St., Melbourne
Phone: MU 5154

★ ADVERTISING
REPRESENTATIVE FOR N.S.W.—
**AMALGAMATED PUBLICATIONS
PTY. LTD.**
83 Pitt St., Sydney
Phone: B 1077

★ SUBSCRIPTION RATES—
6 issues 5/3
12 issues 10/6
24 issues £1
Post free to any address in
the world.

Address for all correspondence:
AUSTRALASIAN RADIO WORLD
Balcombe St.
Mornington
Victoria

VOL. 11

APRIL, 1947

No. 11

CONTENTS

TECHNICAL—

Medical and Biological	7
Trends in Pic-up Developments	13
Easy Reflex Circuits	14
Visual Tuning Indicators	17
Printed Wiring Methods	29
A Relay from an old A.F. Transformer	31

SHORTWAVE REVIEW—

Notes From My Diary	38
---------------------------	----

THE SERVICE PAGES—

Answers	42
---------------	----

EDITORIAL

With the opening of experimental transmissions of frequency-modulated programmes in Melbourne there is now considerable interest being shown in this phase of radio development.

Some radio traders hold the view that F.M. is the answer to all their problems, and see in it the promise of renewed interest in set buying.

Personally I think that the Trade will be disappointed at the public reaction to the improved fidelity possible with F.M. unless it is served out to them from a loud-speaker, for example, which will cost more than a complete radio receiver at present. There seems to be no compromise with F.M. Either you make the most of it, or else it is not worthwhile.

It seems to me that, for several years to come, F.M. will be of greatest interest to the enthusiastic type of experimenter, the type of "Radio World" reader who at present goes to such pains to scrape the last atom of quality reproduction from a gramophone recording. He already has an audio amplifier and speaker capable of handling good reproduction. To fit on the F.M. tuner, discriminator, and so on, will not be such an expensive task.

With a few thousand of these enthusiasts demonstrating the possibilities of F.M. to their wide circle of acquaintances it is possible that the public will learn to appreciate the reason why they should make an outlay of a big sum to buy a genuine high-fidelity F.M. set.

It is possible to receive F.M. with a cheap set, disregarding the improved reproduction possible, but if the Radio Trade rushes sets of this kind on to the market they will surely regret the step in the long run.

—A. G. HULL.

THE BAROMETER OF WORLD OPINION

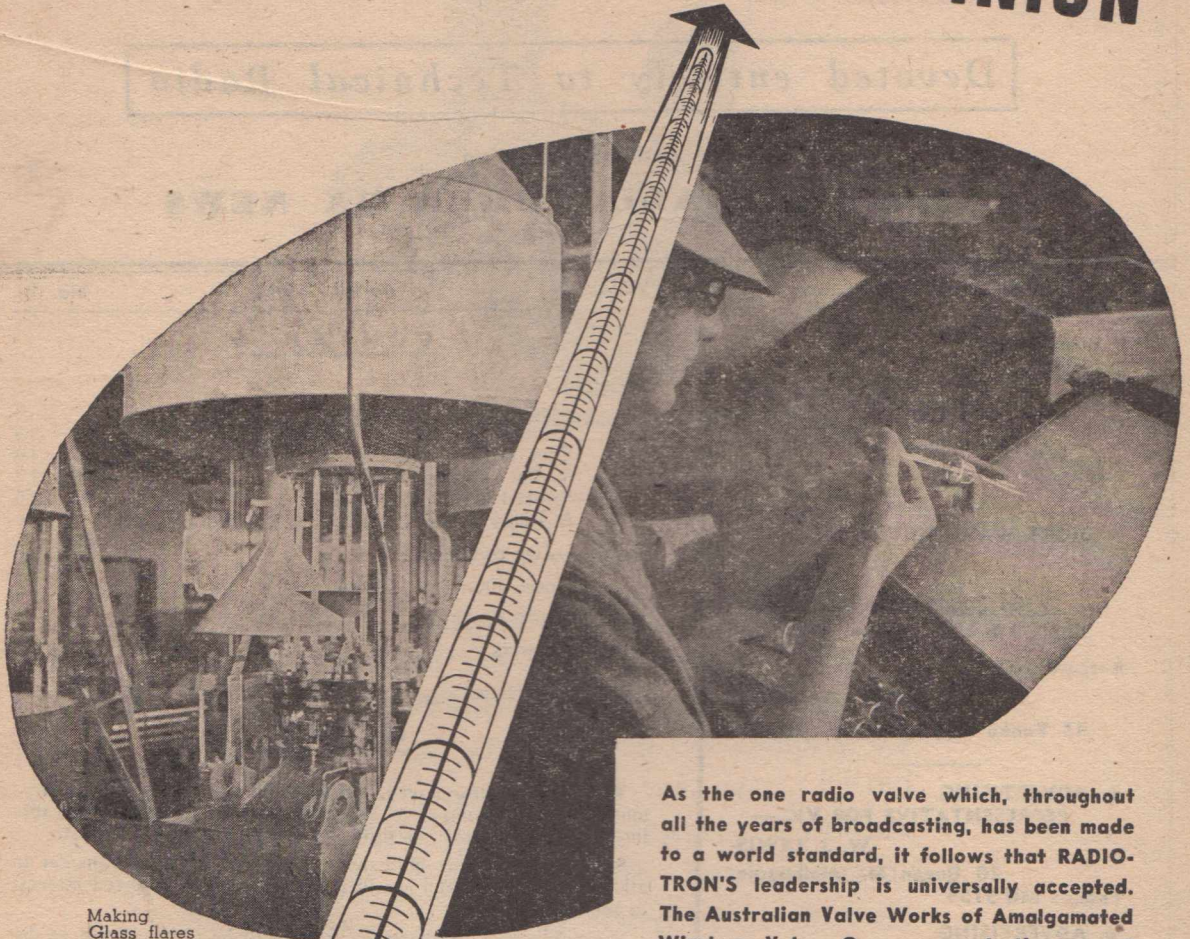

W&S
Making Glass flares for radio valves

. Examining flares over an illuminated screen.

As the one radio valve which, throughout all the years of broadcasting, has been made to a world standard, it follows that RADIO-TRON'S leadership is universally accepted. The Australian Valve Works of Amalgamated Wireless Valve Company met the urgent needs and uncompromising standards of defence throughout the war — the same organisation, to-day, is increasingly competent to provide the growing needs of peace.

W&S
AMALGAMATED WIRELESS VALVE COMPANY PTY. LTD.
S



Radiotron
VALVES
MADE IN AUSTRALIA

Administration 47 York Street, Sydney, N.S.W.
Manufacture Parramatta Road, Ashfield, N.S.W.
Distribution Crown Street, Glebe, N.S.W.

REVOLUTION IN RADIO ?

LISTENING WITHOUT PHONES OR SPEAKER

LISTENING to the radio without speaker or earphones! That is what I did the other day. It was the present-day shortage of speakers that made me start off on experiments to influence our acoustic nerves directly by electrical impulses, without first converting them into air vibrations by means of a speaker or earphones. I got quick results at first, but then the attack came to a standstill. I started

By

PAUL STEVENS

21 Fletcher's Avenue

Bondi, N.S.W.

off by switching on my oscillator and, with modulation on, ran the two leads with the alligator clips all over my head whilst tuning to frequencies from 30 Mc to 170 Kc; but there was no audible effect from modulated r.f.

Then I switched the leads over to the audio socket with the usual 400-cycle note. Holding one lead, the shielded one, in my hands, I moved the other one round my ear with the alligator clip, lightly touching the skin. Here I met instant success. On the areas indicated by arrows in the illustration, I could "hear" the audio note very distinctly, but only as long as I kept the electrode moving slowly along the skin in an up-and-down or circular movement. As soon as I stopped on one spot the sound instantly disappeared. Then I got hold of a radio set, tuned it to a good local station at medium volume, connected a lead with a .0001 mfd. condenser in series to the plate of the output valve and open-circuited the voice coil to mute the speaker. Even without touching the chassis with one hand, I could listen to the station by moving the bent-over pigtail of the condenser around my ear, or even on the long

part of my nose! Touching the chassis with one hand only increased the ever-present slightly-burning sensation on the skin, without affecting the volume. On the other hand, putting a 1 megohm resistor in series with the lead did not have any influence on volume either. The quality of the "reproduction" was rather distorted, but loud. I repeated the experiment on greasy and moist skin, but could not get any results at all.

That is as far as I got, and these are my deductions: (1) No power, only voltage is required, which disposes of our present type of output valves; (2). The electrode has to be in constant, however slow, movement along the skin. I do not know the reason for this, but I think it may be because the electrically-influenced nerve ends or other cells cannot recuperate sufficiently fast from the electric shocks to be ready for the next one within a cycle. Therefore, new clusters of cells have to be used all the time, which is achieved by keeping the electrode moving. I do not know what these little experiments are going to lead to. They may be dead-enders. On the other hand, if taken up by people with biological, as well as radio knowledge, they may result in earphoneless, or even speaker-

less radios of the highest fidelity. It is quite conceivable that our acoustic nerve is tuned to an ultra high radio frequency, a centimeter or millimeter wave, which, modulated, may create the impression of hearing. A little transmitter would then take the place of output valve and speaker in radios and amplifiers.

These, of course, are all dreams. But much closer to the present state of affairs may be a very effective deaf-aid, if the moving-round problem of the electrode can be solved, and if it can be proved that people, even when hard of hearing, can still respond to electrical stimulation of their acoustic system.

I have written this little article to enlist the ingenuity of all interested people in the creation of what may become the dawn of a great revolution in radio. A thousand brains will produce more ideas than a single one; a thousand radio men can start small experiments in all possible directions. And then, if the new principle proves to be practical it will be just a matter of time before some satisfactory result is achieved.

(Deaf aids based on the system of bone conduction of sound have been used for some time past.—Editor.)

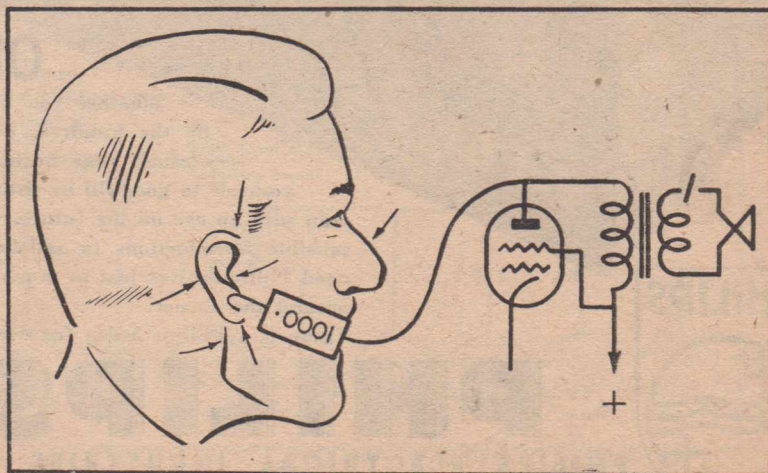

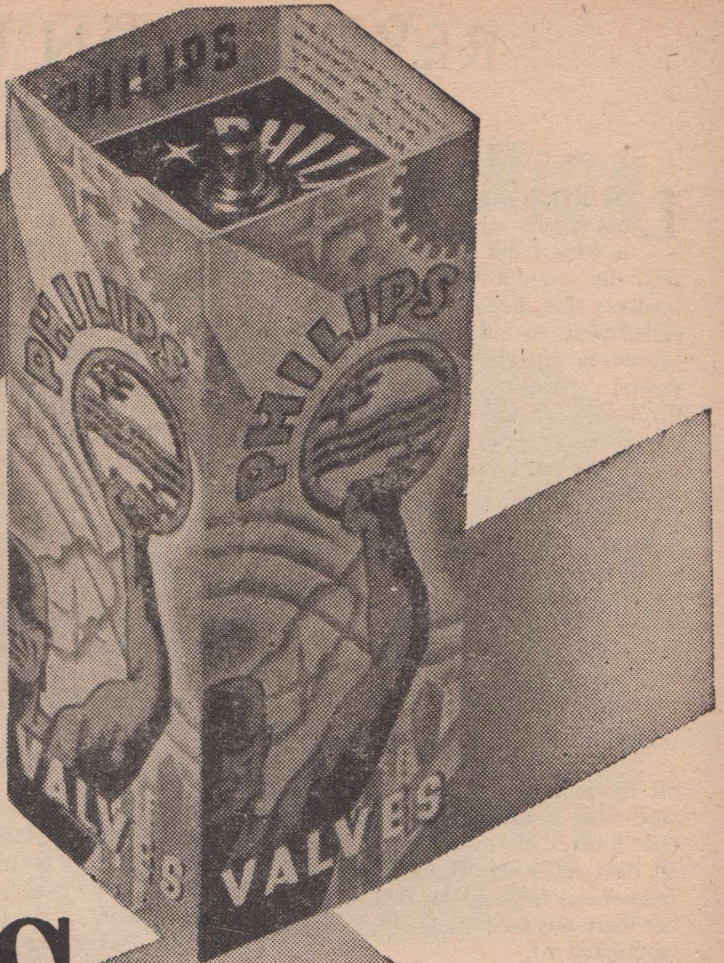
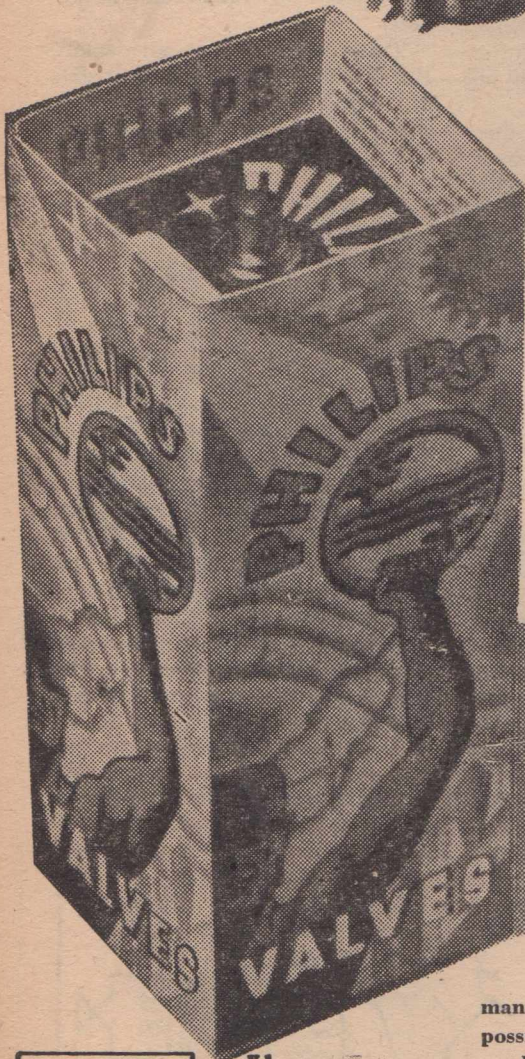

Sentinels OF BETTER RADIO

Whether you build radios by the thousand, service them by the hundred, or make sets as a hobby, Better Radio is very much your business. As a manufacturer, you are helping yourself to goodwill by fitting Philips valves in your sets. As a service man with an eye on the future, you find that Philips valves are your finest possible introductions to satisfied customers. If you are a "ham," you need Philips valves just as much as the factory executive or the dealer just around the corner.

There is a Philips Valve for every socket of any receiver.

PHILIPS VALVES

PHILIPS ELECTRICAL INDUSTRIES OF AUSTRALIA PTY. LTD.
SYDNEY — MELBOURNE — ADELAIDE — PERTH — BRISBANE



MEDICAL AND BIOLOGICAL

APPLICATIONS OF ELECTRONICS

ONCE in a lecture to some students I remarked that all applications of electronics consisted of rectifiers, amplifiers, breakdowns and transducers. Of course I was immediately taken to task with regard to oscillators, photo-electric cells, X-ray tubes and television, but being always ready

By

**JOHN W. STRAEDE, B.Sc.,
A.M.I.R.E. (Aust.)**

Lecturer in Electronics at
Melbourne Technical College

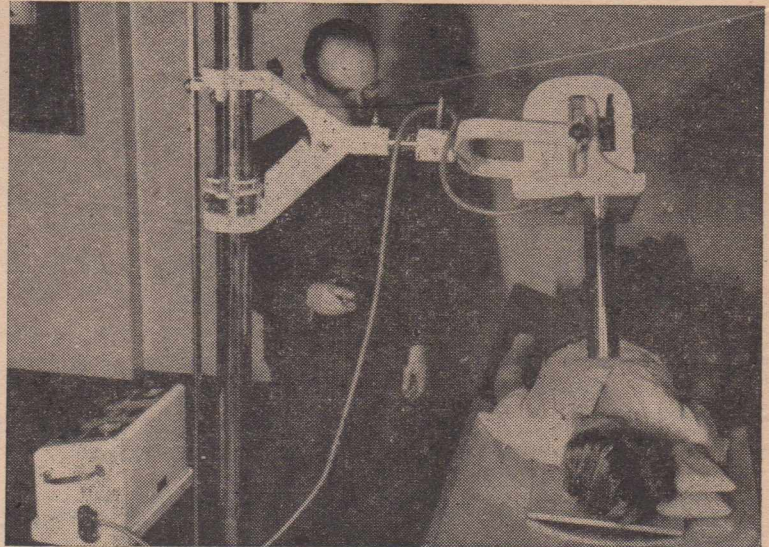

The modern doctor makes use of the latest in electronics.

to declare myself in the right, pointed out that an oscillator is just an amplifier in which the output is connected to the input, while P.E. cells, X-ray tubes and cathode ray tubes are examples of transducers that convert electrical energy or electronic energy to electro-magnetic waves and vice versa. Devices such as square wave gen-

erators are either rectifiers or amplifiers that are not lacking in distortion. Gas-tube oscillators are examples of temporary insulation breakdown that occurs only above a certain critical voltage.

Let us see if medical electronics can be classified in this way. The family tree diagram in Figure 1 shows the four fundamental principles mentioned above. Most ap-
(Continued on next page)

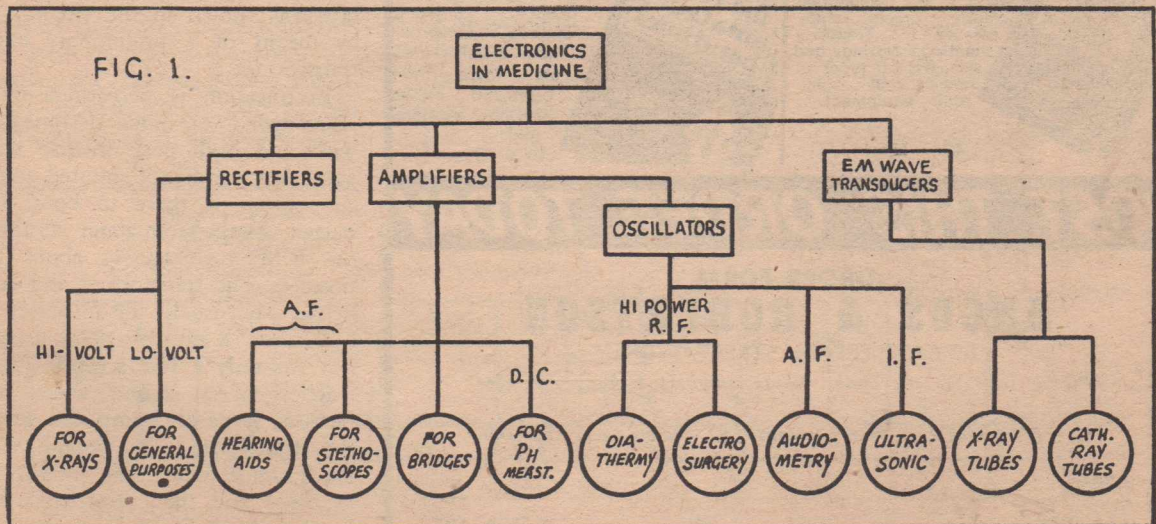

USEFUL RADIO BOOKS

FROM ANGUS & ROBERTSON LTD.

1. Completely Revised Edition "RADIO HANDBOOK"

Thousands of radio amateurs have been waiting for this new edition of the original "Jones' Radio Handbook"—and they will not be disappointed. Latest information on dozens of wartime developments, F.M., U.H.F., Tube design, etc. 704 pages, hundreds of diagrams.



17/6 (Post 1/-)

2. Complete Radio Manual— "RADIO FOR THE MILLIONS"

Pop. Science Monthly Publ. Instructions for building 87 receivers, recorders, radio phonographs, etc.; from one tube to 8 tube sets; from vest pocket to floor models. Trouble-shooting, servicing, testing equipment. 100 wiring diagrams. 450 illustrations.



10/6 (post. 6d.)

3. HOW TO BUILD AND REPAIR RADIO RECEIVERS

"EVERYBODY'S RADIO MANUAL," a "Pop. Science Monthly" publ. Crystal-clear, non-technical instruction on building or repairing any kind of set. Hints, short-cuts, a wealth of diagrams that are easy to follow. 256 pages.



7/6 (post. 6d.)

4. Ninth Edition of F. J. Camm's "THE PRACTICAL WIRELESS ENCYCLOPEDIA"

An alphabetically compiled guide for the construction, operation, repair and principles of wireless receivers. Over 220,000 copies sold. Definitions, explanations, formulas, etc., rapidly consulted.

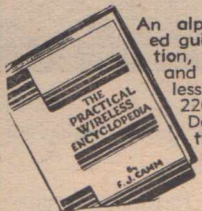

12/6 (Post 6d.)

5. Get This Complete RADIO SERVICING COURSE TODAY!

"Modern Radio Servicing"—By A. A. Ghirdardi; one of the foremost servicing experts in the U.S.A. 1300 pages. 706 illustrations. Everything is explained clearly, simply, step-by-step. Trouble-shooting, testing and servicing all types of home and auto-radio equipment.



40/- (Post 1/3)

6. Most Popular Book on AMATEUR RADIO

"The Radio Amateur's Handbook", 1946 edition, is the standard manual of radio communication. Electrical and radio fundamentals, radio frequency, antenna systems, construction, V.H.F. etc., etc. More than 1,398,250 copies previous editions sold.

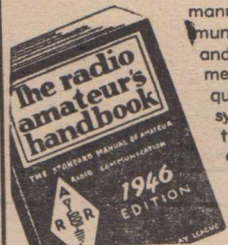

10/6 (Post 1/-)

POST THIS ORDER TODAY

ORDER FORM ANGUS & ROBERTSON

89 CASTLEREAGH STREET, SYDNEY

Please send me the books whose numbers I have encircled

1 2 3 4 5 6

(A) for which I enclose payment, (B) charge to my account.

NAME

ADDRESS (R.W.4/47)

MEDICAL

(Continued)

plications involve more than one principle.

RECTIFIERS

Valve rectifiers are used, of course, to convert A.C. to D.C. in the power packs of most electric devices, and the majority of the examples in medicine are not startlingly different from the usual

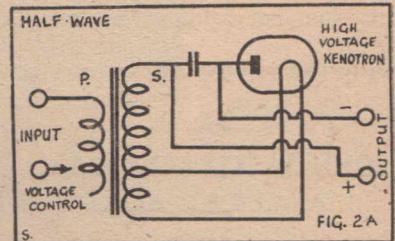

Half-wave rectifier for X-rays.

"B-battery eliminator," or the power pack in an ordinary radio.

However, for X-ray work, the requirements are very different. Extremely high and variable voltages are needed, current drains are intermittent instead of continuous, filtering of the output is usually not required. Most commonly used is the half-wave circuit shown in Figure 2A. The transformer steps the voltage up to some value between 25,000 and 100,000 volts, the step-up ratio being variable by means of a number of primary taps (as shown in the circuit) or by means of a preliminary auto-transformer.

Rectification is performed by a "Kenotron," or diode designed to withstand high peak inverse voltages. Any condenser shunted across the output is there to boost the output voltage from about .45 times the R.M.S. voltage to about 1.4 times it. The transformer and condenser are usually oil-filled.

Because X-ray tubes are usually run for only a few seconds (or a fraction of a second when currents as large as ½-amp. are used) the transformer is wound with much finer wire than might be expected and the entire apparatus is "overloaded" during the exposure time.

Radiokes

**THE NAME
TO KNOW
IN RADIO!**

Radiokes

RADIOKES D.W. UNITS. Highly selective with exceptional wide range. To match 'H' type gang condenser. Incorporates 4-in-1 paddler. Solidly mounted with coils. Ask for type DWQ-1

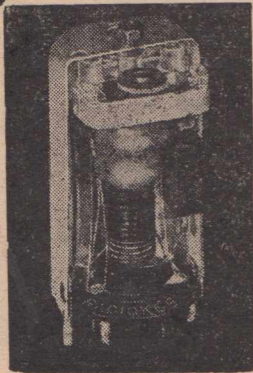

When buying radio parts and components, follow the lead of amateurs and experts alike — specify Radiokes — your guarantee of test-set performance, precision construction and technical excellence.

RADIOKES

PTY. LTD.

P.O. BOX 90

BROADWAY — SYDNEY

R-56

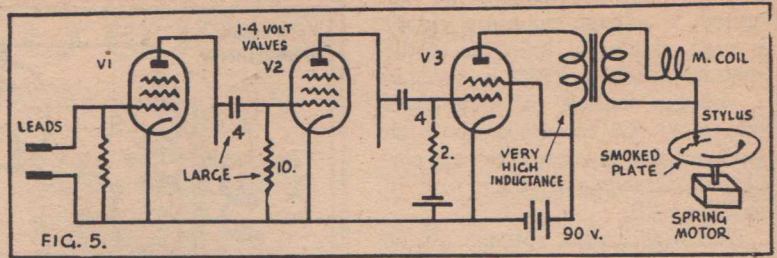

Block diagram of moving-coil electrocardiograph.

the output tube being similar to a 1Q5GT. A block diagram is given in Figure 5.

Electronic stethoscopes are used for diagnosis in noisy locations and for teaching purposes. Special types of contact crystal microphones are employed, the associated amplifier being similar to a small high-gain P.A. amplifier. The higher frequency response is quite important, as the medical practitioner must be able to distinguish between a "lub-dub" and a "lub-duff", so that the valve leakage (i.e. heart-valve leakage) may be detected. The relative loudness of sounds can be demonstrated far more accurately by visual methods on the cathode-ray oscilloscope than by using the ear alone.

Most lie-detectors (and similar equipment used in psychiatry) require simple 2 or 3-stage amplifiers so that delicate sensitive galvanometers may be avoided.

The simplest type of lie detector is a Wheatstone bridge circuit, the patient forming one of the arms. For small changes in patient resistance, the minute voltage developed across the detector is pro-

portional to the resistance change. This minute voltage is amplified by a direct-coupled battery-operated amplifier which can be coupled to a reflex vacuum-tube voltmeter.

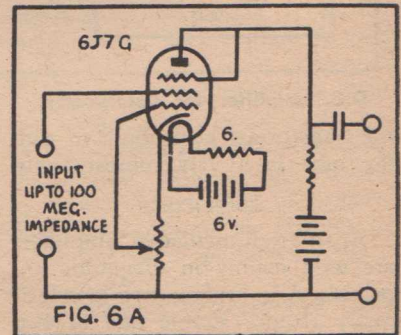
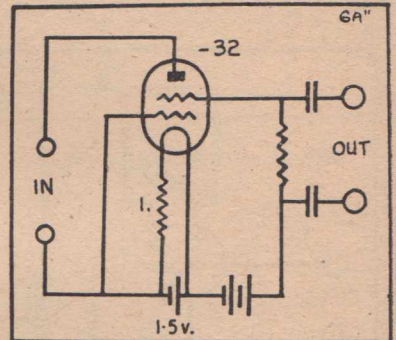

Two high-impedance input circuits.

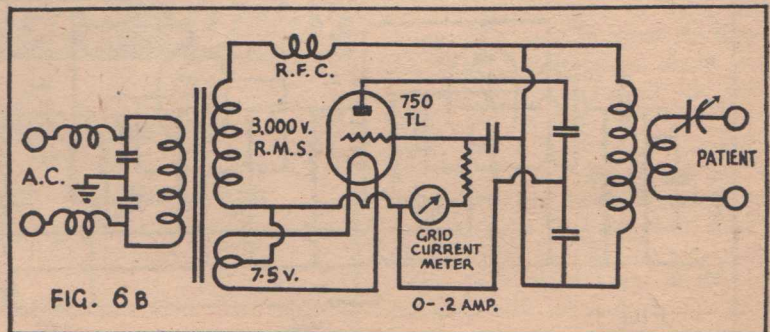

Circuit for Diathermy Apparatus.

Other applications of amplifiers are in the measurement of the "pH", or acidity of a liquid. Here the amplifier must have an extremely high input impedance and the tube may be an inverted triode (using the anode as control electrode) or a tetrode with the second grid as input electrode. Types "32" and "954" tubes are very suitable, the suppressor being the input grid in the latter case. Input impedance is also increased by running the tube with reduced filament current and reduced anode voltage. Some high-impedance input systems are shown in Figure 6A.

OSCILLATORS

An oscillator is really an amplifier with sufficient positive feedback to raise its gain beyond infinity. The most familiar use of oscillators is in diathermy, whose valve oscillators generate high-frequency currents, these latter producing heat in the body of the patient. The conversion of electrical energy to heat can be performed by direct connection, by using the body as an imperfect dielectric between two plates, or by the induction of eddy currents. (The last system is used mainly for the body as a whole and is termed "inductothermy.") Diathermy is classified according to the wave-length of the energy supplied to the patient, some experimenters claiming that the wavelength has a selective action.

Oscillators for diathermy are not dissimilar for those used with the "electric knife," an electrode which burns away tissue in a kind of bloodless surgery. The lack of

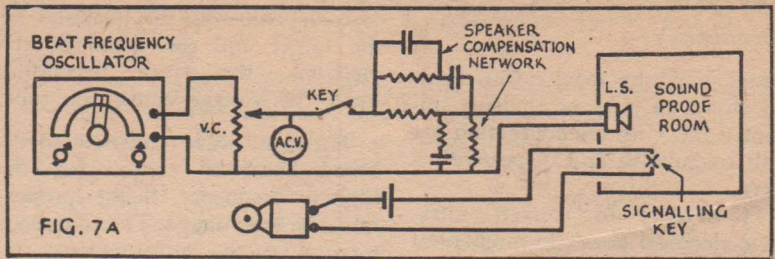

Layout for Audiometry.

blood, due to the coagulation of all but the larger arteries and veins.

General heating of the body is used as an artificial fever to fight germ diseases—the high body temperature being known as electropyrexia.

The circuit of a push-pull diathermy oscillator is shown in Figure 6B.

Oscillators are also used in the testing of hearing. Today deaf-aids are provided with frequency compensation adjusted to suit the losses in the ear. The lay-out for audiometry is given in Figure 7A and the procedure is as follows: The patient sits in an acoustically treated room at a fixed distance from a loudspeaker fitted with a filter so that its response is quite "flat" and free from frequency distortion. This speaker is fed from a beat frequency oscillator, the output of which is adjusted until it can no longer be heard by the patient. Then the level is raised again until the patient hears the sound. Several runs are made at each of about ten frequencies. A "limit of audibility" graph is

drawn, the excess of height of the graph over the standard giving the degree of compensation necessary.

Some years ago it was suggested

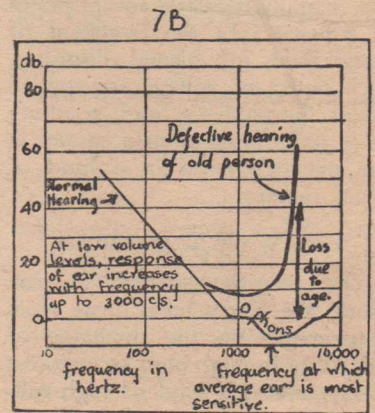

Curves showing hearing response.

that a suitable oscillator could be connected to a loudspeaker, the resultant hypnotising drone being used to put a patient to sleep. Such a device was called a Hypnotone, a circuit of one being shown in Figure 8.

So far as we have discussed high-power high-frequency oscillators for the production of heat and comparatively low power audio-frequency oscillators. What of the range in between?

"Ultrasonic" oscillators are not as yet used in medicine, though it has been suggested that the vibration produced by coupling such an oscillator to a "loudspeaker" might be used to destroy cancer

(Continued on next page)

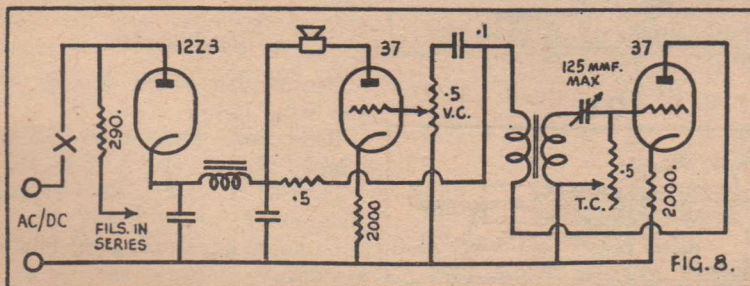

Circuit for Hypnotone Oscillator.

MEDICAL

(Continued)

tissues, break up renal calculi (kidney stones to you) or emulsify unwanted fat. Ultrasonic vibration has both coagulative and dispersive actions.

Transducers to convert ultrasonic electrical power to mechanical vibration are of three main kinds: Moving coil "speakers" similar to the drive units of P.A. speakers, quartz crystal generators and magnetostriction oscillators. In the last, a rod or tube of nickel changes its length in time with an alternating current flowing around it.

An oscillator has been suggested as a nerve stimulator, the idea being to apply regularly abrupt pulses of voltage. In the treatment of some kinds of mental disorders, such pulses of voltage are applied across the patient's head, resulting in a reshuffling of associations in the patient's mind in a kind of shock therapy.

E.M. WAVE TRANSDUCERS

One of the earliest electron tubes, the X-ray tube, arose from experiments on the discharge of electricity through high vacuum. An X-ray tube is a kind of high-voltage cathode ray tube (a power tube!) in which the electrons strike a target and generate pulses of very high frequency electromagnetic

waves. The wavelength of the X-rays depends on the material of the target and the speed of the electrons, the latter depending upon the voltage across the tube.

The e.m. wave emission covers broad band of frequencies, the highest frequency being proportional to the voltage. The frequency response is not uniform, there being several peaks corresponding to the structures of the atoms in the target.

Old-fashioned X-ray tubes were of the cold-cathode type, the tube current depending on (besides the voltage) the amount of gas in the tube. Modern tubes are very highly evacuated and have hot cathodes, the cathode temperature controlled by the heater current, determining the tube current. In Figure 9 there is a series of diagrams showing the change in design of the tube. Today voltages of between 25 and 250 kilovolts and currents up to one ampere are used. The higher voltages are used mainly for treatment, the lower voltages for diagnosis. Transparency of skin and flesh increase with voltage. The larger currents are used when short exposures are necessary, e.g. with wriggling children.

Somewhat similar to the X-ray tube is the ordinary cathode-ray tube familiar to every serviceman

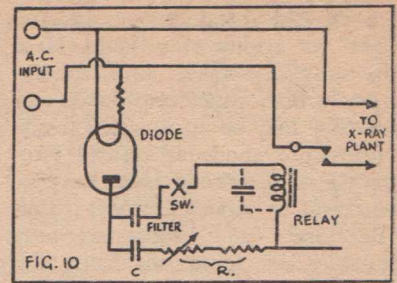

Simplest type of electronic timer.

and used in medicine as part of the cathode-ray electrocardiograph and encephalograph.

MISCELLANEOUS APPLICATIONS

Control devices, part of other medical equipment provide interesting applications of ordinary radio principles. The discharge of a condenser through a resistance is the basis of an electronic X-ray timer. As soon as the voltage across the condenser reaches a certain value an amplifier valve opens or closes a relay. The circuits used are similar to those of photo-timers, one being shown in Figure 10.

Control of diathermy apparatus is achieved by means of a series of thermocouples, an amplifier and a relay. It is very essential that the patient be not overheated to a multiple thermocouple, somewhat similar to a neurocalometer, is placed where heat generation is likely to be greatest. The other end of the thermocouple is placed in a region where the temperature will remain normal. As soon as the temperature difference reaches, say, one degree, the voltage generated is amplified by a valve and causes a relay to shut off the diathermy unit.

BIBLIOGRAPHY

- Australasian Radio World, Jun and Sept., 1943.
- Radiocraft, June 1943 (X-ray tubes).
- Electronics, Feb. 1946 (Nerve Stimulator).
- Radio News, April, 1932 (Radio Fever).
- Radiocraft, Jan., 1946, (Short-wave Diathermy).

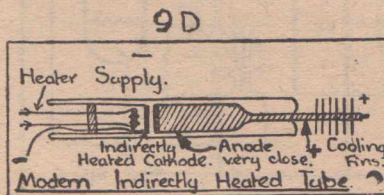
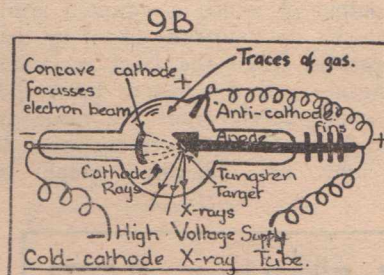
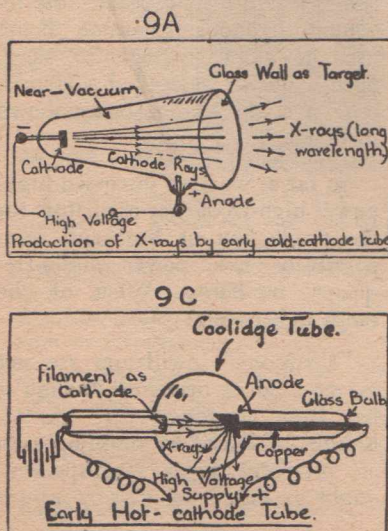

Steps in the development of the modern X-ray tube.

EASY REFLEX CIRCUITS

SIMPLE RULES FOR STABILITY AND PERFORMANCE

There seems to be a generally accepted dogma amongst radio designers, especially those publishing circuits for the benefit of home builders, that a reflex circuit is something awe-inspiring and taboo. In radio magazines we soon find descriptions of the most complicated receivers with noise silencers, volume expansion and tone compensation, than the simple 4 valve reflexer, which

By
PAUL STEVENS
21 Fletchers Avenue
Bondi, N.S.W.

is regarded as something the home builder simply cannot be trusted with, something not to be talked about, like sex matters in a mid-Victorian girls' school.

The description of the "Teleconda" 1 and 2 is intended to dispel these prejudices and show reflex circuits, which are nearly as simple as straight out 4 valvers. They are easy to tame and give

average 5 valve performance without a trace of instability, if a few very simple rules of chassis wiring are observed.

The "Teleconda" 1 is designed to take the place of the straight 4 valver, wherever distance from the local transmitters, or bad position, warrant higher sensitivity. Interstate reception is just as easy with it as with a five valve set, but the lack of AVC does not make it the ideal thing for DX-ing. However, the circuit shown in Figure 1 is simple and foolproof and uses only 3 resistors and condensers more than a simple straight 4 valve circuit. Its main advantage is that it avoids all the main faults attributed to reflex circuits: 1). Minimum volume effect is entirely eliminated by the use of bias volume control (2) Distortion and overload of reflex valve: Negligible. Due to the bias method of volume controlling, the amplitudes of both IF and audio frequencies on the grid of the reflex valve are kept very low, for normal listening only a fraction of a volt, so the curvature

of the valve characteristic has no noticeable ill effects on the quality of reproduction.

The most discriminating feature of both "Teleconda" circuits is the screen grid arrangement of the reflex valves. Contrary to other designs, the audio voltage is taken from the screen instead of the plate. Thus the valve works under full voltage conditions and not, as usual, with greatly reduced plate voltage, which causes a lot of distortion due to overload. The screen dropping resistor acts as audio plate load and its bypass condenser of .002 MF is sufficiently high for IF, but does not cut the treble to any noticeable extent. We thus find ourselves with a receiver containing a full powered IF amplifier and a triode audio driver with an amplification of between 20 and 25. The gain of this arrangement is equal to a five valve set with the valves 6J8G, 6U7G, 6B6G, 6FF6G. By replacing the 6V6GT with an EL3 the gain could be doubled, but the EL3 unfortunately is too tall for many small sets. By using

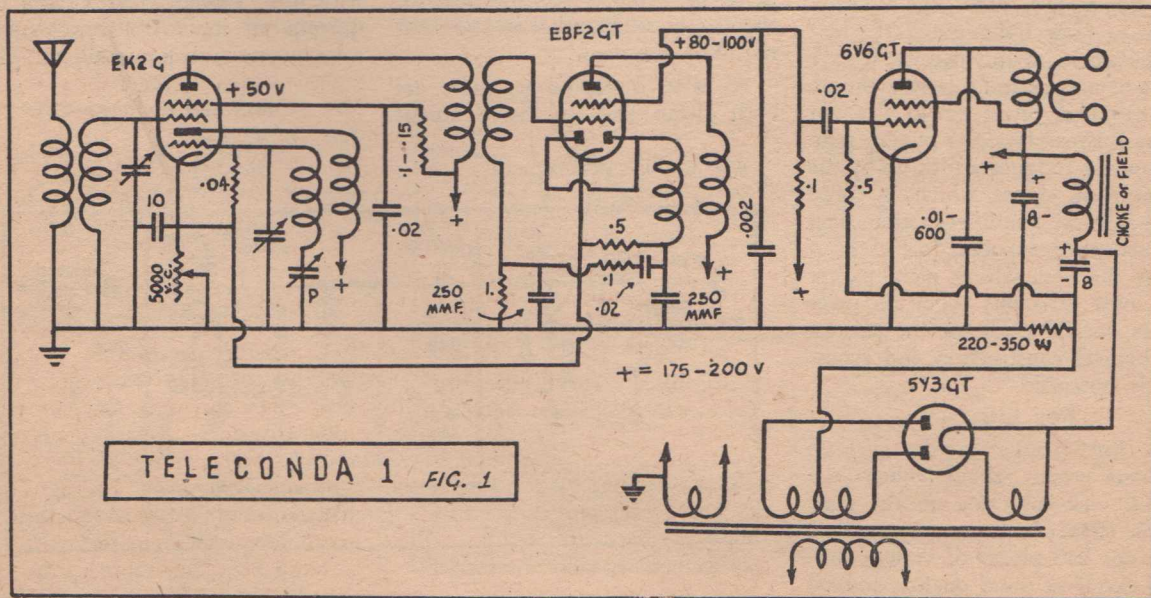

REFLEX

(Continued)

have to please the eye, but the circuit is strictly utility. If you are the type that mounts all resistors and condensers on a bakelite strip and runs long, parallel or even bundled leads to and from them, you can just as well give up the idea of getting any straight out high gain circuit, not to speak of a reflex, to work properly. These "neat and tidy" atrocities have their only tolerable place of abode in big chasses, where the components are so far apart, that not even the longest possible leads can provide enough stray capacities to do any harm. For mantle sets the rule is: Straight point to point wiring, on the shortest possible way, the more criss-cross and the less parallel the better. The only exception is absolutely "cold" leads, such as the heater and, under certain circumstances, B plus, earth wiring etc. Many famous radio manufacturers, who just could not part with the idea of the bakelite strip-cum-"Neat and tidy" leads had to increase their biases, reduce IF transformer efficiency, etc., to get their problem child stable. It often gave me diabolic satisfaction to tentatively decrease converter and IF valve bias from about 5 volts down to three

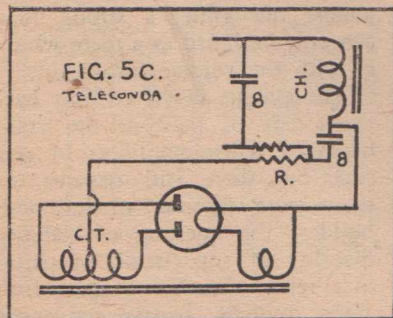

volts in these sets and listen to the beautiful oscillation whistles between stations.

Straight point to point wiring does not mean, that the set has to

be full of "floating" connection. There is always a possibility of finding an anchoring point in an unused valve socket contact or if necessary an insulated supporting lug will have to be fitted to the chassis in the desired position. The only floating connection in the Telecondal circuit, which, for the sake of short leads better stay that way, is the connection between coupling condenser and filter resistor between the diode return and the grid winding of the first IF transformer. The resistors and condensers connected to this last men-

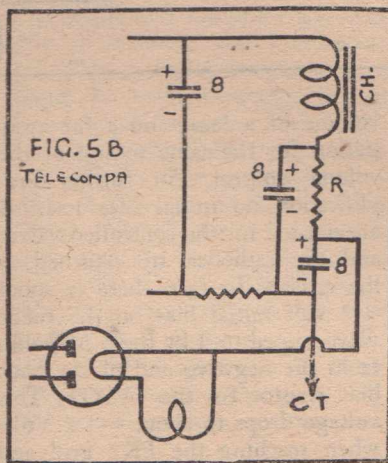

tioned point should have their "hot" pigtails cut as short as possible, which is the main wiring rule for all reflex sets.

The values of resistors and condensers given in the circuit diagrams are merely approximate; for when testing a, let us say, 100,000 ohm colour coded resistor you bought these days, you are just as likely to find it to be a 70,000 than a 150,000 ohm one. So I included the critical voltages in the diagrams, which have priority over associated Resistance values given. The power transformer is a 2×250 Volt sec., 40-50 mA type, but when using a permag speaker the second-

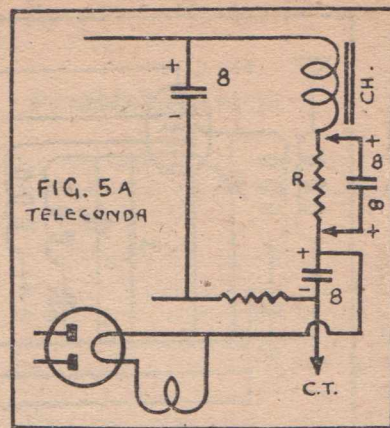

ary should be only 2×225 or 2×200 Volts. B voltage should be between 175 and 200 Volt, to chassis. A dynamic speaker should have a field of 1,500-2,000 ohms, the excitation must be at least 2 Watts. A choke of not less than 10 Hy must be used in connection with a permag speaker, to avoid excessive hum, if the latter is properly baffled. One very important word about putting resistors in series with a choke to break down excessive transformer voltage: A series resistor will not improve the filtering, on the contrary, the hum will increase. Try and bridge out the series resistor (fig 5a) with an 8MF electrolytic and notice, how the hum will decrease. Naturally it will be still better if you connect the extra electrolytic to minus, as shown in Figure 5B. Inductances and resistors can be used separately in filters, but together they won't mix. It is very sad, that these facts do not seem to be known to many designers of test speakers, the dummy fields of which are more often than not just various resistors in series with a choke. If you want to avoid using an extra electrolytic, a dropping resistor can be connected as shown in Figure 5C, where its detrimental effect on the filtering will be greatly minimised.

VISUAL TUNING INDICATOR

PART 1

THE modern radio receiver incorporating automatic volume control (A.V.C.) has a relatively broad tuning effect, due to the action of the A.V.C. circuit tending to maintain a constant output even when the receiver is slightly off resonance. Conse-

By

C. E. BIRCHMEIER

quently, to obviate the resultant distortion from inaccurate aural tuning only, various forms of tuning indicators were evolved over a period of time, all being designed to give positive indication when the state of exact resonance was reached.

Of the indicators developed, one of the most popular and widely used was the cathode ray tuning indicator, probably more commonly and appropriately referred to in the layman's language as the "magic eye" tuning indicator. This type of indicator has been installed in all types of radio receivers, even those not employing A.V.C. and/or diode detection, and by its use the accurate tuning in of a transmitter is greatly simplified.

The operation of this type of valve really seems like "magic" to many, and so in an endeavour to clear up any pertinent points, the theory and application of the shaded sector type of visual tuning indicator will be presented in this, the first of two articles on the subject.

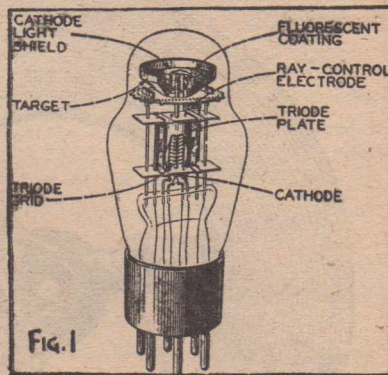

Cutaway drawing of a typical tuning indicator of the angular shadow type.

At the present time there are several types of visual tuning indicator valves in general use, and for most purposes these can be conveniently classified into three main groups:

(1) The type having what is termed as an "angular", or "shaded sector" pattern, and which can be varied from 0 to approximately 90 degrees. Representatives of this type are the 6E5, 6G5, 6N5 and the 6U5. Closely allied to this group as regards method of operation is the EM1—its main difference being the utilisation of four shaded sectors instead of only one, thus giving rise to a clover leaf

PATTERNS ON THE SCREEN

(2) The annular ring type, wherein a doughnut shaped pattern varies in diameter in accordance with the actuating voltages, and the only valve of this particular type is the 6T5. Other than having a different form of indication, its applications are similar to the types mentioned in the preceding paragraph.

(3) The dual indicator type frequently and incorrectly referred to

(Continued on next page)

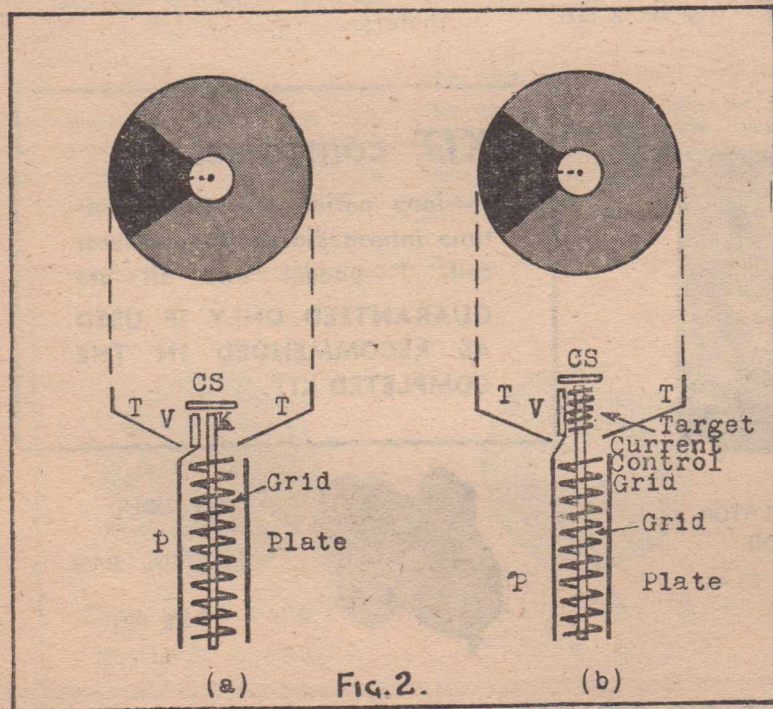

These two diagrams show the general internal arrangement of the various electrodes for the 6E5 and 6G5 respectively. Main difference lies in the use of (a) the target current control grid as in (b) to maintain target current within safe limits.

LOOP Aerial Portable COIL Kit...

42/-

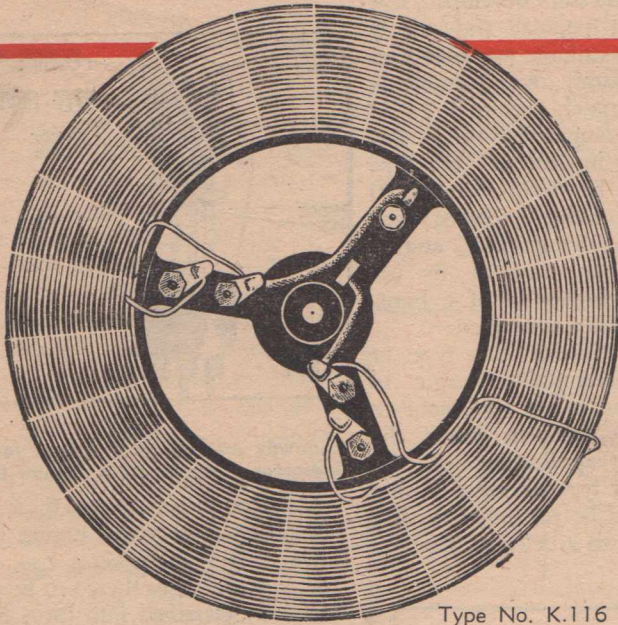

Type No. K.116

● This Special R.C.S. "LOOP AERIAL KIT" has been carefully engineered to give high performance with excellent stability, each component being designed to work efficiently in the complete kit, ensuring the elimination of alignment and tracking problems. This kit is prematched and tracked as a unit at the factory, on precision "Q" meters.



PERMATUNE
INTERMEDIATES

I.F. 162—
PERMEABILITY
tuned
I.F. 163—460 K.C.

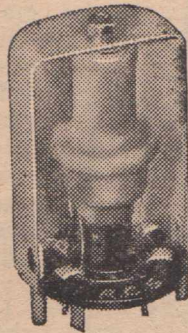

OSCILLATOR
COIL

TYPE E3.44

KIT comprises—

1—loop aerial coil, 2—perma-
tune intermediates, 1—oscillator
coil, 1—padder and all are
**GUARANTEED ONLY IF USED
AS RECOMMENDED IN THE
COMPLETED KIT.**

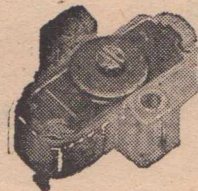

PADDER
TROLITUL BASE
TYPE P21.

● ORDER FROM YOUR USUAL RADIO RETAILER. NO DIRECT ORDERS ACCEPTED

R. C. S. RADIO PTY. LTD.

174 CANTERBURY ROAD, CANTERBURY

CS.57

MAGIC EYES

(Continued)

as the "twin" indicator. This has two separate shaded angular patterns, which may vary together, or independently, depending on the particular application of the valve. The main representatives of this class are the 6AD6G and the 6AF6G.

Since the angular pattern type mentioned in paragraph (1) was the first tuning indicator to be introduced for general use, this first article will deal mainly with the operation and application of these types only. The annular ring and dual indicators will then be fully discussed in the succeeding article.

ANGULAR PATTERN TYPE

The first valve of this type to be developed was the 6E5, and in Figure 1, the disposition of the various internal components of such a valve is clearly shown. The glass envelope is similar in size to that used for small triodes, such as the 37, 56, 76, etc., and is fitted with a small 6 pin base. The heater is 6.3 volts at 0.3 ampere and the cathode of the indirectly heated unipotential type.

The valve proper consists of two main parts, one consisting of a triode section acting as an amplifier, and controlling the action of the second upper section, which is, in

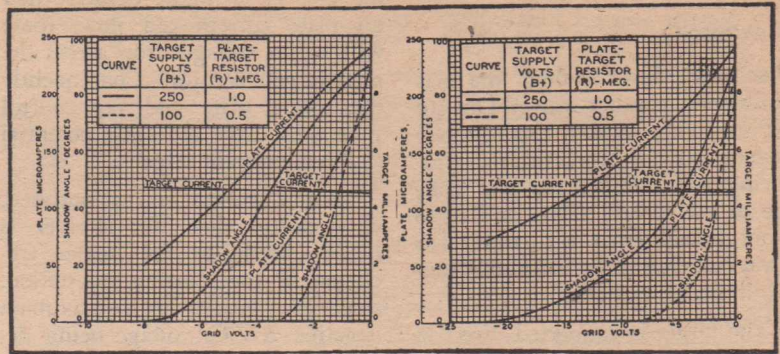

This is how the indicator appears during the tuning-in process. At the left we have a condition of no signal resulting in maximum shadow angle and on the right, for a correctly tuned-in station giving minimum shadow angle.

effect, a special cathode ray tube. The cathode (k) extends upwards, being common to both sections, and

this is fitted with a cathode shield (CS) positioned to prevent any direct light from the hot cathode being visible and interfering with the fluorescent target. (Figure 2.)

The target itself is a shallow cup shaped electrode placed in the dome of the bulb, and surrounding one end of the cathode. Being coated with a special substance, this target under the impact of electron bombardment glows a brilliant green. Between the cathode and the target is a small metal vane—the ray control electrode (V) and this is connected internally to the triode plate (P).

This vane controls the shadow angle opening by blocking the passage of electrons near it, thereby causing a blank area on the target in the shape of a wedge shaped sector.

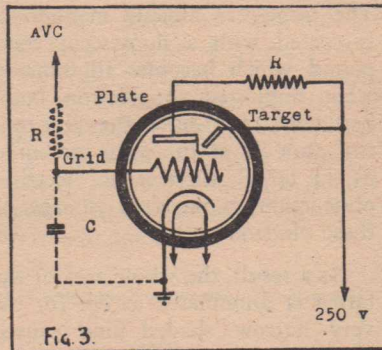

The usual set connections for the tuning indicator are quite simple. The resistor (R) and condenser (C) constitute an a-f filter, and as explained in text are only required in certain circumstances.

GENERAL CONNECTIONS

So much then, for the internal construction of the valve, and now in Figure 3 the usual receiver circuit connections are shown. The grid is wired directly to the A.V.C. line so as to obtain the controlling voltage for the triode section, and although this connection may vary depending on circumstances, it need not cause any concern for the moment.

The cathode is normally earthed, and except for certain special circuits, this connection is preferable, even when the diode load resistor is not grounded. In some receivers it may be found that the cathode current of the visual indi-

(Continued on page 20)

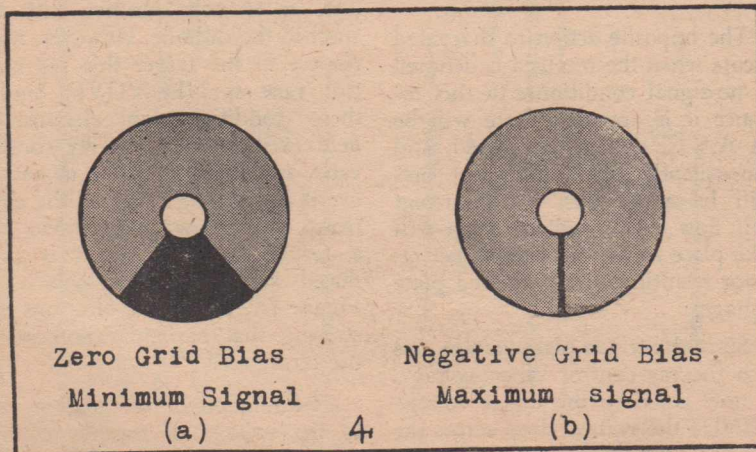

Variations in plate current, target current and shadow angle plotted against grid voltage for the 6E5 and 6G5. A comparison of the curves indicates amongst other things that the negative grid bias for the 6G5 may be nearly three times that for the 6E5.

MAGIC EYES

(Continued)

cator valve flows through the bias resistor of another valve. Due to age or other causes this cathode current may change, thereby producing variations in the bias voltage of the second valve, and so to avoid difficulties of this nature, it is always advisable to earth the tuning indicator cathode.

The target is connected direct to B plus 250 volts, being always maintained at this potential, whilst a resistance (R) is connected between the triode plate and target. Consequently the plate voltage as well as that of the ray control vane can be less than the supply voltage by the amount of the voltage drop through this plate-target resistor. The actual voltage drop across this resistor will naturally depend on the plate current of the triode at this particular time.

Now let us examine the action of the valve under normal operating conditions. The triode plate current is dependent upon the triode grid potential which, in this case, is the applied A.V.C. voltage. So when the triode grid is biased to plate current cut off—that is,

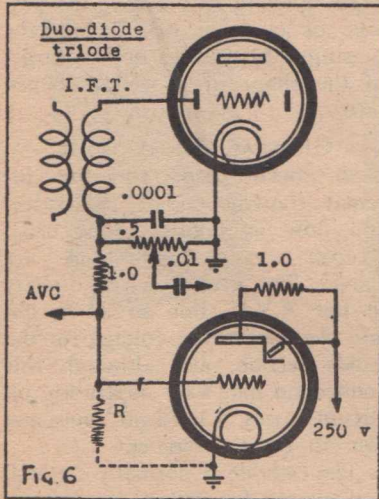

FIG. 6
A typical tuning indicator circuit suitable for receivers not employing delayed AVC. In this case the grid of the indicator valve is connected directly to the AVC filter as shown. Resistor (R) may be necessary to prevent premature closing of shaded sector.

the grid is so highly negative that no plate current can flow, there will be no voltage drop across the plate-target resistor. Consequently the triode plate and ray control vane must have the same potential as the fluorescent target.

Such a condition, as outlined, only exists when the receiver is tuned exactly to the carrier frequency of the transmitting station, since this results in a maximum negative A.V.C. voltage being developed and applied to the triode grid.

The hot cathode is emitting electrons in all directions, and as the target is positive with respect to the cathode, it will naturally draw these emitted electrons over to it. The target, as already mentioned, is coated with a fluorescent compound which becomes illuminated when subjected to electron bombardment, and since the ray control vane is at the same potential as the target, there is no electrical obstruction to the free passage of these electrons.

As a result, the whole area of the target is illuminated except for the very narrow shaded line caused by the mechanical obstruction of the ray control vane. Thus when a station is tuned exactly to resonance only a small shaded angular pattern will result—Figure 4B.

OFF RESONANCE

The opposite action to that cited occurs when the received is detuned to no-signal conditions. In this instance it is apparent there will be no A.V.C. voltage developed, and consequently the triode grid bias will be zero volts. Plate current will flow and a voltage drop will take place across the plate-target resistor resulting in a decreased plate voltage.

Since the triode plate voltage and also the ray control vane voltage is now equal to the target voltage MINUS the voltage drop across the resistor (R), the ray control vane will be at a lower positive potential with respect to the cathode than the target. In other words,

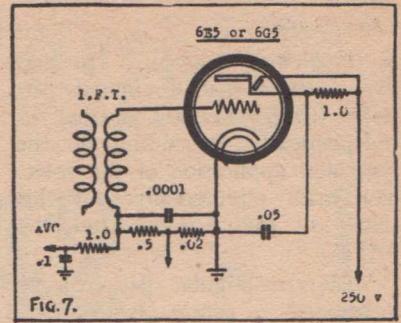

FIG. 7.
An unusual circuit using a 6E5 as combination second detector and tuning indicator. Frequently used in low-priced receivers where the addition of an extra valve is not warranted.

this ray control vane is now a certain voltage NEGATIVE with respect to the target.

To visualise the new situation more easily consider a 6G5 operating under conditions where 250 volts are applied to the target and the plate-target resistor is one megohm. With zero volts on the triode grid, the plate current will be 0.24 ma, and the voltage drop across the plate target-resistor, according to Ohm's Law, will be:

$$\begin{aligned} E &= I \times R \\ &= 0.24/1000 \times 1,000,000 \\ &= 240 \text{ volts.} \end{aligned}$$

The ray control vane being connected to the triode plate will therefore have a potential of 250-240, or 10 volts positive with respect to the cathode. However, with respect to the target this ray control vane is NEGATIVE. Under these conditions an electrostatic field exists around the ray control vane, and being negative in nature exerts a repelling effect on the electrons emitted by the cathode. As a result a shaded sector is produced similar to that shown in Figure 4A, due to the electrons not striking that particular portion of the target area.

The relation of the shadow size to the voltage of the ray control vane may be kept in mind by the simple analogy of thinking of the vane as a pivoted, thin, bladelike structure. When it is appreciably

more negative than the target, it turns in such a manner as to present its greatest area to the light source (the cathode) thus producing the largest shadow on the target. Then if the voltage is varied in the direction where it approaches the same voltage as the target, the vane effectively rotates so as to present its thinnest edge to the light source, and so a smaller shadow is produced on the target.

Whilst, of course, there is no mechanical movement of the vane in the valve itself, the final result depicted on the target is just as though this were the cause.

Summarising the actions so far, under resonance conditions, a large negative A.V.C. voltage is developed and applied to the triode grid. Acting as a negative bias this causes a plate current cut-off, and hence no voltage drop across the plate-target resistor. The ray control vane is therefore maintained at the same potential as the fluorescent target, resulting in a very narrow wedge shaped pattern.

Then again under no signal con-

TYPE	HEATER V. A.	TARGET Volts	TARGET Ma.	PLATE R. Megs.	TRIODE GRID VOLTAGE FOR 0 90	PLATE Ma at 0 Grid volts	TRIODE GRID TYPE
6AB5	6.3 .15	135	4.	.25	-7.5 0	.5	Var. M.
2E5 6E5	2.5 .8 6.3 .3	100 200 250	4.5 4.5 4.5	.5 1. 1.	-3.3 0 -6.5 0 -8 0	.19 .19 .24	Uniform
2G5 6G5	2.5 .8 6.3 .3	100 200 250	4.5 4.5 4.5	.5 1. 1.	-8 0 -18.5 0 -22 0	.19 .19 .24	Var. M.
6H5	6.3 .3	100 200 250	1.5 3.5 4.5	.5 1. 1.	-8 0 -10.5 0 -22 0	.19 .19 .24	Var. M.
6N5	6.3 .15	135	4.5	.25	-12 0	.5	Var. M.
6U5	6.3 .3	100 200 250	4.5 4.5 4.5	.5 1. 1.	-8 0 -18.5 0 -22 0	.19 .19 .24	Var. M.

A table of characteristics of the American-type tuning indicators.

ditions, the A.V.C. voltage and also the bias voltage is zero, causing plate current to flow and result in a voltage drop across the plate-target resistor. This causes the ray control vane to become highly negative with respect to the target, repelling electrons from the cathode and so forming a shaded wedge shaped pattern of up to 90 degrees on the target.

Earlier it was mentioned that under "resonance" conditions the shaded sector would become very narrow, approaching a straight line. This, however, is not necessarily always the case, since the narrowness of the wedge shaped pattern depends partly on the strength of the received signal when the A.V.C. action does not provide sufficient control. This is of no great importance providing it is remembered that a state of exact resonance is always maintained when the shaded sector has a MINIMUM area.

CHARACTERISTIC CURVES

The characteristic curves of the 6E5 and 6G5 visual indicators are combined for comparison in Figure 5. In both cases two sets of operating conditions are shown—one with a target voltage of 250 volts and a plate-target resistor of 1.0 meg. the other with a target voltage of 100 volts and a plate-target resistor of 0.5 meg.

Reference to these curves show that the 6E5 plate current is reduced to a very low value when the triode grid has -8 volts applied to it, whilst in the case of the 6G5 a bias of -22 volts is required to reduce the plate current an equivalent amount. In each case the target voltage is assumed to be 250 volts. Again, when
(Continued on page 23)

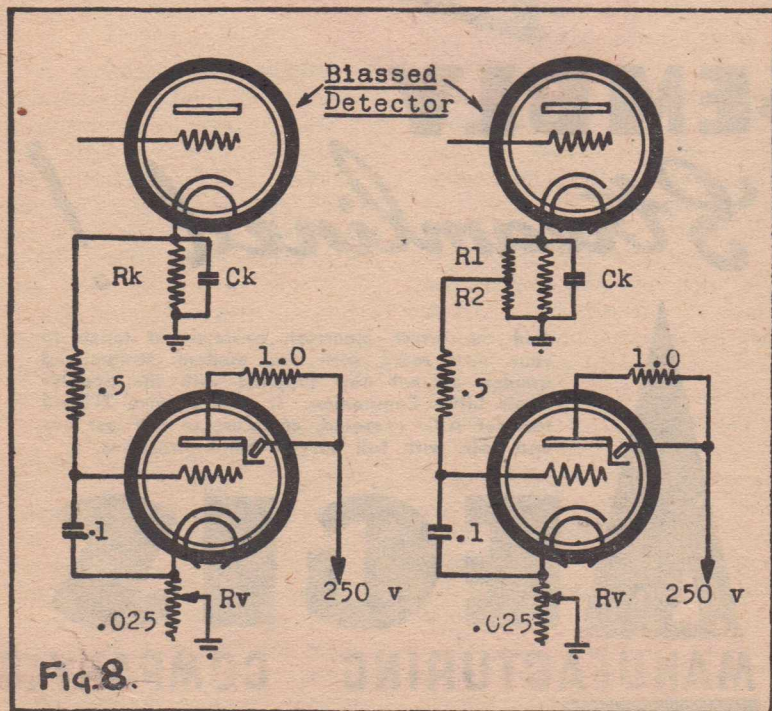

The tuning indicator can also be operated from a cathode bias detector if required. Under these conditions, no signal and resonance indications will be just the reverse of those given with the diode type detection.

THE AEGIS 'LITTLE COMPANION'

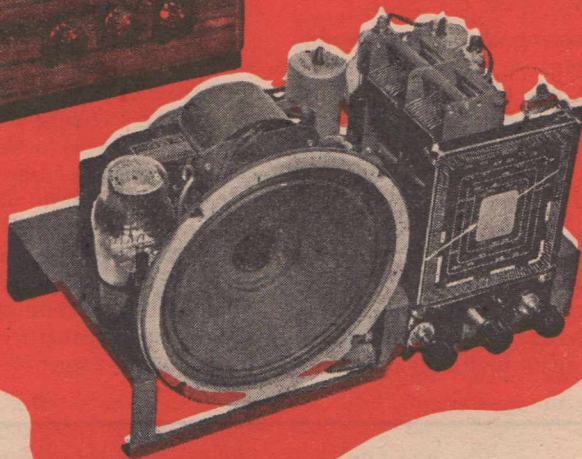

YOUR *Favourite* KIT ASSEMBLY

has been Streamlined!

FEATURES

- ★ Dual-Wave
- ★ Rola Speaker
- ★ Permeability Iron-Cored B/C, S/W.
- ★ Permeability Iron-Cored Intermediates
- ★ Super New Cabinet
- ★ Ducon Condensers, etc.

Add the latest, smartest, professional touch to your new radio with the modern streamlined wooden cabinet now supplied with the popular Aegis Little Companion. It is a 5-valve 2-band receiver A.C. operated, complete to the last nut and bolt, with full easy-to-build directions.

AEGIS

MANUFACTURING COMPANY PTY. LTD.

208 LT. LONSDALE ST., MELBOURNE
THERE ARE AEGIS DISTRIBUTORS IN ALL STATES.

MAGIC EYES

(Continued)

operated with 100 volts on the target with a plate-target resistor of 0.5 meg. the 6E5 plate current will cut off at -3.3 volts, whilst the 6G5 requires -8 volts.

Due to the great difference in cut-off voltages it might at first glance appear a simple matter to decide which valve should be used in a particular circuit. There are, however, many qualifying circumstances to consider and about the only general rule that can be formulated is that the 6E5 is usually suitable for use in receivers having a large number of valves under A.V.C. control, where a small A.V.C. voltage is developed in the diode circuit.

The 6AB5, 6G5, 6H5 and 6U5 all possess a variable- μ triode unit which enables the A.V.C. voltage to appreciably effect the shadow angle on weak signals, and also prevent within limits the complete closure of the shadow angle prior to the proper tuning of a strong signal.

TYPICAL CIRCUITS

A typical tuning indicator circuit for either the 6E5 or the 6G5 is illustrated in Figure 6. The former valve is to be preferred when the maximum A.V.C. voltage is approximately 8 volts and the latter when this voltage is approximately 22 volts. Since simple A.V.C. has been utilised in this circuit, it will be noticed that the grid of the tuning indicator can be connected directly to the A.V.C. filter as shown.

If the A.V.C. voltage exceeds the cut off voltage of the valve being used, the net effect will be to cause the fluorescent area to overlap. To prevent this and reduce the voltage to within the stipulated limits, a resistor, R, should be connected from the triode to earth. The value of this resistor must be determined by trial and experiment—the method being to tune in a strong station and then adjust this resistance until the shadow angle is nearly zero.

When delayed A.V.C. is employed the visual indicator, if connected directly to the A.V.C. circuit, will not become operative until the signal voltage at the diode exceeds the delay voltage. Such a condition is undesirable, since the visual indicator should function constantly so as to provide a positive indication of the incoming signal strength.

To avoid this difficulty the grid of the indicator valve is generally actuated directly from the diode load resistor circuit through an audio filter comprising a resistor and condenser similar to that shown in Figure 3. The audio filter is required in this case to eliminate any a-f component likely to reach the triode grid, otherwise there will be a tendency for the edges of the shaded sector to become blurred on strong modulation peaks.

Care should be taken to ensure that the time constant of this a-f filter is not too great, otherwise there will be a lag in the voltage variation on the triode grid, resulting in sluggish operation. The generally used valves are 0.5 meg. for the resistor and 0.1 mfd. for the condenser.

Some receivers will be found to employ diode circuits in which the detector action and the A.V.C. action are separate and distinct operations. In cases such as this, because the range of signal voltage applied to the detector plate is considerably reduced due to the A.V.C. action on the r-f and i-f stages, it will generally be found preferable to connect the triode grid on the tuning indicator to the audio load rather than to the A.V.C. circuit.

In doing this, it will be necessary once again to incorporate the a-f filter previously mentioned to prevent the blurring of the edges of the shadow angle on strong modulation peaks.

The 6E5 or 6G5 can be used as a combination second detector and tuning unit when connected as shown in Figure 7., and this particular circuit was very popular at one time for use in the low priced

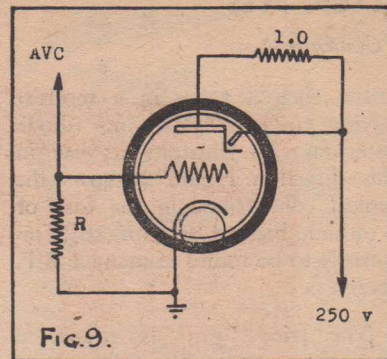

When the sector closes completely before reaching resonance, a resistor (R) may be connected from the triode grid to cathode. Value to use is determined by tuning in strongest carrier and using value of R to just close pattern.

receiver range, with the obvious saving of one valve.

The usual value of grid resistor and condenser are used and the audio voltage obtained from the grid resistor. The plate and target circuit is filtered for audio frequencies, by the .05 mfd. condenser and this prevents the shaded sector from fluctuating at an audio frequency rate. In using this circuit the only point to watch is that the tuning indicator is placed as close as possible to the last i-f transformer, with the length of all leads kept to a minimum.

With the recommended plate-target resistance the no signal shadow angle is less than 90 degrees because the initial plate-target voltage is adjusted to a low value for good sensitivity. The sensitivity is high for weak signals and decreases with increasing signal strength. An important feature of the circuit is that the edges of the fluorescent area do not overlap, irrespective of signal strength, because the DC plate current remains constant.

WITHOUT A.V.C.

So far all the applications of the tuning indicator have been used on the fact of the set having A.V.C., but it is quite feasible to

(Continued on page 24)

MAGIC EYES

(Continued)

utilise such a valve in a receiver having neither A.V.C. nor diode detection. To illustrate its use in this direction Figure 8 shows the typical connections in the case of a cathode biased detector, still frequently to be found in many T.R.F. receivers.

The triode grid is connected through an audio filter comprising a 0.5 meg. resistor and 0.1 mfd. condenser to the cathode side of the detector bias resistor. Assuming no signal conditions, the detector plate current will cause a voltage drop across this bias resistor equal to the no-signal bias and the polarity of this voltage is such that the cathode side of the resistor is positive.

This makes the triode grid positive, in consequence of which the shadow angle opens up. The variable resistor R_v is then adjusted

until the shadow angle is at a minimum, and this will occur when the voltage drop across R_k exceeds the voltage drop across R_v by the cut off value of the particular indicator valve being used.

When a signal is impressed upon the detector grid, the plate current will increase and as the receiver is tuned to exact resonance the voltage drop across the bias resistor will be at a maximum. It should be noted that this action is opposite to that which occurs when the A.V.C. voltage is applied to the triode grid of the visual indicator. However, this should not be particularly disadvantageous, it only being necessary to remember that a state of exact resonance is indicated by a MAXIMUM opening of the shadow angle.

If the shadow angle should open to its maximum before a state of resonance is reached on the strongest signal likely to be received, this can be easily remedied by placing a voltage divider network across

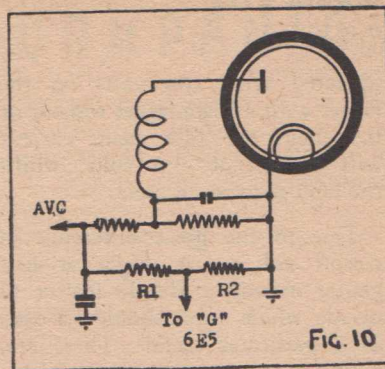

Another method of altering sensitivity of tuning indicator. The sum of R_1 and R_2 should amount to 5 to 15 meg. so as not to interfere with diode operation.

the detector bias resistor and obtaining the triode grid voltage from the tap between them. The values of R_1 and R_2 will naturally vary with different circuits, but their total value should be at least 0.25 meg. Instead of using two separate resistors an alternative method would be to use a 0.25 meg. potentiometer in place of R_1 and R_2 and connect the triode grid to the movable arm.

CHECKING FAULTS

During the discussion on the operation of the valve, mention was made to the effect that when the strongest carrier received by the set is tuned to resonance the shaded sector of the tuning indicator should close to a narrow line. However, in general practice, such a condition may not be obtained on connecting the indicator into the receiver, and usually it will be found that either one of the following faults will exist—namely:

- (1) The shaded sector does not close sufficiently at resonance.
- (2) The shaded sector closes fully before a state of resonance resulting in the edges of the sector overlapping.

Whilst either of these conditions could be due to an incorrect choice of valve, we will assume such is not the case, and now show how

SAVE MONEY WITH A SUBSCRIPTION!

Order Yours To-Day

Make sure you get every issue as soon as it is published. Place an order with your newsagent or send direct to us for a subscription.

IT SAVES YOU MONEY!
IT SAVES YOU TIME!

We guarantee that every subscriber has his copy posted the same day it comes off the press.

Enclosed please find remittance for 10/6 in payment for an annual subscription to the "Australasian Radio World," commencing with the..... issue.

NAME

STREET and NUMBER

CITY..... STATE.....

AUSTRALASIAN RADIO WORLD

Balcombe Street
Morningson

RATES	
★ 6 issues	5/3
★ 12 issues	10/6
★ 24 issues	20/-
POST FREE	

the valve can be made to operate correctly.

Referring once again to the characteristic curves of these valves, it will be noticed that the sensitivity of either one becomes progressively greater as the target voltage is decreased, whilst a decrease in sensitivity occurs if the target voltage is increased. In other words, when the target voltage is decreased, a smaller value of A.V.C. voltage need be applied to the triode grid in order to close the shaded sector. Conversely, when the target voltage is increased a larger A.V.C. voltage is needed to obtain the minimum shadow angle.

One method of changing the sensitivity of the valve then is by varying the resistance value of the plate-target resistor as well as the target voltage. For minimum sensitivity this resistor should be 1.0 meg. with the target potential of 250 volts. For maximum sensitivity apply 100 volts or less to the target and reduce the plate-target resistance to 0.5 meg. or less. However, the target voltage should never be less than 80 volts nor more than 275 volts.

Another means of decreasing the sensitivity of the tuning indicator so as to prevent the premature closing of the shaded sector, is by inserting a resistor between the triode grid and cathode. The value to

use should be determined by tuning in the strongest signal to exact resonance and then using a value that will just allow the shaded sector to fully close, Figure 9.

When all other methods of decreasing the sensitivity fail recourse may be made to that shown in Figure 10. A voltage divider comprising of R1 and R2 is connected between the A.V.C. supply and the diode cathode. So as not to interfere with the correct operation of the diode load proper, this sum of these two resistances should amount to 5 to 15 meg.

The smaller the resistance of R1 compared to R2 the greater the A.V.C. voltage applied to the triode grid. Conversely the lower the resistance of R2 with respect to R1 the lower the A.V.C. voltage applied to the triode grid. Whilst this method prevents premature closing of the shadow angle for strong signals, it has the disadvantage of reducing sensitivity on weak signals. This latter difficulty, however, can be overcome by using a visual indicator valve having a variable- μ triode section, such as the 6G5, 6H5 or the 6U5.

In receivers wherein the diode load is divided into a number of separate sections in order to supply different values of A.V.C. voltage to the various stages, the sensitivity of the visual indicator is easily altered. If the shadow angle closes on strong signals before resonance is reached, the triode grid should be connected to a point on the diode load which is nearer the diode cathode.

On the other hand if the shaded sector does not close sufficiently when a strong carrier is received the triode grid should be connected to a point on the diode load further away from the diode cathode. In all these cases to prevent blurring of the edges of the shadow angle due to a-f modulation peaks, the triode grid should be connected through its own audio filter consisting of a 0.5 meg. resistor and

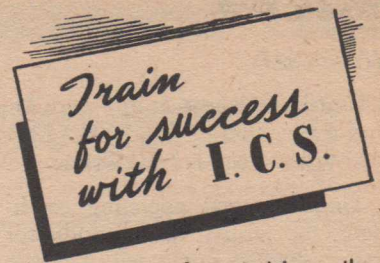

Success comes from training—the right sort of training. I.C.S. have put over 5 million people on the road to success through home training. What about YOU? I.C.S. can help you, too. There are over 400 I.C.S. home study courses. One of them means a success story for you and—SECURITY. Fill in and mail the coupon without delay. An enquiry costs nothing.

INTERNATIONAL CORRESPONDENCE SCHOOLS

140 Elizabeth Street, Sydney
Dear Sirs—Please send me free prospectus showing how I can succeed in the occupation I have marked.

- | | |
|---------------------|----------------------------|
|Advertising |Accountancy Inst. |
|Salesmanship |Secretaries, Inst. of |
|Book Keeping |Cost Accountancy |
|Architecture |Building Cont. |
|Arch. Draw. |Roof & Steel Sq. |
|House Plan. |Build. Plan Draw. |
|Carpentry |Struct. Steelwork |
|Refrigeration |Elect. Eng. or M. |
|Electronics |Radio Eng. or Serv. |
|Plastics |Auto Mechanics |
|Civil Eng. |Ind. Management |
|Textiles |Rayon Weaving |
|Diesel Eng. |Comp. Mech. Eng. |
|Welding |Fitting & Turning |
|Ind. Chemist |Heat Treat. Metals |
|Story Writing |Mech. D'sman. |
|Radio Plays |Reading B'prints. |
|Com. Art |Aero D. & Eng. |
|Sketching |General Education |
|Landscape Ptg. |Coach. any Exam. |
|Wind. Dress. |Showcards, Tickets |
|Dress Design |Shorthand, Typing |

If your subject is not above, write it here _____

Name _____

Address _____



RADIO EXAM COACHING

Special courses of instruction, prepared by experts with individual correction of students' work, ensure success to all I.C.S. students studying for Radio Examinations.

- Aust. Radio Institute (A.M.I.R.A.)
- Commercial Operators' Certificates
- Amateur Operators' Certificates
- Electronics

7/6

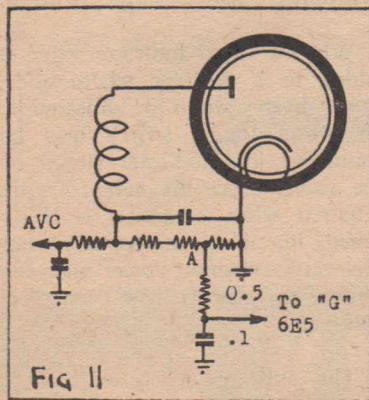

In diode circuits having a number of separate sections, the sensitivity of the tuning indication may be varied by altering position of connection "A."

(Continued on page 26)

MAGIC EYES

(Continued)

0.1 mfd. condenser, as in Figure 11.

WIDE ANGLE INDICATION

Under normal operating conditions the visual tuning indicator has a shadow angle which varies from 0 to 90 degrees, but it is possible to increase this range from the usual maximum of 90 to 180 degrees. This improvement is brought about by using a separate triode in a new circuit to control the action of the ray control electrode in the indicator valve (Figure 12).

The operation of this arrangement is quite simple and effective. When a high negative bias is applied to the control valve grid, no plate current will flow and consequently the voltage drop across the plate-target resistor will be negligible. Since the ray control vane will then be at the same potential as the target the shadow angle will be zero for reasons already given.

When zero volts are impressed upon the control valve grid a sufficiently large plate current will flow so as to result in a voltage drop of 125 volts across the 1.0 meg. resistor. The ray control vane will then be about 125 volts negative with respect to the cathode, and result in the emitted electrons being strongly repelled and up to 180 degree shadow angle will be indicated on the fluorescent target.

The voltage divider network comprising R1 and R2 should be chosen so that the total value will be approximately 15-16000 ohms. Assuming that any of the following valves are used: 6E5, 6G5, 6H5 or 6U5, the grid voltage required to close the shadow angle is dependent on the particular control valve being used. See Table 2.

A well defined shadow is not obtained over the entire range of 180 degrees, although the edges of the pattern are usually sharp up to 150 degrees. From 150 to 180 degrees the edges of the pattern are

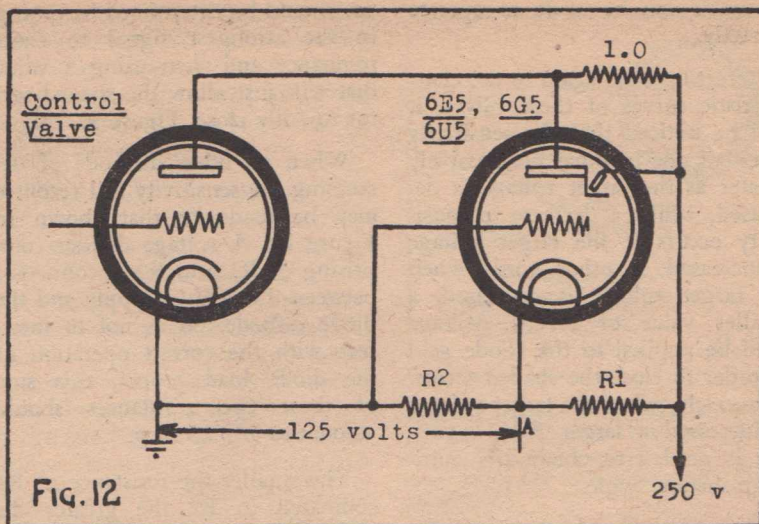

Fig. 12
In cases where wide angle indication is required this circuit should be used. Note that the cathode of the tuning indicator is kept at approx. 125 volts positive. See text for values of R1 and R2.

generally not quite so sharp, and at times inclined to be fuzzy. However, by reducing the potential of point A with respect to ground, the maximum shadow angle will be decreased, but the edges of the pattern can be kept quite sharp over the entire range.

MOUNTING

The visual indicator may be mounted in any position, although for convenience it is generally kept horizontal. External light reflections can be minimised by placing a small hood around the dome and fluorescent target.

The shadow opens symmetrically on each side of the line where it just closes. This is approximately parallel with a line passing through pin 2 and pin 5, so this should assist in mounting the indicator correctly.

Adequate ventilation should be provided, as under certain conditions these valves become extremely hot. In the 6E5 and 6G5, for example the target current was initially limited only by cathode saturation—that is by the maximum emission of the cathode. Due to the age of the valve or line variations, this emission frequently ran to excess-

ively high values, resulting in the overheating and sometimes destruction of the valve.

This difficulty has been overcome by placing a special grid around the cathode—Figure 2B—and connecting it to the cathode within the valve itself. Examples of this are in the 6H5 and 6U5 valve. Such construction limits the target current to safe values. In consequence of this target limiting grid there appears a fixed 90 degree shadow on the side of the target opposite to the controlled shaded sector, and this should not be confused for the controlled shaded angle pattern.

When a visual indicator valve is added to a receiver where additional heater drain is undesirable, an off-on toggle switch may be connected in the heater circuit of the valve. Since the valve is only required when a station is being tuned in, it is unnecessary that this valve consume power once the tuning in process has been performed.

The ensuing article will carry on from this juncture, and the discussion of later types, such as the EM1, annular ring and dual indicator visual tuning aids will be fully detailed.

THIS IS THE FAMOUS FERROTUNE FOUNDATION KIT

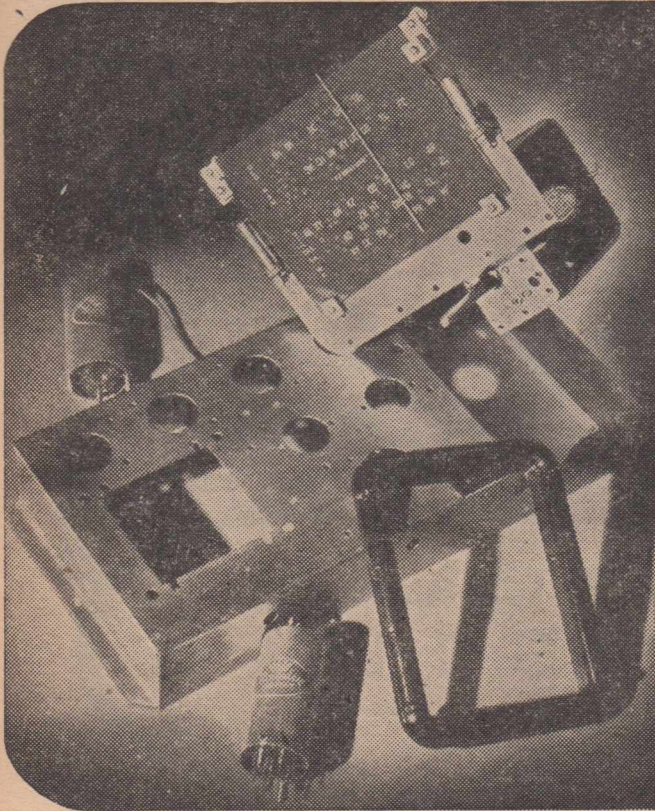

KINGSLEY RADIO brings all amateur set-builders a FOUNDATION KIT that makes any predecessors completely out-of-date. The FERROTUNE FOUNDATION KIT is based on the revolutionary IRON-CORE TUNING which KINGSLEY developed during the war years.

FERROTUNE brings you greater clarity of reception, faultless tuning of every broadcast frequency, increased coil I.F. gain and selectivity. Included in the FERROTUNE FOUNDATION KIT is . . .

1. The outstanding FERROTUNE ferromagnetic gangless tuning unit—it covers the broadcast band and includes tuning mechanism, straight line dial, padding and trimming, etc. It does not need further alignment.
2. Cadmium-plated steel chassis.
3. Two PERMACLAD I.F.'s which have exceptionally high "Q" ratings.
4. Complete attractive plastic escutcheon with glass window.

OBTAINABLE FROM
AUTHORISED KINGSLEY DISTRIBUTORS

Ask your radio dealer for

F E R R O T U N E

FERRO-MAGNETIC IRON-CORE COILS, I.F.'s AND,
GANGLESS TUNING UNITS

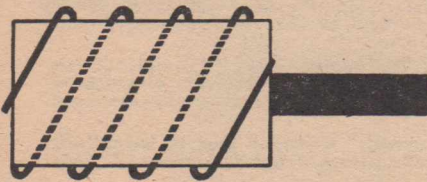

KINGSLEY RADIO

K I N G S L E Y R A D I O P T Y . L T D .

380 St. Kilda Road, Melbourne, Victoria . Phones: MX 1159, MX 3653

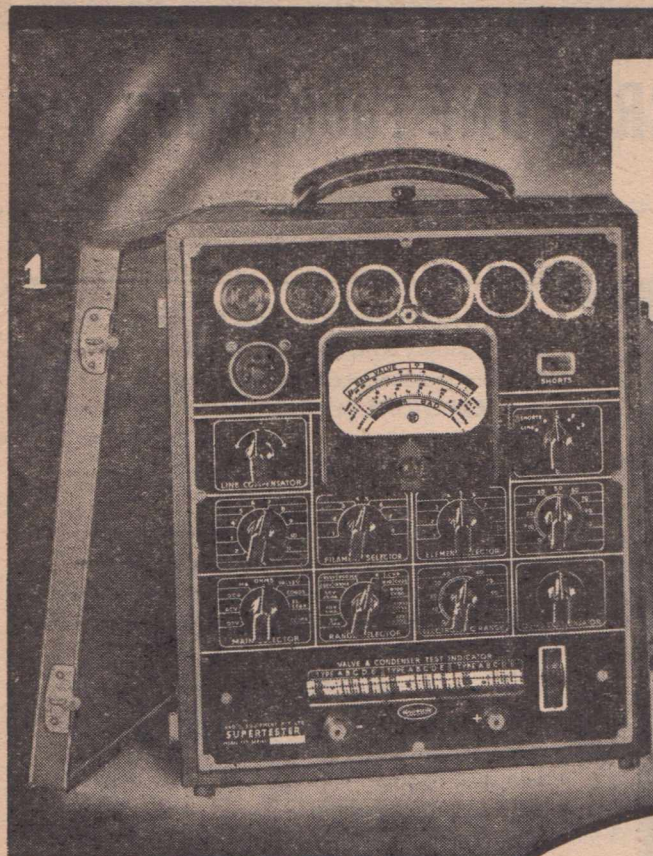

1. The modern, efficient Model T.S.T. supertester combines the functions of a multimeter, output meter, valve and condenser tester. It measures A.C., D.C. and output volts up to 1000 D.C. current is measured up to 250 m.a. and ohms up to 10 megohms. £28/10/- plus tax.

2. Model J.O.B. Oscillator is an extremely efficient instrument, provides R.F. and A.F. signal. Frequency range from 160 K.C. to 32 m'cycles. Carrier frequency quickly adjusted and read on clearly etched dial. Battery operated. £12/15/- PLUS TAX.

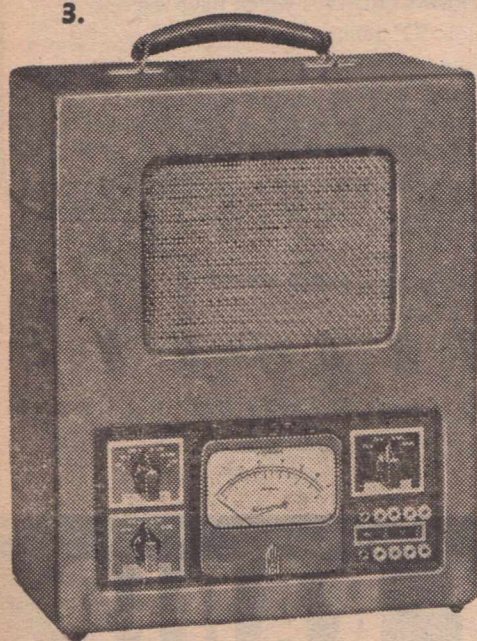
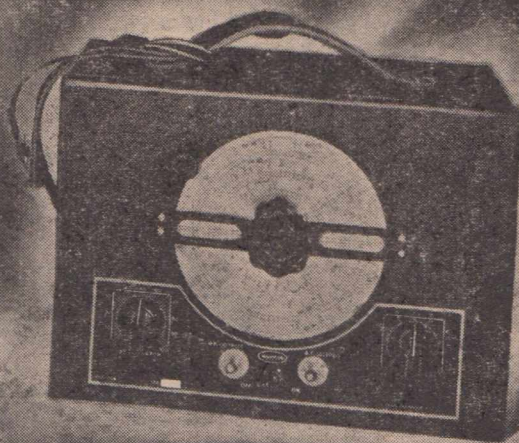

The University "BIG THREE"

In Service Equipment

Successful radio servicemen today must have the best and most up-to-date test equipment. Modern conditions demand it for a very practical reason—the large volume of service work available which he must be able to "trouble-shoot" fast and accurately every time.

Delays and guesswork cost money. Now, "University" offers you, in three basic instruments, the accuracy, dependability and advanced electronic engineering required by successful servicemen.

Never before has "University" leadership been so impressively demonstrated as in these tried and tested examples of "University" research.

Write for our free illustrated brochures.

3. Model U.S.O. Universal Speaker and Output Meter makes set-testing and repair easy. Adaptable to any set. A range of output impedances are matched as needed by a simple switch. A built-in output meter calibrated in D.B. and Watts provides easy accuracy. Simply plug into speaker socket. £15/- plus tax.

RADIO EQUIPMENT PTY. LTD.

5 NORTH YORK STREET, SYDNEY, N.S.W. Telephones: M6391-2

Telegrams: "Raquip," Sydney

DISTRIBUTED BY

N.S.W.: All leading distributors.
 Queensland: Irvine Radio; J. B. Chandler Pty. Ltd.; A. E. Harrold.
 Victoria: Vealls Electrical & Radio Pty. Ltd.; Hortleys Ltd.;
 Replacement Party Pty. Ltd.

South Australia: Gerard & Goodman Ltd.; Radio Wholesalers Ltd.
 Western Australia: Atkins (W.A.) Ltd.
 Tasmania: W. & B. Genders Pty. Ltd.
 New Zealand: Allum Electrical Company Ltd.

PRINTED WIRING METHODS

Further Details of Latest American Process

LONG-HERALDED, but slow in coming, the pocket-size radio now appears to have become an assured reality as a result of wartime production experience in the adaptation of a graphic-arts technique to the manufacturer of electronic devices. This technique is known as a silk-screen printing, a process in which ink is forced through a fine-mesh silk in the desired pattern. By using this method to literally print electrical circuits on thin ceramic plates, it now is possible to eliminate much costly hand wiring and to save considerable space. It was this process that made possible the almost-human proximity fuse which exploded mortar and artillery shells when their trajectory brought them

within a predetermined distance from the target, scattering shrapnel over a wide area. Because such shells did not depend upon contact for detonation, they were considerably more effective in combat.

Putting such shell fuses into the quantity production demanded by military requirements posed many problems for each such fuse is a complete radio transmitter and receiver with various amplifier and control circuits, all enclosed in a single unit measuring about five inches (12.7 cm.) long and three inches (7.6 cm.) in diameter. In this unit, which is not much larger than a standard radio receiver tube, is a turbo-generator which, when the shell is in flight, supplies the electric power for operating the

transmitter and receiver. In addition to being small and compact, the circuits and accessories must be extremely rugged to withstand the tremendous forces imposed in the firing of the shell.

Hand assembly of the circuits for such a fuse was impractical both because of the small size and the demand for quantity production of identical units. Even without the midget tubes and other required accessories, the wiring and resistors which normally would be used in such circuits would occupy considerable space, and the placing of the wires and the soldering of the connections is likely to increase the chance for error during the assembly. In order to overcome these difficulties, research engineers of the Centralab Division of Globe Union, Inc., spent many months in experimental work, and as a result, perfected the technique of printing a radio circuit, complete with conductors, resistors, and capacitors, on a thin ceramic plate. In this way, the circuit becomes practically a two-dimensional affair, as none of these components is raised above the surface of the ceramic plate. Not only does this technique save space, it also eliminates much of the usual assembly process and has the added advantage of maintaining uniformity, because every unit is printed from the same pattern.

The ceramic plates used are made of stealite, which is similar in appearance to porcelain but which has greater strength and hardness. To produce these plates, selected and refined clays are blended into a smooth uniform mass and then granulated. The granules are air-dried and molded to shape under pressures of 10,000 to 20,000 lbs. (4,536 to 9,072 Kg.) per square inch (6.5 sq. cm.). Following this, the pieces are put into rotary kilns,

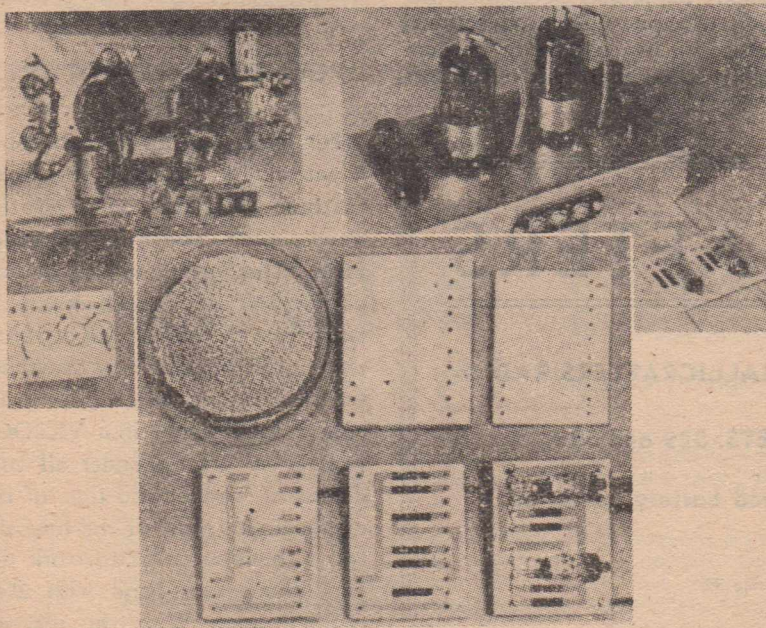

Top—left and right: Here are two views of a conventional circuit assembly compared with its exact counterpart produced by using midget tubes and printing other circuit components on a ceramic plate. The saving in space is chiefted without impairing performance.

Bottom: Steps in the making of a printed radio circuit. Granulated ceramic powder is pressed into shape and then fired, during which it shrinks in size. Silver paste, printed on the vitrified plate, forms the wires of the circuit. Next, a carbon compound is laid on in proper position to form the resistors, and then capacitors and tubes are soldered into place.

(Continued on page 30)

PRINTED WIRING

(Continued)

where they undergo a 24-hour heating cycle, consisting of pre-heating, vitrifying at temperatures up to 2,400 deg. F. (1,315 deg. C.), and cooling. After the firing, the stealite has a hardness approximating that of sapphire, making any machining operations impractical, though if extreme flatness or close dimensional tolerances are required, the material can be ground with wet carborundum or diamond wheels, but this is a slow and costly operation.

The printing of the electrical circuits on the steatite plates is done by what is known as the silk-screen printing process, which finds wide use in preparing billboards, car cards, and other advertising displays. Instead of ink, however, a paste of finely divided silver or silver oxide and suitable binders and solvents are used. The first step in this process is the preparation of the screen or stencil. This consists of square of silk cloth to which is bonded a photographic

screen on which the pattern has been impressed. That part of the pattern which is to be printed is accurately cut from the photographic screen, thus permitting the silver paste to be forced through the silk mesh in an exact copy of the desired pattern. After the silver paste has been laid down on the steatite blank, the units are once again baked in a furnace to bond the silver to the steatite, where it thus forms the necessary conductor paths.

The necessary resistors are added to the circuit in much the same manner, though here the paste used is of different composition. Finely divided carbon mixed with the correct amount of filler, or inert, material to give the proper resistance characteristics is screened or sprayed through accurately positioned masks on the wired blank. Once again the units are baked, this time to stabilize the resistor, which is then coated with a special resinous compound, to protect it against humidity. Despite this unconventional method, it is possible to produce highly stable and accurate resistors

with capacities ranging from three ohms to 200 megohms. The variations in capacities are controlled by varying the area of the resistor and the formulation of the ingredients.

Capacitors for the circuits are made by coating thin ceramic disks of titanium dioxide with silver and soldering these to the silver leads on the steatite plates. A specially compounded, low-temperature bismuth solder with a small percentage of silver added is used for this purpose, because commercial solder lifts the silver deposit from the steatite, preventing a proper bond, and the temperature required is likely to crack the capacitor disks. Capacitors prepared in this manner can be made with values ranging from 6.5 to 2,000 micro-microfarads by varying the thickness and the area of silver on their faces.

—Universal Commerce (U.S.A.)

* * *

ROUND AND ABOUT ON "SIX"

For some time now the Number 1 antenna at VK2NO for "Six" has been (and still is) a quarter-wave earth-potential Ground-Plane. This system, which is simplicity itself to put into operation, apart from the mechanical construction involved, outshines anything yet tried. It is responsible for dropping a solid signal into VK2OC's receiver at Wyong under all conditions of weather and time of the day or night. Most of the time the two stations are able to work duplex phone cross-band with 2OC on 3.58 mcs. With the idea of doing still better at this end, I was tempted to make up an array, popularly known as the "Bi-Square," and comprised of four phased half-waves fed by co-ax at the end of the usual quarter-wave stub.

—VK2NO.

HALLICRAFTERS

Limited Quantity only. NEW HALLICRAFTERS RADIO-

COMMUNICATION SETS. S29 and S39.

For AC/DC or self-contained battery-operation.

For details write to

W. MAHER

60 WENTWORTH AVENUE

SYDNEY

Or phone MA 7043

HOW TO MAKE --

A RELAY from an OLD A.F. TRANSFORMER

Many months ago I mentioned in these columns that the Ham with the ability to handle simple tools can easily make up low voltage relays for AC operation from discarded audio transformers. Most useful for the purpose are speaker output transformer cores, which are small in dimensions, and easily assembled. The illustration shows a simple relay made from a core of this kind. One leg is cut away completely, and this is used later as the armature. After drilling for clamping screws it is arranged to swivel between brass or aluminium strips fitted vertically to the leg opposite the winding. A light tensioned spring is fitted to keep the armature open when the relay is not operating. An important feature of the pole-piece on which the

winding is fitted is the provision of a "shading coil." This consists of a strip of heavy copper fitted into a slot cut across the face of the pole-piece and clamped tightly around one half of this. It is filed flush with the face of the laminations and its function is to minimise chatter of the armature. The armature must rest on the iron face of the pole-piece when the relay is energised. It is not essential to use a laminated armature as in the construction shown; a simple soft iron piece will do; but it must be accurately fitted. As a guide to low voltage operation, the relay shown is wound with 300 turns of 36 double silk covered wire and functions nicely from a 4 volt AC supply taking less than half an ampere for continuous operation. In this

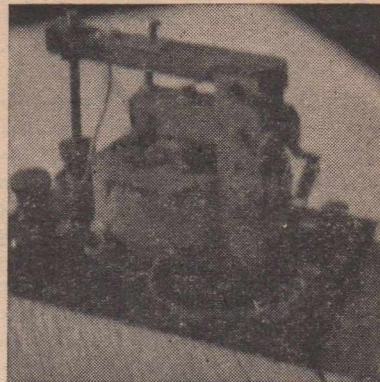

instance the relay is not applied to control of radio transmitting equipment, but serves as a burglar alarm control at the isolated "shack" of a Ham colleague.

—D.B.K.

Now Available in Australia

THE FAMOUS ENGLISH

LEXINGTON

HIGH FIDELITY MOVING COIL GRAMOPHONE PICK-UP

A New and Scientifically Engineered High Fidelity Pick-Up

★ **NOTE THESE FEATURES:** Robust Design—Accidental Dropping on Record will not damage the Pick-Up. Needle or Sapphire can be easily changed by any Amateur. Can be used with normal record changers without fear of damage. New spring Loaded Tracking Arrangement. Pick-Up can also be supplied for 16-inch Recordings and Hill & Dale Recordings.

★ **TECHNICAL DATA.** Frequency Range—Flat from 30 c.p.s. to 12 Kc.p.s. Impedance—10 ohms at 400 c.p.s. Needle trailing angle—5 degrees. Output from Pick-Up one millivolt—from matching transformer 50 millivolts peak. Weight on record— $\frac{1}{2}$ ounce. Uses special replaceable Sapphire tipped or steel needles. Mu-Metal matching transformers ratio 50 : 1 with response curve flat from 30 c.p.s. to 20 Kc.p.s. plus or minus 1 db. also available. Extremely low moment of inertia—total weight of movement only 80 milligrams. Pure Sine Wave with no harmonic distortion. Circuit diagram of pre-amplifier will be supplied upon application.

DENHAMS (MBRO) Pty. Ltd. Maryborough, Qld.

SOLE AGENTS FOR AUSTRALIA

EXPERIMENTS With SINGLE-GANG SUPERS

FITTING PUSH-BUTTON TUNING

I THINK many of your readers will be interested to know that I also built up Corporal Dekker's circuit for a single-gang superhet which appeared in the March, 1946, issue. I have done considerable experimenting with the set and made various alterations, which are as follows: (a) With a 40 milliamp transformer, which was the only one I had on hand, I used a type 41 output pentode to keep the current drain within reasonable limits. (b) I tried an ex-Army 1600 Kc intermediate frequency transformer at first, but the image reception in the 80 metre and marine bands was so fierce that I switched to an iron-

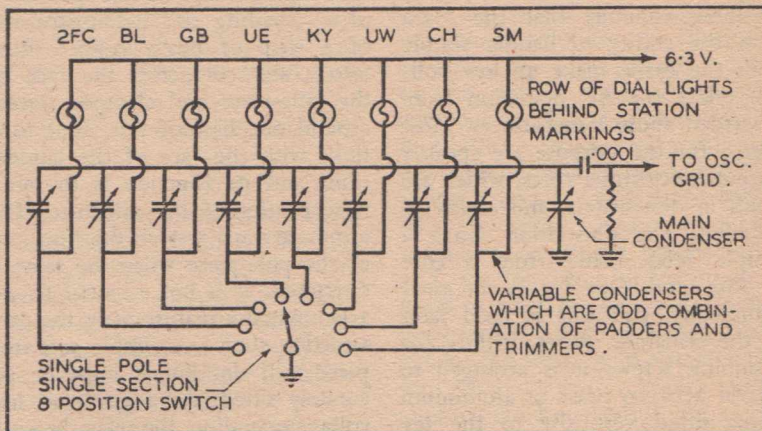

By

DAVID H. PRENTICE

49 Wycombe Road

Neutral Bay, N.S.W.

cored i.f.t. of 465 Kc, which was quite satisfactory. (c) I applied bias to the 6J8G to give about -3 volts bias under no signal conditions with a 300 ohm wire wound resistor and a by-pass condenser of .1 mfd., at the same time raising the screen voltage to about 180 volts with a .005 meg. carbon resistor. All appeared to raise the stability of the set. The stability was raised to a point where the r.f.c. could be left in the circuit instead of using a 20,000 ohm potentiometer, as recommended by a reader in a subsequent issue, June, 1946. (d) The last valve appeared to overload even with these alterations and so I de-coupled the last stage according to instructions in the Radiotron Designers' Handbook, page 29.

Using an R.C.S. loop aerial, the set performs pretty well in this Sydney suburban area. Other departures are the use of a Rola 3C

for compactness and a 4,000 ohm 5 watt resistor to compensate for the lowered resistance of the power choke necessary with the permagnetic speaker. The padder condenser was left out and the use of a tuning condenser of low capacity enabled me to install a modified "push-button" system for the Syd-

ney stations as shown by the circuit below. The reason for this was the smallness of the cabinet I had on hand which had no dial inlet and anyway the chassis was home-made.

To conclude: the set is very satisfactory as it stands and I hope some of the alterations I made may be of interest to your readers.

THE NEW MINIATURE VALVES

SOCKET MARKING NECESSARY

We have received from the Radio Valve Department of Philips Electrical Industries of Australia Pty. Ltd. the following information concerning 1.4 volt miniature valves.

Receivers designed for 1.4 volt miniatures require careful marking of valve sockets to ensure the correct placing of each valve. Reference to valve base diagrams for these valves show a lack of uniformity with respect to the use of the pins. For example, in 1R5, 1T4, 3S4, pin 5 is filament, while

in 1S5 pin 5 is plate. Further, in 1T4 pin 6 is control grid but in 3S4 pin 6 is used for plate connection.

When replacing valves of this series in any equipment, extreme care must be exercised to ensure that only the same type of valve as originally selected by the manufacturer for each socket is used. Exchange or rearrangement of the position of valves in apparatus may result in burnt-out filaments, loss of emission or "shorted" B batteries.

CALLING CQ!

By Don Knock, VK2NO

It would be much nicer to be able to write solely in praise of Ham radio in general than to have to criticise; but criticism, if offered in the right spirit, can be constructive.

Criticism also isn't offered with the idea of being a "nark," none would be evoked at all if reason for it didn't arise.

But you, Mr. Reader, know just as well as I do, that things are not always up to the mark on our bands—things happen that could be avoided with a little thought beforehand.

Perhaps these things happen because there is a tendency to treat an

amateur transmitter as being on a par with a private telephone line. There isn't any forethought that Mr. and Mrs. Public have Dual-Wave receivers and may be turned inflexibly against radio amateurs in general just because of thoughtless drivel into microphones on the popular DX bands. It is well to remember that the majority can suffer because of the inanity of the few in this hobby of ours. It isn't so vital where key-work is concerned, but the spoken word leaves an indelible impression. These remarks are prompted mainly after a landline inquiry from an old hand as to "what the so-and-so are the

Advisory Committees doing to permit the awful drivel heard from some phone stations?" Answer to that one seems to be that the Committees, being comprised of people appointed to the job by the W.I.A. on the one hand, and the P.M.G. on the other, are firstly active Hams themselves, and supporters of active authority secondly. They have a most thankless job and don't relish the abuse levelled at them from some people who may take a reprimand in the wrong spirit. My private opinion is that these Committees are extremely tolerant, perhaps too much so, as evident by the irate VK who made the inquiry quoted. If everything was in order in the Ham Garden of Eden, there would not be any necessity for such Committees. The members of such Committees with which I am familiar seem, to this scribe, to be a decent lot of amateur colleagues—not a bunch of stick-wielding "narks."

If instead of the democratic method of appointment of Committeemen now in force, the members were comprised solely of P.M.G. officers, I imagine that the whole set-up would be much more severe on transgressors.

* * *

Heard a station on 40 metres phone describing his efforts in tuning up two phased half-waves. He mentioned that "a 25 watt lamp across the top of the feeders lights up brightly, in fact it nearly burns out when modulation is applied"—that's a new one on me. He wondered if "anybody ever did that before." Yes, OM, plenty of fellows have used lamps in antennas as tuning indicators, but

(Continued on page 34)

FIRST TRANS-PACIFIC 50 Mc. SIGNALS

There are people who get a lot of interest in trying to do the seemingly impossible on Six metres, and one of these is "Tibby" Scholz, VK4HR, of 95 Stephens St., Morningside, Brisbane. To VK4HR and W7ACS/KH6 (Honolulu) fall the credit for having kept at schedules until some indication of tangible result has come to light. In a letter to VK2NO, VK4HR says . . . "I have been running regular schedules with W7ACS/KH6 for about 12 days. On the 28th February at 1352 E.S.T. I heard his 50 M/cs signal for approximately 5-6 seconds, receiving the callsign '4HR', then a 'V'. About a minute later I heard the letters 'AC'. On the following day I heard him just once, but for about 3 seconds. His signals are 800 cycle modulated CW, and were received at R4-5. On the 3rd of this month W7ACS/

KH6 suggested that I transmit on Six for half-an-hour whilst he remained on Ten metres, working break-in duplex. At 1213 G.M.T. he broke in saying: "I am hearing you at S3 Tibby OM." I sent "R O.K.", but after that my signals on Six faded out. We are keeping up the skeds, but with both of us now on Six. Both of us have heard very weak signals for short duration on our respective frequencies, so we still hope that we can make a two-way QSO on the band soon."

Thus, it seems, the preliminary ice has been partly broken, and don't forget that 25 years ago it was an equally tough struggle to try to get signals across the Pacific on 200 metres—now there is something of the old pioneering spirit displayed in these Six metre attempts.

**RE-VAMPING THE
"FS6" FOR HAM USE**

See this article in
February issue of
"The Australasian Radio
World."

**WE ARE
PLEASED TO
ANNOUNCE WE HAVE
A
FURTHER
LIMITED STOCK
OF
FS6**

Transceivers

**COMPLETE
WITH
8 VALVES
POWER PACK
MORSE KEY
£12/10/-**

Plus

HEADPHONES AND
MICROPHONE, 19/-
SPARE VIBRATOR, 10/-
WOODEN PACKING
CASE, 10/-
AERIALS 25/-

Waltham Trading Co.

Pty. Ltd.

**393 FLINDERS STREET
MELBOURNE**

Cnr. of Queen's Bridge

MU 4719

Mail Orders carefully
attended to.

HAM NOTES

(Continued)

many more have awakened to the fact that it is a sure way of advertising to BCL's that "here is a Ham station." With that lamp blinking away in the sky the BCL with a few electrical appliance noises, etc., in his set will assume at once that his source of trouble lies with that amateur radio fanatic down the road. Tune 'em up with a lamp by all means, but take the advice of an old hand—and remove the lamp when you have finished!

* * *

Those of you who used 28 M/cs consistently through 1946, as most of us did perforce, will remember VK4LP, then at the Loran Station on Graham Moore Island, north of Darwin? He is now VK2YQ, and on 51.1 M/cs from Schofields aerodrome, 30 miles or so from Sydney. F/O Les Page can be heard on the band most nights and is gradually putting a stronger signal toward the coastline. He gets to the "Mountaineers", of course, at S9 over the excellent direct path. Considering that Schofields is only about 50 feet above sea level, VK2YQ does well to reach VK2-NO at R6. Antenna is a stub-matched groundplane.

* * *

Don't you think phonetics are a bit overdone in the DX phone business? Where, for example, is the logic in continuing to "phonetise" the station call letters once contact is definitely established? There is really no need for a boring repetition of "A for America, Z for Zanzibar, H for Honolulu," and things like that every time two stations change over to each other. If, as is usually the case, they are "knocking the meter lots of Db over S9"—the over-emphasizing of call letters by the practice quoted seems to cast a doubt on one or the other's veracity regarding the Signal Report.

* * *

Remarks overheard on Forty phone: "the distortion on the

speech is caused by a sort of Army microphone." Maybe OM, and maybe not, but it is worthwhile emphasising that the capsule in the humble "Army microphone Hand No. 3" is of precisely the same type as those used in the modern house telephone handsets. They don't produce bad speech, otherwise the P.M.G. Department wouldn't be using them. A point to remember is to keep the voltage low on such mikes—around one volt is about all needed.

* * *

The tenacity of some 20 metre phone DX men is considerable—they certainly set out to attract the attention of the DX stations they call. But the lengthy calling procedure, with a belated tacking on of the call sign at the end, is apt to set that DX man tuning off the caller in disgusted exasperation at having to wait too long for the identifying signature. Stations that start off calling "so and so in the Azores . . . this is Australia calling," and go on doing that for about 40 to 50 repetitions with nary a reference to call sign are just asking to be ignored. Reaction would be to avoid waiting for the termination of monotony and to turn to another station probably calling also from Australia, but taking good care to give the call sign with each sentence.

* * *

The Americans tell me that all is not well with that much vaunted 300 ohm feedline when wet weather happens along. The impedance changes considerably—a state of affairs that rather surprises me in light of war-time developments with high grade insulating materials. One assumes that such feedline would use moisture-repellant dielectric, but that obviously cannot be so when the W's find it necessary to "Simonize" such feedline before stringing it for exposure to the elements.

* * *

Here's a thought to act upon. Why on earth don't the gang make more use of 80 metres for daylight CW

working between city and country locations? 3.5 to 3.8 M/cs. is an excellent region for such work and lack of such occupancy shows lack of intelligence in making use of available frequencies for general communication. Ask any ex-Service W/T Op. whether or not he found that region useful during his key-punching experience with Service traffic. One outstanding reason why a lot of VK's don't make better use of 80 is the ever present fear of BCL QRM. Such QRM is not likely to occur at all on CW with sensible precautions, and lots of stations now crowding in corners on 40 would do well to transfer their activities to 80 for daylight work over a few hundred miles. If you are accustomed to keeping skeds with a particular pal 300 miles or so distant on 40, try doing it on 80, and I think you will enjoy a pleasant surprise. Also, that big wide open space is ideal for QRM-free working, although it will be a different story in the winter months at night time. I recall that prewar the RAAFWR didn't have any trouble in daylight CW work between Melbourne and Sydney on the band.

* * *

The issue for 1947 of the NZART's annual call sign book, published in January, has just reached me and I am impelled to say that in comparison our VK book by the P.M.G. Department is a very uninspiring effort. Published in New Zealand by the editors of "Break In", not their Postal Department, this book has everything that the ZL needs to hand. Right up to date are the ZL calls, and there are sections devoted to NZART information, International prefixes, Frequency allocations, Operating data, Signal reporting, The Q Code, Great Circle bearings, Laws of amateur radio, and Operating Procedure. Subscription to NZART is only 7/6 a year, and it is worth it for their excellent issues of "Break In" and this annual call book. Address is P.O. Box 489, Wellington, N.Z.

* * *

Have been glossing through a new high grade American mag

Popular "G" Returns Home

There have been quite a few nautical stations around the seven seas and the Australian coast since the post-war return to the DX bands, but the most well-known and popular with the VK gang on "twenty" phone has been VK-2ANE. This call sign was allocated by our P.M.G. Department to Eric Sherlock, radio officer on the British freighter "Chertsey," and he made very full and excellent use of it. With a handful of watts input and suppressor modulation on an English pentode, known as a PT15, Eric stacked up a pile of QSO's and made a large number of friends among VK's. In a letter to your scribe, here is what ex-VK-2ANE says about things. "At the present moment I am writing this on watch, with the 'Chertsey' rolling along at a mere 10 knots. We are due in Fremantle and the engineers talk of staging a breakdown as they have shopping to do. In that case I might meet a few of the VK6 boys. After checking through my log I find that in 140 days operating I have wroked 32 countries, WAC five times, and worked over 200 VK's. All on 20

metre phone. I don't think that is too bad considering I was some time getting the TX to perk as I wanted it. We are bound for Savona, Italy, and the idea meanwhile is to get one of those XA calls. These are issued by the Services. My G call for the home QTH has not arrived yet, but I hope to hear of it before I get home. The British P.M.G. now issues mobile marine calls for use in home waters, so I am writing for permission to operate while nearing U.K. and around the coast. My address for QSL's will be OK via the VK2 (WIA), RS-GB, and Shortwave Magazine QSL Bureaux. I really enjoyed being a VK and it made the voyage on the coast so much the better. The Ham hospitality was 100 per cent, and fine business, the only catch being that I could not accept all invitations because of the time factor. If you ask me, I think the Hams of the world are the best UNO (that's exactly what this scribe has been saying for nearly two decade). Will write again when I have news of my activities."

—VK2NO.

called "Tele-Tech," and it strikes me as being a very FB job. Don't ask me what the sub is, I don't know; but it would not be cheap. The copy was loaned to me for a brief period, and among lots of interesting articles on VHF., F.M., Television and Radio in general, there were some reviews of American manufacturers' products. Two of them to catch the eye were: a paper tape recording outfit, called the Hyflux. This uses plain paper tape of the telegraphic kind, painted with metallic base powder. As in a steel-wire recorder, the tape passes adjacent to a magnetising head. It records for 30 minutes on a 7-inch diameter 8 MM film reel. The other: latest idea in Television by the Dumont Co.—they make use of a modulated light beam as the

medium for television pictures.

As this is written, early in March, news reaches me that in Brisbane VK4HR has been hearing signals from W7ACS/KH6 Honolulu on Six. If correct, this heralds, no doubt, the Pacific F2 Layer opening to Australia that we of the 50 M/cs band feel in our bones! The VHF world is no longer full of surprises, but there is much to be done south of the Equator. The overseas magazines, "QST", "Short-Wave Magazine," and "RSGB Bulletin" carry the epic story of the first 50 M/cs trans-Atlantic.

* * *

In the Sydney area the DX openings have been less frequent and the two last occasions were in the

(Continued on next page)

HAM NOTES

(Continued)

direction of Tasmania. There are, however, several periods when the band has all the symptoms of being open in some direction, but because of non-occupancy, the signals just aren't there. Stations active in and around Sydney show fluctuation in numbers with some stations off the air for various reasons. That staunch user of the band, VK2AZ, is off owing to an unforeseen change of QTH, with domestic arrange-

ments being such that Ham radio must wait. VK2WJ, also a leader on the band, has made a change of QTH and finds himself now assailed by car ignition troubles, being, perforce, located on a main highway. Among the active stations are listed VK's 2JU, 2AHF, 2EM, 2NP, 2ABC, 2DF, 2AFO, 2LZ, 2LY, 2LS, 2ABZ and 2NO, with newcomers on the band being VK2NI and VK2YQ. The latter station is located at the Schofields aerodrome about 30 miles out of Sydney, and is well down in the hollow with no line-of-sight path

to Sydney. His signal reaches my receiver at S3 only, but the Mountaineers get him at S8. Visiting Sydney has been Elgar Treharne, VK3AFQ, who says that there are about 30 active stations on Six in and around Melbourne. Congratulations are in order for VK3AFQ's OM Treharne Senior, who at no young age has just passed his AOCPE exam and will be appearing on the air with a station of his own. Having two sons, both active licensed Hams, Pop no doubt decided that he wasn't going to let them get away with *all* the honours!

GLADESVILLE (N.S.W.) CLUB NEWS

From Charles Fryar (VK2NP) come details of the doings in this small but active and popular gathering of suburban Sydney amateurs. Call sign of the club is VK2ADY and correct title is Gladesville District Experimental Radio Club.

Address is 113a Tennyson Road, Gladesville. A meeting is held each Thursday night in the club rooms at the address quoted, and for the benefit of A.O.C.P. aspirants, morse code is a feature of these meetings. Four members sat at the the last examination for the "Ticket", and all have high hopes of getting through. A Club station is being planned carefully and has now reached the testing stage. Reason for the establishment of a Club "rig" is for instructional purposes in transmission techniques. Features looked forward to regularly by Field Days and Auction Sales, the latter providing financial benefit for Club funds. The recent W.I.A. N.S.W. Division Field Day held at Wyong was attended by members Sullivan, Reddcliffe, and Fryar, who demonstrated 50 M/cs portable equipment to advantage. Transmitting members total 10 out of the 23 and all are active on all known frequencies excepting 1425 M/cs as yet !!! VHF interest runs high in this club with members

sectionalised in groups such as Antennae, Receivers, RF section for Transmitter Construction, Power supplies and Modulation, Speech Equipment, etc. A Section leader is appointed to each section and is responsible to the Management Committee for progress and work done to club equipment. The scheme assures that all concerned receive proper training in each particular group, and that transference is made to other groups as time and knowledge permit. At a recent election of officers a change-over was made for everybody to ensure that all members got experience of administration. "ARW" watches the progress of this virile Club with interest and notes especially the attention to VHF work undertaken by members, headed by Charles Fryar (VK2NP) "Charlie" has, as this issue goes to press, been appointed Liaison Officer for VHF in the N.S.W. Division of the Wireless Institute of Australia, and "ARW" takes this opportunity of extending congratulations, and an expression of the opinion that the right man is appointed to the right job. Intending members for the Gladesville Club should address correspondence to the Hon. Secretary at 11 Shipley Avenue, Strathfield, N.S.W., marked "attention Mr. Paul Sullivan."

* * *

By courtesy of VK3YT a message came from ZL1AO saying: "Now operating on 50.64, 50.46, and 51.16 M/cs, both phone and CW. Will be pleased to arrange skeds for week-ends." The good Lord knows, we have been trying hard enough at this end—but time will tell. VK3YT says that so far *he* hasn't heard a signal on Six there in Ballarat.

* * *

From VK3WC, Horsham, Vic., comes details of doings on the band there. "Congratulations on the DX—heartening news indeed—at last dividends have been paid for long hours of toil and waiting. I had bad luck as when the DX broke we were in the throes of moving from Melbourne. However, I do feel that I was in it all to some degree, as that night you called me with the QTC (on twenty) and returned to Six yourself; I spent 3 hours getting the Melbourne boys on the band. I am settled, and now back on the band with 12 watts, unfortunately from DC mains. AC is not far off, however. Am working on the 50 and 166 M/cs bands with a 3 element rotary and a 16 element on the way. Am interested in the ground-plane type of antenna (see Philips Technical Communications No. 2, February, 1947, for a special article by G. Thompson). Last week we heard, but did not identify, a station on 53.5 M/cs.

with a badly surging signal, Q1 R1-9, time 1840 hrs EST."

SIX-METRE DOINGS IN N.Z.

* * *

Grounded-grid-technique for RF amplification should show definite advantages on 50 M/cs and it is planned to do some work on a special Converter in the near future, making use of a valve applicable for the purpose. It is noted in the advertisements in American magazines that a twin stage pre-selector for 50 and 144 M/cs is available, using grounded-grid RF amplifiers with lighthouse valves. For those who imagine that any old kind of valve can be used as a grounded grid RF stage, please note: valves used for such work are specially designed for the purpose. The valve for the job, available in short supply in this country, is the RL37.

* * *

A word from ZL3FB, Editor of the excellent ZL magazine, "Break-In": "The work you chaps are doing on 50 and 166 M/cs is very fine. We are very interested in it and are doing our best to get the gang here going on the two bands, so that there may be the chance of that VK-ZL 6 metre QSO before long. Our Ionosphere people here tell us that March should be another good month, so we live in hopes." Because of higher priority on 50 M/cs relative to possible DX, activity on 166 M/cs in and around Sydney is at present very limited.

* * *

In common with many other Hams, I have a habit of browsing around the bookshops, on the look out for anything of interest to read in the shape of copies of overseas periodicals. Normally, such a quest is hopeless in these times; only way to get copies of mags. one was accustomed to see prewar is to subscribe direct. Note, however, that the subscription fee is likely to make a bit of a hole in the pocket, an unpleasant feature which is enough to drive one to the Public Library.

From ZL2BJ, W. R. Hamer, of Napier, N.Z., comes this letter of interest to the 50 M/cs. gang:

"You might like to know what goes on in the Shaky Isles. These days I know that you have a large proportion of readers in N.Z., and I personally read your 'Calling CQ' notes before anything else. I trust that your section of the magazine will continue strong, and that you will keep emphasising the rights of radio amateurs. Here, we now have the full prewar band widths restored and also the promise of a band at 21 M/cs very soon. Six metres has been occupying some attention and there must now be dozens of 50 M/cs rigs scattered through the islands. As far as is known there have not yet been any inter-town contacts. The hilly nature of the country rather restricts line-of-sight distances, but no doubt some DX will be worked soon. Aspirants in Napier are ZL2PD and myself, and both stations are crystal controlled. ZL2PD has automatic tape transmis-

sions on 50.04 M/cs. and they have been heard 120 miles distant. He has an efficient 3 element $\frac{1}{4}$ -wave spaced beam array. 'Eighty' is the QRM band here, with about half the ZL hams having rigs active. At night the band is a mass of heterodynes (yes, OM, we can hear it all over here, but it's all good fun.—D.B.K.) and we do not find many VK's on the band. Those that make an appearance are eagerly sought after by the ZL's. My own station, ZL2BJ is always on the qui vive for QSO's with VK's on '80', either on CW or phone. Frequency is 3590 K/cs. The Six metre rig at my station consists of a 6L6 regenerative oscillator using the 3590 crystal with the 5th harmonic fed to a 6L6 tripler. Anode-circuit of this is tuned to 53.85 M/cs. and feeds a 6V6G buffer. The final stage is an 807 with 25 watts input and modulation is by a pair of AB1 6L6's."

Thanks, ZL2BJ—any more correspondents interested in 50 M/cs from across the Tasman Sea?

~~~~~

Sometimes one *does* run across an odd copy or two of scarce, but very prominent American Technical publications on the bookshop shelves, but a glance at the pencilled price thereon is enough to provoke a loud whistle. Spotted three copies of a high grade American magazine covering radio and electronics, and despite the fact that they were months old, the price marked thereon in pencil was 8/6 per copy! Prewar the figure would have been 2/6, and dear at that. Now for one copy is asked the best part of a year's subscription to "A.R.W."!

Because of such prohibitive prices I have no hesitation where the occasion befits in passing on ideas from overseas publications in these pages, with due acknowledgment, of course. Technical literature is essential to progress of future generations and there is no blinking the fact that Australia does not have access to the very latest in scientific development, and cannot, for lots of reasons, publish magazines to compare with many from overseas. No young man with a yen for things scientific should be faced with extortionate prices for magazines.

(Continued on page 41)



# Shortwave Review

CONDUCTED BY

L. J. KEAST

## NOTES FROM MY DIARY

### TIME, GENTLEMEN, PLEASE!

Listeners are reminded that London clocks were advanced one hour as from March 16, and on April 13 will go forward another hour. That does not, of course, affect Greenwich Mean Time, but it is quite possible before these pages reach you the Pacific Service from the BBC will have reverted to our winter schedule of 3—7 p.m.

### IT IS NOW CRYSTAL CLEAR

Just a little over two years ago Dr. Gaden notified me he had heard HCJB, Quito, on 15.095 mc, 19.87 m. It now transpires this frequency was occasioned by a crystal ground to that particular frequency and an attempt to regrind it was not successful, but just recently a new crystal was obtained, and HCJB then moved to 15.115 mc, 19.84 m, where they can be heard most nights from 10 o'clock.

### SAIGON SPECIAL BROADCAST

I regret that my letter will not be among the many that have doubtless left these shores in anticipation of an acknowledgment from Saigon for a correct report on the special broadcast to "Radio News" on Sunday, March 16. I had hurried home by car and a check of the 25 metre band at 7.30 showed everything O.K., and I heard KNBX on 11.79 mc close at that hour with an excellent signal. But at 8 o'clock local interference just threw a blanket over 11.78 mc, and moving to 4.81 mc I still had no luck. I have since been told that at the last minute Saigon used 6.19 mc. Well that's how it goes, and like golf one hopes to do better tomorrow.

### THEY ARE NOT DINKUM

In March issue of "A.R.W." I mentioned Bryan Hayes had ceased to verify reports on BBC transmissions. The reason is contained

in a letter Mr. Phil Byard, of Launceston, Tasmania, has received from Mr. Phillips (Engineering Controller of the BBC) which reads, "The verification card which you kindly sent on (for GSB) is particularly interesting, because the person who has signed it (B. Hayes) has no connection with the BBC and is not authorised to issue verification of reception of our transmissions. I understand the matter is being taken up from the legal aspect and regret to say that this verification card, from the BBC's standpoint, is spurious."

So toss those cards away if you have received any. The BBC would,

if they could, willingly send verification cards, but with so many transmitters in operation at the same time and so much of their programmes being used in transmissions to many countries on frequencies only a few kilocycles apart actual verification is extremely difficult. They do, however, have their own observers in various parts of the world, and it is through them that so many suitable frequencies are chosen. Don't forget the BBC are always anxious to receive reports on programmes, particularly as to how the subject matter chosen for our Pacific Service, for instance, appeals to listeners.

---

## NEW STATIONS

XICR, ?, Shanghai, 6.04 mc, 49.67 m: Rex Gillett gives particulars of this one, but is doubtful of call letters and location. All programme and not a good transmission is in Chinese and appears to open at 8.30 p.m. So far I have not heard it.—L.J.K. (This is an assigned frequency for XGSA, Nanking.—L.J.K.)

Radio Saigon, 6.195 mc, 48.47 m: Although this frequency allotted to French Indo-China and used a few years ago it was not heard until last ???

This frequency allotted to French-Indo China many years ago and used by them before the war, has apparently been "off the air" for a good while, but as mentioned elsewhere in these pages came back suddenly, replacing 4.81.

TGLB, Mazatenango, 6.905mc 43.44 m: This is a new station in Guatemala and relays TGL-TGLA

from 10 am—1 pm. Its slogan is, "La Voz de Mazatenango" and is reported per air mail by Roger Legge.

### DON'T MISS THIS SWISS MISS

It is quite likely during the winter months that the Swiss Broadcasting Corporation will introduce two new broadcasts to Australia on 11.865 mc, 25.28 m, and 11.715 mc, 25.61 m. The schedule has not yet been determined, but will probably be for an hour or so, commencing around 5 pm.

### CHANGE OF FREQUENCY

ZBW-3, Hongkong, 9.515 mc, 31.53 m: Like several other stations round that part of the globe, Hongkong has had some tripping about, but on this frequency, reported by Rex Gillett, they are heard well at 9 and 11 pm, in relay of BBC news.



# The MONTH'S LOGGINGS



## ALL TIMES ARE EASTERN AUSTRALIAN STANDARD TIME

Pressure on space only permits of unusual Loggings or alterations in schedules or frequencies.

Readers will show a grateful consideration for others if they will notify me of any alterations. Please send reports to L. J. Keast, 6 Fitzgerald Road, Ermington, N.S.W. Phone: WL 1101.

## OCEANIA

### AUSTRALIA

VLA-4, Lyndhurst, 11.77 mc, 25.49 m: Good signal from 6.30—9 a.m.—L.J.K.

VLW-7, Perth, 9.52mc 31.51 m: Excellent signal when opening with news at 8 p.m.—L.J.K.

VLC-4, Shepparton, 15.23 mc, 19.58m: To Forces in Pacific, Japan, and India from 6.55—8 p.m.

VLB-5, Shepparton, 21.54mc, 13.93 m: From 1.15—5.29 p.m. on Saturdays only. Race descriptions, etc.

VLG-7, Lyndhurst, 15.16mc, 19.79 m: From 1.15—5.29 p.m. on Saturdays only. Race descriptions, etc.

### FIJI

Radio Suva, 6.17mc, 48.62m: Can be heard well most nights with weather reports around 9 p.m. (Miss Sanderson).

## NEW CALEDONIA

Radio Noumea, 6.16mc, 48.70m: Note change in frequency. Good signal from 5.30—8 p.m.—L.J.K.

## NEW GUINEA

VLG, Port Moresby, 15.08mc, 19.89m: Often heard at night contacting Australia.

## NEW ZEALAND

ZLT-7, Wellington, 6.715mc, 44.68m: News heard at 7 p.m.

## THE EAST

### CHINA

XGOY, Chungking, 11.92mc, 25.27m: News at 8.30 p.m. (Miss Sanderson).

XGOA, Nanking, 11.83mc, 25.36 m: Splendid signal on this new frequency around 9.15 p.m.—L.J.K.

XORA, Shanghai, 11.69mc, 25.66 m: News and music from 7.45 p.m. (Miss Sanderson).

### CEYLON

SEAC, Colombo, 15.12mc, 19.84 m: Gives programme details at 8.15 p.m.

SEAC, Colombo, 7.185mc, 41.75 m: Heard on Mondays from 4.30—6.30 a.m.

SEAC, Colombo, 6.075mc, 49.38 m: Fair late at night.

### CELEBES

Radio Macassar, 9.36mc, 32.00m: Dutch interspersed with music. Good at 10 p.m.

### FRENCH INDO-CHINA

Radio Saigon, 11.78mc, 25.47m: Good nightly from 8 o'clock.—L.J.K.

Radio Saigon, 4.81mc, 62.37m: m: Very noisy and now seems to have been replaced by 6.19mc, 48.47m.—L.J.K.

Radio Saigon, 6.19mc, 48.47m: Am hearing Saigon here instead of on 4.81mc. (Gillett).

### JAPAN

WLKS, Kure, 6.105mc, 49.14m: This BCOF station is heard nightly with new closing time of 8 o'clock, when station announcements are made. Signals poor. (Gillett.)

Radio Tokyo, 4.95mc, 60.61m: Quite a loud station and easily identified. (Simpson.)

### INDIA

VUD-10, Delhi, 17.83mc, 16.82m: Good in afternoons . . . Chinese programme at 8 p.m.—L.J.K.

VUD-8, Delhi, 21.51mc, 13.95m: News and music at 8 p.m. (Miss Sanderson). Best in late afternoons.—L.J.K.

VUD-3, Delhi, 15.29mc, 19.62m: News in English at 10.30 p.m. (Gillett).

## GEORGE BROWN & CO. PTY. LTD.

267 CLARENCE STREET, SYDNEY. Phone: M 2544

DISTRIBUTORS TO THE TRADE FOR

ROLA SPEAKERS • EVEREADY BATTERIES • AEGIS

RADIO COMPONENTS • ULTIMATE RADIOS • MULLARD

VALVES • I.R.C. RESISTORS

And All Brand Line Radio Components

★ AEGIS 4 VALVE AND 5 VALVE KIT SETS COMPLETE NOW AVAILABLE



VUD-3 Delhi, 11.845mc, 25.33m:  
News in English at 10.30 p.m.  
(Gillett.)

#### PHILIPPINES

KZPI, Manila, 9.71mc, 30.90m:  
Good at night and also fair before  
breakfast.—L.J.K. Heard  
opening at 7.30 a.m. (Gillett.)

KZRH, Manila, 9.64mc, 31.10m:  
An old favourite and always a  
good programme.—L.J.K.

#### PORTUGUESE CHINA

CR8AA, Macau, 9.235mc, 32.49m:  
News in Chinese at 10 p.m.  
(Miss Sanderson.)

#### HONGKONG

ZBW-3, Hongkong, 9.525mc,  
31.49m: BBC relay at 9 p.m. (Miss  
Sanderson.) Has now moved to  
9.515mc, 31.53m (Gillett.)

#### INDONESIA

PLP, Bandoeng, 11.00mc, 27.27m:  
Very good nightly.

PLY, Bandoeng, 10.06mc, 29.79m:  
Also very good nightly.

#### MALAYA

Radio Singapore, 11.735mc, 25.56  
m: News in Dutch and clock  
chimes at 8.30 p.m. (Miss San-  
derson.)

Radio Singapore, 6.77mc, 44.31m:  
Providing conditions satisfactory,  
news in English can be heard at  
10 p.m.—L.J.K.

#### SIAM

HSPP, Bangkok, 5.99mc, 50.08m:  
Difficult to hear because of noise,  
but sometimes audible at 10 p.m.

#### GREAT BRITAIN

##### BBC LONDON

GSK, 26.10mc, 11.49m: Opens at  
9.15 p.m. to East Africa, Near  
East and Eastern Mediterranean  
Area.

GSV, 17.81mc, 16.84m: Directed  
to India and South-East Asia  
from 8 p.m. and puts in an ex-  
cellent signal nightly, especially  
around 10 o'clock.

#### EUROPE

##### ALBANIA

ZAA, Tirana, 7.85mc, 38.15m:  
News in English at 6.15 a.m.  
(Miss Sanderson.)

##### AUSTRIA

Radio Vorarlberg, Dornbirn, 6.005  
mc, 49.95m: Verified by letter in

two months. Is on the air from  
3—4.45 p.m. and 2—9 a.m.  
(Roger Legge).

#### BULGARIA

Radio Sofia, 9.35mc, 32.09m: Very  
poor signal at 6.30 a.m.

#### BELGIUM

RNB, Brussels, 17.84mc, 16.82m:  
Can be heard almost nightly till  
closing at 10.30 p.m.

#### CZECHOSLOVAKIA

OLR-5A, Prague, 15.23mc, 19.7m:  
Scheduled to North America  
daily 10 a.m.—11 a.m.; News in  
English at 10.35 (Radio News).

OLR-5C, Prague, 15.16mc, 19.79  
m: Opens at 1a.m.

OLR-4A, Prague, 11.84mc, 25.34  
m: Good at 6.30 a.m.—L.J.K.

OLR-3A, Prague, 9.55mc, 31.41m:  
News in English to N. America  
at 4.45 a.m. (Radio News).

OLR-2A, Prague, 6.01mc, 49.92m:  
News in English at 4.45 a.m.  
Radio News). News in English  
at 6.45 a.m. (Miss Sanderson).

#### FRANCE

Radio Paris, 15.35mc, 19.54m:  
Very good at night.—L.J.K.

Radio Paris, 15.24mc, 19.69m: Ex-  
cellent late at night.—L.J.K.

Radio Paris, 11.88 mc, 25.22m:  
News in French at 3.45 p.m.  
(Miss Sanderson.)

Radio Paris, 9.52mc, 31.51m: Very  
good at 6 a.m.

Radio Paris, 7.24mc, 41.44m: Be-  
ing heard at 6 a.m.—L.J.K.

#### GERMANY

Radio Leipzig, 9.733mc, 30.83m:  
"Mitteldeutscher Rundfunk"  
heard in early mornings relaying  
Berlin programme. (Gillett.)

Radio Munich, 9.54mc, 31.45m:  
Very good till closing at 7.30  
a.m. (Miss Sanderson.)

Radio Munich, 7.29mc, 41.15m:  
Fair at breakfast time. (Miss  
Sanderson.)

Radio Munich, 6.17mc, 48.62m:  
Only fair in mornings.—L.J.K.

#### GREECE

SVM, Athens, 9.935mc, 30.20m:  
Heard occasionally in early  
mornings.

—, Athens, 7.295mc, 41.21m:  
"Stathmos Athinon" gives news  
at 6.15 a.m. in English.—L.J.K.

#### HOLLAND

PCJ, Hilversum, 17.77mc, 16.89m:  
Tuesdays 6—7.30 p.m. (Cush-  
en).

PCJ, Hilversum, 15.22mc, 19.70m:  
News in English at 11.30 p.m.  
(Miss Sanderson). Special on  
Tuesdays at 6—7.30 p.m. (Cu-  
shen).

PCJ, Hilversum, 9.59mc, 31.28m:  
Special programme for Australia  
and New Zealand on Tuesdays  
from 6—7.30 p.m.

PCJ, Hilversum, 6.023mc, 49.79m:  
Tuesdays 6—7.30 p.m. (Cu-  
shen).

#### ITALY

Radio Italiana, Milan, 9.63mc,  
31.15m: Very good just before  
breakfast.—L.J.K.

#### VATICAN CITY

HVJ, 9.66mc, 31.06m: Excellent  
at 4.30 p.m. (R & H).

HVJ, 6.19mc, 48.47m: Good with  
English at 6 a.m.

HVJ, 5.97mc, 50.27m: See re-  
marks above.

#### SPAIN

Radio Espana, Madrid, 9.37mc,  
32.00m: Very good in mornings.  
—L.J.K.

#### SWITZERLAND

HER-7, Schwarzenburg, 17.784  
mc, 16.87m: Can be heard on Mon-  
days only at 6 p.m. (R & H).

HER-6, Schwarzenburg, 15.30mc,  
19.60m: Opens at 1 a.m.

HER-5, Schwarzenburg, 11.865mc,  
25.28m: Watch for special trans-  
mission to Australia on Mondays  
and Thursdays, commencing  
about 5 p.m. very shortly. (Is  
now being used on Tuesdays and  
Saturdays from 5.15 p.m. —  
L.J.K.)

HEI-5, Schwarzenburg, 11.715mc,  
25.61m: Special for Australia on  
Tuesdays and Saturdays from  
5.15 p.m.

HER-4, Schwarzenburg, 9.35mc,  
31.47m: News in French and Eng-  
lish at 8.15 a.m. (Miss Sander-  
son).



HER-3, Schwarzenburg, 6.165mc, 48.66m: An old timer back again in the mornings.

## SCANDINAVIA

### FINLAND

OIX-2, Pori, 9.503mc, 31.57m: Fair around 6 a.m.—L.J.K.

### NORWAY

LKQ, Fredrikstad, 11.735mc, 25.56 m: Heard well at 7 a.m. . . . seems to sign off at 9 o'clock. (Gillett.)

LKJ, Oslo, 9.54mc, 31.45m: Heard well at 7 a.m. . . . seems to sign off at 9 o'clock. (Gillett.)

LLJ, Oslo, 6.195mc, 48.50m: Heard well at 7 a.m. . . . seems to sign off at 9 o'clock. (Gillett.)

### SWEDEN

SBT, Motala, 15.155mc, 19.80m: Heard fairly well at 5 p.m. (Miss Sanderson.)

SBP, Motala, 11.705mc, 25.63m: Excellent signal in English lesson and music at 5 p.m. (Miss Sanderson.)

SDB-2, Motala, 10.78mc, 27.83m: Very good in early morning and till 6.30 a.m. (R & H).

## CENTRAL AMERICA

### COSTA RICA

TIGPH, San Jose 5.87mc, 51.07m: Heard 10 a.m.—1 p.m. as "Alama Tica;" from 1 p.m.—2 p.m. announces as "La Reina del Aire" (Roger Legge).

### GUATEMALA

TGLB, Mazatenango, 6.905mc, 43.44: See "New Stations."

### PANAMA

HOXA, Panama City, 15.10mc, 19.86m: Good at 11.15 a.m. (Miss Sanderson.)

## SOUTH AMERICA

### CHILE

CE-1180, Santiago, 12.00mc, 25.00 m: Opens at 9.30 p.m. (Gillett.)

CE-1190, Valparaiso, 11.90mc, 25.21m: Heard opening nightly at 9.30 p.m. with playing of "Land of Hope and Glory" (Gillett.)

### ECUADOR

HCJB, Quito, 15.155mc, 19.85m: News in English at 7.45 a.m. (Miss Sanderson.)

HCJB, Quito, 12.455mc, 24.08m: Very good at 8.30 a.m. (Miss Sanderson).

### PERU

OAX4P, Lima, 5.87mc, 51.07m: Note this new frequency . . . was 8.975mc. (Cushen.)

## MISCELLANEOUS

### AZORES

—, Ponta, Delgada, 7.018mc, 42.76 m: "Emissora Regional Azores" with power of 1000 watts has replaced 11.09mc at 6 a.m. (The Azores on 7.018mc, was first reported by Rex Gillett just over a year ago.—L.J.K.)

### IRAN

EPB, Teheran, 15.10mc, 19.86m: Verified after 4 months by registered letter (Roger Legge).

### MARTINIQUE

Radio Martinique, Fort-de-France, 9.342mc, 32.12m: Has moved to here from 9.705mc and is heard much better. Signs on at 9 a.m. (Roger Legge).

### MEXICO

XEHH, Mexico City, 11.88mc, 25.25m: News in Spanish and chimes at 12.45 p.m. (Miss Sanderson.)

### SYRIA

FXE, Beirut, 8.036mc, 37.33m: Verified in 3 months with nice card. Schedule is: 3—4.15 p.m.; 8.15—11 p.m.; 1.30—7 a.m. (Roger Legge.)

### TURKEY

TAP, Ankara, 9.465mc, 31.70m: Excellent daily at 7 a.m.

## WEST INDIES

### CUBA

COKG, Santiago, 8.95mc, 33.50m: Musical selections at 9.30 p.m. (Miss Sanderson.)

COHI, Santa Clara, 6.45mc, 46.48 m: Excellent at 9.40 p.m. (Miss Sanderson.)

### HAITI

HHCM, Port-au-Prince, 6.165mc, 48.06m: News in French at 9.30 p.m. (Miss Sanderson.)

## CALLING CQ

(Continued)

## SIX METRE DX NEWS

### FLASH!

Headquarters station of the A.R.R.L., W1AW, broadcast the following information on April 2, 1947:

"To all radio amateurs. The first two-way contact between North and South America occurred March 23 at 2.50 p.m. E.S.T. (5.20 a.m. 24th Sydney Time), when W4IUJ of West Palm Beach, Florida, worked OA4AE, Lima, Peru, a distance of 3000 miles. W4GJO of Orlando, Florida, also worked OA4AE shortly after. W4IUJ becomes eligible for the Milwaukee Radio Amateur Club 50 M/cs. Cup, offered to the first amateur making two-way contact with another Continent on 50 M/cs. from the Mainland.

Favourable propagation conditions on March 24 resulted in reception of 50 M/cs. automatic transmissions from PAUN by South African stations ZS1P, ZS1T, ZS1AX, and ZS1DJ, over a distance of 6000 miles."

It will be observed from these contacts that the North-South Path is predominant. The Dutch station, PAUN, was granted special permission by the Netherlands Government to use the 50 M/cs. band, which is not yet allocated in that country. This is in sharp contrast to Britain, which flatly refused permission to amateurs there to work in the 50-54 M/cs. region instead of the allotted 58-60 M/cs.

—VK2NO.



# Speedy Query Service

ment winding, but you will have to make allowance for the lower actual voice coil impedance, etc.

**S.D. (Euston) wants a battery-powered amplifier for outdoor work.**

A.—You can get a "disposal" rotary converter from Waltham which will give you 500 volts at 50 milliamps and 275 volts at 110 milliamps for a 12 volt 10 amp. input. Using a couple of car batteries in series you can handle the 10 amp. drain for at least four or five hours, which is all you will need for your purpose. By putting the 500 volts on to the plate of an 807, and the 275 on to the screen and audio amplifiers you could build up an amplifier to give you about 15 watts. Inverse feedback will be desirable and easily fitted.

## PICK-UPS

(Continued)

whole of this set-up calls for an outlay of about £20, but this does not seem to deter the enthusiast in his pursuit of quality reproduction.

And as usual there has been the crop of lesser-informed readers who want to know how to apply a tone-correcting pre-amplifier to their old "Ether-atom" magnetic pick-up. It should be clearly understood that all we say and have said about tone-correcting pre-amplifiers is intended to apply only to the low-output type of moving coil pick-ups. We don't know any way of getting superlative results from ordinary magnetics.

Before going any further, in fact, I really should mention that I have been using the term "frequency response" in a rather loose fashion. There is a great deal more to it than mere frequency response, and the old magnetic pick-up falls down in many other directions, introducing harmonic distortion, changing wave form and so on. In all these directions the moving coil types have considerable advantage. After testing one you soon realise that most amplifiers at present are limited in their performance, largely according to the type of pick-up used, as well as by the recording itself and the speaker.

**C.L. (Euston) is interested in the new-style battery valves.**

A.—At the moment of writing the miniatures do not seem to be ready for release, but they should be on the market shortly now. We have had a little experience with them, and so far they seem to be most promising. We have been playing about with a battery portable which gives much better results than we used to get with the ordinary 1.4 volt valves. Possibly the improved coils have something to do with this, but there is no doubt about the valves performing well and they seem to be reasonably robust internally, possibly due to the close support of the elements. You know the old story about how a mouse can drop twenty feet without hurting itself, but an elephant breaks his leg if you drop him a few inches, or something like that. Probably the same theory will provide that the "peanut" valves will stand up better to being carried in the post than the older valves.

**A.N. (Bathurst) enquires about writing contributions for publication.**

A.—We would prefer you to pick your own subjects on which to write. We have already gone over most of the things we think are suitable and would appreciate a fresh point of view. It is not much use going in for mathematics on account of the problem of printing complicated equations, Greek symbols and so on. When submitting your articles be sure to enclose an invoice showing the amount you wish to receive for the article. We will then pass it to the accountant for payment when the article goes to the printer for publication.

**C.S.S. (Toorak) wants to have his receiver attended to, but is afraid of ordinary radio servicemen, as the set is an imported one of unusual type.**

A.—Sorry, but we haven't anyone in mind that we could recommend as being able to handle the job. So far as we know there is no reliable radio laboratory offering service to the public; a sad state of affairs, but that is how it seems to be.

**M.S. (Geelong) enquires about disposal bargains.**

A.—Sorry, but most of your queries

are beyond us and we will need to go into the matter more deeply to find out just what is what. The gun-laying radar receiver would appear to be of little use except for the bits in it, but these should be handy. Of the valve types you mention, the only one which we know well is the VR65A. This tube and its 4-volt equivalent, the VR65, are Mazda types similar to the EF50, with very high slope and ideal for use in i.f. stages at comparatively high frequency.

## CONTRIBUTIONS

**When posting in their manuscripts, contributors are requested to attach an invoice, showing the value they place on their article. When the article is published a cheque will be posted for the amount shown on the invoice.**

**E.A.D. (Cremorne) asks about a circuit for a receiver suitable for "ham" use.**

A.—In the issue for March, 1946, Don Knock described a circuit which he designed for "ham" use and it should suit your purpose admirably. Copies are still available from our Back Dates Department, at 1/- each, post free.

**F.L.K. (Ararat) asks whether power output can be measured with an a.c. voltmeter.**

A.—You can connect the meter across the voice coil and get a fair idea of the power output, especially if you have a source of a 400-cycle note to feed into the amplifier. Working at 400 cycles, you can assume the voice coil impedance to be according to the maker's rating, 2.3 ohms in the case you mention. If you get a 2.3 volt reading across it the current should be about 1 ampere and the watts about 2.3, as per Ohm's Law. You can work with a 50-cycle note from a power transformer fila-

## TESLA COIL

**Mr. K. Ellis of 74 Barrett Street, Albert Park, Victoria, is anxious to get in touch with anyone who can quote for the winding of a Tesla coil with a secondary to throw a 12" spark.**



# RED



# LINE

## EQUIPMENT

### Frequency Dividing Networks

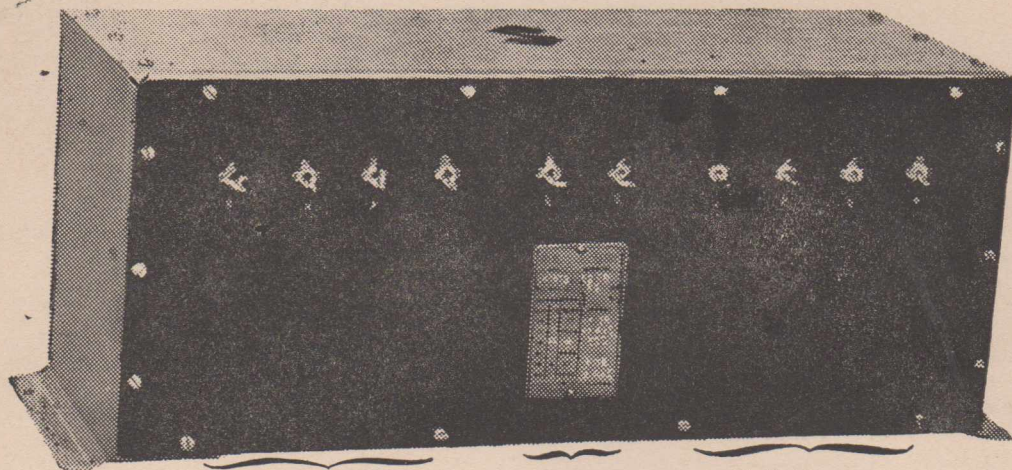

H. F. CHANNEL  
2 OHMS

500 OHM  
INPUT

L. F. CHANNEL  
8 OHMS

### GENERAL

Type D482 is specifically designed for High Fidelity radio gramophones and small talking picture sound installations. The unit consists of a shunt type cross-over network using high "Q" inductances and is intended for insertion in a 500-ohm line. Loud-speaker input transformers are incorporated in the unit, the voice coil winding being brought out for each channel to 4 terminals for connection either in series, for conventional operation, or in parallel for use with loading resistances for medium and high power circuits with wide range characteristics such as the "Full Frequency Range Amplifier."\* This latter method will present what is virtually a constant load to the output tubes with an extremely high damping factor and lead to a marked improvement in transient response.

\* Reprints of the article describing design and construction of this amplifier are available in pamphlet form from:

### SPECIFICATIONS

OPERATING LEVEL: Plus 39 db max. INSERTION LOSS: Approximately .5 db. CROSS-OVER FREQUENCY: 500 cps. ATTENUATION: Low frequency channel—20 db at 1200 cps. High frequency channel—20 db at 150 cps. INPUT IMPEDANCE: 500 ohms. OUTPUT IMPEDENCES: Low frequency channel—8 ohms for 1 "Rola" Type G12. High frequency channel—2 ohms for 1 "Rola" Type 8M (if parallel connected, output impedences will be 2 ohms and .5 ohms and require to be shunted with resistences of 2.67 ohms and .66 ohms respectively). FREQUENCY RESPONSE (Both channels): Within 1 db from 30 cps to 12,000 cps.

Weight: 18 lbs.

Size: 13 x 5½ x 5.

LIST PRICE: £10/10/-.

## SWALES & SWANN

Technical Service, Wholesale and  
Manufacturers

A. T. SWALES, Gen. 4773

2 Coates Lane, Melbourne



Trade Sales: Allen SWANN

MU 6895 (3 Lines)

157 Elizabeth Street, Melbourne

A GUARANTEE

OF DEPENDABILITY



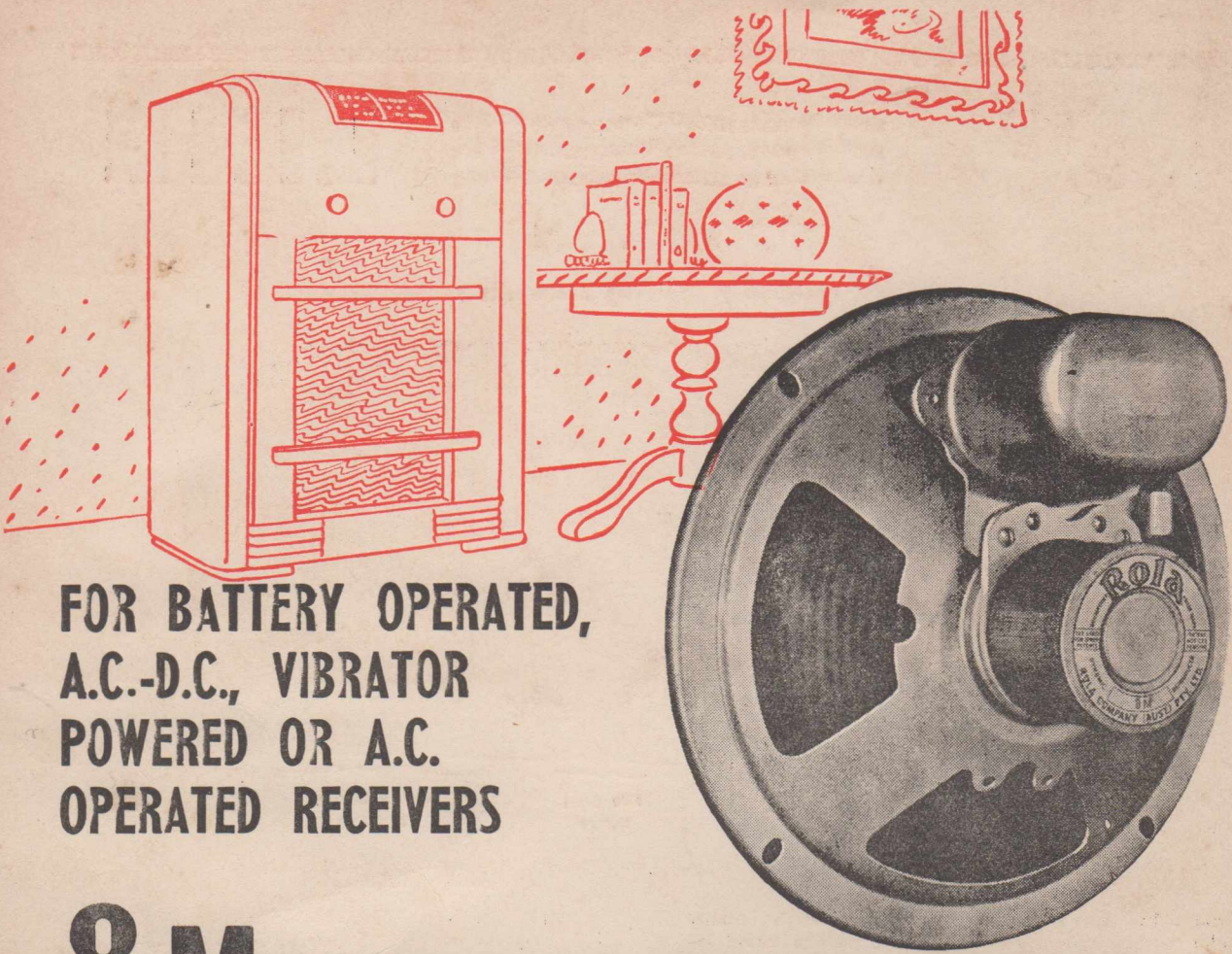

**FOR BATTERY OPERATED,  
A.C.-D.C., VIBRATOR  
POWERED OR A.C.  
OPERATED RECEIVERS**

# 8 M WITH ANISOTROPIC ALNICO

The ROLA 8M Speaker is eminently suited for incorporation in battery operated, AC-DC, Vibrator Powered or AC operated receivers. Wherever higher than normal speaker efficiency is called for the ROLA 8M is the speaker to use.

Here are the facts:— ★ The ROLA 8M is energised by a generously sized magnet of Anisotropic Alnico. ★ Efficiency of the ROLA 8M is appreciably higher than "Standard 8" speakers. ★ Fitted with ROLA isocore (Type C) Transformer, the ROLA 8M ensures against failure due to electrolysis in battery operated receivers.

Specifications: Weight (Speaker and Transformer), 2.87 lbs.; Diameter of cone housing, 8-1/16 inches; Distance front to back, 3-15/16 inches (approx.); Voice Coil impedance, 2 ohms.

*Limited supplies will shortly be reaching Rola Speaker Distributors.*

# **ROLA** LOUD SPEAKERS With ANISOTROPIC ALNICO