

**THE  
AUSTRALASIAN**

Registered at the G.P.O.,  
Sydney, for transmission  
by post as a periodical.

**1/-**

**VOL. 11 . . . . . NO. 10**

**MARCH 15, 1947**

# Radio World



**How to get highest fidelity  
from ordinary speakers.**



**“Maxmin” - circuit of sensitive  
four-valve mantel model.**



**Application of the Franklin  
array for six-metre band.**



**“Ham” notes, short-wave re-  
view and other interesting  
features.**

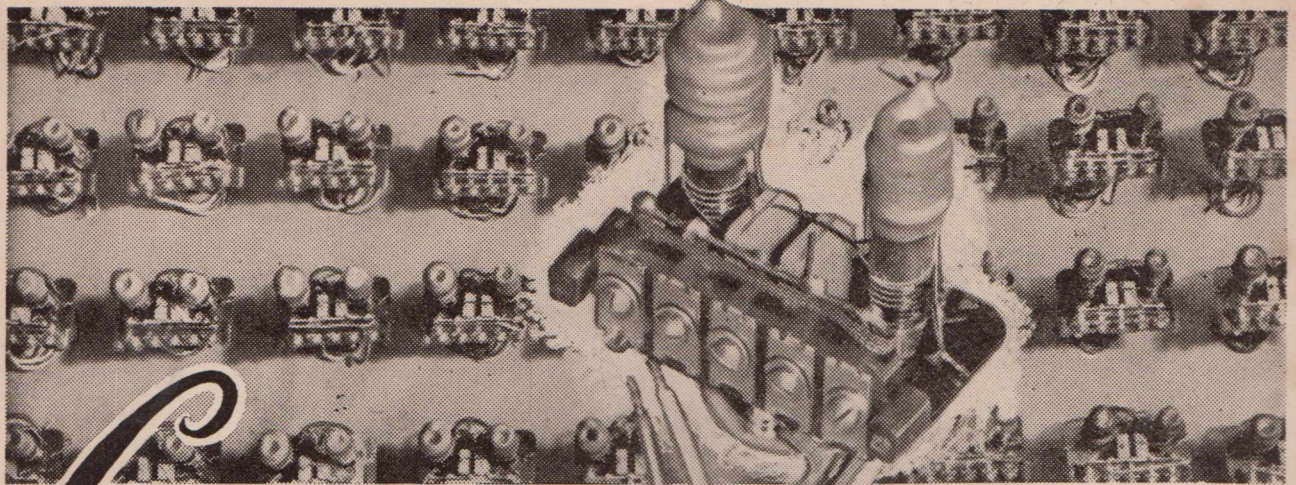

# Crown

## D. C. 2. A. Tuning Units (RANGE 13 TO 42 METRES)

Overall dimensions  $3\frac{1}{4}$ " long, 3" wide,  $2\frac{1}{8}$ " deep. Fitted with coloured leads to aid assembly, its general construction is such that it allows of compact receiver design. Coils are impregnated to withstand humid conditions. Each unit is set tested before leaving the factory. Retail price 36/-. Ample stocks available.

Plan wisely when you are building your Radio Set—insist on CROWN parts: B/C Coils, S/W Coils, I/F Transformers, Tuning Dials, Padders, Trimmers, etc.

CROWN parts are built to rigid standards and are precision tested before they leave the factory; that is your guarantee of quality.

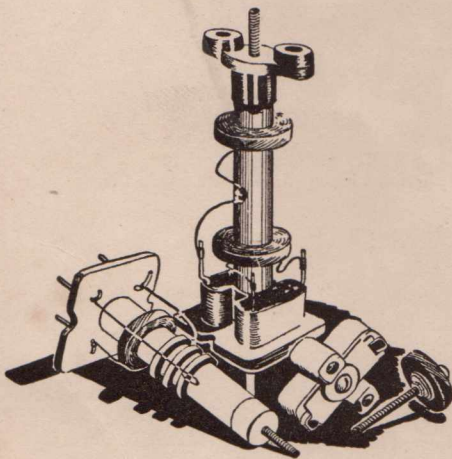

# Crown



RADIO PRODUCTS PTY. LTD.

51-53 MURRAY ST.  
PYRMONT, SYDNEY. TELEPHONE: MW 2628

# THE AUSTRALASIAN RADIO WORLD

Devoted entirely to Technical Radio

and incorporating  
ALL-WAVE ALL-WORLD DX NEWS

★ EDITOR

★ PUBLISHER

★ PROPRIETOR—

A. G. HULL

Balcombe St., Mornington,  
Vic.

★ SHORT-WAVE EDITOR—

L. J. KEAST

6 Fitzgerald Road, Ermington,  
N.S.W. Phone: WL1101

★ HAM NOTES By—

D. B. KNOCK (VK2NO)

43 Yanko Av., Waverley, N.S.W.

★ ADVERTISING  
REPRESENTATIVE FOR VIC.—

W. J. LEWIS

20 Queen St., Melbourne  
Phone: MU 5154

★ ADVERTISING  
REPRESENTATIVE FOR N.S.W.—  
AMALGAMATED PUBLICATIONS  
PTY. LTD.

83 Pitt St., Sydney

Phone: B 1077

★ SUBSCRIPTION RATES—

6 issues ..... 5/3  
12 issues ..... 10/6  
24 issues ..... £1

Post free to any address in  
the world.

Address for all correspondence:

AUSTRALASIAN RADIO WORLD

Balcombe St.  
Mornington  
Victoria

VOL. 11

MARCH, 1947

No. 10

## CONTENTS

### TECHNICAL

Another Type of Beam Array .....	5
Electric-Acoustic Coupling .....	7
Quick Systematic Testing .....	13
Sensitive Four-Valve Circuit .....	17
Radio Frequency Chokes .....	27
The Truth About Television .....	30

### SHORTWAVE REVIEW—

Notes from My Diary .....	38
---------------------------	----

### THE SERVICE PAGES—

Answers .....	42
---------------	----

## GUEST EDITORIAL

The amateur radio world now knows of the achievement of "QST's" VHF Editor, Ed Tilton, W1HDQ, in getting his 50 Mc/s signals across the Atlantic to G6DH and G5BY last November, and of the excitement at the British end. It fits in nicely with two things; firstly, that at the time it happened, the ARRL, through the radio amateur's "Bible" QST, was celebrating that eventful period 25 years ago, when Paul Godley went to Scotland and heard the first American amateur signals to cross the Atlantic. Godley camped in a tent on a Scottish moore. He heard one or two spark stations and quite a few C.W. British amateurs, working at home locations, burned the midnight oil in the dreary winter nights and they also heard the American signals. It was an exciting period, and one which I, as an active amateur then in England, still picture with vivid detail.

Now, 25 years afterward, the Atlantic is again crossed in pioneer fashion, at frequencies very different from those of more than two decades back.

The second point that fits in nicely is the location from which W1HDQ did the trick. This QTH is famous as being the spot where the late Ross A. Hull pioneered "Five meter" work in the 1930's. One can't help feeling that at the Selden Hill location from which W1HDQ at last crossed the Atlantic on "Six," the spirit of "R.A.H." is strongly in evidence. Ponder this over . . . at the time W1HDQ was heard by the G's, there were many American stations on the band trying hard to get across. But Ed Tilton's signal was the one and only one heard, and it held for an hour. Selden Hill is a pip of a VHF location, but is it only a coincidence that no other W's were heard? Maybe . . . but I like to think otherwise.

—D.B.K.

# THE BAROMETER OF WORLD OPINION

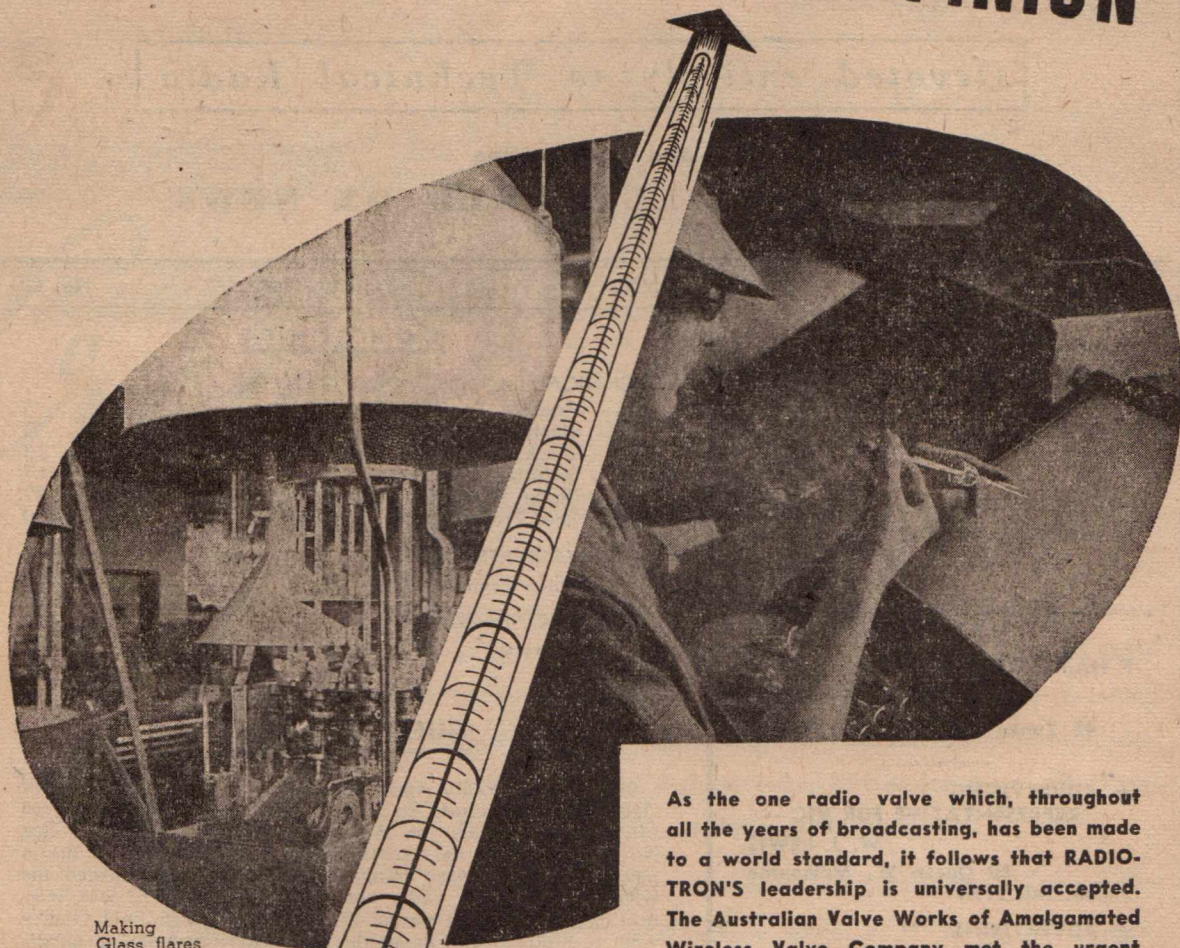

Making Glass flares for radio valves . . . .

. . . . Examining flares over an illuminated screen.

As the one radio valve which, throughout all the years of broadcasting, has been made to a world standard, it follows that **RADIO-TRON'S** leadership is universally accepted. The Australian Valve Works of Amalgamated Wireless Valve Company met the urgent needs and uncompromising standards of defence throughout the war — the same organisation, to-day, is increasingly competent to provide the growing needs of peace.

W&S

**AMALGAMATED WIRELESS VALVE COMPANY PTY. LTD.**

S&E



**Radiotron**  
VALVES  
MADE IN AUSTRALIA

Administration . . . . 47 York Street, Sydney, N.S.W.  
Manufacture . . . . Parramatta Road, Ashfield, N.S.W.  
Distribution . . . . . Crown Street, Glebe, N.S.W.

# ANOTHER TYPE OF BEAM ARRAY

## AS USED BY HOWARD LOVE ON SIX-METRE BAND

SHOWN in the photograph and indicated in the diagram are details of a little-publicised but very interesting form of directive beam array as used at the Mount Waverley, Vic., station of Howard K. Love (VK3KU). The one illustrated is for the 50 Mc/s band but so enthusiastic is VK3KU about its performance that the same scheme is to be applied to 28 and 14 Mc/s.

The array is based on the Marconi-Franklin Series-Phase system, the theory of which is detailed in Ladner and Stoner's "Short-wave Communications." Recently, "QST" had a brief reference to the idea for 50 Mc/s in W1HDQ's "World above 50 Mc/s." Says 3KU: "I find that this thing really works, requires no tuning and has a nice pattern. It takes up very little space . . . not much more than a 3 or 4 element parasitic type . . . and all the elements are driven. After this, I would not bother with any other type. The figures at 42 miles are: Front, 9 db plus; Side, 2 db; and Back, 3 db."

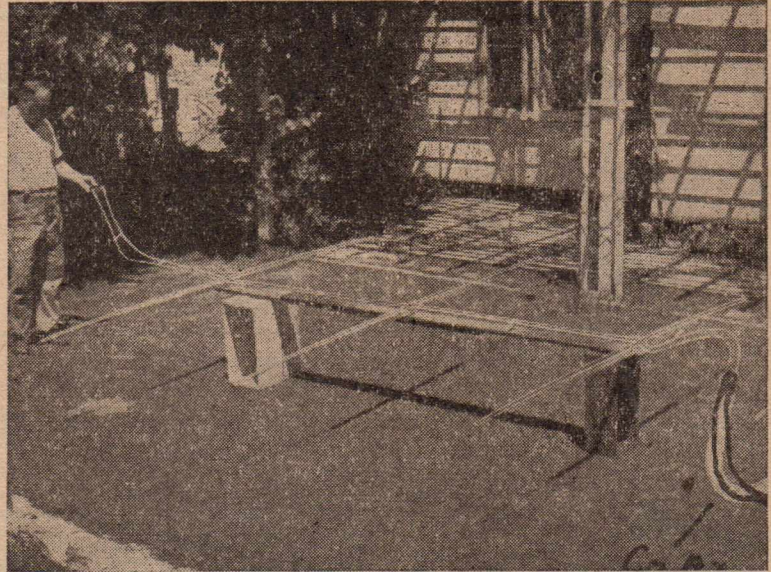

Howard Love with his latest beam array, on the ground ready for erection.

As shown in the diagram, the system is made up with six quarter-wave elements, but anything up to sixteen can be used. Spacing between the folded wires is half-inch only, and the directivity is as indicated. If the system is used hori-

zontally, the stubs at the ends, carrying the termination resistor and coaxial line can be hanging down at right-angles to the elements and consequently need not add to the total length. All that is needed is a light timber frame for support and it is suggested that applied vertically, the scheme would be something well worth-while at 166 Mc/s. Quite obviously the resonant peak of an array of this type will be comparatively broad, which is a useful feature. Those who have struggled to put parasitic arrays on peak tuning will appreciate this. The ease of feeding is also an attractive point . . . the coax. line is simply connected to the stub and the system draws current at the appropriate frequency. Construction for 28 Mc/s would not be difficult, but more of an engineering problem at 14 Mc/s.

—VK2NO.

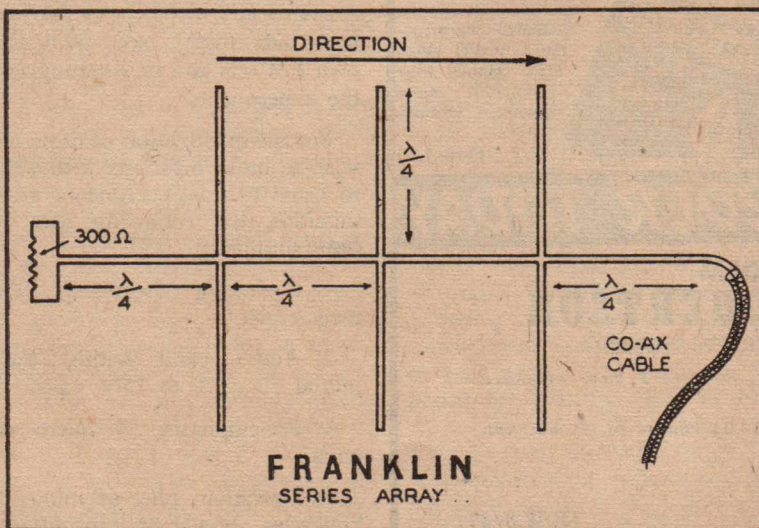

# USEFUL RADIO BOOKS

## FROM ANGUS & ROBERTSON LTD.

### 1. Completely Revised Edition "RADIO HANDBOOK"

Thousands of radio amateurs have been waiting for this new edition of the original "Jones' Radio Handbook"—and they will not be disappointed. Latest information on dozens of wartime developments, F.M., U.H.F., Tube design, etc. 704 pages, hundreds of diagrams.



17/6 (Post 1/-)

### 2. Complete Radio Manual— "RADIO FOR THE MILLIONS"

Pop. Science Monthly Publ. Instructions for building 87 receivers, recorders, radio phonographs, etc.; from one tube to 8 tube sets; from vest pocket to floor models. Troubleshooting, servicing, testing equipment. 100 wiring diagrams. 450 illustrations.



10/6  
(post. 6d.)

### 3. HOW TO BUILD AND REPAIR RADIO RECEIVERS

"EVERYBODY'S RADIO MANUAL," a "Pop. Science Monthly" publ. Crystal-clear, non-technical instruction on building or repairing any kind of set. Hints, shortcuts, a wealth of diagrams that are easy to follow. 256 pages.



7/6  
(post. 6d.)

### 4. Ninth Edition of F. J. Camm's "THE PRACTICAL WIRELESS ENCYCLOPEDIA"

An alphabetically compiled guide for the construction, operation, repair and principles of wireless receivers. Over 220,000 copies sold. Definitions, explanations, formulas, etc., rapidly consulted.

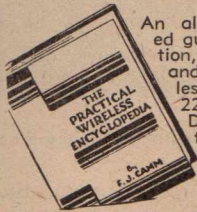

12/6 (Post 6d.)

### 5. Get This Complete RADIO SERVICING COURSE TODAY!

"Modern Radio Servicing—By A. A. Ghirardi; one of the foremost servicing experts in the U.S.A. 1300 pages. 706 illustrations. Everything is explained clearly, simply, step-by-step. Troubleshooting, testing and servicing all types of home and auto-radio equipment.



40/- (Post 1/3)

### 6. Most Popular Book on AMATEUR RADIO

"The Radio Amateur's Handbook", 1946 edition, is the standard manual of radio communication. Electrical and radio fundamentals, radio frequency, antenna systems, construction, V.H.F. etc., etc. More than 1,398,250 copies previous editions sold.



10/6 (Post 1/-)

## POST THIS ORDER TODAY

### ORDER FORM ANGUS & ROBERTSON

89 CASTLEREAGH STREET, SYDNEY

Please send me the books whose numbers I have circled

1      2      3      4      5      6

(A) for which I enclose payment, (B) charge to my account.

NAME .....

ADDRESS ..... (R.W.3/47)

## F.M. TESTS STARTED IN MELBOURNE

The Postmaster-General's Department has begun experiments in frequency modulation from its giant tower at Jolimont, near Melbourne.

"Spot readings" to test the field strength of signals in several suburbs, have been successful.

A complete survey of the metropolitan area will now be made to check official calculations that frequency modulation signals should be received satisfactorily in all districts.

Tests are expected to begin in Sydney soon on the recommendation of the Parliamentary Standing Committee on Broadcasting that FM experiments be conducted in all States.

It is expected to be several weeks before experiments have reached the stage where regular programmes of music and talks will be transmitted from Jolimont.

### AMATEURS LISTEN

It was stated that some radio amateurs and members of the wireless trade might have built their own FM sets and be listening in to the experiments.

For the information of those who wish to build F.M. sets with which to listen to the experimental transmissions, the following data has been supplied:

1. Operating frequency, 91.1 mega-cycles.

2. Audio band width, transmitted 30 c.p.s. to 1500 c.p.s.

3. Pre-emphasis, 75 micro seconds.

4. Deviation, plus or minus 75 kilocycles. Power of transmitter, 2 kilowatts.

# ELECTRO-ACOUSTIC COUPLING

## HOW TO GET HIGH FIDELITY FROM ORDINARY SPEAKERS

WITH the advent of new and improved apparatus in the electronic field, several overseas manufacturers are showing a certain amount of interest in bringing electro-acoustic transducers into line with other devices in the long chain between artist and home listener. Fortunately each of the links in this chain is quite sound in the sections outside the listener's control, namely, the programme and

By

L. A. DAVIES, Ph.B.

505 St. Kilda Road  
Melbourne

transmission end. However, I would like to place on record some amount of reservation on the last statement, in respect mainly to recorded art and, in this country, studio acoustics. Let us look forward to better studios as building becomes less difficult, and better recorded reproduction as those in control of the industry realise that their product has by now become the weakest link by far in the transmission section, and has been surpassed at the home end by even unpretentious speaker systems.

Until about 1937, speakers were universally hopeless from a quality reproduction standpoint, except for a few types of theatre installations, the cheapest of which cost over £180 each, and receiver manufacturers took advantage of this to educate the general public to accept as good reproduction sound which was almost unintelligible to an untrained listener. The listener was asked to train his auditory system to cope with, at great expense of nervous energy, speech which had all the definition frequencies removed and music from a speaker with peaks and troughs in its response curve of up to 30db. be-

tween 1,500 c.p.s. and 3,500 c.p.s., some of these peaks being less than 50 c.p.s. apart. No wonder most of us turned our so-called "tone controls" and listened to what was left under 1000 c.p.s. instead of trying to interpret instruments whose harmonies slid up and down these sharp peaks as the player's intonation varied and as bass notes carried by the same speaker alternately stressed the cone and caused the peaks themselves to move up and down the scale several times the distance between peaks. With this in mind, and also that when two or more frequencies agitate a device in a non-linear region, combination tones of a mainly discordant nature are produced, said tones being capable of producing further beats between themselves, and these beats also falling in non-linear regions, try to visualise the amount of spurious energy of a highly intermittent and kaleidoscope nature being radiated into a room where, due to a poor absorption characteristic, reflected waves can interfere with another batch of distortion from the next note combination and produce further beats.

### SAD TALE

This is the distressing picture we still face when using any one of the many units which flooded the country at one time and which were apparently designed in the costing clerk's office. Interest in overseas F.M. development has brought to the general listening public the belief that better results can be expected from these transmissions. What is not so well known is that for many years some broadcasters, both private and State owned, have been radiating programs flat from 30 c.p.s. to 9,500 c.p.s. within 1.0 db. and less than 1.0 per cent. distortion to 60 per cent. modulation, which is about the depth used for the better musical transmissions. On short wave, where bandwidth permits, the

B.B.C. have standardised on fidelity requirements which are more stringent than those of the Federal Communications Commission in the U.S.A. as applying to F.M. broadcasts (or -0.5 db. from 25 c.p.s. to 15,000 c.p.s. and less than 1.0 per cent. harmonic distortion for modulation depth equal to 75 Kc. frequency excursion. Carrier and studio equipment noise must be 80 db. below this level.).

Having mentioned the frequency characteristic of speakers as being responsible for so much distortion it might be well to point out that at low frequencies and at fairly high frequencies a speaker generates considerable harmonic of its own, even on single tone. The average 12-inch unit radiates considerably more of an input power at 50 c.p.s. as harmonics of this frequency than it does at the fundamental frequency even when loaded with a 24-inch by 18-inch baffle and carrying less than its rated power at 400 c.p.s. Then again at high frequency end, standing waves appear on a cone which is not correctly air loaded or has not the right material transmission speed. Recombination of phase-displaced waves causes distortion, just as cone velocity distribution causes focusing of the highs.

There are four main avenues along which research may be directed to improve reproducers. Firstly, the frequency discrimination may be reduced; secondly, the harmonic and intermodulation distortions may be minimised; then the efficiency may be improved and, lastly, the correct compromise of the first three struck to obtain improvement in damping.

Provided that certain conditions outlined under efficiency are observed, the efficiency of a moving coil speaker will depend on the coupling that exists between the

(Continued on page 8)

Radiokes

**THE NAME  
TO KNOW  
IN RADIO!**

Radiokes

**RADIOKES D.W. UNITS.** Highly selective with exceptional wide range. To match 'H' type gang condenser. Incorporates 4-in-1 padder. Solidly mounted with coils. Ask for type DWO-1

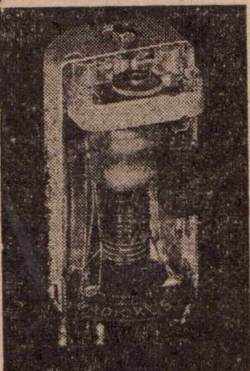

*When buying radio parts and components, follow the lead of amateurs and experts alike — specify Radiokes — your guarantee of test-set performance, precision construction and technical excellence.*

**RADIOKES**

**PTY. LTD.**

**P.O. BOX 90**

**BROADWAY — SYDNEY**

R-56

**SPEAKERS**

*(Continued)*

mechanical system and the surrounding media and the phase at which the load is coupled to the coil. It may seem strange that the word phase appears in discussion of a system which is, on first inspection, one solid unit, but it must be remembered that all materials are elastic in different degrees and that elasticity automatically infers ability to transmit an oscillating force in finite time. Therefore, at various points along the wave path in a material the wave will be in different time angle or phase to all other points. On a speaker diaphragm the wire of the voice coil may be considered as being at zero mechanical degrees to the applied force and all other parts of the system being at some lagging angle to this reference point, the angle becoming progressively wider towards the periphery.

The coupling, and therefore efficiency, of any given cone can be calculated from factors of weight, compliance and diameter. These factors resolve into two opposing curves and a correction curve. For a known cone excursion the output will increase towards the low frequencies as the diameter is increased and increase towards the high frequencies as the mass is decreased, while the correction curve referred to is that rise in bass efficiency in a narrow band of frequencies due to the resonant action of cone compliance with the combined mass of cone and air coupled to it at the resonant frequency.

Interesting at this point is the fact that for optimum efficiency at 400 c.p.s. using a coil of 1¼-inch diameter and a .013-inch felted flax cone of 110 degrees diamedral apex angle, the optimum cone diameter is less than 9 inches. Such a cone, however, to produce uniform output at lower frequencies than this, when mounted on a flat baffle of infinite dimensions, would have to be resonated to about 140 c.p.s. below which the response would fall

sharply and harmonic selectivity increase proportionately. Above 400 c.p.s. the efficiency would fall up to the frequency at which reinforcement by transmission resonances commenced at about 1,400 c.p.s.

Since the speed of sound in the cone material is constant it becomes obvious that increasing the frequency opens the phase angle between the coil and the periphery until a frequency is reached at which 180 degrees difference is encountered and the cone becomes an oscillating system composed of the elasticity of the material itself and a mass compound of the voice-coil and cone material at one end and the air-load and cone material at the other. This is the first of many high frequency peaks encountered on a parabolic or spherical diaphragm while a cone diaphragm has just twice as many. The first appears at half the frequency due to what is known as frequency doubling. Frequency doubling is brought about in a cone to which oscillating force is applied, in the following manner; as the force moves the apex in one direction the combination of inertia and loading causes the walls to be stressed in the reverse direction, then when 90 degrees of the cycle have passed the force decelerates the apex and the stresses are reversed so that the cone walls tend to move ahead of their mathematical position. Analysed, this means that during each half cycle of the applied force, the cone walls also develop two opposed half cycles of spurious energy, that is, it is generating a tone which is double the frequency of the applied force, or second harmonic distortion.

Percentages of such distortion increase with frequency as inertia increases and also if the force is constant the flexure due to loading is constant while fundamental amplitude decreases with frequency for constant energy transfer. Loading of a cone, or improving the acoustic coupling increases the efficiency of a reproducer by an amount depending on the change in the ratio of radiation resistance to cone and



air inertia resistance. Apart from the advantages obtained from greater efficiency and greater acoustic output from a reproducer handling a given electrical power, the harmonic distortion, due to diaphragm transmission resonances, is proportional to the inverse square of the improvement in efficiency and intermodulation distortion is inversely proportional to the efficiency gain. For example a speaker of 4 per cent. efficiency and handling 5 watts with 10 per cent. distortion is loaded so as to increase the efficiency by 4 to 1. The sound level has risen to that of the same unit operated at 20 watts input while the distortion due to cone break-up has fallen to less than 0.63 per cent. and that due to intermodulation to 2.5 per cent. Operating the unit at one quarter of the original input in order to obtain an acoustic level comparable to the unloaded condition can be expected to allow a further reduction in distortion.

This factor of 4 to 1 was selected for illustration only and is on the low side. Actually theatre speakers in the order of 6 to 8 per cent. efficiency are loaded up to nearly 60 per cent. efficiency and it may surprise some to learn that such an installation for a 1000 seat theatre is seldom called upon to handle more than 1.2 watts electrical input. A fully baffled 12-inch speaker would have to handle 15 to 25 watts under the same circumstances, and one can imagine the contrast of distortion levels quite easily.

Two alternatives present themselves to the prospective user of loading horns: either he devotes about one quarter of a suburban dwelling to a simple one, or he builds a complicated and compact unit about the size of an upright piano. Where two-channel reproduction is desired, and there is no point in extending one end of the scale without the other, the tweeter horn has to be exactly the same length as the mean sound path of the low frequency horn to preserve phasing at the output end.

Even this system with all its advantages is subject to compromise. Imagine a horn 25 feet long with a resonance of just over 20 c.p.s. to be responding to a 70 c.p.s. tone. If the curve was perfected and coupling to the outside air was 100 per cent. and also the speaker 100 per cent. efficient, therefore capable of infinite damping with an amplifier of zero output impedance, there would be no standing waves in the horn. Since all of the pertinent factors are less than 1.0, standing waves can and do appear in the horn at the resonance point (20 c.p.s.), this tone being heterodyned with the signal (70 c.p.s.) to produce sidebands at 50 c.p.s. and 90 c.p.s. The 90 c.p.s. tone is not serious as it is within 1.1 c.p.s. of being the fifth semi-tone of the fundamental and therefore is one semi-tone sharp. This analysis applies to 70 c.p.s. input only and a different set of results obtains for each input frequency, some being entirely consonant, but the majority, however, are dissonant. Fortunately, the ear is discriminative against low

level bass and not against high level, so considerable power has to be radiated in these sidebands before the audible effect reaches the annoyance level. An example of where it obtrudes itself is in the rattle noticed on open-diapason organ reproduction.

A horn could be made long enough to reduce the sidebands to a few cycles and so avert this effect. Here is where it is necessary to compromise, since efficiency declines in a horn over a certain critical length. Further, difficulties would be encountered at the high end due to varying attenuation with humidity and the fact that higher tones travel at slightly high speeds than low tones, the difference being greater in a cylinder.

So much for ideals and limitations. For those who subscribe to the idea that the best is never too much trouble, the foregoing covers most of the points to be considered

*(Continued on next page)*

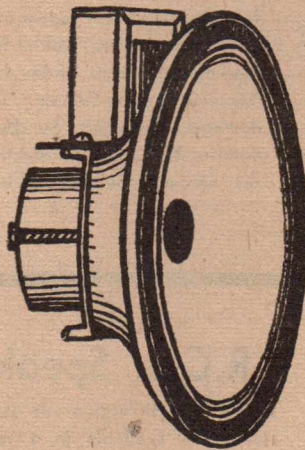

# IMMEDIATE DELIVERY!

**KONTRAST 7 INCH  
ELECTRO - DYNAMIC**

Field 1000 Ohm.  
Dust-proof Construction.  
Moisture-proof Voice Coil.  
Transformer Match Single Penthode.  
Full-range Frequency Response.

**32/- ( INCLUD. TRANS. )** Please Add Postage. **Gross Weight, 4 lbs.**

**ORDER NOW FOR 5-INCH PERMAGS.**

**KONTRAST RADIO** **UA 2405**  
**5 O'CONNOR STREET, HABERFIELD. SYDNEY.**

TO GIVE MAXIMUM PERFORMANCE UNDER  
ALL CONDITIONS . . . . .

2

popular R.C.S. Radio  
components

—with POST-WAR  
IMPROVEMENTS!

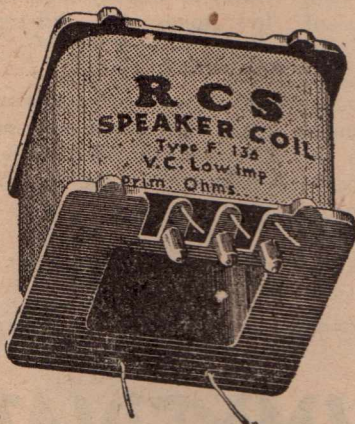

Here is the news you've been waiting to hear! R.C.S. radio parts and components are now coming back—and better than ever! Incorporating all the benefits of the rich war-time experience of R.C.S. radio technicians and incorporating TROLITUL, the miracle plastic, wherever possible in their construction, they are designed to add new laurels to the present proud record of R.C.S.

● R.C.S. SPEAKER Replacement  
COIL

features important advances in design. Heavier gauges of wire wound on moulded Trolitul former afford complete insulation between windings and core under full tropical conditions of high humidity. This new speaker winding relaminates easily, with no possibility of damage to windings by sharp corners of laminations. Burn-outs and deterioration due to electrolysis are definitely minimised, due to the unique moulded bobbin construction. Competitively priced.

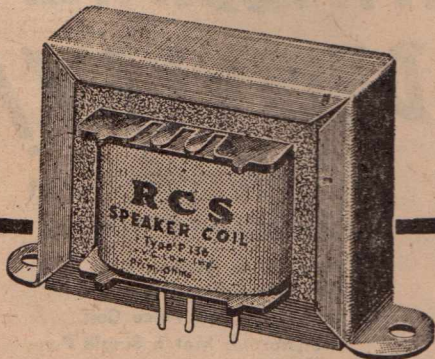

R.C.S. Speaker Transformers,

laminated with high-grade stalloy iron and complete with mounting clamp are available in a range to match any output valve and speaker combination, both single-ended and push-pull.

**R.C.S. RADIO PTY. LTD.**

174 CANTERBURY ROAD, CANTERBURY

● Available at all distributors. Fully Guaranteed.

## SPEAKERS

(Continued)

in reproducer design and application. It is written with a two-fold object in view, one is to put into one article several facets of a problem which has received treatment from one or two standpoints only at a time in diverse articles, the other is to set out the limitations of existing equipment on the principle that even the less experienced have a chance of extracting the most from that which is within their means if they are armed with the facts instead of some of the fanciful claims made in advertising copy. The more creative may even be able to devise means of complementing the characteristics of their equipment when they understand the more obscure principles of vibration mechanics touched upon and so approach one step closer to the ideal.

During the past ten years some publicity has been given to baffling systems for cone speakers which, while they serve no purpose at middle and high frequencies, have some advantages at the low end. The one of these most universally accepted is the vented closure, mainly because it is applicable to standard speakers without alteration to their existing bass characteristics. Its advantages are that the bass register of a given unit can be extended for over half an octave and a reproduction of the cone resonance peak effected. This is achieved at the expense of a narrow band of frequencies in the 120-180 c.p.s. region on a 12-inch unit when the correct dimensions of enclosure, aperture area and cone resonance are selected. It also has a limited ability to reduce distortion at all points in the bass register except the lower frequency resonance and even at this point the distortion radiated for a given level versus that radiated from a flat baffle favours the enclosed baffle since the efficiency has been so markedly increased and the speaker is called upon for less cone excursion.

My compliments to Mr. C. Mutton, and I would refer you to his capable and tactful article on

speaker baffling in the May issue of A.R.W. which gives constructional details of a suitable vented enclosure. To cover the same ground in sufficient detail would make considerable inroads into space which I would like to devote to systems, details of which have not yet proceeded beyond the bookshelves of those acoustic engineers who import technical literature. Besides which, no contribution to technical progress would be made, and it is my aspiration to write nothing which is not advanced on anything previously printed in this paper, so I would not attempt to go further than Mr. Mutton and the Magnavox Corp. of America.

Principles of vibration mechanics, due mainly to Dr. Helmholtz, have been applied for many years in Germany and about ten years ago British engineers commenced to derive some benefits from his work. The Magnavox people derived their first reflex baffle from his laws and then proceeded to develop speakers more suited to it.

The baffle itself is extremely simple to construct and is nothing more than an airtight box of rugged non-resonant construction having dimensions chosen to match that of a special speaker. The features lay mainly in the speaker cone, as this has to be constructed and mounted in accordance with rigid laws. Interest would cease here were it not for the fact that it is possible to approach very closely to the results obtained from special cones, by suitably operating on the cone assemblies of some of the standard flat baffle type cone speakers.

Since the coupling of a 12-inch speaker starts to drop off below 200 c.p.s., some resonant method is the only alternative to horn loading if the output is to be kept constant. Normally the cone stiffness provides the energy storage necessary for a resonant peak to be developed. However, if cone compliance or stiffness is reduced to the point of non-existence and an air-chamber coupled to one side of the cone, this air-chamber having the same resonant frequency as the cone-compliance combination of a standard-type speaker, then the fre-

## THIS ARTICLE

from the pen of one of the leading acoustics authorities, is entirely original and exclusive to Australasian Radio World.

quency curve of the speaker will have a similar shape to the curve of an unaltered speaker on a flat baffle of infinite dimensions.

On first inspection of the above statement it would appear that we have achieved nothing for the expense of a lot of effort. But for this substitution we gain many things; firstly, we do not need any further baffling and so have reduced our baffle from at least 17 feet in diameter to an 18-inch cube for the same results at least at 30 c.p.s. Next we have broadened the peak to cover at least six times the band covered by the usual cone compliance peak and have twice the energy available in a band extending over half an octave each side of the centre point of this peak due to the fact that instead of the back-wave from the cone being baffled-off and dissipated, it is used to supply energy to the resonator storage system and the stored energy returned via the cone to the outside air lead. Of greater importance is the lower distortion of the system. Any resonance due to cone compliance will be distorted and the bands either side of the resonance much more distorted as the resistance to motion is non-linear, introducing third harmonic content into the signal. Also, where two or more signals appear on the slope of a non-linear frequency curve and the device also suffers from amplitude distortion, intermodulation components appear.

The Helmholtz baffle reduces this therefore in two ways: harmonic content due to compliance is removed and the peak is spread over a wider band with a consequent re-

(Continued on next page)

## SPEAKERS

(Continued)

duction in curve slope. In a speaker designed specifically for this type of baffle the coil and pole structure is of different pattern so that no appreciable harmonic is generated here in order that full advantage may be taken of the freedom from distortion inherent in the mechano-acoustical arrangement. But the improvement effected on a flat baffle type speaker is so marked that anyone with any skill at all should not hesitate to make the alterations necessary.

About  $\frac{5}{8}$ -inch strip is removed from the edge of the cone between the support frame and where the actual cone opens out into the displacement folds. The cone is then supported by a ring of chamois leather, or if it is available a ring of "Viscoloid" plastic of about 0.015 inch thickness cemented to the cone and the metal frame. Care should be taken to cut the cone at two diameters which are equal in height from the coil plane or the cone will be pulled in one direction or the other and the coil not central in the gap. A hint to assist in maintaining correct centring is to divide the rim into six sections and replace three sections at a time, allowing the first set up to take before removing the remainder. The chamois should not be pulled tight, just enough so it will not wrinkle when the cone is at rest.

If the speaker used has a good spider system the cone should now be so compliant that a puff from a distance of 4 feet will make it move back about one-eighth of an inch. Most permanent magnet types have a dustproof or full-circle spider to prevent metal particles reaching the gap from behind the cone. These are less satisfactory as they often have some stiffness in the spider which is difficult to remove without damage to the cone or decentering the coil. The spider should only be stiff enough to return the coil to the middle of the gap when the speaker is placed so the coil is on a horizontal axis, while the cone should fall back at least one-

sixteenth of an inch when the speaker is laid back.

## BOX SIZES

A chamber of 18 inches cubed inside dimensions is the maximum practical size that can be used on an Australian 12-inch speaker as they are actually about 10 inches across the cone. While a larger chamber will give a lower frequency cut-off there will be a band of frequencies which lie between the reinforcement band and that which the speaker will reproduce in the un-baffled state. As a result the cone will be unloaded in this band so will tend to move too far in the gap and also a greater air motion through the aperture will be required to produce a given sound pressure in the reinforcement band and again the cone will move too far for the coil to remain wholly within the gap. The slight extension of frequency is poor compensation for the large increase in distortion encountered.

Actually, where the listener will require powers approaching the maximum capacity of the speaker to be handled the better choice would be 16 inches cubed. This will give response flat to 38 c.p.s. with a .015 inch thickness cone which has been resonated in open air to any frequency less than 6 c.p.s. by the method set out earlier.

The interior of the chamber should be lagged with sufficient absorbent material to attenuate the high note reflections from its walls and be of solid construction so that resonances in the materials used can not reach audible levels at the highest input power required. Dimensions quoted are nett internal measurements after lagging and at least 1-inch all round should be allowed for cow-felt, etc. One-eighth felt is desirable between all joints as it is difficult to eliminate buzz when several pounds pressure can be developed on each side and may occur at or near a resonance in the material.

Ventilation is virtually impossible for field-coil type speakers in this

baffle so their desirability ends with their superior spiders. It is well to provide a small hole somewhere in the back, not over one-quarter inch in diameter, to allow air pressure to equalise with change of temperature or the cone will be displaced and second harmonic developed when the coil is forced partially out of the gap. This hole should be kept free of lagging.

It is encouraging to note that Goodmans Industries in England and Western Electric Co. in the U.S.A. are manufacturing for sale to the general public, units developed especially for the Helmholtz baffle and each unit is complete with the complementary chamber required. These units are distinct from any of the so-called "Infinite-Reflex" speakers brought out before the start of the war and should plant the milestone in radio reception progress beyond which there is no excuse for the manufacturer who continues to increase cone stiffness with its attendant increase in bass distortion and attenuation, in the face of wider range transmissions and recordings.

The trend of increasing stiffness in Australian units may be due to a desire to improve the chances of their remaining in operation when subjected to overload in the bass register. A note of warning must be struck here. It is the non-linearity of cone compliance which prevents a cone going far enough to damage the coil, so in the resonance system where this non-linearity does not exist it is possible for the cone to attain dangerously wide displacement. In a closed room of fundamental resonance equal to that of the chamber, motion can continue to build up even after the coil moves so far as to be totally outside the gap on each peak.

From which it may be deduced that things can happen to the voice coil when there is a shoulder on the pole-piece and enthusiasm overrules discretion, as it is apt to when the listener hears some true bass for the first time. The wide excursion

(Continued on page 20)

# QUICK SYSTEMATIC TESTING

## DETAILS OF A PRACTICAL PLAN

WHILE doing the six-monthly basic radar course at the Brisbane Central Technical College during the war years, I palled up with a chap who had managed a service business for years.

As a helping hand to a newcomer to the game, he lent me several books and amongst these was a notebook with notes and data.

Have an idea that he said they

By

**H. ADAMSON**

*Malanda, Q.*

were notes on servicing published by the Radiola Co. in book form to the trade, so they might be familiar to some of our readers.

My first arrangement of the notes took the form of a convenient pocket card index, and I smile now to think of how I came to lean on it. However, it was a real help to me then, and I put it forward in the hope that some others may benefit by this suggestion.

To use it for any benefit, we assume the multimeter and test oscillator and test speaker are available, as well as more than a passing knowledge of circuits and components.

TEST No. 1: Examine aerial and earth system for:

Short circuit—defective lighting arrestor, or lead-in touching earthed metal, etc.

Open circuit—break in lead-in or earth wires concealed by insulation covering.

High resistance contacts—joints not soldered where lead-in connects with aerial and earth connection to earthing point.

TEST No. 2: Test "A" battery voltage:

Dry battery—replace if below 75 per cent. rated voltage under load.

Aircell—replace if below 2.25 volts across terminals under load.

Wet battery—recharge if hydrometer shows less than half charge.

1. Examine and clean terminals and cable clips.

2. Measure current drain from "A" battery.

TEST No. 3: Test "B" battery voltage.

Replace if less than 75 per cent. of rated voltage under load.

Measure current drain from "B" battery.

Test "C" battery and replace if not equal to rated value.

TEST No. 4: Test valves.

Replace any showing defective on merit test or showing leakage on element test.

TEST No. 5: Test resistance of primary of loudspeaker transformer, with receiver switched off. Ohmmeter should show between 20 and 2000 ohms, and speaker should respond with clicking sound at instant of making contact.

No reading on Ohmmeter indicates open circuit speaker transformer primary winding—replace.

No click from speaker indicates defect in voice coil or speaker transformer secondary—repair or replace.

Substitute test speaker for receiver speaker as a check-up.

TEST No. 6: Test resistance between positive and negative of high tension supply with receiver switched off, observing correct polarity with test prods. If below about 3000 ohms, test filter electrolytic condensers and paper bypass condensers in the high tension circuit. If no defect is apparent, test all components associated with high tension direct current circuit flow. Replace defective components.

TEST No. 7: With receiver disconnected from batteries, test the resistance between positive and

negative "B" battery leads, observing correct polarity of test prods. If resistance is below 10,000 ohms, test all condensers and components associated with "B" battery circuit. Replace defective components.

TEST No. 8: With receiver switched on, test voltage at—

High tension maximum—after filter in mains operated receiver.

Plate of output valve.

Screen of output valve (if any).

Plate and screen of audio amplifier valve.

Plate and screen of I.F. amplifier valve.

Plate, screen and anode of converter valve.

Plate and screen of R.F. valve (if any).

If voltage is not present at one of these points, test associated components in the stage concerned—replace defective components.

If any element voltage differs by more than about 10 per cent. from normal working voltage of valve concerned, check all resistors in the plate, screen, and cathode circuits of the valve stage. A variation in the value of a resistor of plus or minus 10 per cent. is permissible and a variation of 25 per cent. or higher may be present without seriously affecting operation, but would indicate that the resistor should be replaced.

With all controls at maximum, a click should be heard from the loudspeaker as the test prods make contact with the respective plate connections of the valves. No click shows stage defective. Test and replace defective components.

With mains operated receivers employing self bias, measure voltage across cathode bias resistors. If fixed bias, check voltage at bias resistor and at grid return connection.

TEST No. 9: If receiver appears alive, but will not receive any tunable signals, substitute a new con-

*(Continued on page 15)*

# LET'S GET TO THE CORE OF THINGS

As with all KINGSLEY radio products the reason why "PERMACLAD" I.F.'s are now spoken of as the best in Australia is found in the ferromagnetic iron-dust cores used in their construction. Apart from the inherent technical superiority of iron-core tuning, every "PERMACLAD" I.F. is turned out on a production line that sets a particularly high standard of quality.

So from the first to the final step . . . that of oscillagraph testing and tuning . . . each I.F. is made to give the absolute maximum in performance. The use of the enclosed pot-type ferromagnetic cores give KINGSLEY PERMACLAD I.F.'s a particularly high degree of permeability, high "Q" and gain.

OBTAINABLE FROM  
AUTHORISED KINGSLEY DISTRIBUTORS

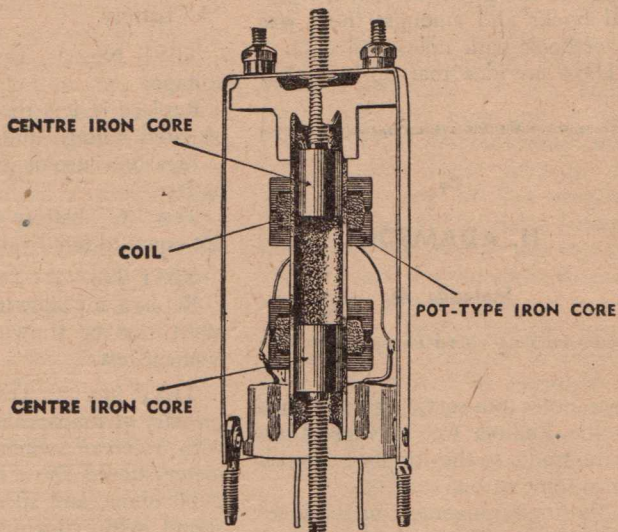

The above diagram is a cut away sketch of a PERMACLAD I.F. Tuning is done by the two centre iron-cores.

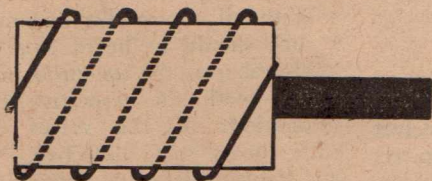

**F E R R O T U N E**  
FERRO-MAGNETIC IRON-CORE COILS, I.F.'s AND,  
GANGLESS TUNING UNITS



# KINGSLEY RADIO

KINGSLEY RADIO PTY. LTD.

380 St. Kilda Road, Melbourne, Victoria . Phones: MX 1159, MX 3653

## TESTING

(Continued)

verter valve (certain defects are not revealed by service tests). If still non-operative, test with receiver switched off, all components in the oscillator circuit—padding condenser, grid resistor, grid condenser, oscillator coil, oscillator trimmer, condenser, oscillator section of gang condenser, wave change switch, etc.

Repair or replace defective components.

TEST No. 10: Test R.F., aerial and I.F. transformer coils for short-circuit, open circuit, or short-circuit between windings.

TEST No. 11: If, in any part of receiver, screwed assembly contacts form part of the circuit, check that screws are tight (does not refer to trimmer condenser adjusting screws).

TEST No. 12: Test all grid returns with Ohmmeter—if open circuit, grid bias will not be effective, resulting in excessive plate current, and distortion in reproduction.

TEST No. 13: Test all condensers in grid circuits for leakage. If leakage is present, plate voltage from preceding stage may outbalance grid bias voltage, causing distortion and possible damage to valve through excessive plate current.

TEST No. 14: Test the A.V.C. at various signal strengths between grid return of coil or I.F. transformer, and filament or cathode of respective R.F. amplifier converter or I.F. amplifier valves (using 20,000 ohm per volt meter—if not available, insert milliammeter in series with plate supply circuit of each of these valves in turn, and note if plate current varies with tuning in of strong signals.

If these tests show no A.V.C. voltage change, or no current variation, test all resistors and condensers in A.V.C. and diode detector circuits.

TEST No. 15: Check whether distortion, noise or weakness is caused by speaker, by substituting

test speaker. Voice coil out of centre, cone damaged or metallic dust in voice coil tunnel will cause distortion or rattle.

Clean out dust with air blast—recentre voice coil—replace cone if necessary.

TEST No. 16: Check I.F. and R.F. alignment, and stage and overall sensitivity, with modulated oscillator.

TEST No. 17: Test voltage at filament or heater contacts of valve sockets with receiver switched on. If nil or low, check wiring and socket contacts for defects. If excessive, check wiring connections to batteries or heater wiring.

TEST No. 18: Test filter electrolytic condensers. Test resistance of field filter choke.

TEST No. 19: Disconnect aerial from receiver and connect aerial to earth terminal. If undesired noise is no longer present—the cause is external to the receiver.

TEST No. 20: Test power transformer windings with ohmmeter,

with receiver switched off. Test for short circuit between windings and iron core. Measure A.C. voltage across each secondary winding with receiver switched on.

• TEST No. 21: Test resistance between positive and negative of high tension supply, with receiver switched off, and all valves and dial lamps removed from their sockets, observing correct polarity with test prods. With D.C. sets, remove speaker plug for this test.

If below 3,000 ohms, test all components associated with the high tension circuit.

Battery operated receivers: Test in this order:

No signals: 1, 2, 7, 17, 4, 3, 5, 8, 9, 10, 11, 16.

Distorted signals: 1, 2, 7, 17, 4, 3, 5, 8, 9, 10, 11, 16, 15.

Weak signals: 1, 2, 7, 17, 4, 3, 5, 8, 10, 11, 12, 13, 14, 15, 16.

Signals normal but accompanied

(Continued on page 26)

**SAVE MONEY WITH A SUBSCRIPTION!**



Order Yours To-Day

Make sure you get every issue as soon as it is published. Place an order with your newsagent or send direct to us for a subscription.

IT SAVES YOU TIME!

IT SAVES YOU MONEY!

We guarantee that every subscriber has his copy posted the same day it comes off the press.

RATES	
★ 6 issues	5/3
★ 12 issues	10/6
★ 24 issues	20/-
<b>POST FREE</b>	

Enclosed please find remittance for 10/6 in payment for an annual subscription to the "Australasian Radio World," commencing with the ..... issue.

NAME .....  
STREET and NUMBER .....  
CITY ..... STATE .....

**AUSTRALASIAN RADIO WORLD**

Balcombe Street  
Mornington

# Build Your Own MULTIMETER!

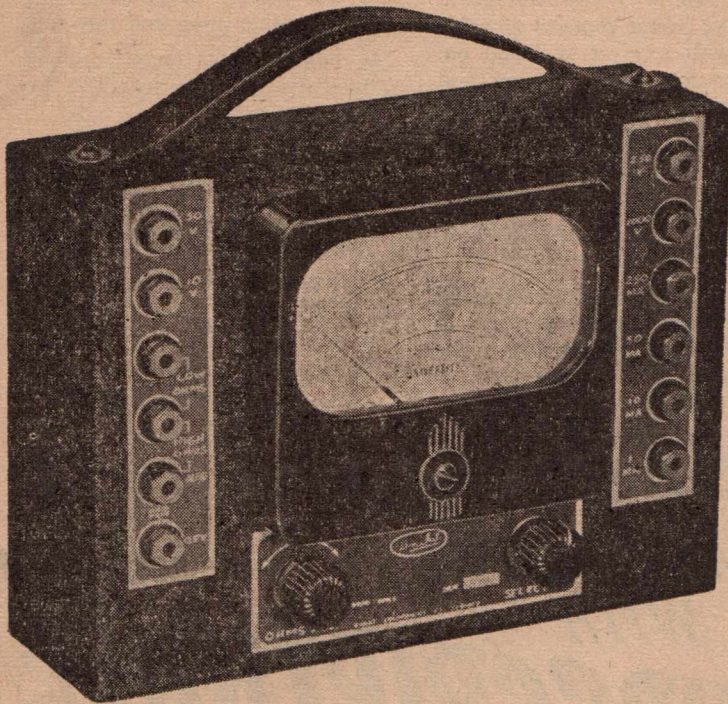

Easily constructed with a few simple tools, the new MK1 uses the popular four-inch square meter with clear multi-scale. Featuring extensive ranges, the finished instrument compares favorably with commercial models. Selected components ensure a high order of accuracy. It comes complete with full wiring and constructional details—circuit diagrams and photographs make assembly easy.

## RADIO EQUIPMENT Pty. Ltd.

375 KENT STREET,  
SYDNEY, N.S.W.  
Telephones: M 6391-2  
Telegrams: "Raquip,"  
Sydney



DISTRIBUTED BY

N.S.W.: All leading Distributors.  
Queensland: Irvine Radio; J. B. Chandler Pty. Ltd.; A. E. Harrold.  
Victoria: Vealls Electrical & Radio Pty. Ltd.; Hartleys Ltd.;  
Replacement Parts Pty. Ltd.

South Australia: Gerard & Goodman Ltd.; Radio Wholesalers Ltd.  
Western Australia: Atkins (W.A.) Ltd.  
Tasmania: W. & G. Genders Pty. Ltd.  
New Zealand: Allum Electrical Company Ltd.

### RANGES

DC volts: 0/10, 0/50, 0/250, 0/1000.

AC volts: 0/10, 0/50, 0/250, 0/1000.

Output volts: 0/10, 0/50, 0/250,  
0/1000.

DC m.a.: 0/1, 0/10, 0/50, 0/250.

Ohms: 0/1000, 0/100,000.

Available from all leading distributors—

Write now for details.

### NOW AVAILABLE

*"University"*

### MULTIMETER KIT

—  
MODEL MK1  
—

Prices:

AC/DC Kit: £7 12s 0d

D/C Kit: £6 0s 0d

Plus 10% Sales Tax



# SENSITIVE FOUR-VALVE CIRCUIT

## ADDING RANGE BY USING 6J8G AS A DUPLEX

I'VE repaired and built numerous sets of the four-valve, come-straight-in-off-the-diode variety and, frankly, in the vernacular of the moderns they just "haven't got it." It's nice to have a second set, or a first one for that matter, especi-

By

**M. ELLIOTT**

123 View Street  
Bendigo, Victoria

ally of the midjet variety, that one can cart around the mansion to hear the latest in news, views and variety. But have you ever found yourself in the position of wanting to listen to a selected programme on the "little beaut" only to find that she's not quite up to receiving dis-

tant stations with the clarity of the locals and nationals? And how many radio stores by super-duper salesmanship have landed themselves into no end of trouble by selling one of these sets to a customer who just couldn't afford anything more expensive? So what?

With a little ingenuity a friend and I have arrived at the accompanying circuit. And, believe me, she works! With a short length of aerial wire she can "drag in" and hold 3MA, Mildura, at night from this location. I have assembled Stevens may claim that the broadcast and dual-wave versions, and the performance is astounding. Actually, with the diodes of the EBL1 and the triode section of the second 6J8G to give an audio driver we really have the equivalent of a five-valve set. Of course, the valve manufacturers may rave at the ap-

parent misuse of the second 6J8G and even be dubious as to its performance. So were we, until we had built up and aligned the first set, then all doubts were dispelled.

The first 6J8G, the converter, is used in a more or less standard circuit. The screen and oscillator plate feed is that usually used with the type 6K8G converter, but the 6J8G works well nevertheless. Paul Paul Stevens may claim that the EK2G would be a better proposition, but as yet I've not given it a try. The pentode section of the second 6J8G is used as an I.F. amp. with permaclad intermediates, a definite "must" with a small set such as this. The oscillator triode of the second 6J8G is used as an audio driver; don't worry, it wouldn't be so used if it didn't

(Continued on page 18)

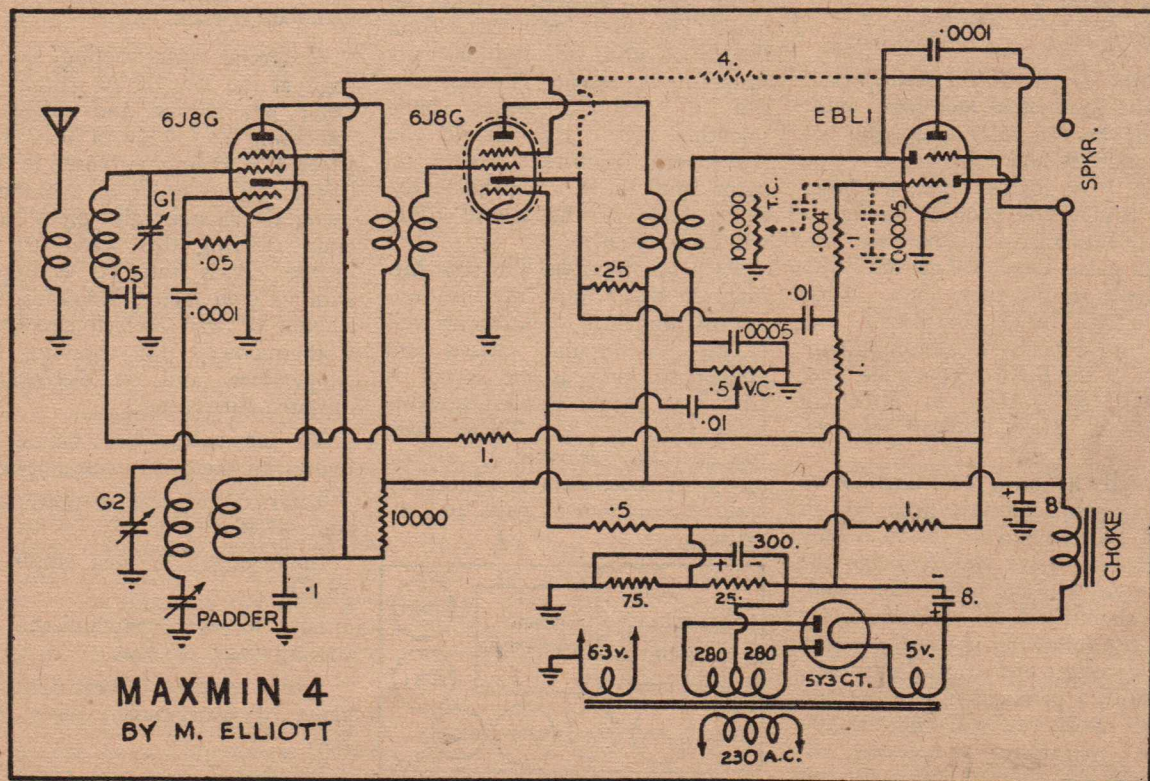

# SOME FACTS ABOUT STATION CMQ, HAVANA

Translated from "Radio-Guia" by V. L. Shillcock (VK2VS)

UNTIL recently the maximum power reached by any station in Cuba was 2,500 watts, which was at one time the aerial power of station CMQ, operating on 880 Kc and located in Havana. The installation of a 25 Kw transmitter represented a definite step forward, for with this power an excellent service to all parts of the republic was assured. It will be appreciated that the overcoming of all technical difficulties associated with such a vast project was no small task and due credit must be given to all those responsible for its practical realisation.

Among the principal features is the system of high-level modulation using water-cooled tubes in a class B amplifier. The filaments of these tubes are operated from a bi-phase

A.C. supply, the d.c. plate potential is 12,500 volts, and the modulation transformer itself is rated at 25,000 watts and capable of reducing all frequencies between 30 and 12,000 cycles. Incidentally, this transformer weighs more than 5 tons and is 7 feet high!

High efficiency in the final r.f. power amplifier is obtained by operating the four water-cooled valves in push pull under class C conditions. The tank condensers are submerged in oil and have mica dielectric. Harmonic suppressors are used both in the aerial transmission line and aerial coupling unit.

The antenna is a vertical type, which has been found to eliminate all fading of CMQ's signals and furthermore increases the radiation

efficiency. The mast is a galvanised steel structure 95 metres high, well anchored as a precaution against cyclones. It is equipped with a red beacon light at the top to serve as a warning to aircraft, and floodlit by mercury vapor lights which lend a fantastic and ethereal appearance to the whole structure.

The transmitter is housed in a specially constructed building equipped with a means of alarm and protection. A system of forced air cooling circulates air in the building and in the steel cabinets and provides adequate cooling for the high-power rectifier tubes.

"Safety first" is a motto which has been well borne out in practice, and hence we find ample protection against shock for the operating personnel. All transformers and other places where there are voltages in excess of 110 are protected by earthed metal screens, the doors of which are equipped with safety switches which automatically turn off all high tension when these doors are opened.

A special water-cooling system cools at the rate of 20 gallons of water per minute and dissipates something like 30 Kw of heat. The water for cooling purposes is distilled, and in order to avoid any chemical change all pipes and tanks carrying this water are of bronze. Each valve is equipped with its own meter, indicating the amount of water which circulates, a thermometer for checking the temperature, and an electrically-operated thermostat.

To conclude, here are some figures on the power consumption:

Total consumption of power per hour: 87 Kw.

Input power to final amplifier: 38 Kw.

Loss of heat communicated to cooling water: 26 Kw.

Power required to heat filaments alone of water-cooled tubes: 8.5 Kw.

Number of water-cooled tubes: 6.

## MAXMIN 4

(Continued)

"work." Try it! You'll be surprised!

The continental type EBL1 must surely be the fairy godmother of sets midjet and inexpensive. One diode I use for detection, the other for AVC. The pentode section is really the trusted EL3N under another guise. Don't tell me the EBL1 is hard to get these days. What radio part isn't? For myself, I've had no difficulty in obtaining supplies of the EBL1 output tube, less, to be sure, than in obtaining speakers, gangs, power trannies, etc.

Well, by now, I'm sure you've been "sold" on this little set; in fact, I'm game to bet you've already started to delve and scrounge the necessary bits and pieces. Go ahead; but should you be so inclined, try out the following if you think they are necessary and worth the trouble.

With a permagnetic speaker and small choke you will find the 300 mfd. electrolytic a necessity, although the 25 mfd. type will suit

if an electro-dynamic speaker be used. The .0005 mfd. mica from the EBL1 grid will iron out any instability if present. The tone control if required works quite smoothly. Of course, should you like inverse feedback a 4 meg. resistor from the EBL1 plate to the triode plate of the second 6J8G will be quite effective.

As a last thought, I'm sure Mr. Magrath won't mind my mentioning that this little set builds up well in his "Metropolis" chassis and cabinet so long as the layout is altered to ensure shortest possible leads (see Fig. 2). There, then, you have the "Maxmin 4," a little set with maximum performance from a minimum of parts and expense.

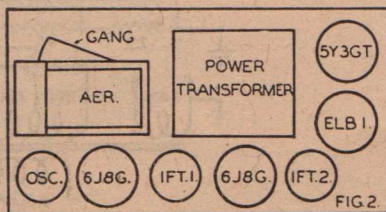

# EXPERIENCES WITH GANGLESS TUNING

## Performance of a "Ferrotune" battery set

FOLLOWING the vario-couplers and tuning by means of sliding a connector of some type along the coil, the tuning condenser came into being as a simpler and more efficient method of selecting the desired station. The evolution of the superhetrodyne principle gave

By

**Messrs. YOUNG AND  
DODDRIDGE**

**Angaston Radio Service  
South Australia**

greater simplicity of operation, and with the design of receivers using this principle, it was found that higher gain and increased selectivity could be obtained by the use of iron-core coils. Further research in this particular field brought to light the fact that by the use of the iron core a highly-efficient means of tuning the receiver without the aid of the ganged tuning condenser could be developed. This method is only another form of variable inductance, but is obtained by moving the iron core in or out of the coils, and not by use of the slider or vario-coupling methods of the early days:

In the particular unit on the market today the single tuning control, formerly performed by the ganged condenser, is still obtained by mechanical means. In this arrangement the iron cores are moved together, thus giving the correct frequency difference overall of the band. Tracking is obtained by means of trimmers and fixed padders and also by a slug adjustment of the position of the cores in relation to one another.

An experimental unit was built up and several interesting features have been noticed. A vibrator-powered unit was chosen, the set-

up being 1C7 as mixer, 1M5 as I.F. amplifier, 1K7 as detector and first audio, output valve being the 1L5 battery pentode. The circuit is a straightforward superhet with full AVC.

### NOTICEABLE FEATURES

1. The first feature of particular interest was that all the frequency intervals on the dial (straight line) were equidistant, i.e., the dial calibrations are linear over the full length of the dial.

2. *Alignment.* Accuracy and simplicity of alignment is claimed by the manufacturers. This fact was borne out to a great extent in the experimental unit and probably would have been quite straightforward if a 6J8 type had been used as specified. Using the 1C7G for the battery version, a different alignment procedure was found to be necessary. The first point noticed was that the dial calibrations were out on the H.F. band, but when the trimmer on the oscillator coil was adjusted as per maker's instructions, in order to correct the calibrations, it was found that the tracking in the centre of the band was shifted further out than before, while the L.F. end was only slightly out.

After a careful check up of the unit and a study as to what individual effect the four adjustments on the unit would have, it was decided to set the slug in the oscillator coil, in order to get the pointer to read correctly on 1100 Kc/s and then return the pointer to 1500 Kc/s and then set the trimmer in order to get correct adjustment there. Then again return to 1100 Kc/s and make the required slight adjustment to the oscillator slug. The tracking was also found to be correct also on 550 Kc/s when this procedure was adopted.

The same procedure was adopted to align the aerial section for maxi-

mum signal strength, the trimmer being used for 1500 Kc/s and the slug for 1100 Kc/s. It will be noticed that this system of alignment differs from the method used in aligning receivers using condenser tuning where trimmers are used for 1500 Kc/s and the slugs used for 550 Kc/s and not 1100Kc/s as with the new unit.

3. *Performance.* A pleasing feature was the freedom from background noise and hiss when tuned to a station. When not on a station the receiver appears "dead." This fact was very noticeable. Excellent tonal quality was another feature that was outstanding.

This is apparently brought about by the fact that there is no cutting of the sidebands and by the flat top resonance curve.

4. *Selectivity.* Another noticeable feature was that the overall selectivity was greater than with the condenser method.

The L.F. end of the band was as "sharp" as the H.F. end, which is not the case in the older method, especially in a design where there is no R.F. stage.

"Sharpness" usually tends to increase the "high" and cut the "lows." This was found not to be the case with this particular unit.

From our experience with this unit it would appear that there is a big future for "gangless" tuning.

### CHANGE OF ADDRESS

Please note that all correspondence should be addressed to:

AUSTRALASIAN RADIO WORLD

BALCOMBE STREET  
MORNINGTON, VIC.

## SPEAKERS

(Continued)

is apt to place a severe strain on the junction between spider and voice coil on the standard units which have been adapted for this system, hence one of the features of overseas design of the special speakers is a centring spider of radius almost as great as that of the cone.

Two other advantages emerge from the system. One is the elimination of the high frequency back-wave which is normally allowed to reflect off walls and ceiling, eventually recombining with the front wave in all different phases so as to add to the complexity of dead-spots and standing-waves in a room. The other is the splitting up of the high frequency beam effect of a cone

speaker into a beam surrounded by common apex cones of increasing apex angle. While this is not smooth distribution, it does give good definition of speech and a more realistic musical attack at 60 degrees from the voicecoil axis, whereas the same cone before re-mounting would be dull outside 15 degrees.

A further development of the principle is the subject of Design Copyright Application by the author and can now be published as filing has been effected. Briefly, it is the operation of mantel radio receivers, etc., within a small cabinet which also serves as a Helmholtz baffle suitably adorned for furnishings sake. Subsidiary copyable features are taken out on methods used to extract the heat

generated within the enclosure and the design of a non-microphonic tuning system with a pressure-tight dial. A complete set, 15 inches by 9 inches by 10 inches, which is not large as mantels go, can outperform the same electrical arrangement used in a large radio-gram cabinet, giving full bass without the boom or bump heard in different parts of a room equipped with the usual baffling.

The full story of this development will probably be told as part of a paper on a mantel or table model Frequency Modulation receiver which I am now preparing for test. Under Mr. Hull's guidance it will be released as soon as it will be of practical advantage to readers who like to scratch their "high-fidelity" itch.

**A  
B  
A  
C**

**AUSTRALIA'S  
BEST  
AMPLIFIER  
COMPONENTS**

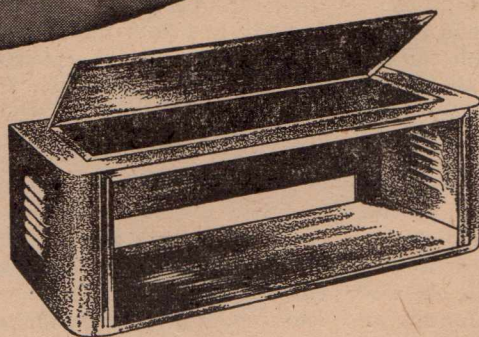

### **ABAC STANDARD RECEIVER**

Or Instrument  
Case. Takes  
19 x 8 $\frac{3}{4}$  panel  
with clear panel  
space 17 $\frac{1}{4}$  x  
7 $\frac{5}{8}$ . Depth of  
case 11-ins.

**MANUFACTURED BY  
TRIMAX TRANSFORMERS**

29-35 FLEMINGTON ROAD,  
NTH. MELBOURNE, VIC.  
(Division of Cliff & Bunting  
Pty. Ltd.)

# TECHNICAL BOOKS IN INDUSTRY

THE industrial expansion of Australia during the past ten years has been very great, but the important part that technical books have played in this expansion is not generally realised. Hundreds of thousands of pounds worth of technical books on every conceivable subject are imported from England and America, and to a lesser extent from the Continent, every year and eventually find their way into research laboratories, universities, technical colleges, etc. Every large industrial undertaking today employs one or more trained librarians to carefully collect and catalogue scientific information culled from these books and journals. The demand for technical books is even greater today because of the number of ex-service men and women taking up reconstruction courses and hobbies, and partly by the fact that an increasing number of people are wanting books showing how things can be done in the home. Much time and money could be saved if people realised that no matter what the problem, invariably there is a book that will tell and show how it can be solved.

Angus & Robertson Ltd. have opened a newly-enlarged and modernised department which gives technical books their proper place in book buying in Australia. It could be said that this department rivals anything in the world for the complete presentation of practical books, and provides the largest selection of technical books in Australia.

Two thousand feet of carefully-planned floor space displays books on any subject at a glance. So complete is the filing and tabulation, that any book published in the English-speaking world can be produced from stock, or if not available, can be ordered by air mail from overseas at no extra cost.

## NEW FEATURES OF THE MODERNISED DEPARTMENT

Under architects, Peddle, Thorp and Walker, the department em-



A photograph of the technical book department at Angus & Robertson's.

bodies new features to make book buying a quick and pleasant experience. B.G.E. fluorescent lighting totalling 400 feet was installed by T. C. Nickson, and gives daylight reading without the unpleasant heat associated with incandescent lights. The Sydney County

Council gave valuable technical advice.

## "GLANCING" COUNTERS

Realising that customers wish to check through books before buying, all related books are sectioned off, shelves are only seven feet high so that each book is within easy eye level, and specially designed counters display books at a tilted angle. Contract for the complete work was undertaken by Howie Moffat & Co. Pty. Ltd., steel shelving supplied by Art Metal (Aust.) Construction Co., and counters done to design by A. W. Edwards Pty. Ltd.

---

## LEXINGTON PICK-UPS

It has been announced that the Australian price for the Lexington pick-up mentioned in last month's issue, will be £11/18/6 retail. Sydney representative is G. C. D. Warren of 75 Pitt Street.

---

## TINY HOLES

G.E. has devised an extremely-sensitive electronic leak detector which can detect a hole so tiny that 15,000 years would be required for the contents of a quart bottle of air—at atmospheric pressure—to leak through. The unit is used in improving methods of obtaining high vacua in electronic tubes.

—“Q.S.T.”

## BOOKS ON RADIO AND ELECTRICAL ENGINEERING

Indicative of the way in which every subject is completely covered, the section dealing with books for the man in the radio and electrical trade occupies several counters and many divisions of shelves. Books on every aspect of industry from the amateur side upwards are sectioned off for quick reference. Catalogues or lists of books on specified subjects are supplied by Angus & Robertson Ltd. on request.

# THE AEGIS 'LITTLE COMPANION'

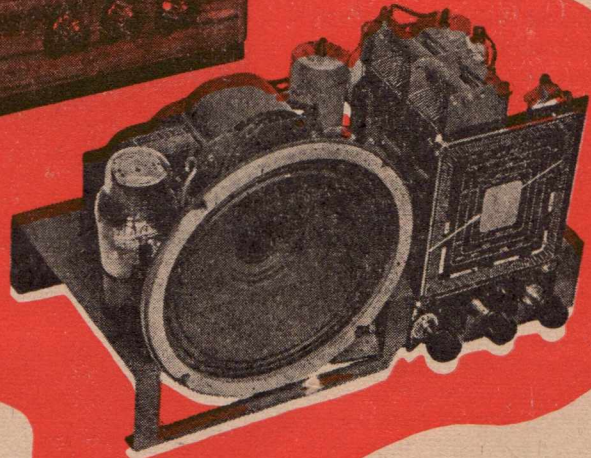

## YOUR *Favourite* KIT ASSEMBLY *has been Streamlined!*

### FEATURES

- ★ Dual-Wave
- ★ Rola Speaker
- ★ Permeability Iron-Cored B/C, S/W.
- ★ Permeability Iron-Cored Intermediates
- ★ Super New Cabinet
- ★ Ducon Condensers, etc.

Add the latest, smartest, professional touch to your new radio with the modern streamlined wooden cabinet now supplied with the popular Aegis Little Companion. It is a 5-valve 2-band receiver A.C. operated, complete to the last nut and bolt, with full easy-to-build directions.

# AEGIS

**MANUFACTURING COMPANY** PTY. LTD.

208 LT. LONSDALE ST., MELBOURNE  
THERE ARE AEGIS DISTRIBUTORS IN ALL STATES.

# ENGLISH COMMUNICATIONS SET

Orders now being accepted in Melbourne

OVER a period of some weeks, we have been able to run comprehensive tests on the new 9-valve Eddystone Type 504 receiver. The notes which follow cover our experiences and the results obtained.

## CIRCUIT

The circuit arrangement is two R.F. stages followed by a triode-hexode frequency changer preceding two I.F. stages, which feed the second detector-first audio-A.V.C. stage, into a pentode output am-

Test Report by the

## SHORTWAVE MAGAZINE

(Eng.)

plifier. A B.F.O. and a noise-limiter circuit using a separate valve function at the L.F. end. A double-crystal switched band-pass filter is provided in the first I.F. stage, and an S-meter is incorporated which is permanently in circuit.

Valves used include Mullard EF39 in the R.F. and I.F. stages, ECH35 frequency changer and a 6V6 in the output.

## WAVE RANGE AND TUNING

The tuning range is 580 Kc. to 30.5 Mc. in five switched bands, with a slight overlap from band to band. All five ranges are calibrated on separate scales.

Using the watch-face analogy, the tuning pointers are "hour hand" and "second hand." The hour hand has a ratio of 140:1 to the "minute hand" (the main control knob). And the second hand—which is a fine tuning scale concentric with the hour hand pointer—gives a further ratio of 20:1 against the latter. It is thus possible to regain a setting on any band with a high degree of

**The Eddystone 504 is available on indent order through J. H. Magrath & Co., 208 Little Lonsdale Street, Melbourne. The price is £77, plus sales tax, less speaker. A sample model is on display in their showrooms for inspection.**

accuracy by having noted the hour and second hand readings. This is mechanical band-spread at its best.

## CONSTRUCTION

The tuning pack forms a separate unit with respect to the rest of the chassis; the coil assembly is contained in a heavy cast aluminium shell, over which are mounted the four-gang main tuning condenser and the valves on the input side.

## FIGURES

The claimed performance is indicated by the following figures: Selectivity, crystal out, 30 db down at 5 Kc. off resonance; crystal in, 30 db. down at 500 cycles off tune, and 50 db. down at 2 Kc off.

The image ratio is given as 35 db. down at 20 Mc. and 75 db. down at 2 Mc.

Sensitivity is in the ratio of 2 micro-volts input for 50 milliwatts output.

## PERFORMANCE

So far as we were concerned, the receiver was tested mainly on the amateur bands 1.8 to 28 Mc.

On all bands, the tuning was found to be smooth and accurate, and dial calibrations good enough for a noted frequency to be refound with certainty. The actual calibration was good, though in the set we had it was a little high on 28 Mc, as checked against a 100 Kc multi-vibrator.

It is not possible to give any satisfactory measure of the spread on the various bands, since this de-

pends entirely upon practice in the reading of the two tuning scales. Though rather sharp on 28 Mc, the tuning of the weakest audible signal with the crystal in was quite easy.

The sensitivity and selectivity obtained on test agreed very closely with the figures given above, and second-channel interference was virtually negligible.

All controls were quite smooth and the S-meter provided an accurate visual tuning indication for telephony reception. Operated in the usual manner for amateur band reception—R.F. gain right up and audio gain down—the receiver was reasonably quiet, having regard to its sensitivity and the noise-limiter dealt successfully with static peaks, car ignition interference and the like.

We used the set on several aeriels, by far the best results being obtained on 14 Mc with a doublet cut for the band. But like all modern high-gain superhets, the 504 also worked well with a few feet of wire lying on the floor, with which many 14 Mc DX phones could be brought up to good speaker strength—though this is not to say that the set need not be provided with a good aerial if the best results are to be obtained.

Reception of broadcast stations, which we did not attempt to log or classify, seemed uniformly good throughout the whole tuning range.

## HOW THE MIGHTY

The proud magnetron, top-notch wartime performer, which travelled in the most exclusive circles during hostilities, is now doing KP duty as the r.f. generator in the Radarange, Raytheon's new electronic stove that grills a frankfurter in eight to ten seconds.

# SERVICING THE VIBRATOR

## HINTS FOR THE REPAIRMAN

**T**HE design of vibrator power packs has advanced considerably during the past few years. This, I think, can be attributed to the great demand by the military forces for such units.

The servicing of any vibrator power pack is greatly simplified if one masters the fundamentals of vibrator technique.

A vibrator power unit usually comprises a vibrator, specially designed transformer, smoothing choke and condensers, as well as the necessary R.F. chokes, buffer condenser and resistors.

The vibrator, transformer and filter unit are screened so as to prevent the radiation of R.F. energy, and it is essential that under no circumstances should this screening be entirely removed.

As for servicing these power packs, examine first Figs. 1 and 2. These schematic diagrams represent the power packs. The former incorporates a full-wave indirectly-heated valve rectifier and filter unit,

whereas the latter is self-rectifying but includes the filter unit.

### FIRST STEP

The procedure adopted for servicing these units differs according to one's experience and method of fault tracing. However, the following is the most efficient way to locate any fault that may be prevalent in vibrator power packs.

Connect an ammeter, in series with the positive battery feed, making sure the meter is large enough to handle a current drain caused by the power pack. This done, connect a D.C. voltmeter across the positive and negative battery feeds (this meter should be capable of reading the full battery voltage).

It is advisable that these meters be connected on the "dead" side of the switch, as this ensures that the meters are not reading continuously when the switch is open.

The fault tracing can now begin by switching on the vibrator packs, plus load, and reading the battery voltage on the voltmeter; this figure

should be compared with the battery rating. It is essential that for the correct operation of the vibrator unit, the battery voltage should not vary more than 10 per cent. of its rated value.

So much for the voltage supply. Next, take a reading on the ammeter, and if this exceeds the figure laid down by the vibrator pack manufacturer, it is a sure indication that something is wrong in the power unit.

Switch off the power supply, substitute a good equivalent type vibrator and take fresh readings. If these readings are identical with the first set of readings, it more or less proves that the vibrator is in order and that some other component in the pack is at fault.

The next step is to locate the faulty component, adopting the scheme whereby each individual component is subject to conventional tests.

The buffer condensers should be carefully checked for open or short circuits, because open and short circuited buffer condensers will speed up and encourage the destruction of the vibrator itself. This is easily understood if one realises that the purpose of this condenser is to control the arcing at the vibrator contacts.

If it is found that this condenser is at fault, it must be replaced with one of the correct value and rating, and not just replaced with any condenser that is to hand. The correct capacitive value can be obtained direct from the unit manufacturer, so long as he is informed of the type of unit at fault.

Today, many packs incorporate a resistor in series with the buffer condenser, the presence of which helps to limit the flow of secondary current and also excessive sparking at the contacts.

It is, therefore, essential that this resistor be checked for continuity, because, if found to be "open circuited," no control is offered over

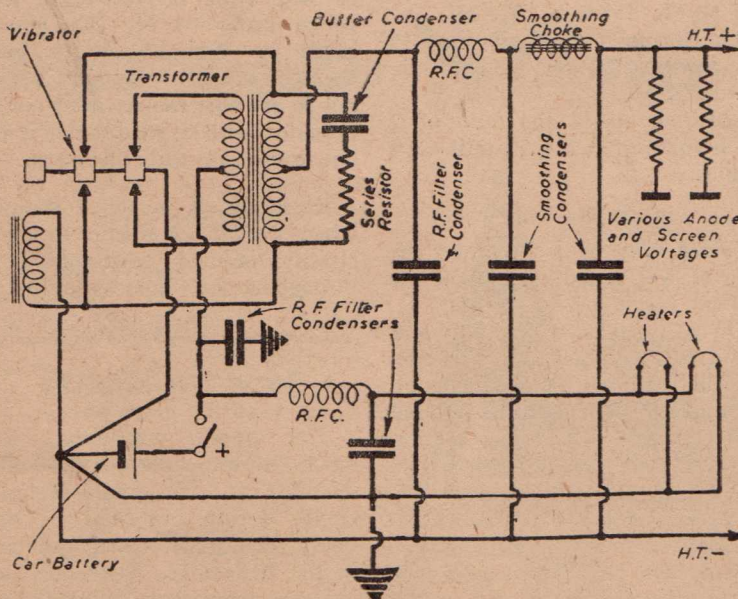

Fig. 1.—A synchronous type of vibrator circuit for a power pack.



the arching at the contacts.

One must not forget, however, that should the buffer condenser be at fault and withdrawn from the unit, it is advisable not to switch on the unit until a replacement has been made.

Vibrators sometimes develop a fault whereby the contacts "chatter." This can sometimes be remedied by mounting the unit upon sponge or rubber cushions. The latest models have, however, adopted this procedure to overcome any fault that is likely to arise in this direction.

Another fault that was extremely common prior to the war, was the sticking of vibrator contacts; this caused the vibrator to operate on only one pair of contacts. This fault can be the result of over-running the vibrator, so causing the reed to lose its springy characteristic. The only cure for a vibrator having these faults is a new replacement.

Contact arcing can occur if the commutator in the ear system becomes defective in any way. A defective commutator prevents an even flow of D.C., which will cause a surging effect, with the result that the contacts either burn up or that the reed loses its temper.

If one discovers that the vibrator contacts are worn, the efficiency of the unit can be improved by substituting a slightly larger buffer condenser. This enables the vibrator to be used whilst the present shortage of radio components is prevalent. One must not forget, however, that when replacing the worn vibrator, the buffer condenser must be replaced with one of the correct value.

#### CHECK THE FUSES

Most vibrator power packs incorporate fuses in the battery supply leads. These fuses will blow if the unit develops a fault whereby it draws more current than the rated value. It is therefore advisable to include fuses in the circuit if they have been omitted, and it is also essential to make sure that the correct value fuses are used.

The R.F. chokes and resistors found in the unit must be checked for continuity, whereas the remain-

ing condensers should be checked for open or short circuits.

It is essential that R.F. chokes and condensers be included in the circuit, the presence of which help to suppress R.F. radiation and interference. This fault cannot be ignored, as it may be necessary to include more chokes and condensers in the unit. To clarify this interference suppression, refer to Fig. 1.

The power pack should be efficiently screened and the screened battery feeds to the pack kept as short as possible. If the necessary precautions have been taken and R.F. is still prevalent, try to eliminate this fault by twisting the battery leads together. Failing this, it is a sure indication that additional filtering is required; this can be carried out in many ways. For instance, suppose the receiver has developed a kind of ripple which becomes amplified as it passes through the various stages of the receiver, it is possible to suppress this by bypassing the anode resistor of the stage at fault with a condenser to earth.

Other ways of suppression can be tried, such as by-passing the H.T. positive and negative feeds to

earth by means of a suitable condenser, or by connecting a condenser across the battery output feeds.

One must not forget, however, that the chassis on the vibrator unit is at earth potential, and should not be used as a negative return for the high tension. It is advisable, therefore, to check to see if the power pack is insulated from the chassis upon which the unit is mounted. If the pack is in electrical contact with the chassis, it is more or less a certainty that ground currents will flow, these being the result of R.F. radiation. It is advisable, therefore, to earth the vibrator pack by by-passing condensers at one point only.

#### RECEIVER INTERFERENCE

Receiver interference, such as hum and ripple noises, are more or less caused by inadequate filtering in the power unit. The only sure cure is for an additional filter to be added; this should first be tried across the battery supply feeds, and, secondly, across the H.T. output feeds.

Another point that is worth men-

*(Continued on next page)*

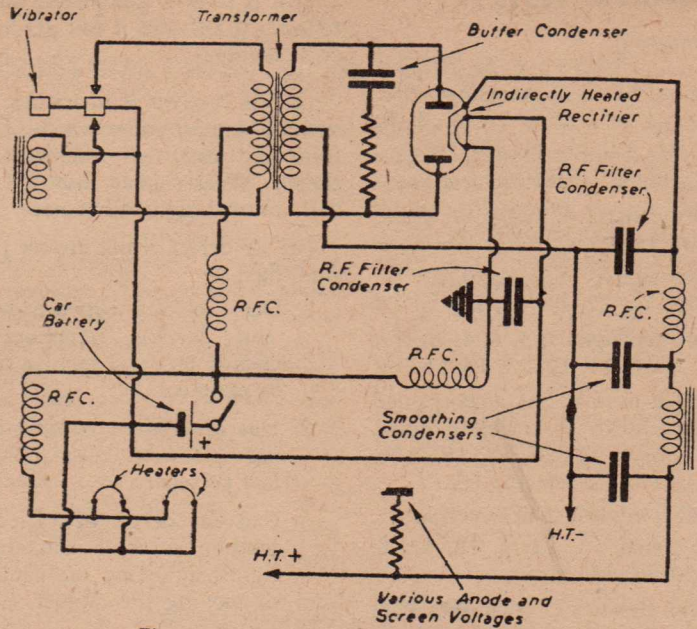

Fig. 2.—A non-synchronous vibrator power pack.

## SYSTEMATIC TESTS

(Continued)

by a hum, howl, or crackling noise, etc.: 1, 2, 7, 17, 4, 19, 3, 5, 8, 8, 10, 11, 12, 13, 14, 15, 16.

*A.C. mains operated receiver:*

No signals: 1, 6, 4, 20, 17, 18, 8, 5, 9, 10, 11, 16.

Weak signals: 1, 6, 4, 20, 17, 18, 8, 5, 10, 11, 12, 14, 15, 16.

Distorted signals: 1, 6, 4, 20, 17, 18, 8, 5, 10, 11, 12, 13, 14, 15, 16.

Signals normal but accompanied by hum, howl, or crackling noise, etc.: 1, 6, 4, 19, 20, 17, 18, 5, 8, 10, 11, 12, 13, 14, 15, 16.

*D.C. on A.C./D.C. receivers.*

No signals: 1, 21, 4, 18, 17, 8, 5, 9, 10, 11, 16.

Weak signals: 1, 21, 4, 18, 17, 8, 5, 9, 10, 11, 16.

Distorted signals: 1, 21, 4, 19, 18, 17, 8, 5, 10, 11, 12, 13, 14, 15, 16.

Signals normal but accompanied by a hum, howl or crackling noise: 1, 21, 4, 19, 17, 18, 5, 8, 10, 11, 12, 13, 14, 15, 16.

The following questions help give some history of the trouble and with the signs and symptoms form a reliable base for determining the trouble:

(a) Is receiver completely out of action? If so—did it fail gradually or suddenly?

(b) If receiver is operating, but unsatisfactorily, under which of the following can the complaint be classed: Weak signals, distorted signals, normal signals but noisy?

(c) If defect is not always present—then—

1. Does it vary between night and daytime reception, or does it occur at regular times or periods?
2. Has it recently developed, or has it always been more or less present?
3. Can the defect be varied by such operation as switching of lights, adjusting the controls, or moving the cabinet, etc.
4. Has the receiver been repaired or adjusted recently?

*With Group A—*

If receiver failed suddenly while in use or between being switched off and later switched on again—

- Aerial disconnected.
- Valve failure.
- Condenser breakdown.
- Resistor failure.
- Wiring failure.

smoothing condensers in the filter unit have been checked for short or open circuits.

So much for the checking of the components and power unit; it is now necessary to mention a few important factors which are so many times overlooked or ignored.

Never overload the power unit by forgetting to check the current the load is taking, and always check the D.C. output voltage. These factors play an important part in car radio; the former can damage the pack if in excess, whereas the latter, if too low, will cause the receiver to be inefficient, because of the wrong potentials that are being applied to the valve electrodes.

—*Practical Wireless (Eng.).*

## MAKE SURE

**of your issue every month by placing an order with your local newsagent.**

Power cable or fittings defective.

Power supply failure.

Coil failure in any component having windings.

Battery leads defective.

Switch defective.

Carry out usual routine tests!

*Group B—*

If receiver failed gradually while in use—

Routine tests.

Dry "A" battery exhausted.

Wet "A" battery exhausted.

"B" battery exhausted.

Valve failure.

Resistor failure.

Electrolytic condenser failure.

Components affected by moisture.

*Group C—*

Fading and temporary distortion.

Mains supply variations: low mains may cause converter to cease work.

Noisy reception — interference from electrical equipment such as fans, mixers, shavers, neon signs, frig. motors, lift motors, etc.

May be external—or internal—set poorly designed.

Check external connections for high resistance or intermittent open circuit joints.

Thoroughly clean chassis by air blast, or by soft brush.

Excess oil or grease on dial drive removed.

Remove dust from gang plates and insulation, and from insulation of wave change switch.

Careful visual inspection.

Efficient aerial and earth.

## VIBRATORS

(Continued)

tioning because it does help to overcome the ripple effect, is to separate the heater supply lines for the valves in the receiver from those of the rectifier valve.

As in receiver servicing practice, it is essential that the valve rectifier be checked for its operating characteristics, as well as for internal shorts and softness. Any fault with the rectifier will no doubt cause the power unit to draw more than the rated current from the battery. This can be verified by checking the current reading as already explained earlier in this article.

If the rectifier is at fault, never replace with a new valve until the

# RADIO FREQUENCY CHOKES

## THEIR DESIGN, CONSTRUCTION AND APPLICATION

WHEN dealing with high-frequency alternating currents such as those which exist in radio apparatus, and the like, it is very important that these self-same currents be confined to their proper circuits, for if they should start wandering about and enter neighboring cir-

By

**LANCE S. HARRISON**

C/- Yengarie P.O.

Maryborough, Q.

cuits where they have no business to be, they can be the source of no end of trouble. There are many ways in which these currents may be kept in check and not the least among which is the use of the radio frequency choke decoupling or filtering method. This method is particularly useful on short waves, and when we speak of short waves nowadays it includes anything from 1600 kilocycles, the high frequency end of the broadcast band of frequencies, to 20 megacycles and beyond.

A radio frequency choke, or more simply RF choke, is purely and simply an air core inductance consisting of many turns of very fine insulated copper wire wound on a former, and can be wound in several different ways, perhaps two of the most popular being the sectional and slot wound types as shown in the diagram (1). The sectional type consists of three or four sections honeycomb wound on a thin solid straight former, the sections being connected together in series. This type of structure makes for a larger component and as the windings are all exposed and that the wire with which they are wound is very fine, care must be

exercised when handling and when soldering into the circuit.

The other type or slot wound type, consists of many turns of the same type of wire wound in a stool or slot arrangement, as shown in the diagram. This type of choke has the advantages that it makes for a more compact job, the windings are all enclosed within the outer discs, are very effective and most important of all are very easily constructed and any radio enthusiast can turn out as many as he desires at little or no cost at all. However, before going into constructional details a little theory would not go astray.

Inductances, or simply coils and condensers offer considerable opposition to the rise and fall of current through them, meaning that they oppose the flow of alternating current through them because they possess an electrical property known as reactance, a term which really explains itself, and means that they react or act back. A coil also possesses resistance, but this is of lesser importance here. Another interpretation of reactance is that it is the influence or action of one turn of coil or conductor upon another conductor which chokes or holds back an alternating current, but at the same time permits the flow of steady direct current through it without any opposition.

Reactance, like resistance, is measured in ohms and from the

simple formula below it can be calculated what opposition or reactance an inductance offers to the flow of alternating current through it. This formula is not absolutely exact, but is sufficiently close for our requirements.

$$\text{Reactance in Ohms} = \frac{\text{Cycles} \times \text{henrys} \times 1000}{159} \text{ or}$$

$$\frac{\text{Kilocycles} \times \text{millihenrys} \times 1000}{159} \text{ or}$$

$$\frac{\text{Kilocycles} \times \text{millihenrys}}{159}$$

A circuit or component having reactance alone does not exist in practice: there is usually enough ohmic resistance present to make a difference in the results, but as reactance is the most important factor when considering inductance, particularly in R.F. chokes, it will be the only factor considered here. The combination of resistance and reactance is called impedance and is expressed by a different formula. Impedance is the total opposition offered to alternating current by an inductance, and if it were considered here instead of reactance it would only mean that the reactance figures given here would be slightly higher.

### SOME APPLICATIONS

Perhaps the most common use of the R.F. choke is in filtering or decoupling in R.F. circuits, and here we must take into consideration another important component, the condenser, as this, plus the R.F. choke invariably go together when R.F. decoupling or filtering is being considered. The condenser, too, as has already been pointed out, has that electrical property known as reactance and is commonly called capacity reactance, and that of evils inductive reactance, and like inductive reactance, capacity reactance can also be calculated to a useful

(Continued on page 28)

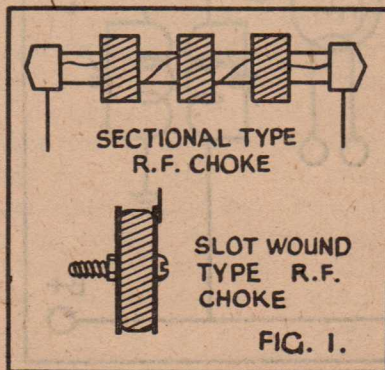

## R.F. CHOKES

(Continued)

degree of accuracy from a simple formula which is:

$$\frac{\text{Capacity Reactance} = 159}{\text{Kilocycles} \times \text{Microfarads}}$$

As an example, let us consider the following. Diagram 2 shows a portion of an intermediate frequency amplifying stage of a superheterodyne radio receiver employing an intermediate frequency transformer of 175 kilocycles, and in the plate circuit and within the dotted circle can be seen an R.F. (2MH) choke bypassed by a .1 mfd. condenser. This arrangement is what is known as decoupling or filtering as referred to earlier. At a frequency of 175 kcs. a 2MH R.F. choke would have a reactance of, using the formula for inductive reactance,

$$\frac{\text{Kilocycles} \times \text{millihenrys} \times 1000}{159} = \frac{175 \times 2 \times 1000}{159} = \frac{350,000}{159} = 2201 \text{ ohms.}$$

The .1 mfd. condenser at the same frequency would have a reactance of, using the formula for capacity reactance,

$$\frac{159}{\text{K/c.} \times \text{Mfds.}} = \frac{159}{175 \times .1} = \frac{159}{17.5} = 9 \text{ Ohms.}$$

Since electric currents always take the path of least resistance, it is obvious that all the 175 kcs. currents after doing useful work in the primary of the I.F. transformer will pass to earth via the .1 mfd. condenser having only 9 ohms reactance rather than attempt to pass through the much greater opposition offered by the R.F. choke of 2,201 ohms, in other words they will be filtered out before they can pass into the B+ circuits and enter into other circuits also connected to the B+ line, there to cause trouble and stability problems.

Some may ask, if this is the case, why not use a straight out 2000 ohm or smaller resistance in place of the R.F. choke? The answer is obvious, a pure resistance would create a voltage drop in the D.C. flowing to the plate which is most undesirable in this position, whereas there being no such thing as reactance to direct current, when a choke is employed, the only opposition which would be offered to the D.C. flowing to the plate of the valve would be the ohmic

resistance of the winding of the choke, which is exceedingly small, too small in fact to cause any noticeable voltage drop in the B+ to the plate. From this it can be seen that the choke offers advantages not to be had by the use of pure resistance.

Again referring to diagram 2, supposing the intermediate transformer was of the 460 kcs. variety, what then? Using the same value of choke and condenser let us once again refer to the reactance formula but substituting the new frequency of 460 kcs. for the one of 175 kcs.

$$\frac{\text{Inductive Reactance in ohms} = \text{Kilocycles} \times \text{millihenrys} \times 1000}{159} =$$

$$\frac{460 \times 2 \times 1000}{159} =$$

$$\frac{920,000}{159} =$$

5786 ohms, and for the condenser

$$\frac{159}{\text{Kilocycles} \times \text{microfarads}} =$$

$$\frac{159}{460 \times .1} = 3 \text{ Ohms.}$$

So by increasing the frequency by 285 kcs. the reactance of the choke has climbed from 2,201 to 5786 ohms, an increase of 3585 ohms while the reactance of the condenser has fallen from 9 ohms to 3 ohms, a decrease of 6 ohms! From this we learn the following important rule (as the frequency increases the inductive reactance also increases while the capacity reactance goes down). It goes, therefore, that if the value of the choke remains constant its action becomes more effective at higher frequencies.

Since an R.F. choke is so effective in its action and creates no objectionable voltage drop in the circuit, its advantages on the shorter waves are readily appreciated.

### STABILITY

From a designer's point of view stability in any piece of apparatus is of major importance, what is more, filtering of the circuits is

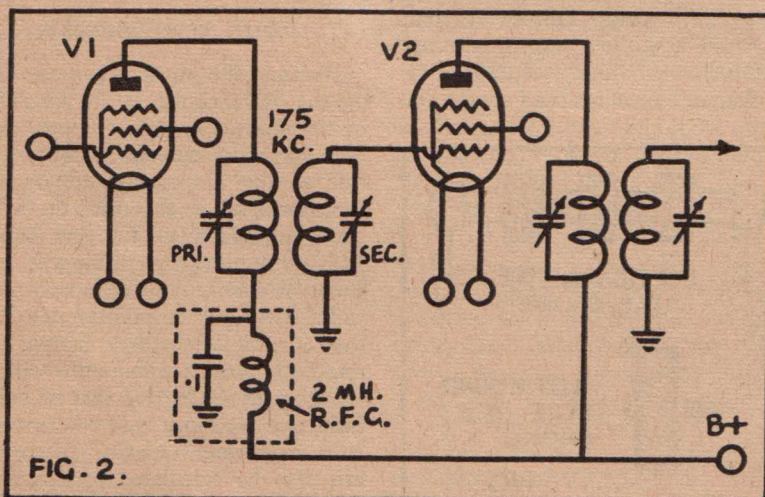

an easy way in which it may be attained and the little extra cost it may entail is more than compensated for by the stability gained.

### CONSTRUCTION

We will now consider the construction of an R.F. choke which is easily constructed, very effective and practical. Most ready made chokes available on the market have an inductance in the vicinity of 2.5 M.H. and, what is more, they cost money when half a dozen or more are required, so in order to make ours a little more effective in its action we will use an inductance of approximately 5MH. The next item to be considered is what type of wire to use. 32 SWG enamelled seems to be about right, single cotton covered or double cotton covered may be used, the only objection being that it occupies a little more space. It is not necessary that new wire should be used either, other wire, such as that taken from old power transformers or audios may be used, so long as it is in reasonably good condition, particularly the insulation. Next cut from very stiff cardboard, fibre, or other thin hard insulating material 2 circular discs  $1\frac{1}{4}$ -in. in diameter, as shown in diagram 3 and drill a hole through the centres of both so that an ordinary round head  $\frac{3}{8}$ -in. brass mounting bolt may later be passed through them. After this cut from wood or other such material a centre piece to separate the two discs by about  $\frac{1}{4}$ -in. as shown, the centre piece should be approximately  $\frac{1}{4}$ -in. long x  $\frac{1}{4}$ -in. diameter, a piece of ordinary round lead pencil with the lead removed and the hole enlarged to the same size as that used for the discs will suffice. The discs and centre piece, etc., are then assembled as shown in the diagram, if a  $\frac{3}{8}$ -in. brass mounting bolt is used as suggested it leaves a portion of the end free so that it can be passed through a metal chassis for secure mounting of the choke. Two small lugs may be riveted to the outer edge of one of the discs, preferably the one opposite the mounting side, for anchoring the ends of

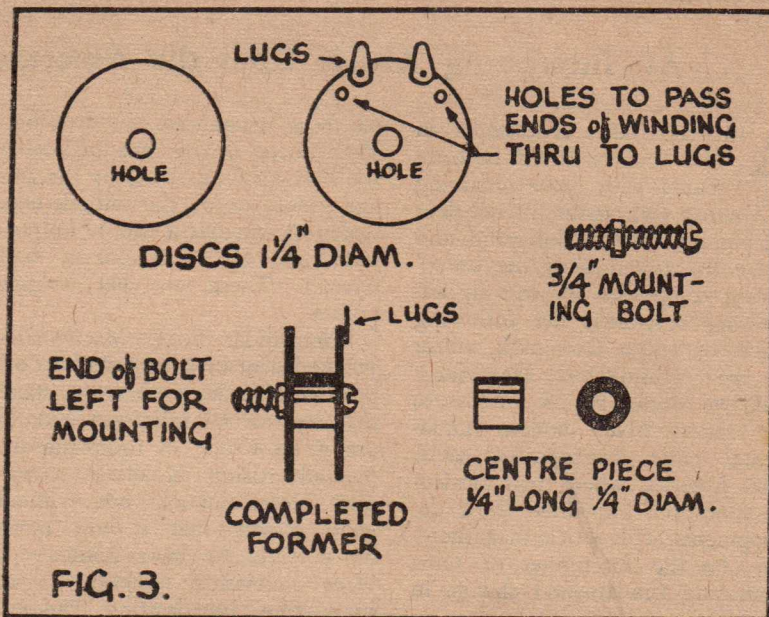

FIG. 3.

the winding, and as terminals; an alternative is to pass the ends of the winding through two small holes in the edge of one of the discs several times and leaving a length of wire free on each end so that they may be taken directly to any point in the circuit.

### TERMINALS

However, the lugs make a more efficient and neater job and should be used when possible. When the former has been completed it should be filled with 32 SWG enamelled or other such wire as suggested earlier, to within  $\frac{1}{8}$ -in. below the tops of the discs, requiring some 500 turns, but if other gauge wire, or cotton covered wire is used it may not be possible to fit all the turns on, in this case the discs may be cut larger if the extra size is not objectionable. The ends of the winding should be passed through two small holes near the lugs, and then cleaned and passed round the lugs two or three times, then soldered, This ensures a firm clean joint. After the job is com-

pleted it may be shellacted or waxed over according to the desires of the owner and usually there is some shellac or wax left over from some other job, the quantity required is very small. The thus finished article is then left to dry, and it is then ready for use.

This makes a very efficient job, and is capable of passing a direct current of 100 mA. or better and can be used on frequencies ranging from 30 kcs., upwards, while its D.C. resistance is small and may be neglected.

Using this method any size choke can be turned out to suit any type of apparatus including vibrator units.

P.S.—If the lug method is employed in constructing R.F. chokes, an additional paper disc the same size as the ones already mentioned should be placed inside the disc holding the lugs, this stops the windings from fouling the terminals.

# THE TRUTH ABOUT TELEVISION

An Interesting Article from the American Point of View

ALTHOUGH conditions in this country cannot be compared with those obtaining in America (where the listener does not pay a licence for his radio, and where the expenses of the broadcasting companies are met by advertising revenue), the following article by Hugo Gernsback, editor of the "Radio-Craft Magazine," will, we think, be of interest to our readers. Many modern fundamental radio developments came from America, where their particular conditions expedited those developments. This article may, therefore, be the forerunner of some interesting fundamental change in television technique.

Recent speeches, press articles and advertisements in the U.S.A. have heralded "the television era" as something immediate. Public expectancy has been built up to the point where the average person thinks that within the next few months he can purchase a high-grade television set at about the price of a radio receiver, and, at the turn of a dial, enjoy a steady stream of programmes on a par with the Louis-Conn telecast. Mr. Gernsback says:

We hear continuously from the general public, who are bewildered as to the true status of television today. There is a great deal of confusion regarding television as a whole. Nor is it abated by the industry, which itself is at odds on more than one of the art's major questions. The entire video picture is highly complex, to say the least, while little is being done to clarify the situation.

Within the industry certain factions are at odds with each other. Much could be written about such points as the disagreement between the industry and the Federal Communications Commission as to time schedules of operation, freezing of standards, etc. Within the industry one faction is for colour television,

which is denounced by the other. Then there is the size of screen for best viewing, whether the image should be on the cathode-tube screen or whether it should be projected on the wall (or a wall screen). These are but a few points.

Commander E. F. MacDonald, Jr., President of Zenith Radio Corporation, has long taken the stand that commercial television procedure is all wrong in following the paid-advertising broadcast technique. He maintains—not without good reason—that it will never be possible to have nation-wide "free" television reception as we have "free" broadcasting. The cost of good television broadcasts is in the order of making good motion-picture films. And, as everybody knows, production of a good motion picture costs anywhere from a quarter of a million dollars to two million dollars.

What makes matters worse in television is that there cannot be any "re-takes." Inasmuch as a television production must be carefully rehearsed and must be letter-perfect at the moment of broadcast, the television director has no way of correcting any mistakes, as is the case in motion pictures.

Therefore, a good television broadcast programme would of necessity cost more than a like motion picture production. Commander MacDonald thinks that the excessively high cost of television broadcasts cannot be met by sponsored advertising, as it is in broadcasting today, but that television programmes should be paid for in some other way; either over line wires or by radio using special equipment, where only those who pay for the service would have sets that could receive such paid programmes. That is one angle.

## FILMING FIRST

Dr. Lee de Forest, of radio fame, pointed out in an article in "Radio-

Craft" (April and May, 1945, issues), that the simplest way would be to take a motion picture film of the production. This could then be edited *before* the broadcast; the final film would *then* be run at the television transmission studios and broadcast. This would make it as cheap, or cheaper than motion picture practice. Sponsored advertising programmes could be presented in this way whereby the admittedly still high production costs would leave a profit to the television broadcasters. That is another angle. This suggestion, however is not at all welcomed by the television industry, who wants none of it, but believes that television's credo is that events should be broadcast *when the event actually occurs*, instantaneously, as for instance, the recent Louis-Conn fight.

This is only one part of the story. So as not to lose our perspective, let us turn the clock back to 1921 when broadcasting started.

At that time anyone with a \$10 bill—or less—could receive radio broadcast programmes simply by either buying a crystal detector and a pair of headphones, or by making the detector himself and buying the phones. From such small beginnings broadcasting began.

A little later the radio wave came into its own, and then with one- or two-valve sets, which gave better selectivity, stronger and clearer reception, broadcasting marched on its triumphant way. Still later, loudspeakers were added. Millions of enthusiasts in the United States now were building their own sets, and the radio age was here to stay. Soon—with tens of millions of listeners getting programmes—the advertised products via the radio waves paid handsomely for the broadcast effort.

## THOUSANDS OF TRANSMITTERS

Now let us turn to television. The situation here is far from

parallel. To begin with, television must in its very nature be broadcast on higher frequencies (low wave lengths). That means that the reception range cannot be greater than an average of 25 to 30 miles from the transmitter. Now then, if the entire country is to be blanketed with television, this requires thousands of television transmitters. The capital outlay, therefore, for the television broadcast industry will be immeasurably greater than was the case with the broadcast industry. At the present time we only have a handful of television transmitters in this country, in actual numbers only six stations, now operating on a schedule, plus three *experimental* stations.

Against this, the radio broadcast industry has 1,003 transmitters as at December, 1945. Even if we soon had a like number of television transmitters in the United States, they would by no means blanket the entire country to support an advertising-sponsored tele-

vision programme that could conceivably pay out. To cover the entire nation with television transmission—as is the case with radio broadcast today—we need a minimum of 1,500 television transmitters. It does not appear that such a programme could be possibly realised within even ten years from today. Until such time, mass production of television receivers, to run into the millions, does not seem feasible.

It is true that Westinghouse has proposed their so-called Stratovision, whereby a small number of television transmitters, cruising continuously in the stratosphere, could blanket the entire country. This, however, is as yet a mere proposal. It is not known if such a scheme is feasible technically and whether or not it could be soon realised. If and when it is and has proven its worth, then, the total number of transmitters and the ten-year estimate mentioned could be cut to a great extent.

For the present, only a few large centres in this country will conceivably be served by television. The programmes will have to be more or less mediocre because highly expensive productions must remain completely out of the picture. The reason: no advertiser is going to spend millions, or even hundreds of dollars, to broadcast to a few thousand television receivers. Today there is no real television audience in existence, and there is not much likelihood that there will be one for a number of years to come. So much for a few of the complex problems that confront television today.

#### COST OF RECEIVERS

Again this is not the whole story. There is, for instance, the high present cost of television receivers. To sell these by the tens of millions the price must be low enough to appeal to the great gen-

*(Continued on next page)*

## RADIO BOOKS

	Post		Post
BABANI, RADIO REFERENCE HANDBOOK .....	16/9 6d.	SMITH: RADIOTRON DESIGNER'S HANDBOOK .....	6/- 6d.
EVERYBODY'S RADIO MANUAL (How to Build & Repair Radio Receivers) .....	7/6 9d.	CHUTE, ELECTRONICS IN INDUSTRY .....	35/- 1/-
AUSTRALIAN OFFICIAL RADIO SERVICE MANUALS: (4 Vols. covering Sets manufactured in 1937-38-39 and 1940-41) .....	15/- 9d. (each)	ATHERTON, PRINCIPLES OF RADIO FOR OPERATORS .....	23/6 9d.
GHIRARDI, RADIO PHYSICS COURSE .....	40/- 1/-	TUCKER, INTRODUCTION TO PRACTICAL RADIO .....	26/3 9d.
GHIRARDI, MODERN RADIO SERVICING .....	40/- 1/-	MARCUS, ELEMENTS OF RADIO .....	28/- 1/-
COOKE, ELECTRONICS DICTIONARY (An Illustrated Glossary of Terms used in Electronics and Allied Subjects) .....	35/- 1/-	TERMAN, RADIO ENGINEER'S HANDBOOK .....	42/- 1/-
MARCUS, ELECTRONICS FOR ENGINEERS .....	42/- 1/-	HALLOWS, RADAR SIMPLY EXPLAINED .....	12/- 6d.
STRANGER, OUTLINES OF WIRELESS .....	17/6 9d.	LADNER, SHORT-WAVE WIRELESS COMMUNICATION .....	54/3 1/-
SCROGGIE, FOUNDATIONS OF WIRELESS .....	10/6 6d.	RIDER, FREQUENCY MODULATION .....	16/- 6d.
STRANGER, MATHEMATICS OF WIRELESS .....	9/- 6d.	HIND, FREQUENCY MODULATION .....	28/- 1/-
HOW TO BUILD & OPERATE SHORT-WAVE RECEIVERS .....	4/- 3d.	RIDER, SERVICING SUPERHETERODYNES .....	16/- 1/-
		RIDER, INSIDE THE VACUUM TUBE .....	36/- 1/-
		CAMERON, SERVICING SOUND EQUIPMENT: (Includes Sound Pictures, Public Address, Radio and Television) .....	68/- 1/3
		RADIO FOR THE MILLIONS: (Published by Popular Science Magazine) .....	10/6 9d.

**ALL MAIL ORDERS DESPATCHED BY RETURN MAIL  
WE CAN ARRANGE SUBSCRIPTION TO ANY RADIO MAGAZINE — PRICES ON APPLICATION**

**TECHNICAL BOOK & MAGAZINE CO. 297-299 SWANSTON STREET  
Opp. Old Melbourne Hospital  
CENT. 2041. MELBOURNE, CI.**

## TELEVISION

(Continued)

eral public in this country. Today the lowest price of video receivers is around \$200.00, and for this amount of money you do not get much.

For a really acceptable televisor that throws a fair-size, clear image, the price is in the neighbourhood of \$500. Remember, television receivers are complex. To have both sight and sound you really must have two sets in one: one for video, the other for sound. This alone increases the price a great deal. It seems improbable at the present state of the television art that the American public would soon be able to absorb 54 million television receivers—even at \$200 a set—a quantity necessary to support continuous daily expensive and elaborate television programmes to parallel the high-quality broadcast programmes current today.

In our estimation, the present

fundamental television technique is not the final word in the art. The popular price televisor will not arrive until our entire conception of television has been radically changed. The means current today are not what television will be in years to come. We have made this clear editorially for many years past. It is certain that the ultimate solution will not be the present-day scanning cathode-ray tube.

We quote from our editorial in the February, 1934, issue of "Radio-Craft":

"This scanning idea, to my mind, is all wrong and totally unnecessary. When the final television invention comes along, one which may be likened to the radio tube of today as compared with the radio crystal of yore, it will be found that the scanning idea is conspicuous by its absence.

"Some 30 million years ago, nature invented the first real television machine, which, so far has not been duplicated by man.

I refer, of course, to the animal eye, which has been in existence on this planet for millions of years, and is open for study by all television aspirants.

"The animal eye (which, of course, includes the human eye) is almost a perfect television receiver and transmitter. Not only does it receive an image from the outside world by means of light rays and then transmit it through the optic nerve to the brain, but it takes the television engineer several steps better; because in the first place, the eye gets along marvelously well *without any scanning mechanism*, but the image is received and transmitted in colours as well."

What was said above in 1934 still hold true now, if the television industry is to succeed as has the broadcast industry.

Basically, television as we know

(Continued on page 42)

CRYSTAL CLEAR

# STYLON ( Etholex Polystyrene )

Which has the Dielectric Strength of High Grade Mica, the Low Loss Factor of Fused Quartz, Zero Moisture Absorption, Insulation Resistance of  $10^{17}$ - $10^{19}$  ohms per centimetre is the logical insulation for Radio Transmitters, Receivers, X-Ray Equipment and H. F. Heating Apparatus.

Stylon is the best insulation for any application where Electrical Efficiency is Essential.

Stylon sheets and rods are available from:

QUEENSLAND  
Mica &  
Insulating  
Supplies Co.  
Pty. Ltd.

N.S.W.  
Mica &  
Insulating  
Supplies Co.  
Pty. Ltd.  
Jefferies  
Pty. Ltd.

Vict.  
Mica &  
Insulating  
Supplies Co.  
Pty. Ltd.  
Menzies  
Electrical  
Pty. Ltd.

S.A.  
Mica &  
Insulating  
Supplies Co.  
Pty. Ltd.

W.A.  
Carlyle & Co.  
Pty. Ltd.

## ETHOLEX PLASTICS

108 Chapel Street, Windsor, Melbourne, Aust.



## CALLING CQ!

By Don Knock, VK2NO

GOOD news for Hams is contained in information from the Philips Co. that the retail price of the type 807 valve is now 14/6d. Of course there is still the 2/- wartime duty tacked on, but that is no fault of the manufacturer. In the minds of some politicians we are still at war. Anyway, with prices of most things, especially the cost of life in general, soaring to crazy heights, it is something for the Ham to know that the most useful valve in radio now costs much less than half the previous price. Reason for the reduction is because this type is now classed as receiving and not a transmitting valve. Another handy type that has taken a drop in price is the 6X5GT,

a small rectifier with plenty of uses, especially in bias packs.

\* \* \*

If one can get through the din at this end, there is plenty of DX around on "forty," both in the early mornings and late afternoons on this side of Australia. But this DX is keywork, an art that lots of people seem to be unfamiliar with. If there is any doubt about that score, try calling some of the more vociferous habitués of the band on the key, and note the deathly silence that ensues. There are those who would find it quite an agitation to scrape through a re-examination involving 16 per.

\* \* \*

Band-hogging is a growing vice in and around parts of Sydney, and, from observations, in Victoria also.

\* \* \*

Apart from the fact that the practice of duplex telephony for periods of an hour or so is not according to regs., it becomes much worse when a group of stations sets out to indulge in *cross-band* duplex phone parties. 20-metre DX men cannot look too serenely on those who hog big tracts of this valuable DX band to duplex with fellows on forty, who moreover are almost within a stone's throw of each other. Such people invite attention by the Committees that were once known as *Vigilance* Committees, but which now use a more polite-sounding title. Sensible thing for these "personality" people who are virtually next-door neighbours is to make use of one of the VHF channels available for short-haul QSO's. One supposes, however, that the more some people talk with knowing mien, the less they really know about the techniques they bandy around so airily.

\* \* \*

Whilst on the unpleasant subject of regulations and committees, both unfortunately necessary to keep things on the rails, a word about callsigns with reference to the prefix may be timely. Many stations, accustomed to regular QSO's with others on 'phone, develop a habit of dropping the VK part of the callsign. This habit prevails more on 40 and 80 than on 20, the subconscious idea being no doubt that the transmission is not likely to go overseas or to distant points. That

—D.B.K.

(Continued on page 34)

## LATE SIX METRE NEWS

Details of important Pacific area schedules are supplied by Mal Urquhart (VK6ML): "KH6DD with 500 watts on 50,001 Kc/s and W7ACS/KH6 with 50 watts on 50,026 Kc/s are active in Pearl Harbour, on Saturday and Sunday (Hawaii) each week-end, from 0000 to 0400 GMT. They transmit on Six and listen for replies on that band and Ten metres. Schedules have been kept with VK and NZ. KH6DD is the station which set the world's Six-metre record by working with J9AAK at Okinawa, a distance of 4600 miles. The latter is understood to have worked also with a station on Wake Island, a distance of 2000 miles.

Nothing much has happened inside Australia since the band opened between Tasmania and N.S.W. in mid-January, and then again on

February 14th similarly for an hour. On the first occasion, VK's 7CW and 7NC tied up with most of the Sydney and Mountains stations, but on the latter occasion they seemed to be hearing only the stations in the high elevation Blue Mountains locations. The Newcastle station, VK2BZ, can be heard at up to R7 at VK2NO by using a horizontal dipole at the Sydney end. There is no sign of VK2BZ when using verticals, even at *both* ends. A 20-metre zepp is used at the Newcastle end and this horizontally polarised signal appears to reach Sydney fairly well. An interesting point is that pre-war 56 Mc/s communication was effected between the two cities with vertical arrays, stations participating being VK2ZC and VK2NO.

## HAM NOTES

(Continued)

is not always the case, of course, and oft-times the signal is dropping into places where the distance listener may wonder about the origin if the prefix is missing. I'm told that a few lads have received official letters, but the remedy is simple: Merely careful, instead of sloppy, phone operation.

\* \* \*

If you are a 20-metre DX phone man, and *you* can't raise those elusive European stations when you can hear stations like ZL2BE giving S9 reports with ease, take heart, and don't let it get you down. In the first place Australia is not New Zealand so far as European DX goes on *any* band. It is much easier to work G's for example from the Antipodean location. Secondly, a station such as that run by Jack Mills (XL2BE) constitutes just about the ideal for DX phone (or CW) work. He has in the first place a zero noise level QTH, and in the second, acres of antennae. Thirdly, he has the last word in high-grade American receiving equipment. Which things, you will agree, go a long way toward the Ham Paradise. Nine times out of

ten, you will be lucky even to hear (in Eastern VK) that G that ZL2BE may be giving R Max reports to.

\* \* \*

Bouquet: About the best sounding amateur phone I have heard for a long time is to be heard at intervals on 50.46 Mc/s in the Sydney area. This comes from VK2JU, John Moyle, who operates gear involving use of 807's with good effect. His station is in quite an elevated position, almost in the seats of the Mighty, up in the tower under the Golden Ball atop the "Sun" building in Sydney city. The quality John gets from his crystal mike sounds more like broadcast studio technique than a Ham station. VK2JU's should be quite a DX location.

\* \* \*

Another Sydney station well up in the sky, and well placed for line-of-sight work on VHF is Leo McMahan, VK2AC, who, nevertheless, operates under difficulties. He is a medico by profession and runs a Ham rig at the hospital. The technique is to get in a few words on Six or Ten, and rush away meanwhile to attend to things like supervising new arrivals by stork express on this earth. It takes enthusiasm for Ham radio to do that.

## VHF AIR BEACONS

Ron Petrich, VK2CZ, refers to the request in January issue for information on American air beacons, and sends along the following details of interest to VHF men. The Sydney beacon, actually a two-directional range, operates on 33.3 Mc/s and has two markers, both operating on 38 Mc/s. The outer is in the Haymarket Post Office and the inner at the Kingsford Smith aerodrome. Some VHF tower frequencies in the Pacific area are:

Tontouta (New Caledonia), 116.1 and 140.58 Mc/s.

Norfolk Island, 116.1 Mc/s.

Nandi (Fiji), 116.1 Mc/s.

Canton Island, 116.1 Mc/s.

Palmyra Island, 116.1 and 140.58 Mc/s.

Johnson Island, 116.1, 126.18 and 140.58 Mc/s.

and 140.58 Mc/s.

Honolulu, 116.1 and 126.18 Mc/s.

Hams interested in the 166 Mc/s band in the Sydney area should note that a harmonic from Sydney airport beacon, the fifth, falls at 166.5 Mc/s. It is a useful guide to receiver operation, but can also be a bit of a nuisance when locals get "under" its signal.

—D.B.K.

## DX RECORDS TOPPLE ON "SIX"

During the week ending January 25-26, 1947, the Pacific area saw the first long distance QSO in the 50-54 Mc/s band. W7ACS/KH6, at Honolulu, worked with a station in Okinawa, assumed to be J9AAK. Distance covered is 4600 miles, and signal strength both ways reported to be Q5, R9. A message from J9AAK to VK2NO says that the Okinawa station is trying now to reach Australia daily between 1800 and 1900 hrs. E.A.T., using a horizontally polarised array. March predictions show that the MUF runs as high as 58 Mc/s around midday to the North of Australia, and is around 48 Mc/s for 30 South. There should be interesting happenings on Six during March, 1947.

Pre-war five-metre enthusiastic, VK2EM, Killara, N.S.W., has arrived on Six with a solid phone transmission from a new transmitter with an 809 running 50 watts in the final. Although the locale is relatively high above sea-level, the immediate surroundings are not the best for VHF's, the house being in a deep gully. Consequence is that a high antenna is imperative and this aspect has been well and truly taken care of by a nicely-engineered ground-plane about 100 feet above ground. Result is that wherever there are stations on Six around Sydney, Arthur Sutton's well-modulated transmission pours in in fine style.

\* \* \*

Consternation was caused among a coterie of 40-metre habitués with glib-tongued tendencies when quite rightly objection was raised to a burst of thinly-disguised advertising. There is a Shakespearian saying "that methinketh the lady pro-*testeth* overmuch." No doubt some people have never heard of the immortal Bard?

## NEW BAND FOR VK HAMS

An interesting phase of QSO's on both 40 and 20 these times has been the presence in Australian waters of Mobile Marine stations using VK callsigns. First of these was VK2ANE, manned by Eric Sherlock, on the S.S. *Chertsey*. Eric, and the ship, are from G-land and his quiet mannerism and interesting microphone chats have endeared him to many VK's. VK3AAB and VK3KO are also well-known ship stations, these two using 40 mainly. It's a generous action on the part of our PMG Department to permit these Ham visitors from overseas to operate their own personal gear thus officially when in our waters. What surprises me is that VK2ANE made application to the British PMG for a Mobile Marine G call for intended use on the way home and was curtly refused. Ever hear of POPI, Eric? *He* was a prominent pre-war G similarly refused by red-tape officialdom.

\* \* \*

"VFO'itis" is the practice in vogue among certain N.S.W. coun-

### POWER LIMITS

STRANGE how matters work out oppositely to things pre-war in some instances. For instance, in VK we had, before the Sept., 1939, shutdown, many stations operating with increased power permits, with power of 150 watts input to the final stage. In those days, our friends the G's were using a nominal power of 25 or 50 watts, with a few special people on higher power. Now the situation is that the licence in the Old Country provides for 150 watts on most bands, and the Australia maximum is at 100 watts. Seems to be in keeping with taxation . . . grab everything possible from Mr. Everyman!

As this is written at the close of February, 1947, we learn that a new band has been made available to Australian Experimental Licence holders. This will become known as the "Eleven Metre Band" and extends from 27,185 to 27,455 Kc/s. It is in line with the assignment in force in U.S.A. where "Eleven" has been in use for some time. W's can often be heard strongly in Australia on the band and it may have slight DX advantages over the long-established 28,000 - 30,000 Kc/s (Ten Metre) band

try "leading lights" on forty who interpolate their "poisonality" on stations contacted by "ghost voice" interjections. One offender obviously doesn't know any better . . . *he* got his license just before September, 1939, happened along, but that doesn't preclude an attitude akin to virtual "ownership" of the band. It cannot be stressed too hard and often that amateur radio in this country, as abroad, exists not as a stamping ground for a few, but as a hobby for the many. The many should see to it that the hobby isn't abused overmuch.

\* \* \*

The W.I.A. Field Day held at Wyong, N.S.W., on Sunday, January 26th, last was voted a first-rate success by those who attended. It is understood much hilarity attended the morse code contest, also the hunt for the Hidden TX. Nobody succeeded in finding that. Some weird and wonderful DF outfits were sighted, against which it was thought that no Hidden TX could possibly survive. However, there's probably "more in a thing than meets the eye"! Field Days are a good way of bringing Hams together; too many are prone to stay

Reason for allocation of the band in U.S.A. was that, as this is a region granted for industrial RF purposes, the amount of QRM that amateur stations would cause would be small in relation to the din from plastic pre-heaters and the like. American amateurs nevertheless report little or no interference from industrial units using the band, a point that speaks well for the electrical and mechanical screening of such equipment.

in their Ivory Towers and know the other fellow merely by callsign and/or voice inflexion. Television might be a good thing when that becomes part of modern life . . . or might it? There's a lot of interest in visualising what the owner of a voice looks like . . . and so often one gets a surprise. No doubt the lads will vote in favour of Field Days as the better means of getting together . . . besides, you can't demolish 10-gal. containers by television!

DX hounds, are you keeping an ear on the 40-metre band? Most mornings just now one can hear G's, HB9's and CR8's on that band between 5 and 7 a.m. Sydney time. The DX I refer to is CW, the stuff for *operators*, and which some garrulous people have forgotten since they scraped through the exam. How do I know that? Try calling some of these wizards who never do otherwise than spout into the mike and whizz their VFO's over the band . . . on your key. I'll wager that most conveniently, they won't hear you. And, if they do, they won't know what you are talking about.

—D.B.K.

# DOINGS OF THE SIX-METRE GANG

IF it appears that preference is given to 50 Mc/s activities in these columns it is emphasised that VHF men write to us about their doings, but the HF men, probably too busy knocking off the DX on the other bands, haven't yet found time to put pen to paper. It is up to you, the population of Ham readers of "ARW." Meanwhile, here are extracts from letters from transmitting and receiving enthusiasts regarding 50 Mc/s activities: Bob 'Keddie, VK5KZ, says: "On December 26th I changed from 166 Mc/s to 50 Mc/s to keep a sked with VK5QR and 5GF. The latter was operating from a launch on the Port river. Whilst listening to him a fading carrier was heard alongside and I was somewhat surprised when it turned out to be VK2NO. Time was 1747 hours, SA, strength R5 on peaks, and fading right out. Word got around and the gang here began feverishly searching the dials for DX. VK5QR worked VK2AZ for a start and the rest is history. TX here uses a type 807 doubler to 50 Mc/s at 16 watts and the antenna is a Jones SWF type. RX is a temporary affair with 955 superregen. detector but is used primarily on 166 Mc/s. A plug-in coil arrangement puts it on 50 Mc/s. (Better keep the 166 Mc/s coil in

all the time OM . . . squeggers are out on Six OM . . . D.B.K.)

In Sydney, Ted Whiting, erst-while SWL contributor to "Radio and Hobbies," has made a start on Six-metre listening. He uses a superhet converter and a half-wave matched impedance aerial. Location is not the best, just a few feet above sea level at Five Dock, but he hears all the locals, and has been in the DX picture by hearing VK4HR on January 8 at 1900 hours. That GOM of listeners, Dr. K. B. Gaden, of Killarney, Qld., is not yet listening on Six but keeps a check on overseas activities on 28 and 14 Mc/s. Through W1HDQ, he heard all about the occasion when the Connecticut station got across to G5BY and G6DH for an hour or so on "Six." He also heard a ZL telling a VK2 on "Twenty" that a VK had been heard there on "Six."

From country 50 Mc/s man, VK-2TC, Monteagle, comes word of results after a period of listening and calling. Jim Taylor says: "Had my first experience of hearing DX on December 26 last when a VK3 popped in suddenly, working a VK4. Decided to put out a CQ and was amazed when VK3YS called me at R4-5 with a 4-7 report.

After this I heard several more VK3's; VK3MJ called me but I missed out on him. At 11.20 a.m. on the 29th I heard a strong carrier on 50.1 Mc/s which turned out to be VK4PG, Bundaberg, testing. Evidently he was not listening and faded after a few minutes."

Bundaberg also has a listener on the band, Mr. M. Tomkins, and he has been well rewarded for his efforts, hearing much of the recent interstate DX. He was instrumental in advising VK4PG that the band was "open" but says that 4PG is troubled by harmonics from the local BC station, being situated under the BC station aerials. In N.S.W., VK2LZ is almost similarly placed but has managed to hear and work DX through strong power leaks and BC harmonics. In Newcastle, N.S.W., VK2CI, using a converter with a few feet of wire, suddenly heard Victorians roaring in and, after realising that he had the converter on "Six" and not on "Ten," telephoned VK2BZ with the result that the latter hooked up with VK3HK. As usual Victoria provides the fullest information on doings on the band and Ken Mc-Taggart, VK3NW, includes in his reports for the past few weeks the following: "VK3MJ was the *first* VK3 to contact VK2 (VK2NO) and VK4 . . . the rest of us were a few minutes behind. A letter was sent to Mt. Stromlo Observatory and a reply received to the effect that they were very interested in getting reports of DX. A new piece of apparatus is being installed for ionosphere prediction work. Increase in activity down here since the DX broke is quite amusing but gratifying also. Those who have appeared on the scene are VK's 3BQ, 3OT, 3OF, 3LR, 3IZ, 3ACM, 3AJH, 3XH and 3DH. Of the 'regulars' on the band, those active include VK's 3MJ, 3GG, 3QO, 3HK, 3ABA, 3YS, 3LS, 3AFQ, 3BW, 3ZD and 3NW. A VHF group has been formed within W.I.A., with meetings well attended. Much enthusiasm is shown

## ZL1NF HEARS VK2AZ ON "SIX"

In a letter to Les Day, VK2AZ, Ross Garrett, ZL1NF, says: "I commenced listening on the band at 6 p.m., N.Z. time, on 9/12/46, when I heard several harmonics from Australian commercials, around 53 Mc/s. A VK2 was heard on about 52.7 Mc/s, calling CQ DX but was not identified. The rig here wasn't wired for CW but I called on speech with the beam West. The commercials were peaking at R6. I next heard your station (VK2AZ) on 50.96 Mc/s, peaking at R3 and fading right out. I called you at once but ND. At 7.10 p.m. I called

CQ and think it most likely that the station heard in Sydney as ZL-4JN was my signal. Several times during the evening I heard fading signals and at about 11 p.m. my time, a phone station was heard, evidently working duplex, but not strong enough to identify. RX here is a 3-valve converter, using 9001 RF, 6C4 mixer, and 6J5 oscillator into an HRO. The TX uses an 815 final with 75 watts input, and antenna is a three-element array horizontal. There is likely to be more activity in New Zealand now."

## D.C. RELAYS IN THE AMATEUR STATION

and lectures cover receivers, transmitters, aeri-als, portable gear, etc." Since the epic January 20th when VK's 7CW and 7NC tied up with Sydney on "Six," Crosby Walch (VK7CW) says on his QSL card to the writer: "How was it that almost *all* the VK2 six-metre fiends were on that night? Did you have premonitions? Are they all on every evening?" Reason for the gathering of the clans may have been that around 6 p.m. that evening your scribe heard a fading carrier about 51 Mc/s and a will-o-the-wisp voice said something about "this is VK7 something or other testing." The gang was warned, and by 8 p.m. that evening all ears were on the qui vive. No, Crosby, the team that you worked with is *not* on the band in Sydney every night! Most evenings the population runs to three or four stations only. It is the case, however, that when a DX signal shows up, fellows appear from the silence like magic. In two instances stations from whom not a whisper had been heard for months appeared from nowhere to snag off DX contacts. Seems that a lot of people do a lot of listening, which is all very well in its way; but *all* listening and no calling means a silent band, an experience many of us had in the early days and nights of 10 metres.

\* \* \*

Too much Ham radio can lead to domestic strife, and with some fanatics who relegate important things to the background whilst they assail the XYL's ears constantly with mike-jargon . . . I have little or no sympathy. But I am a bit sorry for the lad who runs up against it through a streak of carelessness. The other day a worried VK telephoned me and broke the news that, through a mishap, he was obliged to dispose of all his station gear . . . or face domestic cleavage. His baby boy had put his hands on a 750-volt power pack whilst his (the VK's) back was turned, and came close to electrocution. XYL decreed that the

In the course of delving around Disposals dealers' stocks, the transmitting enthusiast is likely to encounter plenty of ex-service radio and radar equipment wherein may be found a few relays. These are invariably of 6, 12, or 24 volt D.C. types and because of the direct current design the average Ham may pass them by as being of little use. A little consideration will show the fallacy of such judgment. Some of the relays are very light current types, and may be used for various applications by operating them from well-filtered H.T. supplies, correct voltage being applied by the simple usage of a resistor or two and Ohm's Law. Those relays that have heavier loading can be put to good use by reconstructing them for antenna feeder switching or H.T. transformer primary switching. Source of power supply for such operation? Simple. A unit that will handle two or three such relays in shunt can be made up with a mercury vapour full-wave rectifier of the battery charger type such as the Philips 328 and a transformer carrying the appropriate windings. A few turns of suitable gauge wire can be wound over a primary on a discarded filament transformer,

usually on the basis of about 8 turns per volt.

Experimentation is necessary, depending upon the core dimensions and inductance of the primary. The 328 type rectifier needs about 24 volts per anode and strikes at a minimum of 16 volts. Filament requirements are 1.8 to 2 volts at 2.8 amperes. Output is around 10-12 volts and, although this rectifier is rated at 1.3 amperes output, in practice it handles more than this with ease. Being a full-wave rectifier, very little filtering is needed, but where any residual "chatter" remains in relays, that may be removed entirely by connecting a 2000 mfd., 40-volt condenser across the output from the rectifier.

The writer has found it possible to use a 2 ampere half-wave Tungar type charger for DC relay operation in this manner by using a high capacity condenser across the output. The higher voltage relays (24 volts) can easily be rewound for lower voltages and in some cases series windings can be connected in parallel to halve the resistance for lower voltage operation. The condensers mentioned are also obtainable from the Philips Co.

—VK2NO.

whole of the gear had to be out of the place by 48 hours or else. The sad part of this is that it needn't have happened if the safety feature had been taken into consideration at the outset. It is certainly likely to lead to trouble in a small flat location, where children are literally on top of the gear, and where "haywire" may invite trouble. How many times does one hear phone transmissions with a background of infant play? If your kiddies must of necessity play in the vicinity of

your gear . . . for Heaven's sake keep them well in mind when planning and constructing power supplies and controls. I mention controls for a very definite reason. Many years ago . . . in the early days of amateur radio, a then-prominent Australian radio amateur was accidentally killed because a child touched a switch whilst Dad was underneath the table fixing up some connections. Death can strike in lots of ways.

# Shortwave Review

CONDUCTED BY

L. J. KEAST

## NOTES FROM MY DIARY

### TELEVISION

Regarding my reference to the Television Set in Sydney . . . see January issue . . . Mr. A. R. McRitchie (AW550DX) from Whyalla, South Australia, writes: "Reading your diary in ARW of January, I noticed reference to 'The first Television RX set in Australia.' I again don't wish to be catty, but during 1938 whilst I was working in Melbourne (I am a native of Melbourne) I happened to call in to see a friend of mine in The British General Electric Co., Bourke Street, Melbourne, and during my visit I noticed they had on display in their Radio Department a mantle and a large console Television receiver which I believe they had specially shipped over from their main office in London just for the purpose of display. I suppose you will receive a few other letters similar to this but I just thought you may be interested."

### BYRD ANTARCTIC EXPEDITION

On board the *Mt. Olympus*, with a call-sign NAVE, this expedition contacts Press Wireless and RCA, New York, on 17.84mc, 16.82mc, and have been heard at 9.30 a.m. Several other frequencies have been allotted as follows: 20.40mc, 17.82mc, 15.96mc, 15.93mc, 12.26 mc, 12.24mc, 9.67mc and 9.28mc, and the varied list should permit of transmissions at any time, so should you pick up NAVE, send your report to Radio-Television Section, Office of Public Information, Navy Department, Washington 25, D.C., U.S.A. The Navy Department states reports must NOT be sent to the *Mt. Olympus* and that verification will take from 5 to 6 months.

### WWV, NATIONAL BUREAU OF STANDARDS

This station situated in Washington, D.C., U.S.A., is now on 8

outlets with frequency checks. The complete list is: 2500, 500, 10,000, 15,000, 20,000, 25,000, 30,000 and 35,000 kc. At present WWV is heard well at 10 p.m. on the first 5 outlets.

DX listeners may like to correspond with International Short Wave Club, Adams Gardens Estate, London, S.E. 16, but if you desire a reply it will be necessary to enclose an Empire Coupon procurable at the G.P.O.). They publish a monthly News Letter devoted entirely to Short-waves and is quite good. The subscription to the Club is 4/- per year. (To this, of course, exchange will have to be added.)

### PITCAIRN ISLAND

Listeners might keep a watch for this station, the call-sign of which is VR6AY and it will most likely be heard on the 20-metre band. The owner is Andrew Young, who operated this station before the war. (I am proud of a verification card from Mr. Young.) During the war the call-sign was ZKG and it was conducted by a New Zealander, Nelson Dyett, and used as a weather reporting station.

### RADIO AUSTRALIA

Here are a few interesting items about "Radio Australia."

Inaugural transmission, December 20th, 1939, directed to British Isles.

Transmits in six languages: English, Dutch, French, Siamese, Chinese, Malay. Also in Japanese until September, 1946.

Is on the air 20 hours a day, seven days a week.

Puts out 24 different programmes a day, including 23 news bulletins.

Played leading part in Allied psychological campaign in Pacific and Asia during the war. Its policy is to tell the world about the Australian way of life in the city and country, and programmes of news, music, sport, literature, agriculture

and finance are directed to that end.

Shepparton transmitters, among the most modern and powerful in the world, occupy a site of 567 acres and cost £A546,000. There are 19 multi-element directional aerial arrays.

The above particulars have been taken from a pamphlet received from the Department of Information. It is most gratifying that these stations are doing such a fine job, as I recall way back in 1939 there was talk that they would be "jammed" . . . Germany would blot them out, but I would never subscribe to that thought and said as much when I was writing for *Smith's Weekly* (vide January 6th, '40).

### HELP WANTED

Two mysteries from Rex Gillett: "On about 6.08mc, 49.34m., I have been hearing a station using French language and playing native music from about 11.30 p.m. At 12.30 a.m. a clock chimes about 5 times. Latest American information says Radio Azarbaijan opens at M/N with chimes and clock striking on 6087 or 6090kc. I could not make my frequency any different and am wondering if I am hearing the same station. Interference from SEAC is rather severe."

The other is French, announcing: "Ici Radio —? Seems to open at 10 p.m. and closes at 11.30 p.m. with a march on about 9.87 mc. Signals have been quite good but just cannot get that last word, which is only a short one."

### VERIFICATIONS

Rex Gillett, of Prospect, South Australia, writes: "Was thrilled to get a nice but plain card from ZPA-5, Encarnacion, Paraguay. This brought up my 71st verified country. I am very much afraid the next 30 are going to be tough. Latest veries here are Klofta, on

6.20mc, Vienna 9.84mc and 12.21 mc, Capetown 9.61mc; CR7BJ, Lourenco Marques, 9.65mc, and VUD-8 on 13.95mc and 21.50mc. Klofta in their verification said they ceased transmitting on September 1st."

Arthur Cushen, of Invercargill, has also received some nice verifications: OAX4M, Miraflores, Peru, 6.315. (They have now moved to 6.22mc as CE622 has been deleted and replaced by CE1173.) The address of OAX4M is: 'Radio Miraflores,' Jesus Nazareno 113, Of. 213-214, Lima-Peru. (I think the slogan of this station is "La Voz de la Democracia."—L.J.K.) CSX-2, Ponta Delgada, Azores, 4.04mc; VUM-2, 7.26mc; Singapore, 11.735mc; LKJ, Oslo, 9.54mc; FZK-6, Dakar, 6.915mc; and Paris on 11.845 and 9.985mc. My verie from LKJ is the 92nd country I have verified." (Very nice work, Arthur.)

And Miss Sanderson, of Melbourne, says: "Veries have been coming along very well, and I now have one from Poland which came by air-mail; a Xmas card from the Swedish Broadcasting Co., besides a card and letter from SDB-2, and a letter from Nairobi for reporting VLQLO on 62 metres back in September."

## SAYS WHO?

An air-mail letter from Charles C. Norton, Editor, "Universalite," states all shortwave notes are to be sent to the new URDXC SW Editor, Lee Neidow, Jr., 1611 Grace Street, Chicago 13, Illinois. No reference to what has happened to Bill Howe or why the change. I am sure we all hope he is O.K. . . . he has done a wonderful job over the many years.—L.J.K.

Miss Sanderson, of Malvern, Victoria, says: "Conditions have been fair and I have heard several stations that are new to me, although they may have been heard by other reporters. ZBW, Hongkong, 6.52mc, 31.49m, is heard at 8.30 p.m. in a programme of music for the Services, then a relay of BBC news is taken with commentary. Another 15 minutes of music and then a programme of news for Chinese listeners.

"NAVE (the station which is broadcasting from the Antarctic) was heard at 9.15 p.m. on a frequency of 17.90mc or wavelength of 16.75m. This station was calling New York with despatches.

"Two stations in Munich are heard with good signals in the 49 and 41 metre bands on frequencies of 6.10mc and 7.29mc. These are heard in music and news in German, French and English at 6.30 a.m. and 7.15.

"Macassar is on another frequency with quite good signal on 24.35m or 12.32mc. Another station, this time in Haiti, is to be heard opening at 9.35 p.m. with news in French and a musical programme. I rate the signal at R9 Q4."

Rex Gillett writes: Here are a few DX tips: Radio Noumea is now on 6.16mc, 48.70m, signing off at 8 p.m. with 'Marseillaise.'

"Radio Brazzaville is now being heard with News in English at 6.45 a.m. on about 7.00mc, 42.86 m, in relay with other outlets.

"Radio Paris on 7.24mc, 41.44m seemed to sign off at 8.15 a.m. following programmes in various languages. Was clear of VLQ.

"Radio Tananarive has been particularly fine on 9.69mc, 30.95m, in relay with 6.065mc, 49.46m outlet. Station identification was clearly given in French. The latter channel was nearly as good.

"You are listening to Bombay' identifies VUB-2 on 3.365mc, 89.15m, at 3 a.m., during a programme of dance music. Scheduled closing time is 3.30.

"Radio Moscow has news in English at 9 p.m. on two 31-metre channels, these being 9.565mc, 31.37m, and 9.545mc, 31.43m. A (?) new frequency is 6.112mc, 49.08m, both in the a.m. and p.m.

# ULTIMATE

*Champion Radio*

Sole Australian Concessionaires:

**GEORGE BROWN & CO. PTY. LTD.**  
267 Clarence Street, Sydney

Victorian Distributors: J. H. MAGRATH PTY. LTD., 208 Little Lonsdale Street Melbourne.

The Ultimate factory has made the changeover from wartime production. Designs for the new models are now completed and production is about to commence.

These models should be available soon — they will be worth waiting for. Watch for further announcements.

**SERVICE:** Servicing of all kinds of radio sets, amplifiers and Rola speakers will continue to be available.

English is concluded at 11.13 p.m. . . . Foreign language commences at 11.15. Two other Moscow outlets heard at 7 a.m. are 6.14mc, 48.86m, and 6.13mc, 48.94m. Yet another at the same time heard through the interference of Luxembourg, I presume, was 6.09mc, 49.26m. Moscow was identified on about 9.80mc, 30.61m at 6.15 a.m. with a Danish-type programme."

\* \* \*

Mr. R. I. Henry, of New Farm, Queensland, writes: "I don't know whether you people are interested or not but recently I noticed when listening to WWV on 10mc that they are broadcasting on 8 frequencies in all. I first heard the announcement of the additional frequencies when listening in during a holiday in Victoria." (Yes, Mr. Henry, we are always pleased to get notes about any alterations. Had your letter been addressed to Ermington, N.S.W., your memo

would have enabled us to show the new frequencies in last issue. However, just before your letter, re-addressed from Mornington, reached me, I had noted the complete list in "Notes From My Diary."—L.J.K.) No doubt you get some adverse reports on the production of ARW and also some good reports. As for me, I consider it the best periodical of its kind in Australia. I particularly like Don Knock's "Calling CQ" each month and the titbits about amateur radio. I am not a licensed Ham but am doing a bit of swatting on theory and a fair bit of practice on the code, so I don't think it will be long before I am on the air. Wishing your paper the very best." (Thank you, Mr. Henry, and I trust it will not be long before you have your licence. —L.J.K.)

\* \* \*

Mr. H. A. Callander, of Richmond, Victoria, writes that he has added two more receivers to his

shack, this time an Hallicrafters S27 Ultra High Frequency Communications receiver—tunes from 27mc to 145mc on three bands and uses AM and FM—and a 32-valve Scott, which incorporates the latest oscilloscope tuning. Just to make sure the S27 would "woik" he purchased a portable Ultra High Frequency antenna of American make which has three sets of interchangeable elements for coverage of ranges from 2½ to 11 metres. As can be imagined, Mr. Callander has made some excellent loggings but, as they are mostly on 10 and 20 metres, I have handed them over to Don Knock. After talking to him about Mr. Callander's luck in picking up such fine receivers, Don told me of a beauty he was using, so with tears in my eyes, I hiked back to Ermington, swearing I would read the Radio Sets and Accessories column before I considered the Parliamentary report.

\* \* \*

Arthur Cushen, from Invercargill, N.Z., says:

"HH3W, Port-au-Prince, Haiti, using 500 watts, now verifying by letter in English. Has English identification at 10 p.m. . . . opens at 9.30. It is news indeed to get a verification from here, as they have religiously refrained from verifying for many years.

"WLKS, Kure, Japan, has good signals to 7 p.m. . . . mainly relays 'Radio Australia' sports programmes. The New Zealand Expeditionary Forces in Japan are to operate WLKW on 1470kc broadcast band with 500 watts and a shortwave outlet. Information on the latter has not been released yet.

"XNCR, Yunan, China, is active on 7.58mc . . . call is heard at 9.15 p.m.

"PLY, Java, 10.06mc, has news in English and commentary at 9 p.m.; chimes at 9.30.

\* \* \*

Roy Hallett, of Enfield, writes: "PCJ is using their rotating aerial on 31-metre transmissions, but

## NEW DISPOSALS EQUIPMENT

### VIBRATOR FOUNDATION KITS

#### KIT No. 1.

TRANSFORMER, A.W.A. SYNCHRONOUS VIBRATOR, CHOKE & CIRCUIT DIAGRAM SUPPLIED.

INPUT . . . 12 VOLTS . . . 5 AMPS.  
OUTPUT . . . 360 VOLTS . . . 150 MA.

£2-15-0.—F.O.R.

#### KIT No. 2.

TRANSFORMER, 7 PIN OAK SYNCHRONOUS VIBRATOR, CHOKE & CIRCUIT DIAGRAM SUPPLIED.

INPUT . . . 6 VOLTS . . . 2 AMPS.  
OUTPUT . . . 150 VOLTS . . . 40 MA.

£2-5-0.—F.O.R.

## PARAGON RADIO

17 KINGSTON ST., HABERFIELD (SYDNEY), N.S.W. Phone UA1872



other bands use another aerial system.

"Radio SEAC has technical talk around 11.15 p.m. on Sundays on their 25-metre outlet. Session commences around 11.15 or so, maybe at late as 11.25.

"A reply to a report I sent to the BBC after some sunspot activity not so long back, was, through a slip, sent to L. Hallett, 200 Baker Street, Enfield, Middlesex, England. (Roy Hallett's address is 36 Baker Street, Enfield, N.S.W.)

My namesake opened the letter when it arrived, and upon discovering the slip very kindly sent the letter over here, accompanied by a short note explaining the situation and requesting information about our Enfield.

"And in conclusion, perhaps your readers would be pleased to know VK3WI on 40 metres at 10.30 a.m. on Sundays and at 7.30 p.m. on Tuesdays gives slow morse transmissions which should help beginners."

## NEW STATIONS

—, Munich, 9.54mc, 31.42m: "Voice of the United States of America" is now being heard on this additional outlet and at 1 a.m. News in English is heard, whilst at 4.45 a.m. "Cross-section" is given. This station is also heard at the same time on 6.10, 6.17 and 7.29mc. I have to thank Arthur Cushman for above information.

XRAY, Peiping, 8.89mc, 33.74 m: And Arthur also advises this new AFRS station. He says they are heard best on Tuesdays with request session for Forces at 8 p.m. but there is plenty of Morse interference.

—, Munich, 6.17mc: The wavelength, due to a typographical error, was shown in last issue as 38.62m. This, course, should read 48.62m.

### WATCH FOR THIS SPECIAL BROADCAST

Date: Sunday, March 16.

Time: 8.15-8.45 p.m.

Station: Radio Saigon, on 11.78 mc, 25.47m, and 4.81mc, 62.37m. The above special broadcast has been arranged by Ken Boord, Shortwave Editor of *Radio News*. A talk, followed by Oriental and other music, will occupy the 30 minutes and correct reports will be verified from Saigon. (As I have mentioned in these columns before, my first verification was from Radio Saigon away back in '27.—L.J.K.)

Reports should be addressed to: M. Pipon, English Dept., Radio Saigon, 198 Rue Chasseloup

Laubat, Saigon, French Indo-China (Indochine).

Do NOT send return postage, as IRC's are not negotiable now in French Indo-China.

Radio Noumea: 6.16mc, 48.70 m: This New Caledonian station has moved from 6.208mc and is still announcing as "The Voice of France in the Pacific"; is on the air from 5.30-8 p.m.

VQ7LO, Nairobi, 4.855mc, 61.41m: Ray Simpson tells me he has been hearing this Kenya Colony station on this new frequency around 5 a.m. (This is the spot allotted to Pietermaritzburg, Northern Rhodesia, and transmitter was to have 500 watts, but VQ7LO has 1,500.—L.J.K.)

Miss Sanderson says she has been hearing a station which gives its locality as Nanking and is an AFRS station with a very good variety programme. As far as I can calculate, it is somewhere in 26-metre band and is heard at 9.45 p.m. Its call-sign sounds like XMAG. (This is the call-sign for Nanking on 7.34mc, 40.87m, and relays AFRS at 2 a.m., according to an air-mail letter from Ken Boord. It looks as though Miss Sanderson has picked up a new frequency for Nanking. They have something like 25 or 30 allotted frequencies but the calls have the prefix XG.—L.J.K.)

And from Ken Boord, Chicago, also comes this:

ETAA is call for Addis Ababa, Ethiopia, on 15.074mc. Turkey will have 100kw. power on a new transmitter now being built.

Bryan Hayes, BBC representative, who has been acknowledging correct reports on BBC transmissions, has ceased verifying.

### CHANGES IN CANADIAN BROADCASTS

CKNC, 17.82mc, 16.84m: M/N-6 a.m. (from 10 p.m. Sundays).

CKCX, 15.19mc, 19.75m: M/N-3 a.m. (from 10 p.m. Sundays).

CKKS, 15.32mc, 19.58m: 3.05-7.30 a.m.

CHOL, 11.72mc, 25.60m: 6.15-9.05 a.m.

CKLO, 9.63mc, 31.15m: 7.45-9.05 a.m.

The Latin-American Service now on CKCS-CKRA. Station CKRZ has been withdrawn.

### PCJ, HILVERSUM, HOLLAND

#### Transmission Schedule

As at January, 1947, of the "Happy Station" programmes produced and presented by Edward Startz:

#### SUNDAY

15.22mc, 19.71m; 11.73mc, 25.57m; 6.02mc, 49.79m: 15.30-17.00 GMT, East and Near East. 1.30 a.m. to 3.00 a.m., Sydney time.

11.73mc, 25.57m; 9.59mc, 31.28 m; 6.02mc, 49.79m: 21.00-23.30 GMT, Africa and Mediterranean. 7.00 a.m. to 8.30 a.m., Sydney time.

11.73mc, 25.57m; 9.59mc, 31.28 m; 6.02mc, 49.79m: 0230-0400 GMT, America (Mond. morning). 12.30 to 2 p.m., Sydney time.

#### TUESDAY

11.73mc, 25.57m; 9.59mc, 31.28 m; 6.02mc, 49.79m: 08.00-09.30 GMT, Pacific and Australasia. 6.00 p.m. to 7.30 p.m., Sydney time.

#### WEDNESDAY

15.22mc, 19.71m: 11.73mc, 25.57m; 6.02mc, 49.79m: 15.30-17.00 GMT, East and Near East. 1.30 a.m. to 3.00 a.m., Sydney time.

11.73mc, 25.57m; 9.59mc, 31.28 m; 6.02mc, 49.79m: 21.00-22.30 GMT, Africa and Mediterranean. 7.00 a.m. to 8.30 a.m., Sydney time.

11.73mc, 25.57m; 9.59mc, 31.28 m; 6.02mc, 49.79m: 02.30-04.00 GMT, America. 12.30-2 p.m., Sydney time.

# Speedy Query Service

**C.D. (Trentham) complains that he gets a lot of funny noises on the shortwave bands besides stations.**

A.—Yes, this is normal. Some of the noises, such as the one you describe as an aeroplane engine noise, is probably a high-speed automatic morse signal. It is quite in order to find that the overseas stations are grouped pretty closely at 19, 25 and 31 metres, with gaps in between.

**S.N.L. (Craigieburn) wants to know why we specified the Rola G12 and 8/42 for the twin speakers for the "F.F.R." when he cannot buy these speakers.**

A.—If there were any other types more plentiful we would have given them consideration, but all speakers are rather on the scarce side these days. You have the best chance with the types we mentioned, as these have been popular with enthusiasts over a number of years and should be easy to buy secondhand, if not new. So far as we are aware, the G12 is still in production and if you place an order with your parts supplier he should be able to get you one sooner or later.

**R.W. (Williamstown) wants to build an amplifier using the 6L6 type valves, but finds these hard to buy.**

A.—The 807 can be used any-

## HEADPHONES

**Brand New! Just Released!**

**S.T.C. &  
STROMBERG CARLSON**

Original cost, £2/10/- pr.

**130 Ohms, 10/- pair  
2,000 Ohms, 25/- pair**

(Postage 1/6 pr. extra)

Can supply in quantity.

**DEITCH BROS.  
210A GEORGE STREET  
SYDNEY**

Phone BW7687

where that a 6L6 is specified, as it has similar characteristics, also the ability to withstand considerable overload. The main difference is in regard to socket connections, the plate being brought out to a cap with the 807. We hear that Philips now list the 807 as a receiving-type valve at a most attractive price, which makes it a great proposition. It is wise with the 807 to take extra precautions in regard to the problem of parasitics, decoupling the screens with 50 ohm resistors being one of the most effective dodges.

## TELEVISION

(Continued from page 32)

it today is technically unsound. Shortly after the year 1800 there was an "automobile" running in the streets of London. It made about two or three miles an hour and was built by James Watt, of steam-engine fame. It was as big as a good-sized room, but nevertheless it was an "automobile." It was totally impractical and nothing came out of it until Gottlieb Daimler perfected the gasoline internal-combustion engine. Then, in 1887, his automobile became the first practical self-propelled road vehicle.

We have always been strong in our belief in television, and are certain that it is here to stay. However, it will slowly evolve, as did radio. Nor do we believe that there is a short cut to country-wide, popular television on the horizon.

We wish to emphasise the point that what has been said here pertains only to broadcast television and programmes received in the home. It does not refer to television in the theatre, television in department stores, and television for other commercial purposes, where the high cost of a receiver does not matter. Such specialised receivers are not bought by the millions and therefore are in a class by themselves.

—"Practical Wireless," England.

Mr. W. J. Bruce, of 624 Bourke Street, Moore Park, writes:

"An answer to F.D. on page 34 of December issue deals with speaker voice coils. The technical points on output transformers are succinctly dealt with in the data on F.F.R. amplifier. The Amplion O1, L1, N (with no hum-buck coil), and Q types were all 2½-ohm voice coils with a DC resistance of 1½ ohms. The 5-inch M type was 3½ ohm total impedance at 400 c.p.s. The R, L5 star of the 10-inch breed, were 13.6 ohm. I opine the T or public address reproducer was the same. The old talkie trumpets made in England and similar to the AWA monstrosities that adorn the Sydney Town Hall, were 15 ohm and always unreliable.

"The AC impedance is always greater than the DC resistance. At 50 c.p.s. it is not usually much greater. Therefore, a trial with an ohmmeter is a valuable guide especially if the brand is obscured by having the set maker's name imprinted in lieu of the component manufacturer's insignia. Servicemen know that a triode works with less distortion into a pentode load, while a pentode is more tolerant of a triode load. So we should add to the DC resistance to bring the voice coil impedance to the standard next higher on the list, to wit, to 1½, 2½, 3½, 5, 8, 15 ohms. Then the orthodox pentode favors the lower ratio of transformer with small loss of power due to the mismatch. There are only 3 audible changes of volume between a portable battery set output and a mains receiver. Any resistance in the tranny windings lowers the ratio, as Partridge has shown. Class B acts in this respect as a pentode.

"I use a VTVM feeding a suitable 5v. or so through the voice coil in series with a resistance, supplied from a filament transformer or audio oscillator. The ratio of voltage drops across coil and resistance gives the proportion of coil impedance at that frequency to the total series impedance.

"Trusting that 'Radio World' may get back the old 'Wireless Weekly' supremacy."

**WANTED — 815 Valve or Valves.** Particulars, price, etc., to **E. Carruthers (VK2AXV), 55 Alexandra Street, Hunters Hill, Sydney.** Phone, Hunter 500.

---

# RED LINE

TRANSFORMERS and CHOKES  
For the **F.F.R.** Amplifier  
**NOW AVAILABLE**

Type No. AR2

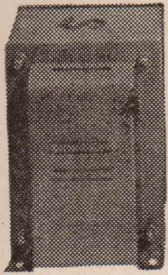

Type No.  
5176



Type No.  
50825



Type No.  
102512

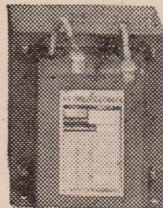

Type No.  
A.W.5

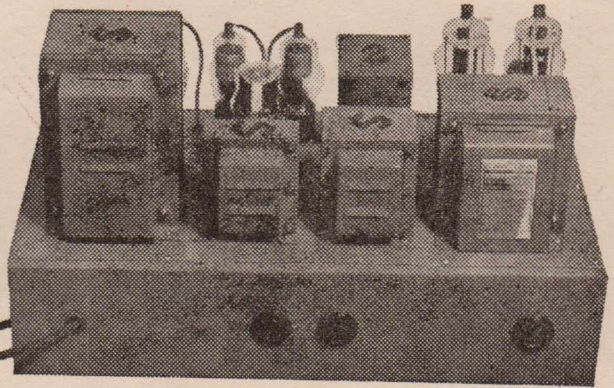

PRECISION IN DESIGN

PRECISION IN CRAFTSMANSHIP

## SWALES & SWANN

Your Transformer problem will be transformed from a headache to that craftsman-built component which you desire but cannot quite figure out. Swales and Swann specialise in Audio Frequency Transformers up to Frequency Modulation Standards; Power Transformers up to 2 K.W. rating;

**BUT**

See Swales and Swann for Transformers of ANY specification, whether they are required for Industrial Applications, Electronic Controls, Broadcasting, Amateur Transmitting or Public Address Systems.

Technical Service, Wholesale  
and Manufacturers

A. T. SWALES. Central 4773  
2 Coates Lane, Melbourne



Trade Sales: Allen SWANN

MU 6895 (3 lines)  
157 Elizabeth St., Melbourne

A GUARANTEE

OF DEPENDABILITY

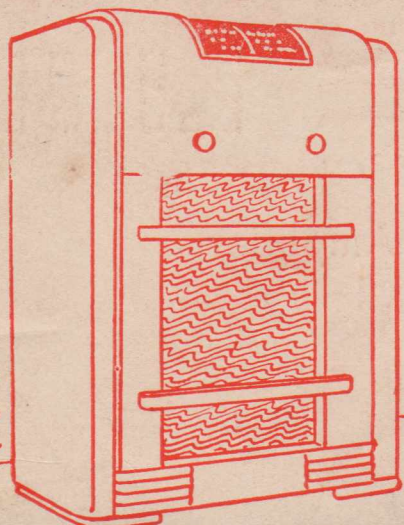

**FOR BATTERY OPERATED,  
A.C.-D.C., VIBRATOR  
POWERED OR A.C.  
OPERATED RECEIVERS**

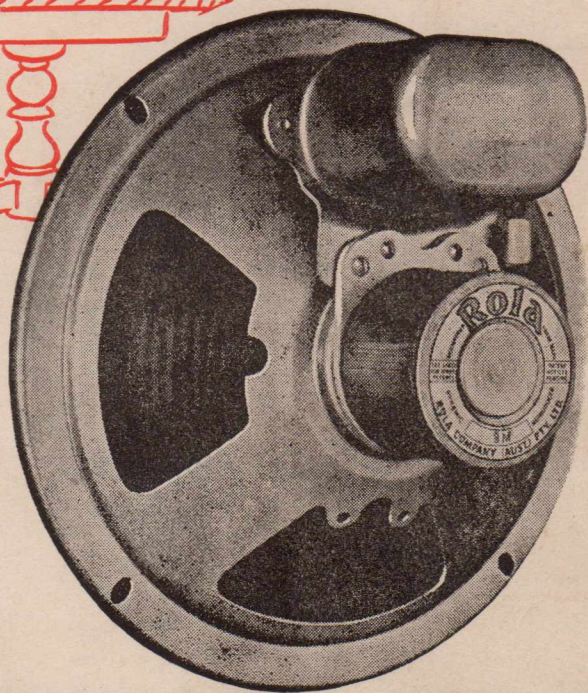

# **8 M WITH ANISOTROPIC ALNICO**

The ROLA 8M Speaker is eminently suited for incorporation in battery operated, AC-DC, Vibrator Powered or AC operated receivers. Wherever higher than normal speaker efficiency is called for the ROLA 8M is the speaker to use.

Here are the facts:— ★ The ROLA 8M is energised by a generously sized magnet of Anisotropic Alnico. ★ Efficiency of the ROLA 8M is appreciably higher than "Standard 8" speakers. ★ Fitted with ROLA isocore (Type C) Transformer, the ROLA 8M ensures against failure due to electrolysis in battery operated receivers.

Specifications: Weight (Speaker and Transformer), 2.87 lbs.; Diameter of cone housing, 8-1/16 inches; Distance front to back, 3-15/16 inches (approx.); Voice Coil impedance, 2 ohms.

*Limited supplies will shortly be reaching Rola Speaker Distributors.*

# **ROLA** LOUD SPEAKERS With ANISOTROPIC ALNICO