

**THE  
AUSTRALASIAN**

PRICE, 1/-

# Radio World

VOL. 4 . . . . . NO. 5

OCTOBER 2, . . . . . 1939

Registered at the G.P.O.,  
Sydney, for transmission  
by post as a periodical

● LATEST LIST OF WORLD  
SHORTWAVE STATIONS

● FIVE-VALVE SHORTWAVE  
1.4-VOLT SUPERHET

● BUILD THE PICNIC  
PORTABLE FOR SUMMER

● WHEN AND WHERE TO  
LISTEN FOR S.W. NEWS



£40,000 air raid shelter at S.T.C. London factory—see page 8.

# Save 30% on your testing equipment -

**SPECIAL REDUCTIONS  
FOR 1 MONTH ONLY**

Now is the time for you to build up your range of testing equipment. For one month only we offer the Triplett Signal Generator (Model 1230) at an amazing reduction of £1/10/- on its stock price.

But remember this offer can't last—rush off the coupon below

Originally priced at

~~£6/10/-~~

NOW

**£5**

This price is available for one month only, and is open to Radio World readers only.

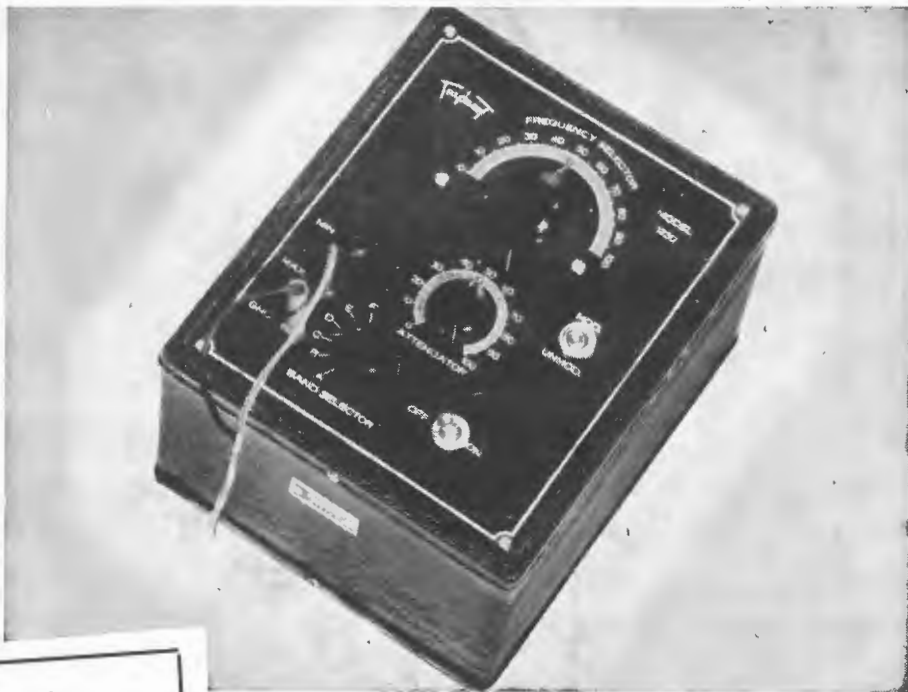

## Triplett Signal Generator Model 1230

Model 1230 All-Wave Signal Generator supplies a continuously variable signal. Frequencies are 100-18,000 k.c., controlled on six fixed positions. Batteries, tubes and six individually calibrated graph charts are supplied. Price, £5 (for one month only and available to readers of Radio World exclusively).

### Amazing Offer to READERS OF "RADIO WORLD"

Model 1230 is one of the leaders of a large range of Triplett instruments—with characteristic accuracy it gives all tests... aligning tuning circuits, locating and isolating actual defects testing tubes in a receiver under actual operating conditions, gain tests, gas tests, set testing.

To Radio World readers ONLY we offer this outstanding instrument for only £5—a saving of 30/- on the normal price (£6/10/-). Don't wait—fill in coupon and post TO-DAY.

★  
**MAIL  
COUPON  
NOW**

SOLVE YOUR  
SERVICING  
PROBLEMS  
WITH THE  
MODEL 1230.

**W. G. WATSON & Co. Pty. Ltd.**

279 CLARENCE STREET, SYDNEY.

Branches in all States.

I wish to avail myself of your special "Radio World" offer. Here-with cheque/money order for £5. Please send me one of your Triplett All-Wave Signal Generators (Model 1230).

NAME .....

ADDRESS .....

# SLADE

## 1.4 VOLT

# CALSTAN

## Portables



### HAVE *EVERYTHING*

FOR THOSE  
WANTING A  
SMALLER AND  
LIGHTER SET

Slade's expert technicians are now working on a new 4 valve model. This set will be even smaller and lighter than the present models. On account of the life and cheaper running cost Slade's are endeavouring to retain the use of the Standard Portable Batteries.

Slade's new Calstan 1.4 volt Portable Radios are proving marvellous sellers . . . available in two models . . . B54P (Broadcast model) and D54P (Dual-wave operation). Both are five-valve sets, and the D54P has a short-wave coverage from 16 to 50 metres. Each set is fitted with a tuned loop aerial and provision is also made for external aerial and earth connection. One PR8 and two PR45 Batteries are used, and are housed in a specially shaped compartment at the rear of the loud-speaker. These batteries give approximately 200 hours' life. The new Rola "6-11" loud-speaker is installed and an R.F. amplifier stage is used. Both sets are housed in smart, leatherette-covered cases, measuring approximately 12" x 11" x 10." These sets are also available in a bakelite mantel cabinet for home use and should be eagerly bought for use in country districts. The bakelite sets are the same prices as the portable models.

#### "CALSTAN" PORTABLE RADIOS

B54P

**BROADCAST MODEL £16-16-0**

D54P

**DUAL-WAVE MODEL £18-18-0**

CALSTAN  
TEST  
EQUIPMENT

**SLADE'S RADIO PTY. LTD.**  
LANG STREET CROYDON N.S.W. UJ5381—UJ5382

CALSTAN  
PRECISION  
RADIOS

#### DISTRIBUTORS:

N.S.W.: Radio Equipment Pty. Ltd., Martin de Launay Ltd., Bloch & Gerber Ltd., United Radio Distributors, John Martin Ltd., Electric Service Co., Newcastle. QUEENSLAND: Chandlers' Pty. Ltd. SOUTH AUSTRALIA: Radio Wholesalers Ltd., Adelaide. WEST AUSTRALIA: Norman L. Burnell & Co., 13 Queen Street, Perth. VICTORIA: Australian General Electric Ltd., Melbourne; Arthur J. Veall Pty. Ltd.; Hartley's Ltd., Flinders Street, Melbourne. TASMANIA: Noyes Bros. (Melbourne) Ltd., Launceston. NEW ZEALAND: New Zealand Electrical Equipment Co. Stocks also available from Turnbull and Jones, all branches.

## Keep Up With The News !

Build the VULCAN SHORTWAVER described in this month's "RADIO WORLD"

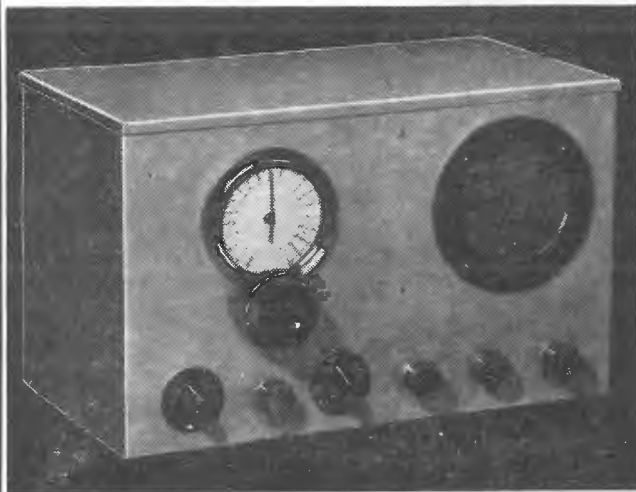

Write or 'phone for quotation on our PRECISION RADIO model—available either in kit form or fully assembled and air-tested.

### "Little Wanderer" Portable Radio

City, beach or bush . . . anywhere, at any time, a flick of a switch will bring you a wealth of radio entertainment from this sensational new 1.4-volt portable radio.

#### MAIN FEATURES INCLUDE:

- Powerful five-valve superhet circuit (using 1.4 volt valves) specially developed to give maximum in performance with minimum running costs.
- Six-inch Rola P.M. speaker with high-sensitivity magnet ensures ample volume with superb tone.
- Litz-wound iron-cored coils and i.f. transformers give exceptionally high sensitivity.
- New improved a.v.c. system, station-calibrated dial, non-directional lid aerial, with provision for attaching outside aerial.

### WANT A RECEIVER BUILT, LINED UP OR SERVICED?

If so, we are fully equipped to handle the job for you. For years we have specialised in building to private orders all types of receivers (A.C., D.C., A.C./D.C., vibrator, battery, dual-wave, all-wave or short-wave), amplifiers of all types (P.A. systems a speciality), auto and portable radios. Sets built to individual requirements, or we will design to suit any conditions.

## PRECISION RADIO

L. T. MARTIN, M. Inst. R.E. (Aust.)

20 CARRINGTON ST. NORTH,  
STRATHFIELD, SYDNEY.

'Phone

UM 7858

*The Australasian*

# RADIO WORLD

*Incorporating the*  
**ALL-WAVE ALL-WORLD DX NEWS**

*Managing Editor:*  
A. EARL READ, B.Sc.

Vol. 4.

OCTOBER, 1939.

No. 5.

### CONTENTS:

Picnic Portable Four .....	3
Vulcan Shortwaver .....	7
£40,000 S.T.C. Air Raid Shelter .....	7
New Era For Battery Radio .....	9
War News On The Short Waves .....	10
Learn The Morse Code .....	11
What's New In Radio .....	16
Falcon Dual-Wave Four .....	17
Testing Transformer Windings .....	18
World Shortwave Stations .....	19
1.4-Volt Shortwave Superhet .....	24
13.5 Watts From 2A3's In Push-pull .....	27
Sixth DX Contest Winner Relates His Experiences .....	31
Latest Loggings On Shortwave .....	33
Broadcast Band DX Notes .....	37

*The "Australasian Radio World" is published monthly by Read Publications, Editorial offices, 214 George Street, Sydney, N.S.W. Telephone BW 6577. Cable address: "Repress," Sydney. Advertisers please note that copy should reach office of publication by 14th of month preceding that specified for insertion.*

*Subscription rates: 1/- per copy, 10/6 per year (12 issues), post free to Australia and New Zealand.*

Featuring the recently-released 1D8GT diode triode output pentode, together with a new dial, condenser gang, and speaker, this American-style 1.4 volt portable incorporates a host of latest features that will appeal strongly to every set-builder.

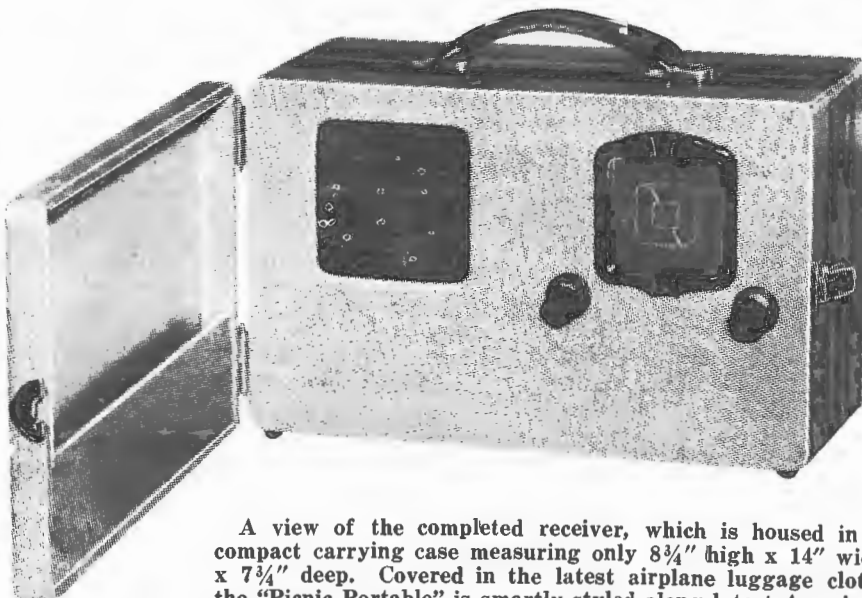

A view of the completed receiver, which is housed in a compact carrying case measuring only 8 3/4" high x 14" wide x 7 3/4" deep. Covered in the latest airplane luggage cloth, the "Picnic Portable" is smartly styled along latest American lines.

## Picnic Portable Four

**A**BOUT six months ago the first commercial model 1.4-volt portable was placed on the Australian market. To-day, there are over twenty models from which to choose, while some thousands of these sets are already in operation throughout the Commonwealth. In America these new portable radios have broken all sales records; actually, it is estimated that sales there are now around the million mark!

The popularity of these little receivers is easy to understand. Light, compact and entirely self-contained, they are ready for instant action anywhere and at any time. Low consumption valves, high efficiency permanent magnet speakers, special long-life batteries that are light and compact, and a small carrying case, make a receiver that is easily carried and that operates anywhere with remarkable efficiency.

### "Picnic" Incorporates Many Attractive Features.

The "Picnic Portable" shown above has been designed to incorporate as far as possible all the attractive features of the latest overseas models. Designed for maximum ease of carrying, the set is housed in a case measuring only 8 3/4" high x 14" long x 7 3/4" deep. It is covered with smart durable airplane luggage cloth, woven

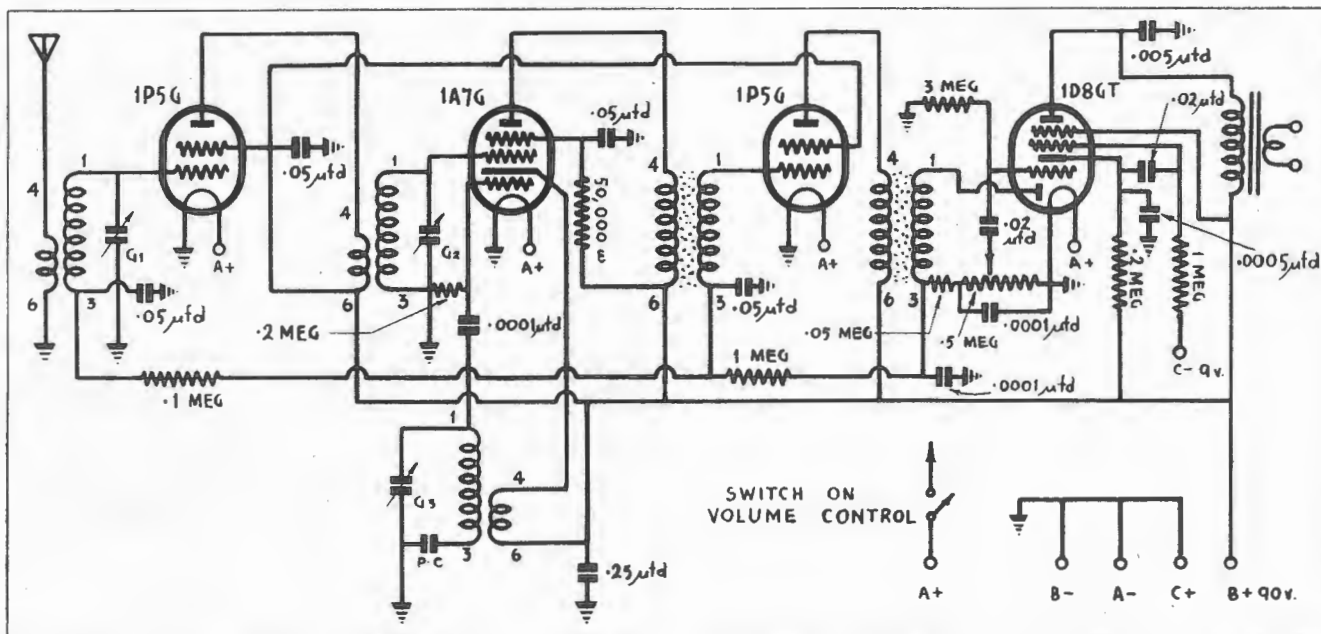

Circuit of the "Picnic Portable," with full constants. Under-socket connections will be found on page 9.

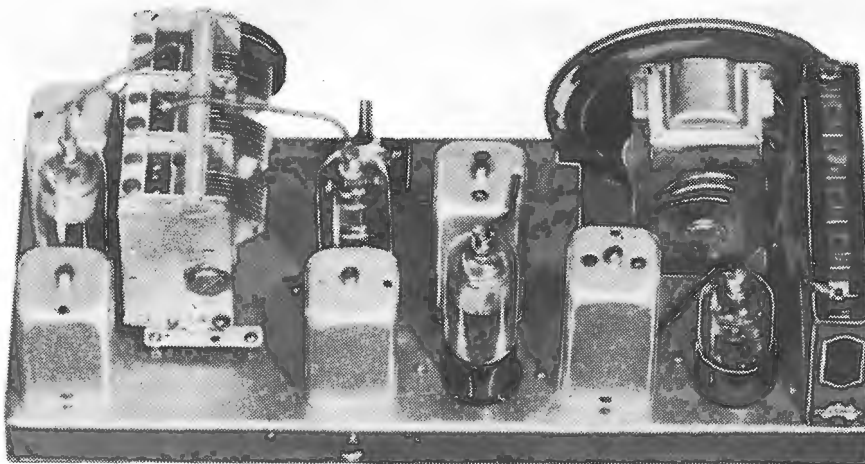

As this chassis view shows, the layout is not cramped in any way, despite the compact size of the carrying case.

Reedtex being used for the speaker grille.

#### An Ideal Layout.

Of the dozen or so layouts considered, that finally adopted has proved ideal for simplicity, balance and compactness, and as well has permitted a very attractive cabinet design. The three "A" and "B" batteries—one Eveready PR8 1½-volt unit, and two PR-45 45-volt units—lie flat side by side in a separate compartment beneath the shelf supporting the chassis. They are readily accessible, as there

are only two screws holding the back of the cabinet in place.

As the chassis photograph shows, the 9-volt "C" battery is located alongside the 1D8GT, and is also easily accessible.

#### Circuit Details.

The circuit chosen is standard, and consequently can be depended upon to be "sure-fire" in operation. A 1P5G is used in the r.f. stage, followed by a 1A7G mixer. Then follows another 1P5G i.f. amplifier and lastly, a

## "PIC-NIC PORTABLE FOUR"

### List of Parts

- 1 sprayed steel chassis to specifications (Acorn).
- 1 canvas-covered carrying case built to specifications (Western Mfg.).
- 1 coil kit, including 1 aerial, 1 r.f., 1 oscillator coils, with 2 465 k.c. i.f.'s and padder (Radiokes, R.C.S.).
- 1 midget 3-gang condenser (Stromberg-Carlson).
- 1 midget tuning dial (Efco).
- 2 brown bakelite knobs.
- 1 .5 megohm potentiometer with switch (I.R.C.).
- 1 4-wire battery cable (2-foot length).
- 4 octal wafer sockets.
- 4 midget grid clips.
- 1 banana socket and 2 plugs.
- FIXED CONDENSERS:**
- 3 .0001 mfd., mica (T.C.C.).
- 1 .0005 " " "
- 1 .005 " " "
- 2 .02 " tubular "
- 4 .05 " " "
- 1 .25 " " "
- FIXED RESISTORS:**
- 1 3-megohm 1/3-watt carbon (I.R.C.).
- 2 1-megohm " " "
- 2 .2-megohm " " "
- 1 .1-megohm " " "
- 2 50,000-ohm " " "
- VALVES:**
- 2 1P5G's, 1 1A7G, 1 1D8GT.
- SPEAKER:**
- 1 5in. permanent magnet speaker to match 1D8GT (Rola).
- BATTERIES:**
- 2 45-volt light duty "B" batteries (Eveready PR45).
- 1 1½-volt "A" battery (Eveready PR8).
- 1 9-volt "C" battery (Eveready W9S).
- MISCELLANEOUS:**
- 2 doz. ¼in. nuts and bolts, insulating washers for aerial socket, push-back (solid and flexible), solder tags, 8 yds. rubber-covered aerial wire, 4 lin. bolts and 6 nuts for mounting gang.

1D8GT. Automatic volume control is incorporated, being applied to the two 1P5G's.

# FOX RADIO . . . CAN SUPPLY ALL YOUR RADIO AND ELECTRICAL REQUIREMENTS

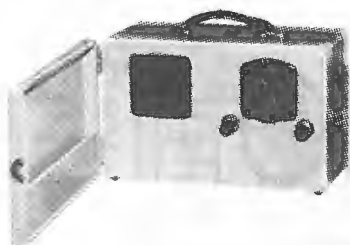

## Special FOXRADIO Kits of Parts . .

are available for the:—

- VULCAN SHORTWAVE FIVE
- PICNIC PORTABLE FOUR
- FALCON DUALWAVE FOUR

Quotations for any of the above kits sent free on request by return mail. Special twenty-four hour mail order service for country clients.

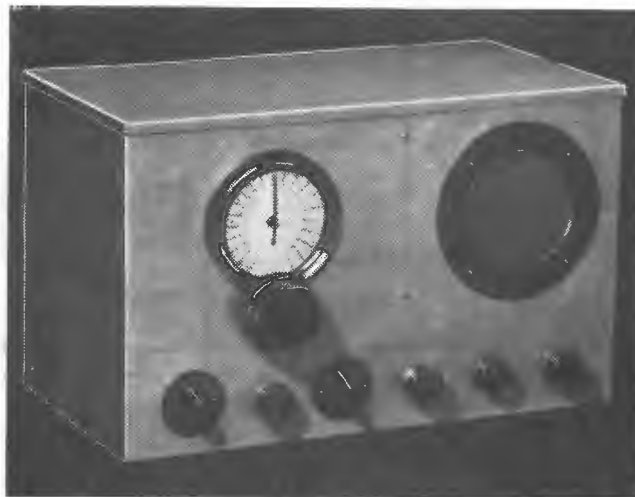

# FOX & MacGILLYCUDDY LTD.

MERINO HOUSE, 57 YORK ST., SYDNEY. Tel.: B 2409.

(In Liq.)

### 1D8GT Diode Triode Output Pentode Used.

A feature of the "Picnic Portable" is the use for the first time in any receiver described in an Australian magazine of the latest 1.4-volt valve—the 1D8GT. A bantam type valve, it possesses characteristics that are particularly attractive for portable work.

In the first place, it is a multiple valve combining in one envelope, diode, triode, and output pentode units. The diode-triode unit is somewhat similar to the 1H5G, while the pentode section has characteristics roughly midway between the 1A5G and 1C5G output pentodes. Its filament current is comparable with that of the former type, but its power output of 200 milliwatts approaches that of the latter.

Total plate and screen currents for the pentode section of the 1D8GT is only 6 m.a., compared with 9.1 m.a. for the 1C5G and 11.1 m.a. for the 1Q5G. As well, the total filament current is only .1 ampere, whereas the total required for the 1H5G-1C5G combination is .15 ampere.

#### Light "A" And "B" Drains Mean Long Battery Life.

Total "A" drain of the "Picnic Portable" is .25 ampere, while the "B" current, with new batteries and without over-biasing the output pentode, is approximately 10 m.a. This figure falls rapidly with the gradual drop in "B" battery voltage, so that the average "B" drain during the life of a set of batteries would be approximately 7 m.a., a figure that is well within the manufacturer's rating for the Eveready type PR-45 portable battery.

Using an Eveready PR8 "A" unit and two Eveready PR45 "B" units, from 220 to 250 hours of service can be expected from a single set of batteries.

#### About The Parts.

The parts required to build the "Picnic Portable" are listed elsewhere.

The coil kit used, comprising aerial, r.f. and oscillator coils and two 465 k.c. i.f. transformers, is a standard Radiokes kit. High-gain litz windings are used throughout, and while air-cored coils and i.f.'s were used in the original model, there is no reason why iron-cored coils could not be used equally well, providing care was taken in the assembly and wiring to avoid instability.

R.C.S. Laboratories have also submitted to "Radio World" two sample kits that would undoubtedly give equally good results.

The condenser gang is the latest Stromberg-Carlson midget three-gang type, which is similar in every respect to the standard model, except that the width has been reduced by approximately 3/4". The 5" speaker is one of the latest Rola 5-8 models which, despite its compactness and size, has remarkably high efficiency.

#### Carrying Case By Western Manufacturing.

The carrying-case shown in the photographs was made to "Radio World" specifications by the Western Manufacturing Company of Sydney. An excellent job throughout, the case supplied is light, but solidly built, and will stand up to years of hard wear. The "airplane" luggage cloth covering is both smart and durable, while the fittings are heavily plated and will resist rust indefinitely.

#### Point-To-Point Wiring Plan Next Month.

Complete kits of parts for the "Picnic Portable" are available from all "Radio World" advertisers specialising in kit-sets and components. Next month a further description covering the assembly of the receiver will be given in a special supplement, together with a point-to-point wiring plan.



**ARE YOU STILL WEARING THE STRAJTJACKET OF INEXPERIENCE?**

**OR HAVE YOU BENEFITED BY THE EXPERIENCE OF OTHERS WHO HAVE GAINED BY OUR**

**QUALITY  
ECONOMY!  
SERVICE!**

**S**OMEONE should tell you that one of the best ways to make money in the electrical and radio business is to send all your orders to Martin de Launay's.

That's the way to get out of the jam you are in, if you're all tied up by High Prices and Slow Service.

Frankly—we're proud of the splendid organisation we have created to give speedy service and keen prices on all orders—whether they are big or small, from any part of Australia. Let us prove this to you with your next order.

*SUGGESTION: Pin this advertisement to your letterhead and send to us. We will send you a handy order pad, free and post free.*

*We cover the Continent*  
**Martin de Launay**  
PTY. LTD.  
Cnr. Druitt & Clarence Sts.,  
SYDNEY, NEWCASTLE & WOLLONGONG

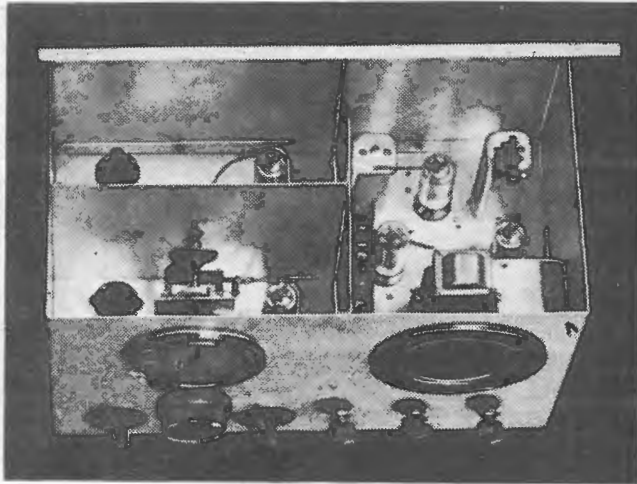

An interior view of the completed receiver. The separate 1N5G oscillator and 1A7G mixer, with their associated tuning circuits, are in the front and rear left-hand compartments, respectively. In the compartment on the right are the i.f. amplifier, second detector and output pentode stages, together with the speaker and bias battery.

# The Vulcan Shortwaver

*This five-valve shortwave superhet, which covers from approximately 9.5 to 200 metres, uses 1.4-volt valves throughout, and employs regeneration on the mixer and second detector stages.*

RECEIVERS and associated radio equipment featured in American magazines cannot always be built by Australian experimenters, primarily because key components in the designs are often unobtainable locally. However, in the September issue of

the American "Radio News" appears a description by an American amateur, Harry D. Horton (W8KPX), of a shortwave superhet that uses easily-obtainable components throughout.

Since the outbreak of war there has been a widespread demand for re-

ceivers capable of picking up news bulletins from shortwave stations in all parts of the world, and because the receiver mentioned above is ideal for this purpose, the "Radio News" article has been re-printed elsewhere in this issue.

The receiver could either be built as described by the author, or the "Radio World" version shown above could be followed. In the latter, the aluminium cabinet, chassis and partitions are as used for the "Air Ace Communications Four," a t.r.f. battery receiver described in "Radio World" for September, 1938. While the "Vulcan Shortwaver" uses an extra valve, this can be easily accommodated on the "Air Ace" chassis.

Uses Five 1.4-Volt Valves.

A shortwave superhet tuning from approximately 9.5 to 200 metres using plug-in coils, the "Vulcan Shortwaver" uses 1.4-volt valves throughout. A 1A7G is used as mixer with a 1N5G as separate oscillator. Then follows another 1N5G as i.f. amplifier, and a third 1N5G as second detector with regeneration, choke capacity coupled to a 1A5G output pentode. While in the original receiver the speaker is a separate unit, in the "Vulcan Shortwaver" it is built into the receiver,

(Continued on page 8)

## THE VULCAN SHORTWAVER

### Tentative List of Parts

- 1 aluminium chassis, panel and cabinet to specifications (Acorn).
- 5 octal, 2 4-pin, 1 6-pin wafer sockets.
- 1 vernier tuning dial.
- 5 4-pin coil formers, 5 5-pin.
- 2 indicator plates.
- 2 iron-core 465 k.c. i.f. transformers (Radiokes, R.C.S.).
- 2 pointers.
- 2 r.f. chokes (see text).
- 4 knobs.
- 2 terminals, "A" and "E".
- 1 'phone jack and plug.
- 1 pair headphones (S.T.C.).
- 1 100-henry audio frequency choke (Radiokes, R.C.S.).
- 2 40-mmfd. midget variable condensers (Radiokes, R.C.S.).
- 2 160-mmfd. midget variable condensers (Radiokes, R.C.S.).
- 1 coupler for ganging 2 40-mmfd. variables.
- 1 2,500-ohm potentiometer (Radiokes, R.C.S.).
- 1 50,000-ohm potentiometer (Radiokes, R.C.S.).
- 1 .5-megohm potentiometer (I.R.C.).
- 1 1-megohm potentiometer with switch (I.R.C.).
- 1 yard 6-wire battery cable.
- 2 valve shields.

- FIXED RESISTORS:**
- 1 50,000 carbon resistor (I.R.C.)
  - 1 70,000 " " "
  - 1 100,000 " " "
  - 1 200,000 " " "
  - 1 250,000 " " "
  - 1 3-megohm " " "

- FIXED CONDENSERS:**
- 1 .00005 mfd., mica (T.C.C.).
  - 1 .0001 " " "
  - 1 .00025 " " "
  - 1 .001 " " "
  - 1 .01 " tubular.
  - 2 .05 " " "
  - 3 .1 " " "
  - 1 .25 " " "
  - 1 .5 " " "
  - 1 1 " " "

- VALVES:**
- 1 1A7G, 3 1N5G, 1 1A5G.

- SPEAKER:**
- 1 5in. P.M. dynamic speaker, input transformer to match single 1A5G (Rola).

- BATTERIES:**
- 2 45-volt Superdyne "B" batteries. (Eveready).

- 1 1.5-volt "A" battery (Eveready X250).
- 1 9-volt "C" battery (Eveready).

- MISCELLANEOUS:**
- Small quantities of 16, 18, 22, 26 and 28 en. copper wire for winding coils; 4 midget grid clips; nuts and bolts; solder tags; hook-up wire; 2 feet of earthing busbar; 4 1/2in. brass spacers, and 4 lin. bolts and nuts for mounting coil sockets.



The accompanying photo shows Sir John Anderson, the Lord Privy Seal, leaving the S.T.C. air-raid shelter following a demonstration of the A.R.P. arrangements made for fastest possible evacuation of all workers from the factory.

# £40,000 S.T.C. Air Raid Shelter

**Accommodation for 6,000  
employees of London  
factory: Complete evacu-  
ation in eight minutes.**

THE arrangements made for the protection of personnel and property at the works of Standard Telephones and Cables Ltd., at New Southgate, London, in case of air raids, were demonstrated recently before Sir John Anderson, Lord Privy Seal, and a large number of interested visitors.

The factory covers 40 acres, has 15 acres of floor space and employs 6,000 persons, of whom a little over 40% are women. A circumstance which has been very favourable to the A.R.P. scheme is that the company has near the factory a large tract of elevated land, the top of which has been occupied by tennis courts and other sports grounds.

This has facilitated the construction of about three-quarters of a mile of tunnels, having above them a minimum depth of 20 ft. of earth, mainly in its natural formation. These tunnels, to which there are numerous entrances through down-grade approach tunnels, are lined with concrete sections, well lit by electricity from two separate supplies and, as a last resource, could be temporarily illuminated by battery lamps carried by the A.R.P. wardens.

The main tunnels have seats along both sides throughout their length to accommodate 5,000 persons, and concrete gutters to carry off any water which might accumulate. Telephones to and from an underground office are provided for communication between wardens. The trained first-aid personnel within the shelters numbers 140.

There are steel doors at the numerous entrances to the tunnels which can be closed to make the sys-

tem gas-tight, but which are normally left open, as there are blast walls outside to protect the entrances from splinters or blast.

As the demonstration showed, the workers can be marshalled from their shops to their places in the tunnels in from 7 to 8 minutes. Control is exercised from a headquarters building, the supervision of the different activities being entrusted to the chief executives of the company, such control being mainly carried out by means of a selective system of loud-speakers suitably installed throughout the factory.

#### Trained A.R.P. Workers.

About 900 people working in three shifts have been trained to deal with fire-fighting, decontamination, medical and first-aid services, cleansing, communications and gas detection, etc., in addition to a number to act as guides and marshals.

The system of dealing with air raid warnings is briefly as follows: The headquarters official's warden alarm units are plugged into the electric light mains so that they receive the first warning. They proceed to the headquarters building, from which, under the direction of the head warden, they carry through the procedure for evacuating the personnel when the final warning is received. Using for this purpose a selective loud-speaker installation, all machinery is shut down and the personnel

form queues under the direction of group marshals and then proceed to the shelters along prescribed routes to their allotted sections in the tunnels.

The firefighting arrangements comprise specially-constructed shelters in each wing of every floor of the factory building, each accommodating an observer, a telephonist and a fireman. From these points all incidents are reported to headquarters.

The actual demonstration proceeded in the following order and the effects of the "raid" were—or in some instances were supposed to be as follows:—A flight of aircraft dropped six bombs in the vicinity of the factory. One fell in the roadway west of No. 7 building, causing four assumed casualties, which were attended to by first-aid parties; another fell on a temporary store south of building No. 10 and caused a serious fire, ably dealt with by the fire brigade, but causing (assumed) injuries to two firemen.

A second flight of aircraft dropped four bombs, two of which were dealt with by a fire-watching crew, and a third flight of aircraft dropped three high explosive bombs and one gas bomb. One of the former wrecked a small building, burying two men (dummies), who were released by the salvage squad and handed over to a first-aid party. The gas bomb was dropped on the east side of building



# CABINET by WESTERN

*Built Specially  
for the . . . .*

## Picnic Portable Four

The carrying case shown in the photograph accompanying the article on page 3 of this issue describing the construction of the "Picnic Portable Four" was built by us to the Technical Editor's specifications.

### EXCLUSIVE FEATURES:

- Solidly built throughout from light, strong timber, dove-tailed joints being used for greatest rigidity, this sturdy lightweight case can be relied upon to stand up to years of hard wear.
- Latest airplane luggage cloth combines smart styling with excellent durability. (Alternatively, grained morocco leather cloth, available in a variety of colours, can be supplied at no extra charge).
- Case is supplied complete with heavily-plated tarnish-proof fittings. (Slight extra charge for lock type catch).

Such an outstanding receiver as the "Picnic Portable" deserves a carrying-case that matches its performance, so be sure and specify a "WESTERN."

### PRICE ON APPLICATION

MANUFACTURERS,  
DEALERS & SERVICEMEN!  
We specialise in making all classes of cases for test equipment, exactly to your specifications. Workmanship and accuracy guaranteed. Recent extensions to our plant ensure unbeatable service.

**WESTERN  
MANUFACTURING CO.**  
18 THIRD AVENUE,  
FIVE DOCK, SYDNEY.  
'Phone . . . . . UA 3444

No. 4 and a gas observer was despatched to headquarters to confirm that gas was present. A decontamination squad came on the scene and cleaned up, while a first-aid party dealt with three supposed casualties who had been splashed with gas.

After an inspection of the tunnels, still occupied by the employees, the duty men and women were paraded for an inspection and the visitors re-assembled at the stand which they had occupied to view the demonstration and heard a few remarks by the chairman of S.T.C. and Sir John Anderson, the Lord Privy Seal. The chairman said he thought that the day's demonstration had shown an excellent degree of efficiency and he thanked Sir John Anderson for the trouble he had taken in coming there to witness it.

Sir John Anderson said the value of such practical exercises was dependent on the manner in which they were carried out, and the workpeople had played their part well. He wished to express his very high appreciation of the manner in which the dis-

### The Front Cover.

This month's front cover photo shows a trial evacuation of workers from the S.T.C. London factory to the air-raid shelters, which are built of concrete with steel doors.

play had been given and the evidence it gave of careful and able organisation. He admired the high standard to which preparations there for civil defence had been brought in a very short time.

The standard of efficiency which had been attained there was due in very large measure to the excellent relations between the management and all grades of workers. He hoped the visitors would profit, and endeavour to induce others to profit by the example given that afternoon.

### Vulcan Shortwaver

(Continued from page 6)

provision also being made for head-phone reception.

### Full Description Next Month.

Preliminary tests on the "Vulcan Shortwaver" have given very promising results, though several minor amendments will have to be made before the design is finalised. A full description will be published next month, though in the meantime a tentative list of parts is published with this article as a guide to prospective builders.

# MURDOCH'S RADIO SPECIALS

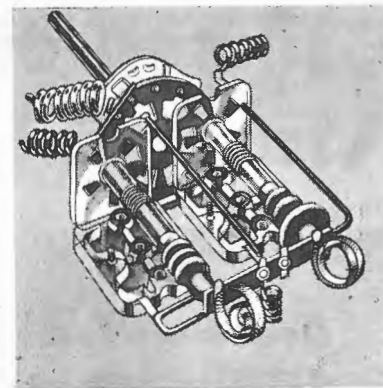

### DUAL WAVE COIL UNIT WITH TROLITUL FORMERS

New extended range embracing—

13 to 42 metres on short wave band.  
180 to 550 metres on broadcast band.

A complete coil unit mounted on a multi switch, with all trimmers and padders. Leads ready to wire into the set. Will go with any modern circuit. Price, **14/6**

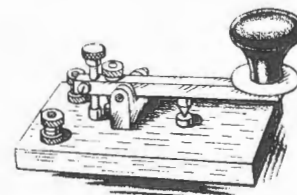

### MORSE KEYS

Highest grade with adjustable gap and tension. Special value.

**9/6**

HIGH NOTE BUZZERS.—Adjustable high pitch, consistent note. 7/11.

### AUDIO OSCILLATOR KIT

Kit comprises chassis, socket, Audio transformer, terminals, and valve for 6-volt battery or 2½-volt A.C. filament.

**15/-**

### VALVES TO CLEAR.

Odd numbers only. Snap them!

6-VOLT BATTERY VALVE, English base. General purpose, 2/6.

6-VOLT BATTERY PENTODE, English base, 2/6.

2½-VOLT A.C. VALVE. General purpose, 5-pin base, 3/-.

2½-VOLT A.C. VALVE. General purpose, English base, 2/-.

7½-VOLT SUPER POWER VALVE, 4/6.

7½-VOLT RECTIFIER. U.X. base, 3/6.

WE PAY FREIGHT. 'Phone: M 4211.

Kindly write to Desk "C52."

**MURDOCH'S**  
LTD., PARK ST., SYDNEY.

An engineer looks at the "one-point-four's"—Mr. T. P. Court, M.I.R.E. (Aust.), A.M.I.R.E. (U.S.A.), Chief Engineer of Standard Telephones & Cables Pty. Ltd., examining a selection of Brimar 1.4-volt valves. Characteristics and under-socket connections of types available to date are given in the article below, which discusses applications of these valves in battery receivers for portable and home use.

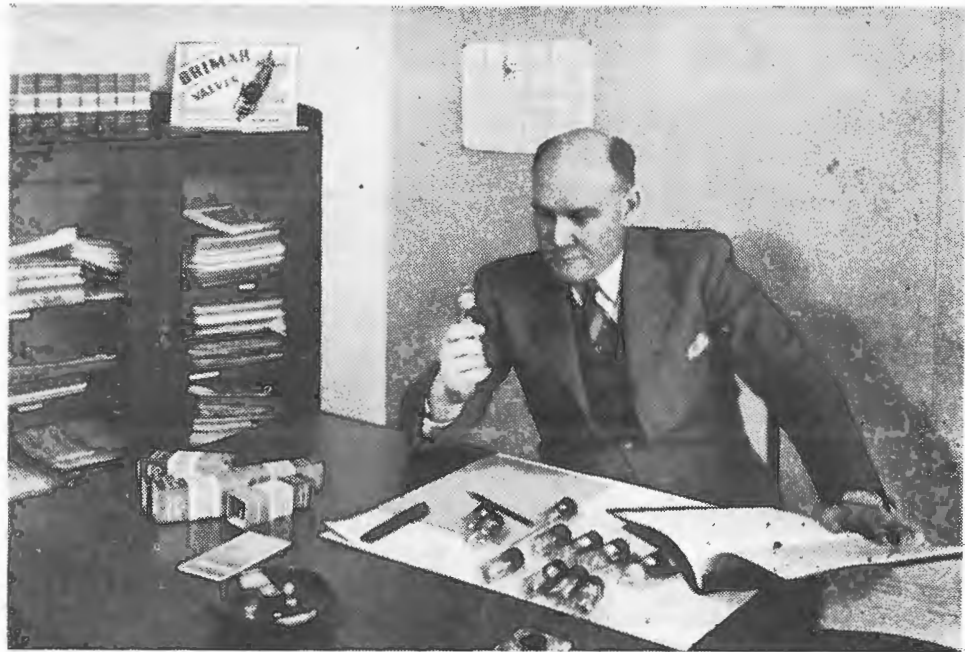

# New Era For Battery Radio

*Most important advance in battery radio technique for some years, the introduction of the 1.4-volt valves has made possible the design of receivers giving excellent all-round performance, coupled with remarkable economy of operation.*

SINCE the introduction of 1.4-volt valves on the Australian market, the question has often been asked, "Have receivers employing these valves any advantages over the orthodox battery-operated receivers?" The following discussion is tendered as an answer.

The use of these special valves has ushered in a new era in the field of portable radio receivers. Considerable reduction in weight has been achieved by the elimination of the heavy accumulator, or wet "A" battery. This has been made possible by the extremely low power required to light the filaments; a single dry

cell of moderate size being adequate for the purpose.

Another disadvantage attending the use of an accumulator in a portable receiver is that, should the receiver be accidentally placed in any but the normal upright position, acid may spill from the battery and cause serious damage to the chassis and cabinet. This possibility is entirely eliminated when a dry cell "A" battery is used.

In addition to this, the 1.4-volt valves have reduced plate current consumption, and what is perhaps more important still, they are designed to operate from a "B" battery of

just two-thirds the usual voltage, i.e., 90 volts, as compared with 135 volts.

The combination of these factors makes possible the use of two small "light-duty" 45-volt batteries, which naturally weigh less and cost less to replace than the standard types previously employed.

So much for 1.4-volt valves in portable receivers; now to consider their use in standard mantel and console models.

For the receiver which must be operated in a location miles beyond the power lines, the source of power supply has always been one of considerable annoyance and trouble.

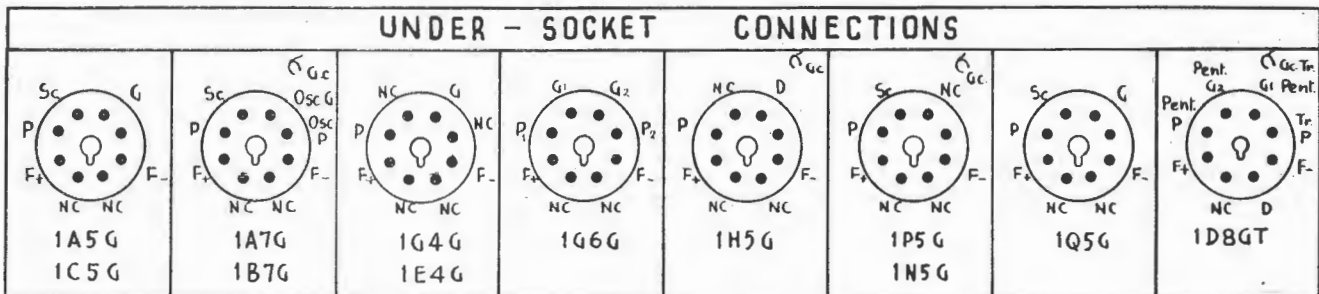

## 1.4-VOLT VALVES: MAIN CHARACTERISTICS.

Type No.	Name	Filament Voltage	Filament Current	Plate Voltage	Plate Current	Screen Voltage	Screen Current	Negative Grid Voltage	Plate Resistance (Ohms)	Mutual Conductance	Amplification Factor	Load for Rated Output (Ohms)	Power Output Watts
1A5G	Power Amplifier Pentode	1.4	.05	90	4.0	90	.8	4.5	300,000	850	255	25,000	.115
1A7G	Pentagrid Converter	1.4	.05	90	.55	45	.6	0	600,000	Conversion Conductance =		250	
1B7G	Pentagrid Converter	1.4	.10	90	1.5	45	1.3	0	350,000	Conversion Conductance =		350	
1C5G	Power Amplifier Pentode	1.4	.10	90	7.5	90	1.6	7.5	115,000	1,550	180	8,000	.240
		Triode Unit:											
1D8GT	Diode Triode Power Amplifier Pentode	1.4	.10	90	.10	0	0	0	45,000	575	25	—	—
	Pent. Unit:	90	5.0	90	1.0	9	200,000	925	—	12,000	.200		
1E4G	Medium-Mu Triode	1.4	.05	90	1.5	0	0	3	17,000	825	14	—	—
1G4G	Medium-Mu Triode	1.4	.05	90	2.3	0	0	6	10,400	825	8.8	—	—
1G6G	Twin Triode Amplifier	1.4	.10	90	1.0a	0	0	0	Peak G to G Signal 18v.		12,000b	.675	
1H5G	Diode Triode	1.4	.05	90	1.5	0	0	0	240,000	275	65	—	—
1N5G	R.F. Pentode	1.4	.05	90	1.2	90	.3	0	1,500,000e	750	1,160	—	—
1P5G	R.F. Amplifier Pentode	1.4	.05	90	2.3	90	.7	0	800,000e	800	640e	—	—
1Q5G	Beam Power Amplifier	1.4	.10	90	9.5	90	1.6	4.5		2,100	—	8,000	.270

(a) Zero signal per element; (b) Plate to plate; (c) Approx.

Receivers employing an accumulator for lighting the filaments, or perhaps for supplying the high tension voltage as well as by means of a vibrator unit, have proved entirely satisfactory in operation, but the absence of adequate charging facilities in many areas has been responsible for considerable interruption in the

use of the receiver, many fine programmes being missed while the battery is away for charging, often for a week at a time.

To combat this trouble, the familiar "Air-cell" was introduced by several manufacturers; these give a long useful life, but replacement cost is high.

Nowadays, with the development of

1.4-volt valves and special batteries for their operation, it is possible to instal a large 1.5-volt dry cell together with two heavy duty 45-volt "B" batteries and obtain approximately one year of trouble-free service from a set of batteries, representing a degree of economy hitherto unobtainable.

# WAR NEWS ON THE SHORT WAVES

## When And Where To Tune

By ALAN H. GRAHAM, Shortwave Editor.

**S**INCE the outbreak of the war, a feature of transmissions on the short-wave bands has been a general re-organisation of schedules to enable the broadcasting of the latest news bulletins. Throughout the day and night the stations of the principal belligerent nations are issuing bulletins at frequent intervals, while on the other side of the Atlantic the American stations are putting over news flashes collected by the army of correspondents in the war zones.

With short-wave conditions as they are, it is possible for the average listener to pick up full bulletins almost hourly. Below are set out as simply as possible the best stations to tune for, and the best times to listen for them.

### England:

The B.B.C. transmissions have been completely reorganised, and now consist very largely of news broadcast in a number of languages including English, German, French, Spanish, Italian, Roumanian and Serbo-Croatian. The English bulletins are given in great detail during each of the six transmissions, together with special news summaries and supplementary bulletins. The best times to hear the B.B.C. English bulletins are:—

**Early morning:** At 2 a.m. and 3.30 a.m. through GSG, 17790kc., 16.86m.; GSF, 15140kc., 19.82m.; GSD, 11750 kc., 25.53m.; and GSA, 6050kc., 49.59m. At 5 a.m., 6.50 a.m. and 7.45 a.m. through GSF, 15140kc.,

19.82m.; GSD, 11750kc., 25.53m.; and GSC, 9580kc., 31.32m.

**Mornings:** At 9.30 a.m. and 10.30 a.m., through GSF, 15140kc., 19.82m., and GSD, 11750kc., 25.53m.

**Afternoons:** At 12.45 p.m. and 2 p.m. through GSD, 11750kc., 25.53m., and GSB, 9510kc., 31.55m. At 4.15 p.m., 6 p.m. and 7 p.m., through GSD, 11750kc., 25.53m.; GSB, 9510kc., 31.55m.; GSI, 15260kc., 19.66m.; GSP, 15310kc., 19.61m.; and GSW, 7230kc., 41.63m.

**Evenings:** At 8.45 p.m., 9.30 p.m. and 11.15 p.m., through GSJ, 21530kc., 13.93m.; GSG, 17790kc., 16.86m.; GSV, 17810kc., 16.84m.; and GSF, 15140kc., 19.82m.

The transmitters listed above are not all those on the air when the various news sessions are broadcast, but merely those through which most satisfactory reception is to be expected.

N.B. These times are correct at time of writing, but may possibly be changed. Listeners should therefore note the announcements regarding programme details given at the commencement of the various B.B.C. transmissions, namely, 3.17 a.m., 6.30 a.m., 9.22 a.m., 12.37 p.m., 3.57 p.m. and 8.45 p.m.

(Continued on page 30)

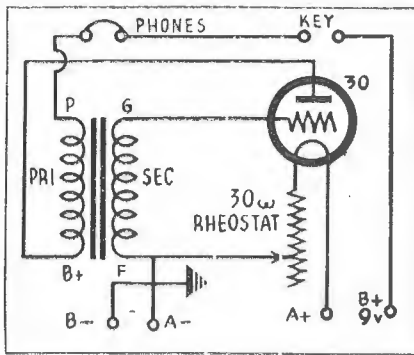

A type 30 valve, an audio transformer and a rheostat are the main parts needed to build this code practice oscillator. A key, pair of headphones and batteries complete the outfit.



# Learn The Morse Code

**Urgent demand in signal units for qualified operators.**

By **DON B. KNOCK (ex-VK2NO)**

FOR several years the writer has stressed the importance of radio amateurs paying full attention to proficiency in the use of the morse code in preference to the microphone, the main reason being that a good working telegraphic knowledge would be of primary utility should we be unfortunate enough to be launched

into war. The worst has happened, and because a group of unscrupulous adventurers who wield the big stick over millions has decreed it, the British Empire is embarked upon a war, the end of which nobody can foresee. Simultaneously with the rapid gathering of the war clouds, amateur radio throughout the Empire perforce

vanished from its seething channels, and many of those once peacefully-engaged private individuals are now handling service radio equipment with serious purpose. Others are not, and in many cases their handicap of poor telegraphic ability has been engendered by their preponderance of attention to the microphone. Many radio amateurs who were once reasonably good telegraphists forsook completely their morse keys and capitulated to the lure of DX working by telephony.

Despite the fact that the maintenance of a modern amateur radio-

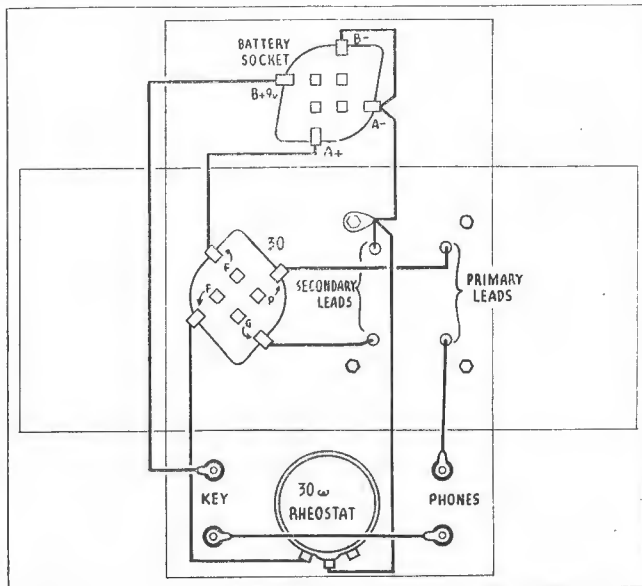

### Code Practice Oscillator: List of Parts.

One aluminium chassis, 4" x 5" x 2 1/4"; 2 4-pin wafer sockets; 1 audio transformer; 1 30-ohm rheostat (Radiokes); 4 terminals—2 red, 2 black; 1 small knob; 1 4-pin plug and 4-wire battery cable; 1 type 30 valve; 1 pair headphones (S.T.C.); 1 Morse key; hook-up wire, nuts and bolts, solder tags; 1 9v. "C" battery (Ever-Ready); 2 1 1/2 v. "A" cells (Ever-Ready), or 1 2v. accumulator (Clyde).

The parts required are listed above, while the sketch on the left shows the under-chassis wiring. After the key, 'phones and batteries have been connected to the oscillator, a loud, clear note should be audible in the 'phones when the key is depressed. If nothing is heard, however, reverse the leads to either the primary OR secondary (not both) of the audio transformer.

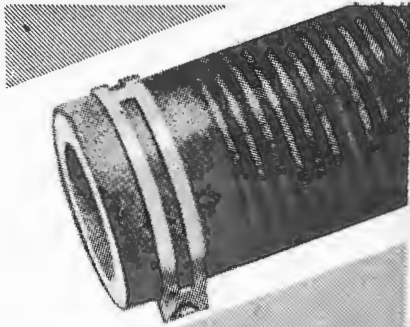

## MILLION VOLT RESISTORS...

Maybe you don't need million volt resistors . . . yet it is worth knowing that the same famous IRC Metallized resistance principle, best known in the little 1/2-, 1- and 2-watt Insulated Resistors for radio use, has now made possible outstanding advances in both high voltage and ultra high frequency resistors for advanced scientific research purposes.

10,000 ohms at 1/2 watt—100,000 volts at 150 watts—1,000 megohms at 150 volts . . . regardless of the need, the IRC Metallized element can supply them all, dependably and economically.

"Metallized" Resistors are made under IRC patents in eight countries. The Metallized type of element is the most adaptable yet produced. No other resistance material holds such an outstanding record of past success. None holds such broad possibilities for future development. Whatever your need—insist on the best!



*"They Stay Put"*



INSULATED

*"Metallized"*  
**RESISTORS**

TYPE BY

**W. J. McLELLAN & Co.**  
55 YORK ST. SYDNEY

telephone station certainly called for careful application of equipment as against the plain telegraphy transmitter, any untutored person can speak into a microphone, but only the qualified telegraphist can make himself understood by means of the morse key.

There are some people to whom the mental acquisition of the morse code in perfect rhythmic sense appears to be a real obstacle, but the root of such failure invariably lies with the method of learning. It is not enough to study the morse alphabet with the idea that the letter "A" is represented by a dot and a dash; that "B" is a dash and three successive dots, and so on. The sense that must be acquired is the rhythmic sound of those symbols which go to make up letters, figures, etc. Once the learner has memorised the complete alphabetical and numerical symbols, he should cease to think of them as dots and dashes.

Most would-be learners are under the impression that it is essential to obtain tuition at the hands of an instructor from the commencement, but such is not the case. Quite a high degree of proficiency can be reached by self-tuition. Having reached a certain stage, it is then desirable to have the co-operation of a good telegraphist for actual sending and receiving practice, as distinct from one's own efforts.

Here is my advice to the would-be telegraphist, or to the telegraphist of poor standard. First thing to do is to obtain or make up a variable pitch audio oscillator for use with a pair of headphones.

The key is something that should not be an afterthought, and if one is not versatile enough to make one's own, then a really good one should be purchased. The kind of key to get is one that costs a little more than the cheapjack type; one that is solidly engineered and smooth in action without effort. It should be remembered that the use of a hand key with a large gap is not conducive to good operating. The key should be adjusted for the smallest possible gap.

Having the audio oscillator equipment all ready for use, one should familiarise oneself with the action of the key and the sounds from the oscillator. If the tone doesn't suit the ear, then adjust the pitch until the note may be considered pleasant to listen to. That is a matter for in-

•	A
••	B
•••	C
••••	D
•••••	E
••••••	F
•••••••	G
••••••••	H
•••••••••	I
••••••••••	J
•••••••••••	K
••••••••••••	L
•••••••••••••	M
••••••••••••••	N
•••••••••••••••	O
••••••••••••••••	P
•••••••••••••••••	Q
••••••••••••••••••	R
•••••••••••••••••••	S
••••••••••••••••••••	T
•••••••••••••••••••••	U
••••••••••••••••••••••	V
•••••••••••••••••••••••	W
••••••••••••••••••••••••	X
•••••••••••••••••••••••••	Y
••••••••••••••••••••••••••	Z
•••••••••••••••••••••••••••	1
••••••••••••••••••••••••••••	2
•••••••••••••••••••••••••••••	3
••••••••••••••••••••••••••••••	4
•••••••••••••••••••••••••••••••	5
••••••••••••••••••••••••••••••••	6
•••••••••••••••••••••••••••••••••	7
••••••••••••••••••••~••••••••••	8
••••••••••••••••••••••••••••••••••	9
•••••••••••••••••••••••••••••••••••	0
••••••••••••••••••••••••••••••••••••	PERIOD
•••••••••••••••••••••••••••••••••••••	INTERROGATION
••••••••••••••••••••••••••••••••~•••••	BREAK (DOUBLE DASH)
••••••••••••••••••••••••••••••••••••••	WAIT
•••••••••••••••••••••••••••••••••••••••	END OF MESSAGE
••••••••••••••••••••••••••••••••••••••••	END OF TRANSMISSION
•••••••••••••••••••••••••••••••••••••••••	RECEIVED (O.K.)
••••••••••••••••••••••••••••••••••••••••••	INVITATION TO TRANSMIT
••••••••••••••••••••••••••••••~••••••••••	(GO AHEAD)
•••••••••••••••••••••••••••••••••••••••••••	EXCLAMATION
••••••••••••••••••••••••••~••••••••••••••	BAR INDICATING FRACTION
••••••••••••••••••••••••••••••••••••••~•••	(OBLIQUE STROKE)
••••••••••••••••••••••••••••••••••••••••	COMMA
•••••••••••••••••••••••••••••••••••••••••	COLON
••••••••••••••••••••••••••••••••••••••••••	SEMICOLON
•••••••••••••••••••••••••••••••••••••••••••	QUOTES
••••••••••••••••••••••••••••••••~••••••••	PARENTHESIS

dividual liking.

Put in some time getting accustomed to the feel of the key, repeating each letter several times until satisfied that the spacing of "longs" and "shorts" is correct. Once the code is fairly well memorised, a good plan is to send to oneself for considerable periods whilst reading from a book. Don't worry about punctuation until thoroughly conversant with letters and figures.

(Continued on page 31)

**1.4**  
VOLT  
COUNTRY  
RADIO



**1.4**  
VOLT  
PORTABLE  
RADIO

# A New Triumph of Radio Engineering

Radio has made gigantic strides in recent years. Newest development is the sensational 1.4 volt economy valve that has made possible an entirely new type of set for country listeners. Operating entirely from Eveready dry batteries, using no more current than an ordinary electric torch, and eliminating the need for an accumulator, it offers listeners greater economy and convenience than ever before. Lighter, more compact and more efficient portable sets have also been designed with the 1.4 volt Valve. Requiring no outside power supply you can carry and use them anywhere. Ask your radio dealer to arrange a demonstration or write **to-day** to Box 37, P.O. Mascot, for advance literature.



● Battery equipment for 1.4 Volt Country Radio.



*Made for  
Each Other*

EVEREADY (AUSTRALIA) PTY. LTD., SYDNEY, N.S.W.

EQUIPPED WITH **EVEREADY** RADIO BATTERIES

A17-1013

# What's New In Radio

## Supply Of Radiokes Products Assured.

Mr. R. K. Stokes, managing director of Radio Suppliers Pty. Ltd., wishes to advise readers that continuity of supplies of Radiokes products is assured for at least the next few months. Furthermore, in the meantime prices will remain unchanged while current stocks of raw materials last.

★

## New Radiotron Valve Data Booklet.

A copy has been received from Amalgamated Wireless Valve Company Pty. Ltd. of a new Radiotron Characteristic Chart.

This time the Valve Company has adopted the booklet style measuring approximately 9" x 6"—a form which should prove most convenient to all radio servicemen whose work calls for frequent reference to this chart. The booklet gives very comprehensive characteristic details and includes the entire range of Radiotron receiving valves.

## A monthly review of latest releases in sets, kit-sets and components

In addition to the general types, of which a large number are, of course, manufactured at the A.W.V. Works at Ashfield, a page is devoted to special Australian Radiotron types, whilst a further supplement is included dealing with recently released general Radiotron types.

The final three pages of the booklet are devoted to illustrations of socket connections.

★

## New Paper For Radio Fans.

"Flash" is the title of a monthly bulletin now being released by Messrs. F. J. W. Fear & Co., of 109 Custom-house Quay, Wellington, N.Z.

The third issue, dated July, 1939, contains complete data with illustrations of a wide variety of latest radio components and accessories, while the circuit, together with brief

details, are given of the "Micromatic 4/5 Pentagrid." This receiver is a battery superhet using 1.4-volt valves, and is available using either single pentode or class "B" output.

Copies of this bulletin are available free on request to "Radio World" readers writing the address given above.

★

## 6K8 Oscillator Grid Current.

A warning is issued by A.W. Valve Co. Pty. Ltd. against the use of the 6K8 mixer-oscillator with coil kits not designed for use with this valve. Recommended oscillator grid current is 150 microamps., and at no part of any waveband should this value rise above 200 or fall below 100 microamps.

A simple method of checking up oscillator grid current is to include a 0-1 milliammeter in the oscillator

SPECIFY

# RADIOKES

Parts for the Sets Featured in this issue.



LOCATING RIBS PREVENT TWISTING

## VOLUME CONTROL POTENTIOMETER

Manufactured under a new process, the new Radiokes Volume Control Potentiometer upholds the quality and precision workmanship of every Radiokes product.

Type W.V.C. Wirewound Volume Controls— List Price

30 to 10,000 ohms.. 4/6  
15,000 ohms ..... 5/9  
20,000 ohms ..... 6/-

## "PICNIC PORTABLE" COIL KIT.

Type RK112, as described by the "Radio World" Editor. Comprising: Aerial, R.F. and Osc. Coils. 2 High Gain I.F.'s. 1 Padder. List Price:

**35/-**

## MIDGET PORTABLE COIL KIT

Type RK113 for smaller models. Comprising: 1 Loop Aerial Coil. 1 Oscillator Coil. 2 High Gain I.F.'s. 1 Padder. List Price:

**32/6**

## RADIOKES INTERMEDIATE TRANSFORMERS

The New Radiokes Trolital I.F.'s are extremely stable, due to the new method of construction, made possible by use of Trolital formers and base. No loose wires to shift and alter frequency. Positively the best I.F.'s produced.

Air Core, 1st, 465 K.C., sq. can, 3in.x1½in.

Type	Price
I.F.I. ....	10/6
I.F.A. ....	7/6

Air Core, 2nd, 465 K.C., sq. can, 3in.x1½in.

Iron Core, 1st, 465 K.C., sq. can, 3in.x1½in.

Iron Core, 2nd, 465 K.C., sq. can, 3in.x1½in.

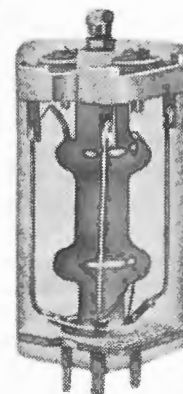

Sole Agents for Radiokes Products:

## RADIO SUPPLIERS Pty. Ltd.

WINGELLO HOUSE, ANGEL PLACE, SYDNEY.

'Phone B 4557.



grid leak return to cathode. The grid current should be noted while the tuning control is swung over each waveband, and should be within the limits given above.

★

### In Latest "Radiotronics."

"A New 2A3 Amplifier—13.5 Watts Output," is the title of an article featured in "Radiotronics" No. 100, issued by the A.W. Valve Co. Pty. Ltd. (This article is re-printed elsewhere in this issue.—Ed.).

Next follows an R.C.A. note entitled "The 6SK7 As An I.F. Amplifier." In this article a comparison is drawn between the valve types 6K7 and 6SK7, the latter being a single-ended type with the grid lead taken to one of the base pins.

Full characteristics are given of the Radiotron 1D8G1, a combination diode triode power pentode in the 1.4-volt valve series. The diode triode unit broadly resembles the 1H5G, while the pentode section is similar to the 1A5G except as regards power output, which is appreciably higher (200 in place of 115 milliwatts).

Data sheets supplied with this latest issue of "Radiotronics" cover the following valve types:—6U5, 6G5, 6T7G, 6S7, 6L6G, 6G6G, 6E5 and 6C8G.

★

### Further Improvements To Rola Speakers: Design Amendments.

Following close upon the introduction of permacentric construction, Rola announces that all 1" voice coil types now leaving the factory are rivetted in one immovable whole. It is anticipated that the ¾" voice coil models will follow suit almost immediately, in fact, this rivetting process is now being used on some of the electro-dynamic models.

In addition, several models have taken on a smart streamlined appearance, due to the re-designed "pot cover," which clamps to the speaker without the aid of screws.

Now that all models except the exceptionally compact 5" types are fitted with isocore transformers (of two sizes) the streamlined effect is complete.

Fitted to the electro-dynamic models F12 (12"), K10 and F10 (10") and K8 (8"), the new pot cover entirely shields the rear portion of the speakers in one piece. Drawn from mild steel, this new pot cover completely protects the electro magnet, and at

the same time imparts balance and design to the appearance of the speakers. Screws have now been done away with. The pot cover clamps to the front plate of the electro magnets, and fits snugly against the speaker housing. The pot cover of the K12 remains unchanged.

### Rivetted Construction.

Following close upon the adoption of permacentric construction, Rola now announce rivetted construction, whereby the housing and magnet assembly are locked in an immovable unit. Although a finely constructed instrument such as a loud speaker is (Continued on page 30)

Expressly designed  
for Console Receivers

The Improved

# ROLA K10 and F10

Electro-dynamic Reproducers

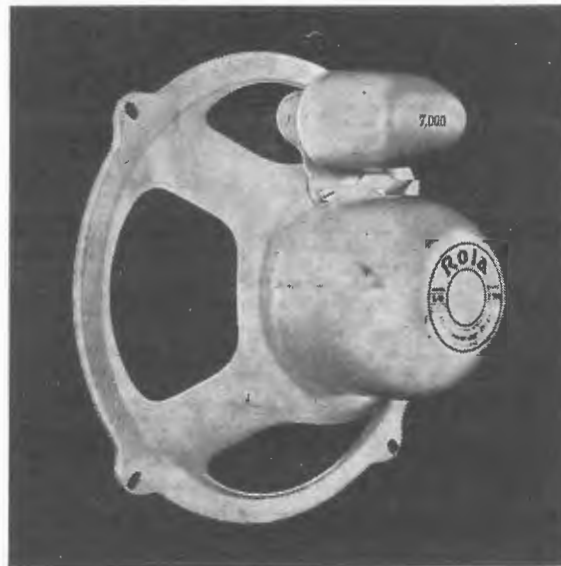

Ten-inch speakers are ideally suited for console receivers, and, in K10 and F10, Rola offers two exceptionally fine reproducers specially designed for high quality receivers. Covering an unusually wide range of frequencies, and being singularly free from frequency discrimination, these two speakers represent by far the best value offering in ten-inch loud speakers to-day.

Mechanically, as well as electrically, these speakers have attained a new peak of perfection. The newly introduced rivetting process ensures a perfect magnetic path and is a guarantee that the component parts of the speakers will not move from their original placing. Permacentric construction ensures that the voice coil maintains perfect alignment and provides the most effective system of dust-proofing found in loud speakers.

Matching the smart general appearance is the isocore transformer, the only transformer that is absolutely proof against electrolysis. Gives unfailing service in all climates.

K10 has a larger electro magnet than F10 and is higher in efficiency. The power handling ability, overall response and other features of the two speakers are generally similar.

Designers and manufacturers are invited to write for further details and samples of these outstanding products.

## Rola Co. (Aust.) Pty. Ltd.

The Boulevard and Park Avenue  
Richmond, E.I. Victoria J 5351  
116 Clarence Street . . . Sydney  
N.S.W. . . . . B 5867

New Zealand Representative: Swan Electric Company Limited,  
High Street, Auckland, N.Z.

*Manufacturers of the World's finest sound reproducers.*

Rola is strictly independent of all affiliations with radio set manufacturers or the personnel thereof.



*Lived out  
with playing*

... Rest will recover a child's energy; but only new valves can bring back the original brilliance to your radio ...

Revalve  
with



Sealed for your protection

Specify ... **RADIOTRONS**  
for the "Picnic Portable"  
and "Vulcan Shortwaver"  
described in this issue.



These photographs were taken by club member I. Skinner on a recent field day arranged by the Gladsville Radio Club. Left: A group of the members who attended. Right: The transmitter used can be seen above the "Y" in "VK2ADY." It was operated by Mr. B. Manly (VK2XH).

## Amateurs Off The Air Radio Clubs Plan To Carry On

### Lakemba Radio Club Anticipates "Business As Usual."

By W.J.P.

IN view of the declaration of war, the activities of all experimental stations throughout Australia were last month brought to a standstill. Amateur experimenters were informed by urgent telegram that they must put all transmitting apparatus out of operation by removing valves, transformers, coils, keys and microphones. A later notice requested the dismantling of the antenna if it had been used for transmitting, while a further letter stated that it would be necessary for those who previously held transmitting licences to take out a broadcast listener's licence (if they still operated a receiver) after the expiry of the transmitting licence.

At a recent meeting of the Lakemba Radio Club it was decided for the time being to continue the club meetings as previously. The proposed radio tests with the Bushwalkers' Club had to be cancelled as a result of the suspension of transmitting licences.

At two meetings of the club, lectures were delivered by Mr. H. Ackling on air raid precautions and the measures necessary to combat gas attacks.

Future club activities are uncertain, but it is anticipated that the "business as usual" policy will be adopted, and members will for the time being at least, branch off into some other phase of radio activity. Several useful suggestions have been sub-

mitted which, together with other matters of vital importance, will be discussed at future meetings.

★

### Waverley Radio Club Notes.

By F.A.B.

"Here's to the memory of 2BV  
Standing unused with silent key."

So quoth the Club's jester, and although true in the main it calls for some explanation. Although of course the transmitter will no longer be heard in its accustomed place in the 40 m. band, the Club's activities in the form of morse classes and so on will continue as usual.

On September 5 a "Question Box" night was held. Ivan Bailue gave us particulars of the problems he had encountered in the building of his portable equipment, and was helped over several tricky spots by the wealth of information usually forthcoming on such occasions.

Bob Wilson, 2AFS, formerly of Moree, was a visitor at the club during the last month, and we hear that he is to become a member in the near future.

Gordon Wells, former president of the Club, treated us to an interesting lecture on A.V.C. at the meeting on September 26, explaining the fundamentals in detail and leaving no one in doubt as to "what makes the wheels go round."

In conclusion, I would like to invite anyone interested in radio to visit the Club rooms at the rear of "Almont,"

(Continued on page 23)

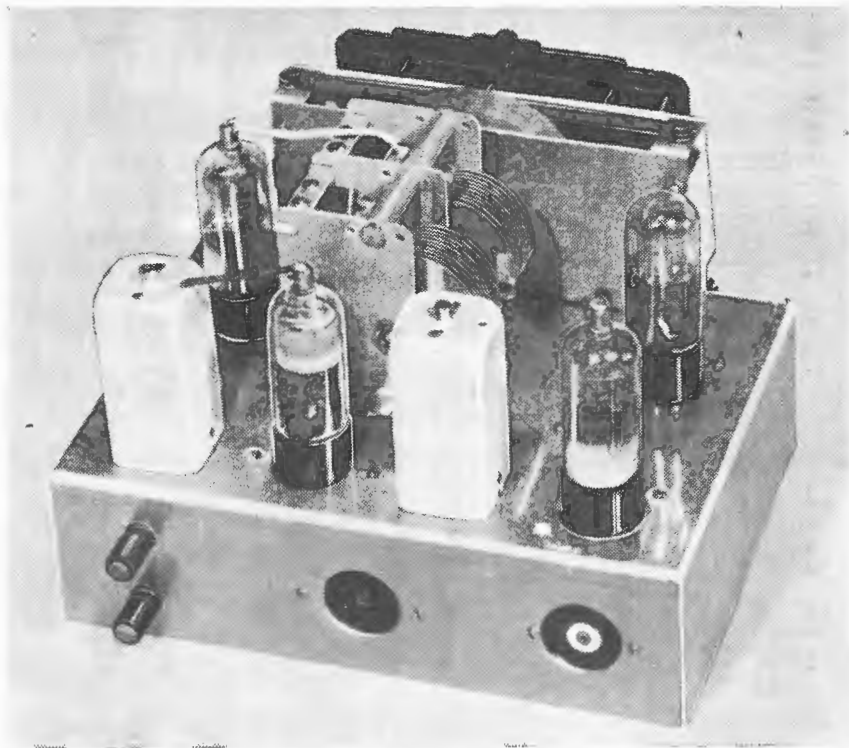

A rear view of the completed receiver. On the left of the condenser gang is the 1A7G mixer oscillator, while in line along the rear of the chassis (left to right) are the first i.f. transformer, 1P5G i.f. amplifier, second i.f. transformer, 1H5G second detector and 1Q5G beam output pentode.

## Falcon Dual - Wave Four

*In this concluding instalment, further details are given covering the assembly and alignment of the "Falcon Dual-Wave Four," a four-valve dual-wave battery superhet using 1.4-volt valves throughout.*

IN assembling the "Falcon Dual-Wave Four," the four valve sockets, aerial and earth terminals, volume control, battery and speaker sockets, and i.f. transformers are mounted first of all. The wiring of the receiver should be then completed from the plate of the 1A7G mixer-oscillator onward, before the dual-wave coil unit is mounted and wired.

The under-chassis diagram published elsewhere shows the wiring in detail. To complete the "A+" side of the filament wiring, a lead should be taken from "X" on the switch mounted on the volume control to the lug marked correspondingly on the 1Q5G socket. A further lead is then run from this lug to the corresponding one on the 1H5G, and so on. "A-" on each valve socket is earthed.

Next, commencing with the plate of the pentode section of the 1A7G, wire the first i.f. transformer in accordance with the colour code supplied with the coil kit. Then wire the

socket of the 1P5G i.f. amplifier, second i.f. transformer, 1H5G second detector and 1Q5G output pentode.

### Mount Gang And Coil Unit.

The assembly should now be thoroughly checked over and, if everything is in order, the two-gang condenser can be mounted. A six-inch length of flexible push-back should be soldered to each fixed plates lug before this component is bolted in position.

All that now remains to be done is to mount the dual-wave coil unit and connect it in circuit according to the colour code supplied.

It will be noted that leads on the under-chassis wiring diagram running to this unit are all numbered. Corresponding numbers appear on the separate sketch of the unit accompanying this article.

Lastly, the tuning dial can be mounted and the control knobs fitted.

Now, before plugging in the valves, connect up the batteries and check all voltages with a voltmeter. If they are all correct, plug in the valves, connect the aerial and earth leads and plug in the speaker. Turn the volume control full on and rotate the tuning dial until a station is picked up.

### Alignment Instructions.

Set the aerial and oscillator trimmers approximately a third of the way out, and tune in a station on approximately 1400 k.c. Now adjust the aerial trimmer for best response. Swing over to a station at the other end of the dial, on approximately 600 k.c. Adjust the padder, at the same time rocking the tuning dial backwards and forwards across the station, until a position is found at which volume is loudest. Carefully repeat this process until the alignment is accurate.

Though the i.f. transformers are

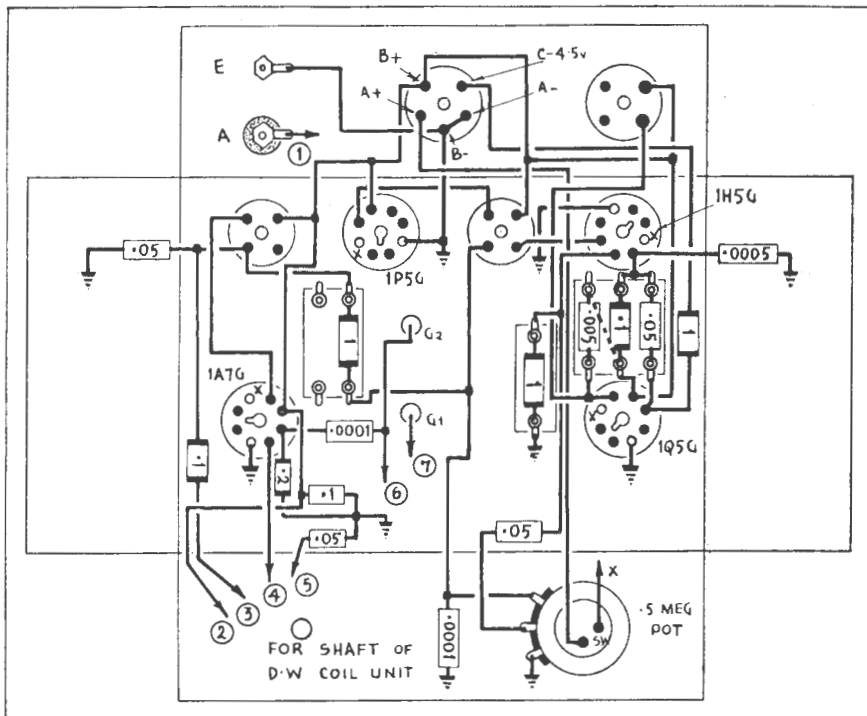

The sketch above shows the complete under-chassis wiring of the "Falcon Dual-Wave Four." Connections running to the coil unit are numbered correspondingly on this sketch and that on the right, of the Radiokes dual-wave unit used in the original receiver.

pre-set to 465 k.c. before leaving the factory, the trimmers can be given a slight adjustment to ensure maximum gain. Commence with the trimmer across the secondary of the second i.f. transformer, and work through to the trimmer across the primary of the first i.f., adjusting each in turn for maximum response.

On the short waves, the aerial trimmer can be adjusted for highest gain on a station somewhere near the centre of the dial.

### "Sky-Chief Dual-Wave Five."

(Continued from last month)

An apology is due to readers for the accidental omission from last month's issue of the concluding portion of the article describing the alignment of the "Sky Chief Dual-Wave Five," and of the sketch showing connections to the coil unit

The alignment instructions appear below, while a sketch of the coil unit appears at the top of the third column of this page.

To align the "Sky-Chief," tune in a station on approximately 1400 k.c. and adjust the broadcast aerial trimmer on the coil unit for greatest response. Keep the volume turned well down while this is being done, because

at low volume levels small changes can be more readily detected, and as well the a.v.c. system is not brought into action. Next, tune in a station near the other end of the band, such as 2FC, and adjust the padder, at the same time rocking the dial backwards and forwards over the station until a point is found at which volume is loudest. The entire procedure can now be repeated.

Finally, the i.f. trimmers can be "touched up" a little, commencing with the trimmer across the secondary of the second intermediate. Adjust each for loudest volume, but at the same time be careful to mark the original positions of these trimmers in case it is found necessary to return them to their former settings.

Correctly built and aligned, the "Sky Chief" is an outstanding performer as regards sensitivity and selectivity, while with a well-baffled speaker, tone is superb.

### Testing Transformer Windings.

Just a short note to let you know that I think "Radio World" is "A1," and just the magazine for anybody interested in radio and wanting to become a ham. I was introduced to "R.W." through AW1DX and have

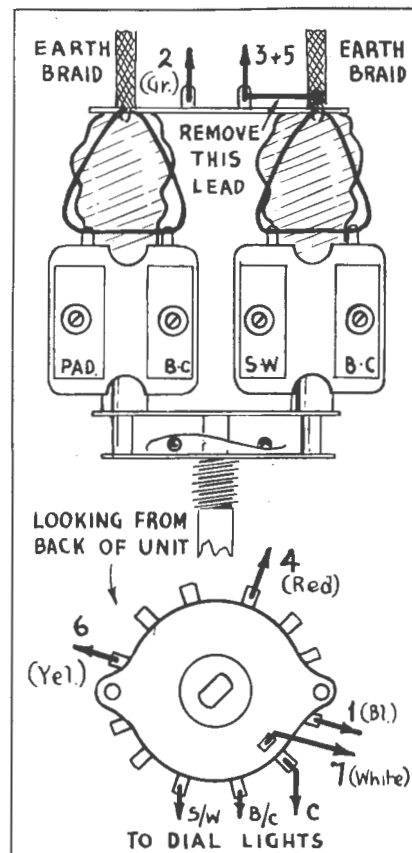

been reading it ever since, and especially enjoyed the articles "Radio Step By Step," "Radio Ramblings," "Breaking Into the Amateur Game," and all radio construction information.

Here is a very simple and effective way to test transformers. Connect a "B" or "A" battery and a pair of headphones in series, take a lead from the negative battery terminal and touch "P" on "PRI." Hold while other side of the 'phones is placed on "B+" of primary winding, and a click will be heard when it touches if winding is O.K. Connect same for secondary winding, but the click will be louder from this as it has a bigger winding. If no click is heard the wire in winding is broken or has come off solder tags.—R. Gallagher (AW521DX), via Donald, Victoria.

### Philips Technical Communication No. 68.

"Hum Phenomena In Receiving Valves" is the title of the feature article in Philips Technical Communication No. 68 (for June-July, 1939). In this article, causes of hum are analysed and methods are outlined whereby it can be reduced to a minimum.

# World Shortwave Stations

Below are listed the principal shortwave transmitters in the world. The schedules given are the latest available, but owing to the international situation frequent alterations in hours of transmission are to be expected. In the case of the B.B.C. shortwave stations, listeners are advised to note the changes detailed at the commencement of the various transmissions.

Compiled by ALAN H. GRAHAM, Shortwave Editor.

Call	K.C.	Metres	Location	Schedule, Address, etc.
W4XA	26150	11.47	Nashville, Tenn., U.S.A.	Addr., C/- National Life and Accident Insurance Co. Daily 2-4 a.m.; 8-30-2 p.m.
W6XKG	25950	11.56	Los Angeles, Calif., U.S.A.	Addr., Washington Blvd. & Oak St. RelaysKGFJ; 24 hours daily.
W8XNU	25950	11.56	Cincinnati, Ohio, U.S.A.	Addr., Crosley Corp. Relays WSAI; 10 p.m.-4 p.m.
WPIT	21540	13.93	Pittsburgh, Pa., U.S.A.	Addr., Grant Building. Relays KDKA; 8.30-11 p.m.
GSI	21530	13.93	Daventry, England.	Addr., B.B.C., London. Trans. 2: 8.45 p.m.- 3 a.m.
GSH	21470	13.97	Daventry, England.	Addr., B.B.C., London. Trans. 2: 8.45 p.m.- 3 a.m.
DJS	21450	13.99	Berlin, Germany.	Addr., Broadcasting House 3.05-10.55 p.m.
TPB-3	17850	16.81	Paris, France.	Addr., 98 Bis. Blvd. Haussmann. "Paris Mondial." 11 p.m.-1 a.m.
DJH	17845	16.81	Berlin, Germany.	Addr., Broadcasting House. 3.05-10.55 p.m.; 11-11.55 p.m.; midnight-2 a.m.
W2XE	17830	16.83	New York City, U.S.A.	Addr.: C.B.S., 485 Madison Ave. Daily, 3-8 a.m.; 9.30 p.m.-midnight; Sat. and Sun., 10 p.m.-2 a.m.
2RO-8	17820	16.84	Rome, Italy.	Addr., EIAR, 5 via Montello. 9 a.m.-noon; 8-11.45 p.m.
GSV	17810	16.84	Daventry, England.	Addr., B.B.C., London. Trans. 2: 8.45 p.m.-3 a.m.
XGOX	17800	16.85	Chungking, China.	Daily 12.30-2.30 p.m. Will change to B.B.C. in near future.
GSG	17790	16.86	Daventry, England.	Addr., B.B.C., London. Trans. 2: 8.45 p.m.-3 a.m.
JZL	17785	16.86	Tokyo, Japan.	Addr., Overseas Section, Broadcasting Corp. of Japan. 7.30-8.30 a.m.; 11 a.m.-noon.
WNBI	17780	16.87	Bound Brook, N.J., U.S.A.	Addr., N.B.C., New York. Daily, 7 a.m.-noon.
PHI-2	17770	16.88	Huizen, Holland.	Addr., N.V. Philips Radio. Daily, 10.10-11.15 p.m. Sundays, 9.10 p.m.-12.35 a.m.
DJE	17760	16.89	Berlin, Germany.	Addr., Broadcasting House. Daily, 7.55 a.m.-noon; 3.05-8.50 p.m.; 9-10.45 p.m.; also 3.10-4.25 a.m. on Mondays.
RV-96	15400	19.47	Moscow, U.S.S.R.	Addr., Radio Centre. Daily, 7-10 p.m.; also irreg. 10 a.m.-12.15 p.m.
HAS-3	15370	19.52	Budapest, Hungary.	Addr., Radiolabor, Gyali Ut 22. Sunday, midnight-1 a.m. Monday.
DJR	15340	19.56	Berlin, Germany.	Addr., Broadcasting House. Daily, 7.55 a.m.-1.50 p.m.
WGEA	15330	19.56	Schenectady, N.Y., U.S.A.	Addr., General Electric Co. Relays WGY, 1.15-8 a.m.
KGEI	15330	19.56	San Francisco, Calif., U.S.A.	Addr., General Electric Co., Treasure Island. Daily, 9.30 a.m.-1 p.m., 10 p.m.-1 a.m.
GSP	15310	19.60	Daventry, England.	Addr., B.B.C., London. Trans. 4b: 6.30-9 a.m., and Trans. 1: 3.57-8 p.m.
2RO-6	15300	19.61	Rome, Italy.	Addr., EIAR, via Montello 5. Daily, 1-3.05 a.m.; 4.38-8.30 a.m.; 9 a.m.-noon; 7.05-7.55 p.m.
VUD-3	15290	19.62	Delhi, India.	Addr., All India Radio. Daily, 11 a.m.-1 p.m.; 4.30-6.30 p.m.; 10.30 p.m.-3.30 a.m.
DJQ	15280	19.63	Berlin, Germany.	Addr., Broadcasting House. Daily, 7.50 a.m.-noon; 12.05-1.50 p.m.; 3.05 p.m.-2 a.m.
GSI	15260	19.66	Daventry, England.	Addr., B.B.C., London. Trans. 1: 3.57-8 p.m.
TPA-2	15245	19.68	Paris, France.	Addr., 98 Bis Blvd Haussmann. "Paris Mondial." Daily, 8 p.m.-1 a.m.
OLR5A	15230	19.70	Prague, Bohemia.	Daily 10.55 a.m.-1.20 p.m.; 7.55-11.15 p.m.
PCJ-2	15220	19.71	Huizen, Holland.	Addr., N.V. Philips Radio. Daily, 10.40 p.m.-12.10 a.m.; Sundays, 9.25 p.m.-12.45 a.m.; also Tuesdays, 4-5.30 p.m.; Thursdays, 12.30-2.30 a.m.
WPIT	15210	19.72	Pittsburgh, Pa., U.S.A.	Addr., Grant Building. Relays KDKA, 11 p.m.-4 a.m.
DJB	15200	19.74	Berlin, Germany.	Addr., Broadcasting House. Daily, 7.50 a.m.-1.50 p.m.; 3.05 p.m.-2 a.m.; also 3.10-4.25 a.m. on Mondays.
TAQ	15195	19.74	Ankara, Turkey.	Addr., Correspondence Dept., Radio Ankara. Daily, 8.30-10 p.m.
XGOX	15190	19.75	Chungking, China.	Will soon replace 16m. transmitter.
GSO	15180	19.76	Daventry, England.	Addr., B.B.C., London. Trans. 4b: 6.30-9 a.m.

Call	K.C.	Metres	Location	Schedule, Address, etc.
RV-96	15180	19.76	Moscow, U.S.S.R.	Addr., Radio Centre. Daily, 10 a.m.-12.15 p.m.; 3.45-6.45 p.m.
LKV	15166	19.76	Oslo, Norway.	Addr. Norsk Rikskringkasting, Stortingasgaten 28. Daily, 9.40 p.m.-1 a.m.
JZK	15160	19.79	Tokyo, Japan.	Addr., Overseas Section, B'casting Corp. of Japan. Daily, 5-7 a.m.; 3-4.30 p.m.; 10 p.m.-12.30 a.m.
SBT	15155	19.79	Motala, Sweden.	Daily, 4-7.15 a.m.
YDC	15150	19.80	Bandoeng, Java.	Addr., N.I.R.O.M. Daily, 9-10.30 a.m.; 1.30-5 p.m.; 7.30 p.m.-1.30 a.m.
GSF	15140	19.82	Daventry, England.	Addr., B.B.C., London. Trans. 2: 8.45 p.m.-3 a.m.; Trans. 4b: 6.30-9 a.m.; Trans. 5: 9.22 a.m.-12.15 p.m.; Trans. 6: 12.37-3.30 p.m.
TPB-6	15130	19.83	Paris, France.	Addr., 98 Bis Blvd Haussemann. "Paris Mondial." Daily, 4-7 p.m.
CSW-4	15120	19.84	Lisbon, Portugal.	Addr., National B'casting Stn. Irreg. 9-11 p.m.
DJL	15110	19.85	Berlin, Germany.	Addr., Broadcasting House. Daily, 1.40-7.25 a.m.; 3.05-5 p.m.; 11 p.m.-midnight.
2RO-12	15100	19.87	Rome, Italy.	Addr., EIAR, via Montello 5. Testing irreg.; heard around 7 a.m.
RKI	15083	19.89	Moscow, U.S.S.R.	Addr., Radio Centre. Daily, 10 a.m.-12.15 p.m.; also 3.15-5.30 a.m.
KQH	14920	20.11	Kahuku, Hawaii.	Relays to U.S.A. Saturdays, noon-1 p.m.; 5-5.30 p.m.; Sundays, 2-2.30 p.m.
IQA	14795	20.28	Rome, Italy.	Addr. as 2RO stations. In Arabic, 7.30-8 p.m.
DZH	14460	20.75	Berlin, Germany.	Addr. as DJ stations. South American programme, 7.50 a.m.-noon.
KKZ	13690	21.91	Bolinas, Calif., U.S.A.	Relays special programmes to Hawaii on Sundays till 2.45 p.m.
HCJB	12460	21.08	Quito, Ecuador.	Addr., Box 691. Daily, 2.30-4.30 a.m.; 7.45 a.m.-1.15 p.m.; 10-11.15 p.m.
RNE	12000	25.00	Moscow, U.S.S.R.	Addr., Radio Centre: Daily, 1-1.30 a.m.; 4-4.30 a.m.; 6-8.30 a.m.; 11.30 a.m.-1 p.m.; 9-9.30 p.m.; Sundays, 9 p.m.-1 a.m.; Mondays, 4-9 a.m.; noon-1 p.m.
CB-1180	11970	25.06	Santiago, Chile.	Daily, 10 a.m.-2 p.m.
CD-1190	11910	25.19	Valdivia, Chile.	Addr., Box 642. Relays CB-69, 1-4 a.m.; 6-9 a.m.; 10 a.m.-2 p.m.
XGOY	11900	25.21	Chungking, China.	Daily 2-2.30 a.m.; 7-9.30 a.m.; 8.30 p.m.-1.30 a.m. Will change to 31ms in near future.
2RO-13	11895	25.23	Rome, Italy.	Addr., EIAR, via Montello 5. Testing irreg. 9 a.m.-noon.
TPA-3	11885	25.24	Paris, France.	Addr., 98 Bis Blvd. Haussmann. "Paris Mondial." Daily, 1.15-8 a.m.; 4-7 p.m.
TPB-7	11885	25.24	Paris, France.	Addr., as TPA-3. Daily, 9-11.15 a.m.; 11.30 a.m.-2 p.m.
VLR-3	11880	25.25	Melbourne, Australia.	Addr., Box 1686. Now used during mornings.
WPIT	11870	25.26	Pittsburgh, Pa., U.S.A.	Addr. Grant Building. Relays KDKA, 4 a.m.-1 p.m.
GSE	11860	25.29	Daventry, England.	Addr. B.B.C., London. Trans. 1: 3.57-8 p.m.
DJP	11855	25.31	Berlin, Germany.	Addr. Broadcasting House. Irreg.; heard testing 2-3 p.m.
XMHA	11850	25.32	Shanghai, China.	Addr. Racecourse Rd. Daily, 8 p.m.-2 a.m.
W2XE	11830	25.36	New York City, U.S.A.	Addr. C.B.S., 485 Madison Ave. Daily, 11 a.m.-1.30 p.m.
2RO-4	11810	25.40	Rome, Italy.	Addr. EIAR, via Montello 5. Daily 1-5.30 a.m.; 9 a.m.-noon; 7.30-11.45 p.m.
DJZ	11801	25.42	Berlin, Germany.	Addr. Broadcasting House. Daily 7.50 a.m.-1.50 p.m.
COGF	11800	25.42	Matanzas, Cuba.	Addr. Gen. Betancourt 51. Relays CMGF 4-5 a.m.; 7-8 a.m.; 9 a.m.-3 p.m.
JZJ	11800	25.42	Tokyo, Japan.	Addr. Overseas Section, B'casting Corp. of Japan. Daily 5-7 a.m.; 10 p.m.-12.30 a.m.
W1XAL	11790	25.45	Boston, Mass., U.S.A.	Addr. University Club. Daily 6.30-9.30 a.m.; Sundays from 5 a.m.
Saigon	11780	25.47	Saigon, French Indo-China.	Addr. Box 412. Daily 2-15-3.15 p.m.; 11.30 p.m.-12.45 a.m.
MTCY	11775	25.48	Hsinking, Manchukuo.	Daily 7-7.45 a.m.
DJD	11770	25.49	Berlin, Germany.	Addr. Broadcasting House. Daily 2.30-7.35 a.m.; 7.50 a.m.-1.50 p.m.
GSD	11750	25.53	Daventry, England.	Addr. B.B.C., London. Trans. 1: 3.57-8 p.m.; Trans. 4a: 3.17-6.15 a.m.; Trans. 4b: 6.30-9 a.m.; Trans. 5: 9.22 a.m.-12.15 p.m.; Trans. 6: 12.37-3.30 p.m.
COCX	11735	25.57	Habana, Cuba.	Addr. Box 32. Relays CMX, 11 p.m.-4 p.m.
LKQ	11735	25.57	Oslo, Norway.	Addr. see LKV, 19m. Daily 1-6 a.m.; 5-9.40 p.m.
W1XAR	11730	25.58	Boston, Mass., U.S.A.	Addr. University Club. Daily 10 or 10.30 a.m.-noon; 12.15-2 p.m.; Sunday and Monday, 5.30-8 a.m.
CJRX	11720	25.60	Winnipeg, Canada.	Addr. James Richardson & Sons Ltd. Daily, 9 p.m.-3 p.m.; Sundays till 7 p.m.
ZP-14	11720	25.60	Villa Rica, Paraguay.	Irreg. 8.25-10.55 a.m.

Call	K.C.	Metres	Location	Schedule, Address, etc.
JVW-3	11720	25.60	Tokyo, Japan.	Addr. International Tele-Communications Co. Ltd. Daily 4.50-10.40 p.m.
TPA-4	11715	25.61	Paris, France.	Addr. 98 Bis Blvd. Haussmann. "Paris Mondial." Daily 9-11.15 a.m.; 11.30 a.m.-2 p.m.; 4-7 p.m.
JLG-3	11705	25.63	Tokyo, Japan.	Addr. see JVW-3. Daily 5-7 a.m.
SBP	11705	25.63	Motala, Sweden.	Daily 4-7.15 a.m.
HP5A	11700	25.65	Panama City, Panama.	Addr. Apartado 951. Daily 1-4 a.m.; 8 a.m.-1 p.m.; 10-11.30 p.m.
CB-1170	11700	25.65	Santiago, Chile.	Addr. Box 706. Relays CB-89, 1-5 a.m.; 6.30 a.m.-2 p.m.
IQY	11676	25.70	Rome, Italy.	Addr. EIAR, via Montello 5. Daily 3.07-3.56 a.m.; 4.50-5.30 a.m.; 9 a.m.-noon; 8.20-8.40 p.m.
CSW-5	11040	27.17	Lisbon, Portugal.	Addr. National B'casting Stn. Daily 2-7.30 a.m.
PLP	11000	27.27	Bandoeng, Java.	Addr. N.I.R.O.M. Relays YDC, 19.8m.
EAL-43	10360	28.96	Teneriffe, Canary Is.	Daily 5.30-7 a.m.; 7.30-10 a.m.; 10.45-11.45 a.m.; noon-1 p.m.
ORK	10330	29.04	Ruyselede, Belgium.	Daily 4.30-6 a.m.
PMN	10260	29.24	Bandoeng, Java.	Addr. N.I.R.O.M. Relays YDC, 19.8m.
PSH	10220	29.35	Rio de Janeiro, Brazil.	Addr. Box 709. Daily 9-10 a.m.
DZC	10050	29.86	Zeesen, Germany.	Addr. as DJ stations. Special Arabic session, around 4 a.m.
COBC	9985	30.04	Habana, Cuba.	Addr. Box 132. Relays CMBC, 9.55 p.m.-4 p.m.
JDY	9920	30.24	Dairen, Manchukuo.	Relays JQAK, 10-11 p.m.
Burgos	9855	30.45	Burgos, Spain.	Has replaced EAQ on this frequency; schedule unknown.
EAQ	9855	30.45	Madrid, Spain.	Replaced by Radio Burgos (or possibly sharing frequency). Addr. Box 951.
IRF	9830	30.52	Rome, Italy.	Addr. as 2RO stations. Daily 3-4 a.m.; 4.50-6.30 a.m.; 9 a.m.-noon; 8.20-8.40 p.m.
COCM	9805	30.60	Habana, Cuba.	Addr. Box 33. Relays CCM, 11 p.m.-4 p.m.
CSW-7	9735	30.82	Lisbon, Portugal.	Addr. National B'casting Stn. Daily 9.13 a.m.-noon.
CB-970	9730	30.83	Valparaiso, Chile.	Daily 8.30 a.m.-2.30 (or 3) p.m.
LRA-1	9690	30.96	Buenos Aires, Argentine.	Addr. Post & Telegraph Bldg. 8 a.m.-noon; Saturdays from 7 a.m.; Sundays from 10 a.m.
ZHP	9690	30.96	Singapore, Malaya.	Addr. Broadcast House, 2 Orchard Rd. Sundays 8.40 p.m.-12.40 a.m.; Wednesdays 3.40-4.40 p.m.; Mon.-Fri. 7.40 p.m.-12.40 a.m.; Saturdays 3.25-4.40 p.m., 7.40 p.m.-12.40 a.m.
GRX	9690	30.96	Daventry, England.	Addr. B.B.C., London. Trans. 2: 8.45 p.m.-3 a.m.; Trans. 4b: 6.30-9 a.m.; Trans. 5: 9.22 a.m.-12.15 p.m.
TGWA	9685	30.97	Guatemala City, Guatemala.	Daily 1-2.30 p.m. Special DX programmes till 6.30 p.m. on alternate Sundays.
Paris	9680	30.99	Paris, France.	Addr. "Paris Mondial," as TP stations. Same programme as TPA-3 and TPA-4 during afternoons.
DJX	9675	31.01	Berlin, Germany.	Addr. Broadcasting House. Daily 1.40-7.25 a.m.
WRCA	9670	31.03	Bound Brook, N.J., U.S.A.	Addr. N.B.C., New York City. Daily 8 a.m.-3 p.m.
2RO-9	9665	31.04	Rome, Italy.	Addr. EIAR, via Montello 5. Daily 3.40-8.30 a.m.; and irreg. from 9 a.m.
LRX	9660	31.06	Buenos Aires, Argentine.	Addr. El Mundo, Calle Maipu 555. Daily 12.15 a.m.-1 p.m.; 9-9.45 p.m.
IABA	9650	31.09	Addis Ababa, Ethiopia.	Daily 2-3 a.m.; 4-6 a.m.; 6.55-7.05 p.m.; 7.15-7.45 p.m.; and Sundays 6.30-6.55 p.m.
CXA-8	9640	31.12	Colonia, Uruguay.	Addr. Belgrano 1841, Buenos Aires, Argentine. Relays LR-3, 8 p.m.-1.45 p.m.
JFO	9636	31.13	Taihoku, Taiwan.	Relays JFAK, 7 p.m.-1.30 a.m.
2RO-3	9635	31.13	Rome, Italy.	Addr. EIAR, via Montello 5. Daily 3.07 a.m.-noon. Also special test for N.Z. at 4 p.m.
TIPG	9620	31.19	San Jose, Costa Rica.	Addr. Box 225, Daily from 10 p.m.
CXA-6	9620	31.19	Montevideo, Uruguay.	Relays CX, 7 a.m.-noon.
RAL	9600	31.25	Moscow, U.S.S.R.	Addr. Radio Centre. Daily, exc. Mon., 9 a.m.-1 p.m.; Mondays 9-10 a.m.; 12.15-1 p.m.
CB-960	9600	31.25	Santiago, Chile.	Daily 10 p.m.-7.30 a.m.; 10 a.m.-3 p.m.
HP5J	9590	31.28	Panama City, Panama.	Addr. Box 867. Daily 3-4.30 a.m.; 9 a.m.-1.30 p.m.; from 10 p.m.
VUD-2	9590	31.28	Delhi, India.	Addr. All India Radio. Daily 11.30 a.m.-1.30 p.m.; 4.30-6.30 p.m.; 10.30 p.m.-3.30 a.m.
PCJ	9590	31.28	Huizen, Holland.	Addr. N. V. Philips Radio. Mon., 4-5 a.m., 10.15 a.m.-12.25 p.m.; Wed., 4.45-6.30 a.m., 10-11.30 a.m., 11.45 a.m.-1.15 p.m.; Thurs., 10.15-11.40 a.m.; Sat., 11 a.m.-noon.
VK6ME	9590	31.28	Perth, W.A.	Addr. A.W.A. Daily, exc. Sunday, 9-11 p.m.
VK2ME	9590	31.28	Sydney, N.S.W.	Addr. 47 York St. Sundays 4-6 p.m.; 8 p.m.-midnight; Mondays 1.30-3.30 a.m.

Call	K.C.	Metres	Location	Schedule, Address, etc.
WCAB	9590	31.28	Philadelphia, Pa., U.S.A.	Addr. C.B.S., 485 Madison Ave., New York City. Tues. and Fri. 8.30-9.15 a.m., 9.30 a.m.-1.30 p.m., 2-3 p.m.; Sun. 8.30-9 a.m., 9.30 a.m.-1.30 p.m.
GSC	9580	31.32	Daventry, England.	Addr. B.B.C., London. Trans. 4a: 3.17-6.15 a.m.; Trans. 4b: 6.30-9 a.m.; Trans. 5: 9.22 a.m.-12.15 p.m.
VLR	9580	31.32	Melbourne, Vic.	Addr. Box 1686. Now used during afternoons and nights.
KZRM	9570	31.35	Manila, P.I.	Addr. Box 283. "Radio Manila." Daily 7.30-9 a.m.; 8 p.m.-midnight (or 1 a.m.),
WBOS	9570	31.35	Boston, Mass., U.S.A.	Addr. Westinghouse Electric & Mfg. Co. Daily 9 p.m.-3 p.m. (Sundays from 10 p.m.),
CXA-2	9570	31.35	Montevideo, Uruguay.	Exact schedule unknown; heard around 7 a.m., and after 1 p.m.
OAX4T	9566	31.37	Lima, Peru.	Daily 2.30-4.30 a.m.; 11 p.m.-midnight.
DJA	9560	31.38	Berlin, Germany.	Addr. Broadcasting House. Daily 9.30 a.m.-1.50 p.m.
WGEA	9550	31.41	Schenectady, N.Y., U.S.A.	Addr. General Electric Co. Daily 8.15-11.15 a.m.
YDB	9550	31.41	Soerabaya, Java.	Addr. N.I.R.O.M. Same schedule as YDC, 19.8m.
DJN	9540	31.45	Berlin, Germany.	Addr. Broadcasting House. Daily 7.55 a.m.-1.50 p.m.; 3.05-5.30 p.m.
VPD-2	9538	31.46	Suva, Fiji Is.	Addr. A.W.A. Ltd. Daily, exc. Sunday, 8.30-10 p.m.
SBU	9535	31.46	Motala, Sweden.	Daily 7.15-8 a.m.
JZI	9535	31.46	Tokyo, Japan.	Addr. Overseas Section, B'casting Corp. of Japan. Daily 7.30-8.30 a.m.
KGEI	9530	31.48	San Francisco, Calif., U.S.A.	Addr. General Electric Co., Treasure Island. Daily 10 p.m.-1 a.m.
WGEO	9530	31.48	Schenectady, N.Y., U.S.A.	Addr. General Electric Co. Daily 6 a.m.-2 p.m.
ZBW-3	9526	31.49	Hong Kong.	Addr. Box 200. Daily 2.30-4.15 p.m.; 8 p.m.-1 a.m.
OZF	9520	31.51	Skamlebaek, Denmark.	Addr. Statsradiofonien, Heibergsgade 7, Copenhagen. Daily 11 a.m.-2 p.m.
RV-96	9520	31.51	Moscow, U.S.S.R.	Addr. Radio Centre. Daily 4-6 a.m.; 7-10 a.m.
YUA	9510	31.55	Belgrade, Yugo-Slavia.	Addr. Emetteur a Ondes Courtes. Testing 4-8.30 a.m.
GSB	9510	31.55	Daventry, England.	Addr. B.B.C., London. Trans. 1: 3.57-8 p.m.; Trans. 5: 9.22 a.m.-12.15 p.m.; Trans. 6: 12.37-3.30 p.m.
HS8PJ	9510	31.55	Bangkok, Siam.	Four nights a week—11 p.m.-1 a.m.
XEWW	9503	31.57	Mexico City, Mexico.	Addr. Box 2516. Daily 10.45 p.m.-3.30 p.m.
YK3ME	9500	31.58	Melbourne, Vic.	Addr. 167 Queen St. Daily, exc., Sun., 7-10 p.m.
XGOY	9500	31.58	Chungking, China.	Will replace 25m. transmitter in near future.
OFD	9500	31.58	Lahti, Finland.	Addr. Finnish B'casting Co., Helsinki. Daily 3.15-8 a.m.
KZIB	9497	31.59	Manila, P.I.	Daily 10 p.m.-12.05 a.m.
TAP	9465	31.70	Ankara, Turkey.	Addr. Correspondence Dept., Radio Ankara. Daily 2.30-8 a.m.
COCH	9437	31.80	Habana, Cuba.	Addr. 2 B St., Vedado. Daily 11 p.m.-12.30 p.m. (Mondays till 3 p.m.).
OAX5C	9390	31.95	Lima, Peru.	Addr. "Radio Universal." Daily 10 p.m.-2.30 p.m.
COCD	9350	32.08	Habana, Cuba.	Addr. Box 2294. Relays CMCD, 1 a.m.-2.30 p.m.
OAXIJ	9340	32.12	Lima, Peru.	Addr. Box 1166. Daily 4-6 a.m., 8 a.m.-4 p.m.
COBX	9200	32.61	Habana, Cuba.	Addr. San Miguel 194, Altos. Relays CMBX, 11 p.m.-2.30 p.m.
COCA	9100	32.91	Habana, Cuba.	Addr. Galiano 102. Relays CMCA, 3 a.m.-3.15 p.m. (or later).
COBZ	9030	33.32	Habana, Cuba.	Addr. Box 866. "Radio Salas." Daily 10.45 p.m.-4.15 p.m.
COCQ	8830	33.98	Habana, Cuba.	Addr. 25 No. 445, Vedado. Daily 9.55 p.m.-4 p.m. Varies in frequency at times.
COJK	8665	34.64	Camaguey, Cuba.	Daily 8.30-9.30 a.m.; 11 a.m.-2 p.m.; and from 9.55 p.m.
TPB-11	7280	41.21	Paris, France.	Addr. 98 Bis Blvd. Haussmann. "Paris Mondial." Daily 1.15-8.15 a.m.
CSW-8	7260	41.30	Lisbon, Portugal.	Addr. National B'casting Stn. Daily 7-8 a.m.
GSW	7230	41.53	Daventry, England.	Addr. B.B.C., London. Trans. 1: 3.57-8 p.m.
YDX	7220	41.55	Medan, Sumatra.	Daily 1.30-5 p.m.; Sunday 10.30 a.m.-4.30 p.m. Also from 7.30 p.m.-midnight. Both native and N.I.R.O.M. programmes.
XPSA	7000	42.80	Kweiyang, China.	Daily 8.30 or 9 p.m.-2 a.m.
XOJD	6880	43.60	Hankow, China.	Daily 9-11.30 p.m.
PMH	6720	44.64	Bandoeng, Java.	Addr. N.I.R.O.M. Native programme 7.30 p.m.-2 or 2.30 a.m.
TGWB	6490	46.20	Guatemala City, Guatemala.	Daily 3.45-6.45 a.m.; 10.30 a.m.-3.15 p.m.; 10.45 p.m.-midnight. Also special DX programmes on alternate Sundays—as TGWA.
IAC	6355	47.20	Rome, Italy.	Addr. as 2RO stations. Daily 6-6.35 a.m.
COCW	6324	47.40	Habana, Cuba.	Addr. Box 130. "La Voz del Radio Philco." Daily 9.55 p.m.-3 p.m.



Call	K.C.	Metres	Location	Schedule, Address, etc.
TG-2	6190	48.47	Guatemala City, Guatemala.	Addr. Director General of Electrical Communications. Tues.-Sat., 9 a.m.-2 p.m.; Sun. 9 a.m.-6 p.m.; 10 p.m.-2 a.m.; Mon. 6-11 a.m.
KGEI	6190	48.47	San Francisco, Calif., U.S.A.	Addr., General Electric Co., Treasure Island. Daily 3-6 p.m.
TILS	6165	48.66	San Jose, Costa Rica.	Addr. "Radio Parati." Opens at 10 p.m.
WPIT	6140	48.86	Pittsburgh, Pa., U.S.A.	Addr. Grant Building. Daily 1-3 p.m.
Manila	6140	48.86	Manila. P.I.	Announces variously as KZRM, KZRF and KZEG. Daily from about 8.30 p.m.
CR7AA	6137	48.87	Lourenco Marques, Mozambique.	Addr. Box 594. Daily 12.30-2 a.m., 3.05-7 a.m., 3.05-4 p.m., 7.30-9.30 p.m.; Sundays 8-10 p.m.; Mondays 1-5 a.m.
XEXA	6133	48.90	Mexico City, Mexico.	Addr. Dept. of Education. Daily 5.30-7 a.m., 10.30 a.m.-3.45 p.m., 11 p.m.-2 a.m.
LKJ	6130	48.94	Jeloy, Norway.	Addr. see LKV, 19m. Daily 3-9 a.m.
MTCY	6125	48.98	Hsinking, Manchukuo.	Strong at night; time of opening varies from 9 to 11 p.m.
FK8AA	6122	49.00	Noumea, New Caledonia.	Addr. 44 Rue de l'Alma. Daily 5.30-7 p.m.
Saigon	6116	49.05	Saigon, French Indo-China.	Addr. Box 412. Daily 9.45-10.15 a.m.; 3.15-3.45 p.m.; 9-11.30 p.m.
KZRH	6110	49.10	Manila, P.I.	"The Voice of the Philippines." Daily around 9 p.m.
YUA	6100	49.18	Belgrade, Yugo-Slavia.	Daily 3-9.30 a.m., 4-6 p.m., 9.30-11.30 p.m.
ZRK	6097	49.20	Klipheuvcl. S. Africa.	Addr. S. African B'casting Co., Johannesburg. Daily 3-7 a.m. (Monday till 5.20 a.m.).
ZRJ	6097	49.20	Johannesburg, S. Africa.	Addr. as ZRK. Daily 12.01-2.30 a.m.; 2.45-3.50 p.m.; 6.15-10.30 p.m.
VQ7LO	6083	49.31	Nairobi, Kenya.	Addr. Cable & Wireless Ltd. Tues., Sat., 2.15-5.15 a.m.; Sun. 2.15-6.15 a.m.; Mon. 1.45-4.45 a.m.
ZHJ	6080	49.34	Penang, Malaya.	Daily 9.40-11.40 p.m.
OAX4Z	6077	49.35	Lima, Peru.	Addr. Radio Nacional. Daily exc. Mon. 10 a.m.-4.30 p.m.
SBO	6065	49.46	Motala, Sweden.	Daily 7.15-8 a.m.
YDD	6060	49.50	Bandoeng, Java.	Addr. N.J.R.O.M. Daily 8.30 p.m.-1 a.m.
WLWO	6060	49.50	Cincinnati, Ohio, U.S.A.	Addr. Crosley Radio Corp. Relays WLW. Schedule uncertain—from 8.45 p.m. till 4 p.m.
GSA	6050	49.59	Daventry, England.	Addr. B.B.C., London. Trans. 4b: 6.30-9 a.m.; Trans. 5: 9.22 a.m.-12.15 p.m.
KZIB	6040	49.67	Manila, P.I.	Transmits simultaneously with 9497kc. transmitter.
RV-95	6030	49.75	Moscow, U.S.S.R.	Addr. Radio Centre. Daily 4-6 a.m., 7-10 a.m.
DJC	6020	49.83	Berlin, Germany.	Addr. Broadcasting House. Daily 2.30-7.25 a.m.
PRA-8	6015	49.85	Pernambuco, Brazil.	Addr. Radio Club of Pernambuco. Daily 7 a.m.-noon.
COCO	6010	49.92	Habana, Cuba.	Addr. Box 98. Daily 10.55 p.m. 3 p.m.
XYZ	6007	49.94	Rangoon, Burma.	Addr. Director General of Posts & Telegraphs. Daily noon-2 p.m., 9.30 p.m.-1 a.m.
ZRH	6007	49.94	Roberts Heights, S. Africa.	Addr. as ZRK. Daily 12.30-6.30 a.m., 2.45-3.50 p.m.
HP5K	6005	49.96	Colon, Panama.	Addr. Box 33. Daily 10 p.m.-midnight.
CS2WD	5977	50.15	Lisbon, Portugal.	Addr. Rua Capelo 5. Daily 6.30-9 a.m.
PMY	5145	58.31	Bandoeng, Java.	Daily 8.30 p.m.-2 a.m.
VUD-2	4960	60.48	Delhi, India.	Addr. All India Radio. Daily 10.30 p.m.-3.35 a.m.
VUM-2	4920	60.98	Madras, India.	Addr. All India Radio. Daily 9.30 p.m.-3.10 a.m.
VUB-2	4880	61.48	Bombay, India.	Addr. All India Radio. Daily 10.30 p.m.-3.30 a.m.
VUC-2	4840	61.98	Calcutta, India.	Addr. All India Radio. Daily 9.30 p.m.-3 a.m.
YDE-2	4810	62.37	Solo, Java.	Native programmes. Daily 7.30 p.m.-1 a.m.
RV-15	4273	70.21	Khabarovsk, Siberia, U.S.S.R.	Daily 4 p.m.-1 a.m.

### Amateurs Off The Air.

(Continued from page 16)

13 Macpherson St., Waverley, on any Tuesday night. Members will doubtlessly be found discussing "hi-fi" amplifiers and new receivers instead of the number of G's and W's they have worked.—G. A. Burke.

★

### Hurstville Amateur Club Notes.

The club was honoured recently by a visit from an associate club, Lakemba. (The visitors, all transmitting

members, form a group known as the "Big Six"). Greetings were extended on both sides, and QSL cards were exchanged by many members who had QSO'd each other, and an invitation was handed to VK2MZ (H.A.R.C.) to visit Lakemba.

The Club have received their badges from the manufacturers, and members or anyone interested may obtain one by calling at the QRA, 13 Clevedon Rd., (bus to door) or by writing to the Secretary, J. Ackerman, 34 Park Rd., Carlton, and full particulars will be forwarded by return mail.—G. J. Boyd, Official Publicity Officer.

### Triplett Signal Generator:

#### Special Offer.

Messrs. W. G. Watson & Co. Pty., Ltd., of 279 Clarence St., Sydney, wish to draw the attention of readers to the special offer made this month in their inside front cover advertisement. For one month only a special reduction of 30/-, from £6/10/- to £5, will be made on the Triplett Model 1230 Ali-Wave Signal Generator, which is supplied complete with batteries, valves and six individually calibrated graphs.

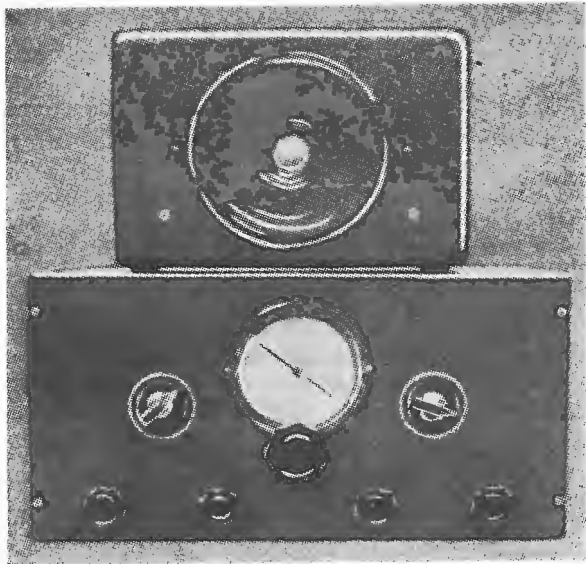

The completed receiver is attractively mounted in a metal cabinet, with the speaker as a separate unit. Standard components, readily obtainable anywhere in Australia, have been used in this latest American design. Main features include the use of 1.4-volt valves, regeneration on mixer and second detector stages, and continuous waveband coverage from 9.5 to 200 metres.

## 1.4 Volt Shortwave Superhet

*Exceptionally high overall gain, coupled with excellent selectivity, are features of this battery-operated shortwave superhet, which uses 1.4 volt valves throughout. Designed by HARRY D. HOOTON (W8KPX), the receiver is described by him in the September issue of the American "Radio News."*

**A**LWAYS on the alert for new developments in economical radio operation, the short wave experimenter should be interested in the little five-tube superhet to be described. Designed around the new 1.4 volt battery-type tubes which were recently released, this receiver operates from only a single 1.5 volt dry cell "A" battery, a small 4.5 volt "C" battery, and two midget 45 volt "B" batteries, yet it is capable of extraordinary performance.

The circuit, as the schematic diagram shows, consists of a 1A7-G mixer, a 1N5-G oscillator, a 1N5-G i.f. amplifier, another 1N5-G as detector

and a 1A5-G as output. Regeneration is used in both the mixer and the detector circuits to boost the sensitivity, especially in the 14-28 megacycle region, and to provide a simple and effective means of receiving C.W. code signals. The method of obtaining feedback in the 1A7-G circuit is novel—a small r.f. choke coil, consisting of 25 turns of No. 24 enamelled wire wound on an old broadcast r.f. choke core, is placed in series with the positive filament lead, close to the tube socket as shown in the photograph.

The negative filament lead is connected to ground through a small tickler winding on the coil form as

indicated in the diagram. A .05 mfd. bypass condenser across the filament terminals of the socket keeps both legs of the filament at the same r.f. potential. Although the 1A7-G tube cannot be made to oscillate in this manner, the sensitivity is enormously increased; it is necessary to provide a 2,000 ohm control across the tickler in order to keep the regeneration within reasonable bounds. The image response, while not completely eliminated, can be very effectively reduced by the use of the r.f. regeneration control and the mixer trimmer condenser.

The separate 1N5-G oscillator pro-

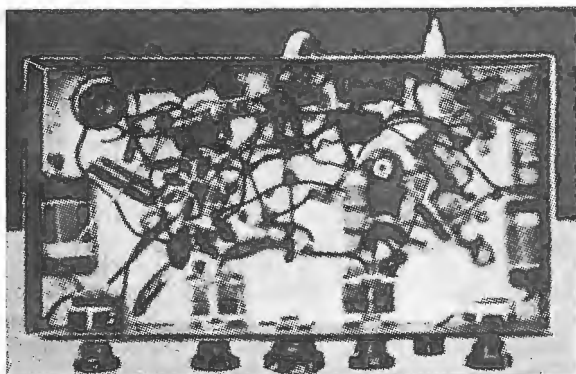

The under-chassis view on the left shows the simplicity of the wiring, while the view on the right shows the above-chassis layout, which has been planned for short, direct wiring.

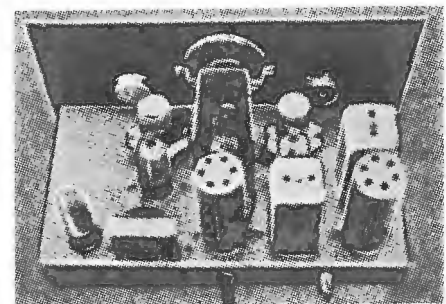

C1, C3, variable condensers, 35 mmfd. each. C2, C4, dual section tuning condenser, 15-15 mmfd. per section. C5, .0001 mmfd. C6, 0.05 mfd., C7, .00005 mfd. C8, 0.1 mfd. C9, 0.5 mfd. C10, 0.1 mfd. C11, 0.1 mfd. C12, .00025 mfd. C13, .001 mfd. C14, 1.0 mfd. C15, 0.01 mfd. C16, 0.05 mfd. C17, 0.25 mfd. R1, 2,000 ohms potentiometer. R2, 200,000 ohms. R3, 70,000 ohms. R4, 50,000 ohms. R5, 100,000 ohms. R6, 3 meg-ohms. R7, 250,000 ohms. R8, 50,000 ohms potentiometer (regeneration). R9, 500,000 ohm potentiometer (volume). R10, 1 megohm potentiometer (tone). L1, antenna coil, three or four turns around "cold" end of the mixer grid coil form (see drawing). L2, L3, L4, L5, mixer and oscillator grid coils. See coil table. L6, 100 henry A.F. choke (A.F. transformer primary and secondary in series will do). L7, 30 henry A.F. choke, 20 m.a. IFT1, 460 k.c., iron-core, input I.F. transformer. IFT2, 460 k.c. iron core output I.F. transformer (see drawing). DPST, switch on potentiometer.

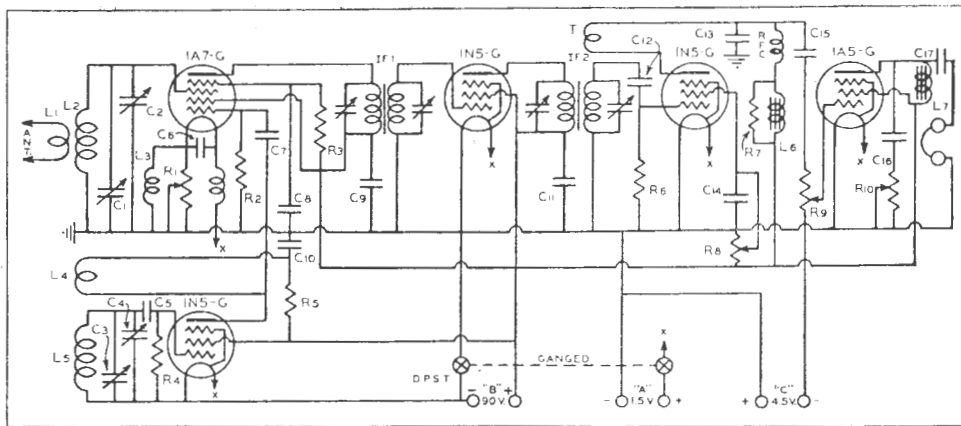

vides much better stability on the higher frequencies, around the 14 and 28 megacycle amateur bands, and is less likely to be affected by adjustments in the antenna circuit. The oscillator output is introduced into the mixer circuit through the 1A7-G grid No. 1, as shown, grid No. 2 being tied directly to the "B" plus end of the 70,000 ohm screen dropping resistor. This arrangement has proved quite effective and should not be changed if maximum performance is to be expected.

The receiver is built up on a 7" x 13" x 2" chassis and a 7" x 14" panel with steel cabinet. The various controls on the front panel, left to right, beginning with the lower row, are as follows: (1) R.f. regeneration control; (2) mixer trimmer condenser; (3) oscillator trimmer condenser; (4) detector regeneration control. Top row: (1) a.f. tone control; (2) a.f. gain control. The dial is of the micrometer type, capable of being read to an accuracy of one-tenth of one division.

The coils are of the plug-in type, five pairs being required to cover the

range from 9.5 to 200 metres. The 10 and 20 metre coils are wound on the midget one-inch isolantite, five-prong forms; the 40, 80 and 160 metre coils are wound on the standard 1½-inch forms. The coils for the three low-frequency bands carry their own band-setting condensers inside their forms; the 10 and 20 metre coils are tuned only by the dual 15-15 mmfd. tuning condenser and the 20 and 35 mmfd. trimmers. This results in a great increase in sensitivity on these bands.

Iron-core, 460 k.c. i.f. transformers and regeneration in the detector circuit boost the gain at the i.f. level. A single 1A5-G pentode a.f. stage provides plenty of volume for speaker operation on most of the stronger signals.

The actual construction of the set is not difficult but the work should be done slowly and carefully. The holes for the tube and coil sockets and the large panel cuttings are made before the panel and chassis are fastened together and before any of the parts are mounted. It is best to drill as

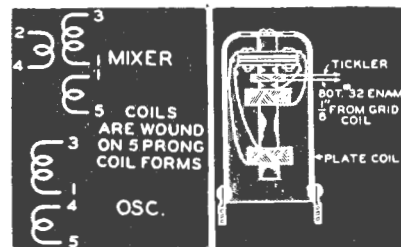

These sketches show details of the coils and of the regeneration winding for the second i.f. transformer.

many of the small holes as possible before mounting the sockets, tuning condensers, etc., in order to keep the metal "dust" off the insulation. Once embedded in the isolantite, these small cuttings are extremely difficult to remove and will certainly impair the efficiency of the set even if they do not cause an actual short-circuit.

The same precautions must be observed when soldering the various connections; use just enough of the rosin-core solder to make a good joint and keep the iron hot, clean and well-tinned. Use either the solid or stranded hook-up wire for connecting the parts together and keep all leads, especially those in the mixer and oscillator circuits, as short and direct as possible.

After the receiver has been wired, go over each circuit carefully in order to make sure that all of the connections are correct. It is always a good policy to test from each "B" plus lead to the chassis in order to determine whether any "shorts" are in existence. If everything appears to be correct,

Coil Data.					
Range	Mixer Grid	Osc. Grid	Ticklers	Wire No.	Spacing
9½-15	4*	4	3	16	1"
15-30	12*	11	6	18	1¼"
30-60	17¾**	15½	8	22	1½"
60-150	38**	31	12	26	1½"
130-270	82**	65	15	28	1½"

\* Wound on 1" forms.  
 \*\* Wound on 1½" forms with 140 mmfd. band-setting condensers inside the form. Range given is in metres. Spacing is the distance between the grid and filament ends of the coil, not the distance between turns. Wind ticklers in the same direction as grid coil and on the "cold" ends of the form. All wire enamelled copper.

the batteries may be connected as shown and the process of alignment carried out.

It is usually best to align the i.f. circuits from the signal of a 460 k.c. test oscillator, if one is available. Transmitted high frequency signals are poor for this purpose because of their rapid fading. If nothing better is on hand, the circuits may be aligned in the following manner: Place the switch in the "on" position and turn up the mixer and detector regeneration controls slightly and try to tune in some weak broadcast station operating on a frequency around 6,000 k.c. Adjust the mixer and oscillator trimmer condensers, or the band-setting condensers, for maximum signal volume.

Now, using a non-metallic screw-driver, beginning with the secondary of the output i.f. transformer adjust each i.f. trimmer in turn for maximum volume. If the volume becomes too great during the adjustment, reduce the input from the antenna to the mixer circuit; do not, under any circumstances, reduce the

volume by turning down the volume or gain controls. It is usually necessary to go over the i.f. trimmers three or four times in order to obtain an accurate alignment.

The tuning and operation of the various controls is extremely simple. The dial shown on the receiver is a new precision type, having a ratio of about 10:1 in 270 degrees and is capable of being read to an accuracy of one-tenth of one division. This is extremely useful when tuning on the crowded amateur bands and actually permits razor-edge logging of signals no matter how weak or distant they may be.

Normally, the mixer regeneration control is turned about three-fourths on while tuning. It is not necessary to adjust this control when changing bands; if the tickler coils are wound exactly as specified in the coil table, the same setting will serve no matter whether the 10 or 160 metre coils are in the sockets. Generally, the following operating technique is used: Rotate the oscillator trimmer condenser to about one-half scale, turn up

the mixer and detector regeneration controls slightly and adjust the mixer trimmer condenser for the highest noise level. Rotate the dial for a signal, keeping the detector regeneration control just below the point of oscillation for phone and just above for C.W. code reception. It may be necessary to readjust the mixer trimmer occasionally in order to obtain the proper "tracking" between the two r.f. circuits.

Having progressed thus far, most readers undoubtedly will wish to know just what results may be expected from the little receiver. At the author's home in West Virginia (which is by no means the ideal receiving location) numerous VK, K6, XU, G and other long distant stations have been heard on the 14 and 28 megacycle amateur bands. Also, the usual British, German and other popular short-wave broadcasters are received with almost local-like regularity and volume. The antennae used are a single wire 25 feet high and 50 feet long and a Johnson "Q" 10 metre beam.

## Velco AMPLIFIERS . . . . . "Tell The World"

Vealls' Sound Department can offer a complete range of equipment from small 7/8 watt up to big 30/40 watt types . . . . one that will suit your own particular needs—at the price you wish to pay. Write for complete catalogue giving full details of all Velco amplifiers—for Dances, Parties, Socials, Lodges, Bands, etc.

FOR CASH, ON EASY TERMS OR DAILY HIRE.

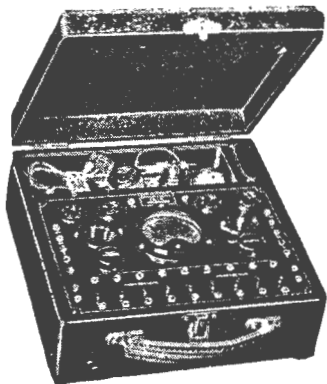
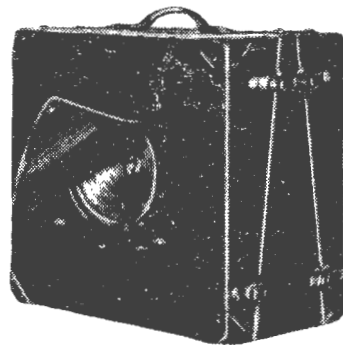

## Test Equipment

SAVES TIME, MONEY AND TROUBLE.

The complete range of Meters and Test Equipment handled by Vealls is particularly comprehensive and covers every possible type — a model for every purpose — from small pocket Voltmeters up to test equipment giv-

ing laboratory precision. Multi-meters, oscillators, valve checkers, analysers, etc., all are shown in our special Test Equipment booklet giving full directions for the use of all classes of apparatus. Write for your copy to-day.

**BIG 24-PAGE INSTRUCTION BOOK . . . . FREE.**

**FASTEST MAIL ORDER SERVICE IN AUSTRALIA.**

Vealls offer a prompt same-day despatch of all mail orders, big or little. Careful expert attention. Get the habit—try Vealls first.

**N.Z. Inquiries Not Solicited**

# VEALLS

Reg. Office, 490 Elizabeth St., Melbourne.

Letters to Box 2135, G.P.O., Melbourne.  
Branches at 168 and 243 Swanston St., Melbourne;  
299 Chapel St., Prahran; 5 Riversdale Rd., Camberwell;  
99 Puckle St., Moonee Ponds. F 3145 (6 lines).

# 13.5 Watts From 2A3's In Push-Pull

IN Radiotronics 78 a full description was given of a 13.5 watt amplifier using a pair of 2A3 valves in the output stage. Although this amplifier has proved very satisfactory, there has been a consistent demand for one providing similar power output, but with fewer valves. Such an amplifier is described in this article.

## The Output Stage.

The characteristics of Radiotron 2A3 are such that two valves, operating in push-pull Class AB1 can, under fixed bias conditions, deliver a power output of 15 watts with 2.5% total harmonic distortion.

Since the plate current varies with the input signal, from 80 mA. at no signal to 140 mA. at maximum signal for two valves, there is obvious difficulty in applying self-bias. If the cathode resistor for self-bias is designed to provide the correct bias with no signal input, the bias developed at maximum signal input will be greater than the optimum. On the other hand, if the cathode bias resistor is designed to give the optimum bias at maximum signal input, then

the bias with no signal input will be so low that the maximum plate dissipation will be exceeded. The procedure which is adopted is therefore to design the cathode bias resistor to give the same plate current at no signal input as is given under fixed bias conditions, and to adjust the value of the load resistance to give maximum power output for limited distortion without exceeding the plate dissipation at maximum input. The reduction in power output is not due to the variation in plate current over the cycle, for it is assumed that the cathode bias resistor is adequately by-passed, but to the restricted choice of operating conditions. Even

if the valves were operated at a fixed bias equal to that produced by the self-bias resistor at maximum signal, and with a load resistance as for self-bias, the performance as regards power output and distortion would be the same as for self-bias.

The maximum power output for self-bias operation of 2A3's in Class AB1 is 10 watts with 5% total harmonic distortion; for 2.5% distortion, the output is necessarily less than 10 watts.

Although the higher power output is desirable, it is usually difficult in a practical amplifier to provide a convenient source of fixed bias. However, by arranging the circuit so that

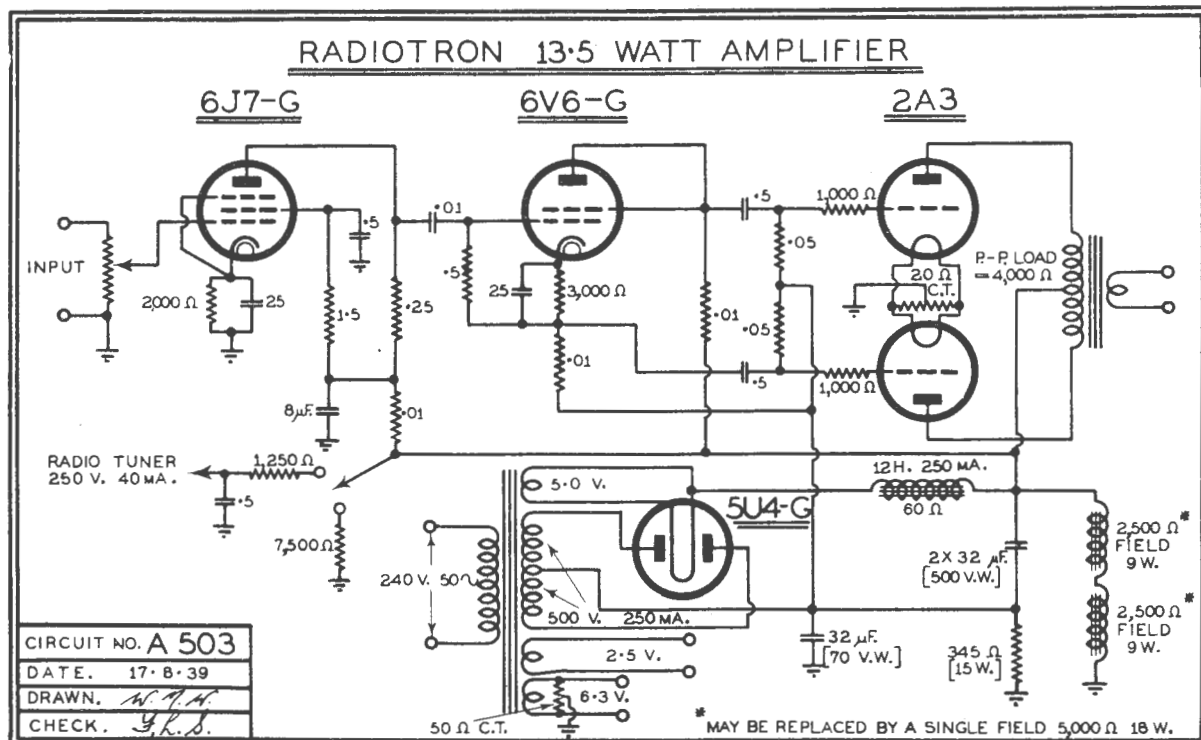

Circuit of the 13.5-watt amplifier, which uses a 6J7G first audio stage followed by a triode-connected 6V6G phase splitter, with a pair of 2A3's in the output.



output is measured across the primary of the output transformer. The power which can be taken from the secondary is, of course, dependent upon the efficiency of the transformer.

In order to reduce the number of valves, it was necessary to find a phase splitter which was capable of fully exciting the output valves without an intermediate stage of amplification.

Investigation showed that, of the valves available, type 6V6-G connected as a triode is most suitable, and may be used to provide the necessary output voltage when connected across the full 360 volts available from the power supply. Accordingly, the cathode return is made to the centre tap of the power transformer instead of to earth. The connection is unorthodox, but quite in order, and provides an additional 60 volts for the valve. Tests showed that the 6V6-G commences to draw grid current as the output of the amplifier reaches 14 watts.

In this application, the plate current of the 6V6-G is approximately 7 milliamps, and the 10,000 ohm load resistors may therefore be of 1 watt

rating. The self-bias resistor in the cathode circuit is comparable in value to the load resistor and is by-passed to avoid unnecessary degeneration. In cases where the value of the bias resistor is very small in comparison with that of the total load resistance, such a precaution is unnecessary. With the by-pass condenser in position, the gain of the stage from input to either grid is 0.78.

The remainder of the amplifier is straightforward and does not call for special comment, being generally similar to the original amplifier featured in Radiotronics 78.

The general characteristics are tabulated below and are self-explanatory. Figures 2 and 3 show, respectively, the linearity and response curves which were taken with the amplifier operating into a pair of typical 10-inch speakers. The curves can therefore be taken as indicative of the performance which can be expected under normal service conditions. It will be seen that the curves for linearity, response and distortion compare favourably with those given for the earlier amplifier.

Figure 4 shows a typical tuner which would be suitable for use with

this amplifier. The supply voltage should not exceed 250, which is 50 volts less than that delivered by the amplifier. It will therefore be necessary to include a dropping resistor of 1250 ohms in series with the tuner supply. Complete coil data for this tuner will be found in Radiotronics 92, page 173, or in Radiotron Service Lecture No. 2.

#### Characteristics:

R.M.S. Input Voltage for Full Output .....	0.34 Volt
2A3 Plate to Fil. C.T. Voltage (no sig.) .....	300 Volts
2A3 Plate to Fil. C.T. Voltage (max. sig.) .....	280 Volts
2A3 Grid Bias (no sig.) .....	-62 Volts
2A3 Grid Bias (max. sig.) .....	-72 Volts
2A3 Plate Current (2 valves no sig.) .....	80 mA.
2A3 Plate Current (max. sig.) .....	112 mA.
Total Amplifier Current (no sig.) .....	188 ma.
Total Amplifier Current (max. sig.) .....	216 mA.
Hum Level Below Full Output .....	-60 db
R.M.S. Plate to Plate Output Voltage (full output) .....	232 Volts

# SAVE MONEY!

## Buy your parts NOW from JOHN MARTIN

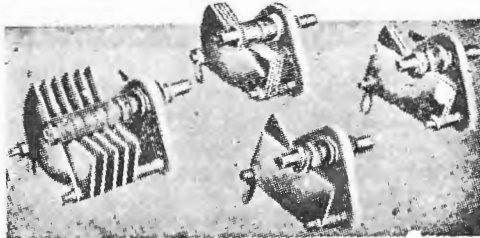

#### CERAMIC SHORTWAVE MICRO-VARIABLES.

Specify "RAYMART" for your midget condensers for the "Vulcan Shortwave 5." "RMX" insulation ensures greatest efficiency at high frequencies, ball races are electrically shorted. Complete range available.

VC15X, 15mmfd. ....	List Price 6/9
VC40X, 40mmfd. ....	7/6

As required for the sets featured in this issue.



#### VERNIER TUNING DIAL.

Specially designed for short-wave operation, this is the famous 100:1 dial, scaled 0-180 degrees.

Type SMD. List Price, 12/6

Don't delay! NOW is the time to buy your parts for the "Picnic Portable" and "Vulcan Shortwave 5," before radio prices start going up! "The Friendly Wholesale House" is able to offer you the best prices and the highest quality range of equipment obtainable—"RAYMART." Write for particulars of "Raymart" equipment, or ANYTHING radio and electrical.

# RAYMART

CRAFT A CREED

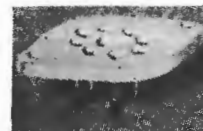

#### R.F. CHOKES.

All Wave High Inductance Choke. Type CHA. List Price ..... 5/-

FLEXIBLE COUPLERS. Insulated with high-grade Dielectric. Type FC. List Price ..... 1/9

#### AMERICAN VALVE SOCKETS.

A really first-class range of H.F. ceramic valve sockets.

Type VA4 4-pin ceramic (for 210, etc.) ..	List Price 3/-
Type VA6 6-pin ceramic (for 58, 6D6, etc.)	3/-
Type VA5 5-pin ceramic (for 46, 47, etc.) ..	3/-
Type VA7 7-pin large ceramic (for 53, 59, etc.) ..	3/-
Type VA7S 7-pin small ceramic (for 6A7, etc.) ..	3/-
Type VA8 8-pin Octal ..	4/-
Type VA50 50-watt (Air Ministry XMB262 H.F. Dielectric) ..	12/6
Type VA50 50-watt, porcelain base .....	15/-

Telegrams: "Jonmar," Sydney.

Telephone: BW 3109 (2 lines).



116-118 CLARENCE STREET, SYDNEY.

# R.C.S.

THE COIL PEOPLE.

1939 TROLITUL COIL KITS.

## THE PICNIC PORTABLE FOUR.

R.C.S. have designed especially midget coils and intermediates for this set. Small in size, but extremely efficient both in sensitivity and selectivity. Order Cat. No. K114. Retail Price, post paid . . . . £1/5/-

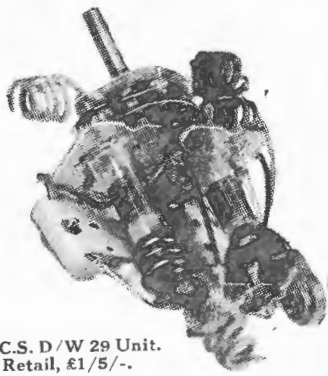

R.C.S. D/W 29 Unit.  
Retail, £1/5/-.

For the Falcon Dual-Wave Four use the R.C.S. Trolitul D/W unit illustrated and obtain the same peak performance as the original receiver. This unit, combined with our Trolitul intermediates specially wound for this set, is the reason for its high sensitivity, selectivity and extremely low noise level. Be a satisfied owner of the Falcon by using Coil Kit, Cat. No. K111. Retail Price, post paid . . . . £1/17/6

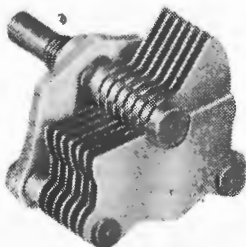

STAR MIDGET.

FOR SHORT WAVE SUPERHET.

Specify R.C.S. Midget Condensers. 15 mmfd. CV35. Price, post paid, 3/3 35mmfd., for ganging No. CV44. Price, post paid . . . . . 7/6 Iron Core Intermediates. Price, post paid . . . . . 10/6 2,500 ohm Potentiometers, No. PT49. Price, post paid . . . . . 4/6 Ask your dealer for free pamphlet describing latest R.C.S. products, or write direct to us.

R.C.S.  
Radio Pty. Ltd.

50 Glebe Street, Glebe,  
SYDNEY.

'Phone - - - - - MW 2405.

## What' New In Radio. (Continued from page 15)

not designed for use as a football, it is claimed that the new process rivetting will be unaffected even when subjected to considerable mis-use.

A further advantage is that the rivetting provides the most scientific means of completing the magnetic circuit.

Finally, all speakers with the exception of the 5" types are fitted with the isocore transformer. Larger speakers employing a 1" voice coil are fitted with the large isocore type, identical in both electro-dynamic and permanent magnet speakers. Small speakers use a new compact type of isocore, which possesses all the virtues of its famous name-sake.

One of Rola's developments has been somewhat too successful—the oval magnet series of permanent magnet reproducers. These speakers, with their extremely high efficiency and splendid frequency response, became popular immediately for use with small battery sets and 1.4-volt portables. Unfortunately, optimistic as were Rola's forecasts of the market's requirements, they were quite inadequate, and the Company announce that they can now supply no more speakers using this type in 8, 11 and 15- oz. grades until October.

### ★ Special R.C.S. Portable Coil Kit

Illustrated below is a new coil kit specially developed by R.C.S. Labora-

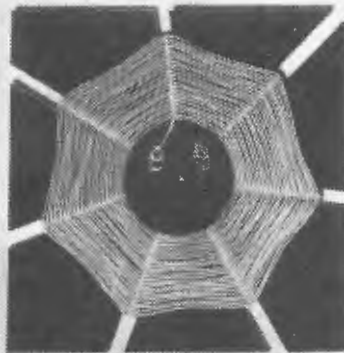
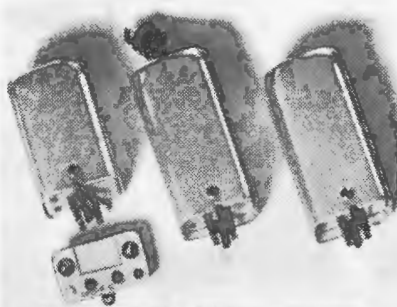

tories for 1.4-volt portable receivers not using an r.f. stage. The kit comprises a specially-wound loop aerial, ready matched at the factory to ensure perfect tracking, an oscillator coil, padder and a pair of high-gain 465 k.c. i.f. transformers.

Further details of this and other latest R.C.S. releases are available free from R.C.S. Radio Pty. Ltd., 50 Glebe St., Glebe, Sydney.



### "R.W." Kits From Veall's.

Messrs. A. J. Vealls, of Melbourne, advise that special kits of parts are available for the "Picnic Portable" and "Vulcan Shortwave Five" described in this month's issue, quotations being available free on request. Postal enquiries should be directed to Box 2135 T, G.P.O., Melbourne.

### War News On Short Waves.

(Continued from page 10)

#### France:

English news sessions are given through the stations of "Paris Mondial" at the following times, and should be heard best through the stations indicated.

Early mornings: At 5 a.m. through TPB-11, 7280kc., 41.21m., and TPA-2, 11885kc., 25.24m.

Afternoons: At 3.30 through TPA-4, 11718kc., 25.6m., and TPA-3, 11885kc., 25.24m.

Evenings: At 6.15 p.m. through TPA-3, 11885kc., 25.24m., and TPB-6, 15130kc., 19.83m. At 9 p.m., through TPA-2, 15243kc., 19.68m.

Nights: At 1.15 a.m. through TPB-11, 7280kc., 41.21m.

#### U.S.S.R.:

The enigmatical policy towards the present conflict adopted by the Kremlin makes broadcasts from Moscow of more than passing interest. The best times to listen for the English sessions from Radio Centre are:—

Mornings: During special English session commencing at 10 a.m. through RV-96, 15170kc., 19.76m.; RKL, 15083kc., 19.89m., and, possibly, through RAL, 9600, 31.25m.

Evenings: At 6.15 p.m. through RV-96, 15170kc., 19.76m., and RNE, 12000kc., 25m. Also on Sunday nights at 9 p.m., and Wednesdays at 9.30 p.m., through RNE, 1200kc., 25m.

#### United States:

During the early stages of the war many of the American shortwave stations remained on the air much beyond the period of their normal transmissions. At present, however,

(Continued on page 32)



## Learn The Morse Code.

(Continued from page 12)

Once a fair amount of confidence is gained, then is the time to enlist the help of a good operator to send copy to you. A good instructor will not try to hurry things along, but will send deliberately and slowly, gradually raising the speed as proficiency in reception improves. Above all, remember that the all-important thing is "correct spacing." A medium-speed operator with perfect spacing is a far better man than a speed merchant with a stumbling "fist."

Here is a tip that helped the writer to morse proficiency in early days.

Once the code is fairly well established in the mind, get the habit of reading shop signs and the like to yourself in morse. Again, never think of dots and dashes, but always of the "dits" and "dahs" of the morse code as it appears to the ear.

The time will come, with constant application, when this becomes second nature, and of course it is only by the acquisition of this second "sense" that the proficient telegraphy operator is made. After all, the morse symbols are but the interpretation of the letters, etc., they represent in a different form, something akin to shorthand, but much easier.

It will be obvious to all that at the present time the demand for good morse operators is a large one, and the lot of the wireless operator in any of the fighting services is an interesting one. The operator on active service has a sense of knowing that he is a valuable item in the machinery of communication, and communications are the heart of the fighting services. If an army pushes too far ahead of its main forces, and communications are poor or perhaps non-existent, then the operation is better not undertaken. An army cut off from all communication is an army lost.

The British Empire is at war, and good telegraphists are needed. Better to present oneself for any signals unit with the knowledge that all you need to be coached in is service procedure, than to expect consideration for enlistment in a signals unit without any previous morse code knowledge. Training operators from the raw means valuable time wasted.

There are many ex-radio amateurs who once had a reasonably good background of the morse code, but have lagged somewhat in recent years. A

little practice will bring back that knowledge, and such men will be welcomed in the communications units of the services.

## SIXTH DX CONTEST.

### Winner Relates His Experiences.

It gave me great pleasure indeed to know I had won the Sixth DX Contest, and I wish to thank you for the Replogle Globe.

My main DX receiver is a 1938 Radiotron Junior Communications Superhet, and as well I use a pre-selector to drag in the hard ones. I have been dx-ing for three years, and in that time have been lucky enough to receive verifications from 102 countries, all on 'phone, ranging from 5 to 90 metres. I have verifications from 42 of the 48 States of America, have heard all American States and all continents, and have veris from all VK States from VK2 to VK9, and all districts of Cuba from CO2 to CO9; total veris, 243.

I do not go in for bulk verifications, but try and log each district or State in each country, etc. Although I do a great deal of dx-ing on the Radiotron Junior, the verification with which I won the Sixth DX Contest—from FZE8, Djibuti, French Somaliland, on 17.36m.—resulted from a transmission picked up on my eight-valve Airzone radio.

My antenna at present is a two half-waves in phase, 33ft. high, and feeders 8 feet long with a lead-in 65 feet long cut for 20 metres. I have tried practically all types of antennae in the last three years excepting a rotary, and have found this to be the most satisfactory for this location. I will be erecting a rotary beam within a few weeks for 20 and 10 metres.

I have logged over 4,000 different stations in the last three years, including nearly 1,800 W's, and consider that FA3HC, VS2AL (5 watts), VP6TR, TI2LR (10m.), FZ 8, VR6AY, OK1LV, HB9J, LA1F, CN1AF, VQ8AE, VR5VV, VS7GJ, VP5PZ, PK6WF, TI4NRH, HC1FS, F'NIC, some of my best veries.

In closing, I want to say that I consider that the "Australasian Radio World" has been the means of logging and verifying a good number of those hard-to-get stations on account of the up-to-the-minute news of all stations.—J. Linehan, 181 South Terrace, Adelaide, S.A.

Quality



Products

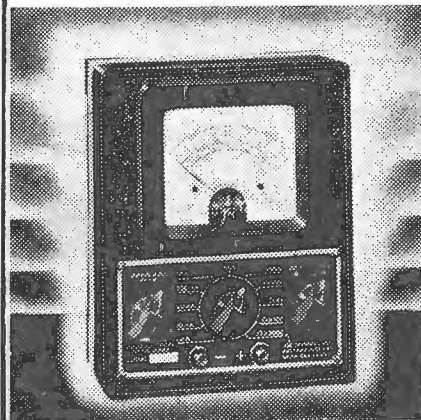

## "PALEC" MODEL "M" SERIES MULTI-RANGE METERS

A new range of multi-meters known as the "M" series is now available. These instruments will appeal strongly to all servicemen and experimenters, because of their reliability, utility, and moderate price.

A solid aluminium case, measuring 8 x 6 x 2½ inches, is used to house all four types. The basis of each instrument is the new "Patec" Model K400 rectangular moving coil meter, which gives excellent accuracy and legibility on a scale 3½ inches in length.

RANGES: Volts, 10-50-250-1000.  
Current, 1-10-50-250 M.A.'s D.C.  
Resistance in three ranges from 1 of an ohm to 1.5 megohms.

Model MCD: 1000 ohms per volt, DC only . . . . . £4/15/-

Model: MCA: 1000 ohms per volt, A.C. and D.C. volts . . . . . £6/17/-

Model MXD: 10,000 ohms per volt, D.C. only . . . . . £6/15/-

Model MXA: 10,000 ohms per volt on both A.C. and D.C. volts £8/17/-

NOTE:—The unusual provision of 10,000 ohms per volt on the A.C. section of model MXA enables the instrument to be employed in lieu of a Vacuum Tube Voltmeter over a wide range of audio applications.

## PATON ELECTRICAL PTY. LTD.

90 Victoria St., Ashfield, Sydney.  
'Phones: UA 1960-1982.

### DISTRIBUTORS:

Sydney: Leading Distributors. Melbourne: Homecrafts Ltd., 211 Swanston Street, Melbourne. Lawrence and Hanson Electric Co. Ltd. Brisbane: Lawrence and Hanson Electrical Co. Ltd. Adelaide: Newton McLaren Ltd. New Zealand: The Electrical Lamp House, Ltd., Wellington; Royds-Howard Ltd., Christchurch. Perth: Carlyle and Co.



## Half the pleasure

of listening is lost when  
valves are too weak to  
drive out Tone Bogy

RE-VALVE WITH



Sealed for your protection

Specify . . . RADIOTRONS  
for the "Picnic Portable"  
and "Vulcan Shortwaver"  
described in this issue.

### War News On Short Waves. (Continued from page 30)

as rigid censorship makes news more difficult to obtain, they have resumed normal schedules, and, for the most part, limit their news broadcasts to regular scheduled sessions. Through the stations listed below it is possible to obtain a complete review of latest developments.

**Mornings:** At 6.55 a.m. through WGE0, 9530kc., 31.48m. At 8.45 (commentary by Lowell Thomas), through WPIT, 11870kc., 25.26m.

**Afternoons:** At 1 p.m. through KGEI, 15330kc., 19.56m.

**Evenings:** At 10 p.m. through WCBX, 17830kc., 16.81m. At 10.30 p.m. through KGEI, 9530kc., 31.48m.

N.B. In addition to the above regular news sessions, it is more than probable that special broadcasts will be arranged by both the N.B.C. and C.B.S. organisations. Listeners should tune for these through the following additional transmitters:—

**Morning and early afternoon:** WBOS, 9570kc., 31.35m.; WCAB, 9590 kc., 31.28m.; WRCA, 9670kc., 31.01m.; and WNBI 17780kc., 16.87m.

**Late Afternoons:** KGEI, 6190kc., 48.47m.; WLWO, 6060kc., 49.5m.; WPIT, 6140kc., 48.86m.; and W2XE, 11830kc., 25.36m.

**Evenings:** WNBI, 17780kc., 16.87m.; WGEA, 15330kc., 19.56m.; and WLWO, 6060kc., 39.5m.

#### Poland:

At the time of writing, the Polish shortwave stations at Warsaw were still on the air, but whether this will still be the case by the date of publication is another matter. An extraordinary feature of the war has been the German tactics of transmitting propagandist material over channels allocated to Polish broadcasters, both medium and shortwave; and listeners will find it difficult to determine whether stations announcing as "Radio Polskie" and "This is Warsaw calling" are really what they purport to be. Should the Polish stations continue on the air they are best heard as follows:—

**Mornings:** From 5 to 8 a.m. through SP-48, 6140kc., 48.86m.; and SP-31, on approximately 31.35m. From 9 a.m. till noon, through SP-19, 15110 kc., 19.85m.

#### Other Broadcasts:

As every country in the world is vitally interested in the outcome of the present conflict, it is only natural that they present latest news concerning it to their listeners. English sessions of these stations are:—

**Italy:** At 7.30 a.m. and 9.30 a.m., through stations 2RO-4, 11810kc., 25.4m., and 2RO-3, 9635kc., 31.13m.

**Malaya:** At 10 p.m. (ZHP, Singapore, 9690kc., 30.96m.).

**China:** At 8 a.m. and 9.20 p.m. through XGOY, 11900kc., 25.2m. (May be altering frequency to 9500 kc., 31.58m.).

**Japan:** At 6.05 a.m. (JZK, 15160kc., 19.79m., and JZJ, 11800kc., 25.4m.). At 10.30 p.m. (JZK, 15160kc., 19.79m.).

**Philippines:** At 10.50 p.m. through KZRM, 9570kc., 31.35m.

**Yugo-Slavia:** At approximately 7.15 a.m., through YUC, 9510kc., 31.56m.

#### A Warning.

In conclusion, a warning to those readers not well versed in shortwave reception. At times conditions on the shortwave bands vary a good deal from day to day, and it is quite possible that the transmissions referred to above may sometimes be inaudible; however, only stations heard at good strength have been listed, and on most occasions good reception should be possible.

#### Latest Loggings On Shortwave.

I have received my Club badge and certificate and must say I am very pleased with both. My set is an ordinary dual-wave type, and I am always trying to improve the reception.

Reception here is wonderful. I have been in different parts of Australia at different times of the year, and have not yet struck a locality to beat it. Even in summer the receiver is very seldom quiet and you can nearly always count on a good programme after 9 p.m. from anywhere on the dial as I do not get much trouble from static.

I have not been doing much DX lately as I am studying a radio engineering course and now devote much of my spare time to it, but nevertheless I am very interested in anything concerned with wireless. Am also a constant subscriber to the "Radio World," and only wish it was a weekly instead of a monthly.

The following stations have been received here, beside many VK's:— HAT4, Budapest, 32.88m., HS8PJ, Bangkok, 32.09m., TFK, HJ1ABE, 31.58m., GSB, Daventry, 31.55m., DJN, 31.45m., VPD2, Suva, 31.45m., DJA, Zeesen, 31.38m., KZRM, Manila, 31.35m., W1XK, 31.35m., CQN, 31.30m., W1XAZ, 31.30m., HP5J, Panama, 31.28m., HBL, Geneva, 31.27m., RNE, Moscow, 31.25m., LRX, 31.0m., and LSX, 28.98m., Buenos Aires, JVN, Tokyo, 28.14m., SM5SX, Sweden, 25.63m., TPA4, Paris, TPA2, Paris, PCJ Holland, 19.71m.—H. Holland (A.W.512DX), Wyandra; Q.

# Shortwave Review

CONDUCTED BY  
ALAN H. GRAHAM

## War News Broadcasts.

During the fateful days which preceded the outbreak of war on September 3, the possibilities of short-wave transmissions for the dissemination of up-to-the-minute news were fully exploited by overseas stations, especially the American transmitted programmed by the N.B.C. and C.B.S. systems. Both these organisations maintained a 24-hour service, including both relays of important speeches (by the King, Chamberlain, Roosevelt and Hitler) and frequent broadcasts from special representatives in London, Paris, Berlin and Warsaw. These transmissions were heard exceptionally well in this country through a number of the American shortwave stations on all wavebands from 11 to 49 metres.

## B.B.C. Transmissions.

As a result of the war the B.B.C. shortwave transmissions have been completely reorganised. Additional transmitters have been placed in use; hours of transmission have been altered, and all previously arranged programmes have been suspended. The B.B.C. Overseas Service is now directed to the whole world, and war bulletins and news summaries are now given in a variety of languages and at frequent intervals.

In addition the B.B.C. Reuters' news bulletins have been made available for re-broadcasting in Australia.

## General Reception Conditions.

During the past month conditions have been very satisfactory. Daylight reception has fallen off a trifle in the period around mid-day, but morning and late afternoon signals are still excellent on 19, 25 and 31 metres. The feature of night reception has been the vast improvement on the higher frequencies, with excellent signals available on 13, 16 and 19 metres. 49 metres is still very good during the late afternoons, and at night. On the ultra high-frequency bands conditions, although still very erratic, seem to be definitely improving.

The attention of listeners is directed to the new 41-metre broadcast band, which became available for European stations on September 1 (although several stations used it before this date). Already the B.B.C. have placed GSW in use.

## Many New Stations Logged.

In the list of stations logged during

**War news through shortwave transmitters ★ Amateurs  
ordered off the air ★ Ultra high-frequency notes ★  
Full list of month's loggings.**

the past month readers will notice many new transmitters. Attention is directed to the following:—MTCY, Manchukuo, now on 19 and 25 metres; YUA, Yugo-Slavia, on 31 metres; the new Paris Mondial transmitter on 30.9 metres; KGEI (ex-W6XBE), on 48 metres; LRA, on 16 metres; DXB, Berlin, on 30.93 metres; Radio Luxembourg, on 25 metres; and a number of other interesting loggings.

★

## Latest Overseas Changes And Schedules. Switzerland.

No doubt readers have been wonder-

ing why nothing has been heard of the new Swiss shortwave transmitters at Schwarzenburg, which were scheduled to come on the air on August 1. News now comes to hand that the station was badly damaged by fire, which destroyed a considerable portion of the building. Orders have been placed for new equipment, and it is expected that the service will start early next year.

Owing to the outbreak of hostilities the League of Nations transmitters, HBO and HBJ, have suspended indefinitely their programmes for Australia and New Zealand, heard here on Monday afternoons.

## ALL-WAVE ALL-WORLD DX CLUB

### Application for Membership



The Secretary,  
All-Wave All-World DX Club,  
214 George Street,  
Sydney, N.S.W.  
Dear Sir,

I am very interested in dxing, and am keen to join your Club.  
The details you require are given below:

Name.....

Address.....

[Please print  
both plainly.]

My set is a.....

[Give make or type,  
number of valves,  
and state whether  
battery or mains  
operated.]

I enclose herewith the Life Membership fee of 3/6 [Postal Notes or Money Order], for which I will receive, post free, a Club badge and a Membership Certificate showing my Official Club Number.

(Signed).....

[Note: Readers who do not want to mutilate their copies of the "Radio World" by cutting out this form can write out the details required.]

## Sweden.

The Swedish national shortwave stations do not verify reports on their transmissions, merely acknowledging receipt of information forwarded.

Latest schedules for these stations:  
**SBO**, 6065kc., 49.46m.: 7.15 to 8 a.m. daily.

**SBU**, 9535kc., 31.46m.: 7.15 to 8 a.m. daily.

**SBP**, 11705kc., 25.63m.: 4 to 7.15 a.m. daily; also 11 a.m.-noon on Thursday and Sunday.

**SBT**, 15155kc., 19.8m.: 4 to 7.15 a.m. daily; also 11 a.m.-noon on Thursday and Sunday.

## Portugal.

The following is the complete schedule for the Portuguese transmitters:—

**CSW-4**, 15215kc., 19.71m.: 3 to 4.30 a.m. and 10 p.m.-midnight.

**CSW-6**, 11040kc., 27.17m.: 4.35 to 7.50 a.m.

**CSW-7**, 9740kc., 30.80m.: 9.13 a.m. to mid-day.

**CSW-2**, 7260kc., 41.32m.: 8.05 to 9 a.m.

## Philippine Islands.

No little confusion has been caused of late by the appearance of quite a number of new stations located in Manila, several of which seem to be operating on identical frequencies. The following should help to clarify matters.

Operating on 6140kc., 48.86m., we have a station which uses no less than three calls—**KZRM**, "Radio Manila"; **KZEG**, "The Sunshine Station"; and **KZRF**, "Radio Philippino."

**KZIB** now operates simultaneously on 9500kc., 31.58m. and 6040kc., 49.67m.

## United States.

The following are changes noted in the call-signs of well-known American stations: **W8XK** to **WPIT**, **W1XK** to **WBOS**, **W2XAF** to **WGEO**, **W3XL** to **WNBI**, **W2XAD** to **WGEA**, **W6XBE** to **KGEL**, **W8XAL** to **WLWO**, **W3XAU** to **WCAB**, **W3XAL** to **WRCA**.

At the present time **W1XAL** and **W2XE** still use their old calls.

Latest schedules for **W1XAL**/**W1XAR** are:—

**W1XAL**, 21460kc., 13.98m.: 1-2.30 a.m. (Mondays); 11790kc., 25.45m.: 6.15-9.30 a.m. (Tuesday-Saturday); and 5-9 a.m. (Sundays); 6040kc. 49.65m.: 5.30-9.50 a.m. (Mondays) and 10 a.m.-noon (Tuesday-Saturday).

**W1XAR**, 15130kc., 19.83m.: 1-2.30 a.m. (Mondays); 6.15-9.30 a.m. (Tuesday-Saturday); and 5-9 a.m. (Sundays). 11730kc., 25.58m.: 10 a.m.-2 p.m. (Tuesday-Saturday).

## Hungary.

Information regarding a new Euro-

pean station is to hand from an English reader, Mr. Cuthbert. Station is **HAAQ-2**, operating on 11850kc., 25.32m., with a power of 210 watts. Schedule is 2-3 a.m.; and **QRA** "Radiolabor," Budapest.

From another source it is learned that **HAAQ-2** will also test on 9625 kc., 31.18m., and 21680kc., 13.84m. (QSA-5).

## Japan.

Complete list of calls and frequencies for the international stations of the Nippon Hoso Kyokai, as at January 1, 1939:—

49 metre band: **JLR**, 6015kc.; **JZH**, 6095kc.; and **JLT**, 6190kc.

31 metre band: **JLG-2**, 9505kc.; **JLU-2**, 9525kc.; **JZI**, 9535kc.; **JLP**, 9605kc.; **JLT-2**, 9645kc.; **JLS**, 9655kc.; **JVW-2**, 9675kc.

25 metre band: **JLG-3**, 11705kc.; **JVW-3**, 11725kc.; **JZI**, 11800kc.

19 metre band: **JLG-4**, 15105kc.; **JLR-2**, 15115kc.; **JLU-3**, 15135kc.; **JZK**, 15160kc.; **JLT-3**, 15225kc.; **JVW-4**, 15235kc.; **JLP-2**, 15325kc.

16 metre band: **JZL**, 17785kc.; **JLU-4**, 17795kc.; **JVW-5**, 17825kc.; **JLP-3**, 17835kc.; **JLS-2**, 17845kc.

13 metre band: **JZM**, 21520kc.; **JLP-4**, 21560kc.; **JLT-4**, 21610kc.; and **JLS-3**, 21620kc. (QSA-5).

## Germany.

A new series of DX stations are announced (power is 50kw.):—**DXA**, 6160kc., 48.71m.; **DXB**, 9610kc., 30.93m.; **DXC**, 17825kc., 16.82m.; **DXD**, 21660kc., 13.85m.; **DXE**, 21720 kc., 13.81m.; **DXF**, 21690kc., 13.83m.; and **DXG**, 6190kc., 48.47m. (QSA-5).



## Ultra-High-Frequency Notes.

### Conditions Improving: New Stations On 11 Metres.

Although conditions on the U.H.F. bands have remained very erratic, on the whole there has been a tendency towards improvement. The feature of the month's reception has been the logging of a new station on the 11-metre band. This is **W9XPD**, St. Louis, which has shifted from 9.49 metres to approximately 11.59 metres (just above **W8XNU** and **W6XKG**). Signals from **W9XPD** have seldom reached more than R4-5, but have been heard fairly regularly. Listeners should be careful not to confuse **W9XPD** with **W8XNU**, as both these stations carry the same N.B.C. programme.

A remarkable falling off in reception of **W6XKG** has been noted. This station has not been heard in this locality since the middle of August, although at that time it was heard till as late as 7 p.m.

The best 11-metre station is now

**W8XNU**, as **W4XA** has become very erratic.

### 11-Metre Loggings.

**W4XA**, 26150kc., 11.47m.: Now very erratic; seldom at good strength (Ratray).

**W8XNU**, 25950kc., 11.56m.: Best station on this band; heard almost every day; often at good speaker strength.

**W6XKG**, 25950kc., 11.56m.: Not heard since mid-August (Ratray).

**W9XPD**, 25890kc., 11.59m. (approx): Fairly regular, though seldom very loud.



## Amateur Bands Review

### Amateurs Ordered Off Air.

One effect of the outbreak of war has been the ordering off the air of experimental transmitters in many countries. This has been particularly noticeable on the 20-metre band, where favourable conditions at the end of August saw many good loggings of European stations. At the present time reception on this band is now limited to American and Asiatic stations.

### 20-Metre Calls Heard.

The stations listed below were, for the most part, logged during the last week of August.

### Africa.

South Africa: **ZS-2AH**, **2AZ**, **5Q**, **5DA**, **6EB**, **6AJ**, **6DY**, **6DJ**.

Southern Rhodesia: **ZE1-JN**.

Tangier International Zone: **EK-1AF**.

Madagascar: **FB8-AB**, **AH**.

Mauritius: **VQ8-JM**.

### Europe.

Leichtenstein: **HB1CE** (QSL via **HB9CE**).

Switzerland: **HB-9DO**.

Denmark: **OZ-5G**, **5BW**.

Germany: **D-4KPJ**.

Gibraltar: **ZB2-B**.

Spain: **EA-7BA**.

Sweden: **SM-5KP**.

Northern Ireland: **GI-2CC**, **5SJ**, **5QX**, **8TS**.

Portugal: **CT-1PM**, **1QG**.

Norway: **LA-6N**.

Holland: **PA-ODR**, **OFH**, **OWF**, **OBE**, **OMZ**.

Belgium: **ON-4US**, **4TO**, **4VG**.

Wales: **GW-2UL**, **3KY**, **5KJ**.

Scotland: **GM-2UU**, **6WD**, **8MN**.

France: **F-3QT**, **3MN**, **3CS**, **3DY**, **8NT**, **8QD**, **8BP**, **8DC**, **8XT**, **8KI**, **8UE**, **8VP**, **8PQ**, **8MX**.

England: **G-2MF**, **2TK**, **2PU**, **2MQ**, **2OC**, **2XV**, **2DH**, **3AH**, **3GQ**, **3DO**, **1RH**, **4FL**, **5LU**, **5BJ**, **5PP**, **6BW**, **6VX**, **6WX**, **6GO**, **6TD**, **6WT**, **6KL**, **8BK**, **8MA**, **8UJ**, **8KD**, **8SB**.

South America.

Peru: **OA-4AI**, **4AW**.

Venezuela: YV- 1AP, 1AQ, 4AE, 5ABH.

Ecuador: HC- 2CC; HK- 2CO.

Chile: CE- 1AR, 1AS, 3AT.

Brazil: PY- 7AI, 8AB.

Argentine: LU- 2DG, 4BC, 8AY.

Central America and West Indies.

Costa Rica: TI-2RC.

Guatemala: TG-5JG.

Canal Zone: K5-AM.

Dominican Republic: HI-5X.

Cuba: CO- 2WM, 3EE, 5EO, 7CX, 8JK.

Haiti: HH-5PA.

Porto Rico: K4- FAY, FKC.

Northern America.

Canada: VE- 1DQ, 2QM, 3PT, 4BT, 4GE, 5EF, 5AHU, 5AAR, 5ACN, 5OT, 5RV, 9AT.

Mexico: XE- 1FF, 1BG, 1GK, 1CX, 1GE, 1FY, 2HB, 2CA.

Alaska: K7-GSC.

Asia.

Ceylon: VS7-RA.

Burma: XZ-2TP.

French India: FN-1C.

India: VU-2XA.

Korea: J8-CI.

Hong Kong: VS6-AA.

Malaya: VS- 1AE, 2AD, 2AL.

Japan: J- 5CW, 6GU, 7CB.

China: XU- 5CS, 5HI, 8ZA, 8RJ, 8NA, 8KM.

Philippines: KA- 1CS, 1JM, 1HS, 1FH, 1LB, 1ME, 1JP, 1BB, 1LV, 1MF, 1MM, 1ER, 3KK, 4LH, 7EF.

Dutch East Indies: PK- 1XZ, 1MF, 1TM, 1GL, 1MJ, 1DG, 2LZ, 2AY, 3ST, 3WI, 4KS, 4MM, 4JD, 4WS.

Pacific.

Dutch New Guinea PK-6XX.

New Guinea: VK9- DW, VG.

Guam: KB6-OCL.

Wake Is.: KC6-IDB.

10-Metre Band Shows Signs of Improvement.

Despite the fact that reception continues to vary greatly from day to day, the 10-metre band has shown definite signs of improvement. On a number of mornings really excellent signals were heard from West Coast W's and once or twice a Canadian was heard.

Calls Heard: 10 Metres.

Canada: VE- 3KE, 5AEZ.

Costa Rica: TI-2RC.

Hawaii: K6- OQM, PLZ.

New Zealand: ZL- 1GI, 2FY, 2BT.

United States: W- 1KQN, 2GWI (marine portable, near Wake Is.), 2JCY, 2BUR, 2MFS, 2AOH, 2LZ, 3HFW, 3DOU, 4FGF, 4NT, 4EZK, 4FLS, 4USA (Mid-South Fair at Memphis), 5GKZ, 5GFN, 5FOK, 5HQC, 5HQQ, 5HLO, 6FZC, 6LWN, 6PIB, 6NHK, 6RRN, 6LTH, 6AGG, 6QNT, 6QQD, 7NKF, 6KYT, 6POZ, 6QGI, 6MRF, 6PQQ, 6NMW, 6BUK, 6PNO, 6PMB, 8NED, 8OLX, 9NMD, 9BHP (marine portable).

## Letters From Readers.

AW509DX, Hurstville, N.S.W.:—Many thanks for your letter, with information regarding KGE1. Hope to hear from you again in the near future.

AW522DX, Mount Hawthorn, W.A.:—Thanks for list of amateur

## DX Club Requirements.

All-Wave All-World DX Club members are advised that the following DX requirements are obtainable from Club headquarters, 214 George Street, Sydney.

REPORT FORMS. — Save time and make sure of supplying all the information required by using these official forms, which identify you with an established DX organisation.

Price . . . 1/6 for 50, post free.

NOTEPAPER.—Headed Club notepaper for members' correspondence is also available. Price, 1/6 for 50 sheets, post free.

DX CLUB STICKERS.—Enlarged two-colour replicas of the Club badge, in the form of gummed stickers, designed for attaching to envelopes, QSL cards, etc. Price, 5 dozen for 1/6, post free.

DX CLUB LOG SHEETS.—Designed by the Shortwave Editor, these headed and ruled log sheets are indispensable to dxers who wish to keep a simply-prepared and accurate list of loggings. Price, 3 dozen for 1/6, post free.

loggings on 20 metres; also for complete data on Manila stations now on the air. Regarding the mystery station you mention—details are rather vague, but might be DZH, 14460kc., 20.75m., with programme for South America.

AW380DX, Koongal, Rockhampton, Q'ld.:—Glad to hear you like the new layout of the S.W. notes. You will find details of KZRF elsewhere.

AW418DX, Manjimup, W.A.:—Glad to hear from you regarding the non QSL-ing amateurs section. This feature will have to be suspended temporarily, while the considerable amount of information forwarded by readers is checked. Revised list in November issue. Write again.

Mr. M. Rattray, Invercargill, N.Z.:—Have answered your query re antenna by mail. Drop us a line occasionally regarding your results on the U.H.F. bands.

Mr. A. W. Eddy (ZL3GP), Irwell, via Christchurch, N.Z.:—Very many

thanks indeed for the fine list of QRA's for the S.W.L. Exchange section.

Mr. C. Cuthbert, Margate, England:—Thanks for letter and card, O.M. Will certainly include your name in list of S.W.L.'s who QSL 100%. Thanks for information regarding European stations, CSW-8, HAAQ-2 and Radio Luxembourg. Nice work with those varies from OFD, LLG, PSE, TFJ, SP-48, CCM and PRA-8.

Mr. F. Lendzioszek, Easthampton, U.S.A. (AW502DX):—Will be pleased to list you in S.W.L. Exchange section. Thanks a lot for nice remarks re "Radio World."

Mr. Lendzioszek forwards an interesting report of reception in his locality, which is reproduced below:—

HH3W, Haiti, is heard on 9645kc., 31.1m., from 10 a.m.-12.05 p.m.

FG8AH, Guadeloupe, is heard regularly on 7435kc., 40.3m. Callsign is seldom used, station usually identifying as "Radio Guadeloupe." American and French numbers are played; occasional announcements in English. QRA is Box 225, Pointe-a-Pitre, Guadeloupe.

HP5F, Panama, is heard at times on 6140kc., 48.83m.

Reports to the Norwegian stations should be addressed to Norsk Rikskringkasting, Stortingsgaten 28, Oslo.

LYR, Lithuania, on 9315kc., 32.2m., has forwarded the following schedule: Daily, 3.30-5.25 a.m. and 4.30-5.15 p.m.

Loggings on the amateur bands include: TG, K4, LU, G, F, and CE on 10 metres, and YV, HH, HK, KA, K6, CO, PY, SP, PA, CT, HI, ON, G, GM, GI, EA and VK on 20 metres.

(N.B. All above times are Australian E.S.T. Mr. Lendzioszek will be pleased to hear from readers in this country, and will answer all letters and cards. Full QRA is: 40 Emerald Place, Easthampton, Mass., U.S.A.).

Readers are requested to address all letters in reference to the S.W. and B.C.B. DX sections to the DX Editor, Alan H. Graham, 258 Lower Plenty Rd., Rosanna N22, Victoria.

★

## This Month's Loggings.

### SOUTH AMERICA.

Peru.

OAX4J, 9340kc., 32.12m., Lima: Still heard in the afternoons; best on Sundays till 4 p.m. (Anderson).

OAX4Z, 6077kc., 49.37m., Lima: Reported from the West as being heard occasionally during the mornings. (Anderson).

OAX4T, 9566kc., 31.38m., Lima: Weaker now, but still heard opening at 11 p.m.

OAX5C, 93.50kc., 31.95m., Ica.: Heard on Sunday afternoons.

## Argentine.

**LRX**, 9660kc., 31.06m., Buenos Aires: Not very loud at present, but still audible in early mornings and afternoons.

**LRA**, 17825kc., 16.82m., Buenos Aires: This station reported last month by Mr. Johns as "Radio Splendid." Heard in early mornings till 9 a.m.

## Ecuador.

**HCJB**, 12460kc., 24.08m., Quito: Still heard in special session for Australasia from 10.30 p.m. (Chapman).

## Brazil.

**PRA-8**, 6015kc., 49.87m., Pernambuco: Weak signal when opening at 7 a.m. just above **DJC**.

## Paraguay.

**ZP-14**, 11720kc., 25.6m., Villarica: Weak and erratic; may possibly be heard on opening at 8.25 a.m. Does not transmit every day.

## Venezuela.

**YV5RM**, 5010kc., 59.88m., Caracas: Reported from the West as heard around 9 a.m., E.S.T. (Anderson).

**YV5RN**, 5040kc., 59.52m., Caracas: Heard at same time as **YV5RM**. (Anderson).

**YV4RQ**, 5020kc., 59.76m., Puerto Cabello: Heard at same time as other YV stations, but very weak. (Anderson).

## Uruguay.

**CXA-2**, 9570kc., 31.35m., Montevideo: Heard in early morning.

**CXA-8**, 9640kc., 31.12m., Colonia: Occasionally very weak around 8 a.m., also at better strength on Sunday afternoons till as late as 4 p.m.

**CXA-6**, 9620kc., 31.19m., Montevideo: Fair around 7 a.m.

## Chile.

**CB-1170**, 11700kc., 25.64m., Santiago: Heard once or twice at 8 a.m. and also just before closing at 2 p.m.

**CB-1180**, 11970kc., 25.06m., Santiago: Also heard fairly well till close at 2 p.m.

**CD-1190**, 11910kc., 25.19m., Valdivia: Also heard in the early afternoons.

**CB-970**, 9710kc., 30.91m., Valparaiso: Heard in the mornings between 8 and 9 a.m.

## CENTRAL AMERICA AND WEST INDIES.

### Guatemala.

**TGWA**, 9685kc., 30.96m., Guatemala City: Strong signals till 6.30 p.m. on alternate Sundays (special DX programme). Also on week-days till around 2.45 p.m. (Anderson).

**TGWA**, 15170kc., 19.77m., same location: Reported as on the air with the 9685kc., transmitter till late on Sunday afternoons. (Anderson).

**TGWB**, 6490kc., 46.2m., same location: Same programme as **TGWA** on Sunday afternoons. (Anderson).

**TG-2**, 6190kc., 48.47m., same location: On Sunday afternoons only, till about 6 p.m. (Anderson).

**TGQA**, 6400kc., 46.88m., Quezaltenango: Heard weakly on Sunday afternoons.

## Costa Rica.

**TILS**, 6165kc., 48.66m., San Jose: Still at good strength opening at 10 p.m. Also heard on several occasions around 5 p.m. at excellent strength.

**TIPG**, 9620kc., 31.19m., San Jose: Good signal opening at 10 p.m.; also heard at 4 p.m. in special broadcast during August. (Anderson, Chapman).

## Mexico.

**XEWW**, 9500kc., 31.58m., Mexico City: Most consistent of Latin-American stations. Good strength every afternoon. (Anderson).

## Dominican Republic.

**HIIS**, 6420kc., 46.73m., Santiago: Reported from the West between 9 and 10 a.m., E.S.T. (Anderson).

**HIN**, 6243kc., 48.0m., Ciudad Trujillo: Heard in West at same time as **HIIS**. Both these stations are seldom if ever reported in Australia. (Anderson).

## Panama.

**HP5J**, 9590kc., 31.28m., Panama City: Good signal at night.

**HP5A**, 11700kc., 25.64m., Panama City: Strong signal at 10 p.m. (Anderson)

**HP5K**, 6005kc., 49.95m., Colon: Weakish signal, opening at 10 p.m. with "Merry Widow" waltz.

## Cuba.

**COCM**, 9850kc., 30.46m., Habana: Fair signal early morning, afternoon and better at night. (Anderson).

**COCH**, 9437kc., 31.8m., Habana: Fair at night; also reported in early morning in the West. (Pepin, Anderson).

**COGF**, 11800kc., 25.42m., Matanzas: Heard weakly in West at 9 a.m., E.S.T. (Anderson).

**COCX**, 11735kc., 25.57m., Habana: As **COGF**. (Anderson).

**COBC**, 9985kc., 30.03m., Habana: Good signal at night from about 10 p.m.; also in early morning in West. (Anderson).

**COBX**, 9200kc., 32.61m., Habana: Heard in West around 10 a.m., E.S.T. (Anderson).

**COCA**, 9100kc., 32.91m., Habana: As **COBX**. (Anderson).

**COBZ**, 9028kc., 33.24m., Habana: Opens at 10.45 p.m. with weak signal; also in mornings in West. (Anderson, Pepin).

**COCQ**, Habana: Up to old tricks of altering frequency almost from day to day in the vicinity of 34m. Opens at 10 p.m. with good signal; also heard during afternoons. (Anderson).

**COJK**, 8665kc., 34.46m., Camaguey: From 10 p.m.; also heard in mornings in West. (Anderson).

**COCW**, 6324kc., 47.4m., Habana: Heard fairly well in West; at 10 a.m. and 9.55 p.m., E.S.T. (Anderson).

**COCO**, 6010kc., 49.92m., Habana: Heard in morning in West. (Anderson).

## NORTH AMERICA.

### United States.

**WPIT** (was **W8XK**), 21540kc., 13.93m., Pittsburgh: Now becoming audible around 10 p.m. as 13-metre band improves.

**WNBI** (was **W3XL**), 17780kc., 16.87m., Bound Brook: Heard very well during early weeks of September with special news broadcasts; best around mid-day and 10 p.m.

**W2XE**, 17830kc., 16.81m., New York: Splendid signals at night during special transmissions in connection with war.

**WPIT**, 15210kc., 19.72m., Pittsburgh: Heard at fair strength around midnight.

**WCAB** (was **W3XAU**), 15270kc., 19.65m., Philadelphia: Heard once early in September at 3.30 p.m., relaying special C.B.S. news programme simultaneously with **W2XE** on 25 metres.

**WGEA** (was **W2XAD**), 15330kc., 19.57m., Schenectady: Excellent signal around 10 p.m. with N.B.C. news broadcasts. (Pepin).

**KGEI** (was **W6XBE**), 15330kc., 19.57m., San Francisco: Heard best after mid-day till 2 p.m.

**WPIT**, 11870kc., 25.27m., Pittsburgh: Heard at varying strength from 8 a.m. till early afternoon.

**W2XE**, 11830kc., 25.36m., New York: Heard exceptionally well with special news programme. Fairly strong from 8 a.m. and then put in a terrific signal in the afternoons, remaining on air at times till 6.30 p.m. (Chapman).

**W1XAL**, 11790kc., 25.45m., Boston: Heard once or twice late in August, but not logged recently.

**KGEI**, 9530kc., 31.48m., San Francisco: Excellent signal from 10 p.m.; afternoon session now on 48 metres. (Pepin, AW522DX, AW509-DX).

**WGEO** (was **W2XAF**), 9530kc., 31.48m., Schenectady: Heard fairly strongly from 8 a.m. (Pepin).

**WGEA**, 9550kc., 31.41m., Schenectady: Reported heard from 8 a.m., E.S.T. in West. (Pepin).

**WBOS** (was **W1XK**), 9570kc., 31.35m., Boston: Heard just before closing at 3 p.m.; fair signal.

**WRCA** (was **W3XAL**), 9670kc., 31.03m., Bound Brook: Special news broadcasts during afternoon and early evening preceding outbreak of war. Hitler's Reichstag speech at good strength through this station. (Pepin, Anderson).

**WCAB**, 9590kc., 31.28m., Philadelphia: Also on air with special broad-

casts till around 6 p.m.; strong signal.  
WPIT, 6140kc., 48.86m., Pittsburgh: Heard at very good strength with extended hours of transmission (till after 5.30 p.m.).

KGEL, 6190kc., 48.47m., San Francisco: Afternoon session from 3 till 6 p.m. changed to this new frequency on September 4.

WLWO (was W8XAL), 6060kc., 49.5m., Cincinnati: Heard well around 4 p.m. and also later at 9 p.m. (Chapman).

KKZ, 13690kc., 21.91m., Bolinas, Calif.: Special relays on Sunday afternoons.

#### AFRICA.

##### Kenya.

VQ7LO, 6082kc., 49.31m., Nairobi: Regular strong signal; best around 4 a.m.

##### Canary Is.

EAJ-43, 10370kc., 28.93m., Teneriffe: Fairly strong signal in early morning, at 6 a.m., and again at 7.30 a.m.

##### South Africa.

ZRH, 6007kc., 49.94m., Robert Heights: Fair early morning signal, after 6 a.m.

ZRK, 6097kc., 49.2m., Johannesburg: Also fairly good in early morning till 7 a.m.

##### Mozambique.

CR7AA, 6137kc., 48.88m., Lourenco Marques: Still heard around 7 a.m., but now much weaker.

#### OCEANIA.

##### New Caledonia.

FK8AA, 6122kc., 49m., Noumea: Opens with "Marseillaise" at 5.30 p.m.

##### Fiji.

VPD-2, 9538kc., 31.38m., Suva: Very loud from 9 p.m.

##### Hawaii.

KQH, 14290kc., 20.11m., Kahuku: Special Sunday afternoon relays to U.S.A.

#### THE EAST.

##### Philippine Is.

KZRH, 6110kc., 49.1m., Manila, "The Voice of the Philippines": Heard nightly at fair strength.

KZIB, 9500kc., 31.58m., Manila: Very strong at night. (Pepin, AW-522DX).

KZIB, 6040kc., 49.65m., Manila: On the air simultaneously with transmitter on 9500kc. Very strong. A listener reports having heard the call-letters KZRD, "The Pioneer Station," used on this frequency. (Pepin, AW-522DX).

KZRM/KZEG/KZRF, 6140kc., 48.86 m., Manila: All three calls have been heard on this same frequency. Stations announce variously as KZRM, "Radio Manila"; KZEG, "The Sun-"

KZRM, 9570kc., 30.96m., Manila, "Radio Manila": Good strong signal from 7 a.m. and again at night. (Pepin, Chapman, AW509DX, AW-522DX).

shine Station"; and KZRF, "Radio Philippino." (Anderson, AW522DX, AW380DX).

##### Malaya.

ZHP, 9690kc., 30.96m., Singapore: Very consistent signal; best after 10 p.m. (Pepin, Chapman).

ZHJ, 6080kc., 49.3m., Penang: Very strong signal from 8.40 till 11.40 p.m. (Chapman).

##### India.

VUD-3, 15290kc., 19.62m., Delhi: Sometimes comes through very well from noon till close at 1 p.m.

VUB-2, 9550kc., 31.41m., Bombay: Reported from the West. (Pepin).

VUD-2, 9590kc., 31.28m., Delhi: Strong signal on opening at 10.30 p.m.

VUD-2, 4960kc., 60.48m., Delhi: From 11 p.m. (Pepin, Chapman).

VUM-2, 4920kc., 60.98m., Madras: Just fair at 11 p.m. (Pepin, Chapman).

VUC-2, 4840kc., 61.98m., Calcutta: Strongest signal of these low-frequency Indians. (Pepin, Chapman).

VUB-2, 4880kc., 61.48m., Bombay: Weakest of four Indian stations, at 11 p.m.

##### Burma.

XYO, 6007kc., 49.94m., Rangoon: Much weaker than formerly, but still audible around midnight.

##### French Indo-China.

Radio Saigon, 6116kc., 49.05m.: Still best signal on band; good English

sessions from 9 p.m. (Pepin, Chapman, AW509DX, AW380DX).

Radio Saigon, 11780kc., 25.47m.: Also a strong signal on changing frequency at 11.30 p.m. (Pepin).

##### Hong Kong.

ZBW-3, 9525kc., 31.49m.: One of best on 31-metre band. (Chapman, Pepin).

##### China.

XGOY, 11900kc., 25.21m., Chungking: One of best stations on air; strong consistent signal at 8 a.m., and at 9 p.m. (Pepin, Chapman).

XGOX, 17800kc., 16.86m., Chungking: Weak to fair around noon.

XMHA, 11850kc., 25.32m., Shanghai: Regular at night.

XGOK, 11810kc., 25.4m., Canton: Still heard just before midnight.

XPSA, 7000kc., 42.8m., Kweiyang: Very strong.

XOJD, 6880kc., 43.6m., Hankow: Also fairly strong from 9 till 11.30 p.m.

##### Manchukuo.

MTCY, 6125kc., 48.98m., Hsinking: One of strongest signals on band. Time of opening varies a good deal.

MTCY, 11775kc., 25.48m., Hsinking: New frequency. On air daily from 7 till 7.45 a.m. Good strong signal. (Chapman).

MTCY, 15205kc., 19.73m., Hsinking: Another new frequency. Does not seem to be on regularly; heard once at 9.30 p.m.

JDY, 9920kc., 30.24m., Dairen:

## Have Your "RADIO WORLD" Posted To You Direct

Readers who want to take the "Radio World" on a subscription basis and have their copies posted to them direct each month are invited to complete the coupon below (annual sub. 10/6). New readers are advised that all back numbers in Volumes 1, 2 and 3 are still available, price 9d. post free for all copies up to and including the December, 1938, issue, and 1/- post free for subsequent numbers.

Enclosed please find remittance for 10/6, in payment for an annual subscription to the "Australasian Radio World," commencing with the.....issue.

Name.....

Street and No.....

City..... State.....

Country.....

Note.—N.Z. Subscribers can remit by Money Order or Postal Note.

THE AUSTRALASIAN RADIO WORLD,  
214 George Street, Sydney,  
N.S.W., Australia.

Strong signal at night. (Pepin).  
Siam.

HS8PJ, 9510kc., 31.55m., Bangkok:  
Excellent signal four nights a week.  
Taiwan (Formosa).

JFO, 9636kc., 31.13m., Taihoku:  
Heard nightly till 1.30 a.m. (Pepin).  
Japan.

JVP, 7510kc., 39.95m., Nazaki: Re-  
ported heard late at night in West.  
(Pepin).

JLG-3, 11705kc., 25.63m., Tokyo:  
Early morning.

JVW-3, 11720kc., 25.6m., Tokyo:  
Very strong at night.

JZK, 15160kc., 19.79m., Tokyo:  
Used regularly for transmissions to  
Europe (5-8 a.m.) and South Seas  
(10 p.m.-12.30 a.m.).

JZL, 17785kc., 16.87m., Tokyo: Used  
for transmissions to North and South  
America at 7.30 and 11 a.m.

JZI, 11800kc., 25.42m., Tokyo:  
Same times as JZK.

JZI, 9535kc., 31.46m., Tokyo: Very  
weak from 7.30 till 8.30 a.m.

#### Dutch East Indies.

YDD, 6045kc., 49.63m., Bandoeng:  
Interfered with by KZIB, but can be  
heard every night. (Pepin).

PMH, 6720kc., 44.64m., Bandoeng:  
Very strong steady signal; always  
native programme. (Pepin).

PMY, 5140kc., 58.31m., Bandoeng:  
Good signal above plenty of noise.  
(Pepin).

YDE-2, 4810kc., 62.37m., Solo:  
Heard very well in West. (Pepin).

YDX, 7220kc., 41.55m., Medan: Both  
native and regular NIROM pro-  
gramme. Strong. (Pepin, Chapman).

YDC, 15150kc., 19.8m., Bandoeng:  
Strong signal at night; also heard  
well opening at 9 a.m. with exercises  
and bright musical programme.

PLP, 11000kc., 27.27m., Bandoeng:  
Same hours as YDC; strong.

PMN, 10260kc., 29.24m., Bandoeng:  
As PLP; weak.

#### Siberia.

RV-15, 4250kc., 70.2m., Khabarovsk:  
Regular, but will not verify. (Pepin,  
Chapman).

### EUROPE.

#### England.

GSW, 7230kc., 41.63m.: New trans-  
mitter on new European broadcast  
band. Heard very well in Transmis-  
sion 1.

GSE, 11860kc., 25.29m.: Now in use  
again as additional transmitter for  
overseas broadcasts.

GSH, 21470kc., 13.98m.: Now being  
heard again as 13-metre band opens  
up. Still weak.

GSJ, 21530kc., 13.93m.: Now put-  
ting in excellent signal in Transmis-  
sion 2 at 10 p.m.

Stations also logged: GSA, GSB,  
GSC, GSD, GSF, GSG, GSI, GSO,  
GSP, GSV and GRX.

#### Germany.

DXB, 9700kc., 30.93m.: New trans-

mitter; heard in early mornings, and  
also between 2 and 3 p.m.

DJP, 11855kc., 25.32m.: Special  
tests with DXB.. Terrific signal be-  
tween 2 and 3 p.m.

Also logged: DJA, DJB, DJC, DJD,  
DJE, DJH, DJL, DJN, DJQ, DJR,  
DJX and DJZ.

DZC, 10290kc., 29.15m.: Very loud  
with Arabic programme around 4 a.m.

DZH, 14460kc., 20.75m.: Special  
programmes to South America around  
8 a.m.

#### France.

A new station announcing as Paris  
Mondial (call unknown) heard at  
good strength in the afternoons on  
9680kc., 30.99m. Same programme as  
TPA-3 and TPA-4.

TPB-11, 7280kc., 41.21m.: A very  
loud signal around 7 a.m. (Chapman).

Also logged: TPB-6, TPA-4, TPA-3  
and TPA-2.

#### U.S.S.R.

RW-96, 15400kc., 19.47m., Moscow:  
This new frequency is still in use;  
loud signals in early morning, after-  
noon and at night.

Also heard: RKL, RAL, RNE, RW-  
96 (9520kc.), RW-96 (15180kc.) and  
RW-96 (15230kc.).

#### Italy.

Rome programmes heard over the  
following: 2RO-4, 2RO-6, 2RO-8,  
2RO-9, 2RO-12, IRF and IQY.

2RO-3, 9635kc., 31.13m., Rome:  
Good strength in mornings, and heard  
very well in special test programmes  
for New Zealand at 4 p.m. (announc-  
ments in English).

#### Sweden.

SBP, 11705kc., 25.63m., Motala: Ex-  
cellent signal till 7.15 a.m. (Chap-  
man).

SBU, 9535kc., 31.46m., Motala: Now  
very weak; from 7.15-8 a.m.

SBO, 6060kc., 49.46m., Motala:  
Good signal at 7.15 a.m.

#### Bohemia.

OLR5A, 15230kc., 19.7m., Prague:  
Heard fairly well till closing at 1 p.m.

#### Hungary.

HAS-3, 15370kc., 19.52m., Buda-  
pest: Sundays at midnight.

#### Yugo-Slavia.

YUA, 6100kc., 49.18m., Belgrade:  
Good early morning signal from 6  
till 7 a.m. (Chapman).

#### Turkey.

TAP, 9465kc., 31.8, Ankara: Still  
putting in a strong signal till 8 a.m.  
every morning. (Chapman).

TAQ, 15195kc., 19.74m., Ankara:  
Heard quite well at night. (Chap-  
man).

#### Poland.

SP-31, 9570kc., 31.35m. (approx.):  
Station heard at good strength on  
September 9 at 7.30 a.m., announcing  
as "This is Warsaw I, Warsaw II,

Poznan and ???" News in English  
and foreign language.

SP-48, 6140kc., 48.86m., Warsaw:  
Heard fairly well from 6 a.m.

SP-19, 15120kc., 19.84m., Warsaw:  
Barely audible at 9 a.m.

#### Portugal.

CS2WD, 5977kc., 50.02m., Lisbon:  
Heard fairly well around 7 a.m.

CSW-7, 9735kc., 30.81m., Lisbon:  
Good signal in mornings.

CSW-8, 7260kc., 41.3m., Lisbon: Ex-  
cellent signal at 8 a.m. (Chapman).

CSW-5, 11040kc., 27.17m., Lisbon:  
Good signal in early morning; around  
7 a.m. (Chapman).

#### Finland.

OFD, 9500kc., 31.58m., Lahti: Weak  
signal in early mornings till close at  
8 a.m.

#### Belgium.

ORK, 10330kc., 29.04m., Ruysselede:  
Good early morning station, closing  
at 6 a.m.

#### Holland.

PCJ-2, 15220kc., 19.7m., Huizen:  
Very strong signal and excellent pro-  
gramme on Tuesday afternoons.  
(Pepin, Chapman).

PCJ, 9590kc., 31.28m., Huizen:  
Heard in the West in the late morn-  
ing. (Pepin).

#### Norway.

LKJ, 6130kc., 48.94m., Oslo: Fairly  
good signal at 7 a.m.

LKV, 15170kc., 19.78m., Oslo:  
Heard fairly well at night, and in the  
early morning.

LKQ, 11740kc., 25.55m., Oslo: Heard  
around 6 a.m.

#### Switzerland.

HBO, 11400kc., 26.31m., and HBJ,  
14535kc., 20.69m., Geneva: Heard  
well late in August. Transmissions  
now suspended.

### Stop-Press News.

#### Additions to List of Month's Loggings.

#### Luxembourg.

A new station heard on approxi-  
mately 11875kc., 25.46m., is **Radio  
Luxembourg**. This station has been  
testing in a number of languages, and  
was heard up till 9 a.m.

#### Spain.

The station operating on 9860kc.,  
30.4m., is causing some controversy.  
Previously known as **EAQ**, it is now  
reported to announce as **Radio  
Burgos**.

#### Additions to Amateur Calls Heard.

##### 10 Metres:

United States: W- 2AFJ, 8GQE,  
8MKG, 8FGV, 9BDT.

20 Metres (from Observers Coggins  
and Taylor):

Europe: G2MQ, G2AK, G2XS, G3-  
FQ, G3IG, G3QK, G3QL, G3RI, G4-  
AJ, G4HV, G4HW, G5ML, G5DT, G5-  
GS, G5JO, G5LJ, G5PQ, G5RV, G5SO,



G5VT, G5ZG, G6BC, G6BY, G6DT, G6JL, G6ML, G6RW, G6WU, G6XP, G6ZI, G8BK, G8GP, G8LP, G8RB, G8SB, G8UJ, G8WS (England); GW-3AX, GW4CC, GW5PH, GW8HI (Wales); GM8KQ (Scotland); EI2L, EI7N (Eire); PAOAD, PAOEO, PAOGR, PAOUN, PAOWN, PAOVN (Holland); F3PS, F8CP, F8DC, F8FN, F8GO, F8GM, F8MG, F8YZ (France); SM7MU (Sweden); ON4IW, ON4AR, ON4CK, ON4MV, ON4MZ, ON4OU, ON4PA, ON4MS (Belgium); LY1J (Lithuania); LA8J (Norway).

South America: CP1BA (Bolivia); LU2AW, LU5AC, LU4BH, LU6DG, LU7BC, LU7BU, LU9AB (Argentina); PY2ER (Brazil); HC1FG, HC-2HP (Ecuador); CE1AO, CE3AG, CE3CZ (Chile); YV1AE, YV5AE, YV-5AK, YV5AC, YV5ABQ (Venezuela).

North America: VE2OR, VE5ACR (Canada).

Central America and West Indies: XE1FA, XE2FC (Mexico); TI4AC (Costa Rica); CO2LY, CO7AS (Cuba); VP5PZ (Jamaica); VP6FO, VP6MY (Barbados).

Asia: KA1AF, KA1BB, KA1CW, KA1JP, KA1ZL, KA1AP, KA7HB (Philippines); VS6AO (Hong Kong); VS7GJ (Ceylon); VS2AK (Malaya); VU2CQ (India); XZ2BH, XZ2TM (Burma); J2CS, J2KN, J2MI, J2NQ, J7CD (Japan); XU1B, XU5HR, XU-5HR, XU2MC, XU7HV, XU8MC, XU-7HV, XU8MC, XU8RB, XU8AM (China); PK1PK, PK1OG, PK1VM, PK1RI, PK3BD, PK3DA, PK3AA (DEI).

Pacific: VK9DK (New Guinea); VK-4NK (Papua); K6BNR, K6MVA, K6CGK, K6LKN, K6OES, K6OJI, K6OKN, K6OQE, K6PCW, K6RBM, K6MYD (Hawaii).

of classical music. Does not verify. RW-25, 556kc., Tchita: Heard well from about midnight, but much better after 6WA closes down. Does not verify.

RW-72, 577kc., Tcheljabinsk: Heard any Sunday night about midnight. Like all other Siberian stations, does not verify.

#### PHILIPPINES AND HAWAII.

KGMB, 1320kc., Honolulu, Hawaii: Opens 2.30 a.m. with Japanese programme (also heard between 7.10 and 7.40 p.m. at close of evening transmission, giving news service and station information).

KGU, 750kc., Honolulu, Hawaii: Programme identical with KGMB when opening at 2.30 a.m.

KZEG, 780kc., Manila: Heard well around 22.30. Closes at 1 a.m., after which KZRS operates in the same frequency till 2 a.m.

KZIB, 900 kc., Manila: Heard well around midnight.

KZRH, 1200kc., Manila: Best around 12.30 a.m. Just a new station on air. Call-sign confused with KZRM by many Dx-ers. A new and easy addition to any Dx-er's log.

KZRM, 618kc., Manila: Closes at 1.30 a.m. and not 1 a.m., as reported formerly. One of three best stations heard in Eastern Australia this year. Verifies promptly.

KZRS, 780kc., Manila: Identifies as Radio Filipino and closes at 2 a.m. Heard after 1 a.m. when K2EG closes down.

#### CHINA.

FFZ, 1400kc., Shanghai: Hard to log but sometimes comes in at surprising strength at about 1 p.m.

XGAP, 640kc., Peking: Heard well at 1.30 a.m. here but subject to bad heterodyne. Does not verify.

XGOA, 1180kc., Location probably Chungking: This is the frequency they operate on. Sometimes heard on 1175kc., but this is due to frequency drift.

XGOW, 1010kc., Hankow: Has been heard as late as 6.45 a.m. Very strong at moment.

XMHA, 600kc., Shanghai: Still operating but does not reply to reports as readily as formerly.

XMHG, 200kc., Shanghai: Closing time indefinite, but comes through remarkably well around 2 a.m. despite low power rating.

XOJC, 660kc., Nanking: Very strong around 2 a.m. Heard well in Eastern Australia at moment.

XOJD, 1400kc., Hankow: Heard well at 2 a.m. Now uses 10 k.w.

ZBW, 845kc., Hong Kong: Very strong at moment. Plays mixed programme of Western and Eastern

## Broadcast Band DX Notes

Conducted by Kevin A. Crowley in collaboration with the DX Editor.

### Station Notes And News.

The following frequency changes have been noted:—2XL, Cooma, N.S.W., from 880kc., to 920kc.; 3UL, Warragul, Victoria, from 900kc., to 880kc.



### Highlights Of The Month.

September 3 was undoubtedly the best night of the month. Many of the American and Philippine stations stayed on the air till well after midnight, giving details of the war. Australian stations also carried out the same idea and many stations which are normally impossible to log were heard at good strength. This applies particularly to Australian stations sharing the same frequency. The editor can vouch for this as he increased his Australasian log by 13 stations. Dx-ers would be well advised to watch very carefully when important news is being broadcast, as the opportunity of adding to one's log is very great on such occasions.

The Hawaiian stations are now coming in at good strength and Dx-ers should try for them now, as Europeans will soon be audible again. They are KGU (750kc.) and KGMB (1320 kc.) and they open their early morning programmes at 2.30 a.m. with Japanese music and talks. Do not let the Japanese programme confuse you.



### Best Stations Of The Month.

The following list sets out those stations which are now reaching their

maximum strength for reception in Australia. Any of them should be easily logged by even novice Dx-ers. JAPAN.

JBCK, 850kc., Seishin, Korea: Heard well in Eastern Australia despite different power ratings. Verifies fairly promptly.

JFAK, 750kc., Taihoku, Formosa: Heard well around 11 p.m. any Sunday night. Often difficult to log on week days.

JOAK-1, 590kc., Tokyo: Heard well in Eastern Australia as early as 8.30 p.m. Closes at 11.30 with musical chimes. Does not give call sign at close of transmission as formerly.

JOAK-2, 870kc., Tokyo: Heard at 11.30 p.m. after 2GB, Sydney, closes. English news around 11.45 p.m. Also closes with musical chimes.

#### MANCHURIA AND SIBERIA.

MTBY, 890kc., Mukden: Heard well on one occasion recently around midnight.

MTCY, 560kc., Hsinking: Strong around midnight-12.30, but badly heterodyned by 6WA till that station closes down.

MTFY, 675kc., Harbin: Heard well around midnight on several occasions this month.

RW-28, 635kc., Vladivostok: Heard recently in Eastern Australia at remarkable strength. Often at entertainment level at midnight. Sometimes puts on excellent programmes

recordings from 12.30 to 1.30 a.m., at which time it closes.

#### INDIA.

VUB, 1231kc., Bombay: Weak but audible in most parts of Eastern Australia.

VUC, 810kc., Calcutta: Strongest at 3 a.m.

VUD, 882kc., Delhi: Best Indian station on air; closes at 3.40 a.m.

VUL, 1086kc., Lahore: Quite strong at 3 a.m.

VUM, 1420kc., Madras: Quite good at 2.30 a.m.

VUT, 758kc., Trichinopoly: Reported at good strength throughout Australia.

VUW, 1015kc., Lucknow: Very strong around 2.30 a.m.

VUY, 1176kc., Dacca: Reported at good strength by listeners throughout Australia.

—, 730kc., Hyderabad: New Indian station reported at great strength during past month.

#### CEYLON.

VPB, 705kc., Colombo: Reaches peak just before closing at 2.30 a.m.

ZHL, 1332kc., Singapore: Reported recently by South Australian listeners. Verifies readily. Best about 1 a.m.

### Around The Dial.

Other stations audible at reasonable strength at present include the following:—

XGOG, 560kc., Chengtu: Reported recently at good strength.

JONG, 600kc., Miyazaki: Closes around 11 p.m. Heard any Sunday.

JOKK, 630kc., Okayama: Scheduled closing time 11 p.m., but has been heard closing around midnight.

JODG, 640kc., Hamamatsu: Sometimes heard after 5CK closes on Sunday nights.

JOBK-1, 690kc., Osaka: Subject to bad interference from 6WF, but occasionally audible at reasonable strength on Sundays.

JODK-1, 710kc., Keijo: Difficult to separate from 6GF.

JFBK, 720kc., Tainan, Formosa: Sometimes at midnight; interference from 6GF.

JOCK-1, 740kc., Nagoya: Sundays at 10.45 p.m.

XHHB, 740kc., Shanghai: Closes at 2 a.m., but despite low power rating has often been logged.

JQAK, 760kc., Dairen: Heard well around midnight, but subject to interference from VUT.

JOKG, 800kc., Kofu: Audible around 11 p.m. Sundays.

JOIK, 810kc., Sapporo: Can be logged around 11 p.m. but usually heterodyned by VUC on same frequency.

JBBK-2, 820kc., Heijo, Korea: Best around 11 p.m.

HS7PJ, 825kc., Sala Denj, Siam: Audible around 1 a.m.

JOFK, 830kc., Hiroshima: Easiest to log on Sundays around 11 p.m.

JOQK, 920kc., Niigata: Best on Sundays around 11 p.m.

JOBK-2, 940kc., Osaka: Best on Sundays around 11 p.m.

### 1939 Atlas All-Waver.

It is regretted that in the circuit diagram of the above receiver, a .005 mfd. by-pass condenser was omitted from the plate of the 1G6G second triode section to earth. Including this effectively prevents any tendency towards uncontrollable oscillation.

JODK-2, 970kc., Seoul, Korea: Easy logging any Sunday night between 11 and 11.30 p.m.

JOCK-2, 990kc., Nagoya: One of the strongest stations heard in recent months.

JBBK-1, 1090kc., Heijo, Korea: Audible on Sundays after 3DB closes.

XGOC, 1130kc., Nanchang: Audible around 1 a.m.

XGOB, 1290kc., Sinan: Heard around 1 a.m.

XQHC, 1300kc., Shanghai: Best at 1 a.m.

XQCT, 1460kc., Shanghai: Strong-

### "CHURCH IN THE WILDWOOD."

#### John Davis' 2CH Presentation.

In these times, even more than previously, Australian and New Zealand listeners are finding solace in "Church in the Wildwood," a 9.15 p.m. Sunday night session, conducted by John Davis on Station 2CH, Sydney.

Featuring hymns which most people have sung, this session is designed for, and has a direct appeal to all, whether church-goers or not. Special Thesaurus recordings by the celebrated baritone, John Segal, and Rose Allegretti, soprano, are selected by John Davis for the session which has gained listeners all over the eastern States and New Zealand.

John Davis frequently receives letters from people as far away as Northern Queensland, Tasmania and all parts of New Zealand in which the writers express their appreciation of the hymns chosen, and of the commentary presented by John Davis himself.

The Thesaurus Library of high fidelity recordings is exclusive to 2CH in N.S.W. and now contains a total

of 3,000 selections of all types of music. "Church in the Wildwood," which was specially prepared as a Thesaurus Sunday programme, comprises a large section.

In addition to this 9.15 p.m. Sunday session, John Davis is well known for his presentations of "Scottish Reveries" for over two years on 2CH.

### QSL Exchange Bureau.

The following readers would like to exchange their QSL card with members of the "All-Wave All-World DX Club":—

Gloria Claes (AW529DX), Reynolds St., Bowen, Q'land.

F. Lendzioszek (AW502DX), 40 Emerald Place, Easthampton, Mass., U.S.A.

Bill Page, First Avenue, Tauranga, New Zealand.

Eric N. Dalziel (AW510DX), "Betholme," Narara Road, Narara, N.S.W.

L. R. J. Knighton, 245 Armajh St., Christchurch, N.Z.

R. Sutherland (AW458DX), "Thanet," 9 Audrey St., Balgowlah, Sydney.

Jack Easlea (AW484DX), 5 Wantley St., Warwick, Queensland.

M. Coutu, 51 Wingfield St., Portsmouth, England.

Jose A. Garcia, S. Trinidad alta 23, Santiago de Cuba, Cuba.

Wilfred Farbotton, 28 Curzon Rd., Bradford Moor, Bradford, Yorks., England.

James W. Newman, 45 Sixth St., New Toronto, Ont., Canada.

### Details Of W6XBE.

"General Electric's Around-the-World Broadcasting Service acknowledges with thanks your communication reporting reception of its station, W6XBE, operating on a frequency of 9,530 k.c.

"W6XBE is located in the Palace of Electricity on Treasure Island at the Golden Gate International Exposition, San Francisco, California.

"Operating on a frequency of 15,330 kilocycles, or 19.56 metres, W6XBE is on the air daily from 3.30 p.m. to 7 p.m., Pacific Standard Time.

"Operating on a frequency of 9,530 kilocycles, or 31.48 metres, W6XBE is on the air daily from 4 a.m. to 7 a.m., Pacific Standard Time."

The above information was received on their verification card and may be of interest to other readers.—H. H. Young (AW333DX), Angaston, S.A.

# World News at Your Fingertips . . . . .

with the

## Falcon D.-W. Four

Builders wanting a battery set giving the utmost in dual-wave performance at the lowest cost cannot do better than build the "Falcon Dual-Wave Four" described this month. Using the latest 1.4-volt valves throughout, with beam pentode output, this little receiver is a magnificent performer, with remarkable economy of operation ("A" drain is only .25 amp., "B" drain, 9 mills.)

WRITE NOW FOR OUR COMPLETE KIT PRICE.

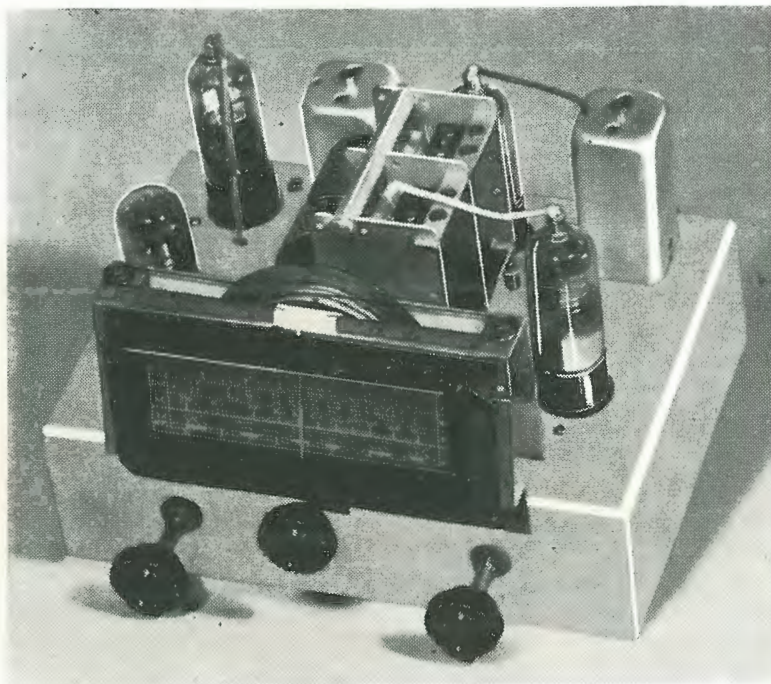

### Picnic Portable Four.

Latest and most sensational portable yet featured in any Australasian radio magazine, the "Picnic Portable Four" described this month gives you the ultimate in portable performance at lowest cost.

WRITE NOW FOR OUR QUOTE.

### Vulcan Shortwave Five.

Using 1.4-valves throughout, with double regeneration, this latest American shortwave superhet will keep you in touch with shortwave stations all over the world. Simple to build. . . surefire in operation. . . exceptionally powerful. . . this receiver is the finest of its type we have ever supplied to builders.

WRITE NOW FOR OUR QUOTE.

### Learn The Morse Code!

Become a qualified operator in a few weeks. . . there is going to be a tremendous demand for skilled men. Write for details of

the FEAR code practice oscillator kit.

### World-wide DX On Three Feet Of Aerial!

. . . . . London, Berlin, Paris, Rome, Tokio . . . . . shortwave stations in all parts of the world can be played at full volume on the "1939 Atlas All-Waver." This sensational new 1.4-volt all-wave three-valver draws only .2 amp. "A" current and 9 mills. "B."

WRITE NOW FOR FREE QUOTE.

### "Sky-Chief Dual-Wave Five."

Giving an exceptionally fine performance on both wavebands, coupled with the superb tone that only triode output can give, the "Sky-Chief Dual-Wave Five" is a receiver we can fully recommend. Write now for free details of our kit of parts.

### Headphones.

FROST, definitely the most popular 'phones in N.Z. . . . 15/-

MICRO, high-grade English 'phones, used extensively in British Government departments . . 18/6

British Post Office pattern, heavy brass morse keys. Here's the key you have tried hard to procure . . . . . 52/6

### Astatic Streamline Pick-up.

Model 0-7 streamline Astatic crystal pick-up gives remarkable quality of reproduction.

NETT PRICE . . . . . £2/7/6

### The "Micro" Vibrator Power Unit.

Special design allows for entirely hash-free operation on any battery receiver using 2, 4 or 6-volt valves. The new "Electronic" synchronous vibrator ensures long, trouble-free performance. Cut out expensive dry batteries now and give your radio new life.

Complete kit . . . . . £4/2/6

Complete kit assembled

and tested . . . . . £4/17/6

# FEAR'S

## FOR EVERYTHING IN RADIO

AN ADVERTISEMENT OF

F. J. W. FEAR & CO., "The Radio Pioneers."  
Temporary Address: Commercial Travellers' Building, 109 Customhouse Quay, Wellington

Ng 621.38405 Aug

7



# BRIMAR VALVES BRING A NEW ERA FOR PORTABLE RADIOS!

## HOME BUILT PORTABLE RECEIVERS AT LAST MADE PRACTICABLE BY THE INTRODUCTION OF 1.4 VOLT VALVES!

Up till recently the construction of home-built portables was something to be avoided . . . cumbersome accumulators had to be installed and kept upright in case the acid spilled. Then again, fumes from the acid played havoc with the fittings and the interiors of the portable cabinets. Heavy batteries were also necessary, which made the so-called portable a very hefty proposition to carry about.

With the introduction of the Brimar 1.4 Volt Valves comes a new era in portable radio history. These valves eliminate the use of accumulators! . . . and reduce by one-third the weight of batteries!



### As finely built as a watch

This composite picture showing the many intricate parts required in the construction of a Brimar Valve indicates how essential is the need for reliability in the modern valve. The assembly of these parts to make the complete valve is the task of skilled operatives, hundreds of whom are engaged in the giant Brimar British Valve factory where valves are produced for use in every part of the world.

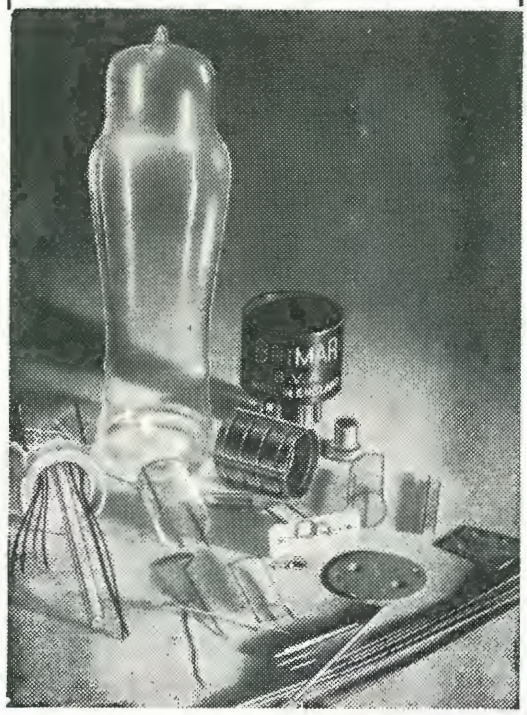

### BRIMAR VALVES INSTALLED IN "QUEEN MARY" & "QUEEN ELIZABETH"



The safety of thousands of passengers carried on these mammoth liners costing £12,000,000 is dependent upon radio communication. It is significant that Brimar Valves are used in the radio installations of these ships. No matter which circuit you construct you will find that you, too, can rely on Brimar Valves to give the best in range and tone.

# BRIMAR VALVES

#### BRIMAR DISTRIBUTORS LISTED BELOW:

N.S.W.: Standard Telephones & Cables Pty., Ltd., 258-274 Botany Road, Alexandria. QUEENSLAND: Trackson Bros. Pty., Ltd., 157-9 Elizabeth Street, Brisbane. SOUTH AUSTRALIA: Radio Wholesalers Ltd., 31 Rundle Street, Adelaide. WESTERN AUSTRALIA: M. J. Bateman, Ltd., 12 Milligan Street, Perth. VICTORIA: Noyes Bros. (Melb.) Ltd., 597-603 Lonsdale Street, Melbourne. TASMANIA: W. & G. Genders Pty. Ltd., 69 Liverpool Street, Hobart; 53 Cameron Street, Launceston, also at Burnie. NEW ZEALAND: Standard Telephones & Cables Pty. Ltd., P.O. Box 638 Wellington, P.O. Box 1897 Auckland; P.O. Box 983 Christchurch.