

THE  
AUSTRALASIAN

OCTOBER 10, 1938  
VOL. 3 — NO. 6  
PRICE, 1/-

# Radio World

Registered at the G.P.O.,  
Sydney, for transmission  
by post as a periodical.



—See Page 8

- "1938 OUTDOOR PORTABLE": "ULTRA-SEARCHER" FOR U.H.F.
- RECEPTION: ADDING AN R.F. STAGE TO THE "ATLAS ALL-WAVER"
- "1938 AMATEUR COMMUNICATIONS EIGHT": LATEST WORLD S.W. NEWS.



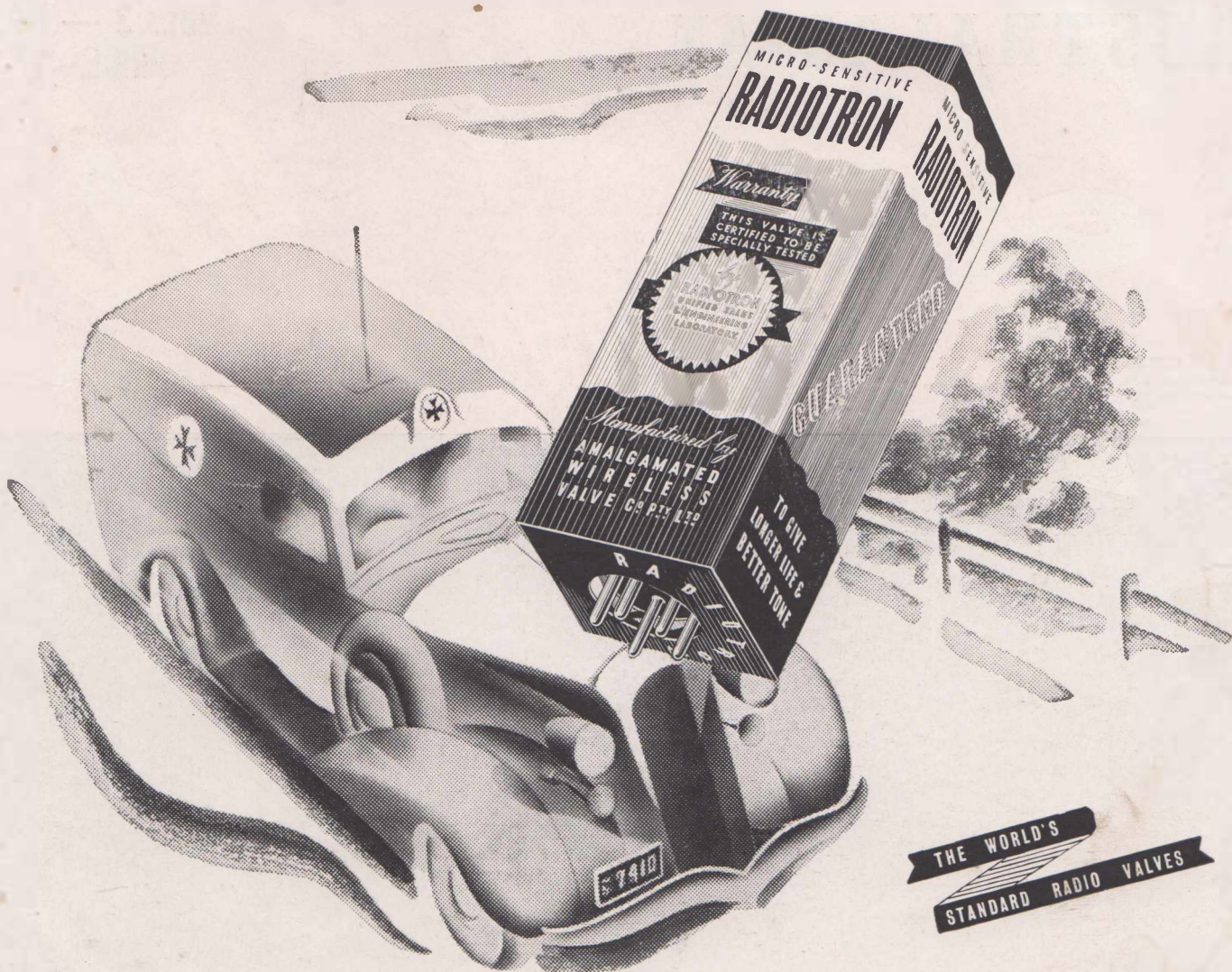

The same valves that bring speedy help by ambulance are the best tonic for your radio set. A regular overhaul of your radio will give better and brighter programmes. See your local Dealer and be sure to Re-valve with . . .

*new micro-sensitive*

# RADIOTRONS

AUSTRALIAN  
GENERAL  ELECTRIC  
LIMITED

Sydney, Melbourne, Brisbane  
Adelaide, Hobart

AMALGAMATED  
WIRELESS  (A/SIA) LTD.

47 York Street, Sydney  
167-169 Queen St., Melbourne

NATIONAL ELECTRICAL  
& ENGINEERING CO. LTD.

Wellington  
New Zealand



THE  
RADIO  
PIONEERS

# Fear's Radio Review

F. J. W. FEAR & CO. - - - - 31 Willis Street, Wellington  
New Zealand :: Telegrams: "FEAR"

FEAR'S  
FOR  
EVERYTHING  
IN RADIO

An Advertisement inserted by F. J. W. FEAR & CO., New Zealand.

## NEW TECHNICAL RADIO MAGAZINE FREE TO N.Z. SET-BUILDERS ! Book YOUR Copy Now

During next month will be published the first issue of "Fear's Radio Review," a new quarterly technical radio magazine packed with constructional articles and items of interest to amateurs, shortwave fans and experimenters generally. Copies will be sent free and post free to everyone on our mailing list. Make sure of your copy by writing us immediately at the above address.

Complete with speaker,  
less valves . . . . . £9/17/6  
(Freight paid to your nearest railway station.)

The kit comes to you with the complete r.f. tuner, dial, gang condenser, and first tube socket ready wired and tested.

### "Meissner All-Wave Seven"

Modern in every respect, band coverage 7.5 to 550 metres, four-colour dial, tone control, etc.

Complete kit, with valves  
and speaker . . . . . £19/10/-

### Headphones For DX Fans

FROST, definitely the most popular 'phones in New Zealand . . . 15/-  
MICRO, high-grade English 'phones, used extensively in British Government Depts. . . . . 18/6

### Morse Keys

British Post Office pattern heavy brass morse keys. Here's the key you have tried hard to procure . . 52/6  
Quality and Value.

### Dynamic & Crystal Microphones

A high-grade dynamic microphone for amateur or P.A. work, frequency response 50 to 9000 cycles . . . £5/5/-

ASTATIC, acorn model T-3 crystal make. Quality reproduction, ideal for dance band or studio work, £6/10/-.

ASTATIC, model D-104 — the "hams" favourite . . . . . £5/10/-

SHURE, model 70SW, crystal with modern desk stand . . . . . £6/10/-

### "1938 Outdoor Portable Four"

Anyone can build successfully the new "Outdoor Portable Four" described this month. Improvements in design . . . in performance . . . in ease of building . . . make it an outstanding receiver. Build one now for Christmas and double your holiday enjoyment. Fear's will supply the complete outfit, including stamped chassis, ready-built cabinet, valves, speaker and batteries, nothing else to buy.

The Complete Kit . . . . . £12

### "1938 Communications Eight"

Learn about the sensational new improved "Amateur Communications Eight" in this issue; its performance is amazing. A study of its technical features will tell you that this is no ordinary receiver. It is new, modern, a remarkable achievement in advanced radio engineering, a receiver that every amateur and shortwave-listener will be proud to build and operate.

WRITE FOR FULL DETAILS  
OF OUR SPECIAL KIT.

### "Atlas All-Waver"

We can supply the complete kit of parts to build either the one, two or three-valve versions of the "Atlas All-Waver." Every part of our special "Add-A-Valve Kit" is exactly as specified by the editor.  
WRITE NOW FOR OUR QUOTES.

### "Micro" All-Wave Automatic Five

This is not just another radio receiver; look over its many features. All-wave coverage from 16 to 150 metres and 200 to 550 metres, then automatic tuning of eight broadcast stations, ultra-modern circuit employs an entirely new output tube, attractive oval four-colour dial, accurately calibrated, and all main short wave bands clearly indicated. Truly an ideal low-priced kit for the ham, DX enthusiast or for a second set in the home.

Complete with valves  
and speaker . . . . . £11/18/6

Illustrated alongside are typical transformers by U.T.C.—the most complete transformer line in the world. Will match any known modulator tube to any class "C" stage.  
VM-0 12-w. audio, 27/6  
VM-1 31-w. audio, 42/6  
VM-2 60-w. audio, 62/6  
VM-3 120-w. audio, 92/6

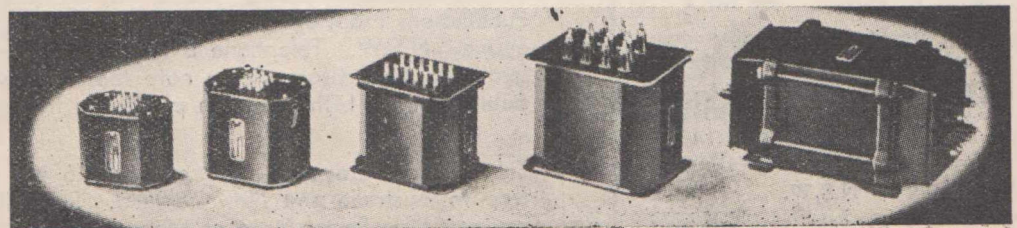

# RAYWAY

COIL KITS ARE SPECIFIED EXCLUSIVELY for the . . .

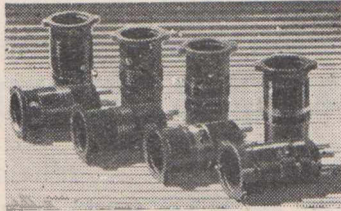

AMATEUR COMMUNICATIONS EIGHT  
.. and the ..



**ATLAS ALL-WAVER !**  
(See descriptions elsewhere in this issue)

Precision-wound on moulded formers of the highest-grade imported bakelite, every RAYWAY coil is scientifically planned to give the last ounce of gain from the lowest to the highest frequency covered.



Used for the "Atlas All-Waver," the new RAYWAY 15 to 600-metre Amateur All-Wave Coil Kit gives continuous coverage from 15 to 600 metres.

Each kit is packed in a solidly-built box intended for use as a permanent container. A pamphlet included with each kit shows under-socket connections of coils, together with their colour code.

Rayway 15 to 600 - metre Amateur All-Wave Coil Kit

**25/-**

If unobtainable from your local dealer, write direct to:—

**Standardised Products**

629 PARRAMATTA ROAD,  
LEICHHARDT, SYDNEY  
N.S.W.

Phone . . . . LM 5957

# THE AUSTRALASIAN RADIO WORLD

Incorporating the  
**ALL-WAVE ALL-WORLD DX NEWS.**

Managing Editor:  
A. EARL READ, B.Sc.

Vol. 3

OCTOBER, 1938.

No. 6.

## CONTENTS:

"1938 Amateur Communications Eight" .....	3
"1938 Outdoor Portable Four" .....	6
Adding A Tuned R.F. Stage To The "Atlas All-Waver" ....	10
Portable Transmitter Taken On Radio Hike .....	12
EM1 Makes Good Indicator For Absorption Frequency Meter	15
A.O.C.P. Questions And Answers .....	17
The Ultra-Searcher .....	20
Radio Book Reviews .....	22
Contest Winner VK2ADE Operates De Luxe Station .....	24
The "Ultra-Shorts" In Review (2) .....	25
Getting That Trophy-Winning "Verie" .....	28
1.4-Volt Valves Announced In States .....	30
What's New In Radio .....	32
Building The A.C. Version Of The "Air-Ace Communications Four" .....	36
All-Wave All-World DX News .....	39
Shortwave Review .....	40
Hourly Tuning Guide .....	44
Result Of Fifth DX Contest .....	45
O. Washfold Wins QSL Card Contest .....	47

The "Australasian Radio World" is published monthly by Trade Publications Proprietary, Ltd., Editorial offices, 214 George Street, Sydney, N.S.W. Telephone BW 6577. Cable address: "Repress," Sydney. Advertisers please note that copy should reach office of publication by 14th of month preceding that specified for insertion.

Subscription rates: 1/- per copy, 10/6 per year (12 issues) post free to Australia and New Zealand. Subscribers in New Zealand can remit by Postal Note or Money Order.



# 1938 Amateur Communi-

# cations Eight

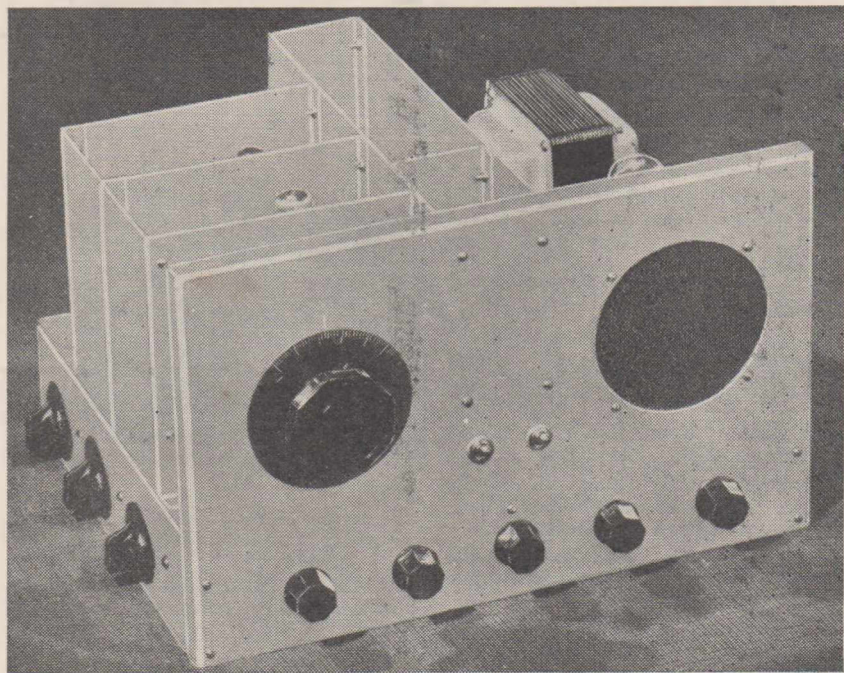

**Features of new model include octal-based valves ★ two-stage i.f. amplifier ★ optional a.v.c.**

A general view of the latest model, which uses the new 6:1 reduction drive Radiomac dial, giving the smoothness and precision in tuning so essential in a receiver of this type.

In the June and July issues of "Radio World" for last year an article was featured covering the design and construction of an eight-valve a.c. communications type super-het, designed in the laboratory of Amalgamated Wireless Valve Co. Pty. Ltd. This has proved easily the

most popular receiver of its type ever described in an Australian magazine.

**A.V.C. And Octal-Based Valves Are Features Of Latest Model.**

Though it has been built by amateurs and short-wave fans throughout the Commonwealth, not one complaint

regarding unsatisfactory performance has come to hand. One very common suggestion for improvement, however, has been for the incorporation if possible of automatic volume control as an optional fitting. The addition of this feature, and the use of octal-based "G" type valves throughout constitute the two main improvements made in the 1938 model illustrated above.

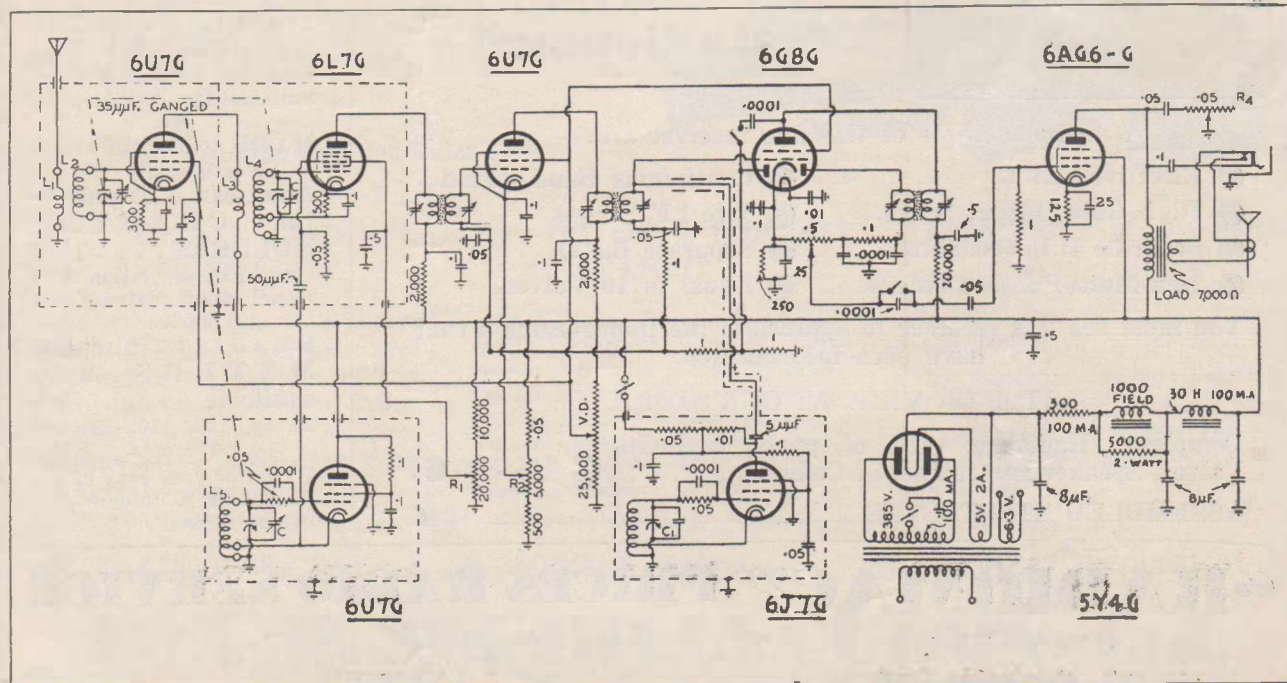

The circuit of the "1938 Communications Eight," which uses octal-based valves throughout and incorporates auto-matic volume control.



### Extra I.F. Stage Included

The alterations made are all included in the circuit from the grid lead of the second i.f. transformer onward. To compensate for the loss of gain entailed by substituting diode for anode bend detection, an extra i.f. stage has been added. The valve used here is a 6G8G duo-diode super-control pentode. The pentode section is used as the additional i.f. amplifier, one diode as second detector and the other to provide a.v.c.

A switch is included so that the control can be cut out at will. This will be used mainly when the beat frequency oscillator is in action; otherwise this locally-generated signal would actuate the a.v.c. system, decreasing the overall sensitivity.

### 6AG6-G High Slope Pentode In Output Stage.

Because the output pentode has to be driven straight from the detection diode, the 6AG6-G high slope pentode announced in last month's issue has been used in this socket. An input of 2 volts r.m.s. will fully load this valve, which will deliver over four watts of output. Apart from several other alterations of constants to suit

the amended circuit, the design is identical with that of last year's model.

### Fourteen Main Features.

To sum up, the main features of this communications receiver are listed below:—

1. Continuous band coverage from 9 to 120 metres.
2. Band spread is provided for simple tuning on the amateur bands.
3. Tuned r.f. stage provides effective image suppression and ensures an excellent signal-to-noise ratio.
4. Electron-coupled regeneration is applied to the mixer, giving greatly improved sensitivity and selectivity.
5. Separate e.c. h.f. oscillator, giving high frequency stability.
6. Two stage high-gain i.f. amplifier, using iron-cored intermediates for greatest selectivity.
7. Optional a.v.c. is incorporated, operating on the two i.f. stages.
8. I.f. and a.f. gain controls.
9. Separate b.f.o. unit, with control

for varying pitch of beat note.

10. Tone control with combined on/off switch for cutting in the .0001 mfd. audio coupling condenser to reduce low frequency interference for c.w. reception of 1000-cycle note.
11. Provision for 'phones or speaker, the latter being automatically silenced when 'phones are plugged in.
12. Receiver and power supply built on one chassis.
13. Latest type octal-based "G" valves are used throughout.
14. No special parts are required.

### Full Description Next Month.

The receiver is assembled on a 16-gauge aluminium chassis measuring 15" x 12" x 3". Also required are an aluminium front panel measuring 15" x 9 3/4", and above and under-chassis shield partitions.

The parts required are listed in a panel on page 46. Next month the construction of the receiver will be described in detail, and a table of correct operating voltages throughout the circuit will be given.

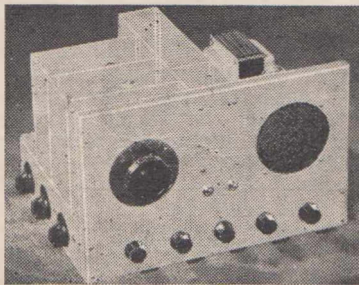

## Build the New Improved Amateur Communications Superhet

with a  
"Radiomac"  
KIT.

Some features of this fine receiver are:—

- Effective A.V.C.
- High Gain Output Stage.
- Separate H.F. Oscillator.
- New Multi-Purpose Valves.
- Continuous Band-spread.
- Two I.F. Stages.
- Separate B.F.O.
- Equal to 10 Valves.

You must see this receiver to appreciate the improvements that have been incorporated.

IT IS ON VIEW AT OUR STORE.

Complete "Radiomac" Kit of parts, including Valves, Speaker and full set of Coils . . . . . £ 19-2-6

ASSEMBLED AND TESTED . . . . . £26

### A Few Bargain Lines That Will Sell Quickly

So rush your order.

**AERO DIALS** . . 3/6  
3 3/4" dia. with pearl  
scale, 12-1 ratio 7/6  
Fitted with pilot lamp  
holders. Suitable for 3/8  
or 1/4 inch spindles.

**HEADPHONES** . 3/11  
Sensitive 4000 ohm type.  
Suitable for crystal sets,  
etc.

**HYDRA 3x-5mf** . 6d.  
Worth easily 2/4.

**American Transmitting CRYSTAL HOLDERS** . . . . 10/6  
Cermitex insulation with  
monel metal plates. Just  
arrived.

**Readrite Millamp. METERS** now  
available . . . . . 5/9  
25, 50, 100, 150, 250 and  
300 m/a.

Write for your copy of our  
1938-39 Catalogue—  
It is Free!

## "RADIOMAC" PRICES RADIO SERVICE

COMPONENTS  
are only obtainable from:—

D. G. McINTYRE  
5 & 6 ANGEL PLACE,  
SYDNEY.



# FOXRADIO "OUTDOOR PORTABLE" Out-Performs All Others!

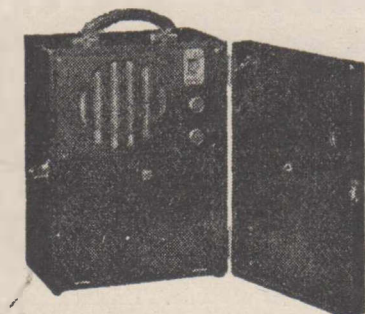

Specially designed for the "1938 Outdoor Portable" the FOXRADIO Coil Kit we recommend for this receiver gives unbeatable sensitivity and perfect tracking. As well, this new coil kit can be substituted for lower gain kits in the 1936 and 1937 models. Exceptionally high gain with full stability are outstanding features.

We also have available a special complete kit of parts including carrying case, batteries and valves for the "1938 Outdoor Portable Four." Every part guaranteed of highest quality and exactly to the designer's specifications.

Don't buy before writing for our special complete kit price, sent post free by return mail.

## Build the "ATLAS ALL-WAVER" with our special FOXRADIO ADD-A-VALVE KIT

This month a further constructional article is featured on the "Atlas All-Waver," outlining the method of adding a tuned r.f. stage.

We have prepared three special kit prices for this receiver—for the single valve model, and covering the parts required to add the r.f. and output pentode stages. Prices on the latter two will apply even if purchased in a year's time.

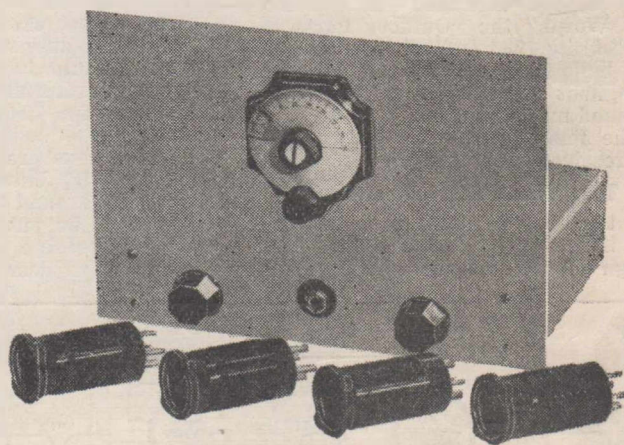

Write For Our Detailed Price List.

### A.C. "AIR-ACE COMMUNICATIONS FOUR"

Short wave fans everywhere with mains power available have been waiting for details of the A.C. "Air Ace Communications Four." A high-performance, low-price communications receiver that gives all-wave coverage.

### 1938 DE LUXE FIDELITY EIGHT

The "1938 De Luxe Fidelity Eight" described in the past two issues of "Radio World" is breaking all records—both for sales and performance. This new 1938 model will out-perform many commercial receivers costing two and three times as much.

### VIBRA DUAL-WAVE FIVE

Using five of the latest 6.3 volt .15 amp. type valves, the "Vibra Dual-Wave Five" is the ideal receiver for those who have adequate charging facilities. Employs built-in vibrator power supply and operates entirely from a 6-volt accumulator.

Detailed Quotes On Any Of The Above Receivers Sent Free By Return Mail.

● FASTEST SERVICE

● LOWEST PRICES

● HIGHEST QUALITY

## FOX & MacGILLYCUDDY Ltd.

MERINO HOUSE, 57 YORK ST., SYDNEY

Tel.: B 2409.



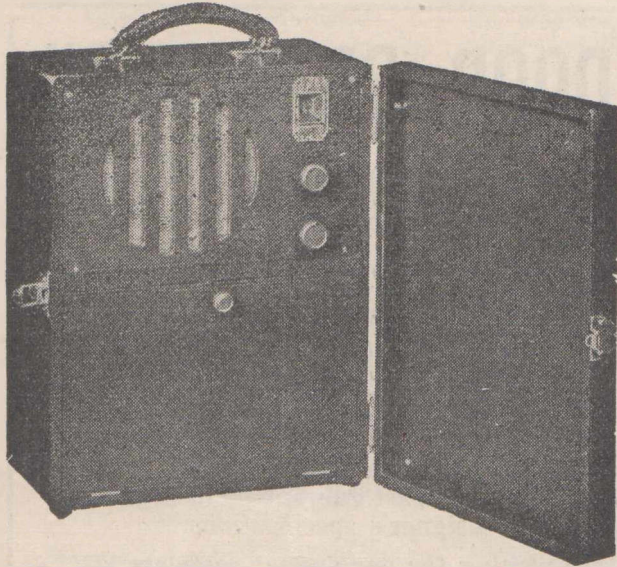

# The . . . 1938 Outdoor Portable Four

**Latest octal-based valves  
and automatic bias are fea-  
tures of new model.**

The "1938 Outdoor Portable" is housed in a leatherette-covered cabinet, measuring 14½" high x 11¼" wide x 7½" deep (including lid). The "A" and "B" batteries are carried in the lower compartment.

ONE of the most popular receivers yet described in "Radio World," the "Outdoor Portable Four" in its 1936 and '37 versions has been built in hundreds by readers throughout Australia and New Zealand, and many letters of appreciation on the fine performance put up by this receiver have been sent in.

### This Year's Improvements.

In this year's model some important improvements have been made, though the chassis and carrying-case

remain the same as for last year's model. Actually, the size is largely governed by the batteries used, and easily the best choice here are two 60-volt light duty "B" units and a two-volt 40-amp. hour accumulator.

It will be remembered that in last year's model a double-pole double-throw economy switch was incorporated. After several months of use, when the "B" battery voltage had dropped to around 95 volts, this switch could be put over to increase the screen voltage on the first two valves, and to decrease the bias on

the output pentode. This restored the performance of the set almost to that obtained when the batteries were new, while a further important advantage was that at no time did the total "B" drain rise above 8 mills., which can be taken as the maximum economy limit for this type of "B" battery.

### Automatic Bias On Output Pentode.

In the 1938 model, automatic bias is incorporated for the output pentode. The 1.5 volts bias needed for the first three valves is obtained from a unit torch cell mounted underneath the chassis. While automatic bias could have been used throughout, this would have necessitated extra components for thorough de-coupling, and

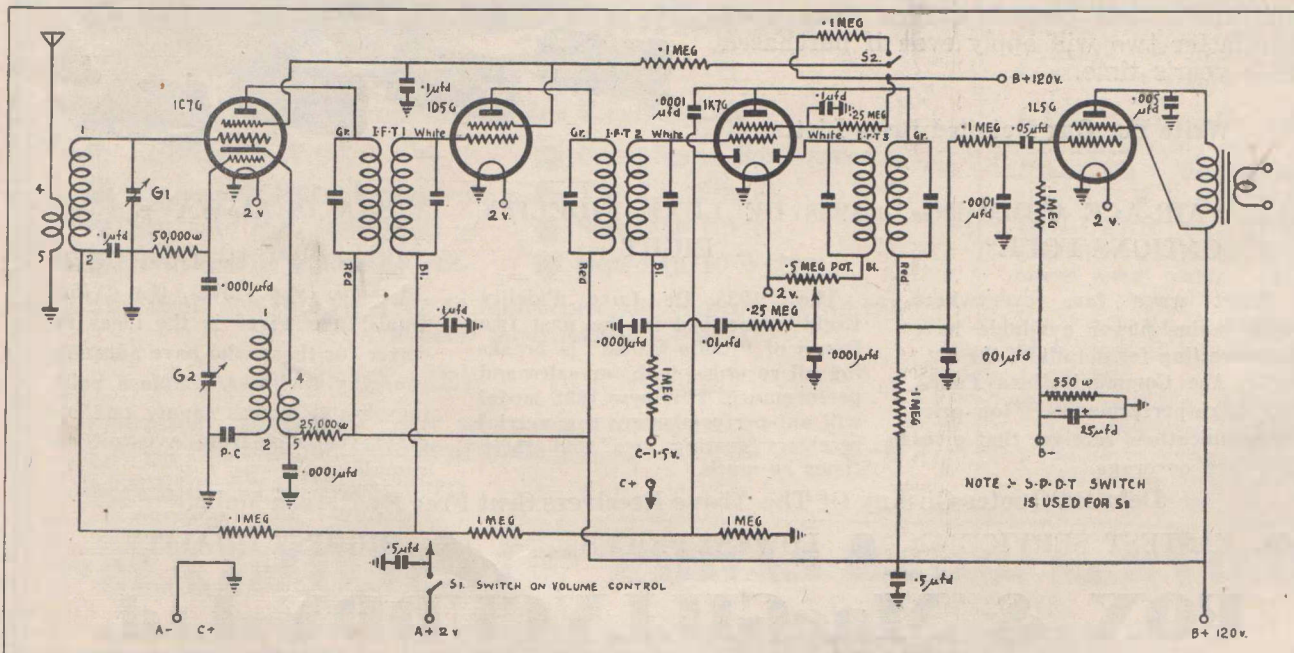

Latest octal-based valves and automatic bias for the output pentode are new circuit features of this year's "1938 Outdoor Portable."



# CLYDE LEADS AGAIN!

SPECIFIED FOR THE 1938  
OUTDOOR PORTABLE  
FOUR



## FOR BETTER RECEPTION, CLYDE RADIO BATTERIES

FOR their silent, smooth-flowing power than ensures best possible results . . . for the remarkable endurance they possess under the most stringent of operating conditions . . . for the all-round excellence of their sturdy construction . . . CLYDE RADIO BATTERIES are second to none. Federal and State Governments show their confidence in Clyde by placing large orders for Clyde's batteries year after year. Clyde Batteries are used exclusively by

the Royal Australian Navy for gun and fire control. Battery failure in wartime could prove disastrous, therefore the Navy relies on Clyde.

From the smallest 2 volt 25 amp. hour 2VS5 to the 6 volt 170 amp. hour "Super" for vibrator receivers, there is a range to suit all radio needs, AND ALL CLYDE RADIO BATTERIES ARE FULLY GUARANTEED. FOR THE FINEST BATTERY BUILT, INSIST ON CLYDE.

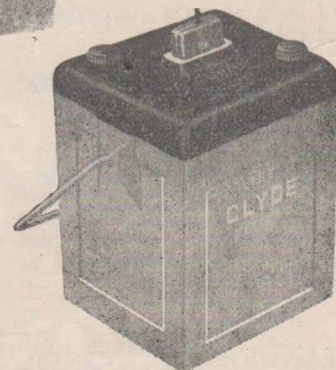

### THE "PLUGG-IN"

Clyde's latest and greatest radio battery achievement is the Plugg-in. By means of the unique cover top for Clyde Batteries instant and correct connection to the receiver is made. Clyde Plugg-ins are foolproof and greatly increase the efficiency and power of your set.

## THE CLYDE ENGINEERING CO. LTD.

61-65 WENTWORTH AVENUE, SYDNEY

Branches and Agents Throughout Australia.



## Here's Your Cabinet for the

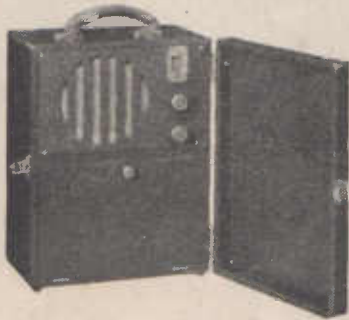

## “1938 Outdoor Portable Four”

DON'T spoil a fine set by housing it in a cheap, shoddy cabinet that won't stand up to hard wear. The cabinet illustrated above was built specially for the job, exactly to the Editor's specifications.

It's light, strong, AND smart—light and strong, because it is built of special timber with dove-tailed joints, smart because it is covered in mottled leatherette, obtainable in black, blue, red, brown, and crocodile, and is fitted with plated hinges and catch.

### PRICE ON APPLICATION

MANUFACTURERS,  
DEALERS & SERVICEMEN!

We specialise in making all classes of cases for test equipment, exactly to your specifications. Workmanship and accuracy guaranteed.

WESTERN  
MANUFACTURING Co.,  
18 THIRD AVENUE,  
FIVE DOCK, SYDNEY

'Phone . . . . . U 3444

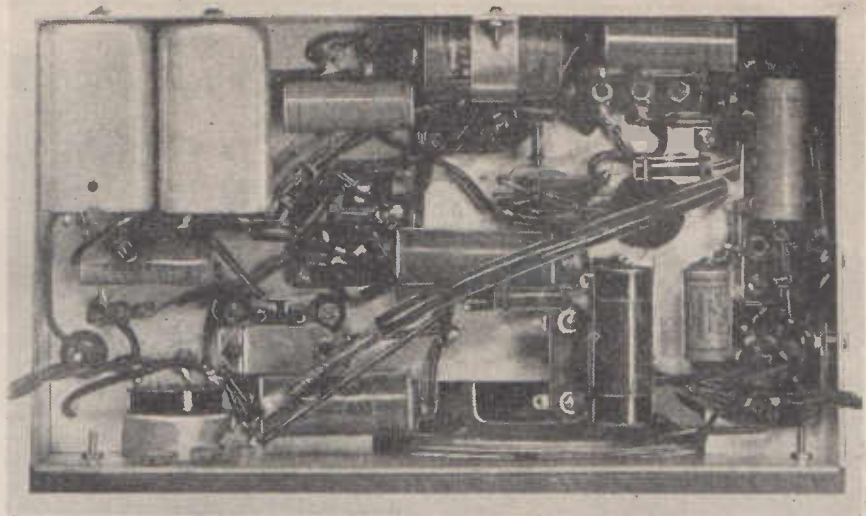

An under-chassis view showing the compact assembly. Note the method of mounting the aerial and oscillator coils, and the way in which the 1½-volt cell is strapped to the rear wall of the chassis. This provides the minimum bias required by the first three valves.

hence it was not thought worth while. As there is no current drain taken from the unit cell, a replacement is required only every year or so.

The main advantage of automatic bias is that the voltage decreases automatically as the “B” battery voltage drops. Thus the bias is maintained always at the value needed for the “B” voltage available. The economy switch has been retained, but as no bias alteration is necessary, a single-pole double-throw switch to increase screen voltage is all that is needed.

The next major change lies in the use of the latest octal-based valves, a 1C7G, 1D5G, 1K7G and 1L5G re-  
(Continued on page 46.)

### The Front Cover

This month's front cover photograph shows a floodlit exterior view of the main studios of station KEHE, of Los Angeles, owned and operated by Hearst Radio Inc. This photograph was sent with a letter of verification of reception to Mr. G. W. F. Rouse, of Potts Point, Sydney, a member of the A.W.A.W. DX Club. KEHE operates on 780 k.c. with a power of 5 k.w. (day) and 1 k.w. (night). A 485-foot vertical radiator is used.

### “1938 OUTDOOR PORTABLE FOUR”: List of Parts

- |   |  |
|---|--|
| 1—leatherette-covered carrying case, with panel, built to specifications (Western Manufacturing).   | 1—.001 mfd. mica (Simplex type P.T.).  |
| 1—coll kit, comprising aerial and oscillator coils, with three 465 k.c. air-core Iitz-wound I.f. transformers and padder (Radlokes, Crown, Foxradio). | 1—.005 mfd. mica (Simplex type P.T.).  |
| 1—2-gang condenser (Stromberg-Carlson).   | <b>TUBULAR FIXED CONDENSERS:</b>   |
| 1—midget tuning dial (Efco).  | 1—.01 mfd. tubular (Ducon).  |
| 2—small bakelite knobs.   | 1—.05 mfd. tubular (Ducon).  |
| 1—.5 megohm potentiometer with switch.  | 4—.1 mfd. tubular (Ducon).   |
| 4—2-lug bakelite strips.  | 2—.5 mfd. tubular (Ducon).   |
| 1—7-lug bakelite strip.   | 1—25 mfd. dry electrolytic, 25v. working.  |
| 1—4-wire battery cable (2-foot length).   | <b>VALVES:</b>   |
| 4—octal wafer sockets.  | 1—1C7G, 1—1D5G, 1—1K7G, 1—1L5G.  |
| 3—goat shields.   | <b>SPEAKER:</b>  |
| 1—banana socket.  | 1—5in. P.M. speaker, input transformer to match single 1L5G (Rola).  |
| 1—sheet copper gauze (10in. x 12in., for aerial).   | <b>BATTERIES:</b>  |
| 6—½in. brass spacers and 6 ½in. bolts and nuts.   | 2—60-volt light duty “B” batteries (Ever-Ready W.P. 60).   |
| 1—S.P./D.T. toggle switch.  | 1—1.5 volt torch cell (Ever-Ready).  |
| <b>FIXED RESISTORS:</b>   | 1—2-volt 40 amp. hour accumulator (Clyde).   |
| 1—25,000 ohm, ½-watt.   | <b>MISCELLANEOUS:</b>  |
| 1—50,000 ohm, ½-watt.   | 1—2-volt 60 m.a. dial light, 3 doz. ½in. bolts and nuts, ½ yard copper braid shielding, insulating washers for aerial socket, push-back (solid and flexible), solder tags, 3 midget grid clips, 8 yards rubber covered aerial wire with banana plug, 3 2-lug bakelite strips, 1 3-lug bakelite strip, 1 9in. length ½in. spaghetti, 4 ½in. mounting pillars, 1 3in. x ½in. aluminium strip for mounting “C” battery. |
| 5—1 meg., ½-watt.   |  |
| 2—.25 meg., ½-watt.   |  |
| 4—1 megohm, ½-watt.   |  |
| 1—550 ohm, wirewound.   |  |
| <b>MICA FIXED CONDENSERS:</b>   |  |
| 6—.0001 mfd. mica (Simplex type P.T.).  |  |



# Vealls 1938 Radio Catalogue Now Ready

An essential to every Radio Fan and Listener—Vealls Big 60-page Radio Catalogue covers the entire field of radio, including Amplifiers, Radio Gramo units and Test Equipment. Write for your copy to-day—it's Free! Merely enclose a 2d. stamp to defray cost of postage—your copy will be sent by return mail.

THOUSANDS OF RADIO ITEMS  
HUNDREDS OF ILLUSTRATIONS



THE MOST COMPREHENSIVE RADIO CATALOGUE PUBLISHED IN AUSTRALIA

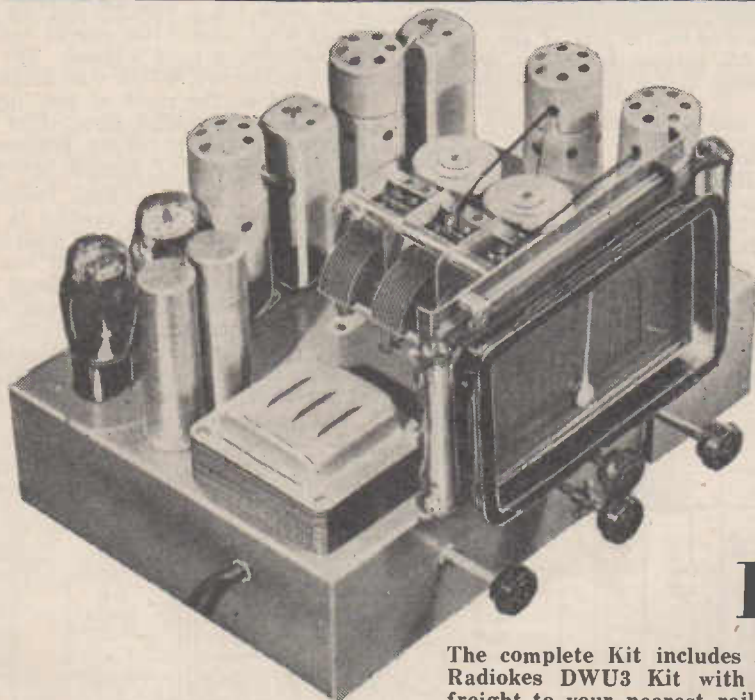

## Challenger Dual-wave Six

For only 13 Gns. you can build the up-to-the-minute Challenger Dual-Wave A.C. Six described in the September issue. Positively the cheapest six-valve Dual-Waver ever offered.

Complete Kit Only  
**13 Guineas**

The complete Kit includes all necessary parts—valves, speaker and Radiokes DWU3 Kit with I.C. I.F.'s—and remember, Vealls pay freight to your nearest railway station.

# VEALLS 6 BIG STORES

All letters to Box 2135T., G.P.O., Melbourne, C1.

490 Elizabeth Street, Melbourne. F 3145.  
168 Swanston Street, Melbourne. C 10524.  
3-5 Riversdale Road, Camberwell. W 1188.

243 Swanston Street, Melbourne. C 3059.  
299-301 Chapel Street, Prahran. Wind, 1605.  
97-99 Puckle Street, Moonee Ponds. FU 7822.



# Adding A Tuned R. F. Stage To The . . . . .

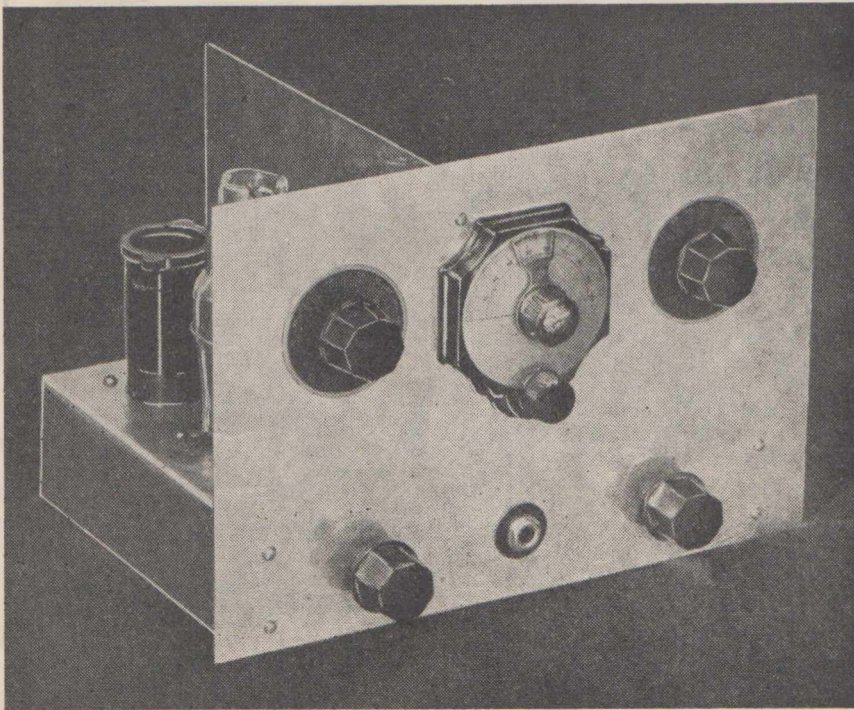

# ATLAS ALL-WAVER

The method of adding an r.f. stage to the single-valve battery-operated all-wave receiver described last month is outlined below.

knob controlling it being that to the left of the main tuning dial in the view shown above.

As in this type of receiver the r.f. tuning control is fairly broad, there is no need for a vernier dial, an ordinary knob and 0-100 degree indicator plate being used instead. The reaction condenser, which was originally located on the right of the 'phone jack, has been shifted upward to the right of the main tuning condenser, and opposite the r.f. tuning control.

Strictly speaking the indicator plate included for this control is not essential, but it matches up with that used for the r.f. control and can be used if desired for jotting down regeneration settings. Incidentally, a white dot of paint placed on these two black knobs will provide indicator settings that are accurate enough for all practical purposes.

The parts required for adding the

The r.f. valve and its associated coil are located on the left of the chassis, an aluminium shield partition screening the r.f. section from the detector. Greatly improved gain and selectivity, with more stable tuning, result from the addition.

In last month's "Radio World" was described the single-valve version of the "Atlas All-Waver," a battery-operated shortwave receiver using a 2-volt class "B" twin valve as detector and audio amplifier.

### R.F. Stage Improves Performance.

An excellent little DX getter, its all-round performance can nevertheless be considerably improved by the addition of a tuned r.f. stage. In the

set illustrated the valve used is the new 1D5G, though as an alternative the older 1A4 equivalent can be substituted. As well as a 1C4 could be used, or in fact any 2-volt battery r.f. pentode.

To prevent inter-action between the r.f. and detector stages, an aluminium shield partition is placed between them. The .00016 mfd. r.f. tuning condenser is mounted on the panel in front of the left compartment, the

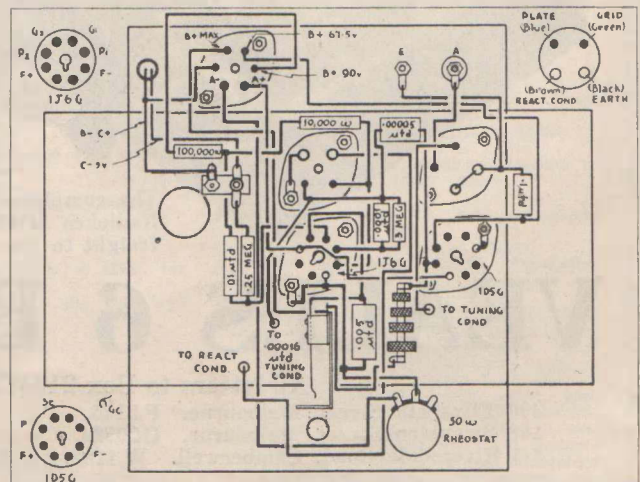
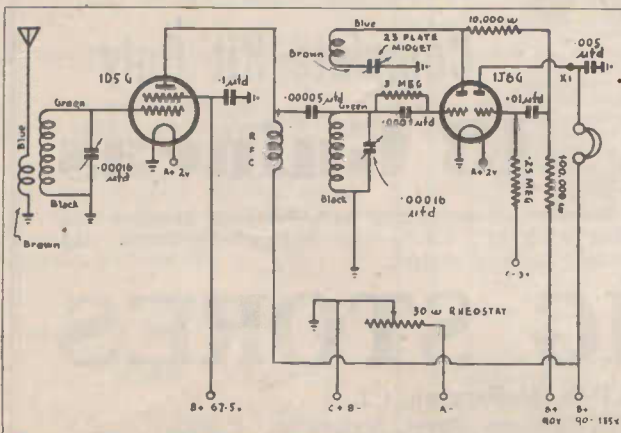

The circuit of the "Atlas All-Waver" as a two-valve is shown above, while the sketch on the right shows the amended under-chassis wiring plan.



r.f. stage are listed elsewhere. The first steps in the construction are to mount the valve and coil sockets, the .00015 mfd. r.f. tuning condenser, and to shift the reaction condenser.

The position of this last-named control is taken by the audio volume control, which is not required until the output pentode is added.

The "A" and "B" voltages taken to the 6-pin power socket are "B-," "B+67.5," B+90," and B+135" volts, "A-" and "A+." The two "C" battery leads—"C+" and "C-3 volts"—are taken out through the rear wall of the chassis via a rubber grommet

**"ATLAS ALL-WAVER"  
PARTS REQUIRED FOR R.F.  
STAGE**

- 1—.00016 mfd. midget variable condenser (Raymart).
- 1—all-wave r.f. choke (Raymart).
- 1—15-600 Metre Amateur All-Wave Coil Kit (Rayway).
- 1—4-pin, 1—octal wafer sockets.
- 1—goat valve shield.
- 1—0-100 2in. indicator plates (Radio-mac).
- 2—knobs.
- FIXED CONDENSER:**
- 1—.1 mfd. tubular condenser.
- VALVE:**
- 1—1D5G.
- MISCELLANEOUS:**
- ½ doz. 3in. nuts and bolts, solder tags, hook-up wire, etc.

mounted to the left of the power socket. The third "C" battery lead—"C-4.5 volts"—will be taken out in the same way when the output pentode stage is added.

**Second Coil Kit Needed.**

A second Rayway All-Wave Coil Kit, identical with that used in the single-valve model, is required for the r.f. stage. In this position the regeneration winding is used as an aerial primary.

The circuit of the complete two-valver is published elsewhere, together with a complete under-chassis wiring diagram, and no difficulty should be experienced in making the necessary assembly and wiring alterations for adding the second valve.

The operation of the set is very similar to that of the single-valve model. Actually, the only additional control is the r.f. tuning condenser, and this is merely kept roughly in step with the main tuning condenser, an increase in noise level—or in volume when a station is tuned in—providing a reliable indication of the point at which the two circuits are in track.

Next month, the addition of an output pentode stage, enabling speaker volume to be obtained from a number of broadcast and shortwave stations, will be described.

**NEW P.A. PROJECTION UNIT GIVES  
GREATEST COVERAGE AT LOWEST  
COST !**

FITTED WITH 8-INCH ROLA REPRODUCER.

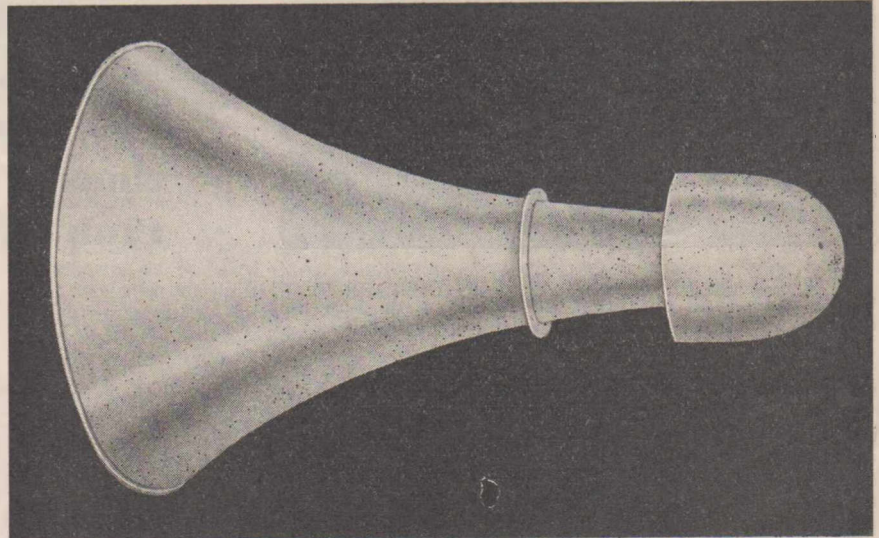

- ★ Horn will increase up to five times the electro-acoustic efficiency of speaker
- ★ Makes speaker output directional
- ★ Allows wanted areas to be covered more efficiently with given amount of power
- ★ Reduces feedback
- ★ Allows more amplifier gain to be used.

**Write for descriptive leaflet**

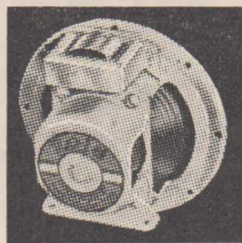

**Rola Speakers For  
"Radio World" Receivers**

Most compact speaker in the Rola range, the Model 5-6 is specified exclusively for the "1938 Outdoor Portable Four." Its remarkable sensitivity and power handling capacity ensure maximum results. The equivalent electro-dynamic model, F-4, is recommended for the "1938 Amateur Communications Eight."

The lately released Rola model 8-14 PM is the ideal speaker for the "Vibra Dual-Wave Five." An eight-inch permanent magnet model with one-inch voice coil, the 8-14 PM has exceptionally high sensitivity and power-handling ability. Is fitted with Rola patented Isocore transformer and is supplied complete with cord and plug. Price, 35/-

Write for latest descriptive leaflet, covering the complete range of Rola Reproducers.

Rola Reproducers are standard with the world's radio and amplifying systems . . . . proof positive of Rola quality !

DISTRIBUTORS AND FACTORY SERVICE FOR N.S.W.

**Geo. BROWN AND CO.  
PTY. LTD.**

268 Clarence Street, Sydney . . . . . (Phone M 3437)  
Sole Australian Agents for **ULTIMATE RADIO**



# Portable Transmitter Taken On Radio Hike



Locating the direction of the base camp by directional radio, and checking the results with map and compass, provided a very interesting experiment.

## Successful Experiments With D.F. Gear ★ Fine For Breach Of Regula- tions ★ Lakemba Radio Club Notes And News

By W. J. P.

**D**URING past months appeals have been made through these columns, at the request of those concerned, for the cessation of unlicensed operating, and, in particular, the use of other amateurs' call signs. The penalties attached to such procedure were very forcibly illustrated last month when an offender in the vicinity of Cessnock, N.S.W., was caught and subsequently fined £50.

### A Radio Hike

In view of the forthcoming summer months when outdoor recreations tend to provide greater attractions than indoor "ham" radio, we will confine the rest of our notes to a brief description of a typical "radio hike" recently conducted by a few members of the Lakemba Radio Club. The objects of the outing in question were to test out some portable radio equipment, and to explore the undeveloped Colong Caves situated on the other side of the Burragorang Valley.

The utility truck was driven as far as possible beyond West Yerranderie on the Saturday, where, after crossing several river fords, we finally pitched camp. A special transmitter was installed at the base camp, and radiated a continuous "toned" signal, while the aerial was arranged to radiate most energy in the desired direction.

Departing on foot at 6.30 a.m. the following morning, a course was plotted by map and compass to take us over ten miles of extremely rough country to the limestone caves. The radio gear and telescopic D.F. aerial were carried in a haversack, and at various stages of the journey a stop was made to make observations. The above photograph illustrates a final check being made on Swamp Head Mountain, and shows 20D making a

directional test, while 2QX is checking this against the map and compass.

The day was very hot and our water supply had run low, due to a number of water holes being dry. The result was that we decided to leave everything at this point except our food and photographic equipment, so as to render the going much easier. After some solid climbing over the Colong switchback and Colong ridge, we descended what seemed like thousands of feet and finally reached the caves area, and best of all, plenty of water.

After lunch, a further 15 minutes was spent in locating an entrance to the limestone caves. The end of a ball of string was attached at the entrance and let out as we progressed, so as to ensure our safe return. Powerful torches were a necessity, as some difficult and dangerous situations were encountered. A number of flashlight photos were taken of the formations inside, one on this page

showing 20D, torch in hand, squeezing between the rock wall and a limestone formation, and being temporarily blinded by our unexpected flash!

As time was limited we were restricted to two hours for exploring purposes, after which we headed back for the base camp. The return journey took about four hours, and necessitated very hard climbing. The transmitter operated successfully throughout the day, and should the occasion have warranted it, would have been quite suitable for guiding us back to camp.

This particular trip was far too long for a single day, but was a most enjoyable one, as it covered some very interesting country, which permitted the testing of certain radio apparatus under very adverse conditions. Might we suggest that if any inexperienced reader undertakes such outings as these, then his party should be fully equipped with accurate maps and compass, as it would be quite a simple matter to become "hopelessly lost,

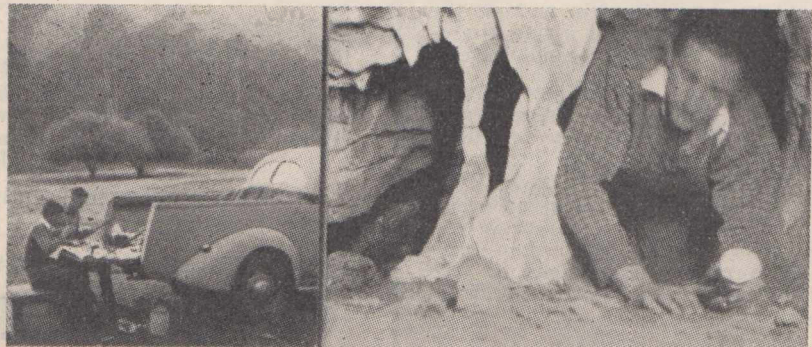

Left: A good breakfast at 6 a.m., prior to starting on the hazardous journey. Right: 20D says that exploring underground caves is not made any easier by unexpected short-range flashlight photos!



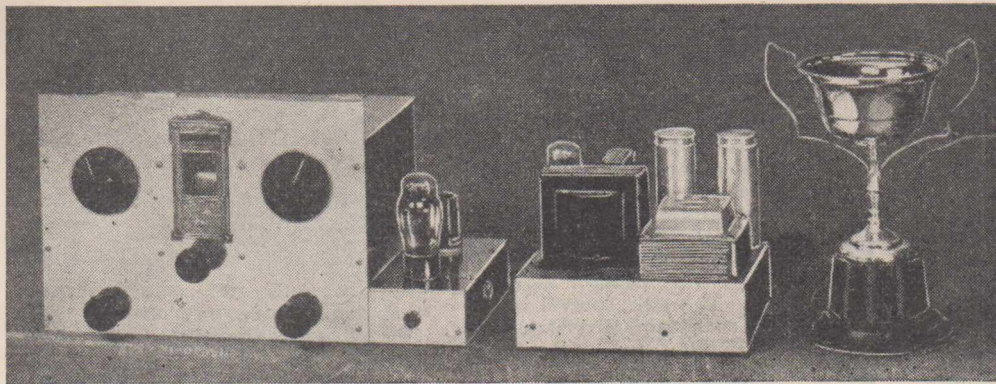

with consequent trouble for police, walking organisations and local bushmen.



### Gladesville District Experimental Radio Club.

On Tuesday, September 12, the club held a meeting which had been keenly anticipated by all members for some time. The receiver-building contest for aspiring "hams" was judged by Mr. Alan Falson, to whom we are indebted for his keen and unbiased inspection of all entries.

A very handsome cup was donated as first prize by Mr. Smith, a local business man, and to him we extend our appreciation of his interest in our club. Two other prizes were donated by city firms, and to them we also say "thank you."

The first prize went to Mr. Frank Shaw, one of our keenest members, and he is to be congratulated on his fine little four-valve t.r.f. receiver. Second prize was won by Mr. Norm. Franks, with a two-valve "Super-Gainer" (described in "A.R.W."), and third prize went to Mr. George Myles, also with a four-valve t.r.f.

Two youngsters, Keith Oldroyd and Harry Preston, received special mention for their fine efforts, and Mr. Falson was warmly applauded when he donated two consolation prizes for these lads.

The remainder of the entrants displayed excellent receivers, and the judge certainly had his work cut out to declare the place-getters.

After supper, the prizes were pre-

The second prize in the Gladesville Radio Club's set-building contest (a two-year subscription to "Radio World") was won by Mr. N. Franks with a two-valve "Super-Gainer" (left in photo). Details were taken from a recent article in "R.W." Third prize (guinea order on Price's Radio) was awarded to Mr. G. Myles, with a four-valve t.r.f. using 58 r.f., 57 det., 56 amp. and 2A5 output (shown on right of photo). Power-packs accompanied both entries, but were not included in the photograph.

sented, together with the prizes in the DX transmitting contest run in conjunction with the North Suburban Radio Club. VK2AII carried off the 809 in this event, and the second prize also went to N.S.R.C. The member's name is not available to the writer, but to those two lucky "hams" we extend our congratulations. The North Shore lads certainly cleaned up the Gladesville crowd, but next time we hope to reverse the result!

General notes have been held over this month owing to the length of the "dope" on the competitions. Photos of the prize-winning receivers are to be seen in this issue, and for this privilege we are indebted to "Radio World." We appreciate their assistance in making our receiver-building contest such a success.

In closing, Mr. Dick Ellis (VK-2AHR) will welcome enquiries about membership of the club. His address is 180 Morrison Road, Gladesville, N.S.W.



### Waverley Radio Club Notes.

By VK2AHJ.

In the last six weeks many items of interest have been discussed and much ground covered by the Waverley Radio Club, the "ground covered" being that between Waverley and Narrabeen Lakes, where the club held its most recent field day on September 18.

Three portable stations were in action, these being 2ABS, 2AFZ and

2AHJ/2TN. "Flea" power was used, genemotors being employed by all for high tension supply. 2ABS derived the best results by getting an R6-7 report from VK4CU on 5-watt 'phone. He was ably assisted by 2AFG's new portable receiver, which was a pleasure to behold.

Home activities have consisted mainly of alterations to the shack, where a new polished-wood desk has been built for the operating position of the new transmitter. The transmitter itself has been the object of much discussion, for it is to be protected by an elaborate system of burglar alarms. The 9-tube receiver will be similarly protected.

The writer was surprised to see the great progress made with the new rig. The gear is most elaborate.

Incidentally, several visitors to the club have decided to become members. Among these are Ivan Bailue (VK2TN), Col Paterson, and Jim and Jack Madden.

Theatre parties are being held every month at a city theatre, and the profit is being used to defray the cost of the new transmitter.

Visitors are always made welcome at the clubroom, "Almant," 13 Macpherson Street, Waverley, and code practice is held every Tuesday evening for the benefit of intending hams. Lectures are also given from time to time; so why not come along one of

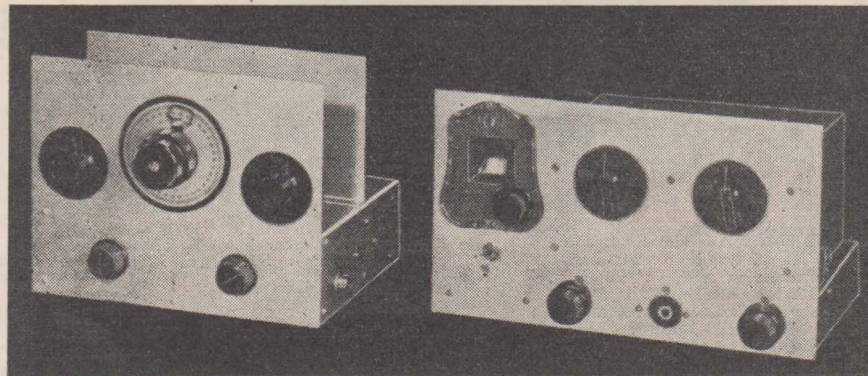



these nights and meet the Eastern Suburbs gang?

### Zero Beat Radio Club Notes

During September the first two lectures were given to the new A.O.C.P. class. Each lecture takes about an hour to deliver, and is then followed by a practical demonstration of the main points covered. The first lecture discussed the elementary principles of electricity, and demonstrations were given of how current flows through various liquids, metals, and gases. In the second lecture, Ohm's law and resistance were dealt with.

The "ham" night during September featured a review on "World Radio" by VK2IQ. This talk was very interesting, to both "hams" and listeners.

The club, realising the unestimable loss to radio caused by the unfortunate and untimely demise of Mr. Ross Hull, sent a radiogram of sympathy and condolence to his relatives, and also recorded the sad occurrence at their last general meeting.

The 18th Field Day of the Club was held at Jannali on the Illawarra line on Sunday, September 25. There

### "Communications Eight" The "Goods"

I have built the A.C. "Communications Eight" and have given it a good tryout on short wave and broadcast. It sure is the goods. I can tune in the main s.w. stations like a local. I am using a 12" fidelity speaker with a 15,000 ohm field, with a 15,000, 2-watt resistor across the field. The tone control is a .05 mfd. condenser (fixed) used with a 15,000 ohm potentiometer (wirewound). The speaker is built in a box, with a baffle 30" x 30" x 1". The tone is superb. I have the front panel and sides of the receiver ducoed white, and the knobs black, and this certainly gives the set a nice appearance.

I, for one, am very pleased with the high quality maintained by the "A.R.W."—R. G. Cook, 162 Alfred Street, Valley, Brisbane, Queensland.

were two transmitters working—2AFQ and 2AEE—practically the whole afternoon. The searchers had to

find 2AEE first, and later were timed to find 2AFQ. Altogether, the gang spent a very pleasant day both from a radio and social point of view. During the morning 2AFQ made contact with VK2AX, of Darling Point, and had a very nice QSO on 'phone.

The winner of the day's outing was VK2IQ, with 146 points. Mr. B. Jones was second with 132 points, and C. Thornthwaite third with 81 points. There were 27 there, and the trouble that some of the receivers gave suggested moths during the winter months! The 19th Field Day will be held on November 27, so there is plenty of time for participants to build new d.f. receivers.

Visitors and intending members are always welcome at the club rooms, situated at "Gregson's Studios," 38 Sydney Arcade, Sydney. Particulars can be obtained from the secretary VK2AJ0 (same address).

The club's station gives two sessions of morse practice between 7 and 7.30 and 8 and 8.30 each Friday night, and also through Club member's stations on Sunday mornings from 10 to 10.30, and Wednesday evenings 7 to 7.30.

## CREATING A FURORE OF ENTHUSIASM...

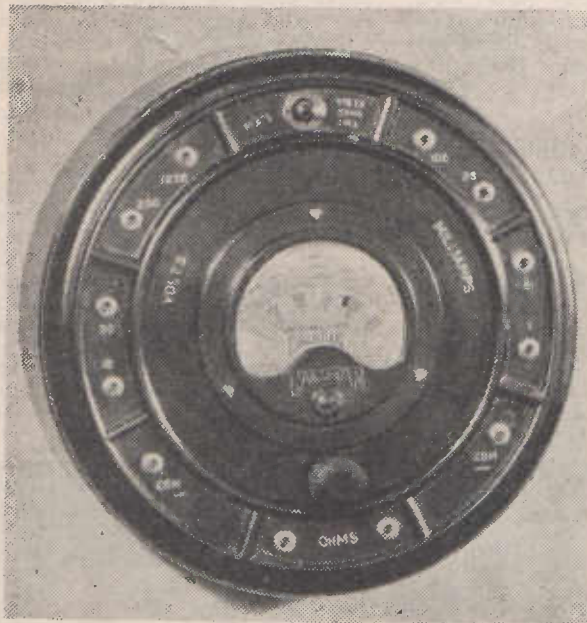

## the NEW CALSTAN CALIBRATED to STANDARD MULTIMETER

# 90/-

PLUS  
SALES TAX

Never before has there been a meter like this! The new Calstan Multimeter is a D.C. volt-ohm-milliammeter in one unit. For the professional service man and the amateur, this unit has many uses and is particularly suitable as a gift. It is built ruggedly for enduring service and conforms to high precision standards.

Range:

M/a's: 1, 5, 25, 100.

Volts, D.C.: 10, 50, 250, 1,250

Ohms: 0-100,000

## SLADE'S RADIO PTY. LTD.

LANG STREET, CROYDON, N.S.W.

### Distributors:

N.S.W.: Australian Radio College, Sydney; Martin de Launay, Ltd., Sydney; Bloch & Gerber, Ltd., Sydney; Fox and MacGillycuddy, Ltd., Sydney; John Martin Ltd., Sydney; Elec-

tric Service Co., Newcastle. Victoria: Australian General Electric, Ltd., Melbourne; Arthur J. Veall Pty. Ltd. Queensland: Chandlers Pty. Ltd.

West Australia: Carlyle & Co., Perth; Normal L. Burnell & Co., 13 Queen Street, Perth. South Australia: Radio Wholesalers Ltd., Adelaide. Tasmania: Noyes Bros.

(Melbourne) Ltd., Launceston.

New Zealand: New Zealand Electrical Equipment Co. Stocks available from Turnbull & Jones, all branches.





This photograph shows the EM1 incorporated as a tuning indicator in an ordinary receiver chassis.

**D**ESPITE the popularity of "oscillator" frequency meters, the absorption type is still a useful device for a number of applications. An important feature of this latter type is its relative simplicity, since it comprises only an accurately-calibrated tuned circuit and an indicator to show resonance.

It is important for such a measuring instrument to have as high a sensitivity as possible, together with a minimum of damping due to the indicator. Generally a thermo-ammeter such as a hot-wire or a thermo-couple meter of compact and robust design has found favour as an indicator. Since instruments of this type consume a certain amount of energy, they exercise a damping effect on the tuned circuit, which restricts the accuracy of calibration by widening the response curve.

#### EM1 Makes Excellent Indicator.

The cathode-ray tuning indicator type EM1 which was introduced for use with receiving sets can also be used to advantage as an indicating instrument for other applications.

An interesting circuit arrangement is given for using the EM1 as an indicator for a frequency meter. It was expected that the EM1 would require a rectifier system for supplying the necessary operating voltages, but it has been found that an alternating voltage can be applied to the plate and target electrodes. In this way the dimensions of the apparatus can

# EMI Makes Good Indicator For Absorption Frequency Meter

**Can Be Added To Existing Equipment: Has Many Advantages**

By Philips Radio Technical Service.

be reduced, and the elimination of the rectifier valve means lower costs.

An instrument built according to the circuit diagram will give improved sensitivity compared with a frequency meter employing a current-operated indicator—and another important feature of this new instrument is sharper tuning. In addition, the EM1 offers the advantage of instantaneous indication without lag, a feature of considerable value where the tuning is subject to rapid variation.

#### Can Be Added To Existing Equipment.

The cathode ray indicator and associated components can be added to an existing frequency meter, but this will alter the original calibration, which must be corrected. The General Radio absorption wavemeter can readily be modified in this way, and the additional parts can be conveniently built into an independent casing and provided with lug contacts to clamp to the normal coil terminals.

From the circuit for the frequency meter employing the cathode ray indicator, it will be seen that the triode section of the EM1 is connected as an anode-bend detector. A resistance of 0.1 megohm is recommended for the cathode.

#### No Rectifier Needed.

The high tension supply has been simplified by employing an alternating voltage. As a result, the EM1 functions only during the small part of each cycle, viz., during the time the target and plate electrodes receive a positive potential of adequate magnitude. Fortunately it has been found that a steady pattern free from flicker is obtained on the fluorescent screen.

The addition of a rectifier would improve the sensitivity of the apparatus, but the advantage gained hard-

ly justifies the extra components. The self-rectification circuit described here is recommended, since it represents the best compromise.

In this frequency meter circuit, the average plate current of the EM1 increases with increasing strength of the radio frequency input, due to the anode bend detection. The voltage applied to the deflector plates drops (as a result of the series resistance) and the pattern becomes smaller with increasing signal strength. In other words, resonance is indicated when the pattern is tuned to a minimum.

#### Will Withstand Heaviest Overloads.

An advantage of considerable importance in the field is that the tuning indicator can withstand almost every conceivable overload, a claim which cannot be made for the majority of current indicators. If it is found that the minimum deflection is rapidly realised, and that no further variation occurs over a section of the tuning control, the coupling between the frequency meter and the source under investigation should be reduced until a sharp resonant point occurs.

—Philips Radio Technical Service.

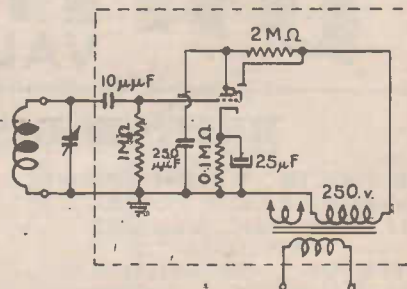

This circuit shows the application of the EM1 as an indicator for a frequency meter.



## IT'S THE BEDSIDE RADIO THAT'S BROKEN

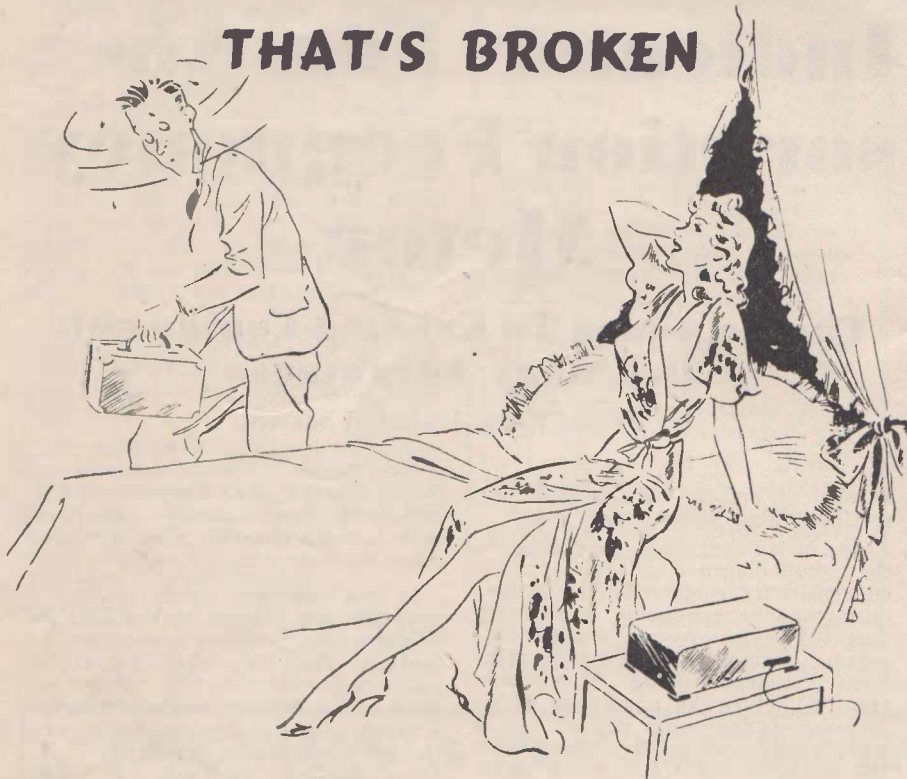

Some radio service men get themselves into some awkward predicaments. But there's one way to avoid valve trouble, and that's change to Brimar. By using a really dependable replacement you gain prestige as a radio man who really knows his valves.

Brimar stocks are immediately available in every possible type in any quantity—no waiting—no substituting.

Make "Brimar throughout" your motto.

# BRIMAR

## VALVES

### BRIMAR DISTRIBUTORS

NEW SOUTH WALES: Standard  
Telephones & Cables Pty. Ltd., 258-  
274 Botany Road, Alexandria.  
VICTORIA.

Noyes Bros. (Melbourne) Ltd.  
597-603 Lonsdale St., Melbourne.

WESTERN AUSTRALIA: M. J. Bate-  
man Ltd., Milligan Street, Perth.

QUEENSLAND: Trackson Bros. Pty.  
Ltd., 157/9 Elizabeth Street, Bris-  
bane.

SOUTH AUSTRALIA: D. Harris &  
Co., 140 Rundle Street, Adelaide.

NEW ZEALAND: Standard Tele-  
phones and Cables Pty., Ltd., Tro-  
jan House, Manners St., Wellington.

### Cheap Chassis And Panels.

I feel it is time I wrote in again and told you how receiving conditions have been here. As we travel around a bit, my set is a portable—only two valves—30's and battery-operated.

Possibly the best DX was OA4AW on 20 m. 'phone—R4, Q4 for an hour, heard September 24, 6-7 p.m. Many Europeans have been heard, and the first "PA" call was logged recently. VK8SK in Broken Hill was heard testing on 6690 k.c. on Friday evening at R6, and quite a few VK8's may be heard nightly, the best being 8TJ and 8TV—R5-6 on a two-valve receiver, too!

LU8EN was heard one Sunday morning after the slow morse code session from a Zero Beat Club member. The XU6's and XU8's are regular on 40 m. A description of the damage done by the hurricane in New York was heard from W8XK (19.72 m.) one morning. This was given by an outdoor announcer and was very interesting. PK1VY has verified and asks for reports as he has increased power.

A kink which may be of use to some experimenters:—

When, for reasons of economy, aluminium chassis and panels are not possible, quite a good substitute can be made by gluing the zinc from tea chests (or the lead foil is quite effective) to pieces of plywood cut to shape and prepared thus:—

After cutting the plywood, smooth and paint all over with shellac. While the shellac is still wet on one side, place a piece of flat zinc on it and roll it on flat with a photographic print roller. Allow the shellac to set, then trim the zinc.

Excellent partitions can be made by attaching the zinc to both sides of the plywood, all being in order as specified in the A.R.R.L. Handbook—this being equivalent to two sheets of aluminium.—G. B. Lance (AW133-RX), C/- "St. Andrew's," Dawson St., Ballarat, Victoria.

★

### An Appreciation From America.

My subscription to your fine magazine, "The Australasian Radio World," is about to expire, so I am writing you to have it extended for another year.

I have enjoyed the magazine very much in the past year and still think that it can't be beaten. The Editor as well as the publishers should be congratulated for putting out such a fine magazine. Its variety of material appeals to everyone whether he be an amateur, DX fan or an experimenter.

In closing I wish the publishers the best of luck, and will be waiting to receive "The Radio World" for the coming year.—H. L. Christine, Parsons, Kansas, U.S.A.



# A.O.C.P. Questions & Answers

A.O.C.P. Examination Paper.  
—January, 1938.

1. Describe with the aid of simple schematic diagrams three of the following types of oscillators:— (a) Hartley, (b) Colpitts, (c) electron-coupled, (d) tuned grid tuned plate.

A.: (a) The Hartley oscillator has the tuned circuit "LC," which determines the frequency, connected between grid and plate of the valve. The cathode or filament is tapped on to the coil near the grid end, the grid excitation depending on the position of this tap. The circuit shown in the diagram is shunt-fed, but many variations of the Hartley circuit are possible.

(b) The Colpitts oscillator similarly has the tuned circuit connected between grid and plate, but in this case the feedback is capacitive instead of inductive. The grid excitation is obtained by tapping portion of the capacitance between grid and plate.

(c) The usual electron-coupled oscillator is a variation upon the Hartley theme. A screen-grid valve is necessary. The tuned circuit is connected between grid and earth, but since the r.f. potential of the screen is practically earth potential owing to the presence of the large screen bypass condenser, the screen is the virtual plate. The cathode which is tapped on the coil as in (a) is now necessarily above earth potential. If the normal plate of the valve were omitted the circuit shown could be described as a series-fed grounded-plate Hartley.

The screen effectively shields the plate from the other elements; the

The questions set for an A.O.C.P. examination for last January, together with model answers, are published in the article below—the sixth of a series specially written for "Radio World" by . . .

H. WHEELER (VK5HW)

oscillator therefore remains very stable during variations in plate conditions. The only coupling between oscillator and plate circuits is through the electron stream.

(d) The tuned grid tuned plate oscillator has separate tuning circuits in the grid and plate of the valve which are not inductively coupled. The feedback is through the inter-electrode capacitance of the valve itself. Oscillation occurs when the two circuits are approximately in resonance.

2. (a) Show three methods of grid biasing. (b) By diagrams indicate the operating points on the characteristic curve of a triode for linear amplification and rectification. Give an illustration of each.

A.: (a) The first method of grid-biasing (see fig. 2) makes use of an external source of voltage, the negative terminal of which goes towards the grid, and the positive to the cathode. A battery is shown providing the bias, but an eliminator may be used, or the bias may be obtained from the negative end of a voltage divider connected across the plate supply.

In the second system shown, a resistor is placed in the cathode circuit. Plate current flowing through this resistor sets up a voltage drop

equal to the product of resistance and current. The lower end of the resistor then becomes negative with respect to the cathode, and this difference of potential is applied to the grid. The bias voltage varies automatically with plate current. It is necessary to bypass the resistor with a suitable condenser.

Grid bias may also be provided by using a grid condenser in conjunction with a grid-leak having a resistance suitable to the amount of excitation available. The bias voltage is equal to the product of resistance and grid current.

(b) Fig. 3 shows the form of the dynamic characteristic curve of a triode. Plate current in milliamps. is plotted on the vertical axis, and grid voltage along the horizontal. The plate current commences to flow at a certain negative value of grid voltage called the cut-off bias, and for a short range the relationship is not linear, but after the lower bend the charac-

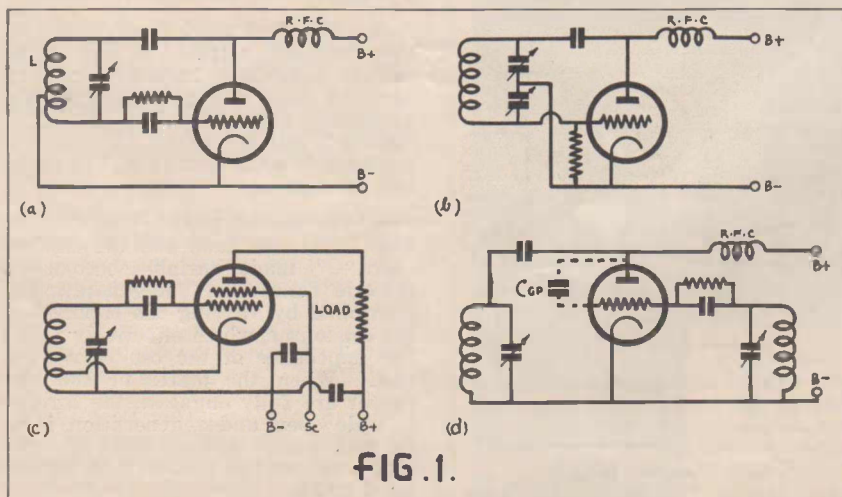

FIG. 1.

Fig. 1.—Types of oscillators (see question 1). (a) Hartley, (b) Colpitts, (c) electron-coupled, (d) tuned grid tuned plate. Fig. 2 (right) illustrates the answer to question 2a. (a) fixed bias, (b) automatic bias, (c) grid leak bias.

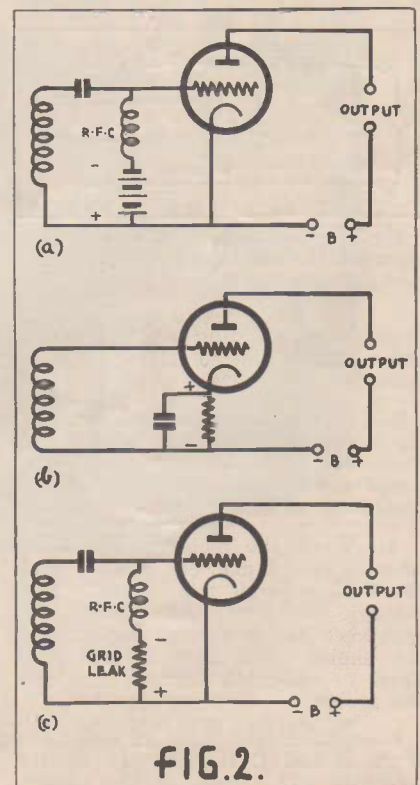

FIG. 2.



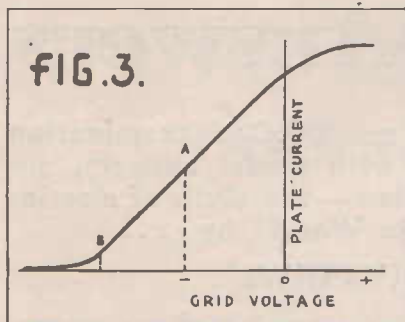

Fig. 3.—Typical triode characteristic curve (see question (2b)).

teristic rises in a straight line until saturation current is attained, or until the positive grid attracts enough electrons to diminish the flow to the plate, causing the curve to flatten again. Amplification is linear only when the grid is biased on the straight portion when a single valve is used. If a point "A" be chosen midway between the lower bend and zero bias, the maximum amount of grid swing can be used, allowing the excitation to swing the grid over the straight negative portion only. Ordinarily the grid should not swing positive. This is the condition for Class "A" audio amplification.

If the grid were biased at point "B" on the lower bend, when excitation is applied only the positive half-cycles will cause a rise in plate current. The negative half-cycles will be much less prominent in the output;

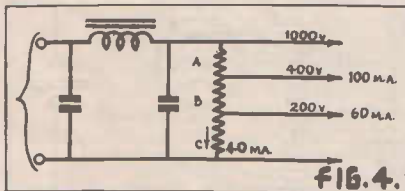

Fig. 4.—Candidates are asked to calculate the resistances A, B, and C (see question 4).

thus the alternating e.m.f. is rectified. This is the condition for plate detection.

3. Given an 0.1 milliammeter, having a resistance of 9 ohms, find the value of the shunt resistance you would use to obtain a full scale deflection of 10 m.a.

A.: When the meter is indicating 10 m.a., only 1 m.a. can flow through the coil, hence 9 m.a. must pass through the shunt. As current and resistance are inversely proportional, the shunt must have a resistance equal to one-ninth that of the coil, i.e., 1 ohm.

4. Calculate the value of resistance of A, B and C respectively in the power supply shown in the accom-

panying sketch. The value of current in Section C is 40 m.a.

A.: The problem is shown in fig. 4. The current through section "A" is  $100 + 60 + 40 = 200$  m.a. or 0.2 amp. and the voltage drop is  $1000 - 400 = 600$ . The resistance is therefore  $600 / 0.2 = 3000$  ohms.

Through section "B" the current is  $60 + 40 = 100$  m.a. and the voltage drop 200. The resistance therefore is 2000 ohms.

In section "C" we have 40 m.a. and 200 volts, requiring a resistance of 5000 ohms.

5. Select and explain briefly, with the aid of simple diagrams, three methods of amplitude modulation.

A.: Two methods of modulation were described in the answers to the second exam. paper in the June issue. A third is given here. (See Fig. 5).

The series plate, or constant potential method of modulation, makes use of a modulator whose plate circuit is connected in series with the plate circuit of the modulated amplifier.

The plate voltage supply must be equal to the sum of the two voltages required. For complete modulation, the plate current must vary between zero and double the mean value. The highest plate current permissible will flow when the grid of the modulator is zero, since the modulator is Class "A" and its grid must not run positive.

The modulator bias is chosen so as to give half the plate current that flows at zero grid, which will be about half cut-off bias. The maximum audio input permissible will swing the modulator grid from almost cut-off to zero, and the plate current from zero to double normal value. The current of the modulated amplifier will vary over the same range since it is in a

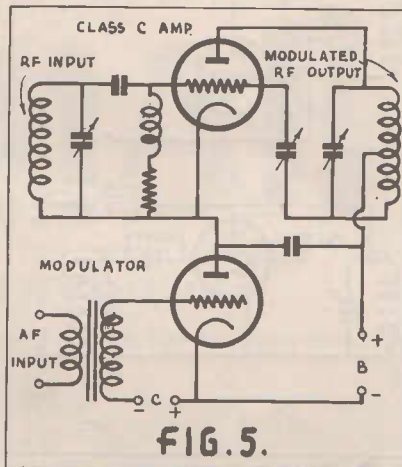

Fig. 5.—Illustrating series modulation (see question 5).

series circuit, and its output will be correspondingly modulated.

6. Describe three causes of interference to broadcast reception due to experimental transmissions and, with the aid of diagrams, explain how each can be eliminated.

A.. For a description of interference due to key-clicks, blanketing, and mains feedback, see the answer to the third question in the July 1937 exam. paper.

7. Give a diagram of a current fed half-wave 40-metre Hertz antenna

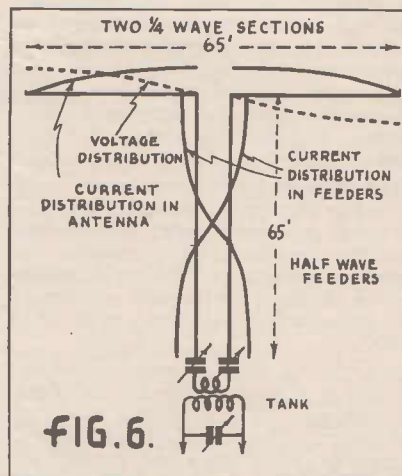

Fig. 6 shows a current-fed Hertz antenna and feeders for the 40-metre band (see question 7).

and feeders. Indicate the dimensions in feet and show standing waves.

A.: See Fig. 6.

8. With the aid of simple schematic circuits, illustrate and describe three methods of regeneration control in a single-valve autodyne receiver.

A.: The first method of regeneration control illustrated in Fig. 7 (a) utilises a variable inductive coupling between plate and grid coils of the autodyne detector. The plate or "tickler" coil is backed off until the feedback is weak enough just to maintain oscillation.

In the second method the coils in Fig. 7 (a) are fixed and the condenser "C" made variable becomes a throttle condenser. Regeneration is controlled by varying the capacity of the condenser, which effectively varies the impedance of the oscillatory circuit. When the plates of the condenser are fully engaged, the throttle is wide open and regeneration is at its maximum. A diminution of capacity weakens the feedback to the desired point.

The third method, shown in Fig. 7 (b), is an example of resistance control of regeneration. The circuit is



the same as before except that a screen-grid valve is used, and its regeneration controlled by a variable screen voltage obtained from a potentiometer "R."

9. State the causes of radio frequency instability due to: (a) mechanical effects, (b) dynamic effects.

A.: Mechanical effects causing frequency instability in an r.f. circuit are due to a non-rigid construction, or to changes in temperature, giving rise to mechanical expansion and contraction. If the coil is shaken the

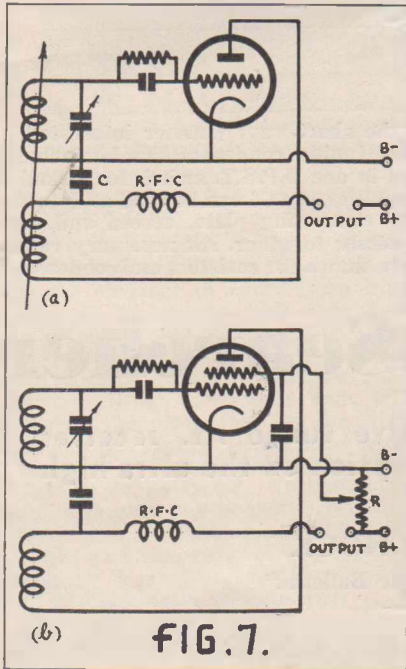

FIG. 7.

Fig. 7 illustrates two methods of regeneration control (see question 8).

spacing of the turns may vary, resulting in varying inductance and distributed capacity values. The vibration of the condenser plates results in varying capacity. All of these effects are reflected in the frequency of the tuning circuit.

Similarly, as the valve electrodes are included in the r.f. circuit, any displacement from their normal positions due to heating also gives rise to mechanical instability. The effects due to varying capacity will naturally be less pronounced in circuits having high "C/L" ratios.

Any factor affecting the dynamic characteristics of the valve, such as variations in plate voltage and load, will give rise to dynamic instability of frequency. The load is not so important in an e.c. oscillator. Inadequate filtering and poor regulation in the power supply are the main causes.

# THE ONE RADIO BOOK You Must Have!

1938

## AUSTRALIAN OFFICIAL RADIO SERVICE MANUAL

# 300 CIRCUITS and Data of Australia's 1937 STANDARD RECEIVERS

COMPLETE SERVICE DATA OF STANDARD 1938 RECEIVERS WITH CIRCUIT DIAGRAMS

Vol. 1 1938

Radio men the length and breadth of Australia declare this to be the outstanding radio book of the year. There are only a few copies left, so order NOW from your wholesaler or from the publishers, The Strand Press, Box 1538-V, G.P.O., Brisbane.

The 1939 issue is now in course of preparation—place your order in advance to avoid disappointment.







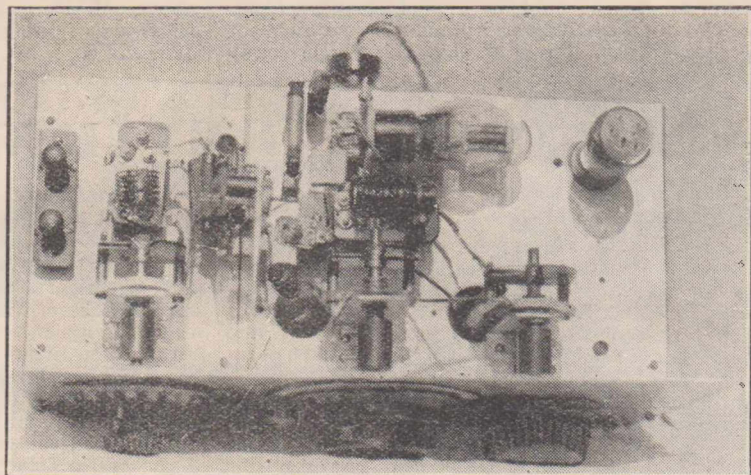

Fig. 2.—The 956 plate is seen projecting through the partition, with a metal cover as additional shielding. The two smaller coils are in the foreground. The detector valve is mounted horizontally.

Covers From 4 To 12 Metres.

What may appear to be a fairly high tuning capacity is used to enable the receiver to cover from four metres to 12 metres with only two sets of coils. The r.f. stage is capacity-coupled to the detector through a small 30mmfd. trolitul trimmer condenser, with an Eddystone 2mh. r.f. choke in the plate feed to the 956. Best detector action is obtained with a 50mmfd. grid condenser and 5meg. leak to earth, as shown. Cathode-bias resistor for the 956 is 1500 ohms, bypassed by a .006mfd. mica condenser, and the 41 audio pentode is cathode-biased by a 400-ohm resistor and a 25mfd. electrolytic condenser.

The heart of the receiver is the oscillation control, and if this is not positive and perfectly smooth the receiver will be practically useless. Oscillation is controlled by a 20mmfd. variable condenser from the B plus side of the reaction coil to earth, the system used in nine out of ten triode-detector regenerative short-wave receivers. It is a "sure-fire" method provided that coil arrangements are suitable and components sensibly laid out. Although the audio transformer is parallel-fed, this is not essential. It is a safeguard against d.c. breaking down the primary in moist climates. The detector is well decoupled against audio instability, as shown in the circuit (Fig. 1). The r.f. choke in the plate of the detector valve is an Eddystone choke similar to that in the r.f. valve-plate feed.

Low-Loss Coils Essential.

It is of little use to employ the conventional form of short-wave plug-in coil in this kind of receiver. Those finally decided upon are logically sound and completely "low loss." With the exception of the reaction, the coils are of heavy-gauge copper and "air-wound." Isolantite padder blocks, obtainable from John Martin Ltd., Clarence Street, Sydney, make ideal coil-mountings for the purpose. The G R. type banana plugs (Price's Radio, Sydney) fit perfectly into the holes moulded in the blocks, and the nuts on the plugs fit snugly into the recesses. Four plugs and one padder block make up a coil-mounting, with four solder lugs locked under the nuts so that the coils can readily be soldered to them.

It is obvious that the reaction coil must be firmly mounted in relation to the detector grid coil in each case, and this problem was solved by making a small bakelite bobbin about 3/8 in. long. This is of a diameter to fit tightly into the turns of the grid coil at the earth end, being cellulose-cemented in place. The reaction coil turns are then wound on this bobbin. After the coils have been wound and soldered to the mounting lugs each grid coil is fixed against vibration by the cementing of two strips of thin celluloid on opposite sides of the coil. The result of this treatment is a solid assembly free from vibration. Specifications are given elsewhere.

The smaller coils are spaced about 1/8 in. between turns, and the larger

	R.F.	DETECTOR	REACTION.
4 to 8 metres . . . .	6 turns 14 enam., 3/8 in. diameter	6 turns 14 enam., 1/2 in. diameter	4 turns 30 D.S.C.
7 to 12 metres . . . .	7 turns 14 enam., 3/4 in. diameter	9 turns 12 enam., 3/8 in. diameter	6 turns 30 D.S.C.

# Boost your Signals from R4 to R9+

**"NOISEMASTER" Aerial Kit drags up signals out of the mush to overload your speaker**

**D**O mush and hellish noise drown these sought-for, rarely heard distant stations? Let the "NOISEMASTER" Engineered All-Purpose Aerial Kit drag them in and boost up signals to overload your speaker. "NOISEMASTER" wipes out noise and local static, and boosts up signals, even as much as from R4 to R9 plus!

No one else would ever dare make such a claim —no other aerial of ANY TYPE can give you such incredible performance, because "Noisemaster" is the only Aerial Kit authorised to use the wonderful American invention "ANTENNEX." It acts like a purifier and cleans out every trace of locally created noise, leaving all stations beautifully clear at astounding volume.

Besides, you get in the "Noisemaster" Kit 200 feet of special aerial wire, 12 specially designed transposition blocks, earth clamp, lead-in strip, screws, lightning arresters, etc. Easy to-follow instructions and drawings with each Kit enable you to set up your aerial in a very short time. No testing. No doubt. No delay. Once "Noisemaster" is fitted, your noisetroubles end! Send this special form for your "Noisemaster" Aerial Kit NOW, and have revealed to you a glorious new thrill in reception that makes you feel your set is new again.

**Send for yours without Delay**

Antennex (A'sia.) Corporation  
Box 3868 T, G.P.O., Sydney.

Send me right away your "Noisemaster" Kit. I enclose 52/6 in postal notes, money order, cheque. (Add exchange to country and interstate cheques.)

NAME .....

ADDRESS .....

A.R.W. 7/38.



coils are close-wound. For the coil-mountings, sockets to suit the G.R. type plugs are used, and the material is WT/22 (loaded ebonite). To make sure that the coil tallies with the mounting a padder block is used as a template to mark out the positions for the holes with a fine steel scriber. As the plugs are of the banana type, a little latitude is permissible, but accuracy in drilling is desirable.

#### Constructional Points.

An aluminium chassis measuring 14in. by 8in. by 3in. is used for the foundation, with a panel 14in. by 9in. Between the r.f. stage and detector is fitted the usual interstage partition, in this case with a hole bored to admit the plate end of the 956 valve. The socket is mounted on the r.f. side of the partition, and for this reason screen and suppressor connections are reversed. If the socket is mounted as indicated in the valve-maker's chart it will have to be on the detector side of the partition. Mounting on the r.f. side makes for better screening between stages.

In order to minimise mechanical noises, which are likely to be troublesome at u.h.f.s., the tuning and reaction condensers are mounted on brackets, with extension shafts of ¼in. insulating rod and insulating couplings. Fig. 2 shows the layout clearly. It will be seen that the detector valve is mounted horizontally with the socket on a metal bracket. This is done in order to obtain the shortest possible leads in the detector-tuned circuit. The coil-mountings are fitted above the chassis on stand-off bakelite pillars. This not only makes for shorter leads, but keeps the coils away from the mass of metal.

In wiring the receiver, heavy-gauge copper is used for r.f. and detector-grid circuits, and earth returns are taken to one central point for each stage.

#### Alternative Valve Types.

Alternative valves that could be used are firstly the new 1851 Radiotron for the r.f. stage and a 6C6 or 6J7 as high-gain triode for the detector. In the latter case plate, screen and suppressor will be connected together. A 6J6G was tried in place of the 76, but oscillation control was found to be difficult. The suggested 1851 valve is a new development for u.h.f.s. by Radiotron. It is a 6.3-volt r.f. pentode of the metal type, and remarkable claims are made for it in overseas technical publications. The valve was not available at the time the receiver was designed.

The experienced short-wave constructor should have little trouble in getting the receiver to work smoothly if construction and wiring are done correctly. When tested, overseas amateur 'phone stations were heard on 10 metres at excellent strength, and local

five-metre amateurs could be copied easily. This kind of receiver is easier for the s.w.l. to get into action than a

superhet, and, above all, it opens a new field of short-wave listening which is well worth while.

## RADIO BOOK REVIEWS

### Radio Frequency Electrical Measurements.

Of interest to radio engineers generally, and to amateurs maintaining an experimental laboratory, is "Radio Frequency Electrical Measurements," of which the second edition has just been released. The author is Hugh A. Brown, M.S., E.E., Associate Professor of Electrical Engineering at the Illinois University. An amateur himself (W9YH), his book is dedicated to his fellow amateurs.

The text presents both the well-known methods of making electrical measurements at radio frequencies in the laboratory, and also details some of the important advances recently made in the solution of r.f. measurement problems.

The following chapter headings will provide an indication as to the content:—Measurements of Circuit Constants; Measurement of Frequency; Antenna Measurements; Electromagnetic-Wave Measurements; Measurement of Electron-Tube Coefficients and Amplifier Performance; Electromotive Force, Current, Power; Measurement of Wave Form; Modulation, Receiver and Piezo-Electric Crystal Measurements.

"RADIO FREQUENCY ELECTRICAL MEASUREMENTS," second edition, by H. A. Brown, M.S., E.E., published by McGraw-Hill Book Co. Inc., U.S.A., Our copy from Angus & Robertson Ltd., price £1/6/-, postage 10d.

### Handbook On Noise Suppression.

Radio noise in its various forms is always a source of annoyance to amateurs and listeners generally. Common types of interference and methods of suppression are covered in the "Radio Noise Reduction Handbook," published recently by "Radio," the well-known American amateur magazine. Constructional data on noise balancers and noise limiters is also included.

"RADIO NOISE REDUCTION HANDBOOK," first edition, published by Radio, Ltd., U.S.A., Our copy from Angus & Robertson Ltd., price 2/6, postage 2d.

### "Wireless Direction Finding"—New Edition.

"Wireless Direction Finding," by R. Keen, B.Eng., has just been published from the offices of "Wireless World" in a third and enlarged edition. There is a comprehensive manual on direction finding dealing with wave propagation and D.F. theory in relation to modern ground, marine and aircraft installations. A comprehensive bibliography is included.

"WIRELESS DIRECTION FINDING," third edition, by R. Keen, B.Eng., published by Hiffe & Sons Ltd., London. Our copy from Angus & Robertson Ltd., price £2/2/-, postage 1/2.

### "Radio Antenna Handbook."

Every amateur should have a copy of the latest edition of the "Radio Antenna Handbook," which presents a comprehensive and practical outline of the whole antenna problem for the amateur and others using the high frequencies. Actually, a little time and money spent on increasing antenna efficiency will do more to increase the strength of the distant received signal than increasing the power output of the transmitter several times.

The matter presented in this handbook is essentially practical rather than theoretical, although each function of the antenna and its associated feeder equipment is discussed in some detail.

"RADIO ANTENNA HANDBOOK," second edition, published by Radio, Ltd., U.S.A. Our copy from Angus & Robertson Ltd., price 6/-, postage 3d.

### "Radio Amateur Course."

A complete radio amateur course covering both the theory and practice of building and operating an amateur radio station is presented in this handbook by the well-known American amateur, George W. Shuart (W2AMN).

In addition to a detailed explanation of the fundamentals of radio and a chapter devoted to hints on learning the code, constructional details are given of a variety of transmitters and receivers, of both simple and advanced construction.

"RADIO AMATEUR COURSE," first edition, by G. W. Shuart, published by Short-wave & Television Magazine, New York. Our copy from Angus & Robertson Ltd., price 4/6, postage 4d.

### VK2ME, 3ME And 6ME —

#### Schedules For November

The following transmission schedules will be observed by shortwave stations VK2ME, VK3ME and VK6ME during November:—

	VK2ME (31.28 m., 9590 k.c.)	
	Sydney Time.	G.M.T.
Sundays:	4-6 p.m.	0600-0800
	7.30-11.30 p.m.	0930-1330
Mondays:	Midnight-2 a.m.	1400-1600
	VK3ME (31.5 m., 9510 k.c.)	
	Melbourne Time.	G.M.T.
Nightly		
Monday to	7 p.m.-10 p.m.	0900-1200
Saturday		
(inclusive)		
VK6ME, Perth (31.28 m., 9590 k.c.)		
	Perth Time.	G.M.T.
Nightly		
Monday to	7 p.m.-9 p.m.	1100-1300
Saturday		
(inclusive)		



MEET THE NEW D1503  
**DELTA**  
 MULTITESTER

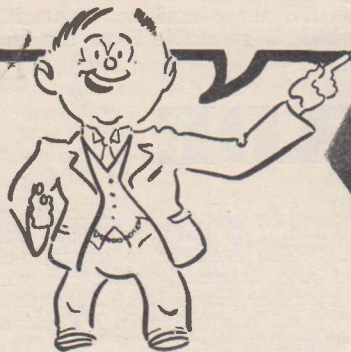

**DELTA MODEL D666**

Small, compact, and highly efficient, this new Delta Portable Multimeter incorporates a precision-built Triplett Model 327 D.C. Microammeter, 0/300. Same scale used for A.C. and D.C. Volts. It is fitted in a highly finished wooden case, 6½ in. x 4 in. x 3½ in., with an attractive engraved panel in black, silver and red.

**RANGES:**

A.C. and D.C. Volts; 10-50-250-1,250; D.C. Milliamperes, 1-10-50-250; Ohms, 0.2-500 and 100-100,000. Selector switch for instrument readings. Ohms adjuster and A.C./D.C. switch, A.C. and D.C. jacks. Self-contained battery. Test leads and prods included. PRICE ..... £6/10/-

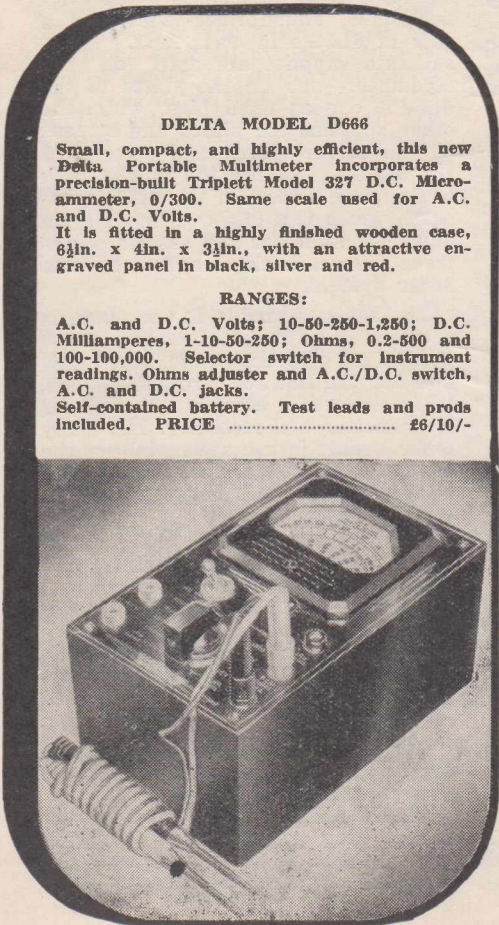

When the Delta Models 735 and D666 were introduced a short time ago, their high standard of accuracy, design and performance met the approval of the most critical. The new DELTA D1503 Multitester is destined to receive the same enthusiastic approval. For this new instrument embodies the precise design, the engineering skill and the careful craftsmanship so essential to fine performance in test equipment. Because the new DELTA Multitester is of such advanced design, it makes possible, for the first time, receiver testing under theoretically ideal conditions! It enables you to localize troubles in a particular stage or part of a receiver with greater speed and more efficiency than ever before, no matter how complicated the circuit.

**SPECIFICATIONS:**

1. COMPLETE VALVE TESTING (American and continental valves). (Emission Method.)
  2. SET ANALYSIS (A.C.-D.C. Voltage, D.C. Milliamperes).
  3. CONDENSER TESTER. Final Analysis multitester:
    - Combines in one instrument the equivalent of eight separate units.
    - Complete tests for all valves by the approved emission method.
    - Separate Diode test.
    - Neon Short Test, detects slightest leakages.
    - Electrolytic Condenser Test.
    - Paper Condenser Test (for shorts and opens).
    - D.C. Voltmeter, 10-50-250-1000 Volts at 1000 ohms per volt.
- A.C. Voltmeter, 10-50-250-1000 Volts.
  - D.C. Milliammeter, 1-10-50-250.
  - Ohmmeter, 0.2-10 megohms in three ranges—0.2-500 ohms.
    - 0 -1 megohm.
    - 0 -10 megohms.
  - Line Voltage adjustment.
  - Attractive, durable, black silver and red etched panel.
  - Triplett Model 426 D.C. Instrument, square De Luxe case, 4½ in. x 4½ in.
  - Portable leatherette covered case, 15½ in. x 9 in. x 6½ in., sturdily constructed.
  - Test leads, prods, alligator clips, 3 core A.C. supply leads and full instructions.

PRICE £16/10/-

**W. G. WATSON & CO.**  
**Pty. Ltd.**

279 Clarence Street, Sydney, N.S.W.

Head Office: 279 Clarence Street, Sydney. Newcastle Branch: King and Bolton Streets, Newcastle. Melbourne Branch: 398-400 Post Office Place, Melbourne. Adelaide Branch: 91a Currie Street, Adelaide. And at Hobart, Launceston and Perth.



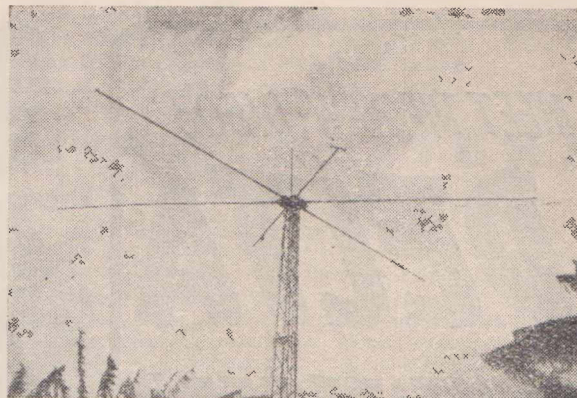
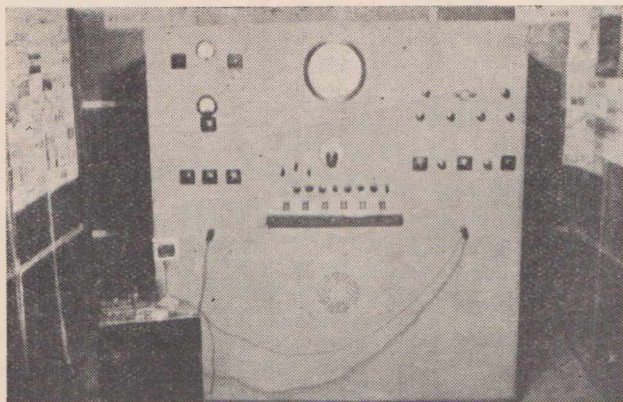

Left: This rack and panel assembly, measuring 60" x 60" x 20", houses 2ADE'S three-band c.c. transmitter, eleven-valve receiver, and five power supplies. Right: 2ADE's beam aerial array, which is rotatable from the shack through a full 360 degrees.

# Contest-winner VK2ADE Operates De Luxe Station

**C.C. Phone And C.W. Transmitter Works  
On 40, 20, And 10 Metres ★ 11-Valve Receiver ★ Rotary Beam Antenna.**

Contributed by J. HAZZARD (AW381DX).

VK2ADE is owned and operated by Mr. C. Miller, of North Street, Casino, who was the Australian winner in the 1937 D.J.D.C. (German DX Contest), and also the winner of the annual VK/ZL DX contest held last October (Senior Section).

The transmitter, as will be seen from the photograph, is a rack and panel job measuring 60" x 60" x 20", and is made up of three steel-framed relay racks. The rack at the left of the photo contains the transmitter, which is crystal controlled and operating on 40, 20 and 10 metres on 'phone and c.w.

The two bottom shelves in the rack contains the five power supplies and filament transformers used on the transmitter. Two pilot lamps in the filament circuits are visible in the photo above, which is the key plug.

The next shelf contains the exciter unit using a 6F6G and a 6L6G completely band-switched from the panel from 40 to 10 metres. The centre control of the lowest three is the band switch, and the other two are the plate tuning condensers of the 6F6 and 6L6, respectively.

Next we have the 807 buffer stage, above which is the final grid meter. This stage is link-coupled to the final which is an 830B, the grid and plate controls are the two at the top of the panel and between them the plate meter.

#### Five Power Supplies.

Five power supplies are used, three standard broadcast transformers for the plates and screens of the exciter unit and 807, and another as power bias for the final. The fifth supply is 800/800 for the final.

5Z3 type rectifiers are used throughout, and each stage, power supplies inclusive, are built on aluminium and steel chassis.

The centre rack contains the dynamic speaker at the bottom, above which is the switch-board containing filament and plate switches for the transmitter and receiver, and modulator. The receiver, the controls of which are visible in the photograph, is an 11-tube superhet consisting of EF5 regenerative r.f., 6J7 mixer, 6K7 h.f. oscillator, screen-injected, 6K7 first i.f., 6K7 second i.f., 6J7 second detector, 6J7 beat oscillator, 6B7 amp-

lified a.v.c., 6J7 noise silencer and first audio, 42 output and 5Z3 rectifier. The receiver is exceptionally quiet and extremely selective, which the operator states is an absolute necessity when working in DX contests on 20 and 10 metres.

The modulation system in the third rack is a 6C6 pentode as pre-amplifier for a Reiss "mike," 6C6 triode driving 6F6G, transformer-coupled to a pair of 6L6G's in class AB1. Three separate supplies are used on the modulator—one on the plates of the 6L6G's, one as fixed bias, while the other supplies the plates and screens of the driver valves and screens of the 6L6G's. At the top of the rack is the plate meter for the 6L6G's, beneath which is a 6E5 over-modulation and level indicator and associate controls. Beneath these again is the fader system.

The antenna visible in the photo is a rotary beam mounted 42 feet above ground on a lattice tower, and rotatable for the full 360° from the shack. It is extremely efficient, both for transmitting and receiving. The many other aerials in use are mainly of the beam type and also include a couple of single-wire types between the two 80-foot masts.

VK2ADE operates on 20 and 10 metre 'phone and c.w. mainly, and has contacted 128 countries and 68 on 'phone. Certificates and cards decorate the walls—cards from 92 countries ('phone and c.w.), W.A.C. certificates and R.C.C. certificates and certificates for VK/ZL and D.J.D.C. DX contest wins.

Readers may wonder what the circular object above the receiver in the centre rack is supposed to be. VK2ADE informs me it is a "Great Circle" Map, and that the pointer is to be geared to the rotary beam to show the direction of transmission.



# The "Ultra-Shorts" In Review . . . (2)

This instalment of a general review of recent progress made in u.h.f. development, deals with aeri-als for mobile working, and discusses new trends in u.h.f. receiver design . . . .

By **DON B. KNOCK (VK2NO)**

Radio Editor, "The Bulletin."

ONE of the fascinations of 56 m.c. communication is that of mobile operation in connection with field days or for purposes of testing locations previous to installation at fixed points. Despite the fact that very low power is usually necessary in such installations, some very satisfactory results can be obtained, as will be remembered by those who were interested in or took part in the mobile tests of two or three years ago, at the time the ultra-high-frequency section of the W.I.A. N.S.W. Division was active.

To-day, mobile equipment, although of the low-power class, has graduated overseas to the better type of equipment as used in fixed stations. Even 5 watts, crystal-controlled, is capable of much better results in mobile work than 50 watts of the modulated oscillator kind. Receivers other than the super-regenerator can be included in portable equipment with no more trouble in design and operation. The receiver question will be discussed later.

Aerials for mobile equipment are of varying types, starting with the quarter-wave Marconi against ground, with its natural limitations, or a half-wave radiator fed by one of the many schemes, and possibly equipped with a reflector or director.

## Reinartz Square Radiator.

A system which has recently been tried by the writer with great success is the Reinartz square radiator. This is nothing more or less than a half-wave radiator folded in the form of a square, with the ends open. Its physical dimensions work out at only two feet square which, will be seen, is a very convenient size for portable work. This aerial was suggested to the writer by the originator, John Reinartz, in a letter previous to an article dealing with the type in an overseas publication.

Recently the necessity arose for designing a portable transceiver for a commercial purpose, to work over quite close range, and this type of

aerial was decided upon. It was found that communication could be had with remarkably low power over ranges far in excess of what was expected, and that not only had this aerial the advantage of directivity, but appeared to give some definite gain. Whether this apparent gain is merely better front-to-back discrimination is settled by the application of a field strength meter in making tests. The meter shows that some gain, perhaps only in the region of two db., is definitely there. In any case, this simple and usefully compact aerial was found to be far superior to the usual straight half-wave twisted pair doublet, and the results obtained with that type are well recalled in the days of two years ago, when cars were out from Sydney at the week-ends.

The only provision is that the Reinartz square aerial must be rotatable through 360 degrees, but because of the small size, this is easily arranged for in the same manner that we used the old loop aerials with broadcast receivers of a decade ago. To those who may be contemplating portable or mobile working on five metres, this simple aerial is strongly recommended.

The mobile station may, of course, take on a more comprehensive aspect by the use of higher power equipment, and a full-sized aerial array, but in such cases the station is more or less a duplication of that used at a fixed location, and calls for much trouble in aerial erection, power supply, etc. Where it would be well worth while taking such a station into the bush in a country like U.S.A., where there are hundreds of five-metre stations constantly active, it is certainly not at present worth the effort in Australia. Meanwhile, 10-watt installations can do very nice work in keeping club interest alive on such occasions as field days.

## Receiver Design.

Since the writer last dealt with receivers for 56 m.c., there has been much done in the way of experimen-

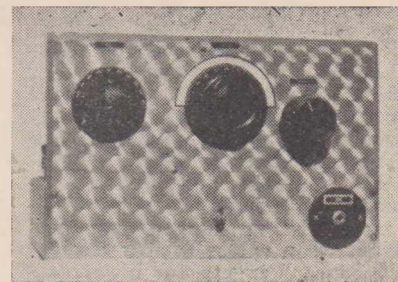

The Ultra-Searcher, a three-valve t.r.f. receiver developed by the author for ultra-high frequency reception.

mentation, and the results obtained have been very gratifying. The results with one type at present in use at VK2NO are such that under no circumstances would the handicap of super-regeneration ever be considered in the future.

It is obvious that with stations on the air with signals of stability equal to the lower frequencies, and there are one or two stations now so equipped in Sydney, the simple tuned r.f. type of receiver can be used to make the most of such signals. Every amateur is familiar with the tuned r.f. type of receiver as a useful form for amateur band work and general short-wave listening.

The t.r.f. type of receiver is by no means new to the five-metre band, for as far back as 1926 two or three of us here in Sydney were using them, even though 201-A's were the order of the day, for half-hearted tests on transmissions of a kind. But this kind of receiver gets a new lease of life in present-day practice, especially with valves of the types now available. Even with standard valves, reception results can be obtained on stable transmissions far superior to the best of super-regenerators. But it must be remembered, like the superhet, the average t.r.f. receiver is likely to be of little use for reception of weak unstable oscillators, particularly so when these are modulated.

## T.R.F. Receiver Uses Acorn Valves.

The receiver at present in use at VK2NO is a t.r.f. type of quite simple design, but making use of valves of the acorn type in the signal circuits. R.F. and detector stages are ganged, the r.f. valve being a 956, and the detector a 954, electron-coupled. The objection is naturally raised of the cost of these acorn valves, but taking into consideration the results obtainable, the cost in proportion is no more than that of some of the components many amateurs use on lower frequencies.

In these days, one must use good efficiency to be anywhere in the running on 20-metre 'phone, so far as consistent DX is concerned. The days



of moulded mud have gone, and high efficiency r.f. insulation is the order of the day. A good proportion of amateurs prominent on 20-metre 'phone have spent quite a lot of money on their transmitters and receivers, and it is not unreasonable to suggest that the seriously-minded ultra-high-frequency experimenter is not wasting money by expenditure on such items as acorn valves for his receiver and good components for his transmitter.

Taking it all round, the expenditure for a modern 56 m.c. installation is not likely to run into the figures that may be imagined. As I stated previously, if high power is the order of things, then the cost will go up.

#### Triode Interrupter Optional.

The receiver referred to is designed expressly for headphone use, and to that end a 41 pentode is used. An additional feature, but one which is seldom if ever used, is the provision of super-regeneration by a triode interrupter valve. This was included in the receiver initially to deal with modulated oscillator signals, but such is the r.f. gain of the receiver that it has to be an R2 or less signal that cannot be identified on telephony transmission, when used without super-regeneration.

It is noticeable that signals can be heard on the band that are not at all audible with super-regeneration in action, and the super-regeneration action in this receiver happens to be particularly quiet.

Other features of interest are the recent addition of the Jones noise-limiter in the form of a 6H6 double-diode across the audio output. This system of noise limitation, recently introduced by Jones in "Radio," is applicable to any receiver whatsoever, and can be strongly recommended. The effect is to practically eliminate power-line noises such as electric light switches, and to reduce car ignition interference very considerably. The system is to be found in the "five-meter Super-Gainer" and the "1938 222 Receiver" in May and July issues of "Radio."

It is noticed also that this noise limiter has a compensating effect on line voltage fluctuations, making the holding of a weak carrier much easier than previously.

The receiver runs from an a.c. power supply with a Westinghouse HT9 dry rectifier, and is perfectly humless on headphones. An important feature is that the r.f. and detector stages are ganged, and an aerial-matching impedance coupling scheme is used. This acts to some extent as a trimming capacity across the r.f. stage, and peaks the stage where wanted in the band.

Because acorn valves are used, it will be obvious that the receiver can

be made quite flexible as to frequency. By changing coils it can be used on 2½ metres, and it is not unlikely that before many years pass that band will be in the status five metres is now in in this country, and five metres will be as much a proved utility band as 10 metres now is.

#### More Experimenters Wanted On "Five."

The lesson of 10 metres should always be kept in mind. It is not so long ago that, apart from 10 metres, it was a difficult job to coax fellows from 40 metres to 20. As for 10 metres, those who stuck at it were considered to be mentally deficient.

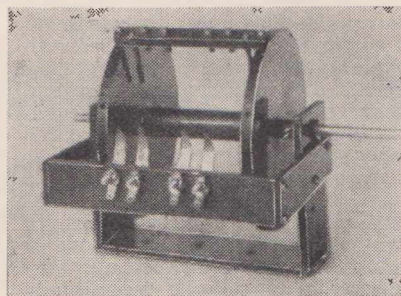

An experimental multi-band automatic coil-changing unit designed and built by Don B. Knock (VK2NO). (Of low-loss design, it possesses the advantages of the switch type unit while preserving maximum gain.

To-day the same is said of five metres, and I have heard remarks on the air that those who tackle it "want their brains brushed." Those same critics will doubtless be very pleased to take advantage of the eventual populating of the band in the long run.

Some idea of the efficiency of the receiver mentioned above can be gleaned, apart from actual wide radius reception of five-metre signals at excellent strength, by the way harmonics are heard from the other bands. Stations as far as 20 miles or more away can often be heard on c.w. and 'phone, when working on 20, and often 40 metres. In fact, the harmonics are often a problem with some local stations, and some of the weaker distant harmonics can be very misleading when searching for possible five-metre DX.

Weak DX signals have been heard on a few occasions, but unfortunately in each instance they were unidentifiable, for the reason that the transmissions were of an unstable nature. One recent transmission logged on a Sunday is considered, on checking up with New Zealand, to be ZL1IR. This signal was stable, but around the R3 mark and modulated by i.c.w. The

modulation depth was down enough to make reading of the morse characters impossible.

To show that it is not essential to use an acorn valve in the detector circuit and still to obtain excellent results, I will refer to a receiver I recently constructed for Mr Eric Trebilcock, of Powell Creek in the Northern Territory. Trebilcock is well-known as probably the world's No. 1 short-wave listener on the amateur bands, holding the BERU number of BERS195.

Recently he decided to turn his attention to 10 and 5 metres, and asked me to design a receiver. Consequently one was worked out using a 956 acorn in the r.f. stage, 76 capacity reaction detector, and 41 audio. This receiver by using two sets of plug-in coils on isolantite bases made from padder blocks, covers everything from 4 to 12 metres. The 76 works smoothly as oscillating detector in the familiar "throttle" control, and the r.f. stage is separately tuned. This is no handi-cap, as the 956 tunes quite broadly.

The receiver is now in constant use in the N.T., and BERS195 is continuously combing five metres for possible DX signals. I venture to suggest that if any five-metre DX listening records are to be made in the near future, Trebilcock will be well to the forefront with that receiver.

His presence in the North of Australia may prove to be invaluable to serious five-metre experimenters in the south, for the distance is about right for the observation of signals at times when 10-metre skip is very short, as may be expected any time from September onward through the summer. This receiver and my own have recently been described in detail in print.

For some time there has been a tendency to shy at the superhet for use on five metres, and probably rightly so. Leaving out of consideration the "resistance-coupled i.f." type, which is no better than a super-regenerator as far as desirable results go, until recently the five-metre superhet has been a fairly expensive and comprehensive type of receiver for the average amateur to tackle. It has had mostly a high noise level and, unless acorn valves have been used in the signal circuits, has not always given the best results.

There have been exceptions, as in the case of one made by an amateur who is also the chief radio engineer of a prominent manufacturing firm. That receiver used standard valves, and gave an astonishing performance on reception of stable telephony transmissions. But the c.w. performance could not be checked, as no beat oscillator of any kind was provided.



As if in answer to the five-metre man's prayer, there comes now from the laboratory of Frank Jones the "Five - Meter Super - Gainer." One glance at the circuit diagram of this will show that it is sheer simplicity, but does a great deal with only three valves. (There are four, but one is the noise-limiter only.)

For the first time a converter valve is used as combined detector-oscillator. This is the recently-released 6J8G Radiotron. Examination of the arrangement shows that Jones has used the oscillator in the familiar ultra-audio method. He claims in his description that with this valve the oscillator is a vigorous one to around four metres. This is something new in a converter valve for "ultra-highs."

The i.f. amplifier uses one valve with high-gain iron-core intermediates at 1600 k.c. A 6D6 or similar type is employed. The second detector is nothing more or less than the type popularised by Jones in his "Super" and "Ultra-Gainer" receivers of the last two years. Here a 6A6 is used with one triode section as the demodulator and cathode regeneration to put this triode into oscillation for c.w. reception. The second triode is the audio output to the headphones.

A more simple but obviously effective superhet for five metres would be hard to visualise, and although I have not at this period had the opportunity of testing the receiver, this will be done in a week or so, as one is under construction for VK2PN, of Tumut, N.S.W. The main trouble has been to get hold of suitable commercial 1600 k.c. intermediates. After much persuasion, I have at last interested one manufacturer, and if these i.f.'s go into production, it follows that others will soon be in line. 1600 k.c. intermediates will undoubtedly come into general use in any

case, following on recent American practice.

This little superhet then seems to me an ideal solution for the inexpensive but fully modern five-metre receiver. For those who like to go further, it would be easy enough to fit an r.f. stage ahead of the 6J8G in the form of a separately-tuned pre-selector, using either an acorn, or possibly the new 1851 Radiotron. The latter is the new metal valve developed by R.C.A. as a "television pentode." It is designed for r.f. use at ultra-high frequencies, and is cheaper than an acorn valve at the present juncture.

It is natural in this discussion of suitable receivers for the band to consider the already existing gear the would-be five-metre amateur has on hand, and what he can do with it. Assuming that he has a four-valve "Super Gainer," which is a good performer on 10 metres, this can easily be used to receive five-metre stations. But don't expect to get good results on modulated oscillators with the 465 k.c. i.f. channel. It can't be done.

The oscillator is used with the 10-metre coil in position, and the detector grid is connected to a separately tuned 56 m.c. circuit with an appropriate coil and condenser. In this way the second harmonic of the oscillator is used for mixing, and during the recent five-metre DX burst in America, many amateurs got in on the DX in this manner. It is a makeshift, but it is at least workable. That it works well is evidenced by the fact that VK2CE, located in a relatively screened position in North Bondi, can hear the five-metre signal from VK2ABC-2LZ at Wentworth Falls in the Blue Mountains by using his receiver in this fashion. The distance is around 50 miles or more.

If any local amateurs are desirous

of trying out their receivers on a good five-metre signal, they have only to telephone me at my residential address to get the station on the air. Any amateur needing calibration of an absorption meter for the band will in addition be willingly accommodated.

#### Stations In Action With Modern Gear.

At the present period, the number of stations working on the band in various parts of Australia is on the increase, and in all instances of correspondence these and others have indicated that the apparatus to be used is of the advanced type, and not of the old-fashioned handicap kind.

Those consistently active in the Sydney area include my own station, VK2NO, with 150 watts input to two 35T's in the final stage of a four-stage transmitter. This is modulated for 'phone on reduced power, and for week-end tests on c.w. with New Zealand and inter-state Australians, the 150 watts is automatically keyed for lengthy periods. An automatic sender is, incidentally, quite easy to arrange. An automatic transmission was in progress at the time listener Morrison logged the signal in New Zealand.

At Killara, up the North Shore line, VK2EM is now using a three-stage transmitter with 809's in the output and c.w. and 'phone. At Kogarah, VK2AZ has a similar transmitter, and at Maroubra, VK2WJ is using 809's in his final with a crystal-controlled transmitter. Excellent signals have been put on the air from crystal-controlled transmitters at VK2VN, VK2RA, VK2TI and VK2HZ, all these stations being maximum strength at any time on the t.r.f. receiver.

(To be continued next month)

**WE'D LIKE YOU AS A FRIEND..  
BUT WE'D RATHER HAVE YOU ALWAYS  
A PLEASED CUSTOMER**



**WE'RE** in the radio and electrical business to do things for you . . . to supply you with the best products . . . to save you money . . . to give you the best service in town. We don't aim to make you a personal friend—but we try our very best to make

you a customer who is downright pleased with the service he gets. This we shall prove to you, every time you call on us. If you have not yet seen how far you can make your money go, get your next radio or electrical requirements from Martin de Launay Pty. Ltd.

**MARTIN DE LAUNAY PTY. LTD.**

Cnr. Clarence and Druiett Streets, Sydney, M 4268 (4 lines); Cnr. King and Darby Streets, Newcastle, New. 959 (2 lines); 36 Keira Street, Wollongong, Woll. 681.



# Getting That Trophy-winning "Verie"

Plenty of patience, a sensitive receiver, and an efficient aerial and earth are three essentials for those wanting to win DX contests. In the article below, dxers R. G. Cook (of Bowen, Q.) and W. T. Choppen (of Timaru, N.Z.), past trophy-winners in "Radio World" shortwave DX contests, tell how it is done.

## Third Contest Winner R. G. Cook Has Variety Of Sets

My main receiver is the latest eight-tube triple-wave Breville, using 6U7 (2), 6A8, 6B6, 6U6, 6C5, 5Y3, 6U6, coupled to a 12in. Rola speaker. This set gives me all the power that is required. I find that it is 100 per cent. efficient, and may add that the climatic conditions of North Queensland are not the best for DX on account of the heat and the heavy atmospheric conditions that prevail at all times of the year. After experimenting with five-valve receivers I have come to the conclusion that nothing smaller than an "eight" is of any use up here if one wants to go into the game properly. At the present time I can bring in any of the southern commercial stations at R6-7 at midday, which is good for this part of the globe.

The second set here is a five-valve Breville vibrator broadcast model, with which I do all broadcast DX and have picked up quite a few foreign stations in the wee small hours. I find that the best time up this way for foreign DX is about 3 to 4 a.m. and make a habit of setting the alarm for those hours. So much for the vibrator job—there is one thing in its favour, and that is low noise level, which in my opinion is a big factor.

I have discarded the three-valve shortwave t.r.f. job and am at pre-

Winner of the third S.W. Contest, dxer R. Cook has a fine selection of commercial and home-built receivers to choose from for his DX listening.

sent constructing an eight-valver using an r.f. stage, with a 6K7 transformer-coupled to the first detector—a 6L7—which has regeneration. The valves used are three 6K7's, 6L7, 6F6, 6C5 and 80. I am looking forward to this set being the goods on DX and hope at a later date to be able to inform you of its efficiency.

## Uses Inverted "L" Doublet.

The antenna used here is an inverted "L" doublet running north and south, hooked up to poles 65 feet high, and with a flat top 120 feet long. I find this type best suitable for my locality and do not find it too long. Earth used is four feet long and is attached to a copper rod buried in the ground to an old bed mattress. Occasionally I sprinkle the wet earth around with a mixture of copper sul-

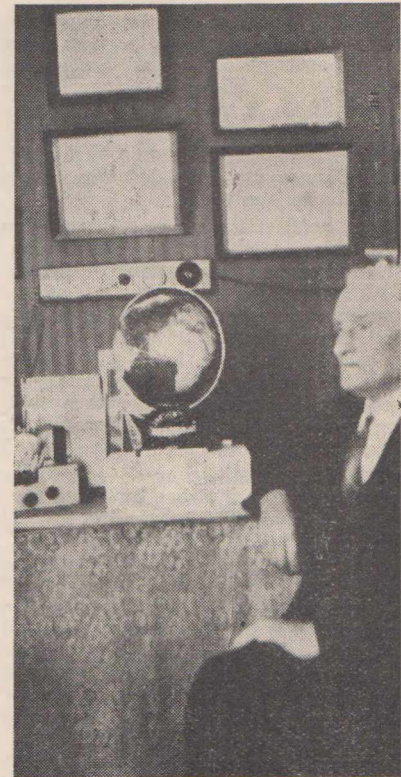

Dyer W. T. Choppen, with the Replogle combination world globe and time converter awarded him as winner of the fourth S.W. Contest.

phate, rock salt and charcoal, which I recommend to any enthusiast who requires the best.

Catching the elusive DX is a matter of sitting up late or early as the





case may be, and by doing this I have contacted or, I should say, logged over 80 countries, giving me a total of 500 odd cards, which include Australia, Alaska, U.S.A., Germany, Belgium, South Africa, India, New Hebrides, South America, France, Austria, Canada, England, Scotland, Ecuador, Panama, Malaya, Manila, Hawaii, and others, which if were typed here would take the entire page. I consider my best card is from K7ANQ, Alaska. I might add that apart from the logging of RNE, Moscow, I have never been lucky enough to contact any other Russian station.

In conclusion, I wish to say that when reports are asked for by VK's and reports are candidly given by dxers (probably some of mine have been too candid!), why doesn't the ham verify if the postage is added? The same applies to members of the A.W.A.W. DX Club who ask for exchange of QSL's. Why don't they reply to cards sent? Those concerned will know whom I mean.—R. Cook (AW122DX), Bowen, Queensland.

### ZL Contest Winner's Experiences.

By W. T. Choppen, Timaru, N.Z.,  
Winner Of Fourth S.W. DX Contest.

It was in 1922 when I first became interested in radio. Before one could listen in it was necessary to build a receiver, as no commercial ones were on the market in those days.

My first set consisted of a two-valve regenerative circuit, French R. Det.,

and Dutch (Fama) first audio, with the now obsolete .001 mfd. variable condenser tuning the aerial. Plug-in coils were wound on cardboard, spider-web fashion, with primary, secondary and tickler windings. The primary and tickler variable, two sets of coils tuning from approximately 150 to 1300 metres. H.T. supply was made up of 4½-volt flat torch batteries coupled together and tapped at 9 volts, which was most suitable for the plate of the French R. At a later date I added another transformer-coupled stage, which gave me volume for using a loud speaker.

Our only broadcasting station in N.Z. then consisted of a few amateurs experimenting in their spare time and putting over a gramophone record or occasionally mustering sufficient local talent to put a concert on the air. Some of our best transmissions in N.Z. were from 2AQ, 2ZM and 3AC, using a power of anything from about 5 to 15 watts, and they used to romp in surprisingly loud and clear.

I remember quite well when 2BL, 2FC, 3LO, 4QG and 6WF first came on the air, and what a thrill we in N.Z. experienced when we heard the post office clock chimes over the air from Sydney! We were also receiving the chimes from KPO, 'Frisco. How many old-timers tuned into 'Frisco in those days on one and two pipers? 500 watts was the highest power this and other American stations were using then.

Farm Outing Relayed From 4QG.

Getting back to the Australian stations again, it will be news to some of

my readers to know that 2FC and 6WF first came on the air on 1100 and 1200 metres, respectively. Uncle George, conducting the children's session from 4QG, was a great favourite in those days, and I think it was at one of these sessions a trip out to a farm was organised. The children entraining, a mouth organ being played on the journey, the arrival at the farm, and the explanation of the various animals and birds which followed came over quite clearly and proved to be a novel event.

Another of 4QG's transmissions was a relay from the Brisbane Town Hall demonstrating a radio studio. The speaker, describing the scene on the stage, said that the rate of travel of radio waves being approximately 186,000 miles per second, people listening in New Zealand would hear his voice before the audience seated in the centre of the hall.

Another eventful relay from the Town Hall by 4QG was of the lecture given by Gipsy Smith, the Evangelist. I would like to mention also the very good concerts and reception of 2BL, 2FC and 3LO, and I have recollection of a very much-appreciated and excellent concert from 2FC on September 17, 1927. (By this time both 2FC and 6WF were down on what is known as the broadcast band). This was given by "Ye Idler Minstrel Troupe," and reception here was ideal. A photo of the troupe was forwarded to all listeners who reported on this transmission, and I am pleased to say the photo I received in reply to a report is still in my possession. (Continued on page 46.)

## AUTO-TUNE FIVE GIVES EXCELLENT RESULTS . . .

To The Editor:—

I have just completed the "Auto-Tune Dual-Wave Five," and believe me, it is a great job! The short-wave sensitivity is amazing for a set of its size and number of valves. The Empire stations at Daventry come in at full strength, and with perfect clarity.

The first time I tested the set I had a temporary aerial rigged up round the eaves of the house. I tuned in London on 31 metres, and walking round the table on which I was testing the set I became entangled in the aerial lead and broke it off about six feet from the set. London still came in at only slightly reduced volume!

The push-button tuning is particularly efficient, and the tone and clarity of reproduction are excellent, being free from the extremes of the usual pentode reproduction. I wish to congratulate you on a very fine job.

—K. Ridgway, 303A Koornang Road, Carnegie, S.E.9, Melbourne Victoria.

The "Auto-tune Dual-Wave Five" mounted in a console cabinet. This 4/5 dual-wave superhet, which was described recently in "Radio World," used the latest permeability tuning throughout, another attractive feature being the provision of push-button tuning as an optional refinement.

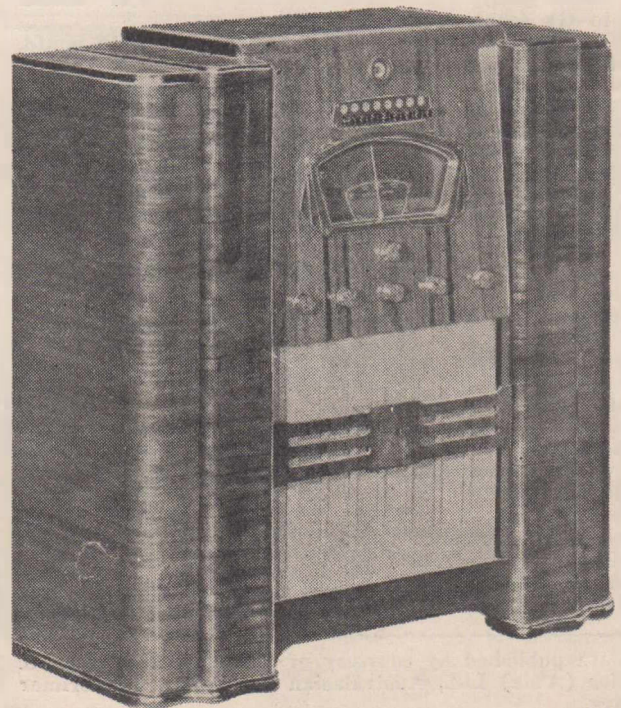



# 1.4-Volt Valves Announced

## In States

A new series of battery valves with 1.4 volt, 50 mill. filaments, specially designed to operate economically from a single dry cell, has been released in the States, though supplies will not reach Australia for some weeks yet. Tentative characteristics are given below on all five types as released in the Brimar range.\*

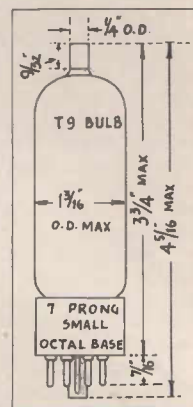
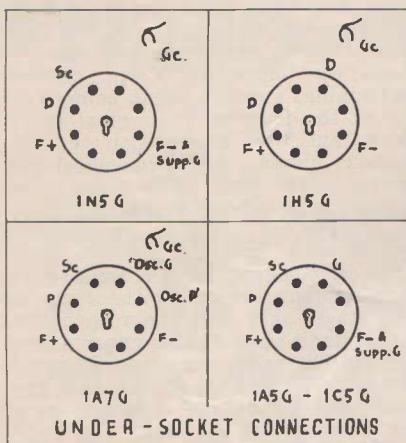

External dimensions of the new types, which all use the "T9" glass envelope and small octal base. Under-socket connections are shown on left.

### Type 1A7G Heptode Pentagrid Converter.

The 1A7G is a pentagrid type converter valve designed for service as a combined mixer and oscillator in receivers operating from a low voltage filament supply.

#### RATINGS.

Filament voltage (d.c.)	1.4	volts
Filament current	0.05	amp.
Maximum plate voltage	90	volts
Maximum screen voltage	45	volts
Maximum grid (No. 2) voltage	90	volts

#### DIRECT INTERELECTRODE CAPACITANCES.

G4 to P (control grid to plate)	0.30*	mmfd.
G4 to G2 (control grid to oscillator anode grid)	0.25*	mmfd.
G4 to G1 (control grid to oscillator grid)	0.11*	mmfd.
G1 to G2 (oscillator grid to plate)	1.4*	mmfd.
G4 to all other electrodes (r.f. input electrode)	6.3	mmfd.
G2 to all other electrodes except G1 (Oscillator output electrode)	4.1	mmfd.
G1 to all other electrodes except G2 (Oscillator input electrode)	3.7	mmfd.
Plate to all other electrodes (Mixer output electrode)	8.0	mmfd.

#### FREQUENCY CONVERTER.

Plate Voltage	90	volts
Screen (grids Nos. 3 & 5) supply voltage	90	volts
Series screen resistor	70000	ohms
Anode grid (No. 2) voltage	90	volts
Control grid (No. 4) bias	0†	volts
Oscillator grid (No. 1) resistor	200000	ohms
Plate resistance	0.6	megs.
Conversion transconductance	125	mmhos.
Plate current	0.6	m.a.
Screen current	0.65	m.a.
Anode grid current	1.1	m.a.
Oscillator grid current	35	m.a.
Total cathode current	2.3	m.a.
Conversion transconductance (approx.)	25	mmhos.

\* Data published by courtesy of Standard Telephones & Cables (Asia) Ltd., Australasian distributors for Brimar valves.

(At control grid bias = -1.4 volts)  
 Conversion transconductance (approx.)  
 (At control grid bias = -2.0 volts)  
 \* Measured with close-fitting shield.  
 † Return to negative filament—pin 7.

5 mmhos.

### Type 1A5G Pentode Power Amplifier.

The 1A5G is a pentode type power amplifier valve designed for service in the output stage of receivers operating from a low voltage battery filament supply.

#### RATINGS.

Filament voltage (d.c.)	1.4	volts
Filament current	0.05	amp.
Maximum plate voltage	90	volts
Maximum screen voltage	90	volts

#### AMPLIFIER—CLASS A.

Plate voltage	85	volts
Screen voltage	85	volts
Grid bias	14.5	volts
Transconductance	800	mmhos.
Plate current	3.5	m.a.
Screen current	0.7	m.a.
Load Resistance	25000	ohms.
Total Harmonic Distortion	10	per cent.
Power output	100	mw

### Type 1H5G Diode Triode Detector Amplifier.

The 1H5G is a diode triode type amplifier valve designed for service as a combined diode detector and amplifier in receivers operating from a low voltage battery filament supply.

#### RATINGS.

Filament voltage (d.c.)	1.4	volts
Filament current	0.05	amp.
Maximum plate voltage	90	volts

#### DIRECT INTERELECTRODE CAPACITANCES —TRIODE SECTION.

G to P (grid to plate)	1.1	mmfd.
G to F (input electrode)	0.35	mmfd.
P to F (output electrode)	4.0*	mmfd.

#### AMPLIFIER—CLASS A—TRIODE SECTION.

Plate voltage	90	volts
Grid bias	0†	volts



Plate resistance . . . . .	0.24	meg.
Transconductance . . . . .	275	mmhos.
Plate current . . . . .	0.15	m.a.

\* Diode plate connected to pin 7.  
 † Return to negative filament pin 7.

Transconductance (approx.) . . . . .	50	mmhos.
(At control grid bias = -3.2 volts)		
Transconductance (approx.) . . . . .	5	mmhos.
(At control grid bias = -4.0 volts)		

\* Measured with close-fitting shield.  
 † Return to negative filament—pin 7.

**Type 1N5G Pentode Amplifier.**

The 1N5G is a pentode type amplifier valve designed for service as a high frequency amplifier in receivers operating from a low voltage battery filament supply.

**RATINGS.**

Filament voltage (d.c.) . . . . .	1.4	volts
Filament current . . . . .	0.5	amp.
Maximum plate voltage . . . . .	90	volts
Maximum screen voltage . . . . .	90	volts

**DIRECT INTERELECTRODE CAPACITANCES.**

G1 to P (control grid to plate) . . . . .	0.007	
	max.*	mmfd.
G1 to F, G2 & G3 (input electrode)	2.2	mmfd.
P to F, G2 & G3 (output electrode)	9.0	mmfd.

**AMPLIFIER—CLASS A.**

Plate voltage . . . . .	90	volts
Screen voltage . . . . .	90	volts
Control grid bias . . . . .	0†	volts
Plate resistance . . . . .	1.5	megohm
Transconductance . . . . .	750	mmhos.
Plate current . . . . .	1.2	m.a.
Screen current . . . . .	0.3	m.a.

**Type 1C5G Pentode Power Amplifier.**

The 1C5G is a pentode type power amplifier valve designed for service in the output stage of receivers operating from a low voltage battery filament supply.

**RATINGS.**

Filament voltage (d.c.) . . . . .	1.4	volts
Filament current . . . . .	0.1	amp.
Maximum plate voltage . . . . .	90	volts
Maximum screen voltage . . . . .	90	volts

**AMPLIFIER—CLASS A.**

Plate voltage . . . . .	83	90	volts
Screen voltage . . . . .	83	90	volts
Grid bias . . . . .	-7	-9	volts
Amplification factor . . . . .	165	180	
Plate resistance . . . . .	0.110	0.115	megs.
Transconductance . . . . .	1500	1550	mmhos.
Plate current . . . . .	7	6	m.a.
Screen current . . . . .	1.6	1.4	m.a.
Load resistance . . . . .	9000	8000	ohms.
Total harmonic distortion . . . . .	10	10	per cent.
Power output . . . . .	200	240	mw.

**INSIST ON THESE WELL-KNOWN**

**RAYMART**  
 CRAFT A CREED

**SHORT WAVE AND ULTRA SHORT WAVE EQUIPMENT!**

Used extensively overseas, Raymart "Craft A Creed" equipment is the very best available. "The Friendly Wholesale House" offers it at the Lowest Prices in the State. Full particulars and catalogues on request.



**DIPOLE AERIAL KIT—Type DPA**

This kit supplies all that is necessary to erect a doublet noise reducing aerial, including transmission line insulators, enamel aerial wire and transformer. LIST PRICE .... 30/-

MAKE SURE YOU GO TO "THE FRIENDLY WHOLESALE HOUSE"

**TRANSMITTER DIAL ; Type TXD**

Individually spun heavy solid nickel dials, with engraved (not etched) divisions and handsome knob. Diameter, 4in. LIST PRICE ..... 12/9

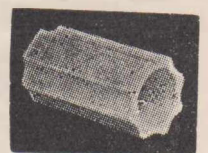
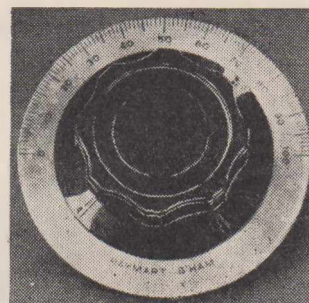

**CERAMIC COIL FORMERS**

These formers are grooved and ribbed. 1 1/2 in. dia., with 2 1/2 in. winding space. Type BTX. List Price, 6/9

**AMERICAN VALVE SOCKETS**

\*Owing to the increasing demand for first quality HF ceramic sockets, John Martin offers the following:—

Type VA4 4-pin Ceramic (for 210, etc.) . . . . .	3/-
.. VA5 5-pin Ceramic (for 46, 47, etc.) . . . . .	3/-
.. VA6 6-pin Ceramic (for 58, 6D6, etc.) . . . . .	3/-
.. VA7 7-pin Large Ceramic (for 59, 53, etc.) . . . . .	3/-
.. VA7S 7-pin Small Ceramic (for 6A7, etc.) . . . . .	3/-
.. VA8 8-pin OCTAL . . . . .	4/-
.. VA50 50-watt (Air Ministry XMB262 HF dielectric) 12/6	

Telephone: BW 3109 (2 lines)  
 Telegrams: "Jonmar," Sydney

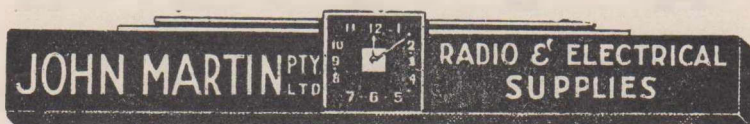

116-118 CLARENCE STREET, SYDNEY



# What's New In Radio

A monthly review of latest releases  
in sets, kit-sets, and components

## First Australian Service Manual Enjoys Exceptional Sales.

The urgent need felt by the radio service profession throughout Australia for a locally-produced service manual has been revealed by the unprecedented sales enjoyed by the "1938 Australian Official Radio Service Manual," published by the Strand Press, Brisbane. Released only three months ago, the manual has enjoyed exceptional sales throughout Australia—in fact, the publishers report that there are now only a few hundred copies left.

The general reaction of the servicing profession to this new manual is typified by the following letter received by the publishers:—

"May I congratulate you on the issue of the 'Australian Official Radio Service Manual,' which is by far the finest book of its type I have seen.

"This book fills a long-felt want of servicemen and dealers and would be cheap at three times the price—as a matter of fact, I more than covered the cost in time saved the very first day I received my copy.

"The concise manner in which the information is given and the split re-

cord reference afforded is a revelation.

"Please do not fail to book my order for your 1939 issue.—R.B.S."

Comprising 391 pages, with 16 chapters, the "1938 Australian Official Radio Service Manual" contains 300 circuits and data applying to standard Australian receivers released during 1937, in addition to a wealth of information invaluable to every radio serviceman, dealer and amateur.

Priced at 12/6 (limp cover) and 15/- (stiff cover), it is obtainable from electrical and radio firms throughout Australia, or from the publishers, the Strand Press, T. & G. Building, Queen Street, Brisbane (postage 1/- extra).

★

## In Latest "Radiotronics."

Practical details of a simple method of hum neutralisation in standard receiver circuits are given in an article in the latest "Radiotronics" (Technical Bulletin No. 90), issued by Amalgamated Wireless Valve Co. Pty. Ltd.

Full data is also given on the new Australian 6K8G triode hexode frequency converter. Designed specially for maximum efficiency on the short waves, the 6K8G provides better image and noise ratios, with minimum frequency drift. Notes are included on application features and operating points.

Other articles in this issue are entitled "Radiotron 6.3-Volt 0.15 Ampere Series," "Radiotron 6AF6G Twin Indicator Magic Eye," "Radiotron 6L6G Equal Plate and Screen Operation," "Radiotron 832-Push-Pull R.F. Beam Power Amplifier."

Valve data sheets released with this latest issue comprise those on the 6K7G, 6C8G and 1E7G, these types being, respectively, a triple-grid super-control amplifier, twin-triode amplifier and twin pentode power amplifier (with 2-volt, .24 amp. filament).

★

## Latest Philips Technical Reviews

"Philips' Technical Review" for March, 1938, contains the following technical articles: — "Auditorium Acoustics and Reverberation," "Barretters," "Secondary Electron Emission," "An Alternating Current Dynamo With A Flat Characteristic For Bicycle Illumination," "The Use Of The Philora Discharge Lamp In Enlarging Apparatus" and "The Examination of the Macro Structure Of Materials And Products With The Help Of X-Rays."

Articles in the April issue include: "Voltage Regulation Of Direct Current Generators By Means Of Triodes," "Behaviour Of Amplifier Valves At Very High Frequencies," "A

Make sure of  
maximum efficiency  
and longest life—

ADOPT AS YOUR  
STANDARD —

# Mullard

## M A S T E R

### RADIOVALVES

MULLARD (AUST.) PTY. LTD., 26-30 CLARENCE STREET, SYDNEY. TELEPHONE B 7446 (3 lines)



A view of the new factory recently opened by the Vesta Battery Co. Pty. Ltd., at Miramar, Wellington, New Zealand. To-day the new factory, which employs nearly 30 New Zealanders in manufacturing departments alone, is in steady production, supplying Vesta branches at Auckland, Christchurch and Dunedin.

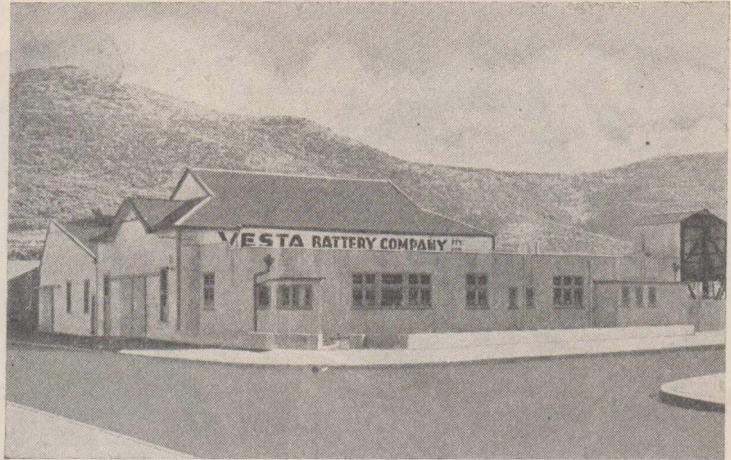

Car Radio," and "The Sealing Of Metal Leads Through Hard Glass."

The subscription (10/- per annum) may be paid to Philips Lamps (A'sia) Pty. Ltd., 69 Clarence Street, Sydney, but subscribers will receive their copies direct from the laboratory at Eindhoven.



**John Martin Sole Australian Distributor For Packard Electric Shaver**

Mr. John Martin, managing director of John Martin Pty. Ltd., 116-118 Clarence Street, Sydney, announces that he has secured the Australian distribution rights for the Packard electric shaver.

One of the leading makes in the States, where some millions of these shavers have been sold over the past few years, the Packard shaver should soon prove a best-seller in this country as well. Features include:—(1) It shaves as closely as a fine blade razor; (2) it does so the first time used, no training period being need-



The Packard electric shaver, which is available in a variety of models for voltages ranging from 12 to 240.

ed; (3) will not irritate the most sensitive skin; (4) is clean and quick to use, no brush, soap or cream being required.

A noteworthy distinction in the Packard is the departure made from the conventional type of cutting head, and the adoption of one of circular cross section, so that the stationary and oscillating sections take the form of concentric solid tubes, so finished as to be devoid of edges or corners tending to nick or irritate the skin.

As with all electrical appliances operated in a bathroom, the safety factor is very important, and for this reason the 6-volt model will be concentrated on. This will be operated from a step-down mains transformer, which will be guaranteed to comply with the requirements of the Electrical Approvals Board. However, other models rated at 240, 110, 32 and 12 volts will also be available.

John Martin Pty. Ltd. will, of course, effect their own distribution in New South Wales, but inquiries are invited from other States for distribution rights.



**Two New Radio Text-books.**

Advance review copies of two radio text-books lately released in London are to hand from the publishers, Messrs. Iliffe & Sons, Ltd.

"Radio Laboratory Handbook" has been specially compiled for amateurs, both beginners and advanced workers, and for industrial and laboratory engineers. It gives the serious wireless worker complete information from first-hand experience about laboratory equipment, the instruments which are necessary and the correct methods of operating them.

The fundamental principles are fully discussed and the sources of power and signals, instruments and measurements are described in detail.

Other sections deal with ultra-high-frequency work, the working out of results, and reference data. There is also a collection of the most useful symbols, abbreviations, formulae, laws, curves, tables and other data.

The information contained covers all that is necessary for advanced work, but a high degree of prior knowledge is not assumed. The book is, therefore, particularly valuable to laboratory engineers, students and teachers in technical colleges and schools running experimental radio classes, and to radio societies.

A complete index, numbered sections and cross references enable the reader to find what is required without loss of time.

The second book, a copy of the 4th edition of "Wireless Servicing Manual," which has been enlarged by the addition of 50 pages of new matter. An extra chapter deals with the subject of television receivers, and the appendices have been extended to include instructions for building a resistance and capacity testing bridge and a valve testing bridge. The matter relating to base-connections for British, Continental and American valves, and the various colour codes has been carefully revised.



**STC Model 5001A Headphones:**

Just released from the S.T.C. factory is the Model 5001A Head Receiver Outfit. With receiving units of moulded bakelite and fitted with magnets, this S.T.C. headphone has earpieces made to British Post Office standards. A feature of the set is the special tinsel conductor, impregnated, silk braided, and cotton covered cord with which it is equipped.

The headband is adjustable and the total weight of the instrument, including cord, is under 10ozs. The D.C. re-





A pair of the new S.T.C. Model 5001A headphones.

sistance of each unit is 1700 ohms, making 3400 ohms in all, and the effective resistance is as follows:—

100 cycles	3660 ohms
800 cycles	8500 ohms
1000 cycles	10500 ohms
2000 cycles	18500 ohms

It is interesting to note that it was S.T.C. who introduced, with the old W.E. type, the first commercial headphones into Australia. Thus there is an old-established reputation for radio headphone receivers behind this latest product of the S.T.C. factory.

Because of their outstanding sensitivity over a wide band of frequencies and lightness in weight, the S.T.C. Model 5001A headphones are especially suitable for hospital installations where dependability and comfortable wear are essential.



### Calstan Nine-Range Multi-Meter With Moulded Case.

A new and very attractive departure from the conventional in multi-meter design has been made by Slade's Radio Pty. Ltd., of Sydney, in their latest multi-meter illustrated below. It is housed in a circular black moulded bakelite case, eight inches in diameter and about three inches deep, the various pin jacks for connection

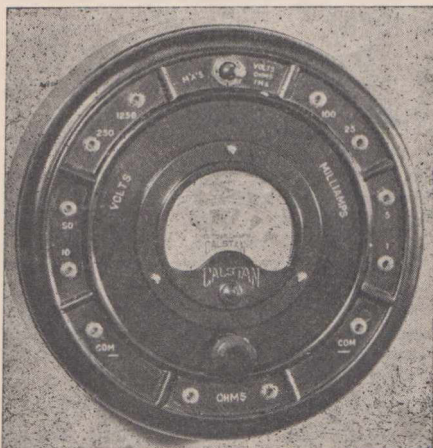

The Calstan nine-range multi-meter.

purposes being located round the circumference.

A standard Calstan type 501 meter with a sensitivity of 1000 ohms per volt is fitted in the centre. The internal assembly is neat and rigid, the unique construction of the instrument making possible short and direct wiring. A 4.5-volt battery for resistance measurements is located inside the case, the necessary rheostat for battery compensation being fitted on the panel.

Ranges are as follows:—D.C. volts, 0-10, 50, 250, 1250. D.C. milliamperes, 0-5, 25, 100. Ohms, 50-100,000.

Rigidly built to give lasting service, this new Calstan multi-meter is an ideal unit for a service workshop or experimental laboratory, and represents particularly good value at £4/10/-.



### New Delta Multi-Tester.

Illustrated above is the Delta Model D-1503 multi-tester lately released by Messrs. W. G. Watson & Co. Pty. Ltd., of Sydney. Combining the functions of an emission type valve checker with a modern multi-meter, the instrument is designed to provide a ready and effective method of performing the necessary tests in the servicing of radio receivers. These include the following:—

Accurate check on all types of val-

ves (element, short and leakage tests are provided), condenser merit (electrolytics and paper types), resistance tests from 10 megohms to 0.2 ohms, four current measurements—0-1, 10, 50 and 250 mills.; D.C. voltages in four ranges, 0-10, 50, 250 and 1000 volts; A.C. and output voltages, 0-10, 50; 250 and 1000 volts.

Each instrument is equipped with a three-core connecting cable and plug for connection to a 200-220 or 230-250 cycle a.c. supply. Accessories supplied include one pair of test leads, two test clips, one top cap bridge lead, one 4½-volt battery and one type 1V valve.

The instrument has been planned in accordance with latest test equipment design technique, the panel layout being so arranged, that all tests can be performed with a maximum of simplicity and speed. Housed in a leatherette-covered box with plated fittings, the tester is provided with a particularly attractive panel finished in red, silver and black.

The model D-1503 has been designed specially to suit Australian conditions, and servicemen will find it combines to a high degree the necessary features of flexibility, accuracy and ruggedness.

Further details may be obtained from the Head Office of Messrs. W. G. Watson & Co. Pty. Ltd., 279 Clarence Street, Sydney, or from any inter-state branch.



The new Delta Model D-1503 multi-tester.



ABRIDGED SPECIFICATIONS AND PRICES OF ROLA REPRODUCERS.

	Type No.	Overall Diameter.	Voice-Coil Diameter.	Voice-Coil Impedance.	Normal Field Excitation.	PRICES		
						Internal Spider.	External Spider.	Dustproof.
ELECTRO-DYNAMIC	G-12	12 1/8"	1 3/4"	8 ohms	18 watts	—	£8	—
	*K-12	12 1/8"	1"	2.3 "	9 "	—	—	55/-
	*K-10	9 3/4"	1"	2.3 "	9 "	—	40/-	—
	*F-10	9 3/4"	1"	2.3 "	8 "	34/-	—	—
	*K-8	8"	1"	2.3 "	8 "	27/6	28/6	30/-
	F-8	8"	3/4"	3 "	6 "	—	24/6	—
	DP-5-B	6 3/4"	3/4"	3 "	6 "	—	—	24/-
	F-4	5"	3/4"	3 "	6 "	—	—	23/-
PERMANENT MAGNET	G-12PM	12 1/8"	1 3/4"	8 ohms	—	—	£11	—
	*10-21PM	9 3/4"	1"	2.3 "	—	—	—	48/-
	*8-21PM	8"	1"	2.3 "	—	—	—	45/-
	*8-20PM	8"	1"	2.3 "	—	—	—	40/-
	*8-14PM	8"	1"	2.3 "	—	—	—	35/-
	*6-14PM	6 3/4"	3/4"	3 "	—	—	—	34/-
	6-6PM	6 3/4"	3/4"	3 "	—	—	—	27/-
	5-6PM	5"	3/4"	3 "	—	—	—	26/-

All speakers except G-12 fitted with leads and plug as standard equipment.

Latest Specifications Of Rola Speakers.

The table above gives dimensions, with most important electrical characteristics, and prices, of the present range of Rola permanent magnet and electro-dynamic speakers.

An illustrated pamphlet just released by the Rola Company may be obtained free on request from Messrs. George Brown & Co. Pty. Ltd., 267 Clarence Street, Sydney.



New P.A. Projection Unit Increases Coverage.

Messrs. George Brown & Co. Pty. Ltd., of 267 Clarence Street, Sydney, announces the release of a projection horn for use with standard Rola eight-inch electro-dynamic and permanent magnet speakers.

The type 150 unit is of special spun 16-gauge aluminium with a heavy rolled bead to reinforce the bell-mouth opening. Complete protection of the speaker unit against damage through rough handling or climatic conditions is assured by the gauze in the throat opening and the streamlined cover over it.

An illustrated pamphlet giving full details, including dimensions and technical specifications, can be obtained free on request from Messrs. George Brown & Co. Pty. Ltd., at the address given above.



Proceedings Of World Radio Convention In Volume Form

A bound volume containing the complete proceedings of the World Radio Convention held in Sydney from April 4 to 14, 1938, has just been published by the Institution of Radio Engineers (Aust.) under whose auspices the Convention was held.

In all, 51 pages were delivered during the Convention business sessions, held at the Sydney University. The variety of subjects covered makes this volume of unique importance to everyone interested in the science of

radio communications and associated subjects.

Well-printed, cloth bound, and indexed for ready reference, these proceedings are available at 21/- per (Continued on page 38.)

PALEC MULTITESTER

MODEL "CM"



Manufacturers of Cathode Ray Equipment, Meters and full range of Testing Equipment.

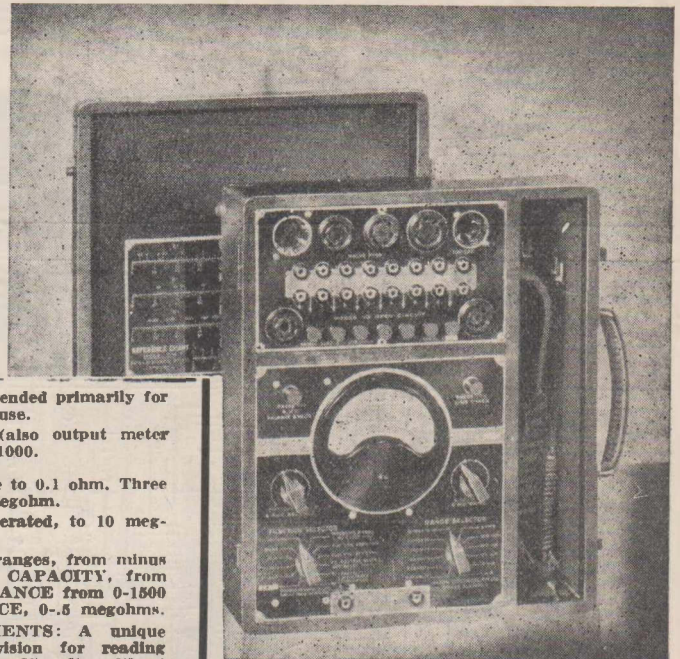

The Model CM is intended primarily for field and workshop use.

VOLTS, D.C.-A.C. (also output meter ranges): 10-100-250-1000.

MA's: 1-10-100-250.

OHMS: Special range to 0.1 ohm. Three other ranges to 1 megohm.

MEGOHMS: A.C. operated, to 10 megohms.

DECIBELS, in two ranges, from minus 10 to plus 35 db. CAPACITY, from .001-5 Mfd. INDUCTANCE from 0-1500 Henries. IMPEDANCE, 0-5 megohms.

A.V.C. MEASUREMENTS: A unique feature is the provision for reading D.C. potentials up to 25 volts without drawing current from the source—the equivalent of infinite ohms per volt.

PAPER CONDENSERS: Tests Paper and Mica Condensers for open circuit and leakage by the Neon flash method.

ELECTROLYTIC CONDENSERS: Instrument reads condition on a Good-Bad scale.

NEW PRICE MODEL CM, £12/15/-, plus tax. MODEL CM, as above, with the addition of a complete Analyser Selector for point to point analysis, £15/10/-, plus tax.

The Paton Electrical Pty. Ltd.

90 Victoria St., Ashfield, Sydney. Phone UA1960

Distributors:

Sydney: Lawrence & Hanson Electrical Co. Ltd., Fox & MacGillivuddy Ltd., Bloch & Gerber Ltd. Melbourne: Lawrence & Hanson Electrical Co. Ltd.; Homecrafts Ltd., 211 Swanston Street. Brisbane: Lawrence & Hanson Electrical Co. Ltd. Adelaide: Newtown, McLaren Ltd. New Zealand: The Electric Lamp House Ltd., Wellington.



Building The A.C. Version Of The . . . .

# Air-Ace Communications Four

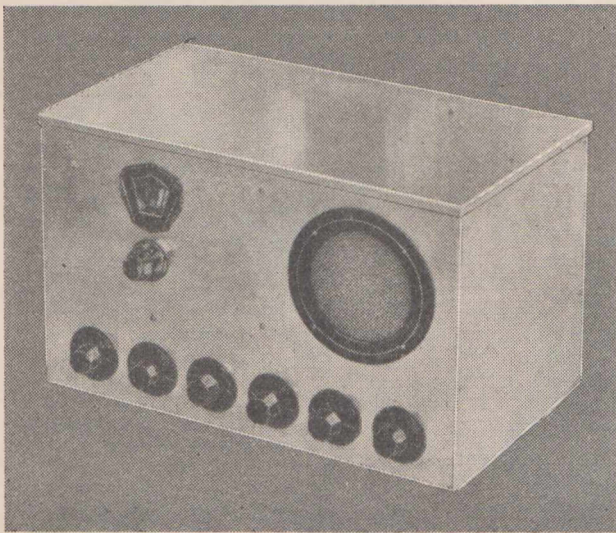

The completed receiver, housed in a frosted aluminium cabinet.

The amendments necessary to convert the "Air-Ace Communications Four" for a.c. operation are outlined below, constructional details also being given of a suitable power-pack.

In the August and September issues of "Radio World", a four-valve battery t.r.f. communications type receiver—the "Air-Ace Communications Four"—was described. Since the description appeared a number of inquiries have come to hand for details of an a.c. version; these are given in the article below.

### Only Minor Changes Needed.

In the first place, as octal-based valves are used in both models, there are only very minor differences between the two. In fact, under-socket connections for the valves in the battery and a.c. models are identical, except that the latter types have a cathode. Consequently, provision must be made to provide self-bias for all valves except the detector, which has its cathode grounded.

For the 6K7G, 6J5G and 6K6G, bias resistors of 250, 1000 and 500 ohms respectively are required. These are each by-passed by condensers of .1, 10 and 25 mfd. capacity, respectively.

### 'Phone Jack Retained.

In the a.c. model the 'phone jack has been retained, connected in series with the speaker voice coil.

Also, the double section rotary on/off switch in the battery model has been replaced by a single-pole single-throw switch in the "B-" lead. This, of course, does not become the main on/off switch, but it comes in handy when adjustments are being made to the set, and also it can be used to switch the "B-" supply off when coils are being changed.

The final amendment is the omission of the two series screen resistors for the r.f. and detector valves and the addition of a 15,000-ohm voltage divider, the necessary screen voltages being taken from appropriate taps.

The .0001 mfd. condenser in series with the .05 mfd. first audio coupling

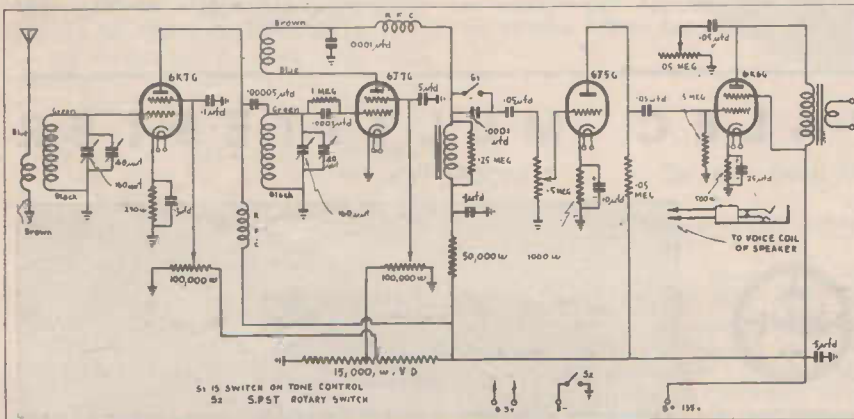

The circuit of the a.c. "Air-Ace Communications Four."

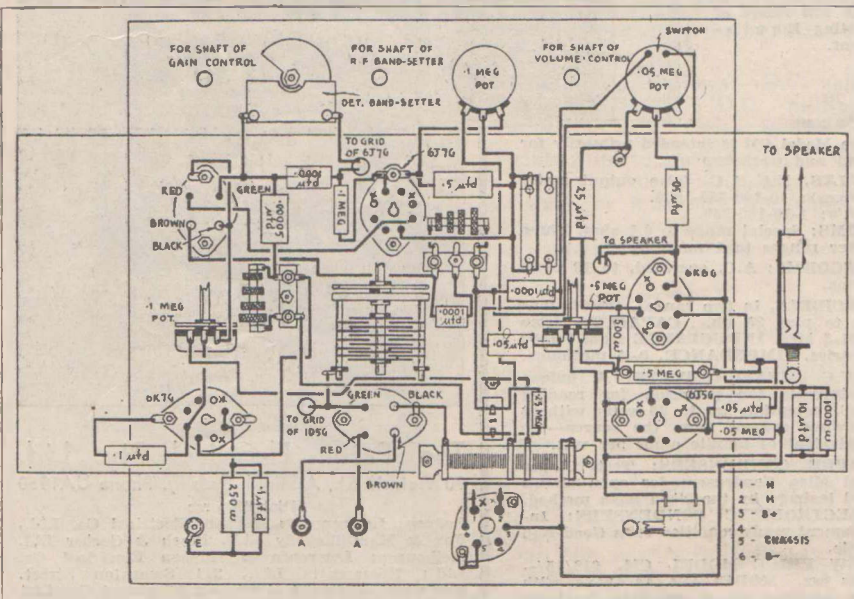

The complete under-chassis wiring is given in this sketch.



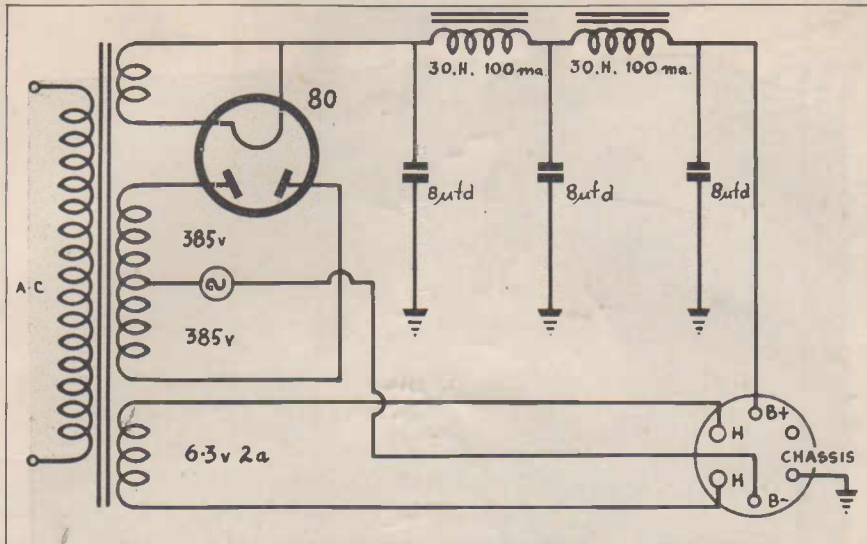

Circuit of the power-pack, which incorporates ample smoothing.

condenser has been retained as a very useful refinement for c.w. reception, a switch "S1" on the tone control being provided to enable the former condenser to be cut in or out of circuit at will.

**Well-Spaced Wiring Essential.**

An effort should be made to keep all leads carrying r.f. away from the heater wiring. Also, the wiring of the r.f. section should be kept well-spaced from that of the detector sec-

tion. It would be an excellent plan to run a shield partition half-way down the centre of the chassis and parallel to the front, thus completely isolating the r.f. and detector sections. The only lead passing from the former to the latter would be that from the .00005 mfd. coupling condenser.

If this shield is included there will, of course, be no need for separate brackets for mounting the .1 megohm (Continued overleaf.)

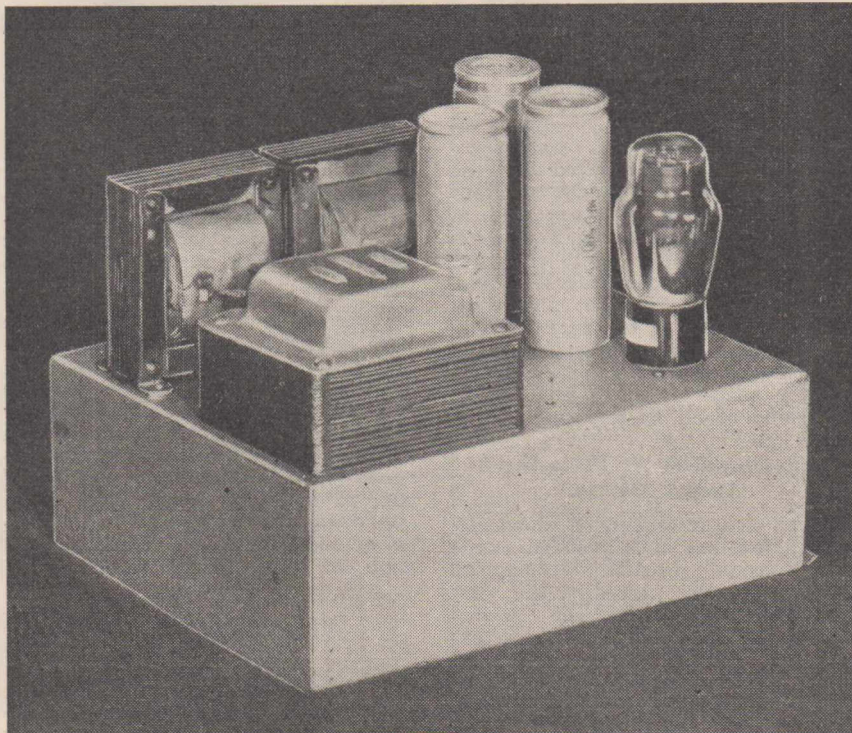

A general view of the power-pack, showing the above-chassis layout adopted.

# SIMPLEX CONDENSERS

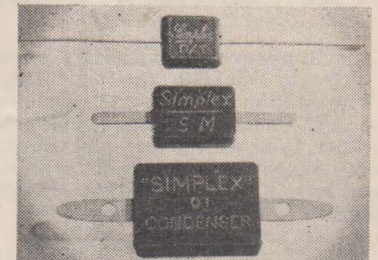

# NEVER

## LET YOU DOWN!

Operated under extremes of heat and humidity, with or without heavy overloads, Simplex condensers will never let you down.

Their exclusive use by many leading factories is proof positive of their unsurpassed reliability . . . of their accuracy in calibration . . . of their superior all-round design.

Type S/M, available in capacities from .000005 microfarads to .01 microfarads.

Type P/T (Pigtails) measuring only 5/8" x 5/8" — capacity range .000005 microfarads to .001 microfarads.

ALL SIMPLEX CONDENSERS ARE SUBJECTED TO A TEST OF AT LEAST 1000 VOLTS A.C. AND D.C.

# SIMPLEX CONDENSERS

"FAVoured BY FAMOUS FACTORIES"

Manufactured by Simplex Products Pty. Ltd., 716 Parramatta Road, Petersham, N.S.W.

'Phone LM 5615.

AGENTS IN ALL STATES:



## COMBINATION VACUUM-TUBE VOLTMETER AND MULTI-METER

### Full Details In Next Month's Issue

IN continuance of the series of articles by VK2MQ, entitled "Amateur Station Equipment," commenced in the July issue, the combination vacuum tube voltmeter and multi-meter illustrated alongside will be described in next month's "Radio-World."

Using a 0-1 millimeter as a basis, the instrument has no less than eighteen ranges. A.C. and D.C. voltage ranges of 1, 10, 100 and 500 volts are available, with a sensitivity of 100,000 ohms per volt. There are also seven D.C. voltage ranges of 1, 10, 100, 500, 750, 1000 and 1250 volts at 1000 ohms per volt, and four current ranges of 1, 10, 100 and 250 m.a. A point worthy of note is that the meter scale is linear for all ranges.

A 6Q7 valve is used, powered by the special three-unit power supply described in the July issue.



### "Air-Ace Communications Four"

(Continued from previous page.)

screen control potentiometer and the r.f. band-setting condenser.

The assembly of the a.c. model follows closely along the lines of that for the battery model as described in previous issues. As well, the complete under-chassis wiring sketch is published elsewhere. Also, the method of operating the receiver is identical with that described for the battery version, and so there is no need to devote further space to the construction or operation of the set. Instead, full details will be given of a suitable power supply.

#### The Power Supply.

The total heater current of the receiver is 1.3 amps. at 6.3 volts, while maximum "B" requirements are approximately 55 mills. at 250 volts. Hence, a standard 60 mill. power transformer will give ample output.

However, as the power pack can be used for a variety of purposes, it is a good plan to leave a little more margin by using an 80 mill. type. Suggested heater windings are 5

volts 2 amps. for the rectifier and 0.3 volt 3 amps. for heater supply.

A humless "B" supply—always an essential in a first-class short-wave receiver—has been ensured by the use of a two-section condenser input filter. For this, two 30-henry 100 m.a. smoothing chokes are required, together with three eight or 16 mfd. wet electrolytic filter condensers. Incidentally, should there be any trace of tuneable hum in the receiver it is a good plan to try connecting a .01 mfd. condenser from one side of the detector heater to earth, the correct side being found by experiment.

#### Fuse Included As Protection Against Shorts.

As an insurance against short circuits, a fuse has been included in the high tension secondary centre-tap return to earth. Actually, the "B-" lead is not earthed to the power-pack chassis, but is taken to one terminal of the 6-pin power socket. The lead from the corresponding terminal on the receiver power socket is taken via an on/off switch to earth. This switch enables the plate supply to the receiver to be turned off while coils

are being changed, or while adjustments are being made.

The power pack is assembled on a steel chassis measuring 8" x 10" x 3½." The layout is not in the least critical, though that shown in the photograph ensures short, direct wiring. The mains and power sockets are located at the rectifier end of the chassis.

Because the two filter chokes have very low resistance compared with the usual speaker field, the smoothed output voltage from the pack is too high for the receiver. This is very simply overcome by placing the full voltage across the divider in the receiver, and tapping down the "B+" supply to the set to 250 volts.

A complete list of parts for the receiver and power pack is published on page 43.

### What's New In Radio

(Continued from page 35.)

volume, post free in Australia (overseas 2/- extra postage), from the Institution of Radio Engineers, Box 3120 G.P.O., Sydney, N.S.W.



The

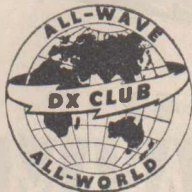

# All-Wave All-World

Official Organ of the  
All-Wave All-World DX Club

# DX News

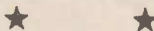

### Latest Shortwave Loggings

Contributed By H. I. JOHNS,  
Nelson, N.Z.

To those who have recently started dxing, perhaps a few stations with the times of hearing, etc., may be of some use to them. All these stations have been logged in the last three months on a four-valve battery set, the times given being the time the station was logged. All times are N.Z. standard time.

**XEBT, Mexico, 50.08 m.**—Can be heard daily at 4.30 p.m.; not a powerful station. The interval signal is a siren and three cuckoo calls. Address is Apartado, 79-44 Mexico City, D.F., Mexico. Verified in 10 weeks.

**COCM, Cuba, 30.49 m.**—Heard daily at 3.23 p.m.; heard fairly well in Nelson, N.Z. English announcement given out twice in half an hour—"Broadcasting COCM S.W. Habana, Cuba"; also in Spanish—"Say-Oh-Say Emmay." Address, Calle, 23 No. 482, Vedado, Habana, Cuba. Verified in 10 weeks.

**W9XF, Chicago, 49.18 m.**—Heard daily at 5.23 p.m. with good signals; call sign heard in several different languages; interval signal three gongs. Address: National Broadcasting Coy. Inc., Chicago, Illinois, U.S.A. Verified in eight weeks.

**XEUZ, Mexico, 49.02 m.**—Heard daily at 4.7 p.m.; chimes are heard fairly frequently; no English announcement was heard. The Spanish is Aykiss-Ay-oo-Traday. Address: Apartado 2641, Mexico City, Mexico. Verified in nine weeks.

**COCH, Cuba, 31.82 m.**—Heard daily at 3 p.m.; interval signal three gongs; no English announcement heard. Listeners will hear the word "Westing-house" used fairly often. Address: Calle B No. 2, Vedado, Habana, Cuba. Verified in 10 weeks.

**PLP, Java, 27.27 m.**—Heard nightly at 9.47 p.m. with usual good programme of music; interval signal six chiming bells. Address: The Netherlands Indies Broadcasting Coy., Bandoeng, Java. Verified in seven weeks, excellent card.

**W3XAL, New Jersey, 49.1 m.**—Heard daily at 4.14 p.m.; interval signal

three gongs sounded before call sign given out; heard well in Nelson, N.Z. Address: 30 Rockefeller Plaza, New York, N.Y., U.S.A. Verified in eight weeks.

**HBO, Geneva, 26.31 m.**—Heard Mondays at 5.23 p.m.; English programme for Australia and N.Z.

**HBJ, 20.64 m.**—Also heard Mondays at 5.48 p.m. Usually follows the transmission of HBO. Address: Information Section, League of Nations, Geneva, Switzerland.

**EAJ43, Canary Islands, 28.93 m.**—Heard almost daily at 7.40 a.m., with a good signal; music and speech in Spanish; closes round 8.24 a.m. Listeners will hear the name "Franco" several times. Address: EAJ43, Radio Club Tenerife Apartado 225,

Canary Islands. Verified in five months.

**RV96, Moscow, 19.75 m.**—Heard recently some nights at 9.52 p.m., with an excellent signal; have not heard any English during programme. Address: Radio Center, Moscow, U.S.S.R.

**SPW, Poland, 22.16 m.**—Heard Tuesday, Thursday and Saturday, at 12.9 p.m. English announcement made as follows: "You are listening to S.W. station SPW, Warsaw, Poland." Signals weak. Address: Polskie, Poland.

**PSE, 20.04 m.**—Heard on Sunday mornings at 7.50 a.m. for half an hour only, the programme being in French. Listeners will hear PSE in French as Pay-Ess-A (as in Hay). Good signals. Address: Cia, Radio Internacional de Brazil, Caixa Postal 709, Rio de Janeiro.

## ALL-WAVE ALL-WORLD DX CLUB Application for Membership

*The Secretary,  
All-Wave All-World DX Club,  
214 George Street,  
Sydney, N.S.W.*

Dear Sir,

*I am very interested in dxing, and am keen to join your Club.  
The details you require are given below:*

Name.....

Address.....

[Please print both plainly.] .....

My set is a.....

[Give make or type, number of valves, and state whether battery or mains operated.] .....

*I enclose herewith the Life Membership fee of 3/6 [Postal Notes or Money Order], for which I will receive, post free, a Club badge and a Membership Certificate showing my Official Club Number.*

(Signed).....

[Note: Readers who do not want to mutilate their copies of the "Radio World" by cutting out this form can write out the details required.]





# Short-wave Review

CONDUCTED BY  
**ALAN H. GRAHAM**

## Conditions Continue To Improve ★ Watch Those UHF Bands ★ Details Of New Stations And Schedules ★ Reports From Observers.

### Ultra-High-Frequency.

Speaking generally, conditions have undoubtedly improved over the last month. This has been especially noticeable on the higher frequencies. The U.H.F. channels are now approaching their peak, and readers with receivers capable of covering from 9-13 metres would do well to concentrate there during the daylight hours. Just at present 9.09- and 9.9-metre police transmitters, and 9.49 and 11-metre broadcasters are there for the logging.

Latest news regarding U.H.F. doings is indicative of the ever-increasing interest being taken in the broadcast bands, in America at least. Several new transmitters are reported to be on the air:—

W9XTC, 26,050 k.c., 11.5 m., Minnburg, Ill., is on the air daily from 4-6 a.m., using a power of 500 watts.

W9XTC, 26,050 k.c., 11.5 m., Minneapolis, relays WTCN from midnight to noon daily. Power 150 watts; reports particularly desired, as extensive antenna tests are being carried out.

W5XD, 31,600 k.c., 9.494 m., Grapevine, Texas. Power, 100 watts; no other details to hand.

W8XOY, 31,600 k.c., 9.494 m., Akron, Ohio. On the air from midnight till 1 a.m. daily.

Many complaints are still being registered regarding the amount of QRM on the 31,600 k.c. channel, on which close on twenty transmitters are now operating. This difficulty will be remedied with the coming into effect of the new F.C.C. regulations on October 13.

### South Americans.

Just at present reception of South and Central American stations is booming.

With a little care the keen dxer should be able to add the following to

his station log.

HJ1ABG, 6042 k.c., 49.65 m.; Baranquilla, Colombia. This station is often on the air on Sunday afternoons carrying a special DX programme. Its regular schedule is from 2 a.m.-2 p.m. QRA is Box 674.

YV1RL, 5935 k.c., 50.52 m., Maracaibo, Venezuela. Heard at night. QRA, Box 247.

YV1RB, 5845 k.c., 51.3 m., Maracaibo, Venezuela. Also to be logged at night from 11.45 p.m. QRA, Box 214.

YV5RC, 5800 k.c., 51.72 m., Caracas, Venezuela. Scheduled from 10-11 p.m.

YV1RD, 6081 k.c., 49.32 m., Maracaibo, Venezuela. Although latest schedule gives hours of transmission as 9 a.m.-2 p.m., this station has been logged around 10.15 p.m.

YV1RH, 6365 k.c., 47.18 m., Maracaibo, Venezuela. Heard best on 9-10.30 p.m. session.

XEFT, 9500 k.c., 31.41 m., Vera Cruz, Mexico. During the afternoons, closes at 3 or 3.30 p.m.

OAX5C, 9580 k.c., 31.32 m., Ica, Peru. Heard around 8 a.m.

COCA, 9100 k.c., 32.95 m., Habana, Cuba. Afternoons, closes just after 3 p.m. Relays CMCA.

XEUZ, 6117 k.c., 49.03 m., Mexico City. Relays XEFO from 4-6 p.m.

TG-2, 6210 k.c., 48.28 m., Guatemala City. Heard around 4 p.m. Relays TG-1.

Mexico.

Information from the publicity department of the Mexican government contains the following information:—

XEXA on 6132 k.c., 48.93 m., relays the BCB transmitter XEDP from 3.30-3.45 a.m.; and from 4.30-8 p.m. The English news session is heard from 7-8.30 a.m.

XECR is on the air from 3-4 a.m. daily on 7830 k.c., 38.8 m.

Guatemala.

Latest information to hand gives the full list of Guatemalan SW stations as:—

TGS, 5713 k.c., 52.3 m.

TG-25, 5902 k.c., 50.8 m.

TG2X, 5940 k.c., 50.47 m.

TG25E, 6400 k.c., 46.56 m.

TGWA, 9685 k.c., 30.96 m.

TGQA, 6440 k.c., 46.56 m.

TG-2, 6210 k.c., 48.28 m. (Incidentally this transmitter has also been reported on 6180 k.c., 48.5 m.)

TGWA, 15,170 k.c., 19.77 m.

Finland on the Air.

Finland has two short-wave transmitters: one in Lahti, power 1 kilowatt and operating on 31.58 and 25.47 m.; and the other in Helsinki, power of 200 watts, and operating on 49.02 m.

A third station is now under construction for operation on the 15 and 19-metre bands.

It is understood that the power of both stations now used will be increased to 10 kilowatts by the end of the year.

The hours of transmission, under normal circumstances, are as follow:

Call OFE, 25.47 m., 1-3 a.m.

Call OFD, 31.58 m., 3-8 a.m.

Call OFE, 25.47 m., 8-9.20 p.m.

All the above sessions are relayed through the Helsinki transmitter on 49 m.—call unknown.

All announcements are made in Finnish and Swedish.

QRA: O. Y. Suomen Yleisradio, A. B., Helsinki, Fabianinkatu 15, Finland.

Turkey.

The two Turkish transmitters recently referred to in these columns are now testing according to latest advice to hand.

TAP, 31.7 m. Location Ankara; power, 20 k.w.

TAQ, 19.74 m. Location also Ankara; power, 2.6 k.w.

Persia.

The 20 k.w. transmitter now under course of construction for the Government at Teheran will operate, it is believed, on 48.7 m.



**Further List of SWL Card "Swappers."**

Continuing the practice begun last month of publishing a short list of overseas dxers who desire to exchange S.W.L. cards with VK and ZL listeners, we bring to your notice the following QRA's. (Readers are invited to express an opinion on this feature of these columns.—S.W. Ed.)

- A. Bettinger, 2645 North 47th Ave., Omaha, Nebraska, U.S.A.
  - Shokichi Yoshimura, 3 Chome, Shoji-machi, Moji, Japan.
  - John C. Gregory, "Arlesey," 71-b Brook Street, Stourbridge, Worcs., England.
  - Dan T. Wallen, 448 Bannock Street, Denver, Colorado, U.S.A.
  - Jesus Ma. Landor Garcia, c/- Caribbean Petroleum Co., P.O. Box 809, Caracas, Venezuela.
  - Kerr W. Teale, 17 Cardinal Cres., Leeds 11, Yorkshire, England.
  - Josef Winter, Muenchen 19, Dom-Pedro-Str. 37, Germany.
  - W. Snell, Astley Street—Box 648, Sydney Mines, Cape Breton, Nova Scotia, Canada.
  - John T. Anglin, 233 Welholme Road, Grimsby, Lincs, England.
  - Ivan H. Witty, 18 Park Street, Lynn, Mass., U.S.A.
  - Cliff Taverner, Rosenberg, Texas, U.S.A.
  - Preston Bates, P.O. Box 52, Lindsay, Calif., U.S.A.
- All the above guarantee 100 per cent. QSL.



**Reports From Observers.**

Mr. C. Anderson (West Australia).

Reception this month has been definitely good. At the beginning of September strong gales were experienced in this locality, and during this period reception on 45-50 metres was exceptional. Among the stations logged were H11S, 46, COCW, 47, HIN and VE9HX, 48—all heard from 7-8 a.m. (local time).

On one occasion a Mexican station was logged on about 48.5 m., opening at 8 a.m. (local time), and announcing as "The Voice of Mexico," XECK, 40.6 metres, and X——. The remainder of the announcement was lost on account of the high noise level. I believe the station to have been XEXA, 6171 k.c.

Two regular South Americans are LRU, 19, around 8 p.m.; and LRX, 31, at 7 a.m. (both local time).

**Loggings for the Month.**

- 11 metres: W6XKG.
- 13 metres: GST, GSH, W2XE, PHI.
- 15 metres: PMA (relaying Holland; very strong).
- 16 metres: GSG, PH1-2, DJE, W3XAL.
- 19 metres: DJR, DJQ, DJB, DJL,

LRU, GSI, GSF, OLR5A, RV96, JZK, YDC, W8XK, SP-19.

- 20 metres: HBJ.
- 22 metres: SPW.
- 25 metres: HP5G, TPA-3, TPA-4, DJD, DJO, W8XK, W1XAL, W2XE, 2RO, COGF, JZJ, Hankow, 25.6 m.
- 26-30 metres: HBO, PLP, PMN, JVN.
- 30-31 metres: COBC, COCM, COCQ, COCH, JDY, CSW, EAQ, EAR, IRF, TI4NRH, TGWA, LRX, ZHP, VUD-2, HJ1ABP, KZRM, HS8PJ, XEWW, GSB, GSC, VPD-2, ZBW-3, W3XAU, W1XK, YDB.
- 32-33 metres: COBX, COBZ, COCA.
- 44 metres: PMH.
- 46-50 metres: H11S, COCW, COCO, HIN, ZGE, VE9HX, VPB, HS7PJ, VQ7LO, W8XAL, W3XAU, W4XB, W1XAL, VK9MI, Rangoon.

**Amateurs.**

- 10 metres: ZL2BT, ZL2FY, ZL1HY.
- 20 metres: NY2AE, TI2FG, ON4AM, PAOMZ, F3HL, F8VP, G6DT, G2TR, G8SB, J5CC, F18AC, VU2CQ, VU2BG, VS2AE, VS7RF, KA1JM, KA1CS, KA1ZL, KA2OV, KA7EF, PK1RI, PK1GL, PK2AY, PK2RN, PK3AA.

Mr. W. H. Pepin (West Australia).

Reception has improved lately as compared with previous months. The higher frequency bands have

been very good in the evenings, with the Americans W2XE, W8XK and W2XAD all heard on the 13-metre band at 8 p.m. (Perth time). The last-mentioned station, W2XAD, is a comparative newcomer and may be heard on 13.95 metres. Also on the 13-metre band is PCJ.

On 19 metres there is a new Russian station, which comes in at excellent strength carrying the same programme as RNE, 25 metres.

SPW, 22 metres, still comes in well. 2RO-4 and IRF are good morning stations.

Around 31 metres HS8PJ, COBZ, JDY, VUD-2 and KZRM are regulars.

Several new Japanese stations have been logged lately. The first of these is JZL on the 16-metre band, heard at fair strength around 9 a.m. (Perth time).

Also, the Japanese now appear to be transmitting regularly on 13 metres. Signals have been quite fair around 5 p.m.

An interesting session is heard from 25-metre W8XK from 8-8.30 a.m. (Perth time). This is conducted by Robert Ripley, of "Believe It Or Not" fame.

About the middle of the month a new commercial was logged on approximately 16.5 metres; this was PMB-6, heard relaying the NIROM programme at 3 p.m. (Perth time).

**Have Your "RADIO WORLD" Posted To You Direct**

Readers who want to take the "Radio World" on a subscription basis and have their copies posted to them direct each month are invited to complete the coupon below (annual sub. 10/6). New readers are advised that all back numbers in Volumes 1 and 2 are still available, price 9d., post free for copies in Volume 1 (May 1936 to April 1937) and 1/-, post free, for copies in Volume 2 (May 1937 to April 1938).

Enclosed please find remittance for 10/6, in payment for an annual subscription to the "Australasian Radio World," commencing with the..... issue.

Name.....

Street and No.....

City..... State.....

Country.....

Note.—N.Z. Subscribers can remit by Money Order or Postal Note.

THE AUSTRALASIAN RADIO WORLD,  
214 George Street, Sydney,  
N.S.W., Australia.



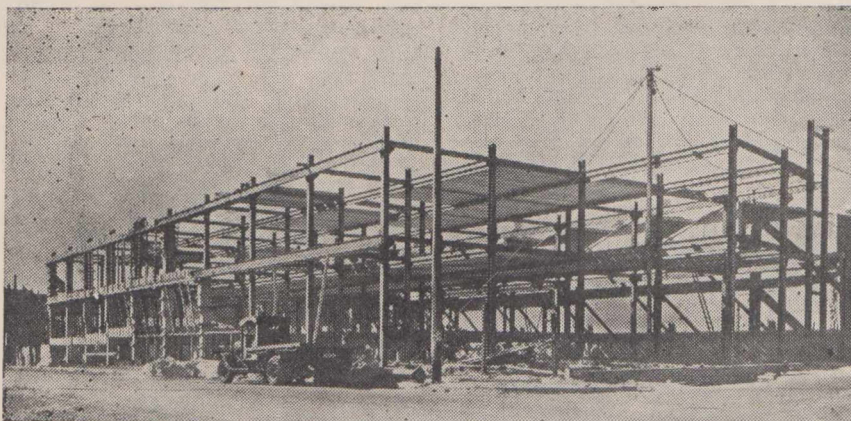

Required mainly to house new lines of manufacture, this extension to the S.T.C. factory is nearing completion. The steel girders provide support for a two-storey building with a total floor area of 33,000 square feet at the rear of the present factory. The ground floor will house the radio transmission manufacturing and testing laboratories, and provides space for new lines of manufacture. The floor above will be occupied by executive offices, and furnishes space for telephone manufacture and for the production of new lines.

TJ, "The Voice of Hankow," has been logged regularly for the past month or two.

Some of the best of the 20-metre amateur loggings for the month:—CO4FB, KA7EF, KA1BC, KA3KK, KA1JM, ZE1JX, XZ2EZ, K6KFN.

Mr. G. O. La Roche (West Australia).

Reception this month has shown a great improvement on the higher frequencies, and a slight improvement on the other bands except on 49 metres. This improvement has been most noticeable during the evening hours; the mornings have not been so good.

A feature of reception has been the number of Spanish-speaking stations heard between the 40-metre amateur band and 49 metres. These are at times rather difficult to identify.

The new Russian on 19 metres, RW96, has been dominating the band during the evening hours.

The 20-metre amateurs are, now very much better, and from 7-10 p.m. (Perth time) Africans, Oceanians, New Zealanders and Americans are easily logged; whilst from 2 to 3 p.m. Europeans are audible, even though not very strong.

Amateur loggings: VS7RA, VS7GJ, F18AC, VS6AG, FA3HC, ZS6DJ, ZS6DW, ZS5AW, ZS5AB, ZS6CZ, ZS6GJ, ZS6H, ZS2AZ, ZS6W, ZS5T, ZS1CN, ZU6P, G6DT, G6CR, G8SB, LA3B, VE4KZ, VP9R, CO8YV, CO2HY, CO2RG, CO2WM, CO2AU, PK6XX, PK6CI, KA1BH, KA1JM, KA1AF, KA1HF, KA1KF, KA3KK, KA3BW, KA2AB, KA7HP, K6DKN, K6GAB, K6KGA, K6GQF, PK1SK, PK1JR, PK3AA, PK4PB, PK3WI, PK3WA, PK1AP, PK1VY, PK1GL, PK3DC, PK2AC, PK3AR, PK2OV, PK3DF, PK3VB.

Best loggings on Broadcast Bands:

SPW (22), W9XF, COGF (25), Saigon, EAQ, ZHP (30), TI4NRH, CS2WA, ZRK, VUD-2, TPB, XEWW, (31), VPB (48), VQ7LO, SBG, COCO, Rangoon (49), VUM-2 (61), NIROM stations 61-98 metres.

Mr. A. E. Bruce (South Australia).

Reviews the wave-bands as follows: 13 metres: Just fair, with the London transmitters peaking at 10.30 p.m. Adelaide time. These are the only worth-while stations on this band.

#### OFFICIAL S.W. OBSERVERS.

N.S.W.: V. D. Kemmis (AW301DX), "Brampton Hall," 49 Kurraba Road, Neutral Bay, Sydney; A. R. Payten (AW352DX), High Street, Coff's Harbour.

SOUTH AUSTRALIA: J. C. Linehan (AW323DX), 181 South Terrace, Adelaide; A. E. Bruce (AW171DX), C/- 54 Currie Street, Adelaide; R. S. Coggins, 8 Glen Rowan Road, Woodville.

QUEENSLAND: J. K. Sorensen (AW316DX), "Fairholme," Station Road, Gympie; E. Neill (AW64DX), 26 Canning Street, Nth Ipswich.

WEST AUSTRALIA: G. O. La Roche (AW155DX), 62 Gladstone Avenue, South Perth; W. H. Pepin (AW402DX), Seventh Avenue, Maylands; C. J. Anderson (AW417DX), Dumbleyung.

TASMANIA: H. A. Callander (AW304DX), 1 Franklin Street, West Hobart.

VICTORIA: J. Ferrier (AW129DX), "Winninburn," Coleraine.

16 metres: Has shown a definite and general improvement. Best in the evenings.

20-metre amateur band: At the beginning of the month conditions were really excellent, many European and Americans being logged, together with a few Asiatics, all at good strength. Lately, however, results have been much less satisfactory.

31-metre band: A large number of stations audible both evening and morning. ZBW-3, VPD-2, KZRM, ZHP and VLR are best.

Amateur Loggings: 10 metres: ZL1MQ, ZL2BE, ZL1GZ, K6APH, W6GCX, W6MSU, W9DRQ.

20 metres: F8VP, F8UE, PAOMZ, LA1F, G6JL, G8CL, XU1QE, J5CC, KA1AP, KA1JM, VS2AE, VS2AB, PK4JD.

Mr. J. C. Linehan (South Australia):

DX conditions have been rather peculiar here in Adelaide, on the 10 and 20-metre bands, especially long slow fading has been noticed. However, this has not prevented the logging of a number of interesting stations.

The higher frequencies have been very good, especially the 10-metre amateur band which has opened up completely, so much so that it is possible to log as many as 50 W's in a couple of hours any day between 8 a.m. and noon.

The 11-metre broadcasters have been a bit patchy, but W6XKG, W9XA, W9XJL and W9XAZ are all easily logged.

The 13-metre band is very strong around 10.30 p.m., the best stations being DJS and GSJ, who put in very strong signals.

KQH, 20.2 m., put over a very interesting programme from 1.30 p.m. on Sundays (Adelaide time). They broadcast Hawaiian music from the Royal Pacific Hotel.

EAQ, 30.4 m., are still logged here, and are still desirous of receiving reports on their transmissions, according to announcements recently noted.

The Singapore transmitter, ZHP, 30.96 m., are still improving weekly. A good amateur catch was VS2AL on 20-metre 'phone, using a power of only 5 watts. This is the lowest DX station I have logged.

Other amateur 'phone loggings:—

10 metres: W9CXU, W9EAS, W9UDO, W5ZA, W5GHP, W4FT, W5GMR, W6PDB, W7FRM, W4EOZ, W1DIK, ZL1HY, VL4GM, VK4JP.

20 metres: F8RV, XE1K, VR6AY, PK6XX, XU6TL, XU8RB, PK4AU, PK1VV, KA7EF, OK1LV, PAOEO, HC2FG, OA4R, LU1HI, CO2WR, VS7RF, XZ2DY.

Incidentally a letter from W9CXU contains the request that VK's on 10



metres should give him a call on any Sunday between 9 and 11 a.m. Australian E.S.T. on the H.F. end of the band.

Mr. J. Ferrier (Victoria).

Conditions here have been very good on the U.H.F. bands during the last month. On September 11 on the 30.1 h.c. band I heard Car 224 of the Los Angeles County Sheriff's Department; signals were very weak. When Car 224 went over, W6XPA came back with an R9 plus signal. I understand that these cars are using a power of 15 watts.

On the 33.1 m.c. band I have heard many new calls, including W2IZ, it seems now that the police can get call-signs without the letter "X" after the numeral.

The 31.6 m.c. broadcast band is good except that there are four stations on the one frequency.

The 10-metre amateur band is good for W's and K6's around 10 a.m., and Africans come in best at about 4.30 p.m. When conditions are good ZE1JR comes in at R8-9.

Mr. V. D. Kemmis (New South Wales):

Mr. Kemmis forwards a splendid list of loggings, especially on the 20-metre amateur bands:—

Amateurs: Chile, CE- 3AT, 3BH, 3BS and 3CH; Morocco, CN8, AR and AV; Cuba, CO- 2RA, 2WM and 7CX; Portugal, CT1PR, Spanish Morocco, EA9AH; Irish Free State, EI- 2L, 3J; France, F- 3DI, 3HL, 3MM, 3OO, 3RV, 8AM, 8NT and 8XT; Scotland, GM- 2UU, 6WD; Wales, GW- 8HI, 5KJ; Ecuador, HC- 1FG, 1JW, 1PZ and 2HP; Haiti, HH2B; Dominican Republic, HI- 5X and 7G; Colombian Republic, HK, 3LC, 5EE; Honduras, HR- 5C; Japan, J5CC; Philippine Is., KA- 1AF, 1AM, 1BH, 1CS, 1FH, 1JM, 1ZL, 1YL, 3KK; Hawaiian Is., K6-BAZ, BNR, CGK, CMC, FAB, FKN, GAS, GQF, ILW, KPF, LKN, MTH, MVA, NTV, NZQ, OJI, OQE, OTH; Norway, LA1G; Argentina, LU- 1HI, 4BC, 4BM, 5CZ, 5FG; Canal Zone, NY2AE; Peru, OA- 4AI, 4AW, 4R; Belgium, ON4- MW and MZ; Holland, PAOBE and PAOMZ; Dutch East Indies, PK- 1BY, 1MX, 1RI, 1VY, 2AY, 2DF, 2WL, 3WI, 4JD and 6XX; Brazil, PY- 2JC, 2LM, 3EN, 9AE; Costa Rica, TI- 2AV, 2FC; Canada, VE5-ABD, ACN and OT; British Honduras, VP1BA; British Guiana, VP3AA; Bahamas, VP7NU; New Guinea, VK9XX; Pitcairn Is., VR6AY; Malaya, VS- 2AI, 3AE; Hong Kong, VS6AB; Ceylon, VS7GJ; Mexico, XE1LK; China, XU8- ET, RJ; Burma, XZ2- DY, PB; Venezuela, YV4- AX, 5AAB, 5ABF, 5AG; New Zealand, ZL2BE.

Broadcast Bands.

13 metres: DJS, GSH, and GSJ,

W2XAD and W2XE.

16 metres: DJE, GSG, JZL, PHI, W2XE and W3XAL.

19 metres: W2XE and W8XK, RW96, OZH (Denmark), JZK, Berlin and Daventry.

20 metres: KHQ, HBJ.

25 metres: SBP, CR7BH, XEWI, XTJ, OLR4A, 2RO-4, CJRX, COCX, JZJ, etc.

31 metres: COCM, ZHP, EAQ, TI4NRH, VUD-2, OAX4T, CXA-8, PRF-4, TGWA, XEWW, HJ1ABP, ZRK, VPD-2, KZRM, JZI, etc.

39-49 metres: JVP, PMH, TIPG and CJRO.

49 metres: W8XAL, HP5K, 9MI, YV1RI, HP5F, ZHJ, DJC.

~60 metres: VUM-2.

Mr. A. R. Payten (New South Wales):

Conditions are changing rapidly, lots of the old regulars are fading right out, while new stations are continually making their appearance. QRN has been very much to the fore.

The first new station noted is 2ZB, Wellington, testing on 6960 k.c., 43 metres. 2ZB puts in a grand signal every night, and is also fair up to 7 a.m.

A new airways transmitter at Karumba, Queensland, has been heard in their first test with Archerfield Aerodrome, Brisbane.

W2XGB, 34-63 metres, calling the "Normandie," and on other 'phone talks with North Carolina. Good strong signals.

Just above W2XGB is VK8XT, nal during conversations with neigh-

Cloncurry, which puts in a good signalling stations.

One very good reception was GBP, Rugby, 27.85 metres, in a 'phone contact with Sydney.

The strongest and most consistent station for weeks past is the NIROM native transmitter, PMH, 44.64 metres.

Moscow on 31 metres are very strong in the mornings.

EA9AH, 21 metres, is good around 7 a.m., with an occasional news session in English. There is another Nationalist station on 41.5 metres, which is heard practically every morning.

The new Russian on 19 metres is very strong in the evenings.

Amateur loggings include: VK8SK, PK6XX, PK1GL and VS2AE.

(The Chinese station you mention is XTJ, Hankow.—S.W. Editor.)

Mr. E. Neill (Queensland):

Conditions generally are falling away at night, whilst a slight improvement is noticeable during the afternoons. All the usual English and German stations are quite strong on the usual variety of wavelengths.

Best logging for the month is YV1RL on 50.5 metres. Signals were not very strong.

The Americans, W2XE and W8XK, are best on 19 metres, and are heard in the mornings at 7 a.m. Also strong on this band is PCJ, around 4.45 p.m.

KZRM and VPD-2 are very strong in the evenings.

Best amateur loggings (20 metres) are HC2HP, XU8RB, PY2JC, VS2AR and PK6XX. A number of Europeans are to be logged in the mornings.

#### "AIR-ACE COMMUNICATIONS FOUR" (A.C. Model): List of Parts

- |  |   |
|--|---|
| 1—aluminium chassis and panels to specifications.              | 1—500 ohm 1-watt carbon.  |
| 2—15-600-Metre Amateur All-Wave Coll Kits (Rayway).            | 1—250 ohm 1-watt carbon.  |
| 2—160 mmfd. midget variable condensers (Raymart).              | MICA FIXED CONDENSERS:  |
| 2—40 mmfd. midget variable condensers (Raymart).               | 1—.00005 mfd. mica (Simplex).   |
| 2—.1 megohm potentiometers.                                    | 3—.001 mfd. mica (Simplex).   |
| 1—.5 megohm potentiometer.                                     | 3—.05 mfd. mica (Simplex).  |
| 1—.05 megohm potentiometer.                                    | PAPER FIXED CONDENSERS:   |
| 1—dual speed vernier dial with escutcheon (Raymart, Type SMD). | 3—.1 mfd. mica (Ducon).   |
| 1—single circuit 'phone jack (Ormond).                         | 2—.5 mfd. mica (Ducon).   |
| 6—0-100 degree 2in. indicator plates.                          | 1—10 mfd. dry electrolytic (Ducon).   |
| 7—black control knobs.   | 1—25 mfd. dry electrolytic (Ducon).   |
| 1—double-pole single-throw toggle type switch.                 | VALVES:   |
| 4—octal sockets, 2 ceramic, 2 wafer.                           | 1—6K7G, 1—6J7G, 1—6J5G, 1—6K6G.   |
| 2—4-pin ceramic sockets.                                       | SPEAKER:  |
| 1—6-pin wafer socket.  | 1—5in. dynamic speaker to match single 6K6G, 2,500 ohm field (Rola).  |
| 1—6-pin plug and 2 yards six-wire cable.                       | MISCELLANEOUS.  |
| 1—H.I. audio choke.  | 2 doz. 3in. nuts and bolts, hook-up wire (solid and flexible), 3 terminals (2 red, 1 black), 2 hinges, 1 ebonite speaker escutcheon (optional). |
| 2—all-wave r.f. chokes (Raymart).                              | PARTS REQUIRED FOR POWER PACK   |
| 3—flexible couplers and bushings (Raymart).                    | 1—sprayed steel chassis.  |
| 2—goat valve shields.  | 1—power transformer, 385v. C.T. 385v. 60 or 80 m.a., 5v. 2a., 6.3v. 3a.   |
| 1—pair of headphones, with plug (S.T.C.).                      | 2—smoothing chokes, 30 h., 100 m.a.   |
| 1—15,000 ohm voltage divider.                                  | 3—16 mfd. wet electrolytic condensers (Ducon).  |
| FIXED RESISTORS:   | 1—fuse holder and fuse.   |
| 1—1 megohm 1-watt carbon.                                      | 1—power socket, with cable and plugs.   |
| 1—.5 megohm 1-watt carbon.                                     | 1—4-pin wafer socket.   |
| 1—.25 megohm 1-watt carbon.                                    | 1—6-pin wafer socket, with 6-wire cable and plugs.  |
| 2—.05 megohm 1-watt carbon.                                    | Hook-up wire, bolts and nuts, etc.  |
| 1—1,000 ohm 1-watt carbon.                                     |   |







19.63 DJQ	19.82 GSF	25.57 Saigon	60.6 VUM	27.27 PLP	31.8 COCH
19.74 DJB	25.4 2RO4	31.35 W1XK	61.4 VUC	29.24 PMN	32.09 COBC
19.79 JZK	25.57 Saigon	31.38 DJA	70.2 RV15	30.61 XGOX	32.59 COBX
19.85 DJL	27.27 PLP	31.49 ZBW3	11 p.m.-midnight.	30.78 COCQ	33.2 COBZ
30.04 COBC	28.14 JVN	31.8 COCH	16.89 DJE	30.96 ZHP	44.64 PMH
31.28 VK2ME	29.24 PMN	32.09 COBC	19.56 DJR	49.96 HP5K	48.7 VPB
(S)	30.96 ZHP	32.59 COBX	19.63 DJQ	31.28 VK2ME	49.5 W8XAL
31.38 DJA	31.28 VK2ME	44.64 PMH	19.68 TPA2	(S)	49.9 COCO
32.15 OAX4J	(S)	46.8 TIPG	19.74 DJB	31.3 VUD	30.9 ZHP
32.59 COBX	31.38 DJA	48.7 VPB	19.82 YDC	31.35 W1XK	49.98 Rangoon
33.26 COBZ	31.45 VPD2	49.5 W8XAL	19.8 YDC	31.38 OAX4T	58.3 PMY
49.18 W3XAL	31.49 ZBW3	49.96 HPSK	19.82 GSF	31.38 DJA	60.0 VUD
49.5 W8XAL	31.55 VK3ME	49.98 Rangoon	19.85 DJL	31.49 ZBW3	60.6 VUM
	34.0 VPD3	58.3 PMY	25.4 2RO4	31.51 HS8PJ	61.4 VUC
	43.1 2GB	60.0 VUD	25.42 JZJ	(Th)	70.2 RV15

4-5 p.m.

13.99 DJS	44.64 PMH
16.89 DJE	70.2 RV15
19.63 DJQ	
19.74 DJB	9-10 p.m.
19.79 JZK	13.99 DJS
19.85 DJL	19.56 DJR
20.64 HBJ (M)	19.58 OLR5B
25.24 TPA3	19.63 DJQ
26.31 HBO (M)	19.68 TPA2
31.28 VK2ME	19.7 OLR5A
31.38 DJA	19.71 PCJ (W)
49.5 W8XAL	19.74 DJB

5-6 p.m.

13.99 DJS	19.82 GSF
16.86 GSG	19.85 DJL (S)
16.89 DJE	25.0 RNE (W)
19.63 DJQ	25.4 2RO4
19.74 DJB	25.57 Saigon
19.76 GSO	27.27 PLP
19.82 GSF	28.14 JVN
25.23 TPA3	29.24 PMN
25.52 GSD	30.23 JDY
28.14 JVN	30.61 XGOX
31.28 VK2ME	30.96 ZHP
(S)	31.28 VK2ME
31.38 DJA	(S)
31.55 GSB	31.28 VK6ME
	31.38 DJA
	31.45 VPD2

6-7 p.m.

13.99 DJS	31.49 ZBW3
16.86 GSG	31.55 VK3ME
16.89 DJE	34.0 VPD3
19.31 PCJ (Th)	43.1 2GB
19.63 DJQ	44.64 PMH
19.74 DJB	48.7 VPB
19.76 GSO	49.5 W8XAL
19.82 GSF	58.3 PMY
25.23 TPA3	70.2 RV15
25.52 GSD	

10-11 p.m.

28.14 JVN	13.99 DJS
31.28 VK2ME	19.58 OLR5B
(S)	19.63 DJQ
31.38 DJA	19.68 TPA2
31.55 GSB	19.74 DJB
	19.8 YDC
	19.82 GSF

7-8 p.m.

13.99 DJS	19.7 OLR5A
16.89 DJE	19.85 DJL (S)
19.71 PCJ (Th)	25.4 2RO4
19.74 DJB	25.42 JZJ
25.57 Saigon	25.57 Saigon
28.14 JVN	25.65 HPSA
31.38 DJA	27.27 PLP
31.49 ZBW3	28.14 JVN
31.55 VK3ME	29.24 PMN
	30.23 JDY

8-9 p.m.

13.99 DJS	30.61 XGOX
16.86 GSG	30.78 COCQ
19.68 TPA2	30.96 ZHP
19.71 PCJ (W)	31.28 VK6ME
19.74 DJB	31.28 VK2ME
19.8 YDC	(S)
	31.3 VUD

## J. FERRIER WINS FIFTH SHORTWAVE DX CONTEST

### Some Excellent Entries

By Alan H. Graham.

ON examination of the entries received for the "Radio World" fifth DX Contest, the judges were pleased to note that two of the entrants submitted verifications confirming reception of a number of U.H.F. transmitters. In view of the high merit of these entries the judges felt that they were quite justified in limiting their choice for first place to the verifications submitted by Messrs. J. Ferrier and R. Simpson.

Owing to the similarity of the entries forwarded by these two competitors, some difficulty was experienced in arriving at a final decision. However, two factors swayed the scales in favour of Mr. Ferrier; firstly, the fact that he used a less powerful receiver than Mr. Simpson; and, secondly, the fact that his winning verification was for reception on 33.1 m.c. or 9.09 m.

The entry for which Mr. Ferrier was awarded the Replogle Globe trophy was a letter from Durham, North Carolina, Police Department, verifying reception of their 9-metre signals. It is interesting to note that Mr. Ferrier used a "Jones Ultra-Gainer" for reception of W4XK, the antenna being an 8ft. dipole. Incidentally, Mr. Ferrier also submitted verifications from Fort Worth (W5XB) and Los Angeles (W6XPA).

The runner-up in the fifth trophy contest was Mr. R. Simpson, who submitted six verifications of great merit, including three for U.H.F. receptions—namely, San Gabriel Police (W6XGC), and 9.49 m. Broadcasters W4XCA and W9XPD. In addition, Mr. Simpson forwarded cards from LRA (30.9 m.), OFD (31.58 m.) and ZEC (51.72 m.). The judges have been struck by the remarkably high

standard of all the verifications submitted by Mr. Simpson for the past three contests—readers will recall that he won the third contest and has been runner-up in the two subsequent contests.

The other competitors, and there was a very pleasing number of them, must be considered more than a trifle unfortunate in that they encountered such high-class opposition. In a number of cases the cards entered were really worthy of a better fate than that of being mentioned among the "Honourable Mentions," as follow:—

Mr. J. C. Linehan: Card from YDH-4, 30 watt, 90.36 metre station of the Bandoeng Radio Society, D.E.I.

Miss Joy McKenzie: Card from HJ4ABU, 34.6-metre station of the "Universidad de Antioquia," Medellin, Colombia.

Mr. C. A. Stiglish: Card from 20-metre amateur station G3DO, using power of only 10 watts.

Mr. C. Broel: Card from amateur station SV1NK, Greece, verifying first report from Australia.

Mr. H. A. Matthews: Card from amateur station CT2AB, Azores—probably the most distant station yet entered for any of the "Radio World" contests.

Summing up the results:—  
Winner :  
Mr. J. Ferrier, Coleraine, Victoria.

Runner-up :  
Mr. R. Simpson, Concord West, New South Wales.

Honourable Mention :  
Mr. J. C. Linehan, Adelaide, South Australia; Mr. H. A. Matthews, Eilerslie, Victoria; Mr. C. Broel, Marriekville, New South Wales; Mr. C. A. Stiglish, Dunedin, New Zealand; Miss Joy McKenzie, Takahiwai, New Zealand.



## Contest Winner's Experiences

(Continued from page 29.)

At this time I was also getting good reception from American stations, including KPO, KGO, KNX, KMOX, KFON and WDAE. I remember one evening tuning in WDAE, Tampa, Florida, broadcasting a special programme for Australian and New Zealand listeners.

The most consistent American in those days was KFON, Long Beach, California, and one of their special features was the broadcasting of a concert given by the Keivanis Radio Frolic every Monday evening from 9 to 12 p.m. P.S.T. Listeners sending a correct report on these transmissions were made a member of the club, my membership card (No. 888) still being in my possession. How many of my readers will remember the closing announcements from KFON each night about 6 p.m. A.E.S.T.?—"This is KFON, 'The Piggly Wiggly Station,' owned and operated by Nicols and Warrimer, Jergins Trust Buildings, Long Beach, California, broadcasting on 1240 kilocycles and a power of 500 watts. Listen to Your Ship Coming In."

About 1935 a vast improvement was made in short-wave stations all over the world, and having plenty of leisure time at my disposal during the day time I concentrated and listened endeavouring to identify the many new shortwave stations that were daily making their appearance. Incidentally, I am in possession of quite a number of veries from s.w. stations, the lowest powered using 7 watts.

The most outstanding veri. is from XEUW, 20 watts, 6020 k.c. I heard this station broadcast at 12.45 p.m. A.E.S.T. on November 30, 1936, using a three-tube super. Incidentally, I sent another report away to this station in July, 1938.

When Mr. Graham commenced the DX contest by donating the first Replogle Globe for first prize I decided to try and win one, and naturally was very pleased indeed when I received word that I had won the fourth contest.

The Globe is a very excellent and attractive trophy, and is greatly admired by our local dxers, who have seen it in my shack.—W. T. Choppen (AW61DX), Timaru, N.Z.

## "1938 Outdoor Portable Four"

(Continued from page 8.)

placing the 1C6, 1A4, 1K6 and 1D4 valves respectively, used in last year's model. As these are all equivalents, no change in the circuit constants required.

### Some Circuit Details.

The secret of the exceptional sensitivity given by the "Outdoor" lies

## "AMATEUR COMMUNICATIONS SUPERHET.": List of Parts

- 1—16 gauge aluminium chassis, front panel, and shield partitions (Radiomac).
  - 1—power transformer, 385v. C.T. 385v.: 6.3v. 3 a.; 5v. 3a. (Radlokes L-100).
  - 1—30-henry 100 m.a. smoothing choke (Radlokes C-100).
  - 3—35 mmfd. isolantite midget variable condensers (Radiomac).
  - 3—160 mmfd. isolantite midget variable condensers (Radiomac).
  - 1—3-plate midget variable condenser (Radiomac).
  - 1—beat frequency oscillator coil unit (Radiomac).
  - 3—iron-cored 465 k.c. I.F. transformers (Radiomac).
  - 1—5,000-ohm potentiometer.
  - 1—20,000-ohm potentiometer.
  - 1—50,000-ohm potentiometer, with switch.
  - 1—5 megohm potentiometer.
  - 1—25,000 ohm voltage divider (Radlokes).
  - 1—vernier dial, panel-mounting type (Radiomac).
  - 3—s.p. s.t. on/off switches.
  - 1—closed circuit output jack
  - 3—0-180 degree indicator plates, 2-inch diam. (Radiomac).
  - 3—pointers to suit.
  - 2—single-pole single-throw toggle switches.
  - 2—4-pin, 1 6-pin isolantite sockets for coils (Amphenol).
  - 1—special kit of 12 plug-in coils, covering 4 bands with 3 coils for each band (Rayway Lowloss).
  - 1—power socket, with plug and flex.
  - 9—octal sockets.
  - 5—goat valve shields.
  - 5—midget screen grid clips.
  - 5—couplers, for ganging 35 mmfd. band-spread (3 flexible).
  - 1—8in. length of 3/16 in. rod (brass or bakelite).
  - 2—terminals, 1 red, 1 black (Dalton).
- FIXED RESISTORS:**
- 1—300 ohm 1-watt carbon.
  - 2—500 ohm 1-watt carbon.
  - 2—2,000 ohm 1-watt carbon.
  - 2—10,000 ohm 1-watt carbon.
  - 3—50,000 ohm 1-watt carbon.
  - 2—50,000 ohm 1/3-watt carbon.
  - 1—100,000 ohm 1-watt carbon.
  - 2—100,000 ohm 1/3-watt carbon.
  - 1—5,000 ohm 2-watt carbon.
  - 1—300 ohm 100 m.a., wirewound.
  - 1—400 ohm 100 m.a.
- MICA FIXED CONDENSERS:**
- 1—.00005 mfd. midget mica (Simplex).
  - 6—.0001 mfd. midget mica (Simplex).
  - 5—.05 mfd. midget mica (Simplex).
- PAPER FIXED CONDENSERS:**
- 9—.1 mfd. tubular (Ducon).
  - 3—.5 mfd. tubular (Ducon).
  - 1—25 mfd. dry electrolytic, 25v. working (Ducon).
  - 3—8 mfd. wet electrolytics, 500v. working (Ducon).
- VALVES:**
- 3—6U7G's, 1—6L7G, 1—6G8G, 1—6J7G, 1—6AG6G, 1—6Y4G.
- SPEAKER:**
- 1—5-inch dynamic speaker, 1,000 ohm field, input transformer to match single 42 (Rola).
- MISCELLANEOUS:**
- 4 doz. 3/16 in. bolts and nuts; 2 doz. solder tags; 3 yds 16-gauge tinned copper wire; hook-up wire.

in the special reflex circuit used for the 1K7G. This valve actually performs four functions. One diode is used for detection purposes and the other for a.v.c., while the pentode section acts both as i.f. and a.f. amplifier.

The remainder of the circuit is quite straightforward.

A 1C7G is used as mixer-oscillator in the usual circuit arrangement, the anode grid drain being kept down to the lowest satisfactory minimum by means of the 25,000-ohm voltage-dropping resistor shown.

The first i.f. amplifier is a 1D5G. Next follows the 1K7G, the pentode section operating as second i.f. amplifier. From the plate of this valve onwards, the reflex circuit comes into the picture. In series with the primary of the third i.f. transformer is a 1 megohm resistor which has no effect on i.f. currents, but which forms the plate load resistor for the pentode section of the 1K7G when it is acting as first audio amplifier.

Diode detection is accomplished in the usual way, a fixed .5 megohm diode load resistor being used. The audio voltages developed across it pass from the "hot" or negative end of this resistor, through a filter network designed to stop r.f. and i.f. also present, through a .01 mfd. coupling condenser, back again to the grid of the 1K7G via the secondary winding of the second i.f. transformer. A bias of 1.5 volts is applied to the pentode section of this valve.

The amplified audio voltages appearing on the plate of the 1K7G pass unhindered through the primary

of the third i.f. transformer, and from the bottom end of this winding are transferred to the grid of the 1L5G output pentode by resistance capacity coupling, in an arrangement that is perfectly normal except for additional filtering, provided by the .001 mfd. and .0001 mfd. by-pass condenser on either side of the .1 megohm resistor.

### Further Details Next Month.

A complete list of the parts required to build the "1938 Outdoor" is given elsewhere. Also, the circuit, wiring diagram and photographs will enable readers who have had some experience in set-building to complete the receiver without further instruction. However, for those whose experience is limited, an article outlining the wiring and alignment will be published next month.

## "Vibra Dual-Wave Five"

In last month's "Radio World" a photograph with circuit and brief details were published of the "Vibra Dual-Wave Five," a vibrator-operated five-valve dual-wave superhet using the new 6.3 volt .15 amp. valves throughout. A full description was scheduled for this issue, but a delay has occurred in production of the new Radlokes dual-wave box chosen for this receiver. It is hoped that the design will be completed in time for the article to appear in the November issue.





★

Mr. J. C. Linchan (AW323DX), of Adelaide, S.A., who donated the attractive trophy shown on the right for first prize in a QSL Card Contest. A reproduction of the winner's card is shown below.

★



# O.G. Washfold Wins QSL Card Contest

## Over Forty Entries In Novel Competition ★ Many Attractive Designs

OVER forty entries were received for the recently-held QSL Card Contest—from DX club members throughout Australia, New Zealand and even as far afield as Cuba. The cards submitted were almost without exception of a particularly high standard, and it was only after some difficulty that the winning card was chosen.

The contest was won by Mr. O. G.

Washfold (AW257DX), of 59 Radnor Street, Camberwell, Melbourne, who accordingly wins the attractive, suitably-engraved trophy generously donated by Mr. J. C. Linehan, of Adelaide, S.A.

A reproduction of the winning card appears on this page (in the original, the printing in the centre is in black with the station call in red on a plain white background). On the

reverse side of the card appears the following lettering:—

REPORT FROM O. G. WASHFOLD

Owner-Operator

AW257DX.

RX..... ANT.....

To.....UR.CW/FONE SIGS. ON...M.

AT..... AEST..... ON.....

QSA..... R..... WX.....

QSB..... QRM..... QRN.....

REMARKS .....

PSE QSL. OM VY73 OP

It should be mentioned that in the judging it was necessary to take utility into account, as well as attractiveness of design. For example, the card from AW304DX reproduced overleaf is of particularly striking design, but space for details is rather cramped, and in addition white ink would have to be used for making out reports. As well, the sample card submitted is on glazed board, which would be particularly difficult to write on. At the same time, this entry reveals an originality of design that is a credit to its owner.

Other entries that were highly commended were received from Messrs. A. R. Payten, A. Nall, R.



The winner's card, which in the original is printed in black, with the letters "AW257DX" in red, centre background being plain white.



TO RADIO..... UR. FONE CW SKS HR..... AM PM 193

R..... QSA..... TONE..... QRH..... QRM.....

TASMANIAN

AW 304 DX

RECEIVING STATION

RECEIVER... 7 TUBE ALL WAVE SUPER... AERIAL..... FT LONG..... HIGH.....

REMARKS.....

PSE... QSL... CARD FOR A CARD OM..... VY.73.FM..... OP

A particularly striking card in black and white, entered by Mr. H. A. Callander, of West Hobart, Tasmania. The original measures 6 1/2" x 5 1/8".

Kennedy, G. O. La Roche, J. Biscoop, R. F. Rubio (Cuba), Mrs. M. M. Anselme, and Miss G. Payten.

One point that should be stressed is that when planning a card, dxers should not sacrifice utility to design. A very effective way of overcoming this difficulty is that adopted by a number of entrants as well as by the winner, in using the back of the card for reception data.

It has been suggested that the winning card be used for a standard club design, space being left so that individual member's names and addresses can be printed in. However, it is possible that members would prefer to use their own designs, and to settle this point they are invited to write in indicating their preference.



**The Late Ross A. Hull.**

**Ross Hull Killed In States**

Last month amateur and commercial radio circles throughout the world were shocked to learn of the accidental death in Vernon, Connecticut (U.S.A.) of Ross A. Hull, editor of the American amateur magazine "QST." He was accidentally electrocuted while

experimenting in his cottage laboratory.

Ross Hull was born at St. Arnaud, Victoria, six years ago, and was educated at Ballarat College. One of the earliest radio experimenters in Melbourne, he was the first to pick up signals from the United States in 1922. In 1926 he came to Sydney, and in 1929 was appointed technical editor of "Wireless Weekly." In 1930 he went to America as associate editor of "QST," later becoming editor.

Ross Hull's work in America in pioneering the comparatively new field of ultra short wave radio communications won him world-wide acclaim. Of late months his energies were devoted to developing a practical system of television on the ultra high frequencies for amateur use. Actually, it was while working on this latest development that he accidentally came in contact with a 6000-volt supply, and was electrocuted.

His loss to radio is almost irreparable, and his passing will be mourned by the thousands of amateurs throughout the world who have looked to him for guidance and inspiration.

**Philips Model 6505 Radioplayer Reduced In Price**

Illustrated below is the Philips Mantel Radioplayer 6505, recently reduced in price from 16 to 14 guineas. This popular five-valve broadcast

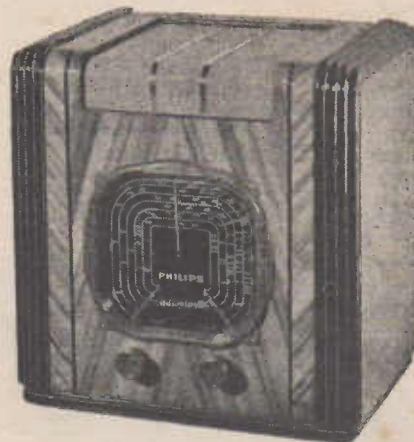

receiver has eight-inch speaker and full-sized chassis and components, and is equipped with these valves: AK2, AF3, ABC1, AL2, AZ3.

Housed in a cabinet, of which a distinctive feature is the use of chromium on the speaker grille, Radioplayer 6505 is the ideal "second set."



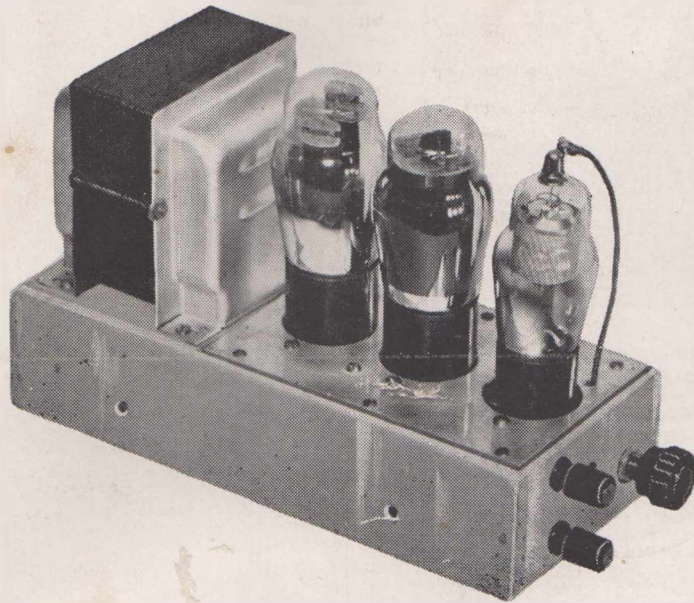

# You can build the Four-Watt Beam Amplifier

FOR ONLY ...

## £5-7-6

The Four-Watt Beam Amplifier fully described in the July issue of this magazine is powerful enough for a small hall, and at £5/7/6 for the complete kit represents really wonderful value. The price includes valves and speaker, and—Vealls pay freight to your nearest Railway Station. ORDER A KIT TO-DAY!

### HAVE YOU WRITTEN FOR VEALLS 1938 CATALOGUE ?

Vealls new 60-page Radio Catalogue for 1938 is now ready—just off the press. Write for your copy to-day . . . merely enclose a 2d. stamp to defray cost of postage.

#### VEALLS PAY FREIGHT.

It pays to deal at Vealls, who pay freight on all Victorian Retail Orders excepting Radio Cabinets and on all Interstate retail orders excepting cabinets and batteries.

**VEALLS . . . THE FASTEST MAIL ORDER IN AUSTRALIA**

## The VIBRA DUAL-WAVE FIVE

See the full details elsewhere in this issue . . . a vibrator operated 5-valve dual-wave super-kit using the new 6.3 volt .15 amp valves throughout. Ask Vealls to quote you for the supply of the complete kit ready for assembly.

## The AIR-CELL FOUR

Designed especially for "Air-Cell" operation, the "Air-Cell" Dual-Wave Four was fully described in the June issue of this magazine, and has proved particularly popular with country readers. Order a kit to-day—Vealls pay freight to your nearest Victorian railway station.

PRICE, £12/10/-  
the Complete Kit of Parts.

# VEALLS 6 BIG STORES

All letters to Box 2135T., G.P.O., Melbourne, C1.

490 Elizabeth Street, Melbourne. F 3145.  
168 Swanston Street, Melbourne. C 10524.  
3-5 Riversdale Road, Camberwell. W 1188.

243 Swanston Street, Melbourne. C 3059.  
299-301 Chapel Street, Prahran. Wind. 1605.  
97-99 Puckle Street, Moonee Ponds. FU 7822.



PHILIPS



**Y**EARS of constant and untiring research in the Philips laboratories have earned for Philips a reputation that is world-wide—a reputation borne out by outstanding performance in almost every phase of the electrical industry.

Lamps, Valves, Radioplayers, Transmitting and X-Ray Apparatus—these are but a few of the many products of this famous organisation.

Look for the name—PHILIPS—your guarantee of supreme quality and reliability.

**PHILIPS**

---

WORLD'S LARGEST RADIO MANUFACTURERS

---