

THE  
AUSTRALASIAN

JULY 1, 1938  
VOL. 3 — NO. 3  
PRICE, 1/-

# Radio World

Registered at the G.P.O.,  
Sydney, for transmission  
by post as a periodical.

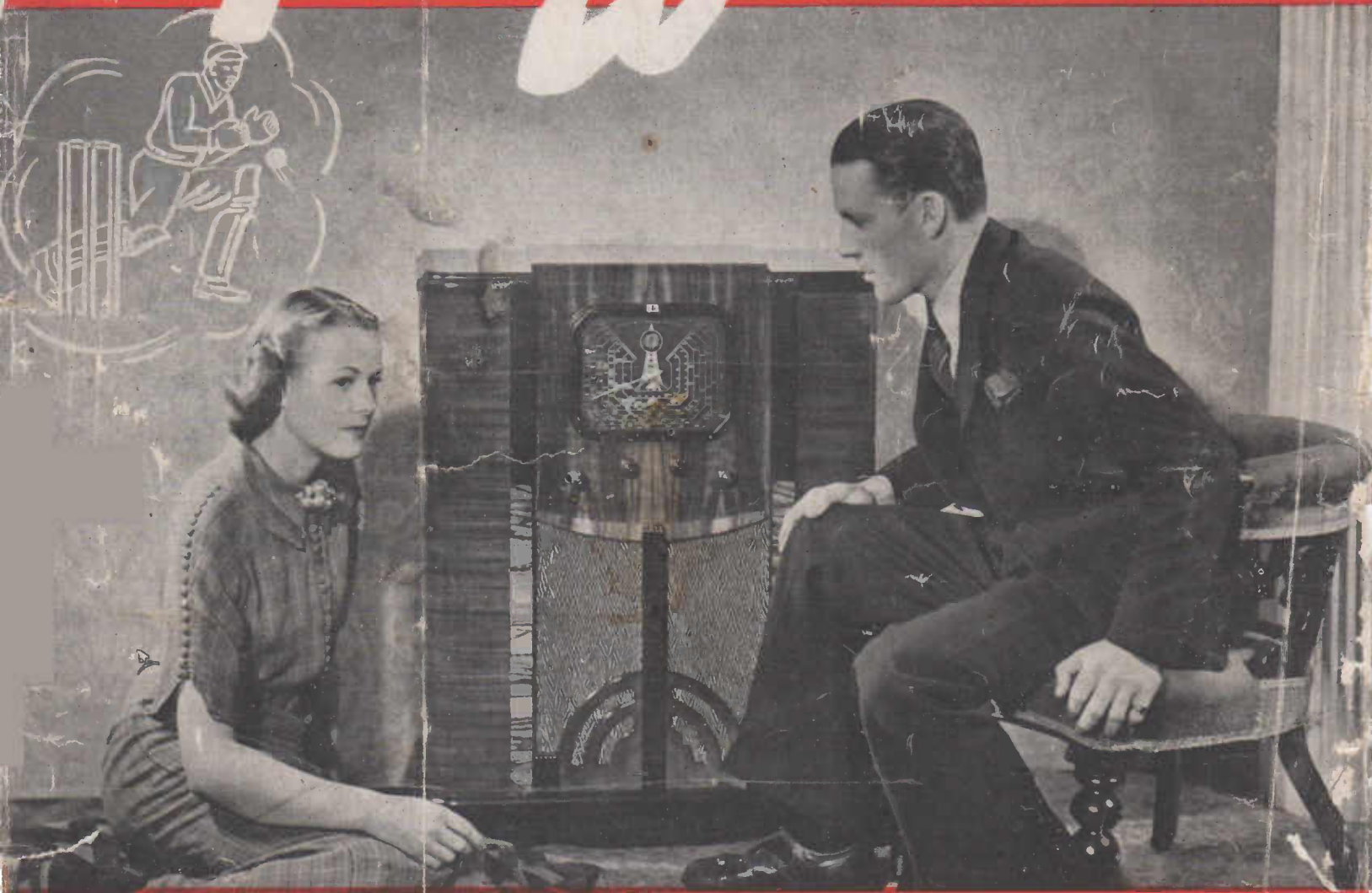

Enjoying a cricket broadcast with an S.T.C. Model "Q" Triple-Wave Console. (See page 10.)

● "AUTO-TUNE DUAL-WAVE FIVE": HOME RECORDING FOR THE

● AMATEUR; FOUR-WATT BEAM AMPLIFIER: AMATEUR STATION EQUIPMENT;

● MONITOR & MODULATION METER: 3-UNIT POWER PACK: LATEST S.W. NEWS

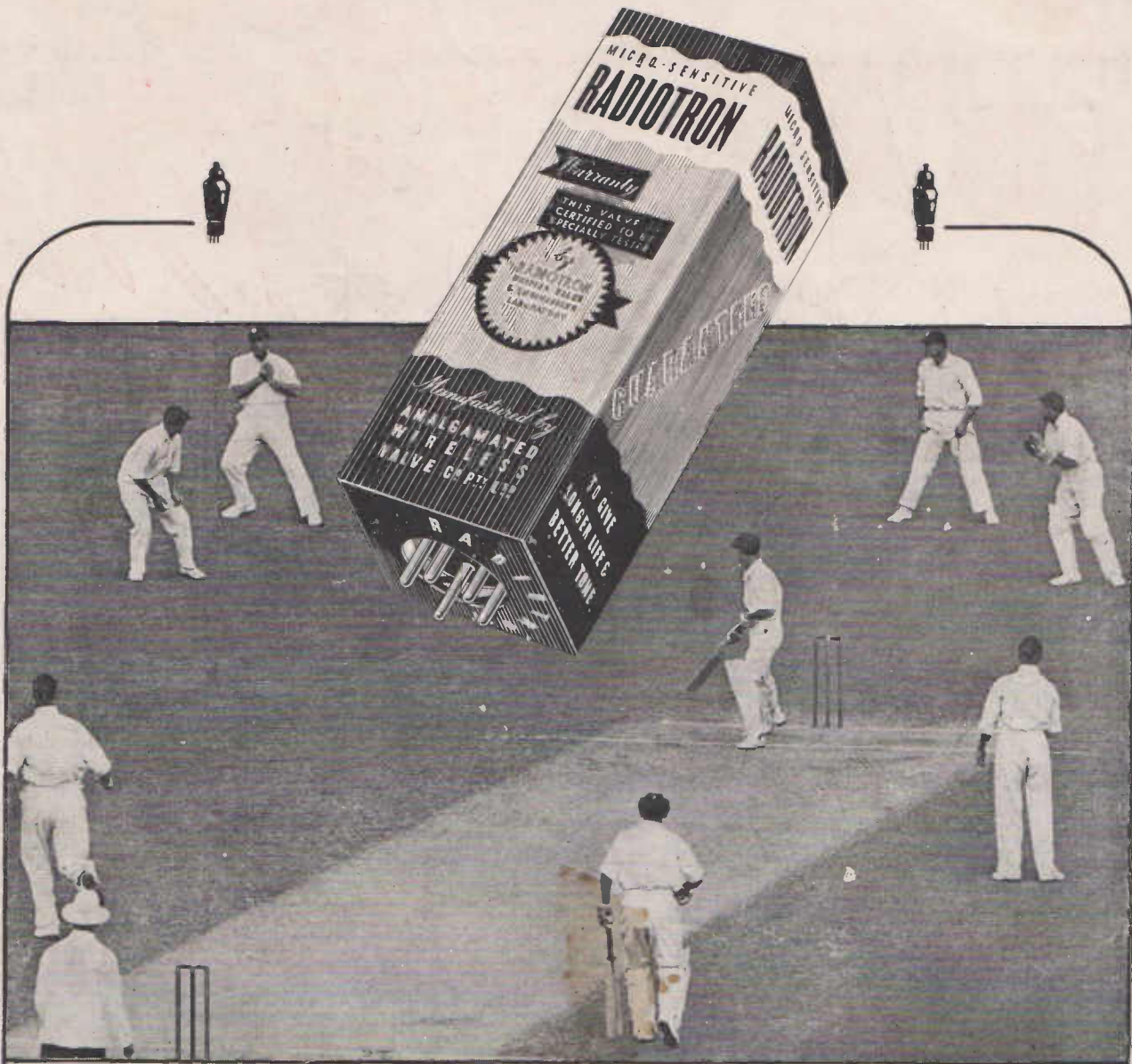

*Caught!*

when your set fails as the English wickets are falling and Australia is piling up victory runs.

Be wise, and have your set overhauled immediately by your local radio supplier and re-valve with new micro-sensitive

# RADIOTRONS

**AUSTRALIAN  
GENERAL ELECTRIC  
LIMITED**

Sydney, Melbourne, Brisbane  
Adelaide, Hobart

**AMALGAMATED  
WIRELESS (AWA) (A/SIA) LTD.**

47 York Street, Sydney  
167-169 Queen St., Melbourne

**NATIONAL ELECTRICAL  
& ENGINEERING CO. LTD.**

Wellington  
New Zealand

# FOXRADIO Presents . . .

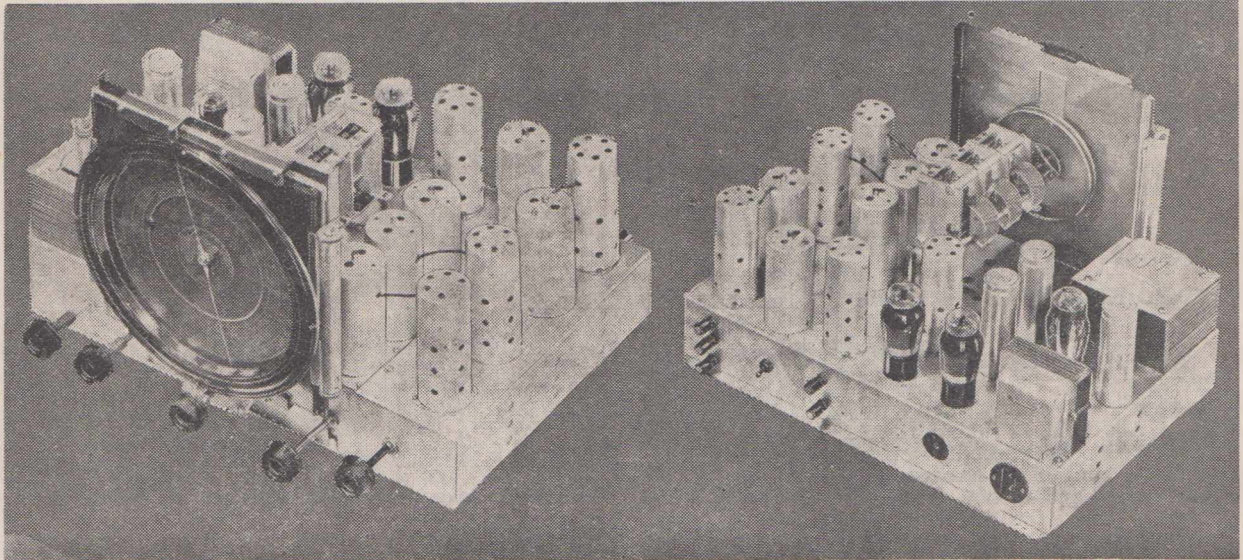

## the "1938 DE LUXE FIDELITY EIGHT"

SUPERB TONE ● MAGNIFICENT ALL - ROUND PERFORMANCE ● LATEST OCTAL-BASED VALVES ● LATEST INERTIA - DRIVE DIAL ● EVERY WORTH - WHILE MODERN FEATURE ● UNSURPASSED IN EVERYTHING BUT PRICE . . .

Newest and greatest of all FOXRADIO triumphs is this 1938 model "De Luxe Fidelity Eight," successor to last year's most popular de luxe receiver. Razor-edge selectivity, amazing sensitivity, tremendous power, and superb quality of reproduction make this receiver one of the most sensational ever released in this country.

Using the latest FOXRADIO three-stage dual-wave coil kit with special FOXRADIO

high-gain i.f. transformers, this latest 1938 model will out-perform many commercial receivers costing two and three times as much.

Write now for our detailed quote—for one part or a complete kit, including valves and speaker. And watch next month's issue of "Radio World" for a full description, with photographs and diagrams of how to build this magnificent receiver.

Quotes on all "Radio World" receivers sent post free by return mail. Best prices and fastest service in Australia.

## FOX & MacGILLYCUDDY Pty. Ltd.

MERINO HOUSE, 57 YORK ST., SYDNEY. Tel.: B 2409.

# RAYWAY

AMATEUR ALL-WAVE  
COIL KIT.



IS SPECIFIED EXCLUSIVELY  
FOR THE "AIR-ACE  
COMMUNICATIONS FOUR"  
(See page 7 of this issue)

Illustrated above is the new RAYWAY 15 to 600-metre Amateur All-Wave Coil Kit. Using a .00016 mfd. tuning condenser, with or without bandspread, continuous coverage from 15 to 600 metres can be obtained using the five plug-in coils shown.

Precision-wound on moulded formers of the highest-grade imported bakelite, each coil is scientifically planned to give the last ounce of gain from the lowest to the highest frequency covered.

Each kit is packed in a solidly-built box intended for use as a permanent container. Of ingenious design, the box opens to permit the removal or replacement of coils in an instant, while when not in use it can be kept closed to exclude dust.

A sheet accompanying each kit shows typical circuits, with full constants for one, two, and three-valve receivers designed to operate with the kit. Also included are under-socket connections of coils, together with their colour code.

Rayway 15 to  
600 - metre  
Amateur All-  
Wave Coil Kit

**25/-**

If unobtainable from your local dealer, write direct to:—

## Standardised Products

629 PARRAMATTA ROAD,  
LEICHHARDT, SYDNEY,  
N.S.W.

'Phone - - - - LM 5957

# THE AUSTRALASIAN RADIO WORLD

Incorporating the  
**ALL-WAVE ALL-WORLD DX NEWS.**

Managing Editor:  
A. EARL READ, B.Sc.

Vol. 3.

JULY, 1938.

No. 3.

## CONTENTS:

The "Auto-Tune Dual-Wave Five" .....	3
Model "Q" Console Is Latest S.T.C. Release .....	10
Four-Watt Beam Amplifier .....	11
Home Recording For The Amateur .....	14
Amateur Station Equipment (1)—Monitor And Modulation Meter .....	18
World Shortwave Stations .....	23
A.O.C.P. Questions And Answers .....	27
Pentode And Beam Tetrode Valves .....	29
200 Visitors Inspect Philips Valve Works .....	31
What's New In Radio .....	32
Palec "VCT" Valve And Circuit Tester .....	35
The All-Wave All-World DX News .....	37
Shortwave Review .....	38
Hourly Tuning Guide .....	41
Official Australian Radio Service Manual .....	45
DX News And Views .....	46
"1938 De Luxe Fidelity Eight" .....	47
International Amateur Prefixes .....	48

The "Australasian Radio World" is published monthly by Trade Publications Proprietary, Ltd., Editorial offices, 214 George Street, Sydney, N.S.W. Telephone BW 6577. Cable address: "Repress," Sydney. Advertisers please note that copy should reach office of publication by 14th of month preceding that specified for insertion.

Subscription rates: 1/- per copy, 10/6 per year (12 issues) post free to Australia and New Zealand. Subscribers in New Zealand can remit by Postal Note or Money Order.

## Standard Or Automatic Tuning At Will!

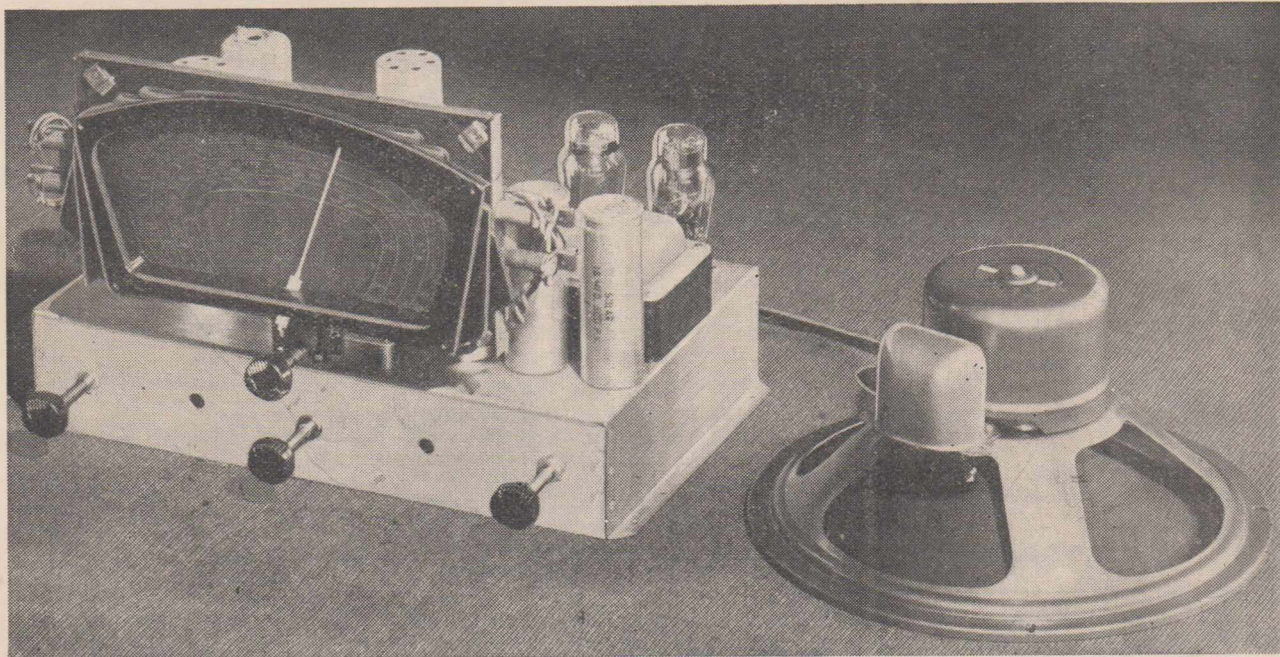

The completed receiver, aligned and ready for the air. On the right is one of the latest Rola K-12 speakers, recommended for use with the "Auto-Tune Dual-Wave Five," which delivers an output of over four watts from a single 6V6G beam tetrode.

The . . .

## Auto-Tune Dual-Wave Five

**A** 4/5 dual-wave superhet of standard design, the "Auto-tune Dual-wave Five" nevertheless incorporates more up-to-the-minute features than any other receiver of its type yet described in the "Radio World."

### Permeability Tuning Throughout.

In the first place, the latest permeability tuning is used throughout—in the Crown D-22 dual-wave box, and in the two I.S.P. 465 i.f. transformers. Another refinement that results in improved all-round performance, particularly on the short waves, is the use of the lately released 6K8 triode-hexode mixer-oscillator.

Improved stability on the short waves results from the method employed in obtaining the oscillator "B+" voltage from the input side of the smoothing filter through a 40,000 ohm resistor, by-passed at the "cold end" with an 8 mfd. electrolytic and a .1 mfd. tubular condenser in parallel.

The second valve is a 6G8G, octal-based glass equivalent of the 6B7S. The pentode section of this valve is

**"Star" features of this outstanding 4/5 dual-wave superhet include permeability-tuned D.W. box and i.f.'s., new 6K8 triode-hexode mixer, 6V6G beam tetrode output with inverse feed-back, and provision for converting to automatic tuning.**

used as i.f. amplifier, one diode as second detector, and the other for a.v.c.—a standard arrangement that has been used with complete satisfaction in other "Radio World" receivers.

### Beam Tetrode Output.

The audio channel comprises a 6J7G pentode driving a 6V6G beam tetrode output valve. The use of a fairly high percentage of inverse feedback ensures excellent quality, at the same time maintaining an output of slightly over four watts.

The power supply and smoothing filter are standard except that 16 mfd. wet electrolytic filter condensers have been used in place of the customary 8 mfd. type, giving improved smoothing and a particularly low hum level.

### Provision For Push-Button Tuning.

As mentioned in previous articles on this receiver, provision has been made for converting it to give automatic push-button tuning. The push-button unit is designed to mount above the dial, a cable from it running down through the chassis to a Yaxley 6 x 2 single-bank switch mounted alongside the dual-wave unit.

Referring to the photograph at the head of this page, the hole in the front wall of the chassis to the left of the wave-change switch is for mounting the additional switch, the extra control being balanced by a double-pole double-throw rotary type switch for change-over to pick-up, mounted on the opposite side.

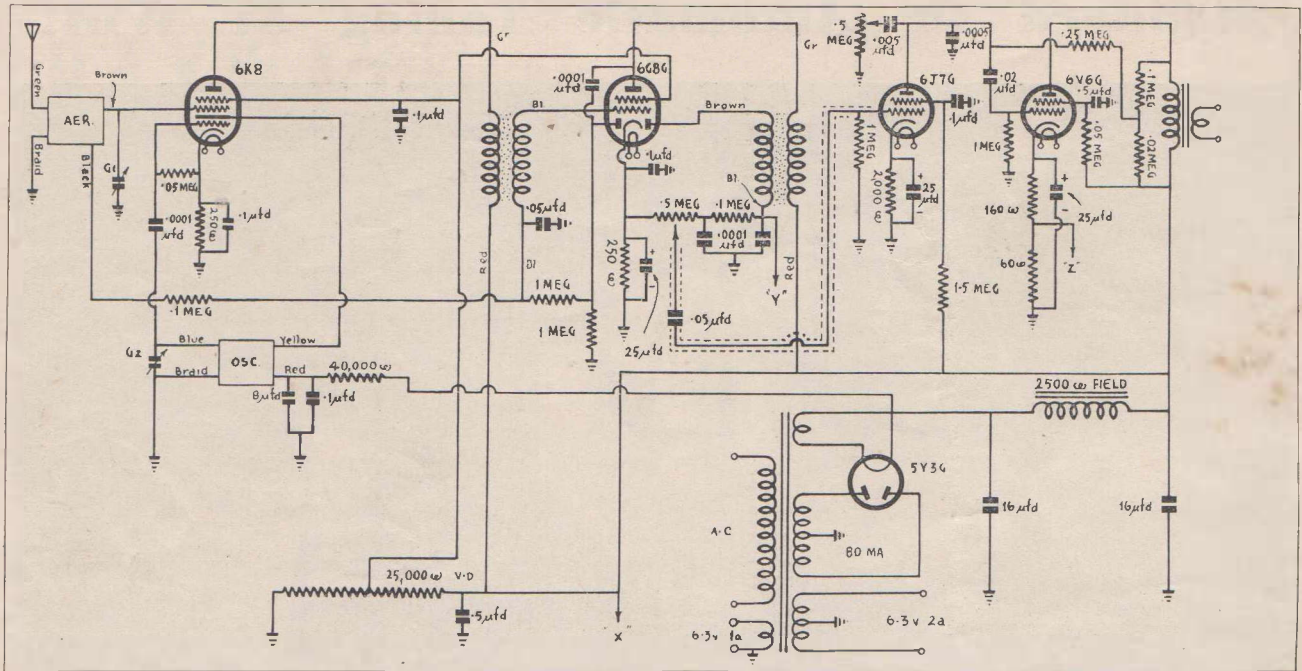

The circuit of the "Auto-Tune Five" incorporates many up-to-the-minute refinements, including the use of the latest improved 6K8 mixer-oscillator.

Shielded Push-Button Unit.  
The Crown push-button unit that is to be used is a standard manufac-

turer's type designed for under-chassis mounting. However, as in the "Auto-tune Dual-wave Five" this unit

is to mount above the dial, it is necessary to enclose it in a box to exclude dust.

SEE PAGE 3 FOR FURTHER INFORMATION

# JOHN MARTIN

## FOR EVERYTHING FOR YOUR "AUTO-TUNE DUAL-WAVE FIVE"

As usual, "The Friendly Wholesale House saves you many shillings in purchasing your components. All parts listed for the construction of the 4/5 are available at the very lowest prices.

John Martin stocks your every radio and electrical need.

SPECIAL: THE "AUTO - TUNE DUAL-WAVE FIVE" WILL BE DEMONSTRATED AT JOHN MARTIN PTY. LTD. DURING THIS MONTH

### SAME DAY SERVICE A SPECIALTY

Telephone: BW 3109  
(2 lines)  
Telegrams: "Jonmar,"  
Sydney.

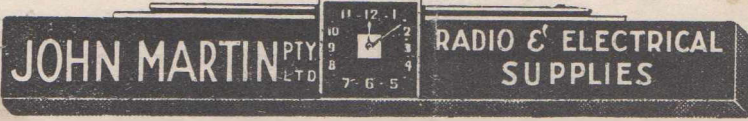

116-118 CLARENCE STREET, SYDNEY.

# Quality Parts Cannot Be Bought For Less . . . . Unbeatable Values Offered By Vealls

Vealls, with their six big stores packed with Radio and Electrical goods, can offer unbeatable values. Look at the prices shown below for the complete kits—money cannot buy better value; so get the habit . . . always try Vealls first.

Remember, Vealls pay freight on all Victorian retail orders excepting Cabinets, and on all Interstate retail orders excepting Batteries and Cabinets.

## THE AIR-ACE COMMUNICATIONS 4

Something out of the box for the DX'er. See the constructional details elsewhere in this issue, and remember, Vealls' price includes Valves, Batteries and Rola Speaker . . . everything necessary as specified in the "Radio World" list of parts.

VEALLS WILL SUPPLY THE COMPLETE KIT

**£14/14/0**

FREIGHT PAID TO YOUR NEAREST VICTORIAN STATION.

## The AUTO-TUNE DUAL-WAVE FIVE

Complete parts as listed in the constructional article elsewhere in this issue (excluding parts to convert to Push-Button Tuning). On this Kit Vealls pay freight to your nearest railway station, anywhere in Australia.

THE KIT OF PARTS COMPLETE

**£14/19/6**



## POWERFUL ENOUGH FOR A SMALL HALL

FOUR WATT BEAM AMPLIFIER . . . . .

**£4/19/6**

The price includes everything required—Valves, Speaker, etc. Freight paid to your nearest railway station, anywhere in Australia.

FREIGHT PAID TO YOUR NEAREST RAILWAY STATION.

### THE FASTEST MAIL ORDER IN AUSTRALIA.

Vealls Mail Order Department is staffed by experts. Same careful attention to all orders—big or little. Prompt same-day dispatch.

## VEALLS 6 BIG STORES

Address all letters to Box 2135, G.P.O., Melbourne.

490 Elizabeth Street, Melbourne.  
168 Swanston Street, Melbourne.  
3-5 Riversdale Road, Camberwell.  
Phone: F 3145 (6 lines).

243 Swanston Street, Melbourne.  
299-301 Chapel Street, Prahran.  
97-99 Puckle Street, Moonee Ponds.  
Telegrams: "ArtVeall," Melbourne.

# IT'S OUT!

## The Most Important Radio Book Of The Year

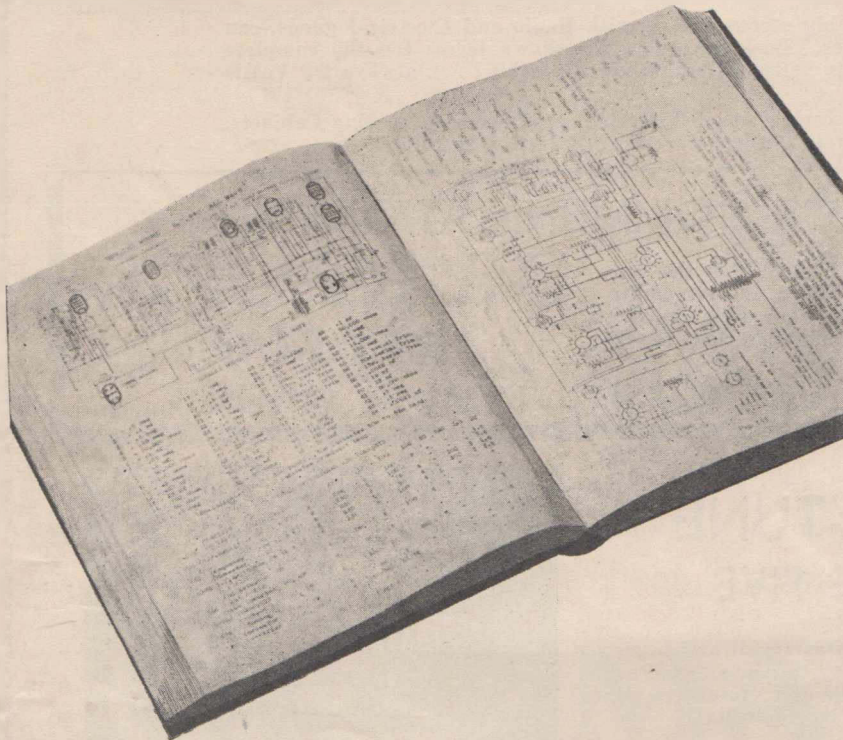

### COMPLETE CIRCUIT BOOK OF STANDARD 1937 RECEIVERS

For the first time, an Australian Radio Service Manual has been published—a book which every dealer, serviceman, and technician will find invaluable. There are 300 pages of circuits and data of Australia's 1937 standard receivers, and 100 pages of valuable reference information you need from day to day.

The price is the exceptionally modest one of 12/6. The book is in a convenient size to fit in car pocket or service kit, with flexible covers. Full stiff bound copies, 15/-.

Order from your wholesaler, bookseller, or the publishers, "The Electrical and Radio World," Box 1538V., G.P.O., Brisbane.

## The Australian OFFICIAL RADIO SERVICE MANUAL

This new unit will not be available for some days, so in this issue the construction of the "Auto-tune Five" as a standard dual-wave superhet only will be described. A further article will be published next month giving instructions for converting the receiver to push-button tuning.

### Exceptionally High Gain.

The "Auto-tune Five" has exceptionally high gain, so much so that it was found necessary to use a dull-chrome-plated chassis in place of the usual sprayed steel type, in order that all earth returns could be soldered direct to the chassis, giving the lowest possible resistance to earth.

For this reason builders are advised to assemble the set exactly according to instructions, because, while if correctly built it should out-perform any other receiver in its class,

### Auto-Tune Dual-Wave Five

#### List of Parts

- 1—dull chrome plated chassis, stamped to specifications, with brackets.
- 1—coil kit, comprising D.W. unit (Crown D-22) and two 465 k.c. i.f. transformers (Crown ISP-465).
- 1—2-gang condenser (Stromberg-Carlson).
- 1—dial to suit (Crown).
- 5—octal sockets, 1—4-pln socket (wafer types).
- 1—power socket and plug.
- 1—length power flex and plug.
- 1—power transformer (Radiokes flat 80 m.a.).
- 4—terminals, 2 red, 2 black (Dalton).
- 2—.5 megohm potentiometers (E.T.O.).
- 1—25,000 ohm voltage divider (Crown).
- 3—knobs.

#### FIXED CONDENSERS:

- 4—.0001 mfd. mica (E.T.C.).
- 1—.0005 mfd. mica (E.T.C.).
- 1—.005 mfd. mica (E.T.C.).
- 1—.02 mfd. tubular (Solar).
- 2—.05 mfd. tubular (Solar).
- 5—.1 mfd. tubular (Solar).
- 2—.5 mfd. tubular (Solar).
- 3—25 mfd. dry electrolytics, 25v. working (Solar).
- 2—16 mfd. wet electrolytics (Solar).
- 1—8 mfd. wet electrolytics (Solar).

#### FIXED RESISTORS:

- 1—60 ohm wire-wound.
- 1—150 ohm wire-wound.
- 2—250 ohm 1-watt carbon (E.T.C.).
- 1—2,000 ohm 1-watt carbon (E.T.C.).
- 1—20,000 1-watt carbon (E.T.C.).
- 1—40,000 ohm 1-watt carbon (E.T.C.).
- 2—50,000 ohm 1-watt carbon (E.T.C.).
- 3—.1 megohm 1-watt carbon (E.T.C.).
- 1—.25 megohm 1-watt carbon (E.T.C.).
- 4—1 megohm 1-watt carbon (E.T.C.).
- 1—1.5 megohm 1-watt carbon (E.T.C.).

#### VALVES:

- 1—6K8, 1—6G8G, 1—6J7G, 1—6V6G, 1—5Y3G (Radiotron, Raytheon, Phillips, Mullard, Ken-Rad).

#### SPEAKER:

- 1—dynamic speaker, 2,500 ohm field, to match single 6V6G (Eola K-12).

#### MISCELLANEOUS:

- 3—grid clips (1 midjet type); 1 yard copper braid; 3—6.3v. dial lights; push-back (solid and flexible); solder tags; bush (for v. cont. shaft).

#### ADDITIONAL PARTS REQUIRED FOR CONVERSION TO PUSH-BUTTON TUNING

- 1—6 x 2 single deck switch (Yaxley).
- 1—push-button tuning unit (Crown).
- 1—d.p./d.t. rotary type switch.
- 2—knobs.



if due care is not taken to assemble the set along the lines indicated, instability troubles will be encountered.

### Commencing The Assembly.

The assembly of the receiver is commenced by mounting the valve, speaker and power sockets, followed by the power transformer. When the sockets are being mounted, care should be taken to ensure that the heater lugs face in the directions shown in the under-chassis wiring diagram.

The heater wiring can now be put in, followed by the wiring for the rectifier and power supply.

### Three Leads From Gang.

Components to be mounted next comprise the condenser gang, three wet electrolytics, aerial, earth and pick-up terminals, i.f. transformers, and tone control potentiometer. Before the gang, which is mounted on  $\frac{3}{8}$ " spacers, is bolted in place, two lengths of flexible push-back should be soldered to the fixed plates terminal underneath the section nearest the front of the chassis, and one lead to the fixed plates terminal underneath the rear section.

One lead from each section passes through the chassis to the aerial and oscillator sections of the coil unit, while the remaining lead from the front section terminates in a midge grid clip fitting over the cap of the 6K8 mixer-oscillator. The gang wipers should be soldered direct to the chassis.

### The Wiring Outlined.

Commencing at the plate of the 6K8, wire the first i.f. transformer, then the pentode section of the 6G8G, second i.f. transformer, and so on until all the wiring it is possible to put in before the dual-wave unit is mounted, has been completed.

It is particularly important that all wiring should be kept as short and well-spaced as possible. All earth returns are soldered direct to the chassis.

It will be noticed that the volume control is mounted by means of a bracket as closely as possible to the 6G8G, the shaft being extended through the front of the chassis by means of a coupling, bush, and 8" length of  $\frac{1}{4}$ " brass rod. A point that should be mentioned here is that the necessary leads should be soldered to the three lugs on the volume control before it is mounted.

When all the wiring has been completed and checked, the D22 dual-wave coil unit can be mounted in position and wired. This wiring has been omitted from the under-chassis diagram, but the leads that run to the



Illustrated alongside is the Rola K-12 De Luxe reproducer as specified exclusively in this month's issue for the "Auto-tune Dual-wave Five" and the "Four-Watt Beam Amplifier."

The highly-developed radio receiver of 1938 demands a loud-speaker that is above reproach electrically, mechanically and acoustically. Vital link between receiver and listener, the speaker can make or mar the performance of the finest chassis ever designed. That is why those who know choose ROLA . . . why for sturdy construction, outstanding performance and thrilling realism, engineers throughout the world insist on Rola.

**REVOLUTIONARY FEATURES IN LATEST ROLA RANGE:** The 1938 range of Rola speakers incorporates the best features of former models and presents new revolutionary improvements, chief of which is the Rola Isocore Transformer, designed to eliminate electrolysis, fully encased and hermetically-sealed in a drawn streamlined case, all vital parts are protected from humidity, ensuring long and trouble-free performance.



# Rola

"THE WORLD'S FINEST  
REPRODUCER"

Manufactured by: ROLA CO. (Aust.) PTY. LTD., The Boulevard, Richmond, Victoria. Telephone J 5451.

Distribution and Service: N.S.W., G. Brown & Co. Pty. Ltd., 267 Clarence Street, Sydney. 'Phone M 2544 (3 lines).

Illustrated above is the Rola 8-20, an 8in. permanent magnet model with patented dust and acoustic filter assembly. New type magnet assembly permits greater power-handling capacity without loss of sensitivity. Also features the new insulated transformer.

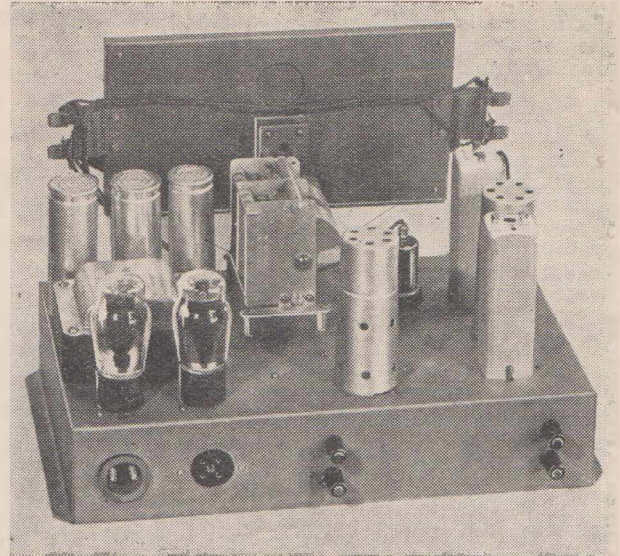
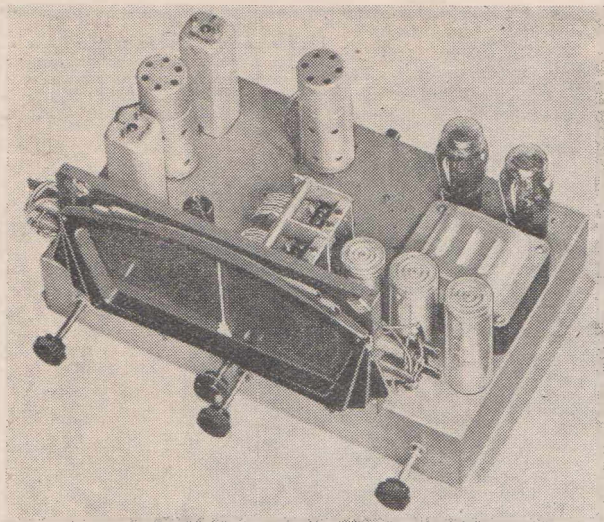

Two views of the completed receiver, showing the well-spaced layout essential to obtain complete stability in a high-gain set of this type.

box have all been numbered. These connect as follows:—

#### Aerial Section.

- No. 1 on diagram—green.
- " 2 " " —black.
- " 3 " " —brown.
- " 4 " " —earth.

#### Oscillator Section.

- No. 5 on diagram—blue.
- " 6 " " —yellow.
- " 7 " " —red.

#### DIAL LIGHT SWITCHING—Colour Code.

- No. 8 on diagram—green—B/C lights
- " 9 " " —yellow—S/W lights
- " 10 " " red—common.

The aerial lead to the unit should be shielded with copper braid, and the shielding earthed. To reduce capacity as much as possible, the lead should be covered with spaghetti before the shielding is slipped over it.

After the wiring has been thoroughly checked, the grid clips can be fitted, the valves and speaker plugged in, and the aerial and earth connected.

#### Aligning The Receiver.

The set is now ready for alignment. Tune in a station near the high frequency end of the band (to approximately 1400 k.c.) and adjust the aerial trimmer for maximum response. Next, tune in a station on approximately 600 k.c. and adjust the padder, at the same time rocking the dial backwards and forwards over

the station until the maximum signal strength setting is found. This process can be repeated, when the alignment will be complete.

#### Alignment By Oscillator Is Strongly Recommended.

For peak results, however, alignment using a signal generator is strongly advised. Where one is used, the following procedure can be adopted:—

Commence by setting the oscillator to the intermediate frequency of the set, and connecting it to the grid of the frequency converter and earth. Advance the volume control of the set to maximum and advance the attenuation control of the oscillator to a

(Continued on page 44.)

Make sure of  
maximum efficiency  
and longest life—

ADOPT AS YOUR  
STANDARD —

# Mullard

## M A S T E R

### RADIOVALVES

MULLARD (AUST.) PTY. LTD., 26-30 CLARENCE STREET, SYDNEY. TELEPHONE B 7446 (3 lines)

**CROWN GIVES YOU THIS  
FEATURE FOUND IN NO  
OTHER COIL UNIT . . .**

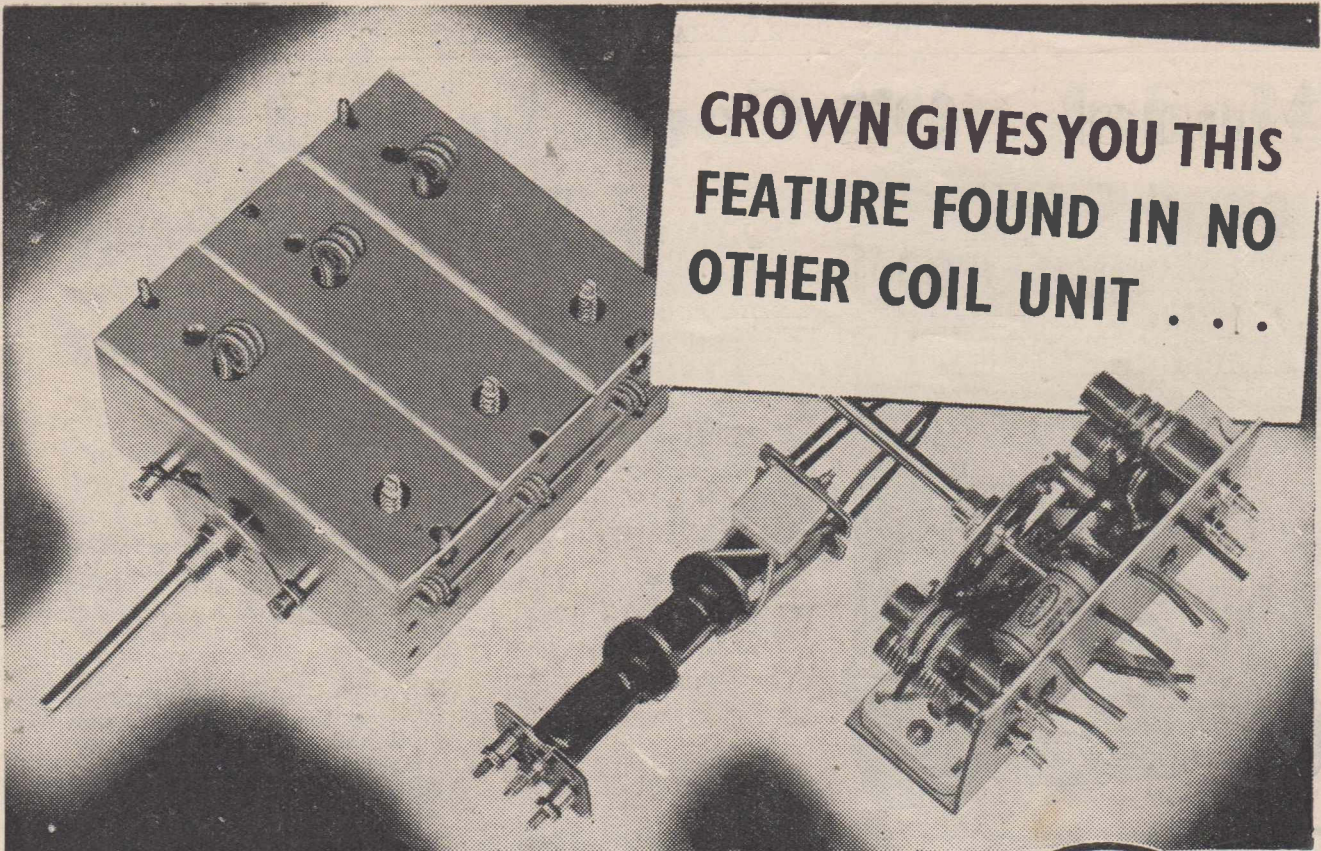

# **PERMATUNE**

## **IRON CORED**

### **BROADCAST COILS and SHORTWAVE COILS**



Permeability tuning is out of the experimental stage—it is a feature incorporated in the new Crown Iron Core I.F. Transformers, Broadcast Coils, and Short-Wave Coils. It is a feature which has been tested exhaustively and proved highly efficient under the most adverse conditions. It definitely prevents frequency drift with its resultant "off-station" tuning and distortion.

The new Crown Dual-Wave Coil assemblies, Types D22 and D26, D32 and D36, feature this wonderful new development, which guarantees maximum performance under the most severe atmospheric conditions.

The use of iron cores in short-wave coils is entirely new and an exclusive CROWN development. It allows the size of the coil to be considerably reduced, whilst the "Q" is greatly improved.

TYPES D22 and D32 boxes contain 12/35 metre coils designed to cover the English and German stations now being received so well on the 13-metre band.

*The sketch above shows how permeability tuning is obtained by moving the iron core up or down in the coil, permanence of setting being assured by a lock-nut and lock-washer. A special hollow "spintight" spanner—available from all distributors—may be used to tighten the lock-nut, whilst the trimmer screw is held by the screwdriver.*

**TYPE D22 and D26, Permatune 4/5**  
D./W. Box. Price . . . . . £2/9/6

This is a complete self-contained unit, comprising Aerial and Oscillator sections mounted and wired together on the one bracket. All units are thoroughly tested on the air and aligned to track with CROWN DIALS in any type of 4/5 receiver, either new models or for converting present B./C. receivers to D./W. DIAL LIGHT SWITCHING is incorporated in all models, and A.V.C. by-pass condensers are wired internally. Size 2 3/4 x 4 1/2 x 1 1/2 in. deep. Fits under 3 in. chassis.

12/35 Metres—TYPE NUMBERS: D22, Penta. A.C. D22/O, Oct., A.C. D22/B, Penta., Batt. D22/OB., Oct., Batt.  
16/50 Metres—TYPE NUMBERS: D26, Penta., A.C. D26/O, Oct., A.C. D26/B, Penta., Batt. D26/OB., Oct., Batt.

**TYPE D32 and D36, Permatune 5/6**  
D./W. Box. Price . . . . . £3/19/6

This is a totally enclosed shielded box, containing Aerial R.F. and Oscillator sections with full switching and A.V.C. by-pass condensers, completely wired inside case. The overall dimensions are exceedingly small—4 1/2 in. x 2 1/2 in. x 5 1/2 in., being intended to fit under 3 in. chassis. The value of Permeability Tuning is most noticeable in this box, due to the ease with which complete tracking is obtained on both bands, notwithstanding the presence of an R.F. section.

12/35 Metres—TYPE NUMBERS: D32 Penta., A.C. D32/O, Oct., A.C. D32/B, Penta., Batt. D32/OB., Oct., Batt.  
16/50 Metres—TYPE NUMBERS: D36, Penta., A.C. D36/O, Oct., A.C. D36/B, Penta., Batt. D36/OB., Oct., Batt.

**PERMATUNE I.F. Transformers, Type I.S.P./465. Price . . . . . 12/6**

These I.F.'s are fitted into 4 1/4 in. x 1 3/8 in. square cans. The trimming screws attached to the iron cores protrude each end for adjustment, which is obtained by INDUCTANCE VARIATION, the usual mica trimmers being replaced by ceramic moulded fixed mica condensers. Once adjusted and locked in position, these units can be definitely guaranteed to retain their adjustment and "Q" factor under all conditions.

**WRITE NOW**

. . . for your copy of the 1938 Crown Catalogue incorporating full particulars of Press Button Tuning and all Permatune units, also full instructive data and circuits for use with all Crown components.

# **CROWN RADIO PRODUCTS Pty. Ltd.**

51 MURRAY STREET, PYRMONT, SYDNEY

'Phone . . MW 2628 (3 lines).

Distributors in all States and New Zealand

Telegrams . . "Crownradio," Sydney.

# Model "Q" Console Is Latest S.T.C. Release

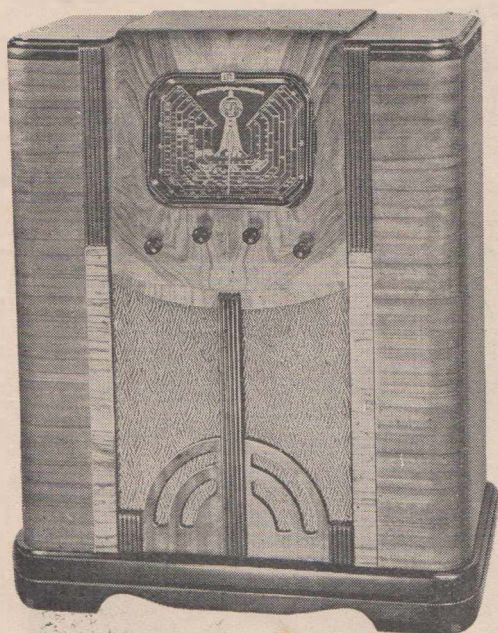

A soundly engineered chassis and artistic cabinet design are features of the new S.T.C. Model "Q" all-wave seven-valve superhet console reviewed below.

## An Outstanding All-Round Performer.

Tested in an average suburban location using a 50-foot outside aerial, the Model "Q" gave an outstanding all-round performance. The use of an r.f. stage ensures high selectivity and a more than ample reserve of sensitivity, enabling the user to bring in any programme on the air sufficiently above the noise level to provide worth-while entertainment.

From every viewpoint—circuit, assembly, performance, cabinet design—the S.T.C. Model "Q" is among the leaders in its class as an excellent example of modern radio receiver design technique, and can be recommended without reserve.

★

The S.T.C. Model "Q" seven-valve triple-band console.

★

ONE of the latest Standard Telephones and Cables Model "Q" console receivers, as illustrated above, and on this month's front cover, was recently delivered to the "Radio World" for test. A seven-valve triple-band superhet, the Model "Q" uses throughout the latest octal-based "G" series valves, comprising a 6U7G r.f. amplifier, 6A8G mixer oscillator, 6U7G i.f. amplifier, 6B8G second detector and a.v.c. voltage generator, 6F6G output pentode, 5Z4G rectifier, and 6T5 magic eye tuning indicator.

### Is Soundly Engineered Throughout.

The receiver is very soundly engineered throughout, both design and assembly being above criticism. The chassis, which together with the majority of above-chassis components is attractively finished in gold, is mounted on four rubber blocks as a precaution against microphonic troubles, and to protect the chassis against damage during transport. The under-chassis assembly is noteworthy for the secure anchorage of every component, and for its accessibility from the service point of view.

### Provision For Doublet And Pick-Up.

Terminals are provided for the connection if desired of a doublet aerial with transposed feeders, while pick-up connections are also included. Another refinement that will be appreciated by servicemen is the sensitivity control mounted on the rear wall of the chassis, enabling the last ounce to be obtained from the receiver in

difficult locations, without danger of "spill over."

### Has Two Shortwave Bands.

The Model "Q" is a three-band receiver, giving continuous coverage on the short waves from 12 to 110 metres in two steps, as well as the broadcast band.

The large, multi-coloured dial is State-zoned on the broadcast band, the five divisions being New South Wales, New Zealand and South Australia, Queensland, Tasmania, and Western Australia, and Victoria. Each shortwave band is calibrated in metres, and as well, the international broadcast and amateur channels are clearly indicated, making location of stations a simple matter. The Magic Eye tuning indicator, which is of the improved concentric circle type, is incorporated in the dial.

### "Spinner" Obviates Laborious Tuning.

The dial movement is velvet-smooth, a valuable refinement being the use of a "spinning" device giving a fly-wheel effect. Thus, though a fairly high ratio is used, making tuning on the short waves simple, on occasions when one wants to tune from a station at one end of a band to one near the other, a single flick of the tuning knob will carry the pointer smoothly around the dial.

The four controls shown in the photograph above are (left to right): Volume, tuning, wavechange switch, and tone. The wavechange switch covers four positions, local broadcast, broadcast, medium shortwave, and shortwave.

### "Outdoor Portable" In N.Z.

I have taken your excellent magazine since its inception and I find much useful reading and hints in it, the "Radio Ramblings" page being exceptionally good.

My only complaints are that the "Radio World" is not published often enough, and so far I have not seen a de luxe all-wave battery receiver described. By de luxe I mean a seven- or eight-valve job, giving high sensitivity over all wave-bands, with a high fidelity audio channel giving enough gain for the set to be suitable for use with a pick-up. I realise, of course, that the "B" battery consumption must be taken into consideration, but there must be hundreds of readers like myself who have facilities for charging "A" batteries and who use vibrators, genemotors and Milnes units to furnish the "B" supply for their sets, and are therefore not worried about a few extra mills.

I am at present building a modulated oscillator using a type 15-valve as electron-coupled oscillator and a type 30 modulator to generate a 500-cycle audio note. The 15 is quite a good oscillator with 36 volts on the plate.

I built the "1937 Outdoor Portable Four" and have had good results with it. I am enclosing a snap taken during a test at about 10 a.m. on Easter Sunday morning. The aerial is the top wire of the fence, and with this, stations 2ZB, 2YA and 3YA were re-

(Continued on page 15.)

# Four-Watt Beam Amplifier

Designed primarily for use with the home recording unit described elsewhere, this compact but powerful amplifier has many other equally useful applications.

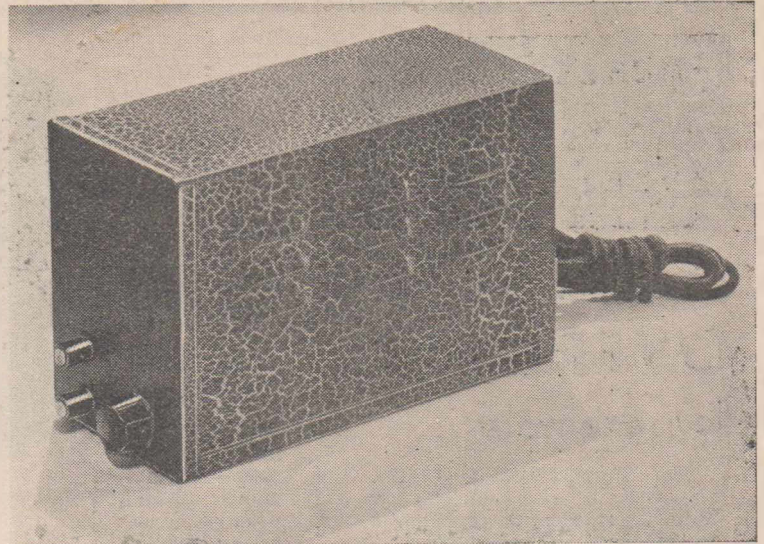

THE amplifier described below is a more powerful version of the midget three-watt model featured in the April, 1938, "Radio World." While the chassis is identical, the valves have been changed to the new octal-based "G" types, a 6J7G pentode being used to drive a 6V6G beam tetrode, capable of delivering over four watts of output. Because of the use of inverse feedback, quality of reproduction is excellent, closely ap-

The complete amplifier is housed in a crackle-finished steel case measuring 4" x 6½" x 9", well provided with ventilating louvres.

proaching that of a single triode such as the 2A3. The rectifier is a 5Y3G.

### Similar To "Auto-Tune" Audio Channel.

Actually, the circuit is practically identical with the audio channel of the "Auto-tune Dual-wave Five" described elsewhere in this issue. The only differences are the omission of the tone control and of the .0005 mfd. 6J7G plate by-pass shown on the latter circuit, though it would be a simple matter to incorporate both of these if desired.

Dimensions of the chassis are shown in a sketch elsewhere. The crackle-finish metal case, which should be adequately supplied with ventilating louvres, measures 4in. x 6½in. x 9in.

### Four-Watt Beam Amplifier — List of Parts —

- 1—chassis and case to specifications.
- 1—power transformer (Radlokes MU60).
- 3—octal sockets.
- 1—4-pin wafer socket.
- 1—.5 megohm potentiometer (E.T.C.).
- RESISTORS:**
- 1—2,000 ohm carbon (E.T.C.).
- 1—20,000 ohm carbon (E.T.C.).
- 1—50,000 ohm carbon (E.T.C.).
- 1—.1 megohm carbon (E.T.C.).
- 1—.25 megohm carbon (E.T.C.).
- 1—220 ohm wire-wound resistor.
- CONDENSERS:**
- 1—.02 mfd. tubular (Solar).
- 1—.1 mfd. tubular (Solar).
- 1—.5 mfd. tubular (Solar).
- 1—25 mfd. dry electrolytic (Solar).
- 2—8 mfd. dry electrolytic (Solar).
- VALVES:**
- 1—6J7G, 1—6V6G (Radlotron, Raytheon, Phillips, Mullard, Ken-Rad).
- SPEAKER:**
- 1—8in. or 12in. speaker, 2500-ohm field, to match single 6V6G (Rola K-12).
- MISCELLANEOUS:**
- 1 red, 1 black Dalton spring terminals;
- 2 doz. 3in. nuts and bolts, hook-up wire;
- 1 yard tinned copper wire, 2 yards power flex and plug, rubber grommet.

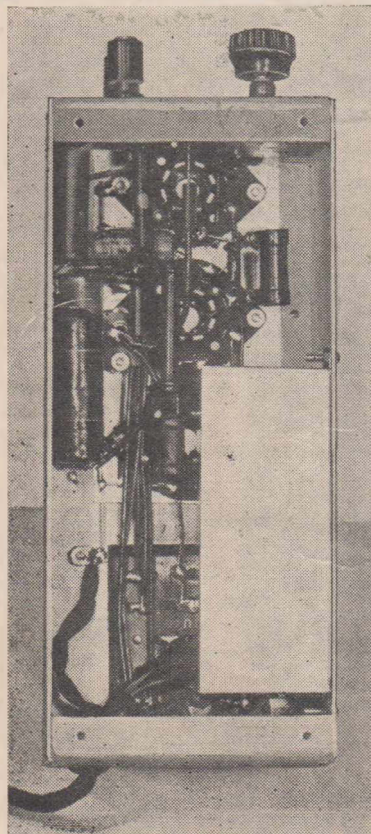

Left: This under-chassis view shows the method of mounting the two 8 mfd. semi-dry electrolytics, which are housed in a single container.

Right: The circuit of the amplifier, which uses octal-based glass valves throughout, with a 6V6G beam tetrode in the output.

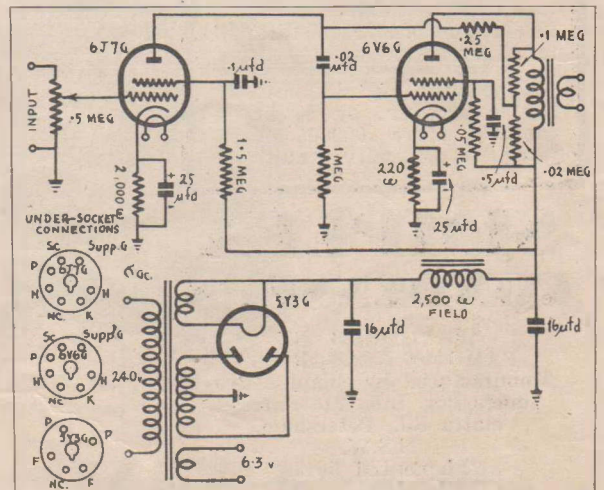

**THOROUGHNESS  
IN  
EVERY DETAIL**

. . . take  
**OVERLOAD**  
for example . . .

The Simplex standard voltage test is characteristic of Simplex thoroughness employed in the production of mica condensers.

Every Single Simplex Condenser is Tested at 1,000 Volts A.C. and D.C.

Before reaching this final and most severe of tests, Simplex condensers are checked and rechecked in every stage of production . . . .

There is no possibility of a faulty condenser leaving the Simplex Factory.

With Simplex condensers you are assured of the utmost in reliability, permanency and accuracy.

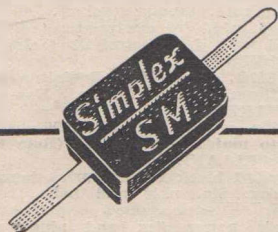

Above is the Simplex Moulded Bakelite type "S/M" (actual size), available in capacities from .000005 microfarads to .01 microfarads.

Type P/T (Pigtails) measuring only  $\frac{5}{8}$  in. by  $\frac{5}{8}$  in. — capacity range .000005 microfarads to .001 microfarads.

# SIMPLEX CONDENSERS

"FAVORED BY  
FAMOUS FACTORIES"  
Manufactured by Simplex Products Pty. Ltd., 716 Parramatta Rd., Petersham, N.S.W.

'Phone LM 5615.  
AGENTS IN ALL STATES.

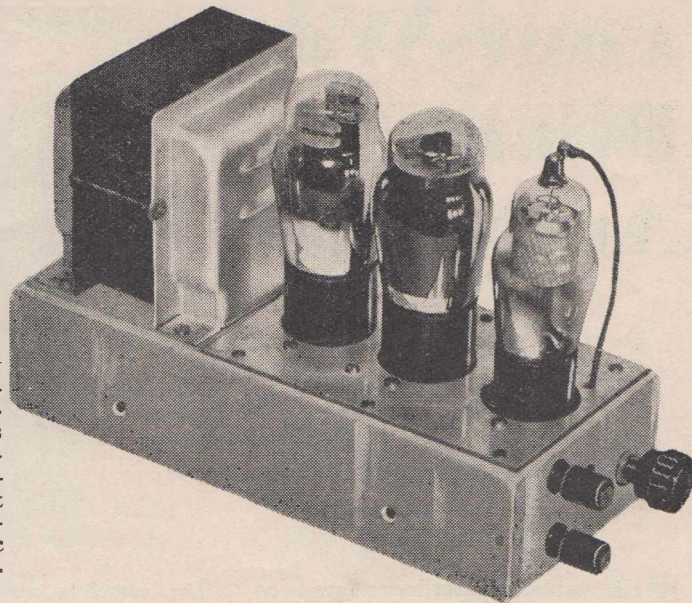

This view of the completed amplifier illustrates its compactness—a valuable asset when it is used for public address work.

### Assembly Pointers.

In assembling the amplifier, the power transformer, valve and speaker sockets, power flex grommet, input terminals and volume control can be mounted, and the wiring completed as far as possible before the  $2 \times 8$  mfd. semi-dry electrolytic unit is mounted in the position shown in the under-chassis photograph.

Compact, powerful and inexpensive, this amplifier will be found invaluable for many applications in the service or home workshop. Designed primarily for use with the home recording equipment described elsewhere, innumerable other uses will be found for it as well, and will amply repay the cost of its assembly.

### Appreciations From Readers.

I have recently become a regular subscriber to your invaluable journal,

and wouldn't miss it for anything. I am very interested in obtaining an A.O.C.P. and, consequently, cannot say how much I appreciate the "A.O.C.P. Questions and Answers" series at present being published, and sincerely hope they will continue for many more issues.—G. F. Reimer, Emerald, Queensland.

"Radio World" is the best magazine I have read and fulfils a long-felt want for a local magazine for DX listeners in Australia. Carry on the good work, and you will not lack my support. In this statement I think I voice the opinions of thousands of DX listeners throughout Australia. May I congratulate "R.W." on the excellent "Hourly Tuning Guide" incorporated in its DX notes.

—K. A. Crowley (AW368DX), Bentleigh, Victoria.

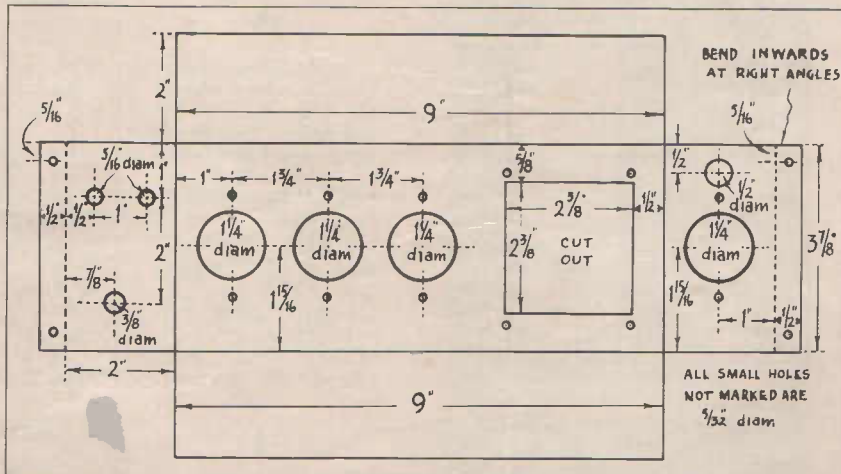

Full chassis dimensions are shown in this sketch.

# If you live in the Country

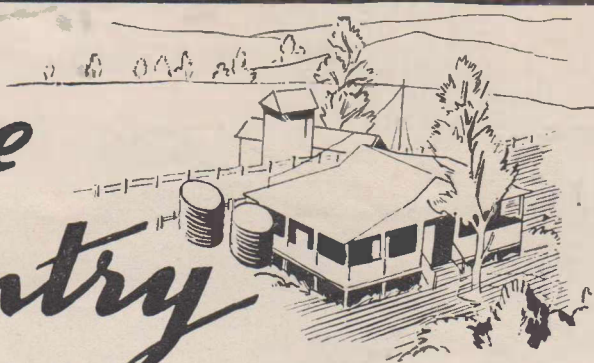

## BUY AN AIR-CELL Operated RADIO

**RADIOLA** (at right): Model 265. 6-valve World Range Air Cell operated. 38 GUINEAS. Others from 20 gns.

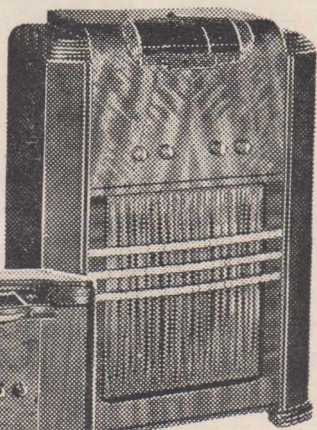

At last! A radio designed for use in the country that is every bit as convenient as an all-electric set! Equipped with an Ever Ready Air Cell, the new-type battery that needs no recharging, no attention and lasts for 12 months with normal use. See one demonstrated next time you are in town.

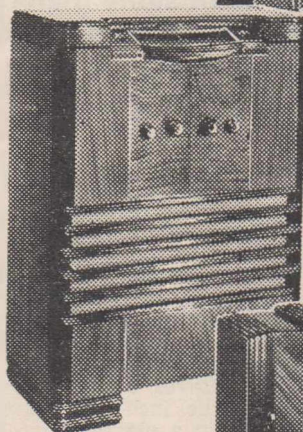

★  
NO RECHARGING — NO ATTENTION WHATSOEVER

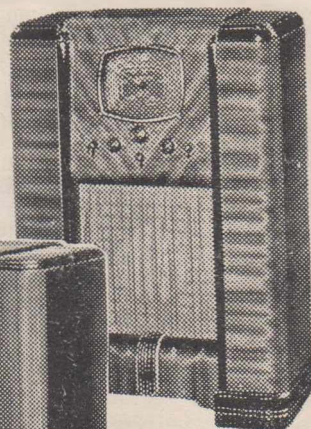

**STROMBERG-CARLSON:** Model 780. 6-valve Dual Wave Air Cell operated. 38½ GUINEAS. Others from 28 gns. (Prices slightly higher in W.A.)

**S.T.C.:** Model 523D. 5-valve Dual Wave Air Cell operated. 35 GUINEAS. Others from 20 gns. (Prices slightly higher in Qld.)

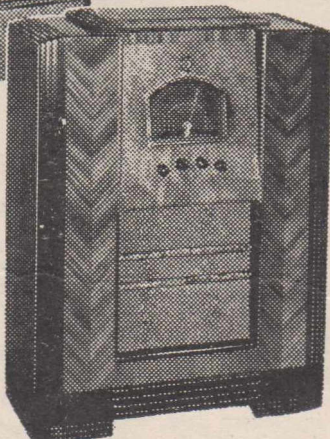

Advt. issued by The Ever Ready Co. Aust. Pty. Ltd., Sydney.

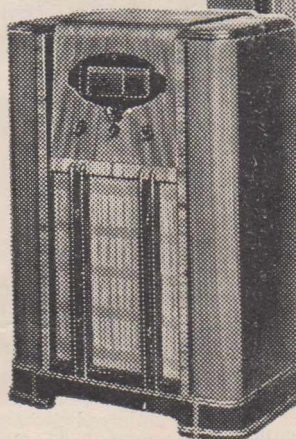

**TASMA:** Model 585. 5-valve Dual Wave Air Cell operated. 37 GUINEAS. Others from 29 gns. (Prices slightly higher in W.A.)

**H.M.V.:** Model 330. 5-valve Dual Wave Air Cell operated. 33 GUINEAS. Others from 27 gns.

● Other well-known makes of Air Cell operated Radio include:—Aristocrat (E.S.M.), Bathyphone, Briton, Calstan, Crammond, Croydon, Genalex, Howard, Kriesler, Lekmek, Paramount, Velco, Weldon, Zenith, Bandmaster, Breville, Westinghouse, etc.

### Equipped with an **EVER READY** Air-Cell

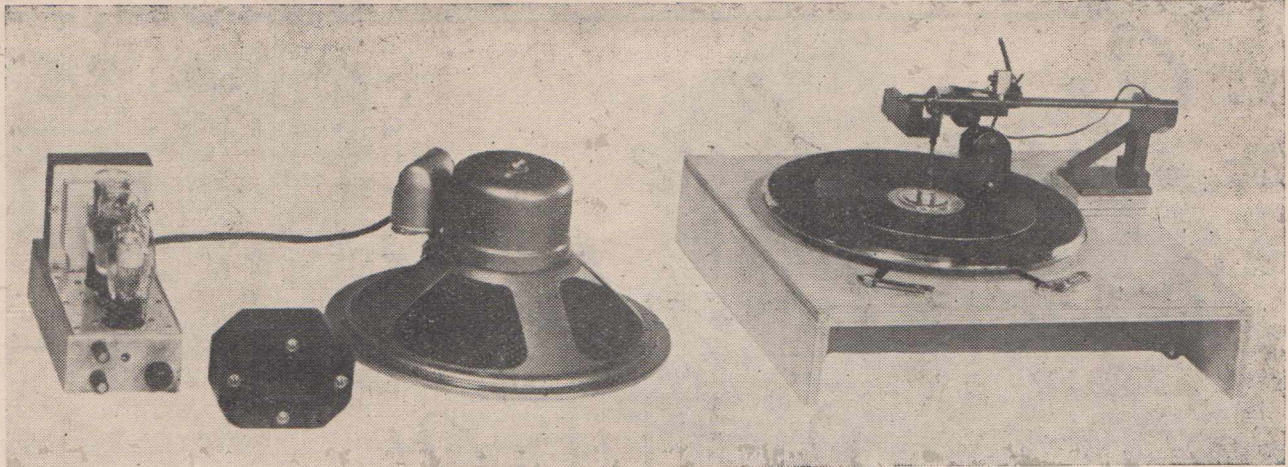

Some of the equipment used to make experimental recordings with the Permarec home recorder. Left to right:—The four-watt beam tetrode amplifier described elsewhere in this issue, with the Reiss microphone described in the "Radio World" for December, 1937, in the foreground. In the centre is one of the latest Rola K-12 speakers, while on the right is the Permarec home recorder, mounted with an a.c. gramophone motor and turntable.

# Home Recording For The Amateur

**H**OME recording is a branch of radio experimenting that is not only a fascinating hobby, but as well can be made highly profitable. Its possibilities are almost endless. Radio talks or commentaries, items from visiting celebrities in the musical world, special overseas broadcasts—all can be recorded simply and with excellent quality with equipment of the type illustrated above.

## Some Further Applications.

Amateur transmitters can also use the equipment for recording QSO's of special interest; in fact, one VK2, when working on 'phone often records the transmissions of amateurs he works, afterwards playing back the records to them over the air to provide an indication of how their signals are being received. DX enthusiasts, too, will find the equipment invaluable for recording transmissions from their best "catches," providing unassailable proof of difficult loggings.

Innumerable other uses will suggest themselves to readers, but two final applications that can be mentioned here are the recording of messages, musical items, etc., for sending to friends overseas and, for home cinema enthusiasts, the recording of spoken commentaries and incidental music to accompany films.

## Little Extra Equipment Required.

For recording radio programmes, all the equipment that is required, apart from the receiver, is a gramophone turntable, a recording head with traversing mechanism, such as the Permarec instrument illustrated

**A Permarec home recorder with some blanks, a standard receiver, and a turntable comprise all the equipment needed to make first-class recordings.**

above, and some recording blanks. The receiver can be a standard type with a single pentode audio stage delivering an output of three watts or more.

The turntable need not be of the electrically-driven type—a good spring motor can be used, as when discs of 8-inch diameter are being cut the recording unit requires little more power to operate than would be absorbed during the playing of a 12-inch record. Also, the recording blanks have a comparatively soft surface, and do not impose a heavy drag on the cutter.

## Microphone Needed For Home Items.

For recording speech and musical items in the home, a microphone is required, the Reiss type illustrated above (and described in the December 1937 "Radio World") would be quite suitable. The secondary of the microphone transformer is merely attached to the pick-up terminals of the radio receiver, or alternatively an amplifier such as the four-watt beam amplifier described elsewhere in this issue can be used.

The blanks supplied with the Permarec equipment (which is available

from Murdoch's Ltd., of Sydney) are of the type that can be played back immediately after cutting, no hardening process being necessary.

The traversing mechanism is driven from the spindle of the gramophone motor by a flexible coupling and two bevelled gears, with a reduction of about 1 to 2.25, and at normal turntable speed gives approximately 90 threads to the inch on the record. This results in a playing time of between two and three minutes.

## Connecting The Recorder Head.

The cutting head used is of the high resistance type, and for recording radio transmissions is merely connected across the primary winding of the speaker transformer, with a 4-mfd. condenser connected in one of the leads. For receivers or amplifiers using push-pull output, the cutting head is connected from plate to plate, with a condenser in each lead. This also permits of the speaker being used as a monitor, while the record is being cut.

The method of inserting the cutting needle in the recording head is illustrated in a sketch accompanying this



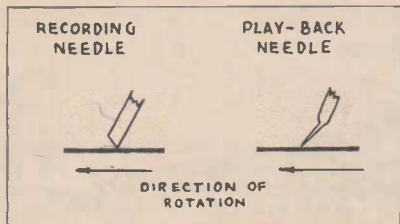

These sketches illustrate the method of inserting the special cutting and play-back needles.

article, a further sketch being included to illustrate the method of inserting the special trailing needles used for playing-back purposes. The recording head and traversing mechanism lift upwards to lock clear of the turntable, facilitating record and needle changing.

One point that should be stressed with home recording is that a few experiments are necessary before success is obtained. Different volume levels should be tried, as well as different recorder head pressures, provision being made in the Permarec equipment for fine variations in applied weight of the cutting head.

If a recording has been made, the surface of the discs should be carefully brushed with a soft camel-hair brush to remove any particles of the

surface material that may have been left in the grooves by the cutter, though the major portion of this comes off as a fine thread which winds itself around the centre boss.

**Further Information In Future Issues.**

Ample information has been given in the above to enable experimenters successfully to instal and operate the Permarec home recorder. However, the subject could not be fully covered in a single article, and so further information will be published in future issues.

**"Outdoor Portable" In N.Z.**

(Continued from page 10.)

ceived at quite good volume. On another test at night I found that with about 10ft. of wire thrown up on the roof of the car all the New Zealand stations were received at good volume, and quite a few Australians were heard, 3AR being the strongest.

The cabinet is not finished yet, as it is home-made from an old box and covered with leatherette, the door being the unfinished part. I might mention that the selectivity is 10 k.c., which I consider very good for a receiver with no r.f. stage.



Excellent DX results were obtained with this "Outdoor Portable," using the top wire of the fence alongside the car as an aerial.

Wishing your magazine every success.—E. J. Schaeffer, Porangahau, New Zealand.

**Regenerative Battery R.F. Stage Gives Good Results.**

Being interested in details of an a.c. regenerative r.f. stage, published some time ago in "R. W.," I decided to see what I could do in the battery line, and below is the result. Its use

# Murdoch's Home Recording Units

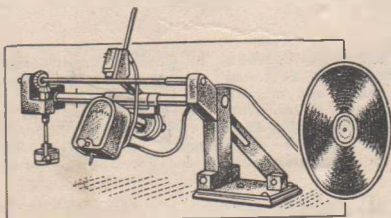

- perfect tracking
- easy running
- British made

This inexpensive and most satisfactory home recorder is specially designed for easy attachment to any existing gramophone, either electric model or one fitted with a good spring motor.

Workmanship throughout these units is of very high standard. For recording broadcast matter, practically no additional apparatus other than the unit is required, for the cutting head is of the high resistance type and can be connected across the primary winding of the output transformer with a 4 MF. condenser in series.

PRICE . . . . . £9/9/-

8in. double-sided blank Records, 2/11; 10in., 4/6; 12in., 6/-  
Steel Recording Needles, each, 1/6

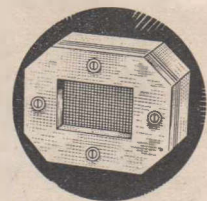
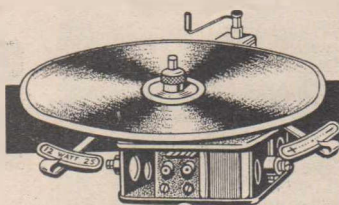

**UNIVERSAL PURPOSE MOTORS . . . . . £5**

Dual power 12 and 25 watts. Adjustable voltage from 110 to 240 A.C. 50 cycle. Automatic stop and switch. Speed regulator. Ideal Universal purpose motor required for recording and playing back at either 33 or 78 r.p.m.

**MICROPHONES FOR . . . . . 29/6**

Transverse current microphones, unassembled, studio model. Will build into a professional model. High quality output unit. Solid teak base, 5ins. x 3½ins. x 2ins. Diaphragm, finest granules, transformer and instructions.

We pay freight. Write to Desk C52.

**MURDOCH'S LTD., Park & George Sts., SYDNEY**

in conjunction with a superhet without an r.f. stage was well justified, both on short waves and the broadcast band.

A KF3 was used because of its all-round economy and good gain. However, any zero bias pentode could be used, variable mu or otherwise.

A U-section chassis was bent up from 14 gauge aluminium, 6" x 8". Thus the chassis is 6" x 5" x 1 1/2". The panel is 7" long and 6" high.

For all-wave coverage, a good .000385 or .0005 mfd. single gang is used. On the short waves a .00025 mfd. fixed condenser is connected in series with the gang, to reduce the max. capacity to about .00015 mfd. A dial of fairly high ratio should be used, say 6:1, as tuning as sharp. The regeneration control potentiometer should be mounted, together with the D.P.S.T. rotary switch, under the chassis at opposite ends.

Input, output and battery plugs are mounted along the rear of the chassis. The screen is decoupled with a .01 mfd. condenser and 10,000 ohm resistor. Valve and coil sockets are mounted along the rear edge of the chassis. The grid connections should be shielded and spaced from the plate leads, as should the grid clip.

The coupling r.f.c. should be a quality, pi-wound short-wave job. A

standard r.f.c. is suitable for de-coupling the plate supply.

The coupling condenser should be varied to find the optimum value for receiver used. From .00005 to .001 mfd. may be used, however, with .00025 mfd. as the average value.

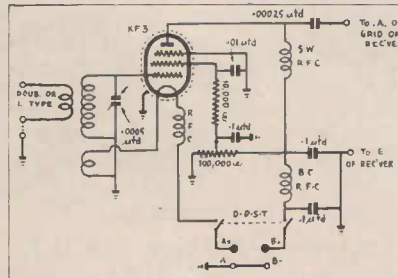

The circuit of the battery-operated regenerative r.f. stage which uses a KF3 with electron-coupled regeneration.

The filter choke consists of 150 turns of 30 gauge enam. or a 1/2" former, closewound.

Coil data is given below covering approx. 13 to 90 metres in three ranges. 26-gauge d.s.c. wire closewound and 1 1/4" 6-pin formers are used. Spacing between aerial and grid windings is 1/4", and 1/8" between grid and regen. windings.

	Aer. Grid Cathode.		
Range 1 . . . .	3	3	6
" 2 . . . .	4	7	6
" 3 . . . .	6	15	6

If a doublet is not used, a shorting link should be connected from one input terminal to earth, or this may be placed in the coil former base.

Some adjustment may be needed to obtain regeneration with as little resistance as possible, when maximum gain will result. Also, too long an aerial or too much coupling between aerial and grid windings will cause "dead spots" in the regeneration. Leads should be short for correct wave coverage.

With careful shielding, regeneration may be used on the b.c.l. band, the following coil details being satisfactory:—

Aerial	Grid	Cathode
10	100	6

30 gauge enam. wire is used, with spacings as before.

The .00025 mfd. condenser is shorted out for b.c.l. work, by including a shorting link in the coil former base.

Keep up the fine work in "R. W." —Australia's foremost radio mag.—  
W. H. Chambers, Oxford, Tasmania.

Ask for

**RAYMART**  
CRAFT A CREED

**SHORTWAVE & ULTRA SHORTWAVE EQUIPMENT**

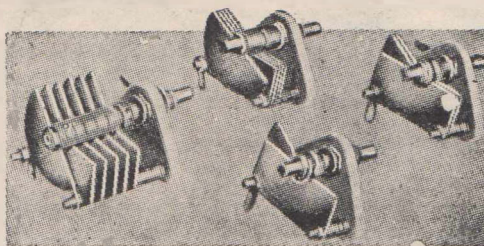

**CERAMIC SHORT WAVE MICRO-VARIABLES.**

The new range of micro-variables employ their exclusive new material "RMX" for greatest efficiency at highest frequencies. Ball races are electrically shorted, ensuring freedom from noise.

	List Price
VC15X 15 mmfd	6/9
VC40X 40 mmfd	7/6
VC100X 100 mmfd	7/9
VC160X 160mmfd	9/9
VC250X 250mmfd (.00025mfd)	10/6
NC15 (Transmitting) Neutralising, 15mmfd spacing .07 in.	8/-
TC40 (Transmitting) Tuning, 40mmfd spacing .07 in.	9/6

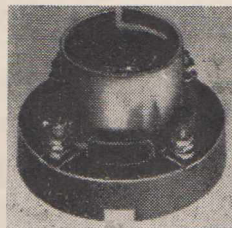

Used extensively overseas by leading manufacturers Raymart "Craft A Creed" equipment assures greater dependability and efficiency. John Martin is confident that every amateur will be more than satisfied with this very excellent equipment. Contact "The Friendly Wholesale House" for everything radio and electrical at the lowest prices in the State.

Same day service a speciality.

**AMERICAN VALVE SOCKETS.**

Owing to the high demand for first quality HF ceramic sockets, we offer the following:

Type	List Price
Type VA4 4-pin Ceramic (for 210, etc.)	3/-
Type VA5 5-pin Ceramic (for 46, 47, etc.)	3/-
Type VA6 6-pin Ceramic (for 58, 6D6, etc.)	3/-
Type VA7 7-pin Large Ceramic (for 59, 53, etc.)	3/-
Type VA7S 7-pin Small Ceramic (for 6A7, etc.)	3/-
Type VA8 8-pin OCTAL	4/-
Type VA50 50-watt (Air Ministry XMB262 HF) dielectric	12/6

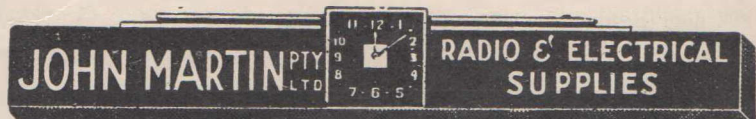

Give yourself  
one of these  
versatile  
multimeters



**DELTA  
MODEL D666**

Small, compact, and highly efficient, this new Delta Portable Multimeter incorporates a precision-built Triplet Model 327 D.C. Microammeter, 0/300. Same scale used for A.C. and D.C. Volts. It is fitted in a highly finished wooden case, 6 1/2 in. x 4 in. x 3 1/2 in., with an attractive engraved panel in black, silver and red. RANGES: A.C. and D.C. Volts: 10-50-250-1, 250; D.C. Milliamperes, 1-10-50-250; Ohms, 0.2-500 and 100-100,000. Selector switch for instrument readings. Ohms adjuster and A.C./D.C. switch, A.C. and D.C. jacks. Self-contained battery. Test leads and prods included. Price: £6/10/-.

**... and save work,  
worry and money**

Better servicing means more profitable business. And there's no advertising that does a better job than the "word-of-mouth" praise of satisfied customers.

Give your customers a good service job—and they tell their friends how good you are. This increases your business.

The best way to do a praiseworthy job is to start off with the proper test equipment . . . Delta Equipment.

The DELTA Model D735 illustrated above is a remarkably compact instrument of the most advanced design for service, speed and precision. Employing a Triplet 326 D.C. Milliammeter 0/1, 1000 ohms per volt, and fitted in a handsome bakelite case, it measures only 3 1/8" x 5 7/8" x 2 1/8" high. Bakelite engraved panel and ohms zero adjuster.

**RANGES.**

1-10-50-250 M.A., 10-50-250-500 Volts, Ohms 0-10,000 and 0-100,000.

Price . . . . . £4/10/-



Write for illustrated literature giving full details of the latest DELTA, TRIP-LETT and READRITE test equipment.

**W. G. WATSON & CO. PTY. LTD.**

279 CLARENCE STREET, SYDNEY, N.S.W.

Head Office: 279 Clarence St., Sydney. Newcastle Branch: King and Bolton Sts., Newcastle. Melbourne Branch: 398-400 Post Office Place, Melbourne. Adelaide Branch: 91A Currie St., Adelaide. And at Hobart, Launceston and Perth.

## Amateur Station Equipment . . . . .

1

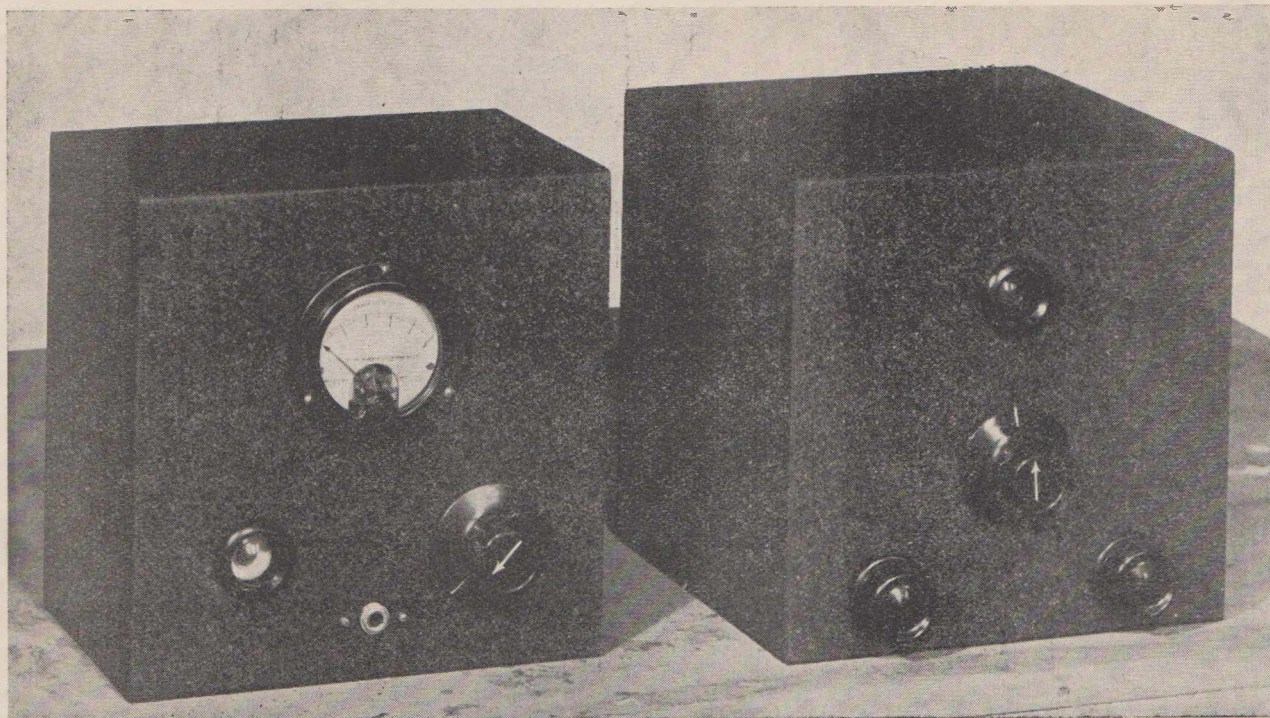

The completed monitor and modulation meter (left) and three-unit power pack (right) are built into crackle-finished steel cabinets of uniform height and width.

# Monitor And Modulation

In the accompanying article—the first of a series on test instruments—the design and construction of a monitor and modulation meter and of a three-unit power pack are described.

## Meter

By VK2MQ

**C**OMPARATIVELY little has been written on the design of test equipment for amateurs, who as a general rule have not the time or laboratory facilities for doing the necessary experimental work. At the same time, the amateur who has not the requisite gear for analysing the kind of signal he is putting out is not only hopelessly handicapped in his experimenting, but as well risks earning the reputation of a slovenly operator. For this reason it is hoped that this and the following articles on test equipment will prove of benefit.

### Economy Plus Efficiency.

As expense is a vital consideration to the average "ham," every effort has been made to keep down the cost of the equipment, consistent with efficiency. For example, only one pack has been used to supply power for three instruments—monitor and mod-

ulation meter, vacuum tube voltmeter, and frequency meter—switching being incorporated so that any of the three can be brought into action in an instant.

The circuit of the power pack is shown overleaf. Three six-pin plugs and three four-wire cables carry heater current and "B" supply to the three units, while the three-position switch connects "B" voltage as needed. The fourth position shown, but left blank, takes care of any additional "B" needed in the future.

### Units Of Uniform Height.

A list of parts needed for the pack are given elsewhere, while main chassis and cabinet dimensions are shown in a separate sketch.

Incidentally, it can be mentioned here that all units are, for the sake of neatness and uniformity, housed in black, crackle-finished steel cabin-

ets of the same height, though depths vary. To prevent joins from marring the appearance, the top, front, and base of each cabinet is bent from a single sheet of steel. Chassis can be of aluminium or sprayed steel.

### Monitor And Modulation Meter.

The monitor and modulation meter illustrated has been designed to overcome the serious drawback of many existing modulation and over-modulation instruments, which are lacking in the ability to register over-modulation peaks of short duration. Percentage modulation is a peak voltage phenomenon, and consequently any unit that does not take this into consideration is not a true indicator.

A reversed rectifier connected to the plate return of the final amplifier when it is being plate modulated is an exception, as it instantly indicates when the plate of the final becomes negative, a condition producing no

carrier output over a fraction of an audio cycle, and an indication of over-modulation.

It has been known for some time that it is the negative peaks of over-modulation that cause the most serious type of interference. This is obvious when one considers the fact that during a negative peak of over-modulation, the carrier is completely cut off, with a resultant "chopping-up" effect each time the negative peaks are cut. It is this effect which produces the hashy side-bands that extend many kilocycles each side of the carrier.

**6E5 Provides Visual Check.**

What is needed is some form of peak vacuum tube voltmeter that will indicate visually when the negative modulation approaches too high a

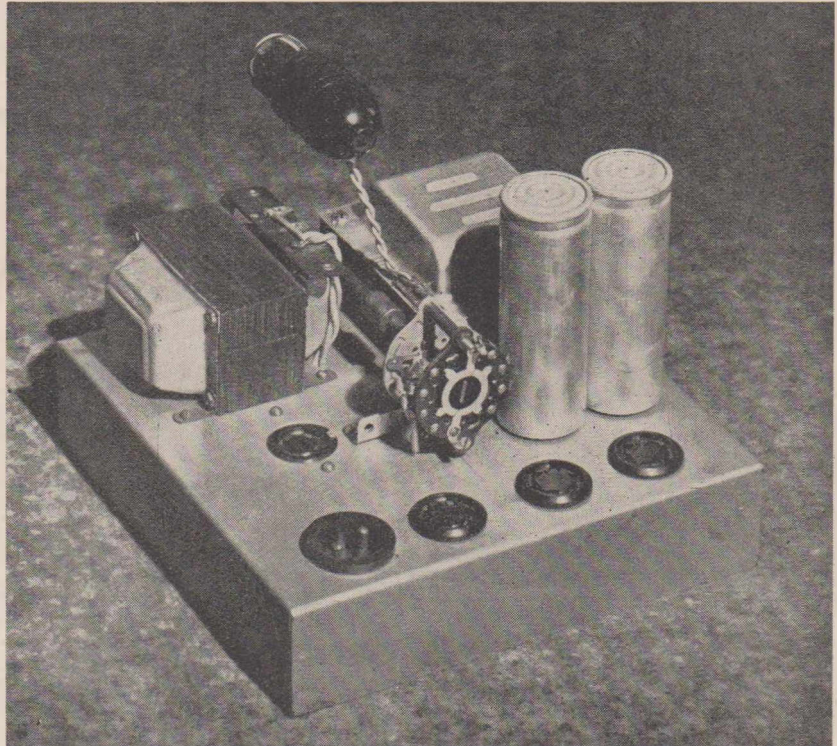

A rear view of the completed power-pack, showing the location of the main components and the method of mounting the rotary switch. The under-chassis view is shown below, while the chassis and panel dimensions for the monitor and modulation meter are shown in figs. 1a and b (left), and for the power pack in figs. 2a and b.

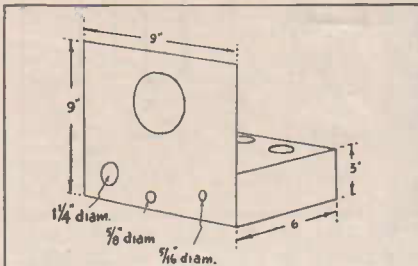

FIG. 1. (a)

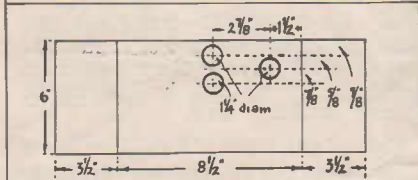

FIG. 1. (b)

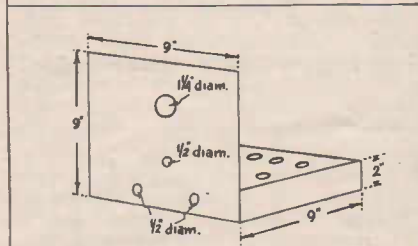

FIG. 2. (a)

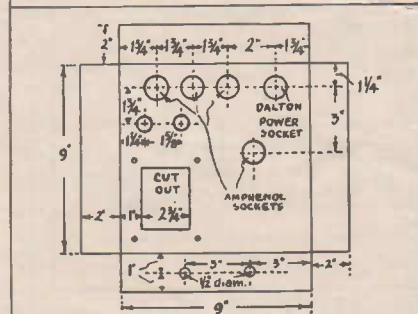
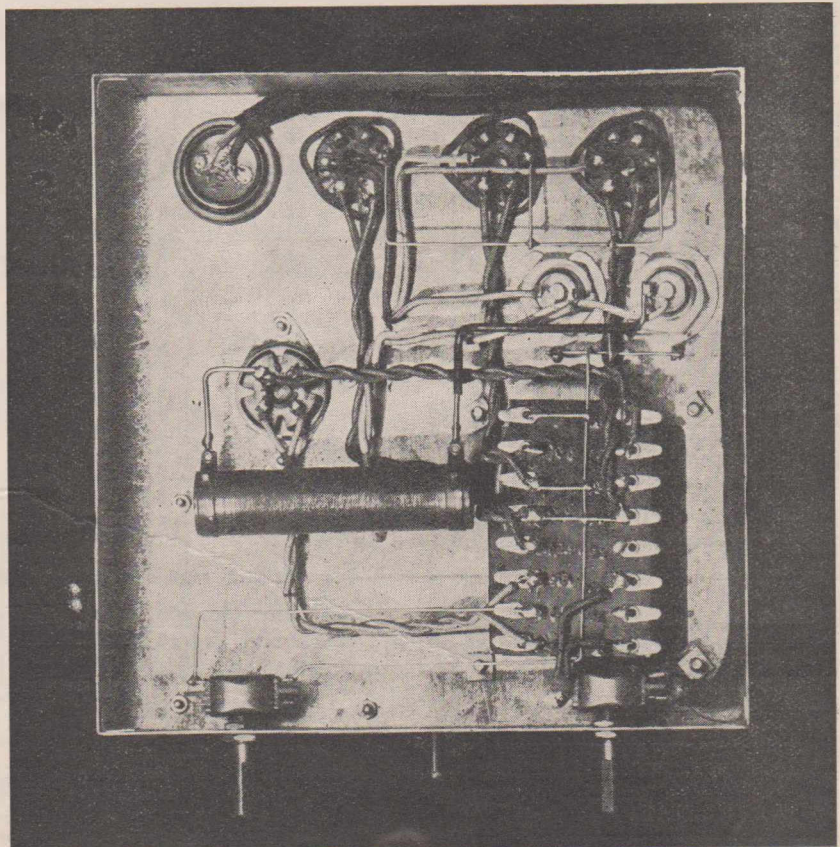

FIG. 2. (b)



# RUSH FOR YOURS



**TWO SHIPMENTS GO LIKE LIGHTNING!**

Available at last in Australia—the world's smoothest, sweetest shave! Over three million Schick Electric Dry Shavers in daily use. We have already sold two big shipments; the third—biggest of them all—arrived last week. Hurry for yours now, or you may have to wait. The Schick Electric Dry Shaver plugs in anywhere, anytime, A.C., D.C. or battery. No soap, lather, or water. No raw, scraped faces. Schick shaves closely with a soft, smooth, massaging action. When you use it, you will regret the time, money and pain it cost you to shave in the old-fashioned way. Order yours now. If you want more information, send coupon.

**LIST PRICE . . . £5/10/-**

Dealers! For details of Discounts, apply to Wholesale Distributors:

## MARTIN DE LAUNAY PTY. LTD.

Cnr. Clarence and Druiitt Streets, Sydney. M 4268 (4 lines).  
Cnr. King & Darby Sts., Newcastle New. 959 (2 lines).  
86 Keira St., Wollongong. Woll. 681  
Free! Art Folder describing the Schick Shaver. Send for yours now!

Martin de Launay Pty., Ltd.,  
Cnr. Clarence & Druiitt Sts., Sydney  
Please send me the free art folder describing the Schick Shaver, and all other details.

Name .....  
Address .....

A.R.W., 7/38.

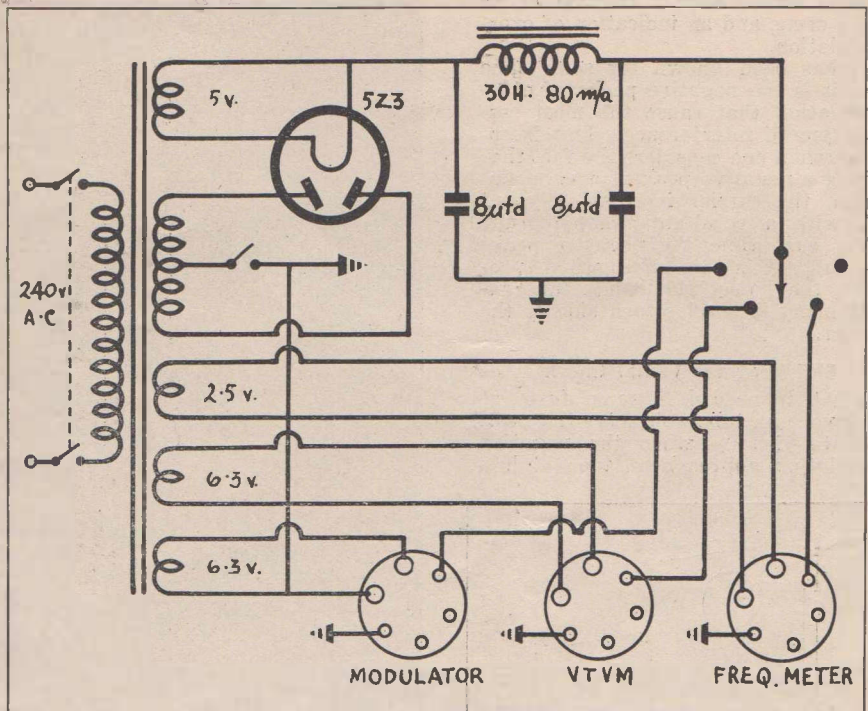

The circuit of the three-unit power pack. If a 385 v. a side power transformer is used, a 1000 ohm 100 mill. resistor should be connected on the input side of the smoothing filter. With a 300 v. a side transformer, this is not required.

value. The 6E5 valve lends itself admirably to this purpose, in that it is a voltage-operated device and gives an effective visual indication. The unit described below was developed around this valve as the actual peak indicator.

### The Operation Outlined.

The functioning of the instrument is as follows:—The input control circuit comprises the condensers C1 and C2, the former acting as a blocking con-

denser for d.c., and the latter as a control varying the amount of input. The first type 1V valve is the r.f. rectifier, rectifying the positive half of the incoming carrier.

The output from the rectifier is filtered to provide modulated d.c. by the choke/condenser combination, r.f.c.'s 1 and 2, and C3 and C4.

The second "1V" is an audio peak rectifier which rectifies audio peaks when they exceed a value of about

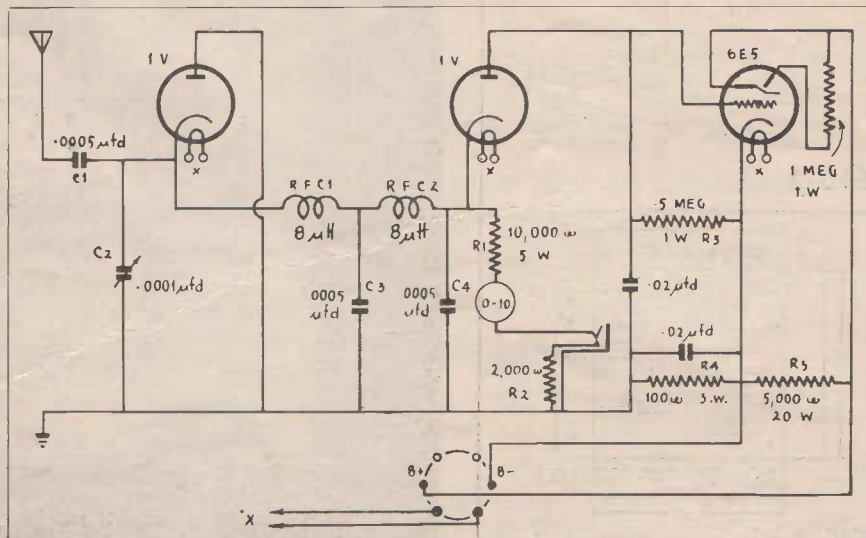

The circuit of the monitor and modulation meter.

**GOOD NEWS FOR THE COUNTRY SERVICEMAN**  
 "Palec" Release a Valve and Circuit Tester for A.C. or Vibrator Operation

Extract Radio Retailer, May 20, 1938.

At last radio servicemen operating in districts "off the power line" can work on an equal footing (as far as equipment goes, at any rate) with their brethren in the cities! This desirable state of affairs has been brought about by the introduction of a "Palec" valve and circuit tester which will operate from either A.C. mains or a 6-volt accumulator with equal efficiency. Prior to this, the country servicemen had to "put up" with equipment which, although optimistically referred to as a "D.C. equivalent," was nowhere near as versatile as similar items of equipment designed for purely A.C. mains operation. Those days are past now, because the new Palec Model "VCT" features a full set of "A.C." specifications, and can be operated on either A.C. mains or a 6-volt accumulator by the simple expedient of changing over a connection cable.



## Country Dealers acclaim this Revolutionary and Exclusive design THE "PALEC" VALVE AND CIRCUIT TESTER

The manufacturers take great pleasure in announcing to country dealers that the popular Model V.C.T. Valve and Circuit Tester has now been developed to operate from EITHER the A.C. supply or from a 6 volt accumulator as desired. In other words the extraordinary utility and service of this instrument is no longer confined to the town area, but can be taken to outlying districts and connected to a 6 volt accumulator. The latter operates the enclosed independent vibrator and power transformer and supplies the necessary e.m.f. to enable every component in a radio chassis to be checked and tested—valves included.

### SPECIFICATIONS AND FEATURES.

**VALVE TESTING**—Shows the condition of all types of valves on the Good-Bad scale, as well as supplying a Neon test for element leakage.

**LOW OHMS**—A range of low ohms, reading from a tenth of an ohm (ten ohms half scale) is provided for coil, contact and dry joint checks.

**OHMS** — Three other ranges supply measurements up to 10 megohms.

### CONVERTING MODEL "V.C.T."

Country owners of Model "V.C.T." (A.C. operated only) can have their instrument changed over for dual operation at a nominal charge—write for particulars.

**ELECTROLYTIC CONDENSERS**—All types of Electrolytic Condensers can be tested and checked on a Good-Bad scale.

**PAPER CONDENSERS**—Paper and Mica Condensers tested for open circuited connections and leakage by the Neon flash method.

**MA's**—In four ranges to 250 M.A.

**D.C. VOLTS**—In four ranges to 1,000 volts.

**A.C. VOLTS**—In four ranges to 1,000 volts.

**OUTPUT VOLTS**—In four ranges to 1,000 volts.

The instrument is equipped with 5in. type meter, having a linear scale for A.C. voltage readings, and is housed in a compact leatherette case, 11in. x 11in. x 7in., Weight 16 lbs.

Trade Price Model V.C.T. A.C. only £15/10/-, plus tax.

Trade Price Model V.C.T. A.C.-Vibrator £17/17/-, plus tax.

Send for 16-page illustrated catalogue detailing the full range of "Palec" Oscillographs, Beat Frequency Oscillators, Multimeters, Valve Testers, R.F. Oscillators, and Moving Coil Meters, etc.

TERMS AVAILABLE.

## THE PATON ELECTRICAL PROPRIETARY LTD.

90 VICTORIA STREET, ASHFIELD, SYDNEY.

Manufacturers of Cathode Ray Equipment, Meters, and full range of Testing Equipment.



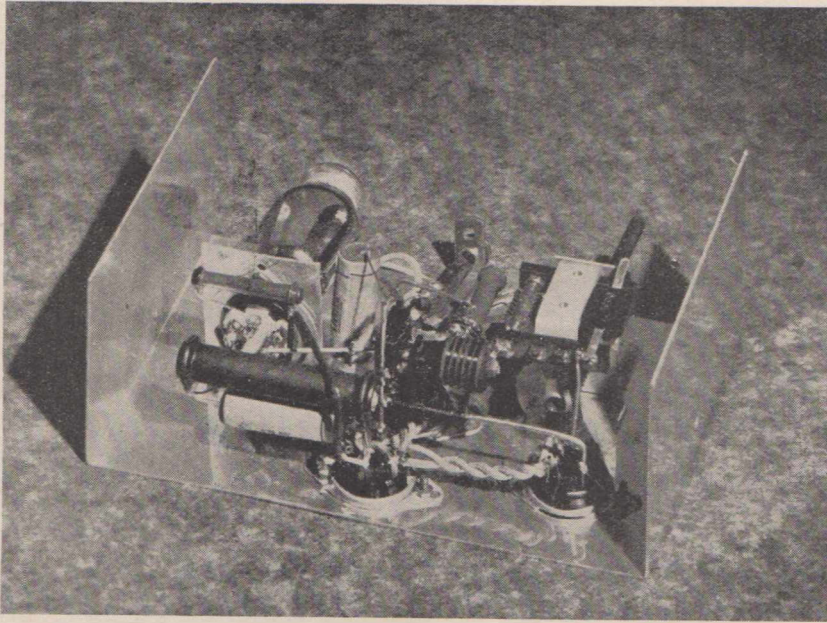

An under-chassis view of the monitor and modulation meter.

90 per cent. modulation, and feeds them to the grid of the 6E5. This valve is the visual over-modulation indicator of all negative peaks in excess of 90 per cent. At 100 per cent. modulation it becomes almost closed.

The combination of load resistors R1 and R2 and the 0-10 m.a. meter comprises the conventional shift indicator. By plugging a pair of headphones into the jack, R2 is automatically substituted by the resistance of the phones, which enables a continual check on the audio quality to be maintained. An important point here is that if calibration is to be constant, R2 should have the same resistance as the headphones used.

#### Housed In Lacquered Cabinet.

The entire unit is mounted in an 18-gauge metal box measuring 9 x 9 x 6 in. deep, and finished in black crystalline lacquer. The construction is conventional, except perhaps, for the 6E5, which is mounted under the chassis to preserve symmetry of the panel.

The actual wiring of the instrument presents no difficulty, and the layout of parts is obvious from photos.

#### Operating Procedure.

The operation of the instrument will be described in some detail to aid in its proper installation. Firstly, the unit should be effectively grounded to the transmitter. Secondly, because the instrument takes from .5 to 1 watt to operate, close coupling to transmitter is required. Of course, each installation will vary, but in most cases an insulated wire wound round the feeders a few times will suffice.

It is important that coupling is to the actual output of the transmitter—otherwise an erroneous impression will be obtained of what is going on the air.

To check the unit, it should be allowed to warm up for a short period,

when the 6E5's eye should be almost closed, leaving only about a 10-degree segment open. It is this same amount of deflection which is observed when the transmitter is on the air and being modulated 100%.

Deflections greater than this indicate over-modulation. The adjustment so that this is true is easily accomplished. With the monitor and the transmitter both on and coupled, the input to the monitor is adjusted by varying its coupling to the transmitter and the setting of "C2" until the meter shows 5 mills. Then, as the transmitter is modulated, no change will be observed until a modulation percentage of 90 is reached, when the eye will start to close. It will be closed by the amount indicated when 100% is reached.

#### Meter Is Carrier Shift Indicator.

The milliammeter itself is the carrier shift indicator, which if showing any up-or-down movement when modulated indicates non-linearity somewhere in the rig. This is, of course, providing the line voltage is constant and the carrier is not being purposely modulated as in controlled carrier.

An explanation of the modus operandi might be of interest. Firstly, when the input carrier is adjusted to show 5 m.a. d.c. through the 12,000 ohms in the circuit, there is 60 volts developed from the cathode to ground of the audio rectifier. However, there is a drop of 5 volts across R4 due to the bleeder current flowing through R5 and R4, and the plate of the audio rectifier is 5 volts above ground.

But from the other position, as the plate is 55 volts negative (60-5) with respect to cathode, there will be no current flow, and the 6E5 grid will remain at cathode potential. Hence there will be no deflection.

Then, as we modulate, the cathode will be swinging above and below 60 volts by the following peak voltage:—

$$\frac{\% \text{ mod.}}{100} \times 60 = E \text{ peak.}$$

When the percentage reaches 91%, it is observed that the cathode will be swinging between peak values of  $60 + 55 = 115$  and  $60 - 55 = 5$ .

At the negative peaks it will be seen that the plate and cathode are at the same potential. As the percentage is increased, the cathode will become negative in respect to the plate over an appreciable period of time, and current will flow through R3 to change the charge on condenser C6 by an amount  $\Delta E$ .

It is this instantaneous potential  $\Delta E$  that is measured by the 6E5 and becomes -5 at 100% modulation.

### Monitor and Modulation Meter — List of Parts —

1—crackle-finished steel cabinet and aluminum chassis, with bracket, to specifications.

1—0-10 m.a. meter (Triplett, Calstan, Palec).

2—8 millihenry chokes.

3—.0005 mfd. mica fixed condensers.

1—.0001 mfd. midget variable condenser (Raymart, Radiokes, Radlomag).

4—wafer sockets, 2—6-pin, 2—4-pin.

1—knob.

1—closed circuit 'phone jack.

1—6E5 escutcheon.

#### RESISTORS:

1—2,000 ohm 1-watt carbon (E.T.C.).

1—10,000 ohm 1-watt carbon (E.T.C.).

1—.5 megohm 1-watt carbon (E.T.C.).

1—1 megohm 1-watt carbon (E.T.C.).

1—100 ohm 3-watt carbon.

1—5,000 ohm 20-watt wirewound.

#### VALVES:

2—1V, 1—6E5.

#### MISCELLANEOUS:

Bolts and nuts, push-back, solder tags, etc.

### Power Pack — List of Parts

1—chassis and cabinet, to specifications.

1—power transformer 385v. C.T. 385v.

.63v. 1a., 6.3v. 1a., 2.5v. 2a., 5v.

2a. (Radiokes).

1—double-pole double-throw switch.

1—30 henry 80 m.a. smoothing choke.

2—8 mfd. wet electrolytic (Solar).

1—4-position rotary switch.

3—6-pin wafer sockets, 1—4-pin.

1—5Z3 rectifier.

Power flex and plug.

1—1,000 ohm. 100 mill. W.W. resistor.

Power socket and plug.

3—knobs.

1—6E5 escutcheon.

1—"B+" on/off switch.

1—Phillips Neon tube and socket



# World Shortwave Stations

(Concluded from last month.)

Below is published a comprehensive list of world short-wave stations, giving call-signs, locations, frequencies (and wavelengths) together with schedules in East Australian Standard Time.

NOTE: To convert kilocycles to megacycles, shift the decimal point three places to the left (e.g., read 21,540 k.c. as 21.54 m.c.).

## Compiled By ALAN H. GRAHAM (SHORT-WAVE EDITOR, "RADIO WORLD")

Call.	Kc.	M.	Location.	Schedule, etc.
HSPJ	9350	32.09	Bangkok, Siam.—	Not in use at present.
CGA4	9330	32.15	Drummondville, Canada.—	Phones England.
OAX4J	9330	32.15	Lima, Peru.—	"Radio Universal"; daily 3-6 a.m., 8 a.m.-4 p.m.
YNGU	9300	32.26	Managua, Nicaragua.—	Daily, 3-5, 9-10 a.m.
GCB	9280	32.33	Rugby, England.—	Phones Canada and Egypt.
HIG	9275	32.34	Ciudad Trujillo, D.R.—	Daily, 3.40-5.10 a.m., 11.10 a.m.-12.40 p.m., 10.10-11.40 p.m.
PDP	9240	32.47	Kootwijk, Holland.—	Phones D.E.I.
COBX	9200	32.59	Havana, Cuba.—	Relays CMBX, 10 p.m.-3p.m.
ZSR	9180	32.68	Klipheuvcl, S. Africa.—	Phones England.
HC1CQ	9176	32.69	Quito, Ecuador.—	Daily, 12.50-1.30 p.m.
WNA	9170	32.72	Lawrenceville, U.S.A.—	Phones England.
YVR	9150	32.79	Maracay, Venezuela.—	Phones Europe.
HAT4	9125	32.88	Budapest, Hungary.—	Sun., 9-10 a.m.; Mon., Thurs., 10-11 a.m.
KUW	9110	32.93	Manila, P.I.—	Tests irregularly.
COCA	9095	32.96	Havana, Cuba.—	Relays CMCA daily, mid-3 p.m.
CGA5	9091	33.00	Drummondville, Canada.—	Phones Europe.
COBC	9090	33.00	Havana, Cuba.—	Relays CMBC daily, 9.55 p.m.-3.30 p.m.
TFK	9060	33.11	Reykjavik, Iceland.—	Phones London.
TYA2	9037	33.19	Paris, France.—	Phones Algiers.
COBZ	9032	33.12	Havana, Cuba.—	Relays CMBZ daily, 10.45 p.m.-3.10 p.m.; irreg., 3.30-5 p.m.
GCS	9020	33.26	Rugby, England.—	Phones U.S.A.
KEJ	9010	33.3	Bolinas, U.S.A.—	Relays NBC and CBS programmes irreg.
CJA5	8975	33.42	Drummondville, Canada.—	Phones Australia.
VWY	8967	33.43	Kirkee, India.—	Phones England.
TPZ2	8960	33.48	Algiers, Algeria.—	Phones Paris.
WEL	8950	33.51	Rocky Point, U.S.A.—	Phones Europe.
COKG	8920	33.61	Santiago, Cuba.—	Daily, mid-1 a.m., 2.30-4.30 a.m., 6-7.30 a.m., 8-9 a.m., 1-2 p.m., 3-5 p.m.
ZLS	8900	33.71	Wellington, N.Z.—	Phones Sydney.
ZMBJ	8840	33.94	ss "Awatear."—	Phones around 4 p.m.
HCJB	8830	33.96	Quito, Ecuador.—	Exc. Tues., 11.30 a.m.-1.30 p.m.
LSD	8830	33.96	Buenos Aires, Arg.—	Tests with New York.
HKV	8795	34.13	Bogota, Colombia.—	Tues. and Fri., 10.10.30 a.m.
TIR	8790	34.14	Cartago, Costa Rica.—	Phones C. America.
				Schedule, etc.
	8775	34.19	Makassar, DEI.—	Phones Java, 7 p.m.
	8765	34.23	Nordeich, Germany.—	Phones ships.
	8760	34.25	Rugby, England.—	Phones Africa.
	8750	34.29	Djibouti, Fr. Somaliland.—	Phones Paris, 5.30 p.m.
	8740	34.33	Fairbanks, Alaska.—	Phones WXH.
	8730	34.36	Rugby, England.—	Phones India, 11 p.m.
	8720	34.4	Suva, Fiji Is.—	Daily 8.30-10 p.m.
	8710	34.43	Manila, P.I.—	Tests irregularly.
	8700	34.46	Bogota, Colombia.—	Tues. and Fri., 10-10.20 p.m.
	8680	34.56	Rugby, England.—	Phones ships.
	8665	34.63	Camaguey, Cuba.—	Exc. Sun. and Mon., 8.30-9.30 a.m., and 11 a.m.-2 p.m.
	8665	34.63	Hicksville, U.S.A.—	Tues. to Sat. news at mid. and 8 a.m.
	8650	34.71	Taihoku, aiwan.—	Relays JFAK; irregular.
	8580	34.92	Managua, Nicaragua.—	Daily, 10.30 a.m.-12.30 p.m.
	8560	35.05	Ocean Gate, N.J., U.S.A.—	Phones ships.
	8550	35.09	Panama City, Panama.—	Phones irregularly.
	8515	35.23	Pisa, Italy.—	Phones irregularly.
	8500	35.29	Nazaki, Japan.—	Phones ships.
	8400	35.71	Guayaquil, Ecuador.—	Daily, 2.30-3.30 a.m., 11 a.m.-2 p.m.
	8380	35.80	Pisa, Italy.—	Phones ships.
	8330	36.01	Rugen, Germany.—	Phones ships.
	8185	36.65	Rio de Janeiro, Brazil.—	Irregular.
	8155	36.79	Kootwijk, Holland.—	Phones Java.
	8140	36.86	Buenos Aires, Arg.—	Tests irregularly.
	8120	36.95	Manila, P.I.—	Phones U.S.A., Japan and Java.
	8110	37.00	Asuncion, Paraguay.—	Daily, 11 a.m.-1 p.m.
	8075	37.15	Rocky Point, U.S.A.—	Irregular.
	8075	37.15	Paris, France.—	Phones Morocco.
	8036	37.33	Rabat, Morocco.—	Mon., 5.30-7 a.m., and irreg.
	7975	37.62	Quito, Ecuador.—	Fri. and Mon., 11 a.m.
	7970	37.64	Shanghai, China.—	Tests p.m.
	7960	37.69	Sydney, Australia.—	Phones Wellington.
	7955	37.71	Bangkok, Siam.—	Phones Berlin, Manila and Java.
	7935	37.81	Rio de Janeiro, Brazil.—	Phones New York & Madrid
	7920	37.88	Rugby, England.—	Phones Sydney.
	7901	37.97	Hurlingham, Arg.—	Phones Rio.
	7894	37.99	San Salvador, El Salvador.—	Irreg., 10 a.m.-2 p.m.
	7890	38.02	Asmara, Eritrea.—	Irregular.
	7890	38.02	Drummondville, Canada.—	Phones Australia.
	7880	38.05	Kemikawa-Cho, Japan.—	Tests irregularly.
	7860	38.17	Abou Zabal, Egypt.—	Phones Europe, 7-9 a.m.
	7854	38.20	Guayaquil, Ecuador.—	Mornings.
	7840	38.27	Kootwijk, Holland.—	Phones Java.
	7812	38.40	Nauen, Germany.—	Phones irregular.
	7797	38.49	Geneva, Switzerland.—	Sun., 8.30-9.30 a.m.
	7790	38.5	Managua, Nicaragua.—	Phones Cent. & S. America.
	7765	38.63	Kootwijk, Holland.—	Phones D.E.I.
	7740	38.76	Santiago, Chile.—	Phones irregular.
	7730	38.81	Kootwijk.—	Holland.—Special relay to D.E.I.

Call.	Kc.	M.	Location.	Schedule, etc.	Call.	Kc.	M.	Location.	Schedule, etc.
KEE	7715	38.89	Bolinas, U.S.A.	Relays NBC and CBS programmes.	KEL	6860	43.70	Bolinas, U.S.A.	Tests irreg., 2 and 9 a.m.
TYC2	7700	38.96	Paris, France.	Phones Egypt.	XGOX	6850	43.80	Nanking, China.	Doubtful.
RIM	7626	39.34	Tachkent, U.S.S.R.	Phones Moscow.	CFA	6830	43.92	Drummondville, Canada.	Phones N. America.
IUB	7620	39.37	Addis Ababa, Ethiopia.	Irregular.	H17P	6800	44.12	Ciudad Trujillo, D.R.	Daily exc. Sun., Mon., 3.40-4.40, 9.40-11.40 a.m.; Sun., 3.40-4.40 a.m.; Mon., 1.40-2.40 a.m.
KWX	7610	39.42	Dixon, U.S.A.	Phones Hawaii, P.I., Japan & Java.	GAB	6795	44.15	Rugby, England.	Phones Canada.
T18WS	7550	39.74	Punta Arenas, C. Rica.	Daily, 9 a.m.-3 p.m.	HIH	6770	44.26	San Pedro de Macoris, D.R.	Daily, 10.30 a.m.-noon; 3.10-4.40 p.m.; Sun., 6-7 p.m.; Mon., 7.15-9 a.m.
RKI	7520	39.87	Moscow, U.S.S.R.	Relays RAN, 10 a.m.-12.15 p.m. Phones RIM.	CJA6	6760	44.38	Drummondville, Canada.	Phones Australia.
KKH	7520	39.87	Kahuku, Hawaii.	Phones U.S.A.	WOA	6755	44.41	Lawrenceville, U.S.A.	Phones England.
JVP	7510	39.95	Nazaki, Japan.	Irregular.	JVT	6750	44.44	Nazaki, Japan.	Irregular.
CFA6	7500	40.00	Drummondville, Canada.	Phones U.S.A.	H13C	6730	44.58	La Romana, D.R.	Daily, 3.30-5, 8.19 a.m.
JVQ	7470	40.16	Nazaki, Japan.	Relays irreg.	PMH	6720	44.64	Bandoeng, Java, D.E.I.	Relays NIROM progs., 8.30-noon.
ZLT2	7390	40.6	Wellington, N.Z.	Phones Sydney, 6-10 p.m.	TIEP	6710	44.71	San Jose, Costa Rica.	Daily, 10 a.m.-1 p.m.
XECR	7380	40.65	Mexico City, Mexico.	Mondays, 9-10 a.m.	CGA6	6690	44.84	Drummondville, Canada.	Phones Europe.
KEQ	7370	40.71	Kahuku, Hawaii.	Special relays.	HBQ	6675	44.94	Geneva, Switzerland.	Broadcasts and phones irreg.
GDL	7345	40.84	Rugby, England.	Phones Japan.	YVQ	6672	44.95	Maracay, Venezuela.	Sundays, 11 a.m.-noon.
DLC	7332	40.92	Rehmate, Germany.	Phones irreg.	HCZRL	6672	44.95	Guayaquil, Ecuador.	Mon., 8.45-10.45 a.m.; Wed., noon-2 p.m.
BKE	7220	41.55	Bogota, Colombia.	Tues., Fri., 9.30-10 a.m.; Wed., Sun., 11 a.m.-noon.	GBY	6650	45.11	Rugby, England.	Phones U.S.A.
EAI8L	7212	41.59	Pontevedra, Spain.	Nationalist station.	IAC	6650	45.11	Pisa, Italy.	Phones ships.
EAI8	7203	41.65	San Sebastian, Canary Is.	Nationalist station.	HIT	6630	45.25	Ciudad Trujillo, D.R.	Daily exc. Mon., 3.10-4.40, 8.40-11.40 a.m.; Sun., 1.40 p.m.-3.40 p.m.
FET8	7202	41.65	Melilla, Spain.	Nationalist station.	PRADO	6625	45.28	Rio Bamba, Ecuador.	Fridays, noon-2.45 p.m.
EAME	7200	41.66	Melilla, Spain.	Nationalist station.	DAF	6600	45.45	Nordeich, Germany.	Phones irreg.
EABAE	7200	41.66	Las Palmas, Canary Is.	Nationalist station.	COCU	6590	45.52	Habana, Cuba.	Relays CMCU, 10 p.m.-3 p.m.
EABL	7200	41.66	Pontevedra, Spain.	Nationalist station.	HCIVT	6575	45.63	Ambato, Ecuador.	Tues., Thurs., Sat., 11 a.m.-1.30 p.m.
YNAM	7200	41.66	Managua, Nicaragua.	Daily at noon.	HI4D	6558	45.74	Ciudad Trujillo, D.R.	Daily exc. Mon., 2.55-4.40 a.m.
EA2BA	7177	41.80	Jaca, Spain.	Nationalist station.	XBC	6550	45.80	Vera Cruz, Mexico.	Daily, 11.15 p.m.-mid.
CR6AA	7177	41.80	Lobito, Port W. Africa.	Sun. & Thurs., 5.45-7.30 a.m.	TIRCC	6550	45.80	San Jose, Costa Rica.	Daily, 3-5 a.m.; Mon., 2-5 a.m., 9-10 a.m.; Fri., 9 a.m.-2 p.m.
FET6	7168	41.85	Palma de Mallorca, Majorca.	Nationalist station.	YV6RB	6545	45.84	Bolivar, Venezuela.	Daily, 9 a.m.-1.30 p.m.
FET	7147	41.97	Las Palmas, Canary Is.	Nationalist station.	YNIGG	6530	45.94	Managua, Nicaragua.	Daily, 11 a.m.-noon.
EA7BA	7142	42.00	Cadiz, Spain.	Nationalist station.	YV4RB	6520	46.01	Valencia, Venezuela.	Daily, 2-5 a.m., 8 a.m.-1 p.m.
FET1	7134	42.05	Ceuta, Spain.	Nationalist station.	HIL	6500	46.15	Ciudad Trujillo, D.R.	Daily, 8.40-10.40 a.m.
FO8AA	7100	42.25	Papeete, Tahiti.	Wed., Sat., 2-3 p.m.	YVIRM	6500	46.15	Maracaibo, Venezuela.	Daily, 9 a.m.-12.30 p.m.
FET5	7090	42.29	Burgos, Spain.	Nationalist station.	HIIL	6490	46.20	Santiago de los Caballeros, D.R.	Daily, 8.40-10 a.m.
PI1J	7088	42.30	Guadalajara, Mexico.	"Radiodifusora del Pueblo," daily, noon-2 p.m.	HI4D	6482	46.28	Ciudad Trujillo, D.R.	Tues. & Sat., 2.55-4.40, 7.40-10.40 a.m.
EA1BO	7070	42.43	Dordrecht, Holland.	Sun., 2.10-2.50 a.m.	EDR-4	6480	46.30	Palma de Mallorca, Balearic Is.	Daily, 7.30-8.15 a.m.
FETIO	7027	42.69	Salamanca, Spain.	Nationalist station.	HI8A	6479	46.30	Ciudad Trujillo, D.R.	Daily, 11.40-1.40 a.m.; Sun., 7.10-8.40 a.m.
FET1	7006	42.82	Vitoria, Spain.	Nationalist station.	YNLAT	6470	46.36	Granada, Nicaragua.	Irregular.
EA2AA	7002	42.83	Valladolid, Spain.	Nationalist station.	YV3RD	6465	46.37	Barquisimeto, Venezuela.	Irregular.
EA1AV	7000	42.85	Saragosse, Spain.	Nationalist station.	HI4V	6450	46.48	San Francisco de Macoris, D.R.	Daily, 2.40-4.40 a.m., 8.10 a.m.-12.40 p.m.
EA2BL	7000	42.85	Salas, Spain.	Nationalist station.	TGQA	6440	46.56	Quezaltenango, Guatemala.	Mon., 4-6 a.m.; Tues., Sat., noon-2 p.m.; Sun., noon-4 p.m.
EA9AH	6996	42.88	Ejea de los Caballeros, Spain.	Nationalist station.	HIIS	6420	46.73	Santiago, D.R.	Daily, 2.40-4.40, 8.40-10.40 a.m., 12.40-2.40 p.m.
PZH	6996	42.88	Tetuan, Sp. Morocco.	Nationalist station.	YV6RC	6416	46.73	Bolivar, Venezuela.	Irregular.
JVS	6990	42.92	Paramaribo, Dutch Guiana.	Daily, 9.06-11.36 p.m., 8.36-11.36 a.m.; Mon., 12.36-2.35 a.m.	TIPG	6410	46.80	San Jose, Costa Rica.	Daily, 3-5 a.m., 9 a.m.-2.30 p.m.
XBA	6977	43.00	Nazaki, Japan.	Phones Eastern stations.					
HCETC	6976	43.00	Tacubaya, Mexico.	Daily, 12.30-4 a.m., 10-11.30 a.m.					
WKP	6950	43.17	Quito, Ecuador.	Fri. around noon.					
GBY	6950	43.17	Rocky Point, U.S.A.	Special relays.					
IUF	6922	43.34	Rugby, England.	Phones U.S.A.					
GDS	6905	43.45	Addis Aabaa, Ethiopia.	Irregular.					
HI2O	6899	43.48	Rugby, England.	Phones New York.					
KEB	6890	43.45	Ciudad Trujillo, D.R.	Daily, 1.40-5.40, 7.40-11.40 a.m., 9.40-11.40 p.m.					
CGA7	6880	43.60	Bolinas, U.S.A.	Phones P.I. and Java.					
			Drummondville, Canada.	Phones Europe.					

Call.	Kc.	M.	Location.	Schedule, etc.	Call.	Kc.	M.	Location.	Schedule, etc.
YV5RH	6400	46.88	Caracas, Venezuela.	Daily, 10 a.m.-2 p.m.	VP3BG	6130	48.94	Georgetown, Br. Guiana.	From 8 a.m. on.
HI8J	6388	46.92	Las Vegas, D.R.	Irregular.	COCB	6130	48.94	Habana, Cuba.	Relays CMCD 10-4 p.m.
VP2LO	6384	46.94	Ste. Kitts, B.W.I.	Daily, 7-7.45 a.m.; Mon., 1-1.45 a.m.	VE9HX	6130	48.94	Halifax, Canada.	Relays CHNS Mon.-Fri., 10 p.m.-2.15 a.m.; Sun., 2 a.m.-2 p.m.; Mon., 3 a.m.-2.15 p.m.
YV5RF	6380	46.96	Caracas, Venezuela.	Daily, 9 a.m.-1.30 p.m.	ZGE	6130	48.94	Kuala Lumpur, Fed. Malay States.	Sun., Tues., Fri., 9.40-11.40 p.m.
TISWS	6370	47.07	Puntarenas, C. Rica.	Daily, 9 a.m.-3 p.m.	LKL	6130	48.94	Jeloy, Norway.	Daily, 2-9 a.m.
YV1RH	6364	47.18	Maracaibo, Venezuela.	Daily, 2-5 a.m., 8 a.m.-2 p.m., 9-10.30 p.m.	CXA-4	6125	48.98	Montevideo, Uruguay.	Daily 1-3 a.m., 5-11 a.m.
HRP-1	6360	47.19	San Pedro Sula, Honduras.	Daily, 10.30 a.m.-12.30 p.m.	HP5H	6122	49.00	Panama City, Panama.	Daily 3-4 a.m., 11 a.m.-1 p.m.
HI1X	6340	47.32	Cuidad Trujillo, D.R.	Daily, 3.10-4.10 a.m.; Sun., 10.40 p.m.-1.40 a.m.; Wed., Sat., 11.10 a.m.-1.10 p.m.	W2XE	6120	49.02	New York City, U.S.A.	Daily 2-3 p.m.
OAX1A	6335	47.33	Ica, Peru.	Daily, 11 a.m.-2 p.m.	XEUZ	6117	49.03	Mexico City, Mexico.	Relays XEFO 4-6 p.m.
COCW	6324	47.40	Habana, Cuba.	Daily, 9.55-4 p.m.; Mon., 1 a.m.-1 p.m.	HJ3ABX	6115	49.05	Bogota, Colombia.	Daily 3-5 a.m., 8.30 a.m.-2 p.m. Mon., 9 a.m.-2 p.m.
HIZ	6310	47.52	Ciudad Trujillo, D.R.	Daily exc. Sun., Mon., 1.10-3.25 a.m., 8.10-11.40 a.m.; Sun., 8.10 a.m.-2.10 p.m.; Mon., 2.40-4.40 a.m.	OLR2C	6115	49.05	Prague, C-Slovakia.	Irregular.
VY4RD	6300	47.62	Maracay, Venezuela.	Daily, 9.30 a.m.-12.30 p.m., exc. Mon.	XEPW	6110	49.10	Mexico City, Mexico.	Relays XEJW 2-4 p.m.
OAX4G	6295	47.63	Lima, Peru.	Daily 10.10 a.m.-1.30 a.m.	VUC	6110	49.10	Calcutta, India.	Daily 6-8.30 p.m., 12.30-3 a.m.; Sun., 10.30 p.m.-3 a.m.
HIG	6290	47.67	Trujillo City, D.R.	Daily 2.40-4.10 a.m., 6.40-11.40 a.m., 10.10-11.40 p.m.	HJ6ABB	6108	49.14	Manizales, Colombia.	Tues., Sat., 3.15-4 a.m.; Wed. and Sat., 10.30 a.m.-1 p.m.; Mon., 5.30-8 a.m.
COHB	6280	47.77	Sancti Spiritus, Cuba.	Daily 12.01-2.30 a.m., 3.30-4.30, 7-10 a.m., 11 a.m.-2 p.m.	YUA	6100	49.18	Belgrade, Jugoslavina.	Daily 4-9 a.m., 3.45-5.30 p.m., 7-11 p.m.
YV5RP	6270	47.79	Caracas, Venezuela.	Daily till 1.30 p.m.	W3XAL	6100	49.18	Bound Brook, U.S.A.	Daily 10 a.m.-4 p.m.; Mon., 9 a.m.-4 p.m.
YV5RJ	6255	47.90	Caracas, Venezuela.	Schedule unknown.	W9XF	6100	49.18	Chicago, U.S.A.	Daily 7-9.50 a.m., 3.05-5 p.m.; Mon., 4-9.50 a.m.
HIN	6243	48.00	Ciudad Trujillo, D.R.	Daily 3-5 a.m., 9 a.m.-1 p.m.	ZRK	6097	49.20	Klipheuvell, S. Africa.	Daily 3-7 a.m.; Mon., 3-6.20 a.m.
HRD	6235	48.12	La Ceiba, Honduras.	Daily 11 a.m.-1 p.m.; Sun., 11 a.m.-4 p.m.; Mon., 7-9 a.m.	ZRJ	6097	49.20	Johannesburg, S. Africa.	Daily exc. Sun., 2.45 p.m.-3.40 p.m. and 6.15-10.30 p.m.; daily exc. Mon., 12.01-2.30 a.m.
YV1RG	6225	48.15	Valera, Venezuela.	Daily 9 a.m.-12.30 p.m.	JZH	6095	49.22	Tokyo, Japan.	Irregular.
6220	48.20		Saigon, Fr. Indo-China.	Daily 7.30 or 8.30 p.m.-12.30 a.m.	CRCX	6090	49.26	Toronto, Canada.	Daily 10.45 p.m.-8 a.m.; Mon., 1.30-3 a.m.
TG-2	6210	48.28	Guatemala City, Guat.	Relays TG-1; Tues.-Sat., 9 a.m.-2 p.m.; Sun., 6-11 a.m.	ZBW-2	6090	49.26	Hongkong, China.	Irregular.
YV5RI	6205	48.32	Coro, Venezuela.	Irregular.	HJ5ABD	6085	49.30	Cali, Colombia.	Daily 3-4.30 a.m. 8.10 a.m.-12.40 p.m.
HI8Q	6200	48.36	Ciudad Trujillo, D.R.	Irregular.	VQ7LO	6083	49.31	Nairobi, Kenya Colony.	Mon., Fri., 8.30-10 p.m.; Tues., Thurs., 2.15-5.15 a.m., 11.15 p.m.-12.15 a.m.; Sun., 2.15-6.15 a.m.; Mon., 1.45-4.45 a.m.
HI1A	6185	48.50	Santiago, D.R.	Daily 10 p.m.-8 a.m.	YV1RD	6081	49.32	Maracaibo, Venezuela.	Daily 9 a.m.-2 p.m.
XEXA	6171	48.61	Mexico City, Mexico.	Daily exc. Fri., Sat., 9.30 p.m.-10 p.m.	ZHJ	6080	49.34	Penang, Fed. Malay States.	Daily exc. Sun., 9.40-11.40 p.m.; Sun., 2-4 p.m.
VPB	6160	48.70	Colombo, Ceylon.	Daily exc. Fri., Sat., 9.30 p.m.-3.30 a.m.; Sun., 10 p.m.-2.30 a.m.	W9XAA	6080	49.34	Chicago, U.S.A.	Relays WCFL, irregular.
YV5RD	6156	48.71	Caracas, Venezuela.	Daily 2-5 a.m., 7 a.m.-1.40 p.m.	DJM	6079	49.37	Berlin, Germany.	Irregular.
HI5N	6153	48.75	Moca City, D.R.	Daily 9.40 a.m.-12.10 p.m.	OAX4Z	6077	49.35	Lima, Peru.	Daily 10 a.m.-1 p.m.
ZRD	6150	48.78	Durban, S. Africa.	Daily exc. Sun., 2.45-3.45 p.m., and 6.30-10.30 p.m.; daily exc. Mon., 12.01-6.45 a.m.; Sundays, 11 p.m.-2.30 a.m.; Mon., 3-6.20 a.m.	VP3MR	6075	49.35	Georgetown, Bri. Guiana.	Daily 7.45-11.45 a.m.; Sun., 10.45 p.m.-1.15 a.m.
CJRO	6150	48.78	Winnipeg, Canada.	Daily 9 a.m.-3 p.m.; Mon., 8 a.m.-1 p.m.	HJ3ABF	6073	49.40	Bogota, Colombia.	Daily 10 a.m.-2.15 p.m.
ZEB	6147	48.80	Bulawayo, S. Africa.	Tues., Thurs., Sat., 4.15-6.15 a.m.; Wed., 2-3 a.m.; Fri., 1-3 a.m.	CFRX	6070	49.42	Toronto, Canada.	Relays CFSB 10.30 p.m.-3 p.m.; Mon., 1 a.m.-3 p.m.
HJ4ABE	6145	48.80	Medellin, Colombia.	Daily 2-3 a.m., 9 a.m.-1.30 p.m.	VE9CS	6070	49.42	Vancouver, Canada.	Daily 9-10.30 a.m.; Mon., 4.45 a.m.-noon, 1.30-4 p.m.; Wed., 9-10.30 a.m., 2.30-4.30 p.m.
W8XK	6140	48.86	Pittsburgh, U.S.A.	Relays KDKA daily, 2-4 p.m.		6069	49.42	Tananarive, Madagascar.	Daily 1-2 a.m., 3.30-3.45 a.m., 6.30-7.30 a.m.; Sun., 5.30-7.30 p.m.
CR7AA	6137	48.87	Laurenco Marques, Port E. Africa.	Daily 12.30-2 a.m., 3.05-7 a.m., 7.30-9.30 a.m.; Sundays, 8-10 p.m.; Mon., 1-4 a.m.					

Call.	Kc.	M.	Location.	Schedule, etc.	Call.	Kc.	M.	Location.	Schedule, etc.
SBO	6065	49.46	Motala, Sweden.—Relays Stockholm, 4.30-8 a.m.		YV4RP	5913	50.71	Valencia, Venezuela.—Irregular.	
W8XAL	6060	49.50	Cincinnati, U.S.A.—Relays WLW 2-5 p.m., 8.45 p.m.-11 a.m.		ZNB	5900	50.84	Mafeking, S. Africa.—Daily 4-5.30 a.m., 9-10 p.m.	
W3XAU	6060	49.50	Philadelphia, U.S.A.—Relays WCAU 11 a.m.-2 p.m.		TILS	5900	50.84	San Jose, Costa Rica.—Daily 9 a.m.-1 p.m.	
HJ6ABA	6054	49.52	Pereira, Colombia.—Daily 9.30 a.m.-1 p.m., 12.30-3 a.m.		YV3RA	5898	50.86	Barquisimeto, Venezuela.—Daily 3-4 a.m., 9 a.m.-1 p.m.	
HP5F	6050	49.59	Colon, Panama.—Irregular.		HH2S	5892	50.89	Port-au-Prince, Haiti.—Daily 10 a.m.-12.15 p.m.	
XETW	6045	49.62	Tampico, Mexico.—Irregular at 10 a.m.		JIC	5890	50.90	Taihoku, Formosa.—Works Tokyo 9 p.m.	
HJ1ABG	6042	49.65	Barranquilla, Colombia.—Daily 2 a.m.-2 p.m.; Mon., 2-11 a.m.		HI9B	5885	50.95	Santiago, D.R.—Irregular 9 a.m.-2 p.m.	
W4XB	6040	49.65	Miami Beach, U.S.A.—Temporarily off air.		HRN	5875	51.06	Tegucigalpa, Honduras.—Daily 4.15-6.16 a.m., 11.30 a.m.-1 p.m.; Mon., 6.30-8.30 a.m., 11.30 a.m.-12.30 p.m.	
W1XAL	6040	49.65	Boston, Mass., U.S.A.—Daily exc. Sun., 10 a.m.-noon.		HI1J	5855	51.25	San Pedro de Macoris, D.R.—Daily 3-5 a.m., 9.30 a.m.-noon.	
YDA	6040	49.65	Tandjongpriok, Java.—Daily 1.30-5 p.m.; Sun., 10.30 a.m.-5 p.m.		WOB	5853	51.26	Lawrenceville, U.S.A.—Phones Bermuda.	
HP5B	6033	49.75	Panama City, Panama.—Daily 3-4 a.m., 10 a.m.-1.30 p.m.		YV1RB	5850	51.29	Maracaibo, Venezuela.—Daily 2.15-3.15 a.m., 7.45 a.m.-12.45 p.m., 11.45 p.m.-12.45 a.m.; Mon., 2.45 a.m.-3.45 a.m.	
VE9CA	6030	49.75	Calgary, Canada.—Fri., 12.01 a.m.-4 p.m.; Mon., 3 a.m.-3 p.m.		TDD	5830	51.46	Shinkyo, Manchukuo.—Phones Tokyo, 9 p.m.	
OLR2B	6030	49.75	Prague, C-Slovakia.—Tues., Wed., Fri., Sat., 7.40-8 a.m.		TIGPH	5825	51.50	San Jose, Costa Rica.—Daily 2-4 a.m., 9 a.m.-1 p.m.	
XEUW	6023	49.82	Vera Cruz, Mexico.—Daily 11 a.m.-3.30 p.m.		TIGPH-2	5813	51.59	San Jose, Costa Rica.—Irregular.	
DJC	6020	49.83	Berlin, Germany.—Daily 1.40-7.30 a.m.		YV5RC	5800	51.72	Caracas, Venezuela.—Daily 1.30-5 a.m., 6.45 a.m.-noon, 11 p.m.	
ZHI	6018	49.84	Singapore, Malaya.—Mon., Wed., Thurs., 8.40-11 p.m. Sun., 1.40-4.10 p.m.		JVU	5790	51.81	Nazaki, Japan.—Irregular.	
HI3U	6017	49.85	Santiago de los Caballeros, D.R.—Daily 3-5, 8-10 a.m., 11 a.m.-12.30 p.m., 10.30 p.m.-mid.; Mon., 3.30-5, 8-9 a.m.		YNOP	5758	52.11	Managua, Nicaragua.—Daily 11 a.m.-12.30 p.m.	
PRA-8	6015	49.85	Pernambuco, Brazil.—Daily 9 a.m.-noon.		YV2RA	5740	52.23	San Cristobal, Venezuela.—Daily 2.30-3 a.m., 8.30 a.m.-noon; Mon., till 1 p.m.	
OLR2A	6010	49.92	Prague, C-Slovakia.—Tues., Wed., Fri., Sat., 7.40-8 a.m.		TGS	5740	52.23	Guatemala City, Guatemala.—Irregular.	
COCO	6010	49.92	Havana, Cuba.—Daily 10.55-3 p.m.		HC1PM	5735	52.28	Quito, Ecuador.—Irregular 1 p.m.	
9MI	6010	49.92	ss Kanimbla.—Irregular at night.		OK1MPT	5145	58.31	Prague, C-Slovakia.—Thurs., Sun., 8.15-8.30 a.m.	
CJXC	6010	49.92	Sydney, Canada.—Relays CJC, 7-11 a.m., 10 p.m.-4 a.m.		PMY	5145	58.31	Bandoeng, Java.—Daily 8.30 p.m.-2 a.m.	
ZRH	6007	49.94	Roberts Heights, S. Africa.—Daily exc. Mon., 1-5 a.m.; Sun., 11 p.m.-3 a.m.; Mon., 3.15-6.15 a.m.		WCN	5077	59.03	Lawrenceville, U.S.A.—Phones England; irregular.	
HP5K	6005	49.96	Colon, Panama.—Daily 2.30-4 a.m., 9 a.m.-2 p.m., 10 p.m.-midnight.		ZFA	5025	59.65	Hamilton, Bermuda.—Phones N.Y.C.	
CFCX	6005	49.96	Montreal, Canada.—Relays CFCF, 10.45 p.m.-4 p.m.; Mon., 12.01 a.m.-2.15 p.m.		TFL	5000	60.00	Reykjavik, Iceland.—Phones Europe.	
VE9DN	6005	49.96	Drummondville, Canada.—Sun., 2.30-4 p.m.		GHC	4975	60.30	Rugby, England.—Phones ships.	
RV59	6004	49.97	Moscow, U.S.S.R.—Irregular, 6-8 a.m.		HJ3ABH	4900	61.19	Bogota, Colombia.—Daily 3-5 a.m., 9 a.m.-2 p.m.; Mon., 7 a.m.-2 p.m.	
CXA-2	6002	49.98	Montevideo, Uruguay.—Relays LS-2, Buenos Aires, daily 2.30 a.m.-2.30 p.m.		HJ4ABP	4880	61.44	Medellin, Colombia.—Daily 11 a.m.-2 p.m.	
ZEA	6000	50.00	Salisbury, S. Africa.—Same as ZEB, 6.147 kc.; also Sun., 6.30-8 p.m.		HJ3ABD	4842	61.95	Bogota, Colombia.—Daily 3-5 a.m., 10 a.m.-2 p.m.; Mon., 8 a.m.-noon.	
XEBT	6000	50.00	Mexico City, Mexico.—Daily 11 p.m.-4 p.m.		GDW	4820	62.24	Rugby, England.—Phones New York.	
CS2WD	5977	50.15	Lisbon, Portugal.—Daily 6.30-9 a.m.		YDE-2	4810	62.37	Solo, Java.—From 8.30 p.m.	
OAX4P	5975	50.16	Huancayo, Peru.—From 11 a.m.		HJ1ABB	4780	62.72	Barranquilla, Colombia.—Daily 2.30-4 a.m., 7.30-9 a.m.	
HVJ	5968	50.27	Vatican City, Italy.—Daily 5-5.15 a.m.; Sun., 8-8.30 p.m.		HJ1ABJ	4772	62.85	Santa Marta, Colombia.—Daily 2.30-5 a.m., 8.30 a.m.-2.30 p.m. exc. Thurs.	
TG2X	5940	50.47	Guatemala City, Guatemala.—Daily 7-9 a.m., noon-2 p.m.; Sun., 5-8 p.m.		WOO	4752	63.10	Ocean Gate, U.S.A.—Phones ships.	
PCJ-1	5940	50.47	Curacao, Dutch W. Indies.—Daily 9.36-11.36 a.m.		HJ6ABC	4740	63.25	Ibague, Colombia.—Daily 10 a.m.-3 p.m.	
YVIRL	5935	50.52	Maracaibo, Venezuela.—Daily 2.43-4.43 a.m., 8.13 a.m.-1.13 p.m.; Mon., 12.13-6.13 a.m.		WOO	4272	70.22	Ocean Gate, U.S.A.—Phones ships.	
					RV15	4250	70.42	Khabarovsk, U.S.S.R.—Daily 4 p.m.-1 a.m.	
					HCJB	4107	72.99	Quito, Ecuador.—Daily 2.45-5.30 a.m. (exc. Tues.); Mon., 3-4.30 a.m., 8.30 a.m.-1 p.m.	
					YDA-7	3270	91.74	Petalongan, Java.—From 8.30 p.m.	
					YDA	3040	98.63	Tandjongpriok, Java.—From 8.30 p.m.	

# A.O.C.P. Questions & Answers

A.O.C.P. Examination Paper  
July, 1937.

1. Why is it desirable to operate a crystal oscillator with light load and moderate plate voltage? Give at least two reasons.

A.: In order to obtain maximum stability from a crystal oscillator, the amplitude of oscillation of the crystal must not be excessive. Operation with a high plate voltage causes the crystal to vibrate vigorously and generate heat, thereby bringing about a drift in frequency depending on the temperature coefficient of the crystal. Furthermore, violent oscillation may fracture the crystal.

Operation with the plate circuit tuned to the point where the oscillator delivers maximum power to the load is also undesirable, since the crystal is then oscillating at its hardest; in addition, slight variations in the circuit constants or loading at this point have an appreciable effect on the crystal, and may stop the oscillations altogether.

2. Draw a full schematic diagram of a three-stage crystal controlled C.W. transmitter incorporating oscillator, frequency doubler and amplifier and explain briefly the function of each stage. Power supply and values of components need not be shown.

A.: See Fig. 1. The first stage, on the left, is a crystal-controlled pentode, operating in the 80-metre band. Its function is a very important one: that of maintaining the frequency of the transmission constant. Since self-oscillation is rendered impossible in subsequent stages, the wave finally transmitted will be an amplified second harmonic, having the characteristics of the output of this stage.

Capacitively-coupled to the crystal oscillator is the second or frequency-doubling stage. The essential points about the frequency-doubler are that the plate circuit is tuned to double the exciting frequency, and the grid bias adjusted so that plate current flows only for the duration of one half of one positive half-wave of exciting voltage. Under these conditions, pulses of the correct period will be delivered to the plate circuit once in every four half-cycles of doubled frequency. The tuned circuit maintains the oscillations for the other three half-cycles. The optimum bias for this condition is equal to cut-off bias plus the r.m.s. value of the r.f. exciting voltage.

The doubled frequency then excites the grid of the third stage, on the right of the diagram, which is a capacitively-coupled neutralised Class-C amplifier working in the 40-metre

Published below is the third of a series of six articles comprising questions, with model answers, set in recent A.O.C.P. examinations. Specially written for the "Radio World" by . . . . .

H. WHEELER (VK5HW)

band. Its function is simply that of a power amplifier, delivering the amplified oscillations to the aerial. Keying for c.w. is performed in the filament centre-tap.

3. Explain how to eliminate the following forms of interference to broadcast reception—"key clicks," "blanketing," and "mains feedback." Illustrate your answers with diagrams.

A.: Key-clicks may be eliminated by preventing the power from starting and stopping too rapidly when the key contacts close and open respectively. An inductance of a few henries inserted in series with the key (see Fig. 2) will not allow the current to start and stop immediately, but make the change gradual.

A condenser across the key will absorb the spark which would otherwise occur at the opening of the contacts. In series with this condenser is a resistor, which serves the dual purpose of slowing the charging current of the condenser when the contacts open, and preventing a spark at the closing of the contacts which would occur were the charged condenser short-circuited by the key.

Blanketing of reception, caused by strong interfering signals from a nearby source, may be prevented by shifting the receiving aerial to a more favourable position where pick-up is less, or, where this is impracticable, by inserting a rejector circuit tuned to the interfering frequency in the lead-in of the receiving aerial. See Fig. 3.

Mains feedback, due to r.f. energy surging back into the power line, may be prevented by installing an r.f. filter between the mains and the primary of the power supply. See Fig. 4.

4. Quote three major considerations in the design of a Hertz antenna of high efficiency.

A.: See the "Radio World," February, 1938, p. 36 (10).

5. Calculate the voltage of the battery in the following circuit if the current is 12.5 milliamps:—

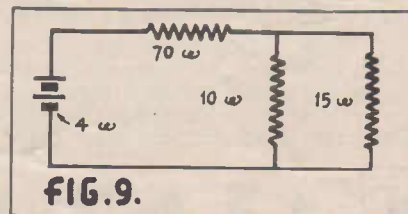

FIG. 9.

5. The joint resistance of 10 and 15 ohms in parallel is—

$$\frac{1}{\frac{1}{10} + \frac{1}{15}} = 6 \text{ ohms}$$

The total resistance of the circuit, including the internal resistance of the battery, is  $4 + 70 + 6 = 80$  ohms. The e.m.f. required to send a current of 12.5 milliamps (0.0125 amp.) through a resistance of 80 ohms is, by Ohm's Law,  $80 \times .0125 = 1$  volt.

See Fig. 9.

6. State two reasons for the greater selectivity of a superhetero-

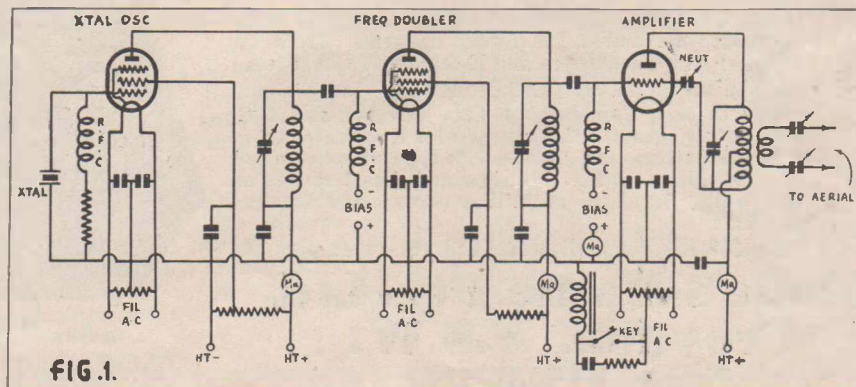

FIG. 1.

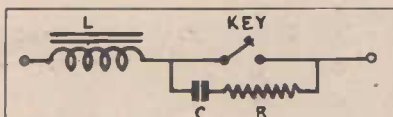

FIG. 2.

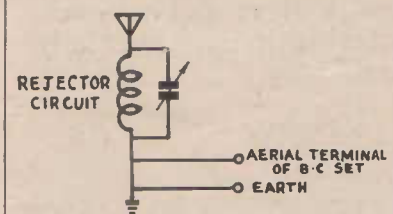

FIG. 3.

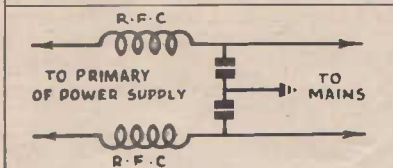

FIG. 4.

to resonance is attended with much difficulty in practice, especially at high frequencies.

Generally the system is more or less inaccurate when too many condensers require tuning, and the usual t.r.f. high frequency receiver is limited to one r.f. stage.

The r.f. amplifier responds relatively broadly to signals, and although the detector circuit following sharpens the tuning, signals some distance off resonance can still affect the detector. In the superhet receiver signals undergo frequency conversion, and with a selective i.f. amplifier, only a narrow band of signal frequencies can beat with the oscillator to converted frequencies which can be handled by the i.f. amplifier. The second detector working at i.f. is affected only by those signals which can pass through the i.f. amplifier. Thus frequency conversion is a contributing factor to the superior selectivity of the superhet.

The t.r.f. in the usual case has an autodyne detector, which must oscillate weakly for the heterodyne reception of weak signals. Under these conditions, a strong signal further amplified by the r.f. stage, a little way off resonance, can force the detector to oscillate at the strong signal's frequency.

This "pulling" of the autodyne detector gives rise to the phenomenon of

"widening of zero beat." The strong signal may then spread over the tuning dial to such an extent as possibly to obliterate several weak signals, resulting in a serious loss of selectivity.

In the superhet, however, this cause of poor selectivity is absent, since in a properly designed converter stage the oscillator frequency is not "pulled" to any appreciable extent by a strong signal in the first detector.

7. Why are two tubes necessary in a Class B audio output circuit, whereas only one tube is necessary in a Class B linear radio frequency amplifier?

A.: A single tube operating as a class "B" amplifier has its grid biased to cut-off, and its excitation arranged so that the tube is worked only on the linear portion of its characteristic curve.

In these circumstances only the positive half-cycles of excitation function on the grid, each one causing a complete half-cycle of plate current to flow, the negative half-cycles being without effect.

As an r.f. amplifier one such tube is satisfactory, since the "flywheel effect" of the tank circuit at radio frequencies maintains the oscillations during the negative half-cycle. As an a.f. amplifier one class "B" tube

(Continued on page 30.)

dyne receiver when compared with a t.r.f. (tuned radio frequency) receiver.

6. Considerable selectivity can be attained in the t.r.f. receiver by the use of a number of tuned stages, but the problem of simultaneously keeping a number of circuits accurately tuned

# CALSTAN (CALibrated to STANDard) PRECISION TEST EQUIPMENT

.. "The RADIO TRADE'S choice by TEST" in a comprehensive range of SERVICE INSTRUMENTS, including the following - - -

- |                   |                     |                        |
|-------------------|---------------------|------------------------|
| ● TUBE CHECKERS   | ● SIGNAL GENERATORS | ● THERMO-COUPLE METERS |
| ● VOLT OHM METERS | ● OUTPUT METERS     | ● OSCILLOGRAPHS        |
| ● SET ANALYSERS   | ● MULTIMETERS       | ● GALVOMETERS          |

## VALVE-TESTER-MULTITESTER

● Model 223 will test every valve used in Australia, the Multitester range is A.C. & D.C. volts, 5, 10, 50, 250 and 1250. Milliamperes, 5 ranges, 1, 5, 25, 100, 250.

Ohms, 5 ranges from 1 ohm to 5 megohms also is an excellent instrument for lining up sets. Tests all types of Dry Condensers and Electrolytic Condensers

● The D.C. VALVE TESTER MODEL D223 is also available as a Combination Tube Checker and D.C. Multimeter. As a D.C. Valve Tester it operates from a 6-volt battery and tests every type of valve used in Australia. As a D.C. Multimeter it has 5 ranges of D.C. volts, 5 ranges of Milliamperes and 4 ranges of Ohms.

Price £18/6/-, Portable Model £18/16/-, both plus tax

**Slade's Radio Pty. Ltd.**  
**Croydon, N.S.W.**  
Phones UJ 5381-5382

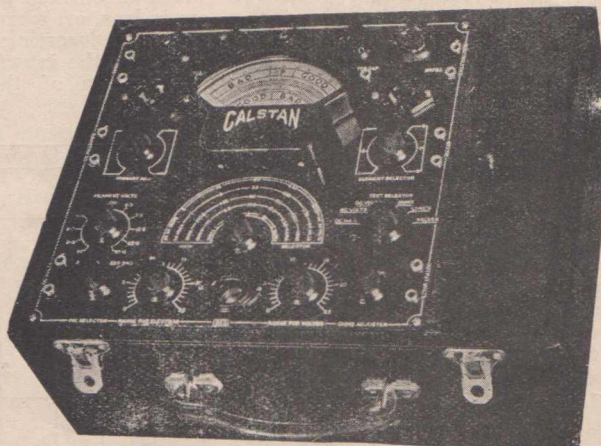

A.C. Model 223, £17/17/-, Plus Tax

CALSTAN EQUIPMENT AVAILABLE ON TERMS  
WRITE FOR PARTICULARS.

# Pentode And Beam Tetrode Valves

OUR last lecture referred particularly to triode valves, that is, to valves having but a single grid. When additional grids are added, the number of applications in which the valve may be used is increased enormously.

## Adding A Second Grid.

A valve with two grids is generally referred to as a screen-grid valve, since the second or outer grid is used to screen the inner or control grid from the plate. Early valves of this type were used as r.f. amplifiers and detectors in t.r.f. receivers. Screen-grid valves suffer from a kink in the characteristic curve which limits their application to arrangements in which the plate voltage never swings below that of the screen grid.

## Adding Suppressor Makes Pentode.

Pentode valves are similar to screen-grid valves, except that the suppressor grid has been added between the screen grid and the plate. The purpose of the suppressor grid is to create a region of low potential between the screen and the plate so that electrons emitted by the plate are not attracted to the screen, even when the plate voltage swings below that of the screen.

## The Beam Tetrode.

There are other methods for reducing the effects of secondary emission from the plate, and one of the most popular of these utilises the beam principle, with deflector plates. Beam tetrode valves have an even better plate characteristic than a pentode, and this is referred to as a characteristic having a "sharp knee." This sharp knee permits a higher output to be obtained with less distortion, and the plate voltage may be reduced even lower than in the case of a pentode valve.

The different applications in which pentode and tetrode valves are used require different characteristics. An r.f. amplifier requires a valve having a high mutual conductance and a high plate resistance, combined with a reasonably small plate current.

## Super-Control R.F. Pentode.

In order to form a convenient control of volume, which really amounts to a control of the amplification in the valve, a special characteristic known as the super-control characteristic has been applied to r.f. pentodes. The plate current characteristic of an r.f. pentode is curved with approximately logarithmic form, so that the mutual conductance of the valve decreases as the grid voltage is made more negative, yet without any sudden change of curvature which would introduce serious distortion.

Published below is a precis of the second of a series of monthly lectures arranged for engineers, servicemen, and radio enthusiasts generally, by Amalgamated Wireless Valve Co. Pty. Ltd.

Truly logarithmic curves avoid cross-modulation, but do not prevent distortion when the signal exceeds a certain value. Due to the curved characteristic, the maximum voltage output for a limited distortion is less in the case of a super-control pentode than of one of the "sharp cut-off" variety. However, designs have been developed which have proved satisfactory compromises under normal conditions, both as r.f. and i.f. amplifiers.

## Applications For Sharp Cut-off Pentodes.

Sharp cut-off pentodes may be used as detectors or as audio amplifiers.

As detectors, they may be used either with leaky grid (cumulative) or anode bend (plate) detection. For several years self-bias with plate detection was used in the majority of commercial receivers, but has since been almost entirely superseded by diode detection.

Sharp cut-off pentodes as audio amplifiers provide the highest amplification per stage, with the least distortion, of any method of amplification known. They are particularly valuable when feedback is applied to the output valve, since in this case their high amplification, which is necessarily reduced by feedback, still remains sufficiently high for proper functioning.

## Power Pentodes A Special Class.

Power pentodes are a class almost apart from r.f. pentodes, since they are designed to operate with high plate currents in order to deliver the maximum power output.

Pentodes have the advantage over triode power valves that the current drain is less than that of a triode capable of producing the same power output. They also have the advantage that the grid input voltage is less than in the case of triode valves. They have the serious disadvantage that the harmonic distortion is high, particularly third harmonic, which is most distressing. They also produce spurious combination tones and audio cross modulation.

These defects may be removed by operating the pentode valve with negative (inverse) feedback. Many methods of feedback are known, but the most popular is that known as series inverse feedback, whereby resistance coupling may be used between the audio and power stages. Transformer coupling with inverse feedback may also be used.

Approximately 10 per cent. effective feedback will reduce the harmonic distortion to one-half, and 15 per cent. feedback will reduce it to one-third, so that the distortion, which is the principal objection to a pentode valve, may be reduced as much as desired.

The quality of pentode valves with feedback may be made to approach

## DX Club Requirements.

All-Wave All-World DX Club members are advised that the following DX requirements are obtainable from Club headquarters, 214 George Street, Sydney.

**REPORT FORMS.**—Save time and make sure of supplying all the information required by using these official forms, which identify you with an established DX organisation.

Price . . . 1/6 for 50, post free.

**NOTEPAPER.**—Headed Club notepaper for members' correspondence is also available.

Price, 1/6 for 50 sheets, post free.

**DX CLUB STICKERS.**—Enlarged two-colour replicas of the Club badge, in the form of gummed stickers, designed for attaching to envelopes, QSL cards, etc. Price, 5 dozen for 1/6, post free.

**DX CLUB LOG SHEETS.**—Designed by the Shortwave Editor, these headed and ruled log sheets are indispensable to dxers who wish to keep a simply-prepared and accurate list of loggings. Price, 3 dozen for 1/6, post free.

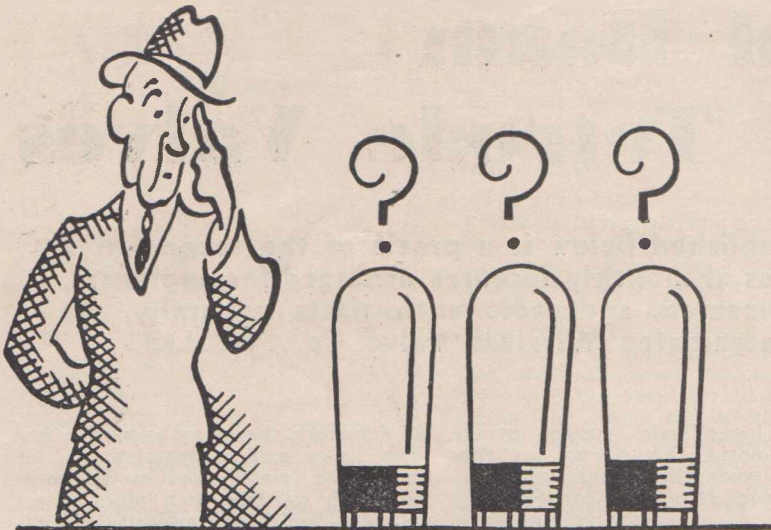

## HOW DO YOU KNOW .. you are getting GOOD VALVES?

**H**UNDREDS of valves, all looking alike . . . good valves, poor valves, well-known valves, unknown valves . . . all competing for your choice. Confusing. Bewildering. How can you choose? How can anyone who is not a radio expert pick the good valves? There is nothing to indicate quality, not even price, for the inferiority of the poor valve is often disguised with the same price as the good one.

How can you choose? Just by asking this simple question of your dealer — "Has it got 4 pillars instead of two?" If it has, then it's Raytheon and it's the valve you want. Other valves have only 2 supports for their fragile elements. A fundamental principle of balance demands four for perfect stability. That is why only Raytheon can withstand cruel treatment and incessant vibration without budging a hair's breadth from their vital accuracy. Remember, it's Raytheon for longer life, Raytheon for greater accuracy that means surer tone. And 4-pillar valves cost no more.

If unobtainable from your local dealer write to Standard Telephones & Cables (A/sia) Pty. Limited, 258-274 Botany Rd., Alexandria

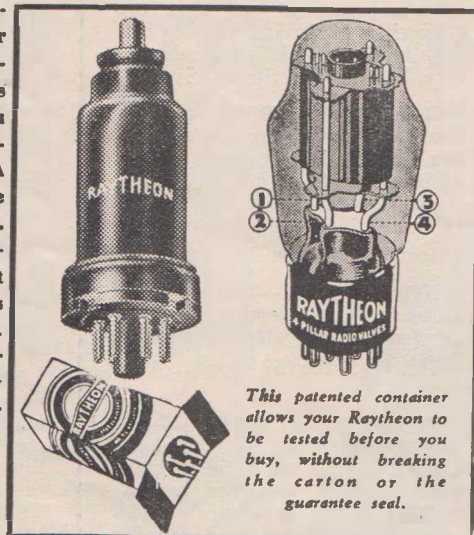

This patented container allows your Raytheon to be tested before you buy, without breaking the carton or the guarantee seal.

# RAYTHEON

THE MAKERS OF

## 4-PILLAR VALVES

### Pentodes And Beam Tetrode Valves.

(Continued from previous page.)

very closely to that of triode valves, provided that sufficient feedback is used, the percentage recommended being 15-20 per cent. Feedback decreases the sensitivity of the amplifier in proportion to the decrease of harmonic distortion. Too great a decrease in amplification is not convenient, and radio receivers are generally limited to 10 or 15 per cent. effective feedback for this reason.

Beam tetrode valves are particularly valuable when feedback is used, since in these types the third harmonic distortion is much less than in pentodes and less feedback is required for the reduction of third harmonic to a satisfactory level.

#### Feedback Increases Damping.

The damping of the loudspeaker by the power valve is also made much heavier by the use of feedback, and it is possible to increase the feedback sufficiently for the damping to be equivalent to that of a triode valve.

### A.O.C.P. Questions And Answers.

(Continued from page 28.)

would only deliver half of the audio signal, since the output circuit is not resonant and is enormously deficient in the capacity necessary to give the flywheel effect at these relatively low frequencies. Hence it is necessary to instal a second audio tube to supply the other half-cycle to the load. The two tubes are worked alternately in the push-pull circuit.

### VK2MZ—Hurstville Amateur Radio Club.

(Affiliated with the W.I.A., N.S.W. Division.)

The A.O.P.C. classes held by the Club are being taken very seriously by all members of the club.

Under the capable direction of Mr. W. Laing, who holds a Broadcast Engineer's Certificate, all lectures are very interesting. A test paper set by Mr. Laing proved that all aspirants are studying seriously; incidentally, 2VT showed them that the questions could be answered.

The usual monthly meeting will be held in the clubrooms, 316 Forest Road, Hurstville, on Thursday, July 7. Visitors and intending members will be welcome.

The secretary, whose address is 34 Park Road, Carlton, will be pleased to give any information regarding club activities.—P. J. Healy, Publicity Officer.

### QSL Exchange Bureau.

The following member would like to exchange QSL cards with other readers: E. Larsen (AW287DX), Booyal, Isis Line, Queensland.



# 200 Visitors Inspect Philips Valve Works

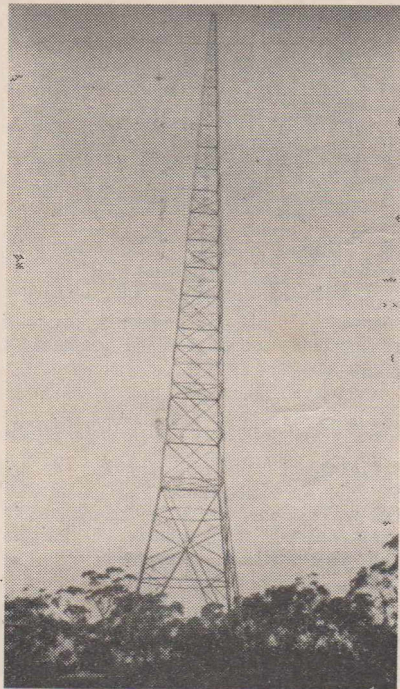

One of the aerial towers of station 2KA—"Voice Of The Mountains"—located at Wentworth Falls.

AKEMBA Radio Club members were recently afforded the opportunity of inspecting the radio valve works established at Camperdown, Sydney, by Philips Lamps (A/sia) Pty. Ltd. The inspection took place on the evening of June 21, approximately 200 visitors attending.

The average person knows very little about the actual manufacture of radio valves, and of the precision required in the course of their manufacture, and it is only by making such an inspection that one can realise the intricate work involved in modern valve production. It is not intended to describe any portion of the process in these columns, as this was fully covered in the January, February and March issues of "Radio World."

One outstanding feature, and a point requiring stressing, however, is the consideration given at the valve works to the welfare of the staff. Spacious floors, good lighting and ventilation, a cafeteria and even amplifiers throughout the building providing occasional music, all assisting to bring about better co-operation between employer and employees, resulting in increased and more efficient output. Great credit and support should be given to those manufacturers in Australia who consider their employees in this manner, and treat them as human beings rather

## 2KA "Voice Of The Mountains": Serviceman Injured By Exploding Electrolytic: Lakemba Radio Club Notes and News.

By W. J. P.

than as parts of a mechanical machine.

The inspection concluded with an excellent supper provided by the firm. All visitors were high in their praises of the very pleasant evening spent at Philips, many expressing surprise that this new Australian industry had made such remarkable progress in so short a time.

★

### 2KA—"The Voice Of The Mountains."

The photograph on this page shows one of the aerial towers of "B" class station 2KA, "The Voice of the Mountains," located at Wentworth Falls on the Blue Mountains. The station was recently visited by a few Lakemba members, who found VK2LZ in charge of operations.

2KA is situated at an excellent location on the heights of Wentworth Falls, and puts a very good signal into Sydney during daylight hours. A new transmitter is to be installed in the near future by A.W.A., and should result in the coverage of an even wider service area. The studio is at present located in Sydney and connects by landline with the transmitter.

A few months ago the station was cut off from its Sydney studio for many hours when a motor truck collided with a telegraph pole and brought down all the Western lines. A new studio is being erected in the main street of Katoomba, about six miles from Wentworth Falls, and will be put into operation when the new transmitter is installed.

★

### Watch Your Electrolytics.

Electrolytic condensers which have been in use for some time should be examined to ascertain if there is any blockage of the small holes at the top of the condenser can. Should there be any white powder around the top, it should be removed and the vent holes freed by piercing them with a pin. If the top of the can is showing

any signs of bulging the condenser should be replaced immediately, as it can become quite dangerous.

During the past 12 months several cases have been encountered where electrolytic condensers have blown off their caps. In one instance the top of a cabinet was splintered as though it had been hit with a heavy hammer from underneath the lid; in another case the cap went right through the cabinet top, cutting a hole so clean that it appeared as though a small shell had passed through. A more serious case occurred last month when one of our radio servicemen, while bending over a radio set waiting for it to heat up, was struck a terrific blow in the face by the condenser cap.

The customer was greatly startled by the explosion, but surprise turned to horror when the serviceman emerged with his face covered in blood. Apparently the gas formed inside the can builds up to a considerable pressure, and if it cannot escape, then something is sure to go.

★

### Invitation To Readers.

A cordial invitation is hereby extended to any reader of "Radio World" to attend a meeting of the above club, without the slightest obligation to join. The meetings for July are 5th and 19th, then each alternate Tuesday, held at the clubrooms, "Sunrise Hall," Canterbury Road, right near Canterbury Railway Station. Any particulars regarding the club may be obtained from Mr. V. Bennett, Secretary, 14 Park Ave., Concord.

### A Radio Trouble Light.

While torches are hardly economical enough for the many uses to which they can be put in connection with experimental radio work, a small trouble light similar to those used by motor mechanics can be made by fitting a small reflector made from the tinfoil

(Continued overleaf.)

# What's New In Radio

A monthly review of latest releases  
in sets, kit-sets, and components

## Triplett Technical Bulletins Free On Request.

An innovation that is certain of widespread popularity among present and prospective users of Triplett test equipment is a service just instituted by the Australian representatives, Messrs. W. G. Watson & Co. Pty. Ltd., of Sydney, with the release of their "Sales Talk No. 1." This is in the form of a four-page bulletin—the first of a series of technical articles dealing with Triplett electrical and radio measuring instruments and testers.

The first article deals with the Triplett Model 1200A volt-ohm-milliammeter, the ever-popular a.c./d.c. multi-meter with twin meters (for a.c. and d.c.). The design of the instrument is briefly reviewed, and its many applications then described in detail.

Owners and intending purchasers of Triplett instruments can obtain this and future issues of "Sales Talk" free and post free by writing Messrs. W. G. Watson & Co. Pty. Ltd., 279 Clarence Street, Sydney.

## A Radio Trouble Light.

(Continued from previous page.)

top of a tobacco tin to a torch bulb holder.

Cut a circular piece 2in. in diameter, then cut out about one quarter and solder the edges together to form a cone. Now cut a hole in the apex of the cone to fit the outside of the metal thread of the bakelite torch bulb-holder and solder into place. One end of a length of flex is passed through holes in the holder and connected to the screws on it and the other end is connected to an accumulator by means of clips or to the filament winding of a power transformer as the case may be. A switch may be inserted in one of the leads if desired. Screw in a dial lamp or a torch bulb of the correct voltage and this very handy gadget is completed.

As no electric power other than that from "A" batteries is available at VK2UJ, this little light supplies all the illumination for the shack. Being small in size, it is especially useful for getting the light right on the spot when soldering in awkward places.—H. W. Unger, Allectown, via Parkes, N.S.W.

## Local Manufacture Of Power Factor Correction Condensers.

E.T.C. Industries Ltd. announce an addition to the E.T.C. Solar Sealtdite Capacitor range with the production of power factor correction condensers.

These condensers will be greatly in demand for use on neon signs and motors, or used in multiples, in any case where bad power factor is prevalent on the line circuit.

These condensers are now available in types ranging from 2 to 20 mfd.

★

## New Raymart Lines.

Among Raymart components now available from the Australian representatives, Messrs. John Martin Pty. Ltd., 116 Clarence Street, Sydney, of special interest to amateurs are the ceramic coil form, transmitter dial, and beehive stand-off insulators illustrated below.

The ceramic type TFX grooved and ribbed coil form designed for low-loss transmitting inductances is 2½in. in diameter, with 5in. of winding space.

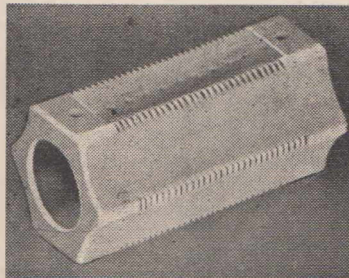

The 4in. transmitter dial is an individually spun heavy nickel dial,

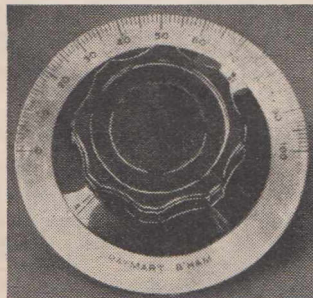

with engraved divisions and an attractive knob.

An exceptionally long leakage path is offered by the beehive stand-off insulators, two varieties being available, types SG (brown glazed), and SL. They are supplied in special r.f. ceramic, the brown model being glaz-

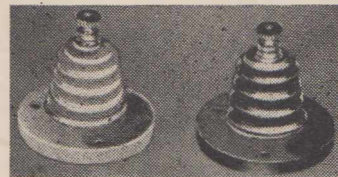

ed inside and out. Both are fitted with insulated terminals.

A catalogue giving full details of these and other Raymart lines is available on request from the address given above.

★

## E.T.C. Yaxley Potentiometers.

Manufacturers and servicemen will be interested to note that the well-known E.T.C. Yaxley potentiometer range has been partially re-designed and still further improved.

The use of a new nickel silver alloy in the construction of the contact arm permits superior contact between roller and element, lowering noise level and increasing the element life.

Latest laboratory findings resulting from continual research and experiment by E.T.C. Industries' engineers are incorporated in the element, while a special brass alloy is used in the making of the bushing. The terminals are made of lighter gauge brass, heavily silver plated.

## Ken-Rad 6J8G Now Available.

Information is to hand from E.T.C. Industries Ltd., that supplies of Ken-Rad valve type 6J8G, a triode heptode converter, are now available.

This new valve simplifies high frequency coil design and shows several advantageous characteristics, being equipped with pin connections, making it interchangeable with the 6A8G. A conversion conductance of 290 micromhos is obtained with a total cathode current of 9.0 milliamperes.

When employed in circuits having coils and intermediates of careful design, a high plate resistance of 4.0 megohms will result in better selectivity figures and increased gain.

An Engineering Bulletin on the 6J8G has been prepared, copies of which are available on application to E.T.C. Industries Ltd.

★

## Philips Technical Communication No. 67.

Highlights of Philips Technical Communication No. 67 include an article on the Philips high-mu power pentode type EL3G. Characteristics are given and applications discussed,

a circuit being included of a seven-watt amplifier using a pair of EL3's in push-pull.

"Oscillograph For Cathode Ray Tube DG7-1" is the title of a further article, which outlines the construction of an oscillograph using standard receiver type components. Also included with Communication 67 is an index to Volume III.

★

### Calstan Model 223 Valve Tester And Multi-Meter.

Released some months ago by Slade's Radio Pty. Ltd., of Lang St., Croydon, N.S.W., the Calstan Model 223 valve tester and multi-meter has already attained widespread popularity among servicemen throughout the Commonwealth. Solidly-built, and housed in a carrying case measuring only 14 x 11 x 6½ inches, the instrument is not only extremely portable, but also widely flexible in its applications.

Five basic sets of calibrations provided on the sector-scale type meter used are as follows:—Valve testing—"bad, ?, good" and percentage; d.c. and high a.c. volts and d.c. milliamperes; a.c. volts below 25; resistance 0-50,000 ohms; and electrolytic condenser leakage—?, bad, good. A five-position range selector and six-position function selector are provided, while in addition, controls are incorporated for the built-in power supply unit which uses a type 1V. rectifier and may be operated from any 200 to 260-volt a.c. supply. A neon leakage indicator and valve element selector are also fitted.

Following is a review of the various tests covered by the instrument:—

**Valves.**—Emission test and element short check on any type of valve in general use in Australia. Two line voltage controls, with a total of 22 adjustments, enable the instrument to be accurately adjusted to suit the prevailing line voltage and a special "line check" position is provided on the meter. An 11-step filament voltage selector with a range of 1.5-30 volts enables all valves to be operated at their correct heater rating, while a wide range of emission test voltages is provided to suit valves of varying plate current rating. Element shorts or leakage are checked by means of a 6-point element selector and a Neon indicator.

**D.C. Voltage.**—Five ranges are provided; 0-5/10/50/250/1250 volts, at 1000 ohms per volt.

**D.C. Milliamperes.** Five ranges are provided; 0-1/5/25/100/250 mA.

**A.C. Voltage.** Five ranges are provided and each of these may be employed for output indications; a special pair of terminals and an isolating condenser being provided for

the latter purpose. The ranges and "sensitivity" are the same as for D.C. voltage, but a special calibration is provided for readings on the 5 and 10 volts ranges.

**Resistance.**—Five ranges are provided. These are multiplications and divisions of the primary meter scale (0-50,000 ohms) and provide the following measurements:—0.2-500/5000/50,000/500,000/5 megohms. The first four ranges are obtained by means of internal batteries (1-15 v. and 2-4.5 v.), and the last is obtained with the aid of the inbuilt power supply unit.

**Electrolytic Condenser Leakage.** This enables leakage tests (with meter indication) to be made on electrolytic condensers with applied voltages of 10, 25, 100, 150 or 250 volts. A "range" adjustment is provided to compensate for variations in capacity between 2 and 50 mfd.

**Paper Condenser Leakage.**—This enables paper condensers to be tested for leakage at 250 volts D.C., with the aid of a Neon indicator. The capacity range for useful indications is from 0.005 mfd. to 4 mfd.

A special model of the 223, known as the D223, has been made available for servicemen in country districts, and operates from a six-volt accumulator.

Full details regarding both of the above instruments can be obtained free on request by application to Slade's Radio Pty. Ltd., Lang Street, Croydon, N.S.W.

★

### Two New Astatic Microphones.

Described by the makers as a watch-case type dual-diaphragm crystal microphone, the new Astatic Model D-2 is destined to become a firm favourite among amateurs and public address specialists.

Embodying all the features of larger microphones, it is at the same time small, sturdy, and compact. Ruggedly built to withstand hard wear, it weighs only nine ounces, and is non-directional. It incorporates two opposed diaphragms acting on a single bimorph crystal, resulting in very compact assembly and exceptionally fine frequency response, substantially flat from 50 to 6000 cycles. Excellent sensitivity is claimed, the output level being stated as -60 db. Three models are available.

The Astatic Acorn Model T-3 crystal microphone has been designed for public address, broadcast, recording,

and amateur use. The new crystal assembly claimed to offer greatly improved frequency response over previous single diaphragm types, is suspended within the microphone case to prevent vibration and shock; eliminating the need for any external shock-absorbing device.



sorbing device.

Main characteristics include the following:—

1. Tilting mount permits uni-directional or non-directional pick-up.
2. Acoustic feedback definitely reduced.
3. Output level -52 db. across 5 meg. load resistor.
4. Frequency response 30 to 10,000 c.p.s. (Flat plus or minus 5 db.)
5. Equipped with standard plug and socket, tapped ⅝-27 thread for stand mounting.
6. Astatic spring cable protector.
7. Dimensions, 2 9/32 in. in diameter, 3 in. long.
8. Weight, complete with cord and receptacle, 18oz.
9. Polished chrome finish.

★

### Two-Inch C.R. Tube Available.

According to advice from Amalgamated Wireless Valve Co. Pty. Ltd., stocks of the new Radiotron type 902 2in. cathode ray tube are now available, the Australian price being £2/15/- nett.

★

### New Radiotron Releases.

A complete series of 6.3v. .15a heater valves is now available in the Radiotron range. These are particularly intended for use in receivers operating from a 6 or 12-volt supply where a reasonably heavy current is practicable, but where economy is desired over the heavier drain types commonly used in a.c. receivers.

It is now possible to construct a five-valve receiver using indirectly-heated valves and drawing only 0.75 ampere at 6.3 volts, which would be suitable in locations where charging facilities are available. It is not expected that these valves will be very widely used where it is necessary to transport the accumulators for recharging, since the two-volt battery series provides equivalent performance for less than one third of the "A" current drain.

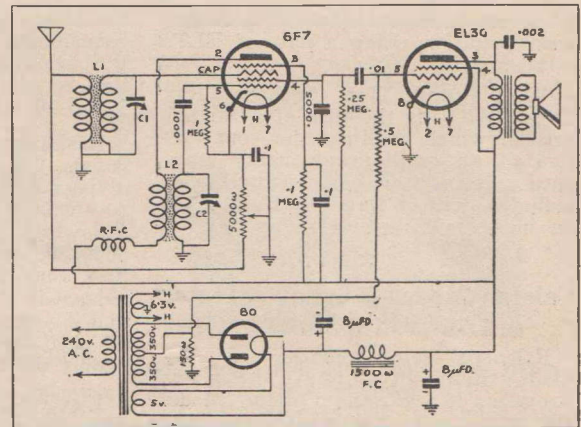
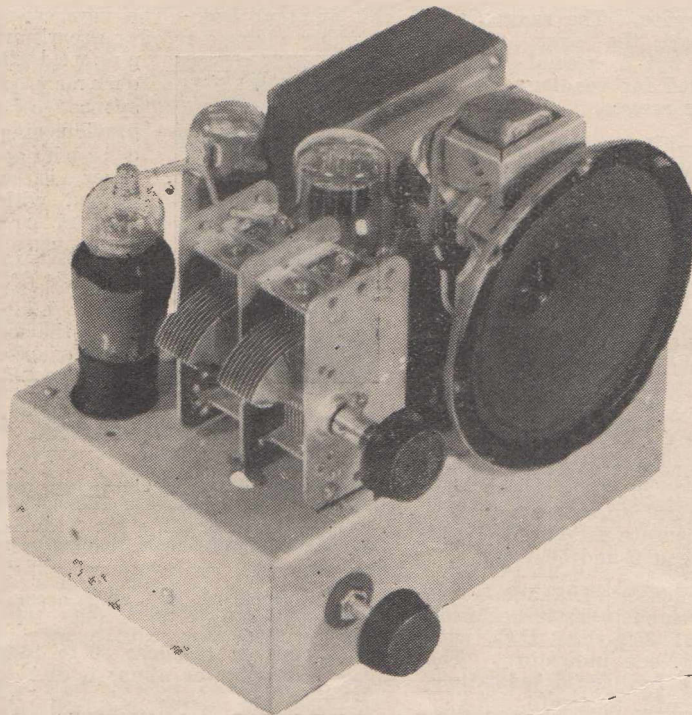

The circuit and a general view of the "Ashbox Midget," marketed by Reco Radio.

The range comprises the following types:—

6D8G Converter: Heater 6.3v. .15a.  
6G6G Power Pentode: Heater 6.3v. .15a.

6L5G General Purpose Triode: Heater 6.3v. .15a.

6N5 Magic Eye Tuning Indicator: Heater 6.3v. .15a.

6S7G Super Control R.F. Pentode: Heater 6.3v. .15a.

6T7G Duo-Diode High Mu Triode: Heater 6.3v. .15a.

In addition to these types there are also two twin triodes, each fitted with two units having similar heaters, but the total current being twice as great since the two are connected in parallel.

6C8G Twin Triode Amplifier: 6.3v. .3a.

6Z7G Twin Class B Amplifier: 6.3v. .3a.

Small quantities of all these types are held in stock, and those interested are requested to refer to the Unified Sales-Engineering Service.

#### Radiotron Television Pentode And Photo-Tubes.

Radiotron 1851, television amplifier pentode with a mutual conductance of 9000 micromhos, is now available from stock at a price of £1/2/6 nett.

The new cartridge-type Radiotron photo-tubes 922 and 923 are now available, complete with mounting socket at an inclusive price of £1 nett.

#### "Ashbox Midget" Is Low-Priced Three-Valver.

While the console type of receiver is favoured by most radio users, occasions often arise as, for example, during the present Test broadcasts, when a small mantel model that can be carried about from room to room is almost indispensable. Such a receiver is the "Ashbox Midget," marketed by Reco Radio, of 9 Royal Arcade, Sydney. Housed in a compact mantel cabinet of particularly attractive design, the "Ashbox Midget" sells at £5/15/- for a complete kit of parts, including valves, speaker and cabinet, or £6/5/- assembled in cabinet, license-plate extra.

#### 6F7 Triode-Pentode And EL3G Output.

The circuit shown above reveals that a 6F7 triode pentode is used as combined pentode r.f. amplifier and triode leaky grid detector. As the pentode section is of the multi-mu type, volume is effectively controlled by simultaneously varying the bias on the pentode section and the signal input applied across the primary of the aerial coil, by means of a 5000 ohm potentiometer.

For a t.r.f. receiver the "Ashbox Midget" has remarkable selectivity, due, no doubt, to the use of Sirufer iron-cored coils. With an aerial 300 feet long suspended directly under the transmitting aerial of station 2UW, 2GB can be tuned in at excellent speaker volume.

The triode section of the 6F7 is resistance capacity coupled to the EL3G

output pentode, which has a particularly high sensitivity. Back biasing is applied to the EL3G, so that it is necessary to insulate the first 8mfd. electrolytic filter condenser from the chassis. A 1500 ohm speaker field, together with a further 8 mfd. condenser on the output side of the filter, completes an effective smoothing arrangement.

The view above shows the compact above-chassis arrangement of components, the valves being (left to right) 6F7, EL3G and 80. There are only two controls, tuning and volume, fixed control of tone being effectively provided by the .002 mfd. condenser from output pentode plate to earth.

For a receiver of its size, the "Ashbox Midget" has remarkable sensitivity. Used anywhere around Sydney, no trouble is experienced in playing all the local stations without interference, using only a small indoor aerial. Tested in an average suburban location, several inter-state stations were received at good volume with an outside aerial.

Further details regarding the assembly of the receiver, etc., may be obtained free on request from Reco Radio, of 9 Royal Arcade, Sydney.

#### New Edition of "Foundations Of Wireless"

To hand by the latest English mail is an advance copy of "Foundations of Wireless" (second edition) by A. L. M. Sowerby, M.Sc.

This edition has been thoroughly revised and made up-to-date by the addition of new material on negative feedback, automatic tuning and automatic selectivity control.

The object of this elementary text book on radio is to give the reader a complete understanding of the way a receiving set operates. Starting from

the simplest elementary conceptions, it deals first with the separate components of a radio set, later combining them to form simple circuits. Valves are dealt with in detail, and all usual methods of performance-analysis are discussed. The process of detection, dealt with very sketchily in most text books, is here treated in adequate detail and shown to be the point about which the whole design of a receiver revolves.

The general reader will appreciate the clarity and simplicity of the explanations, while the careful student, ambitious to become a professional radio engineer, will find it a most satisfactory elementary text-book.

"Foundations of Wireless" by A. L. M. Sowerby, M.Sc., 272 pages, 2nd edition, published by Iliffe & Sons Ltd., Dorset House, Stamford St., London, S.E.1, will be available shortly from Messrs. Angus & Robertson Ltd., 89 Castlereagh Street, Sydney, price 7/6; postage 5d.

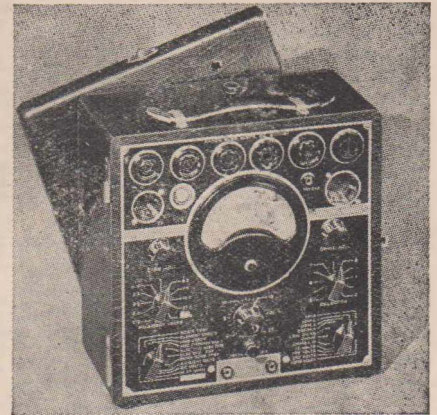

The Palec "VCT" valve and circuit tester.

## Palec "VCT" Valve And Circuit Tester

### Operates From A.C. Or 6v. Accumulator

WHAT must be one of the most versatile radio test instruments of its kind in the world is the latest Palec Model VCT valve and circuit tester, manufactured by the Paton Electrical Instrument Co., of 90 Victoria Street, Ashfield, Sydney. Year by year this instrument has been improved upon—more ranges added, a larger and more accurate meter used, and the flexibility extended—until now it is difficult to imagine what further improvement could be made.

#### Operates From Mains Or Accumulator.

The latest feature is one that is of vital interest not only to country servicemen, but to those specialising in portable public address systems, and in fact in all types of portable equipment powered by vibrators or generators. The Palec Model VCT valve and circuit tester can be operated with equal efficiency on either a.c. mains or a 6-volt accumulator. The latter operates a built-in independent vibrator and power transformer unit, enabling every component in the receiver chassis, including valves, to be checked and tested. The change-over from a.c. to battery operation or vice-versa is made by the simple expedient of changing over a connection cable.

An important feature is that the normal a.c. "line adjust" control is common to both a.c. and battery supplies.

The condition of all types of valves is accurately indicated on a good/bad scale, while a neon test is incorporated for element leakage. Eight valve sockets are provided, enabling accurate tests to be made on every valve in common use in Australia today. A filament voltage selector, with a range of 1.5 to 30 volts in 11 steps, is provided.

On the multi-meter side, in addition to four a.c. and d.c. voltage ranges, providing indications up to 1000 volts, there are four d.c. milli-ampere ranges, extending to 250 m.a. Next there are four resistance measurement ranges. Three of these are

"powered" by an internal battery, and enable measurements between a fraction of an ohm and 200,000 ohms to be effected. The fourth is powered by the built-in power supply unit and provides indications up to 10 meg-ohms.

The large, 1000-ohm per volt meter used has a knife-edge pointer, moving over a finely-engraved sector scale 3 3/4 in. long. An 11-point "function selector" switch, used in conjunction with an 11-point "range selector" switch, selects any one of the seven basic sets of calibrations en-

graved on the meter scale. Additional voltage, current, and resistance ranges are covered by multiplying factors.

Settings of the "function selector" switch are as follow:—

Merit Test.—Gives "Bad, ?, good" check of valves on meter scale.

Element Short. Six-point electrode selector enables element leakage neon test to be applied.

Line Check. Enables line voltage

## INTRODUCING . . . RADIO'S WONDER SET OF 1938

### LIST OF PARTS.



### The "ASHBOX" MIDGET

Complete in attractive cabinet.

£6-5-0

	s.	d.
Chassis .....	2	9
Power Transformer ..	6	6
2-Gang Condenser ..	5	6
2 Electrolytics .....	5	6
3 Sockets .....	1	4
1 Volume Control ...	2	6
2 Special Coils .....	6	0
1 R.F. Choke .....		6
1 .0001 Mica Con'ser	1	0
1 .01 Mica Condenser	1	6
1 .002 Mica Condenser	1	0
2 .1 Tubular .....	1	6
1 1meg. Resistor ....		4
1 .25meg. Resistor ..		4
1 .5meg. Resistor ....		4
1 .1meg. Resistor ..		4
1 150 ohm 100ma. ...		6
1 Rola Speaker ....	14	6
1 80 Valve ..	11	3
1 6F7 .....	18	6
1 EL3G .....	15	6
1 Cabinet .....	14	6
2 Knobs .....		8
Sundry Hardware ..	1	8

£5 15 0

Kit of Quality Parts, £5/15/-; or Assembled in Cabinet, £6/5/-, Plus 7/- License Plate.

We Invite You to Call and Hear This Remarkable Set.  
Obtainable from

## RECO RADIO

9 ROYAL ARCADE, SYDNEY. 'PHONE: MA 7249.

to be accurately adjusted.

**Megohms (scale by 500)**—gives resistance indications between 5000 ohms and 10 megohms with aid of 225 volt internal D.C. supply.

**Electro. Leakage (500 volts)**—gives direct reading of high-voltage electrolytic condenser leakage. Has series resistor in circuit to protect meter in case of actual shorts.

**Electro Leakage (25 volts)**—gives direct reading of low-voltage electrolytic condenser leakage. Compensated to use same scale calibration as for high-voltage electros. Limiting resistor is fitted.

**Paper Condenser Leakage**—tests mica or paper condensers for leakage at

250 volts D.C. Neon lamp used as indicator.

**Milliamperes and Ohms**—enables D.C. milliampere measurements over range from 0.01 to 250 mA (in four steps), and resistance measurements from 0.1 to 200,000 ohms (in three steps) to be effected. Meter range selector and internal 4.5 volt battery (for resistance tests) used for these measurements.

**D.C. Voltage**—enables D.C. voltage from 0.1 to 1000 volts (in four steps) to be measured with aid of meter range selector.

**A.C. Voltage**—enables A.C. voltage from 0.1 to 1000 volts (in four steps) to be measured on some scale calibrations and with same range selector settings as for D.C. voltage. Valve rectifier is used.

**Output Voltage**—same as A.C. voltage but with isolating condenser in circuit.

The 11 position meter range selector operates in conjunction with the function selector (as indicated above) to provide the following measurements:— 0.1—1.0/10/100/250 mA. D.C.: 0.1—30/20,000/200,000 ohms; and 0.1—10/100/250/1000 volts D.C. or A.C. All of the external measuring ranges are brought out to one pair of sockets and heavy insulated leads, provided with test prods and insulated alligator clips, are provided for connection purposes.

Excellent Value At 17 Guineas.

Altogether, this new Palec release provides an outstanding contribution to the service equipment field, and at seventeen guineas (plus tax) represents excellent value. A further model, designed for a.c. mains operation only, is available at fifteen guineas (plus tax).

Further information on these instruments is available free on request from the Paton Electrical Instrument Co., 90 Victoria Street, Ashfield, Sydney.

★

### Philips EK2G New "G" Type.

The Octode EK2G is an important addition to the "G" type valves available on this market. This six-grid converter valve is electrically equivalent to the EK2, which has already achieved much popularity due to special characteristics such as high impedance (2 megohms) and low plate current, ensuring minimum background noise and high sensitivity.

A feature of this valve is the internal self-neutralising condenser between oscillator grid and signal input grid, which serves to reduce undesirable coupling between these two electrodes.

The recommended grid coupling condenser for EK2G is 50 mmfd., together with a grid leak of 50,000



ohms, which should be connected to cathode. At broadcast frequencies the oscillator grid current is approximately 300 microamps, while a current of 200 microamps may be realised on shortwave bands. The EK2G is fitted with a miniature cap in line with other valves of the "G" series.

Operating data and socket connections are shown on Philips Valve Chart, which is available on request from Philips Office in any State.

★

### Price's Catalogue Now Available.

Announced in last month's issue as being in the course of preparation, the 1938-39 catalogue issued by the well-known firm of Price's Radio Service, of 5 and 6 Angel Place, Sydney, is now off the press.

A much superior production to last year's catalogue, this 1938-39 version has an attractively printed three-colour cover, and is well illustrated throughout. Specialists for some years in parts and equipment for amateur transmitters and shortwave enthusiasts, this firm has now an unrivalled range of components.

Copies of this latest catalogue can be obtained free on request from the address given above.

★

### "In Latest Radiotronics."

Details covering the installation and application of the Radiotron OA4-G-cold cathode glow discharge triode are contained in the latest issue of Radiotronics (Bulletin No. 87). Applications of the OA4-G include its use as a voltage regulator, relaxation os-

(Continued on opposite page.)

# Foolproof Radio-

Clyde 'Plugg-in' Radio Batteries eliminate the possibility of wrong connections or short circuits and improves reception from every Battery-operated Radio Set.

## CLYDE 'PLUGG-IN' RADIO BATTERIES

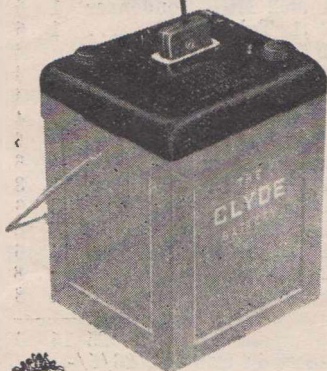

THE CLYDE ENGINEERING CO. LTD.  
61-65 Wentworth Avenue, Sydney  
Branches in all States

The

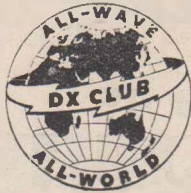

# All-Wave All-World

Official Organ of the  
All-Wave All-World DX Club

# DX News

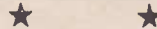

### Waverley Radio Club Notes.

By VK2AHJ.

The Waverley Radio Club's annual field day was held on Sunday, June 5, at National Park, and proved a wonderful success. The event took the form of a hidden transmitter hunt, the transmitter being supplied by 2ABS, and consisted of a 6P6 e.c.o. on 40 metres with suppressor modulation. Built on the same chassis was a 57-57 receiver, which was also used as a modulator taken transmitting.

About twenty-five participated, both members and visitors, including ZL3GS, and receivers of various shapes and sizes took part. The general idea was for the use of frame aerials, and many useful points were learned of their application to direction finding.

The most unique piece of apparatus taking part was, in my opinion, that of Morrie Lusby, VK2WN, whose complete 'phone transmitter and D.F. receiver occupied an aluminium box 12in. x 7in. x 3in.

Credit is due, however, to Eric Johnson (VK2AFZ) for being the first to locate the transmitter over a distance of about two miles of rough country.

Batteries were used as a source of power in all units except that of 2ABS, where two 180-volt generators were employed. It was learned later that 2ABS's signals were heard by Gerald Dillon, of Waverley, at R8.

### Further Field Day On July 15.

So popular was the field day with the participants that it was agreed upon to conduct a similar event on July 15. The 80-metre band will be used, as the ground wave on that band is more consistent and more suitable for D.F. work.

The club's new transmitter is progressing very satisfactorily under the capable direction of Gordon Wells, our president, and it is hoped that, in the very near future, by virtue of its thermostat frequency control apparatus, 2BV's transmitter will provide a reliable marker signal for the band limits.

In conclusion, I would like to re-

mind all those interested in "ham" radio, no matter how meagre their technical knowledge may be, that they would be welcome at the clubroom, 13 Macpherson Street, Waverley, any Tuesday evening.

in "B" and "C" batteries, and an article stressing the importance of keeping within the + 10% tolerance with both heater and filament type valves.

### In Latest Radiotronics.

(Continued from opposite page.)

illator, and to obtain remote control of line-operated electrical devices, by means of an electrical impulse generated at radio frequencies and transmitted over the same power line.

Other articles of technical interest include an application note on hum in heater-type valves, revised characteristics of the Radiotron 6K8, notes on discharge problems arising

### VK3SE Changes QRA.

I have been a subscriber to your fine magazine for about 14 months now and have found many interesting articles published, while the amateur calls and addresses are very useful for my DX work. I hold an experimental license under the call sign of VK3SE, and have now changed my address from 515 Lydiard Street, Ballarat, to 703 Macarthur Street, Ballarat. Wishing your magazine luck.

—S. E. Widgery, Victoria.

## ALL-WAVE ALL-WORLD DX CLUB Application for Membership

The Secretary,  
All-Wave All-World DX Club,  
214 George Street,  
Sydney, N.S.W.

Dear Sir,

I am very interested in dxing, and am keen to join your Club.  
The details you require are given below:

Name.....

Address.....

[Please print both plainly.] .....

My set is a.....

[Give make or type, number of valves, and state whether battery or mains operated.] .....

I enclose herewith the Life Membership fee of 3/6 [Postal Notes or Money Order], for which I will receive, post free, a Club badge and a Membership Certificate showing my Official Club Number.

(Signed).....

[Note: Readers who do not want to mutilate their copies of the "Radio World" by cutting out this form can write out the details required.]



# Short-wave Review

CONDUCTED BY

## ALAN H. GRAHAM

### Observers Report Consistently Poor Conditions ★ Hourly Tuning Guide ★ International Amateur Prefixes.

**R**EPORTS from "Radio World" Observers in all States indicate that reception conditions are not too good at present. This falling-off is especially noticeable on the higher frequency bands (i.e., below 16 metres). The 9-metre bands are now "dead," and will stay so till Spring. The only DX in the U.H.F. region is on the 10-metre amateur band, where quite a number of American, Hawaiian and New Zealand hams are busy.

#### TEST BROADCASTS.

Overseas short-wave transmissions received a great advertisement through the medium of the ball-to-ball descriptions, direct from the ground, of the first and second test matches. Thousands of interested listeners have been entertained and thrilled by the first-class running commentaries.

The work done by the G.P.O. and A.W.A. in this connection is worthy of the highest praise.

It is interesting to note that the wavelengths giving the best results were found to be: GSP, 19.6 m., midnight-1 a.m.; GSD, 25.5 m., 1-3.40 a.m. The 13 and 16 m. transmissions proved of little use, at least in the Eastern States.

#### AMERICAN STATIONS EXPAND.

Apparently political and trade considerations have resulted in the American F.C.C. removing the power restrictions on the short-wave stations in that country.

The G.E.C. transmitters, W2XAD and W2XAF, will soon be using the tremendous power of 1200 k.w. Special directional antennae to South America would appear to be intended to blot out European propaganda in that direction.

Another significant development is the announcement by the N.B.C. that it will erect two new 25 k.w. stations at Bound Brook, N.J. These will

be devoted expressly to transmissions to South America—16 hours daily.

#### GUATEMALA.

The latest information re. the Guatemala stations:—

TG2, Radio Morse, operates on 6180 kc., 48.5 m., with 200 w., relaying TG1. Schedule: Tuesday to Saturday, 9 a.m.-2 p.m.; Sundays, 9 a.m.-4 p.m.; 10 p.m.-2 a.m.; Mondays. 6-11 a.m.

TGQA, La Voz de Quezaltenango, Quezaltenango, 6440 kc., 46.56 m., with 200 w., relaying TGQ. Schedule: Tuesday-Saturday, noon-2 p.m.; Sundays, noon-4 p.m.; Mondays, 4-6 a.m. Previously the call TG1X was used by this station, but now that regular transmissions are being undertaken the letters TGQA are used.

Reports for both these stations should be addressed to the Director General of Electrical Communications at Guatemala City.

#### JOTTINGS FROM OVERSEAS STATIONS.

Radio Malaga, Spain, 14,440 k.c. 20.78 m., now broadcasts war news in Spanish, relaying the Nationalist key station at Salamanca.

SBG, Motala, Sweden, 11,700 kc., 25.65 m., is now scheduled as follows: 10.30 a.m.-2 p.m.; Mondays, 12.01-2 p.m. At present it uses only ½ kw. However, in the near future, special beam antennae will be placed in use by all the Swedish transmitters.

HAS-3, Budapest, Hungary, 15,370 kc., 19.52 m., now broadcasts a special programme to New Zealand every Monday from 12.01-1 a.m.

#### DX—SOME UNUSUAL STATIONS.

Roumania.—A number of 20 m. hams are giving S.W.L.'s a chance to add another new country to their logs. Look for YR5KW and YR5CF (low frequency); also YR5AA.

Paraguay.—Another country per the amateur bands if one is lucky

enough to log ZP2AC, a regular on the 20 m. band.

Uruguay.—Look for amateurs CX2AK and CX3BL.

Pitcairn Is.—VR6AY is reported on 14,346 kc. by S.W.L.'s all over the country. An American source also reports this interesting station on 15,320 kc., 19.5 m., contacting a KEM, Port Reyes.

Greenland.—The McGregor Expedition at Reindeer Point, near Etah, Greenland, is still operating as an amateur on 14,368 kc., and also as a commercial on 12,860 kc., 23.3 m. The old call, OX2QY, is not in use now, having been banned by the Danish Government. Call used is W10XAB.

Tristan da Cunha.—This lonely island in the Pacific now has what must be the world's loneliest radio station. Permission has been granted for the use of the call letters ZOE, to be used when in touch with passing ships. ZD9AB will be used for experimental work, presumably on the 20 m. band.

#### LATEST SCHEDULES.

##### Radio Nations, Geneva.—English Broadcasts. (Mondays)

Aust. E.S.T.	St.	Kc.	W/L.
1.45-2.30 a.m.	HBH	18,480	16.23
4.45-5.30 a.m.	HBJ	14,535	20.64
	HBQ	6675	44.94
10-10.45 a.m.	HBO	11,402	26.31
4-4.14 p.m.	HBO	11,402	26.31
4.30-4.45 p.m.	HBJ	14,535	20.64

##### Prague—English News Sessions.

1. For North America. Daily at 11.50 a.m., OLR4A-OLR4B or OLR5A-OLR5B.
2. For Europe. Daily at 7.30 a.m., OLR4A-OLR4B.



#### Reports From Observers.

Mr. V. D. Kemmis (New South Wales):—

The recent weeks have been very uneventful as far as DX is concerned. Conditions have been disgusting over here, and as erratic as it is possible to imagine. On the 20 m. band during the evening, one is extremely



lucky to hear anything more than a couple of VK's; although occasionally the band will open up for about half an hour, and a few East Coast W's push their way through—but they are hardly DX. The few Europeans I have heard have been landed around 6.45-7.30 a.m.

I have done a good deal of listening on the lower frequencies this month, logging quite a number of ZL's on 80 m. There are also a few weak American signals audible on 75 m., but QRN is a great problem here.

Frequently of an evening I can hear a number of Spanish-speaking stations on the 49 m. band. Though their signals are quite good, I have found it very difficult to identify them.

I also get a good deal of amusement from the 45.5 m. aircraft channel. Salamaua, Archerfield, etc., aerodromes put in good signals.

### CALLS HEARD.

#### Broadcast Stations.

JVA (15.8 m.), KGU (16.7), HSP (16.9), GSP (19.6), YDC (19.8), PCJ-2 (19.7), JZK (19.7), KAY (20.03), VLZ (22), RNE (25.0), DJD (25.4), JZJ (25.42), 2RO (25.4), COGF (25.4), W8XK (25.2), TGWA (25.47), CJRX (25.6), COCX (26.2), HBO (26), CSW (27.17), PLP (27.27), ZLT (27.32), JVN (28), PMN (29.24), TGWA (30.9), JDY (30.18), COBC (30.47), KZRM (31.3), W1XK (31.3), VK2ME, VK6ME (31.2), VPD-2 (31.45), PCJ (31.2), RAN (31.2), VUD (31.3), XEWW (31.58), ZBW-3 (31.49), VK3ME (31.5), HS8PJ (31.58), OAX5C (31.7), PMH (44.64), W8XAL (49.5), COCO (49.92), 9MI (49.9), DJC (49.8), HP5K (49.96), PMY (58.3), RV15 (70.2), YDA (98).

#### Amateur Stations:—

20-metre Phone: CN8- AV, MA (Morocco), CO-2RA, 7VP (Cuba), CT1AY (Portugal); F-3CP, 8KW, 8LX, 8VC (France), F18AC (Fr. Indo China); G-2AK, 2PU, 2TR, 2WD, 2XV, 5QN, 5ZG, 6BY, 6DT, 6US, 6VX, 8KD, 8MA, 8MX (England); GW8HI (Wales); HC-1FG, 1FK (Ecuador); HH-2B, 5PA (Haiti); HI7G (Dominican Republic); HK5AR (Colombia); HS1BJ (Siam); J-2KG, 2MI (Japan); K6-CMC, GAS, GQF, KGA, KPF, NZQ, OJI, OQE (Hawaii); K7AOC (Alaska); KA-1BH, 1CS, 1FH, 1FX, 1ME, 1MM, 1JZ (Philippine Is.); LU6KE (Argentina); OA-4AI, 4R (Peru); ON-4MZ, 4VK (Belgium); PA0AA (Holland); TI2RC (Costa Rica); PK-1MX, 1PK, 1ZZ, 2AY, 2DF, 2WL, 6XX (D.E.I.); VE-1CR, 3AHN, 4IF, 4JJ, 5ABD, 5ACN, 5AEJ, 5BF, 5EF, 5HI, 5NY, 5OT, 5PE, 5VO, 5VP (Canada); VU2BG (India); XE-1DT, 1NB, 2PJ, 2FC (Mexico); XU-8ET, 8RB (China); YV1AP (Venezuela); ZL2BE (New Zealand); ZS3F (South Africa).

80-metre Phone: ZL-1BI, 1FB,

1HA, 1JO, 1KJ, 1MY, 2AU, 2BH, 2BN, 2BT, 2JB, 2JC, 2JT, 2QL, 2RC, 2UI, 3AH, 3CV, 3DC, 4AS, 4BK, 4CU, 4FM (New Zealand).

Mr. G. O. La Roche (West Australia):—

Conditions this month have been terrible. Reception from 8-12 p.m. from 25 m. down is absolutely nil; reception from 3-7 p.m. is only fair, but few stations are on the air at that time.

The 20 m. amateur band has only brought in one or two overseas hams. The only stations of any note are: V-2VR (India), VS1AI (Malay),

### Official Shortwave Observers

N.S.W.: V. D. Kemris, "Brampton Hall," 49 Kurraṭa Road, Neutral Bay, Sydney; A. R. Payten, High Street, Co.'s Harbour, South Australia; A. E. Bruce, C/- 54 Currie Street, Adelaide; Joseph C. Linehan, 181 South Terrace, Adelaide. Queensland: Ern Neill, 26 Canning Street, Nth. Ipswich; J. K. Sorensen, "Fairholme," Station Road, Gympie. West Australia: G. O. La Roche, 62 Gladstone Avenue, South Perth. New Zealand: Robert Russell, Taupo Road, Taumarunui. Tasmania: Henry Alexandra Callander, 1 Franklin Street, West Hobart. Victoria: James Ferrier, "Win-ninburn," Coleraine.

ZS1AX (South Africa), CO2RA, CO7CX (Cuba), PK1VY, PK3VL (D.E.I.), KA1ZL, KA1FH, KA1HS (Philippine Islands).

Possibly the most interesting development this month is the whistle on VK6ME. As yet I have not definitely identified the offender, but I think it is the new Delhi station, as times of transmission, frequency, and type of programme correspond with Delhi.

#### Broadcast Calls Heard:

HAS-3 (19.52 m.), TPA-2 (19.68). OLR-5A (19.69), YDC (19.8), JZJ (31.3), KZRM (31.3), YDB2 (31.4), (25.42), PLP (27.26), JVN (28.14), PMN (29.24), ORK (29.04), JDY (30.2), CSW (30.2), COCQ (30.77), JFAK (31.06), VUD (31.3 (?), VLR (31.3), KZRM (31.3), YOB2 (31.4), XEWW (31.58), VK3ME (31.5), PMH (44.64), Rangoon (49.9), VQ7LO (49.3), PMY (58.3), YDL-2 (62.3), RV15 (70.2), 9MI (49.9), YDA (98). Mr. J. K. Sorensen (Queensland):—

I have very little to report this month, as I am now in Gayndah, and have no S.W. receiver at present. I was in Gympie for a couple of days early in the month, and found conditions very ordinary, except for the usual Daventry and Zeesen transmitters. The only reasonable signals

during the evenings are those from VLR, VK3ME and JVN.

Mr. A. E. Bruce (South Australia):—

There has not been very much to report as far as the evenings are concerned, as conditions here seem to have been rather poor. The 13 m. band is dead until midnight, and then brightens up a little; 16 m. conditions are much the same. 19 m. has been disappointing, only the D.E.I. transmitter, YDC, putting in a strong signal.

The 20 m. amateur band has had some bright moments, a number of good U.S.A. hams, and also a few Straits Settlements stations. The 25 and 31 m. bands carried a number of stronger signals, but the noise level has been very troublesome, and it has been very hard to copy them. There are two Japanese stations on about 43 and 49 m., respectively, which are fairly strong and clear. (JVT, 44.44 m., and JZH, 49.22 m.—S.W. Ed.)

The mornings till 8.30 a.m. (Adelaide time) have been quite fair—London, Berlin and Java on 19 m., and Paris on 25 m.

In the afternoons the 20 m. amateur band is very good, and over 60 American hams have been logged recently. The London and Berlin stations provide splendid entertainment on 25 and 31 m., and are nearly as good on 19 m. They are usually R Max, with very little background noise.

I have recently received cards from HI2G, TI2RC and HS1BJ.

Mr. A. R. Payten (New South Wales):—

I'm afraid I've got a very poor report for the past month, as conditions are very, very poor at present.

Night reception has been terrible. Only KZRM (31.3) and 9MI (49.9) have been worth while.

Daylight conditions have been fairish, but only the usual stations are audible—such as London, Berlin, Paris, Java, Moscow, etc. In the early mornings CSW and EAQ are still fairly good. Around 11 a.m. Daventry are good on 19 m. Reception peaks around 4-5 p.m. on 25 m.; after that all stations "simply fade away."

The best reception for the month was TGWA on 31 m., at 3.45 p.m. Signals were very strong and all announcements (relaying TGW) very clear.

#### Broadcast Calls Heard:

TPA-2, DJB, DJQ, DJL, GSP (19 m.), TPA-3, TPA-4, RNE, GSD, JZJ, DJD (25); CSW (27); DFL (27.63); DZC (29); EAQ, COCQ, COCM (30); VLR, KZRM, TGWA, VK3ME, VPD-2, Paris, GSB, GSC (31); 9MI (49).

Mr. J. C. Linehan (South Australia):

Conditions this last month have been a little better. 10 m. has been practically dead until 10.30 a.m., and from then till 2 p.m. it livens up a little. 13 m. has been very erratic; after 11.30 p.m. GSJ is reasonably good. A newcomer on this band was W3XAL, 13.94 m., heard testing and asking for reports on their transmission; they were on the air from 11.30 p.m.-12.45 a.m. On 16 m. the German stations are better than they were last month.

Running through the various bands, I have found that from 2 a.m. to 4.30 a.m. all bands except 10 and 31 m. are quite good; more particularly the 49 m. band, and the lower frequency D.E.I. stations. PMY simply roars in on 58.3 m.

The best stations on the various bands are as follow:—

- 11 m.—W6XKG.
- 13 m.—W3XAL, DJS, GSJ.
- 16 m.—DJE, PHI, GSG.
- 19 m.—YDC, DJR, W8XK.
- 25 m.—2RO, JZJ, RNE.
- 27 m.—PLP.
- 29 m.—PMN.
- 31 m.—KZRM, XEWW, W1XK.
- 49 m.—VQ7LO, YDA2, Rangoon,

DJC, ZRH, ZRK.

I have just received a very interesting QSL from VR6AY, who men-

tioned that I was one of the first VK-SWL's to report his signals. Other QSL cards recently to hand are from PHI, XZ2EZ, CO8JK, F8DL, PK4AU, ZL4FK (10 m.), NY2AE, COBX, COBC, COCM, COCA, COCW, COCQ, COBZ.

For real DX the period between 2-4 a.m. on 20 m. is ideal; many new countries are rolling in. On Sunday 19th I logged 18 G's, 4 ON's, 2 YR's, 7 PK4's, 3 F's, 2 K4's, etc. Calls Heard On 20 m. Phone:

- G6DT, G8AW, G6BW, G6UX, G2TR, G6YU; ON4MZ, ON4DV, YR5AA, PAOUN, ZS5CL, XU8RB, XU8ET, VS1AI, VS2AK, VS7GJ, XZ2ED, KA1ME, KA2OV, KA1JZ, K6OQE, VR6AY, K7FBE, VE3MD, VE1MW, H15G, HH5PA, HC1FG, XE1K, LU1HI, K4EMS, PK4OB, PK4GB.

Calls Heard on 10 m. Phone:

- J2MI, ZL2FY, ZL3DJ, ZL4FK, ZL3AJ, ZL3AH, K6LCV, W6CMB, W4CNJ, W5CGS.

Mr. R. Russell (New Zealand):

DX has been very poor here; but the veries recently to hand have somewhat compensated for this: HB9CL, HB9BR, G2TR, ON4BG, VR6AY, SU1RD and HP1A.

Just at present the 20 m. band is full of Yanks. but even they do not

last for long—ever since the eclipse of the moon conditions have fallen off considerably.

20 m. Phone Calls Heard.

Europe: F3MF, F8XN, F300, F8JC, F8LX, F3JD, F8XT, F3KH, F8BP, F8AB, F8DC, F8QD, F3DI (France); G6XM, G2MI, G6WN, G8MX, G6DT, G2HQ, G2TR, G6ZI, G2UT, G5ML (England); ON4VK, ON4AU, ON4AN, ON4BG (Belgium); GW8HI (Wales); CT1AY, CT1AM, CT1AZ (Portugal); SV2KA (Greece); YR5AA, YR5CF (Roumania); SP2H.I (Poland).

Africa: FA3HC, FA8HQ (Algeria); CN8MA, CN8AI (Morocco); CR7AS (Mozambique).

Asia: XU8PP, XU8ET (China); VS1AI (Malaya).

America: HR5C (Honduras); VP1BA (Brit. Honduras).



Reports From Readers.

Mr. R. S. Coggins (Woodville, South Australia):

Mr. Coggins sends reports covering the past three months' reception on the 20 m. amateur band. During that period, the following stations have been logged.

Europe: G- 5GA, 5BJ, 6BY, 5DR, 2MF, 5DT, 8MA, 5GO, 8MX, 8XT, 2TR, 6XR, 8NJ, 5GX, 8QH, 2AI, 2AK, 6LL, 6JF, 2CU, 8SB, 5ZG (England); GI2CC (Northern Ireland); GM2UU (Scotland); EI6G (Irish Free State); PA- OAA, OMZ (Holland); F- 8XT, 8KI, 8KW, 8VP (France); HB- 9JK, 9CE (Switzerland); HA1P (Hungary).

Africa: CN8AV (French Morocco); FA3CW (Algeria); SU1RD (Egypt); ZS- 6AJ, 2AL, 2AH, 2X, 5TL, 6EG, 2NW (South Africa).

Asia: FI8AC (Fr. Indo-China); VS- 1AI, 2AI, 2AK (Malaya); VS- 7GJ, 7GP (Ceylon); VU- 2CQ, 2DR (India); XZ- 2EZ, 2DX (Burma); J- 2NF, 2FI, 2MI, 2OI, 2NG (Japan); XU- 8RB, 8RL, 8RT (China); VR6AY (Pitcairn Is.); PK- 1JR, 1GW, 2WL, 2AY, 2CA, 3WI, 3DB, 3ZZ, 4JD, 4GD (D.E.I.); KA- 1AM, 1AF, 1BH, 2OV, 2OJ (Philippines); K6- KGA, CMC, BNR, BJJ, MZQ, KKC, KMB, JLV, CJK, CGK, OQE (Hawaii).

North America: VE- 1DT, 2HN, 2EW, 2QL, 4ABZ, 4JJ, 3MD, 5VO, 5GA, 5ACN, 5OT, 5HU, 5AEJ, 5MY, 5JK, 5DK, 5JB, 5CN, 5ABD, 5OQ, 5BF (Canada).

South America: OA4R (Peru); HC1JW (Ecuador); YV1AP (Venezuela); CE1AH (Chile); LU4BTS (Argentine).

Central America and West Indies: K4- SA, EMG (Porto Rico); XE- 1GK, 2BJ, 2KA (Mexico).

# Have Your "RADIO WORLD" Posted To You Direct

Readers who want to take the "Radio World" on a subscription basis and have their copies posted to them direct each month are invited to complete the coupon below (annual sub. 10/6). New readers are advised that all back numbers in Volumes 1 and 2 are still available, price 9d., post free for copies in Volume 1 (May 1936 to April 1937) and 1/-, post free, for copies in Volume 2 (May 1937 to April 1938).

Enclosed please find remittance for 10/6, in payment for an annual subscription to the "Australasian Radio World," commencing with the.....issue.

Name.....

Street and No.....

City..... State.....

Country.....

Note.—N.Z. Subscribers can remit by Money Order or Postal Note.

THE AUSTRALASIAN RADIO WORLD, 214 George Street, Sydney, N.S.W., Australia.



25.42 JZJ	31.55 GSB	49.5 W8XAL	31.28 VK2ME	31.49 ZBW3	25.42 JZJ
25.45 W1XAL	11 a.m.-noon.	4-5 p.m.	(S)	31.8 COCH	25.57 Saigon
25.49 DJD	19.56 DJR	13.99 DJS	31.38 DJA	32.09 COCB	27.27 PLP
25.51 OLR4B	19.6 GSP	16.86 GSG	31.45 DJN	32.59 COBX	29.24 PMN
25.53 GSD	19.63 DJQ	16.89 DJE	31.49 ZBW3	44.64 PMH	30.61 XGOX
25.60 TPA4	19.74 DJB	19.63 DJQ	31.55 VK3ME	48.7 VPB	30.78 COCQ
30.31 CSW	25.26 W2XK	19.74 DJB	31.45 VPD2	49.5 W8XAL	31.28 VK2ME
31.09 CS2WA	25.34 OLR4A	19.76 GSO	34.0 VPD3	49.98 Rangoon	(S)
31.13 2RO3	31.27 HBL (S)	19.85 DJL	44.64 PMH	58.3 PMY	31.35 W1XK
31.27 HBL (S)	31.28 W3XAU	19.82 GSF	70.2 RV15	70.2 RV15	31.38 DJA
31.28 W3XAU	25.51 OLR4B	20.64 HBJ (M)	9-10 p.m.	11 p.m.-midnight.	31.45 DJN
31.32 GSC	(F, Sat)	25.24 TPA3	13.93 GSJ	13.93 GSJ	31.49 ZBW3
31.35 KZRM	25.53 GSD	25.42 JZJ	13.97 GSH	13.97 GSH	31.51 HS8PJ
31.35 W1XK	25.61 TPA4	25.53 GSD	13.99 DJS	13.99 DJS	(Th)
31.48 W2XAF	31.13 2RO3	26.31 HBO (M)	16.86 GSG	16.86 GSG	31.8 COCH
31.49 LKJ1	31.25 RAN	31.28 VK2ME	16.89 DJE	16.89 DJE	32.09 COCB
31.55 GSB	31.28 PCJ	(S)	19.58 OLR5B	16.88 PHI	32.59 COBX
31.58 PRF5	(M, T, Th)	31.38 DJA	19.63 DJQ	19.56 DJR	33.2 COBZ
31.46 JZI	31.32 GSC	31.45 DJN	19.68 TPA2	19.63 DJQ	44.64 PMH
38.48 HBP (S)	31.38 DJA	31.55 GSB	19.7 OLR5A	19.68 TPA2	48.7 VPB
49.75 OLR2B	31.45 DJN	49.5 W8XAL	19.71 PCJ (W)	19.74 DJB	49.5 W8XAL
(Th)	31.48 W2XAF	5-6 p.m.	19.74 DJB	19.8 YDC	49.9 COCO
49.92 OLR2A	31.55 GSB	13.99 DJS	19.8 YDC	19.82 GSF	49.98 Rangoon
(Th)	9-10 a.m.	16.86 GSG	19.82 GSF	19.85 DJL	58.3 PMY
	11 p.m.	16.89 DJE	19.85 DJL (S)	25.4 2RO4	70.2 RV15
	13.99 DJS	19.63 DJQ	25.0 RNE (W)		
19.56 DJR	19.56 DJR	19.63 DJQ	25.4 2RO4		
19.56 W2XAD	19.63 DJQ	19.63 DJQ	25.57 Saigon		
19.6 GSP	19.66 GSI	19.74 DJB	27.27 PLP		
19.63 DJQ	19.74 DJB	19.76 GSO	28.14 JVN		
19.72 W8XK	25.26 W8XK	19.82 GSF	29.24 PMN		
19.74 DJB	25.34 OLR4A	25.23 TPA3	30.23 JDY		
19.8 YDC	(T, W, F, Sat)	25.52 GSD	30.61 XGOX		
22.0 SPW	25.49 DJD	28.14 JVN	31.28 VK2ME		
25.34 OLR4A	25.51 OLR4B	31.28 VK2ME	(S)		
25.42 JZJ	(T, W, F, Sat)	31.38 DJA	31.28 VK6ME		
25.45 W1XAL	25.53 GSD	31.45 DJN	31.38 DJA		
25.49 DJD	25.60 TPA4	31.45 DJN	31.45 DJN		
25.51 OLR4B	31.28 PCJ (F)	31.55 GSB	31.45 VPD2		
25.53 GSD	31.32 GSC	6-7 p.m.	31.49 ZBW3		
25.61 TPA4	31.38 DJA	13.99 DJS	31.55 VK3ME		
30.31 CSW	31.45 DJN	16.89 DJE	34.0 VPD3		
31.09 CS2WA	31.48 W2XAF	19.63 DJQ	44.64 PMH		
31.13 2RO3	31.55 GSB	19.31 PCJ (Th)	48.7 VPB		
31.27 HBL (S)	1-2 p.m.	19.74 DJB	49.5 W8XAL		
31.32 GSC	19.56 DJR	25.23 TPA3	58.3 PMY		
31.35 W1XK	19.63 DJQ	28.14 JVN	70.2 RV15		
31.38 DJA	19.66 GSI	31.28 VK2ME	10-11 p.m.		
(M)	19.74 DJB	(S)	13.93 GSJ		
31.45 DJN	25.49 DJD	31.38 DJA	13.97 GSH		
31.49 LKJ1	25.53 GSD	31.45 DJN	13.99 DJS		
31.48 W2XAF	25.61 TPA4	7-8 p.m.	16.86 GSG		
31.55 GSB	31.28 PCJ (F)	13.99 DJS	16.88 PHI (S)		
38.48 HBP (S)	31.32 GSC	19.71 PCJ (Th)	16.89 DJE		
49.1 GSL	31.38 DJA	19.74 DJB	19.58 OLR5B		
10-11 a.m.	31.45 DJN	25.57 Saigon	19.63 DJQ		
19.56 DJR	31.48 W2XAF	28.14 JVN	19.68 TPA2		
19.6 GSP	31.55 GSB	31.38 DJA	19.74 DJB		
19.63 DJQ	2-3 p.m.	31.45 DJN	19.8 YDC		
19.74 DJB	25.61 TPA4	31.49 ZBW3	19.82 GSF		
19.8 YDC	31.48 W2XAF	31.55 VK3ME	19.7 OLR5A		
25.26 W8XK	3-4 p.m.	8-9 p.m.	19.85 DJL (S)		
25.34 OLR4A	13.99 DJS	13.93 GSJ	25.4 2RO4		
(T, W)	16.86 GSG	13.97 GSH	25.45 JZJ		
25.49 DJD	16.89 DJE	13.99 DJS	25.57 Saigon		
25.51 OLR4B	19.63 DJQ	16.86 GSG	27.27 PLP		
(F, S)	19.74 DJB	19.68 TPA2	28.14 JVN		
25.53 GSD	19.76 GSO	19.68 TPA2	29.24 PMN		
25.61 TPA4	19.85 DJL	19.71 PCJ (W)	30.23 JDY		
26.31 HBO (M)	19.82 GSF	19.74 DJB	30.61 XGOX		
31.13 2RO3	25.42 JZJ	19.8 YDC	30.78 COCQ		
31.25 RAN	25.53 GSD	19.82 GSF	31.28 VK6ME		
31.28 PCJ	31.28 VK2ME	25.4 2RO4	31.28 VK2ME		
(M, T, Th)	(S)	25.57 Saigon	(S)		
31.32 GSC	31.38 DJA	27.27 PLP	31.35 W1XK		
31.38 DJA	31.45 DJN	28.14 JVN	31.38 DJA		
31.45 DJN	31.55 GSB	29.24 PMN	31.45 DJN		
31.48 W2XAF	49.18 W3XAL	29.24 PMN			
31.49 LKJ1					

Valuable Mullard  
Publication Free To  
Readers.

A copy of the lately-released Mullard Valve Reference Charts (July, 1938, edition) has been received from Mullard (Aust.) Pty. Ltd., of 26-30 Clarence Street, Sydney, N.S.W. Similar in form to the widely-popular edition of last year, this year's edition is almost twice as large, comprising 26 pages and index. All the latest octal and ordinary-based valves are listed, with full characteristics, as well as the older types. In all, there are no fewer than 232 valve types included.

In contrast with the ordinary wall charts, this publication includes a great deal of application data, as well as the main characteristics listed on the Charts themselves. In addition, incorporated in the latest edition is a "Valve Classification Chart," which sorts out the 232 types according to their respective functions and filament groupings.

Up-to-the-minute in content, and unusually comprehensive, this new Mullard publication provides an invaluable reference on valve data, and undoubtedly will be eagerly sought after by all. "Radio World" readers can obtain copies free of charge from the address given above or, alternatively, by telephoning B 7446.

THE  
RADIO  
PIONEERS

# Fear's Radio News

F. J. W. FEAR & CO. - - - - 31 Willis Street, Wellington  
New Zealand :: Telegrams: "FEAR"

FEAR'S  
FOR  
EVERYTHING  
IN RADIO

An Advertisement inserted by F. J. W. FEAR & CO., New Zealand.

## "Air-Ace Communications Four" Is Outstanding Shortwaver

**Ganged Tuning With Band-spread ★ Built In Speaker ★ Provision for Regenerative R.F. ★ All-Wave Coverage.**

The first communications type receiver within the means of every shortwave fan, the "Air-Ace Communications Four" is a sensational design that is assured of immediate popularity.

Features include the use of new octal-based valves, r.f. and audio gain controls, all-wave coverage, high note pass for c.w. reception of 1000-cycle note, provision for 'phones or speaker, and for adding a regenerative r.f. stage if desired.

WRITE NOW FOR FURTHER DETAILS.  
SENT FREE BY RETURN MAIL.

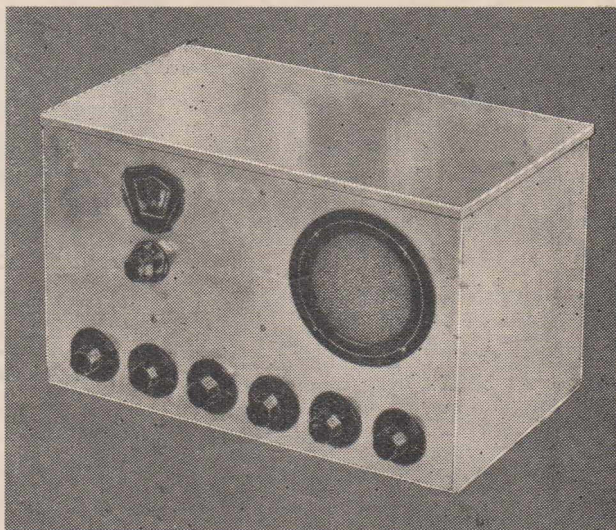

### News Items For Amateurs. SHURE MODEL 70SW CRYSTAL MICROPHONE.

A new and better communication mike—produces double power on important intelligibility speech frequencies, with only 56 per cent. of the amplification previously needed. Recommended for high efficiency voice communication in commercial and amateur transmitters. Here is a real start to quality in your 'phone.

Features: Chromium-plated Head  
★ Morocco Grain Black Desk Stand  
★ Complete with 7 feet of Shielded Single-conductor Cable ★ Output Level 42 DB. below 1 Volt per Bar.

Nett Price to Hams, £6/10/-

Also other Shure Mikes,  
Prices on Request.

### AMPHENOL CABLE AND MIKE CONNECTORS.

A full range of 4, 5, 6, 7 and 8-pin plugs and sockets, suitable for speaker and power supply extension and connection. Moulded bases with black metal clip-on covers.

4 and 5-pin . . . . . 10d. each net.  
6 and 7-pin . . . . . 11d. each net.  
8-pin octal . . . . . 1/2 each net.

Heavy cadmium-plated shielded microphone cable connectors and

chassis plugs—ideal for crystal and velertron mikes—shields cable right into chassis or panel.

Type MC3M plug . . . . 4/-  
Type MC3F socket . . . . 4/-

Many other combinations are available—send in your enquiry and get quotation.

### NEW JOHNSON PRODUCTS.

FLEXIBLE SHAFTS: Phosphor bronze, when used with suitable couplings, control of units at angles up to 90 deg. with panel is possible. Available in two sizes—

6in. long 1/4in. hub, nett 2/6 ea.  
3in. long 1/4in. hub, nett 1/8 ea.

PANEL BEARING: Cadmium-plated brass, will fit panels up to 3/8in. thick for extension shafts, etc.

Type No. 255 nett price, 10d. ea.

COMPRESSION SHAFT COUPLING: Cadmium-plated brass, will not burr or mark shaft, stronger than set-screw types, for 1/4in. shafts, 10d. each nett.

FLEXIBLE COUPLING: Isolantite insulation, phosphor bronze springs, no backlash; for low-loss coupling in receivers and transmitting equipment, 3/6 each.

ALSO JOHNSON INSULATORS,  
SOCKETS AND CONDENSERS.

### Most Comprehensive And Up-To-Date Stock In N.Z.

We carry the most comprehensive and complete stock of radio equipment, and represent the following well-known manufacturers of quality equipment in U.S.A., England, etc.:-

U. T. C., MEISSNER, C R O W E, NATIONAL, TAYLOR, TRIPLETT, HAMMARLUND, EIMAC, WARD LEONARD, HAMMOND, JOHNSON and others.

### Auto-Tune Dual-Wave Five

The finest "4/5" ever described in any magazine, the "Auto-Tune D.W. Five" described this month incorporates many sensational new features. We can supply the complete kit of parts, exactly as specified.

WRITE FOR OUR DETAILED QUOTE.

### Four-Watt Beam Amplifier.

Using a single 6V6G in the output, with inverse feedback, the Four-Watt Beam Amplifier described this month will be found invaluable for many applications in the service or home workshop.

WRITE FOR OUR DETAILED QUOTE.

# Boost your Signals from R4 to R9+

## "NOISEMASTER" Aerial Kit drags up signals out of the mush to overload your speaker

DO mush and hellish noise drown these sought-for, rarely heard distant stations? Let the "NOISEMASTER" Engineered All-Purpose Aerial Kit drag them in and boost up signals to overload your speaker. "NOISEMASTER" wipes out noise and local static, and boosts up signals, even as much as from R4 to R9 plus!

No one else would ever dare make such a claim—no other aerial of ANY TYPE can give you such incredible performance, because "Noise-master" is the only Aerial Kit authorised to use the wonderful American invention "ANTENNEX." It acts like a purifier and cleans out every trace of locally created noise, leaving all stations beautifully clear at astounding volume.

Besides, you get in the "Noisemaster" Kit 200 feet of special aerial wire, 12 specially designed transposition blocks, earth clamp, lead-in strip, screws, lightning arresters, etc. Easy-to-follow instructions and drawings with each Kit enable you to set up your aerial in a very short time. No testing. No doubt. No delay. Once "Noisemaster" is fitted, your noisetroubles end! Send this special form for your "Noisemaster" Aerial Kit NOW, and have revealed to you a glorious new thrill in reception that makes you feel your set is new again.

## Send for yours without Delay

Antennex (A'sia.) Corporation  
Box 3868 T, G.P.O., Sydney.

Send me right away your "Noisemaster" Kit. I enclose 52/6 in postal notes, money order, cheque. (Add exchange to country and interstate cheques.)

NAME .....

ADDRESS .....

A.R.W. 7/38.

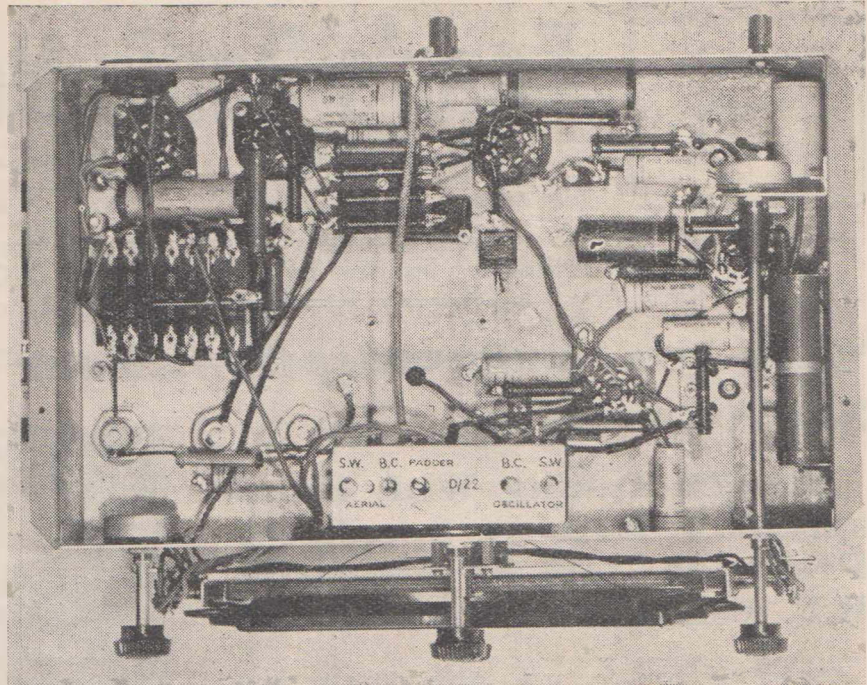

This under-chassis view shows the short, direct wiring it is essential to use if highest gain with complete stability is to be obtained. Note the method of mounting the volume control by means of a steel bracket bolted to the right wall of the chassis.

## "Auto-Tune Dual-Wave Five"

(Continued from page 8.)

point at which the desired signal strength is heard in the speaker. Now adjust the intermediate transformers to the oscillator frequency by adjusting the trimmer screws of each stage with the "spin tight" spanner provided, and a screw-driver. Commence

at the first stage and advance to the last. It is advisable to repeat the procedure at least twice before sealing the trimmers.

When the i.f. stages are finished, the gang condenser trimming will complete the job. Commence by setting the oscillator and receiver dial to 1400 k.c. (B.C. band) and adjust the oscillator (set) gang trimmer un-

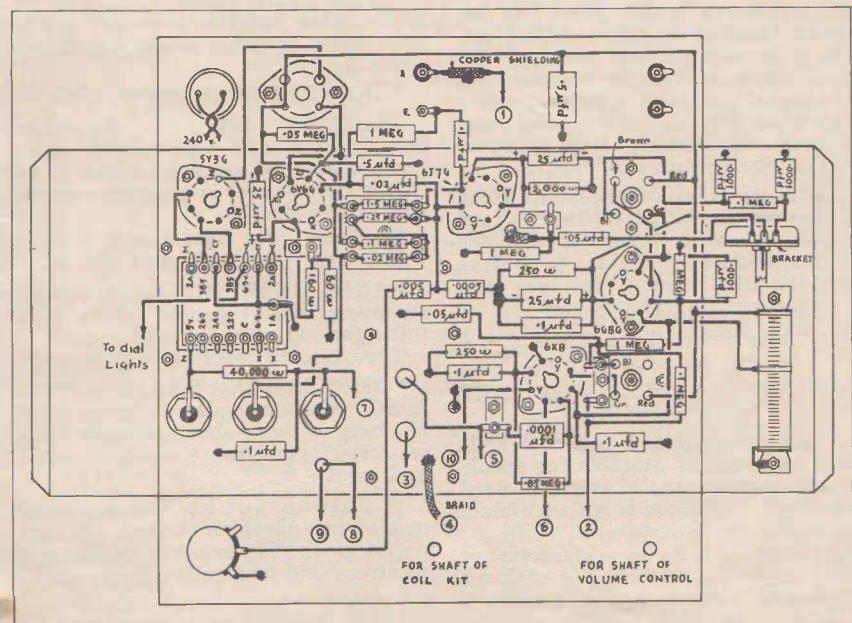

The under-chassis wiring is shown in this sketch.

til a signal is heard. Then adjust the aerial gang trimmer until maximum signal is obtained.

Now set the receiver dial to 600 k.c., adjust the oscillator dial until a signal is obtained, and then adjust the padder. While this is being done, rotate the oscillator frequency back and forth, noting when the greatest output is obtained. (An output meter will provide an accurate guide.) The above procedure should be repeated twice before sealing the trimmers.

**Checking The S.W. Section.**

When checking the s.w. band in superhet receivers, there are usually two points at which the signal may be heard—one being the fundamental and the other the image frequency, which is separated from the fundamental by twice the intermediate frequency (i.e.  $2 \times 465 \text{ k.c.} = 930 \text{ k.c.}$ )

Care must be taken in determining which signal heard is the fundamental. With Crown coils and boxes, as with the majority of receivers which have an oscillator frequency higher than the signal frequency, the fundamental will be as follows:—

If locating a signal with the receiver dial, the highest frequency (lowest wavelength) is the fundamental frequency. However, when tuning the oscillator to a given receiver dial setting, the lowest frequency (highest wavelength) on the oscillator dial is the fundamental frequency.

Now that the reason for the two spots has been explained, the actual aligning of the s.w. band will be much clearer. Proceed as follows:—Set the oscillator and receiver dials to 16 metres (in the case of the 12-36 metre box or at 25 metres with the

# 1938 Australian Official Radio Service Manual

## 391 Pages and 300 Circuits

**F**OR many years now there has been a serious need in Australia for a comprehensive radio service manual covering circuits and operational data on Australian-built receivers.

The need is one that has grown more urgent as each succeeding year has brought with it new and more complex valves and circuits, and as the number of receivers in operation throughout the Commonwealth has grown to over a million. The voltmeter and screw-driver mechanic has now given way to the highly-trained serviceman, and the status of servicing has changed from that of an "orphan" occupation to a profession.

The urgent need for service data on Australian receivers has at last

been filled with the publication of the 1938 Australian Official Radio Service Manual. Published by the Strand Press, Brisbane, and edited by A. G. Brayne, A.M.I.R.E. (Aust.), this manual contains complete service data on standard 1937 receivers, with circuit diagrams.

**391 Pages And 16 Chapters.**

Comprising 391 pages, with 16 chapters, the subject matter is tabulated in a form calculated to be of simplest access to the serviceman. Chapter 1 acquaints the reader with the purpose and content of the manual, and outlines the simplest and quickest way of applying the information in the book. Recommended test equipment, with a brief outline of how to use it, is dealt with in Chapter 2.

**Includes Nearly 300 Circuits.**

Chapter 3 comprises the circuits and essential characteristics of nationally-known Australian brands of 1937 receivers. It includes circuit, voltage, and current analyses, and component values, enabling the serviceman to locate defective components in the shortest possible time. Close on 300 circuits are included, arranged alphabetically according to brands.

**Will Become More Valuable.**

A point worth while mentioning is that a book of this kind will not be out of date in twelve months' time; on the contrary, it will become more valuable as time goes on—as the receivers whose circuits it contains require servicing more frequently, and as service data on them becomes more difficult to obtain, as it does with obsolete and near-obsolete receivers.

**Subsequent Chapter Headings.**

Subject matter covered in the thirteen subsequent chapters is as follows:—Valve socket connections; radio symbols; servicemen's formulae; rapid calculating charts; radio interference, its cause, location and cure; air cells; accumulators; Standards Association rules and regulations for the installation of radio receivers; general service hints; electricity supplies available throughout Australia; public address equipment—its service and maintenance; the world's short wave stations; Australian and New Zealand broadcast stations; conversion tables.

Altogether, this new manual is packed with information of vital importance to every serviceman in Australia; information that is worth many times the price of 12/6 asked for the volume.

16-50 metre box) and adjust the oscillator gang (set) trimmer until a signal is obtained. Then adjust the aerial trimmer until maximum strength is obtained.

Next make certain that the fundamental and not the image signal is being used. Should it prove to be the image signal, the oscillator gang trimmer will require to be reduced (less capacity) until another (fundamental) signal is heard. Re-adjust the aerial trimmer and then seal. This completes all the adjustments necessary and leaves the set ready for installation in the cabinet.

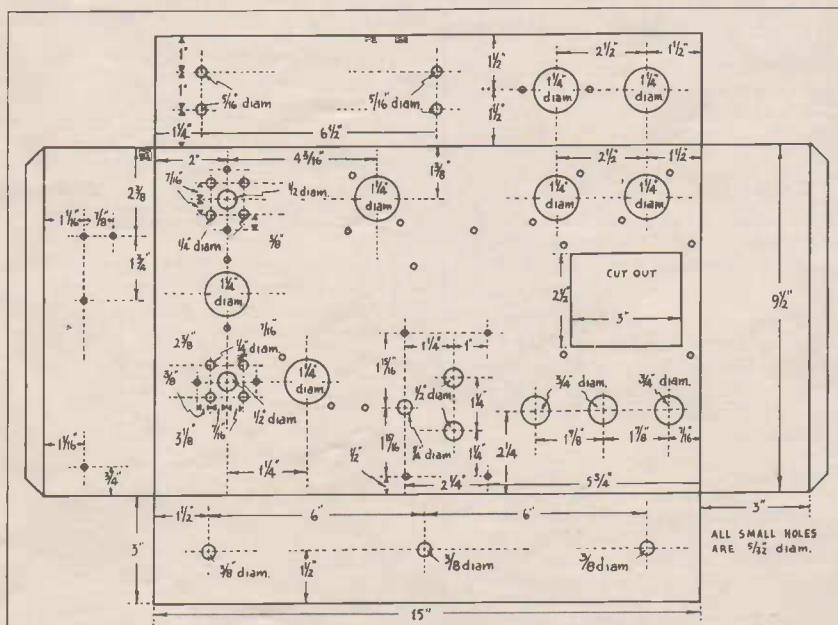

Dimensions for preparing the chassis are given in this sketch.

# DX News and Views

A page for  
letters from  
DX readers

## New French S.W. Station.

This month's issue of "R.W." is as usual very fine. Like many of my fellow-members, I am patiently awaiting verification, although this week I received several from the Cuban s.w. stations. Broadcast bands veris. received lately are as follows:—2NR, 2CH, 2MW, 2LF, 2FC, 2KO, 2NZ, 2CA, 3BA, 3TR, 3SR, 5SE, 5PI, 7NT and 1YA. Shortwave stations: 2AFP, 4NX, 4PL, 4RM.

Noteworthy in the above list is the card of 3BA, which maintains its frequency (1320 k.c.) to within .001%, and uses as an earth a radial mat comprising four miles of wire buried at a depth of one foot. VK4RM has a card with a view of the main street of Mackay as a background to the print. This station is a Wireless Reserve of the Royal Australian Air Force 4A6.

The Paris Mondiale, formerly "Radio Coloniale," is preparing new verification cards, which promise to be very attractive. At first Radio Coloniale broadcast through an old station erected at Pontoise near Paris, and operated since 1931 with an output of 12 k.w., wavelengths 19.68, 25.24, 25.60m. Since April 1, the new transmitter built at Les Essarts le Roi, also near Paris, with an output of 25 k.w. with directional antennas, broadcasts on 16.88, 19.83, 25.24 and 31.25, with two transmitters broadcasting at the same time. A 100 k.w. transmitter is now in the course of construction in the centre of France.

Our Official Observer for South Australia is to be congratulated on his suggestion re members' QSL Card Contest, and I trust all members with cards, no matter what they think their chances are, will send one along and swell the entries, which would, I am sure, give the greatest satisfaction to Mr. Linehan. So here is mine.—Gordon Young (AW245DX), Brisbane, Queensland.

★

## AW129DX Verifies W4XK On Nine-Metre Band.

I received a letter the other day from Mr. A. L. de Bruyne, who is the radio engineer at W4XK, the Durham Police Dept., North Carolina. Their transmitter is a Collins 150C, crystal-controlled with 100 watts to a half-wave vertical antenna. They

intend putting 15-watt transmitters in all their cruising cars very shortly. The following is a copy of a cutting from the Durham Sun."

## Durham Police Radio Again Is Picked Up In Australia .

### Calls Broadcast Here At Night Heard Across Pacific On Next Morning.

"The circle of foreign acquaintances of Durham's police radio station, W4XK, was extended to-day when a second Australian listener notified the Durham station that he had received messages sent from here.

"Anthony De Bruyne, radio engineer for W4XK, to-day received a letter from Jamie Ferrier, operator of a station at Coleraine, Victoria, Australia, stating that early in April he had heard calls being broadcast to Durham patrol cars.

"During the winter another radio operator in Melbourne wrote to de Bruyne that he had received W4XK's calls. The first overseas reception of local calls of which De Bruyne was in-

formed occurred last fall, when an amateur in Liverpool, England, caught a message. Ferrier seemed to have picked up the broadcasts more clearly than either of the others. He wrote that he had no difficulty in receiving the calls, stating that W4XK was about the loudest on the 9-metre police band that he has heard so far.

Two calls that he repeated had to do with instructions from the desk lieutenant to pick up drunks in two sections of Durham. Ferrier received the messages at 10.56 o'clock on the morning of April 3, but when they were broadcast it was 7.56 o'clock on the night of April 2 here."

"R. W." is the best radio book in VK.—Jamie Ferrier (AW129DX), Coleraine, Vic.

## 100 K.W. Paris-Mondiale Is Latest French Shortwave Station.

A noteworthy addition has been made to the number of powerful European short-wave stations, according to Philips Radio Press Service.

The new transmitter-Paris-Mondiale, situated at Essarts-le-Roi—was officially opened for international short-wave radio early in April, in the presence of the French Postmaster-General and Minister of the Colonies.

Paris-Mondiale, which is regarded by an enthusiastic French press as being the most modern short-wave station in the world, can attain a power of 100 k.w. with modulation. It is maintained that the twelve special aerials used, ranging in height from 49 to 80 feet, will operate with exceptional freedom from fading.

At present Paris-Mondiale is broadcasting daily on the following wavelengths and at the times (E.S.T. mentioned:—

16.88 m.	—11.30 p.m.-1.00 a.m.
19.68 m.	—8.00 p.m.-1.00 a.m.
19.83 m.	—9.00 a.m.-11.15 a.m.
25.24 m.	—11.30 a.m.-2.00 p.m.
	4.00 p.m.-7.00 p.m.
	1.00 a.m.-8.00 a.m.
25.60 m.	—9.00 a.m.-11.35 a.m.
	11.30 a.m.-2.00 p.m.
31.25 m.	—4.00 p.m.-7.00 p.m.
	1.00 a.m.-8.00 a.m.

## Looking Forward To "1938 Fidelity 8"

Like Donald A. Ashford, of Bowenfels, N.S.W., I have built the "Fidelity Eight," and agree that it is the finest set I have heard. I am using a Rola K12 speaker, and the tone of the set is everything that can be wished for, and every note is reproduced faithfully.

On the short waves I have logged London, New York, Berlin and Tokio, without any trouble. One afternoon about 5 p.m. London came in at 4.5 watts!

I am eagerly looking forward to the 1938 version of the "Fidelity Eight" because I am sure it will be a "knock-out" set.—L. M. Simpson, East Kew, E.5, Victoria.

★

The "De Luxe Fidelity Eight" is great, and may the 1938 version be likewise. Wishing your excellent publication continued success.—D. F. Locke, Binalong, N.S.W.



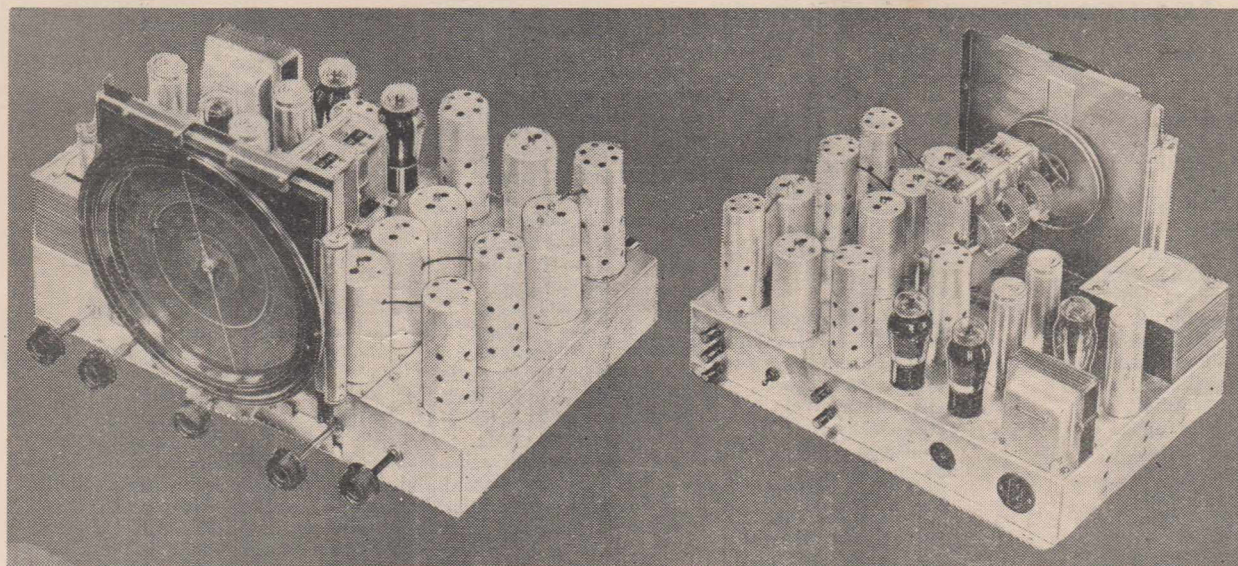

## “1938 De Luxe Fidelity Eight”

**F**EATURED above are two views of the 1938 “De Luxe Fidelity Eight”—an eight-valve dual-wave superhet with an r.f. stage, and incorporating a seven-watt high fidelity audio amplifier. Last year’s model of this receiver proved to be the most popular de luxe set ever described in “Radio World,” and some excellent reports have been received from build-

### Full Description Next Month: Also “Air-Ace Communications Four”

ers, including the two extracts published on page 46.

The 1938 model incorporates every up-to-the-minute improvement, and will undoubtedly prove even more

popular. Next month’s “Radio World” will contain a full description of the assembly, wiring, and alignment.

#### “Air-Ace Communications Four.”

Another receiver that will also be featured next month is the “Air-Ace Communications Four,” of which a general front view is shown alongside. A four-valve t.r.f. receiver, it has been designed to use the well-known Ray-mart shortwave components wherever possible, and as well is the first receiver to feature the new Rayway 15-600 Metre Amateur All-Wave Coil Kit.

#### Regenerative R.F. Stage Optional.

The “Air-Ace Communications Four” will be described for both battery and a.c. operation. As well, provision is made for the subsequent addition if desired of a regenerative r.f. stage, with a buffer valve ahead of the detector to prevent inter-locking between the ganged tuning circuits.

Readers are advised to make sure of obtaining their copies of this coming issue by ordering now—either from their nearest newsagent or direct from “Radio World,” 214 George Street, Sydney.

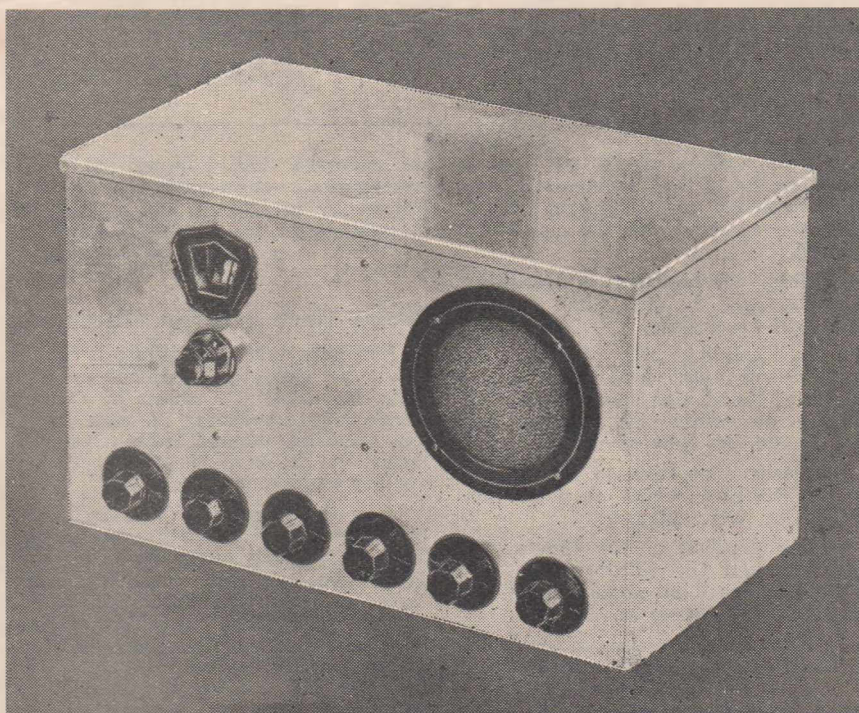

A general front view of the “Air-Ace Communications Four,” the six controls being two bandsetters, r.f. and audio gain controls, detector regeneration, and tone control.

## International Amateur Prefixes

AC4—Tibet.	FY8—Fr. Guiana.	OX—Greenland.	VR4—Brit. Solomon Is.
AR—Syria.	G—Great Britain.	OY—Faroe Is.	VR5—Tonga Is.
CE—Chile.	GI—Northern Ireland.	OZ—Denmark.	VR6—Pitcairn Is.
CM—Cuba (Code).	GM—Scotland.	PA—Holland.	VS1 VS2 VS3—Malaya.
CN—Morocco.	GW—Wales.	PI—Holland (Schools)	VS4—Borneo.
CO—Cuba (Phone).	HA—Hungary	PJ—Curacao.	VS5—Sarawak.
CP—Bolivia.	HB—Switzerland.	PK—Dutch East Indies.	VS6—Hong Kong.
CR4—Cape Verde.	HC—Ecuador.	PX—Andorra.	VS7—Ceylon.
CR5—Port Guinea.	HH—Haiti.	PY—Brazil.	VS8—Bahrain Is.
CR6—Angola.	HI—Dominican Republic.	PZ—Surinam.	VS9—Maldive Is.
CR7—Mozambique.	HJ, HK—Colombian Repb.	SM—Sweden.	VU—India.
CR8—Port India.	HP—Panama.	SP—Poland.	W—U.S.A.
CR9—Macao.	HR—Honduras.	ST—Sudan.	XE—Mexico.
CR10—Timor.	HS—Siam.	SU—Egypt.	XT, XU—China.
CT1—Portugal.	HZ—Hedjaz.	SV—Greece.	YA—Afghanistan.
CT2—Azores.	I—Italy.	TA—Turkey.	YI—Iraq.
CT3—Madeira.	J—Japan.	TF—Iceland.	YJ, FU8—New Hebrides.
CX—Uruguay	K4—Porto Rico, Virgin Is.	TG—Guatemala.	YL—Latvia.
D—Germany	K5—Canal Zone.	TI—Costa Rica.	YM—Danzig.
EA—Spain	K6—Guam, Hawaii,	U, UE, UK, UX—U.S.S.R.	YN—Nicaragua.
EA8—Canary Is.	Midway Is.	VE—Canada.	YR—Roumania.
EI—Irish Free State.	Samoa (U.S.A.), Wake	VK—Australia.	YS—Salvador.
EL—Liberia.	Is.	VO—Newfoundland.	YT, YU—Yugo-Slavia.
EP, EQ—Iran (ex-Persia).	K7—Alaska.	VP1—Brit. Honduras.	YV—Venezuela.
ES—Estonia.	KA—Philippine Is.	VP2—Dominica, Grenad-	ZA—Albania.
F3, F8—France.	LA—Norway.	St. Lucia, Antigua,	ZBI—Malta.
FA—Algeria.	LU—Argentine.	St. Kitts-Nevis.	ZB2—Gibraltar.
FB8—Madagascar.	LX—Luxembourg.	VP3—Brit. Guiana.	ZC1—Transjordan.
FD8—Togoland (French)	LY—Lithuania.	VP4—Trinidad & Tobago.	ZC2—Cocos Is.
FE8—Cameroons (French)	LZ—Bulgaria.	VP5—Cayman Is., Jamaica	ZC3—Christmas Is.
FF8—Fr. West Africa.	MX—Manchukuo.	Turks & Caicos Is.	ZC4—Cyprus.
FG8—Guadeloupe.	N—U.S.A. Naval Com-	VP6—Barbados.	ZC5—Palestine.
FI8—Fr. Indo-China.	munications Reserve	VP7—Bahamas.	ZD1—Sierra Leone.
FK8—New Caledonia.	Stations.	VP8—Falkland Is., South	ZD2—Nigeria, Cameroons
FL8—Somali Coast.	NY—Canal Zone.	Georgia.	(Brit.)
FM8—Martinique.	OA—Peru.	VP9—Bermuda.	ZD3—Gambia.
FN8—French India.	OE—Austria.	VQ1—Fanning Is.	ZD4—Gold Coast, Togoland
FO8—Fr. Oceania, Tahiti.	OH—Finland.	VQ2—Northern Rhodesia.	(Brit.)
FP8—St. Pierre & Miquelon	OK—Czecho-Slovakia.	VQ3—Tanganvika.	ZD6—Nyasaland.
FQ8—Fr. Equatorial Africa	OM—Guam.	VQ4—Kenya.	ZD7—St. Helena.
FR8—Reunion.	ON—Belgium.	VQ5—Uganda.	ZD8—Ascension.
FU8—New Hebrides.	OQ5—Belgian Congo.	VQ6—Brit. Somaliland.	ZE1—Southern Rhodesia.
		VQ8—Mauritius.	ZK1—Cook Is.
		VQ9—Seychelles.	ZK2—Niue.
		VR1—Gilbert & Ellice Is.	ZL—New Zealand.
		VR2—Fiji Is.	ZM—Western Samoa.
		(VR3—Fanning Is. Sug-	ZP—Paraguay.
		gested.)	ZS, ZT, ZU—South Africa.
			ZU9—Tristan da Cunha.

### "Radio World" Fifth Short-wave DX Contest Closes On May 1

The fifth "Radio World" Short-wave DX Contest will close on September 1, and entries can be forwarded at any time up to this date. The rules are as follows:—

1. For this Contest a trophy (a Replique World Globe with time converter, value 59/6) will be awarded to the reader who submits the best individual verification.

2. Verifications from any short-wave station between 5 and 100 metres may be submitted. Thus cards from broadcast, commercial, radio-phone and amateur transmitters are all eligible.

3. All verifications must bear a date (a post-mark on the card or enve-

lope will suffice where no date is given on the actual verification); and the frequency on which the station has been received must be clearly indicated.

4. Only verifications of reception between July 1, 1937, and closing date will be eligible.

5. In judging the entries, the judges will take into account the power of the station received, the frequency on which the station was heard, and the type of receiver used.

6. There is no limit to the number of verifications which may be submitted by any entrant.

7. The decision of the judges will be final; and the result of the fifth competition will be announced in the October, 1938, issue of "R.W."

8. All entries should be addressed to the Shortwave Editor, and should

be endorsed "DX Competition." All verifications submitted will be returned by registered post as soon as possible after the closing date.

—The Shortwave Editor.

### Home-Made Lead-In Insulators.

Excellent lead-in insulators can be made by using glass dishes or jars, but the difficulty arises in drilling large holes in them. I have found the following method quite successful, holes up to  $\frac{3}{8}$  in. in diameter being drilled without any difficulty.

A copper pipe, the diameter of the required hole is used in place of the drill, turpentine being used as a lubricant and sand as an abrasive. The work may be greatly facilitated by the use of a drilling machine, obviating the necessity of holding the drill in position.

# RADIO KITS and KIT SETS

## ... Special Low Prices

Here's a chance to save money — but act quickly. Limited stocks only are available, and prompt action is necessary to procure the bargains listed . . . in many cases, almost half regular prices. The kits listed are all complete, and comprise standard parts, brand new and fully tested. All prices include the complete kit with the necessary valves, speaker and, where required, "A" and "B" batteries.

### For Broadcasting Reception

This new 1937 kit incorporates every worth-while improvement. Improved quality, increased sensitivity and better performance.

#### The Velco MONEY - BOX A.C. 5

Pi-wound Litz coils with a Stromberg-Carlson condenser takes care of the tuning in. The valves used are 1 6A7, 1 6D6, 1 6D7, 1 42 and 1 80. For only £9/7/6 Vealls will supply the complete kit with Radiotron or Ken-Rad valves and Rola K8 speaker. Freight paid to your nearest Railway Station.

The price includes everything necessary.

**£9'7'6**

#### The Velco A.C. " SCOUTMASTER " FOUR

Everything to build the complete receiver, usual price £7/15/-.

**£6'2'6**

Here is an A.C. four valve superheterodyne of remarkable tone and efficiency at a ridiculously low price. This uses 6B7S valve as I.F. amplifier and diode detector, coupled directly to the 42 output tube. The price includes the complete kit, with Radiotron or Ken-Rad valves and Rola speaker, and . . . freight paid to your nearest Railway Station.

### THE VELCO

## FIDELITY A.C. FIVE

To those accustomed to ordinary reception, this Velco Fidelity kit set will come as an amazing revelation. The complete kit comprises everything necessary, and only first quality parts are supplied, giving results equal to that of a de luxe receiver, costing many times the amount.

With three to four watts undistorted output, this set is powerful enough for a small dance hall. The valves supplied are 1 6A7, 1 6B7S, 1 6C6, 1 2A3 and 1 80, whilst the speaker is the famous Rola K7. The complete Hi-Fidelity A.C. kit set is priced at only 14 guineas, and freight is paid to your nearest Railway Stn.

**DESIGNED FOR HIGH FIDELITY RECEPTION**

### ADVANCE 1937 DUAL WAVE A.C. FIVE

Everything necessary to build this Dual Wave receiver is included in the price.

Even the beginner can tackle this set with a certainty of success. The valves supplied are 1 EK2, 1 6D6, 1 75, 1 42 and 1 80. The speaker being a Rola, and the price for the complete kit set, with valves and speaker, only £11/12/6, freight paid to your nearest Railway Station. Write for full constructional details.

**£11'12'6**

### " MONEY - BOX " DUAL WAVE BATTERY 5

Here's a Dual Wave five valve battery kit set, complete with Radiotron or Ken-Rad valves, heavy duty "B" batteries, 2 volt 110 amp. accumulator, and Rola speaker for only £12/19/6. You save pounds when you purchase this kit. Everything necessary to build the complete chassis is embodied in the price.

**£12'19'6**

## THE PRE - SELECTED MELODIOUS THREE

For only £8/10/-, Vealls will supply the complete kit of parts to build the Pre-Selected Melodious Three, as described in Listener In Handbook No. 10. This price includes the necessary valves, heavy duty "B" batteries, and 2-volt 100 amp. accumulator, together with a Rola speaker. Only three of these kits are available, so act quickly.

Everything necessary to build the complete kit is included in the price.

**£8'10'-**

Vealls pay freight on this kit anywhere in Victoria.

### VEALLS PAY FREIGHT

Vealls pay freight on all Victorian retail orders excepting cabinets, and on all Interstate orders excepting batteries and cabinets.

### THE FASTEST MAIL ORDER SERVICE IN AUST.

# VEALLS

RADIO and  
ELECTRICAL

# STORES

ADDRESS ALL CORRESPONDENCE TO BOX 2135, G.P.O., MELBOURNE.

490 ELIZABETH STREET, MELBOURNE.  
168 SWANSTON STREET, MELBOURNE.  
243 SWANSTON STREET, MELBOURNE.

'Phone F 3145 (6 lines)

299 CHAPEL STREET, PRAHRAN.  
97 PUCKLE STREET, MOONEE PONDS.  
3-5 RIVERSDALE ROAD, CAMBERWELL.

**BETTER RADIO IN THE MAKING**

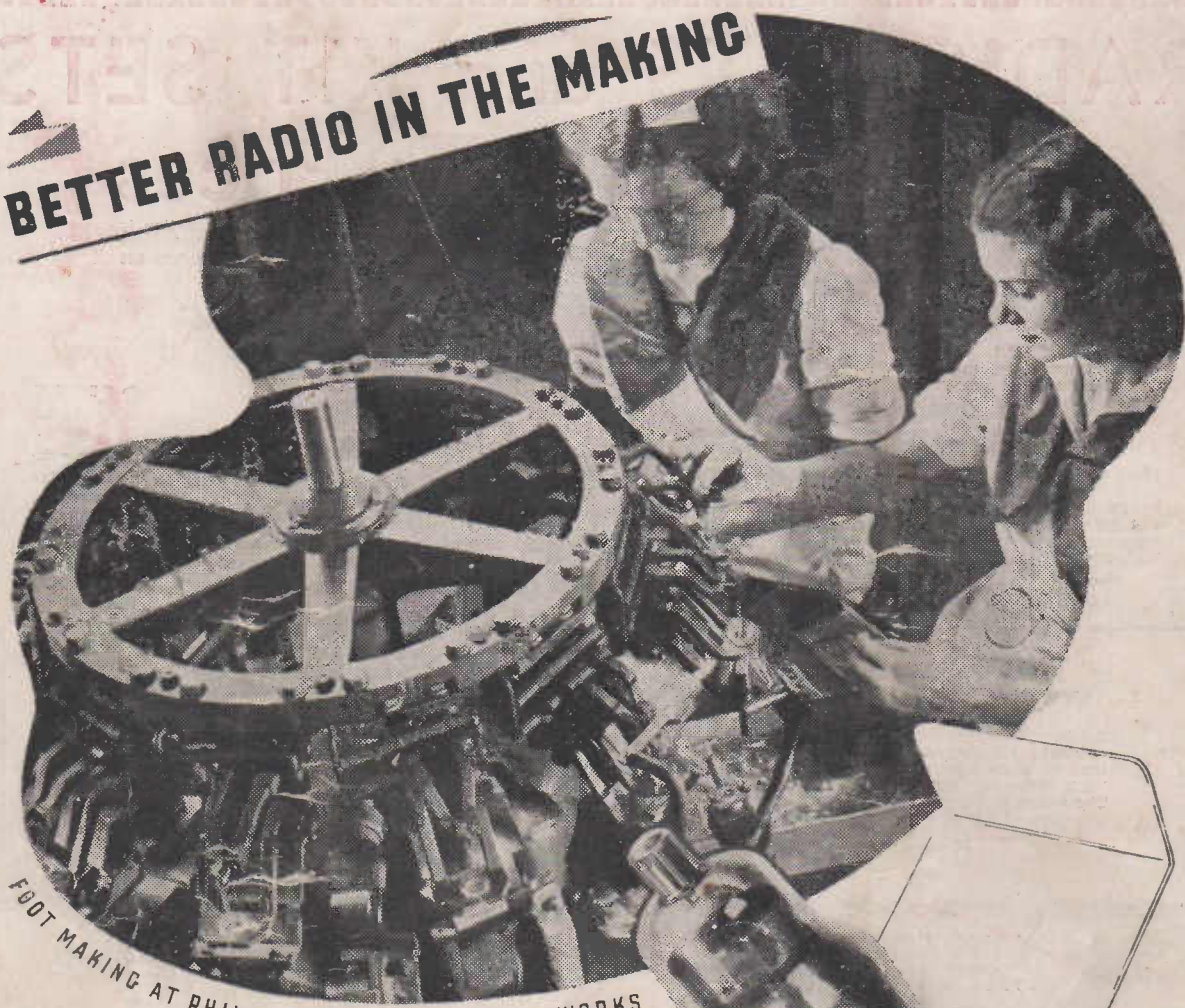

FOOT MAKING AT PHILIPS AUSTRALIAN VALVE WORKS

**T**INY metal supports and a glass flange are welded by this machine into a complete "foot" upon which the elements of the valve are subsequently mounted. It's just one of the interesting processes in the making of valves in the Philips Australian Valve Factory.

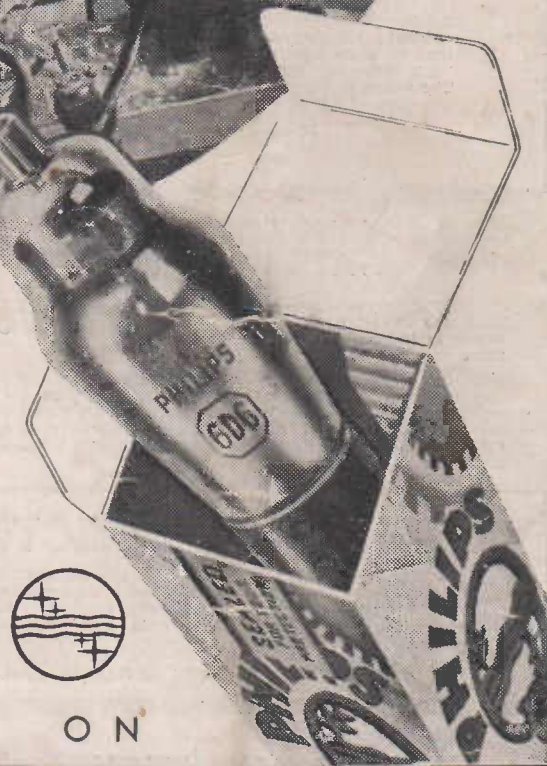

ALWAYS INSIST ON

# PHILIPS VALVES

MADE BY THE MAKERS OF THE FAMOUS PHILIPS LAMPS

(Advt. of Philips Lamps (Australasia) Pty. Ltd. (Radio Dept.), Head Office & Showrooms, Philips House, 69-73 Clarence St., Sydney)7V10