

THE  
AUSTRALASIAN

NOVEMBER 1, 1937  
VOL. 2 — NO. 7  
PRICE, 1/6

# Radio World

Entered at the P.O.,  
for transmission  
post as a periodical

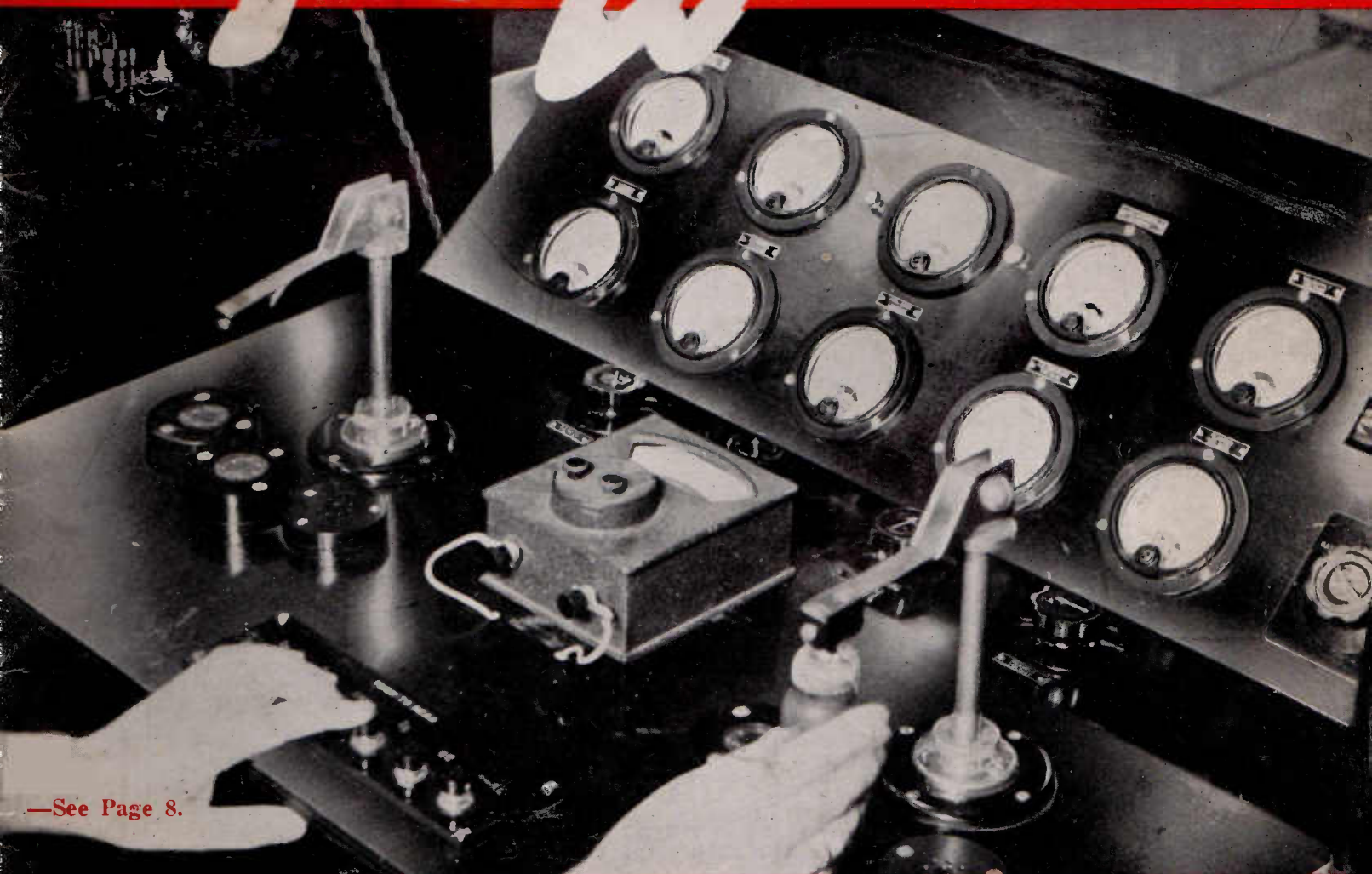

—See Page 8.

- "DE LUXE FIDELITY EIGHT": MORE ABOUT THE "1937 OUTDOOR
- PORTABLE FOUR": USING THE 1C6 ON SHORTWAVE: BREAKING INTO
- THE AMATEUR GAME: RESULT OF THIRD SHORTWAVE DX CONTEST.

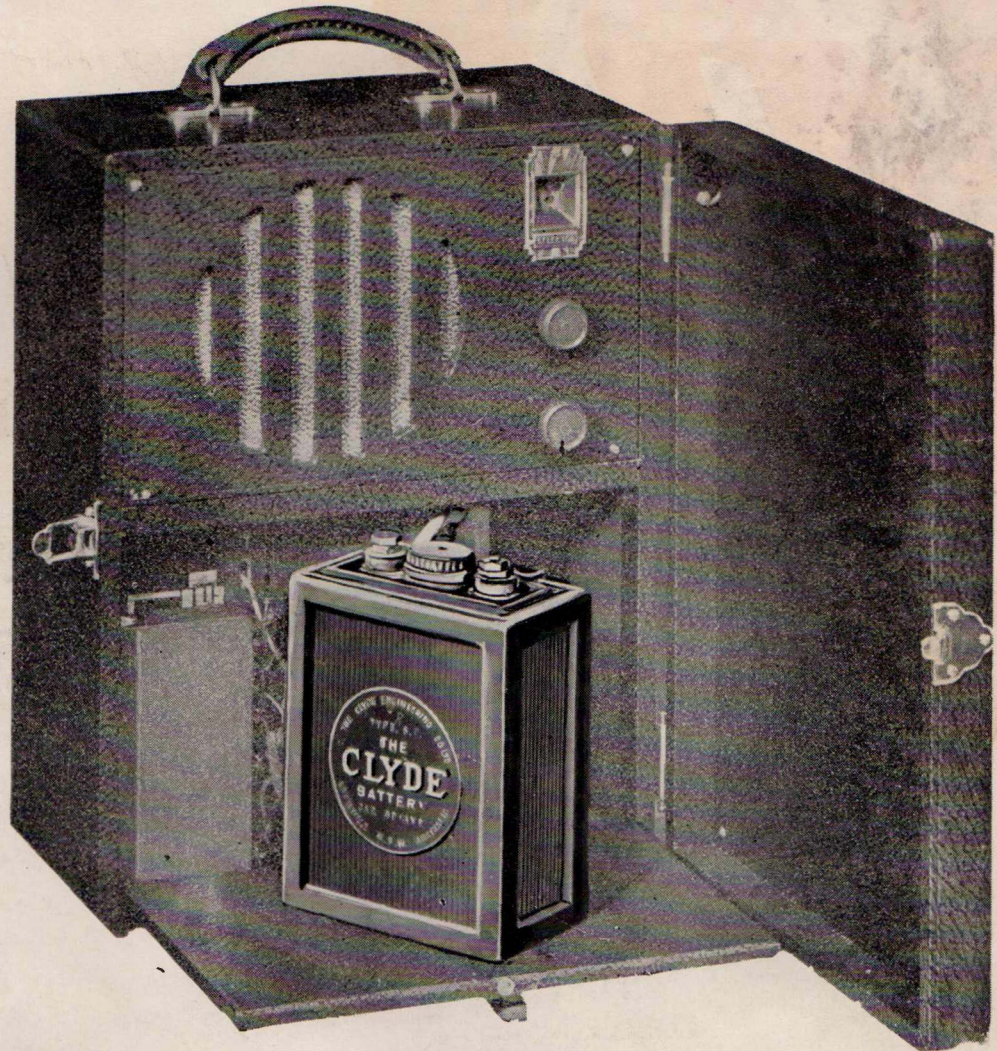

## For Better Reception **CLYDE** RADIO BATTERIES

**F**OR their silent, smooth-flowing power that ensures best possible results . . . for the remarkable endurance they possess under the most stringent of operating conditions . . . for the all-round excellence of their sturdy construction . . . **CLYDE RADIO BATTERIES** are second to none.

Federal and State Governments show their confidence in Clyde by placing large orders for Clyde's batteries year after year. Clyde Batteries are used exclusively by

the Royal Australian Navy for gun and fire control. Battery failure in wartime could prove disastrous, therefore the Navy relies on Clyde.

From the smallest 2 volt 25 amp. hour 2VS5 to the 6 volt 160 amp. hour "Super" for vibrator receivers, there is a range to suit all radio needs, **AND ALL CLYDE RADIO BATTERIES ARE FULLY GUARANTEED. FOR THE FINEST BATTERY BUILT, INSIST ON CLYDE.**



### **CLYDE BATTERIES**

(type 2VS7) are specified exclusively for the 1937 Outdoor Portable Four described in this issue (Page 3).

# **THE CLYDE ENGINEERING CO. LTD.**

61-65 Wentworth Avenue, Sydney.

Assoc. Distributors: Hipsleys Pty. Ltd., 27-45 Palmer Street. FL 4141.

Obtainable from all Leading Garages and Radio Dealers throughout Australia.

# THOROUGHLY Dependable

## REPLACEMENTS

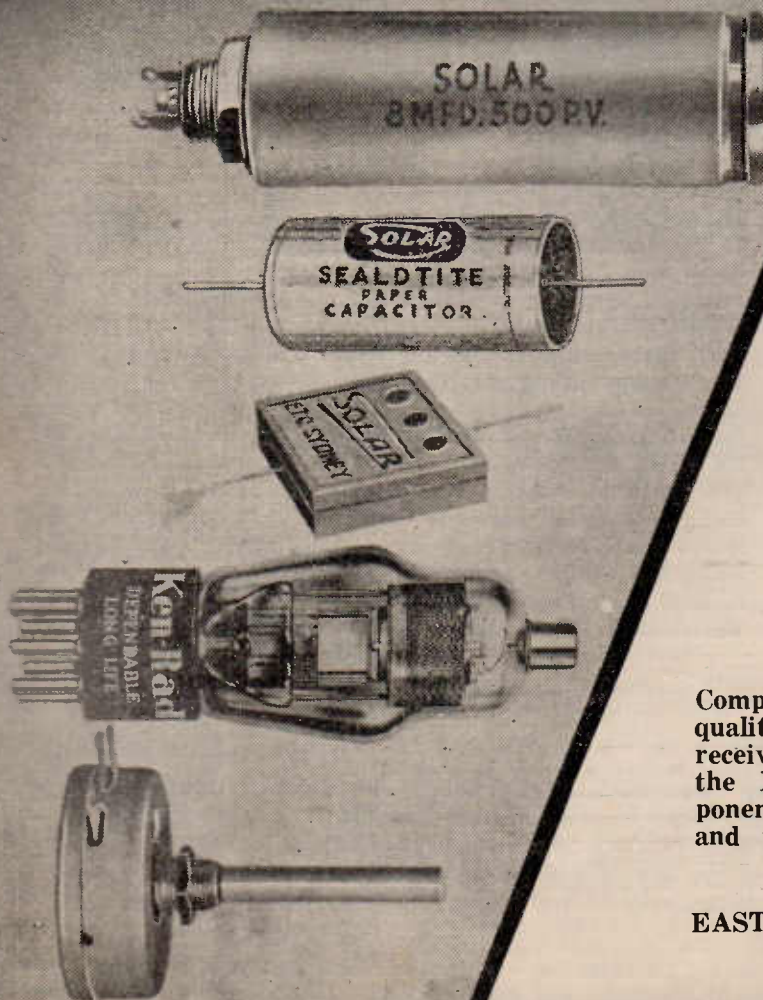

*Insist on---*

### **SOLAR**

Electrolytic Condensers

"Sealtdite" Paper  
Capacitors

Mica Capacitors

RELIABLE IN EVERY  
CLIMATE

### **YAXLEY**

SWITCHES AND  
POTENTIOMETERS

### **KEN-RAD**

THE FINE VALVES  
OF RADIO

Component parts with the high quality necessary for modern radio receivers can always be found in the E.T.C. range. Every component is unsurpassed in its sphere and will give long and faithful service.

EASTERN TRADING CO. LTD.  
Sydney & Melbourne.

**5 to 500 ohms**  
**IN 1/4-WATT**  
**CARBON**  
**RESISTORS!**

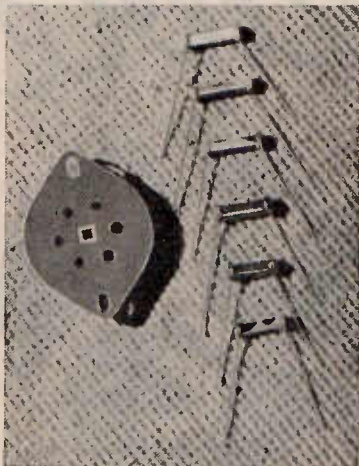

**BIFROST**  
**triumphs again!**

The wide range of BIFROST high-grade carbon resistors available has now been extended to include values of 5 to 500 ohms, in 1/4-watt and 1/2-watt ratings. Compact, noise-free, and with a guaranteed tolerance of plus or minus 10 per cent., these latest BIFROST resistors are ideal for cathode bias purposes for R.F., mixer, and I.F. stages. Another recommended use is to provide automatic bias for battery receivers.

For resistors that can be depended on to give noiseless, trouble-free operation, insist on BIFROST.

Following stringent tests applied to recognised makes of resistors, Bifrost have been chosen as standard by receiver manufacturers throughout Australia — undoubted proof of their superiority.

**BIFROST**  
**CARBON RESISTORS**  
 Manufactured in Australia by  
**WM. J. MILLS**

187 Catherine Street,  
 Leichhardt, N.S.W.  
 'Phone: Pet. 2191.

**THE AUSTRALASIAN**  
**RADIO WORLD**

Incorporating the  
**ALL-WAVE ALL-WORLD DX NEWS.**

Managing Editor:  
 A. EARL READ, B.Sc.

Vol. 2.

NOVEMBER, 1937.

No. 7.

**CONTENTS:**

De Luxe Fidelity Eight .....	3
Valve Manufacture In Australia .....	8
Radio Ramblings .....	10
W.I.A. National Field Day On Dec. 4 .....	13
Breaking Into The Amateur Game (10) .....	14
Round The N.Z. "B" Stations (5) .....	18
The 1937 Outdoor Portable Four .....	20
25 Years In Amateur Radio (7) .....	24
Radio Step By Step (12) .....	26
Improved Operating Conditions For 1C6 On Shortwave .....	28
What's New In Radio .....	32
New Adelaide Station Has Up-to-date Transmitter .....	36
The All-Wave All-World DX News .....	37
Shortwave Review .....	38
Second "Radio World" S.W. Contest .....	39
DX News And Views .....	41
Ten Thousand Miles On Five Metres .....	42
Radio Aids Flying Doctor In Outback .....	43
Round The Shacks (4) .....	45
Shortwave Station Addresses .....	46
E. Neill Wins First S.W. DX Contest .....	47
VK Amateur Transmitters—Additions And Amendments ..	48

The "Australasian Radio World" is published monthly by Trade Publications Proprietary, Ltd., Editorial offices, 214 George Street, Sydney, N.S.W. Telephone BW 6577. Cable address: "Repress," Sydney. Advertisers please note that copy should reach office of publication by 14th of month preceding that specified for insertion.

Subscription rates: 1/- per copy, 10/6 per year (12 issues) post free to Australia and New Zealand. Subscribers in New Zealand can remit by Postal Note or Money Order.

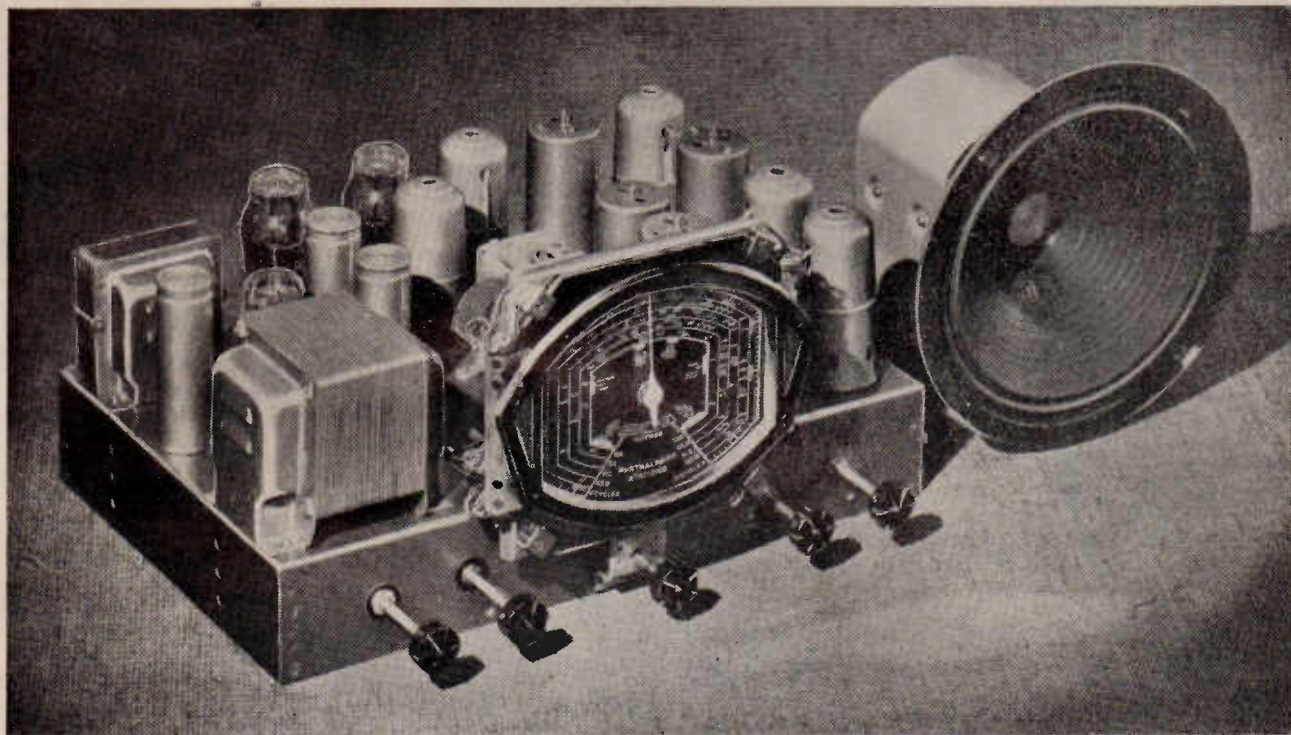

A general view of the completed receiver, with one of the latest Amplion Model "T" auditorium speakers on the right.

## The . . . De Luxe Fidelity Eight

**T**HE "De Luxe Fidelity Eight" has been designed in response to many requests from readers wishing to build a more powerful dual-wave version of the "Fidelity Broadcast Five," described in the January and February issues of the "Radio World."

Designed primarily for high quality of reproduction, the latter receiver used an audio channel comprising a 6C6 high-gain voltage amplifier driving a single 2A3 in the output. In this way, pentode sensitivity was combined with triode quality in an ideal arrangement that gives over 3 watts of high fidelity output at low cost.

### Seven Watts Of Distortionless Output

For the "De Luxe Fidelity Eight" pushpull 2A3's are used, the audio amplifier being one developed recently by Amalgamated Wireless Valve Co. Pty. Ltd., and described in the August "Radio World." A power output of 7 watts, with a total harmonic distortion not rising above the unusually low figure of 2.5 per cent. under all conditions, is obtainable. Thus, fidelity of reproduction is exceptionally good; in fact, for all practical purposes the output can be regarded as distortionless.

**An eight-valve dual-wave superhet with r.f. stage, and incorporating a seven-watt high fidelity audio amplifier using push-pull 2A3's in the output. A de luxe design giving exceptionally high quality of reproduction, combined with excellent sensitivity and selectivity.**

In this amplifier, a 6C6 is used as a high-gain resistance coupled pentode, followed by a similar valve operating as a triode phase splitter, equal resistors being used in the plate and cathode circuits.

### Elaborate Smoothing Ensures Minimum Of Hum

The circuit of this amplifier as published in the August issue is followed in its entirety in the "De Luxe Fidelity Eight." Adequate filtering for the power supply is obtained by the use of a two-stage filter, comprising a 30 henry 150 m.a. smoothing choke and 750-ohm speaker field. A 300-ohm 200 m.a. wirewound resistor and three 8 mfd. 600-volt working wet electrolytics complete the smoothing, which is so effective that with the amplifier fully opened up, no trace of hum can be heard three feet away from the speaker.

The high tension supply for the two 6C6's is derived from the first

stage of the filter, so that the 2A3's can be fully loaded, a peak voltage from grid to grid of 90 volts being required for full output.

The amplifier as a whole thus uses standard components without involving any heavy expense for a high fidelity audio transformer. Sensitivity is ample, while the frequency response is wider and the harmonic distortion lower than that given by any broadcast station.

### The Tuner Section

The circuit of the tuner portion follows closely that of the "Fidelity Broadcast Five," except that an additional 6D6 r.f. stage has been incorporated. As well, a Foxradio three-stage dual-wave coil unit has been used, in conjunction with two iron-cored i.f. transformers to ensure adequate gain and selectivity. This kit is simple to wire and align, and as well gives very even tracking over both wavebands.

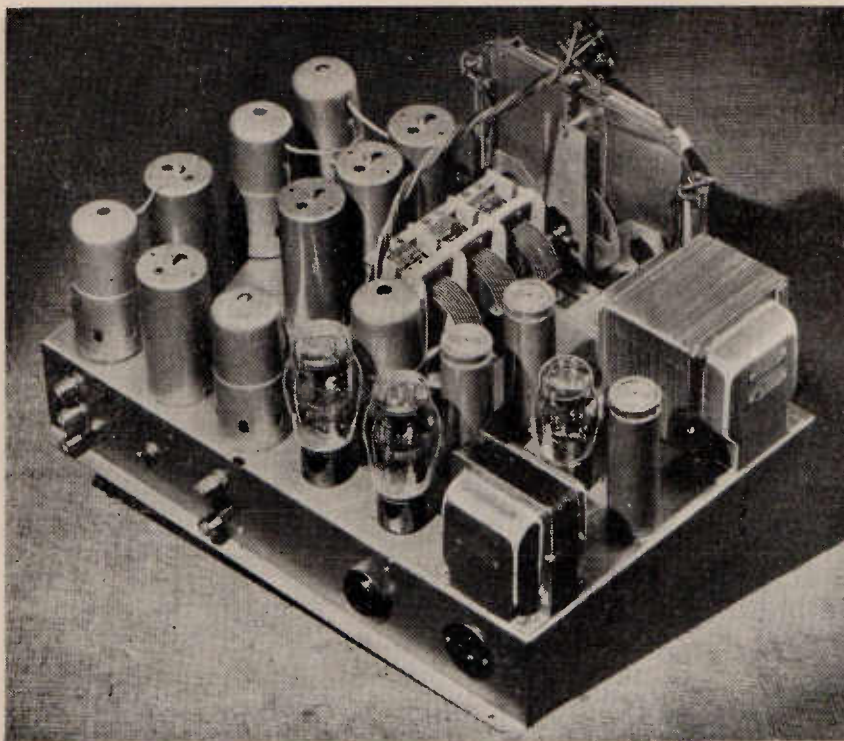

A rear view of the "De Luxe Fidelity Eight," with the 30-henry 150 m.a. smoothing choke in the foreground. The circuit is shown below.

**Complete Cut-Off On Pick-Up**

This control also has another valuable use. It has been found that when a pick-up is being used, the double-pole double-throw "pick-up" switch provided does not ensure complete cut-off with all valves in the tuner stage working at maximum sensitivity. However, with the sensitivity control turned right back there is not the slightest sign of "break through."

The five controls shown in the photograph at the head of this article are, left to right, tone control (incorporated in plate circuit of first 6C6), r.f. gain control, tuning, wave-change switch and volume control.

The parts required for building the "De Luxe Fidelity Eight" are listed elsewhere. A steel chassis 18" x 11 1/2" x 3" is required, stamped to specifications, together with two small steel brackets. The latter are used for mounting the tone and volume controls towards the rear of the chassis, thus avoiding long straggling leads.

The chassis, coil and valve cans, wet electrolytics, together with the power transformer and smoothing choke, are all sprayed dark blue in the original model, giving a unique and very attractive finish to the completed receiver.

A 150 mill. power transformer is required, delivering 385 volts either side of the centre tap. Heater windings are 5v. 2a. (for the 83V rectifier), 2.5v. 5a. (for the 2A3's), and 6.3v. C.T. 2a. for the remainder of

Sensitivity is particularly high—in fact, the set rarely needs to be opened "full out." Any station providing a signal powerful enough to ride in over the noise level can be brought in at full speaker volume.

**Sensitivity Control A Desirable Feature**

As an alternative to introducing automatic noise suppression, a sensitivity control has been incorporated, acting on the r.f. and mixer stages. This is intended purely for local re-

ception, and is a refinement that is well worth while.

When local stations only are required, the control is turned back a little, thus eliminating the objectionable inter-station mush that is automatically brought in when the a.v.c. goes out of action between stations. This control, incidentally, should be turned back just sufficiently to provide the required effect, the volume of individual stations then being controlled by the .5 megohm potentiometer acting as diode load resistor.

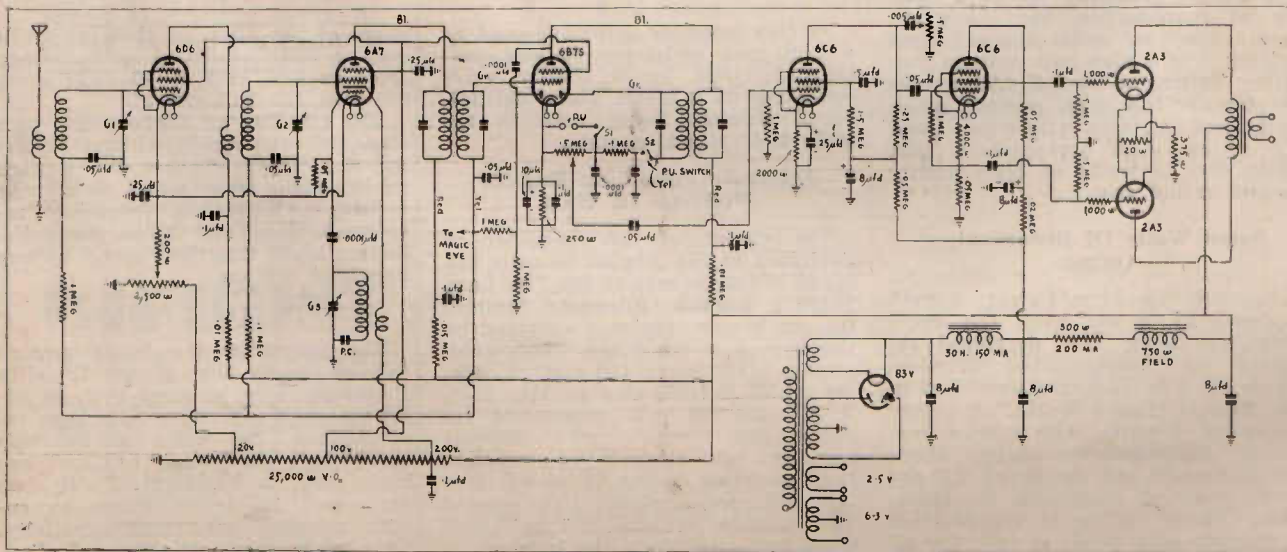

# "DE LUXE FIDELITY EIGHT"



• • **great in everything but price**

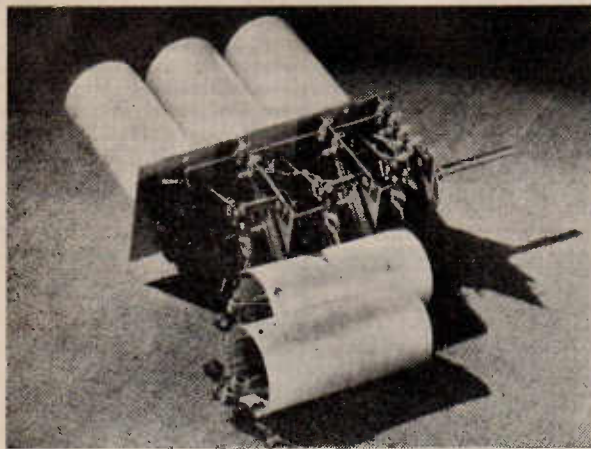
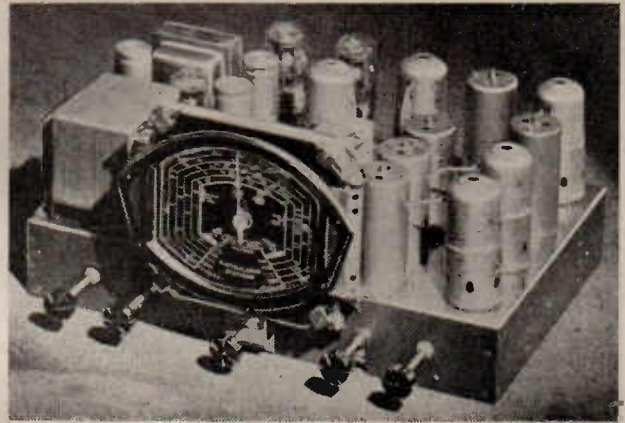

Newest and greatest of all "Radio World" achievements is this "De Luxe Fidelity Eight," using a special FOXRADIO coil kit.

Never before have we been able to offer a receiver combining so many outstanding features—razor-edged selectivity, amazing sensitivity, tremendous power, and superb quality of reproduction make this set easily one of the most outstanding performers yet designed in this country.

The FOXRADIO Coil Kit with which this receiver was built gives excellent results and greatly simplifies construction. It comprises Aerial, R.F. and Oscillator Coils with Switch, two Iron-cored Intermediates, 465 k.c.

Complete Coil Kit ..... **£5/10/-**

Call in or write for our quote  
and list of parts for  
the complete kit.

# FOXRADIO

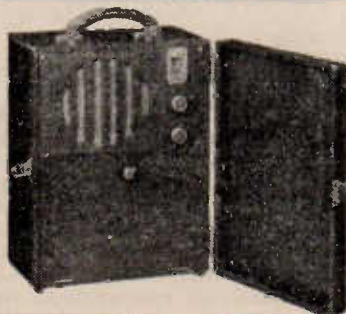

## New and Improved "Portable"

The 1937 "Outdoor Portable Four" is the finest receiver of its type ever offered to home constructors. More compact, more powerful than last year's "Portable," it features many new improvements, including: Full Automatic Volume Control, improved aerial system, simplified chassis layout, and greatly improved tone. Write for our quote and list of parts.

**FOX & MacGILLYCUDDY PTY. LTD.**

MERINO HOUSE, 57 YORK STREET, SYDNEY.  
Telephone: B 2409-10 . . . . . Telegrams: Foxradio.

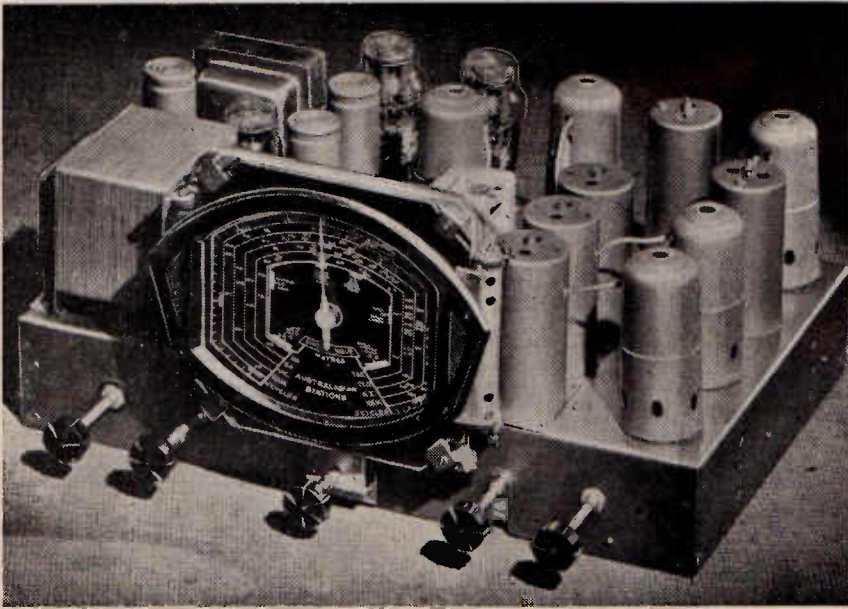

Another front view of the "Fidelity Eight," taken from a different angle to show the layout of the tuner section of the receiver.

the valves and dial lights. A 30-henry 150 mill. smoothing choke is also required.

The Foxradio coil kit specified is designed to track with the Efco full-vision dial shown in the photographs.

#### Choosing A Speaker

One of the main considerations is the type of speaker to be used. That illustrated is the latest Amplion auditorium Model "T," which will handle comfortably an output of up to 10 or 12 watts with excellent quality of reproduction. It is fitted

with the new Amplion multi-impedance transformer, which enables the speaker to be accurately matched to any single or pushpull output valve or valves. Using a 750 ohm field as specified, the field dissipation is approximately 14 watts.

Another speaker that can be recommended without reservation is the new Rola "G12" Wide Range 12" model. Up to 18 watts can be dissipated in the field, and so the 750-ohm field as specified can be used.

Two less expensive alternatives are the Amplion model "SA" 10-inch and the Rola "K12" 12-inch. As the fields of these speakers will not dissipate more than a maximum of 12 watts with safety, some provision has to be made for limiting the current passing. The best plan is to use a 1,000-ohm field and to connect in parallel across it a 1,500-ohm 100 m.a. wire-wound resistor, thus reducing the power to be dissipated in the field to about 9.5 watts. All four speakers mentioned above will comfortably handle the full output from the "De Luxe Fidelity Eight."

For **CAR OWNERS** too, the exclusive quality of...

## Rola reproduction

Long recognised as affording maximum performance and dependability in sound reproduction, it is but logical that Rola speakers are standard equipment for leading makes of car radio sets throughout the world. The development of types of speakers necessary for satisfying operation of car radio apparatus was pioneered by Rola . . . another of the famous "Rola Firsts!" To-day, by reason of specialised experience and world-wide resources, Rola speakers cater for those who demand the best in car radio performance. And, further, Rola is best able to produce special types of speakers required by builders of special apparatus. Enquiry is invited from interested manufacturers.

FOR CAR RADIO, SPECIFY THE WORLD'S  
FINEST SOUND REPRODUCERS

# ROLA

Distributors and Factory Service for N.S.W.: GEO. BROWN & CO. LTD., 267 Clarence St., Sydney (Phone: M 3437).  
Distributors for Victoria: A. J. VEALL PTY. LTD., 243-249 Swanston Street, Melbourne, C.1. (Phone: C 3053).  
Made and Guaranteed by the ROLA COMPANY (AUST). PTY. LTD., 77-83 City Rd., South Melbourne, S.C.4, Vic.



THE  
RADIO  
PIONEERS

# Fear's Radio News

F. J. W. FEAR & CO. - - - - 31 Willis Street, Wellington  
New Zealand :: Telegrams: "FEAR"

FEAR'S  
FOR  
EVERYTHING  
IN RADIO

An Advertisement inserted by F. J. W. FEAR & CO., New Zealand.

## De Luxe Superhet Gives Amazing Tonal Realism

**Seven Watts Of High Fidelity Output From Latest World-Range Eight-Valve Superhet.**

For sensitivity, selectivity and volume, but above all for sheer tonal beauty, the "DE LUXE FIDELITY EIGHT" described this month is unrivalled.

An output of seven watts, giving ample volume to fill a dance hall, can be obtained from the high fidelity audio amplifier. Other attractive features include provision for pick-up and doublet aerial, R.F. gain control, and latest 6U5 magic eye tuning indicator. The ideal receiver for the discriminating set-builder.

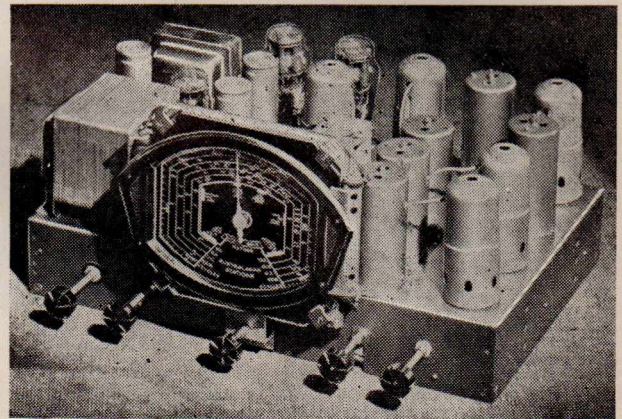

WRITE FOR OUR DETAILED QUOTE.  
Every Part Guaranteed as Specified.

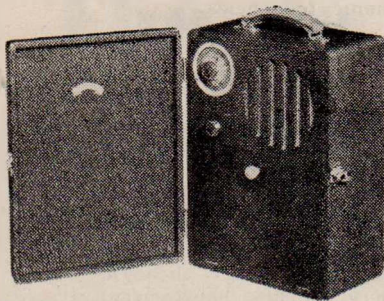

### "1937 OUTDOOR PORTABLE FOUR"

Built your "1937 Outdoor Portable" yet? If not, then you've just comfortable time to buy your kit and complete the assembly of this amazing receiver before the Christmas holidays. Wherever you're going, whatever you're planning to do, take an "Outdoor" along with you and have radio "on tap" day or night.

Exceptionally sensitive and giving plenty of volume, the "1937 Outdoor" will out-perform many battery sets twice its size. AND it is economical to run, the average "B" drain during the life of the set being only 6 mills.

WRITE FOR OUR DETAILED QUOTE.  
Every Part Guaranteed as Specified.

### "TOM THUMB ALL-WAVE PORTABLE TWO"

Those wanting a portable for head-phone reception only will find the "Tom Thumb" ideal.

Compact, and weighing under 12 pounds complete, it can be taken anywhere—to the city, seaside or bush—and is instantly available for use. With low "A" and "B" drain, the batteries will last for months, and are cheap to replace.

Our kit of parts for the "Tom Thumb Portable Two" is exactly as specified by the designer, and includes everything listed—case, batteries, valves, and all accessories.

WRITE FOR OUR DETAILED QUOTE.



### ANOTHER MICROMATIC KIT-SET!

Only the designers of the revolutionary Micromatic Tuning Unit could produce such a receiver as the "De Luxe Metal Miracle Ten." Uses 6L6 beam power valves with inverse feedback, giving 25 watts output. Frequency compensated tone control—all-wave coverage from 15 to 550

metres—large, oval, accurately-calibrated dial—metal valves. 100 per cent. results are assured with the Micromatic factory-adjusted and guaranteed coil unit.

Complete kit with valves and power supply ..... £33/15/-

With valves, power supply and Magnavox Model 305 speaker ..... £40/-/-

WRITE FOR FURTHER DETAILS—SENT FREE BY RETURN POST.



### "EMPIRE ALL-WAVE THREE"

Described in the May and June issues of the "Radio World," the "Empire All-Wave Three" is proving exceptionally popular.

Tunes from 12 to 600 metres with standard two-gang condenser. Uses latest 1K4 screen-grid detector with electron-coupled regeneration. Low "A" and "B" drain, giving low initial and running costs. Automatic bias is used, no "C" battery being required. Complete kit of parts £10/-/- (including batteries, valves, speaker and 'phones).

**"DE LUXE FIDELITY EIGHT"**

## LIST OF PARTS

- 1—Steel chassis to specifications (18in. x 11½ in. x 3in.) with two small steel brackets.  
 1—Power transformer to specifications (385v. C.T. 385v. 150 ma., 5v. 2a., 2.5v. 5a., 6.3v., 3a.) (Radiokes).  
 1—Smoothing choke to specifications (30 H. 150 m.a.) (Radiokes).  
 1—Dual-wave coil unit, with 2 iron-core intermediates (Foxradio).  
 1—3-gang condenser (Stromberg-Carlson).  
 1—Full-vision dial (Efco).  
 8—Socket, 2—7, 3—6, 3—4-pin wafers (Stromberg-Carlson).  
 1—5-pin speaker socket.  
 1—Power socket and plug.  
 5—Valve shields.  
 2—5 megohm potentiometers (Yaxley).  
 1—2,500 ohm potentiometer (Radiokes, Microhm).  
 1—25,000 ohm voltage divider (Radiokes).  
 1—Single-pole double-throw toggle switch.  
 5—Knobs.  
 1—Length power flex and plug.  
 5—Terminals, 3 red, 2 black (Dalton).  
 1—3in. rubber grommet.  
 5—Grid clips.  
 2—Feet tinned copper braid.  
 2—Extension shafts.  
 2—Flexible couplers.  
 2—12in. lengths 3in. brass rod.  
 2—4in. bushes.
- FIXED CONDENSERS:—**  
 4—.0001 mfd. (Simplex PT).  
 1—.005 mfd. (Simplex PT).  
 5—.05 mfd. (Solar).  
 7—.1 mfd. (Solar).  
 2—.25 mfd. (Solar).  
 1—.5 mfd. (Solar).  
 2—.8 mfd. dry electrolytics (Solar).
- 1—10 mfd. dry electrolytics (Solar).  
 1—25 mfd. dry electrolytics (Solar).  
 3—8 wet electrolytics, 600v. working (Solar).
- RESISTORS —**  
 1—200 ohm 1-watt (E.T.C.).  
 1—250 ohm 1-watt (E.T.C.).  
 2—1,000 ohm 1-3 watt (E.T.C.).  
 1—2,000 ohm 1-watt (E.T.C.).  
 1—4,000 ohm 1-watt (E.T.C.).  
 2—10,000 ohm 1-watt (E.T.C.).  
 1—15,000 ohm 1-watt (E.T.C.).  
 1—20,000 ohm 1-watt (E.T.C.).  
 4—50,000 ohm (1—1-3 watt) (E.T.C.).  
 3—100,000 ohm (2—1-3 watt) (E.T.C.).  
 1—250,000 ohm 1-watt (E.T.C.).  
 3—500,000 ohm 1-watt (E.T.C.).  
 3—1 megohm 1-watt (E.T.C.).  
 1—1.5 megohm 1-watt (E.T.C.).  
 1—20 ohm wirewound C.T. (Rentrade).  
 1—300 ohm wirewound 200 m.a. (Rentrade).  
 1—375 ohm wirewound 150 m.a. (Rentrade).
- VALVES.—**2—6C6, 1—6D6, 1—6A7, 1—6B7S, 2—2A3, 1—83V (Radiotron, Mullard, Ken-Rad, Raytheon, Philips).
- SPEAKER.—**1—Dynamic speaker to match P.P. 2A3's, 750 ohm field (Amplion Rola).
- MISCELLANEOUS.—**4—6.3v dial lights; push back; 2 bakelite terminal strips (double); 1—single lug strip; 2 feet 4 mm. spaghetti; solder tags; nuts and bolts.

## Further Details Next Month

Next month a further article will be published outlining the assembly and wiring of the receiver. Instructions will also be given as to the method of connecting up the new 6U5 electron ray tuning indicator that has just been released.

Sketches will be published showing complete wiring of the coil unit, though at the moment it is not intended to include a complete under-chassis wiring diagram. However, if there are any readers who would like to build this receiver, but who are perhaps doubtful of their ability to wire a set of this type from a circuit diagram, then one will be prepared.

## Handy "A" Circuit Tester

This gadget costs only a few pence, but over a period of years will save the owner many pounds' worth of valves. A 60 m.a. fuse bulb is wired in an old valve base, which is then filled with candle grease or sealing wax. The leads from the globe are soldered to the filament pins.

Before inserting the valves in a newly-wired battery set, plug this gadget in a socket. If the globe lights up and does not burn out, it is safe to plug in the valves.—C. F. Frost (AW22DX), Seymour.

**Valve Manufacture In Australia****This Month's Front Cover**

This month's cover photograph shows one of the many test sets in use in the factory of Amalgamated Wireless Valve Company Pty. Ltd. at Ashfield, where Radiotron valves are made. The many delicate measuring instruments ensure that each valve is correctly constructed and that the electrical characteristics conform to the published values, so that all Radiotron valves bearing the same type number may be inter-changed without any effect on the performance of the receiver.

Not only are tests made for such items as plate current and total emission, but delicate tests are also made for gas and for leakage from the grid to the other electrodes. On certain types, additional tests are made for grid emission, and under these conditions the valves are seriously over-run under the worst possible conditions so that the slightest trace of trouble of this kind may be detected.

Valves are also tested for heater-to-cathode leakage in the

case of all indirectly-heated valves, so that no leakage may occur between these electrodes and so that hum may be eliminated. It is not always realised that leakage between the heater and cathode is a potential source of hum, even though the insulation may not have completely broken down.

In the case of power valves, a test is also incorporated for power output, and this is measured under dynamic conditions with an applied grid input voltage, and the correct impedance of output load. In the case of r.f. amplifier valves, such as the 1C4 in the battery series and the 6D6 in the A.C. series, the mutual conductance is measured at two points, firstly at the normal working point, and secondly at the most extreme negative bias.

All valves have to pass between certain definite limits under both these conditions. When valves are removed from the electrical test set, they are then placed in a socket connected to an amplifier

and speaker and tested for micro-phonous tendencies.

While being tested, the valves are tapped with a form of drumstick, so that very severe conditions are imposed. The amplifier to which they are connected has extremely high gain, so that the speaker can show up even a comparatively minor defect.

This is not the only test that the valves pass through, since there are also short circuit tests, mechanical tests for symmetrical basing, and finally, after having passed through the store, the valves have to face a test immediately before packing which repeats practically all the previous tests which they have been through.

In addition to these electrical tests, extreme care is exercised in the production of the individual elements before assembly. It is therefore apparent that not only is every valve given the best and most careful attention during manufacture, but also that by every possible measurement the valves are checked to provide uniformity and satisfactory performance.

# £12 Buys Everything

to build the 1937

## OUTDOOR PORTABLE

Read the full constructional details as published in the "Australasian Radio World." Learn how simply and easily you can assemble this new 1937 Outdoor Portable . . . just a few hours' pleasant occupation and you will be the proud owner of this really outstanding receiver. Nothing else to buy when you purchase your Kit from Vealls. For only £12, freight paid to your nearest Victorian station, Vealls will supply the

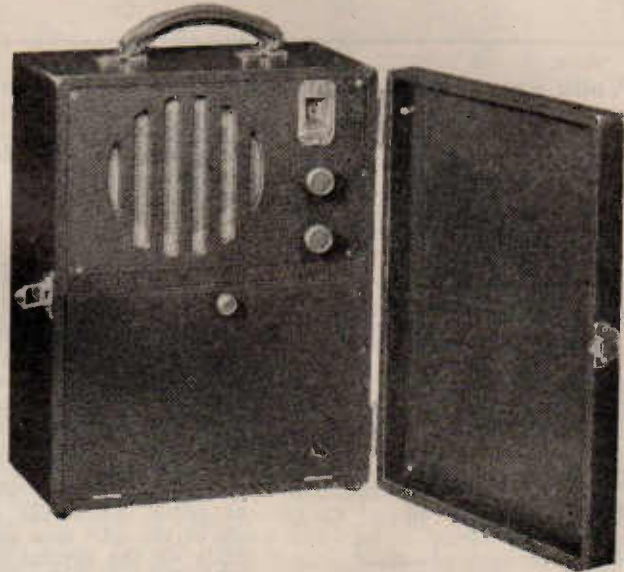

COMPLETE KIT, INCLUDING VALVES . . . SPEAKER . . .  
"A" AND "B" BATTERIES AND READY-BUILT CABINET.

## The de luxe FIDELITY 8

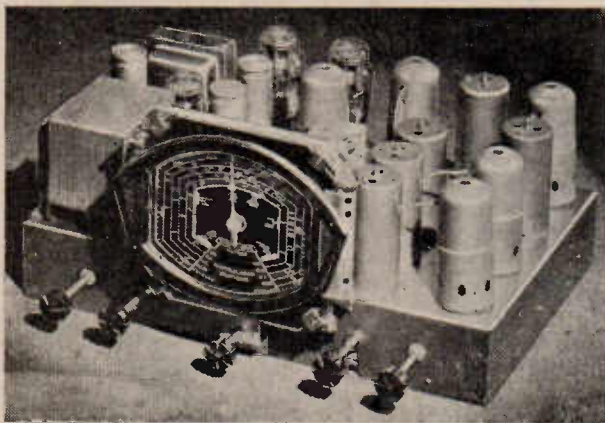

You have not experienced the real thrill of radio until you have listened to the amazing reproduction from the De Luxe Fidelity Eight described in this issue. Radio at its best. True to life reception that will leave you astounded . . . you cannot be satisfied with less.

Vealls offer the complete Kit—everything necessary—many pounds below the price you would be asked to pay for a receiver of this class ready built. Write for special price list of complete parts.

**Price £19-12-6**

EVERYTHING REQUIRED  
EXCEPTING SPEAKER.

# VEALLS RADIO & ELECTRICAL STORES

243-249 SWANSTON ST., MELBOURNE.  
299-301 CHAPEL STREET, PRAHRAN.

3-5 RIVERSDALE ROAD, CAMBERWELL.  
168 SWANSTON STREET, MELBOURNE.

Central 3059 (7 lines), 10524, Wind. 1605. W 1188.

# Radio Ramblings

A page for letters from readers.  
A prize of 2/6 will be awarded  
for every technical contribution  
published.

## 6.3 Volts From A 2.5 Volt Winding

The sketch below shows a method of boosting heater voltage, as supplied by a power transformer, from 2.5 to 6.3 volts. "L" is made by winding 100 turns of No. 20 gauge wire on an old audio transformer

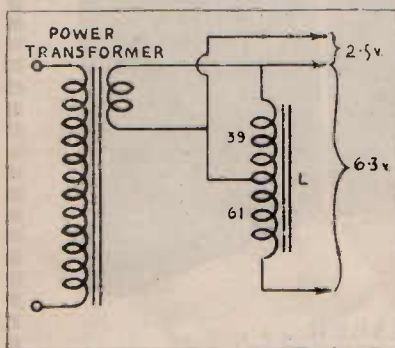

core. A tap is brought out from the 39th turn, and is connected as shown in the sketch. This makes 2.5 and 6.3 volts available from a single 2.5-volt winding.

Since last writing I have increased my log of stations heard on a two-valve shortwaver, using a 6C6 electron-coupled detector with a 37 audio stage. I have now heard 70 countries, and all continents.—K. W. Craig, Stockton, N.S.W.

## Improvising An I.F. Transformer

I must congratulate you for publishing the best radio magazine here in Australia. I look forward every month to receiving it, and when I do get it, well, I read every word. I would like to submit a "Rambling" which may help some reader out of a tight corner at some time or other.

Recently I was stuck for an I.F. transformer, and having two burnt-out ones on hand, and ten minutes of time to spare, I made one out of the two. As in most cases it is the primary that burns out, it leaves the secondary in quite good order.

First of all unsolder the pig-tails of the pie-windings from the trimmer lugs, taking special care with those belonging to the secondary. Then take the bobbins out of their mountings in the frames and cut both in the middle with a fine saw, making four halves. Now take the two secondaries and put them together, inserting half a nail or a piece of

hard wood in the holes of the bobbins as tight as possible so they will stay together. Lastly, replace in the frame and re-solder the pig-tails to their respective lugs.—J. E. Sorbell (AW277DX), Silkwood, Q'land.

## Quadrupling With A 6A6

A lot is heard these days about quadrupling in crystal oscillator stages with a 6L6 tritet, but for lower power the 6A6 or 53 Jones exciter with regeneration is just as good. One advantage is that there is less danger of damaging the crystal, as sometimes we hear of good crystals being fractured while tuning up the tritet, while the oscillator section of the 6A6 does not place undue strain on the crystal.

An important factor in obtaining good fourth harmonic output from the 6A6 is the use of rather low "C" in the quadrupler section. The use of regeneration brings the output up considerably, but another advantage is that it lowers the plate current, and the valve is not overloaded. With an 80-metre crystal the 20-metre output is about three or three and a half watts, which is enough to drive most small valves. Link coupling should be used between the 6A6 and the following stage, except to a 45, if best power is to be obtained.

The rig here is a two stage, 6A6 exciter and a 46 P.A. The 6A6 drives the 46 fully on 3.5, 7, and 14 m.c., and the input to 46 is from 18 to 20 watts. An advantage of using regeneration in the 6A6 is that on 3.5 m.c. it can neutralise the doubler section, and it may be used as a straight buffer. This saves the bother of switching out the doubler, as is usually done.—C. H. Miller, Tasmania.

## Home-Made Name Plates

Here are two simple ways of making name plates for radio equipment. Cover a piece of metal cut to the size required with candle wax, and with a sharp pointed tool trace out in the wax the required name. Pour nitric or hydrochloric acid (spirits of salt may be used, but this will not act on zinc) into the tracing. Allow it to stand for three or four hours and then rinse well, finally scraping or melting off the wax.

The other method produces more attractive plates. Cut out the required name on a piece of thin black

celluloid, being careful not to lose the middle of the "o's," etc. Then cover the celluloid left with thin paste and stick on piece of white paper. These two methods can also be followed for making professional-looking dial pointers, and graduated scales.—K. P. Mackinnon, Bondi, N.S.W.

## Two Chassis Assembly Hints

When mounting various components on the chassis, such as coil cans and condenser gangs and other parts, it is easy to attach nuts to the bolts if a mirror is stood on the table and the chassis tipped up on its end, as shown in the sketch.

The second sketch shows a hint that will save the dial and other parts from being scratched or bent

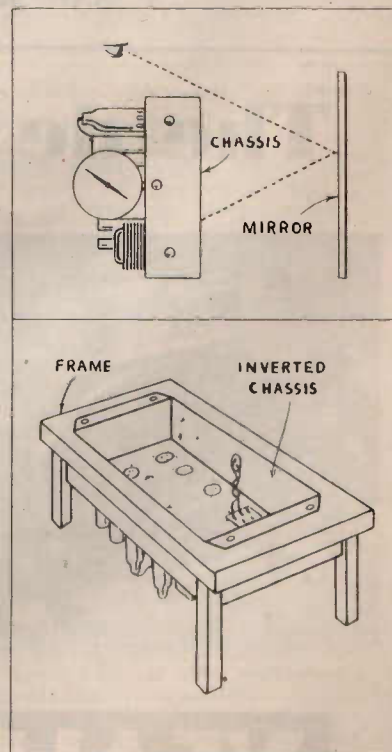

while the set is being wired. If a suitable frame is made as shown to hold the chassis by the flanges, and four legs attached to the frame, then it will be found this not only keeps the chassis off the table, but holds it firmly in the one position.—K. D. Vincent, Wellington, N.S.W.

### A Vernier Reaction Control

For those dxers employing simple regenerative receivers the following hints should prove helpful. I have found that a form of simple automatic reaction can be obtained by ganging the reaction with the main tuning condenser, and using a small variable condenser as vernier. In this way the set can be easily kept at the highest sensitivity while it is being tuned. For those who do not care for this method, a slow-motion dial may be used on the ordinary reaction control.

[The new Raymart reduction drive, which is compact, simple to fit, and gives a 6 to 1 reduction, is ideal for this purpose.—Ed.]

In cases where hand capacity is troublesome, I use a piece of rubber-

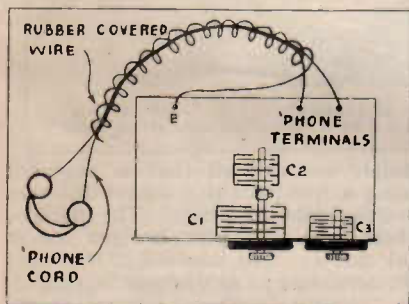

covered wire bound around the headphone cord and connected to earth. If howling sets in while the hands are removed from the receiver, it can be corrected by resting the hands on the headphone cords.—I. L. Griffin, Marong, via Bendigo.



### Simple All-Wave Tuning System

Here is a very simple method of tuning a receiver that is required to work on the short waves as well as on the broadcast band.

A 23-plate midget condenser is connected in series with a .0005 mfd. variable condenser across the tuning coil. To the last moving plate on the midget condenser solder a strip of thin brass about a quarter of an inch wide and half an inch long. This acts as a switch and must ride over the last fixed plate when the condenser is nearing its minimum capacity, so that it is shorted out, giving the usual .0005 mfd. for the broadcast band. For the shortwave bands, the midget condenser is used to spread the band to any width desired, the maximum capacity with the plates of both condensers fully meshed being approximately .0001 mfd.

This circuit is in use at VK2UJ,

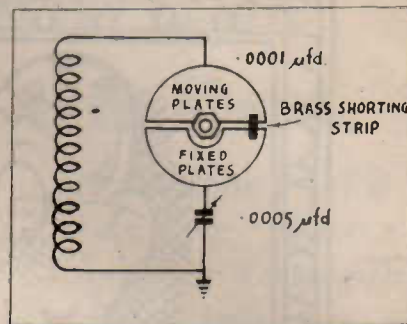

and is quite satisfactory.—H. W. Unger, Parkes, N.S.W.



### “Straight” Or Inverse Feed-Back Output

I have been very interested in the recent excellent articles concerning greater tonal fidelity, chiefly in those dealing with inverse feedback. Experience shows that inverse feedback applied to a small set e.g. 6C6 det., 76, 42 and 80, results in an appreciable loss in sensitivity. For those fans who live in suburban areas, this decrease in sensitivity does not matter, but on shortwave, when every ounce of gain is needed, it is realised that a small receiver employing

# SHORT WAVE!!

We are Sydney's leading shortwave specialists, and can supply you with a specially-designed receiver to suit your purse and purpose. A few of the types available are listed below, but we will be pleased to quote you for any type receiver, and will design one to suit you.

#### JONES SUPER-GAINER 2

Described in July and August issues of "Radio World." A highly efficient two-valve super. using the multi-purpose 6F7 and 79 valves. Incorporates regeneration on the detector and B.F.O. Gives the results of four valves.

Complete Kit of Parts, £6/11/6.

#### JONES SUPER-GAINER 4

The most popular "ham" receiver that we have handled. Uses a regenerative detector, H.F. oscillator. Iron-cored transformers. A 79 as combined second detector and B.F.O. This machine is more than equal to the average 6-valve receiver.

Complete Kit of Parts, £9/5/-.

#### THE RADIOTRON EIGHT

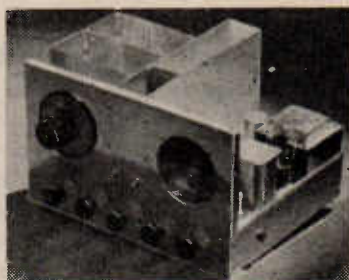

Fully described in June and July issues of "Radio World." The ideal "ham" receiver. Fully shielded. R.F. stage. H.F. oscillator. B.F. oscillator. Built-in speaker. Full band-spread. Wound plug-in coils.

Complete Kit of Parts, £18.  
Completely Assembled and Tested ..... £25/10/-

#### ULTRA GAINER 5

Five metal valves are used in this modern receiver. A regenerative R.F. stage, together with an efficient I.F. stage, results in the utmost selectivity. On crowded 'ham' bands it is a pleasure to use. It is also an ideal machine for the shortwave listener.

Complete Kit of Parts, £13/10/-.

#### THE RADIOTRON 13

The ultimate in "ham" receivers. There are too many features to detail here, but we will forward full specifications on receipt of a card.

Watch for the New 2-Volt Ham Super.

**PRICE'S RADIO SERVICE** 5 & 6 ANGEL PLACE, SYDNEY.

D. G. McINTYRE,



## •He who never made a mistake

**H**E who never made a mistake probably never made a discovery either. We sometimes learn wisdom better by our failures than by our successes . . . often find out what will do by finding out what will not do.

But this trial-and-error method is a slow and costly way of finding out about radio valves. You've got to be sure with valves. They're the vital part which determines the quality and performance of your radio set.

And there's only one way to be sure: look for four pillars in a valve—not two. The only valve with this extra support—Raytheon—costs you no more. And how much it means to the accuracy, tone and life of the valve! Remember, look for the four pillars—you can't pick the wrong valve then.

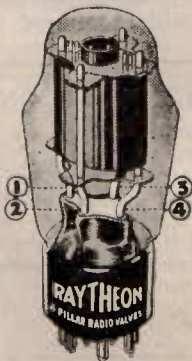

This patented container allows your Raytheon to be tested before you buy, without breaking the carton or the guarantee seal.



If unobtainable from your local dealer write to Standard Telephones & Cables Pty. Limited, 258-274 Botany Rd., Alexandria

# RAYTHEON

THE MAKERS OF

## 4-PILLAR VALVES

inverse feedback falls short of the mark.

The solution thus lies in a method of changing from inverse feedback to the straight pentode at will. The accompanying diagram shows a

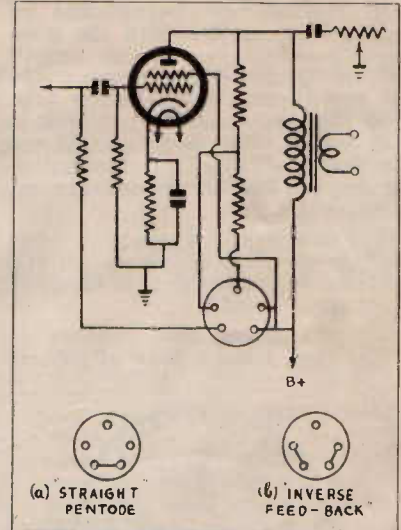

simple method, all that is required being a five-pin valve socket and two five-pin speaker plugs. The speaker plugs with the pins bridged as in (a) and (b) are inserted in the socket according as to whether "straight" or "inverse feedback" output is required.—J. B. Healey, Malvern, Vic.

### Identifying S.W. Plug-In Coils

For the many readers who use plug-in coil formers, the following suggestions may prove helpful. From a piece of thin white cardboard cut

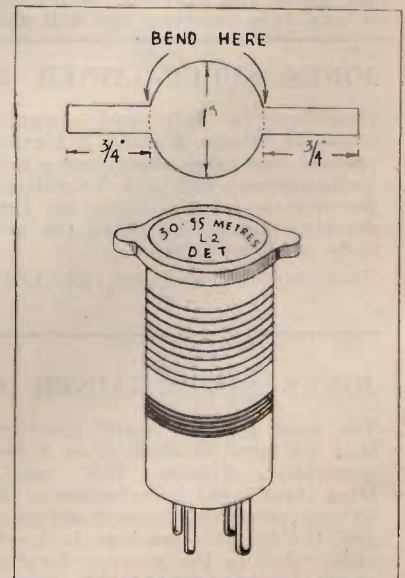

a circle with two "ears," as shown in the sketch. This is then slipped inside the top of the former, and can be marked as desired so that the coils can be readily identified.—L. Hanson, Earlwood, N.S.W.

# W.I.A. National Field Day

## On Dec. 4

### A Watery QSO : Another "Joey" Caught : Lakemba Radio Club Notes and News.

by W.J.P.



**T**HE Australian National Field Day organised by the Wireless Institute of Australia, and set down for December 4 and 5, should prove extremely popular with those amateurs who experiment with portable radio apparatus.

Many successful outdoor tests have been conducted by amateurs in this district during the past few years, and although the transmitters have been of the "flea power" variety, using not more than one watt input, nevertheless some rather startling results have been obtained from various bush and mountain locations.

Dry batteries have been the chief source of power supply, though generators and a hand-driven generator have also been used. The hand generator has since been discarded in favour of the more modern power supplies. It consisted of an ordinary telephone generator which had been mounted on a solid base and attached to the gears and drive of an emery wheel.

It usually took three operators to manipulate this part of the equipment—one to stand on the base to hold it firm, one to turn the handle, and another to stand by with an oil can. Obviously, when telephone generators are operated at about 2,000 revolutions per minute, the bearings get quite hot! However, it served very well for the purpose, thanks to Ian Gardiner (now VK-2ABY), who originated the idea.

While on the subject of portable tests, the above photograph would suggest that it is perfectly unnecessary to limit one's activities to QSO-ing from a tent on a hot summer's day. 2OD is seen speaking to 2YX Balmain from mid-stream at a remote portion of Cattai Creek on the occasion of a recent holiday camp. He has the microphone in one

hand and is keeping afloat by means of an inflated inner tube, while at the camp station about 150 yards away 2CL is seen about to plug in the "mike" land-line.

We wanted 2OD to put on a pair of headphones so as to listen to 2YX's reply, but as we had no output transformer for the receiver, 2OD did not seem too keen about the idea, as even 100 volts can become quite uncomfortable when one is floating in water!

The apparatus shown belongs to 2CL, and is made up from old receiver parts, the maximum power used being a watt.

★

### Another "Joey" Caught

Early last month an unlicensed transmitter was prosecuted at the

Police Court, Parkes, N.S.W. An official of the P.M.G. Dept., in making the charge, stated that defendant had been in communication with a station at Moree, and had used the call-sign of a station located at Kogarah.

The department took a serious view of such an offence, he continued, as, under the regulations, before anyone could operate a transmitter they must sit for an examination to show their capabilities of doing so. Such unauthorised operators caused a great deal of bother and interference to other operators.

For the defence, it was stated that defendant had been studying for the examination, and the offence was only due to over-anxiousness to get on the air.

★

### 2PX Has Worked 84 Countries

VK2PX is owned and operated by Harold Ackling, and is located in a good DX position at Bankstown, N.S.W. A photograph of the complete station appears below.

(Continued on page 36).



This up-to-date transmitting station belongs to VK2PX, who has worked 84 countries to date.

# Breaking Into The Amateur Game . 10

**R**ADIO waves, like light waves, travel at a speed of about 186,000 miles per second. They have an electrical and a magnetic component, and thus are known as electro-magnetic waves. The components have a phase relationship of 90° in space, and the plane of these forces is always at right angles to the line along which the waves travel.

Vertical polarization is the term given to waves that travel from the right angles to the earth's surface (vertical to it). Likewise, horizontal polarization is the case when the electrical force is parallel to the earth.

Generally speaking, a vertical aerial will radiate vertically polarized waves, although they may change before reaching the receiving antenna, due, for instance, to conductors in the path of the waves, etc.

## Vertical Aerials Best For U.H.F.

We might mention something here which is borne out in practice on the ultra high frequencies. When a receiving aerial is placed so as to be in the correct relationship to the waves radiated by the transmitting aerial, maximum signal strength is obtained. At present, the majority of ultra-high-frequency transmitters in Australia use an aerial which radiates in the main vertically polarized waves, and we find in most cases that a vertical receiving aerial is superior to a horizontal one.

In the same manner as light waves are reflected and refracted by mirrors and prisms, radio waves are similarly affected by conductors. When a conductor (wire) is placed in the path of a radio wave, a current is set up in the wire, causing it to radiate a wave of its own. If this wire, called a reflector, is placed near the aerial, it may be made to cancel radiation in the direction away from the aerial in the line of the reflector.

## Ground And Sky Waves

Radio waves not only travel along the surface of the earth in the portion we know as atmosphere, for comparatively short distances communication, but also through the "ionosphere" or upper regions above the earth's atmosphere. Radiation commonly known as the "ground wave" is the direct radiation from the transmitting aerial—in a line more or less parallel to the surface of the earth.

These "ground waves" are more rapidly attenuated as the transmitting frequency is increased. Thus the ground wave of a shortwave transmitter cannot be heard over very long distances, but a long-wave transmitter has a ground wave which is useful for much greater distances.

A region far above the earth, call-

**In this instalment, the theory and design of transmitting aerials are discussed, and the phenomenon of fading explained.**

**By GEORGE THOMPSON (VK3TH)  
and IVOR MORGAN (VK3DH)**

ed the ionized atmosphere, exists at various heights according to the locality, time of the year or day, or weather. If it were not for this ionized layer, or "ceiling," the part of the radiation which takes place at angles above the horizontal and up to the vertical from the transmitting aerial would travel on into space and be lost.

### A Warning To Readers.

Readers are reminded that before a person may be in possession of radio apparatus capable of emitting a signal, he must at least be the holder of an experimenter's licence.

## Kennelly-Heaviside Layer

However, this is not so, and the bending back or reflection which takes place at various angles is responsible for our very long distance communication on low power, using the higher frequencies, i.e. 3.5 m.c. to 28 m.c. (we don't know enough about 56 m.c. yet to make any statements). This ionosphere that reflects our "sky waves" is named after the two gentlemen who suggested its existence many years before short-wave communication proved it—the "Kennelly-Heaviside" layer.

As waves from the aerial enter the ionosphere, where there are present a number of free electrons resulting from ionization, the velocity of the wave is increased, because of the greater conductivity created by the free electrons. In this way the wave course is gradually turned back towards the earth, and again there is a relationship between angle of refraction and frequency.

The lower frequencies, e.g. 3.5 m.c., are turned back more sharply than the higher frequencies. For example, with 3.5 m.c. signals, the wave will often return to the earth's surface at a comparatively short distance as well as at greater distance. Thus the signal may appear within the "ground wave" zone. However,

at the higher frequencies, such as 7 m.c. and 14 m.c., there is usually a fairly large "silent area" between the point at which the ground wave ceases to be useful and where the sky wave re-appears—commonly known as the "skip distance."

## Angle Of Radiation Explained

This discussion of reflection and refraction naturally brings to mind the important question of how to make the most of a wave that will return to earth at a great distance, that is, many miles after the ground wave has died out or become attenuated to the extent that it is useless. Now to deal briefly with this important question, namely, that of "angle of radiation."

Taking as an objective a receiving point at a given distance, the question is at what angle should the greater part of the aerial's radiation be directed in order to produce a signal, reflected from the ionosphere, of greatest strength at the receiving point? We will see from this that a low angle of radiation on, say, 7 and 14 m.c. will be most desirable for long-distance communication, since the further away the point where refraction starts, the further distant will be the area where the sky wave returns to earth. An angle of about 30 degrees and less is good for frequencies on the 7 and 14 m.c. bands, whereas about 45 degrees is suitable for 3.5 m.c.

## The Causes Of Fading

From the foregoing it is evident that there exists the extreme possibility of the simultaneous reception of the sky and ground waves. Since the sky wave really travels along two sides of a triangle, while the ground wave traverses one, there will be a phase difference in the two voltages arriving at the receiver.

These voltages, being of the same frequency, but of different phase, could cancel in the receiving aerial, resulting in no signal. However, the phase difference will vary continuously in accordance with the ionosphere alternating the lengths of the



two paths; and so a continuous variation in the effective received signal is the result. This, briefly, is the story behind the familiar effect known as "fading."

Phase difference is not completely responsible for fading—even shifting polarization from vertical to horizontal can be responsible for very considerable variations in the received signal. "Selective fading" is almost wholly associated with phone communication, since all the frequencies constituting a speech modulated wave do not have a uniform path length, and so out-of-phase cancellation varies over the frequency range in use, resulting in peculiar distortion effects.

#### Marconi And Hertz Aerials

Turning now to actual aerials, we find, in the main, two classes only: (Marconi) earthed and Hertz (not dependent on earth connection).

A Marconi or grounded aerial is the usual type employed with the old-fashioned crystal receiver—that is, a vertical or horizontal or part vertical and part horizontal "sky wire," connected to earth through a suitable coupling medium and tuning arrangement. For a bent grounded aerial, the natural frequency or wavelength is about 4.2 times its actual length in metres, the length being measured from the free end of the antenna to the actual connection to earth.

#### Calculating Aerial Lengths

The length of a Hertz aerial depends not only on the actual wire length, but on various factors which go to alter the length it would naturally have in free space. Roughly aerial with the electrical force at speaking, the natural wavelength is about twice the actual length of wire. In practice, the wavelength is somewhat more than twice the wire length in metres, due mainly to surrounding objects, etc.

The length in feet of a Hertz aerial is approximately 1.6 times the wavelength in metres. For example, an aerial for 20 metres would be  $1.6 \times 20 = 32$  feet. This formula gives the length for a half-wave aerial, but any length may be used, providing that there are whole numbers of standing waves appearing on the aerial. Thus a 64-foot aerial for 20-metre use would be two half-waves or a full-wave 20-metre aerial. Likewise, the same length would be a half-wave aerial for 40 metres, and so forth.

#### Typical Radiation Patterns

A half-wave aerial in clear space, that is, not considering any absorbing or reflecting conductors in the vicinity, will have a radiation pattern similar to a life-belt, visualising the aerial as running centrally through the hole. On the other hand, a full-wave aerial radiation pattern will

resemble two cones, point to point, with the wire running through the centre.

With regard to angle of radiation of half-wave aerials, on comparatively low frequencies such as 3.5 m.c. there is very little directivity, but a half-wave 14 m.c. aerial radiates best in a direction at right angles to the length of wire, and there is very little horizontal or low-angle radiation, due to the reflecting effect of the earth under the aerial.

For low-angle radiation, a half-wave aerial should be always at least a half wavelength above ground in the case of a horizontal installation. However, a vertical aerial of an odd number of half-waves in length will give better low angle radiation.

When the resistance of a half-wave Hertz aerial in free space is measured at various points, it is found to be something approaching 70 ohms at the centre, or current anti-node, and to rise gradually to about 2,000-3,000 ohms at the ends or voltage anti-node (or voltage loop). The impedance is about equal to the resistance at the centre, namely, 70 ohms.

#### Coupling Aerial And Transmitter

This brings us to ways and means of coupling the aerial to the transmitter. A coil and condenser in series may be inserted at the centre of a half-wave aerial, the system being then called current feed, since the power is introduced at the current anti-node. Likewise, a coil shunted by a condenser may be connected at the end of a half-wave aerial, making a voltage feed system, as the voltage anti-node appears at the two ends of a half-wave Hertz.

The thing to remember about this part of the subject is that for current feed, always have the condenser as large as possible and in series with the coil. For voltage feed, since we have to feed at high voltage and low current, have the condenser small and the coil large, to produce highest possible r.f. voltage. This applies to a Hertz aerial for use on practically any amateur band.

#### Tuned and Untuned Transmission Lines

And now just a word or two about transmission lines. Generally speaking we may divide "lines" into two classes, tuned and untuned. In the case of the tuned line, it should have a length equal to either an odd or even number of quarter waves. The pair of wires are considered as one, that is, a folded half-wave is a quarter-wave line, a full wave being two quarter-waves of line, etc.

This line method of introducing power to the aerial may be utilized in two different ways. In the case of a line the length of which is an



PRIZEWINNER  
AWARDED  
**REPLUGLE**  
GLOBE  
IN RADIO WORLD  
DX CONTEST

The de luxe Replugle combination World Globe and Time Converter illustrated above is one of the three being awarded as prizes in the "Radio World" Shortwave DX Contests now being held.

Designed especially for short-wave listeners, an ingenious rotary time converter is built into the base so that world time differences can be read off in an instant. As well, the principal shortwave stations of the world are shown, together with over 5,000 cities and towns.

Finished in chromium and black, the model illustrated is very reasonably priced at 59/6.

Other models include the Standard full meridian globe, available in 7, 8, 10 and 12 inch sizes, priced as below:—

7-in. ....	15/6	8-in. ....	19/6
10-in. ....	29/6	12-in. ....	49/6
		10-in. Starlite ....	39/6.

All these scratch-proof, washable Replugle Globes are available in floor and table models.

A 32-page illustrated book showing how to use the Replugle Globe—how to tell the time in any part of the world at a glance—is given FREE with every 10-inch and 12-inch model. Ask your radio dealer about them, or write us direct.

**REPLUGLE**  
WORLD GLOBES  
REG. ROSE & CO. PTY. LTD.  
Kembla Building,  
58 Margaret Street, Sydney.  
Telegraphic Address: "ESOR"  
BW 2114.

odd number of quarter waves, the effect is to transform a voltage loop to a current loop, or in other words, if we have a three-quarter wave line, voltage coupled to an aerial (one end of half-wave), then we must current-feed the line at the transmitter, and vice versa. In the same way, a line which is an even number of quarter waves in length must have current feed at each end or voltage feed at each end.

#### Untuned Transmission Line

Whereas these two systems of line operate with standing waves on them, but do not radiate due to out-of-phase relationship, there is the untuned transmission line which does not have standing waves along its length, but has a surge impedance determined by the size of the wire and the spacing between the two. Standing waves will not occur on a line of this kind if it is terminated by an impedance equal to its surge impedance, and so no radiation takes place from the line.

The impedances of lines of the spaced parallel wire variety are usually around 600 ohms or lower, and so are usually coupled to the centre of the antenna. As the distance between the wires of a parallel spaced

untuned line is decreased, the impedance decreases until it approaches 70 ohms (the impedance at centre of antenna), thus simplifying the line problem by introducing the twisted pair, an exceedingly convenient means of feeding power to the aerial.

The latter method of aerial feed has proved very popular with the ultra-high-frequency experimenters, mainly because of its convenience. Taking as an example the half-wave aerial for 56-60 m.c. band operation, we find that a half-wave is about 8 feet in length, and practice has shown that a good all-round 5-metre aerial is the vertical half-wave.

#### Voltage Feed Problems

Since we need the aerial in a vertical position as high as possible, or at least in clear space, voltage feed presents something of a problem, since the line would have to be rather long. The easiest way out is the twisted pair arrangement. However, there is one objection to feeding a vertical half-wave aerial at the centre. The feeders are not only in the field of greatest radiation, with attendant inefficiencies, but present a problem of construction, since they are required to run away from the

aerial, more or less at right angles, for the first three or four feet.

#### Matching Feeder To Aerial

This trouble can be easily overcome by a system of matching the feeder impedance to the end of the aerial impedance with a matching quarter-wave section, and so making the job more convenient mechanically.

In practice, this operation consists essentially of a vertical eight-foot section with an impedance-matching section below, consisting of two four-foot sections spaced four inches. The lower end of the aerial attaches to the top of one of the four-foot sections, and the feeders join to the lowest points of the matching section.

The function of this is easily understood from the discussion on quarter-wave feeders, which are similar. The half-wave vertical has a voltage loop at the bottom to which we join one end of the quarter-wave line; therefore the other end of the quarter-wave line will be a current loop, where we may attach our low impedance twisted pair feeders.

Next month we will continue along these lines, dealing with ultra-high-frequency work.

## AC and DC TUBE CHECKERS

COUNTER ——— PORTABLE ——— and EMPORIUM MODELS

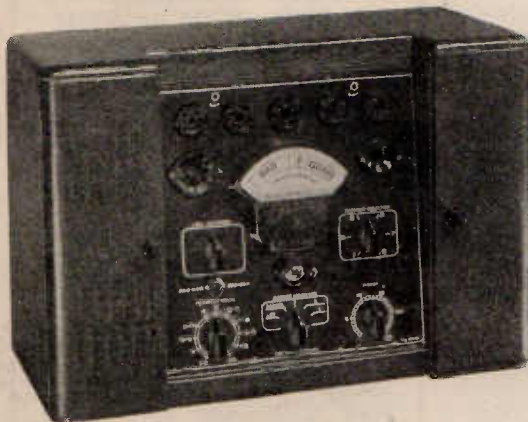

1938 CATALOGUE  
**FREE**  
and POST FREE.

★ Calstan Tube Checkers incorporate the most advanced circuit features for valve analysing, and are years ahead in design, performance and simplicity.

High resistance leakage and shorts between elements are immediately recorded by the Neon Lamp . . . even as high as 1,000,000 ohms. They include percentage readings in conjunction with the "GOOD-BAD" section on the scale of the large fan-shaped meter, and features Line Voltage regulation with meter check. Completely test American, Philips, Osram, and Mullard Valves, including Metal Philips, P. and V.

MODEL D.C. 222 is a boon to Country Dealers, as it is BATTERY OPERATED . . . will work from a 6-VOLT BATTERY . . . the High Tension being supplied by means of a VIBRATOR UNIT . . . Thus enabling it to be used in any place or time independently of Power Lines. Don't be misled . . . the D.C. 222 is positively the only Tube Checker which will test all tubes, both A.C. and Battery Types.

EMPORIUM

£12/5/0

A.C. COUNTER

£11/5/0

A.C. PORTABLE - D.C. COUNTER - D.C. PORTABLE

£11/15/0

£16/16/0

£17/6/0

ALL PLUS TAX.

## Slade's Radio Pty.

LANG ST., CROYDON, N.S.W. — Phone UJ 5381 - UJ 5382.

Victoria: Australian General Electric Ltd., Melbourne; Arthur J. Veall Pty. Ltd.

Queensland: J. B. Chandler and Co., Brisbane.

South Australia: Radio Wholesalers Ltd., Adelaide.

West Australia: Carlyle & Co., Perth.

Tasmania: Noyes Bros. (Melbourne) Ltd., Launceston.

New Zealand: New Zealand Electrical Equipment Co.

Stocks available from Turnbull and Jones, all branches.

#### Distributors:

N.S.W.: Radio House Pty. Ltd., Sydney; Martin de Launay Ltd., Sydney; Bloch and Gerber Ltd., Sydney; Fox & Macgillcuddy Ltd., Sydney; John Martin Ltd., Sydney; Electric Service Co., Newcastle.

# Read these Winning Letters in the RADIOKES CONTEST

## FIRST PRIZE

"I have built up an International Kit-Set, using the following Radiokes 1937 Parts:—AD465 I.F. Transformers, DWA3 Coif Box, Resistors.

"My choice was made after comparing both the 1935 Kit-Set (an excellent job) and the 1936 circuit, with the current commercial sets. I have never regretted this choice. Only one commercial set utilised the improvements listed on your 1936 circuit, and that set used only iron cored coils of an inferior quality.

"What choice did I have? Here was a dual-wave set with iron cored intermediates plus an independent coil box, plus metal valves. I knew by comparing different parts that the Radiokes article was by far the best in quality and workmanship, so it was not long before I purchased the necessary parts.

"It was my first attempt at radio assembling, but apart from a few technical errors, which were soon rectified when I wrote to your office, I made a good job of it.

"My set cost me £34 (including a good cabinet), and for selectivity and quality of reproduction is far superior to any of the commercial sets in the higher price class. In fact, I would not exchange it for any of the 1937 commercial sets. If you continue to improve your products as much as you have done in the past, the commercial factories will have something to do to keep up with you. Wishing you every success.  
B. J. SORLEY."

THE Radiokes Competition has now been finalised, and the prize-winners are as follows:—1st, Mr. B. J. Sorley, Hollywood, W.A.; 2nd, Mr. F. J. Kemble, Katanning, W.A.; 3rd, Mr. L. S. Lane, Weethalle, N.S.W., and a special prize to Mr. A. Yates, Inverell, N.S.W., the prizes being respectively Radiokes goods to the value of 10, 3, 2 and 2 guineas.

As a token of appreciation on the part of Radiokes Pty. Ltd., a set of Radiokes Transposition Blocks has been sent to each unsuccessful entrant. The winning letters are reproduced here:—

## SECOND PRIZE

"I am writing to tell you all about a great thrill I have just had—all by myself I have constructed a dual-wave receiver from a Radiokes Kit-Set. Advancements in periodicals of Radiokes Kit-Sets have always had a big fascination for me, a fascination kindled by the fact that these great Kit-Sets are made in Australia, by Australians, and are supplied complete in sealed packets down to the very last bolt, nut, and soldering tag. I wanted to have a first-class receiver, and one I could proudly say I built myself—so I invested in a Radiokes four-valve dual-wave Kit-Set. It was great fun, and terribly interesting constructing the set step by step, from the easily followed instruction sheet.

"How excited I was when I finished, gave it a test on the air, and found that she worked like a big commercial!"  
F. J. KEMBLE."

## THIRD PRIZE

"I needed a new Radio, one that was ultra-modern, and, being unable to buy one, I decided to build one if it was in my capacity to do so. As my tool kit is strictly limited and I live in the country, where facilities for testing and lining up are totally absent, I thought the problem beyond me until I read an advertisement of Radiokes about their complete Kit-Sets. These sets solved my problem, everything manufactured to suit one another and to work harmoniously when built up into the Pentagrid Four, which proves to be an economical battery set of surprising range and power. I am pleased I chose a Radiokes, because they are guaranteed and the firm behind them is both capable and willing to stand back of their guarantee, and the price was competitive. Few tools were needed, only those found in the average country house, and I now own a very modern, satisfactory set.  
L. S. LANE."

# NEW RADIOKES CATALOGUE...FREE



Send this coupon NOW for your copy of the new 1938 Radiokes Catalogue. Now being printed . . . ready by the time your request arrives. It's the finest catalogue Radiokes have ever produced. Tells you all about the famous Radiokes parts; packed with valuable information, essential to all interested in Radio. Let us post you a free copy, or get one from your dealer or wholesale distributor.

## SEND THIS COUPON NOW!

Radiokes Pty. Ltd.,  
Box 10, P.O., Redfern, Sydney.

Please rush me a copy of your new 1938 Catalogue, free and post free.

NAME .....

ADDRESS .....

A.R.W., 11/37.

## Round The N.Z. "B" Stations

5

# 3ZR Greymouth

"From The Golden West Coast"

The fifth of a series of articles on the New Zealand "B" class stations, written for the "Radio World" by . . . . .

"THE SOUTHLANDER"

The home of 3ZR in Mackay Street, Greymouth. The studios are on the second floor, while the transmitter is situated 100 yards away at the rear.

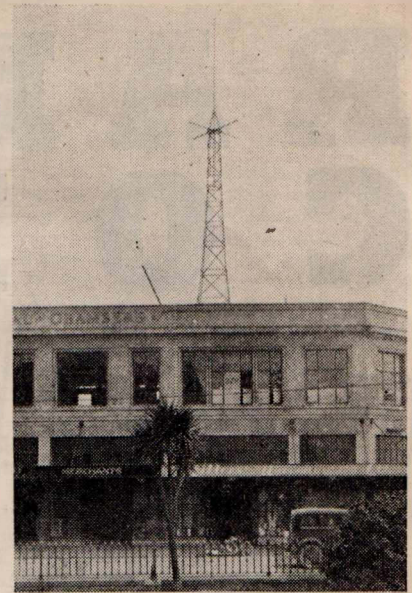

**S**TATION 3ZR, Greymouth, came on the air as a "B" station on February 19, 1931, then operating on 820 k.c. Prior to this the Greymouth Radio Society operated ZL3CW on 80 metres. The listeners of the West Coast, particularly in Greymouth and Hokitika, were subjected to very annoying interference from howling receivers, morse, and electrical disturbances, which made distant listening next to impossible.

A meeting was convened in 1930 by Mr. M. E. Spiers, a local radio technician, and as a result the Grey Radio Society was formed. The name of this club was later altered to the West Coast Radio Society.

With the co-operation of the Post and Telegraph Department and the local Power Board, the club was able to rid the district of much of the interference. However, howling valves still constituted a real nuisance, but the building of 3ZR by Mr. Spiers solved this problem. Just after the completion of the station, the Napier earthquake took place, and 3ZR came on the air till all the available news had been given out—at about 4 a.m.

### Location, Power And Frequency Changes

Later, Mr. Spiers rebuilt the transmitter and shifted it from Cowper Street to Sturge Street, Cobden. A further shift brought the studios and transmitter back to Mackay Street, Greymouth. Later the frequency was changed from 820 to 1,300 k.c., and now the station transmits on 940 k.c. The power has risen from 80 watts until to-day there is 800 watts input to the final stage, and the equipment is valued at some thousands of pounds.

The transmitter is the latest type, push-pull throughout, and the carrier output is 500 watts, 100 per cent. modulated, with a Marconi aerial system. It has a reliable range of transmission of 150 miles in daylight, and thus the station serves the whole West Coast of the South Island; it is the only station in Westland. A correct report of reception has been received from as far away as Canada.

The programmes submitted are bright, and are varied with studio items, recordings and plays. Special features appreciated by listeners are the early morning news session at 7.30 and Sambo and Uncle Mick in the Saturday Children's Hour. Relays have been carried out from as far away as Ninety Mile Beach (at the top of the North Island), Blenheim, Nelson, Ashburton and Christchurch.

The manager of the station is Mr. Spiers, the operators, Messrs. A. Hopgood and H. Bradshaw, and the station announcers, Messrs. R. B. Low, W. Gunn and B. Hunter.

### Over Six Years Of Service

3ZR has given West Coast listeners over 6½ years of trouble-free service. Recently there occurred a most important change, which may possibly alter the whole future of the station. Along with the majority of other "B" class stations, 3ZR passed into the hands of the Government, whose policy is to close down the "B" stations as soon as an adequate State service is provided.

In the meantime, 3ZR is continuing with increased hours on the air, and it is now on practically all day and every night until 8.30 p.m.

E.A.S.T. and sometimes later. 3ZR's latest schedule is filling a long-felt want, and local listeners are emphatic that the station be kept on the air.

### 20 K.W. Station For South Africa

(From Our South African Correspondent)

According to a statement recently made by the South African Broadcast Corporation, tenders are to be called for the supply and erection of a new 20-kilowatt shortwave station.

Arrangements have also been finalised with Overseas Communications for the use of their new high-power transmitter near Capetown, and with the Union Postal Department for the use of ZUD at Robert's Heights. These stations, which will carry the Capetown medium-wave programmes and the Johannesburg programmes respectively, will be used to ascertain which is the most effective locality for the erection of the new station—in the Cape Peninsula or on the Transvaal high veld.

### Mafeking—ZNB

The high-powered station at Mafeking, British Bechuanaland, continues to provide excellent entertainment for listeners throughout Africa. The station is on the air at various times of the day and night, and uses a wavelength of 50.3 metres. Programmes consist of gramophone records.

The station is used extensively for keeping in touch with the administrative and military outposts in the protectorate.—Roy Alexander, South Africa.

ON ANY WAVELENGTH..

IN ANY RECEIVER..

YOU'LL GET BETTER RECEPTION WITH..

**PHILIPS VALVES**

MAKERS OF THE LAMPS THAT LIGHT YOUR HOME

(Advt. of Philips Lamps (Australasia) Ltd. (Radio Dept.), Head Office and Showrooms, Philips House, 69-73 Clarence St., Sydney.)

# The . . . . 1937 Outdoor Portable Four



Left: The "Outdoor Portable" complete and ready for the road. The photograph on the right shows the set ready for operation — anywhere and at any time.

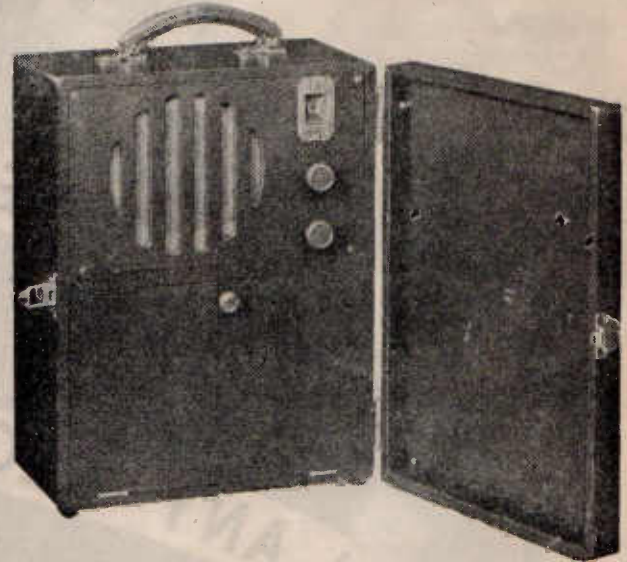

**T**HOUGH the layout used for the "1937 Outdoor" is very compact, neither the assembly nor the wiring will offer any difficulties if they are completed along the lines indicated in the following article.

The first step is to assemble the complete kit of parts as listed last month. These are all standard, so no difficulty will be experienced in procuring any of them. Ready stamped and drilled chassis are available from firms handling the kit of parts, though for readers who prefer to make their own, a diagram showing full dimensions is given elsewhere this month.

### Radiokes Coil Kit Used

The coil kit supplied by Radiokes for the original model comprises 1 type BCS-465 aerial coil, 1 type BCS-465 OB oscillator coil, 3 type QS-465B I.F. transformers, and 1 type IK7 padder.

With the kit of parts assembled, the construction can be commenced by mounting the four valve sockets, which should be arranged so that the filament lugs face in the directions shown in the wiring diagram published last month. When these sockets are mounted, the bases for the three goat valve shields should be bolted in position at the same time. Also, when every component is mounted, a solder lug can be slipped underneath each mounting nut, to be used later for earth connections.

### Completing The Filament Wiring

The filament wiring can now be put in. To do this, the "F+" terminals (see wiring diagram) are all joined together, and also the "F—" terminals. Also a lead is taken from the "F—" terminal of the 1C6 to the nearest earth solder lug. A further lead is taken from the "F+" terminal of this socket to one side of the on/off switch mounted on the

volume control. Later, another lead is taken from the other side of this switch to the "A+" lug on the terminal strip mounted on the rear of the chassis.

Next, the following components can be mounted—aerial socket, padder, volume control and the condenser gang. The latter is supported above the chassis by means of 1/2" brass spacers. Before it is mounted, a 6" lead of flexible push-back should be soldered to each fixed plates terminal under the gang. These leads pass through the chassis, and are soldered to the appropriate coil lugs (terminal 1 in each case).

### Mounting The Aerial And Oscillator Coils

The mounting bolts on top of the aerial and oscillator coil cans are then removed, and the aerial coil is withdrawn from its can. The orange lead soldered to terminal "1," and passing through the top of the can, is then removed.

The bolt locking each coil within its can is then passed through the hole provided for it in the rear of the chassis, and in this way the two coils are mounted horizontally under the latter, with their bases facing the front of the chassis.

Next, the three I.F. transformers can be mounted. These are arranged so that the coloured leads pass through the holes provided for them in the way shown in the wiring diagram. After these have been bolted in position, a two-lug bakelite strip is locked to the mounting bolts of each I.F. transformer by means of two further nuts (see wiring diagram). One other two-lug strip is needed, this being located on the left 1D4 socket. It is mounted by means of a bolt passing through the centre, and is supported clear of the chassis by about 1/4".

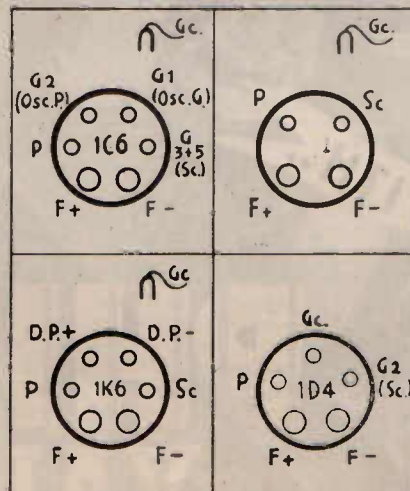

Under-socket connections of the four valves are shown in the sketch above.

### Putting In The Wiring

Now, commencing with the aerial socket, wire the aerial coil, oscillator coil, 1C6, first I.F. transformer, 1A4, second I.F. transformer, and so on. After the main portion of the wiring has been completed, the 7-lug bakelite strip can be mounted along the rear wall of the chassis, and the double-pole double-throw economy switch mounted in the position shown. The remainder of the wiring can now be completed.

All leads should be as short, direct and as well-spaced as possible, and all by-pass condensers should be mounted as close as possible to the points they are intended to by-pass. As well, the green lead from the 1C6 plate to the first I.F. transformer should be kept well spaced from all other wiring. The only shielding required is that on two of the leads from the volume control (these are indicated in the wiring diagram). These leads should be shielded along their entire length, and the shielding earthed at several points along its route.

### Mounting The Tuning Dial

When the wiring has been completed, the three grid clips can be fitted and the tuning dial mounted. To do this, bend the bottom portion of the mounting bar back at right angles

so that it lies flat on the chassis, and pass a bolt through both bar and chassis, securing it with a nut and washer. Of the two dial light lugs, one is earthed to the dial frame, while a length of push-back is run from the other through the chassis to the terminal of the volume control connected to "A+".

The speaker can now be bolted to the front of the chassis, and the leads from it connected to the plate and screen lugs on the 1D4 socket. The 7-wire battery cable can now be connected up, two of the leads ("A—" and "B—") being soldered to the "A—B—C+" lug. The connection between "B—" and "C+" is made in the battery compartment.

With the wiring completed and checked, the set can be tested and aligned before it is mounted in the cabinet.

### The Alignment Procedure

With the batteries connected up, and using a few yards of flex plugged into the aerial socket as a makeshift aerial, switch on and check over the valves to make sure all the filaments are alight. Then set the two trimmers on top of the gang and the padder about halfway out. Advance the volume control, and tune in a station operating on about 220 metres.

Adjust the aerial trimmer on top of the gang for best results. If no

peak is found, screw in the oscillator trimmer a turn or so and re-tune the station. Then again adjust the aerial trimmer. Next, a station towards the top end of the waveband should be tuned in, and the padder adjusted. While this is being done, rock the dial backwards and forwards across the station until a point is found at which volume is greatest. This alignment procedure can then be repeated once again.

Finally, the trimmers on the three i.f. transformers can be given a slight adjustment to ensure peak results, commencing with the third transformer and working towards the first. These trimmers should only be shifted a fraction of a turn, and also the original positions should be marked so that the trimmers can be returned to them if desired.

If carefully carried out, the above should result in substantially correct alignment that will hold satisfactorily over the entire waveband. However, alignment using a service oscillator will ensure maximum results. With the volume control full on, there should be no instability whatsoever, and it should be easily possible to tune in several dozen stations at good speaker volume.

(Continued overleaf)

## Build Your "1937 Outdoor Portable"

### With Full-Vision Station-Calibrated Dial!

For the past two years we have specialised in the manufacture of portable receivers, for distribution right throughout the Commonwealth. Many letters of appreciation of the amazing and dependable performance of our "My Companion" portable bear testimony to the excellence of its design and assembly.

We are now offering to "Radio World" readers a special kit of parts for the "1937 Outdoor Portable," described in this issue. Every part is guaranteed exactly to the Editor's specifications, or, alternatively, a special full-vision station-calibrated dial of our own design, together with a condenser gang using dual-reduction planetary drive, will be supplied at NO EXTRA CHARGE.

Complete kit of parts, with battery, valves, cabinet and speaker, £12/-/-  
Receiver, assembled, aligned and fully tested ..... £13/5/-

### WE GUARANTEE RESULTS.

If you have any difficulty in obtaining satisfactory operation, we will re-build the receiver for you at a nominal charge.

## Ashleigh Radio Products

WEMBLEY HOUSE, GEORGE ST., SYDNEY, N.S.W.

'Phone

MJ 4284

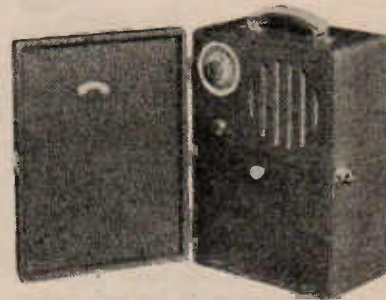

### ASHLEIGH AUTO RADIO

Designed for discriminating motorists, Ashleigh Auto Radio is a powerful six-valve superhet that gives excellent results. Exceptional sensitivity, excellent tone, A.V.C. and remote control are outstanding features. Complete kit of parts, together with full assembly instructions,

£14/14/-

Completely assembled, aligned and tested ..... £17/10/-  
Installation charge (built in aerial extra ..... £1/10/-

Results Guaranteed —  
Write for details.

## Western Custom Built CABINETS

are specified for the



### TOM THUMB Portable Two and the



### 1937 Outdoor Portable Four

Built of light, durable timber with dove-tailed joints, covered with smart mottled leatherette, and fitted with plated hinges and catch, a Western-built cabinet adds that professional finish to any home-built portable. Colours available are red, green, blue, brown, black and crocodile.

Don't spoil an outstanding set by housing it in a shoddy cabinet—

#### SPECIFY A WESTERN

as used and recommended by the Technical Editor.

Prices On Application



WESTERN  
MANUFACTURING CO.,  
18 THIRD AVENUE,  
FIVE DOCK, SYDNEY.

'Phone - - U 3444

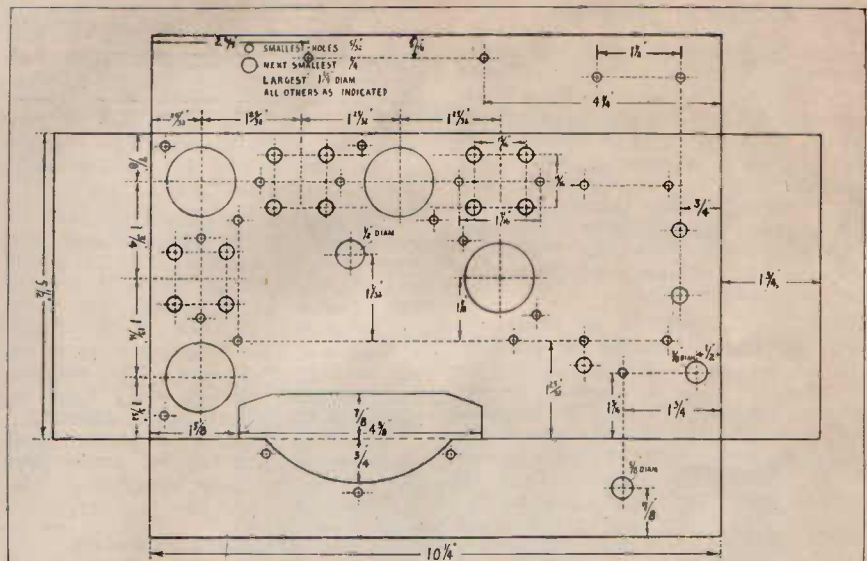

Full dimensions for stamping and drilling the 16-gauge frosted aluminium chassis are given in this sketch.

#### Fitting The Copper Gauze Aerial

The set can now be laid aside while the copper gauze aerial is mounted in the lid.

After taking out the four corner screws, the inside cover of the latter is removed, and the sheet of gauze placed flat in position underneath. The top wood screw attaching the top hinge section to the lid is taken out and is replaced by a  $\frac{5}{8}$ " bolt. One end of a 2" length of flexible pushback is now soldered to the copper gauze at a point nearest the bolt, while the other end is wound around the projecting end of the latter and locked in place with a nut. The inside cover of the lid can now be replaced.

Next, the lower of the two wood screws attaching the top section of the hinge to the cabinet is removed and replaced by a  $\frac{5}{8}$ " bolt, as with the lid. A 6" length of flex, terminating in a banana plug, is attached to this bolt inside the cabinet.

The leatherette-covered front panel is now placed into position in front of the receiver chassis, and the two bolted together by means of two  $\frac{5}{8}$ " bolts and nuts, located one in each bottom corner.

#### Mounting The Set In The Cabinet

Next, the battery cable is passed through the hole in the horizontal shelf provided for it, and the set slipped into the cabinet. The aerial is plugged into its socket while this is being done.

The control knobs and dial escutcheon are then fitted, and the front panel secured in position by means of a wood screw passing through each top corner. The "B" batteries are now connected up and slipped in

in an upright position, one at a time. The four "C" battery leads are connected as well, and finally the two "A" battery leads are passed through the small hole at the top of the vertical partition and connected to the accumulator, which is then slipped into its compartment.

The Clyde type 2VS7 "A" battery specified for the "1937 Outdoor" will give nearly 70 hours of service from a single charge. An excellent plan is to use two of these batteries, so that a fully-charged one is always instantly available.

The aerial carried in the accumulator compartment consists of about eight yards of rubber-covered flex wound around a piece of three-ply, as mentioned in last month's article.

The battery compartment flap is next closed and the lid replaced, making the set ready for operation.

With normal use, the two 60-volt light duty Ever Ready "B" batteries will last from four to five months, depending on the use they are given. After about two months' operation, when the "B" voltage will have dropped to approximately 100 volts, the economy switch can be put over. This will restore the performance so that it becomes more or less equivalent to that obtained when the batteries were new, and also enables the last ounce of power to be obtained from the "B" units.

#### An Outstanding Performer

For sheer "pulling power" on DX work, combined with excellent volume and tone, the "1937 Outdoor" is in a class of its own. Correctly built and aligned, it will easily outperform any other standard four-valve battery superhet taking the same "B" drain.



# FOR POWER SENSITIVITY – essential for inverse feedback circuits the **EL3**

The Mullard EL3 high-gain pentode requires, for a given power output, only one-quarter as much input as an ordinary pentode and produces 30% less harmonic distortion.

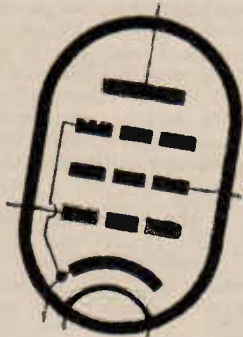

Performance Characteristic	Mullard EL3			Mullard 42
Plate and screen voltage	250	250	250	250 volts
Power output	3.0	3.65	4.4	3.0 watts
Total harmonic distortion	4.75	7	10	7 per cent.
R.M.S. input for stated output	2.85	3.4	3.9	11.6 volts
Power sensitivity	368	316'	288	22.3mW/V <sup>2</sup>

**it's a**



# Mullard

## MASTER VALVE

31M7



## 25 Years In Amateur Radio . . . (7)

The seventh instalment of a biography covering the early days of radio, written for the "Radio World" . . .

By DON B. KNOCK

Radio Editor, "The Bulletin."

**J**ACK PIKE, of VK2JP, is about the oldest active amateur in Australia, and a key-puncher of no mean repute. When he realised the emergency, he "sat in" on VK6NK and put daily business in the background.

Some idea of the traffic handled on this occasion can be gained when I say that almost 20,000 words were handled over a period of two or three days, and one of the QSO's went on for over nine hours non-stop. I shudder to think of an attempt to duplicate such traffic in these days, with the poor old 20-metre band seething with 'phones from all over the world! Then it was an "open go" and the devil take the hindmost on the key!

At this stage of operation from Wyndham Meatworks, the big machinery had not fully started up on the working season; consequently a small Diesel engine ran a puny 230-volt D.C. generator for lighting the offices and residences at night, until cut off at 10.30 p.m. Normally this was satisfactory, but often, when in the middle of traffic with VK2JP, the voltage would drop to around 100, and lights would dim to

nothing. Then 2JP had to wait while I stormed around trying to find who was using an electric kettle or ironing pants! A few expletives, and off would go the load, and traffic proceeded.

The first day had gone by, and at intervals VMZAB was sending that plaintive SOS, asking for help and, above all, food. A search party had been organised, and was threading its way through the long spear grass in the direction where it was thought the 'plane lay. They returned, disheartened—no sign! (Later it transpired that they had been only 10 miles away, with a mountain range between).

Reports of the search party were passed on to Sydney, and meanwhile organisation at Mascot aerodrome had progressed to the extent of getting a big three-engined Fokker ready to come North and search. It was not needed, for radio eventually saved the day.

### Missing 'Plane Found

On the third day, another search party was equipped under Sgt. King, of the W.A. police, with bushman Bill Flinders, of Wyndham town, in-

★  
The author on horseback at Wyndham, North-West Australia, where he spent a year installing and operating a shortwave radio telephony communication system at Wyndham Meatworks.  
★

cluded. Instructions were given to the effect that if they found the 'plane, the pilot should immediately call me and let me know.

Another day and a half passed, and sitting in the operating position in that corrugated iron-walled radio room was no joke in the heat of the North-West afternoon sun. At 2.30 p.m. this day there had been a long period of silence from VMZAB. It was obvious that the batteries were getting weaker, and soon there would be no juice left for transmission. I had called them repeatedly in the hope that a receiver was on board, until Sydney notified me otherwise.

Suddenly that weak signal was heard calling, "Knock, Knock, Wyndham—Sgt. King's party arrived O.K. All safe now." What a relief! In three minutes Pike had word away down in Sydney, and in another fifteen, newspapers were out on Sydney's streets with the news.

In three days' time Dave Smith, pilot of the 'plane, and his engineer, Wally Shiers, arrived at the works. They described vividly their experiences, and how Flinders had instinctively driven his motor truck straight through the dense spear-grass almost to the stranded 'plane. They stayed at Wyndham while a new camshaft arrived by air from the South, and Shiers, aviation engineer par excellence, went back and fitted it to the engine in the staggering heat while being eaten alive by mosquitos and flies.

In a few weeks' time the 'plane was ready again, and I enjoyed a radio test flight with Smith. The Kimberley country around Wyndham looks magnificent from a few thousand feet—a well-watered country.

Early one morning they took off on resumption of the flight to England. Crossing the Timor, the signal from their baby transmitter, powered from 300 volts of "B" battery, romped in until they landed at Bina. They never reached England, run-

ning short of fuel in the Siamese forests, and crashing on landing. Neither was hurt.

A few months later I was shocked to find myself copying Sydney Press one night to the effect that young Dave Smith had been killed at Mascot in an accident. To-day, Wally Shiers is Chief Engineer of Airlines of Australia Ltd.—a man with flying in his blood and modern aero engines at his command. He has good reason to know the vital importance of emergency radio communication for aeroplanes flying anywhere over Australia. Shiers is the same Sgt. Shiers who made the historic flight from England with the late Sir Ross Smith just after the War.

#### Experiments With a Portable

During that year in the North-West there was plenty of opportunity to get inland and see much of the country. The hospitality of the settlers is outstanding, and a visitor is speedily made to feel at home.

#### QSL Forms, Notepaper, And Stickers

Headed notepaper and QSL forms printed for the use of members of the All Wave All World DX Club are available from the "Radio World," 214 George St., Sydney, N.S.W., price 1/6 for 50 sheets, post free. Enlarged two-colour replicas of the Club badge, in the form of gummed stickers, are also available, price 5 dozen for 1/6, post free.

The mobile station 6JU went with me on these travels, and many interesting effects were noticed in shortwave communication.

One of the most interesting places for remarkable reception is La Crosse island, at the mouth of the Cambridge Gulf. A night was spent on this island, when three of us arrived by launch to run tests with VIX. Only a two-valve "blooper" receiver was used, but the whole world seemed to appear in great strength on the dial. The strength of American amateurs on 40 metres as early as noon was phenomenal. But for the water problem, this island should be an ideal place for a radio centre for flying boats on the overseas air-mail.

La Crosse, incidentally, is a laying and hatching sanctuary for turtles, and hundreds of the little fellows were seen emerging from the warm sand and flopping their way to the water to get their first swim. It is the island from where De Rougemont is reputed to have crossed to the mainland on the back of a turtle.

#### A Fortnight In Perth

At the conclusion of the season, the works' activity ceased, and I

shipped to Perth en route home, spending two weeks with the G.O.M. of radio there, Wally Coxon (VK-6AG), and meeting the very enthusiastic and hospitable bunch of VK6's, many of whom I had chatted with from VK6NK.

Back in Sydney, I found that life had taken on a dreary aspect. The notorious "depression" was in full swing, and the outlook was anything but pleasant. Trade was stagnating, but broadcasting was at least alive and doing, so a business offer in connection with a proposed country "B" station at Gunnedah, N.S.W., was accepted.

This station (2MO) started off with next to nothing in the way of finance, and with a broadcast transmitter fashioned mainly from such suitable components as had been available at VK2NO.

Despite the QRP, this station in its early makeshift form reached out with a good signal, and reports began to flow in from all over Australia and overseas. Technical difficulties were innumerable, as the town in those days had 240 volts D.C. It was a case of rotary converters for filaments and motor-driven generators for H.T.

As most readers will know, "B" class stations derive their revenue solely from advertising time. Imagine in 1931 trying to solicit air advertising in a wool and wheat district when prices were down almost to zero! Stores wouldn't advertise as their business was all "credit." City stations were "in clover," but the small country station had a very hard road to tread in those times.

#### Back To The "Big Smoke"

After a month or two with little or no financial return, and power bill, etc., soaring still higher, I decided that two partners could not make ends meet satisfactorily under such a handicap, and disposed of my share. As much as I had grown to love the Australian countryside, it was a case of back to the "big smoke."

One man could manage where two could not, and I am glad to say that my former partner weathered the economical storm. To-day his station is a permanency known to listeners far and wide.

Back in Sydney, some radio service work and trading was undertaken, with occasional contributed articles to radio and daily newspapers, and back on the air went VK2NO. A keen amateur cannot be kept QRT for long, and gradually the station assumed previous proportions and once again reached out all over the world. The YL became the XYL, and in due course came to know what "BCL QRM" and other jargon implied.

(To be continued)

TESTED AND



OK'd

AT 1,000 VOLTS  
A.C. & D.C.

Now you can buy moulded Mica condensers tested at 1,000 volts A.C. and D.C.—Mica condensers that have extremely high resistance to moisture—Mica condensers you can depend upon for the utmost in reliability, accuracy and permanency of calibration. Simplex . . . the "Custom-built" condensers . . . are made in three types; Type M with a capacity range of .004 microfarads to .02 microfarads. Type S/M—.000005 microfarads to .01 microfarads; Type P/T (Pigtails) .000005 microfarads to .001 microfarads.

"Favoured By Famous  
Factories"

SIMPLEX  
CONDENSERS

Manufactured by Simplex Products Pty. Ltd., 716 Parramatta Rd., Petersham, N.S.W.

'Phone LM 5615  
Agents In All States

# Radio Step By Step . . . . . 12

## The Leaky-Grid Detector At Work

The twelfth instalment of a series of articles specially written for beginners.

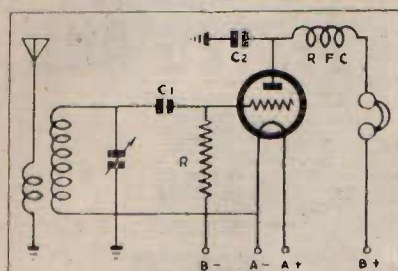

FIG 1

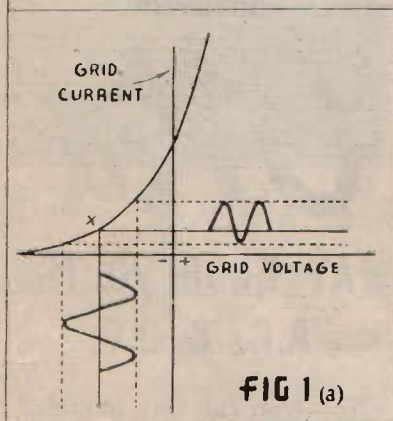

FIG 1 (a)

**N**EXT to the diode detector, now almost universally used in commercial receivers, the leaky grid system of detection is the most popular. Its most important advantage is that it is highly sensitive, while its main drawback is that it cannot handle large inputs. However, in most applications where it is used, power handling capability is of secondary importance, highest possible sensitivity being the main requirement.

Fig. 1 shows a single valve receiver using a triode as leaky grid detector. When a signal is applied via the grid condenser "C1," the grid potential changes in sympathy with it. The resistance "R" is the grid leak; this is generally returned to the negative side of the filament, though with some types of battery valves returning it to "A+" gives best all-round operation. With indirectly heated valves, the grid leak is returned to the cathode.

### How Rectification Is Accomplished

In the leaky grid detector, rectification is made possible by the curvature of the grid-voltage grid-current curve. A typical curve for a valve of the indirectly-heated variety is shown in fig. 1 (a). It will be noted that a tiny grid current, amounting perhaps to a microamp. or so, flows even when the grid is negative to filament.

This is due to the fact that a few of the electrons leave the cathode with sufficient velocity to pass to the plate through the grid, despite the repelling force exerted by the latter.

This tiny grid current flows through the grid leak "R," the resultant voltage drop across it being such that the grid end is negative in respect to the filament. Thus the value of the grid leak (usually of the order of 5 megohms) governs the position of the operating point on the grid current curve. To ensure rectification, this point should fall on the curved portion, as shown at "X" in fig. 1 (a).

If a modulated radio frequency signal is now applied to the grid via "C1," the grid voltage changes in sympathy. Because of the bend in the grid current curve, the grid current increases more when the grid is positive than it decreases during the negative half-cycles of the alternating input voltage. Thus the negative half-cycles are largely suppressed, while the positive half-cycles are allowed to pass.

### Cumulative Charging Effect

Each wave-train of high frequency alternations has a cumulative effect on the grid, as owing to the high resistance of the grid leak, a charge given to the grid by one high frequency impulse does not have time to leak away before the next comes along. Thus the constantly varying charge on the grid follows more or less faithfully the shape of the modulation envelope impressed on the radio frequency carrier at the transmitting station.

The result is a net change in the grid current—in this case an increase. This increase in grid current means an increase in voltage drop across the grid leak, which in turn means an increase in negative bias applied to the grid. This has the effect of decreasing plate current. Thus, the audio grid current changes produce corresponding plate current changes.

### Detection And Amplification Combined

In a leaky grid detector, therefore, there are two effects, detection and amplification. The grid and filament (or cathode) can be regarded as a simple diode detector effecting rectification.

As well, the audio frequency voltages appearing on the grid as a result of this rectification directly influence the filament-to-plate electron stream, so that an amplified version of the audio frequency voltages developed on the grid appears across the plate load resistor, which in the case of fig. 1 is a pair of headphones.

### Removing Unwanted R.F.

Condenser "C2" and the radio frequency choke "R.F.C." are included to remove unwanted radio frequency voltages that appear in the plate circuit of the detector. The reactance of the choke is such that while it is high enough to block r.f., it has no effect on audio frequencies.

Also, the condenser "C2," which generally has a capacity varying from .0001 to .0005 mfd., allows the blocked r.f. impulses to pass unhindered to earth. At the same time, a condenser of this capacity has far too high a reactance to permit audio frequency currents to pass freely through it.

### Power Grid Detector

The power grid detector is an adaptation of the leaky grid detector, to allow bigger inputs without distortion. So that power can be developed, the plate voltage is increased to 150 or 200 volts, while the capacity of the grid condenser is reduced to .0001 mfd. A typical value of grid leak for this purpose is .25 megohm.

For sensitivity and power handling capability, this type of detector can be regarded as a compromise between the "C" bias and leaky grid types.



At to-day's low prices, "Instruments by Triplet" means **Precision Without Extravagance**

Shown above is the Triplet Model 1200-A Volt-Ohm-Millammeter. Has two instruments (A.C. and D.C.) in moulded case. Can be tilted to any reading angle. Scale readings: D.C., 10-50-250-500-1,000 volts at 2,000 ohms per volt; 1-10-50-250 M.A.; Low ohms .5-500; 1,500 ohms, 1.5 and 3 megohms. A.C. 10-50-250-500-1,000 volts. Resistance measurements have individual zero adjustments. Selector switch for all readings includes 22½ volts and 1½ volt batteries.

Price £9, or kit of parts complete down to last nut and bolt, with full assembly instructions and wiring diagrams, £7. Write for details.

The instruments illustrated opposite are, from top to bottom:

Model 1503 Multi-Purpose Tester. Checks any type valve for merit (including separate diode test). Tests paper condensers for opens and shorts, and electrolytics for leakages. D.C. voltmeter and milliammeter, ohm-meter, decibel meter. Price: £19/5/-.

Model 666 Universal Pocket Volt-Ohm-Millammeter for measuring A.C. or D.C.

volts, ohms and mills. Price: £5/15/-.

Model 1250 Self-calibrating Vacuum Tube Voltmeter. Price £13/15/-.

Model 1260 Compact Portable Audio Frequency Oscillator. Price: £10/15/-.

Model 1295 Modulation Monitor with tilting type twin instrument. Price: £9/15/-.

New illustrated catalogue of Triplet and Readrite equipment sent post free on request.

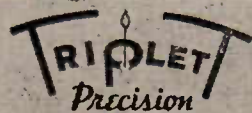
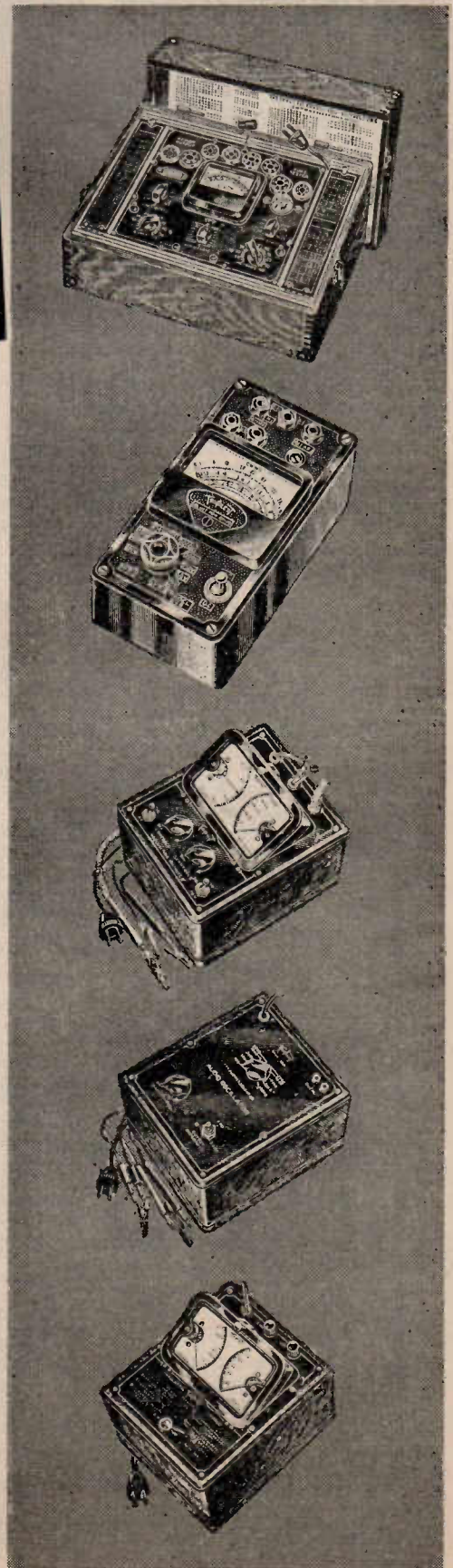

ELECTRICAL INSTRUMENTS

Exclusive Factory Representatives for Australia and New Zealand:

**W. G. Watson & Co. Pty. Ltd.**

279 CLARENCE STREET, SYDNEY

398 Post Office Place, Melbourne  
31 Hunter Street, Newcastle

And at Hobart, Tasmania, Launceston  
and Wellington, N.Z.

91a Currie Street, Adelaide

Western Australian Distributor:  
Queensland Distributor:

ATKINS (W.A.) LTD., 894 Hay St., Perth  
W. E. PETERMAN, 160 Edward St., Brisbane

# Improved Operating Conditions For 1C6 On S.W.

**Z**ERO bias operation for the 1C6 gives lower "B" battery drain, together with distinctly higher sensitivity, than operation with a negative bias under similar conditions (states "Radiotronics" No. 79). While it has been very widely adopted on broadcast frequencies, it has been less widely adopted on the shortwave band owing to the fear of unsatisfactory performance.

As a result of improvements made in the production of the Australian-made Radiotron 1C6, this valve is now capable of operating at zero bias on the shortwave band with entire satisfaction. In order to enable every user to obtain equally satisfactory results on the shortwave band, a set of conditions has been standardised which is recommended for the shortwave band of all dual-wave receivers. These conditions may also be used in receivers having more than one shortwave band.

### 16 To 51 Metres

These new conditions cover a waveband range from 16 to 51 metres, and will not only give satisfactory coverage under the conditions specified, but also give a very satisfactory margin of safety, so that the valves do not fail to oscillate even with the "A" battery run down to 1.8 volts and the "B" battery at 90 volts simultaneously. The sensitivity under these recommended conditions is very much superior to that which the 1C6 is capable of giving under nega-

**Lower "B" battery drain, higher sensitivity, and improved all-round performance of the 1C6 on shortwave are obtainable under the improved conditions for zero bias operation outlined below. Complete coil specifications as recommended by Amalgamated Wireless Valve Co. Pty. Ltd. are included.**

tive bias, and, as a consequence, the zero bias conditions are much to be preferred.

This preference is made even greater since the Australian-made 1C6 valves are factory-tested under conditions of zero bias simulating the conditions of shortwave operation over the band 16 to 51 metres.

### Recommended Coil Specifications

In order that satisfactory results may be obtained, it is essential to use the best coils which can be designed for the particular application, and a considerable amount of investigation has been made in the laboratory of Amalgamated Wireless Valve Co. Pty. Ltd., with the result that coils made according to the specifications given on the opposite page are satisfactory in every regard.

These coils were designed for use with a gang condenser having a capacity of 9-398 mmfd. If condensers having other capacity limits are used, it will be necessary to adjust the inductance of the coils so that the correct band coverage is obtained without having to increase the capacity of the trimmer condenser. The coils will cover the correct waveband, provided that the total effective minimum stray capacities, including those of the coil, the wiring, the trimmer condenser and the valve do not exceed 35 mmfd. It will be necessary to adopt a layout giving short leads and the minimum of stray capacities in order that this value should not be exceeded.

The trimmer condenser used in the tests on these coils had a capacity of 2-20 mmfd., and was adjusted to as

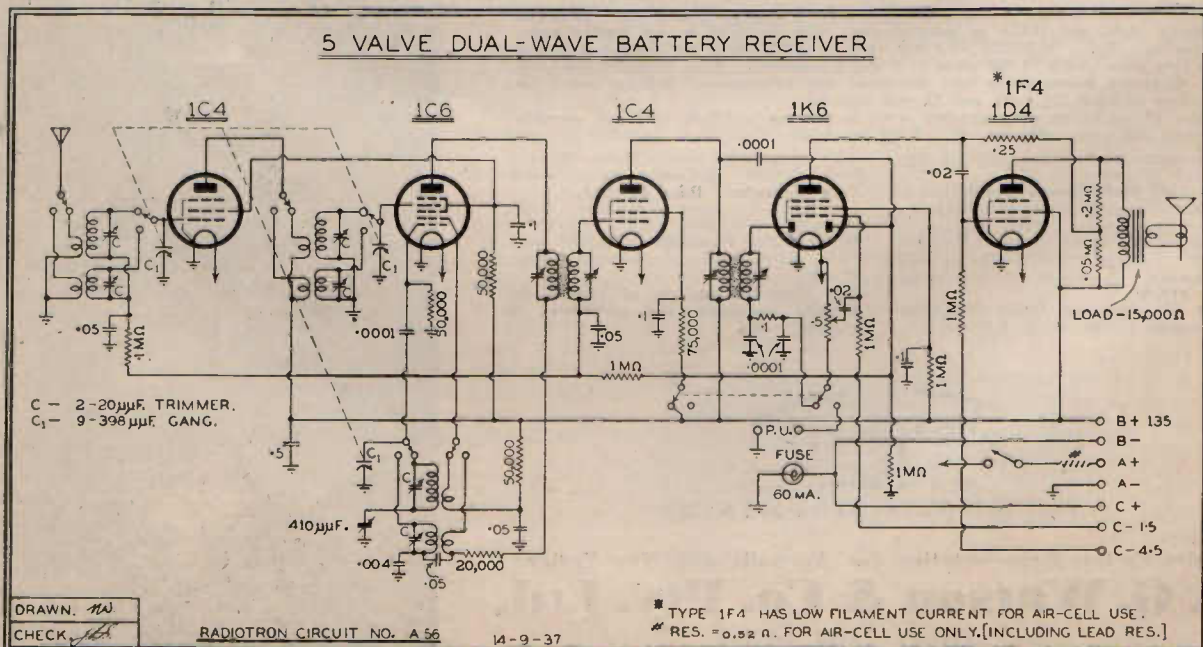

This circuit incorporates the padder feedback arrangement recommended to give a slight additional assistance to oscillation at the low frequency end of the shortwave band.

## COIL DETAILS

Note that these coil data apply only to particular conditions, and adjustment will normally be required in differing layouts. The effective inductance of the coils is affected by the length of leads, the shield cans, and proximity to other components in the case of unshielded coils. The band coverage is affected by the total stray capacities, as well as by the capacity of the gang condenser. Using gang condenser B, the band coverage will be wider than with condenser A. Any minor adjustments in the coils should be made in the same proportion to both primary and secondary.

Coil.	Primary.	Secondary.
AERIAL 550-1500 K.C. ....	375 turns 40 S.W.G. S.S.E. with one turn over hot end of secondary.	120 turns 5/44 Litz, in three equal sections.
AERIAL 16.0-51 metres ....	4.25 turns 28 B. & S. D.S.C. interwound from bottom of secondary.	11.7 turns 22 B. & S. E., wound in screw cuts 16 T.P.I.
R.F. 550-1500 K.C. ....	950 turns 40 S.W.G. S.S.E. with one turn over hot end of secondary.	120 turns 5/44 Litz, in three equal sections.
R.F. 16.0-51 metres ....	8.75 turns 28 B. & S. D.S.C. interwound from bottom of secondary.	11.45 turns 22 B. & S. E., wound in screw cuts 16 T.P.I.
OSCILLATOR 550-1500 K.C. ....	30 turns 34 B. & S. E. wound over bottom of secondary.	100 turns 31 B. & S. E.
OSCILLATOR 16.0-51 metres ....	6.5 turns 44 S.W.G. D.S.C. interwound from bottom of secondary.	10.9 turns 22 B. & S. E., wound in screw cuts 16 T.P.I.

SHIELD CAN:—Internal Diameter, 2 1/8 inches.

TUNING CONDENSER:—A. 10- 390 mmfd. See note above.  
B. 9- 398 mmfd.

Max. effective stray capacities:—A. 34 mmfd. (including valve input, trimmer, wiring and coil).  
B. 35 mmfd.

low a capacity setting as possible. In order to obtain the full sensitivity, it is essential that correct tracking should be obtained, and in every differing layout a certain amount of work is necessary in order to obtain this result. Experience has shown that with different layouts (affecting stray capacities and lead inductances) a variation of capacity in the padder condenser may be necessary, even with identical coils and other operating conditions.

In the receiver on which tests were made, the padder condenser had a capacity of 4,000 mmfd.

### More Uniform Oscillation

In order to give a slight additional assistance to oscillation at the low frequency end of the band (51 metres), the padder feedback arrangement, as shown in Radiotron circuit A56, described in "Radio-ronics" 80, is strongly desirable. [The circuit referred to is reproduced on the opposite page.—Ed.]

Although better feedback is obtainable by the use of a small padder condenser, it is not desirable to use a lower capacity padder than is necessary for correct tracking. If the recommended conditions are followed, there is no necessity for de-

creasing the capacity of the padder below that for satisfactory tracking in order to obtain increased oscillator strength on 51 metres.

### Conditions Of Shortwave Operation

#### AUSTRALIAN-MADE RADIOTRON 1C6

Waveband coverage:—16-51 metres.  
Gang condenser:—9-398 or 10-390 mmfd.

Total effective stray capacities:—35 or 34 mmfd. respectively.

Coils:—As shown in diagram.

"B" battery:—135 volts (minimum).  
Screen voltage:—135 volts through 60,000 ohms dropping resistor.

Anode grid voltage:—135 volts through 20,000 ohms dropping resistor.

Control grid bias:—0 (fixed).

Under these conditions the operating characteristics of an average valve will be:—

Plate current .....	1.5 m.a.
Screen current .....	1.3 m.a.
Anode grid current .....	1.9 m.a.
Total .....	4.7 m.a.
Oscillator grid current for above conditions 120 microamps.	

Under conditions in which the oscillator grid current is considerably

less than 120 microamps. (less than about 40 microamps.), the total current drain will increase. As a guide to those using the Australian-made 1C6, the following values are given for typical conditions:—

Average oscillator grid current .....	120 microamps.
Maximum oscillator grid current .....	180 microamps.
Minimum oscillator grid current .....	25 microamps.

An average valve will draw 60 microamps. on 51 metres. No valve under correct conditions should draw less than 25 microamps. on 51 metres. No valve should draw more than 180 microamps. under any short-wave conditions. Individual valves may vary between these two limits, and there may also be variations due to the "Q" of the coils and to other minor details.

### Adequate Safety Factor

It is obvious that with an absolute minimum oscillator grid current of 25 microamps., a large factor of safety is allowed for run-down batteries or for reduced emission in the valve, and it would be very undesirable to permit receivers to be manufactured having a smaller tolerance than that stated. This particular

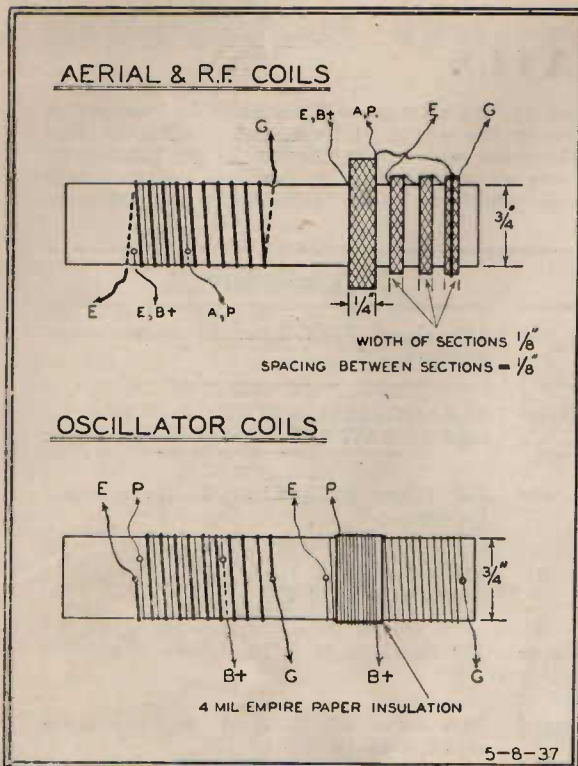

Details for winding the aerial, r.f. and oscillator coils recommended are given in these sketches.

valve is specially interesting in that the oscillator grid current decreases gradually to zero without going suddenly out of oscillation. It is also frequently found that a valve may still oscillate, although very weakly, when the oscillator grid current is zero. This is on account of the contact potential being such that no oscillator grid current flows on zero oscillator grid voltage. It may therefore be possible to use the valve as a converter with an oscillator grid current of zero, although naturally the sensitivity will be very poor.

**Plate And Screen Voltages**

Under the conditions specified above, no mention was made of the screen voltage or of the anode grid voltage actually applied to the electrodes. This omission has been made

on purpose, since no value would be served by such a statement and since no advantage is gained by a measurement of these voltages. The valves are factory tested under the conditions given, and although the effective voltages of these electrodes may vary within certain limits, this will not affect their operation.

In cases where it is desired to have a wider shortwave coverage than 16-51 metres, it is recommended that more than one shortwave band should be employed. In such cases each band should be limited to a frequency range not exceeding 3:1, and on the highest frequency band it is preferable to reduce the ratio to a still lower figure.

**Operation On The Broadcast Band**

The conditions given for the shortwave band hold equally for the broadcast band, and may be used without the slightest hesitation. At the same time, it is realized that economy may be made by operating the valve with a lower total "B" battery drain, which is possible, since the conditions under which the valve is working are much easier. It is recommended that no change should be made to the grid bias or to the screen voltage, but that, if desired, the anode grid dropping resistor may be

(Continued on page 46)

**FERRANTI gets you Holland-  
but not in "Double Dutch"**

When you tune in PHI Holland on your Ferranti All Wave Receiver you won't need to explain to your friends: "Oh, that's the wooden shoes the Dutchmen wear," for, though Ferranti gives you ALL the programme, it's the programme only—no extras.

The Magnascope Dial, exclusive to Ferranti, is the sensation of the year. Its magnified tuning scale, 6 feet long in effect, gets you a front seat in any programme—anywhere.

Make friends with Holland—and the world. Let Ferranti introduce you.



**FERRANTI**

**WORLD RANGE RADIO**

SOLE AGENTS **NOYES BROS (SYDNEY) LTD.**

115 Clarence St., Sydney. Phone: B 7581 (10 lines).  
11 Watt St., Newcastle. 197 Elizabeth St., Brisbane.

★ **ARCADIA**  
Superhet All Wave  
A.C. Variable selectivity,  
high fidelity Console.

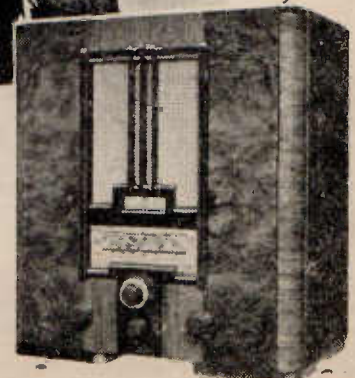



**MANY . . .**  
**a good programme**  
**can be heard on**  
**an old radio set**  
**and heard**  
**very well**  
**indeed**  
**if you . . .**



**Re-valve with**



# Radiotrons



**THE WORLD'S STANDARD RADIO VALVES**

**AMALGAMATED WIRELESS (A/SIA) LTD.**  
 47 York Street, Sydney  
 167-169 Queen St., Melbourne

**AUSTRALIAN  
 GENERAL ELECTRIC  
 LIMITED**  
 Sydney, Melbourne, Brisbane  
 Adelaide, Hobart

**NATIONAL ELECTRICAL & ENGINEERING  
 Co. Ltd.**  
 Wellington, N.Z.

ADVERTISEMENT OF AMALGAMATED WIRELESS VALVE CO. PTY. LTD.

# What's New In Radio

A monthly review of latest releases  
in sets, kit-sets, and components

## "Wireless Servicing Manual"

A copy of the third revised and enlarged edition of "Wireless Servicing Manual," by the well-known English radio writer, W. T. Cocking, has been received from the publishers, Iliffe & Sons Ltd., London.

The purpose of the book is to explain in detail those principles of testing upon which the servicing of receivers depends, and to explain them in such a way that the book forms a practical guide to which both amateur and professional can turn for reference. The arrangement of material is consequently based largely on the symptoms of faults rather than exclusively on the faults themselves.

Essential testing apparatus is described in detail, and correct testing methods explained. The greater portion of the book is devoted to methods of locating and remedying the various defects that can develop in receiving equipment.

In addition to this, the appendices have been revised to include the latest reference material. This section of the book includes base connections for British, Continental and American type valves, colour codes, wire-tables, etc.

The book is obtainable in Australia from Messrs. Angus & Robertson Ltd., 89 Castlereagh St., Sydney, price 7/6, postage 9d.

GREATER EFFICIENCY AT LOWER COST!

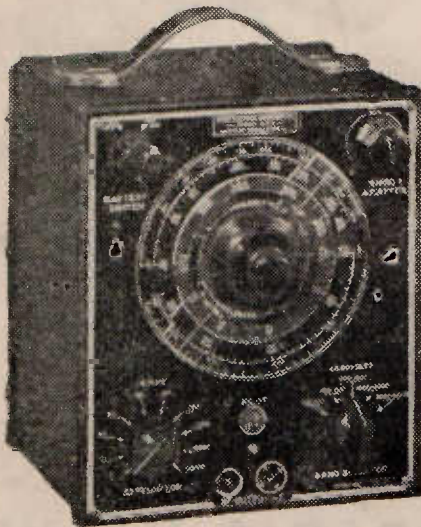

Manufacturers of Cathode Ray Equipment, Meters, and full range of Testing Equipment.



AVAILABLE FROM LEADING DISTRIBUTORS.  
**Paton Electrical Instrument Company**

90 VICTORIA STREET, ASHFIELD.

## PALEC ALL-WAVE OSCILLATOR

Although small in size (9" x 7½" x 6"), and sufficiently compact for outdoor work, the Model "DR" Oscillator is remarkably efficient and admirably suited for factory use.

### Model "DR" Features:

Direct Reading Dial in five ranges from 150 K.c. (2,000-19 metres). Reads simultaneously in K.c.'s and Metres, fitted with differential slow motion drive. The attenuator incorporated is particularly effective, having the negligible leakage necessary for the alignment of a super sensitive set with A.V.C. Heavy batteries, pilot light, variable modulation and variable A.F. output are added features.

Price complete with two valves and batteries, £10/15/- plus tax.

## New Amplion Auditorium Speaker

The latest Amplion speaker is the Model "T" illustrated below, priced at £7/10/-. Up to 15 watts can safely be dissipated in the field. Outer suspension is incorporated to permit free play of the cone, the voice coil being 1½" in diameter.

The model "T" is fitted with the 33 oz. multi-impedance transformer lately released by Amplion, and which enables the speaker to be

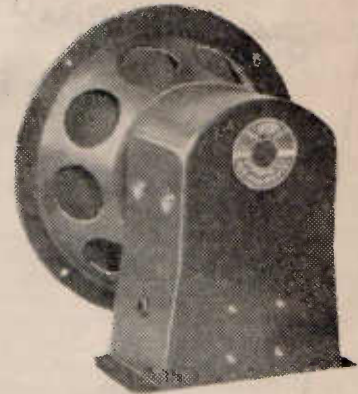

matched to any type output valve or valves. The transformer is wound with heavy gauge wire, and will safely carry up to 80 mills., so that the speaker is well suited for use with 6L6 beam power valves.

Up to 12 watts of undistorted output can be obtained from this latest Amplion release, with first-class quality of reproduction.

★

## New Radiotron "G" Series

Amalgamated Wireless Valve Co. Pty. Ltd. advise that a complete "G" series of valves has now been added to the Radiotron range. In addition to the American "G" series, there have been added the following "G" equivalents to the existing Australian types:—

Existing Glass Types.	Equivalent "G" Types.
1C4	1M5G
1D4	1L5G
1K4	1K5G
1K6	1K7G
6B7S	6G8G

With the exception of the 1M5G, the above types are identical electrically with the existing glass types.

The 1M5G incorporates higher plate resistance, higher amplification factor, and an improved A.V.C. characteristic, enabling receivers fitted with this type to be capable of handling large signal voltages without overloading.

There are also two additional types not included in the American Radiotron range, namely the 6U7G and the 6B6G, being exact equivalents of the 6D6 and 75 respectively. These two

types will be manufactured in Australia.

Stocks of the American types are already available, and supplies of the Australian made "G" series are due for release in the early part of November.

The complete range to be manufactured in Australia is:—

1C7G	1K5G	5Y3G	6G8G
1D5G	1K7G	6A8G	6J7G
1F5G	1L5G	6B6G	6U7G
1J6G	1M5G	6F6G	6V6G



**Latest S.T.C. Metal-Valve Superhet**

The latest S.T.C. Model 5035 K is a three-band superheterodyne using the following six metal valves.—6K7 r.f. and i.f. amplifier, 6A8 pentagrid converter, 6B8 diode detector, a.v.c. and audio amplifier, 6F6 power pentode, and 5Z4 rectifier.

A special feature of this latest S.T.C. release is that it is guaranteed to give dependable performance down to 11 metres, the three wavebands being as follows:—11 to 33 metres, 18.5 to 55 metres, and 200 to 550 metres. An output of 3.5 watts is obtainable, very good quality of reproduction being ensured by the special 10-inch S.T.C. speaker employed. The five controls comprise tuning, volume, tone, wave-change and sensitivity, a local position be-



Model 5035K S.T.C. all-wave superhet.

ing provided on the wave-change switch.

Other attractive features include a steel chassis with removable reinforced end plates, an edgelit tri-coloured dial complete with Ovaloid bakelite escutcheon, provision for a doublet aerial, iron-cored i.f. transformers, and an air-trimmed oscillator. An added feature is the stabiliser fitted in the oscillator cir-

cuit, this undoubtedly being largely responsible for the complete absence of fluttering at any frequency on the short waves.

Quietness in operation is a noticeable characteristic. There is an ample reserve of sensitivity, while the selectivity is such that it ensures easy separation of all stations.



**Ken-Rad Type 6U5 Tuning Indicator**

Listing at 15/-, the new Ken-Rad 6U5 Electron Ray tuning indicator is now available from Eastern Trading Co. Ltd.

This valve is identical with the type 6G5, except for the fact that the size of the glass envelope has been reduced, which permits the mounting of the valve in restricted space, and is particularly adaptable to those arrangements where the tuning indicator forms portion of the dial mechanism.

The overall dimensions of the envelope are 3 1/8" long, 1 1/8" diameter, while the maximum overall length of the valve is 4 1/4".

Improvements which have been made in the internal construction of this valve make for more reliable operation and longer life.

In the course of the next few days a suitable moulded bakelite holder, especially designed to take this valve,

**3 NEW**

**AMPLION**

**RELEASES**

**MODEL "T"**

This new auditorium speaker is Amplion's latest and finest product and is a masterpiece of Australian design and manufacture.

A beautiful reproducer, taking full care of the whole frequency range and with an undistorted output of 10 to 12 watts.

PRICE, £7/10/-

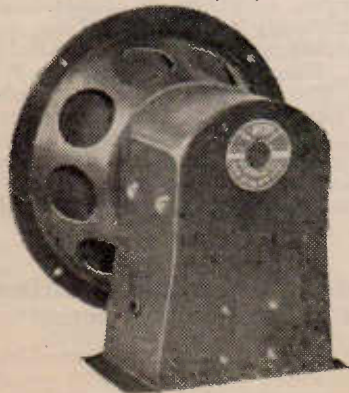

TYPE "T"

**AUSTRALIA'S FIRST MULTI-IMPEDANCE TRANSFORMER**

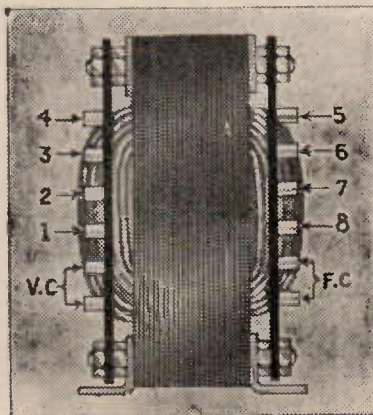

Illustrated with cover removed  
**MULTI-IMPEDANCE TRANSFORMER**  
 Impedances available from 2500 to 12,000 ohms single or push-pull. Weight 33 oz. Standard equipment on all "SA" and "T" Model Speakers.

PRICE, £1/10/-

Ask for publication No. 55 giving full details of these new Amplions.

**MODEL "SA"**

An improved 10in. speaker fitted with the new Multi-Impedance Transformer. Extended low frequency response with entire absence of boom. New process enables waterproofing of cone during fabrication.

PRICE, £3/10/-

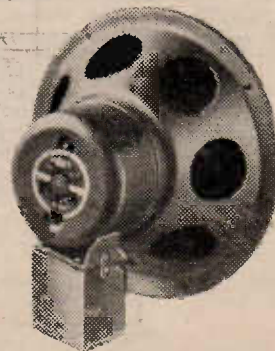

TYPE "SA"

**AMPLION (A'ASIA) PTY. LTD., 66 Clarence Street, Sydney**

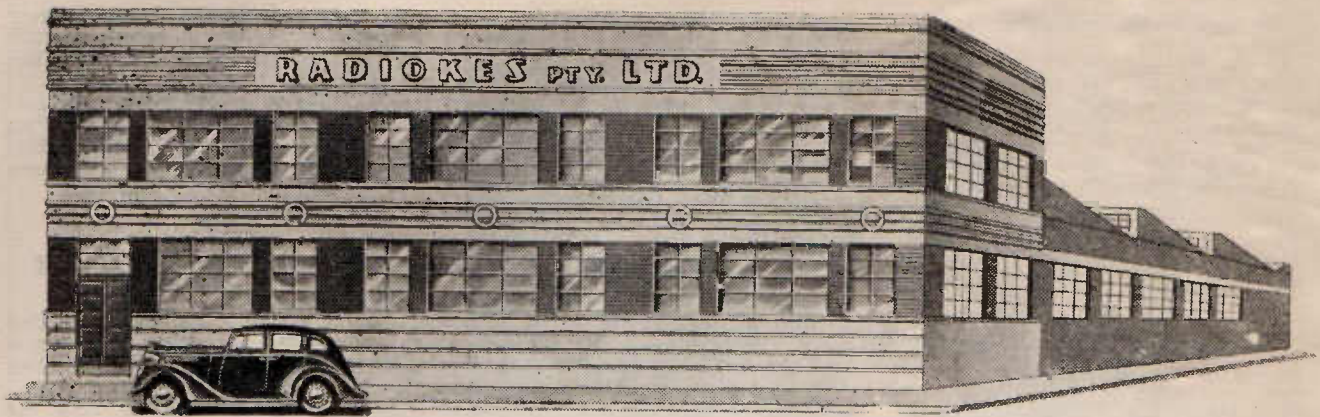

An artist's impression of the new factory now being erected for Radiokes Pty. Ltd. in Redfern, Sydney. It is expected that the building, which will comprise one ground floor of 10,000 square feet and a mezzanine floor for offices, will be ready for occupation early in 1938.

will be available from the Commonwealth Moulding Co. Ltd.



### Triplet Model 1200-A Volt-Ohm-Milliammeter

Messrs. W. G. Watson Pty. Ltd., of Sydney, advise that for servicemen, set-builders and amateurs who prefer to build their own test equipment, complete kits of parts for the well-known Triplet Model 1200-A volt-ohm-milliammeter are available. Designed for simplicity of operation, high accuracy, and flexibility, the 1200-A is an instrument that has found universal favour among radio technicians both in this country and the United States.

A unique and practical arrangement is the separate A.C. and D.C. instruments combined in a single bakelite case, and fastened to the panel on two strong hinges. The purpose of this exclusive type of mounting is to give an accurate reading angle at any position the

tester may be placed, thereby avoiding parallax, one of the most common sources of error. By pulling forward on the knob at top of meter case, the bakelite case housing the two meters can be instantly tilted to any desired reading position, which will place the meter scale in direct vision with the operator's eyes.

The instrument scale readings are 0-10-50-250-500-1,000 volts, both A.C. and D.C. The D.C. meter is used also for measuring 0-1-10-50-250 milliamperes and resistances—on a low ohm scale from .5 to 500 ohms, with approximately 13 ohms centre scale, and on 1,500 ohms, 1.5 megohms and 3 megohms scale with approximately 240, 24,000 and 48,000 ohms centre of scale. All meter readings are obtainable by setting the selector switch to the proper position, marked to correspond with the scale numerals.

The zero setting for ohms readings is accomplished by adjusting the meter needle to full scale by using a small screwdriver to turn any

one of the three rheostats. The shafts of these rheostats have slotted heads projecting through the panel, and are marked "Ohms Adjustment." There is an individual rheostat adjustment for each of the "HI OHM" scale readings, making it unnecessary to readjust each time the scale is changed. A single rheostat controls the zero adjustment for the "LOW OHMS" and 1,500-ohm scales, as the current consumed is the same. Thus one setting serves for both adjustments.

Two jacks are used for the measurement of A.C. and D.C. volts, D.C. milliamperes—1,500 ohms, 1.5 and 3 megohms. A third jack is used for the measurement of output voltages when the meter is used in conjunction with an oscillator, and another jack is used when measurements are made in the low ohms scale. The output jack has a condenser in series with the meter movement to prevent the application of D.C. current to the A.C. output meter.

The Model 1200-A complete is priced at £9, while the kit of parts, with ready-drilled and engraved panel and including everything required, sells at £7. Supplied with each kit is a 12-page booklet, well-illustrated with step-by-step wiring diagrams, describing in minute detail the assembly and wiring of the kit.

Further particulars are obtainable from Messrs. W. G. Watson Pty. Ltd., 279 Clarence St., Sydney, who will also supply on request, free and post free, a copy of their latest eight-page catalogue, describing and illustrating the wide range of latest Triplet test equipment now available.



### Model 537 Stromberg-Carlson 4/5 Dual-Wave Superhet

One of the latest Stromberg-Carlson releases—the Model 537 console illustrated opposite—was recently received by the "Radio World" for

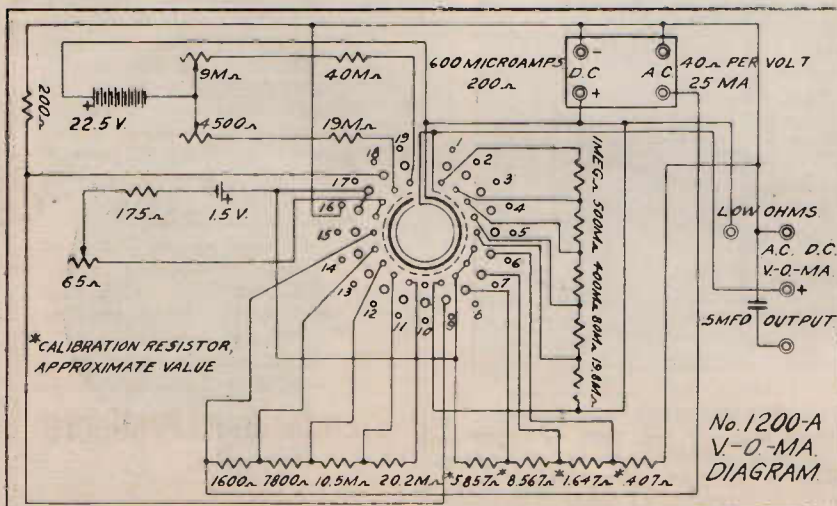

The circuit of the Triplet Model 1200-A volt-ohm-milliammeter.

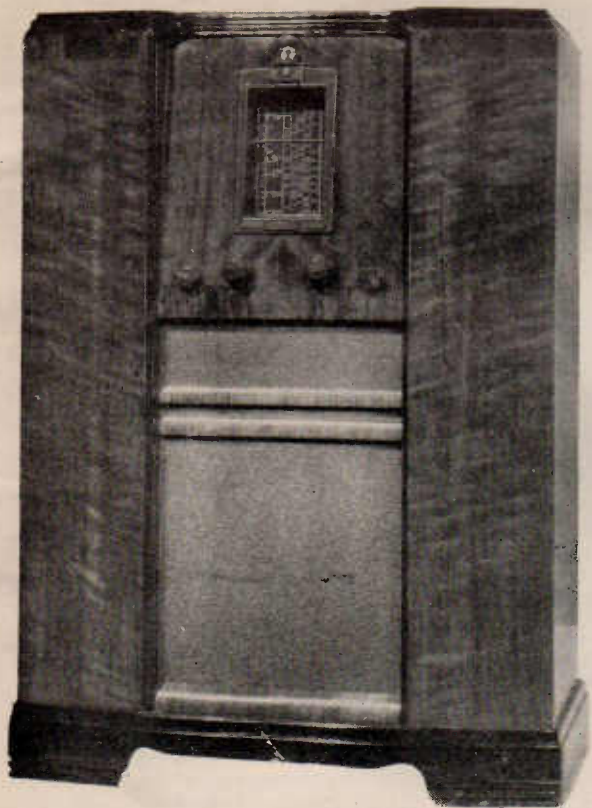

The Stromberg-Carlson Model 537 a.c. dual-wave superhet.

On test, the 537 revealed excellent sensitivity on both wavebands, while selectivity on the broadcast band was particularly high. Reproduction is crisp and pleasing, while volume is far more than sufficient for all domestic purposes.

In design, assembly, appearance and general performance, the Model 537 is a receiver that is difficult to fault, and it should have a particularly strong appeal to prospective set-owners.



test. A 4/5 dual-wave a.c. superhet mounted in the well-known Stromberg-Carlson Concert Grand cabinet, the 537 is soundly engineered throughout, and is assured of popular favour.

The valve line-up comprises a 6A7 pentagrid frequency converter, 6K7 metal i.f. amplifier (intermediate frequency 465 k.c.), 75 diode detector, a.v.c. rectifier, and triode audio amplifier, AL3 high mu output pentode, and EZ3 indirectly-heated rectifier. A type 6G5 magic eye tuning indicator is also used.

Ample selectivity on the broadcast band is ensured by the use of a band-pass filter ahead of the mixer oscillator, together with iron-cored i.f. transformers. Provision is made for the attachment of a pick-up, while terminals are also provided for a doublet aerial.

Every effort has obviously been made in the assembly and wiring to ensure years of trouble-free operation. In particular, an idea worthy of mention is that of housing all paper by-pass condensers in small upright metal cans mounted on the chassis. This scheme relieves these components of all strain on the pig-tails, with consequent risk of breakdown.

There are four controls—tone, volume, tuning (with concentric vernier), and three-position wavechange switch, the three positions being "shortwave," "distant" and "local."

### 1938 Radiokes Catalogue Is Outstanding Production

Printed in orange and black throughout on heavy art paper, the 1938 Radiokes catalogue just released sets a new standard in catalogue production, and offers an excellent indication of the splendid progress that has been made by this firm during the fifteen years it has been operating.

The complete range of Radiokes products listed and illustrated includes the well-known dual and tri-wave coil boxes, plain and litz-wound air and iron-cored coils and i.f. transformers, sirufer, air-trimmed and variable selectivity i.f.'s, a wide variety of audio and power transformers, smoothing chokes, and mid-ge variable condensers (bakelite and ceramic insulated).

Miscellaneous components listed include padding and trimming condensers, i.f. bases, r.f. chokes, voltage dividers, wirewound potentiometers and transposition blocks. The catalogue is lavishly illustrated throughout, cutaway views of coils and i.f. transformers being included so that the internal assembly can be seen.

For many years now Radiokes have specialised in manufacturing components for set-builders, and so every reader interested in home construction should make a point of obtaining a copy of this latest catalogue, which is obtainable free on request from any Radiokes distributor or direct from Radiokes Pty. Ltd., Box 10, Redfern, Sydney, N.S.W.

## "Tom Thumb Portable Two"

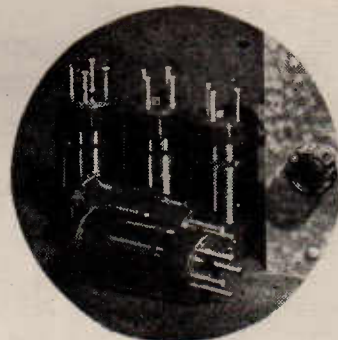

USES

## RAYWAY COILS

To get results equal to those obtained with the original "Tom Thumb Portable Two" (described in last month's "Radio World"), it is essential to use a set of "RAYWAY" coils, as chosen by the designer for their extremely high efficiency.

Each of the five coils comprising the "Tom Thumb" Kit is precision wound on plug-in formers of a special low-loss material, and is colour-coded to "Radio World" specifications.

Complete kit of 5 **21/-** coils packed in box



Complete coil kits are available for any of the following "Radio World" shortwave and all-wave receivers:—

- "All-Wave All-World Two"
- "Eaglet Shortwave Two"
- "Empire Shortwave Three"
- "All-Wave Bandsread Two"
- "Empire All-Wave Three"
- "Amateur Communications Eight"
- "Jones' Super-Gainer"

(Note: Due to the use of more expensive bakelite in the latest "Rayway" formers, all previous prices advertised for single coils are cancelled).

If unobtainable from your local dealer, write direct to:—

### Standardised Products

Note new address:—

629 PARRAMATTA ROAD,  
LEICHHARDT, SYDNEY.  
N.S.W.

'Phone - - - LM 5957

# New Adelaide Station Has Up-to-Date Transmitter

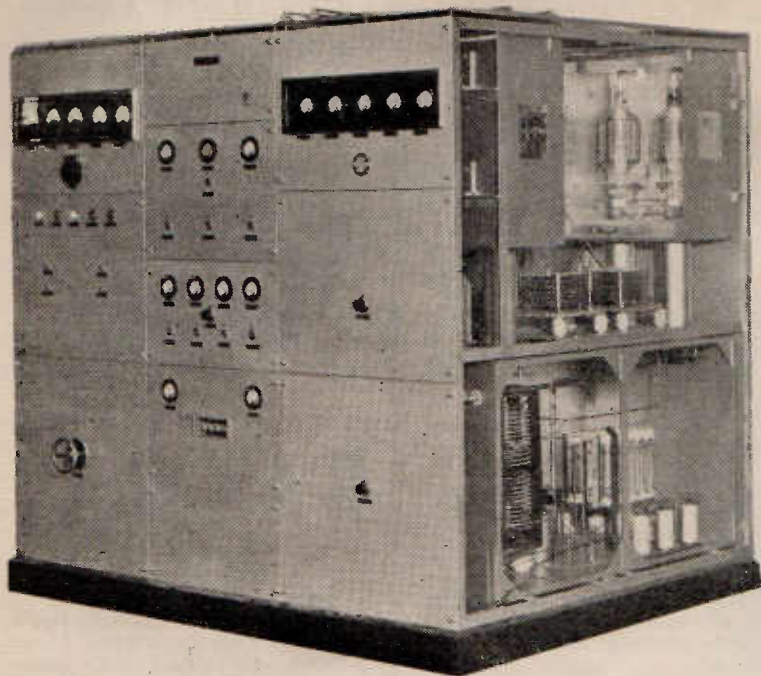

## 1.8 k.w. Air-Cooled Valves Are Used In Latest S.T.C. Install- ation

A view, with end covers removed, of the two-kilowatt transmitter recently installed for National Station 5AN, Adelaide, by Standard Telephones and Cables Pty. Ltd.

**T**HE new unit of the national broadcasting network recently installed in the Telephone Exchange Building in Adelaide—Station 5AN—incorporates many latest developments in broadcast engineering.

The equipment, which was designed and built in Australia by Standard Telephones and Cables Pty. Ltd., Sydney, to the order of the Postmaster-General's Department, incorporates several new features. The full power of the transmitter is two kilowatts, capable of 100% linear modulation, but the equipment will be operated initially at reduced power on 500 watts.

### 1.8 K.W. Air-Cooled Valves Used

An unusual feature for a transmitter of this size is the fact that no water-cooled valves are employed. This is made possible by using in the final stage four S.T.C. type 4279-A valves. These valves are each capable of handling a total input power of 1.8 kilowatts, and are the largest air-cooled valves made.

The whole transmitter is totally enclosed, and is cooled by filtered air pumped through the unit from an external blower. By "air conditioning" the transmitter in this way, the components are protected against damage from dust or insects.

### Transmitter Is Crystal Controlled

The transmitter employs the latest method of grid modulation with

stabilised reversed feed-back, which results in exceptional fidelity of reproduction of speech and music, and practically eliminates distortion and "background noise." The carrier frequency is maintained constant within 10 parts in a million by means of a low temperature co-efficient quartz crystal in a thermostatically controlled oven.

### Safety Isolator Switch

The equipment is made entirely safe to operate by means of a safety isolator switch and key inter-lock system. The keys are normally kept in locks associated with the isolator switch in the front panel. Before these keys can be removed, the isolator switch must be opened and locked open. It is, therefore, impossible to open the transmitter doors until the isolator switch has been opened and all dangerous voltages removed.

Conversely, the high voltage cannot again be switched on until the transmitter doors are closed and locked, when the keys can then be removed and replaced in the isolator switch.

### Is Entirely Automatic

The transmitter is entirely automatic in operation, and can be switched on or off by push buttons located in a different part of the building. The circuit components are fully protected by means of fuses, overload relays, and a system of electrical

inter-locks.

The transmitter panels are attractively finished in aluminium grey with nickel-plated fittings, and the high-class appearance reflects the high quality of workmanship in every part of the apparatus.

## 2PX Has Worked 84 Countries

(continued from page 13)

The transmitter consists of five stages with the following line-up:—47 C.O., 46, 46, 10, '03A. The aerial is 134' long with 45' feeders, and is about 65' high at one end. The total countries worked is 84, while WAC and WBE have been obtained. Experimental work has been conducted on 10, 20, 40 and 80 metres.

2PX first came on the air on May 21, 1930, the first rig being a Hartley with a 202 valve. Since then, thousands of DX cards have accumulated, most of the DX being worked in the early mornings before the operator goes to work.

For many years the receiver was the conventional detector and two audio, but owing to the numerous "hams" now located on the Bankstown line, an eight-valve super became a necessity. The transmitting aerial does not appear to be very critical as far as directional properties are concerned, as the strength of reports received is fairly consistent from all directions.



# The All-Wave All-World

Official Organ of the  
All-Wave All-World DX Club

# DX News



### Closing Date Of Third DX Contest Postponed Till January 1

Owing to the widespread interest aroused by the first two "Radio World" Shortwave DX Contests, and in accordance with several requests from new readers, the closing date for the third "Radio World" Shortwave DX Contest has been postponed from December 1 until January 1, 1938. Entries can be forwarded at any time up to this date. The rules are as follows:—

1. For this Contest a trophy (a Replogle World Globe with time converter, value 59/6) will be awarded to the reader who submits the best individual verification.

2. Verifications from any shortwave station between 5 and 100 metres may be submitted. Thus cards from broadcast, commercial, radio-telephone and amateur transmitters are all eligible.

3. All verification must bear a date (a post-mark on the card or envelope will suffice where no date is given on the actual verification); and the frequency on which the station has been received must be clearly indicated.

4. Only verifications of reception between January 1 and November 31, 1937, will be eligible.

5. In judging the entries, the judges will take into account the power of the station received, the frequency on which the station was heard, and the type of receiver used.

6. There is no limit to the number of verifications which may be submitted by any entrant.

7. The decision of the judges will be final; and the result of the third competition will be announced in the February, 1938, issue of "A.R.W."

8. All entries should be addressed to the Shortwave Editor, and should be endorsed "DX Competition." All verification submitted will be returned by registered post as soon as possible after the closing date.

—The Shortwave Editor.

### VK2ME, 3ME And 6ME — Transmission Schedules For November.

The following transmission schedules will be observed by shortwave stations VK2ME, VK3ME and VK6ME during November:—

**VK2ME (31.28 m., 9590 k.c.)**  
Sydney Time G.M.T.  
Sundays: 4-6 p.m. 0600-0800  
7.30-11.30 p.m. 0930-1330  
Mondays: Mdt.-2 a.m. 1400-1600

**VK3ME (31.5 m., 9510 k.c.)**  
Melbourne Time G.M.T.  
Nightly  
Monday to 7 p.m.-10 p.m. 0900-1200  
Saturday  
(inclusive)

**VK6ME, Perth (31.28 m., 9590 k.c.)**  
Perth Time G.M.T.  
Nightly  
Monday to 7 p.m.-9 p.m. 1100-1300  
Saturday  
(inclusive)

### Want To Exchange QSL's

The following dxers would like to exchange QSL's with other readers:—

James Mildenhall (AW156 DX), Byron Bay, N.S.W.

Adrian Nall (AW162DX), "Ilford Lodge," 25 Griffith Street, Hurlstone Park, Sydney.

E. J. Bayley (AW212DX), "The Palm," 709 Macarthur St., Ballarat Nth., Victoria.

## ALL-WAVE ALL-WORLD DX CLUB Application for Membership

The Secretary,  
All-Wave All-World DX Club,  
214 George Street,  
Sydney, N.S.W.

Dear Sir,

I am very interested in dxing, and am keen to join your Club. The details you require are given below:

Name.....

Address.....

[Please print both plainly.] .....

My set is a.....

[Give make or type, number of valves, and state whether battery or mains operated.] .....

I enclose herewith the Life Membership fee of 3/6 [Postal Notes or Money Order], for which I will receive, post free, a Club badge and a Membership Certificate showing my Official Club Number.

(Signed).....

[Note: Readers who do not want to mutilate their copies of the "Radio World" by cutting out this form can write out the details required.]



# Short-wave Review

CONDUCTED BY

**ALAN H. GRAHAM**

## Latest About Police Transmitters! ★ Sino-Japanese War News ★ Interesting Loggings on 20-Metre Band ★ Official Observers' Reports.

**R**ECEPTION during the past month has been rather patchy on all frequencies, and, generally speaking, conditions have taken a definite turn for the worse. This falling-off is probably due to seasonal changes, together with the effects of sunspot activity, which apparently was responsible for several remarkable "fade-outs" early in October.

### Police Stations

High frequency reception has been amazingly inconsistent on both 30.1 and 33.1 megacycles. At times, good signals were audible on both channels from 9 a.m.-noon; and yet, on the next day complete silence would reign, even such regulars as W2XEM and W5XB being completely inaudible.

However, during the periods when reception was reasonably good, quite a number of calls were heard. Outstanding signals were logged from the following:—

30.1 meg. (9.9 m.): W2XEM, Newark, N.J.; W9XEH, Evansville, Indiana; W2XIJ, W6XGC, San Gabriel, California; W3XAR, Brookline, Pa.; W1XHC, Hartford, Connecticut; W6XKW and W4XJ, Winston-Salem, N.C.

33.1 meg. (9.0 m.): W9XAC, Paducah, Kentucky; W6XBF, Piedmont, California; W9XBA, Peoria, Illinois; W9XKC, St. Louis, Missouri (?); WSXB, Fort Worth; W6XMW, Arcadia, California; W4XK, Durham, N.C.; and W3XBG, Norfolk, Virginia.

If conditions continue the same as during the past month, many more police transmitters should continue to be logged; and if the warmer weather brings improved high-frequency reception, as it should, the police bands will be as crowded as the 20 m. amateur band, and in all

probability QRM will reach disturbing proportions.

### Americans On 9 And 11 Metres

Although conditions have not been very satisfactory, several of the American commercial transmitters have been heard on 31.6 and 26 meg. Despite information received earlier in the year that many of the 31.6 meg. stations intended to alter their frequencies in order to reduce interference, it seems that no such steps have been taken, and QRM remains most troublesome. W9XPD, St. Louis, and W9XHK, Minneapolis, are the only stations whose signals were sufficiently loud during October to be

### Official Observers Wanted For N.S.W., S.A., And Tasmania

Official Shortwave Observers for the "Radio World" appointed to date are as follows:—

West Australia: Mr. G. O. La Roche, of Perth.

Queensland: Messrs. J. K. Sorensen, of Gympie, and Ern. Neill, of North Ipswich.

New Zealand: Mr. R. Russell, of Taumaranui, Nth. Island.

The positions of shortwave observer for New South Wales, South Australia and Tasmania have yet to be filled, and any readers in these States who are interested in this matter are invited to communicate with the Shortwave Editor as soon as possible, setting out the experience they have had in DX work, and also giving brief details of their receiving equipment.

—The Shortwave Editor.

readable above the noise level. (Incidentally, the address of W9XHW has now been ascertained. It is C/WCCO, Nicollet Hotel, Minneapolis, Minn.)

On 11.56 m., the twenty-four hour station W6XKG, Los Angeles, continues to be heard in the late morning and early afternoon.

### Sino-Japanese War News

With the eyes of the world turned to the East, where the armies of China and Japan are struggling for mastery, the part to be played by shortwave transmitters in modern warfare is clearly indicated. Both Chinese and Japanese stations are broadcasting to the world at large a perfect barrage of boasts, threats and pleas.

The most interesting phase of the war broadcasts has been the relays from Shanghai to America (on similar lines to those from Addis Ababa during the Abyssinian campaign). Two Shanghai stations have been heard in the middle of the 20 m. American 'phone band—XOB1 and XRC1. These stations call America via San Francisco and the N.B.C. network.

XGOX, the station of the Nanking Government, has commenced transmissions on 30.6 m. It is audible at good strength around 10 p.m., announcing as XGOA and XGOX, Nanking. News is given in English by a woman announcer.

The other side of the question is to be heard from the Japanese transmitters, of which JDY, Radio Dairen, on 30.2 m., is of outstanding interest.

Latest information from the Kokusai-Denwa Kaisha Ltd. indicates that the following frequencies are now in use:—

11,800 k.c.: 25.42 m.: call JZJ  
15,160 k.c.: 19.79 m.: call JZK  
10,660 k.c.: 28.14 m.: call JVN  
14,600 k.c.: 20.55 m.: call JVH

### Radio Tananarive, Madagascar

In previous issues, occasional references have been made to the activities of Radio Tananarive, Madagascar. The information given was in most cases unofficial, but at last authentic data as to frequencies and schedule are available.



No call letters are used, so it would seem that the call-letters FIQA, which are often mentioned, must be queried.

The frequencies in use are 6,010 and 9,520 k.c., or 49.9 and 31.5 m. Both transmitters are used to relay the long-wave station at Tananarive on a daily schedule as follows:—1-2 a.m.; 3.30-3.45 p.m.; and 6.30-7.30 p.m.

### SBG, Sweden

The experimental station SM5SX, which used to be heard so well on 25.63 m., has now been replaced by the new Swedish transmitter SBG, which broadcasts on both the 49 and 25 m. bands—on 49.46 m. from 10 a.m.-2 p.m.; and on 25.63 m. from 10.30 p.m.-10.30 a.m. The QRA of the station is Motala Rundradio Station SBG, Tjansterbrev, NR4, Motala, Sweden.

### Official Observers' Reports

Comprehensive reports of general conditions are to hand from Observers La Roche (West Australia), Sorensen (Queensland), and Russell (New Zealand). The information contained in them is too detailed to be reproduced in full, but the following summary will prove of great assistance to dxers.

#### EUROPEANS

Quite a number of the "rarer" Europeans are being heard at present, when conditions are favourable. Mr. La Roche has done good work in logging the majority of the following:—

HAS3, Budapest, 19.5 m. On the air for only one hour per week—midnight on Sunday till 1 a.m. Monday. Always heard best in Western Australia.

SPW, Warsaw, 22 m. Early rising is needed to log this splendid DX "catch," as SPW transmits only on Tuesdays, Thursdays and Saturdays from 3.30-4.30 a.m.

TFJ, Reykjavik, 24.52 m. Those dxers who might be tempted to rise in the very early morning on the off-chance of logging SPW should also keep a lookout for the more reliable TFJ, whose schedule is 4.40-5.30 a.m.

CSW, Lisbon, 27.17 and 30.1 m., sends a most attractive QSL card, well worth the trouble of a report. The 27 m. transmission from 5-8 a.m. was very good for some months, but early morning conditions are less satisfactory now, especially around 6.30 a.m.

EHZ, Teneriffe, Canary Is., 28.9 m., is still being heard in Western Australia, although it seems to have practically faded out in the eastern States.

ORK, Ruysselede, 29.04 m., is one of the early morning (4.30-6a.m.)

## 2nd "RADIO WORLD" S.W. CONTEST

### A. Maule Of N.Z. Is Winner

A large entry—55 verification cards in all—was received for the second DX contest, the closing date for which was October 1. The task of awarding the handsome Replogle Globe trophy donated by the "Radio World" was rendered exceedingly difficult by the high standard of many of the verifications submitted. However, after careful consideration of all the relevant factors, the following awards have been made:—

The winner of the trophy is Mr. Alex Maule, of Patea, Taranaki, New Zealand (AW306DX), the prize-winning verification being a card from the Spanish rebel transmitter EAJ8, Radio Requete, San Sebastian, which was logged on June 10 on 41.65 m.

In addition to this winning entry, Mr. Maule also submitted two other verifications of considerable merit. One was from G8CZ, Melton Mowbray, England, verifying a report on his 10-watt 'phone signals on 20 m.; and the

other from ZS6AJ, Johannesburg, South Africa, also heard on 20 m.

The receiver used by Mr. Maule was a four-valve dual waver.

Honourable mention—first class—goes to Mr. H. Whyte-Meach, of 55 Godfrey St., Artarmon, Sydney. His best verification was a card from the 20-metre amateur VP9R, Devonshire, Bermuda, whose signals were R4 on a two-valve Schnell receiver.

Entries of merit were also received from Mr. G. M. Anselme, of 16 Hartley St., Rozelle, Sydney; Mr. H. A. Matthews, of Ellerslie, Victoria; and Mr. G. O. La Roche, of 62 Gladstone Ave., South Perth, W.A.

One of the most interesting verifications submitted was sent in by Mr. J. Ferrier, of "Winniburn," Coleraine, Victoria. It related to reception of an American transport plane, heard on 54 m. Unfortunately, the verification was not sufficiently specific for the purposes of the competition.

—The Shortwave Editor.

regulars which can be logged almost any day at good strength. EAQ-EAR, Madrid, (30.4 and 31.65 m.). Mr. La Roche reports EAQ as still audible at the beginning of October. However, no trace has been heard of its transmissions in the east. EAR is still on the job.

#### AFRICANS

Poste Bizertin, in Tunis, North Africa, has been reported by a Victorian dxer. Surely one of the best catches of the year would be a verification from this African! The station is believed to operate on 48.78 and 24.3 m., but the latter wavelength is more suitable for reception in Australasia. Very probably few listeners will have occasion to use the QRA of this station, but here it is: Amicale du Poste Bizertin, 14 Rue Hersent, Bizerte, Tunis.

CR7BH, Laurence Marques, Mozambique, are still to be heard on 25.6 m.

VQ7LO, Nairobi, 49.3 m., is now being heard in all States, in the small hours of the morning. However, a veri. from such a renowned station is well worth the sacrifice of a few hours' sleep—or is it?

#### LATIN-AMERICANS

##### Cubans Best

Of the Spanish-speaking American stations, the numerous Cubans are

still the most reliable. In fact, so many new CO's have made an appearance during the past few months that it is almost impossible to keep trace of them, especially on the 30-31-32 m. stretch. The stations in this vicinity have an annoying habit of not giving their calls in English, and the task of distinguishing a rapidly-spoken call in Spanish is amazingly difficult. However, a careful check indicates that the following stations have been more or less definitely identified:—

Call.	K.C.	M.	Loc.	Relays.
COGF	11,790	25.45	Matanzas	CMGF
COCX	11,438	26.2	Habana	CMX
Still listed in some journals as transmitting on 11,600 k.c., 25.86 m.				
COCQ	9,740	30.78	Habana.	CMQ
COCH	9,428	31.8	Habana.	
COBC	9,363	32.03	Habana.	CMBC
(Previously reported as COBP).				
COBZ	9,030	33.32	Habana.	CMBZ
COJK	8,665	34.62	Camaguey.	CMJK
COCW	6,880	42.6	Habana.	CMCW
COHB	6,282	47.76	Sancti Spiritus.	CMBH
COKG	6,200	48.39	Santiago.	CMKG
COCD	6,130	48.92	Habana.	CMCD
COCO	6,010	49.92	Habana.	CMCF

In addition to the above, there is an as yet unidentified Cuban on approximately 9,860 k.c. (30.4 m.). The call is generally believed to be COCN, though some say it is COCS.

## SHORTWAVE STATION OF THE MONTH . . . . 3

## CR7BH, LAURENCO MARQUES, MOZAMBIQUE.

METRES: 25.6.

KILOCYCLES: 11,718.

STANDARD TIME: 8 hours behind Australian E.S.T.

ANNOUNCERS: Man announcer week-days; woman announces on Sundays.

DISTANCE FROM SYDNEY: Approximately 6,750 miles.

LANGUAGES: English and Portuguese.

TIMES OF TRANSMISSION: Daily 12.30-2 a.m., 3.30-6.30 a.m., 7.30-9.30 p.m.; Sunday 9-11 p.m.; Monday, 1-3.30 a.m.

REPORTS TO: Caixa Postal 594, Laurencio Marques.

IDENTIFICATION: Announces at beginning, middle and end of transmissions—"This is Laurencio Marques, CR7AA, calling on 6,137 k.c., 48.88 metres, and CR7BH, testing on 25.60 meters, 11,718 k.c."

Signs on with various march selections. No set sign-off.

REMARKS: The session commencing shortly after midnight is most suitable for reception in Australia.

## ASIATICS

Reference has already been made to the Japanese and Chinese broadcasts of war news. Apart from these, conditions have remained unaltered so far as Asiatic stations are concerned. KZRM (24 and 31 m.), Saigon (25.5 m.), Colombo (48.7 m.) and Rangoon (49.9 m.) are all easily logged in the West, reports Mr. La Roche. But in the Eastern States, information indicates that they are rather more elusive, with the exception of KZRM.

## Amateur Review

Without fear of contradiction, it can be said that the year 1937 has been outstanding as far as conditions on the 20 m. 'phone bands have been concerned. Throughout the winter months, Americans, Europeans and Asiatics have continued to be logged with amazing consistency. And when the power of some of these transmitters is taken into account, one is forced to the conclusion that the 20 m. channel is the best DX medium available at present.

This was very forcibly impressed on the writer during the judging of the verifications submitted for the DX contests now being conducted by the "Radio World." Readers will recall that the first trophy was awarded for a card from a 10-watt Irish Free State station (EI4L).

Verifications received in recent mails by the writer serve to emphasise this point. They include cards from the following low-powered amateur stations:—

PAOUT, Utrecht, Holland. 8 watts.  
G8AZ, Derby, England. 10 watts.  
GW8CT, Blackwood, Wales. 10 watts.  
G6XM, Farnborough, England. 10 watts.

PK6HI, Celebes, D.E.I. 8 watts, with special antenna directed to North America.

Other cards to hand are from:—  
F3IX, France; J2NF and J2MI, Japan; VE1DQ, Canada; XE2BJ, Mexico; VP9R, Bermuda; YV5AK, Venezuela; and SM5SD, Sweden.

## CALLS HEARD

In the compilation of the following specially enlarged list of calls heard on the 20 m. 'phone bands, great assistance was rendered by Mr. Russell (Official Observer for New Zealand) and Mr. V. C. Kemmis, of Neutral Bay, Sydney, N.S.W.

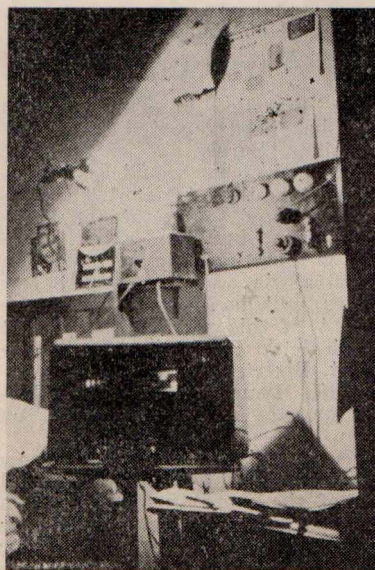

A corner of the shortwave listening post belonging to Raymond A. Kelly, a well-known DX enthusiast of Wellington, New Zealand.

(by the way, XZ is the new prefix for Burma, which is now considered a separate country from India. All Burma calls are merely the former Indian calls with XZ substituted for VU. Thus to find XZ2EH's QRA in your Call Book, just look up VU2EH).

EUROPE: G2PU; G2BY; G2AK; G2XV; G2AV; G2GF; G2A1; G5RV; G5PT; G5OV; G5FA; G5BU; G5N1; G5BO; G5TP; G6GF; G6GF; G6LK; G6DL; G6IK; G6DT; G6CL; G6PC; G6FS; G6YK; G6WT; G6VF; G6HL; G6WY; G6RS; G6RH; G6VX; G6XR; G6JF; G8MG; G8MX; G8SB; G8LP; G8KZ; G8BK, England. GM5NW; GM6RV; GM6RZ, Scotland. GW5KJ, Wales. EI2L, Irish Free State. PAOUN; PAOCV; PAOAD; PAOMQ; PAODE; PAOGN; PAOUT; PAOEO; PAOXF, Holland. CT1AY, Portugal. LA1G; LA3A, Norway. ON4VK; ON4BB, Belgium. HA4A; HA8N, Hungary. F3JD, F3NF, F3OO, F3MF, F3VD, F3HE, F3HO, F3HL, F3XL, F3OK, F3GR, F8KI, F8LX, F8XT, F8MM, F8HK, F8KW, F8DS, F8QE, F8AH, F8DX, F8DC, France; SM7YA, Sweden.

AFRICA: CN8AJ, French Morocco; EA9AH, Spanish Morocco; ZE1JR, Southern Rhodesia; ZS6AA, ZS6AJ, ZS6S, ZT6AK, ZU6AF, South Africa; FB8AH, Madagascar.

ASIA: VS6AB, Hong Kong; VS-7GJ, Ceylon; XU8MC, China; VS1AF, VS2AK, Malaya; KA1AP, KA1BH, KA1ER, KA1HS, KA1MO, KA1ME, KA1MH, KA1MM, KA1VL, Philippines.

OCEANIA: PK1GL, PK1ZZ, PK-1MX, PK1RI, PK2WL, PK3AA, PK-3WI, PK3GO, PK3ZM, Dutch East Indies; K6BAZ, K6BNR, K6BNZ, K6CMC, K6MXM, K6NTV, K6NZQ; K6OQE, Hawaii.

WEST INDIES: K4SA, Porto Rico; HI7G, Dominican Republic; CO2BY, CO2EG, CO2HY, CO7CX, CO8YB, Cuba; VP5PZ, Jamaica.

AMERICA (North, South and Central): VE1DQ, VE3KX, VE5OT, Canada; TI1AF, TI2AV, TI2RC, Costa Rica; XE1DT, XE1G, XE1Y, XE2AC, XE2FC, Mexico; HK1Z, HK3JA, Colombian Republic; HC1FG, HC1JB, HC2CG, Ecuador; LU9BV, Argentine; NY2AE, Canal Zone; OA4AB, OA4AI, OA4R, Peru; CE1AH, CE1AO, Chile.

Apart from the Cubans, reception of South and Central American stations is definitely in the doldrums. Conditions in the afternoons have been very disappointing, even Sundays failing to bring forth anything of much interest. Those who have not yet logged XEUZ, Mexico City, on 49.02 m., can still get them around 5 p.m.; while HJ1ABE, Cartagena, 31.57 m., have been logged again around 10 p.m., with their inevitable programme of organ music.

# DX News and Views

A page for  
letters from  
DX readers

## DXing With A Two-Valver

DX here in N.Z. is now getting really good in my locality. The 20 m. band has been very lively during late afternoons, and also in the evenings from approx. 11 p.m. Latest loggings on 20m. are KA1BH, HJ1Z (a good catch here), OA4AL, LU6KG, PK1RA. I also picked up a Manila ham on Sunday morning working on board a yacht; he gave his call as KA1YL. Unfortunately, he stated he is not listed in a call book. Can any dxer send me his address?

VK's have been good, and the following have been logged:—VK's 3SS, 4NO, 5JC, 2AZ, 2ADE and 2ABD. Of the commercials, I have reports away to KZRM (second report), PLP and LRU (second report). Verifications to hand lately are K6NZQ, W6BKY, XEWW (a card worth having), W6GCX; VK's 2XU and 5DI. All stations are logged on my little two-valve job.—A. Green (AW181DX), Mt. Eden, N.Z.

## 1ZM's First Report From VK4

I have received my Life Membership Certificate, Club badge and report forms in good order, and am very proud of them. I have not been dxing very long; in fact, I sent my first report out in April, 1937, and up to time of writing I have 114 verifications and 29 reports out.

I do most of my dxing on the B.C. band, but have done a little on s.w. lately. I also wish to congratulate you on your splendid magazine—it's the goods. Here is my log of verified stations:—Q'land, VK4's, QG, RK, QN, BH, BK, AK, GR, CA, TO, RO, MB, BU, AY, IP, MK, VL. N.S.W., VK2's, CR, FC, DU, CO, NR, BL, GB, LM, UE, GL, CA, HD, WG, BL, GB, LM, UE, GL, CA, AD, HD, WG, KA, NZ, CH, GF, TM, BH, MO, QN, RG, AY, BS. Victoria, VK3's AR, SH, KZ, TR, BA, GL, MA, XY, MB, AK, UL. South Aust., VK5's CK, CL, RM, DN, KA, AD, PI, MU. West Aust., VK6's WA, GF, WB, PR, AM, PM. Tasmania, VK7's ZL, NF, BU, UV, LA, HT. New Zealand, 1YA, 2YA, 3YA, 4YA, 1ZB, 2ZB, 1YX, 2YC, 2YB, 2ZH, 3ZR, also 1ZM, being their first report received from Queensland.

The following is from a cutting in the DX page in the "Broadcaster," 1ZM's monthly programme magazine.

"With a battery-operated set and an inverted 'L' aerial, 55 feet high and 80 feet long, a dxer at Booyal,

near Bundaberg, heard 1ZM between 5.57 p.m. and 7 p.m. (N.Z. time) on Sunday, May 30. This listener, Mr. E. Larsen, is to be congratulated. Owing to the closely-packed channels and the dual frequencies of Australian stations, a report of this nature is not common, and conditions must have been just right on both sides of the Tasman to get through."

For information of other dxers, this station is picked up on good nights on 1,250 k.c.

Other verifications on B.C. are ZJV, Suva. KNX, KSL. VK's on broadcast, 4EA, 4LW, 4JN, 4GG, 4PK, 4RJ, 4XW, 2VY, 2BQ, 3HF, 3WE and 3RJ. Verified reports on shortwave: 3LR, 2ME, 3ME, 6ME. 4HA, 4FE, 4TY, 4UX, 4KO and 2ADE. Reports out to b.c. stations: 4BC, 4WK, 4LG, 4ZR, KGU, 2KO, 2KY, 2HR, 2KM, 2UW, 2NC, 2SM, 2ZJ, 2MW, 2GN, 2WL, 2XL, 2PK,

3AW, 3YB, 6KG. VK's 4CB, 4JO, 4LD, 2ZO, 2DF. Reports out on s.w. stations: PCJ, KZRM, ZBW, OXY.

That is my list so far. The Chinese and Japanese stations are picked up very easily early in the evenings, one or two on clear channels. An English news session can be heard from a Japanese on 810 k.c., and on 920 k.c. the Europeans are strong in the mornings well after sunrise, but so far I have not reported to any of them.—E. Larsen (AW287DX), Booyal, Q'land.

## 200 Stations In Two Months

Since last writing to the club, I have spent much more time dxing. In approximately 65 days I have logged nearly 200 stations, among them being the following:—VK2's VQ, VJ, ADN, AH, FG, QV, AEF, XI, EH, QK, AEH, QM, IM, ABH, ME and WQ. VK3's DX, WQ, IW, YG, EN, JD, LR, XU, RE, YB and ZR. VK4's AW, JU, FG, ND, TY, ES, FB, UX, LQ, AH, AF, UW, VH, HQ, SA, FE, and FL. VK5's FL, SL, BH, RJ and GM. VK6ME. VK7's YL and AB, and VK9MI.

Since I read my first copy of "R.W." I have purchased every issue. I like the sets described in it, and I made up the audio code oscillator described in the February issue. The articles I like best in "R.W." are:—"Radio Ramblings," the articles by W.J.P., and "DX News and Views." The VK lists and additions each month are very handy.

In conclusion, I might say it is handy to enclose stamps, etc., when writing to DX "hams." I wrote to VE4CF, and as a result of enclosing several rare postage stamps, he passed them on to his brother-in-law, who wrote me.

Wishing the "R.W." best of luck—it is the best radio magazine I have read.—Adrian Nall (AW162DX), Hurlstone Park, Sydney.

## DX On Twenty Metres

My latest DX on 20m. 'phone—VP5PZ, VE5OT, NYZAE, W6NNR. 20m. C.W.—OE7JH, D4SZK, F8NR, G5IH, HB9BN. Heard VK3SE QSO-ing OE7JH, D4SZK, F8NR and G5IH. This local amateur has been working some excellent DX, mostly on c.w.

I would be interested to know if any Club member has heard VJZ, Rabaul, New Guinea, lately. Heard



A fine collection of QSL's from all over the world lines the walls of this DX shack, belonging to dxer E. J. Bayley (AW212DX), of Ballarat North, Vic.

this station on 31m. band some 12 months ago, but have not heard it since.

I would not be without the "Radio World" now—it is the finest Australian radio magazine ever published.—T. Bayley (AW212DX), Ballarat Nth., Victoria.

#### Descriptions Of Portables Appreciated

I have been particularly busy of late, but under all circumstances I always find time to read the "Australasian Radio World."

I am always delighted when the first of the month comes around, and I do most sincerely anticipate the arrival of my magazine. All the articles in the October issue were of outstanding merit, but the one that appealed to me most was that describing the "1937 Outdoor Portable Four." This is the last word in portable receivers, and I am sure that all who build it will meet with unqualified success. The "Tom Thumb Portable Two" proved interesting also, and I am sure that this receiver would be ideal for the experimental station operator who wishes to take a rig with him when he is away for the Christmas holidays. There may be many experimenters

who would appreciate a constructional article on a portable transmitter.

"Radio Ramblings," of course, is always interesting; also the list of call-signs of experimental VK stations. I have my list near my receiver ready for use when required.—Cedric W. Marley (AW150DX), South Brisbane, Q'land.

#### Australian Trained Radio Servicemen's Institute—Queensland Division.

By W. J. HUDSON

THE usual monthly meeting of the Institute was held at the Chamber of Commerce rooms, Adelaide St., Brisbane, on October 20, 45 members being present.

Correspondence received: From Mr. R. C. Meadows, Field's Radio, Mackay, who wanted to start a branch of the Institute in Mackay. Mr. Meadows is ex-technical editor of "Wireless Weekly." Resolved we thank Mr. Meadows for his letter, and the secretary to supply him with the necessary data. From Arthur Greenaway, Wyper Bros. Radio, Bun-

daberg, offering to start the Bundaberg branch. The secretary to write to him also.

This is a list of branches to date: Townsville, Hillman's Radio; Mackay, Mr. Meadows of Field's Radio; Rockhampton, A. Minchin, A.M.I.R.E.; Maryborough, Ella Wilcox, of Wilcox Radio; Bundaberg, Arthur Greenaway, of Wyper Bros. Radio; Brisbane, call or write to Eric H. Cantelin, Edgar V. Hudson's Radio.

#### Affiliation With Radio And Electrical Federation

After routine business was concluded, a lively discussion ensued concerning the proposed affiliation with the Queensland Radio & Electrical Federation. Mr. Miller, of Noyes Bros., who is a member of the Institute, is also chairman of the radio section of the Radio & Electrical Federation. Mr. Miller explained that the Federation were amending their rules to permit the Institute to affiliate. Such affiliation means the endorsement by the Federation of the Institute's radio proficiency certificate.

Some members favoured asking the Government Electrical Workers' Board to endorse our certificate. Finally, it was resolved to affiliate with the Electrical Federation when their rules are amended as stated by Mr. Miller.

Copies of the examination syllabus were issued to members. This covers both theory and practical work, and has been endorsed by the Electrical Federation.

The total financial membership of the Institute is 93, about 95 per cent. of Brisbane servicing mechanics now being members. It was resolved to keep the Institute's room at Albert House open three nights per week, also from 1 to 2 daily. Visitors to Brisbane should see Mr. Cantelin, the president, at Edgar V. Hudson's Radio, for particulars.

#### Employment Available In Australia

After business was concluded, the usual lecture by a member was proceeded with. Mr. W. J. Hudson was selected, and the speaker dealt with the following matters:—The types of employment in radio available in Australia; wireless operators—marine and broadcast technicians; service mechanics; schools of instruction; wages and conditions of employment; technical societies; institute of radio engineers; society of radio technicians and Queensland servicemen's institute; New Zealand Servicemen's Act.

At the conclusion of the lecture, a vote of thanks was given the speaker by acclamation. The secretary announced that it had been decided to ask Mr. Hudson to give a special lecture on a date to be decided, the subject to be "Aircraft Radio and Direction Finding." The meeting adjourned at 10.30 p.m.

## Ten Thousand Miles On Five Metres!

### VK2NO Receives Confirmation Of Earlier Report From England

Ten thousand miles on five metres! It sounds fantastic in view of theory, but it is evidently an accomplished fact. "A.R.W." announced in the issue for September last that Mr. Don B. Knock (VK2NO) reported that it was believed that 5-metre telephony from his station had been heard in North Wales.

According to VK2NO, indisputable confirmation has now been received in a letter received by him from Mr. C. Mellanby, the observer in Pwllheli who heard the signals. Apart from merely quoting bare facts of reception, Mr. Mellanby gives the details of his log for November 22, 1936, at 7.30 a.m. B.S.T.:—"VK2N—on 56 mc. phone working a station with 'L' in the call-sign. Talking about using two Eimac 35T's with 100 watts input, and rotary beam antenna. Severe noise level. Signal varying from R2 to R4."

This, with the fact of the log at VK2NO showing that at the corresponding time on that date he was in communication with VK2HL, of Chatswood, Sydney, using his transmitter with two 35T's in the final and a Reinartz

rotary aerial, leaves no room for doubt.

Mr. Mellanby states that he had logged the station on previous occasions, but too weakly to identify as a VK2. At that time last year, VK2NO was operating almost daily and every week-end very consistently, mostly with his beam aimed due north-west.

It appears that the 5-metre band must exhibit some of the characteristics of 10 metres during October, November and December in Eastern Australia, and Mr. Knock urges those VK's interested in trying possible DX on five this summer to instal stable transmitters, and above all to make extensive use of directional aeriels of the Reinartz, Bruce, or twin di-pole types.

VK2NO thus holds the world's 56 m.c. transmission DX record, and Cecil Mellanby, of Pwllheli, North Wales, the world's 56 m.c. receiving DX record. If conditions are similar this year, and they appear to be even better judging by 10-metre DX, the first outside Australia 56 m.c. two-way working should soon be an accomplished fact.



★  
Mr. A. H. Traegar working the pedal "transceiver" with which the outback settler summons the Flying Doctor.

# Radio Aids Flying Doctor In Outback

★  
Shortly another Flying Doctor base is to be established at Broken Hill by the Australian Aerial Medical Services. The splendid work that has already been accomplished with this unique service for the outback is outlined in this article, which also explains the vital part radio plays in its maintenance.

**M**OST of us have heard something about the Flying Doctor and the sterling service which he and his associates are rendering in bringing to the lonely settlers of the outback the medical comfort and assistance which, by reason of their extreme isolation, they were previously denied.

We have heard, also, in a vague sort of way, of hazardous journeys made over hundreds of miles to bring in some badly-injured station hand or stockman to the nearest aerial medical base—where, in the nick of time, a speedy operation has saved his life.

We have heard of these things, but what do we know of the pioneers who laid the foundations of this wonderful service, of the years of planning, building, and envisioning, the almost insuperable difficulties which have been met and overcome, the present extent and future possibilities of what must surely be the only organised humanitarian institution of its kind in the world?

## Twenty Years Of Planning

Actually, the Flying Doctor service is no mushroom growth, but is the outcome of some twenty years of gradual and painstaking development.

★  
The prime mover, of course, was the Rev. John Flynn, of the Australian Inland Mission, a man of rare vision, whose practical experience of the dangers, the discomforts, and the utter loneliness of the real outback led to the realisation that many lives were lost unnecessarily because the scenes of accident or illness were hundreds of miles, and many weeks of travel, from the nearest medical aid.

## First Base At Cloncurry

After years of laborious groundwork, the unremitting enterprise and determination of the Rev. John Flynn, and other kindred spirits associated with him, won through, and culminated in the establishment of the first aerial medical base at Cloncurry. Right from its inception, the Cloncurry base has rendered medical service of inestimable value, and has been instrumental in saving many lives.

The Cloncurry area, however, extends some 800 miles at its widest, and as may be expected, one of the greatest difficulties which presented itself from the very start was this: how could the people for whose assistance the base was built and

equipped—the men and women scattered over hundreds of square miles of almost trackless bush—call on the Flying Doctor in their hour of need?

## Pedal Transceiver Provides Solution

By wireless, obviously. But how? And to a South Australian engineer, Mr. A. H. Traegar, goes the credit of devising a satisfactory solution to the problem—the pedal "transceiver," consisting of a small combined transmitting and receiving set operated by power obtained from a pedal-driven generator.

The idea itself was not new, having been used during the Great War, but it was left to Mr. Traegar to evolve the first type actually designed to suit the outback conditions.

The first pedal "transceiver" designed by Mr. Traegar was not built in a few days, or even weeks. The principal features, of course, had to be comparative cheapness, ease of portability, and, most important of all, simplicity of operation. In 1928, after years of experimenting, the first pedal set was installed in the Cloncurry area, and in the next few

years some fifty of them were placed in this territory.

#### Ingenious Typewriter Sends Morse

Their chief disadvantage, however, lay in the fact that they could transmit only in morse, so Mr. Traegar went to work again and finally perfected a set by which morse could be sent out merely by touching the letters of an ordinary typewriter keyboard. This was a great advance, but still Mr. Traegar was not satisfied, and in 1934 he reached his ultimate goal, wireless telephony.

#### 120 Phillips-Equipped Transceivers

To-day there are about 120 pedal "transceivers" in use in Australia. They are small, they cost only £75, and every one of them is equipped throughout with Philips valves.

To operate them, and a child can do it, one simply pedals and speaks, and thus, through the magic aid of radio, men and women of the outback can instantly summon the Flying Doctor's aid in times of sickness or accident—or pedal and gossip with their neighbours over a backyard fence that is anything up to a hundred miles away.

#### Now Two Flying Doctor Services

To-day, there are two separate Flying Doctor services, which, between them, make for a very effective coverage of outback areas all over Australia. One, the Australian Inland Mission, still maintains the Cloncurry base; the other, Australian Aerial Medical Services, is of far more recent institution, but has, in the space of three years, established well-equipped bases at Wyndham and Port Hedland (W.A.).

It is anticipated that a section of Australian Medical Services will eventually take over the base at Cloncurry, and also Kalgoorlie (the latter now privately owned), and so bring all bases under the control of one national organisation.

#### Station Being Built For Broken Hill Service

In June last a start was made in establishing a base at Broken Hill to service the western portion of New South Wales and the greater part of South Australia. A previous appeal for funds had raised the sum of £3,451/16/2, and the Governments of New South Wales and South Australia each provided a subsidy of £1,000.

Although an aeroplane and the services of a Flying Doctor have been procured to work in conjunction with the existing hospital at Broken Hill, the work is not yet complete. A radio station is in the course of construction, and a powerful transmitter has just been built at a cost of £2,000.

#### Over 50,000 Miles Flown Yearly

The expense of establishing and maintaining an important base such

as Broken Hill is, as may well be appreciated, extremely heavy. Aerial medical service is no longer an experiment—it is a proven safeguard in time of need—and each year over 50,000 miles are flown by the various Flying Doctors on errands of help and healing, providing medical and nursing service which was impossible before, and saving many lives which would otherwise be lost.

The following is a practical example of aerial medical service carried out recently at the Broken Hill base:—

An urgent call was received from Tibooburra, 230 miles away. Sent by telegram to the Adelaide police, it was received there 20 minutes after despatch, having been sent via Bourke, Dubbo, Sydney and Mel-

#### New A.A.M.S. Station Testing Next Month

The new Australian Aerial Medical Services station, VK-8SK, at Broken Hill, will be testing on telephony and I.C.W. early in December. Mr. H. W. Blue (ex VK2YI), engineer in charge, advises that an input power of 800 watts will be used, approximate frequencies being 8,630 k.c., 5,300 k.c., and 1,600 k.c.

As reports are invited, this provides dxers with an excellent opportunity to add a VK8 to their logs. Return postage must be included if a verification is required.

bourne—a total distance of 1,850 miles. Arrangements were immediately made for Mr. Roy Gropler to take off for Broken Hill in his German Klemm monoplane, where he picked up Dr. McGilvray and continued the flight of 230 miles to Tibooburra.

Fortunately, the doctor knew the country well, and with his assistance no time was lost in locating the town. The residents had spent many hours preparing a strip of ground for the plane to land on, and gave the doctor and pilot a wonderful welcome.

The doctor remained with the patient, and so that the pilot could return to Broken Hill without delay, the residents insisted on one of their number flying to Broken Hill as a passenger in the plane. The fact that the resident was willing to face a two days' journey back to Tibooburra, through rough country, amply demonstrates the urgency of the establishment of medical service to those in the outback, since the journey from Broken Hill to Tibooburra and back may be made by plane in little over five hours.

The tremendous saving in time might well mean the saving of a human life. Even the 20 minutes spent in relaying a telegram through three States—and 20 minutes may mean the difference between life and death—will be saved when the Broken Hill radio station is in operation.

#### Transceivers Eliminate Isolation

Apart from medical service of this kind, the value of the pedal "transceiver" in breaking down the barriers of isolation is typified by a recent report in the Perth "Daily News" of July 20, 1937, as follows:—

"The utter isolation of Timber Creek, that brave Never-Never police station that has figured in some of the most amazing man-hunts in the police history of the world, was ended to-day when the Australian Aerial Medical Service completed the installation there of a pedal radio telephony plant.

"It was at Timber Creek that the famous Constable Langdon was stationed in 1934, and from those headquarters he chased Nimaluk, the native killer of Japanese, and the nine natives who murdered two white prospectors and threw their bodies to the crocodiles.

"It is the farthest western outpost of the North Australian police, situated a hundred miles up the Victoria River, it is right in the heart of the aboriginal country. North of it lies the Fitzmaurice River, which can be reached only after riding through a wide area of almost trackless country populated only by a thousand or more nomadic black-fellows.

"Until to-day, communication had been maintained by a 50-ton vessel, the 'Maroubra,' which made monthly trips up the Victoria River. An older model telegraphic radio set was installed some time ago, but now it has been replaced by telephony, thus bringing the constables into actual conversation thrice daily with the Wyndham base radio station, and into direct touch with the Flying Doctor service."

It is a national work, a wonderful humanitarian work that must go on, but can do so only through the help of Australians as a whole.

Already citizens of four States have responded generously in this nationally important cause, but funds are still needed to cover the heavy maintenance charges which must continually be met. Donations to Australian Aerial Medical Services should be addressed to the Honorary Treasurer, Perpetual Trustee Co., 33 Hunter St., Sydney, or to any branch of the Bank of New South Wales or Rural Bank.

## Round The Shacks . . 4

# - VK4UX -

The fourth of a series of articles on Australian amateur stations, written for the "Radio World"

By "REPORTER"

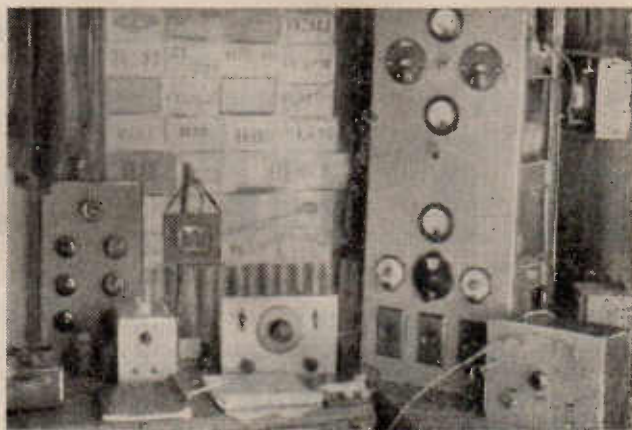

THE station first came on the air on April 9, 1936, the only power available being provided by genemotors and dry batteries. The first rig was an M.O.P.A. using a T.P.T.G. 41 linked to a 79 in the P.A. with about 2 watts input. The antenna was an S.W.M.I.

'Phone was tried shortly afterwards, loop modulation being used for a start. We obtained about 10% modulation and approximately 90% distortion! Grid bias 'phone was next tried, a modulator using a 30 as speech amplifier and a 33 as modulator being built to modulate the 79. This was very unsatisfactory indeed, so it was decided to scrap 'phone and stick to C.W. But, needless to relate, the "bug" started biting again, and we decided to have another shot at 'phone, so built up a class "B" modulator using a P.M.G. "mike" into a 30 driving another 30, followed by the 79 modulator. The r.f. side

remained the same—41 and 79. Power was derived from two genemotors at this stage.

This rig was open to considerable improvement, but it got out, and that was all that mattered at the time.

The next transmitter was a three-stage rig using a 41 electron-coupled osc., 79 buffer, and 6A6 in the final. This was modulated by a 79 driven by an 89, in turn driven by two resistance-coupled 30's. We invested in a bank of accumulators at this stage to give 300 volts. These are still in use, and after nearly nine months of constant work as as good as new. Input now was about 22 watts.

Then, after spending about eighteen weeks in hospital as the result of an argument with a bridge while on a mo' bike, and having plenty of time to think about radio and listen to the boys on "40" yarning on a s.w.

A general view of VK4UX, Theodore—owned and operated by C. P. Singleton.

set loaned to me by 4CD, of Rockhampton, I arrived back at Theodore with plenty of new ideas.

I started to rebuild the rig the day following my arrival home, and soon completed a two-stage rig using electron-coupled osc. link-coupled to a 6P6. This was modulated by a 6A6 driven by 76's.

This rig was used for a few weeks and then, after being finally convinced by 4TY that crystal was better than electron coupling, we decided to rebuild yet again! The present rig then took shape, using an 89 crystal oscillator capacity-coupled to a 41 doubler, link-coupled to a 41 in the P.A. Input is 9 watts, class "B" modulation being used.

A Reiss microphone is employed, working into a 76, transformer-coupled to another 76, transformer-coupled to the 6A6 modulator.

The receiver used is the same that was first used in S.W.L. days—a two-valver, using a 6F7 and a 41. I also have a six-valve "super" that is used for 'phone. The antenna, after the usual string of experiments, is a full-wave on 40, fed with both half-waves in phase by zepp feeders. The receiving antenna is a half-wave doublet.

The station works on 40 and 80—we have never been down on 20, but hope to be shortly. The rig is built up on aluminium chassis, and the upright angle supports are also of aluminium.

### 4CW's Call Being Pirated

VK4CW is the licensed call-sign of Claude W. Welsh, of Pratten Street, Warwick, Q'land, and never before September 19, 1937, was this station on the air. As a pirate has been using this call-sign, amateurs are asked to kindly look out for him. I am at present on the 7 m.c. band.—C. Welsh (VK4CW).

## Have Your "RADIO WORLD" Posted To You Direct

Readers who want to take the "Radio World" on a subscription basis and have their copies posted to them direct each month are invited to complete the coupon below (annual sub. 10/6). New readers are advised that all back numbers in Volume 1 (May 1936-April 1937) are still available, price 9d each, post free.

Name.....

Street and No.....

City..... State.....

Country.....

NOTE.—N.Z. subscribers can remit by Money Order or Postal Note.

THE AUSTRALASIAN RADIO WORLD,  
214 George Street, Sydney,  
N.S.W., Australia.

# Boost your Signals from R4 to R9+

**"NOISEMASTER"**  
Aerial Kit drags up  
signals out of the mush  
to overload your speaker

**D**O mush and hellish noise drown these sought-for, rarely heard distant stations? Let the "NOISEMASTER" Engineered All-Purpose Aerial Kit drag them in and boost up signals to overload your speaker. "NOISEMASTER" wipes out noise and local static, and boosts up signals, even as much as from R4 to R9 plus!

No one else would ever dare make such a claim—no other aerial of ANY TYPE can give you such incredible performance, because "Noisemaster" is the only Aerial Kit authorised to use the wonderful American invention "ANTENNEX." It acts like a purifier and cleans out every trace of locally created noise, leaving all stations beautifully clear at astounding volume.

Besides, you get in the "Noisemaster" Kit 200 feet of special aerial wire, 12 specially designed transposition blocks, earth clamp, lead-in strip, screws, lightning arresters, etc. Easy to-follow instructions and drawings with each Kit enable you to set up your aerial in a very short time. No testing. No doubt. No delay. Once "Noisemaster" is fitted, your noise-troubles end! Send this special form for your "Noisemaster" Aerial Kit NOW, and have revealed to you a glorious new thrill in reception that makes you feel your set is new again.

**Send for yours  
without Delay**

Mr. K. G. Leydin,  
Antennex (A'sia) Corporation,  
Kembla Building,  
48-60 Margaret Street, Sydney.

Send me right away your "Noisemaster" Kit. I enclose 52/6 in postal notes, money order, cheque. (Add exchange to country and interstate cheques.)

NAME .....

ADDRESS .....

A.R.W. 11/37.

## Shortwave Station Addresses By Alan H. Graham

**VATICAN STATE**  
HVJ—Radio Vaticano, Citta del Vaticano.  
**YUGO-SLAVIA**  
YUA—Milosa Velikog 16, Belgrade.

## AFRICA

**ANGOLA**  
CR6AA—P.O. Box 103, Lobito, Angola, Port. West Africa.

**CANARY ISLANDS**  
EAJ43—Apartado 225, Santa Cruz de Tenerife.

**EGYPT**  
SUV, SUX, etc.—Marconi Radio Telegraph Co. of Egypt, P.O. Box 795, Cairo.

**ETHIOPIA AND OTHER ITALIAN POSSESSIONS**  
ITK, IUA, IUB, etc.—Ministerio della Marina, Rome.

**KENYA COLONY**  
VQ7LO—P.O. Box 777, Nairobi.

**MADAGASCAR**  
FIQA and FIU—Administration des Postes des Telegraphes et des Telephones, Tananarive.

**MOZAMBIQUE**  
CR7AA, CR7BH—Caixa Postal 594, Lourenco Marques.

**FRENCH MOROCCO**  
CNR—Rabat.

**SPANISH MOROCCO**  
EA9AH—Apartado 124, Tetuan.

**RHODESIA**  
ZEA, ZEB—P.O. Box 792, Salisbury, Southern Rhodesia.

**UNION OF SOUTH AFRICA**  
ZTJ—African Broadcasting Co. Ltd., P.O. Box 4559, Johannesburg.

ZSS—Overseas Communications of S.A. Ltd., Box 682, Cape Town.

ZUD—Chief Engineer, G.P.O., Pretoria.

## NORTH AMERICA

**CANADA**  
CFN, CFU—Consolidated Mining and Smelting Co. of Canada Ltd., Slate Creek, B.C.

CGA, CJA, etc.—Canadian Marconi Co., Box 1690, Montreal, P.Q.

CGP, CZQ, VXX—N-W Telephone Co., 768 Seymour St., Vancouver, B.C.

CFCX, VE9DN—Canadian Marconi Co., Box 1690, Montreal, P.Q.

CFRX—Rogers-Majestic Corp., Toronto, Ont.

CHNX, VE9HX—Maritime Broadcasting Co. Ltd., Lord Nelson Hotel, Halifax, N.S.

CJRO, CJRX—Jas. Richardson & Sons Ltd., 155 Royal Alexandra Hotel, Winnipeg, Man.

CRCX—Canadian Broadcasting Co., 805 Davport Rd., Toronto, Ont.

VE9BJ—Admiral Beatty Hotel, St. John, N.B.

VE9BK—Radio Sales Service Ltd., 780 Beatty St., Vancouver, B.C.

VE9CA—Western Broadcasting Co. Ltd., Toronto General Trusts Bldg., Calgary, Alberta.

VE9CS—1001 Stock Exchange Bldg., Vancouver, B.C.

## Improved Operating Conditions For 1C6 On Shortwave

(Continued from page 30)

increased to 50,000 ohms in place of 20,000 ohms. This will bring about a reduction of "B" battery drain from 4.7 to 3.8 microamps. total. Under these conditions and with the coils as specified in the diagram, the oscillator grid current should be within the limits of 90-200 microamps.

## Conditions Should Be Followed Closely

It is strongly recommended that in order to obtain the best results, the conditions as specified should be adhered to in every detail. There are circumstances in which it may be

## "Radio World" Binding Covers Available

Readers wishing to keep their back copies of the "Radio World" in safe and handy form for reference purposes are advised that special covers for Volumes 1 and 2 are available. Using a strong, durable leather board covered in dark blue book-cloth, they are attractively printed in gold with the title of the magazine, volume number and dates of issue.

Twelve strings are attached along the inside back portion of the cover, so that each issue of the magazine as it is bought can be slipped into place in a few moments. This method of binding is simple, effective, and very convenient, as any issue can be instantly removed if desired.

These covers are now available from the "Radio World," 214 George Street, Sydney, price 3/6 each (or for two covers for Volumes 1 and 2, 6/- post free).

necessary as a temporary measure to operate a receiver with unsatisfactory coils, and under these conditions it is possible to obtain a slight increase in oscillator strength by omitting the 20,000 ohm anode grid dropping resistor. When this is short-circuited, the total drain will increase to 5.5 m.a., and a slight increase in oscillator grid current will be noted. The improvement given is so slight that the increase in battery drain does not appear to be warranted. It is suggested that this method should not be adopted, except as a temporary expedient under special circumstances.



# E. Neill Wins First S.W. DX Contest

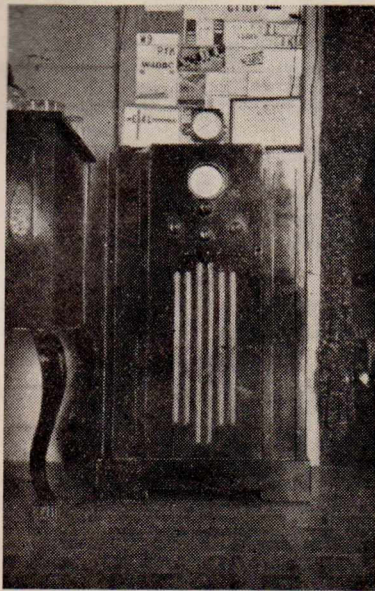

The winner's receiver—an eight-valve a.c. superhet console.

**W**INNER of the first of a series of three Shortwave DX Contests now being held by the "Radio World," Ern. Neill (AW-64DX), of Ipswich, Queensland, in the following article gives details of his receiver and of his experiences in dxing since he first became interested in it, eighteen months ago.

## Operates An Eight-Valve Breville

"I was delighted to hear that I had won the 'Radio World's' first Shortwave DX Contest, and would like to thank both the magazine for sponsoring these competitions, and also Mr. Alan H. Graham for donating such a fine trophy for the first contest.

"My receiver is an eight-valve Breville triple-wave superhet, covering from 15 to 90 metres on the short waves, as well as the usual 250-500 metre broadcast band. The valves used are Radiotrons—three 6D6's, 6C6, 75, 76, 42 and 80. The set is a 1935 model.

"The aerial is an 'L' type about 80 feet long, being 20 feet high at the far end and 35 feet at the near end, ordinary 7/22 gauge aerial wire being used. The earth lead is of the same gauge wire, and is soldered to a piece of one-inch copper pipe driven four feet into the ground. The pipe is kept full of water.

## Has Heard Three Irish Stations

"When I first heard E14L I could not distinguish what he was saying,

The first of the series of three shortwave DX Contests now being held by the "Radio World" was won by Ern. Neill (AW64DX) of Ipswich, Queensland. In the following article the winner gives details of his DX experiences, and describes how he logged the winning station.

but he came out of a fade up to about R4 and stopped there long enough for me to hear him call CQ and give his call-sign. Since then I have heard two more EI stations, and hope to receive their cards shortly.

"My experience as a dxer dates from the day when I bought the second number of the 'Radio World,' which I saw displayed at one of our local newsagents. The following is a list of the stations comprising my log at present:—W's 1BTL, 1GOJ, 21DQ; W4's DRD, DBC, DSY, DLH; W5's ZA, AHK, BKV; W6's IXZ, CQG, LIP, LLQ, ETX, ITH, W9PYK and 9GIC. VE's 4LX, 5EF, 5OT, 5HU, VP6TR, VU2FY and 2DY; XE1AI and 2FC; ZL's IKJ, ICD, IDC, 2SY, 4CU; LU1QA, HI7G, CT1DV, KA1AK, NY2AE, PK1MX. OA4R, G5TZ, EI4L, and about 150 VK's. Shortwave broadcast stations:—VK9MI, 2ME, 3ME, DJB, DJE, JVN, FYA, PCJ and RNE.

Cards are out to the following:—W's 1AXA, 1BQQ, 2IKV, 3AHS, 3BBB; W4's DXP, NN, EL, EHG, CJ, DAA; 5DQ and EEN; W6's BAY, TT, KNI, BPM, EBJ, BAW, YU, XR,



The winner, with his receiver and some of the QSL's he has collected from stations all over the world during the past eighteen months.

FTU, OCH; W7ADH, 8LSA; W9's SYJ, GCT, VOO, HOI, NFA and FJ. VE3LL, 4MO, 4AW, 4BD, 5BF, VP5AF and 3BG; VS3AE and 7RA; F3JD, F8EO, F8VR; G's 2XV, 5SA, 5OB, 5BJ, 6LK; J's 2KJ, 2IN, 2MI; HA4A and HA8N; PK1VM, EI8L, EI8J, CE1AH, HK1Z, CO7CX, VO1A, CT1AA, ZS6AJ, XE2BJ, K4SA, TI2RC, K7FBE, K7FST, EA8AE, EA9AH, ZE1JY, K6NTV and XE1GK.

"I am enclosing one photograph of myself, and another showing my receiver and some QSL's."

## QSL From Africa Gives V.A.C.

Last week I received a QSL from Africa, which gives me V.A.C. By a strange coincidence, my friend, AW-129DX, received his V.A.C. by the same mail.

On my three-valve Reinartz I have heard the following on 20 m.:—HH31, VS7RP, VU2FF, VQ8AS, J8CD, J5CC, PK1GL, VO6M, K7EQF, PY2AE, VS2AR, LA7J, XW1AM, CN8MS, CN8AJ, CT2BE, FT4AG, YS1AP, OZ7A, D3DRF, OK2PN, PAOWG, F3KH, F3JD, ON4AU, EI2L, EI2M, XU8IS, KA1FM, OE-3AH, HA6D, CO8JK, VR4HR, K4UG, K5AN, HC1FG, TI2OFR, VP5JB, GI6TK, and dozens of W's, VK's, ZL's, K6's and G's.

For my reports I use the club report forms exclusively, and I find them very successful. I overprint my call letters on the forms.

My latest QSL's are from:—CN8MS, OZ7A, G2YK, F3JD, LA1G, XE2BJ, KA1ME, OA4R, OA4AI, VE4AAI, VE4AEP, W2XAF, W3EMX, K7EQF, VPD2, G5NI and ZL4FW. Incidentally, CN8MS, G2YK and W3EMX are keen to receive reports from Australia, and guarantee 100 per cent. QSL.—Tom D. Dowling (AW97DX), Geelong, Vic.

## VK AMATEUR TRANSMITTERS

### Experimental Stations—Additions.

Call.	Name.	Address.
5LR	Lester, Jack,	Coneybeer St., Berri, S.A.
4WE	Armstrong, W. E.,	Mt. Sisa, Misima Island, Papua.
2AHA	Whyte, Harold,	7 William St., Jesmond, N.S.W.
2AHB	Pearce, A. C.,	14 Pearce St., Double Bay, N.S.W.
3IM	Seventh Battalion Radio Club,	Riverside Avenue, Mildura, Vic.
6ZO	Potter, E. T.,	17 Allen St., East Fremantle, W.A.
2AHC	Curlewis, N. U.,	5 Kardella Ave., Killara, N.S.W.
2AHD	Grennan, G. P.,	32 Norfolk St., Paddington, N.S.W.
2AHE	Pratt, A. J.,	70 Cary St., Marrickville, N.S.W.
2AHF	Jones, R. H.,	319 Prince's Highway, Kogarah, N.S.W.
2ABL	Tanner, L. S. C.,	Delamere St., Canley Vale, N.S.W.
2AHG	Bushell, Harold,	17 Kingston St., Haberfield, N.S.W.
6ST	Stewart, W. A.,	89 Blencowe St., West Leederville, W.A.
3TK	Kinsella, T. W.,	Cromie St., Rupanyup, Vic.
4CW	Welsh, C. W.,	Pratten St., Warwick, Qld.
7LG	Chick L. G.,	20 Campbell St., Launceston, Tas.
3QN	Moore, E. B.,	"Boughton Grange," Pantom Hill, Vic.
2AHH	Carter, A. R.,	4 Bishop Court, Moira Cres., Randwick, N.S.W.
4QA	Khan, Kullandar,	30 Grafton St., Cairns, Qld.
2AHI	Martin, R. W.,	158 West St., Casino, N.S.W.
2AHJ	Paterson, G. C.,	22 Pine St., Randwick, N.S.W.
6MH	Hill, Mrs. M. L.,	33 Trenton St., Wiluna, W.A.
4PL	Proposch, W. C. L.,	Heeny St., Chinchilla, Qld.
3KU	Love, H. K.,	7 Valency Rd., East Malvern, S.E.6, Vic.
2AHK	Smith, C. S.,	81 Charles St., Ryde, N.S.W.
2VU	Partridge, G. D.,	16 Hunter St., Singleton, N.S.W.
3CQ	Cobb V. L.,	241 Peel St., North Melbourne, N.1, Vic.
2AHL	Brown, George,	308 Old Canterbury Rd., Hurlstone Park, N.S.W.
6AH	Hill, A. S.,	33 Trenton St., Wiluna, W.A.
3QT	Norgate, A. W.,	104 Melbourne Rd., Nth. Williamstown, W.16, Vic.
2AHQ	Quilty, H. E.,	140 Brighton Boulevard, Bondi Beach, N.S.W.
2AHM	Whyte, R. J.,	Willow Point Station, Wentworth, N.S.W.
4VC	Cummins, R. V.,	Cnr. Chermiside Rd. and Barry St., Ipswich, Qld.
5CS	Bested, J. P.,	Spains Road, Salisbury, S.A.
4IR	Irvine, William,	Cross St., Mitchelton, N.W.3, Qld.
2AHO	Parker, G. J.,	70 Bryant St., Rockdale, N.S.W.
6PP	Paterson, P. P.,	6 Thompson St., Wiluna, W.A.
2AHP	Ramage, J. E.,	92 Edenholme Rd., Abbotsford, N.S.W.
4ZP	Peters, H. Z.,	Yerra, via Maryborough, Qld.
9VG	Gilchrist, V. H.,	Slate Creek, via Wau, New Guinea
2AHR	Ellis R. C.,	180 Morrison Road, Ryde, N.S.W.
6BX	Baxter, A. H.,	231 Lester Ave., Geraldton, W.A.

### Changes Of Address.

2CV	Ferrie, R. J.,	28 Goodhope St., Paddington, N.S.W.
3FL	Johnson, A. L.,	34 Stanley Grove, Canterbury, E.7, Vic.
3LI	Rogers, L. C.,	14 Greig St., Seddon, W.12, Vic.
2ACP	Zech, W. J.,	45 Megalong St., Katoomba, N.S.W.
3TQ	Reading, L. W.,	7 Ford St., Newport, W.15, Vic.
3DH	Morgan, I.,	7 Melrose Ave., East Malvern, S.E.5, Vic.
3GO	McGowan, R. C. G.,	Thompson St., Sale, Vic.
3JU	Phillips, H. E. J.,	475 Chapel St., South Yarra, S.E.1, Vic.
2ACL	Burghard, H. A. B.,	Warbreccan, Deniliquin, N.S.W.

Call.	Name.	Address.
2FM	Murray, F. A.,	38 Rangers Ave., Cremorne, N.S.W.
3PW	Webber, H. P.,	37 Lucerne Crescent, Alphington, N.20, Vic.
2NJ	Johnson, A. K.,	11A Duncan St., Punchbowl, N.S.W.
3MP	Hosken, S. V.,	69 Mason St., Hawthorn, E.2, Vic.
6ZZ	Stephens, H.,	70 Eddy St., Victoria Park, W.A.
3JD	Davies, J. C.,	17 Langridge St., Middle Park, S.C.6, Vic.
4VR	Rickaby, L. D.,	32 Macaulay St., Coorparoo, S.F.2, Qld.
5KY	Stapleton, J. W.,	9 King St., Alberton, S. A.
2AO	Friar, A. O.,	7 Fitzroy St., Grafton, N.S.W.
6MN	Madden S. J.,	123 Harbourne St., Wembley, W.A.
2MZ	Hurstville Radio Club,	316B Forest Rd., Hurstville, N.S.W.
2TN	Bailue, I.,	19 Church St., Randwick, N.S.W.
2AEL	Bailue, I.,	19 Church St., Randwick, N.S.W. (Portable).
2TE	Boyd, A.,	224 Western Rd., Rozelle, N.S.W.
2QP	Hughes, L. W.,	52 Shadforth St., Punchbowl, N.S.W.
2TV	Lenon, R. J.,	Liverpool St., Cowra, N.S.W.
3TO	Rogers, J. E.,	2A O'Connor St., Haberfield, N.S.W. (See also alterations to call signs).
4JW	Larsen, H. P. C.,	18 McLeod St., Cairns, Qld.
2IJ	Gray, A. H.,	19 Buckingham Road, Killara, N.S.W.
5FM	Bowman, H. N.,	Battams Road, Payneham, S.A.
4HJ	Mackenzie, A. A.,	Fire Station, Wynnum, E.2, Qld.
2BN	Flood, R. F. J.,	1 Togo St., Penshurst, N.S.W.
9KO	Blue, H. W.,	C/- A.A.M.S. Box 50B, Broken Hill, N.S.W. (See also alterations to call signs).
2TH	Heimann, T. R.,	58 Duntroon St., Hurlstone Park, N.S.W.

### Cancellations.

2ACR	Heimann, T. R.,	93 Gurwood St., Wagga, N.S.W. (Portable).
4CE	Connor, E. B.,	Gindie, Qld.
4BJ	Brown, J. G.,	45 Baden Powell St., Rockhampton, Qld.
3UR	Logan, E. G.,	12 Burke Rd., East Malvern, S.E.5, Vic.
3DA	Webber, H. P.,	37 Lucerne Crescent, Alphington, N.20, Vic.
2II	Brown, R. A.,	Lucasville Rd., Glenbrook, N.S.W.
3RQ	Quick, M. R.,	15 Tasman St., West Preston, N.18, Vic.
2GL	Richmond River Listeners' League,	83 Orion St., Lismore, N.S.W.
2TL	Watson, T. W.,	70 Calero St., Lithgow, N.S.W.
2ADY	Vaughan, D. E.,	3 Hampden St., Lakemba, N.S.W. (Portable).
2NB	Buchanan, N.T.O.,	206 Sydney Rd., Manly, N.S.W.
2ACM	Newcastle Radio Service Company,	102 King St., Newcastle, N.S.W.
2ACF	Welzel, K.,	23 Woonona Rd., Northbridge, N.S.W. (Portable).

### Alterations To Call Signs.

3TO	Rogers, J. E.,	15 Dominic St., Camberwell, E.6, Vic. Now VK2AHN. (See also changes of address).
9KO	Blue, H. W.,	Rabaul, New Guinea. Now VK2YI. (See also changes of address).

### Amendments.

2VB	Wood, R. E.,	483 Anzac Parade, Sth. Kensington, N.S.W. Now 483 Anzac Parade, Kingsford, N.S.W.
2EN	Hulme, E. C.,	42 Kennedy St., Sth. Kensington, N.S.W. Now 42 Kennedy St., Kingsford, N.S.W.
3UD	Denholm, I. H.,	36 Royal Parade, Coburg, N.13, Vic. Now 40 Royal Parade, West Coburg, W.7, Vic.

**FREE— Use This Coupon —FREE**

Write for your copy of Vealls Big New 1937 Radio and Electrical Catalogue . . . 88 pages, over 500 illustrations. Your name and address on this coupon will bring you a copy. Enclose 2d. stamp for postage.

NAME..... ADDRESS.....

**THE JONES**

**SUPER - GAINER TWO**

Read the complete details in the August issue—the "Jones Super-Gainer Two," a shortwave superhet designed to give the utmost in results from two valves. Covers 10, 20, 40, 80 and 160-metre amateur bands. For only £8/19/6 Vealls will supply the Complete Kit, including valves and ready-wound coil kit of 10 coils, chassis, panel, etc.

VEALLS PAY FREIGHT TO YOUR NEAREST RAILWAY STATION.

COMPLETE KIT **£8/19/6**

**A SPECIAL OFFER**

Write for Big Special Offer Folder of RADIO and ELECTRICAL GOODS.

**KIT-SETS SACRIFICED**

Vealls are offering a complete range of Kits, 3, 4, 5 up to 8 valves, A.C. and battery, at special low prices, pounds below the usual list price. Write for a copy of this list and snap one of these bargains while stocks last. Positively amazing value is offered, but you must act quickly—WRITE TO-DAY.

**BRAND NEW VALVES SACRIFICED**

- Bond 227 Gen. Pur. A.C. 2.5v. 4/11d.
- Bond 201A Gen. Pur. Batt. 5v. 4/11d.
- Bond 235 R.F. Amp. A.C. 2.5v. 4/11d.
- Bond 245 Power A.C. 2.5v. 6/11d.
- Bond 280 Rect. Full Wave 5v. 7/11d.

All Fully Tested.

**"GILCO" CONVERTERS**

With a Gilco Converter you can use any standard make of all-electric Receiver or Amplifier. These converters are designed to operate from a direct current supply, and deliver 240 volts A.C. Measure, 10 in. long by 8 in. wide, and weigh 20 pounds.

- 32 or 110 volt D.C. to 240 volt A.C. 50 cycle 100 watts filtered ..... £15/10/-
- 300 watt for P.A. 32 volt D.C. to 240 volt 50 cycle unfiltered ..... £23/10/-

**LET VEALLS QUOTE.**

No matter where you live, Vealls can supply—at keen Melbourne prices. Remember . . . Vealls pay freight on all Victorian Retail Orders, excepting Radio Cabinets, and on all Interstate Orders excepting Batteries and Cabinets.

**THE VELCO PORTABLE AMPLIFIER 15 WATT OUTPUT**

For PUBLIC ADDRESS, CROONERS, DANCE HALLS, BAZAARS and PARTIES.

The Velco Portable Amplifier is designed by Vealls' experts and offers a value unobtainable elsewhere in Australia. The Amplifier closed measures 17 in. x 17 in. x 9½ in. Both sides are detachable and form the Speaker Baffles and Stands. The centre portion carries the Amplifier and Controls.

Separate inputs for both Pickup and Microphone. Chassis, black crackle finish. Case, leatherette covered, provided with door flaps for weather protection of speakers. Two Rola K8 speakers, either one or both may be used. 50 feet speaker cable provided. Crystal Microphone. 38 pounds weight. Operates from 200-240 volts A.C. Output, 15 watts undistorted, sufficient for hall holding two hundred couples **£22/15/-** when dancing. Price .....

Battery-Operated Amplifiers can also be supplied. Vealls are Amplifier experts. Write for particulars.

**VEALLS RADIO & ELECTRICAL STORES**

Your nearest letter-box is Vealls' nearest store.

243-249 SWANSTON STREET, MELBOURNE, C.1.  
299-301 CHAPEL STREET, PRAHRAN, S.1.  
Phone Orders—Cent. 3058 (7 lines).

168 SWANSTON STREET, MELBOURNE, C.1.  
3-5 RIVERSDALE ROAD, CAMBERWELL, E.6.  
Telegrams: "ARTVEALL," Melbourne.

*IF YOU LIVE IN  
THE COUNTRY*

WHATEVER BRAND OF  
SET YOU BUY . . .

MAKE SURE THAT IT'S AN  
**AIR CELL**  
OPERATED RADIO

The fact that so many leading radio manufacturers are to-day producing AIR CELL models testifies to the extraordinary appeal of this new type of country receiver.

Fitted with an Eveready Air Cell—the newest means of supplying power to your radio in non-electrified areas—they offer the man on the land a set that is no more trouble to run than those designed for the city. The Eveready Air Cell requires no RECHARGING and yet is capable of delivering a consistently smooth flow of power for upwards of 12 MONTHS under normal conditions of use. Therefore, for a more efficient, more convenient, and 100% reliable radio, insist on the AIR CELL operated model.

EQUIPPED WITH AN  
**EVEREADY**  
*AIR · CELL*

The Ever Ready Co. (Australia) Pty. Ltd., Sydney

SEA. 5

