

“Q-PLUS”

INDUCTANCE

DATA BOOK



PROVIDING COMPREHENSIVE DATA
ON THE “Q-PLUS” RANGE OF
I. F. TRANSFORMERS, AERIAL R.F. and
OSCILLATOR COILS, Etc. Etc.

A ‘MUST-HAVE’ FOR SERVICEMEN,
MANUFACTURERS, HOBBYISTS, ETC.

Price. 2/6

P R E F A C E

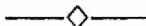

The complexity of the modern radio circuit has for many years demanded more of inductances and transformers than ever before, and with the advent of T.V. and F.M. in particular, the day when any old coil will do, will be only a dream.

With this in mind together with the fact that we felt that customers were entitled to know just "what was in the can," we have released this catalogue — loose leaf because naturally you will want to keep it up to date, and we will be continually releasing new sheets as new products are manufactured.

From time to time new sheets may be released replacing obsolete ones as improvements in manufacture take place.

Acknowledgment is made to Messrs. Radio and Hobbies for their kind permission in allowing us to use five of their circuits. We would stress that home-constructors cannot go beyond all the Radio and Hobbies circuits for accurate wiring and assembly details.

**R. W. STEANE & CO. PTY. LTD.,
EASTERN PLACE, AUBURN, VIC.**

Telephone: WA2677

FURTHER DATA SHEETS.

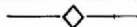

From time to time corresponding to the release of new lines, further sheets will be released, and to those of you who have not purchased the Data Book direct from R. W. Steane & Co. Pty. Ltd., it will be necessary to tear off the coupon below and forward, so that you will be sure of being registered.

Remember if you have purchased your book direct from R. W. Steane & Co. Pty. Ltd., your name has been automatically recorded and no further action is needed.

REGISTRATION COUPON.



R. W. Steane & Co. Pty. Ltd.

Auburn, Vic.

Dear Sir,

Please record my name for supply of further Data Sheets.

M.....

Address.....

State.....

The next release of these new sheets is free.

HINTS ON GETTING THE BEST FROM COILS, I.F. TRANSFORMERS, ETC.

So as not to confuse the beginner a few points are made hereunder on how to select the correct type of Coil and I.F. Transformer for any particular receiver.

Firstly size — Q-Plus coils are made in miniature and standard sizes. Therefore be sure you see under the heading "Midget" or "Standard" as may be required for each item.

If the set is to be of the normal type super-het an I.F. frequency of 455 Kc. is standard and so only those I.F.'s of 455 Kc. are selected, and of course the corresponding oscillator coil.

Generally speaking the less the number of valves a set has, the higher gain a coil or I.F. is needed, conversely if tubes are many high gain is not necessarily called for, and I.F.'s and coils are used for selectivity or specified band-width, etc.

One important coil however where gain is never in excess of requirements is the aerial coil. A high gain aerial coil helps to solve many worries occurring in later stages of the receiver, it helps to overcome noise and gives that added pleasure, when finally the set is aligned, of hearing a set that is live.

It goes without saying therefore that for all set building other than car radios and portables the Q-Plus AC5, standard size, or AC1 miniature size, aerial coils should be selected. The standard size aerial coil type AC4 is to be regarded mainly for replacements or for local station receivers only.

Due to the special requirement of aerial matching however, the AC2, miniature, and AC7, standard, aerial coils are available for Car Radios. For car radios it is recommended that wherever possible the AC7 be fitted as it is in this application that our remarks apply more than anywhere.

In order to provide correct coupling in Car radio aerial coils a tapped secondary is provided, and a 100 pf condenser is required between aerial and tap on type AC2 but this is inbuilt in the larger AC7 version.

Some constructors tell us they have used the AC7 coil with remarkable results in AC B/C receivers, with short indoor aerials and a small capacity across aerial to earth (about 10 pf) to simulate the car type coax lead-impedance.

Of course Q-Plus do not make a loop aerial but there is no reason why you cannot do so yourself. Early in 1954 we have a surprise for you in this regard — something which even the Commercial Manufacturers

in the country have not yet used, but which will revolutionize loop antennas.

In addition to these normal coils Q-Plus market additional Band Pass Coils which have been specially designed to match our ordinary coils. For details see Band Pass Kit Data Sheets.

Q-Plus standard size aerial coils incorporate a small coupling condenser between the Aerial pin and Grid pin. This is between 5-8 pf and is provided to increase the gain at the high frequency end, providing a more even gain curve over the whole band.

However space does not allow this to be incorporated in the miniature series and it is strongly recommended that a small condenser be provided externally. This applies to Type AC1 and RC1 only. A very useful improvement in high frequency gain will result. If one has not a small condenser, a satisfactory substitute can be made by winding a few turns of about 22 SWG enamel or cotton/enamel wire over a piece of tinned copper wire about 16 SWG. Care must be taken not to allow a short circuit between the two types of wire.

When large outside aerials are used the additional capacity therefrom may cause an objectionable whistle when the set is tuned near the low frequency end of the set. A small resistor of several hundred ohms across aerial to earth will cure this from this fault.

If the set under construction is a DC receiver — mains supply a condenser will be necessary in the aerial lead. This should be high enough so as not to interfere with the coils normal performance, and a recommended value is 1000 pf. mica.

R.F. COILS.

It has been said that any old coil will do for an R.F. coil but this is only partially true. The R.F. stage in a receiver is used generally for two purposes, (a) to improve gain; (b) to improve selectivity.

Unfortunately the stage gain in a R.F. coil is disappointingly low due to the step down ratio existing which is necessary when proper impedance matching and tuning range are used. Gain from the stage results primarily from the extra valve.

The coil however does play an important part and one which valves are unable to do, i.e. selectivity, although even this can be lost if care is not taken in accurately aligning the stages, particularly on SW Bands.

Generally speaking the RC1 miniature and RC5 standard are those selected for R.F. stage receivers. The type RC4 being mainly used for replacements.

The R.F. stage of a receiver is one where leads must be kept to a minimum in length and then "fields" kept away from the AVC and other R.F. circuits. Two stages of R.F. are never recommended nowadays, be it for a TRF or any other set.

OSCILLATOR COILS.

Having selected the converter type there is little choice in selecting the correct oscillator coil — it is the choice between standard size and miniature.

Due to the different oscillator transconductances, different coils are needed in order to bring the oscillator grid current on the correct part of the transconductance curve. We have heard it said that such and such a coil will work with any valve and so well it may, but the measure is how well will it work.

Well with those remarks the only remaining worry will be the padder value. A fixed mica padder condenser of 430 — 435 pf is needed and for accurate alignment a $\pm 5\%$ tolerance is required too — remember most commercial condensers are $\pm 20\%$ tolerance.

I.F. TRANSFORMERS.

In the 455 Kcs I.F.'s we can divide the requirements into three major types, low gain, medium selectivity, high gain medium selectivity or low gain high selectivity. All these are available in the standard sizes but in the miniature series the only type available is a medium gain medium selectivity.

As their designation indicates there is little to be said except that for general purpose local receivers the low gain medium selectivity are quite satisfactory, whilst for D.W. and more sensitive sets, the high gain medium selectivity are essential — particularly for Dual Wave Receivers. The low gain high selectivity types are only recommended for communication type receivers, using two stages of I.F. (i.e. 3 I.F. transformers).

At the risk of repeating our advertising however, it is essential in the special classes of I.F. transformers to use the lower numbered unit in the first stage and the higher numbered unit in the second stage. This gives better gain and correct bandwidth for any two stages.

I.F. 10 and 11 are worth special mention, for should the receiver being built be of the battery type, these I.F.'s are ideal.

It is imperative that I.F. leads to plates and grids be kept to minimum distances and wired directly. Decoupling condensers should be wired direct to the I.F. base terminal, this is one reason why Q-Plus went to such extraordinary pains to provide a heavy silvered terminal in a non-softening base. The practice of taking a lead from the base to a terminal strip a short distance away is not recommended.

Q-PLUS

AC 1

MIDGET B/C AERIAL COIL

"SPHEROCLAD"

FREQ. COVERAGE — 520 — 1600
Kcs.

TUNING CAPACITY — 25 — 445
uufd. (Inc. strays)

PHYSICAL SIZE— $\frac{3}{4}$ " x $\frac{3}{8}$ " x $1\frac{1}{8}$ ".

PIN CONNECTIONS—

P = Aerial.

B + = Earth—primary.

F = Earth—secondary.

G = Grid.

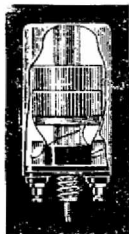

MOUNTING— $3/16$ " whit nut onto moulded insert
in base—template supplied.

PRIMARY INDUCTANCE—1.65 mH.

SECONDARY INDUCTANCE when tuned to 1000
Kcs.—210 uH.

APPROXIMATE GAIN at 600 Kcs.—5 times.

SECONDARY "Q" at 600 Kcs.—100.

REMARKS

Construction is of 9/41 litz wound secondary with H1 Z primary designed to match about 14 feet of indoor aerial. Coupling of approximately .2 is maintained by gauged fibre washers. Top coupling is not included but may be added externally by means of about a 5-8 uufd. condenser between P & G terminals.

Earthing of can is accomplished by folded can lugs. care should be taken to see that sprayed chassis are cleaned at these points before assembling.

R. W. STEANE & Co. Pty. Ltd. Auburn, Vic.

SUBJECT TO CHANGE WITHOUT NOTICE.

Q-PLUS

AC 2

MIDGET B/C CAR TYPE AERIAL COIL

"SPHEROCLAD"

FREQ. COVERAGE — 520 — 1600
Kcs.

TUNING CAPACITY — 25 — 445
uufd. (Inc. strays)

PHYSICAL SIZE— $\frac{3}{4}$ " x $\frac{3}{4}$ " x $1\frac{1}{8}$ ".

PIN CONNECTIONS—

P = Aerial.
B + = Primary Earth.
F = Secondary Earth.
G = Grid.
A2 = Secondary Tap.

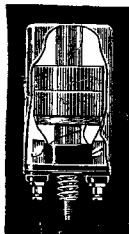

MOUNTING— $\frac{3}{16}$ " whit nut onto moulded insert
in base—template supplied.

PRIMARY INDUCTANCE—1.45 mH.

SECONDARY INDUCTANCE at 1000 Kcs.—210 uH.

APPROXIMATE GAIN at 600 Kcs.—8 times.

SECONDARY "Q" at 600 Kcs.—100.

REMARKS

Construction is of 9/41 litz wound secondary with Lo. Z primary designed to match can type aerial and coax lead. Hi Secondary Q is obtained by use of Carbonyl Iron Dust Cups. Secondary is tapped and it is recommended that a 100 uufd. condenser be placed between P & A2 to complete correct coupling. Earthing etc. (see AC1).

This unit is specially designed for car radios or other midget sets, with small or High "C" component aeriels.

R. W. STEANE & Co. Pty. Ltd. Auburn, Vic.

SUBJECT TO CHANGE WITHOUT NOTICE.

Q-PLUS

AC 4

STANDARD GENERAL PURPOSE B/C COIL

FREQ. COVERAGE—520—
1600 Kcs.

TUNING CAPACITY—25—
445 uufd.
(includes strays)

PHYSICAL SIZE—1³/₈" diam.
x 2¹/₄".

PIN CONNECTIONS

- 1—Grid.
- 3—AVC.
- 4—Aerial.
- 6—Earth.

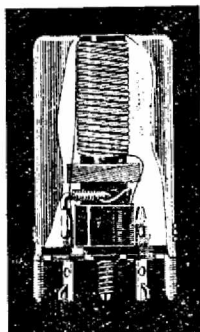

MOUNTING—2 x ¹/₈" holes, 1³/₈" apart.

PRIMARY INDUCTANCE—1.65 uH.

SECONDARY INDUCTANCE when tuned to 1000
Kcs.—210 uH.

APPROXIMATE GAIN at 600 Kcs.—6.5 times.

SECONDARY "Q" at 600 Kcs.—110.

REMARKS

This unit is of the progressively wound type 7/41 litz wire is used and a moderately high gain and "Q" is achieved. It is a good general purpose unit when high gain is not called for. Has inbuilt top coupling condenser.

R. W. STEANE & Co. Pty. Ltd. Auburn, Vic.

SUBJECT TO CHANGE WITHOUT NOTICE.

Q-PLUS

AC 5

STANDARD HIGH GAIN B/C AERIAL COIL

"SPHEROCLAD"

FREQ. COVERAGE— 520—
1600 Kcs.

TUNING CAPACITY— 25—
445 uufd.
(includes strays)

PHYSICAL SIZE—1 $\frac{1}{2}$ " diam.
x 2 $\frac{1}{4}$ ".

PIN CONNECTIONS—

- 1—Grid.
- 3—AVC.
- 4—Aerial.
- 6—Earth.

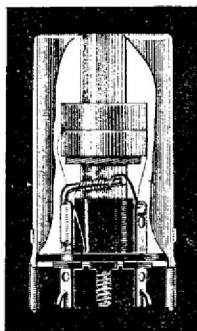

MOUNTING—2 x $\frac{1}{8}$ " holes, 1 $\frac{1}{2}$ " apart.

PRIMARY INDUCTANCE at 100 Kcs.—1.65 uH.

SECONDARY INDUCTANCE when tuned to 1000
Kcs.—210 uH.

APPROXIMATE GAIN at 1000 Kcs.—10 times.

SECONDARY "Q" at 600 Kcs.—176.

REMARKS

Construction is of 9/41 Litz wound in special carbonyl pots giving extremely high "Q" and gain. High Z primary is designed to match about 14 feet of aerial. Coupling is approximately .25. An inbuilt top coupling condenser of 5 uufd. is used to increase high frequency power transfer

R. W. STEANE & Co. Pty. Ltd. Auburn, Vic.

SUBJECT TO CHANGE WITHOUT NOTICE.

“Q-PLUS” A.C.7

Standard size car-radio aerial COIL

Freq. Coverage—520—1600 Kcs.

Tuning Capacity—25—445 uufd
Inc. strays.

Physical Size—1 $\frac{3}{8}$ " diam x 2 $\frac{1}{4}$ "

Pin Connections

- 1 . . . GRID
- 3 . . . AVC
- 4 . . . AERIAL
- 5 . . . SEC. TAPPING
(not used).
- 6 . . . EARTH

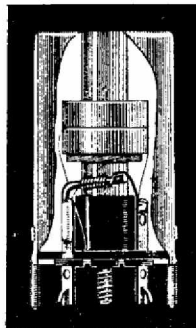

Mounting—2 x $\frac{1}{8}$ " holes, 1 $\frac{3}{8}$ " apart.

Primary Inductance—1uh.

Secondary Inductance—210uh (when tuned down to 1000Kcs.)

Secondary—“Q” 200 in can.

Inbuilt Coupling Condenser—100 uufd.

REMARKS

An exceptional coil bringing to all the gain previously only obtained by big manufacturers. Litz wound primary and secondary with special pi windings enclosed in carbonyl pots for the very exceptional high Q—only suitable for Low Z aeriels of the Car Radio type. 100 uufd. condenser is inbuilt between pin No. 4 and 5 (Aerial and sec. tap).

R. W. STEANE & CO. PTY. LTD. AUBURN, VIC:
SPECIFICATIONS SUBJECT TO CHANGE WITHOUT NOTICE

"Q-PLUS" Band-Pass Aerial Kits.

STANDARD SIZE—TYPE AC5 & AC8
MINIATURE SIZE—TYPE AC1 & AC3

To accomplish band pass tuning two matched aerial coils are required. The above types are those recommended for this purpose. The AC5 and AC1 are to be used in the first section being coupled by a common .02 mica condenser for the low frequency end and by a 2-3 pf. condenser at the high frequency end. Whilst types AC8 and AC3 belong to the second section.

With correct use 10 Kc band width may be obtained using these coils.

We recommend that prospective users refer to Radio & Hobbies December issue.

SPECIFICATIONS

Type AC5 has previously been covered.

Type AC8 is identical with the exception that no primary is wound.

Type AC1 has previously been covered.

Type AC3 is identical with the exception that no primary is wound.

CONNECTIONS

	AC3	AC8
Grid	G	1
Bottom coupling cap	F	3

REMARKS

To enjoy the fullest fidelity with these coils it is urged that Type IF12A and IF13 be used in the miniature size and 2-IF15 in the standard size—these are 1600 Kc and 1900 Kc IF's respectively and require type 010 and 011 oscillator coils respectively.

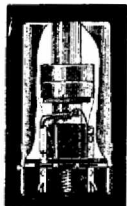

AC5

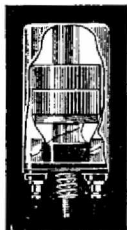

AC1

"Q-PLUS" RC I

MIDGET B/C R.F COIL

"SPHEROCLAD" CONSTRUCTION

FREQ. COVERAGE—520—1600

Kcs.

TUNING CAPACITY — 25—445

uufd.

(Inc. strays)

PHYSICAL SIZE— $\frac{3}{4}$ " x $\frac{3}{4}$ " x 1 $\frac{3}{8}$ "

PIN CONNECTIONS—

P=Plate.

B+=B+.

F=Earth—secondary.

G=Grid



MOUNTING— $\frac{3}{16}$ " whit nut onto moulded insert
in base-template supplied.

PRIMARY INDUCTANCE—8.5 mH.

SECONDARY INDUCTANCE when tuned to 1000
Kcs.—210 uH.

APPROXIMATE GAIN at 600 Kcs.—12 times.

SECONDARY "Q" at 600 Kcs.—110.

REMARKS

Construction is of 9/41 utz wound secondary with primary designed for optimum RF coupling. Coupling of approximately 2 is maintained by gauged fibre washers. Top coupling is not included but may be added externally by means of about a 5-8 uufd. condenser between P & G terminals

Earthing of can is accomplished by folded can lugs, care should be taken to see that sprayed chassis are cleaned at these points before assembling

R. W. STEANE & Co. Pty. Ltd. Auburn, Vic.

**DUE TO PREVAILING CONDITIONS SPECIFICATIONS
MAY CHANGE SLIGHTLY WITHOUT NOTICE.**

"Q-PLUS"

RC 2

MIDGET B/C CAR TYPE R.F. COIL

"SPHEROCLAD CONSTRUCTION"

FREQ. COVERAGE—520—1600

TUNING CAPACITY—25—445
uuufd.

(Inc. strays)

PHYSICAL SIZE— $\frac{3}{4}$ " x $\frac{3}{4}$ " x $1\frac{1}{2}$ ".

PIN CONNECTIONS—

P=Plate

B—= B+.

F=Secondary Earth.

G=Grid

A2=Secondary Tap.

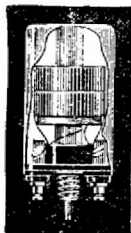

MOUNTING— $\frac{3}{16}$ " whit nut onto moulded insert
in base-template supplied.

PRIMARY INDUCTANCE—2.5 mH.

SECONDARY INDUCTANCE at 1000 Kcs.—210 uH.

APPROXIMATE GAIN at 600 Kcs.—8 times.

SECONDARY "Q" at 600 Kcs.—110.

REMARKS

Construction is of 9/41 litz wound secondary with primary designed to give optimum coupling and correct alignment when used with AC2. Hi Secondary Q is obtained by use of Carbonyl Iron Dust Cups. Secondary is tapped and it is recommended that a 100 uuufd. condenser be placed between P & A2 to complete correct coupling. Earthing etc. (see AC1).

R. W. STEANE & Co. Pty. Ltd. Auburn, Vic.

DUE TO PREVAILING CONDITIONS SPECIFICATIONS
MAY CHANGE SLIGHTLY WITHOUT NOTICE.

"Q-PLUS"

RC 3

MIDGET B/C R.F. COIL WITH REACTION "SPHEROCLAD CONSTRUCTION"

Freq. Coverage—520—1600Kcs.

Tuning Capacity—25—455uufd.
(Including strays.)

Physical Size = $\frac{3}{4}$ " x $\frac{3}{4}$ " x $1\frac{1}{8}$ ".

Pin Connections—

P=Plate of first Valve V1.

B+=B+.

F=Secondary Earth.

G=Grid.

A1=Plate of V2.

A2=B+ or Reaction con-
denser.

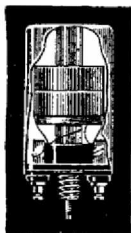

Mounting— $\frac{3}{16}$ " Whit. nut on to moulded insert
in base—template supplied.

Secondary Inductance—when tuned to 1000 Kcs.
210 uH.

Primary Inductance—8.5 mH.

REMARKS

*Construction is of litz secondary with suitable primary
and reaction coils for R.F. stage with reaction work.*

*Coil gain and "Q" are not stated owing to the varying
conditions met with but are substantially the same as
for type RC1.*

R. W. STEANE & Co. Pty. Ltd., Auburn, Vic.

**DUE TO PREVAILING CONDITIONS SPECIFICATIONS
MAY CHANGE SLIGHTLY WITHOUT NOTICE.**

“Q-PLUS”

RC 4

Standard General Purpose B/C R.F. Coil

FREQ. COVERAGE—520—
1600 Kcs

TUNING CAPACITY—25—
445 uufd
(includes strays)

PHYSICAL SIZE—1 $\frac{1}{2}$ " diam
x 2 $\frac{1}{2}$ "

PIN CONNECTIONS

1—Grid.

3—AVC

4—Plate.

6—B+.

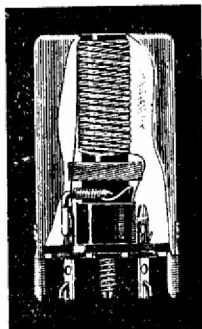

MOUNTING—2 x $\frac{1}{8}$ " holes, 1 $\frac{1}{2}$ " apart.

PRIMARY INDUCTANCE—8.5 mH.

SECONDARY INDUCTANCE when tuned to 1000
Kcs.—210 uH

APPROXIMATE GAIN at 600 Kcs.—12 times.

SECONDARY “Q” at 600 Kcs.—110.

REMARKS

*This unit is of the progressively wound type 7/41 (itz
wire is used and a moderately high gain and “Q” is
achieved. It is a good general purpose unit when high
gain is not called for. Has inbuilt top coupling condenser*

R. W. STEANE & Co. Pty. Ltd. Auburn, Vic.

**DUE TO PREVAILING CONDITIONS SPECIFICATIONS
MAY CHANGE SLIGHTLY WITHOUT NOTICE.**

"Q-PLUS"

RC 5

STANDARD B/C R.F. COIL

"SPHEROCLAD CONSTRUCTION"

FREQ. COVERAGE—520—
1600 Kcs.

TUNING CAPACITY—25—
445 uufd.
(includes strays)

PHYSICAL SIZE—1½" diam
x 2½"

PIN CONNECTIONS

- 1—Grid.
- 3—AVC.
- 4—Plate.
- 6—B+.

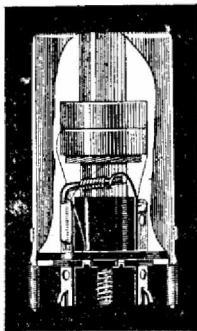

MOUNTING—2 x ½" holes, 1½" apart.

PRIMARY INDUCTANCE, 8.5 mH.

SECONDARY INDUCTANCE when tuned to 1000
Kcs.—210 uH.

APPROXIMATE GAIN at 600 Kcs.—14 times.

SECONDARY "Q" at 600 Kcs.—140

REMARKS

*Construction is of 9/41 litz wound in special carbonyl
wire giving extremely high "Q" and gain. Coupling is
approximately .25. An inbuilt top coupling condenser of
5 uufd is used to increase high frequency power transfer.*

R. W. STEANE & Co. Pty. Ltd. Auburn, Vic.

DUE TO PREVAILING CONDITIONS SPECIFICATION:
MAY CHANGE SLIGHTLY WITHOUT NOTICE.

“Q-PLUS”

RC 9

UNTUNED B/C R.F. COIL OR 16 MH R.F. CHOKE

Inductance Value
—16 MH.

Current Rating —
100 ma max.

Pins—Pigtail con-
nections.

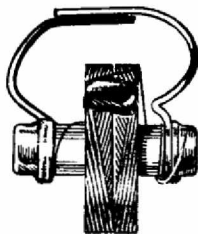

REMARKS

The type RC9 R.F. coil is designed for untuned R.F. stages in portable or other sets.

Operation is achieved by inserting same into plate circuit second stage valve to B+ and coupling a small condenser of about 100 uufd to the following grid. It is mainly used in some commercial sets for replacement purposes.

R. W. STEANE & Co. Pty. Ltd., Auburn, Vic.

**DUE TO PREVAILING CONDITIONS SPECIFICATIONS
MAY CHANGE SLIGHTLY WITHOUT NOTICE**

Q-PLUS R.F. CHOKES 2.5 M.H.

TYPES RFC1, RFC2, RFC3.

TYPE RFC1.

PHYSICAL SIZE 5-8" x 1"
INDUCTANCE: 2.5 MH plus-
minus 10 pc RFC1.

CURRENT CAPACITY: 50
Ma.

MOUNTING: Wound on cer-
amic former; pigtail leads.

TYPE RFC2 — 3 PL.

PHYSICAL SIZE $\frac{3}{4}$ " x 1 3-8"
INDUCTANCE: 2.5 MH plus-
minus 10 pc RFC2

MOUNTING: Wound on cer-
amic former; pigtail leads.

SELF-RESONANCE: 2.5 m/cs

TYPE RFC3 — Iron Cored.

PHYSICAL SIZE $\frac{3}{4}$ " x 1"
INDUCTANCE: 2.5 MH plus-
minus 10 pc.

CURRENT CAPACITY: 100
Ma.

MOUNTING: 1-8in nut and bolt supplied. Wound
on iron post core with 2 lug terminal strip sup-
plied.

R. W. Steane and Co. Pty. Ltd., Auburn, Vic.

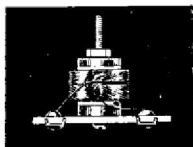
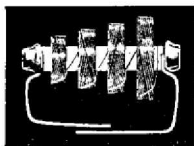
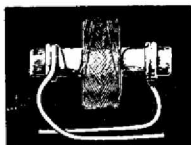

"Q PLUS"—0.2

MIDGET B/C OSCILLATOR COIL

TO SUIT I.R.5, 6J8

Freq. Coverage—520—1600 Kcs.

Tuning Capacity—25—445uufd.
(inc. strays)

Physical Size— $\frac{3}{4}$ " x $\frac{3}{4}$ " x $1\frac{1}{8}$ "
Pin Connections

	1R5	6 J8
P=	Screen	Osc. plate
B+=	B+	B+
F=	Earth	Padder
G=	Grid	Grid

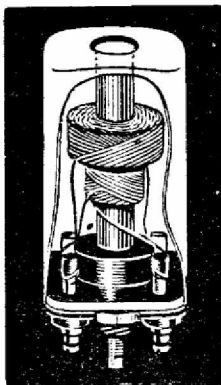

Mounting— $\frac{3}{16}$ " Whit. nut onto moulded insert in base—template supplied.

Primary L.—20uH.

Secondary L.—when core adjusted to 1455 Kcs—116uH.

Recommended Padder—for 455 Kc I.F.'s 430uufd.

Obtainable Grid Current

.20 ma @ 520 Kcs.

.27 ma @ 1600 Kcs.

REMARKS

Litz wound secondary with special design to give constant grid current at recommended value.

Best results will be obtained by placing padder in series with gang condenser and coupling condenser and not between coil and earth.

R. W. STEANE & CO. PTY. LTD., Auburn, Vic.

Due to prevailing conditions specifications may change slightly without notice.

"Q PLUS"---0.4

MIDGET B/C OSCILLATOR COIL TO SUIT ECH33/35, X61M, 6AN7, 6AE8, etc.

Freq. Coverage—520—1600 Kcs.

Tuning Capacity—25—445uufd
(inc. strays)

Physical Size— $\frac{3}{4}$ " x $\frac{3}{4}$ " x $1\frac{3}{8}$ "

Pin Connections

- P=Osc. Plate
- B+=No connection
- F=Padder
- G=Osc. Grid.

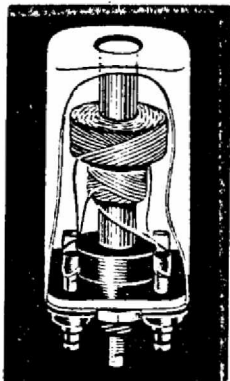

Mounting— $\frac{3}{16}$ " Whit. nut onto moulded insert in base.

Primary L.—13uH.

Secondary L.—when core adjusted to 1455 Kcs—116uH.

Recommended Padder—for 455 Kc I.F.'s—430uufd.

Obtainable Grid Current.

- 20 ma @ 520 Kc.
- 34 ma @ 1600 Kc

REMARKS

Construction is similar to type 02. More consistent grid current results with the inclusion of a 2000w resistor between pin "P" and oscillator plate

R. W. STEANE & CO. PTY. LTD., Auburn, Vic.

Due to prevailing conditions specifications may change lightly without notice

"Q PLUS"---0.5

MIDGET B/C OSCILLATOR COIL

TO SUIT 6BE6 —
6SA7 CONVERTORS

Freq. Coverage—520—1600 Kcs

Tuning Capacity—25—445uufd.
(inc. strays)

Physical Size— $\frac{3}{4}$ " x $\frac{3}{4}$ " x 1 $\frac{1}{8}$ "

Pin Connections

P=Cathode

B+=No connection

F=Earth

G=Osc. grid via padder

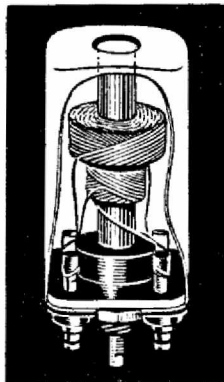

Mounting— $\frac{3}{16}$ " Whit. nut onto moulded insert in
base—template supplied.

Secondary L.—when core adjusted to 1455 Kcs.—
116uH.

Recommended Padder—for 455 Kc I.F.'s—430uufd.

REMARKS

Special construction enables cathode voltage to be kept at a recommended value of 1.4 V.R.M.S. (Ref. Radiotronics Nos. 95 & 120) thus giving maximum conversion

R. W. STEANE & CO. PTY. LTD., Auburn, Vic.

Due to prevailing conditions specifications may change slightly without notice.

“Q-PLUS”-07

**STANDARD SIZE B/C OSCILLATOR COIL TO
SUIT 6J8, 6A8, 1A7 CONVERTERS.**

Freq. Coverage—520—1600 Kcs.

Tuning Capacity—25—445 uufd
(inc. strays).

Physical Size—1 3-8in diam x
2¼in.

Pin Connections

- 1=Osc. Grid.
- 3=Padder.
- 4=Osc. Plate.
- 6=B+

Mounting—2 x 1-8in holes, 1 3-8in
apart.

Primary “L” — 11 uh.

Secondary “L”—116 uh.
when signal tuned to
1000 Kcs.

Recommended Padder for 455 Kc IF's—430 uufd.

Obtainable Grid Current: .25mA, 1600Kcs.
.30 mA, 520 Kcs.

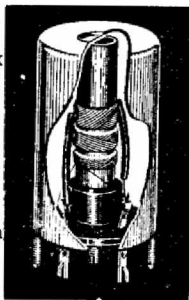

REMARKS

A Litz wound feedback type oscillator coil with a remarkably even grid current range. Mounted on non softening base with silverplated terminals.

R. W. STEANE & Co. Pty. Ltd., Auburn, Vic.

SPECIFICATIONS SUBJECT TO CHANGE WITHOUT
NOTICE.

“Q-PLUS”-08

**STANDARD SIZE B/C OSCILLATOR COIL TO
SUIT 6SA7/6BE6 CONVERTERS.**

Freq. Coverage—520—1600 Kcs.

Tuning Capacity—25—445 uufd.
(inc. strays).

Physical Size—1 3-8in diam. x
2¼in.

Pin Connections

- 1=Osc. Grid.
- 3=Earth.
- 6=Cathode.

Mounting—2 x 1-8in holes, 1 3-8in
apart.



Recommended Padder for 455 Kc IF's—430 uufd.

Obtainable Grid Current: .35 mA, 520 Kcs.
.35 mA, 1600 Kcs.

REMARKS

A tapped type coil for use with the above converters, optimum results are sometimes difficult to obtain and the user is advised to study the articles in Radiotronics 95 and 120 where the problems are discussed at length.

R. W. STEANE & Co. Pty. Ltd., Auburn, Vic.

**SPECIFICATIONS SUBJECT TO CHANGE WITHOUT
NOTICE.**

“Q-PLUS”-09

**STANDARD SIZE B/C OSCILLATOR COIL TO
SUIT X61M, ECH33/35, 6AN7, 6AE8, ETC.**

Freq. Coverage—520—1600 Kcs.

Tuning Capacity—25—445 uufd
(inc. strays).

Physical Size—1 3-8in x 2½in high.

Pin Connections

- 1=Osc. Grid.
- 3=Padder.
- 4=Osc. Plate.
- 6=B+

Mounting—2 x 1-8in holes, 1 3-8in
apart.

Primary “L”—5.6 uh

Secondary “L”—116 uh.
when signal tuned to
1000 Kcs..

Recommended Padder for 455 Kc IF's—430 uufd.

Obtainable Grid Current: .19 mA, 520 Kcs.
.22 mA, 1600 Kcs.

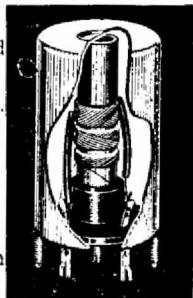

REMARKS

A feedback type Litz wound oscillator coil with constant grid current characteristics. Designed for most modern Triode Hexode converters.

R. W. STEANE & Co. Pty. Ltd., Auburn, Vic.

**SPECIFICATIONS SUBJECT TO CHANGE WITHOUT
NOTICE.**

“Q-PLUS”—011

SIMILAR TO O9 BUT FOR 1600—1900 KC IF's.

Freq. Coverage—520-1600 Kcs.

Tuning Capacity—25—445 uufd.
(inc. strays).

Physical Size—1 3-8in diam. x
2½in high.

Pin Connections

- 1=Osc. Grid.
- 2=Earth.
- 3=Padder. (No connection)
- 4=Osc. Plate.
- 6=B+

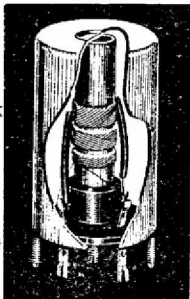

Mounting—2 x 1-8in holes 1 3-8in apart.

Primary—“L”—10 uH.

Secondary “L”—53 uH.
when signal tuned to
1000 Kcs.

PADDER: A padder of 80 uufd. is inbuilt between pins 2 and 3. It is recommended that 3—30 uufd trimmer be placed in parallel with this for accurate aligning for 1900 Kc IF's and a further 50 uufd fixed condenser for 1600 Kc IF's. For alignment use variable padder for low freq. end, osc. core for middle freq. and osc. trimmer for high end.

Grid current .125—.400 mA over band.

R. W. STEANE & Co. Pty. Ltd., Auburn, Vic.

SPECIFICATIONS SUBJECT TO CHANGE WITHOUT
NOTICE.

Q-PLUS SPOT-FREQUENCY ALIGNMENT OSCILLATOR

A POCKET-SIZED
I.F. ALIGNMENT
SOURCE

PHYSICAL SIZE:

1 7-8in x 3in x 3 $\frac{3}{4}$ in.

WEIGHT with batteries
1 $\frac{1}{2}$ lbs.

BATTERY LIFE:

approx. 27 hours, in-
termittent use.

VALVE: Type 3V4.

BATTERIES: 2 only.
Type 703.

FREQUENCY—SIGNAL: 455 kc plus-minus 1 pc
(or to special order).

MODULATION: 400cps plus-minus 20pc.
(depending on battery condition).

N.B.—Only modulation signal varies with battery
life. 455KC signal remains unchanged.

OUTPUT: Banana sockets.

REMARKS

This unit is supplied complete with comprehensive
alignment details, showing that all broadcast re-
ceivers can be aligned correctly with this unit.

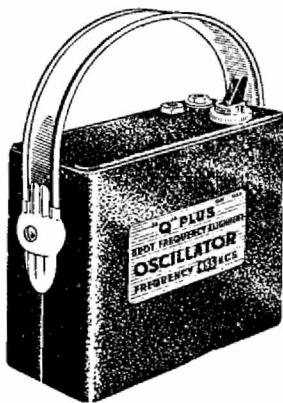

"Q-PLUS" MAGNETIC BIAS OSCILLATOR COIL—TYPE OME

PAGE 1

PHYSICAL SIZE. 1 3/8
inch diam. x 2 1/4 in.

PIN CONNECTIONS.

- 1—Grid
- 2—Low 2 output
- 4—Plate
- 5—Low 2 output
- 6—B +

MOUNTING—2 x 1/8 in
holes (1 3/8 in apart)

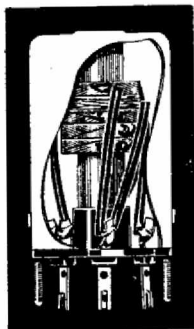

OUTPUT—Depending on valve, etc . . 2 watts.
High, medium or low impedance.

PRIMARY INDUCTANCE . . . 3 MH (in can)

SECONDARY INDUCTANCE 2.4 uH (in can)

FREQUENCY—With .004 ufd condenser—40
Kcs.

REMARKS

A single winding Hartley type oscillator coil for use with 6V6, 6AQ5, or other output pentodes. For lower harmonic distortion these may be triodes. For circuit recommendations see page 2.

R. W. Steane & Co. Pty. Ltd., Auburn, Vic.

SUBJECT TO CHANGE WITHOUT NOTICE

"Q-PLUS" Magnetic Bias Oscillator Coil—Type Ome

PAGE 2

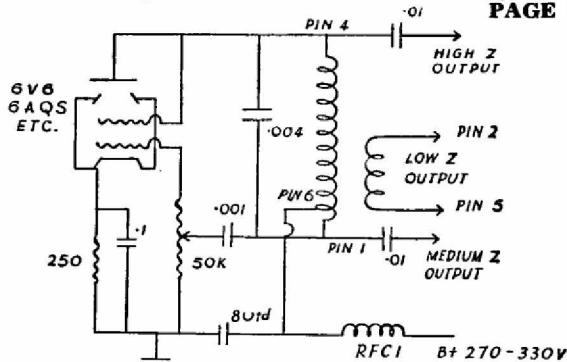

The Q plus O.M.E. magnetic bias coil has been developed to provide in conjunction with other components, etc., the supersonic bias voltage needed for tape recording and erasing. The circuit provided herewith has been found to be eminently suitable, but the following points should be noted.

1. Greater output may be obtained by using the valve as a pentode—but at the cost of harmonic distortion. To do this merely take screen to B plus. Reducing cathode bias resistor, even to zero, will also increase output but care should be taken in case the valve stops oscillating.
2. B plus should never exceed 330V.
3. High impedance output is taken from plate and earth via .01 ufd. condenser as shown. No load volts at this point should be 200-220 volts (use only VTVM). A load of less than 2500w may stop the valve oscillating. It may be necessary to provide a series resistance with some heads to prevent this. Max. energy from low impedance winding occurs at 10 ohms. Similarly too low a load will stop the valve oscillating.

In order to correctly set the potentiometer the oscillator output should be viewed on a C.R.O., and set to the maximum output that retains a good sine wave output.

The iron core should normally be used in its outer-most position. It is useful for varying the frequency slightly so as to avoid interference effects, particularly when using the recorder for recording broadcast items.

"Q-PLUS" I.F. 1 & 2

MIDGET GENERAL PURPOSE I.F. TRANS.

Physical size— $\frac{3}{4}$ " x $\frac{3}{4}$ " x 2".

Mounting—3-16" whit nut onto moulded insert in base—gummed paper template supplied.

Pin Connections—

P=Plate
G=Grid
B+ = B+
F=AVC

I.F. Frequency—455 Kcs.

Transformer Gain—

No. 1 10
No. 2 10

Winding L.—1.05 MH.

When tuned to 455 Kc.

Winding "Q"—120 in can.

Coupling Factor—1.F.1. .8k

I.F.2 9k.

Tuning Capacitor—100 uufd. silver mica.

REMARKS.

A general purpose midget 455 Kc I.F. having abundant gain. No. 1 for 1st position; No. 2 for 2nd. Silver plated terminal pins in non softening base. Carbonyl potted construction 5/41 litz wound. Negative temperature co-efficient condensers Medium selectivity type.

R. W. STEANE & Co. Pty. Ltd., Auburn, Vic.

SPECIFICATIONS SUBJECT TO CHANGE WITHOUT NOTICE.

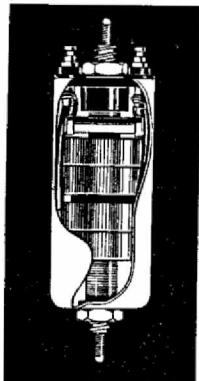

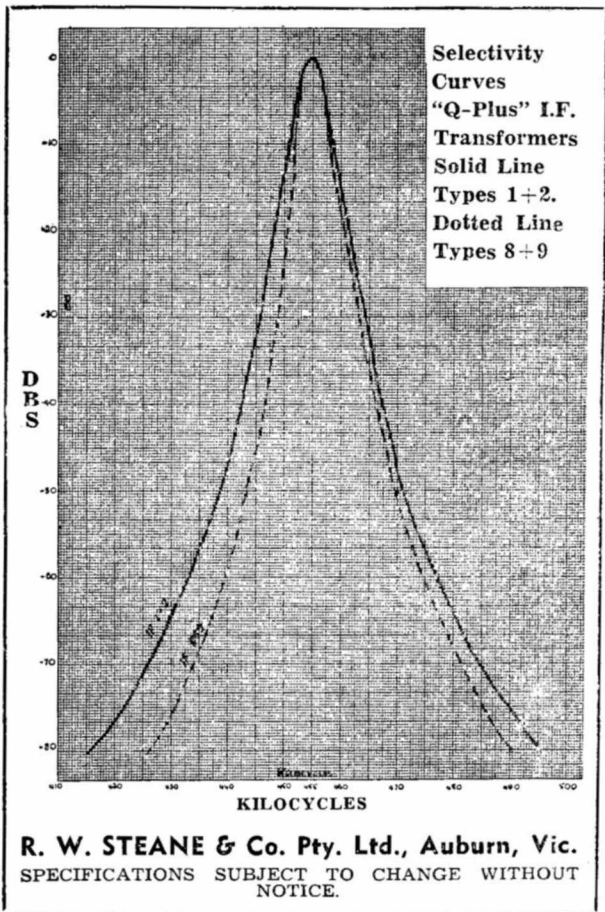

"Q-PLUS" I.F. 3 & 4

STANDARD GENERAL PUROPSE I.F. TRANS.

Physical Size—1 3-8" diam
x 3".

Mounting—2 x 1-8" holes—
1. 3-8" apart.

Pin Connections—
1=Grid
4=Plate
3=AVC, etc.
6=B+

I.F. Frequency—455 Kcs.

Transformer Gain—
No. 3 10
No. 4 10

Winding L.—1.05 MH.
When tuned to 455 Kc.

Winding "Q"—100 in can.

Coupling Factor.—I.F.3. —
.8k. I.F.4. 9k.

Tuning Capacitor—100 uufd.
silver mica.

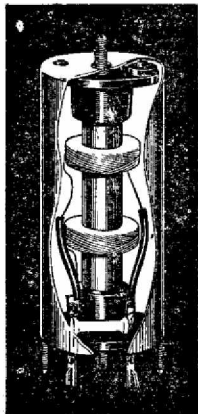

REMARKS.

A general purpose medium gain, I.F. 7/41 litz wound single pi construction No. 3, for 1st position; No. 4 for 2nd. N.B. By using No. 4 I.F. for the 1st position and again a No. 4 for 2nd position a broader bandwidth can be obtained. See graph.

R. W. STEANE & Co. Pty. Ltd., Auburn, Vic.

SPECIFICATIONS SUBJECT TO CHANGE WITHOUT NOTICE.

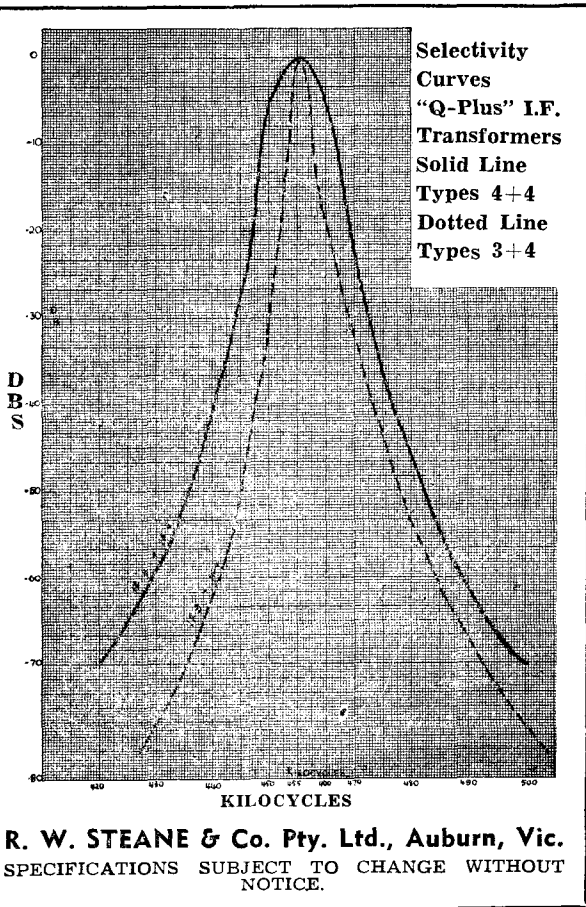

R. W. STEANE & Co. Pty. Ltd., Auburn, Vic.
SPECIFICATIONS SUBJECT TO CHANGE WITHOUT NOTICE.

"Q-PLUS" I.F. 8 & 9

STANDARD SIZE HIGH GAIN I.F. TRANSFORMER

"Spheroclad Construction"

Physical Size—1 $\frac{3}{8}$ " x 3" high.

Mounting—2" x $\frac{1}{8}$ " holes, 1 $\frac{3}{8}$ "
apart.

Pin Connections

- 1 . . . GRID.
- 4 . . . PLATE
- 3 . . . AVC, etc.
- 6 . . . B plus

IF Frequency — 455 Kcs.

Transformer Gain

- IF8 20
- IF9 20

Winding Inductance — 1.25 Uh (when tuned to

Winding—"Q" 130. In can.

Coupling Factor — IF8 .8k. 1F9 .9k.

Tuning Capacity—100 uufd silvered type.



REMARKS

A High gain medium selectivity I.F. designed for long range reception. Litz wound windings are of the potted type. No. 8 for 1st position, No. 9 for 2nd. See graph for selectivity characteristics.

R. W. STEANE & CO. PTY. LTD. AUBURN, VIC:
SPECIFICATIONS SUBJECT TO CHANGE WITHOUT NOTICE

“Q-PLUS” I.F. 10 & 11

STANDARD SIZE MEDIUM GAIN I.F. TRANSFORMER

Physical Size— $1\frac{3}{8}$ " diam x 3"
high.

Mounting — $2\frac{1}{8}$ " holes, $1\frac{3}{8}$ "
apart.

Pin Connections

- 1 . . . GRID
- 4 . . . PLATE
- 3 . . . AVC
- 6 . . . B plus

IF Frequency — 455 Kcs.

Transformer Gain—IF 10 15

Transformer Gain—IF 11 15

Winding Inductance — 1.25 Uh (when tuned to
455 Kc).

Winding Factor—IF 10.9k. IF 11k.

Tuning Capacity—80uufd silvered type.

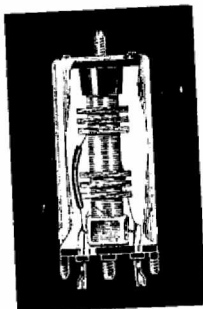

REMARKS

An unscotted Litz wound high gain broad band width type of I.F. specially designed for battery and portable sets. I.F. 10 can be used with type I.F. 4 for good performance in B/C band AC set. 3 pi construction No. 10 for 1st position, No. 11 for second. See graph for selectivity characteristics.

R. W. STEANE & CO. PTY. LTD. AUBURN, VIC:
SPECIFICATIONS SUBJECT TO CHANGE WITHOUT NOTICE

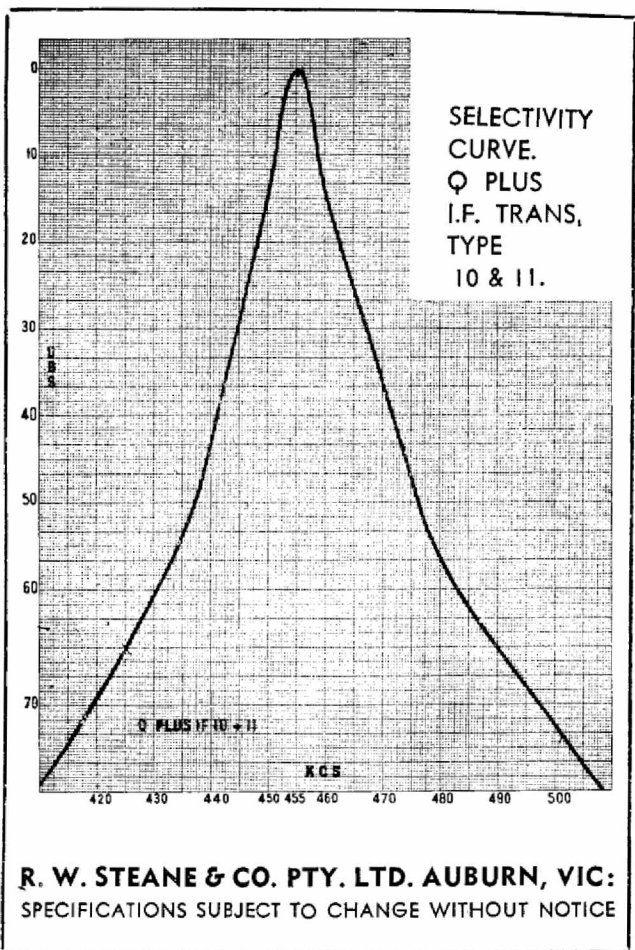

"Q-PLUS" I.F. 12, 12A & 13 I.F. Transformers

MINIATURE SIZE 1600 KC IF's

Physical Size $\frac{3}{4}$ in x $\frac{3}{4}$ in x 2in

Mounting 3-16in Whit nut onto moulded insert in base — Gummed template supplied.

Pin Connections

P = Plate
G = Grid
B+ = B+
F = AVC

Transformer Gain

IF 12	4
IF 12A	4
IF 13	4

Winding "L"

(When tuned to 1600 Kcs)

Winding "Q" 90 in can

Tuning Capacitor

Coupling Factor

IF 127	K
IF 12A8	K
IF 139	K

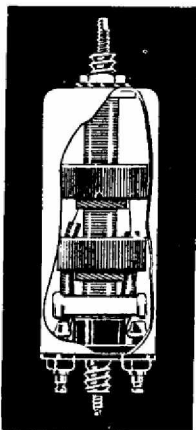

REMARKS

This combination of midget 1600 Kc IF's offers a vast range of band width characteristics —see graph for details.

Usual Q Plus midget specifications of non-softening base, silver plated pins, etc., are employed. Semi-potted construction.

R. W. STEANE & Co. Pty. Ltd., Auburn, Vic.

SPECIFICATIONS SUBJECT TO CHANGE WITHOUT NOTICE

**Selectivity
Curves
'Q-Plus'
I.F.
Transformer
Types 12,
12a & 13**

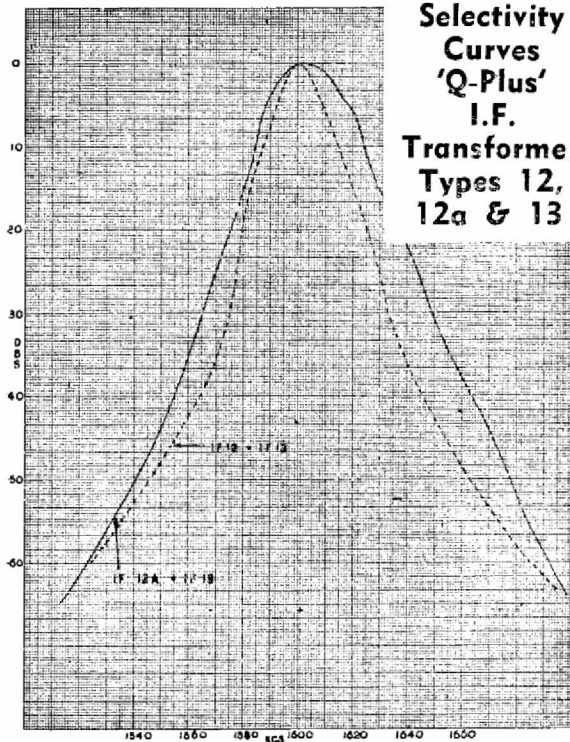

R. W. Steane & Co. Pty. Ltd., Auburn, Vic.

"Q-PLUS" IF. 14 & 15 I.F. Transformers

STANDARD SIZE 1900 KC IF's

Physical Size 1½in diam. x 3in high.

Mounting—2 x ⅜in holes 1½in apart.

Pin Connections

1	Grid
4	Plate
3	AVC
6	Br.

I.F. Frequency 1900 Kcs

Transformer Gain

IF 14	5
IF 15	5

Winding "L"

(When tuned to 1900 Kcs)

Winding "Q" 140 in can

Coupling Factor

IF 144	K
IF 155	K

Tuning Capacity 100 uufd.

REMARKS

A general purpose 1900 Kc pair of IF's when IF14 is used in first position and IF15 with second. However by using an IF15 in first and second position an ideally wide band is obtained — see graphs for actual figures. Usual non-softening base with silver plated pins are employed. Litz wound windings.

R. W. STEANE & Co. Pty. Ltd., Auburn, Vic.

SPECIFICATIONS SUBJECT TO CHANGE WITHOUT NOTICE

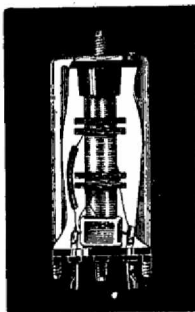

Q-Plus Car-Radio Coil and I.F. Kits

- Type CRK1 Complete midget kit of coils
plus IF's
CRK2 Midget kit without RF coil
CRK3 As for CRK1 but with higher
gain standard size aerial coil

KIT DETAILS

CRK1 comprises:

- 1 IF1 IF transformer 455 KC
- 1 IF2 IF transformer 455 KC
- 1 AC2 Car radio aerial coil
- 1 RC2 Car radio RF coil
- 1 05 6BE6/6SA7 oscillator coil
- 1 IC1 Ignition filter coil

CRK2 As above, but less type RC2

CRK2A As for CRK3 but without RC2

CRK3 As for CRK1 but type AC7
aerial coil replaces type AC2.

See Respective Data Sheets For Individual
Coil & IF Performances.

CIRCUIT RECOMMENDATIONS

The user is referred to April, 1953, and March, 1952, issues of Radio & Hobbies for full instructional details. Commercial Set Performance is easily obtainable when using these Kits.

R. W. Steane & Co. Pty. Ltd., Auburn, Vic.

“Q-Plus” Unwound S.W. Former—Type USWI

An unshielded polystyrene former with high frequency iron core, terminals and mounting.

SIZE. O/all height 2in (without core protruding). Above chassis height 1 $\frac{3}{4}$ in.

FORMER DETAILS—
Polystyrene. Grooved
16 turns per inch.

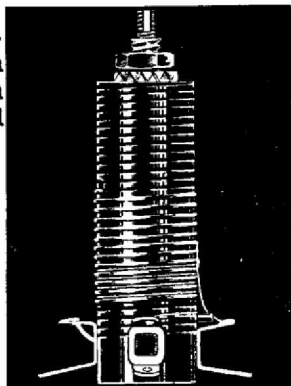

MOUNTING—3/16in hole.

INDUCTANCE AVAILABLE—See graph—
using 23 B & S enamel wire 2.375 uh MAX.

NOTE. If core is left in, a minimum value between the two graphs will be obtained. Heavier wire for the lower values is recommended and will not materially affect available inductance.

23 B & S is optimum size for 16 turns.

R. W. Steane & Co. Pty. Ltd., Auburn, Vic.

SUBJECT TO CHANGE WITHOUT NOTICE

**INDUCTANCE V.
TURNS
DATA GRAPH
Q—PLUS
UNWOUND SHORT
WAVE FORMER
TYPE USW1
WOUND WITH
23 B & S ENAM
WIRE**

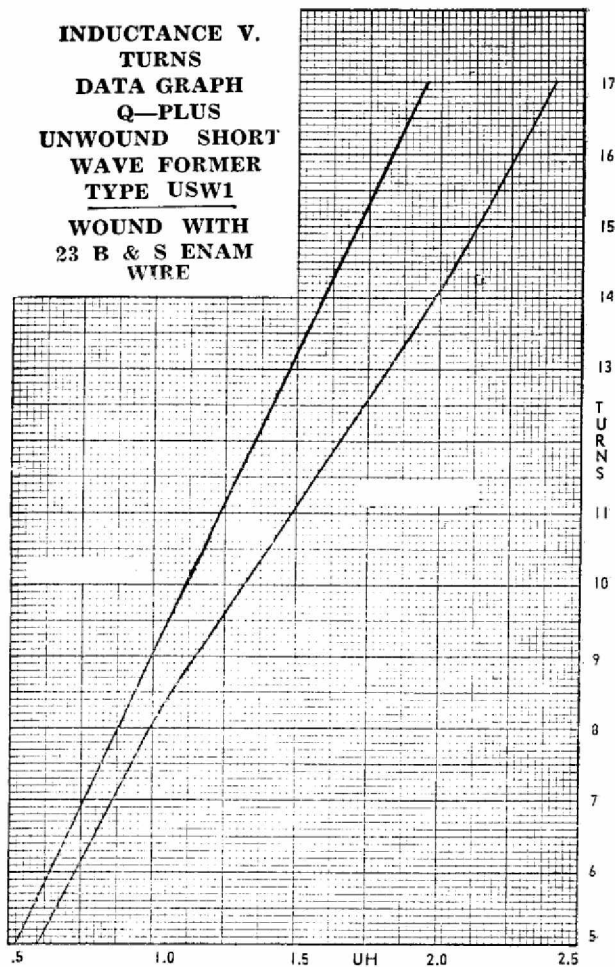

Q-Plus Short Wave Coils

Unshielded High Performance High Frequency Aerial, RF and Oscillator Coils.

Size: O/all Height 2in (without core protruding). Above or below chassis $1\frac{3}{4}$ in.
O/all diameter $\frac{3}{4}$ in.

Former Details: Moulded polystyrene grooved 16. t.p.i.
 $\frac{9}{16}$ in o/s diam.

Mounting: Single $\frac{3}{16}$ in hole

Tuning Capacity required for Nominated Frequency Coverage.
25—445 of inc. strays

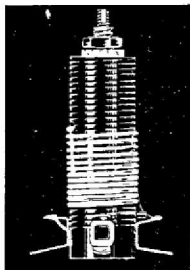

Wiring Code

	Aerial Coil	RF Coil	Osc Coil
Blue Pin	aerial	plate	Osc. plate
Red Pin	earth	B+	B+
Black Pin	AVC	AVC	padder
Green Pin	grid	grid	osc. grid

Frequency Coverages Available 7.2—23 m/cs SW13
5.9—18 m/cs SW16
2.0—6 m/cs SW50

Padder Value Required 4000 pf 13 and 16 m bands
2000 pf 50 m. bands.

REMARKS

General purpose s.w. coil using lo-loss materials. polythene covered wire, high frequency carbonyl cores, etc., etc. Normal oscillator coil is designed to operate with Innoval or triode hexode converters only—e.g. 6AN7 ECH35, 6AE8, X61M, etc.

Aerial coils are dotted with blue dot

RF with green dot and osc. coils with red.

In order to order, the prefix A=Aerial, R=RF, O=Osc. is used. Thus. SWA/13=13m aerial coil, SWO/50=50m osc. coil

“Q-PLUS” Whistle-Filter

CHOKE—W.F.C.I.

Size— $\frac{7}{8}$ " diam. x $1\frac{1}{8}$ " high
(to chassis)

Inductance — 100 MH
Minimum— 95 MH
Maximum— 115 MH
(Adjusted by variable iron
core)

Mounting — Push fit into
 $\frac{5}{16}$ " hole — speed nut
type.

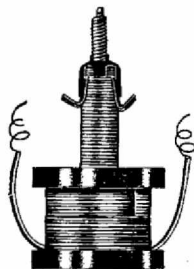

Winding Q at 10,000 Cps.—40.
Current Carrying Capacity DC 15 MA.

General Description and Remarks

Wound on iron dust bobbin which reduces stray fields. Turns may be easily removed or even added to obtain other values.

Designed primarily for Radio & Hobbies Whistle Filter circuits and tone control unit, etc. See October, 1952, Radio & Hobbies.

R. W. STEANE & CO. PTY. LTD., AUBURN, VIC.

"Q-PLUS" D.W.R. Brackets

PAGE 1

Miniature R.F. STAGE Tuning Units B/C—S.W.—GRAMO.

SIZE
Height,
2½"
Width,
2½"
Depth,
5¾"

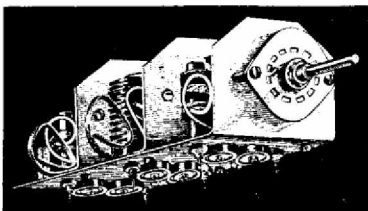

TUNING RANGE.
535—1630 Kcs
+
5.9—18 M/CS
(16—50M—)
or
7.2—23 M/CS
(13—42M—)

Tuning Capacity—25—445 uufd. Inc. strays.

CONVERTER TYPES

DW4—6J8, 6A8, 1A7, etc., B/C + 5.9—18 M/CS only.

DW5—6AN7, 6AE8, ECH33/35, X61M, etc.

DW6—1R5, B/C + 5.9—18 M/CS only.

DW7—6BE6, 6SA7.

MAIN FEATURES:

Carbonyl high frequency cores on all bands.

All trimmers and adjustable cores accessible from one side.

Built in mica padder condensers—4000 pf + 430 pf.

Oak type wave change switches.

Polystyrene short wave coils wound with polythene.

Covered wire for absolute minimum losses.

Litz wound broadcast coils.

3 sets switch contacts for dial light and Gramo switching B+ opening, etc.

DW6 type requires external bias source.

See page two for further information.

"Q-PLUS" D.W. Brackets

PAGE 1

MINIATURE SINGLE STAGE B/C—S/W TUNING UNITS

SIZE
Height,
1 $\frac{1}{8}$ "
Width,
3 $\frac{1}{8}$ "
Depth,
2 $\frac{1}{2}$ "

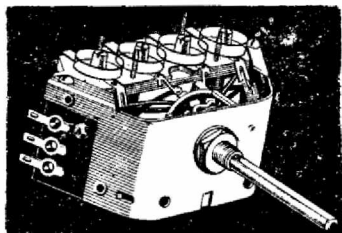

**TUNING
RANGE**
535—1630
K/CS
+
5.9—18
M/CS

Tuning Capacity—25—445 uufd. inc. strays.

CONVERTER TYPES

Four types are available and to obtain best results it is essential that the correct one be used.

DW4—6J8, 1A7, 6A8, etc.

DW6—1R5

DW5—ECH33/35, X61M, 6AE8, 6AN7

DW7—6BE6, 6SA7

MAIN FEATURES:

*Carbonyl iron cores on all coils Sw and B/C.
All trimmers and adjustable cores accessible from one side.*

4000 pf and 430 pf padder—condensers inbuilt—mica type.

Oak type wave change switch.

Narrowed neck construction to allow dial spindle and volume control to be closely fitted.

Polystyrene Short Wave formers, polythene covered windings for absolute minimum losses.

Litz wound broadcast coils.

See page two for further information

"Q-PLUS" D.W. & D.W.R. Brackets

PAGE 2

GRID CURRENT DETAILS.

If converter section is operating correctly, oscillator grid current should be approximately as follows:—

SW HF end	LF end	BC HF end	BC LF end
DW4 .3 ma	.45 ma	.37 ma	.25 ma
DW5 .22 ma	.20 ma	.26 ma	.20 ma
DW6 .4 ma	.1 ma	.32 ma	.20 ma
DW7 .2 ma	.2 ma	.43 ma	.36 ma

ALIGNMENT

The alignment of these units is of extreme importance as otherwise the full performance of the unit cannot possibly be obtained.

High gain I.F. transformers are desirable and it is assumed that these have been aligned. A Q Plus spot frequency alignment oscillator is a very useful article for this work and is available for only 75/- plus sales tax. Full instructions for I.F. alignment are included with that unit.

First see that dial calibration is designed to match the gang type and frequency range, particularly on S.W. band, then set dial pointer to the end of the calibrations when tuning condenser is in maximum and minimum positions respectively. BROADCAST Set Oscillator at 600 Kcs or thereabouts and move the dial until signal is heard — of course make sure that the switch contacts are in the B/C position. Each bracket is prealigned and no trouble should be encountered in this. Adjust B/C oscillator core until signal occurs when dial is at 600 Kcs. Next adjust B/C Aerial core for maximum output. Swing dial to 1600 Kcs and set generator to identical frequency. Rock dial until signal is heard, next adjust B/C oscillator trimmer and move dial until signal is maximum at 1600 Kcs Then adjust B/C Aerial trimmer for maximum output. Repeat low frequency alignment procedure and tidy up High Frequency end again. N.B. AVC should be shorted if set has same.

SHORT WAVE. Switch to S/W position on bracket. Set generator to 6.00 M/cs if 16-50 M or 7.5 M/CS if 13-42M and dial to similar setting. Adjust S.W. oscillator core for maximum signal. Swing dial and generator to 17 M/CS or 22 M/CS and use S/W oscillator trimmer to set dial position and S/W aerial trimmer to maximum output. Usually at the High Frequency end of the S/W band two spots will be found at which the generator will be heard — use the lower frequency one for alignment purposes.

In the case of the R.F. Brackets the procedure is identical with the addition of having the R.F. coil to align; this is done after the oscillator section has been aligned. It is necessary to rock the dial slowly around the alignment point as the trimmer is adjusted, as otherwise pulling effects will interfere with true alignment conditions. This is most prevalent at the H.F. end.

SEE PAGE 3 FOR FURTHER DETAILS.

Q-Plus D.W. Brackets

WIRING CODE, ALIGNMENT CODE AND FURTHER OPERATING DATA

WIRING CODE

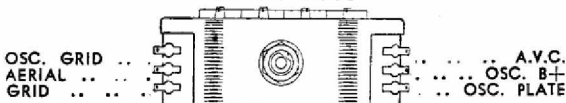

SHAFT TOWARDS VIEWER

N.B.: When unit is type DW7, i.e. for tapped oscillator coil, the Osc. B+ pin is not used whilst the oscillator plate becomes the oscillator cathode connection.

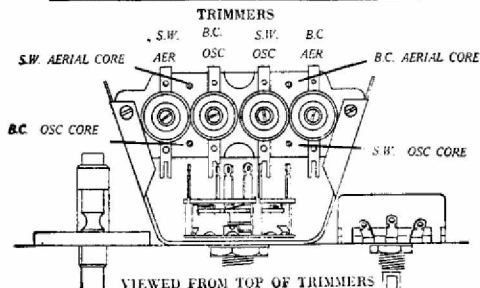

PADDER FEEDBACK. For maximum performance with Q Plus D. W. and D.W.R. Brackets Padder feedback is recommended on S.W. bands. This tends to improve stability over the band and lift sensitivity at the low frequency end. It is simple to incorporate and is accomplished merely by altering the position of the oscillator decoupling condenser from earth to the padder/coil junction—see alignment code below.

GRID STOPPERS AND OSC. GRID COUPLING CONDENSERS Care should be taken to use the minimum value of oscillator grid coupling condenser — values recommended are from 50pf-100 pf. It is sometimes necessary to compromise on the value for correct operation in both B/C and S/W bands. In the event that the size chosen for suitable low frequency or B/C band causes instability of the H.F. end, a small 1/2 watt resistor of about 30-40 ohms should be inserted in the oscillator grid circuit, between the valve grid and coupling condenser.

Q-Plus D.W.R. Brackets

PAGE 4

WIRING AND ALIGNMENT CODE

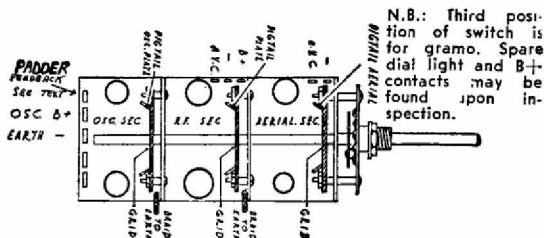

N.B.: Third position of switch is for gramo. Spare dial light and B+ contacts may be found upon inspection.

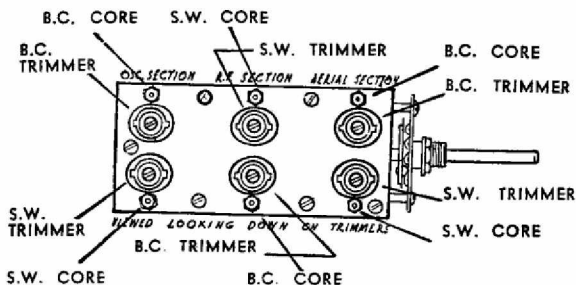

See Type DW for padder feedback and osc. grid coupling condenser recommendations.

NOTE

Every set and every Q-Plus DW or DWR bracket is actually set tested and sensitivity measurements taken.
Subject to change without notice

Useful Electrical Laws—Formulae

OHM'S LAW.

$$I = \frac{E}{R}$$

Can be remembered from the word THEIR--thus:

$$E = I \times R \qquad \text{Where: } I = \frac{E}{R} \qquad R = \frac{E}{I}$$

Where: I = Current in AMPS.
E = Voltage in VOLTS.
R = Resistance in OHMS.

RESISTORS IN PARALLEL.

$$R = \frac{1}{\frac{1}{R_1} + \frac{1}{R_2} + \frac{1}{R_3}} \text{ Etc.}$$

CAPACITORS IN SERIES.

$$C = \frac{1}{\frac{1}{C_1} + \frac{1}{C_2} + \frac{1}{C_3}} \text{ Etc.}$$

REACTANCE OF COIL.

$X_L = 2\pi fL$
Where: f = Frequency in Cycles per Second.
 $\pi = 3.14$
L = Inductance in Henrys.

RESONANT FREQUENCY OF TUNED CIRCUIT.

$$f = \frac{1}{2\pi \sqrt{LC}}$$

Where: f = Frequency in C.P.S.
 $\pi = 3.14$
L = Inductance in Henrys.
C = Capacitance in Farads.

In making Radio freq. calculations it is more convenient to reduce L + C to smaller units so that f may be expressed in M/CS. The equations then

become—

$$f^2 = \frac{25,330}{LC}$$

$$L = \frac{25,330}{f^2 C}$$

$$C = \frac{25,330}{f^2 L}$$

Where: f = Frequency in M/CS.

L = Inductance in Microhenries.

C = Capacity in Micro Micro Farads.

TIME CONSTANT OF RESISTANCE + CAPACITANCE IN SERIES.

$$T = R \times C$$

Where: T is the time constant in seconds R = OHMS. C = Farads.

STAGE GAIN — VALVE AMPLIFIER.

$$M = \frac{UR_A}{\gamma_a + R_A}$$

Where: U = Amplification factor of valve.

γ_a = Impedance of valve.

R_A = Anode load resistor in OHMS.

OUTPUT TRANSFORMER RATIO.

$$N = \sqrt{\frac{R_a}{Z}}$$

Where: N = Turns ratio.

R_a = Load resistance of valve.

Z = Impedance of loudspeaker.

BABY 2 VALVE A.C. BROADCAST

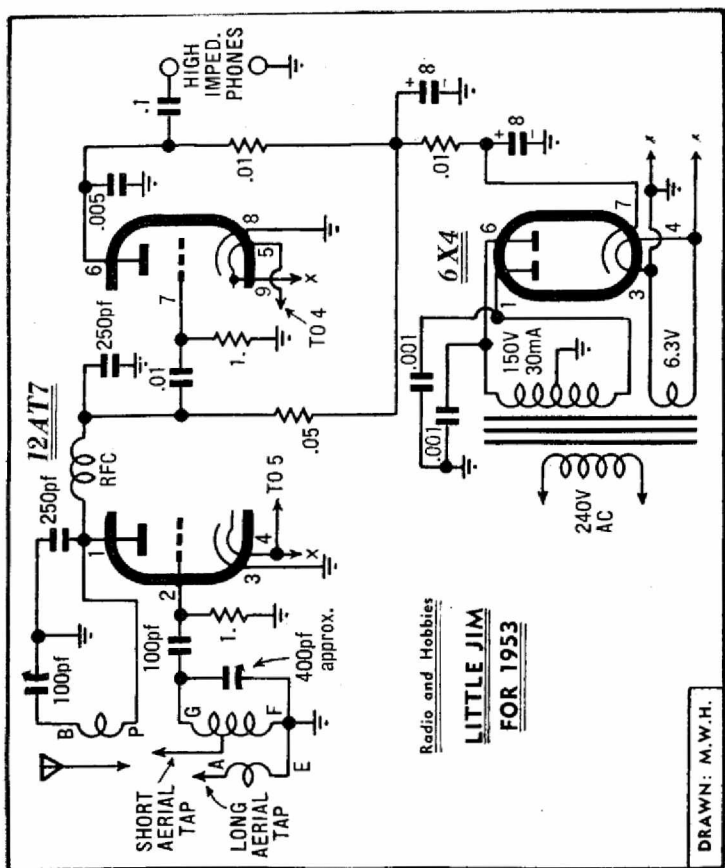

By Kind Permission of Radio & Hobbies.

As its name implies the simplest AC set which could be built — fully described in May 1953 Radio & Hobbies.
Use RC6 Midget or RC8 Standard Size Reinartz coil.

3/4 AC BROADCAST RECEIVER

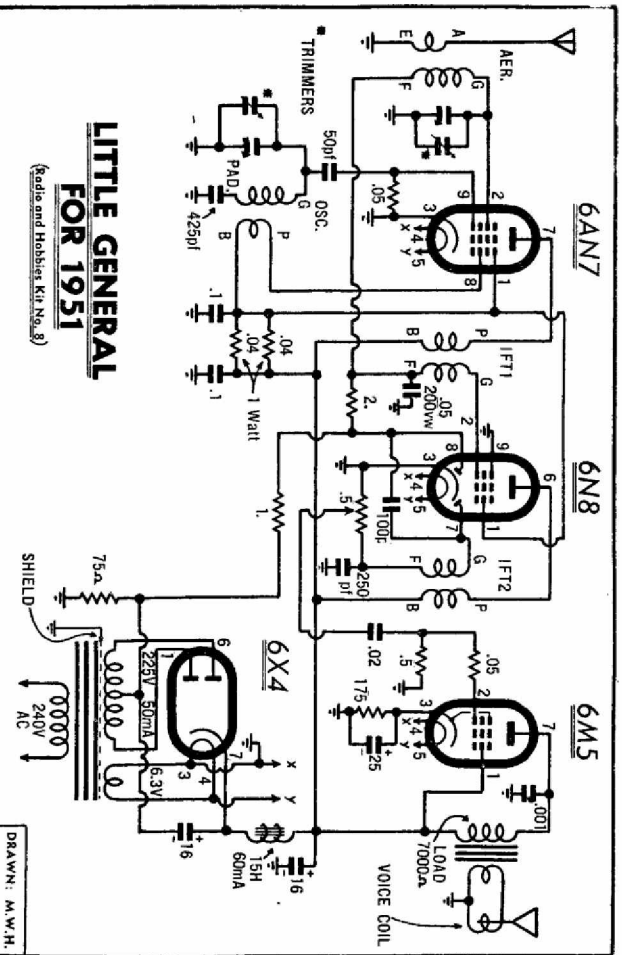

LITTLE GENERAL FOR 1951

(Radio and Hobbies Kit No. 8)

DRAWN: M.W.H.

The most popular small set yet described. Full instructions. Reprints are available from Radio and Hobbies, for its manufacture appeared in July 1951 Radio and Hobbies; or AC1, 04, IF1, IF2 respectively miniature size. Use AC5 Aerial Coil 09 Oscillator coil IF3 IF Transformers. By Kind permission of Radio & Hobbies.

5 VALVE BATTERY - DUAL WAVE

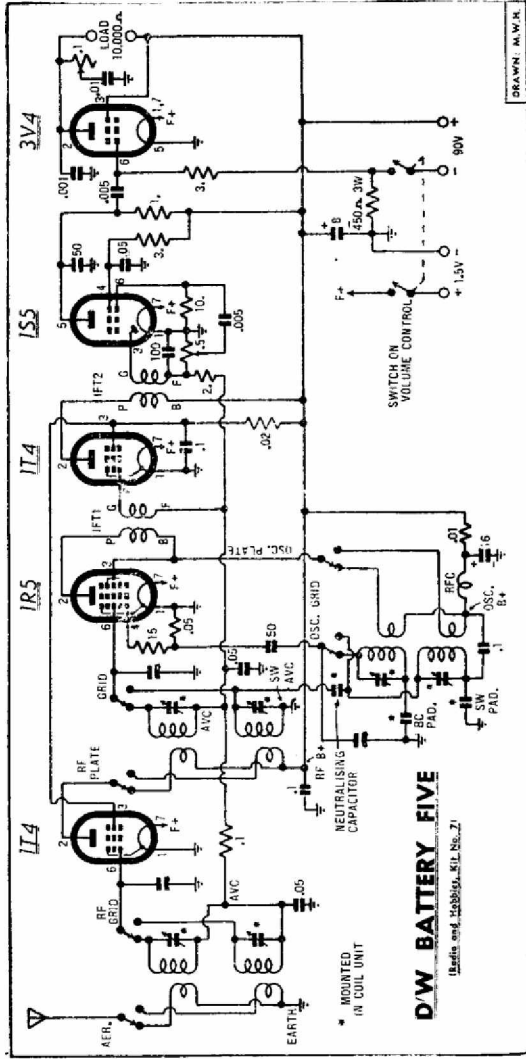

We would not recommend anyone to build this set without full reference to the June 1951 issue of Radio & Hobbies. The type DWR6 Bracket is used together with IF8 and IF9 Standard size IF Transformers or IF1 and IF2 MIDGET.

By Kind Permission of Radio & Hobbies.

5 VALVE BATTERY - DUAL WAVE

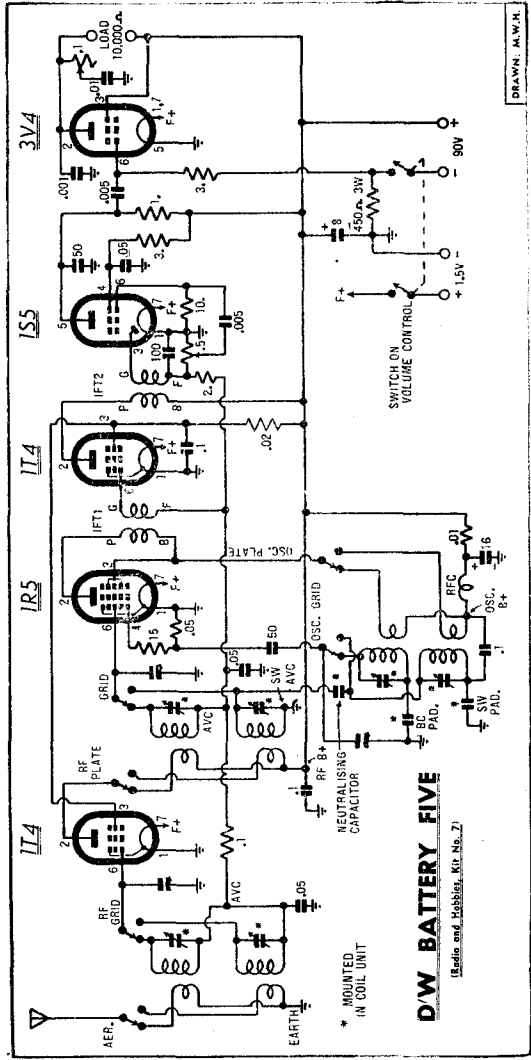

We would not recommend anyone to build this set without full reference to the June 1951 issue of Radio & Hobbies. The type DWR6 Bracket is used together with IF8 and IF9 Standard size IF Transformers or IF1 and IF2 MIDGET. By Kind Permission of Radio & Hobbies.

INDUCTANCE, CAPACITANCE AND FREQUENCY CHART — 1.5—40 MC.

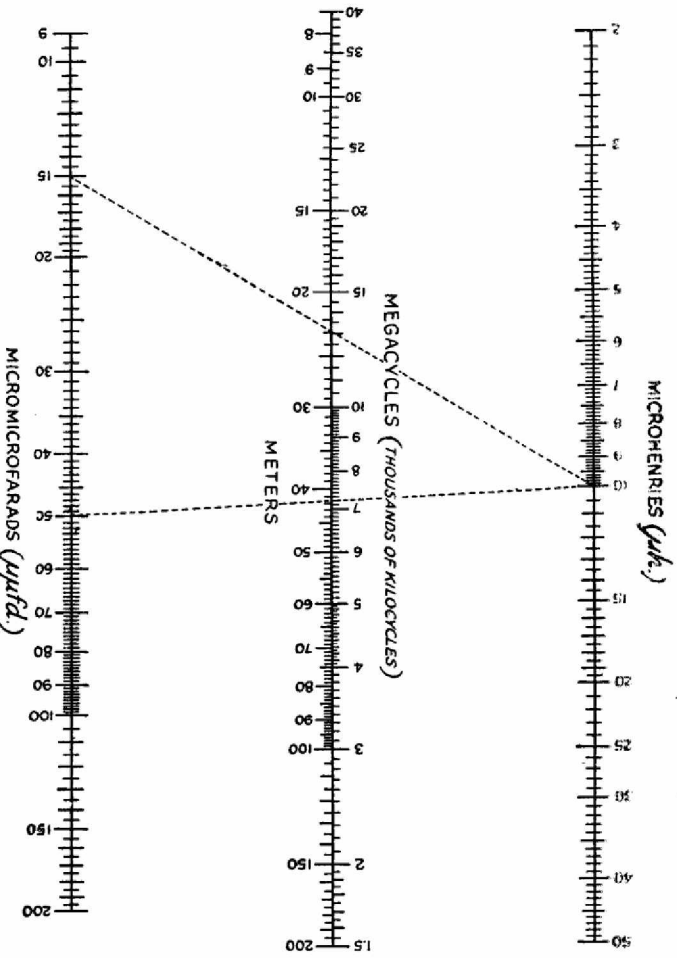

This chart may be used to find the values of Inductance and Capacitance required to resonate coils in the Band 1.5—40 M/Cs. It will also show what frequency coverage a given capacity will give — in the example shown and capacitor (with strays) of 15 pf — 30 pf will cover 13 m/cs — 7.2 m/cs with an inductance of 10μh.

INTERNATIONAL PREFERRED VALUES (10% TOLERANCE)

The following table lists the standard resistor value in ohms available in the 10% tolerance range. Each resistor covers values within $\pm 10\%$ of its nominal value.

10	100	1,000	10,000	100,000	1.0 Meg
12	120	1,200	12,000	120,000	1.2 "
15	150	1,500	15,000	150,000	1.5 "
18	180	1,800	18,000	180,000	1.8 "
22	220	2,200	22,000	220,000	2.2 "
27	270	2,700	27,000	270,000	2.7 "
33	330	3,300	33,000	330,000	3.3 "
39	390	3,900	39,000	390,000	3.9 "
47	470	4,700	47,000	470,000	4.7 "
56	560	5,600	56,000	560,000	5.6 "
68	680	6,800	68,000	680,000	6.8 "
82	820	8,200	82,000	820,000	8.2 "

RESISTOR COLOUR CODE

In the standardised system of colour coding the colours are read from the end of the resistor adjacent to the colour bands. The third colour always indicates the number of "noughts" following the first two numerals. The colour code is as follows:—

Black	...	0	Brown	...	1	Red	...	2	Orange	...	3	Yellow	...	4
Green	...	5	Blue	...	6	Violet	...	7	Grey	...	8	White	...	9

If a fourth band is added on resistors, it indicates the tolerance according to the following code:—

Gold, plus or minus 5% tolerance.	Silver, plus or minus 10% tolerance.
-----------------------------------	--------------------------------------

If the fourth metallic indication is absent, the tolerance is assumed to be 20%.

Examples: 1. Red, Violet, Orange, Silver 27,000 ohms plus or minus 10%
 2. Yellow, Violet, Black, Gold 47 ohms plus or minus 5%
 3. Blue, Grey, Brown 680 ohms plus or minus 20%

'Q PLUS' Coils are available from :-

George Brown & Co. Ltd.	267 Clarence St., Sydney.
Bloch & Gerber Ltd.	46 York St., Sydney.
Davis Radio	841 George St., Sydney.
Dominion Factors P/L.	124 Castlereagh St., Sydney.
Electronic Parts P/L.	Cnr. City Rd. & Broadway, Sydney.
Fox & MacGillycuddy Ltd.	46 York St., Sydney.
Homecrafts P/Ltd.	100 Clarence St., Sydney.
Lawrence & Hanson P/L.	33 York St., Sydney.
John Martin P/L.	93 York St., Sydney.
Martin de Launay P/L.	Cnr. Clarence & Druitt Sts., Sydney.
Prices Radio	5 & 6 Angel Place, Sydney.
Radio Despatch Service Ltd.	841 George St., Sydney.
Radio House P/L.	296 Pitt St., Sydney.
United Radio Distributors P/L.	173 Phillip St., Sydney.
Cooke Bros. P/L.	481 Kent St., Sydney.
Boyts Radio P/L.	3 Barlow St., Sydney.
Breville W/Salers Ltd.	161 Parramatta Rd., Annandale.
Homecrafts P/L.	290 Lonsdale St., Melbourne.
Radio Parts P/L.	157 Elizabeth St., Melbourne.
Warburton Franki Ltd.	380 Bourke St., Melbourne.
Motor Spares Ltd.	547 Elizabeth St., Melbourne.
Crouch & Connah P/L.	40 Makerston St., Brisbane.
Denradio Industries	Maryborough, Q.
Trackson Bros. P/L.	157 Elizabeth St., Brisbane.
Edgar V. Hudson Ltd.	316 Adelaide St., Brisbane.
Irvines Ltd.	Elizabeth St., Brisbane.
Chandlers P/L.	Cnr. Albert & Charlotte Sts.,
A. E. Harrold	123 Charlotte St., Brisbane.
Gerard & Goodman Ltd.	192-6 Rundle St., Adelaide.
A. G. Healing Ltd.	151 Pirie St., Adelaide.
Radio & Elect. W/Salers Ltd.	26 James Place, Adelaide.
Newton McLaren Ltd.	17-23 Leigh St., Adelaide.
Atkins (W.A.) Ltd.	894 Hay St., Perth.
Carlyle & Co. Ltd.	915-17 Hay St., Perth.
Homecrafts P/L.	68 Brisbane St., Launceston.
Lawrence & Hanson P/L.	20 Patterson St., Launceston.
W. & G. Genders P/L.	68 Liverpool St., Hobart.