

AUSTRALIAN RADIO & TELEVISION COLLEGE PTY. LTD.

# PRACTICAL RADIO COURSE

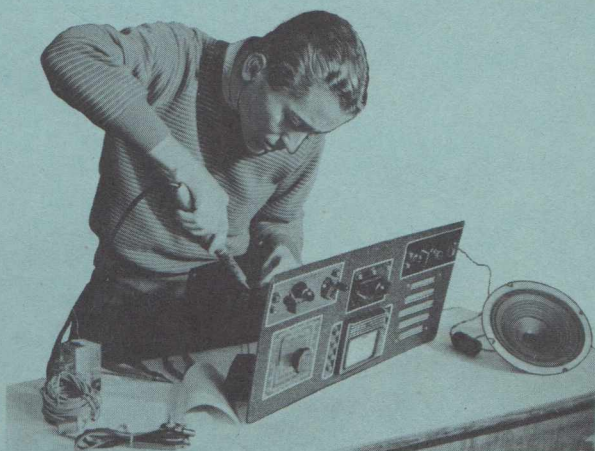

of

**HOME PRACTICAL INSTRUCTION**

**Lesson No. 4**

**T**HIS Radio Course of practical home instruction is the result of many years' experience, and months of final experimental work by some of Australia's most competent Radio engineers. It is designed so that you acquire a thorough and most comprehensive practical Radio training by building up the kits which are supplied with these lessons. When the course is finished, and all the kits have been built up into the final unit, you will possess a complete professional outfit of Radio testing apparatus, which in itself is not only worth far more than the money you pay for it, but which will also enable you to earn many times its actual value from the Radio work you can perform with it.



## CONSTRUCTING A MULTIMETER (Cont'd.)

This lesson will show you how to:—

- Complete the Multimeter Assembly .. .. Page 1
- Wire the Multimeter .. .. Page 4
- Test the Multimeter .. .. Page 7

## VALVE EXPERIMENTS

- Triodes, Pentodes and Diodes .. .. Pages 10 - 15
- Filament Testing and Voltage Effect .. Pages 13, 17
- Control Grid Effect .. .. Page 22
- Curves, Characteristics, and Application .. Pages 25 - 28
- Rectifiers—Valve and Copper Oxide.. .. Pages 29, 33

# HOME PRACTICAL INSTRUCTION

## LESSON No. 4

The first portion of this Lesson will be devoted to instructions for completing your multimeter unit, while the second portion of the Lesson will describe the operation of some types of radio tubes and will describe a number of experiments you can undertake to determine some of the characteristics of the valve supplied with this kit of parts.

The fourth kit of parts comprises the following material:—

- 1 75,000 ohm resistor
- 3 .25 megohm resistors accurate within  $\pm 1\%$ .

1 Multiple shunt for milliamp ranges.

1 Single bank 4 position rotary switch

6 Tip jack sockets and nuts

7 Moulded insulating bushings  
1 5/8" x 3/8" x 1/64" bakelite washer

1 Spring contact for low ohms range.

6 Soldering lugs with 1/4" dia. holes

2 Small pointer knobs

1 2000 ohm potentiometer

2 1.5 volt dry cells

1 Bantam valve socket

1 Type 3S4 valve

1 Metal switch collar or washer

2 Sheets of graph paper

### ASSEMBLY.

Your first assembly operation should be to mount four of the tip jack sockets provided, by means of red insulating bushings, into the vacant holes on left-hand side of the meter. The method of insulating these tip jack sockets was described fully in Lesson 3 and illustrated in Figure 2 of that Lesson.

In a similar fashion a tip jack socket and red bushing should be mounted in position in the vacant hole near the marking "+ 1000" at the right of the meter.

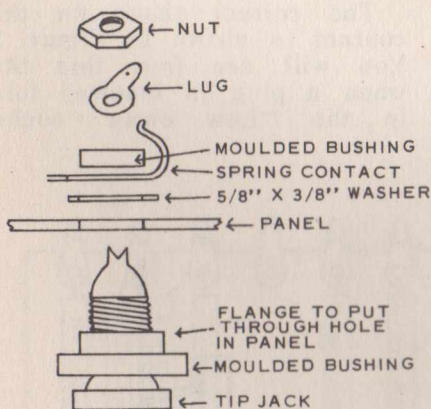

Fig. 1.

The remaining tip jack socket and black insulating bushings should be mounted in the hole on the right-hand side of the main label. Before placing the solder lug and nut on the rear of this socket there are some additional parts to be mounted on it as illustrated in Figure 1. The tip jack socket is passed through the moulded bushing, the panel, the 5/8" diameter bakelite washer with the 3/8" diameter hole, the curved springy low ohms contact, then through the second moulded bushing with its ridge facing the panel, the solder lug and finally the nut. Be especially careful to see that the ridge on the bushing fits snugly into the hole in the spring contact and also in the bakelite washer so that the spring contact is centred around the tip jack socket without any possibility of actually touching it.

After having assembled the tip jack sockets in position it is necessary to test them for short circuits by means of your ohmmeter.

Plug the test lead into the sockets marked "high ohms", connect one test lead to the clean spot you prepared on the back of the panel and touch the other test lead in turn to each of the sockets you have just installed. If you obtain any reading on the meter scale this shows that the bushing is not centring the tip jacket socket properly in its hole so that it

is touching the panel. You should then loosen off the socket concerned and re-centre it so that no reading is obtained. You should then apply the same test to the 1000 Volt socket.

The "low ohms" socket you have just installed should also be tested in a similar fashion and then in addition, you should touch one of the test leads to the socket and the other test lead to the springy, curved contact. Before making this test, see that the contact is bent in such a fashion that it does not quite touch the nut on the rear of the socket but yet will press against the side of one of the plugs on the end of your test lead when it is inserted in this socket.

The correct shape for this contact is shown in Figure 2. You will see from this that when a plug is inserted fully in the "Low ohms" socket

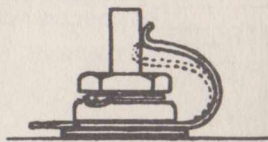

Fig. 2.

it then protrudes through far enough to press against the springy contact. When the plug is pulled out of the socket the springy contact will move slightly but must not move far enough to touch the nut on the rear of the socket.

The position of the springy contact when the plug is withdrawn is shown by dotted lines in Figure 2.

The rotary switch may now be mounted in position. After removing the nut from the threaded bushing in front of the switch, place the thick metal washer or "collar" over the threaded portion of the switch and then pass this threaded portion of the switch from the rear, through the panel. The toothed lock washer is then placed on the threaded part of the switch and finally the nut is screwed on. Before finally tight-

ening the nut on the switch, rotate the switch so that the bolts and nuts which hold it together are in a horizontal position. If you examine the switch carefully you will see that most of the connecting lugs on it are placed on the rear of the switch but that three are placed on the front side of the switch. Of these three, one is placed directly underneath one of the lugs on the rear of the switch. This pair of connecting lugs should be pointing in the direction of the slotted loudspeaker opening. When the switch has been rotated to its correct position, the nut on the front may be tightened securely, and the pointer knob fitted on to its shaft by means of a small screwdriver. The screw in the knob should be screwed down on to the flattened portion of the switch shaft so that it may grip securely and so that it will point to the four

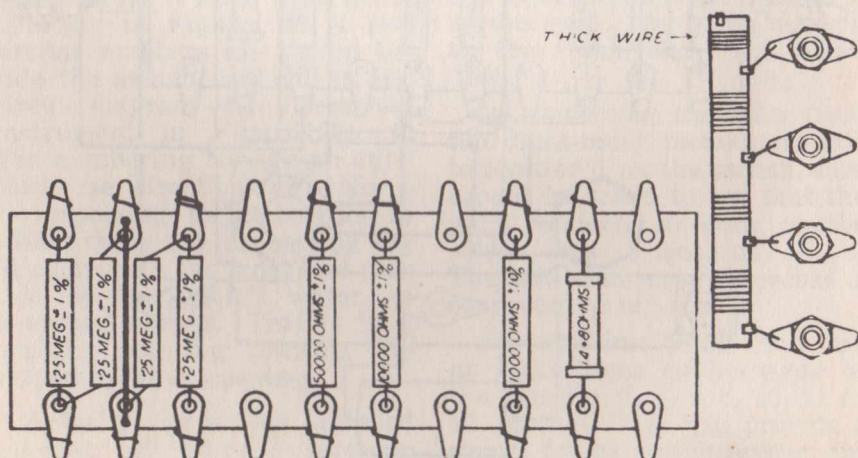

Fig. 3.

markings on the label in turn, as the switch is rotated through its four positions.

The three .25 megohm resistors, the multiple wire-wound shunt resistor and the 14.8 ohm resistor supplied with Kit No. 2 may now be soldered into position as shown in Figure 3. The milliamp shunts now being supplied differ slightly from those shown in Figs. 3 and 4. They are now made in two separate sections joined at the centre. The twisted pigtail wires where the sections join should both be

soldered to the 50 ma. socket. Be careful to see that the shunt is placed so that the thick wire on it or .8 ohm section is near the top of the panel and the thin wire or 180 ohm section is near the socket marked "+ 1".

## WIRING.

The wiring of the instrument should be carried out as shown in Figure No. 4. Wires which are already in the instrument and which do not have to be changed in any way are shown

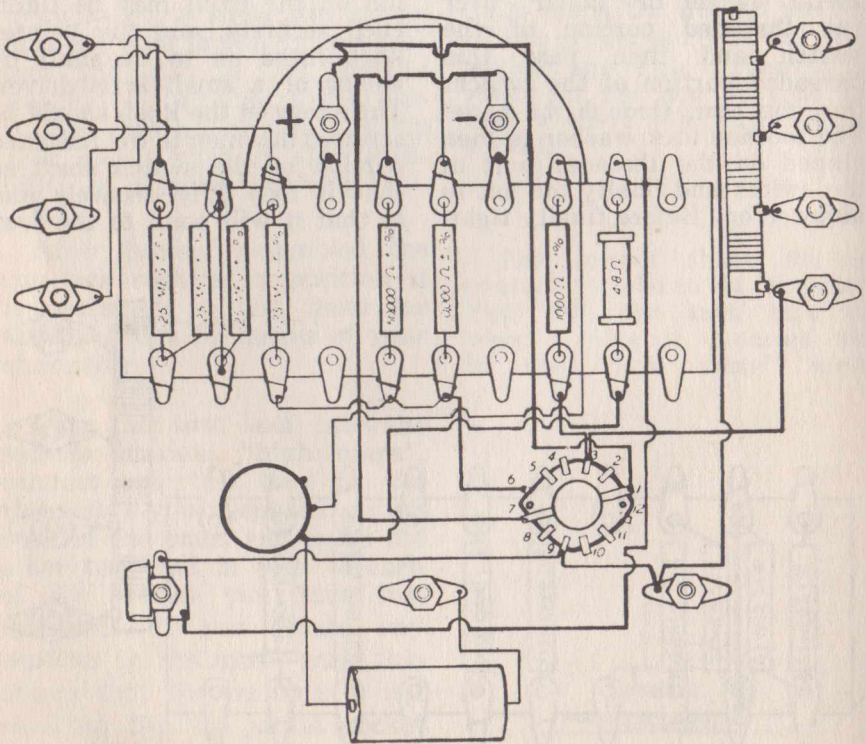

Fig. 4.

in this diagram as thin lines, whereas new wires or wires which must be altered at this stage are shown as thick lines.

Commence by connecting the "1000 volts" socket to the upper left-hand connecting lug on the resistor panel, then by joining the second lug from the left-hand end at the top of the resistor panel to the second lug from the left-hand end at the bottom.

You should also remove completely the 200 ohm resistor soldered across the two meter connections as this resistor will no longer be required, its place being taken by the multiple milliamp shunt which has a total resistance of 200 ohms. You should also disconnect and remove completely the wire connecting to each meter terminal.

To assist in wiring the rotary switch, the various connecting lugs around it have been given numbers in Figure No. 4 and similar numbers are placed beside the switch contacts in the circuit diagram of the complete instrument in Figure No. 5. The numbering runs in an anti-clockwise direction with No. 1 corresponding to the position in which there is a connecting lug fitted on both the front and rear side of the switch wafer as described earlier. This is in a position pointing towards the slotted speaker opening.

Actually the switch supplied consists of three separate switches grouped together for compactness and convenience so

that all three switches are operated by the one knob. Contacts 1, 2, 3, 4 and 5 form one complete switch. Contact No. 1 is a connection to the moving or "rotor" section which continues any circuits connected to lug No. 1, through to lug No. 2, 3, 4 or 5, depending upon the position to which the switch is turned.

You should slowly rotate the switch and watch the motion of the rotor section so that you may understand just how this section of the switch functions.

Lug No. 7 forms a connection to the rotor section of a second switch. The rotor of this switch may be moved in turn to positions 8, 9, 10 or 11.

The third switch consists of the three lugs mounted on the front side of the wafer. Lug No. 6 is the connection to the rotor and the protruding tooth on this rotor connects to lug No. 12 or to the front lug No. 1, in the switch positions marked on the front label "A.C." and "D.C."

In connecting the wire from the right-hand meter terminal to position 1 on the switch, care should be taken to see that the wire connects to both of the solder lugs in position No. 1. The left-hand meter terminal is connected to lug No. 7.

For the time being there are no connections to be made to the lugs No. 2, 4, 5, 8, 10, 11 or 12, as these lugs will provide a means for using the instrument in conjunction with other equipment for later experiments.

Although you will actually be carrying out the wiring of the instrument from Figure No. 4, it is desirable that you also follow each wire and part in the circuit diagram in Figure No. 5. In this way your proficiency in reading circuit diagrams will be improved.

There are two separate connections to be made to the "low ohms" socket, one to the solder lug and one to the spring contact.

A length of wire should start from the uppermost end of the milliamp shunt and run straight down to the solder lug on the negative tip jack socket immediately below. The wire should then connect from this socket to lug No. 9 on the switch and then across to the solder lug on the "low ohms" socket.

Another piece of wire should be carefully soldered on to the spring contact and should connect

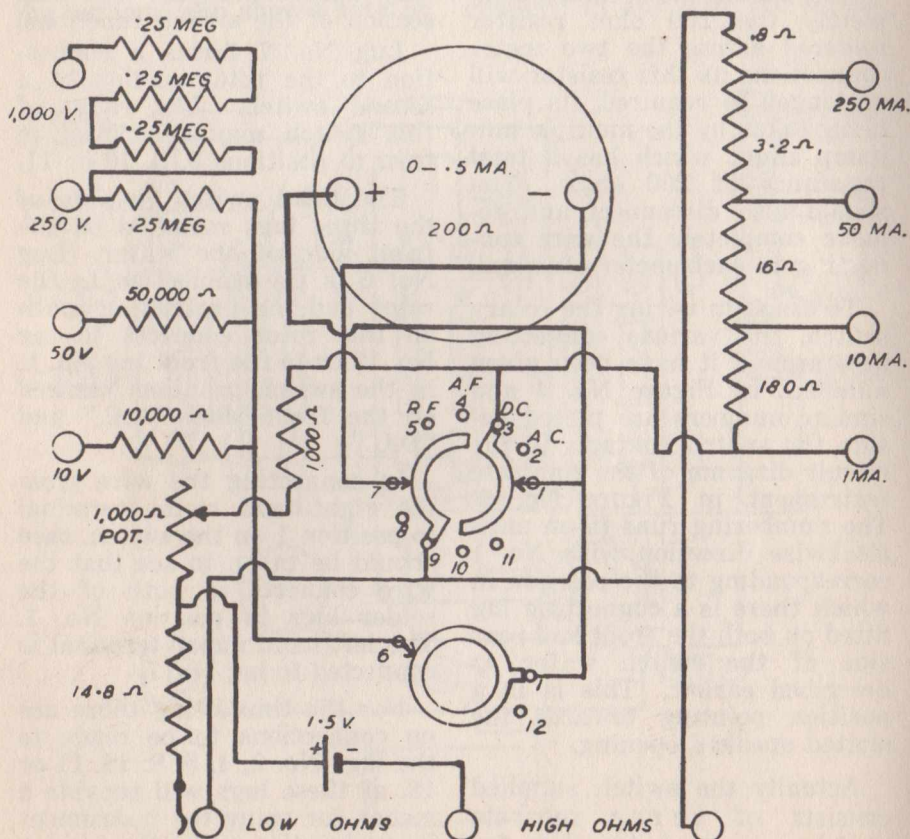

Fig. 5.



nect on to one end of the 14.8 ohms resistor. The other end of the 14.8 ohms resistor is connected to the lower lug on the potentiometer together with one of the flexible leads from the battery.

### OHMMETER BATTERY.

The 1.5 volt torch cell supplied with this kit will be used for the ohmmeter in future instead of using one section of the  $4\frac{1}{2}$  volt battery. The  $4\frac{1}{2}$  volt battery will be needed for other experiments. To connect the  $1\frac{1}{2}$  volt battery to the ohmmeter it is necessary to solder the flexible lead from the lower lug on the potentiometer to the small brass cap on one end of the battery. The other flexible lead, from the ohms socket, in the centre of the multimeter label should be soldered to the zinc bottom of the battery. It will be necessary to leave your soldering iron in contact with the bottom of the battery for a matter of four or five seconds before the solder will adhere properly to the zinc can, and it is desirable to scrape the zinc can carefully first before soldering is attempted.

### TESTING.

The multimeter will only operate when the four-position switch is turned to the position marked "D.C.", so be sure to turn the switch to this position before attempting to use the instrument.

To test the 1000 volts range, insert the test lead fitted with the black test prod into the socket marked "-", and touch the other end of this lead to the negative terminal of your  $4\frac{1}{2}$  volt battery. This battery will not now be connected to the ohmmeter as you will have replaced it by the  $1\frac{1}{2}$  volt cell.

The second test lead may be plugged into the socket marked "+ 1000 volts" and its other end touched to the positive terminal of the  $4\frac{1}{2}$  volt battery. It is impossible to measure  $4\frac{1}{2}$  volts accurately on the 1000 volts range, but if you watch the pointer of your meter carefully, you will observe it move very slightly when connection is made. If the needle moves appreciably across the meter scale it shows that you have made an error in connections and it is necessary to check the wiring carefully. The movement of the meter pointer should normally be only about a quarter of one small graduation.

If you have a radio receiver, you may test the 1000 volts range by measuring some of the high direct voltages present in the receiver.

To test the milliamp ranges, leave the black test lead plugged into the socket marked "-" and plug the red test lead into the socket marked "+ 250 milliamps."

### WARNING.

On no account must the test leads be connected directly to

the terminals of a battery when the milliamp ranges are in use. A good battery is capable of supplying many thousands of milliamps, and if the two test leads were touched directly to a pair of battery terminals so much current would pass through the meter that it would be certain to be damaged. The milliamp meter must only be connected in series with a circuit in which there is sufficient resistance to restrict the current

flowing to a value of 250 milliamps or less.\*

To test the milliamp ranges, connect the 75,000 ohms resistor to the 4.5 volts battery as shown in Figure 6. Touch the black coloured test lead to the negative terminals of the battery and the red coloured test lead, which may be plugged into the socket marked "+ 1", to the end of the 75,000 ohms re-

\* See A.R.T.C. Service Engineering Course Lessons 7 and 41.

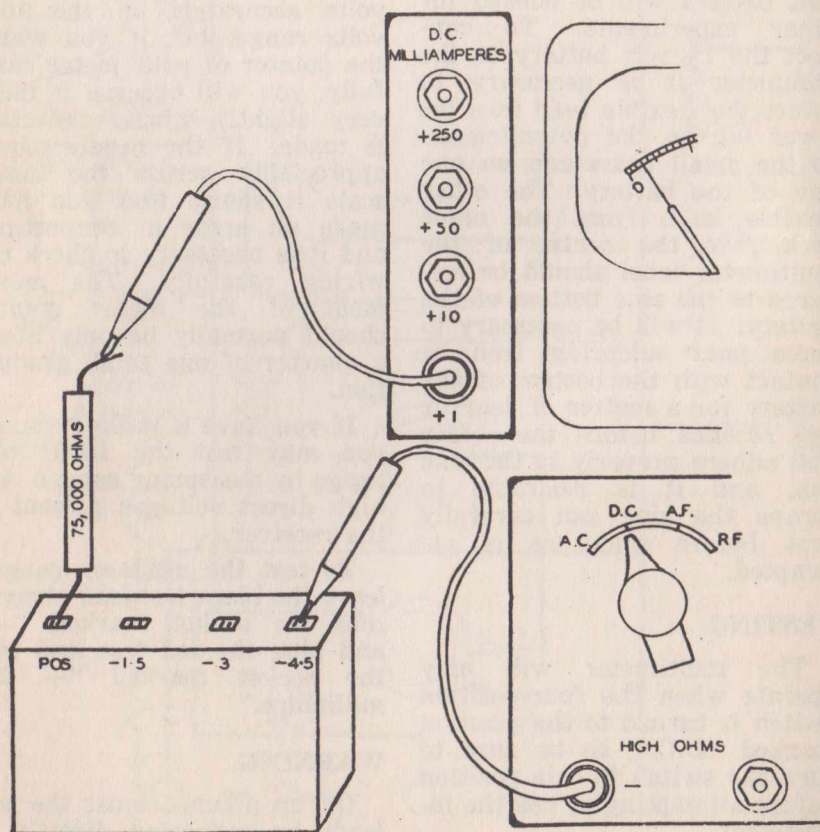

Fig. 6.

sistor. If your battery is in good condition, the 75,000 ohms resistor will limit the current

flowing to a value of  $\frac{4.5 \times 1000}{75,000}$

which equals .06 milliamps. This should cause the meter to move approximately three small graduations across the scale.

You may then plug the red test lead into the +10, +50 and +250 milliamp sockets in turn and note that the movement of the needle decreases in each case. There will scarcely be any noticeable movement in the +10 position and the needle will hardly move at all in the +50 or +250 position.

If there is as much movement, or nearly as much movement, when any of these three sockets are used as was the case when the +1 milliamp socket was used, then this indicates an error in wiring, or a fault in the multiple shunt, which must be corrected before any attempt is made to measure larger values of current.

If everything appears to be in order before this check has been carried out, you may then connect the 200 ohm resistor to a  $1\frac{1}{2}$  volt section of your battery as shown in Figure 7. With a value of  $1\frac{1}{2}$  volts applied to a resistor of 200 ohms, the amount of current flowing will

be equal to  $\frac{1.5 \times 1000}{200}$  or 7.5

milliamps. Obviously this amount of current would be too

much to be registered on the 1 milliamp range so that you must not insert the red coloured test lead in the socket marked "+1" when using the 200 ohm resistor for testing.

With the test lead plugged into the "+10" socket, the needle should move about three-quarters of the way across the scale. When plugged into the "+50" socket, the needle should move just past the first heavy graduation on the scale. When plugged into the "+250" socket the needle should move about one and a half small graduations.

The low ohms range may be tested by plugging the test leads into the tip jack sockets between which the words "low ohms" are marked. Before making the test, the ends of the test leads should be touched together and the needle made to register zero ohms at the right-hand end of its scale by means of the knob marked "Ohms Zero". After this preliminary adjustment, the ends of the test leads may be separated and applied to the ends of the 200 ohm resistor. This resistor should of course be disconnected from the  $4\frac{1}{2}$  volt battery for this test.

You will recall that when using your ohmmeter with the test leads inserted in the sockets marked "High Ohms", it was necessary to observe the position of the needle on the scale and then multiply the value indicated by 100. When using

the "Low Ohms" scale, no such multiplication is necessary. You simply apply the test leads to a resistor or other circuit to be tested and its value will be directly indicated by the graduations on the ohms scale. Thus, when testing the 200 ohm resistor you will observe that the needle takes up a position very close to the graduation marked "200".

You may then apply the two test prods to the connections on the 2.5 volt lamp supplied to you with kit No. 2. You will observe that the resistance of this lamp is only a few ohms.

You have now completed the construction of your multimeter and it is ready for you to employ in making tests and measurements on the units you will construct with later kits.

## VALVE TYPES.

Prior to making some tests with the valve supplied with this kit, we will proceed to explain the action of radio, valves in general.

In 1884, when Edison was conducting some experiments with electric lamps, he noted the effect that an electric current could pass between a heated filament in a lamp and an additional piece of metal or wire contained in the lamp envelope. Although he noted the effect in his notebook, he did not pursue the subject any further at that stage. This effect, known as the "Edison Effect", led to the ultimate development

of radio tubes, by a series of gradual advancements over a period of many years.

Some years later, in 1896, Fleming commenced to investigate the "Edison Effect" and as a result of his investigations developed what has become known as the "Fleming Valve". This valve was a two-element valve or "diode" consisting merely of a heated filament and an additional metal plate called an anode. When the filament was heated and the anode was made positive compared with the filament, a number of electrons would be emitted or thrown out from the hot cathode and attracted across the space in the valve by the positive voltage applied to the anode. In a simple valve such as this, where the electrons start out from the heated filament, the filament might also be called the "cathode".

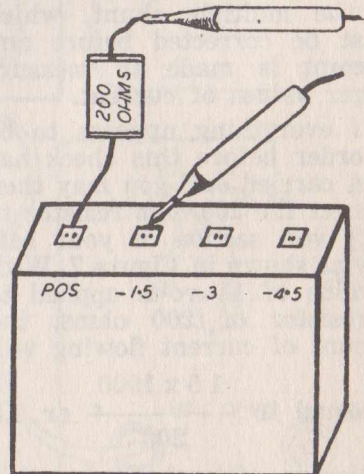

Fig. 7.

If the plate of the valve is made negative compared with the filament, no electrons will pass across the space between the two and the valve will therefore prevent any flow of current in the circuit. If an alternating voltage is applied to a circuit containing the valve, it is thus obvious that only the half-cycles which make the plate positive will be able to cause any current flow and the valve will have the effect of allowing the current to flow only in one direction. In other words, the valve will act as a rectifier or detector. Because of this effect, the Fleming valve was employed as a detector in radio receivers and thus became the first radio valve.

## THE TRIODE.

The sole application of the Fleming Diode was as a rectifier or detector and it was not until 1907 that De Forest conceived the idea of introducing a grid into the tube so that amplification could be achieved. With three elements present the tubes were known as "Triodes" and thus made possible the first method of actually amplifying a received signal so that its power could be increased a number of times in a receiver.

In order that a triode tube may be used as an amplifier, it is necessary to apply the comparatively weak signal voltage between the grid and cathode of the tube and to include in the plate circuit of the valve a

resistance or impedance which is known as the "plate load". The signals applied to the grid of the valve produce changes in plate current which in turn produce variations in voltage across the plate load and these represent the output signal which may, in many cases, be several times stronger than the input signal. In other words, the signal has been amplified.<sup>1</sup>

Although the triode valve is quite efficient when employed as an amplifier of low frequency signal, it is difficult to achieve much useful amplification from it at high frequencies because of oscillation which occurs due to capacity inside the valve between the plate and control grid.<sup>2</sup>

To make possible the efficient amplification of radio frequency signals, a fourth element, a screen grid, was introduced between the plate and the control grid and screen grid valves or "tetrodes" were made available commercially in 1928.

Whilst the introduction of the screen grid effectively reduced the possibility of oscillation occurring, it still did not provide an entirely satisfactory amplifying valve, and in 1929 a "pentode" valve employing a third grid or, in all, a total of five elements was developed in Europe. This pentode valve proved to be an extremely successful and efficient type of am-

<sup>1</sup> See A.R.T.C. Service Engineering Course Lessons 12 and 18.

<sup>2</sup> See A.R.T.C. Service Engineering Course Lesson No. 21.

plifier and is still the most commonly used form of amplifying valve at the present time. Naturally, in the intervening years many minor improvements in construction and characteristics have occurred but for general amplifying purposes pentode valves are still extremely widely used at the present time. The valve supplied with your kit of parts is a pentode containing a filament, three grids and a plate. However, we will use it in a number of interesting experiments as a diode and triode valve also, to become familiar with the characteristics of these types.

Some radio valves employ even more elements than a pentode but these are special types of tubes developed to perform some particular task such as frequency-changing in super-heterodyne receivers and are not used as ordinary amplifiers.<sup>3</sup>

## DESCRIPTION OF PENTODE TUBES.

If you examine the valve supplied to you, you will see through the glass envelope a large metal cylinder which is the plate or anode. Across the top and bottom of this cylinder is a perforated disc of mica which is provided with a number of small holes to separate and hold in their correct positions the other elements of the tube.

The three grids are oval-shaped spirals placed inside the

plate and therefore not readily visible. If you look at an angle downwards through the top of the plate or upwards from the bottom, you may just be able to see some of the very fine turns of the grid coils. The grid windings are attached to thick upright wires which protrude through the holes in the mica at top and bottom.

The filament consists of two very fine strands of wire which you may just be able to see protruding upwards from the centre hole in the mica disc. These two fine filament wires run down from the centre hole in the top mica disc to the centre hole in the bottom mica disc and are thus held in the centre of the oval shaped grids and plate.

Connection is made to the various elements by means of the prongs protruding from the base of the valve. You can see that these prongs are extended upwards inside the valve and bent over to connect to the various elements.

Connection of the valve to the circuit is made by means of the valve socket supplied. You will see that the valve has seven pins with a wide spacing between two of them so that it cannot be inserted in the socket in the wrong position.

When plugging the valve into the socket, or when removing it, push the valve straight in or straight out and do not wriggle it from side to side. If you bend it from side to side in re-

<sup>3</sup> See A.R.T.C. Service Engineering Course Lessons 21A and 32.

moving it from the socket you will probably find that the glass base cracks around one or more of the wires and allows air to enter the valve, making it useless.

Most battery-operated valves simply have two connections to the filament, one to each end, so that they will operate from one particular value of filament voltage only. The valve supplied to you is somewhat adaptable in that the filament is in two separate sections. These two sections can be operated in series with one another from a source of 2.8 volts, that is, the voltage provided by two dry cells, or alternatively, the two portions of the filament can be connected in parallel and may be operated from a single dry cell giving a voltage of 1.4 or 1.5 volts.

To accomplish the change over for series or parallel operation, there are three connections to the filament, a connection to each end and a connection to the centre point. This is illustrated in Fig. 8 at the left which shows the centre tap being disregarded and the voltage from a three volt battery being applied so that current flows through the two portions of the filament in series. Notice that the connection No. 5 on the valve socket, to the centre tap of the filament is not employed and that current from the battery has to flow firstly through one half of the filament and then through the other. To

the right in Fig. 8 is shown the method of operating the valve from a 1.5 volt battery. In this case the socket contacts one and seven are connected together and to the negative side of the battery. There are thus two paths for current through the two halves of the filament. If we imagine current as starting out from the positive side of the battery it will flow from contact No. 5 to the centre point of the filament and then portion of the current will flow to the left and back to the negative terminal of the battery through connection No. 1, whilst the other part of the filament current will flow to the right from the centre point through the second half of the filament and back to the negative side of the battery through pin No. 7. In practically all of our tests and measurements we will be operating the valve with the two filament sections in parallel as shown at the right of Fig. No. 8.

## TESTING THE VALVE FILAMENT.

Before proceeding to use your valve I suggest that you test each portion of the filament with your multimeter to make sure that both parts of the filament are in good order. To do this, plug the test leads into the terminals marked "Low Ohms" on your multimeter, connect one of the test leads to pin No. 5 on the valve socket and the other test lead in turn to pin 1 and then to pin 7. In

both cases your multimeter should give an indication of approximately 20 ohms. At the moment that the test leads are applied, the ohmmeter needle may rise to a value of about 10 ohms but then the needle will rapidly drop back to the position corresponding to about 20 ohms as the filament sections heat under the influence of the testing current. It is due to this heating effect you will find, if you will check the whole filament resistance by measuring between pins 1 and 7, that instead of getting twice 20 ohms or 40 ohms you will only obtain a reading of about 35 ohms. This is due to the fact that the filament does not become quite as hot under these conditions as when you are testing each half individually.

Although the valve filament is rated to operate from a source of voltage providing either 1.4 or 2.8 volts, it is actually quite in order to operate the valve from a 1.5 volt or 3 volt dry battery. There is a permissible variation of plus or minus 10% in filament voltage, and 10% of 1.4 volts amounts to .14 so that it is quite in order to apply up to 1.54 volt to the filament of the valve. Similarly, when the two halves are operated in series, it is permissible to apply 10% more than 2.8 volts, that is, 3.08 volts, without any risk of damaging the valve.

In addition to the filaments, there are, as previously explained, three grids and a plate inside the valve. Grid No. 1, usually called the "control grid"

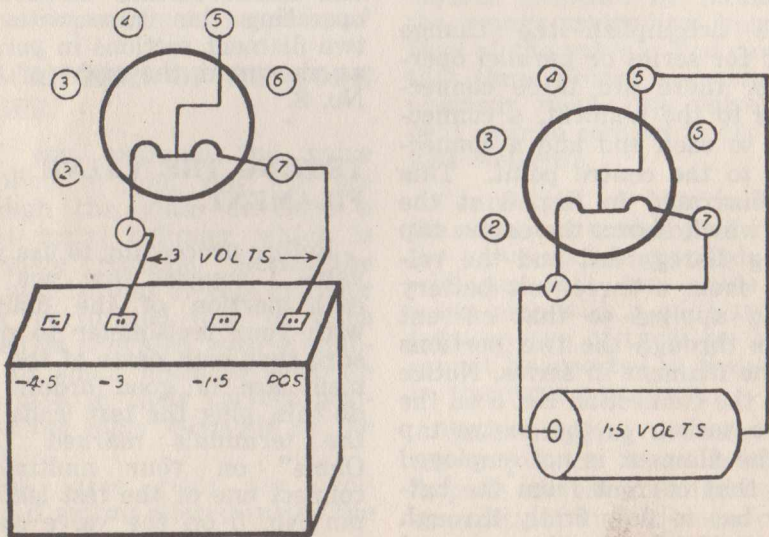

Fig. 8.



and the one to which signal voltages are normally applied, is connected to pin No. 3 on the valve base. Grid No. 2, frequently referred to as the "Screen Grid", is connected to pin No. 4. The third grid, sometimes called the "Suppressor Grid", is connected to pin No. 5 together with a connection to the middle part of the filament. The plate is connected to pin No. 6. These valve base connections are shown in Figure No. 9, which represents the position of the socket connections when viewed from underneath, that is, from the position of the valve socket when it is turned over for wiring purposes.

#### OPERATION AS A DIODE.

As a first experiment, we will connect our valve so that it acts as a diode and repeat some of the experiments conducted by Edison in 1884.

As previously explained, a diode valve has only two elements, a filament or cathode and a plate or anode. To form the anode in our valve, we will join together the control grid-screen grid and plate by connecting together on the valve socket pins 2, 3 and 4. These three elements all being connected to one another act as one large element which we will regard as the anode in our valve. The suppressor grid is already connected inside the valve to portion of the filament, so that this grid, together with the filament, becomes the cathode. The

two portions of the filament are to be connected in parallel by joining together pins 1 and 7 as shown at the right in Figure 8. The centre brass contact on one of the 1.5 volt cells supplied to you should be connected to pin 1 or 7, whilst the wire soldered to the centre of the bottom of the zinc can should be connected to pin No. 5. These connections are also shown to the right in Figure 8. Current from this 1.5 volt cell will then heat the filament of the valve, the 1.5 volt cell being known as the "A" battery.

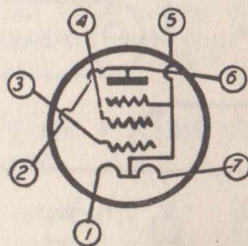

Fig. 9.

We will use our 4.5 volts battery as a "B" battery by connecting a wire from the battery terminal marked "-4.5" to pin No. 5 on the valve socket. Plug one of our test leads into the minus terminal of your multi-meter and connect this test lead to the anode of the valve at pin 2, 3 or 4 on the valve socket. The other test lead should be plugged into the "+10 milliamp" socket and its remote end connected in turn to the -3, the -1.5 and the plus ter-

minimal on the 4.5 volts battery. These connections are shown in Figure 10.

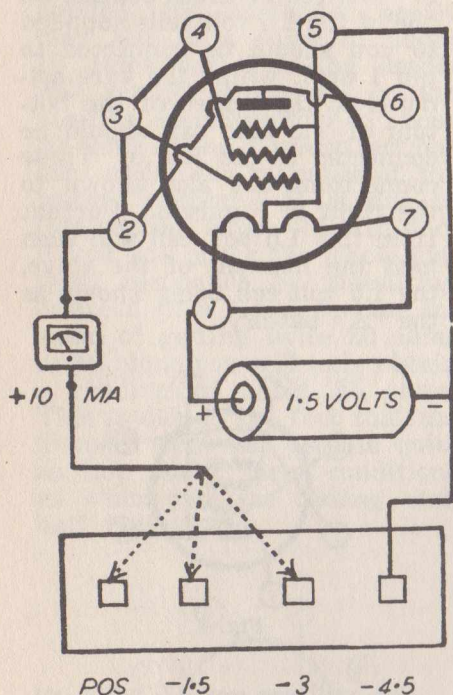

Fig. 10.

You will observe that when the anode of the valve is connected through the meter to the plus terminal of the battery, several milliamps of current are indicated by the meter. Actually this is the result of electrons emitted by the hot cathode being attracted across the space in the valve by the positive voltage applied to the anode. The electrons, once attracted to the anode, strike the anode and flow on around

through the wires, through the meter and back to the positive terminal of the battery.

A reduction of positive voltage applied to the anode will have a smaller attraction for the electrons so that fewer of them will reach the anode. This is indicated by the fact that, when you touch the lead from the positive terminal of the meter to the  $-1.5$  terminal on the battery, the anode of the valve becomes 3 volts positive compared with the negative side of the filament and this will result in a current flow of about  $1\frac{1}{2}$  or 2 milliamps.

If you still further reduce the positive voltage applied to the anode by connecting the lead from the meter to the  $-3$  volt tapping on the battery, this actually makes the anode only 1.5 volts positive compared with the negative side of the filament and the plate current will be still further reduced to somewhere about .25 milliamps. To obtain an indication of this small value of current it will probably be desirable to remove the positive lead from the socket marked "+10" and insert it instead into the socket marked "+1" on the milliamp label.

Edison noted that current would only pass between the heated filament in a valve and the other elements when the other elements were made positive compared with the filament.

We can confirm Edison's find-

ing by reversing the connection to the  $4\frac{1}{2}$  volts battery so that it applies a negative voltage to the anode. This is shown in Figure No. 11. You should connect the lead from pin No. 5 on the valve socket to the positive terminal of the  $4\frac{1}{2}$  volts battery. The other three terminals will then provide voltages which are  $-1.5$ ,  $-3$ , and  $-4.5$  volts negative compared with the filament respectively.

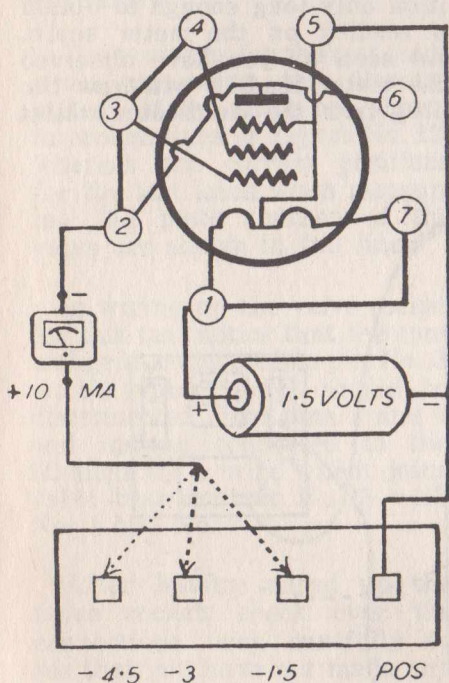

Fig. 11.

If you now touch the test leads from your meter to these three terminals in turn, you will observe that no current whatsoever flows, due to the fact that

the negative voltage reaching the plate of the valve, through the meter, does not attract any electrons from the hot filament.

This experiment demonstrates that electrons will definitely only pass in one direction through a valve, that is from cathode to plate; and consequently, if an alternating voltage is applied to the plate, current will only flow in one direction, so that the valve will act as a rectifier. You will see a practical application of a diode valve used as a rectifier in this manner when we use the valve to act as a rectifier for measuring alternating voltages in conjunction with your multimeter later on in this Lesson.

### EFFECT OF FILAMENT VOLTAGE.

The strength of positive voltage applied to the anode of a diode valve is not the only factor in determining the amount of plate current which will flow through it. The current is also a function of the temperature of the cathode.

To determine the effect of the cathode temperature, connect the valve as shown in Figure No. 12. It will be necessary to use the multimeter for two distinct purposes in making these tests, firstly, to measure the amount of voltage applied to the filament of the valve and secondly, to measure the resulting strength of plate current. When measuring the filament

voltage, the instrument will be used with the positive test lead plugged into the socket marked "+10" on the volts label, and for measuring milliamps the same lead will be withdrawn from the voltage label and plugged into the socket marked "+1" on the milliamps label. The negative test lead will remain in the socket marked "-" on the large label.

A distinct possibility for damage to occur to the instrument exists if one is careless in changing ranges from milliamps to volts. In changing from one measurement to another, it is

imperative that the test lead be withdrawn from the multimeter socket before the test prod at the other end of the lead is connected to the plate or filament of the valve. It will probably be found convenient to use one of the spring clips pushed on the end of the test lead, and when it has been connected to the correct position on the valve, the plug may then be inserted into the appropriate socket on the multimeter and left in position only long enough to obtain a reading on the meter scale. As soon as you have observed the meter reading withdraw the plug from the multimeter whilst

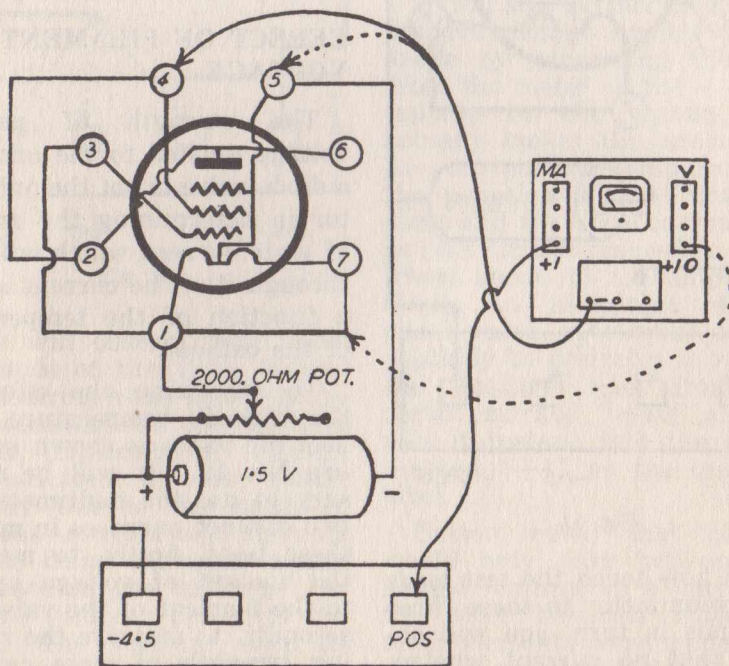

Fig. 12.

you are changing the connections for the following readings. If by any chance you touch the positive test lead of your meter to the filament of the valve while the other end of it is plugged into the "+1 milliamp" socket, you are almost certain to damage the instrument. On the other hand, if you make sure that the connections are correct in the circuit before plugging the plug into the appropriate multimeter socket then no harm will result.

The positions for the test leads when measuring the filament voltage of the valve are shown in broken lines in Figure No. 12, whereas the correct positions for the test leads when measuring the plate current of the valve are shown in full lines.

In wiring up the valve socket for this test notice that the control grid, connected to pin No. 3 on the valve socket should be disconnected from pins 2 and 4 and instead connected to the filament by a wire which joins valve base contact No. 3 with No. 1 and No. 7.

After having wired up the valve socket, check over the connections very carefully to see that you have not made any mistakes. Then, connect the multimeter, set on the 10 volt range, as shown by broken lines, to measure the filament voltage. Adjust the setting of the 2000 ohms potentiometer until the meter reads a filament voltage of .2. This will corres-

pond with the first small graduation on the meter scale.

Now transfer the meter to measure the plate current of the valve. As pointed out before it is imperative to remove the positive test lead entirely from the multimeter before changing any connections, and after changing the points to which both test prods are attached so that the negative test lead connects to the valve socket pin 2 or 4 and the positive lead to the positive terminal of the  $4\frac{1}{2}$  volt battery, you may then reinsert the plug on the end of the positive test lead into the "+ 1" milliamp socket and register the plate current if any. With only .2 volts applied to the filament of the valve it is doubtful whether the valve filament will heat sufficiently to allow any electrons at all to be emitted and to reach the plate. Consequently, the milliamp meter needle will probably remain at zero in this first instance.

Next, remove the positive test lead entirely from the multimeter, restore the connection as shown by the broken line in Figure No. 12, reinsert the positive test lead into the "+10" volts socket on the multimeter and move the control shaft on the potentiometer slightly to increase the filament voltage to a value of .4, that is, two small graduations on the meter scale.

Next, following the procedure described previously, con-

vert the meter to measure the plate current and in this instance you will probably observe a very small indication of perhaps one or two graduations on the meter. If the needle moves across two graduations this will correspond to a current of .04 milliamps and you should record this on a table as set out below.

You should then reconnect the meter as a voltmeter, increase the filament voltage to .6 volts, switch over the meter to measure milliamps and again record the value of plate current flowing. In this instance you will find the needle moves considerably further across the scale and will probably register

a value of between .1 and .2 milliamps.

Continue to repeat these tests until you have compiled a table something like the one set out below. This table was obtained by testing one particular valve but individual valves vary considerably when operated at such low values of plate voltage and consequently your figures may be considerably different from those in the table.

Filament Volts	Plate Milliamp
.2	0
.4	.04
.6	.2
.8	.36
1	.54
1.2	.68
1.4	.86

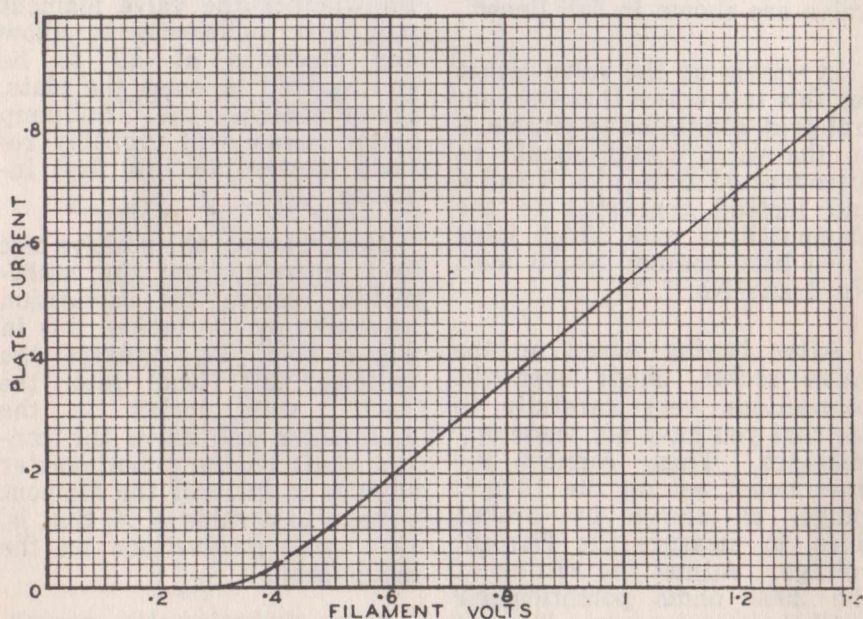

Fig. 13.

Having made a table of the values of plate current corresponding to various filament voltages, it is desirable to set out the information in graphical form. To do this, take one of the sheets of graph paper supplied and draw a rectangle on it, 7" by 5". Against the heavy lines on the graph paper mark the values of filament voltage horizontally along the 7" line and values of plate current vertically along the 5" side. The form of the graph is shown in Figure 13.

With .2 volts applied to the filament we found the plate current was zero so put a spot on the base line of the graph at a point corresponding to .2 volts.

With .4 volts applied to the filament, we had a resulting plate current of .04 milliamp. To determine the position for this spot, find the vertical line corresponding to .4 volts and follow up this until you reach the second small line which corresponds to a current value on the left-hand scale of .04 milliamp. At the intersection of these two lines place the spot as shown in Figure 13. Of course, if your particular valve had a plate current of some value other than .04 milliamp, put the spot on a horizontal line corresponding to the plate current of your valve instead of on the line corresponding to .04 milliamp, but put it directly above the point marked .4 volts on the base line.

Continue to mark in the spot corresponding to the other values of voltage and current, then join up the seven dots to form a curve somewhat like the one shown in Figure 13.

Do not be disappointed if the spots you obtain when you plot the various values of voltage and current do not lie exactly in the line of a normal smooth curve because it is very difficult to adjust the filament voltage exactly to the values of .2, .4 volts etc., because of the small reading provided on the meter scale. Any slight inaccuracy in setting the filament voltage will of course put the dots out of position on the graph and they will not be in line with one another when the graph is completed. However, it is permissible to draw the line slightly to one side or the other of the dots in order to make it a smooth curve because in practice a valve will always have a smooth curve and if the dots are a little out of position then this is due to an error in reading the meter rather than to peculiar variations in the valve characteristics. An error such as this is shown with the upper part of the curve where the dot for 1 volt appears to be a little too high and the dot for 1.2 volts appears to be a little too low. You will notice that the line has not been drawn through these dots but rather a little to one side or the other because obviously the dots are a little out of position due to an error in reading the meter.

## EFFECT OF CONTROL GRID.

The following tests in which we apply a variable voltage to the control grid will reveal its effect in controlling the stream of electrons passing through it from the filament or cathode to the plate. For the purpose of this test, it is necessary to rearrange the connections to the valve sockets and batteries in accordance with Figure No. 14. From this Figure, it is clear that when the moving arm on the potentiometer is moved to one extreme position it will connect the grid of the valve to the negative end of the 1.5 volt cell. When moved to the other extreme it will connect the grid of the valve to the positive end of the  $4\frac{1}{2}$  volts battery. Thus,

the grid voltage may be varied to any value between  $-1.5$  volts and  $+4.5$  volts.

In making the tests with this arrangement, it will be necessary to again use our multi-meter for two purposes, namely, to measure the grid voltage and and to measure the plate current. Once again in changing over the connection to the multi-meter so as to enable the grid voltage to be set to a definite value firstly, and then to permit the measurement of the resulting plate current, it is necessary to exercise the same caution and to follow the same procedure as outlined in connection with the filament voltage plate current curve, previously described. In this test, the 1.5

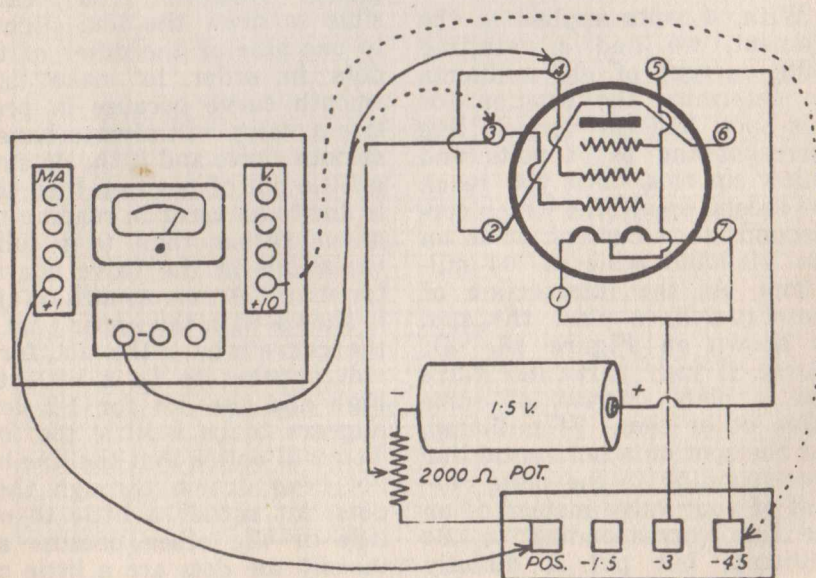

Fig. 14.



volt cells acts as the "C" battery or "bias battery." The portion of the  $4\frac{1}{2}$  volts battery between the  $-4\frac{1}{2}$  and  $-3$  volts tapping is used as the "A" battery, whilst the whole of the  $4\frac{1}{2}$  volt battery between the  $-4\frac{1}{2}$  terminal and the positive terminal acts as the "B" battery.

Commence with the meter connected as a milliammeter with the positive test lead inserted in the socket marked "+1" milliamp, and the other end of the test lead connected to the test circuit as shown in full lines in Figure 14. With the potentiometer set about half-way through its range of travel, there will be a substantial reading on the meter. You should slowly and carefully rotate the potentiometer so that the reading on the milliammeter decreases to zero. You will find that the current will decrease fairly rapidly at first, as the potentiometer is turned, and then, when the current has been decreased almost to zero, the decrease will be very slow until finally the needle drops right down to the zero mark on the scale.

Once the plate current has been reduced to zero, change your multimeter over to measure the negative bias applied to the grid of the valve, by connecting the negative lead of the multimeter to the grid and the positive lead, one end of which is plugged into the socket marked "+10 volts" to the

$-4\frac{1}{2}$  volt terminal on the  $4\frac{1}{2}$  volt battery. You will probably find that the value of negative bias is somewhere between zero and  $-1$  volt. Read the value of bias carefully on the voltmeter scale and mark this on a piece of paper so that you commence another table similar to that set out below, neglecting for the moment the second column of plate milliamperes.

Grid Voltage	Plate Mills. at 4.5v.	Plate Mills at 6v.
-1.0		0
-.8	0	.01
-.6	.005	.02
-.4	.01	.04
-.2	.02	.07
0	.04	.11
.2	.08	.18
.4	.13	.26
.6	.19	.34
.8	.24	.42
1.0	.31	.52
1.2	.37	.62
1.4	.44	.72
1.6	.51	.81
1.8	.58	.91
2.0	.66	1.01
2.4	.74	
2.6	.82	
2.8	.91	
3.0	1.0	

Next, adjust the negative grid bias to a value a little less negative than before so that the plate current will increase to a value slightly greater than zero. Use a value of bias which comes out to an even fraction of 1 volt such as  $-.8$ ,  $-.6$ , or  $-.4$  volts, the exact value you choose depending upon the par-

ticular characteristics of the valve supplied to you. Once you have set the negative bias at an appropriate value, change over your meter connection so that it registers the plate current and mark this value of current down on the table you will compile for your particular valve.

Continue to repeat the process by changing the grid bias a fifth of a volt or .2 of a volt at a time, as suggested by the accompanying table, and record the values of plate current until you reach a plate current of 1 milliamp.

After you have made two or three tests you will find that the negative grid bias has been reduced to zero. To continue to produce further increases in plate current, it will be necessary to move the potentiometer a little further, thus making the grid positive in comparison

with the negative terminal of the  $4\frac{1}{2}$  volt battery. In order to read the positive values of the grid, reverse the connections to your voltmeter so that the positive test lead will be connected to the grid and the negative test lead to the  $-4\frac{1}{2}$  volt terminal of the battery. This reversal of connections will enable you to measure the values of bias starting from  $+.2$  volts and going on to a value sufficient to make the plate current increase up to about 1 milliamp.

To determine the effect of a change in plate voltage, we will borrow the 1.5 volt cell from the multimeter and connect this in series with the  $4\frac{1}{2}$  volt battery so that the total plate voltage will be increased to 6. The method of connecting this 1.5 volt cell is shown in Figure 15. Of course, you should disconnect the battery entirely from the multimeter by unsoldering the wires to it before connecting it to the  $4\frac{1}{2}$  volt battery as shown in Figure 15.

You should now commence again to plot another column of plate current values under these new operating conditions. You

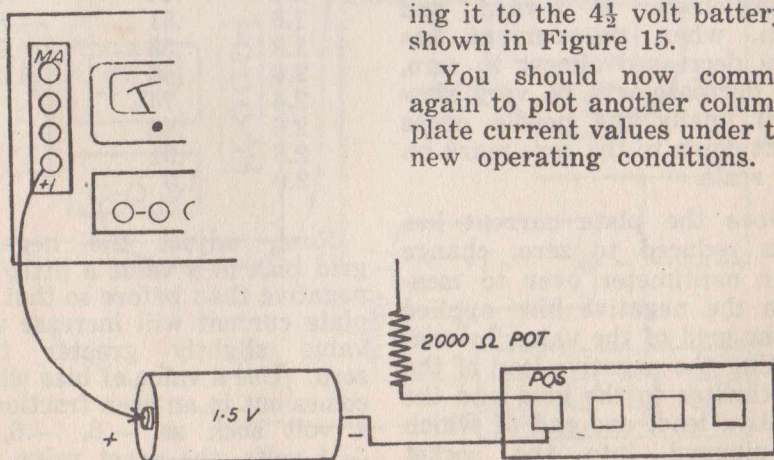

Fig. 15.

will find that it is necessary to use a slightly greater value of negative grid bias, to reduce the plate current to zero, than previously and you will find that because of the greater attraction of the higher positive voltage for electrons, the value of plate current will be higher in each instance, for the same amount of grid bias, than it was in the case of the last set of figures.

Tabulate this second set of figures in a third column as shown above. Once again, the figures you obtain for your particular valve will probably be somewhat different from those shown in the table. The table serves merely to illustrate the manner in which you should undertake the work.

### **PLOTTING GRID VOLTAGE-PLATE CURRENT CURVES.**

It is desirable to set out the information we have just obtained in the form of characteristic curves, from which we may determine the valve's actual characteristics under the operating conditions we have employed.

To draw the grid voltage-plate current curve, draw out a rectangle six inches by 5 inches on a piece of graph paper and mark off values of grid bias along the base and the plate milliamps upwards along one side as shown in Figure 16.

Now, start with the column for grid voltage and the column for plate milliamps at 4.5 volts and mark in the series of

points corresponding to the positions on the graph at which these lines intersect as indicated in Figure 16. Once you have plotted all the points corresponding to a plate voltage of 4.5, join these points together to make a smooth curve. If the curve does not exactly pass through some of the points do not worry because, as explained previously, it is difficult to always read the meter accurately, and this will cause some of the points to be placed a little higher or a little lower than should be the case.

Having drawn one grid voltage-plate current curve, you should now proceed to mark on the graph the second row of points corresponding to the values of grid voltage and plate milliamps at 6 volts plate voltage. These points should form a second curve a little to the left of the last one, somewhat as shown in Figure 16.\*

### **DETERMINING VALVE'S CHARACTERISTICS.**

An amplifying valve has three important characteristics which will reveal to a radio engineer the manner in which it will perform as an amplifier. These characteristics are known as the "amplification factor", which indicates the maximum possible amplification to be obtained from the valve under ideal conditions, the "plate resistance", which indicates the

\* See A.R.T.C. Service Engineering Course Lessons 12 and 18.

internal resistance of the valve to signal currents under operating conditions and thirdly, the "mutual conductance", which indicates how effective a signal voltage applied to the grid is in producing a change in plate current.

The values of these three characteristics are not constant for any type of valve but will change, depending upon the voltages and current at which the valve is operating. The values we obtain from our curve in the following calculation will reveal the characteristics of your particular valve under the conditions you have tested it, that is, with a plate voltage of only  $4\frac{1}{2}$  or 6 volts. Naturally,

these characteristics will be somewhat different from those which exist when the valve is operated at a higher voltage such as 45 or  $67\frac{1}{2}$  volts in an ordinary radio receiver and this accounts for the fact that the characteristics you will determine will be different from those published for the valve in valve data sheets printed by Valve Manufacturers. However, the characteristics you determine from your calculations will be the characteristics of the valve under the conditions of test we have just employed.

To determine the characteristics, it is necessary to mark three points on the set of curves as shown in Figure 16. Point

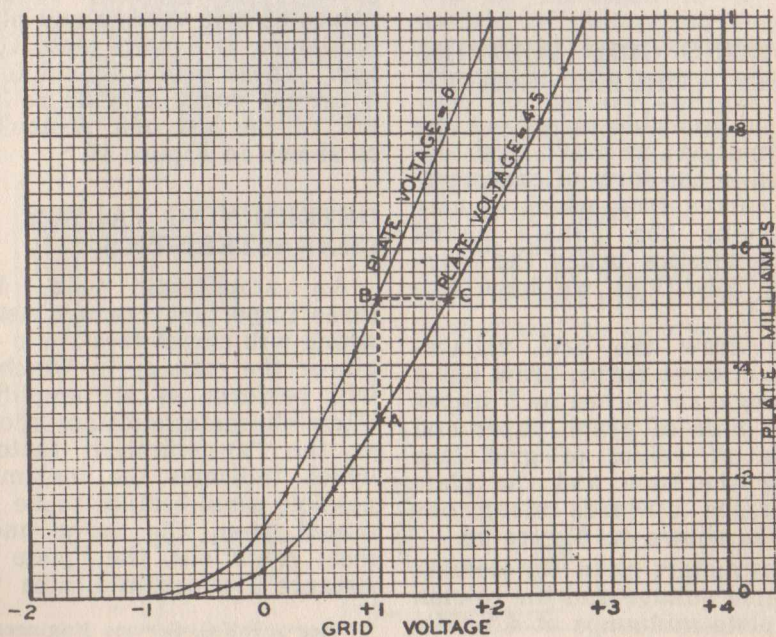

Fig. 16.

"A" should be marked at the position where the right-hand curve crosses the vertical line corresponding to a grid voltage of +1. Point "B" should be marked directly above point "A" at the position where the left-hand curve crosses the vertical line corresponding to a grid voltage of +1. Point "C" should be marked on the right-hand curve exactly level with point "B".

To determine the amplification factor of the valve, we divide the difference in plate voltage between the two curves by the difference in grid bias at a constant value of plate current. The difference in plate voltage will be 1.5 volts, that is, the difference between 4.5 and 6 volts, the two voltages at which we made the tests resulting in the curves. The difference in grid bias is the difference between the bias corresponding to point "B" and that corresponding to point "C" on the diagram. In Figure 16, point "B" corresponds to a bias of +1 and point "C" corresponds to a bias of 1.6 volts. This is determined by following directly downwards from point "C" to the scale of grid voltage at the bottom. The difference between 1 and 1.6 volts is of course .6, so we divide the difference in plate voltage, 1.5, by the difference in grid bias, .6, and as a result have an amplifi-

$$\text{cation factor of } \frac{1.5}{.6} = 2.5.$$

An amplification factor of 2.5 is not very great but we must remember that this amplification factor applies when the valve is operated as a triode and the amplification factor will be many times higher when it is used in later experiments as a pentode. Further, the low value of amplification factor is accounted for by the very low value of plate voltage employed.

To determine the value of internal plate resistance, we divide the change in plate voltage by the change in plate current at a constant value of grid bias. In this case the change in plate voltage is again 1.5, and the change in plate current is the difference in plate current values between point "A" and point "B" on the curve. In figure 16, the value of current corresponding to point "A" is found by following across horizontally to the scale of milliamps and is .31 milliamps. The value of plate current at point "B" is found from the scale at the right-hand side to be .52 milliamps. The difference is therefore .52 minus .31 or .21 milliamps.

Because our value of plate current is expressed in milliamps instead of amps., our formula for determining the plate

$$\text{resistance becomes } 1.5 \times \frac{1000}{.21} = 7143 \text{ ohms.}$$

To determine the mutual conductance, we divide a change in plate current by the change in

grid voltage producing it, at a constant value of plate voltage. The change in plate current is the difference in plate current corresponding to points "A" and "C" on Figure 16 and in Figure 16 this difference, as we have already seen, is .21 milliamps. The difference in grid voltage producing it is the difference between the grid voltage corresponding to points "A" and "C", that is, the difference between +1 and 1.6 volts, or .6 volts. Dividing .21 by .6 gives an answer of .35 milliamps per volt for the mutual conductance. Another way of expressing mutual conductance is in "micromhos". To express our mutual conductance in micromhos, we merely multiply the number of milliamps per volt by 1000. Thus, the valve will have

a mutual conductance of 350 micromhos.\*

### APPLICATION OF VALVE.

The experiments we have just completed have revealed a vast amount of information about the characteristics of the valve but so far we have not seen a practical application for it. To employ the valve as an amplifier, it is necessary to have available a source of signal voltage which is applied to the grid of the valve and to put a resistor, coil or transformer in the plate circuit of the valve as shown in Figure 17. The device in the plate circuit is known as the "plate load" and the actual am-

\* These characteristics may also be determined from a group or "family" of plate voltage—plate current curves as explained in A.R.T.C. Service Engineering Course Lesson 23.

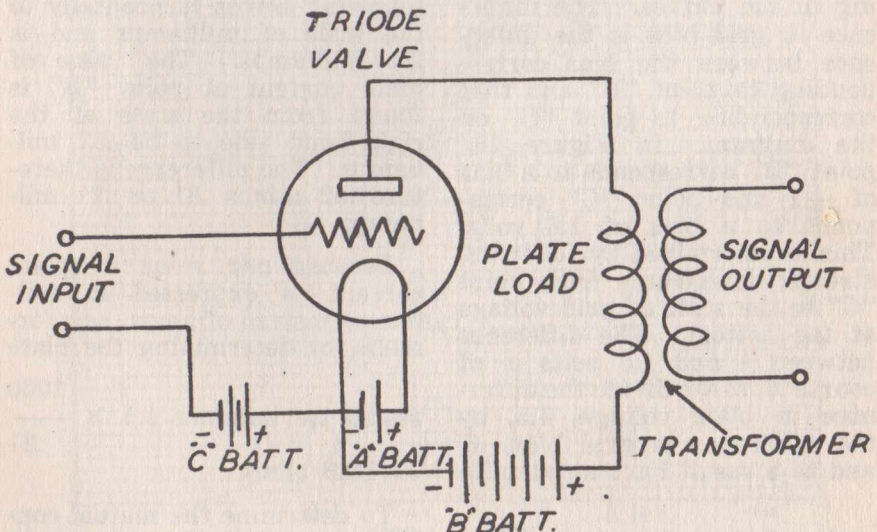

Fig. 17.

plification obtained depends largely upon the value of plate load impedance. The actual value of amplification obtained from the valve is not necessarily equal to the valve's amplification factor but is usually somewhat less than this. We will conduct a number of experiments in a later lesson, with various values of plate load impedance to illustrate this fact.

The curves shown in Figure 16 and the characteristics we have obtained from them apply to the valve when used as a triode. Actually, the valve supplied to you is a pentode and in most amplifier circuits will be used in this fashion. To employ the valve as a pentode it is simply necessary to connect the screen grid to a point

of positive voltage instead of connecting it to the plate as we have been doing so far in our experiments. A diagram of a pentode amplifier is shown in Figure 18.

### USING THE VALVE AS A RECTIFIER.

One practical application to which we may put the valve at this stage is to use it as a diode and to connect it to our multimeter so that the multimeter may become capable of measuring alternating voltages as well as direct voltages. In this application, the valve will act as a diode rectifier and will cause the alternating voltages to be measured, to produce pulses of direct current which will operate the meter.

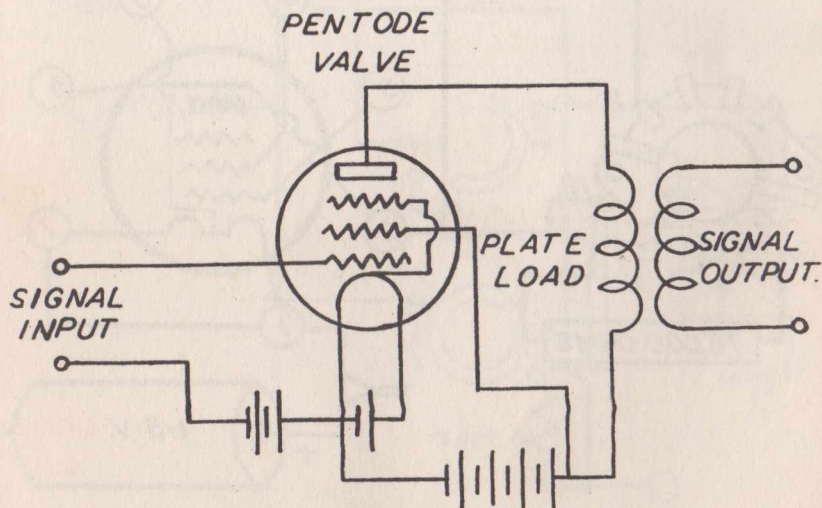

Fig. 18.

Figure 19 shows the manner in which the valve should be wired to contacts 2, 8, 9 and 12 on the multimeter switch.

The 1.5 volt battery used to heat the filament of the valve in this application must not be the one which is connected to the Ohms Range. You have two 1.5 volt cells supplied, so one can be connected to the Ohmmeter section of the instrument and the other one can heat the filament of the valve when it is required as a rectifier. Of course, this battery must be disconnected from the valve filament when the instrument is not actually in use for measuring alternating voltages, otherwise battery current will

be flowing constantly through the valve filament and the battery will be discharged in the matter of a day or two. It is not possible to make the multimeter switch disconnect the battery from the valve filament and as you have no other switch yet provided, it will be necessary to employ two pieces of wire, one attached to the battery and the other to contact 1 or 7 on the valve socket, so that these two wires may be twisted together to act as a switch, when the instrument is to be used for measuring alternating voltage and the ends separated to prevent the battery discharging when the instrument is not in use for this purpose.

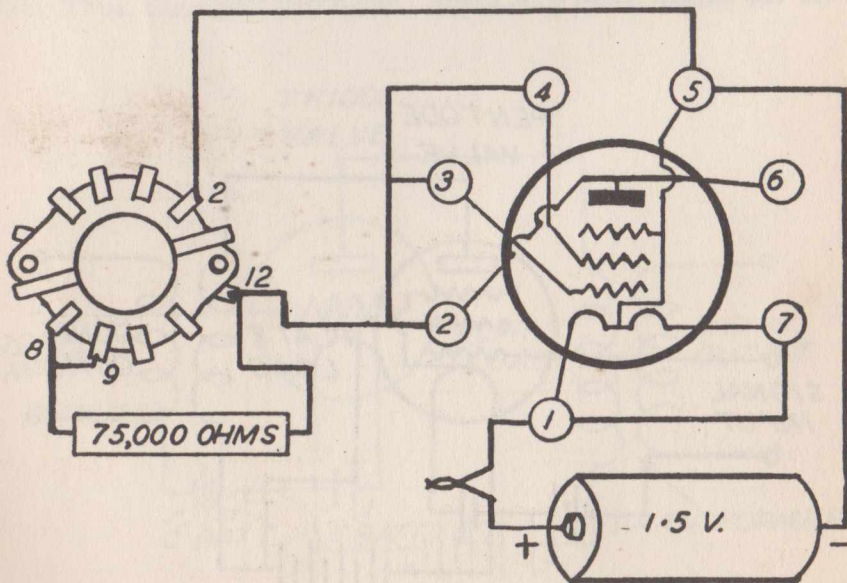

Fig. 19.



A circuit diagram of the voltage section of the instrument incorporating the valve is shown in Figure No. 20. In this diagram, we have deliberately omitted the milliamp shunt and the ohms section of the instrument because these are not in the circuit when the main switch is turned to the position marked "A.C."

If an alternating voltage is now applied to one of the volt-

age sockets on the multimeter, one half cycle will cause electrons to start at the negative terminal of the multimeter, pass through the meter from left to right, then be emitted by the filament in the valve and pass through the valve from filament to plate and then out, through one of the voltage multipliers on the other side of the circuit. During this half cycle, no appreciable amount of current will

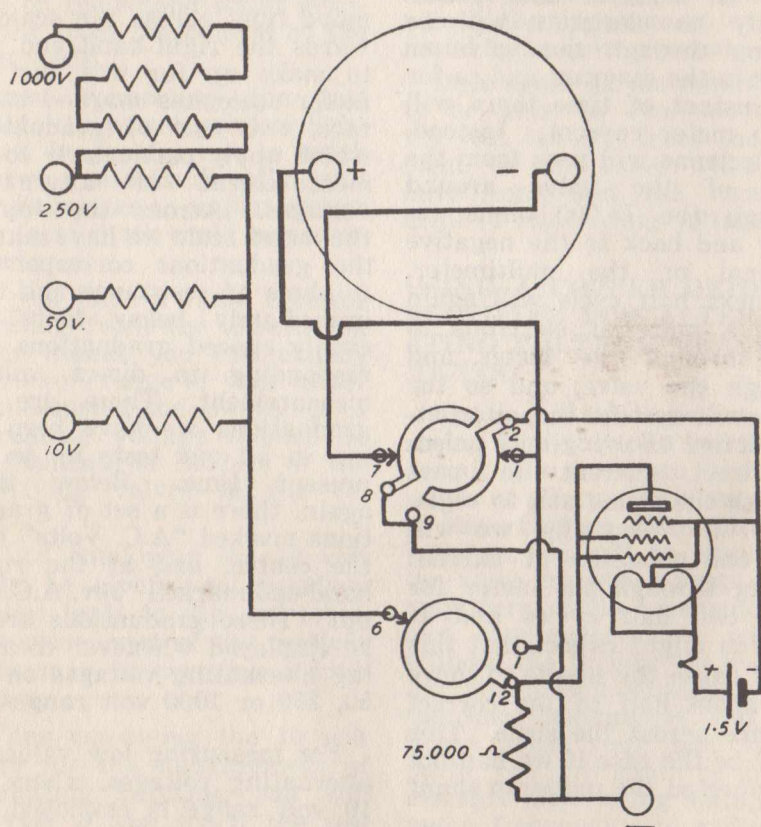

Fig. 20.

pass through the 75,000 ohms resistor because the value of this resistor is so much higher than that of the meter and valve.

On the next half cycle of alternating voltage, a negative voltage will be applied through the voltage multiplier to the plate of the valve. We have already observed, from our experiments earlier in this lesson, that no electrons can pass through the valve when the plate is negative and consequently no electrons will be passing through the valve or meter in the diagram and so for this instant of time there will be no meter current. Instead, the electrons will pass from the plate of the valve around through the 75,000 ohms resistor and back to the negative terminal of the multimeter. The next half cycle will again cause a pulse of electrons to pass through the meter and through the valve, and so the valve will rectify the alternating current allowing only pulses of direct current to pass through the meter and to register on it.\* Actually, we will have one pulsation of current passing through the meter for every two half cycles and at first you might expect that this would cause the needle to move only about half of the correct distance across the scale. This would be the case if we had not disconnected the milliamp shunt

from the meter in turning the switch from the D.C. to the A.C. position. Because the milliamp shunt is disconnected in the A.C. position, the meter becomes twice as sensitive as it would be with the shunt connected across its terminals, and so the needle will reach nearly to the right-hand end of the scale when the full voltage corresponding to any of the voltage ranges is applied.

Actually, the needle will not move fully across the scale towards the right-hand end, and to make up for this fact the meter scale has marked on its face, two sets of graduations which apply particularly to the measurement of alternating voltages. Across the top of the meter scale we have marked the graduations corresponding to ohms of resistance and then immediately below these the evenly spaced graduations corresponding to direct voltage measurement. These are the graduations we have been using in all our tests up to the present time. Below these again, there is a set of graduations marked "A.C. Volts" near the centre, and at the right-hand end marked "50v. A.C. and up." These graduations are to be employed whenever measuring alternating voltages on the 50, 250 or 1000 volt ranges.

For measuring low values of alternating voltages, where the 10 volt range is employed, we observe the position of the needle on the innermost set of

\* See A.R.T.C. Service Engineering Course Lessons 26 and 32.

graduations. These are the graduations marked at the right-hand end "10v. A.C. only."

If you live in a building in which alternating power mains are available, you may test the A.C. ranges of your multimeter by plugging one test lead into the socket marked "—", and the other test lead into the socket marked "250 volts". The other end of the test leads can be applied to the contacts of a power point or light socket and the voltage will be registered on the second set of graduations from the bottom of the meter scale.

When connecting the test leads to the power point or light socket, be careful not to touch the two contacts directly with your fingers as an unpleasant or even fatal shock could be experienced.

If you have a radio receiver operating from the alternating power mains, you can employ the 10 volt range of your meter for measuring the low values of alternating voltage applied to the filaments or heaters of the amplifying valves in the receiver.

When employing the 10 volt range, be careful not to allow the test leads to slip and touch some other part of the receiver which may be carrying a high voltage.

When employing the 10 volt range for the measurement of alternating voltages, you will observe, if you touch the test prods directly to one another

without any voltage applied, that the meter needle moves a short distance across the scale. It will probably move up to a reading corresponding to 1 volt on the lower scale on the instrument. This initial movement of the needle will cause a slight error in measuring the value of alternating voltages up to about  $1\frac{1}{2}$  volts but for higher values of alternating voltage than this, the initial movement of the needle produces no appreciable effect on accuracy and from 2 volts upwards the instrument will be found to be quite accurate.

Once again let me remind you to be sure to disconnect the 1.5 volt battery from the filament of the valve when you have completed the measurement of alternating voltages.

### **USING A COPPER OXIDE RECTIFIER FOR ALTERNATING VOLTAGE MEASUREMENTS.**

The use of the valve wired as shown in Figures 19 and 20 will permit the accurate measurements of alternating voltages up to the value of 1000 volts, but later on, we will be employing the valve for other purposes in amplifiers, radio receivers, etc., and consequently we will be without the facility for measuring alternating voltages. With the final instrument you construct with your last kit of parts, you will again be able to measure alternating voltages at audio frequency and radio frequency by means of the meter

but you will not have a ready means for measuring power mains voltages, etc. For this reason, you may consider it desirable to purchase a copper oxide instrument rectifier which can be permanently wired into your multimeter to make available the immediate reading of alternating voltages at any time. This rectifier is not included with your kits of parts because of the fact that it is not an essential in radio service work

but is a luxury which some may think is worth including. If you do decide to purchase one of these rectifiers, you should specify a full-wave 1 milliamp instrument rectifier, such as the Westinghouse type MBS1.

The rectifier will have four terminals or connecting leads, one of which will be marked plus or coloured red. This lead should be connected to contact No. 2 on the multimeter switch. Another of the leads will be

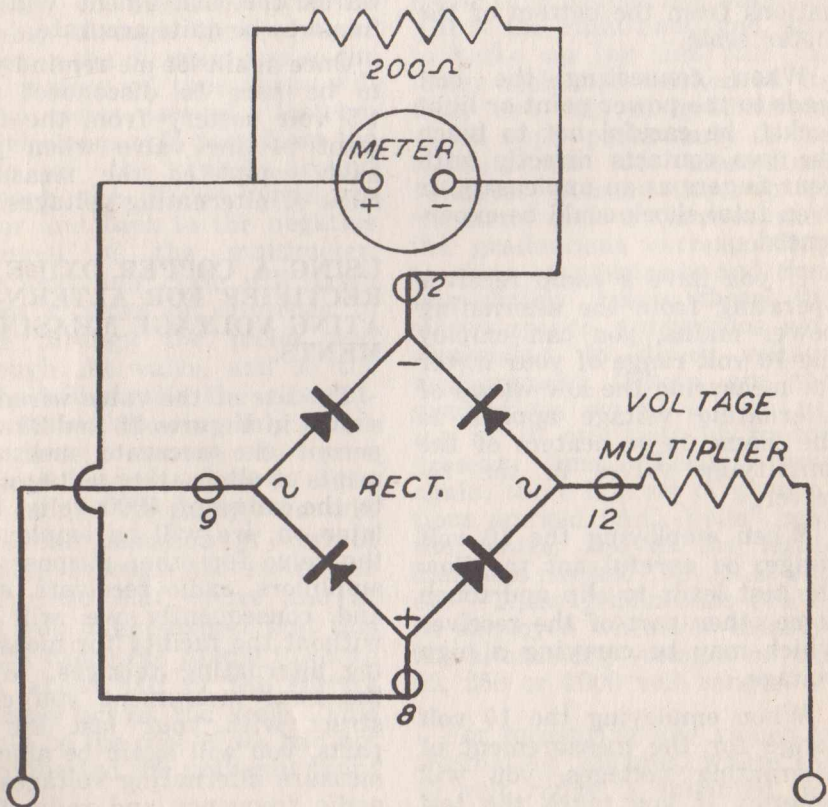

Fig. 21.

marked minus or coloured black. This one should be connected to contact No. 8 on the switch. The other two leads will be marked A.C. or marked with a symbol “~” or may be coloured white. One of these should connect to lug No. 12 on the switch and the other one to No. 9. The leads will probably be long enough to allow the rectifier itself to be bolted onto the right-hand end of the resistor panel. The 200 ohm resistor previously supplied can also be mounted between the two unused lugs at the end of the resistor panel and connected to lugs 2 and 8 on the switch.

One of these instrument rectifiers actually contains four small “copper oxide” rectifiers connected in what is called a “bridge” circuit. The circuit of the voltage measuring section of the multimeter incorporating a copper oxide rectifier is shown in Figure No. 21. You will be able to follow the passage of current through the instrument if you consider that current can only flow through the rectifier in the direction in which the arrows are pointing. Thus, current entering at the right-hand side of the diagram would pass through the voltage multiplier, the upper right-hand rectifier to the positive terminal of the meter and 200 ohm resistor, and then, through the meter and resistor to the negative terminal, back to the bottom of the rectifier, upwards through the

lower left-hand rectifier and out through the other test lead. When the alternating voltage reverses, current would enter at the left-hand test lead, pass through the upper left-hand rectifier, again to the positive side of the meter, through the meter and resistor, back to the bottom of the rectifier and through the lower right-hand rectifier back through the voltage multiplier to the other test lead. Thus it will be observed that regardless of which test lead is positive at any instant of time, current will always flow in the one direction through the meter and the meter will register the strength of alternating voltage on its scale.\*

As when using a valve rectifier, it is necessary to measure low values of alternating voltage on the 10 volt scale, which is the lower set of graduations on the meter dial. Alternating voltages employing ranges of 50, 250 or 1000 volts should be observed on the second set of graduations from the bottom.

As mentioned previously, it is not essential to purchase one of these copper oxide rectifiers, but the information is given in this Lesson in case you may consider it desirable to do so and in any case, by studying Figure No. 21, you will be able to understand the action of these rectifiers should you come across them at any time.

\* See A.R.T.C. Service Engineering Course Lesson 41.





# Lesson No. 4



**All Rights Reserved.**

**Australian Radio & Television College Pty. Ltd.**

**206 Broadway, N.S.W.**

**AUSTRALIA**