

The magazine for AUSTRALIAN  
Amateurs 

February 2004  
Volume 72  
No 1 & 2

# Amateur Radio



\$ 6.50  
inc GST

**BELIEVE IT OR NOT,  
you are looking at  
a huge...**

**Free  
HAMADS**



**On-air**

# NEW YEAR PARTY!

**WIA welcomes first-time HFers in style**

**Riding and talking  
Turning my motorbike  
into a mobile station  
[Steve Trebilco VK3NF]**



**A Transmission Quality  
Checker, "TQC"  
[Drew Diamond VK3XU]**

**A high performance  
1 kHz to 25 MHz  
signal generator  
[Dale Hughes VK2DSH]**

# BENELEC

## YAESU

### FT-897



#### FIELD/MOBILE/BASE/STATION

#### HF/VHF/UHF High-Power multi-mode Transceiver

#### Features:

- Tiny 200x80x262mm
- TX Frequency Coverage: 160-6m, 2m, 70cm (Amateur bands only)
- RX Freq. Cover.: 0.1-56 MHz, 76-108 MHz, 118-164MHz, 420-470MHz
- Power Output:
  - 160-6m: 100W / 25W
  - 2m: 50W / 12.5W
  - 70cm: 20W / 5W
- Innovative FC-30 bolt-on (optional) Automatic Antenna Tuner
- Big-Radio Tuning Dial & Ergonomics in Ultra-Compact Transceiver
- Optional Internal Battery or power supply
- Built-in CTCSS / DCS Encoder / Decoders
- Emission Modes: CW, AM, SSB, FM, 9600 & 1200 bps packet
- 200 Memories plus Home Channels and Band-limiting Memories
- High performance PLL Design
- Upgrade with Collins Mechanical Filters for SSB and CW!



#### Accessories



ATAS120



**FC-30**  
External Auto Antenna Tuner



**YF-122C**  
Collins Mechanical Filters



**MH59A8J**  
Full Remote Control DTMF Microphone

...many more accessories available

## Rotators

Auto Tune Antenna  
6m, 2m, 70cm



**G-2800DXC**

Heavy Duty Applications



**G-1000DXC**

Medium Heavy Duty Applications



**G-800DXZA**

Medium Duty Applications

**G-5500**

Azimuth-Elevation for Satellite Transmission



**G-450A**

Light to Medium Duty Applications



For Full Range of Accessories refer to our website

Colour brochures, Operating Manuals and full details on all Yaesu products can be found on our web site! Check it out...

[www.benelec.com.au](http://www.benelec.com.au)

Authorised Yaesu Retailers

NSW  
Andrews Communications Systems  
Tel 02 9636 9060  
lee.andrews1@bigpond.com

VIC  
Strictly Ham P/L  
Tel 03 9729 7656  
sales@strictlyham.com.au

Qld  
Kyle Communications  
Tel 07 3857 4400  
mark@kyle.com.au

Newcastle Pro Sound & Communications  
Tel 02 4965 6899  
sales@newcastleprosound.com.au

G&C Communications  
Tel 03 5996 3298  
gccomm@netspace.net.au

SA/NT  
POSNAV Systems P/L  
Tel 08 8342 4700  
brenton@posnav.com.au





# Amateur Radio

Volume 72, Number 1 & 2  
February 2004

The Journal of the Wireless  
Institute of Australia  
ISSN 0002-6859

## Editorial

Editor: Colwyn Low VK5UE  
edarmag@chariot.net.au

Technical Editor: Peter Gibson VK3AZL

Publications Committee Members  
Brenda Edmonds VK3KT  
Ron Fisher VK3OM  
Don Jackson VK3DBB  
Evan Jarman VK3ANI  
Tom Potter VK3UBS  
Bill Roper VK3BR

## Submission of material to Amateur Radio Magazine

General and Technical articles to  
Secretary  
AR Publications Committee  
3 Tamar Court  
Mentone VIC 3194  
or armag@optusnet.com.au

Columns and Letters to the Editor to  
Editor  
AR Magazine  
34 Hawker Crescent  
Elizabeth East SA 5112  
or  
edarmag@chariot.net.au  
(Tel and Fax 08 8255 2138)

Harnads to  
"Hamads" Newsletters Unlimited  
PO Box 431  
Monbulk VIC 3793  
Fax 03 9756 7031  
newunltd@bigpond.net.au

Advertising  
All enquiries to  
Newsletters Unlimited  
PO Box 431  
Monbulk Vic 3793  
Phone: 03 9756 7797  
Fax: 03 9756 7031  
newunltd@bigpond.net.au

Registered Office  
10/229 Balaclava Road,  
Caulfield North VIC 3161  
Australia  
Phone: 03 9526 5962

## Production Deadlines

Advertising booking and articles for  
publication 10<sup>th</sup> of preceding month.

Hamads and advertising material  
deadline 18<sup>th</sup> day of preceding month

The contents of Amateur Radio are Copyright  
Wireless Institute of Australia © 2004

## General

- Riding and talking. Turning my motorbike into a mobile station ..... 9 & IBC  
*Steve Trebilco VK3NF*
- Students link up with outer space ..... 21  
*Doug Tamblin VK5GA*
- On air party-goers revel in amateur radio's new era ..... 27  
*Jim Linton VK3PC,*
- Amateur Radio Magazine Index 2003 ..... 30
- Gil Sones VK3AUI—Quiet achiever, good friend (Silent Key) ..... 35

## Technical

- A Transmission Quality Checker, "TQC" ..... 4  
*Drew Diamond VK3XU*
- A high performance, 1 kHz to 25 MHz signal generator ..... 11  
*Dale Hughes VK2DSH*

## Columns

- |                         |            |                                  |        |
|-------------------------|------------|----------------------------------|--------|
| ALARA .....             | 42         | Gridsquare standings .....       | 26     |
| AMSAT .....             | 58         | Hamads .....                     | 62     |
| Beyond Our Shores ..... | 49         | Ham Shack Computers .....        | 49     |
| Contests .....          | 45         | HF Predictions .....             | 56     |
| Club News .....         | 29, 43, 48 | Intruder Watch .....             | 23     |
| WIA Division News       |            | Over to you .....                | 24, 44 |
| VK1 News .....          | 37         | Silent Key .....                 | 35, 36 |
| VK2 News .....          | 38         | Spotlight on SWLing .....        | 61     |
| VK3 News .....          | 39         | Sunspots graph .....             | 63     |
| VK6 News .....          | 40         | VHF UHF an expanding world ..... | 52     |
| VK7 News .....          | 41         | WIA Comment .....                | 3      |
| DXCC Standings .....    | 22         | WIA Division Directory .....     | 64     |
| Editor's Comment .....  | 2          | WIA Federal Directory .....      | 2      |
| Education .....         | 48         |                                  |        |

## Our Cover this month

Mai Johnson VK6 LC operating VK6WIA for the welcome to HF QSO party 1 January, 2004. It may not have looked huge, but it was. Read Jim Linton VK3PC's article on page 27, President Ernie Hocking VK1LK's comments, and many other reports of the great event in Division and Club notes.

## Contributions to Amateur Radio

Amateur Radio is a forum for WIA members' amateur radio experiments, experiences opinions and news. Manuscripts with drawings and or photos are always welcome and will be considered for publication. Articles on disc or email are especially welcome. The WIA cannot be responsible for loss or damage to any material. A pamphlet, How to write for Amateur Radio is available from the Federal Office on receipt of a stamped self-addressed envelope.

## Back issues

Back issues are available directly from the WIA Federal

Office (until stocks are exhausted), at \$4.00 each (including postage within Australia) to members.

## Photostat copies

When back issues are no longer available, photocopies of articles are available to members at \$2.50 each (plus an additional \$2 for each additional issue in which the article appears).

## Disclaimer

The opinions expressed in this publication do not necessarily reflect the official view of the WIA and the WIA cannot be held responsible for incorrect information published.

## Amateur Radio Service

A radiocommunication service for the purpose of self-training, intercommunication and technical investigation carried out by amateurs; that is, by duly authorised persons interested in radio technique solely with a personal aim and without pecuniary interest.

## Wireless Institute of Australia

The world's first and oldest  
National Radio Society  
Founded 1910

Representing

The Australian Amateur Radio Service

Member of the

International Amateur Radio Union

Registered Federal Office of the WIA

10/229 Balaclava Road  
Caulfield North Vic 3161

Tel: (03) 9528 5882 Fax (03) 9523 8191  
http://www.wia.org.au

All mail to

PO Box 2175 Caulfield Junction VIC 3161  
Business hours: 9.30am-3pm weekdays

### Federal Secretary

Peter Nalsh VK2BPN

### Federal Office staff

Jane Fox Bookkeeper  
Rita Trebilco VK3IF Examinations Officer

### Council

President	Ernest Hocking	VK1LK
VK1 Federal Councillor	Gilbert Hughes	VK1GH
VK2 Federal Councillor	Terry Davies	VK2KDK
VK3 Federal Councillor	Jim Linton	VK3PC
VK4 Federal Councillor	Glenn Dunstan	VK4DU
VK5 Federal Councillor	David Box	VK5OV
VK6 Federal Councillor	Trevor Ward	VK6HTW
VK7 Federal Councillor	Phil Corby	VK7ZAX

### Executive

David Jones	VK4OF
David Pilley	VK2AYD
Don Wilschefski	VK4BY
Brenda Edmonds	VK3KT (ex officio)

### Federal Coordinators

AMSAT	Graham Ratcliff	VK5AGR
ARDF	Jack Bramham	VK3WWW
Awards	Mal Johnson	VK6LC
Contests	t.b.a.	
Education	Ron Smith	VK4AGS
FTAC	John Martin	VK3KWA
Historian	John Edmonds	VK3AFU
IARU	Neil Penfold	VK6NE
Intruder Watch	Harry Anderson	VK8HA
International Travel Host	John Miller	VK3DJM
ITU Conference and study group	Gilbert Hughes	VK1GH
QSL Manager (vks, vko)	Neil Penfold	VK6NE
Videotapes	VK2 Division	
Web	Joe Burford	VK6UJ
WICEN	John Weir	VK3ZRV

### ACA Liaison Team

Peter Nalsh VK2BPN,  
Gilbert Hughes VK1GH  
Keith Malcolm VK1ZKM  
Glen Dunstan VK4DU

## Editorial comment

Colwyn Low VK6UE

## A new year and a big step forward for amateur radio in Australia

Morse code is no longer an examination requirement to operate on the HF bands from Australia. The great "Welcome Party" has been held and was very successful. I was able to make a few contacts to welcome some of the new users to the HF bands.

Other changes to Amateur Radio will become known as 2004 progresses and the matter of interference will be one of the most important to Amateurs as our interpretation of the ACA proposals was not to our benefit. The ACA did try to assure us that their position was not as draconian as some of us thought. I hope the WIA will be able to clarify both its position and the ACA position and come to a mutually acceptable position, with poorly designed commercial equipment not being used to limit amateurs operating their correctly operating stations.

There have been some problems with my advertising dates on events and contests in AR. I hope that the Calendar of Amateur events published in the December January issue will be used to ensure dates are correctly published. For example the dates for the end of the Ross Hull VHF contest were initially published as 11<sup>th</sup> January, while it luckily could be corrected to the 18<sup>th</sup>. However we did not get the weekend of the Summer VHF/UHF contest completely incorrect in the November issue and the 2004 Calendar. I would like to publish the calendar 2 or 3 times a year for the following 12 months, so would contest managers and event organisers please let me know the dates of their events as soon as they are confirmed. I am happy to initially publish in the most probable month without a specific date just to help people do some preliminary planning.

Amateur Radio is supposed to be an experimental activity with self-learning. I try to do something new every now and then. WICEN has a requirement when supporting Car Rallies in the Adelaide area to use vertical omnidirectional aerials at

reasonable heights. A collinear with 4 or more elements at 6 or so metres above the ground does quite well. I had been given a design for a 2 metre/70 cm collinear using RG58 and insulated wire with an air wound choke (QST, September 2003 p 28). I built this and was quite surprised to find it worked as claimed with a 1:1 SWR on both bands. I am currently building a 70 cm collinear from a design used by the Summerland ARC in one of their aerial project days. (ref www.rason.org by N1HFX) I will let you know how I get on.

AR still needs a DX columnist, I have had an offer to provide the Contest Column and we are negotiating the requirements. I also need some good Cover pictures. I have had some technically good pictures but the subject matter was more for local club members rather than an Australia wide audience. Portrait orientation, about 500kb file and a novel activity or piece of equipment with a person for human interest. See what you can do.

Submission of material. Technical and 1000 word plus general articles go to the Secretary, AR Publications Committee, 3 Tamar Court, Mentone, VIC., 3194. E-mail armag@optusnet.com.au. Electronic text preferred, diagrams in a bitmap format, jpeg etc. Will be redrawn to AR Magazine standards so clarity is more important from the author than neatness (too a degree). OTU letters and all columns to the Editor.

73 for 2004,

Colwyn VK6UE

The much admired photo of the young gentleman on the December/January cover was taken by Robert Broomhead VK3KRB. Many apologies for not including the appropriate acknowledgement at the time.

## What a News Years Day party!

**What a day it was!** After attending an early evening party I made it back to the shack for midnight 1 January 2004. Tuning across the bands the first thing that struck me was that all frequencies were occupied and were even running nets to welcome on board everyone after the change in the Morse Code requirements allowed all Australian amateurs onto HF. To quote many of you from on air "we had a ball". Thanks to Jim Linton for organising the event for us all and I look forward to hearing all of the new call signs on air again over the coming months.

### Watershed meeting held in Sydney

On Saturday 13 December 2003 a number of amateurs attended a meeting in Sydney to discuss options for the future of the WIA and specifically to consider the question of how to make the WIA a true National body rather than the Federation of States and Territories that it is today. This meeting was precipitated partly as a result of events taking place in VK2 and partly as a result of the ongoing WIA Strategic review. In one of those unusual holiday and work circumstances all except 2 of the current 7 WIA divisions (VK3 and VK7) was able to be represented at the meeting. I should stress that the meeting was not an official WIA meeting but simply a group of people who all wish to see the ongoing success of WIA as the peak body representing amateur radio here in Australia

In addition we were incredibly fortunate to have Michael Owen present. Many of you will know Michael from his work in IARU. Michael's presence was particularly important to the meeting since he had been involved in the writing of the current WIA constitution. At the start of the day Michael outlined the thinking behind the original WIA constitution. This was something of a revelation since he indicated that even 20 years ago that the intention had been to have a national body but that practical difficulties at that time did not allow such a single national body to be created and we therefore ended up with the current federated arrangement in place today.

A quick straw poll of those present

revealed a unanimous view that a single national WIA as the best outcome for all concerned. The reasoning behind this position was different for each of those present although the importance of the consensus view should not be underestimated. We spent a lot of time during the rest of the day discussing many of the practicalities involved in changing the current WIA into a national body. These issues covered items such as number of directors, regional or direct elections, dealing with current assets, locations of offices and a whole lot more. At the end of the discussions everyone was relieved to see that no one had thrown up any reason not to proceed.

So all in all the day was a great success but we now need to ask the question "where to from here?" There are number of actions that we all carried away from the meeting:

1. We would set up working parties to look in detail at issues such as the administration, finance, business operations and transition requirements that need to be put into place to undertake the transformation of the WIA from a federal to a national body.
2. Individuals would return to their Divisions to brief them on the meeting and the consensus position that was arrived at. Each Division was to be asked to discuss the proposal with their members in order to achieve an "in principle" agreement that could be taken to the 2004 WIA AGM to be held in Queensland in April 2004 (I have since the meeting briefed the Divisional Councillors of VK3 and VK7 who were unable to attend the

meeting and they are now also addressing this question).

3. A "draft" of a constitution reflecting a National rather than a Federal body would be developed that could serve as the basis for discussion amongst all WIA members.

Some of you may well say "So what – that same debate all over again!" This time I personally believe that success in this endeavour is highly likely. This is due to a number of factors including.

1. Moves to establish a foundation licence that will require extensive work and planning by a national amateur radio body.
2. Continuing increases in the costs of administering separate bodies and National, State, Region and club levels, and
3. Most importantly the high degree of support for this move being voiced at this time.

I'll leave you to make up your own minds but whatever you do please, please make your views known to your local Division representatives. As always I look forward to hearing direct from anyone who wishes to offer their view on these proposals

### The rest of the year

2004 looks like it will be a very interesting year for amateur radio and I look forward to being able to report on the WIA reorganisation, discussions with the ACA on licence reform and a whole host of other matters.

Yours in amateur radio

73 de Ernest Hocking VK1LK

# A Transmission Quality Checker, "TQC"

Drew Diamond, VK3XU,  
45 Gatters Road,  
Wonga Park, 3115.

For the amateur who uses a separate transmitter and receiver, signal monitoring is easy, because the receiver, if not overloaded, provides an indication as to transmitted signal quality and netting accuracy. However, the almost universal operating mode now is to use a transceiver. Inevitably there will be occasions when another operator will allege that there is some fault with your transmissions. They usually go something like this; "you're not netted properly", or "you're splattering right over our frequency", or on CW; "ur key clix 10 kHz wide OM", or (increasingly), "your signal has hiss and noise" and so on. The conscientious amateur will investigate any such comments or complaints either by obtaining off-air reports (which may be inaccurate), or by self-checking.

Self-checking is by far the better approach. A spare receiver may serve as monitor, but the problem is that your local signal, even with the receiver's input shorted, may be too strong, which causes various distortions, and may not give a true picture of what the signal is like (usually appears much worse than it really is). A more ideal quality checker would be a relatively insensitive battery-operated receiver that uses a very stable source of local oscillator signal, such as a quartz crystal.

The prototype TQC is (hopefully) an improved model based upon a bright

idea offered by Vic Kitney, VK7VK (Ref. 1), and may be used to check

- netting accuracy
- SSB quality
- AM quality
- CW keying characteristics, and
- quartz crystals for go/no-go.

## Circuit

The scheme is very similar to that employed by our old friend the heterodyne frequency meter (Refs 2 and 3). Essentially we have a simple untuned direct-conversion receiver with a crystal-controlled local oscillator (Fig 1). Oscillator signal and external signal are combined in a single 1N914 diode mixer. Detected product (audio) is filtered with an RC filter and applied to a popular LM-386 audio amplifier chip, where the signal is raised to speaker or headphone level. Sensitivity is such that a  $10\mu\text{V}$  applied signal may be heard, so the TQC will work with QRP and high power transmitters.

A cheap 3.579545 (3.58) MHz crystal (for example) will permit transmitter outputs to be checked at approximately 3.58, 7.16, 14.32 and 28.64 MHz, and conversely, the TQC's signal is available as fundamental and diode-generated harmonics at the Sig(nal) connector for injecting (by radiation) into the receiver section of a transceiver.

A 78L05 regulator chip supplies positive 5 V for the oscillator in order to prevent frequency "pulling" should the battery voltage vary.

AM may be monitored by coupling a small amount of transmitted signal into the TQC, a short length of wire or wire rod connected to the 'signal' connector will supply sufficient energy for the diode to act as a simple "crystal" detector.

## Construction

The TQC pictured in Photo 1 is housed in a readily available plastic 'jiffy' box measuring 130 x 68 x 44 mm. The oscillator and amplifier components are mounted upon a 55 x 100 mm rectangle of plain (double or single-sided) circuit board. Layout is not at all critical, and just about any preferred wiring style should do. However, a suggested "paddyboard" layout (Ref. 4) is shown in Photo 2. Note that the wiring to the 50 k Vol(ume) pot is made with shielded wire. Ordinary hook-up wire may be used for the speaker and battery connections. An external holder is recommended for the 9 V 'transistor' battery.

A 6-land 'substrate' accommodates the oscillator components, these being soldered onto the board with reasonably short lead lengths, as shown in Photo 2.

The 386 chip is fitted into an 8-pin DIL socket, which is soldered upon a substrate, tracks upwards, made from a 25 mm x 6-strip Vero off-cut (visible in Photo 2). The 'lands' of the substrate must be divided down the middle with a single junior hacksaw cut. The pins of the socket poke through the Vero, so a



Photo 1 Completed TQC . Modified crystal holder in foreground

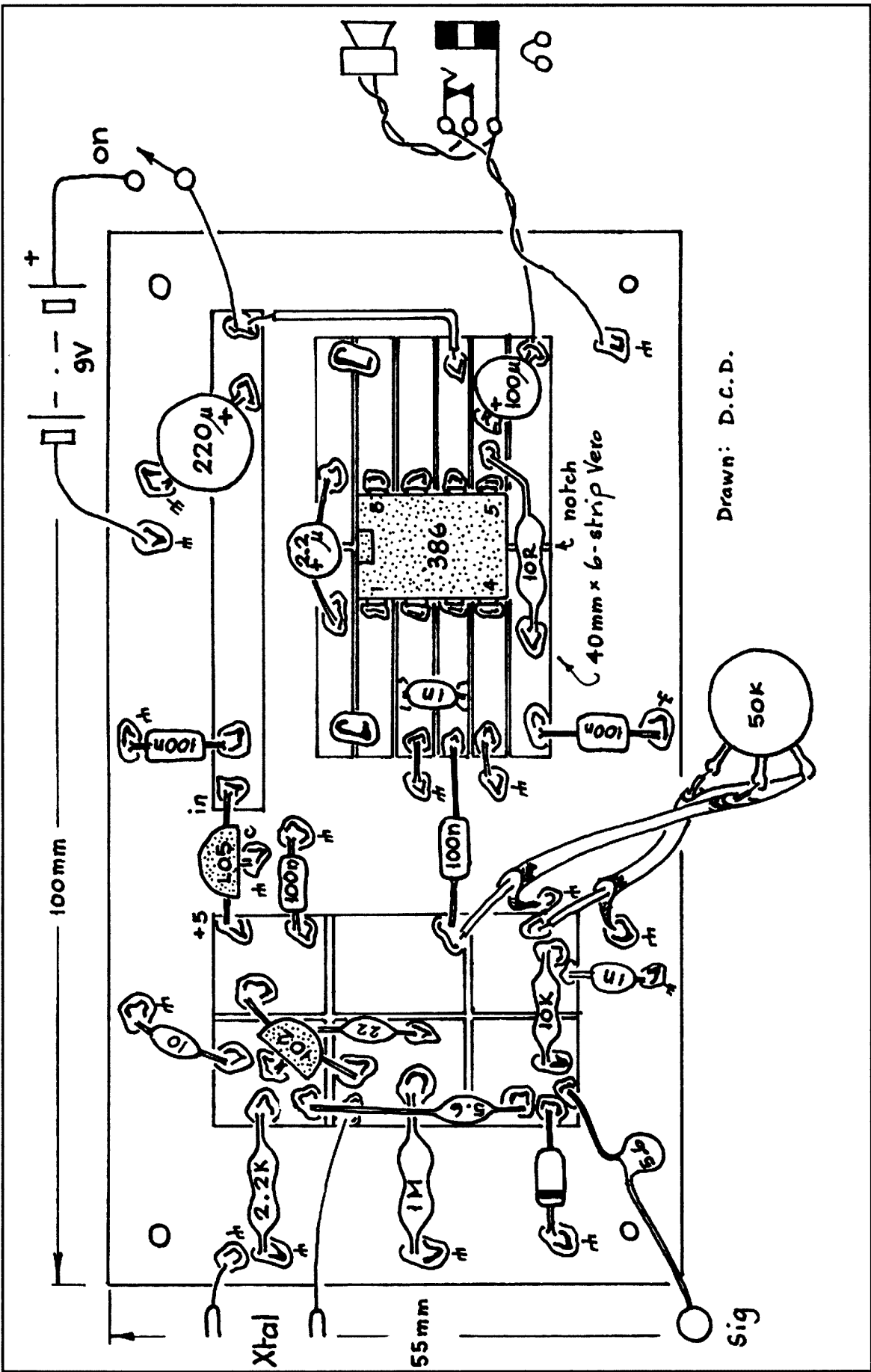

Figure 1

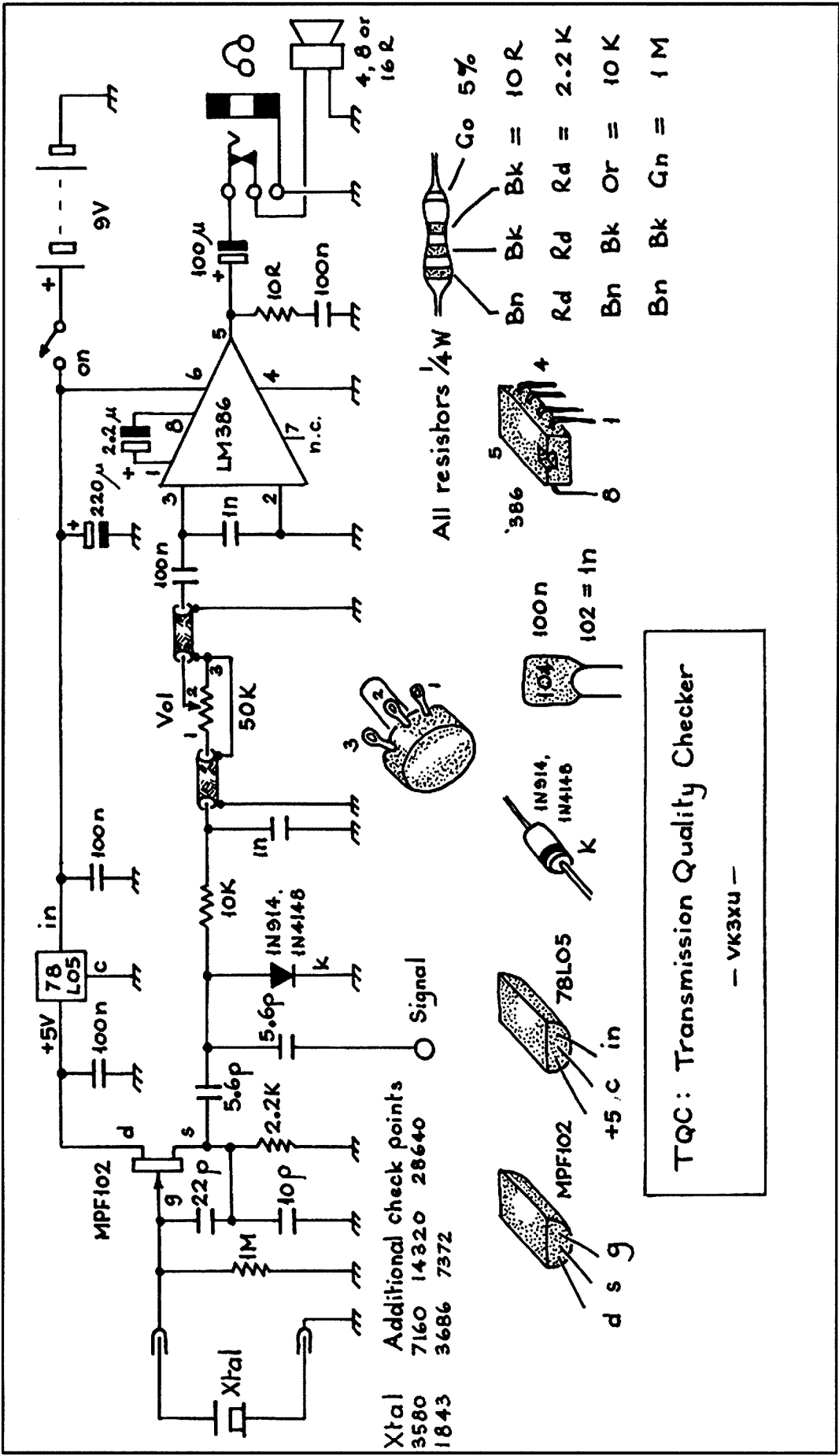

Figure 2



similarly sized rectangle of plain circuit board should be super-glued between, foil side down of course.

In the foreground of Photo 1 is an FT-243 crystal holder, which has been hollowed out (with a sharp wood-chisel) to accommodate a small 3.58 MHz crystal, for which a corresponding socket has been placed in the top of the jiffy box. Sockets for other desired crystal types may be wired in parallel.

## Operation

Verify parts placement and their polarity, pay particular attention to the orientation of the '386 chip. Set the Vol pot at about half travel. Switch on. Plug an appropriate crystal into the TQC, which will cause a click to be heard, indicating that the oscillator has fired-up. Clockwise rotation of the Vol pot may cause a slight increase in noise from the 'speaker, which should be just a soft hiss, showing that the audio amplifier is working.

For the following tests, attach a small length of insulated hook-up wire to the 'Sig' connector, by which the TQC's oscillator signal is radiated into your receiver, and conversely, the transmitted signal is applied to the TQC. In practice, the wire may be wrapped a few times around the transceiver's coax. It should then be possible to hear the crystal's fundamental and harmonic signals on the receiver. Use headphones with the TQC for best results.

**Check netting accuracy:** Tune the receiver for zero-beat on the crystal frequency (or harmonic). Set transceiver's RIT to '0' offset. Key the transmitter on. Demodulated voice (SSB) from TQC must be correctly resolved. On CW, the demodulated tone shall be very close to zero-beat.

**Check SSB quality:** Tune-in TQC's signal. Apply transmitter's output to a dummy load. Key the transmitter on. Demodulated SSB should sound natural, without perceptible distortion, hum or noise. Vary the transmit frequency whilst speaking (hence the dummy load) and check for any splatter or excess "whiskers" each side of the signal.

**Check AM quality:** No crystal required for the TQC. Key the transmitter on. Detected voice should sound natural without distortion, hum or other extraneous noises.

**Check CW keying:** Tune TQC's signal for about 1 kHz note. Apply transmitter's

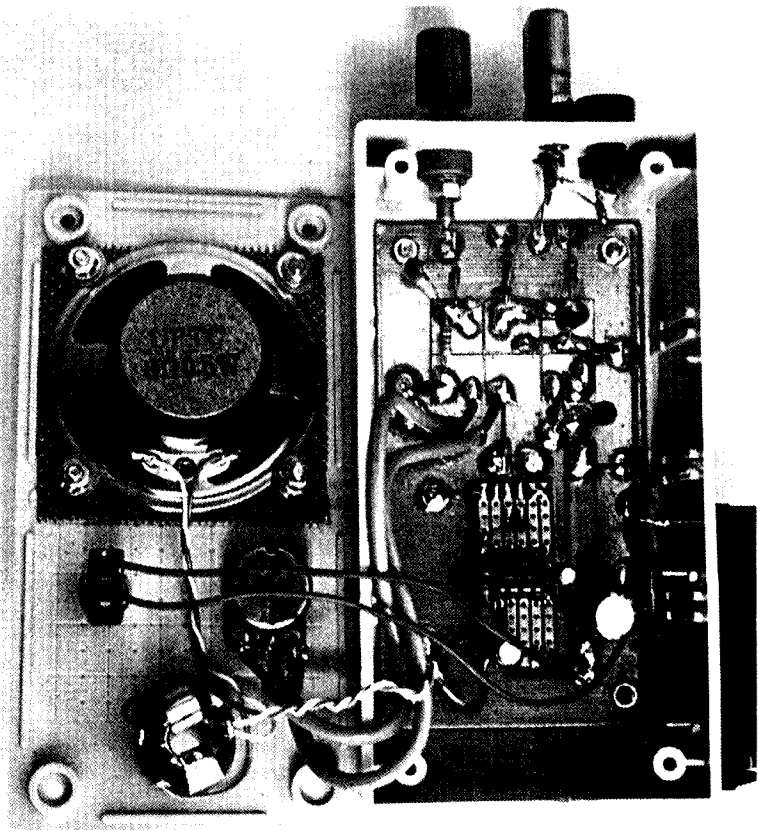

Photo 2. Internal view showing layout of components

output to dummy load. Send string of dots whilst varying transmit frequency beyond audibility. Detected signal should sound clean, without excess ripple, noise, clicks or chirp.

**Test crystals from about 2 to 25 MHz for go/no-go:** Plug crystal into TQC and tune receiver to expected crystal frequency.

## Parts

Most of the components required (including crystals on 1.843 and 3.579545 MHz) are available from our usual electronics suppliers: Altronics, D.S.E, Jaycar and Electronic World. Crystal sockets seem no longer to be stocked; ask your mates at the radio club, or look out for suitable items at the next hamfest. The speaker may be an 8 or 16 ohm salvaged from a defunct transistor radio.

## Summary

With the almost universality of transceiver operation, it may be difficult to ensure that transmitted signals are of acceptable quality, and are properly 'netted' onto the operating frequency.

Therefore, the sensible amateur should maintain a reliable, local method of checking transmission characteristics, without having to rely on (perhaps) inaccurate reports.

Details are given for a transmission quality checker (TQC); a simple device based on a crystal-controlled version of the conventional heterodyne frequency meter principle, which may be used to test netting accuracy, and SSB, AM and CW transmission quality.

## References

1. "A Netter Monitor"; Try This, V. Kitney, VK7VK, AR Nov. '95.
2. "Notes on the BC-221"; H. Gordon, W1KWB, CQ Aug '62 and AR Dec. '62.
3. Radio Servicing, Unit 1; Test Equipment. R.M.I.T., 1958 pp 32 - 40.
4. "Paddyboard Circuit Construction"; Diamond, AR Feb. '95.

# Cable and Connectors

**Belden**

- RG58C/U Belden 8259 @ \$0.90 per metre
- RG213/U Belden 8267 @ \$4.45 per metre
- RG8/U Belden 9913 Low Loss @ \$5.15 per metre
- RG8/U Belden 9913F7 High Flex Low Loss @ \$5.55 per metre
- RG8/U - RF400 Belden 7810 Low Loss Sweep Tested to 6000MHz @ \$6.30 per metre

**LINK**

- RG58: B80-006 UHF connector (M) @ \$7.65 each
- RG8/213: B80-001 UHF connector (M) @ \$8.80 each
- RG213: B30-001 N connector (M) @ \$9.10 each
- RG8: B30-041 N connector(M) @ \$14.00 each

**connektron** Pty Ltd

- \* All prices include GST
- \* Minimum order value \$50 payable by Visa, Mastercard, Bankcard or Money Order
- \* Packing and Delivery \$15 within Australia (Outside Australia P.O.A.)

ABN 19 413 484 007

email [sales@connektron.com.au](mailto:sales@connektron.com.au) or Phone (03) 9761-5220  
connektron Pty Ltd, 45 - 49 Merrindale Drive, Croydon South, Victoria 3036

**www.connektron.com.au**



*Systems*

## TTS Systems Communications Equipment

FREE CATALOGUE

[www.ttssystems.com.au](http://www.ttssystems.com.au)

### HF and VHF Transceivers, Autotuners and Kits

#### Ten Tec 6N2 VHF Multi-Mode Trans.

- Modes LSB, USB, CW, FM • Tunes 40-54 MHz and 144-148 MHz. • Transmit 1 to 20 watts • Meter Forward power TX, S Units RX • Separate low level drive connections for UHF and Microwave Transverters
- 12-14VDC 6A transmit.

#### Ten Tec RX350 Communications Receiver

- Modes AM/DSB, SAM/LSB, SAM/USB, AM, LSB, USB, CW, DIG, FM
- Tunes 100 KHz to 30 MHz.
- Stability +/- 90Hz at 25 deg C.
- S Meter S9 calibrated to 50mV standard
- Spectrum Sweep Display
- Selectivity 34 filters
- PC Interface



#### Ten Tec Jupiter HF Transceiver

- Pegasus features plus a LCD panel and controls. Use under PC control in Pegasus emulation Mode. GUI software at no charge. With the command set for control of both the Pegasus and Jupiter you can write your own control software.



#### Ten Tec Argonaut V QRP Transceiver

- Modes USB, LSB, AFSK, AM, FM, CW
- Tunes (RX) 500 KHz to 30 MHz. TX
- All HF amateur bands • Selectivity 35 built-in IF Filters from 200-2800 Hz, 4, 6KHz, AM, SSB, CW, 15, 15 KHz FM • Transmitter power adjustable 1 to 20 watts • Meter RF • Output 1 to 20W TX, S Units RX Power supply 13.8VDC (6A Transmit)



#### Autek Analysers & Power Meters

- RF1 Measures SWR, Z, L & C over 500 KHz to 32 MHz
- VA1 Measures SWR, Rs, Xs, Z, L, C, Phase angle, Rp, Xp, F<sub>1/2</sub> over 500 KHz to 32 MHz
- RF1 Measures SWR, Z over 50 to 500 MHz.
- WM1 HF computing power meter ranges 20W, 200W and 2KW both peak and average.

#### Davis Weather Stations

Davis Weather Monitoring Products for home use or serious weather observations Call for catalog.

**Amidon Cores** . Call for a stock/price list

#### Baluns and Transformers

LDG 4:1 200W balun in weatherproof enclosure. Custom baluns or RF transformers — Please call.

Build a **TEN-TEC KIT**

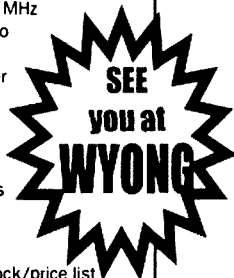

#### TEN TEC AND SGC GO NATIONAL

Three of Australia's leading amateur suppliers now re-sell these famous products.

Obtain the best at

Strictly Ham in Melbourne,  
Tower Communications in Perth  
and Kyle Communications in QLD.  
Watch for SA and TAS

WE SPECIALIZE IN MAIL ORDER. VISA AND MASTER CARD ACCEPTED.

CALL FOR A FREE CATALOG WITH PRICING.

DETAILED DATA SHEETS ARE AVAILABLE ON REQUEST FOR MOST PRODUCTS.

Phone 03 59774808. Fax 03 59774801 [info@ttssystems.com.au](mailto:info@ttssystems.com.au)

# Riding and talking

## Turning my motorbike into a mobile station

Steve Trebilco VK3NF

Steve VK3NF with Dave VK3GDL, Craig, John VK5NJ and Brian

Early in 2003 I was asked to go to Darwin, but my time was limited. Alice Springs was about as far as I could go on my motorbike. We started talking on air. VK5NJ John at Mt Gambier said he would like to go as well.

That's when I decided that I would like comms back to home. I began the process of seeing if it was possible to turn my motorbike into a mobile station.

I looked around in the motorbike shops for a pack rack and found that none were strong enough to hold a base and the Terlin Outrunner antenna. So necessity being the mother of invention I made one out of 12mm box section steel which I had purchased a while ago for another project. After a few prototypes that didn't work, I finally found the one that would withstand the stresses of the antenna and also approximately 108 kilogram of radio gear. The gear consisted of MFJ 941E antenna coupler, an Alinco DR 570, 17 amp hour gel cell battery, 80 m dipole with 300  $\Omega$  open wire feeder and of course the trusty soldering iron, accessories for minor repairs and the mandatory clothing, tent, sleeping bag and pillow. Well, that was that out of the way. Now, where to put the Alinco DX70?

It needed to be in a position where it was visible and reachable. To solve the problem I made a tank bag out of one of the kids' backpacks with some redesign work. The straps were repositioned and Velcro was used to fasten the bag to the struts underneath the tank. This made it easy to take on and off as necessary.

The coax ran underneath the tank, but well away from the electrical system of the bike. I found it to be adequate with about S2 ignition noise. I also ran the DC lead the same route. The main concern was whether the battery could handle the current drain. John, Dave and I conducted tests in the back yard on 80,

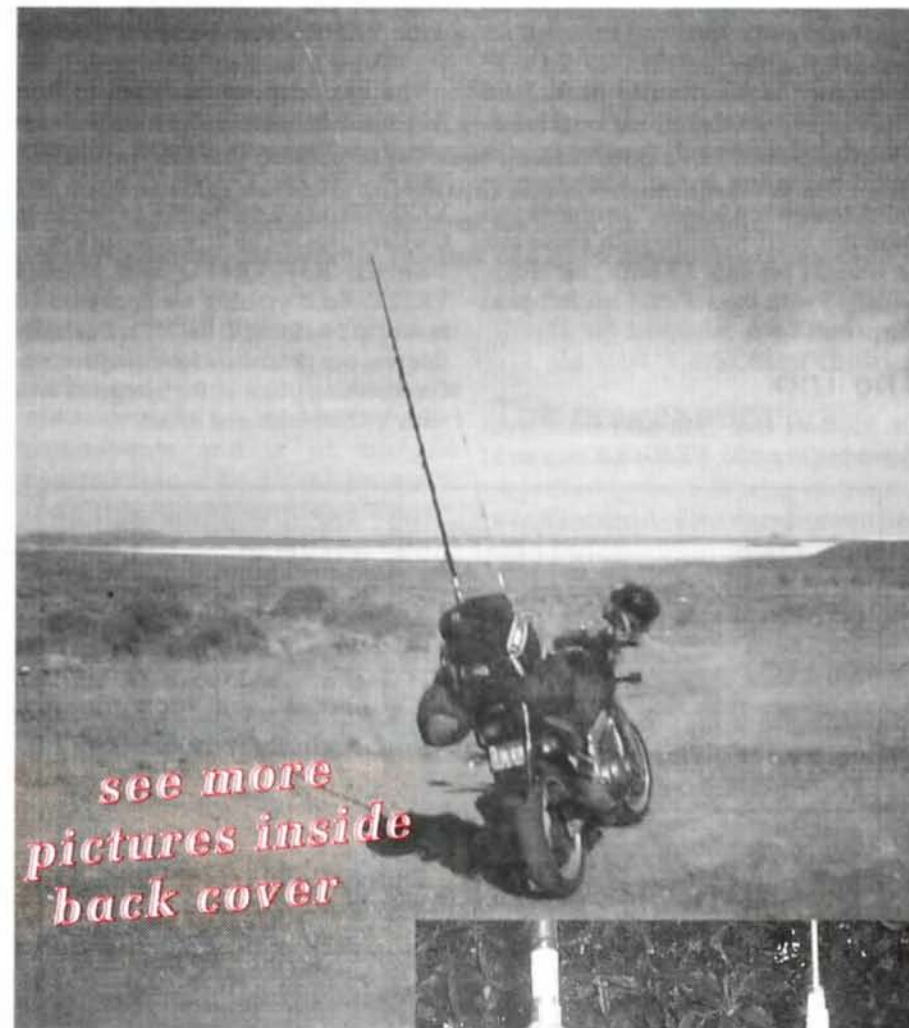

see more pictures inside back cover

The bike with all the gear packed

40 and 30 metre for about half an hour with no noticeable deterioration.

Next was to work out some way of talking while riding. Into the junk box I went. Putting earphones and a mic into the helmet proved to be economic. The junk box had a set of old army tank headphones, which I modified to fit inside the inner of the helmet padding. I found an old rocking armature telephone insert, which I sewed into the front of the helmet with foam covering the insert to try to reduce wind noise. I tried using

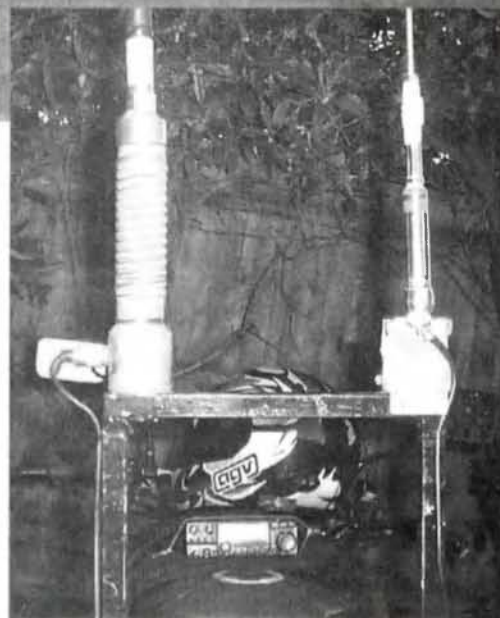

The bracket for the aerjals

vox circuitry but the wind noise tripped it too often, so a toggle switch was mounted onto the microphone lead close to the radio.

Now for the road test. I set off Saturday morning two weeks before the big day and started transmitting on 40 metre. David, John and Rita (the better half VK3IF) were listening to establish the signal and audio quality. I travelled for about 20 minutes and then QSYed to 30 metre for the 20 minutes back. John couldn't believe that it was working so well and commented, "you've got the audio but when is the video camera being put on the bike?" "I suppose you want the heart monitor with pulse rate as well", I replied. I heard him laugh. Satisfied with the set up, I left things as they were.

## The Trip

On Mothers Day 12th May (that went down really well), VK3GDL Craig and I

set off at 9.00am. First stop was Ballarat where we met up with VK3MKZ Keith who supplied breakfast. We were joined by VK3LSM Lindon, VK3VCW Ken and their partners. We left Ballarat at midday – it was time to make a mile. After a break at Birchip, the first stopover was Redcliff near Mildura. We'd travelled some 550 km. We made contact on 80 m with VK3IF, Peter VK3CPJ. Time to unpack get a meal and go to bed.

The next day we travelled to Port Augusta where we had contacts as we were travelling with VK5ON, VK5KGP, VK5FJ, VK5ZK, VK5NB VK5AVR and VK3SWD on 40 metre. We called in to the travellers net on 20 metre with Peter VK6HH, Roy VK6BO and Maurie VK3ZT. Each evening we spoke on 30 metre on 10.120 with the XYL. Basically this was our procedure for the entire trip. Our meeting place at Port Augusta was with VK5NJ John and Brian.

On Day 3 we rode from Port Augusta to Coober Pedy through the salt plains and had a quick chat with Colin, VK3LO on 10.120. How good is this – great signals both ways? Some 640 km ridden this day, time to find a place to stay. Dave VK3GDL had settled on the underground backpackers accommodation. Contact was made back to Melbourne that night on 80 m but the conditions weren't great, so 40 m was the go with good reports both ways. It was hard to put the microphone down with some 12 contacts made with people that had been informed about the trip.

Day 4 was from Coober Pedy to Alice Springs. Well I thought we had done a few long stints! Alice Springs proved to be the toughest on our bodies. We rode 870 kilometres that day. We ached all over, and were sure glad to be there. During the day we'd made contacts with Bill VK3SWD mobile and Mike VK3XL at home on 20 metre. Later in the day we went to 30 metre and spoke with the XYL, Bruce VK3UV mobile and Bill VK3BR. We had a break and I finished the QSO with Rita. During the next half an hour I listened to Rita and Brent VK2PB talking until I thought it was time to break in.

Given that it's open speed limit in the NT I had to try it out – high speed mobile. Brent asked "how fast you going?" "150 kph" I replied. Brent said "Its sounds good! The audio is overriding the wind noise". We had a few days looking at the sights of the Alice and an oil change for the bikes. It was time to say goodbye to Dave and Craig. They were half way to the top of Aussie.

John, Brian and I started the trip home, staying overnight at Curtin Springs. After we set up the tents, out came the dipole, the spare battery and the *mice*. Nothing had been said about that plague! The little rodents were bouncing off the tent roof all night. Not much sleeping was done.

Uluru the next morning and the climb! What a sight in every direction! John was impressed by the telephone service. [For those who travel to Uluru, it's worth the climb].

The rest of the trip was much the same as going up. We are all looking forward to the next trip. TNX to all the contacts.

ar

29th Feb 2004

Central Coast Amateur Radio Club Field Day

Wyong Race Course

For more info: CCARC Field Day, 18 Daley Ave, Daleys Point, 2257 NSW  
Phone 02 43402500 Web www.ccarc.org.au Email vk2afy@hotmail.com

Gates open 8:30 Admission General \$10 Concession \$5 Children U/12 free

# A high performance, 1 kHz to 25 MHz signal generator

Dale Hughes VK2DSH

A signal generator is one of the most useful items of test equipment that an amateur can own. There are many designs available, ranging from very simple free running oscillators to Phase Locked Loop and Direct Digital Synthesis types (see Ref (1) for example), each offering particular advantages and disadvantages. For accurate work the generator must be stable and re-settable to a particular frequency. An accurate attenuator is especially useful for accurate measurement of gain and bandwidth. The lack of a good attenuator is where many simple designs fall short.

This article describes the design and construction of a signal generator that uses a Direct Digital Synthesiser (DDS) IC to generate any frequency between 1 kHz and 25 MHz. The completed instrument has many uses: e.g. a stable signal source for receiver or antenna testing, a local oscillator for a receiver, an exciter for a CW or FSK transmitter etc. The project grew out of a desire to build a signal generator that would replace an elderly HP602 unit that was big and heavy. Also I wanted to learn about, and use, some up to date components such as the newer micro-

processors and DDS components that are now available at low cost.

This design achieved the above and makes extensive use of surface mounted components and is of modular construction. The signal generator consists of four main parts:

- The DDS module that generates a user programmable frequency referenced to a stable 50 MHz crystal oscillator.
- A precision step attenuator that has a range of 0 to 63 db attenuation.
- A microprocessor that controls the DDS module, the step attenuator, a

16 key keypad and a 2 line by 16-character liquid crystal display.

## The power supply

Each of the above sub-assemblies is described in the following sections. A significant part of the development time was the software which runs the microprocessor, and the end result offers many facilities, allowing the user to set the output frequency of the generator in various ways, set the output attenuator and modulate the carrier - either CW or FSK.

The various modules interconnect as shown in the Figure 1

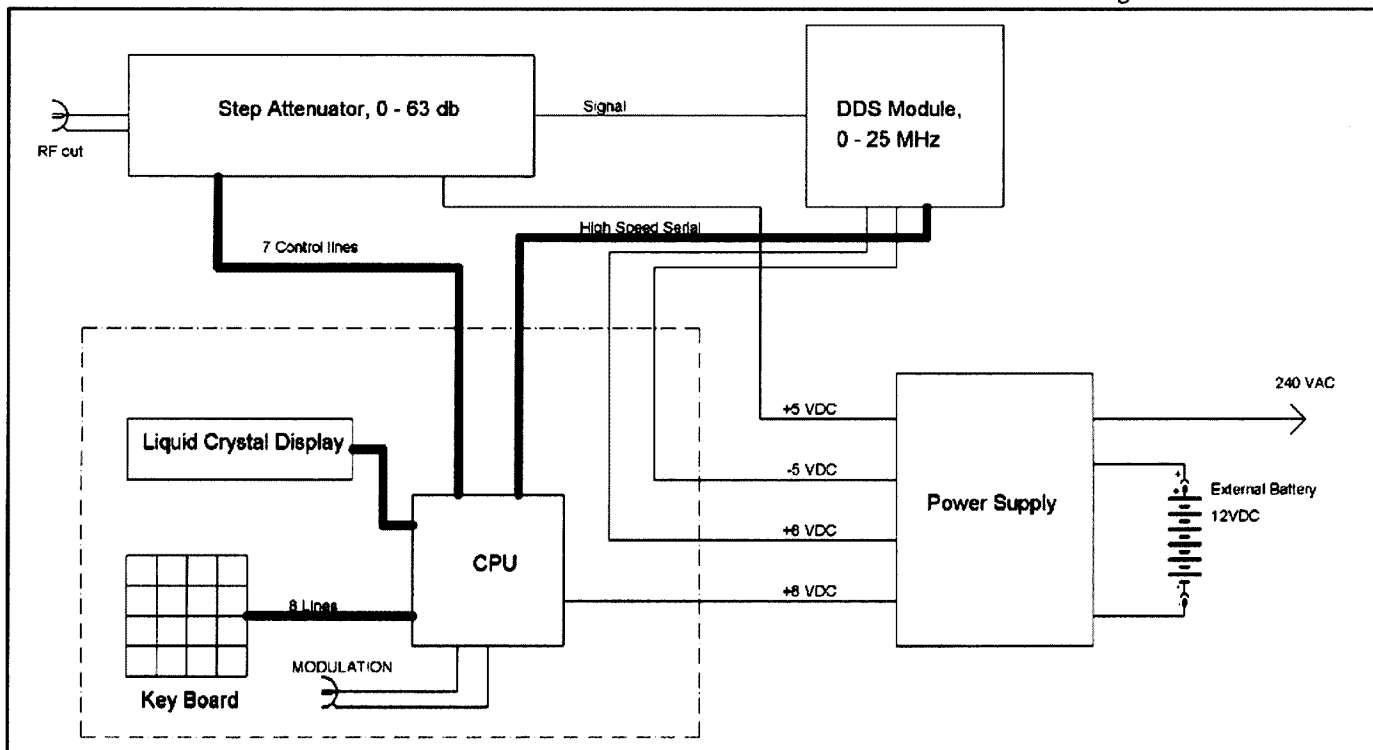

Figure 1: Block diagram of the signal generator.

This article does not include much in the way of mechanical details as the actual construction is dependent upon what tools and equipment the individual constructor has access to. However it is important to state that the mechanical aspects of the unit have a large effect on its electrical performance, especially with respect to frequency stability and the nature and extent of spurious emissions from the high-speed digital circuitry. Best performance will be achieved if each section is built in a well-screened, mechanically stable enclosure.

## The DDS module

The generation of the output signal is performed by a 'numerical oscillator', which consists of a stable clock source, a phase accumulator, a cosine lookup table and a digital to analog converter to convert the numerical information to an analog output. In this design a 50 MHz signal from a crystal oscillator is used as a clock source. The user can select an output frequency that is a fraction of the 50 MHz clock and the following equation is used to calculate a value that is used to program the DDS module:

$$C = \frac{F_o \times 2^{32}}{F_{clk}}$$

Where

$C$  = 32 bit value used to set the DDS output frequency,

$F_o$  = desired output frequency,

$F_{clk}$  = reference clock frequency (50 MHz in this design).

It can be seen from the above equation that we can program the DDS chip to produce one of a large number of discrete frequencies, spaced at approximately 0.01 Hz. For example, if we require a 1 kHz output, the above equation would give us a value of 85899.345. The value we write to the DDS module is 85899 or 14f8b Hexadecimal. The controller software does this calculation for us; however the user can calculate and enter the 32-bit value if desired. A hexadecimal calculator makes this task much easier, a suitable calculator is a HP 6S Scientific Calculator, which is available from Dick Smith Electronics at low cost. Note that there might be a small rounding error in the above calculations, depending on the relationship between the selected output frequency and the clock frequency, in

Figure 2: DDS module schematic.

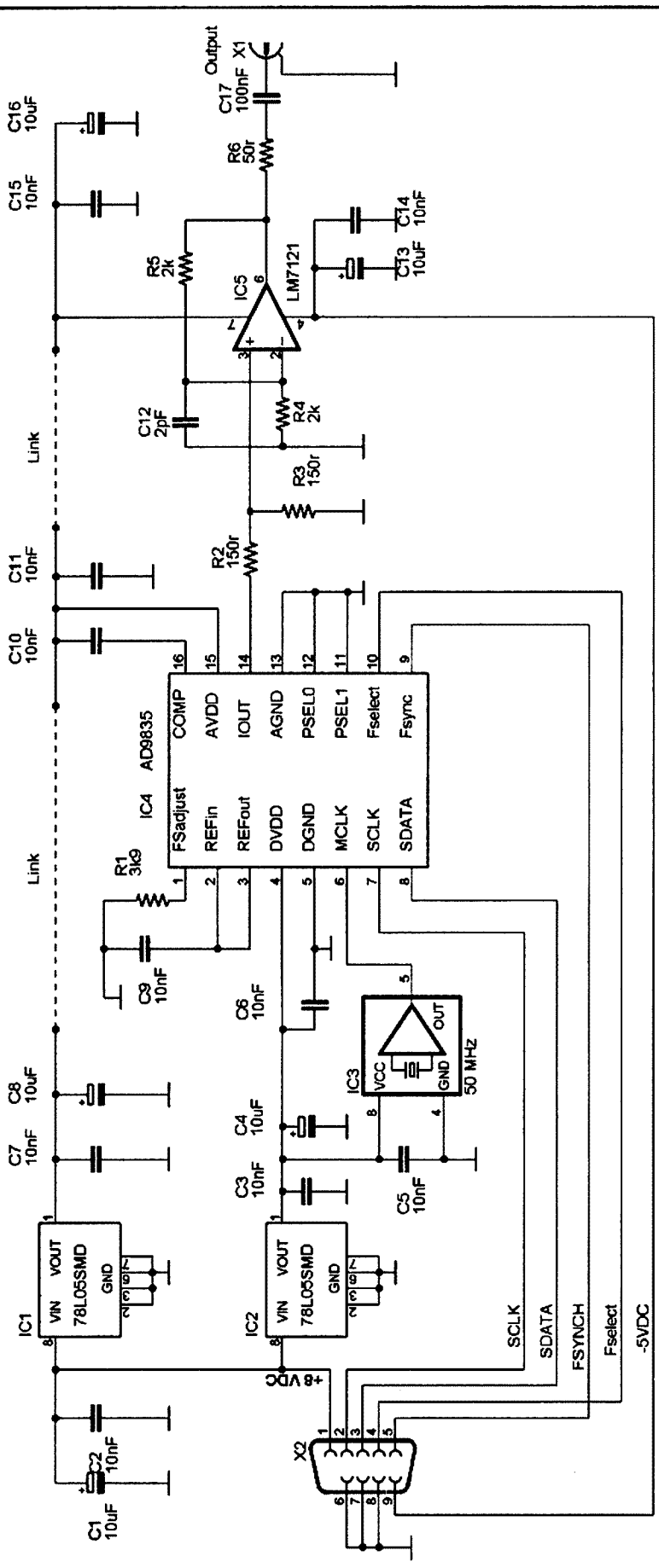

practice this is a very small value. Figure 2 is the schematic diagram of the DDS module. An Analog Devices AD9835 DDS chip is used, as this chip is readily available. For a complete data sheet and application examples see Ref (2). A LM7121 operational amplifier amplifies the sine wave output from the DDS chip. The amplifier has a gain of 2 and an output impedance of approximately 50 ohms. Separate voltage regulators supply power to the digital and analog components of the DDS module and extensive de-coupling ensures that little digital noise is coupled into the analog circuitry.

Control of the DDS chip is by means of a high-speed serial interface that controls various registers inside the DDS chip. The AD9835 contains two sets of registers for setting the output frequency, either one of which can be selected by the level on the frequency select pin ( $F_{select}$ ). The  $F_{select}$  input is also used for FSK modulation. Another register controls the output of the DDS and can be used to key the DDS output. The same

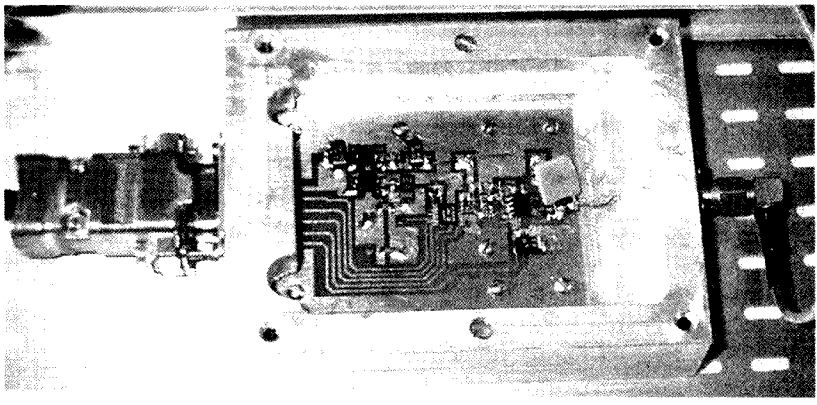

Figure 3: The DDS module with top cover removed.

register is used to setup and initialise the DDS chip.

The DDS module can be used with the Analog Devices evaluation software that can be downloaded from the Analog Devices website. The evaluation software can be used to test the module alone. In this case the DDS module is connected to several lines of a PC printer port, and the evaluation software allows the user to set the output frequency and to program the DDS to act as a basic

sweep generator. See Ref (3) for more details.

As can be seen from Figure 3, the DDS module uses surface mount components and the DDS chip itself requires a very fine soldering iron and a steady hand, as the spacing between the pins is only 0.63 mm. The rest of the components present no difficulty in soldering. For good screening and stability, the DDS module was built into a milled aluminium case and all signals, into and out of the unit, are via screened cable.

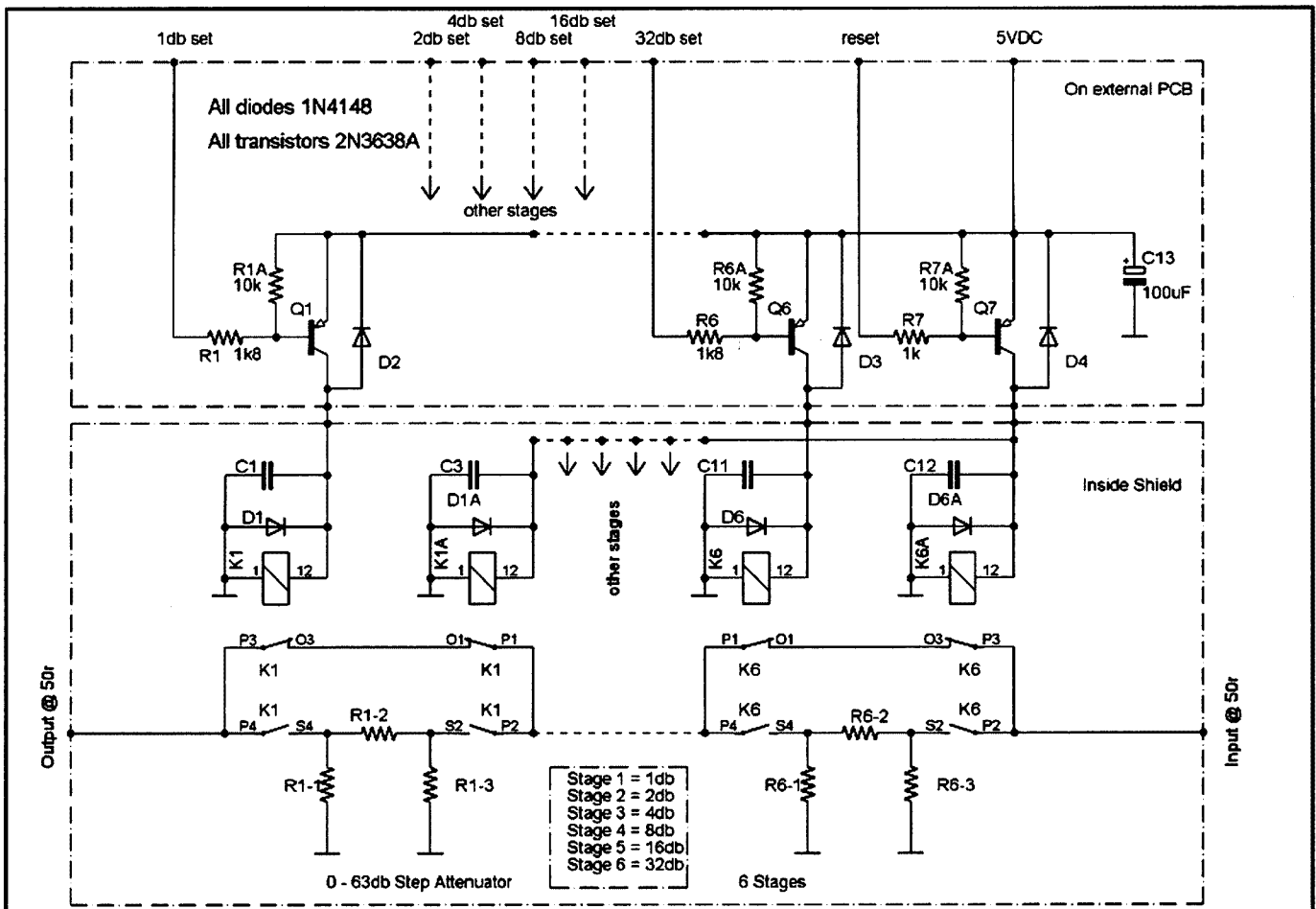

Figure 4: Attenuator schematic diagram.

# The step attenuator module

So that the output level of the DDS module can be controlled, a constant impedance step attenuator has been designed; Figure 4 shows the schematic diagram. The attenuator has a range of settings from 0 to 63 db in 1 db steps and the attenuator is controlled by the user via the microprocessor. A binary sequence (1, 2, 4, 8, 16 & 32 db) of individual PI type attenuators can be switched in or out of series to give the required value of attenuation. The value of the series and shunt resistances to give a specified attenuation (A) in db can be calculated from the following equations: (Ref 4)

$$e = 10^{\frac{A}{20}}$$

$$r = R_o \frac{1+e}{1-e}$$

Attenuation (db)	r (R1-1 & R1-3 etc)		R (R1-2 etc)	
1	869.54	910//20k	5.77	11//12
2	436.21	510//3k	11.62	12//360
4	220.97	390//510	23.85	24//3k6
8	116.14	120//3k6	52.84	62//360
16	68.83	82//430	153.78	220//510
32	52.58	56//820	994.64	1k//180k

Table 1: Attenuator resistor values.

$$R = \frac{2rR_o^2}{r^2 - R_o^2}$$

Where  
 A = Attenuation in db  
 R<sub>o</sub> = Impedance (50 ohms in this case)  
 R = Series resistor (R1-2 through R6-2 on the schematic diagram)  
 r = Shunt arm resistor (R1-1 & R1-3 through R6-1 & R6-3)  
 The values for each attenuator step are tabulated in Table 1, along with a

parallel combination of standard E24 resistors that gives a close approximation to each value. Tests of the complete attenuator gave the following results, showing that the measured and calculated attenuation are very close. The measured attenuation of any setting is approximately 0.1 db greater than the calculated setting; the maximum error over the whole range was -0.3 db.

The relays in the prototype attenuator are latching types, this has the advantage that no power is consumed to hold the relays in the required state, and this comes at the expense of added circuit and software complexity. The attenuator elements are made of parallel combinations of Surface Mount resistors (1206 size). Each section of the attenuator is screened from each other by means of shields made from scrap PCB material, and each relay coil is connected via feed-through and decoupling capacitors to minimise any stray coupling of the DDS signal between stages. PNP transistors (Q1 through Q7) are used as an interface between the logic level outputs of the controller and the associated relay.

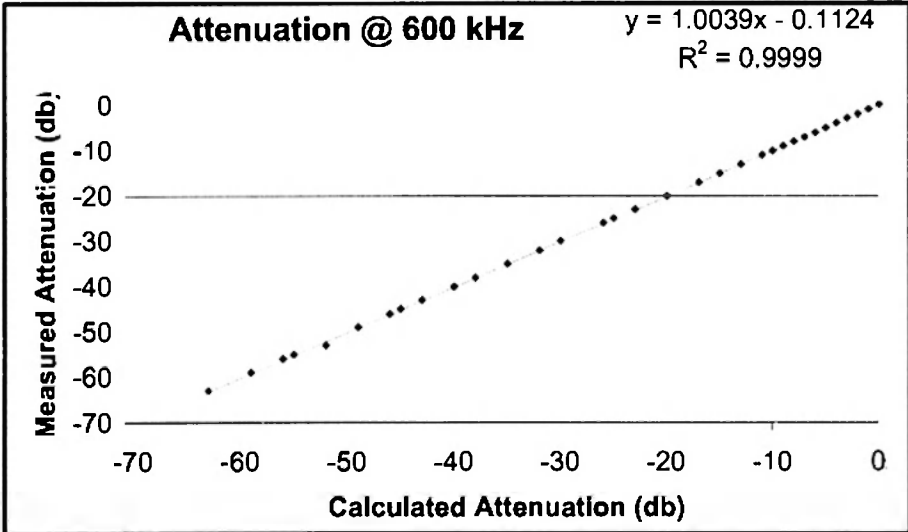

Figure 5: Measured Attenuation Vs Calculated Attenuation (at 600 kHz). This was measured using a Siemens D2055 selective level meter.

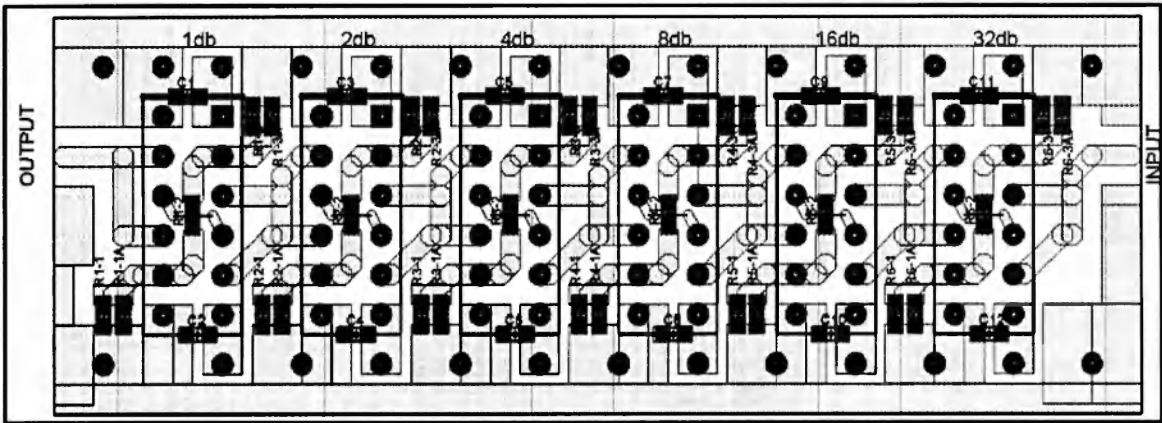

Figure 6: The step attenuator parts layout. The switching relays for each stage are mounted on the underside of the circuit board. Screens are fitted between each attenuator stage on both sides of the board and the complete assembly is housed inside an aluminium box. The control interface is on another PCB mounted on top of the attenuator enclosure.

# The micro-controller module

The micro-controller module controls the operation of the user interface (i.e. the keypad and the LCD), the DDS module and the step attenuator. I choose the AT90S8535 microprocessor as it offers high performance at a low cost. The



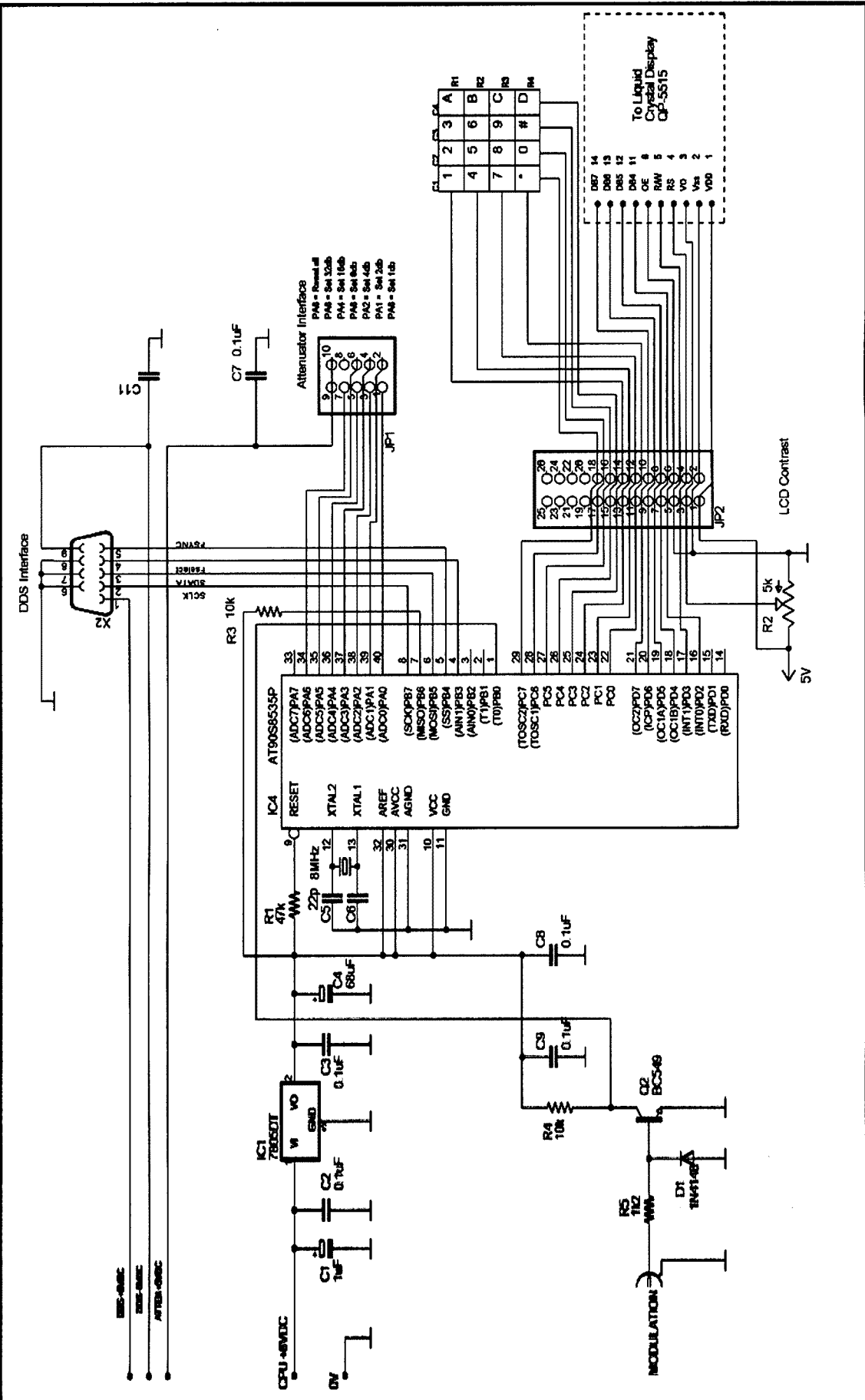

Figure 7: Micro-controller schematic diagram.

device runs at 8 MHz and it has a rich set of instructions that make it very suitable for applications such as this which make extensive use of the available input-output lines. The microprocessor interfaces to the 4 by 4 keyboard, the Liquid Crystal Display, the DDS module and the step attenuator. Figure 7 shows the circuit of the micro-controller and the interface between the various parts of the signal generator. It can be seen that 26 Input/Output lines are required to service the various parts of the system, and these lines are as follows:

The keyboard uses 8 lines, arranged as 4 row and 4 column lines, this allows the use of a low cost and readily available keyboard. The LCD uses 6 lines as it is configured in the 4-bit interface mode, that is, 4 data lines and 2 control lines. As each character is 8 bits wide, 2 write operations are required for each

character to be displayed. The DDS requires 4 lines to be used; they are the high-speed serial interface lines, the DDS reset and frequency select lines. The modulation input requires 1 input line. Seven output lines control the Attenuator, 6 lines set the relays to the required state and 1 line is used to reset the relays when the attenuation value is changed.

The external modulation input can be used to amplitude modulate, or frequency shift the output signal. When CW is selected a high level on the input turns the carrier on, a low level turns the carrier off. When FSK is selected, high selects frequency 1, a low selects frequency 0. As the AM mode uses the 'sleep' facility of the DDS, the maximum keying rate is limited to less than 500 Hz (approximately), however for ordinary CW or on/off keying that rate will be more than adequate. Frequency

Shift Keying is not limited in this way and high speed frequency shifting is possible.

Software controls most parts of the signal generator. The software for this design was written in assembler and the code is approximately 1 k words when assembled. The assembler I used is part of the AMTEL 'AVR Studio 4' development system and it is freely available from the AMTEL website (<http://www.atmel.com/>). A simple menu system allows the user to set the output frequency, set the attenuator and control modulation. All of this is done via the keypad and LCD. The micro-controller module was built on a small piece of prototype board (DSE H 5613) and is housed in its own screened section, all signals into and out of the unit are via feed-through capacitors.

# G&C COMMUNICATIONS

Authorised dealer for ● Kenwood ● Icom ● Barrett RFDS ● GME Electrophone ● Uniden ● YAESU

## KENWOOD

### TH-F7E Amateur VHF/ UHF Transceiver

Freq: TX: 144-146 / 430-440 MHz  
RX: 0.1-1300 MHz  
Mode: TX: FM RX: AM/FM/SSB/CW  
RF Power output: Hi: 5/5 W  
Lo: 0.5/0.5 W EI: 50/50 mW  
Volt: Int: 5-7.5 VDC External: 12-16

Weight: 250 gr (inc lithium-ion batt. pack)

### TM-D700A dual bander APRS, GPS and SSTV technologies. Built-in TNC, AX.25 protocol. Send and receive SSTV images using Kenwood's optional VC-H1. The TM-D700A

makes the most of APRS -  
Automatic Packet/Position  
Reporting System.  
Wideband receive 118 MHz  
to 1.3 GHz (cellular blocked).  
Includes MC-53DM DTMF  
backlit hand mic.



● Australia-wide orders welcome  
Credit card, cheque, Money order ●

## ICOM

### IC-208 Amateur VHF/UHF Transceiver

Freq: TX: 144-146 / 430-440 MHz  
RX: 118-1000 MHz  
Mode: TX: FM RX: AM/FM  
RF Power output:  
Hi: 50 / 50 W, Mid: 15 /  
15 W, Low: 5 / 5 W  
Voltage: 13.8 VDC  
Weight: 1.2 Kg



### IC-910H Amateur VHF/UHF Transceiver

Freq: 144-148 / 430-  
440 MHz 1240-  
1300MHz  
Mode: FM/FM-N/  
SSB/CW  
RF Power output: 5-100 / 5-75 W  
Volt: 13.8 VDC Imp: 50 ohms, SO-239 / N  
Dimensions (W\*H\*D): 241\*94\*239 mm



Most popular mono-banders  
**TE series EMTRON HF ANTENNAS**  
Storm tested — Call

## YAESU

### VX-7R 5 W Ultra- Rugged, Submersible Tri-Band Magnesium Handheld

Freq: RX: 0.5 - 999 MHz  
TX: 50, 144, 430 MHz Amateur Bds  
True Dual Receive: V-V/U-U/V-U/  
GEN-HAM  
Power Output: 5 Watts 222 MHz:  
300 mW) 6 m AM: 1 W— MANY GREAT FEATURES



### FT-897 Multimode high-power base/mobile transceiver

Freq: RX: 100 kHz-56  
MHz, 76 MHz-108  
MHz (WFM only) 118  
MHz-164 MHz 420-470  
MHz TX: 160 - 6 m,  
2m, 70 cm Amateur  
Bands: SSB/CW/AM/FM/FM-W/Dig.Modes  
100 Watts Power Output (HF/6 m); 50 W (2 m);  
20 W (70 cm) Opt. Int. Batteries: 4800 mAh x 2  
Built-in - Digi.Signal Proc. - 3-Message Memory  
Keyer- VOX —AF Speech Processor.  
MANY MORE GREAT FEATURES



207 High St. Cranbourne VIC 3977  
Ph: 03 5996 3298 Fax: 03 5995 0184

Email: [gcomm@netspace.net.au](mailto:gcomm@netspace.net.au)  
[www.gcomm.com.au](http://www.gcomm.com.au)

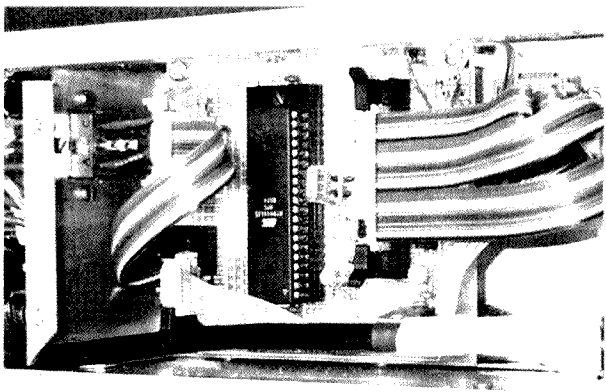

Figure 8: The micro-controller module.

## Signal generator functions

Table 2 lists the functions that exist in the current version of the DDS software. Each function is accessible from the local keyboard and the selections make setting the frequency and attenuation very easy. Preferred, or frequently used, settings can be saved in EEPROM for later use.

The power supply is conventional and generates the required voltages to operate the various modules of the unit. Two 8-volt outputs are used to provide power to the DDS module and the Micro-controller module. The power supply also provides 5 VDC for the step attenuator and -5 VDC for the DDS output amplifier. The DC-DC converter that generates the negative 5 VDC is overkill and was used because I had one, lower power devices would work just as well. Provision is made to power the unit from an external supply, such as a battery. The unit consumes approximately 125 mA, depending on the function selected.

## Power supply

The power supply is conventional and generates the required voltages to operate the various modules of the unit. Two 8-volt outputs are used to provide power to the DDS module and the Micro-controller module. The power supply also provides 5 VDC for the step

- 0 = Set Frequency Register 0 (f0:1 - 25000 kHz)
- 1 = Set Frequency Register 1 (f1:1 - 25000 kHz)
- 2 = Set Attenuator value (0 - 63 db)
- 3 = Select output frequency register (f0 or f1)
- 4 = Toggle output generator on and off
- 5 = Save contents of frequency registers and attenuator in EEPROM
- 6 = Set frequency registers and attenuator to values held in EEPROM
- 7 = Direct entry of HEX values into f0 or f1
- 8 = Enable external CW or FSK modulation (sub menu)
- 9 = Enable internal CW or FSK at fixed rate (sub menu)
- \* = CLR entry or Show function selections
- # = ENTER key
- A = Advance to next selection or increment value
- B = Go back to previous selection or decrement value

Table 2: Signal generator commands.

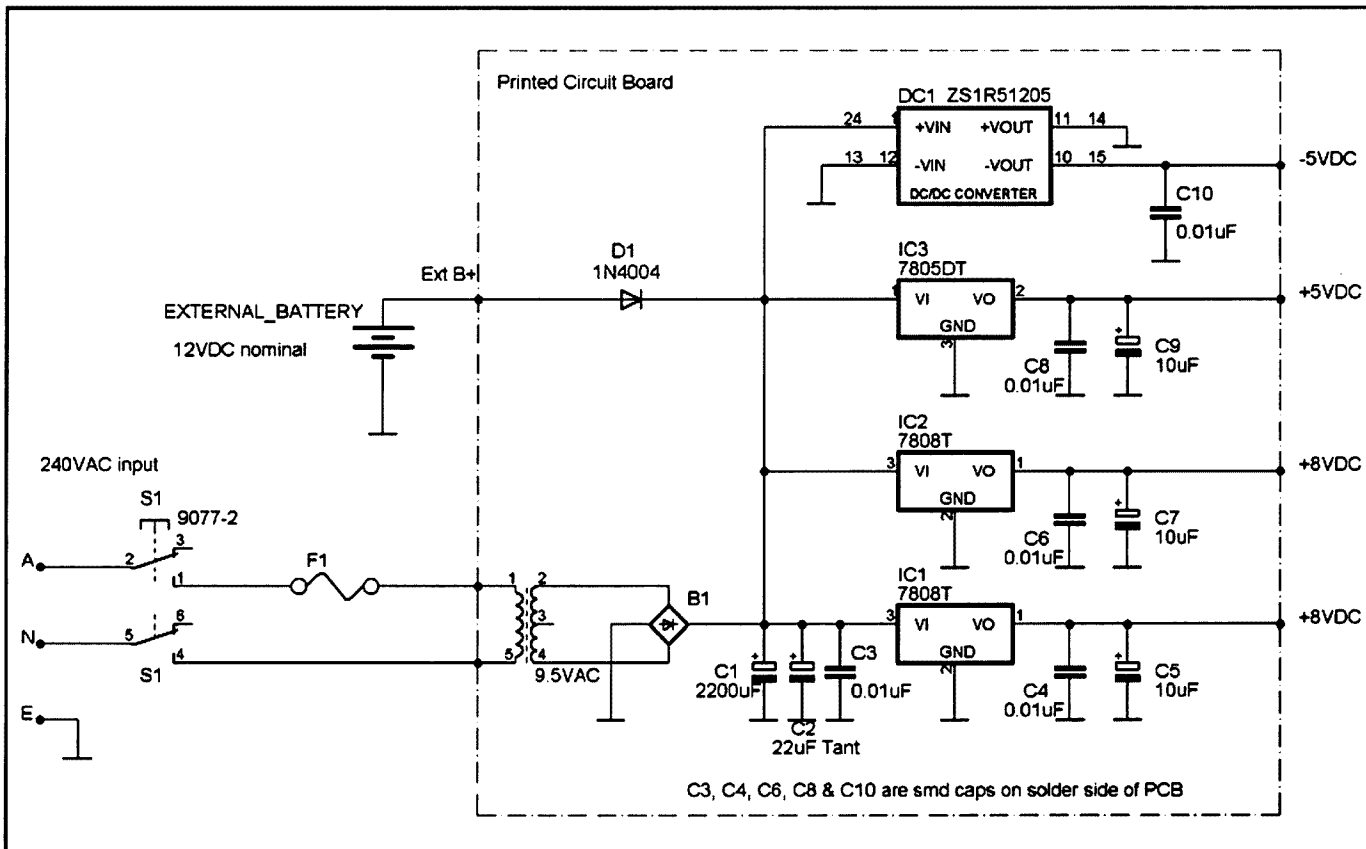

Figure 9: Power supply schematic diagram.

## QSL Travels:

# ALASKAN Amateur Radio Adventure

Join us for an

## ADVENTURE.

August, 2005

Join us for an Alaskan  
Amateur Radio Adventure  
as the South-Eastern  
Wisconsin Chapter 162  
QCWA (K9AKG) hosts the  
*International QCWA  
(W2MM) 2005 Convention.*  
The Convention will be  
held on a cruise to Alaska  
with options of joining a  
*DX-Pedition to Fox Island*  
or an *extended pre-cruise  
land excursion.*

The Alaskan Adventure is open to  
all Radio Amateurs and interested  
parties.

You do not need to be a member of  
QCWA to take part.

This is an excellent opportunity to  
get to know hams from around the  
world and also to BE THE DX.

There are several options available  
for this Alaskan Amateur Radio  
Adventure. The extended land  
excursion and the DX-pedition are  
both before the cruise. The hams in  
the family may wish to take part in the  
DX-Pedition while the other family  
members join us for an extended land  
excursion by rail.

We invite you to browse our website  
and see what Alaskan Amateur Radio  
Adventures await.

[www.qsltravels.org](http://www.qsltravels.org)

## General construction and performance of the signal generator

As various parts of the signal generator consist of high-speed digital circuitry, there is a high likelihood of digital noise being coupled into the output signal if appropriate preventative measures are not taken. To avoid this problem it is important that the various sub-assemblies are well screened from each other and screened cable is used for all analog signal lines. It is also important that the power supply is sufficiently decoupled and adequate filtering is provided so that noise is not coupled via the power supply, thus extensive use of feed-through capacitors is made and each section of the system is supplied through its own voltage regulator.

As the DDS chip generates the output signal digitally, a filter will be required to ensure a completely clean output frequency (depending upon the application of the device). The AD9835 data sheet indicates that wide band noise is generally less than 50 db below the carrier, with appropriate output filtering it should be possible to reduce the noise to better than 70 db below the carrier. This design incorporates no filtering as it was meant to be a general-purpose instrument. In practice, it appears that outputs below approximately 10 MHz

are very clean. As the output frequency rises the output waveform gets increasingly distorted and wide band noise increases as the number of steps in each cycle decreases. The theoretical maximum output frequency of the DDS chip is 25 MHz, or half the clock frequency, however one author suggests that an upper limit should be  $F_{clk}/3$  rather than  $F_{clk}/2$  (Ref 5). The frequency of any spurious outputs can be calculated easily using:

$$F_{spur} = M \times (F_{clk} \pm F_o)$$

Where

$F_{spur}$  = Frequency of spurious output,

$M = 1, 2, 3$  etc,

$F_o$  = desired output frequency,

$F_{clk}$  = reference clock frequency  
(50 MHz in this design).

It can be seen that spurious outputs approach the frequency of the wanted output as the wanted output rises towards  $F_{clk}/2$ . Thus removal of spurious frequencies is more easily achieved by keeping the output frequency less than  $F_{clk}/2$ . The worst-case amplitude of the spurious components is approximately 6N db below the carrier, where N is the number of effective DAC bits - 10 bits in this case. Reference (5) gives a very good account of the noise, distortion and spurious frequency effects in DDS systems.

Most of the minor components should be readily available from a number of

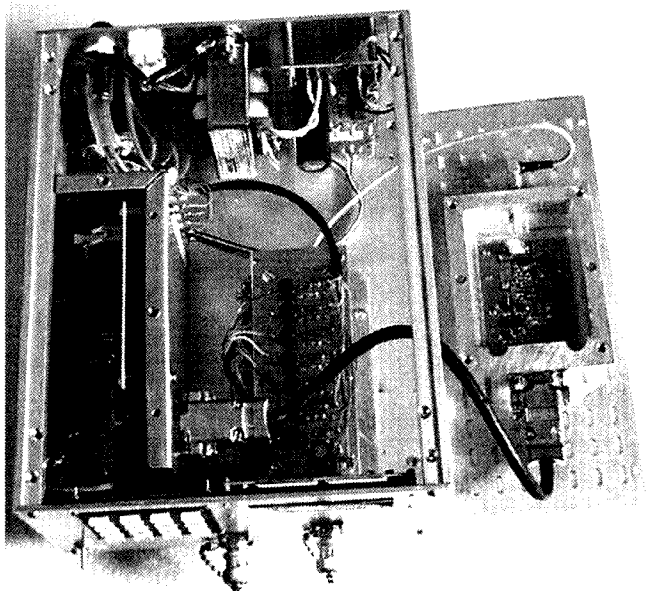

Figure 10: An inside view of the generator showing the DDS on the right, the attenuator module in the centre, the microprocessor module on the left and the power supply on the rear panel.

sources. A description of some of the major components and their source is listed below:

LCD: Jaycar QP-5515

16 Key Pad: Jaycar SP-0772

DDS Chip: Analog Devices AD9835, Farnell 334-3042

Microcontroller: AVR 90S8535, Dick Smith Z-9205

The bistable relays used in the attenuator were sourced from the junk box and may be difficult to find. They were manufactured by 'Aromat' and the type number is S2EB-L2-5. A search on the internet should find a source or possible equivalents.

## Conclusion

A design for a DDS based signal generator has been presented, which offers a high level of performance and flexibility. Artwork for the printed circuit boards can be provided to interested constructors. Also, I'm happy to provide programmed micro-controllers for the cost of the device and postage. Email me at: Dale\_E\_Hughes@bigpond.com



Figure 11: The complete instrument.

## References:

- (1) 'A 10 MHz Direct Digital Synthesis Generator', D. L. Jones. Silicon Chip, May 2003.
- (2) Analog Devices data sheet for AD9835 DDS chip\*
- (3) Analog Devices Application note EVAL-AD9835EB\*

- (4) 'Solid State Design for the Radio Amateur'. ARRL 1977. P150
- (5) 'Direct Digital Synthesis', B Bergeron, NU1N. Communications Quarterly, Vol 3, Num 3, 1993.
- (6) The Internet offers many pages of DDS information.

\* Available from <http://www.analog.com>

ar



EASTERN AND MOUNTAIN DISTRICT RADIO CLUB INC.

# WHITE ELEPHANT SALE

Great Ryrie Primary School  
Great Ryrie Street Heathmont  
Doors open at 10:30 AM  
Entry \$6.00 per head

Sunday 21 March 2004

Selling space: \$18.00 per table (inc entry for one person).  
For Bookings call Robert VK3R.RB on 0405 066 686 or email [wes@emdrc.com.au](mailto:wes@emdrc.com.au) by 12 March

Hundred of components, pre-loved radios, test gear, computers, software and commercial displays.

Talk in on VK3REC



147.175 MHz

Soft drinks, hot dogs, hamburgers on sale.  
Free tea and coffee.

WE ARE HERE

MELWAYS 49 K11



# Beyond our shores

David A. Pilley VK2AYD  
davpil@midcoast.com.au

Looking back over the 3 years I have had the privilege of writing this column, there has been so much happening involving Radio Amateurs. They have been involved in big disasters, providing communications where other means of communications have failed. Probably the most significant change was the removal of telegraphy and the new licence levels in the U.K. No doubt we will follow a similar path here in Australia. On the last weekend in November, I took part in the CQ CW WW contest and, although conditions were not good, there appeared to be twice as many stations participating. Perhaps taking something away from some people has given them the incentive to use it? Whatever, we look forward to a great future and I am sure there will be many new changes around the world that will effect us home here during the next 3 years.

## Future RFI

**As a regular user of our local library this one caught me eye – Book RFI!**

Remember those Radio Frequency I-D tags that are of such concern to ham radio? You will never guess where they are about to show up. Ken Butler, W1NNR, tells us: The San Francisco Public Library plans to track books by inserting an RFID tag to each one. These are the same radio tags that hams tried to get the FCC to not deploy earlier in 2003. Now, library officials in the Bay area say that they will install the RFIDs into the roughly two million books, CDs and audio visual materials. The system still needs funding and probably will not be ready for deployment until at least 2005. So in a few years when you receive QRM to your ham radio operations, you might find that its coming from that novel you are reading late at night.

(Science Today via ARNewsLine)

## Look for more ZAs

**Ham radio training is now available in Albania thanks to a new internationally sponsored training programme.**

A unique amateur radio program started in Tirana, Albania the 9th of November. Thirty-four third and fourth-year university students began a five-week amateur radio course using RSGB study material as the reference books. The course will culminate in CEPT licence examinations. It is being run in cooperation with Mr. Spartak Poci, the Albanian Minister of Telecommunications, and the Polytechnic University of Tirana.

A unique part of the program is the way in which amateur radio is being integrated into the regular university courses. The course will not only teach amateur radio up to the RAE Full-license

standard, but also the role of amateur radio in society, QSLing practices and successful DXpeditioning. As this is a 5 week course, by the time you read this you should have added a few ZAs into your log!

(ARNewsline)

## Sam Voron VK2BVS honoured by Prime Minister

Australia's Prime Minister John Howard and Foreign Minister Alexander Downer expressed gratitude for Australian ham radio training in developing countries. A certificate sent on 26 September 2003 to Sam Voron VK2BVS reads. "The Australian Government expresses its gratitude to Sam Voron for a valued contribution towards assisting developing countries to reduce poverty and achieve sustainable development". Signed by Prime Minister John Howard, Foreign Minister Alexander Downer and Member of House of Representatives Dr Brendan Nelson MP. In 2003 Sam spent 6 months overseas in Somalia where he organised an amateur radio training course.

(QNEWS)

## Real broad band radio

The CGC Communicator are reporting police or fire engines may soon be able to override the radio in your car. Jacksonville Florida based Safety Cast announces that it will soon test a new mobile alert system. One that will allow a police officer or ambulance driver to take over a car radio within a distance of about 1000 feet and broadcast a brief alert tone and warning message. *It doesn't say whether it's HF or VHF but the mind boggles at the type of transmitter that will be used!*

(ARNewsline)

## South Africa makes changes

It's proposed the Morse requirement for the ZS licence be dropped 12 to 5 wpm. Also that applicants for the ZU license will no longer be tested for proficiency in Morse code. A new licence class is to be introduced with the callsign prefix ZT. This license will not have any Morse code requirement. The holders of ZT licenses will have full VHF privileges and will be permitted to transmit with a maximum power output of 100 W on portions of the 160/80/40 and 15 meter bands.

(QNEWS)

## High school amateurs

49 youngsters are now licensed hams and are the newest members of Pennsylvania's Trinity High School Radio Club. This, thanks to a program called "Train the Trainer" by Pete Di Volpi K3PD, a teacher named Sean Barnes N3JQ and the Harrisburg Radio Amateurs Club V-E Team.

The Trinity High School Radio Club operators station KB3JAG. Barnes started the radio club so lower classmen could get exposure to the hobby before they attend their physics class. He notes that the school's physics program and the principles of amateur radio tend to integrate very well. The Harrisburg Radio Amateurs Club is a Special Services club in central Pennsylvania. It has only 100 members, but has seen over 100 new licensees produced in the last two years from their V-E and Train the Trainer programs. Teachers that are interested in Sean Barnes curriculum can e-mail him to SeanBarnesPolo@aol.com (W3UU, K3PD)

(ARNewsline)

# Students link up with outer space

Doug Tamblyn VK5GA

Renmark Primary School students heard about the hairier moments of life in outer space this week. Year 6 and 7 students were given the opportunity to ask astronaut Mike Foale questions about life on the International Space Station.



Renmark Primary School students with Mike Foale projected in the background, Photos courtesy of Doug Tamblyn VK5GA



Students from Renmark Primary School talk to Mike Foale on the ISS with Ivan Smith VK5HS assisting.

Student Brianna Barton 12 asked about Mr Foale's scariest moment as an astronaut. "I asked him what his most nerve-racking moment in space was and he said there was a collision with their supply ship". I also asked what he does for fun and he told me he writes in his journal and makes videos for his family". Student Tom Athanassiou 13 asked Mr Foale what it sounds like in space. "He told me that at one stage he turned off all the fans and he couldn't hear anything, it was dead quiet".

The astronauts are not able to leave the fans off for long because it would lead to a carbon dioxide build-up. Mike Foale also told the students he believes people will be living on the moon in another 10 years, and he had wanted to be an astronaut since the age of six. The link-up between the school and the space station was done by a group called ARISS which stands for Amateur Radio International Space Station.

These are a group of Amateur Radio

enthusiasts who work with NASA to link up schools with astronauts.

The link-up was assisted by Renmark Radio enthusiast Ivan Smith VK5HS. Event organiser school teacher Faye Brodie said the idea of the link-up came from a former Paringa man Tony Hutchison VK5ZAI. "It all started last year with Tony Hutchison VK5ZAI, he had a lot of connections with the international space station," Mrs Brodie said. He connected up with (astronaut) Andy Thomas at one stage.

The *revolutionary* VK4VKD

## One Man Tower

### Freestanding Self-erecting 10m to 25m



Fully adjustable delta loop rotatable antenna  
1-2-3-4 element

D.I.Y. delta loop element to boom 'hubs'  
350kg SWL 5:1 braking winches

Galvanised steel boom to mast clamps  
VHF and UHF beams  
High tensile 'U' bolts

Safety harnesses for above ground work  
Arrays easily taken to ground level for maintenance and wind protection

Easily erected without cranes  
*(Ideal for confined areas or remote repeater sites)*

proudly built in Australia by

### Australian Enterprise Industrial

Unit 1/34 Tradelink Avenue  
Hillcrest QLD 4118

(PQ Box 1013 Browns Plains QLD 4118)

<http://homepages.ihug.com.au/~aeitower>

aeitower@ihug.com.au

Tel: 07 3800 0551 Mob. 0414 254 080

Fax 07 3800 8003

# WIA DXCC Standings (335)

- 1st January, 2004

Mal Johnson VK6LC

Callsign	Countries	Callsign	Countries	Callsign	Countries	Callsign	Countries	Callsign	Countries
<i>Honour</i>									
<i>Roll(326)Phone</i>									
VK5MS	335/389	JA3EY	296/300	VK5ATU	126/128	VK7TS	219/000	VK2HV	289/000
VK4LC	335/382	VK4EJ	291/293	VK2IRP	125/101	IK1ZOD	210/000	VK3CIM	284/288
VE6VK	335/371	VK2HV	288/000	TG8NE	125/000	DL7PA	203/000	VK3VQ	276/293
VK4UA	335/370	VK4BAY	287/290	SM6PRX	121/126	VK5UO	171/172	VK6ANC	276/280
VK5WO	335/368	VK2CSZ	286/289	VK4EZ	119/125	VK4UA	151/164	VK6MK	256/259
VK6LK	335/360	VK7TS	285/286	VK2MH	116/118	VK4AAR	144/146	VK8NSB	256/000
VK3AMK	335/354	VK3DP	274/277	VK5UO	112/115	VK8AM	138/000	PY2DBU	254/257
VK3QI	335/349	VK6ANC	273/277	VK2JAU	111/000	N0TM	135/000	VK5UO	251/255
VK3AKK	335/348	VK2CA	265/000	VK3MRG	108/000	VK7DQ	131/132	VK2CWS	251/253
VK2FGI	335/341	<i>General listing-Phone</i>		VK2QV	107/000	DL6UGF	126/000	VK3DQ	246/275
VK3DYL	335/341	VK3UY	264/266	AX4EJ	105/000	DK6AP	120/000	VK2FHN	243/000
VK3SX	335/341	VK3VQ	261/278	VK9RS	104/000	K5QNM	110/113	VK4DA	237/239
VK3EW	334/340	VK2XH	257/000	ZS6IR	102/104	VK5BWW	110/113	VK8AM	236/000
VK6NE	333/349	VK8NSB	255/000	VK6ISL	102/000	SM6GZN	110/111	VK4CHB	177/179
VK2AVZ	333/344	VK3CIM	254/258	SV1GYG	102/000	VK4CXQ	106/000	9A4KA	168/000
VK1ZL	333/339	VK8DK	249/250	SV1FTY	102/000	UR5BCJ	103/105	DL6UGF	161/000
VK6HD	332/358	VK2FHN	238/000	3W2LC	102/000	SM6PRX	101/102	VK5ATU	158/160
VK2DEJ	332/338	VK8KTC	231/233	VK2EJM	101/103	<i>Honour</i>			
VK3OT	331/345	VK4AO	227/000	VK3KTO	101/102	<i>Roll(326)Open</i>			
VK4OH	330/337	VK8AM	225/000	<i>General listing-Phone</i>		VK4LC	335/382	VK2SPS	142/143
VK6APK	330/335	9V1RH	216/218	VK1PRG	101/000	VE6VK	335/380	VK4EZ	140/147
VK4AAR	330/334	VK4IL	212/000	HS1NGR	101/000	VK4UA	335/372	ON9MCR	129/140
CT1EEN	330/000	VK3DVT	206/209	VK5JAZ	100/000	VK5WO	335/372	VK3OZ	126/127
VK3CSR	329/338	VK6BH	200/000	<i>Honour Roll(326)CW</i>		VK3AMK	335/354	VK7CQ	123/125
VK3YJ	327/333	PY2DBU	195/197	VK3QI	334/346	VK3QI	335/350	N0MSB	117/000
<i>General listing-Phone</i>									
VK7BC	324/329	VK7JAB	186/000	VK6HD	333/354	VK3AKK	335/348	VK9RS	111/000
EA3AKN	323/331	G0VXX	184/000	VK5WO	331/347	VK3OT	334/348	VK2AJE	109/000
VK5FV	323/326	VK6EH	170/000	<i>General listing-CW</i>		VK7BC	334/343	VK3MRG	109/000
VK3EUZ	323/324	VK4CHB	167/168	VK3AKK	312/317	VK6HD	333/360	<i>General listing-RTTY</i>	
VK4SJ	321/322	VK4BP	164/000	VK3KS	307/335	VK2AVZ	333/344	VK3EBP	253/255
VK6VS	319/323	VK4ARB	159/160	VE6VK	303/326	VK3UY	333/336	VK3AMK	200/202
VK1TX	319/000	VK2EJK	153/000	VK4LV	297/300	<i>General listing-Open</i>			
VK6ABS	316/000	VK2GSN	152/000	VK4ICU	291/000	VK4AAR	332/336	SP3CUG	124/000
VK4LV	313/307	VK7LUV	148/000	VK3JI	274/299	VK2UK	323/318	VK5RY	100/102
VK2UK	312/317	VK5EMI	148/000	VK6MK	249/252	VK3JI	322/351	(Vacant)	000/000
VK3JI	310/325	VK2SPS	141/143	VK7BC	246/255	VK4LV	320/319	<i>Gen-listing 6m. Open</i>	
VK6LC	307/310	VK8LC	137/000	VK2CWS	245/247	VK6RO	315/322	VK4FNQ	137/000
VK6RO	306/313	OK1ZSV	136/000	VK3DP	245/247	VK4DV	313/328	VK4ABW	109/000
VK4ICU	303/305	VK3DQ	133/147	VK4DA	237/239	VK4ICU	311/313	<i>Gen-listing-2m. Open</i>	
VK3IR	302/306	SV1XV	130/131	VK3CIM	235/236	VK6LC	308/311	(Vacant)	000/000
VK6DY	297/301	VK4FNQ	130/000	VK3DQ	234/261	VK3DP	305/308	<i>Gen-listing-Satellite</i>	
		VK4VIS	127/129			VK7TS	295/296	VR2XMT	112/114

The WIA DXCC program has been audited to the month of Dec 2003, if you find your Callsign not listed it means you have not updated in the past 5 years

or your score has dropped below 100. The "New" Federal Awards Website in Perth was officially opened on 26th December 2003. Two years of design and

developments are now featured on our website, to view and to download computer files in many Microsoft versions of our 8 awards and



## The removal of the CODAR on the 24 MHz band

Many thanks to Arasu, VU2UR, our Chief at the Region 3 IARU. The Hong Kong Codar was moved at the end of September, 2003 to the GREAT JOY of the Local Radio Amateurs in that area.

The Humpty Doo Codar seems to be still operating on the same frequency but with very little interference to VK8HA at the 'rear' of his antennas. It does not even lift the S-Meter off 0, so no interference working DX. Antenna used is an 8 Element Log above the Gum Trees!

Have not been able to obtain official frequencies of the Codar but according to my receiver, they are just over the 25.000 MHz mark.

I was listening on the 24 MHz band, 24 hours a day for three weeks, with Japanese and other Asian stations coming in here strong after daylight, around 2230, working North and South Americans. The DX stations were very low here during the daytime, VK stations were also heard calling DX. From Humpty Doo, DX in Europe and Africa were worked with good signals around 0800.

From VK4, VK4ZRT, reports 13 UNIDENTIFIED intruders on the 14 MHz band, appear to be mainly

Indonesian SSB stations, but also a few TTY stations. On 28 MHz 3 Asian SSB stations were heard.

VK6XW reports hearing 53 SSB Intruders on the 14 MHz band mainly Indonesian.

The Indonesians who have been using 14335 have vanished and have not been found again. The 14.144 have gone LSB and up to 14.145. 14.252 has also stopped and not found again. The 'Digital' on that frequency may have shifted them ?? Karl says that 14333 has also been abandoned!! Also 'SEASON GREETINGS' from Karl, vk6xw..

That concludes the report for this Month. So FELICES FIESTAS to all Observers and see you next year.

### To Be or Not To Be

#### Intruderwatch Observer and Coordinator guidelines

1. You need to be able to Receive and Transmit on all Amateur Radio HF Bands.
2. You need to be able to receive twenty words per minute of Morse and Asian CW.
- 3 You need to have an understanding of Region III languages, mainly

Indonesian and Chinese.

- 4 You need to have one Beam Antenna, TH6DXX or similar, with an accurate Control Unit for obtaining accurate Bearings.
- 5 You need a Log Periodic Antenna to cover 10, 18, and 24MHz Bands. For 7MHz, if possible a three element Beam, otherwise dipole, and for 3.5MHz, a dipole.
- 6 A 'lot of time' to chase Intruders on our Bands .
- 7 We need IDENTIFICATION of Intruders so action can be taken to remove them from OUR Bands. The least is Language-Country-and if possible, the position of the Transmitter.
- 8 The 'Pirates' that occur mainly on the Eastcoast of Australia should be Located and Reported to your Local Radio Inspector who will organize a 'trip' with the Federal Police who will set a stop to the 'Illegal' Operations.

Please bear this in mind as you will need all your resources when in amongst Intruders.

Cheers de Henry in Humpty Doo, vk8ha@octa4.net.au

### WIA DXCC Standings (335)...continued

information. The National Website URL is unchanged: <http://www.wia.org.au/awards>

It has a direct link to: <http://members.iinet.net.au/~vk6wia/wia-awards-federal-1-index.html>

The "New" Federal Awards CD-ROM is now available free to all WIA affiliated clubs. Its contents include all our 8 awards, a 3 minute Audio Visual PowerPoint presentation suitable for field days and club nights, saved in Windows 98 and WindowsXP versions,

### WIA DXCC Certificate achievement awards

DXCC 125, 150, 175, 200, 225, 250, 275, 300, 325. DXCC Honour Roll. 326. DXCC Excellence 335. Achievement award

labels are free for one Certificate only to financial W.I.A. members. A small fee is charged for all non-financial members and extra award labels.

Those who would like to upgrade their Certificate should enclose a SAE including two of your QSL cards to prevent postage distortion. These are available now from the Federal Awards Manager.

Members submitting DXCC updates and require returned confirmation please enclose a SAE.

2004 will also see a "New designed DXCC Certificate", suggestions are welcome.

If you notice a call sign listed and they are deemed to be "silent key" please advise me. All of the Federal Awards are now computerised and we are in the

process of scanning all existing documents. We have developed our Award Documents using the standard intelligent Microsoft Excel spreadsheet document, these are saved to a common file that will run on Excel 5.0/95 & 97-2002 versions.

For those that are on internet email system we recommend you enjoy the fast service offered by our new computerised awards system. One document is used repetitively for the life of the DXCC award.

Awards and information are available by Email to [awards@wia.org.au](mailto:awards@wia.org.au) or by post to

Federal Awards Manager P.O.Box 196. Cannington. Western Australia. 6987.

"de Mal. VK6LC"

# **Protocol 802.11 in Australia— use of Spectrum at 2.4 GHz**

I write in my capacity as Deputy Manager Spectrum Planning in the Australian Communications Authority (ACA) to offer comment on the article "802.11 Protocol and Ham Radio" in the September 2003 issue of the Amateur Radio (AR) magazine. The article discusses opportunities for amateur radio operators to use 802.11 technologies, mainly in spectrum around 2.4 GHz.

The article makes reference to the Rules and Regulations of the Federal Communications Commission in the USA for information on what is provided for under those regulations, both in terms of what is authorised specifically for amateur radio and generally for short-range 802.11 applications in that country. Unfortunately, the article does not refer to the regulatory arrangements that apply in Australia. A reader could be excused for believing that USA regulation somehow directly applies to Australia, or that there are no applicable Australian regulatory arrangements.

I encourage Amateur radio operators wishing to experiment with 802.11 technologies to acquaint themselves with the bands of operation authorised for amateur radio activities and the other conditions of operation provided for by the Radiocommunications Licence Conditions (Amateur Licence) Determination. AR readers can view or download a copy from the ACA's website at URL:

[http://www.aca.gov.au/aca\\_home/legislation/radcomm/determinations/lcd/amateur.htm](http://www.aca.gov.au/aca_home/legislation/radcomm/determinations/lcd/amateur.htm)

Under the determination, spectrum immediately below 2.4 GHz is not available for amateur use in Australia (the September article refers to the FCC Rules that support amateur use down to 2.39 GHz in the USA). In January 2000,

the Minister for Communications, Information Technology and the Arts designated the band 2302 - 2400 MHz throughout Australia as part of the spectrum to be allocated by issuing spectrum licences. It is now licensed across most of the populated areas of this country to various organisations that currently use it mainly for the delivery of pay-TV services.

The spectrum between 2.4 and 2.45 GHz can be used by amateur radio operators under the determination. It is part of a larger band of spectrum beginning at 2.4 GHz and extending in many cases up to 2.4835 GHz that is used also for many short-range applications. These applications include cordless telephones, radio LANs and various other computer peripherals, video-audio senders, barcode readers, wireless projection systems and video surveillance equipment. The ACA's radiocommunications class licences for low interference potential devices and for spread spectrum devices authorise anyone in this country to operate these types of devices, provided the devices are operated within the technical conditions of the relevant licence. Readers can view or download copies

of these class licences from the ACA's website at URL:

[http://www.aca.gov.au/aca\\_home/licensing/radcomm/class\\_licensing/index.htm](http://www.aca.gov.au/aca_home/licensing/radcomm/class_licensing/index.htm)

In recent years, this band has become very popular for short-range applications, which must rely mainly on the use of low radiated power (as specified in the class licences) to reduce the likelihood that they will cause radio interference to each other - they are operated without individual frequency coordination or registering of location.

I note that under the determination, amateur radio operators may transmit in this band at much higher power levels, so the risk of amateur operations causing interference to the other users of the band is increased. The ACA encourages the amateur radio community to conduct any higher powered experiments in this band with a sense of goodwill towards the many users of low powered devices, so that all parties can continue to share this popular band of spectrum.

**Len Bray, Deputy Manager  
Spectrum Planning Team Radiofrequency  
Planning Group  
Australian Communications Authority  
(ACA)**

## **A timely warning to ail men**

Nearly six years ago at age 49 I was diagnosed with prostate cancer. It was successfully treated with surgery, and I am now quite well. In the last few months there have been some mates who have come to me knowing what I had, with the news that they also had been diagnosed with prostate cancer. A number of these have been Radio Amateurs, some from my local radio club. Hence my desire to speak out to you all.

Because ours is predominately a male hobby, I urge all of you men to take an

interest in your health in this area, and the XYs talk to their men. I feel that you are in a better position to deal with these issues if you have thought about them before they arise. I am not a medical person and am not advocating any particular course to follow, except to say in the interests of having a long and enjoyable time in amateur radio, be aware of this disease. There is a lot of information both on the Internet and from your local Cancer Council.

**73 de David Clegg.  
vk5amk@chariot.net.au**

**Views expressed in the 'Over to you' column are those of the authors, and do not necessarily reflect the policies of the Wireless Institute of Australia.**

**Send contributions to:**

**The Editor  
Amateur Radio Magazine  
34 Hawker Crescent  
Elizabeth East SA 5112  
or email:  
edarmag@chariot.net.au**

## ACA is failing its customers

The attitude of the ACA in its reply to Lindsay Lawless VK3ANJ's inquiry is disturbing.

While you cannot expect the ACA to investigate every noise source, they are after all, the controlling authority for such matters.

Their high-handed manner is reminiscent of the departmental attitude in the 1950s and 1960s when the Radio Branch was administered by a batch of ultra conservative, very grumpy old men.

I well remember some time ago that we were told new legislation was coming that would define all sources of radio emissions as transmitters and action could then be taken to control even such things as powerline noise, if it interfered with reception.

The current stance of the ACA seems a long way removed from that bold statement.

If the reception of WWV is "fortuitous", does that also mean my

neighbour's reception of my signals on his TV is also "fortuitous"? It should be, as I don't broadcast a signal to his or anyone else's TV.

The ACA is a business and accepts payment from its customers, which normally would result in a service being provided in return in any other business situation. How then can the ACA (as it so frequently does) accept payment from its customers and fail to provide a service in return? Any normal business operating in such a fashion would have to justify its actions under consumer protection legislation.

The ACA is not some sacred cow and should be reminded of its duties to its customers who provide its operating revenue, both as clients and as taxpayers. There is nothing frivolous about a complaint of RFI from commercial equipment. If there are hundreds or thousands of such defective devices in operation it would seem obvious that problems will be very

widespread. The public should expect protection if the fault is due to poor design and not be fobbed off by some departmental clown using semantics to try to confuse the issue and the customers.

Public servants are just that - servants of the public.

Geoff Wilson VK3AMK

## ACA Proposals re Licence classes

After reading the November edition of AR, I noticed that the VK1 News, mentioned the current topic on ACA submissions. The point on absorption of the Novice licensees into the body of the AOCPL licensees, is a very valid one.

There is a definite need to provide a realistic bridge between the Proposed Foundation and the current AOCPL licences. The idea of Rolling the Limiteds into the full privileges for each licence class, is a sound idea.

Peter Scales VK6IS

---

## Silent Keys

---

### Athol Manning VK7LR

It is with regret that we inform you that Athol Manning VK7LR passed away early on the morning of 8th December 2003 in the Mersey Hospital. Born in August 1916, during the Depression he got a part-time job helping to wire houses and became interested in electronics. Athol became involved with Devonport's first radio station - 7DR, an amateur station. Athol sat for his amateur radio ticket and was licensed in 1934. He was called up in 1939 with many other amateurs he spent the next 4 years in the Airforce, mainly in the Darwin area and experienced the worst of the Japanese bombing.

When television started, Athol built the first television set in Devonport together with a camera. His brilliance as an electronics technician was recognized by the rather rare award of a fellowship of the Television and Technicians Institute of Australia. Someone summed it all up by likening

Athol's passing to the burning down of a whole library. Our sincere condolences go to his wife and family.

Vale Athol VK7LR

(Ron VK7RN)

### Keith Johnstone VK7RX

Keith was born in 1912 and in the 1920s his family lived at a sawmilling settlement on Blackman Bay where there were steam logging locomotives. At the sawmill they had two eighty foot aerial poles and he remembered using a regenerative receiver to make a contact with Dunalley, seven miles away.

Keith obtained his amateur licence in the early 1950s and was always a very active DXer. I remember the distinctive signal from his homebrew AM and SSB rigs, but then he bought a commercial rig and sounded just like everyone else.

His dummy loads made from large electric motor slip rings were popular in Hobart and several of us are using power transformers rewound by Keith.

Vale Keith Johnstone VK7RX

(Richard VK7RO)

### David Thorne VK7MR

Dave Thorne VK7MR, died peacefully in his sleep on 18th December 2003 following a long illness. Dave was first licensed in the late 1950s as VK7ZAI and became VK7MR in the late 1960s.

Dave trained as a technician in the Post Master General's Department and spent his whole life working in radio, joining the PMG's Radio Branch and continuing as his employer's name changed several times over the years to the now Australian Communications Authority.

Vale Dave Thorne VK7MR

(Dave VK7DM & Richard VK7RO)

### Bruce Amos VK7ZBA

Bruce was well known to amateurs especially on the East Coast and was based in Swansea. He ran the East Coast repeater, VK7REC.

Bruce will be sadly missed, our condolences to his friends and family.

Vale Bruce Amos VK7ZBA.

(Harry VK7AR)

# Gridsquare Standings

## at 25 November 2003

Prepared by Guy VK2KU

### 144 MHz Terrestrial

VK2FLR	Mike	107
VK2KU	Guy	101
VK3FMD	Charlie	82
VK2ZAB	Gordon	76 SSB
VK2KU	Guy	68 SSB
VK3BRZ	Chas	68 SSB
VK3EK	Rob	62 SSB
VK3KAI	Peter	62
VK2DVZ	Ross	61 SSB
VK3CY	Des	58
VK2EI	Neil	54
VK3XLD	David	54 SSB
VK3TMP	Max	53
VK3ZLS	Les	51 SSB
VK3BDL	Mike	50
VK2KU	Guy	47 Digi
VK7MO	Rex	47
VK2DXE	Alan	46
VK3BJM	Barry	45 SSB
VK2TK	John	44
VK3KAI	Peter	44 SSB
VK3WRE	Ralph	44 SSB
VK2DXE	Alan	43 SSB
VK3CAT	Tony	39
VK3KEG	Trevor	39
VK4TZL	Glenn	38
VK4KZR	Rod	33
VK3ZUX	Denis	31 SSB
VK3HZ	David	30
VK7MO	Rex	30 SSB
VK2TK	John	29 SSB
VK3KME	Chris	28 SSB
VK6HK	Don	28
VK2KRR	Leigh	27 FM
VK4DFE	Chris	26 SSB
VK7MO	Rex	24 Digi
VK2TG	Bob	23 SSB
VK3YB	Phil	23
VK3KAI	Peter	21 Digi
VK5ACY	Bill	21 SSB
VK6KZ	Wally	20
VK3BBB	Brian	19
VK3TLW	Mark	19 SSB
VK3AL	Alan	18 SSB
VK2TK	John	16 Digi
VK6KZ/p	Wally	16
VK3ZYC	Jim	14 SSB
VK3DMW	Ken	13
VK2CZ	David	12
VK7ZSJ	Steve	12
VK2EI	Neil	11 Digi
VK2DXE/p	Alan	10
VK3ANP	David	10
VK2EAH	Andy	5 SSB
VK2TWO	Andrew	5
VK3ZDR	David	5 SSB
VK2AKR	Neil	3 Digi
VK2DXE	Alan	3 Digi
VK3BG	Ed	3 SSB

VK4TJ	John	3 SSB
VK2AKR	Neil	1 SSB

### 144 MHz EME

VK2FLR	Mike	110
VK2KU	Guy	74
VK3CY	Des	70
VK2KRR	Leigh	10
VK7MO	Rex	8
VK3KEG	Trevor	4
VK3FMD	Charlie	3
VK2DVZ	Ross	2
VK2DXE	Alan	2

### 432 MHz Terrestrial

VK2ZAB	Gordon	53 SSB
VK3BRZ	Chas	49 SSB
VK3XLD	David	46 SSB
VK3FMD	Charlie	43
VK3ZLS	Les	40 SSB
VK2KU	Guy	37
VK3EK	Rob	34 SSB
VK2KU	Guy	33 SSB
VK3CY	Des	31
VK2DVZ	Ross	29 SSB
VK3BJM	Barry	29 SSB
VK3BDL	Mike	26
VK3KAI	Peter	26 SSB
VK3HZ	David	25
VK3TMP	Max	25
VK3WRE	Ralph	25 SSB
VK3KEG	Trevor	21
VK7MO	Rex	16
VK3CAT	Tony	14
VK4KZR	Rod	14
VK2TK	John	13 SSB
VK3TLW	Mark	13 SSB
VK3ZUX	Denis	13 SSB
VK6KZ	Wally	13
VK2KRR	Leigh	11 FM
VK4TZL	Glenn	11
VK3AL	Alan	10 SSB
VK3ANP	David	10
VK3YB	Phil	10
VK2TG	Bob	9 SSB
VK4DFE	Chris	9 SSB
VK3BG	Ed	8 SSB
VK3KME	Chris	8 SSB
VK6KZ/p	Wally	8
VK3BBB	Brian	7
VK2FLR	Mike	6
VK2KU	Guy	5 Digi
VK3BRZ	Chas	4 Digi
VK3ZYC	Jim	4 SSB
VK2CZ	David	3
VK2TWO	Andrew	3
VK7MO	Rex	3 Digi
VK2DXE/p	Alan	2
VK3KAI	Peter	2 Digi

VK4TJ	John	2 SSB
VK2AKR	Neil	1 SSB
VK3DMW	Ken	1

### 432 MHz EME

VK4KAZ	Allan	14 CW
VK3FMD	Charlie	4

### 1296 MHz

VK3FMD	Charlie	32
VK3XLD	David	32 SSB
VK3BRZ	Chas	31 SSB
VK2ZAB	Gordon	26 SSB
VK3ZLS	Les	26 SSB
VK2KU	Guy	21
VK3EK	Rob	20 SSB
VK2KU	Guy	19 SSB
VK3KWA	John	19
VK3WRE	Ralph	16 SSB
VK3KAI	Peter	15
VK3KAI	Peter	14 SSB
VK2DVZ	Ross	13 SSB
VK3BDL	Mike	12
VK3BJM	Barry	12 SSB
VK3TMP	Max	11
VK4KZR	Rod	10
VK7MO	Rex	10
VK2TK	John	8 SSB
VK3HZ	David	8
VK3TLW	Mark	8 SSB
VK3AL	Alan	7 SSB
VK2CZ	David	5
VK3ZYC	Jim	5
VK6KZ/p	Wally	5
VK3BVP	Shane	4
VK3YB	Phil	4
VK3ZYC	Jim	4 SSB
VK6KZ	Wally	4
VK2KU	Guy	3 Digi
VK3BBB	Brian	3
VK3BG	Ed	3 SSB
VK3KEG	Trevor	3
VK3ZUX	Denis	3 SSB
VK2DXE/p	Alan	2
VK2FLR	Mike	2
VK3CY	Des	2
VK3KAI	Peter	2 Digi
VK3KME	Chris	2 SSB
VK4TJ	John	2 SSB
VK3DMW	Ken	1
VK3ZYC	Jim	1 Digi
VK4TZL	Glenn	1
VK7MO	Rex	1 Digi

### 2.4 GHz

VK3BRZ	Chas	11 SSB
VK3XLD	David	11 SSB
VK3FMD	Charlie	8

VK3WRE	Ralph	8 SSB
VK3KAI	Peter	7 SSB
VK3EK	Rob	5 SSB
VK6KZ	Wally	4
VK3BJM	Barry	3 SSB
VK3KAI	Peter	2 Digi
VK4KZR	Rod	2
VK3TLW	Mark	1 SSB
VK4TZL	Glenn	1

### 3.4 GHz

VK3FMD	Charlie	8
VK3WRE	Ralph	6 SSB
VK3KAI	Peter	5 SSB
VK3XLD	David	4 SSB
VK6KZ	Wally	4
VK3EK	Rob	3 SSB

### 5.7 GHz

VK3FMD	Charlie	10
VK3WRE	Ralph	9 SSB
VK3KAI	Peter	7 SSB
VK3XLD	David	5 SSB
VK6KZ	Wally	4
VK3BJM	Barry	2 SSB
VK3EK	Rob	2
VK6BHT	Neil	2
VK3KAI	Peter	1 Digi

### 10 GHz

VK3FMD	Charlie	9
VK6BHT	Neil	9
VK3WRE	Ralph	8 SSB
VK3KAI	Peter	7 SSB
VK3XLD	David	7 SSB
VK3EK	Rob	5 SSB
VK6KZ	Wally	5
VK3TLW	Mark	3 SSB
VK3ZYC	Jim	3 SSB
VK2EI	Neil	2
VK3BJM	Barry	2 SSB
VK7MO	Rex	2
VK4KZR	Rod	1
VK4TZL	Glenn	1

### 24 GHz

VK6BHT	Neil	3
VK2EI	Neil	2
VK6KZ	Wally	2

### 474 THz

VK7MO	Rex	1
-------	-----	---

Additions, updates and requests for the guidelines to Guy VK2KU, vk2ku@hermes.net.au, or by mail (QTHR 2002).

The guidelines (and the latest League Table) are also available on the website

of the NSW VHF Dx Group at www.vhfdx.oz-hams.org - click on Gridsquares.

Next update of this table will be in February 2004.

Stations who do not confirm their status for more than 12 months may be dropped from the table.

ar

# On air party-goers revel in amateur radio's new era

By Jim Linton VK3PC,  
WIA Welcome to HF QSO Party organiser

Soon after the ACA made its announcement in late October last year that mandatory Morse code tests for amateur licensing would end on 1 January 2004, thoughts turned to how to celebrate this historic occasion.

The author of this article volunteered to take on the task on behalf of WIA Federal and developed an "on air party" concept that enabled all radio amateurs to be involved.

The aim was to maximise participation both within Australia and overseas. The relatively short period of time available to promote the event was the biggest threat to its success.

However once the party invitation was issued all WIA Divisions and many radio clubs quickly gave the event their support. Several IARU member radio societies also joined in by promoting the WIA event globally.

As a result of the publicity campaign, DX stations were looking for VK contacts during the 35-hour long party, giving many first-timers to HF a real taste of working DX.

Noticeable on the bands were a number of long-time full-call radio amateurs, including those not heard on air for many years, who reactivated their stations to be part of the event.

## Fellowship and the amateur spirit

Another measure of success was the interaction between the new arrivals on HF and those who were experienced on those bands.

There was nothing but goodwill shown. Through the efforts of many individuals and groups, Limited and Novice-Limited licensees were given advice and assistance including a few HF transceivers on loan.

It brought the amateur fraternity closer together. One of many examples was the Sunraysia Radio Club that encouraged and assisted local radio amateurs to get

on air by providing help mainly with antennas.

Club Secretary, Noel Ferguson VK3FGN said four new stations began operating in the Mildura district as a result of the party. The enthusiasm flowed through to those who have not yet got a licence but were keen to set up listening equipment to tune into the event.

Noel said that he had received nothing but positive comments about the party including no-code licence club members who said: "This has opened up a whole new aspect of amateur radio for us.

"We will join the WIA, as they have done such a great job in bringing about this change that can only benefit amateur radio. Great contacts, a great event."

Numerous radio clubs reported similar experiences. Some of the larger groups operated their club stations to either give members without gear the opportunity to get on HF and/or as a control point for net style operation.

The Eastern and Mountain District Radio Club station VK3ER worked 30 new HF stations during a two hour net. A bacon and eggs breakfast was turned on at its clubhouse with members swapping their experiences of the party.

Many stations displayed their determination to get on HF by using very basic set-ups including a gaggle of transmitting gear from yesteryear.

Bell wire strung around a room got one on air using QRP. A few admitted visiting their local hardware shop for supplies to make an antenna, on New Year's Eve.

Not all were successful with their first time on HF due to teething problems.

These included high SWR, faulty equipment or a lack of experience in how to operate it.

On air lessons were provided on the appropriate use of compression and the RIT/clarifier control.

The skills required for VFO operation were new to many who had only known the channelised environment of VHF/UHF FM. The leaving a three second pause between overs, a requirement for repeaters but not HF operation, was noticeable.

One H-call who did not make himself heard sufficiently to get a single contact during the party still enjoyed the experience of giving it a try and is determined to join others on the HF bands as soon as possible.

Several portable and mobile stations also struggled their way through the saturated band 80-metre in the first 30 minutes of 2004, but by persevering made

contacts.

## Midnight bedlam as party begins

As the clock struck midnight Australian Eastern Daylight Time the 80-metre band came alive with wall to wall QSOs.

In the Novice portion of 80 m band every single SSB slot had at least one QSO. While the 40-metre band was not as crowded, it seemed to be the haunt of more long-time Z-call holders. The 20 m band was abuzz with Z-calls on New Year's Day.

Refugees from the overcrowding moved up to 15 m and 20 m. The QSOs mostly were chatty with greetings to HF being freely exchanged, and appreciation by the new arrivals to HF.

WIA stations often manned by office-

**The only quick way to describe the WIA Welcome to HF QSO Party is a 'grand success' that created many memories and reinvigorated participants about amateur radio**  
— Jim Linton, Organiser

# WIA Welcome to HF QSO Party – Gift Draw

Excellent support for the party was given by six sponsors who donated 25 gifts for a draw containing entries from genuine first timers to the HF amateur bands on 1 January, 2004.

To enter, Limited and Novice-Limited licensees had to send a log extract of at least ten HF contacts made during the party with WIA stations counting as equal to three contacts.

Here are the draw results:

**\$1,000 gift voucher provided by ICOM Australia**

Ray Finlayson VK7TRF

**ARRL Handbook donated by WIA NSW Bookshop**

Trevor Lewellin VK3HTL

**Yaesu FT100 HF-plus transceiver – donated by WIA**

Anthony John Sutton VK4TJS

**2004 Australian Radio Amateur Callbook & CD donated by WIA**

Andrew Russell VK5ZUC

Jacek Szczurek VK3TJS

Dudley Thomas Teakle VK5HBG

Samantha Scafe VK4TTT

Ken Taylor VK3TKQ

**Yaesu FT-817 HF, VHF/UHF portable transceiver supplied by Benelec**

Norman Partridge VK2TOP



Drawing the entries is Rob Carmichael JP VK3DTR with scrutineer Keith Proctor APM VK3FT

**WIA Awards Program CDs from WIA Awards Manager, Malcolm Johnson VK6LC**

Viv Weekes VK2TVW

David Timms VK3YLV

Colin Thompson VK2TRC

Ian Gillard VK3ZZG

Gregg Zonneveld VK4ZON

Greg Ryan VK4HDG

Paul Barrett VK5ZRT

Robyn Edwards VK6XRE

Raff Lerro VK4XRF

Vince Page VK6ZAR

Ian Rowley VK5ZIR

Michael Borthwick VK3UBM

Ryan Lovett VK2XRL

Warren Frost VK5HWF

Matthew McNeil VK4HAM/3

**Kenwood TS50 HF Transceiver from Kenwood Electronics Australia**

Johnny Quarel VK3HJQ

*Check logs received from:* VK3ZWI, VK5EMI and VK6WIA.

*continued from previous page*

bearers were pounced upon as soon as they were free. A sterling effort was made by Mal Johnson VK6LC who operated VK6WIA for 23 hours during the party.

Mal reported that "VK6WIA operated on 10, 15, 20 and 80. All states were worked and a total of 135 newcomers to HF logged.

"In the closing minutes of the party many stations came on frequency to voice their appreciation of VK6WIA, the organisation of the party, the WIA generally and the gift draw sponsors."

Special VK6WIA QSL cards for each party contact will be issued via the QSL Bureau.

**Media publicity achieved**

The party and the end of the Morse code requirement was recognised by the WIA as an opportunity for it to get some good publicity in the news media.

WIA ACT Division Publicity Officer, Peter Ellis VK1KEP issued a media release and as a result was interviewed

by Canberra radio stations ABC 2CN and the commercial station 2CC.

Well done Peter! Your initiative generated publicity for the WIA and amateur radio generally.

Another media release issued by Jim Linton VK3PC scored radio interviews in Perth 6PR, on ABC Gold Coast Queensland and ABC Tasmania. Other radio stations simply included reports in their news bulletins.

ar

Rob Broomhead VK3KRB  
EMDRC Club President

## EMDRC welcome to HF

The EMDRC's club station VK3ER was active from its Burwood clubrooms from 00:00 hours 1st January 2004, manned by Jack Bramham VK3WWW, Keith Proctor VK3FT and Rob Broomhead VK3KRB.

After listening to the on-air activity the team elected to assist the QSO party by running a net on 80m. The two hour net assisted over 30 new stations make contact with the club station and systematically make contact with each and every other station participating in the net.

For the EMDRC, the lead up to QSO party saw many of its full call members actively assisting those with limited and limited novice tickets set up and tune up their home or portable stations prior to the event. This proved both very beneficial for the new folk preparing to use the bands and quite rewarding for the full calls giving the guidance. Encouragingly, only two folk ended up needing to use the clubroom equipment, one who ended up with microphone problems and the other who appears to have purchased a faulty second hand radio.

Kicking off at 8:30 the following morning the club hosted a special Bacon and Eggs celebratory breakfast at the clubrooms to help mark the occasion. Over 30 members turned up and much enthusiastic discussion and sharing of experiences took place between the limiteds who had been operating the night before and some of the Club's more experienced HF operators. Photographs of the event are available on the EMDRC's website <http://www.emdrec.com.au>

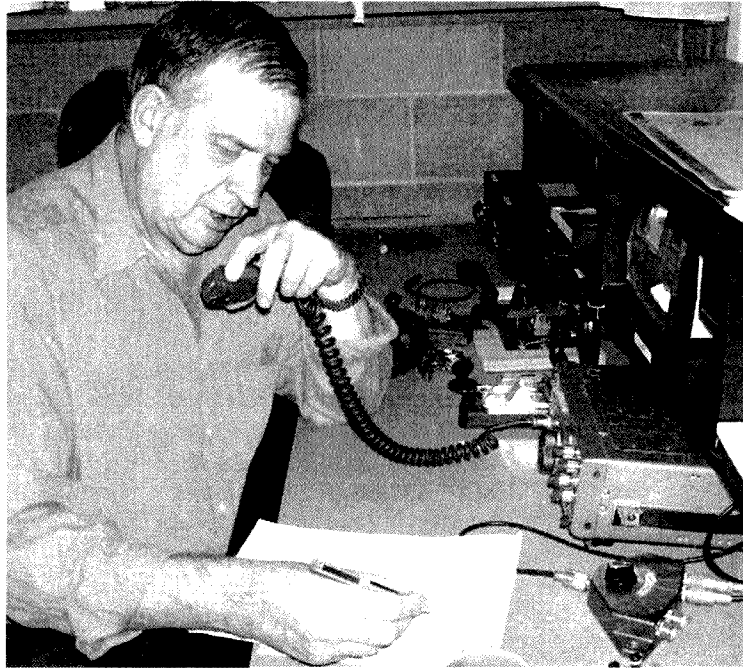

EMDRC club member and full call operator Keith Proctor VK3FT at the EMDRC clubrooms just after midnight on the 1st of January. The EMDRC ran a net for the Welcome to HF party assisting the new folk to make contact with our club station as well as each other.

Healesville Amateur Radio Group Inc. C/o P.O. Box 346, Healesville, Vic, 3777

VK3GHA **WHITE ELEPHANT** Sale

Sunday 29th February, 2004  
10am to 2pm  
Healesville Memorial Hall  
Maroondah Highway, Healesville

For booking of trestles and further  
information:  
Gavin VK3TLN 5968 8482  
or Carol 5778 7518  
or email to  
[gpt@celestial.com.au](mailto:gpt@celestial.com.au)

# Amateur Radio Magazine Index 2003

Classification	Title	Author	Month	page	
ARDF	5th region 3 ARDF Championships Ballarat ARDF Championships	Jack Bramham VK3WWW	July	14	
			February	21	
Awards	New additions to the Federal Awards scheme Southern Cross Award SSA Activity Award 2003 Tasmanian Awards	VK7Notes	April	26	
			June	23	
			July	20	
			August	35	
			May	46	
Computers	Open Office review	Alan Gibbs VK6PG	May	46	
Conferences	GippsTech 2003 The Wonderful World of GippsTech 2003 pictures	Jim Linton VK3PC Jim Linton VK3PC	October	17	
			October	28	
Contest Results	2003 Trans-Tasman Contest results		August	41	
	CQ WW CW Contest 2002 Results (VK only)		December	41	
	CQ WW DX CW Contest 2001	Ian Godsil VK3VP	March	41	
	CQ WW DX SSB Contest VK Results		November	46	
	CQ/RJ WPX RTTY Contest 2003 Results		September	41	
	CQ/RJ WW RTTY DX 2002 Contest Results		October	41	
	Harry Angel Sprint 2003 Results		July	41	
	Jack Files Contest 2003 Results	John VK4AJS	November	46	
	Oceania DX Contest 2002 Results (Complete)		November	42	
	Oceania DX Contest 2002 Results (Extract)		August	41	
	Pacific 160 metre Contest 2003 Results	Ian Godsil VK3JS	November	41	
	Port Macquarie Field Day Results 2003		July	44	
	Ross Hull Memorial VHF-UHF Contest 2002-2003	John Martin VK3KWA	April	45	
	Seonet Contest 2002	Ian Godsil VK3VP	April	41	
	Spring VHF/UHF Field day results	John Martin VK3KWA	February	53	
	Summer VHF-UHF Field Day 2003	John Martin VK3KWA	April	42	
	Victorian wins the first Wadda Cup	Vince Henderson VK7VH	March	46	
	Contest Rules	ARRL International DX Contest		February	51
		Clara and Family HF Contest 2003	ALARA	March	40
		Commonwealth Contest	Ian Godsil VK3VP	March	42
		CQ WW WPX Contest 2003	Ian Godsil VK3VP	March	43
		Harry Angel Memorial Sprint 2003	Ian Godsil VK3VP	March	41
		Jack Files Contest 2003 Rules	John Spooner VK4AJS	May	41
		Japan International DX Contest 2003	Ian Godsil VK3VP	March	42
		John Moyle Field Day Contest Rules	Eric Fittock VK4NEF	February	49
		Oceania Contest 2003 Rules	Brial Millar ZL1AZZ	September	41
		PNG Independence Day Scramble 2003 Rules		September	42
PSK Rumble 2003 Rules			October	41	
Remembrance Day Contest 2003 Rules			July	42	
Ross Hull Contest Corrections			December	41	
Ross Hull VHF -UHF Contest 2003/4 Rules		John Martin VK3KWA	November	47	
Spring UHF-VHF Field Day 2003 Rules			October	41	
Summer VHF-UHF Contest 2004 Rules		John Martin VK3KWA	November	50	
Thelma Souper Memorial Contest		ALARA	March	40	
VK/Trans Tasman Contest 2003		Ian Godsil VK3VP	April	43	
VK/Trans Tasman Contest reminder			May	44	
Wadda Cup 2003 Rules		Kelran Blyth VK3BTV	May	42	
Waitkere Sprints 2003			July	41	
Education		Amateur Radio Study Course by G. Scott VK2KE	Colwyn Low VK5UE	May	44



Classification	Title	Author	Month	page
General	420-430 MHz band Victoria meeting 4 March	E Hocking , G. Hughes	April	7
	5.7 GHz ATV distance record 110 km	L.G. Benjamin VK5RD	December	13
	5th IARU Region 3 ARDF Championship	Jack Bramham VK3WWW	August	44
	A weekend at Barrenjoey Lighthouse	Richard Murnane VK2SKY	October	11
	ACA seeks hams' feedback	Colwyn Low VK5UE	November	11
	ALARA Nets Contests etc		July	27
	Amateur Radio 2002 Index		February	30
	Amateur radio and the challenge of change	Jim Linton VK3PC VK2ZRH	April	13
	Amateur radio in Solomons and Somalia East Africa	Sam Voron VK3BVS	September	2
	Australian summer wildfire	Jim Linton VK3PC	March	3
	Brush up your Morse and join the action	Drew Diamond VK3XU	August	12
	Cocky proof those antennae	Bernie McIvor VK4EJ	July	8
	Codan HF transceivers Part 1	Malcolm Haskard VK5BA	April	23
	Codan HF transceivers Part 2	Malcolm Haskard VK5BA	May	14
	Computer security	Alan Gibbs VK6PG	April	4
	Home brew computers	Alan Gibbs VK6PG	July	39
	How do you know that you are a real ham?	Josef HB9CIC	December	5
	How to get into ham radio and why	Scotty VK2KE	December	24
	IARU Region 3 Monitoring system note	B.L. Manohar VU2UR	August	55
	ICOM Australia celebrates 20th anniversary	Jim Linton VK3PC	November	12
	Lesotho 7P8 Dxpediton	Tom Anderson WW5L	June	14
	Macquarie FD Pictures		July	IBC
	Mister Speaker! The president of the RSGB		April	38
	Our DX vacation to 8Q - Maldives	Mai Johnson VK6LC and John Gillespie K4JWG	December	18
	Power backup - UPS (Ham Shack Computers)	Alan Gibbs VK6PG	December	44
	QE46 Cape Hauy VHF Dxpediton	Rex Moncur VK7MO	November	25
	RAAF Williamtown ARC	Jim Linton VK3PC	May	30
	Radio as it used to be	Roger Graham VK2AIV	September	20
	Red Cross provides communication link...	Jim Linton VK3PC	March	7
	Reflections		August	IFC
	Rekindling the magic	Michael J. Charleris VK4IQ	November	19
	Remembrance Day Contest	Colin Harvey VK1AU	September	34
	Revised regulations for the amateur service	Jim Linton VK3PC	February	3
	Roll Call		August	IBC
	Ross A. Hull VHF Trophy winner 2003 encourages...	Jim Linton VK3PC	November	17
	RSGB 90 (BOS)	David Pilley VK2AYD	September	27
	Six-monthly update operational AR satellites	William Magnusson VK3JT	July	46
	Telegraphy is not dead I	Vladimir Sidorov EU1SA	June	22
	The "Silent Key" Forest	Joseph Obstfeld 4X6KJ	October	53
	The John Moyle Field Day across the country	Various	May	18
	The Silent Service	David Pilley VK2AYD	June	15
	The Sparks Era	Malcolm Haskard VK5BA	December	17
	Try this your computer as a sound recorder	Peter Parker VK3YE	December	48
	UK Foundation Licence one year on	David Pilley VK2AYD	February	3
VK Amateur Radio calendar 2004	Colwyn Low VK5UE	December	29	
Weekend at Barrenjoey Lighthouse pictures	Richard Murnane VK2SKY	October	IBC	
What's all this LINUX business	Peter Barrett VK6PEC	July	13	
WIA DXCC Standings Dec 31st 2002	Mai Johnson VK6LC	February	48	
Working 3B9C -A how-to guide	Neville Cheadle G3NUG and Bill Wells VK4UA	December	22	
ZD1FG 44 years QSL at last		May	27	
Intruder Watch		December	28	
IOTA	Lady Julla Percy IOTA OC_251	Peter Forbes VK3QI	March	10
Operating	Grid league table February 2003	Guy Fletcher VK2KU	April	48
	Portable operation with AO-40	Bill Magnussen VK3JT	April	50

<b>OTU</b>	"Micky Mouse" language	Graham Kinge VK3XK	May	55	
	75th anniversary of trans-Pacific flight	Tom Hieronymus N6RQQ	May	53	
	Amateur radio fascinates a new generation	Lachlan Bruce VK2LGB	August	27	
	Bloody Fine Gentlemen	Bob Slutzkin VK3SK	April	52	
	CB a start, at least.	Tim Parrey VK2TA	May	55	
	Charlie or Canada	Bob Elms VK6BE	October	51	
	Circuit board manufacture	Terry Power VK2TIL	October	51	
	Circuit board manufacture	VK2COX	July	7	
	Cocky problems	David Pilley VK2ADY	August	52	
	CQ to teach hams	Matt Ryan VK2KVE	March	53	
	Dinosaurs Dreaming	Fred Backer VK2JFB	February	61	
	DX spots via SMS or email	Stefano IZ5ENH(KC9AJF)	August	52	
	Foundation Licence	Nigel Dudley VK6KHD	April	52	
	Foundation Licence	Neville Chivers VK2YO	February	6	
	Leading the horse to water does not necessarily.....	Pete D. Williams VK3IZ	September	53	
	Letter on Interference to ACA and reply	Lindsay Lawless VK3ANJ	December	27	
	May I add a bit to the CW controversy	Hans Kiesinger L-40370	October	52	
	Memories of Ross Hull activities	Kerry Adams VK2BXT (VK5SU)	December	60	
	More info please !	M Morris VK3GMM	October	42	
	More on "The Licence"	Steve Mahony VK5AIM	August	23	
	New noise source	Colin Harvey VK1AU	October	52	
	Re Foundation Licence VK5GX	Paul M. Spinks VK5GX	August	52	
	PC board manufacture	Peter Stuart VK2BEU	October	51	
	Polarisation of VHF beacons	Mike Farrell VK2FLR	December	60	
	Poor communications vocabulary	Peter Cossins VK3BFG	March	52	
	Re Dinosaurs Dreaming 1	Richard VK2SKY	March	52	
	Re Dinosaurs Dreaming 2	Chris Flak VK2QV	March	53	
	Re tribute to VK3AGV by VK2SIG Sept 2002	Ray Jones VK7RQ	March	45	
	Review of equipment	Christopher VK1DO/VK2DO	August	52	
	Reviews of equipment	Alan VK3VD	July	55	
	Ron Bertrand VK2DQ review	Adam Jaroszek VK4LAJ	February	60	
	Some hams are frequency hogs	Alan Sorenson ZL3JU	December	60	
	Thank you to anonymous donor	John Martin VK3KWA	April	52	
	The Dick Smith way	J Robertson	March	53	
	The elusive page 16	David Dunn VK3DBD	April	53	
	The last word	Don Jackson VK3DBB	May	55	
	The new licence	David Downie VK2EZD	August	50	
	Towering victory	Don Jackson VK3DBB	August	11	
	Two topical matters	Chris Bourke VK4YE	August	50	
	Virus attack	Malcolm Haskard VK5BA	December	60	
	Wanted: More operators on the new digital modes	Craig VK6JJJ	August	51	
	Why amateur radio is dying	Ken Fuller VK4KF	March	53	
	WIA. Advocate for amateurs	John Sparkes VK6JX	July	55	
	<b>People</b>	Bill Rice retires from AR	Colwyn Low VK5UE	November	2
		Dorothy Bishop VK2DB	John VK2ZOL	July	24
		Grote Reber	VK7 Notes	October	33
		Joy Charles VK5YJ	Christine Taylor VK5CTY	July	25
		Technical Winner	Godfrey Williams VK5BGW	February	IBC
		The Creator of WSJT Joe Taylor K1JT	Jim Linton VK3PC	October	19
	Women in Radio	Christine Taylor VK5CTY	July	24	
	<b>Propagation</b>	AREPS	Leigh Rainbird VK2LRR	May	33
		Sunspot numbers March 2003		May	44
		Sunspot numbers August 2003		November	15
		Sunspot numbers June 2003		August	55
		Sunspot numbers October 2003		December	63

Classification	Title	Author	Month	page	
<b>Review</b>	Amateur radio transceivers I have owned -FT-707	Steve Mahony VK5AIM	December	30	
	Product review ICOM-910H VHF/UHF Tcvt	Doug McArthur VK3UM	July	50	
	Review of the BHI NSE 10-2 DSP Speaker	Stephen Newlyn	October	20	
<b>Safety</b>	Tower Climbing Training	ALARA	May	28	
<b>Silent Key</b>	"Snow" Hodder VK2DV	Henry Lundell VK2ZHE	October	52	
	Brian Jeffery Slarke VK2ZCQ	Bill Sinclair VK2ZCV	April	33	
	Bryan Robert Forbes VK3ASF	John Van Kerkwijk VK3ALF	November	37	
	Cec Bardwell Ex-VK2IR	Brian Mennis VK4XS	September	44	
	Doug Sim VK4BP	SCARC	September	51	
	Ed Mann VK5KAV	David Box VK5OV	May	35	
	Eric Vidler VK2ZEV	Norman Deitch VK2ZXC	September	47	
	G. E. (Bill) Gronow VK3BG	Jim Linton VK3PC	March	51	
	Gil Sones VK3AUI SK		December	2	
	Harry Bird VK2XI	Greg Bird	August	36	
	Harry Williamson VK2JHW	Brian VK2BUF	October	31	
	Ian Fisher VK4FB	Deane Laws VK4ALN	August	53	
	Ian J. D. Dalrymple VK2XU	David Sinclair VK2ZCV	December	43	
	J.T. Jim Cunningham VK4BS	Andrew Hosking	May	35	
	John Kerr Tutton VK3ZC	Graham Thornton VK3IY	September	46	
	Joseph Nelson VK2KJN	John Stacy VK2JJS	August	53	
	Les Daniels VK2AXZ	Greg Smith VK2CW	May	35	
	Lloyd (John) Gough VK5QD		December	61	
	Neil Gough VK2NG	Ray Taylor	October	36	
	Pat Geeves VK7GV	VK7 Notes	October	34	
	Patrick Charles Ryan VK3BIT	Allen VK3SM	March	45	
	Rej Allinson VK2MP	Mike Farrell VK2FLR	April	39	
	Rex Corthorn VK3VG ex VK2VG	Ben Mills VK2AJE	May	35	
	Roland Bruce VK5OU	VK5ANW and VK5UL	May	35	
	Ron Reynolds VK2AFR	Ray Taylor	October	38	
	S.F. "Sugar Fox" Medford VK7SF	Justin Giles-Clarke VK7TW	December	39	
	Sid Ward VK2SW	Tony Mulcahy VK2ACV	April	33	
	Ted Beard VK7EB	Justin Gilles-Clarke VK7TW	September	39	
	<b>Technical Abstracts</b>	6146 replacements	Gil Sones VK3AUI	November	29
		A Large Low Loop	Gil Sones VK3AUI	June	29
A Simple Power Attenuator		Gil Sones VK3AUI	June	29	
Adding a crowbar		Gil Sones VK3AUI	June	28	
Adding a crowbar, notes		Gil Sones VK3AUI	November	21	
Balanced line antenna tuner		Gil Sones VK3AUI	November	21	
Cable entry		Gil Sones VK3AUI	August	21	
Cardboard box antenna for Oscar 40		Gil Sones VK3AUI	September	22	
Centre insulator for dipoles		Gil Sones VK3AUI	September	26	
Circular polarised twisted loop		Gil Sones VK3AUI	December	48	
Common faults and cures		Gil Sones VK3AUI	February	26	
Compact 100 watt Z-match antenna tuner		Gil Sones VK3AUI	May	21	
Compact fluorescent lamps		Gil Sones VK3AUI	November	29	
Feeder losses		Gil Sones VK3AUI	April	29	
Gate dip oscillator		Gil Sones VK3AUI	September	25	
Ground rod driver		Gil Sones VK3AUI	September	26	
GW4ZXG remote tuner		Gil Sones VK3AUI	February	30	
Hands free microphone for the Yaesu FT-817		Gil Sones VK3AUI	December	58	
Hanging wires flexibly from trees		Gil Sones VK3AUI	October	23	
Horizontal loop for 80 m DX		Gil Sones VK3AUI	March	47	
Installing insulators on loop aerials		Gil Sones VK3AUI	May	24	
LA8AK loop antenna for LF		Gil Sones VK3AUI	March	27	
Low pass filter		Gil Sones VK3AUI	December	20	

Classification	Title	Author	Month	page
<b>Technical Abstracts</b>	MOBMU LF Loop	Gil Sones VK3AUI	February	28
	Magnetic loop antenna for 2 metre band	Gil Sones VK3AUI	December	39
	PA0FRI's S-match antenna tuner	Gil Sones VK3AUI	October	21
	Passive grid	Gil Sones VK3AUI	April	27
	Portable 2 metre Yagi	Gil Sones VK3AUI	April	28
	Push button memory adjuster for antennas	Gil Sones VK3AUI	October	43
	Quiet antenna tuner	Gil Sones VK3AUI	February	31
	Rusted threads	Gil Sones VK3AUI	April	29
	T5	Gil Sones VK3AUI	December	46
	Terminated vee beam	Gil Sones VK3AUI	August	20
	The protector	Gil Sones VK3AUI	October	22
	Transceiver-computer interfacing techniques	Gil Sones VK3AUI	August	16
	Using plug pack power supplies	Gil Sones VK3AUI	May	29
	VHF-UHF J-pole antenna	Gil Sones VK3AUI	May	23
	VHF-UHF low loss diplexer	Gil Sones VK3AUI	March	30
Watch dog timer	Gil Sones VK3AUI	December	59	
<b>Tech – Aerials</b>	20 - 40 metre EH antennas	Lloyd Butler VK5BR	April	9
	A Crossed Field Antenna for 3.5 MHz	Lloyd Butler VK5BR	May	24
	Aerial experiments	Lindsay Lawless VK3ANJ	June	16
	An experimental patch antenna for 70cm Part 2	Greg Chenco VK3BLG	March	24
	An experimental patch antenna for 70 cm	Greg Chenco VK3BLG	February	4
	AO-40 dual frequency L S Dish Feed	John Roberts VK4TL	August	9
	EH antennas update	Lloyd Butler VK5BR	May	13
	Improved coupler for balanced and single wire feed	Drew Diamond VK2XU	October	4
	Measuring aerial field strength	Lindsay Lawless VK3ANJ	June	21
	Measuring aerial field strength – Notes	Lindsay Lawless VK3ANJ	July	23
	My new beam for DX on two	W.M. (Bill) Sinclair VK2ZCV	February	19
	Six co-axial baluns for VHF/UHF antennas	Gordon McDonald VK2ZAB	August	4
	Six metre halfwave vertical using a CB whip	Peter Cosway VK4DU	February	6
	The EH dipole antenna (Follow up)	Lloyd Butler VK5BR	November	4
	<b>Tech – ARDF</b>	An 80 metre receiver for ARDF radio sport	Bryan Ackerly VK3YNG	September
An alignment transmitter or 80 m mini-fox		Bryan Ackerly VK3YNG	November	13
<b>Tech – Inst</b>	A "Kalitron" gate dip oscillator/crystal checker	Drew Diamond VK3XU	March	19
<b>Tech – power supply</b>	A 3-30 volt, 2 amp DC power supply	Drew Diamond VK3XU	May	9
	RS 20 power supply: Errata and Notes	Jim Tregellas VK5JST	February	21
<b>Tech RX</b>	ICOM IC-Q7 tweaking	Alan Gibbs VK6PG	October	44
	New life for your old broadcast receiver	Peter Parker VK3YE	July	21
<b>Tech TX</b>	A CW transmitter for 40 metres	Joe Rotenberg VK3BBN	December	15
	A solid state AM/CW transmitter for 1.8 and 3.5MHz	Drew Diamond VK3XU	December	6
	The "NoPA" 40 metre DSB transmitter	Peter Parker VK3YE	July	4
<b>Technical</b>	12 to 28 Volt DC-DC converter	Keith Gooley VK5OQ	July	15
	600 metres and beyond : A long wave adventure	Dale Hughes VK2DSH	June	8
	802.11 Protocol and ham radio	Darryl Smith VK2TDS	September	18
	A stepped range controller for the 80 m sniffer	Bryan Ackerly VK3YNG	October	12
	Amateur TV In VK5	Barry Cleworth VK5BQ	October	24
	An oscilloscope In the shack	Drew Diamond VK3XU	September	12
	Another use for ex-computer crystals	Steve Mahony VK5AIM	July	12
	Hidden microHenries exposed	Neville Chivers VK2YO	December	4
	Measuring echoes and propagation on HF bands 2	H de Waard PA0ZX	February	9
	Morse Code practice generator	Alan Gibbs VK6PG	October	9
	Passive components at RF	Pieter Kriel	June	19
	The state of the art on long wave	John Adcock VK3ACA	June	4
	Using crystal oscillator modules	Peter O'Connell VK2EMU	July	11
<b>WIA General</b>	WIA Federal accounts 2002	David Pilley VK3AYD	May	7
	WIA looks to the future. Federal Convention 2003	David Jones VK4DF	May	4

## Gil Sones VK3AUI —Quiet achiever, good friend

The Australian amateur radio fraternity was saddened to hear of Gil's passing on 27 November 2003. He was a good friend and mentor to countless amateurs over four decades.

Gil's interest in amateur radio began in his student days. He spent a year at Melbourne University, then transferred to RMIT. After graduating he became a communications engineer with the State Electricity Commission, and this kindled his interest in amateur radio. He first came on the air in the early 1960s as VK3ZGS, and obtained his full call VK3AUI a few years later.

Gil's greatest interest was in VHF, and he was a very competent and courteous operator. Although his main interest was DX, he was just as happy to chat with friends in the local area. However he also became actively involved in many other aspects of the hobby.

He was an active member of the Melbourne VHF Group in the 1960s and 1970s, and served for a time as its president. For some years he also handled the sale of kits and components for the VHF Group and at club meetings, and was always there to lend a hand at all VHF activities. He was also a foundation member of the Eastern and Mountain District Radio Club, and helped out for some time on the Broadcast Committee of the Victorian Division.

Gil particularly enjoyed activities such as scrambles and foxhunts. Sometimes he used his foxhunting skills with great glee to track down illegal operators and to encourage them to become licensed amateurs.

He also enjoyed field days and other outdoor activities. He was very active in WICEN, and in more than 20 years he hardly ever missed the annual Red Cross Murray River Canoe Marathon. He enjoyed the outdoor activity and the social contact, but just as important was the fact that he was there to help other



people. His last trip was to north-east Victoria to help during the bushfires in early 2003.

Gil was a familiar figure at club meetings and conventions. If you wanted to find him in the crowd, you simply looked for his trademark hat. Only a few months ago he also became a member of the RAOTC – the Radio Amateurs Old Timers Club.

Gil's most sustained contribution was his work for the WIA Publications Committee, which continued from 1973 until his death. His work for "Amateur Radio" magazine was professional and demonstrated a high level of technical understanding. He didn't always say much at the meetings of the Publications Committee, but when he did speak, everyone took note.

He served as Assistant Editor in 1978 and 1979, Technical Editor from 1980 to 1983, and Editor until June 1984. After that he continued as a Technical Editor from 1984 until his death, and for many

years compiled the popular *Technical Abstracts* column.

Over the years Gil also found the time to indulge his urge for travel. During the 1970s and 1980s he made at least eight overseas trips that led him to Russia, China, Europe, the USA, South America, Alaska, Iceland and even Antarctica.

Gil took an early retirement from the SEC in the late 1980s, and took up several new interests including the study of birds, habitat reclamation projects, and community activities such as Neighbourhood Watch. He continued to be active on the air and took every opportunity to get together with his amateur radio friends at meetings and conventions.

In more recent years Gil was committed to caring for his mother, who lived well into her nineties. His own health problems took a more serious turn after the loss of his mother, but never once did he complain. No matter what happened, he would say, "Well, it's just

---

# Silent Keys

---

## Henry (Harry) S. Michael VK3ASI

1928–2003

Harry passed away in October this year after a short illness. He had lived most of his life in Geelong and looked after a family owned second hand store. After leaving school, Harry joined the Citizens Military Force and attained the rank of Captain.

During the 1950s he joined the Geelong Amateur Radio Club (GARC). He took an active role in the club and served on the committee as Treasurer, Secretary and President. In 1959 he passed the AOCF exam and was issued with the callsign VK3ASI.

Harry saw the need for a different kind of club in Geelong. One that not only catered for radio but for anyone with an

interest in audio, model control etc. He and a group of others formed the Geelong Radio and Electronics Society (GRES). This society was formed in 1963 and Harry served 2 terms as President in 1963 and 1964.

Harry was active on HF and took part in the regular "Geelong" 80 m net of a Sunday morning. He was also active mobile on 2 m FM. The first 2m repeater in Geelong was initially a joint venture between the 2 clubs (the GARC and the GRES). Harry was on the committee of management for this repeater for 12 months.

After retirement from working life

Harry continued to live in Geelong for a while, but he and his wife Poppy decided to shift to Lancefield to be closer to their family. Again Harry set up his station to keep in contact with his friends in Geelong. He was active on air until his death.

There is a saying "gone but not forgotten". This will certainly apply to Harry. Due to his foresight and leadership he has left a legacy for the people of Geelong. This legacy is the Geelong Radio and Electronics Society that he founded.

*Submitted by Rod Green VK3AYQ on behalf of the GRES.*

## Ann Renton VK4MUM

It is my sad duty to report that Ann Renton VK4MUM has become a Silent Key. Ann lost her struggle with cancer on Thursday January 8th 2004.

Ann was for many years the Ladies Group Co-ordinator of The Townsville Amateur Radio Club Incorporated, a long term member of the Australian Ladies Amateur Radio Association, active member of the Queensland Electrical Institute and an active member of the Townsville Family History

Association Inc right up to when her health started to fail mid year 2003.

Ann spent most of December 2003 at the Mater Hospital Pimlico and was supported with love and care by many of her closest friends and family on a continuous basis. With Ann's passing amateur radio has lost an operator whose nurturing, caring nature and organisational skills will be sorely missed.

Ann is survived by husband Peter VK4PV (a former secretary of the TARCinc and current secretary of the QEI), daughter Fiona, sons Mark and Paul and grandchildren. Friends and acquaintances of the Renton family attended Ann's funeral at Wongarra Crematorium, Bruce Highway, Julago (south out of Townsville towards Ayr) on Monday January 12th .

Vale Anne Renton VK4MUM – SK  
*Submitted by Gavin VK3ZZ*

---

## Gil Sones VK3AUI – Quiet achiever and good friend ...continued from previous page

one of those things, you know". Then he would press on regardless, still looking forward to some new activity. Even in the last months of his life when he knew that time was running short, he was still optimistic and upbeat.

Gil was highly intelligent and knowledgeable, but he never made a big deal of it. He was a modest man who was always there to share his knowledge and help in a constructive way. Over the years he was a mentor to many new or aspiring amateurs, and he was always ready to help if anyone needed technical advice or just a friendly chat. He had such wide knowledge that he could chat

on just about any subject. If you had any problems, Gil would always lighten the burden with his good humour and his positive attitude to life.

Just one of many tales of Gil's thoughtfulness was his unannounced visit to an amateur who was confined to his sick bed. Gil had brought along his handheld transceiver so that the ill amateur could stay in touch with his friends.

Gil accepted people as he found them - he never lost his temper or had a harsh word to say about anyone. You could never hope to meet a more good-natured

person. He gained respect from everyone just by being himself.

For many of the Australian amateur radio fraternity, Gil has always been there. For us, his passing leaves a gap that can never be filled. We can only say that we were privileged to have known him.

*[Compiled from contributions by Ron Cook VK3AFW, Ian Cowan VK1BG, Lionel Curling VK3NM, Eric Gray VK3ZSB, John Hutchinson VK3JH, John Martin VK3KWA, Ken and Bett McLachlan, John Nieman, Bill Roper VK3BR, and John Weir VK3ZRV.]*

ar

## VK1 News

### Forward Bias

During the general meeting on Monday, November 2003, the Division extended a big Thank You to those members who had gone out of their way during the year to promote the interests of Amateur Radio and the Division in particular. The Divisional President, Alan Hawes, VK1WX handed out certificates of appreciation to 16 members for help and assistance given during WICEN and other activities, and expressed his appreciation for technical support given in maintaining repeater sites and equipment, and the setting up of new services related to APRS and IRLP. One person in particular, Paul Bell, VK1BX, aka Dinger, was singled out as a person with exceptional dedication to maintaining the operational capability of the Division's repeater system. The time had come to thank him for his efforts because Paul will retire from his job here in Canberra halfway through 2004, and move to Adelaide. It is a fair

assumption that he will probably continue his efforts there for our southern confreres.

The VK1 Division assisted the Southern Highlands and Goulburn ARC to restore the 438.025/433.025 MHz repeater on their High Range site west of Mittagong. This site has coverage of the Sydney basin and the Hume Highway, and is a key access point to the 70 cm linked repeater project. While 'off air' linking to Mt Gray at Goulburn is currently configured, this will change once the Mt Ginini hub and link equipment is installed.

Amazingly, although 26 km from the Southern Suburbs of Canberra, LIPD transmissions do interfere with the long standing Ginini 70 cm 438.375/433.375 MHz service – rendering its linking useless. We have ordered the replacement crystals to lower this channel 25 kHz and aim to have this done by Xmas this year. This will also

Peter Kloppenburg VK1CPK

avoid the co-channel interference to the Blue Mountains repeater users on the same channel pair. During the year, the Division received gifts from deceased estates in the form of radios, components and antenna towers. Some of these were brand new and others were more than 70 years old i.e. domestic radios and transmitting valves. A Trash & Treasure sale was held on October 26, which resulted in the sale of about 80% of the goods that were held in storage. Visitors and buyers on the day benefited from the free Sausage sizzle, but were asked to make a gold coin donation for soft drinks from the fridge.

December will be a quiet month for the Division, with only a committee meeting on the second Monday. The next General Meeting will be held at Scout Hall, Longerenong St., Farrer, on Monday, January 26, 2004, at 8.00 pm.



TTS Systems

TTS Systems Communications Equipment

FREE CATALOGUE

[www.ttssystems.com.au](http://www.ttssystems.com.au)

HF and VHF Transceivers, Autotuners and Kits

NEW



We now have an extensive range of USA built SGC products, built with the three C's uppermost in mind – clarity\*, convenience and cost-effectiveness

Talk to us about it

\*Using ADSP – amazing pushbutton control of noise. Self-contained or PCB versions

### SG 202 HF Transceiver

Small, light, rugged, recessed face.

Pre-set for 20 watts PEP with front panel power adjustments down to 1W for QRP'ers or up to 20W for serious USB or LSB "hamming". 20 pre-programmed memories preset to each of the 9 worldwide ham bands. Each memory position can be selected for a specific transmitter output power, specific amount of bandwidth filtering, mode and split VFO. Crystal clear.



### ADSP2 Speaker

Noise reduction Works with the press of a button.

You can select from three modes of operation: no noise reduction, the original ADSP, and the new ADSP2 noise reduction modes which provides up to 26 dB of noise reduction within the passband. The ADSP2 Speaker is "One Touch" simple to operate.

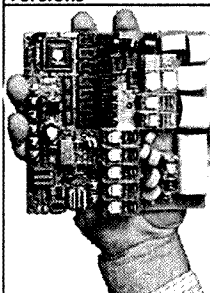
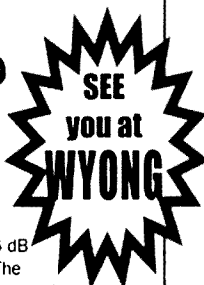

### A Very Big Handful

#### SG-237 HF-VHF SMARTUNER®

Worlds Smallest High Performance Antenna Coupler Tested. Available as a Finished Product or PCB

- 100 watts
- 1.8 to 60 MHz

### The SG-239 Smartuner™ antenna coupler

The SG-239 works with any transceiver to provide long distance communications. With the SG-239 antenna coupler, achieve great results with a longwire antenna or a coaxial fed multi resonant antenna at the apartment window or on a low roof, fits the coupler requirement of many low cost HF transceivers: Scout, Yaesu FT-817, Kenwood TS 50, Icom IC-706, and the K2 kit. Ideal with the legendary SG-2020 transmitter. Silent receiver tuning or within 1.5 to 200 watts with a high power transceiver. 170 memory bins, independent sensors, inc.VSWR, phase, magnitude, low impedance, and forward sensing.

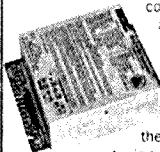

Strictly Ham (Melb.)  
Tower Comms (Perth)  
Kyle Comms (QLD)  
International Comms  
Systems (SA)  
Marcom-Watson Group (TAS)  
all re-sell these famous products

Phone 03 5977 4808. Fax 03 5977 4801 [info@ttssystems.com.au](mailto:info@ttssystems.com.au)

## VK2 News

Tim Mills VK2ZTM.

### Welcome to the New Year

That is just what so many Australian Amateurs did as New Years Day commenced. The HF bands became alive at midnight and without a break they partied on until after dawn. They were then joined by those who had preferred their bed until a more civilized hour. This was the view from VK2WI when the station operated in the WIA Welcome to HF QSO Party. VK2WI spent the night hours on 80 metre – 3595 kHz – logging just over 100 contacts in the first three hours. For the next few hours the pace was a little slower until a break for breakfast at 9 am. After that, operations switched to 40 and 15 metre. Operations ceased from VK2WI at 1 pm with 152 contacts in the logbook. The chief operator for VK2WI was Norm VK2TOP. He was assisted by Brian VK2WBK and Owen VK2AEJ. Also in attendance were Mark VK2XOF and Tim VK2ZTM who kept a supply of antennas and refreshments up to the front line staff.

In a separate competition to the national 'Welcome to HF', the VK2 Division extracted from the log, all Limited and Novice Limited VK2 members making their first HF contact. The winner was Bill VK2ZZF. He received a copy of the ARRL Antenna Handbook, which no doubt he will put to good use as he sets up a new QTH in the Snowy Mountains Region. Bill was a recent announcer on the VK2WI team and still contributes the monthly star report to the news sessions.

Elsewhere in this issue of "AR" VK2 members will find the notice of the forth coming AGM and a call for nominations for the Divisional Council for 2004/2005. Your assistance is required, as is your attendance at the AGM.

The 2004 callbook is available from the VK2 Bookshop. Cover price is \$25 with a discount for members at \$22. A \$3 pack and post applies. The Bookshop plans to be in attendance at the Central Coast Wyong field day on Sunday 29th

February. It is being held, as usual, at the Wyong Race Course, which is beside the railway station.

During the recent holiday break, the VK2WI news sessions observed their summer format with morning only transmissions. Included was a three part technical talk on Digital Radio Technology, given by Mathew VK2YAP. This will be repeated this month. The script will be included in the news text on the Division's web site. Thanks have to be extended to Jack VK2GJH, for his regular 6 metre DX report, which he submits to VK2WI. An invitation is extended to operators on the higher frequencies, to compile and submit similar news and activity reports to VK2WI.

The Hunter Radio Group in Newcastle has recently refurbished their 6 metre beacon. VK2RHV has moved to the new frequency of 50.288 MHz where it operates in the CW mode, with 25 watt into horizontal crossed dipoles. It is now located on Mt. Sugarloaf, Newcastle's RF hill. The Hunter Radio Group resume their Monday evening net, which includes segments from the VK2WI news. This will be on Monday 9th February at 7.30 pm. Their first meeting for the year will be on Friday 13th February. A two metre repeater has been licensed for the Bathurst district. The frequency is 146.675 MHz, negative offset. A 70 cm repeater is operational at Dubbo.

The VK2WI morse training transmission, on 3699 kHz and 145.650 MHz., has had some new text installed. It is surprising the number of operators using 80 metre as a band condition indicator. Being 1 kHz from the top of the main 80 metre segment, it provides a band edge marker and reminder of the commercial portion between there and the 80 metre DX window. Maybe the DX portion should be referred to as 75 metre. That is the phone portion for American amateurs, which they refer to as 75 metre. The live CW training session on 80 metre – 3550 kHz – continues several nights per week. While we all know that

an ability in code is no longer required for examination, the British experience after the introduction of their Foundation License was an increased interest in Morse code. Both the automatic and manual training will continue as long as there is a demonstrated demand for the service.

The Parramatta office reopened for the year on Tuesday 13th January. Novice classes at Parramatta resumed on Monday 19th January. A Trash and Treasure was conducted in January. The next will be at the end of March. A reminder that the VK2 QSL Bureau is conducted for the Division by the Westlakes Club. The Bureau postal address is P. O. Box 3073, Teralba, NSW, 2284. If any VK2 member needs a postal address for their station, inquire at the VK2 office. A postal address is available for this purpose. See the inside back cover of "AR" for contact points for the Division.

### VK2 Notice

## VK2 Annual General Meeting

will be held on

**Saturday**

**April 17, 2004**

**Nominations are invited for the nine positions on Council.**

Nominations are to be received at the Parramatta Office on or before the close of business on **Friday, March 5, 2004.**

Nominations in writing must be signed by the proposer, seconder and nominee, all of whom must be financial Ordinary Members of the NSW Division on **March 5, 2004.**

**Owen Holmwood VK2AEJ**  
Divisional Secretary



## VK3 News

By Jim Linton VK3PC

WIA Victoria web site: [www.wiavic.org.au](http://www.wiavic.org.au) email: [wiavic@wiavic.org.au](mailto:wiavic@wiavic.org.au)

### Oh what a party

**The WIA Welcome to HF QSO Party on new year's day generated a lot of new activity that is continuing, albeit at a less hectic level.**

A sincere thank you to the large number of WIA Victoria members who supported this WIA Federal initiative by getting on air. Congratulations to the party gift recipients who are listed elsewhere in this edition of AR magazine.

It is clear that the party was fun and united the amateur radio community like nothing else has previously. We can drop the labels "H-call" and "Z-call" because they have now lost their meaning.

The only concern arising out of the large influx of arrivals on the HF bands is the potential for increased television and other alleged interference issues.

The ACA is closely watching to see if interference complaints increase as it considers the future of amateur radio and the proposed introduction of a new entry level licence.

If you are new to HF take precautions against interference. At the first sign of an interference problem seek help from the WIA, your radio club or a knowledgeable radio amateur.

Possible causes of interference include hurriedly created antenna systems, lack of a low pass filter at the transceiver output, or poor adjustment due to unfamiliarity with controls. There is also plenty of literature available on the causes, prevention and cures of interference.

### ACA review of amateur service regulations

This very important exercise is still continuing. The ACA has already made a number of decisions in addition to giving no-code licence holders access to HF bands.

However the big issues, including the ACA proposed draconian "no interference" policy for radio amateurs

and consideration of changing amateur licences from apparatus licence to class licence, are yet to be decided.

Several WIA Victoria members and at least one radio club have taken their concerns to their local member of federal parliament. This is a good idea and it's not too late for anyone to let their federal MP know what is happening.

There are real concerns arising out of the ACA's discussion paper and its public consultation process. No harm can be done by exercising your rights by making these concerns known directly to your federal parliamentary representative. On the positive side it will provide these decision-makers with an awareness of amateur radio.

The WIA Victoria Council is continuing to explore ways it can achieve the best outcomes that lead to the long term sustainability of the amateur service in Australia.

### QSL Bureaux

A reminder that the WIA Victoria inwards and outwards QSL Bureaux are a free WIA Victoria membership service. Newcomers to HF will need to register their call sign(s) with the bureau to receive cards through distribution points.

It is also important that before having QSL cards printed that the requirements in terms of card sizes and card weight be checked on the WIA Victoria website or obtained from the WIA Victoria office.

Cards that are oversize or printed on very lightweight card or paper cannot be handled by overseas QSL Bureaux and will not be sent.

Also if you are new to HF, also please check out the WIA band plans which can be found in the callbook or on the WIA Victoria website.

### Review of WIA structure

Informal discussions about the restructure of the WIA began around the middle of 2003 with some interested people having a meeting in Sydney in December.

The WIA Victoria Council discussed the matter late last year but had been provided little detail of what others were proposing and considering.

The Council believes it is essential that any change to the federal structure of the WIA must be fully costed. A business plan is being drafted for a proposed restructure that would see all WIA Divisions hand-over their members, and presumably their assets and liabilities to a new single Institute.

WIA Victoria is seeking to assist in the development of a business plan to determine how a new WIA can be financed and provide membership services.

That exercise should include exploration of how repeaters, beacons, their licence fees, site licences and other costs can be funded, along with a QSL bureau, enhanced membership services and effective representation. Will WIA Victoria members be better or worse off?

There are a lot of "what-ifs" to be considered and answered in this the latest WIA restructure review over the past 30 years. The matter is again due to be discussed when the WIA Victoria Council meets this month.

### WIA Victoria office

Full membership services resumed with the reopening of the office at 40g Victory Boulevard, Ashburton on Tuesday, 3 February.

The first meeting of the WIA Victoria Council was also scheduled to be held on that day. During the holiday closure annual corporate and statutory reports were being completed and assistance given to our auditors.

A reminder that the Annual General Meeting will be held on Wednesday 26 May. Notices of Motion for the AGM close at 2.30pm Friday 20 February.

During the holiday break mail orders received for the 2004 Australian Radio Amateur Callbooks and CD were handled, and some copies are still available for sale.

ar

# Division News

## VK6 News

Compiled by Will McGhie VK6UU

Input to: will2@iinet.net.au

08 9292 7165

VK6 notes are back and hopefully will be for a while. Retirement has resulted in less time but provided I can dig up what's happening in VK6 there should be monthly input to Amateur Radio magazine. If any amateurs in VK6 would like their state represented in Amateur Radio magazine, and you have any news, even no news let us all know from time to time that nothing is happening in your area, please email to the above address or phone number.

### Snippets of news from the VHF-SHF region

Here are some of the current activities. Terry VK6ZLT made a quick trip to Busselton (200km South of Perth) beacon to reactivate VK6RBS (1296MHz beacon) which has been out of commission due to power supply problems. Operation confirmed by Alan VK6ZWZ in Perth soon after activation. Groundwork was carried out in preparation for the installation of a 10 GHz beacon at the same site due in the very near future. Everything is built and ready to go. Just the co-ordination of the installation team time wise. I will let you know as soon as the new beacon becomes fully operational.

Cheers and 73, Terry VK6ZLT

### VK6 QSL Bureau statistics

The following refers to the incoming QSL cards from overseas, handled by the buro in 2003.

The country is given first, then the number of cards received for that country, then the number of deliveries received from that country.

JA	2175	11	YL	38	2	VE	285	2	Z2	2	1
LZ	180	1	SM	169	2	DL	685	2	OH	188	2
HL	230	2	W	672	3	I	585	1	LA	77	1
9V	98	2	YV	7	1	SP	313	2	G	707	1
OE	158	1	ON+PA	188	2	YO	13	4	PY	4	1
OZ	106	2	4X	83	1	9H	10	1	YB	3	1
HA	183	2	ZS	148	1	EI	38	1	CE	4	1
UA	755	7	HB9	119	2	OK	300	1	YO	33	1

TOTAL of 8640 cards

As reported last year, there have been no cards received from some bureaux for over 2 years.

The outgoing cards totaled 2074. Not a good exchange rate.

For comparison QSL cards handled by the JA buro April 2002 to March 2003 11,244,687 incoming cards for JA - 2,018,235 outgoing cards from JA

From Neil Penfold VK6NE

### Annual General Meeting 2004

It is hereby notified that the Annual General Meeting of the Wireless Institute of Australia Western Australian Division Incorporated will start at 10am on Saturday 17th April 2004.

The venue for this year's AGM event will be the Dining Room at CWA House 1174 Hay Street West Perth and the agenda will be:

1. Consideration of the Council's annual report
2. Consideration of the financial report
3. Consideration of other reports
4. Election of office-bearers (President, Vice President and seven other Councillors)
5. Election of two Auditors
6. Appointment of a Patron
7. General business, which has been duly notified.

Notices of Motion for the AGM must be received by the Secretary not less than 42 days prior to the meeting (i.e. by the 5th March 2003), and must be signed by at least three members.

The Secretary's postal address is WIA WA Div. PO Box 10 West Perth WA 6872.

Nominations of candidates for

election to Council must be received by the Secretary, in writing, not less than 42 days prior to the meeting (i.e. by the 5th March 2003), with an intimation that the candidate is willing to act.

A candidate may submit a statement, not exceeding 200 words, outlining his or her experience and case for election. Each nomination shall be signed by two members proposing the candidate. Candidates must possess a current amateur licence.

Any financial member who is entitled to vote may appoint a proxy, who must also be a financial member who is entitled to vote, to speak and vote on his or her behalf. Written notice of such proxy must be received by the Secretary prior to the meeting, and be in the following form:

*I (full name), a member of the Institute, hereby appoint (full name), also a member of the Institute, to act for me as my proxy, and in my name do all things which I myself being present could do at the meeting of the Institute held on the 17th April 2004. Signed: ..... Witness:..... Date: .....*

Lunch will be provided in the form of sandwiches, cakes, biscuits, coffee and juice.

Council trusts there will be a quorum for the AGM by 10am. Lunch will be at 12 o'clock. It could be followed by up to two hours of discussion about Amateur Radio and the \*National WIA\* plus "Any Questions"

Listen to NewsWest for more information.

With thanks from the contributors:

Neil VK6NE

Christine VK6ZLZ

# Amateur Radio

## 100% amateur radio!

## VK7 News

Justin Giles-Clark VK7TW

### Divisional News

The Divisional Annual General Meeting will be held in mid March 2004, 2-3 weeks prior to the WIA Federal Convention in Brisbane. The location is Launceston and will be hosted by the Northern Branch. Stay tuned to the weekly Divisional broadcast for more information. If you are thinking of getting more involved in the running of the Tasmanian Division or your local branch then this is the time to nominate!

### Branch Meetings

#### North

The Northern Branch's Christmas BBQ was held at Myrtle Park on the 10 December and was attended by about 25 people. There were many guests and members who came along to enjoy the

hospitality. Sterling Heights vineyard was in attendance with all those Christmas beverages, thanks Geoff!

#### North West

A very enjoyable time was had by all who attended our final meeting for 2003. This meeting was made all the better, of course by the attendance of our NW ladies including our newest amateur Judy Kubank. The supper was a beauty - thanks ladies.

The Joan Fudge award for outstanding work for the branch in 2003 was easily won by Tony VK7AX. Tony has really brought the Northwest into focus on the amateur radio scene this year.

#### South

The last meeting for the year was a quiet affair with a BYO BBQ on the Domain. After the BBQ we tried our hand at

Amateur Radio Direction Finding. Thank to Richard VK7RO who supplied the fox and our intrepid band of DFers who raced off into the bush to try and locate the fox. The most successful technique seemed to be the body shielding method of direction finding without antenna and the handheld held close to the body.

### New Southern 6m repeater

The new six metre repeater, VK7RAD, is now fully operational from the Southern Branch clubrooms on the Queen's Domain. It is using a Halo omnidirectional antenna for transmit on 53.825 MHz and a horizontal dipole for receive on 52.825 MHz. Thanks to Dave VK7DM and his helpers for getting this repeater on air.

73, Justin Giles-Clark VK7TW



Northern Branch Members - Danny VK7DA, Phil VK7JJ, Joe VK7JG, Kevin VK7KVN and our Divisional President, Phil VK7ZAX .



North West Branch Members - Peter VK7LCW, Steve VK7ZSJ, Ken VK7KH, John VK7KDR and Ron VK7RN

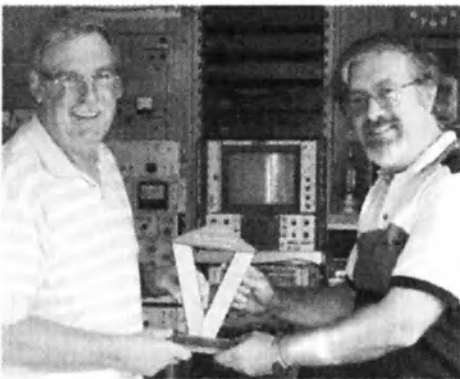

North West Branch's Joan Fudge Award recipient Tony VK7AX (left) being presented by NW Vice President, Steve VK7ZSJ



The author and Southern Branch Secretary, Dale VK7DG, cornering the fox!



Roger VK7XRN, in harness, installing the 6m repeater receiving dipole on the Queen's Domain Clubroom's tower.

Christine Taylor VK5CTY  
vk5cty@vk5cty or geencee@picknowl.com.au

## Did you hear the news about the changes that happened on January 1st?

As from January 1st this year the ACA have declared that there will be no requirement to pass a CW exam. Also, as a consequence of this decision all those who held a Limited licence will have full HF privileges and all those who hold a Novice Limited licence will have full Novice privileges. Did you operate

on Jan 1st? Did you give the new HF folk some contacts? I hope so. We have been looking forward to the time Australia would join with the other countries who have changed their licence conditions in the last year or so. Now let us show that we wanted the changes.

And for those of you who like CW. Go

for it! There are plenty of operators who enjoy the special contacts that can only be made on CW. I do not think we will be surprised to find some of the new HF operators trying their hand at the more difficult techniques involved in CW operation.

## Response to those keys

Remember the photo of the morse keys published in the November issue of AR? We have had two responses to our request for information.

The first was from Gerry VK7DQ who recognised several of the keys from very earliest experiences. In 1938 Gerry attended the Radio Holland College for Wireless Operators, the only institution that trained WOs for the Dutch Mercantile Navy. It was here he first encountered the key on the left of the picture.

It was pretty heavy as it was made of solid brass. Some operators use a rounded knob like the one in the photo, others preferred a flat knob.

Gerry remembers how they were taught Morse Code. Can you visualise a class of about 20 17-18 year-olds reciting "down 2-3 up down up down 2-3 down up down 2-3 up 2-3-4-5" to learn -.- ? That is the way they had to learn.

Gerry also remembers the second small key. This was used by the Royal Signals in England. It was used in conjunction with a telephone line, to be used when the line was too noisy. He said it was difficult to adjust and if you could do 10 wpm with it you were lucky.

The "speed keyer" on the right was the type used in the Netherlands after WW2 as everything with copper or lead in it

had been removed by the Germans for use in their armament factories. The one in the picture is a little different to the one Gerry recalls but substantially the same. A good operator could send 35-40 wpm with one of those.

The other respondent is much younger, he has only been on air for 25 years or so, but Warren remembers a 'bug' key similar to the one on the right and the key in the middle of the picture from his Army Reserve experiences, and he thinks one the on the left is similar to what is commonly called a Post Office key.

Interesting, isn't it?

## Luncheons

Oh dear, I have got it wrong again about the VK6 lunches. They are held on the LAST THURSDAY of the month, not on a Friday, at all. Sorry girls.

Please do contact Poppy VK6YF or Norma VK6PNS if you are likely to be in Perth.



The November Perth Luncheon

If you are in Adelaide contact me, Christine VK5CTY, or Meg VK5YG and in Melbourne, contact Bron VK3DYF or Gwen VK3DYL for more information.

## The AHARS Buy and Sell

As usual the ALARA table was very busy selling pies, pasties and drinks to the 200+ souls who came in through the doors.

Jean VK5TSX was not able to be present due to other commitments but she had ably organised all the goodies for us. Shirley VK5JSH, Meg VK5YG and Marilyn VK3DMS were joined from time to time by Jenny VK5ANW, Tina VK5TMC and Faith VK5ZFC and Leslie XYL of Hans VK5YX.

We had some YLs come to the

table and ask for a membership form and another has approached us since then so the numbers of YLs in ALARA continue to increase nicely.



At the Buy and Sell, L to R Christine VK5CTY, Marilyn VK3DMS, Meg VK5YG, Leslie, and Shirley VK5JSH.



## Published!

Deb VK5JT has had a book of poems published. Deb was historian for ALARA for several years. She produced a video tape of our History using many of the photographs of our early members. Congratulations Deb.

## Geelong Radio and Electronics Society

The syllabus for 2003 meeting nights was a mixture of talks by club members, guest speakers, and outside visits. One club member Mr. Bill Collins talked on his experiences while stationed in Antarctica. Guest speaker David Learmonth VK3XLD gave an excellent demonstration of his portable microwave equipment. He talked at length on this subject and told of the many problems associated with microwave propagation. Another guest speaker demonstrated the use of the Linux operating system for home computers. Club member Neil Hancock VK3XNH assisted by Rex Ford VK3ARG

gave a demonstration of APRS.

Visits to outside organisations were well attended. These included the projection room at the Reading Cinema and a demonstration of security products by Armour Security. A visit to the local astronomy club was most informative and gave us an insight into what amateur astronomers do.

On August 21 a dinner was held. This was to celebrate the Club's 40th birthday. It was pleasing to see many existing and past members attend.

The Club has again been actively involved in WICEN. In November the Geelong Touring Cycling Club held the

"Otway Classic", a 160km ride which attracted over 200 entries. This ride raises money for medical research. Club members manned the many checkpoints around the course. For the first time APRS was used to track the position of the official car and the ambulance. This test was most successful and showed the position of both vehicles through the rugged terrain of bushland and the Great Ocean Road.

Club meetings are held every Thursday evening at 2000 hrs local time. The meeting rooms are at the rear of the Belmont Youth Club in High St. Belmont.

## Waverley Amateur Radio Society

**The Waverley Society, which has been established for 85 years, provides a meeting place located in the Eastern Suburbs of Sydney for hams and others interested in amateur radio.**

The society has its own well-equipped clubhouse located in the old scout hall in Vickery Avenue, Rose Bay. Evening meetings, usually with a lecture, are held on the third Wednesday of each month. The Club is also open on the first Saturday afternoon of the month when members and visitors can meet informally to operate the Club station, fix faulty gear, improve the facilities or just have a ragchew. Other regular activities include portable operation for the John Moyle and Lighthouse weekends, an annual auction in June, training and examinations for licences and provision of a scout radio station for JOTA.

Members have a wide range of radio-

related interests including HF/DX operating, satellites, newer modes such as PSK31 or IRLP, equipment construction or repair, use of computers in ham radio, portable and mobile operation, collecting early equipment and are happy to share their expertise with others.

The Club is responsible for the Paddington 2m and 70cm repeaters, the latter having an IRLP facility. Apart from informal contact on these repeaters, the Club has an active group email list and a large and up-to-date website.

The website, set up in 1995 and updated at least monthly, contains contact information including location

maps, a list of members with joining procedures, details of past and future activities with many photographs, information for hams visiting Sydney including useful radio frequencies, items for sale and wanted, as well as the Club's history in early photographs, QSL cards and interesting correspondence with the licensing authorities. This can be found at [www.vk2bv.org](http://www.vk2bv.org).

The club welcomes overseas or local visitors and new members and can be contacted by email via the web site, through the President, Eric VK2VE, on (02) 9337 2909 or by post to PO Box 581, Vaucluse NSW 2030.

## The International YL Meet in Korea in 2004

The closing date for applications is now the end of February 2004, with payment due by the end of June 2004.

In August 2003 there were 104 attendees (59 from the 7 countries and 45 attendees from Korea). The YL Meeting Activities from 8-11 Oct 04 have not changed but there is a change to the Option program I and II as previously announced.

### Program Change

8 Oct-11 Oct, YL Meeting, same.

12 Oct, we have Option Tour I (one day, Kyongju City, 1000 years old dynasty capital city)

12-14 Oct, Option II (Kyongju city and Jeju island trip.)

The organisers would love to see more attendees at the Seoul YL 2004, from many countries. They have lots of things to show you and to introduce you to Korea. They are preparing much fun for you. All Korean YLs and OMs want to meet you!.

Decide now – Korea is not far off. If you are busy with your work, don't you need a vacation to recharge your batteries? Don't you need to enjoy the chance of sharing friendship again?

### From Chae HL2KDW

*YL 2004 Meeting period is good season for the tour, nice weather.*

*Safety is guaranteed (you can walk thru the night in the downtown, everywhere)*

*All the cost is very cheap (Seoul is a Paradise of Shopping)*

*Good Hotel accommodation.*

*Fantastic Jeju island tour chance!!*

*First of all, Warm hearted Korean YLs are waiting and welcome to you!*

*All of us, we are looking forward to seeing you.*

*73! and 88!*

## Australian Made ANTENNAS

### "Setting a New Standard" COM-AN-TENA

(Formerly a j and j coman)

6 Muir Court  
CHELSEA HEIGHTS 3196

All new 5/8 vertical 16 radials	\$160
Dual drive 26-30 5 ele yagi beam	\$315
4 ele 10-11m yagi beam	\$278
5 ele high gain antennas 11m	\$327
3 ele delta loop 10-11m	\$326
11m 5/8 vert./4-1/4 wave radials	\$175
Duoband 10-15 3 ele each band	\$385
Tri-band 5 ele HB35C s/steel fix	\$730
3 ele 20m computer opt	\$420
3 ele 15m computer opt	\$295
M B Vert Auto switch 10-80m	\$330
40m linear loaded 2 ele beam	\$595
6m 5 ele compt opt beam	\$268
6m 7 ele compt opt beam	
boom — 60mm	\$387
10 ele high performance 2m	\$145
17 ele high performance 70cm	\$125
2m vert 2-5/8 co-linear 4 rad	\$120
Log-periodic 9 ele 13-30 MHz	
7.7m boom	\$990

### Guyed Masts

21 metres                      13 metres

Winch-up & tilt-over. Aluminium and stainless steel  
three-sided construction. Auto-brake winches.

### Free Standing Masts

9.5 metres

#### New Baluns

1-1 to 16-1 to 3kV

#### Our Masts

meet

Australian Standards.  
We supply all the  
computations and data  
you will need for  
a permit.

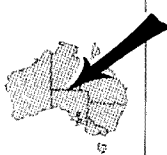

03 9773 3271

Mob: 0419 542 437

Andy VK3IV

## Over to you

### ALARA's challenge

In the JOTA para of the ALARA column of last month's AR you wanted to know, "Can you match this?" Not really but I am going to tell you about our JOTA activity, anyway! Not only in words but also in pictures!

We have been helping Clunes 1st Guides group with JOTA for a little more than half of VK5KR's involvement with the Black Forest Scouts. There is no doubt that 30 years is a marvellous effort. Congratulations! This year we set up a portable station, VK2GGL, at the home of their leader, Helen Hargreaves. Her residence is situated approximately 30 kilometres west of Byron Bay and is surrounded by 4000 macadamia nutrees (a few can be seen in the pics). (The Dunoon area is reputed to be the macadamia nut capital of the world!)

The portable station consisted of a Kenwood, TS570s being fed into a windom antenna of 41 metres, each end hung over a nut tree about 25 feet above earth. This HF station was situated at the rear of the house with a clear view of

Mount Warning. A Kenwood, TM241A, was set up at the front of the house and this was fed to a three element delta loop cut for 2 metres.

The whole set up was similar to JOTA, 2002, but fewer contacts were made this year on both HF and VHF. The reasons for this were that conditions on HF were not as good as last year and there were fewer VHF stations operating this time. However, the enjoyment of the group was just as great as the previous year.

Christine, do hope that this is of interest to you.

I do browse through your column in each 'Amateur Radio' and do appreciate that you do a very fine job of putting it together each month. Congratulations to you and keep up the good work!

88. Bill.



From left to right: Amelia (just about out of the picture), Nina, Catherine, Bethan and Louise.



The three element beam above the roof line.

The line-up from left to right: Warwick, VK2EDE, (second operator), Helen, Sally, Ruby, Phoebe, Nina, Maddie, Louise, Keisha, Catherine, Bethan, Ashlee, Amelia, and Jill.

## CONTEST CALENDAR 2004

Feb	28-29	NZ Jock White Memorial Field day		
March	20-21	John Moyle Field Day	(CW SSB)	Feb
April	17	Australia Post Code Contest		
April	24	Harry Angle Sprint	(CW SSB)	
May	15	QRP Day	(CW SSB)	
May	22	VK/trans-Tasman 80 m	(Phone)	
June	5	VK/trans-Tasman 80 m	(CW)	
June	?	Wadda Cup		
July	17	VK/trans-Tasman 160m	(CW Phone)	
July	3	ZL memorial 80 m		
July	?	Jack Files		

### Contest Notes

#### VK/trans-Tasman Contests

The VK/trans-Tasman Contests have been expanded to include both 80 and 160 m.

**80 m Phone - SAT 22 May**

**80 m CW- SAT 05 June**

**160 m Phone and CW- SAT 17 July**

All of this up-dated information is available on the Contest web-site, at <http://home.iprimus.com.au/vktasman>

#### New 160 metre contest

I have received permission from WIA (Fed), to replace the struggling "160 m Pacific DX Contest", in July, with a new Contest under my management.

The New Contest (160 m VK/ trans-Tasman Contest) will be on SAT 17th JULY '04, and will use the same Rules as the 80 m VK/ trans-Tasman Contest (held May - June).

A separate trophy and Certificates will be awarded in the 160 m Contest, with

Phone and CW Categories on the same night.

Hopefully, with the new format and a lot more advertising, the new Contest will make a resurgence. I am also hoping that the old "Limited Licensees" will be eager to try something totally new for them, on 80 m and 160 m.

All the relevant info is on the Contest URL at: <http://home.iprimus.com.au/vktasman>

**73, Bruce Renn (VK3JWZ - Contest Manager)**

## John Moyle Field Day Contest 2004

Presented by Eric VK4NEF

**20 - 21 March, 2004**

**0100 UTC Sat - 0059 Sun**

**Once again those who enjoy a weekend in the bush should be planning for this year's John Moyle Field Day.**

If anyone wishes to contact me privately to discuss rules etc, my home phone number is 07 3390 5664, and my address is as shown in the Log Submission section below. I wish all entrants good luck, and look forward to hearing you on air during the contest!

N.B. new Email address: [jmfd2004@wia.org.au](mailto:jmfd2004@wia.org.au) and or check out latest info at <http://www.wia.org.au/contests/>

#### Overview

1. The aim is to encourage and provide familiarisation with portable operation, and provide training for emergency situations. The rules are therefore designed to encourage field operation.
2. The contest takes place on the 3rd full weekend in March each year, and runs from 0100 UTC Saturday to 0059 UTC Sunday, 20-21 March 2004.
3. The contest is open to all VK, ZL and P2 stations. Other stations are welcome to participate, but can only claim points for contacts with VK, ZL and P2 stations.

4. Single operator portable entries shall consist of ONE choice from each of the following (e.g. 6 hour, portable, phone, VHF/UHF):
  - a. 24 or 6 hour;
  - b. Phone, CW, or All mode;
  - c. HF, VHF/UHF or All Band.
5. Multi-operator portable entries shall consist of ONE choice from each of the following (e.g. 24 hour, portable, phone, VHF/UHF):
  - a. 24 or 6 hour;
  - b. Phone, CW, or All mode;
  - c. HF, VHF/UHF or All Band.
6. Home and SWL single operator entries may be either 24 hour or 6 hour, All mode, All band.

## Scoring

7. Portable HF stations shall score 2 points per QSO.
8. Portable stations shall score the following on 50 MHz:
  - a. 0-49 km, 2 points per QSO;
  - b. 50-99 km, 10 points per QSO;
  - c. 100-149 km 20 points per QSO;
  - d. 150-199 km 30 points per QSO;
  - e. 200-499 km 50 points per QSO;
  - f. 500 km and greater, 2 points per QSO.
9. Portable stations shall score the following on 144 MHz and higher:
  - a. 0 to 49 km, 2 points per QSO;
  - b. 50 to 99 km, 10 points per QSO;
  - c. 100 to 149 km, 20 points per QSO;
  - d. 150 km and greater, 30 points per QSO.
10. For each VHF/UHF QSO where more than 2 points is claimed, either the latitude and longitude of the station contacted or other satisfactory proof of distance must be supplied.
11. Home stations shall score:
  - a. Two points per QSO with each portable station.
  - b. One point per QSO with other home stations.

<b>Icom 706MK2G</b>	<b>\$1,299</b>
<b>Yaesu FT100</b>	<b>\$1,050</b>
<b>Icom 207H</b>	<b>\$479</b>
<b>Kenwood TS2000</b>	<b>\$2,599</b>
<b>Icom 910H</b>	<b>\$2,199</b>
<b>Kenwood TMV7A</b>	<b>\$699</b>
<b>Yaesu FT8900R</b>	<b>\$749</b>
<b>Icom AT180</b>	<b>\$649</b>

All second hand – all immac.

### Computer interface

Icom and Yaesu	\$69
Mobile Kit IC706	\$99

**COD to anywhere in VK**

Visit [WWW.VK3AJJ.COM](http://WWW.VK3AJJ.COM)

or telephone Paul 03-9504 2628

Licensed second hand dealer No.10229 (Vic.)

## Log Submission

12. For each contact: UTC time, frequency, station worked, RST/serial numbers sent/received and claimed score. (VHF and above location of other station and distance.)

Logs must be accompanied by a summary sheet showing: callsign, name, mailing address, section entered, number of contacts, claimed score, location of the station during the contest, and equipment used, and a signed declaration stating "I hereby declare that this station was operated in accordance with the rules and spirit of the contest and that the contest manager's decision will be accepted as final". For multi-operator stations, the names and callsigns (legible) of all operators must be listed.

13. Paper logs may be posted to "John Moyle Contest Manager, 108 Queensport Road, Murarrie Qld 4172, Australia" (They will be forwarded onto the new contest manager). Alternatively, logs may be e-mailed [jmfd2004@wia.org.au](mailto:jmfd2004@wia.org.au). The following formats are acceptable ASCII text or Office or Excel. Logs sent by disc or e-mail must include a summary sheet and declaration, but the operator's name (legible) is acceptable in lieu of a signature.

Logs must be postmarked no later than 30 April 2004.

## Certificates and Trophy

14. At the discretion of the Contest Manager, certificates will be awarded to the winners of each portable section. Additional certificates may be awarded where operation merits it. Note that entrants in a 24 hour section are ineligible for awards in a 6 hour section.
15. The Australian portable station, CW section, with the highest CW score will be awarded the President's Cup, a perpetual trophy held at the Executive Office, and will receive an individually inscribed wall plaque as permanent recognition.

## Disqualification

16. General WIA contest disqualification criteria, as published in Amateur Radio from time to time, applies to entries in this contest. Logs which are illegible or excessively untidy are also liable to be disqualified.

## Definitions

17. A portable station comprises field equipment operating from a power source, e.g. batteries, portable generator, solar power, wind power, independent of any permanent facilities, which is the normal location of any amateur station.
18. All equipment comprising the portable station must be located within an 800 m diameter circle.
19. A single operator station is where one person performs all operating, logging, and spotting functions.
20. A single operator may only use a callsign of which he/she is the official holder. A single operator may not use a callsign belonging to any group, club or organisation for which he/she is a sponsor except as part of a multioperator entry.
21. A multioperator station is where more than one person operates, checks for duplicates, keeps the log, performs spotting, etc.
22. A multioperator station may use only one callsign during the contest.
23. Multioperator stations may only use one transmitter on each band at any one time, regardless of the mode in use.
24. Multioperator stations must use a separate log for each band.
25. A station operated by a club, group, or organisation will be considered to be multioperator by default.
26. None of the portable field equipment may be erected on the site earlier than 28 hours before the beginning of the contest.
27. Single operator stations may receive moderate assistance prior to and during the contest, except for operating, logging and spotting. The practice of clubs or groups providing massive logistic support to a single operator is, however, totally against the spirit of the contest. Offenders will be



disqualified, and at the discretion of the manager, may be banned from further participation in the contest for a period of up to 3 years.

28. Phone includes SSB, AM and FM.

29. CW includes CW, RTTY, and packet.

30. It is not expected that any other modes will be used in the contest, but if they are, they shall be classed as CW.

31. All amateur bands may be used except 10, 18 and 24 MHz. VHF/UHF means all amateur bands above 30 MHz. Note: On 50 MHz, the region below 50.150 has been declared a contest free zone, and contest CQs and exchanges may only take place above this frequency. Stations violating this rule will be disqualified.

32. Cross-band, cross-mode and

contacts made via repeaters are not permitted for contest credit. However, repeaters may be used to arrange a contact on another frequency where a repeater is not used for the contact.

33. Stations may make repeat contacts and claim full points for each one. For this purpose, the contest is divided into eight consecutive three-hour blocks: 01-0359: 04-0659: 07-0959: 10-1259: 13-1559: 16-1859: 19-2159: 22-0059 UTC. If you work a station at say 0359 UTC a repeat contact may be made after the start of a new block providing, they are not consecutive or are separated by five minutes, since the previous valid contact with that station on the same band and mode.

34. Stations must exchange ciphers comprising RS (T) plus a 3 digit number commencing at 001 and

incrementing by one for each contact.

35. Portable stations shall add the letter "P" to their own cipher, eg.59001P.

36. Multioperator stations are to commence each band with 001.

37. Receiving stations must record the ciphers sent by both stations being logged. QSO points will be on the same basis as for Home Stations, unless the receiving station is portable.

38. The practice of commencing operation and later selecting the most profitable operational period within the allocated contest times is not in the spirit of the contest, and shall result in disqualification. The period of operation commences with the first contact on any band or mode, and finishes either 6 or 24 hours later.

## Results of 2003 John Moyle Field Day Contest

Stn.	S/M OP	Mode	Band	Stn.	S/M OP	Mode	Band
<b>Portable, 6 Hour</b>				VK5MX	Single	Phone	All bands 272 *
VK5SR	Multi-op	All Mode	All bands 1906 *	VK5UE	Single	Phone	All bands 154 *
VK4WID	Multi-op	All Mode	All bands 308 *	VK4EV	Single	Phone	HF 110 *
VK3APC	Multi-op	All Mode	All bands 158 *	VK4BAF	Single	Phone	HF 104 *
VK3FRC	Multi-op	Phone	All bands 264 *	VK3VTX	Single	Phone	V-UHF 1408 *
VK1AI	Multi-op	All Mode	HF 118 *	<b>** = Presidents Cup Winner VK5NJ</b>			
VK2UQ	Single	CW	HF 42 *	<b>HOME, 24 Hour</b>			
VK2KUR	Single	Phone	All bands 66 *	VK2CZ	Home	All Mode	All bands 315 *
VK5VH	Single	Phone	HF 18 *	VK3DBQ	Home	All Mode	All bands 294 *
VK5AVQ	Single	Phone	V-UHF 644 *	VK4IRW	Home	All Mode	All bands 175 *
VK5ACE	Single	Phone	V-UHF 280 *	VK2ASU	Home	All Mode	All bands 77 *
VK3VP	Single	Phone	V-UHF 50 *	VK2EA	Home	All Mode	All bands 41 *
<b>Portable, 24 Hour</b>				VK2IGS	Home	All Mode	All bands 33 *
VK4WIS	Multi-op	All Mode	All bands 6576 *	VK5ATQ	Home	All Mode	All bands 57 *
VK2SRC	Multi-op	All Mode	All bands 5062 *	VK4WIL	Multi-Op	All Mode	All bands 255 #
VK3CNE	Multi-op	All Mode	All bands 4732 *	<b># = Encouragement Award</b>			
VK3AEF	Multi-op	All Mode	V-UHF 4580 *	<b>HOME, 6 Hour</b>			
VK3ER	Multi-op	Phone	All bands 8370 *	VK3KTO	Home	All Mode	All bands 111 *
VK4BAR	Multi-op	Phone	All bands 2858 *	VK4RF	Home	All Mode	All bands 108 *
VK5BP	Multi-op	Phone	All bands 2410 *	VK2GR	Home	All Mode	All bands 72 *
VK3ANR	Multi-op	Phone	All bands 2268 *	VK2AKB	Home	All Mode	All bands 64 *
VK4CO	Multi-op	Phone	All bands 754 *	VK3VD	Home	All Mode	All bands 18 *
VK2AFY	Multi-op	Phone	All bands 96 *	<b>SWL, 24 Hour</b>			
VK5BAR	Multi-op	Phone	HF 520 *	Roy Ford	SWL	All Mode	All bands 109 *
VK4WIT	Multi-op	Phone	HF 330 *	<b>Check logs:</b>			
VK3EGC	Multi-op	Phone	HF 130 *	VK5RG			
VK3ATL	Multi-op	Phone	V-UHF 3398 *	VK5AIM			
VK5NJ	Single	CW	All bands 296 **	VK4CHB			
VK3JS	Single	CW	All bands 156 *				
VK4OE	Single	Phone	All bands 2594 *				
VK3KG	Single	Phone	All bands 2234 *				

# Education

Ron Smith VK4AGS  
Federal Education Co-ordinator

## The test of time

**A new year has come. We can expect a different amateur radio after the end of this year. What will the coming year bring for education?**

When you raise the subject of amateur radio education in discussion somewhere thoughts and comments usually go to courses, resources, examinations, and of course the usual comments about pass and failure rates. Why do we think so much about what is really a nano-smidgen of what education should be in amateur radio?

Ever since its inception, most likely with Hertz and Marconi, amateur radio is about self-learning. The real education, the vast majority of education, is what those already with a

license actually do to learn more about electronic communications technology, and its uses and applications. This is enshrined now, and always has been, in international policies about amateur radio. The more formal training and assessment systems are just the entry, a very small part of the real education scene.

There are two issues to consider at the start of another year. What self-training can each of us do this coming year and what applications can we use to provide service our community?

These are easy questions to ask and they are even easier to answer. There is just so much in the vast scope of amateur radio that we all should be able to self-educate for centuries, if the medical world could keep us alive that long.

So I take the opportunity to extend the very best wishes to all operators (existing and future), their families, and all readers a very successful 2004, and issue the challenge to take up the real meaning of education.

ar

## Club News

### Adelaide Hills Amateur Radio Society

The Buy and Sell on November 23rd was the usual success. The weather was hot but the hall was well air-conditioned. The queue outside waited in the shade but was as long as ever.

Old friendships were renewed and new friendships were formed. Also, as usual, your 'junk' became my 'treasure'. New projects were decided upon and extra stages were added to old ones. Fun was had by all.

The November meeting was a construction night, again organised by Graham VK5ZFZ. This time everyone made a dummy load. Most of them were

successfully completed but those people who cut off the 'tails' of the resistors too soon had to use extra solder to make some of the connections. No doubt some of the dummy loads are already in use.

### Lower Murray Radio Group Christmas Dinner

This was held at the Wellington Hotel, one of the older pubs in SA. It is right beside the river so the diners were able to watch the Wellington Ferry gliding back and forth. The reflections in the water were quite beautiful.

Fourteen people enjoyed a good meal and pleasant company.

This group has increased in size considerably in recent years, which is satisfactory to those who kept in going in the lean years.

### Fleurieu Peninsular Radio Group

This used to be called the Southern Radio Group but to distinguish it from the South Coast ARC a new name has been adopted.

This group meets for a meal every three months but talks on the air most days. The numbers coming to these lunches is also on the increase. In general the club scene in VK5 is growing.



The Fleurieu Pensular Group, Garry VK5ZK and XYL Cecily, and Leslie XYL of Hans VK5YX, nearest the windows.



Some of the younger members of the Lower Murray Group. From l to r Chantelle, XYL of Brenton VK5JBJ, next to her, and Shane VK5NRV, who is responsible for the repeater 5RMB that is heard over so much of the southern area.

## Part 33 – The Ultimate QRP Project

Every licenced Radio Amateur should have a worthwhile home construction project on hand. These days, just being 'an appliance operator' is not exactly what the 'experimental' ethos of the licence is all about. Some readers will protest by suggesting that they don't have the facilities, or they can't be bothered anymore. This article might just tickle your fancy, especially with the increased interest in CW operating, the opportunity to use your computer wisely, and to take advantage of building a CW transceiver from a kit in just one evening. For readers on a budget, here's a cost-effective solution for getting on air and ideal for newcomers to our wonderful hobby of Amateur Radio.

### Some Background

First published in QST April 2003, Dave Benson K1SWL described his well known RockMite QRP transceiver kit which has sold well over 1,000 kits worldwide - and the numbers are still growing very fast indeed. What's special about this kit:

1. PIC controlled.
  2. Full QSK CW break-in.
  3. No coil winding.
  4. Receive crystal filter.
  5. Switchable sidebands.
  6. Inbuilt Iambic CW keyer.
  7. Runs from a 9-volt battery.
  8. Web site supported.
  9. Up to 1-watt RF output.
  10. 20m and 40m versions.
  11. Silk screened, drilled PCB ...
- and it only costs \$25:00 US!

### Applications

For newcomers to AR, this is a chance to get active on a very slim budget. Veterans can try QRP techniques just for fun and give the 'big rig' a rest. Portable fanatics can get cracking with a tiny rig that'll run off a single 9-volt battery. For those thinking of dabbling with QRP from their vehicles - then the cigarette lighter socket will be ideal. In the shack, the RockMite can act as a test bed, propagation tester, CW practice oscillator - AND a full-blown QRP

transceiver with all the trimmings.

### Computer control

For serious operators, try connecting the RockMite (or any other QRP transceiver) to your computer logging and control system - add DigiPan for a waterfall display, and dovetail a Timewave DSP9 audio processor and you end up with a very powerful transceiver and operating system - especially if you also connect the CW control features including the computer macro's. But first, let's look at the RockMite kit in a little more detail.

### The RockMite TX/RX Kit

Small Wonder Labs offers the kit for sale on the Internet, and has facilities to purchase the kit on-line using PayPal for secure transactions. The kit comprises all the components, ICs and sockets, transistors, crystals, resistors, capacitors, RF chokes and a very nice silk-screened printed circuit board. You have to supply the diecast aluminium case (Jaycar HB-5062) plugs and sockets, volume control and a mini push switch. The antenna connection is a standard chassis mount BNC socket.

Once the kit has been purchased, and all the hardware acquired locally, download a copy of the Small Wonder Labs RockMite assembly manual from the HSC Web Site - Hot Links page. The

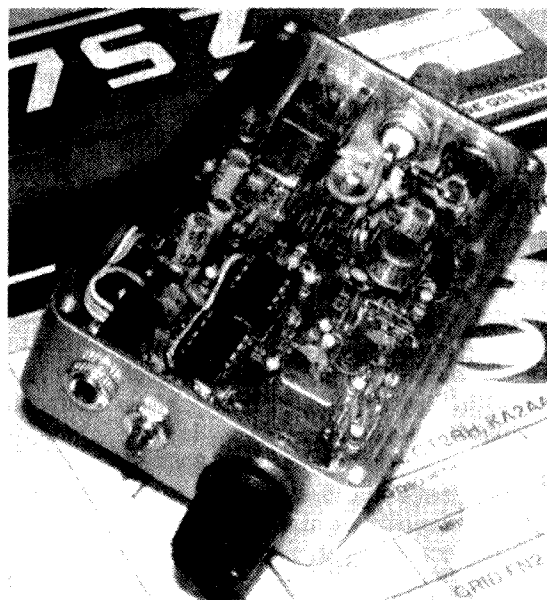

Figure 1

document provides the circuit diagram and a description of operation. Tips and assembly tricks are also offered to help newcomers with home brewing, even hints on soldering techniques on how to install the surface mounted 8-pin front-end IC package.

The writer collected all the paperwork, including copies of the QST article, web page information and the helps manual adding them all to a display book. The plastic transparent pockets thus protect the pages from grubby fingers, and it makes for a fileable handbook for future use if needed once the job is finalised and the rig becomes operational.

### RockMite Specifications

In its basic form, the RockMite runs about 300mW output from a 2N2222 PA into 50-ohms. The kit comes in the 40m (7.040 MHz) or 20m versions for the same price. The writer chose the 20m version operating on 14.060 MHz. The receive front end uses a surface mount SA612AD acting as a mixer/oscillator. A 14.060 crystal acts as a receive filter offering a nice sharp peak on the QRP channel. The SMD chip is followed by a

LM1458N audio stage feeding headphones. On transmit, two 2N4401's feed a 2N2222 PA. A pre-programmed micro-controller PIC (12C508A-02/P) provides iambic keying with roughly 17 WPM default on switch on. CW speed can be varied using a miniature push switch. One long push outputs the character "S" in Morse code. By sending dots on the key, the speed is reduced. Conversely, using the dash key the speed can be increased. This might seem clumsy, but one tried it's a dream to use. The letter "S" used when programming is not sent to air. After about 2 seconds, the PIC drops back into the ready to send mode at the new programmed speed. Keyed side-tone at around 700 Hz is sent to the audio output, and transmit offset is handled by a vari-cap diode. A short push on the switch changes sidebands so you won't miss callers off channel. For QSK keying, the PIC switches a 2N7000 then the driver-PA. In addition, audio reduction via another 2N7000 semi-mutes the audio on transmit so you can hear your own outgoing CW comfortably. All up, the transceiver is a brilliant design that simply must be tried. Remember the whole kit only costs US \$25:00 post paid into Australia!

For readers who would like the ultimate die-cast enclosure for your RockMite, American Morse Equipment (3) offers an especially milled case (US \$20) designed exactly for the job, and it's even anodised blue for a superb durable finish. However, for around \$10, the Jaycar product does just as well, and looks good if sprayed with an oil-based paint finish and oven baked for a very hard durable finish.

## Suggested modifications

Rich Arland K7SZ in QST for May 2003 suggests increasing the power output to almost 1-watt by replacing the 2N2222 with a 2SC799 transistor. The writer chose a 2N3053 (Jaycar ZT2299) and obtained 900mW continuous output with an added TO5 push-on heatsink (Altronics H0670) cut down to half size so it fits into the diecast case easily. The kit does not come with an audio volume control, but it can easily be added using

a 1-Meg linear potentiometer (Altronics R2248) in place of R5 on the circuit diagram. Look for the 16mm small size pots otherwise it won't fit nicely into the Jaycar diecast case. Once the 1/4 inch spindle is cut down, and a nice little knob fitted, the transceiver becomes very desirable and easy to use.

Many other suggested modifications and feverish discussions can be found on the RockMite Internet reflector at:

rockmite@yahoo.com

It's amazing to see the various designs offered by RockMite users. Some use Altoids tins, tuna tins, empty computer mouse housings and many more. If you are considering the RockMite 40/20 then your own imagination can run wild. Some constructors have built in Morse keys and even 12-volt power supplies, others have 9-volt battery clips attached to the case. The choice is yours depending upon the intended use for your own creation.

For a shack power supply, the writer used a commonly available 1-amp DC plug pack from the junk box. However, remember to switch off the plug-pack when not in use. Other options include the 12-volt accessory terminals on the big rig PSU, or you can easily build a tiny PSU with a 7812 regulator, a bridge rectifier and appropriate smoothing etc. Use your imagination and you'll be well rewarded.

For portable/mobile applications, kit out a case/box with an assortment of leads, Morse key, headphones and roll-up antennas. The whole kit should fit into a nice sized floppy camera bag all ready for your next excursion. Remember to take some QSL cards, some paper and a pen to act as a temporary logbook. The tiny mobile logbook from the RSGB in the UK is an ideal solution for serious operators. For readers thinking about an International holiday, you'll love the RockMite option because it's light, easy to use and the whole kit fits into a "bum bag" - Great!

## Operating the RockMite

For newcomers to QRP, the antenna is the first consideration if DX is the objective. RAs with an existing 20-metre beam antenna, or operators with a

healthy 40-metre vertical with plenty of ground radials are the lucky ones. However, an optimised dipole works well fed directly from the RockMite without an ATU or SWR meter. This is fine for casual portable operation, but in the shack at home, the big antennas will always win the day. The HF bands are busy enough so you'll need plenty of wire in the sky to winkle out those much wanted countries using QRP.

Above all, your own skill at listening and using CW will be foremost in being a successful QRP operator. 14.060 is the international QRP calling/working frequency, and with the RockMite you are rockbound on this channel. The receive bandwidth is wide enough to hear stations several kHz HF and LF of 14.060, and the crystal receive filter offers a nice peak at 700Hz. A short push on the switch reverses sidebands allowing a small change in frequency - and that's it. Watch for openings on the band and listen carefully for callers. Use your own skill to winkle out other stations, and do some calling in an effort to make contacts. It's best to follow the propagation charts looking for openings to your favourite country. For example, when open to the USA, good signals will be heard, but you'll need to use your experience as to when and how you call the other stations. Many times you may not be answered because the remote station is not digging deep listening for QRP DX stations, or your signal might be drowned in his local QRM. Persistence will win in the end. Once the DX location knows you are active, other stations will wait until you are ready to be called again.

A nice big fish can always be caught on a fine line. The same with QRP operation and only 300mW - not exactly high power but great fun when other stations call you back. The writer's first RockMite QSO was into Queensland with another QRP enthusiast who was amazed at my 0.3-watt output signal. 559 were exchanged between us with much delight.

The current world record between RockMites is between the USA and New Zealand. How about an Australian station taking out this record?

**To all those readers who have responded..., a big thank you. Without feedback, this series would not have been a success for over two years. The topics featured were, in fact, driven by the wider interest of our readers - which is the way things should be in a modern interactive world.**

## Computer Control

Most readers would argue - What's all this QRP business got to do with computers anyway, and why feature the RockMite in Ham Shack Computers? Well, it's about bringing together all the techniques featured in this series of articles.

With a good computer logging program installed on your computer, and using the DSP capabilities of the sound card, your RockMite receiver becomes a very powerful and 'hot' little device. It gives you a unique advantage to be able to hear all the stations that your 'big rig' can hear. For readers with YPlog software installed, and the pre-programmed YPlog CW macro's configured for DXing on 20m. Add DigiPan and use the waterfall so you can actually SEE the DX calling, measure your receive bandwidth, and develop your own strategies in amongst the QRM seen on the waterfall.

## The DigiPan Waterfall

How did we ever manage before DigiPan came along? - one will never know. Figure 2 shows the true power of using the DigiPan waterfall as a spectrum analyser. Adding a Timewave DSP-9 audio processor between the RockMite and the input to the computer sound card turns your RockMite into a very powerful receiver. The lower portion of the display reveals the RockMite bandwidth from 300Hz - 2.5kHz. The marker sits on the 700Hz optimum sidetone frequency. This is the ideal setting for general listening ready to pounce on wanted stations. With the RockMite sideband switching, some

5kHz centred on 14.060 can easily be monitored. The middle of the display above shows the bandwidth reduction when the DSP9 is switched to CW, and the upper part of the waterfall shows the narrow bandwidth of 100Hz when the QRM becomes difficult. Add the noise reduction capabilities of the DSP9 and you have the ultimate QRP, computer controlled rig. The same techniques can be used with your 'big rig' to help gain a significant advantage - especially for serious contesters and DX chasers.

## Summary

This topic has covered an innovative approach to modern QRP kit building and operation using the power of DSP and computer exploitation. For only \$25 US you can work the world with your RockMite, but all the skills learned from your AR experience will also come into play. It's the ultimate challenge for proactive operators. In addition, this article brings together many of the topics covered in the Ham Shack Computers series. Above all, it's great fun to do, and the RockMite adds a new dimension to your own lifelong hobby of Amateur Radio.

## Epilogue

Sadly, this brings the Ham Shack Computers series to an end in this magazine. Hundreds of topics have been covered in the last two and one half years of publication. From building your own computer with parts found at the local tip, DOS, all the Windows packages through Linux have been described. Not to mention the best AR software currently available worldwide that opens up the world of modern AR

communications. From packet radio, all the digital modes, spam, firewalls, virus protection, networking, and fine tuning your computer have all been featured. Lastly, web design, HTML, email and the Internet have been integrated together with the best options available for our readers. Every item of software and technique has been researched and tried by the writer before words had been committed into print. Highlights have included PSK31 - The Easy Way, Cleaning Windows, Computer Noise, Networking and Firewalls. Hundreds of readers have followed the series with supportive interest, and adopted much of the advice given. Adding the Ham Shack Computers Web Site (1) has allowed readers to download specific articles, especially featured software, and offered links to related subjects worldwide.

At times the writer's email inbox has filled daily with messages from interested readers asking for further advice, in trouble with their own computing systems or just mystified with the subject at hand and asking for more advice and help. All requests were acknowledged. Above all, many readers have saved hundreds of dollars on software, found nasty viruses, protected themselves from spam, coupled their rigs and computers together and dabbled in the new digi-modes with delight. To all those readers who have responded to the writer, a big thank you. Without feedback, this series would not have been a success for over two years. The topics featured were, in fact, driven by the wider interest of our readers - which is the way things should be in a modern inter-active world.

**Ham Tip No. 33:** Now is your chance to crack a new world distance record with your own RockMite. Has the writer done this yet? Well, there is a QSL card here in the shack from the US that clearly states a power level of 0.003-watt - but that's for our readers to guess!

- (1) Ham Shack Computers Web:  
[www2.tpg.com.au/users/vk6pg](http://www2.tpg.com.au/users/vk6pg)
  - (2) Dave Benson, K1SWL at:  
[www.smallwonderlabs.com](http://www.smallwonderlabs.com)
  - (3) American Morse Equipment at:  
[www.americanmorse.com](http://www.americanmorse.com)
- 73, and have fun de Alan VK6PG SK

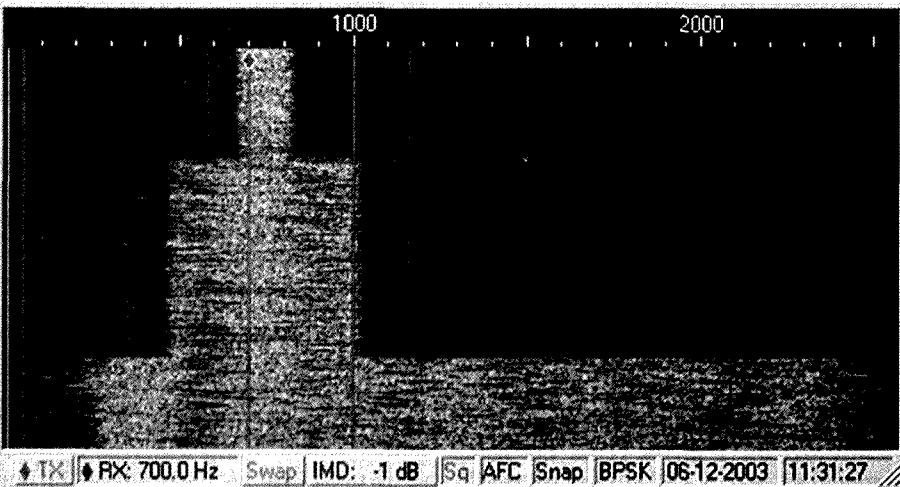

Figure 2

# VHF/UHF - An Expanding World

David Smith VK3HZ – vk3hz@wia.org.au

Leigh Rainbird VK2KRR –

vk2krr@telstra.com

## Weak signal

David Smith VK3HZ

**Summer is the season for good propagation on the VHF/UHF bands, and so far this summer has been spectacular, particularly between the East Coast and New Zealand.**

On 16/11 Ross VK2DVZ in Cundletown worked Nick ZL1IU, Steve ZL1TPH/p, Bob ZL3NE and Steve ZL1TWR on 2 m, ZL1IU on 70 cm and ZL1TPH/p on 23 cm (after Steve did the one hour round trip to home to get the 23 cm gear). Steve ZL1TPH/P also worked Neil VK2EI on 2 m.

On 20/11 in what was possibly a sporadic E opening, Guy VK2KU worked Nick ZL1IU on 2 m. Nothing heard on any higher bands.

On 18/12, Gordon VK2ZAB worked ZL1IU, ZL3TY, ZL3TJZ, ZL2TAL and ZL2IP on 2 m and ZL1IU on 70 cm. Guy VK2KU worked ZL1IU, ZL3TJZ, ZL2TAL and ZL3TY on 2 m. Remarkably, stations from the Bay of Islands in the far north of ZL down to Greymouth half way down the South Island were all workable at the same time.

On 19/12, Gordon worked ZL1SWW on 2 m and Ross VK2DVZ worked ZL1IU and ZL1TPH on 2 m and ZL1IU on 70 cm.

Then, on 30/12, one of the most extensive and long-lasting ducts in memory (at least, in the memories of those involved) commenced over the Tasman Sea. So many stations were worked at each end on all bands from 6 m to 23 cm that it is difficult to acknowledge them all.

Bob ZL3TY reports on 30/12, working VK2FZ, VK2JXA, VK2DXE, VK2TK, VK2AWD, VK2TS and VK2TDN on 2 m. On 31/12, he worked VK2FZ, VK2DXE, VK7MO (FSK441), VK2AWD, VK2DVZ, VK2TK, VK2ZAB, VK2KU, VK2JXA, VK2TG, VK2APG, VK2BHO, VK2AAS/p, VK2BZE, VK2ZXC, VK2FHN, VK2BA, VK2TS, VK2UBF, VK2FHN, VK4APG, VK4LC, VK2JJK, VK2EAH and VK2GKA on 2 m and VK2DVZ, VK2TK, VK2BZE and VK2FZ on 70 cm. He also worked John VK2TK using JT44 on 70 cm, setting a new Australian 70 cm Digital Record.

On 01/01, Gordon VK2ZAB reports working ZL2TAL, ZL2IP, ZL3TY, ZL1IU, ZL1TPH/p, ZL3TJZ, ZL1BK, ZL3UCP, ZL3ADH and ZL1AMO on 2 m and ZL3TY, ZL1IU, ZL1TPH/p and ZL3ADH on 70 cm. Signal levels varied between S2 and positively painful (ZL3TY). On the same day, Steve ZL1TPH reports working VK2ZAB, VK2KU, VK2DVZ, VK2DXE, VK2TK, VK4AR, VK4AML, VK4KZR, VK4LC, VK4QV, VK4OE and VK4DFE on 2 m and VK2ZAB, VK2KU and VK2DVZ on 70 cm and VK2DVZ on 23 cm. Guy VK2KU worked Ian ZL1AOX on 23 cm setting a new VK2 distance record.

On 02/01, Bob ZL3TY reports “just another average day”, working 1xVK7, 13xVK2, 6xVK4 and 3xVK3, all on 2 m. Following his success on the previous day, Guy VK2KU teamed up with John VK2TK for a 23 cm portable foray into the Blue Mountains. Once on site, with a clear view east and excellent conditions, gremlins crept into the equipment causing a nerve-racking 15 minute delay. However, once the earthing problem was sorted out, Guy and John worked Ian ZL1AOX (2270 km) and Harry ZL1BK/p (2277 km), again setting a new VK2 distance record.

On 03/01, Bob ZL3TY again worked a large number of VK2 stations, including Rod VK2TWR. As the morning progressed, signals crept steadily further west into VK3. Bob worked VK3EK, VK3DUT, VK3RS, VK3ZUX, VK3KAQ, VK3HZ, VK3ZYC, VK3KAI, VK3HY, VK3DMP and VK3FMD on 2 m and VK3EK on 70 cm. Robbie VK3EK also managed to work Ian ZL1AOX on 2 m and 70 cm. Andrew VK3KAQ worked Bob ZL3TY on 2 m on JT44 setting another new Australian record (but not for long). After a lull in conditions, Bob re-appeared and worked VK3HZ and VK3FMD on 2 m on JT44. He then worked VK3HZ, VK3KAQ and VK3FMD on 70 cm. The two contacts with David

VK3HZ set new Australian digital records on 2 m and 70 cm (2275.5 km) and were the furthest west that the duct reached.

Finally, on 04/01, Gordon VK2ZAB reports working several ZL stations with signal levels dropping throughout the day. The duct was finally fading!

The duct to ZL had lasted 6 days and reached as far west as Melbourne, well inland into NSW and well into northern Queensland. That stations did not work across the Tasman on bands higher than 23 cm was probably only due to lack of operational equipment. Hopefully, we won't have to wait another 25 years for such an event.

On 08/01, 6 m displayed what was thought to be double-hop sporadic E. Ron VK3AFW reports hearing VK6JR working into ZL. Murray ZL3MH also reported VK6 to ZL contacts on 6 m. Denis VK3ZUX worked VK4FNQ, VK6HK, VK6ZKO and VK6DI and then the band went dead. Len VK3UH reports hearing both side of VK6 to ZL2 contacts. The ZL TV video carriers were very strong as was the Toowoomba sound carrier. John VK3ACA reported that there was strong Es ionisation over Sydney. Glen also reported MUF above 50 MHz. The propagation seemed to be more extensive than single hop, which is limited to about 2,200 km. Double hops do occur, but aren't anywhere near as common.

Barry VK3BJM has been busy working stations on 2 m and 70 cm while travelling from central Victoria to central Queensland and back in early December. Barry has a very good mobile setup in his vehicle with decent power and “big wheel” horizontally-polarised antennas on both bands – raising a few “looks” from passing traffic. Using a keyer to call CQ and taking advantage of aircraft enhancement, Barry managed contacts of up to 614 km on 2 m to Jim VK3II and 544 km on 70 cm to Gordon VK2ZAB –

all while mobile! A good effort by any measure.

Several new beacons have been brought into operation recently. John VK3KWA advises that a new 23 cm beacon - VK3RTC - is testing at present. Ed VK3BG built the beacon using a UHF base station TX followed by a varactor tripler and filter. It is located at Cobram (QF24) on 1296.534 running 10 W to an Alford slot. The current site is temporary (Daryl VK3KLN's QTH) and with any luck it may move to the top of a wheat silo.

Russell VK3ZQB reports that a new 3 cm beacon is running from the Mt Warrnambool repeater site in western Victoria (QF11iq). VK3RWL is on

10.368538 GHz running 2 W to a double-sided slotted waveguide giving 10 degree beams to the east and west. Russell built the beacon using a modified 12 GHz commercial exciter followed by an amplifier of his own design. The keyer uses a modified PIC-controlled CW identifier designed by his son Jeremy VK3TFH. Russell has endeavoured to make the beacon easy to build. He will replicate the design and make a beacon for Mt Gambier to be completed and on air before the end of the year. Ralph VK3WRE has already heard the beacon from as far away as Mt Tassie in Gippsland. Please email reports on the beacon to Russell at vk3zqb@dodo.com.au.

The VK beacon list has just been updated and is available from the WIA web site at [www.wia.org.au/beacons/Beacons%20VHF-UHF%202004-01.pdf](http://www.wia.org.au/beacons/Beacons%20VHF-UHF%202004-01.pdf)

If anyone is interested in undertaking the first-ever activation of Christmas Islands on 2 m EME, there might be an opportunity in Nov/Dec 2004. David VK2CZ is planning an HF trip at that time and has a large 2 m antenna that he could ship over. There are many EME stations keen to work VK9X. If you have a rig with some reasonable power (and maybe a WSJT/JT44 digital setup), and are keen to join David, contact him via email on k3hz@ieee.org.

## EME

This is a summary and my log for the both weekends of the ARRL International EME contest. I ended up with a total of 48 QSOs X 27 multipliers. This is some 10 fewer than last year with the multiplier count down by 3. My total operating time was only 7+ hours some 8 hours less than 2002. This was due to the lack of European window and one NA window when I could not operate due to gale force winds. On both chosen weekends I had Moon Set minutes after the contest period began. The second window was short and the Moon elevation was too low in Europe for many. Low elevations are not a problem for me, though I naturally suffer longer periods of ground noise.

Stations worked include: UA3PTW, JW/SM2BYA, OH2PO, RL3LE, SM3AKW, DJ9MB, DF3RU, DL9KR, VK4AFL, JL1ZCG, HB9Q, JH4JLV,

HB9JAW, JR9NWC, K5GW, JA6AHB, N9AB, N2IQ, KL6M, K2UYH, KU4F, K4EME, JH0WJF, K1FO, K0RZ, VE6TA, JA9BOH, KJ7F, OE3JPC, DL7APV, UA9FAD, SM2CEW, PA2CHR, SM5IOT, SP6JLW, ON5OF, OE5JFL, OK2BDQ, F2TU, G4RGK, OZ4MM, G3LTF, DJ3FI, DL1YMK, YU1EVY & G3LQR.

All contacts were completed without skeds, loggers, phone calls, spotting, digital modes etc. Just the good old fashioned and most enjoyable 5 finger digit CW!

Conditions for the second part were interesting. The NA window I would consider "normal" although I noticed Steve K1FO and Trevor VK4AFL were using polarisation offsets way off the norm (for me) with greatly diminished signals (at times) indicating significant but well defined shift angles. The EU window was certainly different from

Doug McArthur VK3UM

normal where, at times, there appeared a 90° shift with H being preferred where V is norm. Peter SM2CEW and Hannes OE5JFL and I tried all polarisations and basically found all were equal and ill defined! From about 2230-2330 on the 16th Nov there were short periods of almost total black out followed by fast fluctuating polarisation changes the likes of what I cannot previously remember experiencing. Libration also became predominate. These periods lasted for up to 5 minutes at a time and it was strange to hear some one calling on "your frequency" when you stood by. Conditions were coming and going so quickly as to confuse many of us! Well that's over for another year with a (sadly) seemingly lower level of activity. I hope next year will see us "down under" getting a better go.

Rex Moncur VK7MO

The new mode is highly constrained to transmit only the minimum information required to complete a QSO and uses a 60 second TX/RX cycle compared to 30 seconds on JT44. The first version did not do the averaging effectively and was far less tolerant of frequency instability than JT44. In the latest version the averaging works effectively and there is an option of using different frequency spreads that are more tolerant to frequency instability. The different frequency

## Digital modes

### New Digital Records

Tropo openings to Bob ZL3TY produced new national digital records using JT44. On 1 Jan 2004 John, VK2TK, extended Guy VK2KU's 70 cm record by 7 km to around 2060 km. On 4 Jan 2004, Andrew VK3KAQ extended Rex VK7MO's 2 m digital record by 100 km to around 2246 km. This was extended shortly after to 2276.8 km by David, VK3HZ, followed by a contact with Charlie, VK3FMD, just 1 km less. David, VK3HZ, then worked Bob, ZL3TY on 70 cm on JT44 to extend

the 70 cm record to 2275.5 km. Charlie, VK3FMD, and Andrew, VK3KAQ, also worked Bob, ZL3TY on 70 cm JT44. Congratulations to David, VK3HZ, who now holds both the national 2 metre and 70 cm digital records at 2275.5 km.

### New Digital Mode

Joe, K1JT, has released beta versions of a new digital mode called JT65 that is designed to provide 3 to 6 db improvement over JT44 on EME. It can be downloaded at: <http://pulsar.princeton.edu/~joe/K1JT/>

spreads are called JT65a, b and c. JT65a is the most sensitive but requires the best frequency stability and it looks like JT65b is a good compromise and will become the standard mode.

A key advantage of JT65 compared to JT44 is that it uses pairs of tones to send the special messages OOO RORO, RRR and 73. These messages can be copied down to -30 dB with reference to 2.5 kHz passband and enable a contact to be completed very quickly once call signs are exchanged. The use of these special messages make the new mode a clear winner on EME. On troposcatter paths

the higher level of QSB means that JT44 with its faster cycle time can take advantage of QSB peaks and tests to date suggest that JT65 may have little advantage. In the long run a version of JT44 which includes the special messages of JT65 might be the optimum for troposcatter propagation.

Guy VK2KU has completed an easy contact with the new mode on 2 metre EME. Leigh VK2KRR and Bill VK5ACY have completed in normal conditions on two metre over a near 900 km path. Chas VK3BRZ and Rex VK7MO have been working over a 600 km path on 70 cm

with good copy down to 20 watt.

From Craig VK6JJJ: WSJT activity is continuing in the West with VK6JJJ, VK6KHD and now Phil VK6ADF. So far six pings have been received in Perth by VK6KHD from VK6JJJ in Karratha, and five pings received in Karratha by VK6JJJ from VK6KHD in Perth. The sked is Saturday and Sunday 23:00 – 24:00 UTC, now on 145.140 USB and any new stations are most welcome. Hopefully a QSO will be completed soon. (Late update: Phil and Craig have now successfully completed an FSK441 QSO – 922 km).

## 2 m and 70 cm FM DX

Happy New Year to all and hope 2004 brings some interesting openings to you in the months to come.

In this 2 and 70 FM DX edition, we will be covering a bumper two months of exciting DX activity that occurred during the months of November and December 2003. While there were quite a few more openings than space will allow here, I have listed some of the more interesting. Enjoy!

November saw the transformation of the weather conditions to allow summer type duct conditions to return to the southern areas of Australia. In contrast, it would appear that the VK4 boys are now not enjoying quite as good propagation in comparison to the previous few months.

It would also appear there have only been around 4 instances of major conditions with elevated ducts over the whole two months in the south, but there have been quite a few days of extended local conditions that I know of and only around one decent full High pressure cell has made it through into the Great Australian Bight, the rest have all been partial areas of lower pressure, but mostly there has been an east west track of High pressure or multiple linked cell centres which can be a good thing.

In the South East, the first major summer duct was noted in the morning of the 7th of November. I think most operators still had the winter blues, as not too many operators surfaced. A few simplex contacts were made, some new repeaters worked.

Working simplex on 2 & 70 were Terry VK3ATS in Mildura into Leigh VK2KRR near Wagga @ 466 km. Terry also worked

the Wagga 2 m repeater. Brian VK5ZMB (now VK5UBC) at Gawler also worked VK2KRR on 2 m @ 764 km. Brian had a comparable signal to Terry, around S9+10dB and we had a QSO for about half an hour.

Both 2 m and 70 cm repeaters had good signals in the south and the west from here. Some of the harder to get repeaters were dug out, such as Ballarat 438.475, Willunga Hill 146.675 VK5RSV and a new one for me was Port Lincoln 438.225 VK5RPL @ 1026 km. On low power tests, Crafers VK5RAD was workable on just 2.5 watts @ 764 km.

The 12th was a bit more major and there were a few more people aware of the good conditions by this stage. Another early morning starter, around 2.30 am, produced some good results. From here, the opening covered most of the South East area, excluding areas west and north of Adelaide.

A report received from Brian VK5UBC (ex VK5ZMB) about the opening, indicated very good conditions from the Adelaide area across to the east and southeast. Brian reports - This morning was a beauty. Turned on at 6.30 am and I could hear repeaters from all across Victoria. Highlights were working 3NAJ & 3YDK via Mt Baw Baw @ 750 km, and working 3XDJ/m simplex near Wangaratta @ 698 km. Also worked Bill 3LY at Nhill simplex as well as thru several repeaters. Brian is only running 20 W into an 8 element yagi.

Another station that did amazingly well was David VK3XDJ. David was stationary mobile near Wangaratta in Victoria and was using a vertical omni antenna to work as far as the Crafers

5RAD repeaters in Adelaide on both 2 m & 70 cm. This is around 690 km for David. I believe David was also able to work the Mt Gambier 70 cm repeater @ 513 km. David also worked Brian VK5UBC on simplex. Well done also to Bruce VK3AYM, north of Albury, being able to make it to Murray Bridge and Crafers in Adelaide on 2 m, being 725 and 753 km respectively.

Another operator, stationary mobile and in a rare radio location was Wayne VK2PDW. Wayne was at Hay in Western NSW. Wayne was using a vertical omni antenna and reported hearing signals deep into VK3 towards Melbourne.

George VK3HV just happened to be in the right place at the right time. George was acting as second operator at VK3BG's QTH near Yarrowonga at the time and claims to have filled a number of pages in his logbook within a few days! As far as I can recall, George worked up around Wagga NSW and all around the western half of Victoria, and had some great fun in the process.

VK2KRR was able to work simplex on 2 m to Tony VK5ZAI in Kingston @ 672 km and also to VK3LY and VK3AEF in Nhill. Repeater around Adelaide and the SE VK5 areas were worked, as well as many in VK3. Some of the more distant examples on 2m are, Mt Gambier, Kingston, Barossa Valley and Bumbunga Hill @ 833km. On 70 cm, Summertown, Barossa Valley and Mt Terrible @ 778 km.

During the evening on the same day at about 1200 UTC, signals emerged from Frank VK6DM in Albany. Frank made it to the Crafers Adelaide repeater 147.000, a distance of 1892 km. Frank also was

Leigh Rainbird VK2KRR



able to get into Houghton, another Adelaide repeater on 148.850, a distance of 1900km. Rob VK5MM was doing the duty of providing Frank with signal reports into both devices. Nice to get some signals from VK6 to the east, well done Frank.

On Sunday the 16th, very early in the morning, some interesting contacts were made in the South East. This time conditions did extend past Adelaide to the west and north. Not a great deal of activity noted, but for those who were around, some astonishing simplex contacts were available. These contacts being simplex from VK2KRR to John VK5ZTY at Eudunda, north of Adelaide. John's signal here was 5/3 @ 741 km. John was running with an 8 element yagi and only 3 watt! At the same time, Rob VK5MM at Mt Barker was a 5/3 signal @ 747 km. Rob was using a vertical omni antenna at roof height and down to 5 watts! Next up, Bill VK5ACY on Kangaroo Island, SA, was worked. Bill had a good 5/9 signal over the 893 km path using a 5 element. Over a slightly shorter distance, Bob VK3HBJ, near the Melbourne Ford Factory was also worked with a 5/5 signal here.

It was unfortunate that there were not more operators active on simplex for this opening, as conditions were quite extensive and strong as shown by the following repeaters. Barossa Valley 5RBV on both 2 & 70 was full scale @ 741 km, Port Pirie 5RMN was +20 dB @ 867 km; Port Lincoln 5RAC was +20 dB @ 1019 km; Central North 5RLH was +50 dB @ 833 km; Willunga Hill 5RSV was S9 @ 771 km; Berri 5RLD was +20 dB @ 601 km; Cowell 5REP was +60 dB @ 961 km; and Port Augusta 5RAE was +20 dB @ 913 km. Most of these could easily be accessed with minimal power down to 2.5 watt from here.

Being licensed for only two weeks at the time, Dion VK7YBI gave everyone a shake up when he was able to make a number of brilliant 2 m contacts from Burnie to the Adelaide area. Dion's contacts began late on Thursday night, the 20th of November, when he was able to make it through to the legendary VK5RMB Murray Bridge repeater on 146.875. This distance is 913 km for Dion who subsequently worked VK5HKS on the repeater. Around an hour later Dion made it to the Crafers 5RAD repeater on 147.000 @ 925 km where VK5UBC (ex VK5ZMB), VK5MM

and VK5CQ were eager to reply back to the distant signal. Dion is running a 6 element yagi. Also making it through from Tassie was Paul VK7BBW in Launceston. Dion reports that Paul was making it through to VK5 at the same time, but Paul's signal dropped out an hour before Dion lost it. Since then Dion has made numerous contacts with the mainland and is planning on adding a second yagi to the tower to help with his DX quest and is also considering 70 cm.

In the first week of December there were some great conditions in the southeast, from VK7 to the mainland and around VK5. Brian VK5UBC had some great luck and repaid the favour to the VK7's by working back into the Tasmanian area from his portable QTH at Corny Point, southern Yorke Peninsula SA. On the 3rd, Brian worked Bill VK3LY simplex at Nhill with a 5/5 signal @ 450 km. Also VK3VTX via the Ararat repeater, S7 @ 600 km. Brian goes on to report - Much to my surprise at around 9.00am I started to hear Mt Barrow 7RAA in northern Tasmania, which is 1152 km. I heard VK7's talking on the repeater and then 7UK calling, but I could not get in. I worked Dion 7YBI via Crafers 5RAD repeater at around 11.00 am, which is 925 km for Dion.

The SE VK5 and 7RAA repeaters kept coming in and out all day, and around 9.00 pm the SE repeaters were all S9 and I was hearing 7RAA and Mt Duncan 7RMD @ 1047 km. VK3's were working VK7's on the Tasmanian repeaters and I was able to eventually break in and work VK7LCW, VK7YBI & VK3ARC via 7RAA. Peter 7LCW reported he could hear me on reverse and we had a simplex contact starting 10.10 pm for about 20 min's. Signals were only S1 to 2 but readable 5. My 1st VK7 and a distance of 1044 km. Brian is running two 5 element yagis and 20 watt from his portable QTH.

On the 23rd of December, Mike VK4MIK reports that conditions were slightly better. Mike worked simplex to John VK4FNQ in Charters towers @ 310 km. In the morning on the 24th Mike also reports being able to work the following more distant repeaters - Mackay 4RMK @ 558 km, Hodgson Range 4RHR @ 644 km and Springsure 4RSP @ 793 km. Well done to Mike for cracking the Springsure repeater, and also to Felix VK4FUQ who

I believe also worked the same repeater, not a real easy path across all the mountain ranges.

Saving the best till last, Boxing Day, 26th December 2003 saw an extremely rare path that stretched east west across Australia's south. The duct became workable here at about 1600 Z, in the usual way. Around 1900 Z things started to move along with strong signals. Brian VK5ZMB was worked here simplex 4/3. Brian was also noted making a contact into the Canberra 146.950 repeater, noisy, but a rare path and over 900 km to the repeater, Brian was working VK1NPW.

At 2029 Z, VK2KRR was hearing the Port Lincoln 70 cm repeater at a great 5/9 signal @ 1026 km. Next thing I know, at 2035 Z, a strange signal is copied on 147.250. Very weak copy but this ends up being the Boddington repeater VK6RMS on Mt Saddleback, 126 km SE of Perth and a 2817 km signal path to VK2KRR. Being very early morning in the Perth area, it was not until 2144 Z that Frank VK6ZGU at Wagin was confirmed as replying to VK2KRR's calls. By now the signal was S7 from near Perth and Brian VK5UBC was able to call in and was also eventually confirmed by Frank. The distance for Brian was an amazing 2062 km! Brian is 40 km north of Adelaide. Not long after hearing all the commotion on their normally quiet local repeater, Glen VK6IQ at Wandina around 45 km NE of Perth called in, Glen is approx 200 km north of the repeater. Glen thoughtfully went to notify any other stations of the opening, but could only find one, which was Doug VK6TDC in Perth. VK5UBC and VK2KRR both checked for VK6 direct signals on reverse, but nothing was heard. A number of other VK6 repeaters were said to have been heard, but none could be confirmed.

The opening to the Boddington repeater lasted around 3 hours, and was last heard at approx 2340 Z. It should also be noted that the Boddington repeater is the highest repeater in VK6 at 590 m asl. Thanks must go to the operators around the Mt Macedon repeater in Melbourne for realizing the significance of this contact and standing by while this opening was running, as Macedon is on the same frequency as Boddington.

af

**Adelaide-London**

132

**Brisbane-Dunedin**

148

First F 0-5

Long 23755 km

Second 2F18-24 2E

Short 2561 km

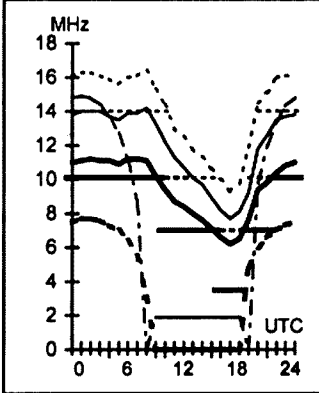
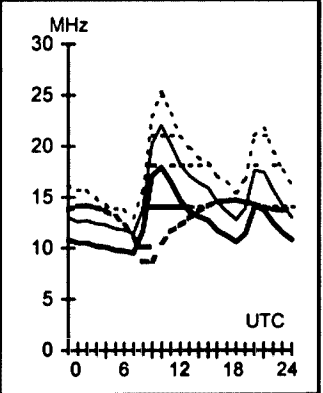
**February 2004**

T Index: 54

**Legend**

Frequency scale

--- UD  
 - - - E-MUF  
 - - - OMF  
 - - - F-MUF  
 - - - ALF

■ >10%  
 ■ >50%  
 ■ >90%

Time Scale

**HF Predictions**

by Evan Jarman VK3ANI  
 34 Alandale Court Blackburn Vic 3130

These graphs show the predicted diurnal variation of key frequencies for the nominated circuits.

These frequencies are identified in the legend are:-

- Upper Decile (F-layer)
- F-layer Maximum Usable Frequency
- E-layer Maximum Usable Frequency
- Optimum Working Frequency (F-layer)
- Absorption Limiting Frequency (D region)

Shown hourly are the highest frequency amateur bands in ranges between these key frequencies, when usable. The path, propagation mode and Australian terminal bearing are also given for each circuit.

These predictions were made with the Ionospheric Prediction Service program: ASAPS Version 4

**Adelaide-London**

312

**Brisbane-Honolulu**

49

**Canberra-New York**

58

**Darwin-Auckland**

130

First F 0-5

Short 16269 km

Second 3F5-10 3E0

Short 7569 km

First F 0-5

Short 16217 km

Second 3F12-17 3E

Short 5136 km

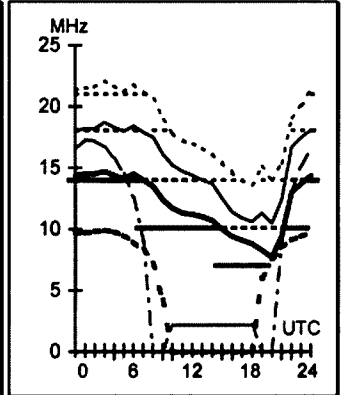
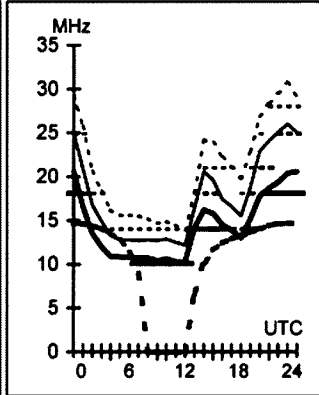
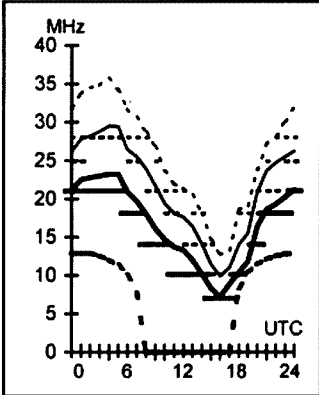
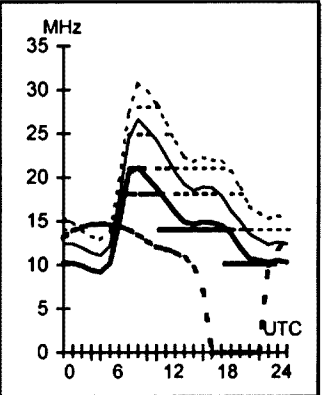
**Adelaide-Manila**

338

**Brisbane-Miami**

79

**Canberra-Tokyo**

352

**Darwin-New Delhi**

309

Second 3F 10-17 3E

Short 5813 km

First F 0-5

Short 14761 km

Second 3F4-9 3E0

Short 7948 km

Second 3F5-11 3E0

Short 7345 km

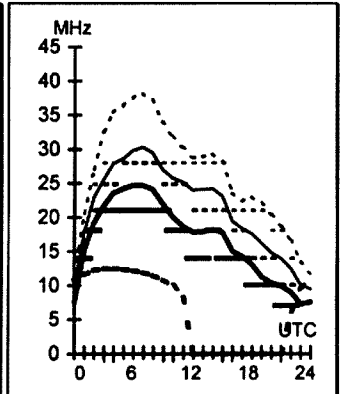
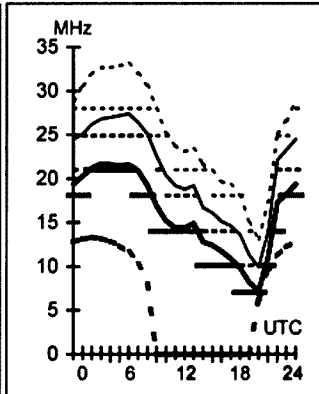
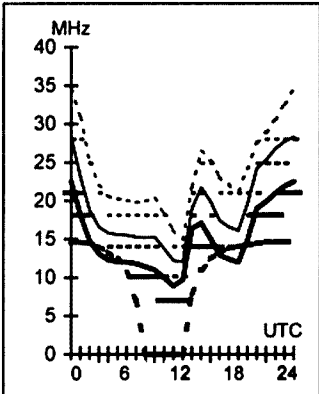
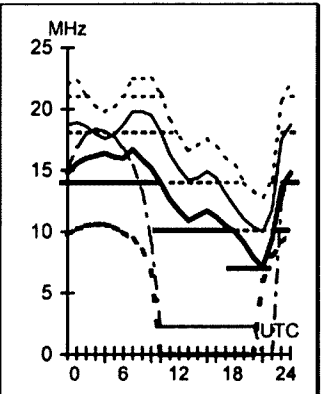
**Adelaide-Vancouver**

49

**Brisbane-Singapore**

293

**Canberra-Washington**

70

**Darwin-Osaka**

6

First F 0-5

Short 13421 km

Second 3F9-15 3E0

Short 6146 km

First F 0-5

Short 15938 km

Second 3F11-19 3E

Short 5262 km

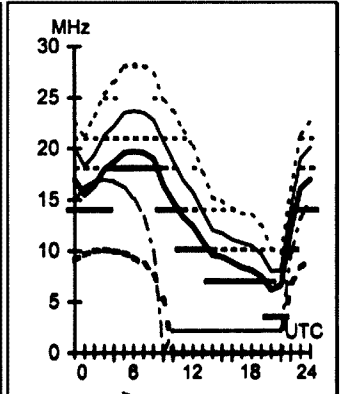
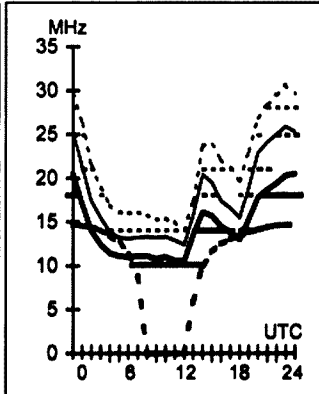
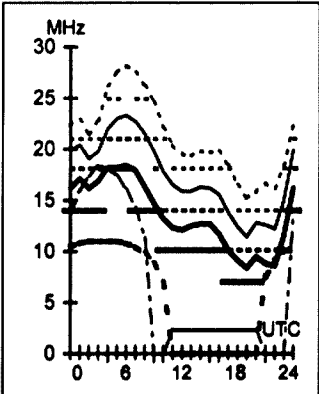
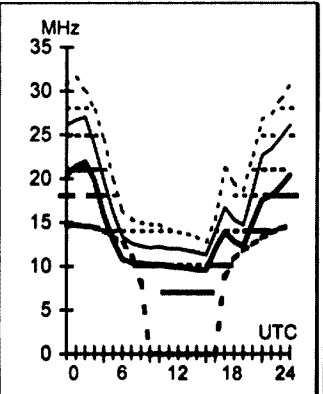

**Hobart-Cairo 278**    **Melbourne-Moscow 316**    **Perth-Dakar 259**    **Sydney-Barbados 119**

First F 0-5    Short 14263 km    First F 0-5    Short 14428 km    First F 0-5    Short 14918 km    First F 0-5    Short 16155 km

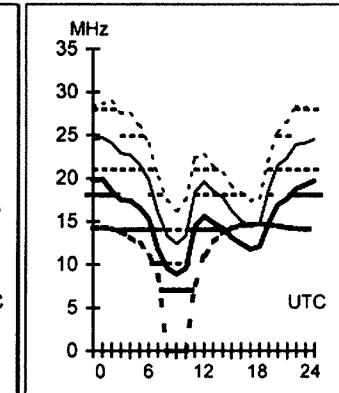
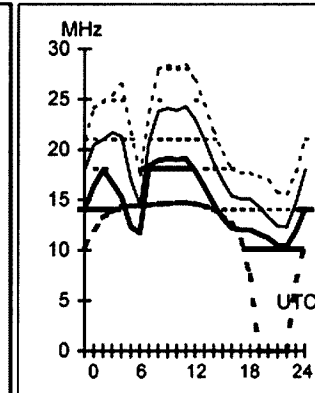
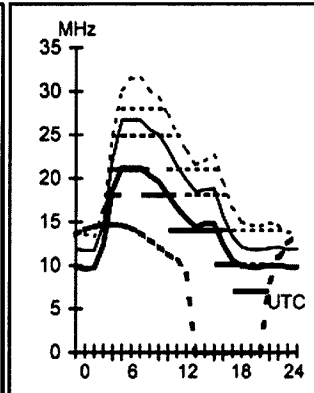
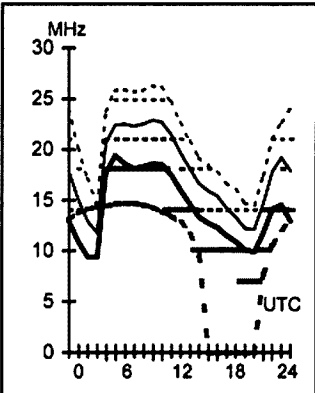

**Hobart-Capetown 220**    **Melbourne-Ottawa 63**    **Perth-Johannesburg 248**    **Sydney-London 139**

Second 4F5-11 4F0 Short 10026 km    First F 0-5    Short 16566 km    First F 0-5    Short 8315 km    First F 0-5    Long 23032 km

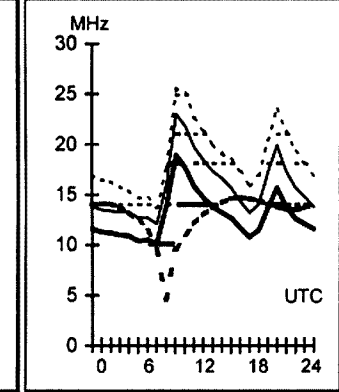
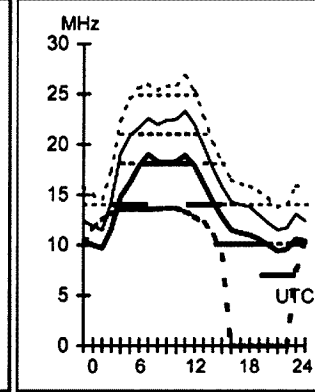
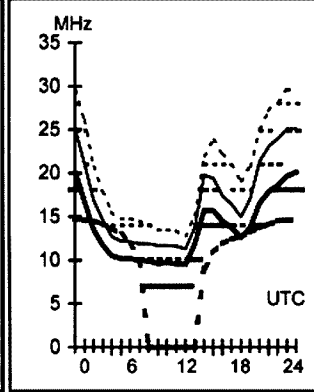
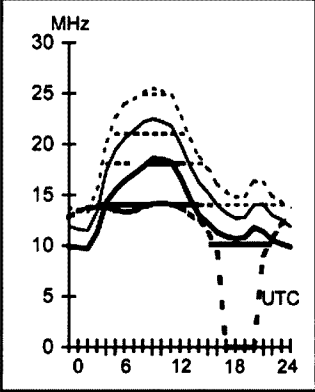

**Hobart-Chicago 72**    **Melbourne-Seattle 60**    **Perth-Montevideo 187**    **Sydney-London 319**

First F 0-5    Short 15576 km    First F 0-5    Short 13178 km    First F 0-5    Short 12536 km    First F 0-5    Short 16992 km

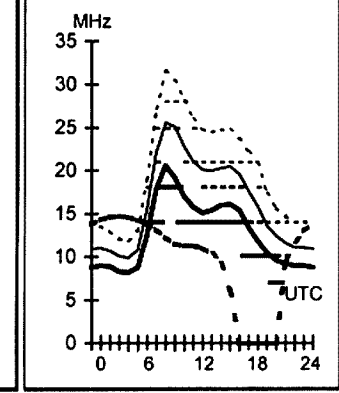
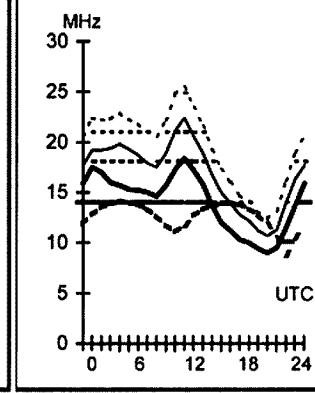
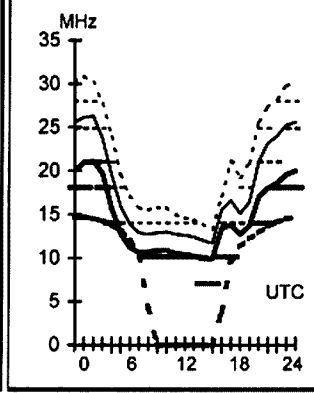
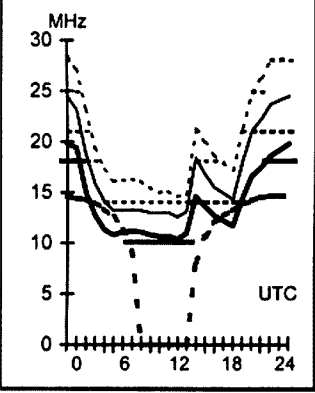

**Hobart-Santiago 149**    **Melbourne-Sofia 296**    **Perth-Tel Aviv 302**    **Sydney-Warsaw 133**

First F 0-5    Short 10688 km    First F 0-5    Short 15132 km    Second 4E3-7 5E0 Short 11091 km    First F 0-5    Long 24435 km

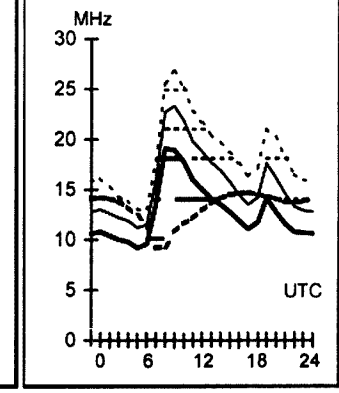
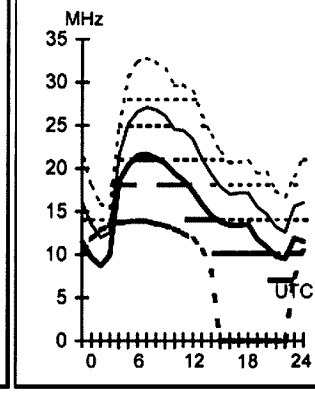
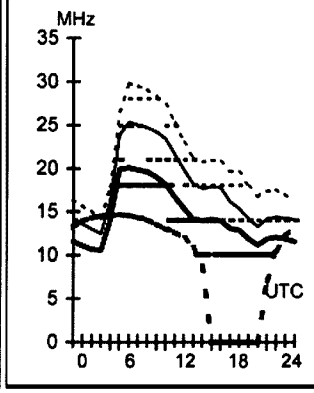
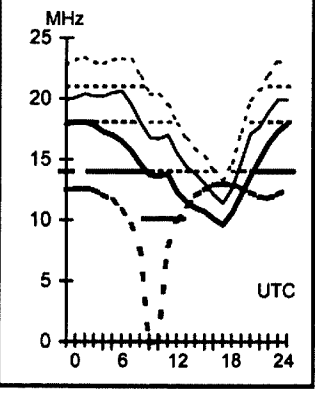

## AMSAT-VK net via Echolink

On Sunday 6th December 2003 the first "dress rehearsal" of the AMSAT-VK Echolink net was successfully conducted by Graham VK5AGR. As planned several amateur radio satellite operators connected to the AMSAT-NA conference server via Echolink. Graham welcomed everyone and then initiated a 'round-table' discussion, which ran to nearly two hours, such was the interest. Stations from VK2/3/5 and 8 joined in and we had calls from America, Canada and Germany during the net. Several items associated with the operation of Echolink itself were discussed and it was generally agreed that the system had merit and warranted further tests. It must

be remembered that in the early stages the nets may not be quite regular. I therefore suggest that if you are interested in joining or commenting on this idea it would be beneficial to contact Graham VK5AGR at his above e-mail address and ask to be included on the AMSAT-VK mail-out list. You can then expect to be notified of any net operations or changes of plans in time to take part. The use of Echolink in conjunction with HF and VHF/UHF linking has great possibilities for the establishment of a regular, truly Australia-wide net, something we have never been able to achieve before.

## AO-40 telemetry for all

**Chris VK6KCH recently posted a bulletin board message regarding "AO-40 Streaming Telemetry" .... 'catch-your-eye' title eh?**

Those operators interested in capturing telemetry data from AO-40 or any other satellite for that matter will have realised you just can't jump up and do it. You need to get a few things organised first. In the case of AO-40 you need to be able to receive the 13cm middle beacon signal with a good signal/noise ratio - around 15-20 dB and for this you need a better-than-average receive set-up. Then you need a demodulator, either sound-card or hardware and finally you need some sort of decoding software to display the engineering data on your screen. Those of us who've been in the business for some time will either have, or be able to get together most of the above requirements and get down to business. But it can represent quite a tall order for the newcomer. Add to this the fact that the satellite is not always in your sky or as is often the case, squint angles are less than optimal and the whole process can be daunting. Chris VK6KCH brought this to the fore with his post to the BB in December 2003. There is an alternative. Don't run away with the idea that it's an 'easy' alternative but it means that just about everyone can join in the fun of snooping on the behind-the-scenes engineering

stuff of satellite operations. For some time now a number of well equipped stations around the world have been sending 'real-time' raw telemetry data to a web server at the Goddard Space Flight Centre for processing and re-distribution via the Internet. This system is known as "streaming" and it has a number of advantages. Pretty well all the time someone somewhere, with a good AO-40 receive set-up will be in the footprint of the satellite, so the stream of data has a good chance of being continuous if enough station operators are willing to participate. The new FEC format of the telemetry means that the displayed engineering data is highly reliable. These two things alone mean that good telemetry is now available to anyone with an Internet connection rather than being solely the province of those with better than average 2.4 GHz receive equipment. The appropriate software is easily obtainable from the site mentioned below. Here is the essential part of Chris's posting.

"Thanks to Gunther, W8GSM, I now have a copy of UDPTelem.exe, and I am currently streaming AO-40 telemetry to Goddard. If you want to see the telemetry as it arrives, then here's what to do:"

## The AMSAT group in Australia

The National Co-ordinator of AMSAT-VK is Graham Ratcliff VK5AGR. No formal application is necessary for membership and no membership fees apply. Graham maintains an email mailing list for breaking news and such things as software releases. Members use the AMSAT-Australia HF net as a forum.

## AMSAT-Australia HF net

The net meets formally on the second Sunday evening of the month. In winter (end of March until the end of October) the net meets on 3.685 MHz at 1000utc with early check-ins at 0945utc. In summer (end of October until end of March) the net meets on 7.008 MHz at 0900utc with early check-ins at 0845utc. All communication regarding AMSAT-Australia matters can be addressed to:

AMSAT-VK,  
9 Homer Rd,  
Clarence Park, SA. 5034

Graham's email address is:  
vk5agr@amsat.org

1. Obtain a copy of Stacey Mills' P3T program (v2.08) from <http://www.keplerian.com/>
  2. Once you have installed and configured P3T, start the program and select the "Menu | Internet" screen.
  3. Click on "Client (data in)"
  4. Enter "128.183.143.104" in the "Host TCP/IP Address:" field.
  5. Leave the "Port:" field at the default of 1024
- (You need an open Internet connection for the remaining steps).
6. Press the "Connect" button. You should see a message at the bottom of the window similar to "Connect to: garc9.gsfc.nasa.gov"
  7. From the main P3T window, select the "Status" option; you should now see values update in near real-time as each block comes in via the Goddard telemetry server.....73 Chris VK6KCH".

I can vouch for these instructions having followed them and got it working easily and quickly. While you are on Stacey's site you may wish to download his whole-of-orbit-data program which adds yet another dimension to the telemetry business.

## While we're on the subject.....

There is often confusion regarding the functioning of some of the telemetry software mentioned from time to time. The two main programs that I have settled on are Stacey Mills' P3T program and Moe Wheatley's AO40rcv. They have many similarities but serve differing purposes. To appreciate the differences it's essential to be aware of the two quite separate functions, demodulating and decoding. These two functions were separate for many years due to limitations in home PCs, but that is changing. Often they are spoken about as if interchangeable but that's not so. A *demodulator*, as its name suggests, demodulates the signal. That is, whether PSK, FSK, AFSK, AM, FM or SSB, it separates the modulation from the 'carrier'. In a receiver we call that 'detecting'. Telemetry demodulators can

be either hardware e.g. James Miller's ubiquitous demodulator boards - or software e.g. one of the many sound-card based demodulator programs now available. These use the D to A converter in the computer's sound card.

*Decoding* programs are designed to apply mathematical formulae to the already demodulated raw data and display the resulting engineering values in a meaningful way, usually in columns, in panels or in graphical form. P3T is a decoder. It needs to be presented with demodulated data to do its calculations. It is very versatile. The data can be raw data from your hardware or software demodulator, receiving directly from the satellite, or it can be drawn from either a pre-recorded file or, as in the above article, via the Internet from a source such as Goddard.

AO40rcv, to a certain extent combines the two functions. It is an excellent "sound-card" demodulator with FFT 'waterfall' display and a measure of in-built decode and display functions. It is a very useful program and one may ask, 'Why use the hardware model to do the same job?'. Good question - but at present the hardware demodulator does a more robust job of extracting the data from the original signal, particularly in the presence of noise. This may not always continue to be the case. Moe Wheatley's program has been developed over a period of time to compete very well and it may be that in the future the sound-card programs will do away with the need for hardware demodulators. But don't throw away that old G3RUH demodulator board just yet.

## Reception of Mars and Saturn "flotilla" by amateurs

James Miller G3RUH reports that Charles Suckling G3WDG has received signals from the Mars-Express mission using quite modest equipment.

This is no mean feat. It requires an EME-class station retuned to the frequency of the European Space Agency's Mars Express satellite to hear the very weak signals. In November 2003 the AMSAT-DL team at Bocham, Germany used a 20 metre dish to receive the signals from Mars Express and Mars Odyssey in a test of the communication budget for the planned P5A Mars mission. The Bocham dish will form part of the ground control station of the P5A project due for launch in 2007. In August 2003, VK3UM had received the 435.1 MHz test signal from Mars Global Surveyor during the Mars relay tests using his well known EME station.

Now, the 20 metre diameter Bocham dish is a serious instrument and by comparison Charles' 3 metre EME dish

is tiny. Charles reported: "Just to let you know that this evening (Dec 9) I successfully heard Mars Express on X-Band with the 3m dish here. System NF is about 1dB, and I used your (G3RUH) S-Band 2.25 turn helix scaled to 8.4GHz as the feed (LHCP feed). Signals seemed very consistent for about 2 hours. Signal level was very approx 0dB S/N in 2.5 kHz. Moon noise was about 1.05dB, compared to my normal 1.8dB on 10.368 GHz (EME) with the Andrews feed. I have not yet optimised the feed position or anything - just a quick 'throw together'. Will check sun noise tomorrow and see how it compared to 10.368 GHz. Signal was not too difficult to find. It took about 10 mins of searching the RX +/- 100 kHz and el/az tweaks".

The original posting included an audio recording and a spectrum scope picture showing a surprisingly prominent signal on both the 'waterfall'

and spectrum displays. Charles' success in this experiment has proved that the reception of weak signals from the vicinity of Mars is possible for amateurs. Other reports have shown that Charles is not alone. The Cassini probe, carrying the Huygens lander on its way to a rendezvous with Saturn's moon Titan in mid-2004, was received by a school station in Germany (amateur callsign DL0SHF). Cassini was 1.17 billion km away, eight times as far as we are from the Sun. The signal from Cassini took 65 minutes to reach Earth from its position closing on Saturn. This will no doubt spark interest in the P5A plans by AMSAT-DL among the general amateur satellite and EME community. Details of P5A are available on the AMSAT-DL website. Radio amateurs will, after all, have the chance to be involved in a mission to Mars. Not long ago this would have been fantasy. Congratulations to all involved. We live in interesting times.

## A potentially worrying development

How would we satellite enthusiasts fare if 2-line Keplerian elements were not freely available? I remember when there were no such thing as TLEs. We had to make do with observed AOS/LOS times, calculated EQXs (equator crossings) and mechanical aids like the "Oscar-Locator", a plastic map centred device with a movable cursor. It didn't matter then because no one had a computer, much less automatic antenna tracking.

TLEs however would certainly be missed today. The automatic entry of TLEs has been built in to every satellite tracking program worth its salt. Auto-Doppler correction and auto-tracking antennas are also used by many people and both these operations rely on fresh, accurate "keps". This worrying situation was brought up on the BB early in the New Year. It appears that the US Air Force (USAF) has for some time been trying to

take over responsibility for dissemination of TLEs from NASA. The reasons may be rooted in US politics but the effect would be felt right throughout the "amateur" satellite-aware community. Military organisations are by nature reluctant to let out information except on an absolute 'need-to-know' basis. As amateurs we could well be deemed as 'not-needing-to-know'. Let's all hope that the worst case scenario doesn't prevail.

# Six-monthly summary of operational amateur radio satellites

## AO-40 AMSAT Oscar 40

Uplink: V-band 145.840 - 145.990 MHz  
CW/LSB

U-band 435.550 - 435.800 MHz CW/LSB

L1-band 1269.250 - 1269.500 MHz CW/LSB

L2-band 1268.325 - 1268.575 MHz CW/LSB

S1-band 2400.350 - 2400.600 MHz CW/LSB

Downlink: S2-band 2401.225 - 2401.475  
MHz CW/USB

K-band 24,048.010 - 24,048.060 MHz CW/  
USB

Beacon: 2401.323, 24,048.035

Status: ACTIVE!

For the current transponder-operating  
schedule visit:

<http://www.amsat-dl.org/journal/adlj-p3d.htm>

## ARISS - International Space Station

Region 3 voice uplink: 144.490 MHz FM

Worldwide packet uplink: 145.990 MHz FM

Worldwide downlink: 145.800 MHz FM

Status: Operational.

Digipeater: Active

The current Expedition 8 crew is:

Commander Mike Foale, KB5UAC

Flight Engineer Alexander Kaleri,

U8MIR

Astronaut Mike Foale fired up the new Phase 2 Amateur Radio on the International Space Station (ARISS) equipment December 21 2003 to make a number of 2-meter contacts with amateurs around the world. He completed QSOs with amateurs in Australia, Europe and North America. ARISS International Chair Frank Bauer, KA3HDO, said official permission to use the new gear came December 17. The RS0ISS packet system also is back in operation. Activation of the new gear means a power boost from 5 W to 25 W for the NA1SS downlink signal. It also means the ISS now has two functional ham stations. Additional Phase 2 equipment planned to go into space very soon is to include a slow-scan television (SSTV) system and a Yaesu T-100 HF/VHF/UHF transceiver. U.S. callsign: NA1SS, Russian callsigns: RS0ISS, RZ3DZR, TNC callsign: RS0ISS-1.

## AO-7 AMSAT Oscar 7

Return to active status: June 21, 2002

Uplink: 145.850 to 145.950 MHz CW/USB  
Mode A

432.125 to 432.175 MHz CW/LSB Mode B

Downlink: 29.400 to 29.500 MHz CW/USB  
Mode A

145.975 to 145.925 MHz CW/USB Mode B

Beacon: 29.502 MHz, 145.972 MHz, 435.1  
MHz, 2304.1 MHz

Status: Semi-operational in sunlight.

For more AO-7 info: [http://](http://www.amsat.org/amsat/sats/n7hpr/ao7.html)

[www.amsat.org/amsat/sats/n7hpr/ao7.html](http://www.amsat.org/amsat/sats/n7hpr/ao7.html)

## RS-15 Radio Sport RS-15

Uplink: 145.858 to 145.898 MHz CW/USB

Downlink: 29.354 to 29.394 MHz CW/USB

Beacon: 29.352 MHz (intermittent)

Status: Semi-operational, mode-A, (2-metre  
uplink, 10-metre downlink).

## FO-20 JAS-1b

Uplink: 145.90 to 146.00 MHz CW/LSB

Downlink: 435.80 to 435.90 MHz CW/USB

Beacon: 435.795

Status: Semi-Operational. FO-20 is in mode  
JA continuously.

## FO-29 JAS-2

Voice/CW Mode JA

Uplink: 145.90 to 146.00 MHz CW/LSB

Downlink: 435.80 to 435.90 MHz CW/USB

Beacon: 435.795 MHz

## Digital Mode JD

Uplink: 145.850 145.870 145.910 MHz FM

Downlink: 435.910 MHz 1200-baud BPSK  
or 9600-baud FSK

Callsign: 8J1JCS

Digitaltalker: 435.910 MHz

Status: Operational Mode JA (at the time of  
writing).

## SO-41 SaudiSat-1A

Uplink: 145.850 MHz

Downlink: 436.775 MHz

Broadcast Callsign: SASAT1-11

BBS: SASAT1-12

Status: Operational

Further information is available at:

<http://www.amsat.org/amsat/sats/n7hpr/so41.html>

## SO-50 SaudiSat-1C

Uplink: 145.850 MHz (67.0 Hz PL tone)

Downlink: 436.795 MHz

Status: Operational.

SO-50 carries several experiments, including a mode J FM amateur repeater experiment operating on 145.850 MHz uplink and 436.800 MHz downlink. The repeater is available to amateurs worldwide as power permits, using a 67.0 Hertz tone on the uplink, for on-demand activation. This satellite is being activated on passes over VK but activity is very light.

## UO-11 Oscar-11

Downlink: 145.826 MHz FM (1200-baud  
AFSK)

Mode-S Beacon: 2401.500 MHz

Status: Semi-operational.

UO-11 is still battling on and is useful  
for checking 2.4GHz receiving gear and

of course is of major interest to telemetry  
buffs.

## UO-22 UOSat

Uplink: 145.900 FM 9600-baud FSK

Downlink: 435.120 MHz FM

Broadcast Callsign: UOSAT5-11

BBS: UOSAT5-12

Status: Operational. But only reliable in  
sunlight. Check for latest information on  
the following URL: <http://www.sstl.co.uk/>

## NO-44 PCSat

Still struggling along, PCSat has been on  
borrowed time for many months now  
and may not survive the next eclipse  
season.

Uplink/downlink: 145.827 MHz 1200 baud  
AX.25 AFSK via W3ADO-1

Status: Semi-Operational.

PCSat is a 1200-baud APRS digipeater  
designed for use by stations using hand-  
held or mobile transceivers. Downlinks  
feed a central web site at

<http://pcsat.aprs.org>

The APRS-equipped PCSat was built  
by midshipmen from the U.S. Naval  
Academy under the guidance of Bob  
Bruninga, WB4APR.

For more information, visit the PCSat  
web site at: <http://web.usna.navy.mil/~bruninga/pcsat.html>

## NO-45 Sapphire

Downlink: 437.095 MHz 1200 baud AX-25  
AFSK

Uplink: 145.945 MHz UI Digipeater

Digi Callsign: KE6QMD

Status: Operational.

It will be authorized for UI digipeating  
very soon. Student-built Sapphire was  
launched through the U.S. Naval  
Academy Satellite program. Its primary  
missions are sensor experiments, a  
camera, and voice synthesizer. For more  
information, visit the Sapphire web site at:

[http://students.ccc.wustl.edu/~sapphire/sapphire\\_overview.html](http://students.ccc.wustl.edu/~sapphire/sapphire_overview.html)

## MO-46 TiungSat-1

Uplink: 145.850 or 145.925 MHz 9600-baud  
FSK

Downlink: 437.325 MHz

Broadcast callsign: MYSAT3-11

BBS: MYSAT3-12

Status: Operational at 38k4-baud FSK.

TiungSat-1 is Malaysia's first micro-  
satellite and in addition to commercial  
land and weather imaging payloads it  
offers downloadable picture files which  
can be decoded and displayed with  
Colin VK5HI's program CCD  
Display2000.

ar

# Spotlight on SWLing

by Robin L. Harwood VK7RH

**In the closing days of December, several International Broadcasters left shortwave, either for the Internet or permanently closing their shortwave senders. The Americans, via the International Broadcasting Bureau, ceased programming in several European languages and dialects, preferring instead to concentrate on programming in Arabic, Farsi and Indonesian.**

They also permanently closed the Holzkirchen senders in Bavaria and the site is to be converted into a golf course. There was a push in the US Congress for the retention of the European languages but the Bush Administration wants to concentrate in supporting the ongoing War on terrorism. That is why Arabic, Farsi and Indonesian are now priority languages.

Denmark and Norway also disappeared from HF on 31st of December, due to budgetary cuts. Both are going to increasingly rely on Internet feeds plus distribution of programs compiled on to DVD for the exclusive use of expatriates. The Voice of Malta in Valetta also made a hurried exit from shortwave. This station was a joint venture between Libya and the Maltese but the Libyans pulled out unexpectedly with negotiations underway for overdue payments from the Libyans. It is unclear at this stage whether the Maltese can find another joint venture partner to continue shortwave broadcasts.

That station in Costa Rica, located at the campus of the United Nations University of Peace, Radio for Peace International (RFPI), did indeed close down after being evicted. They did manage to get their equipment out and have found a place within Costa Rica to store it, announcing that they were hoping to re-establish RFPI. However they do face several large hurdles, including getting a license from the authorities plus obtaining ongoing finance. Apparently whilst on United Nations territory they did not feel that they had to apply for a license from Costa Rica but it is different now since their eviction. It does look likely that it may be some time before RFPI reappears, especially if their financial base dwindles even further. It has also been suggested that RFPI should consider hiring airtime from one of the many commercial shortwave stations with the U.S.

Iran also was contemplating leaving shortwave for the Internet, and at the beginning of Ramadan, indeed did

reduce their programming but they asked their listeners whether they would prefer to use the Internet and after receiving their feedback, decided to quickly reintroduce their shortwave streams. I did report last month about the "Voice of Justice" which sounded like a clandestine station in Teheran, but it was identical to the established Voice of the Islamic Republic of Iran. Apparently English programs directed to North America are identified as the "Voice of Justice from Teheran". You can hear both programming streams from 1030 on 15550 but be aware that the VOJ stream can unexpectedly go silent. I believe that the VOJ stream is for broadcast later in the day.

Ireland also exited suddenly on 31st of December from shortwave. They have opted for delivery via the Internet and for satellite delivery via WorldSpace. The latter is not available in the Americas or Australia and they had a plan to offer "free" satellite radios for Irish expatriates in Africa. WorldSpace also announced they were going to a subscription-based format thus defeating the purpose, in my opinion, of a free to air platform.

With this exodus of the major international broadcasters from shortwave, an opportunity now exists for signals and stations to be heard, after being buried under the major stations. Some Brazilian domestic shortwave relays are now being observed on the 9 and 11 MHz allocations at 0900Z, corresponding to their local sunrise. I also believe that they can also be heard at our local sunrise around 1900.

On 27th December I came across a station on 6925 at 1057 UTC. It was on USB and was playing Rock music by the Rolling Stones. A female identified the station as "Moonshine Radio" in a Dixie accent. At 1110 the signal level started to drop and a male came on and the music also seemed to change format. My information is that they were two separate stations, one following the other. These stations are presumably in

the USA and are titled hobby pirates and suddenly appear around New Year's Eve and occasionally during holiday weekends.

A word of warning: make backups of your vital information especially email addresses and loggings. My computer was completely disabled on New Year's Eve by a hidden virus. It came in through an online upgrade of my firewall and destroyed several registry entries plus my address book and some data. It took several frustrating days to get my computer running and I am still discovering lost data.

Well that is all for now. Keep monitoring and all the best for 2004.

Robin L. Harwood VK7RH

**radio and electronics school**

## Become a Radio Amateur

**Or study radio electronics to  
support your hobby**

Australia's premier training institution for  
**AMATEUR RADIO AND HOBBYISTS**  
courses available in radio & electronics  
technology for all ages

**COURSES AVAILABLE ONLINE**

Be guided through your course by one or  
more of our 20 experienced volunteer  
facilitators, email hundreds of other students

**IN A HURRY?**

Become a novice radio operator in 4 weeks  
with our computer-based

**NOVICE FAST-TRACK COURSE**

Courses for schools, youth organisations and  
seniors

**Australian Radio Certificate Scheme (ARCS)**

Use our accredited bridging program for radio  
amateurs to obtain a

**CERTIFICATE IN**

**ELECTROTECHNOLOGY**

Download all course materials free

(CD Rom has a small fee)

For Further Information visit

<http://radioelectronicschool.com>

or email

[manager@radioelectronicschool.com](mailto:manager@radioelectronicschool.com)

Tel: (07) 5573 2795 12-5 (EST)

# Hamads classifieds

# FREE

## WANTED ACT

• **Service Manual or circuit diagram for Marconi Type TF 1066B/6 F.M. Signal Generator.** Peter VK1CPK QTHR Phone 02 6231 1790 fax 02 6296 5712 pkloppen@austarmetro.com.au

## FOR SALE NSW

• **Motorola R2200B service monitor** in excellent condition s/n 606CK0017, \$3000 negotiable. Ray Wells VK2TV Phone 0417 428 220.

• **KM 160W VHF linear amp \$195. Ampere 120W UHF linear amp \$315, incl manuals. Kuranishi Thru-line 50/144/450 wattmeters, two units, each \$100. 144 MHz 7 el homebrew yagi ant \$150. Two homebrew antenna tuners PI network rotary inductors, each \$150. Microwave modules 144/28 in/out converter \$70.** Art VK2AS, QTHR, Phone 02 9416 7784.

• **Power supply - 240V in, 14V, 43A out,** variable voltages, over-volts protect, over-current limit. Proper Japanese Industrial supply, \$75 with information plus circuit. Will post anywhere in VK (5kg). Bob VK2CAN, QTHR, Phone 02 9416 3727.

• **Kenwood TS-930S w/ATU, \$850. Emtron Tuner EAT-300, \$150. Codan 7727 10 channel/3 fitted, \$150. Tono Communicator THETA-7000e for CW, RTTY, all self contained, \$100.** VK2TSB, Phone 0414 671 875, rivers@1earth.net.

• **Selsyn motors.** Two available. Useful for home brew beam direction indicators, \$20 each. Peter, VK2BEU, Phone 02 9872 3381.

• **Rare 1960s bakelite Blue Point XX20B KOB practice set,** incorporating light and buzzer. For offers email hermanw@smartchat.net.au

• **FT-ONE Deluxe HF tcvr FM & RAM fitted,** inbuilt power supply and workshop manual \$600. **FT-726R VHF UHF tcvr** all mode sat board fitted, **DTMF mike \$600. FL-2100Z amp** with spare valves \$600. **DX-160 HF receiver** with frequency meter connection \$100. All in good condition with ops manuals. Contact Tim, VK2ZR, email: bartho@northnet.com.au

• **Complete beam, rotator and tower, Chirnside 10/15/20 m Yagi 502SAX Emotor rotator,** together with freestanding wind-up tilt-over tower, approx 12 m including two winches, all fully operational plus engineering drawings and manuals for all items. Offers to Ian VK2MW QTHR 02 9144 4985

## WANTED NSW

• **Spectrum analyser, plug-in HP-8557 or 8558.** VK2EDD, Phone 02 4982 9847.

• **Vibroplex bug key.** Email hermanw@smartchat.net.au

## FOR SALE VIC

• **Spider quad hub IMTR alum welded** extension 8 solid f/glass spreaders to match \$200 VK3YJ, QTHR, Phone 03 9315 9387.

• **Laser printer Lexmark Optra.ptx** with software, manual, near new, had very little use. Would suit commercial use. \$400. Ring Charlie, VK3DCS, QTHR, Phone 03 5331 7425, email charlie@coopcom.com.au.

• **Yaesu FT-890** all mode transceiver. This radio is in excellent condition, only one owner, s/n is 3L220492. ATU fitted, manual, hand mike, DC Cable, original packaging. This radio is in stock standard condition. No modifications have been attempted! I'm asking \$1250. Clint Jeffrey, VK3CSJ, Phone AH 03 9792 4500, csjeffry@ozemail.com.au

• **Icom IC-706 MK IIG with UT-102** voice synthesizer unit. Excellent condition. Manual and original packing all available. \$1400 Julian, VK3EJR, Phone 0418 578 214 or 03 97512253 Email: julianrose@connektron.com.au

## WANTED VIC

• **Fukuyama FDK multi 2000** 2 metre multi mode tcvr. VK3EGG, Phone 03 9819 9065.

• **Battery container** to fit Standard dualband hand-held model C500, either dry cell or Ni-cad type acceptable. If latter, Ni-cad condx unimportant. VK3DBD, QTHR Yackandandah. Email vk3dbd@rm.quik.com.au, or Phone 02 6027 0570.

• **Kenwood R-820 receiver** in top condition, also SP-820 ext. speaker. Damien, VK3RX, Phone 03 5427 3121, Email vk3rx@amsat.org

## FOR SALE QLD

• **Yaesu FT-101E, FT-101B, FV-101 VFO, Kenwood TS-120S, EC. FC-757 auto-tuner. FC-707 tuner,** handbooks, mikes and cables, tubes and spare modules. Paul, VK4DJ, Phone 07 4775 7998, 0401 860 769.

• **Amateur radio transceiver, Yaesu FT-107.** Early model less memory, 2 WARC bands, CW filter, a/c power supply, hand mic, s/n 9M030140, with operator's and service manuals and extension service board. Also Yaesu FV-107, s/n 9M020327. \$400 or your nearest offer. Details gladly. VK4BTW, QTHR, Phone 07 4638 3828,

## FOR SALE SA

• **Deceased Estate: Icom IC-725** transmitter, **Icom AH-3** auto tuner, **Icom SM-6** desk mic, **GME electrophone 35 amp power supply** (current model) \$1610. Will not separate. All in excellent condition with very little use. Paul, VK5MAP, QTHR or Phone 08 8651 2398 after 7.00pm

• **Tower:** Three, seven inch triangular, 10ft sections + pole, to 39ft. Has tilt base. \$100. Ready for trailer or transport. Phone 08 8323 9150. Email glenhardy@chariot.net.au

## WANTED SA

• **MC-60A Kenwood desk mic,** must be in excellent condition. Pages 75-80 inclusive for Kenwood TS-440S service manual, photocopies OK. Will pay costs. Paul, VK5MAP, QTHR, 08 8651 2398.

## FOR SALE TAS

• **Yaesu SP-5 ext speaker** as new, box etc, suit FT-1000, FT-920 etc, \$150. **Icom IC-2720H service manual,** new \$30. **Daiwa CNW-418 ATU** WARC 80-10 m 500 W meter \$255. **BL-50A balun,** G.C. used, \$25. Phone Allen, VK7AH, QTHR, Phone 03 6327 1171, 0419 755 124

## About hamads....

- Hamads may be submitted by **email** or on the **form on the reverse of your current Amateur Radio address flysheet.** Please print carefully and clearly, use upper AND lower case.
- Separate forms for For Sale and Wanted items. Please include name, address STD telephone number and WIA membership number if you do not use the flysheet.
- Deceased estates Hamads will be published in full, even if the ad is not fully radio equipment.
- WIA policy recommends that the serial number of all equipment for sale should be included.
- QTHR means the address is correct in the current WIA Call Book.
- Ordinary Hamads from those who are deemed to be in general electronics retail and wholesale distributive trades should be certified as referring only to private articles not being re-sold for merchandising purposes.
- Commercial advertising (Trade Hamads) are pre-payable at \$25.00 for four lines (twenty words), plus \$2.25 per line (or part thereof), Forty word maximum, minimum charge of \$25.00. Cheques are to be made out to: WIA Hamads.
- Copy typed or printed clearly please, and received by the deadlines shown on page 1 of each issue of Amateur Radio.

Email: [newuntd@bigpond.net.au](mailto:newuntd@bigpond.net.au) Fax: 03 9756 7031

Postal: Newsletters Unlimited, PO Box 431, Monbulk Vic 3793

### TRADE PRACTICES ACT

It is impossible for us to ensure that the advertisements submitted for publication comply with the Trade Practices Act 1974. Therefore, advertisers and advertising agents will appreciate the absolute need for themselves to ensure that the provisions of the Act are strictly complied with.

### VICTORIAN CONSUMER AFFAIRS ACT

All advertisers are advised that advertisements containing only a PO Box number as the address cannot be accepted without the addition of the business address of the box-holder or seller of the goods.



**MISCELLANEOUS**

• **FREE** coaching via mail and small by professional radio engineer. All theory subjects in all licence grades and upgrades. Lindsay Lawless VK3ANJ Box 760 Lakes Entrance Vic.3809 and email: [lilawless@net-tech.com.au](mailto:lilawless@net-tech.com.au)

• The **WIA QSL** Collection (now Federal) requires **QSLs**. All types welcome, especially rare DX pictorial cards, special issue. Please contact the Hon Curator, Ken Matchett VK3TL, 4 Sunrise Hill Road, Montrose Vic 3755, tel. (03) 9728 5360

**TRADE ADS**

**PSK-31, SSTV, RTTY SOUNDBOARD**  
Interfaces Fully Isolated, ready to plug in.  
<http://www.G3LIV.CO.UK>,  
[Johnny@melvin.com](mailto:Johnny@melvin.com), G3LIV QTHR.

**Did you have trouble emailing your ad?**

The correct address for Hamads is [newunltd@bigpond.net.au](mailto:newunltd@bigpond.net.au)

Many apologies for publishing an incorrect address last issue.

**HAMADS ARE FREE!**

**"Hey, Old Timer..."**



If you have been licensed for more than 25 years you are invited to join the **Radio Amateurs Old Timers Club Australia**

or if you have been licensed for less than 25 but more than ten years, you are invited to become an **Associate Member** of the RAOTC.

In either case a **\$5.00** joining fee plus **\$8.00** for one year or **\$15.00** for two years gets you two interesting OTN Journals a year plus good fellowship.

Write to

RAOTC,  
PO Box 1100  
Sandringham VIC 3191

or call Arthur VK3VQ on 03 9598 4262 or Bill VK3BR on 03 9584 9512,

or email to [raotc@raotc.org.au](mailto:raotc@raotc.org.au) for an application form.

**AMIDON FERROMAGNETIC CORES**

For all RF/electronic applications. See our website for complete data on all cores including prices.

[www.eatchnet.com.au/~rfandusimports](http://www.eatchnet.com.au/~rfandusimports)  
**RJ & US Imports**  
PO Box 431, Kiama NSW 2533.  
A 3.5" PC disk containing all data is available for \$5.00 incl. post.

**Agencies**

Active Electronics, Tas  
Truscotts, Electronic World, Melb.  
TTS Systems, Tyabb (VIC)  
Tower Communications, Perth

**GROW WIA—MAKE IT YOUR JOB**

**RECRUIT A NEIGHBOUR\*, NON-MEMBER LICENSE HOLDER TODAY.**

One to one approaches are very successful and it is in your interest to have a strong WIA.

If you need to know who your neighbouring operators are call John (03) 9756 7797 AH and he'll tell you.



**JACKSON BROS**  
**JACKSON OF THE UK IS BACK**

Highest quality products made by UK Craftsmen

Full range now available off the shelf in Australia

Variable and trimmer capacitors, reduction drives, dials, ceramic stand-offs

CATALOGUES AND PRICE LISTS NOW AVAILABLE

CHARLES I COOKSON PTY LTD  
GPO BOX 812, ADELAIDE, SA 5001

Tel: (08) 8235 0744 Fax: (08) 8356 3652

FreeFax: 1800 673355 (Within Australia)

Email: [jackson@homplanet.com.au](mailto:jackson@homplanet.com.au)

ALL MAJOR CREDIT CARDS ACCEPTED  
SOLE AGENTS FOR AUSTRALIA AND NEW ZEALAND



**Sunspot Numbers**

Monthly Sunspot Average Dec 2003: 47.0

Annual Sunspot Average Jun 2003: 65.3

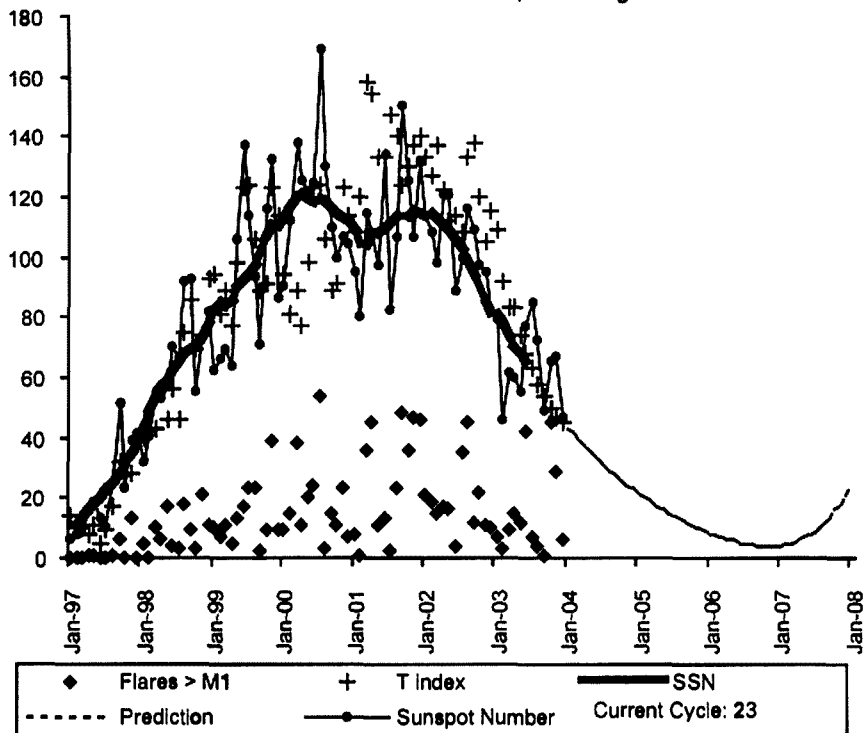

Drawn from monthly data provided by the Ionospheric Prediction Service

**HF, VHF, UHF ANTENNAS & ACCESSORIES**

Aluminium towers, guys etc  
Diamond VSWR/PWR meters.

HD copper antenna wire & insulators,  
TX tubes & pwr transistors, Create Rotators

Quality coax cables & connectors. Free advice & catalogue.

(Disregard the rumours, we are still here!)

**ATN Antennas**

Ph 03 6492 2224 Fax 03 6492 2666,  
email [atnant@inet.net.au](mailto:atnant@inet.net.au)

<http://www.hamsearch.com>

a not-for-profit site that is a search engine for hams



# Division Directory

The Amateur Radio Service exists for the purpose of self training, intercommunication and technical investigation. It is carried out by amateurs who are duly authorised people interested in radio technique solely with a personal aim and without pecuniary interest.

The Wireless Institute of Australia represents the interests of all radio amateurs throughout Australia. National representation is handled by the executive office under council direction. There is one councillor for each of the seven Divisions. This directory lists all the Divisional offices, broadcast schedules and subscription rates. All enquiries should be directed to your local Division.

## VK1 Division Australian Capital Territory,

GPO Box 600, Canberra ACT 2601

President Alan Hawes  
Secretary Deane Walkington  
Treasurer Bob Howie

VK1WX  
VK1DW  
VK1HBB

## Broadcast schedules All frequencies MHz. All times are local.

VK1WI transmits each Thursday evening at 2000 hrs local time on VK1RGI 146.950 MHz and 438.375 MHz including the linked repeater system on VK2RGN Goulburn, VK2RHR High Range, VK2RMP Madden Plains and VK2RTW Wagga Wagga.  
VK1 Home Page <http://www.vk1.wia.ampr.org>

**Annual Membership Fees.** Full \$80.00 Pensioner or student \$71.00. Without *Amateur Radio* \$48.00

## VK2 Division New South Wales

109 Wigram St, Parramatta NSW

(PO Box 9432, Harris Park, 2150)

(Office hours Tue., Thu., Fri., 1100 to 1400 hrs.)

Phone 02 9689 2417

Web: <http://www.wiansw.org.au>

Freecall 1800 817 644 (NSW only)

e-mail: [vk2wi@wiansw.org.au](mailto:vk2wi@wiansw.org.au)

Fax 02 9633 1525

President Brian Kelly  
Secretary Owen Holmwood  
Treasurer Noel May

VK2WBK  
VK2AEJ  
VK2YXM

VK2WI transmits every Sunday at 1000 hrs and 1930 hrs on some or all of the following frequencies (MHz): 1.845, 3.595, 7.146, 10.125, 14.170, 18.120, 21.170, 24.950, 28.320, 29.170, 52.150, 52.525, 144.150, 147.000, 432.150, 438.525, 1273.500. Plus many country regions on 2m and 70cm repeaters. Highlights are included in VK2AWX Newcastle news Monday 1930hrs. on 3.593 , 10 metres and local repeaters. The text of the bulletins is available on the Divisional website and packet radio. Continuous slow morse transmissions are provided on 3.699 and 145.650. VK2RSY beacons on 10m, 6m, 2m, 70cm and 23cm. Packet on 144.850.

**Annual Membership Fees.** Full \$83.00 Pensioner or student \$66.00. Without *Amateur Radio* \$50.00

## VK3 Division Victoria

40G Victory Boulevard Ashburton VIC 3147

(Office hours Tue 10.00 -2.30)

Phone 03 9885 9261

Web: <http://www.wiavic.org.au>

Fax 03 9885 9298

e-mail: [wiavic@wiavic.org.au](mailto:wiavic@wiavic.org.au)

President Jim Linton  
Secretary John Brown  
Treasurer Jim Baxter

VK3PC  
VK3JJB  
VK3DBO

VK3BWI broadcasts on the 1st Sunday of the month at 20.00hrs Primary frequencies, 3.615 DSB, 7.085 LSB, and FM(R)s VK3RML 146.700, VK3RMM 147.250, VK3RWG 147.225, and 70 cm FM(R)s VK3ROU 438.225, and VK3RMU 438.075. Major news under call VK3ZWI on Victorian packet BBS and WIA VIC Web Site.

**Annual Membership Fees.** Full \$87.00 Pensioner or student \$72.00. Without *Amateur Radio* \$55.00

## VK4 Division Queensland

PO Box 199, Wavell Heights, Qld. 4012

Phone 07 3221 9377

e-mail: [office@wiaq.powerup.com.au](mailto:office@wiaq.powerup.com.au)

Fax 07 3266 4929

Web: <http://www.wia.org.au/vk4>

President Ewan McLeod  
Secretary Bob Cumming  
Treasurer David Gulley

VK4ERM  
VK4YBN  
VK4DCG

EVERY SUNDAY, at 9am LOCAL (Sat 2300 UTC). From Far North Queensland On 7.070/2 MHz. From South East Queensland:- 1.825, 3.605, 7.118, 10.135, 14.342, 21.175, 52.525, 147.000, 438.500 MHz. Right throughout VK4 scan 146.6 to 148.0 MHz again at 9am local. SUNDAY 6:45pm hear LAST week's QNEWS broadcast 3.605 and 147.0 MHz from South East Queensland. MONDAY 7:00pm hear YESTERDAY's news again on 146.875 MHz broadcast from Brisbanes Bayside repeater, and then 7:30pm on 3.605 and 147.0 MHz from Sth East Queensland. Text editions on packet internet and personal email, visit [www.wia.org.au/vk4](http://www.wia.org.au/vk4) News is updated 24/7 in both text and audio on this site. MP3 Audio from same website by 2300 hours each Saturday. Contact QNEWS, packet sp QNEWS@VK4WIE.BNE.QLD.AUS.OC email [qnews@wia.org.au](mailto:qnews@wia.org.au)

**Annual Membership Fees.** Full \$95.00 Pensioner or student \$81.00. Without *Amateur Radio* \$63.00

## VK5 Division South Australia and Northern Territory

(GPO Box 1234 Adelaide SA 5001)

Phone 08 8294 2992

web: <http://www.sant.wia.org.au>

email: [peter.reichelt@bigpond.com](mailto:peter.reichelt@bigpond.com)

President Trevor Quick  
Secretary Peter Reichelt  
Treasurer Trevor Quick

VK5ATQ  
VK5APR  
VK5ATQ

VK5WI: 1843 kHz AM, 3.550 MHz LSB, 7.095 AM, 14.175 USB, 28.470 USB, 53.100 FM, 147.000 FM Adelaide, 146.800 FM Mildura, 146.900 FM South East, 146.925 FM Central North, 438.475 FM Adelaide North, ATV Ch 35 579.250 Adelaide. (NT) 3.555 LSB, 7.065 LSB, 10.125 USB, 146.700 FM, 0900 hrs Sunday. The repeat of the broadcast occurs Monday Nights at 1930hrs on 3585kHz and 146.675 MHz FM. The broadcast is available in 'Realaudio' format from the website at [www.sant.wia.org.au](http://www.sant.wia.org.au) Broadcast Page area.

**Annual Membership Fees.** Full \$91.00 Pensioner or student \$76.00. Without *Amateur Radio* \$61.00

## VK6 Division Western Australia

PO Box 10 West Perth WA 6872

Phone 08 9351 8873

Web: <http://www.wia.org.au/vk6>

e-mail: [vk6@wia.org.au](mailto:vk6@wia.org.au)

President Neil Penfold  
Secretary Roy Watkins  
Treasurer Bruce Hedland-Thomas

VK6NE  
VK6XV  
VK6OO

VK6WIA: 146.700 FM(R) Perth at 0930hrs Sunday relayed on 1.865, 3.564, 7.075, 10.125, 14.116, 14.175, 21.185, 29.120 FM, 50.150 and 438.525 MHz. Country relays 3.582, 147.200 (R) Cataby, 147.350 (R) Busselton, 146.900 (R) Mt William (Bunbury), 147.000 (R) Katanning and 147.250 (R) Mt Saddleback. Broadcast repeated on 146.700 at 1900 hrs Sunday relayed on 1.865, 3.564 and 438.525 MHz : country relays on 146.900, 147.000, 147.200, 147.250 and 147.350 MHz..Also in "RealAudio" format from the VK6 WIA website

**Annual Membership Fees.** Full \$71.00 Pensioner or student \$65.00. Without *Amateur Radio* \$39.00

## VK7 Division Tasmania

PO Box 371 Hobart TAS 7001

Phone 03 6234 3553 (BH)

Web: <http://www.wia.org.au/vk7>

email: [vk7dg@wia.org.au](mailto:vk7dg@wia.org.au)

President Phil Corby  
Secretary Dale Barnes  
Treasurer Dale Barnes

VK7ZAX  
VK7DG  
VK7DG

VK7WI: At 0930 hrs every Sunday on 146.700 MHz FM (VK7RHT, Hobart) and relayed on 147.000 MHz FM (VK7RAA, Launceston), 146.625 MHz FM (VK7RMD, Ulverstone), 146.750 MHz FM (VK7RNV, Ulverstone), 147.075 MHz FM (VK7RWC, Rosebery), 3.57 MHz LSB, 7.090 MHz LSB, 14.130 MHz USB and UHF CB Channel 15 in Hobart area.

**Annual Membership Fees.** Full \$90.00 Pensioner or student \$77.00. Without *Amateur Radio* \$57.00

**VK8 Northern Territory is part of the VK5 Division and relays broadcasts from VK5 as shown received on 14 or 28 MHz. The broadcast is downloaded via the Internet**

# Riding and talking

Steve Trebilco VK3NF

## Turning my motorbike into a mobile station



Bike and antenna – Salt lake north of Port Augusta



Craig, Brian, Dave VK3GDL and John VK5NJ



Steve VK3NF with bikes – Bottom of Uluru



John VK5Nj sending morse – Curtin Springs

see article on page 9



Steve VK3NF and John VK5NJ – Top of Uluru



Helmet, transceiver and the antenna base – HF and 2 m



# MEET ICOM'S CHAMPIONS AT WYONG FIELD DAY



**Find out Wyong Special & opportunity  
to Win an Icom Radio**

**Visit Icom and Dealer:** Newcastle Prosound,  
Action Communications and Mastercom-Countrylink.

Central Coast Field Day, Wyong 29th February 2004

Venue: Wyong Racecourse

For more information on Central Coast Field Day  
please visit: [www.ccarc.org.au](http://www.ccarc.org.au)

**ICOM**

Clearly Ahead

**2 YR WARRANTY**

find your nearest ICOM dealer at

[www.icom.net.au](http://www.icom.net.au) or (03) 9387 0666

The magazine for AUSTRALIAN amateurs



March 2004  
Volume 72 No 3



# Amateur Radio

\$6.50  
inc GST

Preparing for change  
**LIFT-OUT**  
WIA Constitution



**AMSAT-UK  
Space Symposium  
2004**

**Rub shoulders**  
with the designers of  
the latest amateur satellites

- Some useful wire antennas for HF [Rob Gurr VK3RG]
- A high power RF attenuator [Ron Sanders VK2WE]
- Traps for multi-band antennas [Lindsay Lawless VK3AW]
- Know your secondhand equipment [Ron Fisher VK3OM]
- Protecting your equipment [Alex Santana of NSW police]

ISSN 0002-6859

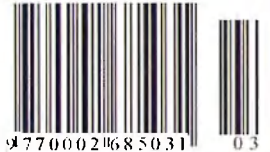





9 770002 685031 03

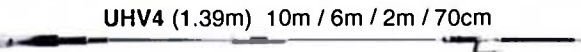

# BENELEC

## Mobile Antennas



-  SBB1 (0.41m) 2m / 70cm
-  SBB5 (0.95m) 2m / 70cm
-  UHV4 (1.39m) 10m / 6m / 2m / 70cm
-  UHV6 (1.9m) 40m-15m-10m / 6m / 2m / 70cm
-  CX 702 (2.1m) 6m / 3m / 70cm

## Base Antennas

-  GP9N (5.15m) 2m / 70cm
-  GP3 (1.78m) 2m / 70cm
-  GP15 (2.42m) 6m / 2m / 70cm

Made in Japan

**SOLARCON**  
**Imax2000**

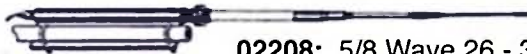

02208: 5/8 Wave 26 - 31 MHz  
02208GK: Ground Plane Kit

Made in USA

## Accessories



0301 BENELEC VSWR / Power  
1.8-520MHz 200/400 Watts



172001205 50ohm Load UHFp  
100 Watts PFP DC-600MHz



Revex Switch Ns  
DC-1500 MHz



CF 706 Duplexer  
1.3 - 57 MHz/75-550MHz  
UHF p-s

# BENELEC

## HF Broadband Base Antennas



0202310 3.5 - 30MHz Single Wire 34m 100W PEP  
0202320 2 - 30MHz Single Wire 48m 100W

0202410 2.6 - 30MHz Multi-Wire 27m 100W  
0202415 2.6 - 30MHz Single Wire 54m 250W PEP

Made in Australia

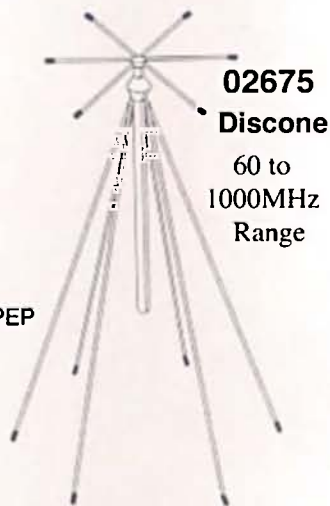

02675  
Discone  
60 to  
1000MHz  
Range

[www.benelec.com.au](http://www.benelec.com.au)

Authorised Yaesu Retailers

NSW  
Andrews Communications  
Systems  
Tel 02 9636 9060  
lee.andrews1@bigpond.com

Newcastle Pro Sound  
& Communications  
Tel 02 4965 6899  
sales@newcastleprosound.c  
om.au

VIC  
Strictly Ham P/L  
Tel 03 9729 7656  
sales@strictlyham.com.au

G&C Communications  
Tel 03 5996 3298  
gcomm@netspace.net.au

Qld  
Kyle Communications  
Tel 07 3857 4400  
mark@kyle.com.au

SA/NT  
PQSNV Systems P/L  
Tel 08 8342 4700  
brenton@posnav.com.au

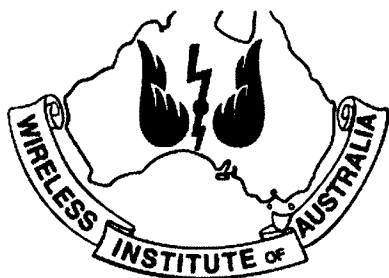

# Amateur Radio

Volume 72, Number 3  
March 2004

The Journal of the Wireless  
Institute of Australia  
ISSN 0002-6859

## Editorial

Editor: Colwyn Low VK5UE  
edarmag@chariot.net.au

Technical Editor: Peter Gibson VK3AZL

Publications Committee Members  
Brenda Edmonds VK3KT  
Ron Fisher VK3OM  
Don Jackson VK3DBB  
Evan Jarman VK3ANI  
Tom Potter VK3UBS  
Bill Roper VK3BR

## Submission of material to Amateur Radio Magazine

General and Technical articles to  
Secretary  
AR Publications Committee  
3 Tamar Court  
Mentone VIC 3194  
or armag@optusnet.com.au

Columns and Letters to the Editor to  
Editor  
AR Magazine  
34 Hawker Crescent  
Elizabeth East SA 5112  
or  
edarmag@chariot.net.au  
(Tel and Fax 08 8255 2138)

Hamads to  
"Hamads" Newsletters Unlimited  
PO Box 431  
Monbulk VIC 3793  
Fax 03 9756 7031  
newunltd@bigpond.net.au

Advertising  
All enquiries to  
Newsletters Unlimited  
PO Box 431  
Monbulk Vic 3793  
Phone: 03 9756 7797  
Fax: 03 9756 7031  
newunltd@bigpond.net.au

Registered Office  
10/229 Balaclava Road,  
Caulfield North VIC 3161  
Australia  
Phone: 03 9528 5962

## Production Deadlines

Advertising booking and articles for  
publication 10<sup>th</sup> of preceding month.

Hamads and advertising material  
deadline 18<sup>th</sup> day of preceding month

The contents of Amateur Radio are Copyright  
Wireless Institute of Australia © 2004

## General

Protecting your equipment .....	9 & IBC
<i>Alex Sentana LU9BAW</i>	
In Charlie's way, Part 1 .....	14
<i>Ross Frazer VK2WN</i>	
Know your secondhand equipment .....	15
<i>Ron Fisher VK3OM</i>	
Just how old is the direct conversion receiver? .....	19
<i>Steve Mahony VK5AIM</i>	
Book Review: Signor Marconi's Magic Box: .....	24
<i>Dr John Dawes VK5BJE</i>	
Proposed new WIA Constitution .....	25
AMSAT-UK - Space Symposium 2004 (Cover Story) .....	43
Pileups are dangerous .....	55
<i>HB9CIC Josef, translated by Mike Krochmal, VK3KRO</i>	

## Technical

Some useful wire antennas for HF .....	4
<i>Rob S Gurr VK5RG</i>	
A high power RF attenuator .....	11
<i>Ron Sanders VK2WB</i>	
FT-817 compact fast charger (Technical Abstracts) .....	17
<i>Peter Gibson VK3AZL</i>	
Solid-state those pilot lamps (Technical Abstracts) .....	18
<i>Peter Gibson VK3AZL</i>	
Traps for multi band antennas .....	21
<i>Lindsay Lawless VK3ANJ</i>	

## Columns

ALARA .....	22	Hamads .....	62
AMSAT .....	42	HF Predictions .....	56
Beyond Our Shores .....	58	Intruder Watch .....	54
Contests .....	49	Over to you .....	60
Club News .....	23, 44	Silent Key .....	7, 17, 41, 53
WIA Division News		Spotlight on SWLing .....	54
VK2 News .....	45	Technical Abstracts .....	17, 18
VK4 News .....	47	VHF-UHF an expanding world .....	51
VK6 News .....	48	WIA Comment .....	3
VK7 News .....	48	WIA Division Directory .....	64
Editor's Comment .....	2	WIA Federal Directory .....	2
Education .....	13		

## Our Cover this month

The International Space Station. Picture released by NASA to support  
the AMSAT-UK - Space Symposium 2004

'This 3 day event always attracts Radio Amateurs from across Europe as  
well as North America, Africa, Asia and the Pacific.' See rest of story on  
page 43

### Contributions to Amateur Radio

Amateur Radio is a forum for WIA members' amateur radio  
experiments, experiences opinions and news. Manuscripts  
with drawings and or photos are always welcome and will be  
considered for publication. Articles on disc or email are  
especially welcome. The WIA cannot be responsible for loss  
or damage to any material. A pamphlet, How to write for  
Amateur Radio is available from the Federal Office on  
receipt of a stamped self-addressed envelope.

### Back Issues

Back issues are available directly from the WIA Federal

Office (until stocks are exhausted), at \$4.00 each (including  
postage within Australia) to members.

### Photostat copies

When back issues are no longer available, photocopies of  
articles are available to members at \$2.50 each (plus an  
additional \$2 for each additional issue in which the article  
appears).

### Disclaimer

The opinions expressed in this publication do not necessarily  
reflect the official view of the WIA and the WIA cannot be  
held responsible for incorrect information published.

## Amateur Radio Service

A radiocommunication service for the purpose of self-training, intercommunication and technical investigation carried out by amateurs; that is, by duly authorised persons interested in radio technique solely with a personal aim and without pecuniary interest.

## Wireless Institute of Australia

The world's first and oldest  
National Radio Society  
Founded 1910

Representing

The Australian Amateur Radio Service

Member of the  
International Amateur Radio Union

Registered Federal Office of the WIA

10/229 Balaclava Road  
Caulfield North Vic 3161

Tel: (03) 9528 5982 Fax (03) 9523 8191

http://www.wia.org.au

All mail to  
PO Box 2175 Caulfield Junction VIC 3161  
Business hours: 9.30am-3pm weekdays

### Federal Secretary

Peter Naish VK2BPN

### Federal Office staff

June Fox Bookkeeper  
Rita Trebilco VK3IF Examinations Officer

### Council

President	Ernest Hocking	VK1LK
VK1 Federal Councillor	Gilbert Hughes	VK1GH
VK2 Federal Councillor	Terry Davies	VK2KDK
VK3 Federal Councillor	Jim Linton	VK3PC
VK4 Federal Councillor	Glenn Dunstan	VK4DU
VK5 Federal Councillor	David Box	VK5OV
VK6 Federal Councillor	Trevor Ward	VK8HTW
VK7 Federal Councillor	Phil Corby	VK7ZAX

### Executive

David Jones	VK4OF
David Pilley	VK2AYD
Don Wilschefski	VK4BY
Brenda Edmonda	VK3KT (ex officio)

### Federal Coordinators

AMSAT	Graham Ratcliff	VK5AGR
ARDF	Jack Bramham	VK3WWW
Awards	Mal Johnson	VK8LC
Contests	t.b.a.	
Education	Ron Smith	VK4AGS
FTAC	John Martin	VK3KWA
Historian	John Edmonda	VK3AFU
IARU	Neil Penfold	VK8NE
Intruder Watch	Harry Anderson	VK8HA
International	John Miller	VK3DJM
Travel Host		
ITU Conference and study group	Gilbert Hughes	VK1GH
QSL Manager (VKS, VKO)	Neil Penfold	VK8NE
Videotapes	VK2 Division	
Web	Joe Burford	VK5UJ
WICEN	John Weir	VK3ZR

### ACA Liaison Team

Peter Naish VK2BPN,  
Gilbert Hughes VK1GH  
Keith Malcolm VK1ZKM  
Glenn Dunstan VK4DU

## Editorial comment

Colwyn Low VK5UE

## The big questions

The year is now well advanced and the WIA Divisions are preparing for their AGMs. The Federal WIA is also in the process of finalising this year's Convention in Brisbane and the selection of Directors and Coordinators. The WIA runs on volunteers and if no one volunteers we will have a group of "N. O. Ones" on our Committees and we all know "N. O. One" does nothing.

We need to think about where we go in the next 12 months, who we know will support that position and be able to put the case for its implementation. Then we should try and talk them into standing for election. If some one thinks we have the "Right Stuff" we should think seriously about accepting nomination. We should also look on the positions as being for one year at a time and not a life sentence.

The other big issue is "How do we set up a National WIA?" In this issue you will find a draft constitution for a National rather than a State based WIA. Please read the material carefully, discuss it with your amateur friends, discuss it at your Radio Club and discuss it with your Divisional representatives. There are some issues that will have to be sorted within a new structure. There is the provision of basic communication facilities like repeaters. Should there be local control and financial support? Should there be a national linked repeater network supported by the national body? How do we treat existing Divisional resources in the transition to a national body? However the primary decision is "Is NOW the time to recast the structure of the Australian Wireless Institute?" Given a yes and good will between all the Divisions, we can move forward to a new structure and a better WIA. It is in your, the members, hands, let us make sure we make decisions for the greater good and for the future of AMATEUR RADIO not immediate self interest.

I received a saddening letter this week from A.W. (Alex) Ellison ex VK4RU. Alex's health is not the best and his age prevents him continuing with the hobby that has provided him

with many enjoyable years. He felt he had to sell all his station equipment and cancel his Amateur Radio Magazine which he enjoyed reading. He has been an avid CW operator and I'm sure his fist will be missed. He closed by wishing us all the best for our hobby. Thank you for the letter Alex and your good wishes. We hope you will find other activities to enliven your life. 73 VK5UE

Last month I told you I was building an 8 element 70-cm collinear from notes used by the Summerland ARC. Well I got it all together and it works quite well. The SWR is acceptable but I need to get the fine day and a couple of hours to set it up with some equipment and optimise the position of the toroids that block the currents in the coaxial cable outer. This has been a useful exercise. I learnt something and got a useful antenna.

I am currently thinking about what to do for the John Moyle Field, where to go and which bands to operate. There is always the decision on aerials. I feel wire aerials, which are multiband, are most convenient and use aerials with links at the appropriate lengths to get 80, 40 and 20 metre dipoles. I have also constructed yagi for 2 metre, 70 cm and 23 cm and wooden or fibreglass poles to get them about 6 metre off the ground. I think this year I will use the collinear for 2 metre and 70 cm and the yagi on 23 cm. Come to think of it its time I completed the 23 cm amplifier I started 2 years ago to lift my 200 mw towards a watt.

Well I hope you are all able to find some satisfying amateur activity this month, possibly you may get a chance to let someone know the variety of things you can do if you have an amateur licence.

You might even be able to set them on the road to get a licence.

73 Colwyn VK5UE



## Turning point

I will keep this very short and to the point this month since there is much of far greater importance that this issue of AR contains. Since February much work has been performed by the group to explore and document the issues in moving towards a National WIA. This issue contains a number of documents including a draft of a new constitution. Many thanks are due to Michael Owen for his expertise in this area and offering his time to assist in the exercise. It is impractical to include all of the material that has been produced in this issue of AR. The other documents will be published on the WIA web page over coming days. Again I would like to thank everyone who helped but especially Chris Jones for putting in an incredible effort on the business planning side of things.

## The proposed new WIA Constitution

Elsewhere in this issue you will find a copy of the proposed new constitution.

The "Constitution" is the proposed Constitution to replace the current Memorandum and Articles of Association of the Wireless Institute of Australia, as described in the Explanatory Memorandum.

While today companies are no longer governed by state law, but by the Commonwealth Corporations Act, the Wireless Institute of Australia is a company limited by guarantee incorporated in 1972 under the Victorian

Companies Act 1961 and holding a certificate of the Victorian Attorney General to dispense with the word "Limited" in its title, and which imposed certain additional conditions.

The consent of the Victorian Attorney General is required to change the Memorandum and Articles of Association of the WIA, and so an application for that consent and the amendment of the Attorney General's certificate has been lodged, so that in future that consent will not be

required. In the future the company will be subject to the Federal act, administered by the Australian Securities and Investments Commission, ASIC, and the new Constitution will be lodged with it.

With the consent of the Attorney General and the amendment of the certificate, the Divisions will have the opportunity to adopt the new Constitution at the Federal Convention at the start of April by passing a Special Resolution.

Before closing this month I would like to express my congratulation to Peter Naish on behalf of the amateur radio community of Australian. Peter has been elected as the next Chairman of IARU

Region 3. After many years of service to amateur radio here in Australia it is a pleasure to see him taking on the role of representing amateurs across the whole

of the Asia Pacific Region. Well done Peter

So 73s and all the best in amateur radio.

# Join WIA today



## WIA is active in:

- QSL services
- Major role in amateur radio education
- Coordination of contests and awards
- Monitoring of illegal activity

## How to join WIA

- Through your local amateur radio club
- Through your Division (contact details on page 56)
- Contact WIA Federal Office (03) 9528 5962

“There is no denying that radio today still has all the magic that attracted people to the hobby all those years ago, when it first emerged onto an unsuspecting world.”

Ernie Hocking, President  
Amateur Radio April 2002

# Some useful wire antennas for HF

## Part 1

Rob S Gurr VK5RG

35 Grandview Avenue, Urrbrae SA, 5064,

Rob shares his comprehensive knowledge of wire antennas with us.

*[This article originally appeared in Amateur Radio Magazine Vol. 64, No 3, March 1996. (Other parts of the original three part series will appear in future issues. Editor VK5UE)]*

When a new amateur operator makes his first enquiries to those already on the air, seeking advice on the best antenna to erect, he is frequently greeted with a short answer, which is actually an amateur calisign. "The G5RV" will be the response from some, the "G8PO" from others, and perhaps even the "ZL Special" from a few. Others may recommend a "W8JK", a "HB9CV", or a ..... These names mean very little to a beginner who is looking to establish his own station.

What do these and other similar titles mean, and what benefits does he get by using such an antenna? Why are there so many choices, and why can't he go straight to the best type, fully confident that it will work first try? In this article I will discuss the above antennas, and also describe some other very useful HF wire antennas, which, as yet, have not been given a title that identifies a person, rather than a physical item. Firstly, though, a few general matters about antennas.

## Some wire antenna considerations

### The wire

A 100 metre reel of 2.5 mm<sup>2</sup> stranded copper earth wire with PVC insulation costs about \$40 from electrical trade outlets. Don't buy it by the metre at retail hardware shops or you may pay up to three times this price. One hundred metres may last a long while; however, a friend may share the cost with you. In most cases, by the time an antenna and feedline are constructed, there will be little surplus. Also available is electric fence wire, from farming supply outlets;

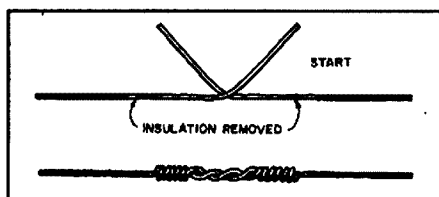

Figure 1-Splicing antenna wire.  
(Reprinted from The ARRL Antenna Book 15th Edition, page 21.3)

a sample reveals this to be multi-stranded steel wire, with one conductor of copper.

### Connectors

Soldering wire joints outdoors is not always practical. The use of commercial brass earth connectors, such as Clipsal Type 56312, or similar, is recommended. These may be covered over with insulation tape or, additionally, silicone rubber, if improved weatherproofing is required. The soldered joint is to be preferred; however, it should be a mechanically suitable joint, with wires twisted a number of times, or clamped, before solder is applied. I have had satisfactory experience with the "Post Office", or "Lineman's Joint", and find them quite suitable for copper wire aerial connections (see Figs 1 & 2).

### Masts

Steel tubes, section-alised masts, wooden or bamboo poles are all suitable. The use of trees, house fascias, and other elevated supports is also possible, providing suitable anchoring techniques are used. "U" bolts, turnbuckles, etc. are a standard hardware shop line. Height above ground will generally legally be restricted to 10 metres. However, if

you are willing to obtain the necessary permit, heights up to 15 metres may be used in a number of suburban installations. There is, unfortunately, a significant disadvantage in using this additional height on some frequencies. With trees, due to wind sway, use of halyards and pulleys utilising springs and counterweights is recommended. Wet foliage under certain circumstances may be a problem.

### Guy wires

Stranded steel galvanised wire may be used, and often surplus stainless steel rope is available. Joints can be made using clamps, turnbuckles and thimbles, as well as the above-mentioned Post Office splice (see Fig 2) method. It is good practice to use insulators liberally

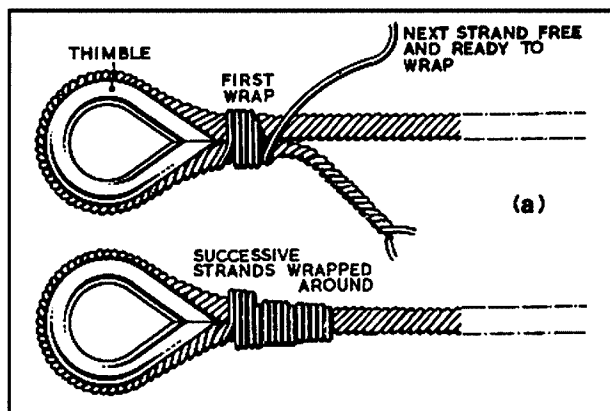

Figure 2 - The "Post Office" splice for securing stranded wire around a thimble or insulator. (Reprinted from RSGB Radio Communications Handbook, fifth edition page 12.91)

(about every 3 metres), however, if a one-length guy wire is preferred, an insulator at the top and bottom is essential. This requirement is to ensure that the length of wire associated with any unbonded metal-to-metal contact (thimble through the eye of a turnbuckle) is as short as possible.

This prevents large signal pickup and subsequent re-radiation should corrosion at the junction occur. We are all familiar with unexplained "crackles" on our receivers, and also with cross-modulation involving broadcast stations, which mysteriously worsens on dry windy days! Should it be necessary to have a long length of guy wire, or a cable catenary system that cannot be broken up with insulators, all metal to metal flexible contacts should be bonded over, or liberally coated with a graphite (conducting) grease; EMF Welder Grease, by Golden Fleece, has been my favourite, but other brands are available. It is not necessary to break guy wires into short sections using insulators. If you are inclined to do so, break them at quarter wavelengths on the highest frequency in use, i.e. every 2.5 metres for 28 MHz.

## Transmission lines and spreaders

The construction of a suitable open wire line can be simplified by the use of 16 mm, or 20 mm, heavy-duty electrical conduit.

Doubts may be held by some readers about the suitability of plastic as an insulator for feedlines in this manner, but I don't think a contact has ever been lost due to such small losses. Another insulator material, already protected for UV radiation, is the popular black

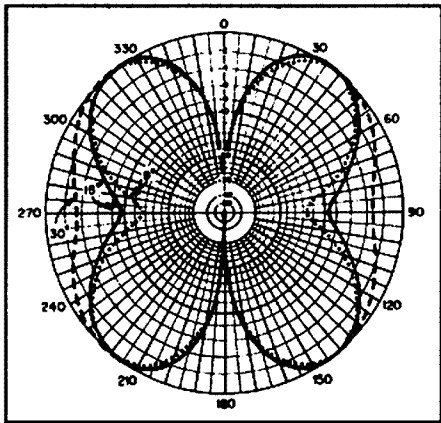

Figure 4 - Horizontal patterns of radiation from a full-wave antenna. (Reprinted from the ARRL Handbook, 1988 Edition, page 17.8)

garden automatic water sprinkler hose, about 4 mm diameter. Feedlines should be drawn away from antenna arrays at right angles, particularly where close to towers and other metallic supports. The use of UPVC to ensure minimum deterioration due to ultraviolet radiation is not considered necessary. Holes in the conduit to allow the wire to pass through, and a smaller diameter tie wire to prevent the spacer slipping down the feedline are required. Textbooks and practical experience vary. A line constructed for 300 to 800 ohms would be suitable in most cases, e.g. the 300 ohm open wire TV ladder line is satisfactory; however, do not use any other type of 300 ohm commercial feed line. A home-made line, of spacing between 50 and 150 mm is recommended, with spacers installed every 300 mm for narrow spaced lines and every one metre for wide spaced lines.

Lines could be pulled tight, but a loose hanging line with no right angle bends is acceptable. Wind sway may be a minor problem unless the lines are running close to earthed metal surfaces such as roofs, towers, etc. I would inject a word of warning here. Do not treat a tiled roof as an unearthed surface. Usually below the tiles you will find hot and cold water, and gas pipes, electrical

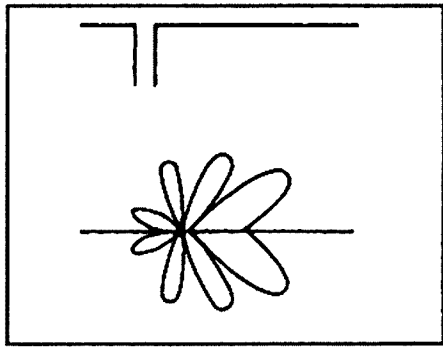

Figure 5 - Radiation pattern of a long wire antenna fed from a low impedance point near one end. (Reprinted from The Radio Handbook, twenty-first edition, page 28.3)

wiring, TV antennas and associated cables, telephone wires, etc, all of which have an influence on any nearby aerials or feedlines. The entry of the feedline (2 x 2.5 mm<sup>2</sup> insulated copper stranded wire) to the radio room is best via feed-through insulators; there are many variants available, most of which suggest themselves.

Do not run through a metal frame window and close the window on the line. The window may be at a quarter wave point and the high voltage will burn the insulation through, and so on. Brickwork entry is possible using small diameter glass tubes in mortar courses, etc.

Be certain to maintain the same spacing between the conductors for the full length of the line to the ATU. A good test of a feedline is to listen on it, through the ATU, when the aerial is disconnected. If you hear nothing, then it is balanced.

It is good practice to have an integral number of quarter waves in a feedline; however, random lengths do not inhibit good results, they only make the ATU work into complex reactive loads.

In some cases a number of ATUs, tuned for separate bands, may be remotely located and fed from the transmitter through coaxial cable.

## Element spreaders

Spreaders for separating the elements can also be made from electrical conduit, with a wooden dowel, or fibreglass rod, inserted internally to give rigidity. The conduit lengths available are, regrettably a maximum of four metres. Some ingenuity may be required to make simple spreaders longer than this.

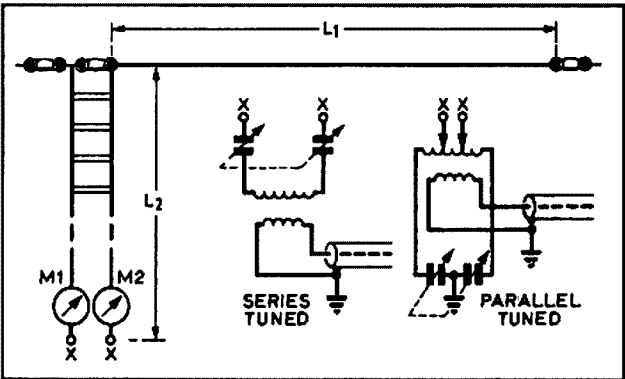

Figure 3 End-Fed Zepp. (Reprinted from the RSGB Radio Communications Handbook, fifth edition, page 12.61)

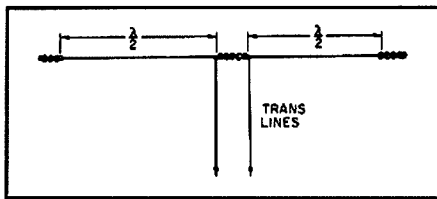

Figure 6 – A two-element collinear array (two halfwaves in phase). (Reprinted from The ARRL Antenna Book, 15th Edition, page 8.32)

Aluminium tube, 25 mm in diameter, may be suitable for up to five or six metres and, as it is usually at right angles to the antenna wires, should have little effect on radiation. Short aluminium tube lengths may be also used for joining wooden dowels, prior to enclosure in PVC conduit. Conduit end caps (Clipsal 252 series) are recommended, to finally enclose the spreader.

Fibreglass rods may also be fabricated to form elongated “cages” for spreaders up to five metres long.

### Coupling units

Most of the antennas to be described are balanced and symmetrical. The feedlines are not always ‘flat’ (SWR terminology) and the impedances

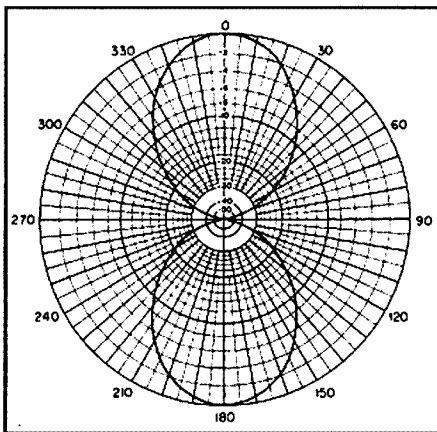

Figure 7 – free-space E-plane directive diagram for a two element collinear array. (Reprinted from The ARRL Antenna Book, 15th Edition, page 8.32)

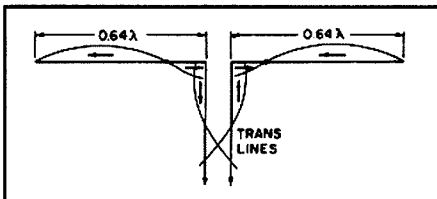

Figure 8 – The extended double Zepp. This system gives somewhat more gain than two half-wave collinear elements. (Reprinted from The ARRL Antenna Book, 15th Edition, page 8.34)

presented at the amateur equipment may vary from less than 20 to over 1000 ohms. Most multipurpose ATUs (‘Z’ Match, ‘T’ match with balun) may be adjusted, with the assistance of a suitable SWR meter, to convert these impedances to 50 ohms, to interface with standard amateur equipment. The description of a suitable ATU is included at the end of this article.

### Earthing systems

It is desirable for all aerial installations to have a good RF earth, and when using end-fed wire antennas (verticals or horizontal), it is essential. There are many practical reasons for this, and if one very good earth point can be established immediately adjacent to the ATU, and all other equipment bonded back to this point, it should be sufficient for most applications. The earth lead should be as short as possible as the ATU is part of the antenna system. All bonding earths to equipment are ancillary to this main lead.

(It should be remembered that the amateur equipment itself should be separately earthed through the three wire power cable. The General Purpose Outlet and the whole electrical system, all complying with the requirements of the SAA Wiring Rules AS3000).

A suitable earth stake may be a two-metre length of 20 mm water pipe driven into the ground, with a standard electrical earth clamp for connection of

the wire. In the case of end-fed wires, or ground planes, all nearby exposed metal such as carport supports, roof decking, galvanised fences, domestic water pipes, should be bonded back to the earth stake. A suitable wire is 6 mm<sup>2</sup> insulated earth wire (Green/Yellow) from an electrical trade outlet. Remember, the longer the earth lead, the higher the ATU is above radio frequency ground. The reason you get “bites” from microphone cases and equipment is that these items are often a quarter wave above ground where a high RF voltage exists.

Never rely on the mains earth as it may be a long way to the main switchboard, and even longer to the main earth stake. These aspects are most important in the end-fed antenna situation. In a practical situation, most amateurs should be able to achieve an earth wire of no more than a metre in length. Do not place your ATU at the top of everything else, or you may easily encounter that undesirable quarter-wave!

### End-fed “Zeppelin”

A halfwave dipole fed at one end with a non-radiating feedline, exhibits bi-directional radiation properties near its resonant frequency and on lower frequencies only (see Fig 3). At higher frequencies, major and minor lobes appear and its use on harmonics for multiband operation provides useful gain, particularly when considering harmonics above the fourth or fifth (see Fig 4).

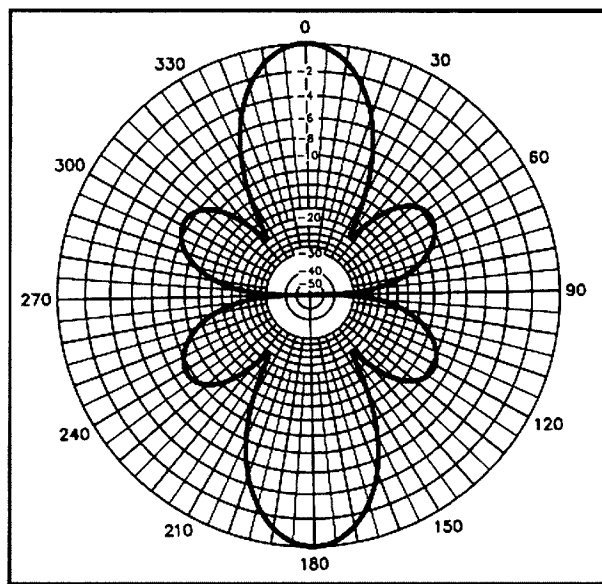

Figure 8a – E-plane pattern for the extended Zepp. (Reprinted from The ARRL Antenna Book, 15th Edition, page 8.34)

One such aerial is usually known as the end-fed “Zepp”. Actually, the figure eight pattern of the dipole radiation, and symmetry of the lobes on harmonics, is somewhat distorted, to give a directional radiation away from the feeder end (Fig 5). These aspects are worthy of further reading; however, for a “backyard” installation, its application is somewhat limited if directivity is required. The above aspects do not preclude the end-fed dipole being used as the driven element of a collinear phased array. In

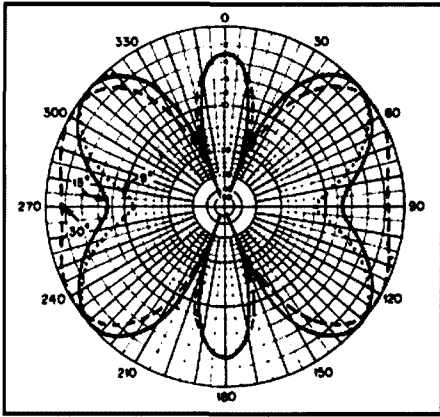

Figure 9 – Horizontal patterns of radiation from an antenna three half-waves long. (Reprinted from the ARRL Handbook, 1988 Edition, page 17.8)

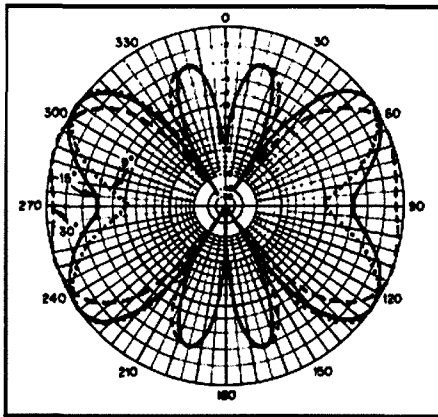

Figure 10. – Horizontal patterns of radiation from an antenna two wavelengths long. (Reprinted from the ARRL Handbook, 1988 Edition, page 17.8)

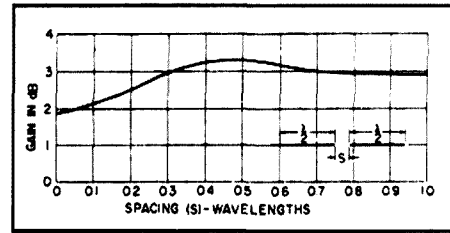

Figure 11 – Gain of two collinear half-wavelength elements as a function of spacing between the adjacent ends. (Reprinted from The ARRL Antenna Book, 15th Edition, page 8.32)

Specific dimension for this is simply calculated by assuming a design frequency of 10.1 MHz, where a half wavelength is 14.85 metre. This gives a somewhat improved DX performance on the G5RV (mentioned later), where bi-directional properties occur on the 3.5 and 7 MHz bands only, and multi-directional lobes become evident on 10.1 MHz.

As an ATU is necessary to get multi band operation from this antenna and a G5RV, this shorter antenna has more to offer.

Maximum gain possible in any combination of two dipoles is 3 dBd; i.e. two arrays with unity power can only produce twice power under any condition. This is an important fundamental in understanding antenna gain (Fig 11).

*Part 2 of Some Useful Wire Antennas for HF will appear in a later issue of Amateur Radio.*

ar

fact, some physical layouts may require such a feed (sometimes the line of support poles may be at right angles to that necessary for the use of an alternative directional array). Such arrays stay bi-directional, in a direction at right angles to the line of their support masts.

## Centre-fed "Zepp"

An array of two in-line (collinear) half-wave elements (Fig 6), fed in the centre with a tuned feeder, exhibits a gain of 1.8 dBd (4 dBi) (see Fig 7). This is known generally as two half waves in phase. By extending the dipole lengths to 5/8 wave, the array becomes two extended half-waves in phase (Double Extended Zepp), with a gain of 3 dBd (5.2 dBi) (see

Fig 8). Such an antenna, usually with end feed, is well known to 144 MHz operators as a "Ringo". When such an array is erected and tuned for 14 MHz, it is coincidentally two half waves in phase on 10.1 MHz. On 7 and 3.5 MHz the array is effectively a long dipole and a short dipole respectively, but with still the same bi-directional radiation. We now have a bi-directional array for 3.5 to 14 MHz, with a useful gain on both 10 and 14 MHz.

On higher bands the bi-directional lobes are replaced by multiple lobes (Fig 9), at various angles, however the main lobes continue to exhibit even higher gain. Regrettably, they may not be in the direction that you may wish to frequently contact (Fig 10).

## George Hunt VK3ZNE

**It is with regret that we record the passing of George Hunt VK3ZNE. He died on 9 November 2003, aged 72.**

Long time listeners to the VK3BWI broadcast will know that George was the WIA Victoria Broadcast Officer for a number of years and did a fine job.

He was employed by ABC radio from about 1969 to 1985 in the recording and production section working on many of the well known shows broadcast during that period.

George obtained his amateur licence in the mid-1970s and was one of about

a dozen members of the unofficial ABC amateur radio club.

After developing a heart condition George retired from the ABC on health grounds. A few years later he joined the WIA Victoria Council serving as the Broadcast officer, Disposals Officer and had responsibility for building maintenance.

He excelled as Broadcast Officer and

announcer, with his friendly disposition an asset that kept the broadcast team both on its toes in terms of transmission quality, and maintained their enthusiasm.

Vale - George Henry Hunt VK3ZNE.

Submitted by Jim Linton VK3PC,  
President, WIA Victoria

## Silent Key

*"the box that brought my amateur radio hobby back to life"*

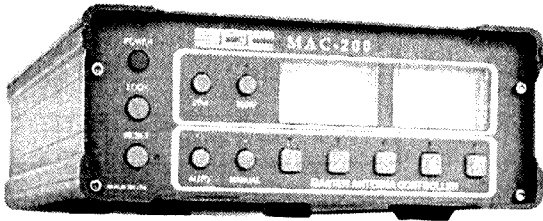

## MAC-200

### MASTER ANTENNA CONTROLLER (Smartuner Built-in)

The MAC-200 brings together a Smartuner and an Antenna Switch in a single compact unit.

#### Controls

#### 5 ANTENNAS

#### 3 SO239 COAXIAL CONNECTORS

#### 1 BALANCED ANTENNA OUTPUT

#### 1 END FED LONG WIRE

Displays Forward power on 20 and 200 watt scales and VSWR

Smart enough to do the job without operator attention.

The Mac-200 from SGC is THE answer for feeding multiple antennas from a single transceiver! It's more than a

switch, it shares a tuner between all of the antennas. It knows which antenna you're on and remembers the last successful tunes on each antenna so it can get back there fast. All of this works in less than 10ms for frequencies you've been on before, less than 2 seconds for randomly chosen frequencies with a no compromise Pi Network output. The Smartuner remembers everything for quick, perfect matching.

The push of a button is all that's needed to make it work, everything else is automatic. Built in meters for easy monitoring,

low power consumption, and rugged construction make it useful for complex field portable operation as well.

*"... reports I was given were from 5x5 to 5x9+ on eighty and forty meters QRP. I am told it sounds like 100 watts is being used ... my slogan now is 'the Box that brought my amateur radio hobby back to life'"*

(One of UK's most active low-power amateurs talking about the MAC-200)

**Email us and we will send you a pdf brochure and pricing details.**

**This device is a most cost-effective way of empowering your current Amateur gear**

### Somewhere in Australia

## The Orion has landed

And if we can ever separate the overjoyed owner from his new gear long enough to talk with us, we will bring you an assessment of how it all works. But until then, the list of primary benefits says it all:

- Dual 32-bit floating point ADI SHARC DSP processors
- Full dual receive capability
- Very high RX intercept points
- 590 receive IF-DSP bandwidth filters independently selectable on each of the main and sub receivers
- Adjustable receiver filter shape factors
- Programmable AGC response

- time for main receiver
- True diversity reception using both receivers
- Continuous real time spectrum display allows monitoring of band activity
- "Instant Two Radio Mode" allows ORION to instantly SQY between two different bands
- Virtually indestructible 100-watt PA
- Superb SSB audio is yours at a touch of

- the AUDIO button
- Ten-Tec's new Panoramic Stereo receive feature
- Adjustable rise and decay times for transmitted CW waveform
- Nine adaptive DSP noise reduction filters
- Dual noise blankers
- Voice keyer and CW memory keyer built in
- On-the-fly reset button
- Flash ROM updatable

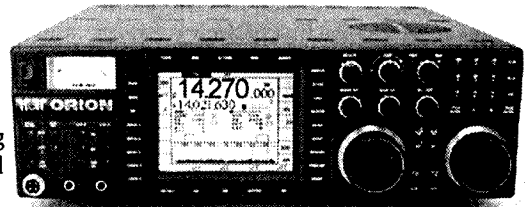

We have a range of SGC devices that use the amazing ADSP noise suppression technology. Talk to us about them. We will hear you!

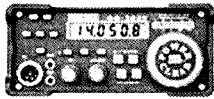

SG 2020 ADSP



We have these world famous kits and remember, it sounds better on something you built yourself. Start with a small kit and build up to a transceiver. Check out the full list on the site.

**Not only but also---**  
Auttek Analysers & Power Meters

Davis Weather Stations

Amidon Cores . Call for a stock/price list

Baluns and Transformers

WE SPECIALIZE IN MAIL ORDER.  
VISA AND MASTER CARD ACCEPTED.  
CALL FOR A FREE CATALOG  
WITH PRICING.

DETAILED DATA SHEETS ARE AVAILABLE ON REQUEST FOR MOST PRODUCTS.



Systems

## TTS Systems Communications Equipment

FREE CATALOGUE

[www.ttssystems.com.au](http://www.ttssystems.com.au)

**HF and VHF Transceivers, Autotuners and Kits**

Phone 03 5977 4808. Fax 03 5977 4801 [info@ttssystems.com.au](mailto:info@ttssystems.com.au)

# Protecting your equipment

Alex Sentana LU9BAW, ECL  
NSW Police, Fairfield LAC  
sent1ale@police.nsw.gov.au

**Burglary is one of the more common crimes in Australia; it has a high incidence across jurisdictions and is a major concern to the Australian community. Burglary accounts for over one fifth of all offences recorded by the police. Most urban Australians, if they have not already been the victim of a burglary, would know someone who has. The odds are that most urban residents will become the victim of a burglary at least once in their lives.**

Being burgled can have a devastating impact on families whose privacy has been violated and household belongings stolen. The impact of walking into a burglary is huge. You may experience fear, anxiety, anger and rage, especially if the offenders have taken your beloved rigs!

One of my tasks as Ethnic Community Liaison Officer for the NSW Police is to deliver information sessions on crime prevention for the culturally and linguistically diverse communities in NSW.

The aim of these sessions is to promote individual and community awareness in preventing and reducing property crime and improving personal safety.

Being a radio amateur for 28 years, it came to my mind that part of the session directly relates to amateur radio and so decided to write an article to help hams in preventing their equipment from being stolen.

Thieves like portable, high value, easily saleable goods like music CDs, mobile phones, jewellery, and others such as videos, computer hard drives, cameras etc. Communications equipment these days are very portable and some of them are small enough to be carried in a pocket. However, some may cost more than a car.

By introducing some practical security precautions into everyday life, you can take an active role in reducing the chance to get burgled. One of these security precautions is to mark your property, which can be done in a number of ways such as using an engraving tool, ultra violet pens or microdot technology.

## Engraving

A simple procedure to avoid rigs going for a walk with strangers is to mark them

in such a way that is easily identifiable. This can be achieved by engraving them. You can engrave your callsign on your equipment or any other mark that you will remember, or simply (my preferred method) engrave your driver's licence following the letters NSW (Picture 1).

If eventually you sell your rig, place a neat line through your engraving to show that it is no longer valid.

It is also a good idea to give the person a receipt to prove the sale of the item.

Engraving serves two purposes. Firstly, engraving or marking your rigs makes them less attractive to offenders, since it is more difficult for them to resell them. Pawnbrokers will verify that the engraving on the equipment is the same as the driver's licence of the person trying to sell it; otherwise they will call the police immediately. Secondly, if your rig is stolen and later recovered by police, it is much easier to return it to you. Police recover thousands of stolen items annually but unfortunately a large amount of this property cannot be returned to the owners since it cannot be identified.

## Where do I get an engraving tool?

There are several low-cost engraving tools obtainable from electronic and hardware shops. However, if you cannot afford one or simply do not want to spend that money,

you can borrow an engraving tool from NSW Police free of charge. Yes! We can lend you one at no cost.

There is a Crime Prevention Officer (CPO) at each of the 80 Local Area Commands across NSW, you can call your local police station and ask your CPO for an engraving tool, he or she will be more than happy to assist you (Picture 2).

## Make an inventory

Another useful tip is to have an inventory of all equipment you own. When making the list you should include brands, models and serial numbers. It is also important to include the price of the items. If you make the list on your computer, print it (in case your computer also gets stolen) and ensure this information is secured for future reference. If you are unfortunate enough to be burgled, having an inventory will enable you to identify what is missing and assist police by giving a full description of the missing

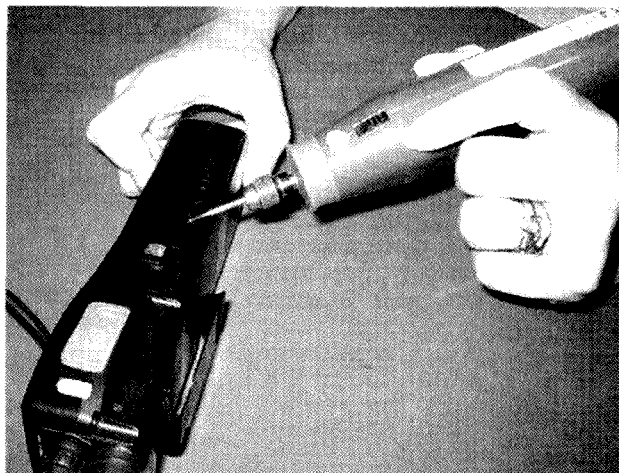

Photo 1. Engraving your equipment

This article refers to protection in general. While NSW programs are specifically described, all states have similar programs. For local information, contact your local Police Community Liaison Officer or the Neighbourhood Watch local group. Phone numbers should be in the phone book. Ed



Photo 2: CPO at Fairfield Police Station assisting a client on how to use the engraving tool.

Insurance are providing a "Property Safe" asset register for households to list their most valuable possessions. This register is a part of a brochure distributed with the October 5 2001 edition of the Daily Telegraph. The brochure, which is also available to download from the NSW Police Internet web site, encourages the

## What to do if you do become a victim of a home burglary

If you think that the offence is in progress or that the offenders are still in your home, DO NOT enter your home; ask one of your neighbours to call 000 Emergency.

In other cases call the Police Assistance Line on 131 444 to report the matter.

If you are waiting for police to attend, try not to touch anything and leave your home as you found it. Make a list of the property you think has been stolen. This is where your inventory is helpful.

Remember, crime prevention and reduction is not only a police responsibility; the community have an important role to play in preventing and reducing crime. For more information on how you can assist please contact the Crime Prevention Officer at your Local Area Command.

For more tips and information, log onto the NSW Police website at [www.police.nsw.gov.au](http://www.police.nsw.gov.au)

property. A sample of such an inventory is shown in Figure 1.

If for any reason your equipment cannot be engraved, they should be videotaped, photographed or marked with an ultra-violet pen. This marking is only visible under an ultra-violet (black) light.

You can also take advantage of the Property Safe Project, designed to reduce break and enters and stealing offences. NSW Police in conjunction with the Daily Telegraph and NRMA Home

public to engrave personal items and record the details on the brochure that is then stored in a secure place. It has a key holder information section, which you have to fill out and sent to the local police station for registration.

A sample of the brochure is shown in Figures 2 and 3.

In the event of a theft, you would present the brochure to your local police command and assist in the identification and recovery of the stolen goods.

BRAND	MODEL	SERIAL No	DESCRIPTION	DATE OF PURCHASE	PRICE

Figure 1

**Attach photographs of Jewellery or Antiques to register**

- Only use valuable property such as cameras, TVs, video, hi-fi, and your stereo system. This will save money on replacement.
- Please ensure you have a full description of the item and other items in it kept there with your Property Register.
- Attach a lock external to your door and windows wherever you leave home.
- Install smoke alarms in all rooms of the house on a battery and test them.
- Only 1 hour to secure any valuable items home. Check them all the local Police station.
- Update alarm systems can be done. Please, through a lock to better ensure it protects.
- The Property Safe shows you your door or window open and not closed.

For more tips and information, log on to The NSW Police Service website at [www.police.nsw.gov.au](http://www.police.nsw.gov.au) or the NRMA Insurance website at [www.nrma.com](http://www.nrma.com)

**Police contact numbers:**  
**Local Police:** 000  
**Police Assistance Line:** 131 444  
**Other Support:** 1800 973 973  
**NRMA Insurance:** 130 130  
**Home Security:** 130 955

A Community Service Initiative

**Property Safe**  
Your Personal Property Register

Fill in this form and keep in a safe location away from valuables.

Description	Make	Model/Year	Serial number
1			
2			
3			
4			
5			
6			
7			
8			
9			
10			
11			
12			
13			
14			
15			
16			
17			
18			
19			
20			

Figure 2

Fill in this form and keep in a safe location away from valuables.

Description	Make	Model/Year	Serial number
1			
2			
3			
4			
5			
6			
7			
8			
9			
10			
11			
12			
13			
14			
15			
16			
17			
18			
19			
20			

**Daily Telegraph**  
KEYHOLDER INFO

Name: \_\_\_\_\_  
 Address: \_\_\_\_\_  
 Date: \_\_\_\_\_  
 Telephone: \_\_\_\_\_  
 Email: \_\_\_\_\_

In case of emergency please contact:  
 Name: \_\_\_\_\_  
 Address: \_\_\_\_\_  
 Telephone: \_\_\_\_\_  
 Email: \_\_\_\_\_

Following is my:

This section is sent to local police to update keyholder information X

Figure 3



# A high power RF attenuator

Ron Sanders VK2WB  
PO Box 439, KIAMA NSW 2533

It is sometimes useful to be able to use low-level instruments on high power RF equipment. A typical use could be to observe the output signal on a cathode ray oscilloscope (CRO) while the transmitter is still operating. Normal resistive attenuators are usually not suitable because of power dissipation requirements. This article will show a very low loss method of sampling the output of an amateur transmitter, which may be operating at relatively high power levels.

## Principle of operation

Use is made of the impedance transformation of a transformer between primary and secondary windings. Refer to figure 1. If the secondary winding has  $m$  turns and the primary side  $n$  turns, then the impedance ratio is  $(m/n)^2$ . If we terminate the secondary winding with  $50\ \Omega$  ( $R_{\text{secondary}}$ ) the primary ( $R_{\text{primary}}$ ) will appear to be  $50 (m/n)^2$  ohm. Suppose the primary is just 1 turn and the secondary is 10 turns. The primary impedance will be  $50/10^2$ , which is  $0.5\ \Omega$ . If we had 20 turns on the secondary the ratio would be  $1/400$  and the primary impedance would be  $0.125\ \Omega$ .

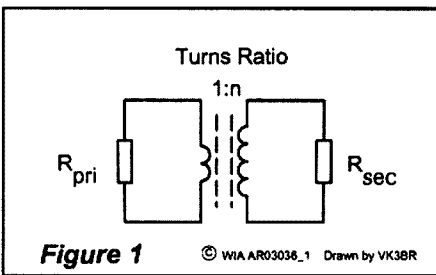

watt to  $0.5$  watt is  $100:1$  which when expressed in decibels is  $20$  dB attenuation. Following the same logic you can see that a twenty turn secondary produces  $0.125$  watt dissipation and represents a reduction from  $50$  watt to  $0.125$  watt which is a ratio of  $400:1$  or  $26$  dB attenuation.

NB: You can see that if the secondary is not terminated a very high impedance can be reflected into the primary. If you leave the transformer permanently in line you should always have a  $50\ \Omega$  (or short circuit) termination on the secondary port. Alternatively you could include a  $10$  dB resistive attenuator permanently in ahead of the low level output.

load for correct matching. It will now see a load of  $50.5\ \Omega$ , which for practical purposes is not a significant change. With a  $20$ -turn secondary the series impedance on the transmitter output will appear, as  $0.125\ \Omega$  and actual load seen by the transmitter will be  $50.125\ \Omega$ , which is even less significant. Of course the system could be scaled down for  $75\ \Omega$  if necessary. Note that the operation is bi-directional unlike the VSWR meter, so that the RF input and output ports are interchangeable.

## Practical considerations

The transformer core must be chosen for low loss over the range of frequencies required, typically  $1.8 - 30$  MHz. In addition the core must not approach magnetic saturation under the conditions of use. This means that the maximum flux density in the core must be reduced as the frequency is increased. This is normally controlled by choosing a core of sufficient size for the application. Toroid ferrite cores made from material with permeability of  $850$  are suitable for  $1.8 - 30$  MHz. Cores of  $13$  mm diameter (FT-50-43, FT-50A-43) are satisfactory for up to our legal limit.

To keep feedline impedance

## Circuit

Figure 2A shows an arrangement where the output of a transmitter is passed through a toroidal core forming a single turn and a secondary winding on the core has say  $10$  turns and is terminated in  $50\ \Omega$ . The series impedance on the transmitter output will appear as  $0.5\ \Omega$  due to the impedance transformation as mentioned previously. The equivalent circuit is shown in figure 2b. The transmitter normally requires a  $50\ \Omega$

The transformer is actually a current transformer, which is used in many power line applications but specially chosen for RF use. A toroid core has a unique characteristic when used as a current sensing transformer. If the conductor carrying the main current passes through the hole in the core, it forms a single turn winding on the core. Assuming that the transformer is  $100\%$  efficient the power in the primary and secondary circuits will be equal. Consider the case with a  $10$ -turn secondary and  $1$  ampere of RF flowing into the load ( $50\ \Omega$ ). The power consumed in the  $0.5\ \Omega$  reflected in the primary will be  $(i^2R)$  which is  $0.5$  watt. Now the reduction in power from  $50$

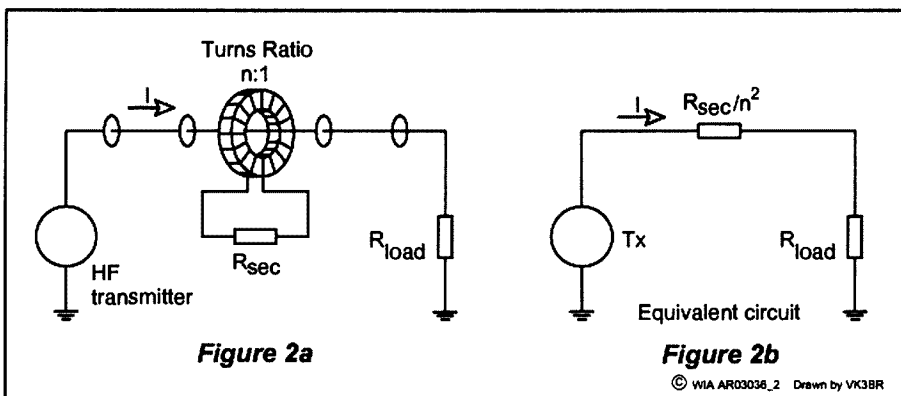

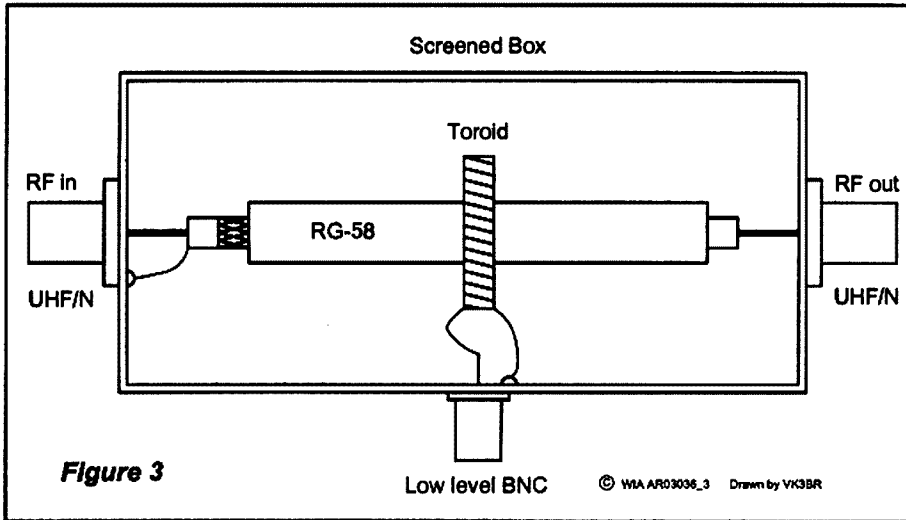

frequency. Use a multi-filar winding if necessary.

The circuit should be housed in a small metal enclosure with coaxial connectors for each of the 3 ports. It is a good idea to use a BNC connector for the low-level port and either UHF or N connectors for the other ports. This way there is no chance of connecting high power to the low level port.

In practice the 50 Ω load on the secondary would be a 50 Ω variable resistive attenuator feeding the measuring instrument. In that case, note that the attenuator must be capable handling the power, which should not be allowed to exceed 0.5 watt in most cases. As shown above, the dissipation can be controlled by choosing the number of turns on the secondary winding. When running the legal power limit the current in the secondary would need 32 turns to keep the power dissipation below 0.5 W. This would produce approx. 30 dB attenuation.

disturbance to a minimum, the primary winding should be a short piece of coax (RG-58) with the screen grounded at one end only so that the shield provides a Faraday screen to prevent capacitive coupling to the secondary winding. The length of coax need not exceed 50 mm.

Place a dab of adhesive to secure the toroid on to the coax once you have completed construction. See Fig.3.

The secondary winding is made from 0.3 - 0.5 mm enamelled copper wire and should not be so large as to approach self resonance at the highest operating

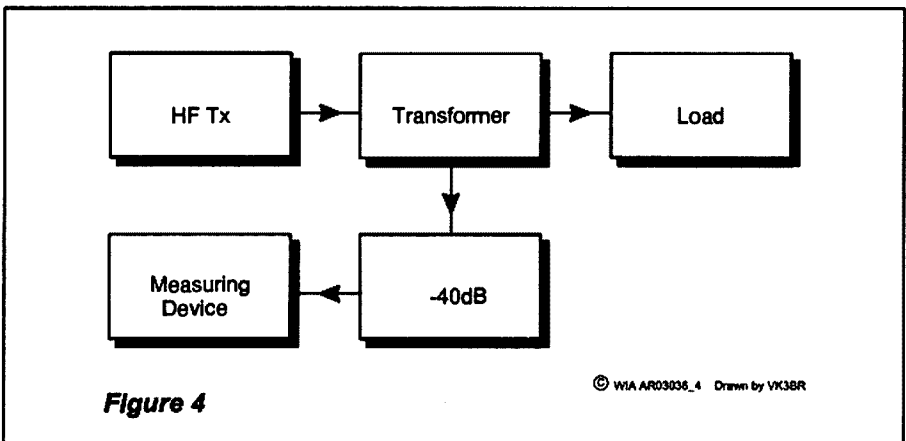

## Conclusions

A cheap and simple wideband attenuator for HF frequencies can be constructed using easily obtainable parts. The amount of attenuation required can be calculated and implemented by changing the secondary turns on the sensing transformer. I suggest that you use a turns ratio which gives a recognisable dB figure; e.g. 20 dB, 26 dB, 30 dB. Uses include, where a low level sample of a high power RF signal is required, such as a spectrum analyser or transmission monitor.

ar

# Wanted:

copy of a few pages from *RF Components and Circuits* by Joe Carr.

I am interested in an oscillator circuit with an LM6511 device, SMD type - a direct at apparently better (speed wise) replacement for the LM311.

The first reference I can find that suggested using a "Frequency Shift Oscillator" connected to a frequency counter to measure C and L at least in the "HAM" literature is Dr. Hegewald in "Funkamateur" in 1988. I am

interested in looking at page 342 or thereabouts in the book by the late Joe Carr, "RF Components and Circuits." Apparently the AADE LM311 Oscillator is described there and from what I have been told referenced to someone else,

but I need to see the pages to confirm this. I do not have this book or can get access to a copy locally, so if you could check this for me I would be grateful.

Dr Gary S. Evans  
argentumag@ hotmail.com

## Challenge or chaos?

**Amateur radio in Australia, as well as other places around the world, is at a time of change. Locally there are changes in technology, changes in modes, changes in regulations, changes in the WIA structure, and changes in education methods, to name but a few. There is much debate about whether the changes are for good or otherwise.**

Change is inevitable in life. It is natural and necessary. It is not automatic, though. Studies in psychology show that on the whole people are uncomfortable about change. So continuing the theme of last month about educating ourselves being fundamental to amateur radio, it is worth at this time to have a look at the change process and people's reactions to change.

Regardless of where people stand on a continuum ranging from a strong supporter of proposed changes to strongly against the changes, (perhaps somewhere in-between), all people go through six distinct stages in response to change. What differs is the depth reached of each stage, and length of time spent in each stage.

### Stage 1. Shock

This is usually the first reaction. People commonly feel shut out of the change process. Some supporters will feel shock that the changes were even proposed or shock at the reactions of others. Opponents will also feel shock at the nature of the proposed changes. This is usually a short time, but importantly makes 'immediate knee-jerk' responses to changes inaccurate..

### Stage 2. Retreat

Proposers of the changes feel that maybe they have gone too far or start to see good things in the old ideas. Opponents retreat, usually deeply, into past ideas and commonly start to propose alternatives which are usually the old ideas dressed up in different words or in some other way. There is an element of doubt and at the same time some respond by searching. Emotions are starting to run high which leads automatically to Stage 3.

### Stage 3. Reaction

This is where supporters and opponents usually engage in inappropriate behaviour. Arguments rage, sometimes in media where they usually should not be. Polarisation is common. This is the time for letters to editors or politicians. This is the most inaccurate time to gauge the response to change but in view of the 'noise' and inappropriate behaviour, managers of change commonly intervene here or use the data from here for future decisions as much is available, but it is inaccurate.

### Stage 4. Acceptance

This is still a negative stage. The changes are accepted but there is usually no enthusiasm for them. Both sides have run out of energy or been hurt during Stage 3. Some questions still remain.

### Stage 5. Exploration

In this stage all parties start to explore the possibilities of the changes. As time progresses the changes expand and the features are confirmed by most. Fine tuning is starting to be suggested and maybe even accepted. However, this is not the time for good planning for the future either. It is a restricting time, but positive feelings are appearing.

### Stage 6. Challenge

Changes do issue challenges. In this stage the potential of the changes is acknowledged and the main feature of the changes start to have a real impact. Here also fine tuning and reviews take place but they are more visionary, less emotional, and well considered, but the impetus of the changes is not reversed.

Understanding the change process is important for all of us. It does not matter

whether we are proponents or opponents of change. Further, it does not matter whether we are charged with the administration of change or 'on the receiving end'. If we don't appreciate the six stages and allow the change process to work its course we usually end up with a low quality system.

One of the big mistakes that administrators and managers responsible for change make is to intervene and make further changes, usually backwards to 'keep the peace', at Stage 3. This has two major problems. One is this response starts the change process over again and keeps people in the stages where there is controversy and high emotions, not very effective at 'keeping the peace'. The second problem is that the change usually does not happen very effectively as the timing is all wrong, and mediocrity usually results.

Amateur radio has so much to offer the current participants and the future participants. Like much of life, it cannot operate in a changeless environment. The challenge for us is to educate ourselves in change, understand what we see as the change process works through, and importantly not to react in a manner and at a time which work negatively.

If I use a baby analogy of badly mixed metaphors. We can change the baby to a clean and comfortable one, removing the smelly or unwanted things, or we can throw the baby out with the bath water.



**Proposed new WIA  
Constitution see page 25**

ar

# In Charlie's way

A short story about a ham, his mates and the CW receiving exam

Ross Fraser VK2WN

## Part 1 –

### *Charlie's torment*

**C**OLIN WATTS sat staring at his desk and the old Kenwood high-frequency (HF) transceiver radio (sometimes impolitely referred to as a 'boat anchor') that sat silently just in front of him. Colin is a keen radio amateur and radio enthusiast but he was reluctant to turn his radio on this morning. His friend and fellow amateur, Charlie, had organised a sked for seven o'clock with Colin and some others but Colin wasn't keen to talk. Colin and Charlie normally had a QSO in the morning but Charlie was keen to let everyone know, especially Colin, about his exam result. Colin knew that Charlie would have news about the radio exam that he had just sat and he didn't want his friend to have failed. Charlie had sat for the morse code receiving exam four times previously and had been unsuccessful each time. Sometimes Charlie had got half way through his exam and the code seemed to take on an erratic and overwhelming nature. All he could do was just sit there, not writing just staring at his desk and partly filled out exam form and wishing he was somewhere else.

Colin wished he could make it easier for Charlie but he seemed to take each failure pretty hard. Colin has his 'full-call', or unrestricted, ham radio licence and Charlie was keen (desperate would be a better way of expressing it!) to get his. Quite a few years earlier Charlie had passed his morse code sending exam and was sometimes a bit annoyed that it had taken so long to get his full call. He knew he'd get it one day but he seemed to worry about it too much.

The radio desk and the Kenwood TS-520S that Colin had been staring at blankly started to come into focus as though it had just materialised in front of him. He reached up and switched the radio on and immediately could hear a

QSO a few kilohertz up the band. Colin adjusted the dial to tune in the stations and could hear Steve and George talking to each other. Steve was talking about his dog, Raptor, and how Raptor likes to chase birds and run around like mad, barking his head off but never seeming to catch any. Steve was sort of complaining but he loved talking about his dog and didn't really mind his annoying habits.

Colin flicked the heater switch on the '520S so he could join in on the chat and waited a few minutes before tuning up his radio. Colin was just about to wander off to the kitchen to make a cup of coffee when he heard Charlie break in to the QSO with Steve and George.

'That dog thinks it's a bleeding bird, Steve, that's the trouble with it,' said Charlie in his typical stirring manner.

Steve was always quick to give as good as he got and replied by saying: 'I'm surprised that you're up at this hour Charlie. Did the birds wake you?'

Colin decided that his coffee could wait so he sat down and waited for the right moment before breaking in to the chat. George was more of a gentle commentator than a stirrer so, when it was his turn to talk, said:

'If that dog of Steve's was barking round here at sparrow fart he'd be as popular as a fart in a space-suit'. George liked expressing himself in a manner that allowed for breaking wind to be incorporated in the conversation at least once every morning. George continued: 'But anyway, how'd you go in the exam Charlie?'

There was a pause and Colin breathed in deeply. Charlie spoke quietly: 'Well it was the best result so far,' said Charlie obviously wanting to be a bit dramatic. Colin hoped the news would be good. 'Aaaand' Steve said in a sort-of-agitated

manner wanting to hear the full story. 'I didn't get it' Charlie said straight to the point.

Everyone offered sympathy to Charlie, as they knew how much it meant to him to pass the exam. 'I'm sorry to hear that,' said George who'd sat eight times for the same exam before he finally got it.

Even Steve offered his best wishes and encouraging words to Charlie. Colin knew only too well how much this setback would mean to Charlie. He silently vowed to do what he could to help Charlie and boost his confidence. 'Let's face it', he thought to himself, many people had struggled with the exam and got through eventually. Eventually being the operative word, thought Colin as he smiled to himself remembering his own struggles.

'Oh well I'll just have to stay on eighty metres for a bit longer' said Charlie with a hint of pain in his voice, but then continued with 'but I'll get it next time'.

Everyone on the net offered support and encouragement to Charlie. Many had had similar struggles with the diddly-dahs so sympathised with Charlie's situation. He thanked everyone for their encouragement and kind words and then signed off the net.

Colin wished him well and said he'd catch up with him tomorrow morning. He felt sad for his friend and wanted to help him to feel better about the situation. Failing a morse exam is not the end of the world. He also wanted to help Charlie to get ready for the next exam. Colin knew that his friend could copy CW without any great trouble - except when he was in an exam. It seemed that Charlie suffered from 'exam fright' and also sometimes lacked faith in his own abilities.

***To be continued – Part 2 next month***

# Know your secondhand equipment

Ron Fisher VK3OM  
ronlyn@nex.net.au

If you think that heading sounds familiar, you're right. Back in the middle 1980s I wrote a series for *Amateur Radio* to look at a range of equipment that might have turned up in hamsheds at that time. A lot of that same equipment is still listed in advertisements. Which just shows how reliable that early equipment was, and still is.

However, times change and a lot of equipment has arrived on the market in the intervening years. Times have also changed with many amateurs now able to operate on the HF bands who were not permitted to in those far off days.

I have decided to start off this new series, therefore, with equipment at the lower price end of the range, the type of equipment that might be ideal for a "Z" call to become familiar with the HF bands before spending big money on a newer transceiver

## The Kenwood TS-520 and TS-520S HF Transceivers

It's easy to get these two mixed up, but the "S" on the 520S makes a very major improvement in performance.

However, let's look at the TS-520 first. Released on the Australian market in the latter part of 1974, it was Kenwood's answer to the very popular FT-101 series. It covered the usual HF bands of 80 through to 10 metres. There were no WARC bands in those days, so if you are looking for operation there, look further on. The circuit was solid state up to the transmitter final and driver stages that used a 12BY7 and a pair of 6146s in the final. A double conversion circuit was used with a first IF around 8.8 MHz and the second IF was at 3.395 MHz using a 2.8 kHz bandwidth crystal filter. An optional filter was available for CW.

In terms of performance, I have always considered that the 520 was better than the FT-101B which was the contemporary Yaesu offering. Solid state receiver front ends of this time left a bit to be desired. Receiver overload with

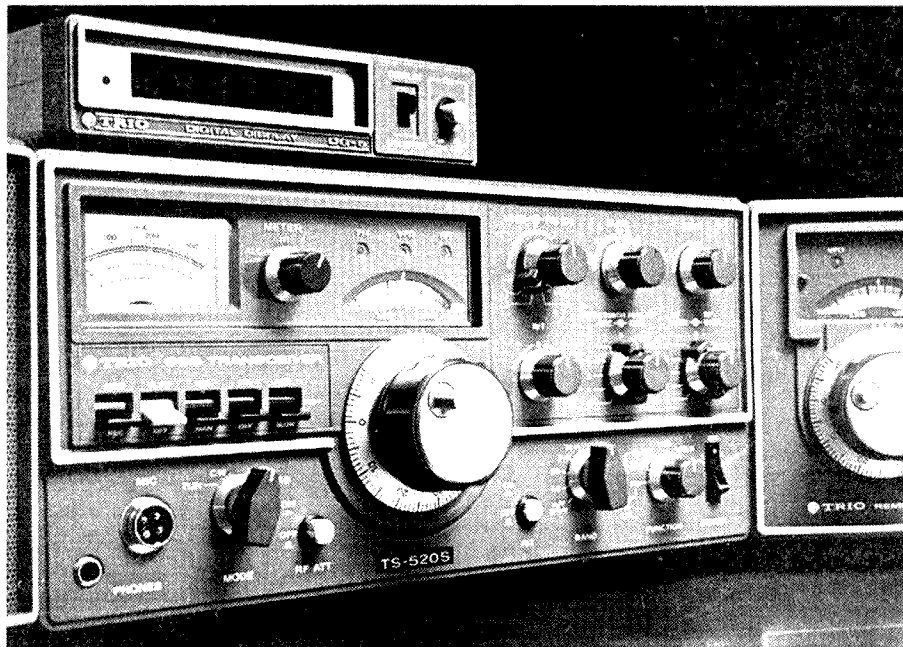

TS520S transceiver with the DG-5 digital display unit, and partial views of the external view and extension speaker.

strong signals was a common problem. In this regard, the 520 was the better of two, but still not perfect. Both transmit and receive audio quality were very superior to Yaesu and possibly this started the old saying that Kenwood transceivers sound better.

Some of the things that our new-to-HF-amateur will have to get used to are first the analogue frequency readout. If you want reasonably accurate frequency read-out you will need some practice in using the calibrator. Also, of course, tuning up the final stage needs a degree of skill. But more about this later on.

A range of optional matching accessories was available at the time. These include an external VFO for split

frequency operation, a matching speaker and, slightly later, a two metre transverter.

When new, the TS-520 sold for \$550. Secondhand value today for a clean unit in good -working order would be about \$175. However, after thirty years of use, finding a good one is not easy. So, on to the TS-520S that is easier to find and provides somewhat better performance.

## The TS-520S

This updated version of the original TS520 was released on the Australian market in late 1977. The price was \$650. Appearance was very similar to the old model, but with the dial area improved for better readability. The 160 metre

I hope to continue this series on a bimonthly basis. If you would like to see any particular piece of equipment reviewed, please let me know.

band was added but the DC power supply, which was a standard feature on the old model, was now an optional extra. The general receiver performance was much better. Available as an option was the DG-5 digital read-out, which was a very handy unit also able to be used as a 40 MHz counter. When used with the TS-520 it gave accurate readout to 100 Hz. Other options were an external VFO, and an extension speaker of excellent quality.

Secondhand value today is between \$175 and around \$250 for one in top condition. The matching DG-5 readout is very hard to find these days and I would suggest \$100 would be a fair price to pay for one in very good condition.

Finally, back to tuning up the final amplifier stage of valve transceivers. It is essential that this is done quickly. My method is:

1. Set the drive or pre-selector control for maximum receiver sensitivity.
2. Set the load control to the mid position
3. Select the tune or CW mode.

4. Set the final tuning to the centre of the band chosen.
5. Increase drive and rotate the final tune and load controls for maximum power output as indicated on your SWR or power output meter.

All of this should take no more than about five seconds. If the finals in your

TS520 or TS520S are in good order you should see at least 120 watt carrier power which will equate to about 140 watt PEP.

Both of these transceivers make an excellent start for a newcomer to HF operation.

## UA2 QSL Bureau

On the 6th December 2003, during UA2 annual meeting, we decided to start our own incoming QSL bureau.

This means, we stop getting incoming QSL cards from SRR QSL Bureau in Moscow (P.O.Box 88). The new address is: UA2 QSL Bureau, ROSTO Technical School, ul.Ozyornaya 31, Kaliningrad, 236029, Russia.

Kindly please update your QSL bureau address book and from now on

send all QSL cards for UA2 only to the address above. Otherwise, we won't get them.

We rely on your understanding and look forward to our cooperation.

Thanks and 73,

Victor Loginov, UA2FM  
UA2 QSL Bureau official  
ua2fm@gazinter.net

# G&C COMMUNICATIONS

Authorised dealer for ● Kenwood ● Icom ● Barrett RFDS ● GME Electrophone ● Uniden ● YAESU

## KENWOOD

### TH-F7E Amateur VHF/UHF Transceiver

Freq: TX: 144-146 / 430-440 MHz  
RX: 0.1-1300 MHz  
Mode: TX: FM RX: AM/FM/SSB/CW  
RF Power output: Hi: 5/5 W  
Lo: 0.5/0.5 W El: 50/50 mW  
Volt: Int: 5-7.5 VDC External: 12-16

Weight: 250 gr (inc lithium-ion batt. pack)

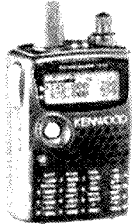

**TM-D700A dual bander APRS, GPS and SSTV technologies.** Built-in TNC, AX.25 protocol. Send and receive SSTV images using Kenwood's optional VC-H1. The TM-D700A makes the most of APRS - Automatic Packet/Position Reporting System. Wideband receive 118 MHz to 1.3 GHz (cellular blocked). Includes MC-53DM DTMF backlit hand mic.

● Australia-wide orders welcome  
Credit card, cheque, Money order

207 High St. Cranbourne VIC 3977  
Ph: 03 5996 3298 Fax: 03 5995 01 84

## ICOM

### IC-208 Amateur VHF/UHF Transceiver

Freq: TX: 144-146 / 430-440 MHz  
RX: 118-1000 MHz  
Mode: TX: FM RX: AM/FM  
RF Power output:  
Hi: 50 / 50 W, Mid: 15 /  
15 W, Low: 5 / 5 W  
Voltage: 13.8 VDC  
Weight: 1.2 Kg



### IC-910H Amateur VHF/UHF Transceiver

Freq: 144-148 / 430-440 MHz 1240-1300MHz  
Mode: FM/FM-N/SSB/CW  
RF Power output: 5-100 / 5-75 W  
Volt: 13.8 VDC Imp: 50 ohms, SO-239 / N  
Dimensions (W\*H\*D): 241\*94\*239 mm

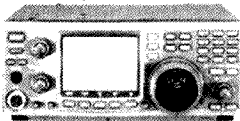

Most popular mono-banders  
TE series EMTRON HF ANTENNAS  
Storm tested - Call

## YAESU

### VX-7R 5 W Ultra-Rugged, Submersible Tri-Band Magnesium Handheld

Freq: RX: 0.5 - 999 MHz  
TX: 50, 144, 430 MHz Amateur Bds  
True Dual Receive: V-V/U-U/V-U/  
GEN-HAM  
Power Output: 5 Watts 222 MHz:  
300 mW) 6 m AM: 1 W— MANY GREAT FEATURES



### FT-897 Multimode high-power base/mobile transceiver

Freq: RX: 100 kHz-56 MHz, 76 MHz-108 MHz (WFM only) 118 MHz-164 MHz 420-470 MHz TX: 160 - 6 m, 2m, 70 cm Amateur Bands: SSB/CW/AM/FM/FM-W/Dig.Modes 100 Watts Power Output (HF/6 m); 50 W (2 m); 20 W (70 cm) Opt. Int. Batteries: 4800 mAh x 2 Built-in - Digi.Signal Proc. - 3-Message Memory Keyer - VOX - AF Speech Processor. MANY MORE GREAT FEATURES



## FT-817 compact fast charger

In *QST* for November 2003, Phil Salas, AD5X describes a compact fast charger for the battery pack in his FT-817.

Whilst the internal NIMH battery pack in the FT-817 can give several hours enjoyable operation, even at 5 watt, the subsequent 20 hours of charging time using the internal charger can be a little tedious. One part of the solution was to install the One Plug Power (OPP) by W4RT Electronics ([www.w4rt.com](http://www.w4rt.com)). The OPP provides an 1800 mAh NiMH battery pack along with a new battery cover that includes a 2.1 mm x 5.5 mm charging jack. This jack allows the use of an external fast charger, without having to remove the batteries from the radio.

All that is needed now is a suitable fast charger. The FT-817 is part of a compact, portable kit, including all accessories. As most of the fast chargers available had mains input and therefore were too big and heavy to fit into this kit, a better solution was needed. Since 13.8 V dc was already available from the ac supply that was part of the kit, the charger could use this or any other source of 13.8 V as a source, making it much more compact.

### Silent key

#### Dietmar (Don) Grigoleit VK3NQ

Don died suddenly on Saturday 14th February 2004 at Loch Sport, Victoria.

Don was first licensed many years ago and some ten years ago took over VK3NQ on the death of a friend.

He had a number of regular skeds and when I was on holidays at Lake Sport, I spent many pleasant hours sitting in his shack listening to these skeds.

I am not a radio amateur so this is my only way of letting his friends know of Don's passing.

Condolences to his wife Jutta.

Good bye dear friend.

Wilhelm Hirsch,

17 Southwell Avenue, Newborough, Vic 3825

The compact charger is built around the Maxim MAX712/713, Fast-Charge Controller IC. Either MAX712 or 713 can be used with the NIMH batteries. These are very versatile ICs that permit fast charging of many different types of battery packs (NiCd, NIMH) with many different voltages. In this case, the 8 cell, 9.6 V NIMH battery-pack used in the FT-817 was of interest, which results in a very simple circuit.

The circuit shows the final design. The fast charge current is about 600 mA, and it will charge a depleted pack in 3 to 4 hours. It is also designed for a time-out of 4.4 hours. This controller automatically senses when the battery is charged and switches to trickle. The green LED is just a 'power' indicator. The red LED is on during fast charge, and turns off when the charger is in the 'trickle' mode.

The MAX712/713 is available from

Farnell plus possibly some other suppliers around Australia. All other components should be available from the usual suppliers. All resistors are 1/4 W. You can download the IC data from the Maxim website ([www.maxim-ic.com](http://www.maxim-ic.com)) for other charging conditions or number of batteries.

The entire charger was built into the smallest plastic enclosure possible, with a metal cover. Most of the parts are mounted on a piece of perforated board, using point to point wiring methods. The TIP32 transistor must be mounted to the metal cover to dissipate the heat during the high current charging. The enclosure has a 2.1 mm dc socket for the 13.8 V input. The output is on a flying lead with a 2.1 mm plug that plugs into the OPP 2.1 mm socket.

This charger can be also used with other battery packs, depending on how you may wish to adapt and access them.

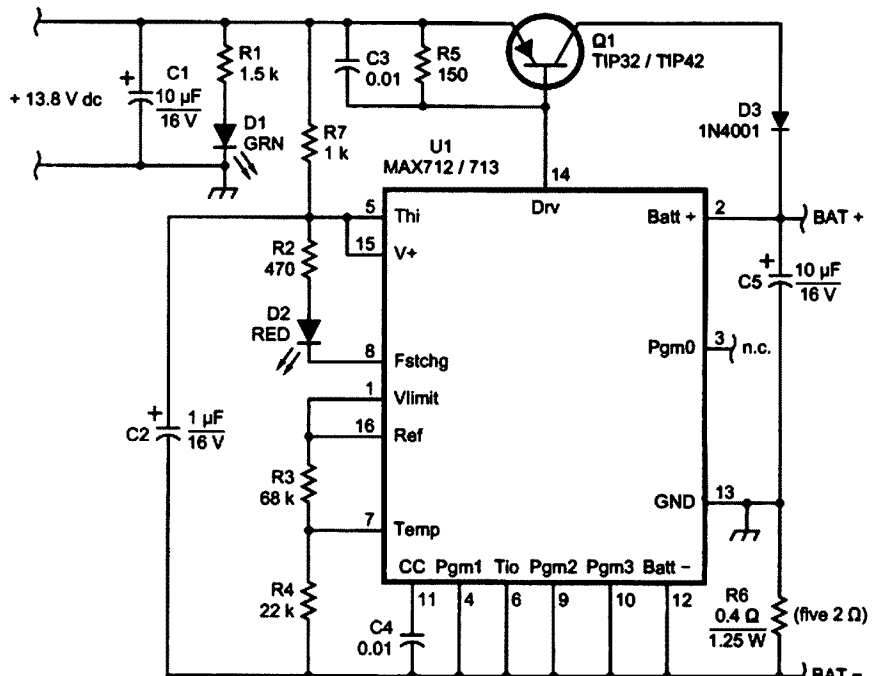

Except as indicated, decimal values of capacitance are in microfarads (µF); others are in picofarads (pF); resistances are in ohms; k = 1,000. n.c. = No connection

## Solid-state those pilot lamps

Recent years have seen development and introduction of relatively inexpensive ultra bright white LEDs.

Phil Salas, AD5X in 'Solid State Those Pilot Lamps' (QST September 2003) describes his experiences in replacing the incandescent lamps in a number of the old style 'boat anchor' radio equipment.

The common types on lamps used in the old equipment used #44 or #47 pilot lamps that normally operate at voltages of about 6 V ac while consuming up to 250 mA each (1.5 watt). As well as these lamps having limited life, they are also often in hard to reach locations and the relatively high heat output of such lamps in confined spaces such as dials and meters contributes to their discolouration over a period of time.

AD5X notes that the prices of the ultra bright lamps have dropped significantly recently and can be up to three times brighter than the incandescent lamps found in the old radios. However, this light is directional and they have to face forward to achieve this brightness.

Most ultra bright LEDs have a normal operating current of about 20 mA. Remember that LEDs are diodes, so they rectify the ac voltage if being run on AC and that LED polarity doesn't matter. If being run on dc, polarity does matter and the anode of the diode has to go to the positive side of the supply voltage.

The value of the series resistor to provide suitable diode current depends on the colour of the LED, if you wish to use other than white. Suitable resistor (R) values for 20 mA/6.3V ac are: White (4V) 82 ohm; Green (3V) 120 ohm; Amber (3V) 120 ohm; Blue (3V) 120 ohm; Red (2V) 160 ohm. If the LED is going to be run on DC, use Ohms law to calculate the correct value of R.

If the LEDs are for retrofitting into old equipment, it is easiest to build the resistor LED combination into old discarded lamp bases, which can then directly replace the old lamps.

AD5X prepares the lamp base as follows:

- Put on safety glasses

- Wrap the pilot lamp in a small plastic sandwich bag and gently crush the glass part with pliers
- Using the pliers, gently squeeze and rotate the base. This should break the remainder of the glass and cement in the base. When complete, ensure that the base is as round as possible.
- Shake out the glass, and then use a solder sucker or wick to remove the solder from the tip of the base.
- Using needle nose pliers, pull the remaining pieces of bulb and wiring out of the base. If necessary, use the solder sucker or wick to clear out any remaining solder.

Using 1/4 W resistor and a 3000 mcd white LED, the new lamp is assembled as follows;

- Cut one lead of the resistor and one lead of the LED to 3mm.
- Overlap these short leads and solder together.
- Bend the remaining LED lead over and up.

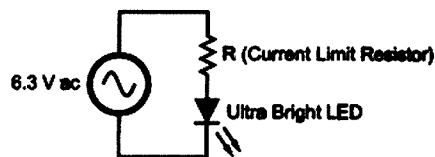

- Insert the long resistor lead through the hole in the base until the body of the resistor bottoms out on the base.
- Solder the resistor lead in place
- Solder the bent up lead of the LED to the side of the lamp base.
- Optionally, fill the lamp base with Epoxy or hot glue to give it some stability.
- Clip off excess lead lengths.

Fitting the LED decreases current drain by at least a factor of ten, and significantly increases reliability. In most cases, the light output will also be noticeably higher.

Suitable LEDs should be available from all of the usual suppliers in Australia.

ar

## Can you help?

### Envelopes with stamps from East Timor

Michael Kalka, P.O. Box 866, Tullamarine, 3043 wrote to me recently asking assistance in his search for whole covers or envelopes with stamps from the UNTAET period in East Timor April 29th 2000 to May 20th 2002.

Apparently only two stamp denominations were issued in this

time and they are hard to find. He was wondering if any Amateurs had received correspondence, (possibly QSL cards) from East Timor during this period. If they still had the envelopes and were willing to part with them Michael would be delighted to hear from them and negotiate a purchase.

Colwyn VK5UE Editor



# Just how old is the direct conversion receiver?

Steve Mahony VK5AIM

The QRP enthusiast has adopted the direct conversion receiver as his/her pet! With the advent of the mixer IC - most recently the NE602 - along with suitable audio ICs, this small, simple receiver requiring little electrical power has become very popular.

An article in *Wireless World*, June 1995, by Tom O'Dell makes interesting radio (wireless) history reading. Under the title "Whose Heterodyne?" he discusses and describes attempts by several experimenters to improve 'wireless reception' at the turn of the century. John Erskine-Murray is credited with first use of the term 'heterodyne'. Professor R. A. Fressenden had patented an electrodynamic telephone receiver in 1913. The patent describes the idea of producing a beat frequency, but from the description it is unlikely that it would work at radio frequencies!

Rudolph Goldschmidt of Berlin submitted a patent for a mechanical (yes, mechanical!) high frequency alternator mixer in 1909. According to the circuit the CW signal was fed from the aerial (not an antenna) to an input circuit, L-C tuned to the desired frequency  $F_s$ . The signal passed to a 'sound wheel' or commutator, similar to that in a DC motor, of 800 segments running at 3,750 rpm. A pair of headphones were connected from the opposite contact of the commutator. See Fig. 1 "Mechanical Mixer".

The action of the commutator as a mixer is explained in the following way.  $F_o$  is the oscillator frequency = number of switching events = 3750 rpm X 800 = 3,000,000 per minute (50 kHz), If  $F_o$  equals  $F_s$  signal frequency, then nothing would be heard in the headphones. See the chart marked " $F_o = F_s$  NO AUDIO OUTPUT". But if the speed of the commutator was increased or decreased, then a 'beat' or difference frequency would be heard. See lower chart, marked " $F_s - F_o =$  AUDIO OUTPUT FREQUENCY", where some significant parts of one audio output cycle are shown.

A Direct Conversion Receiver! Remember, we then had CW on a very low frequency, at kHz rather than MHz.

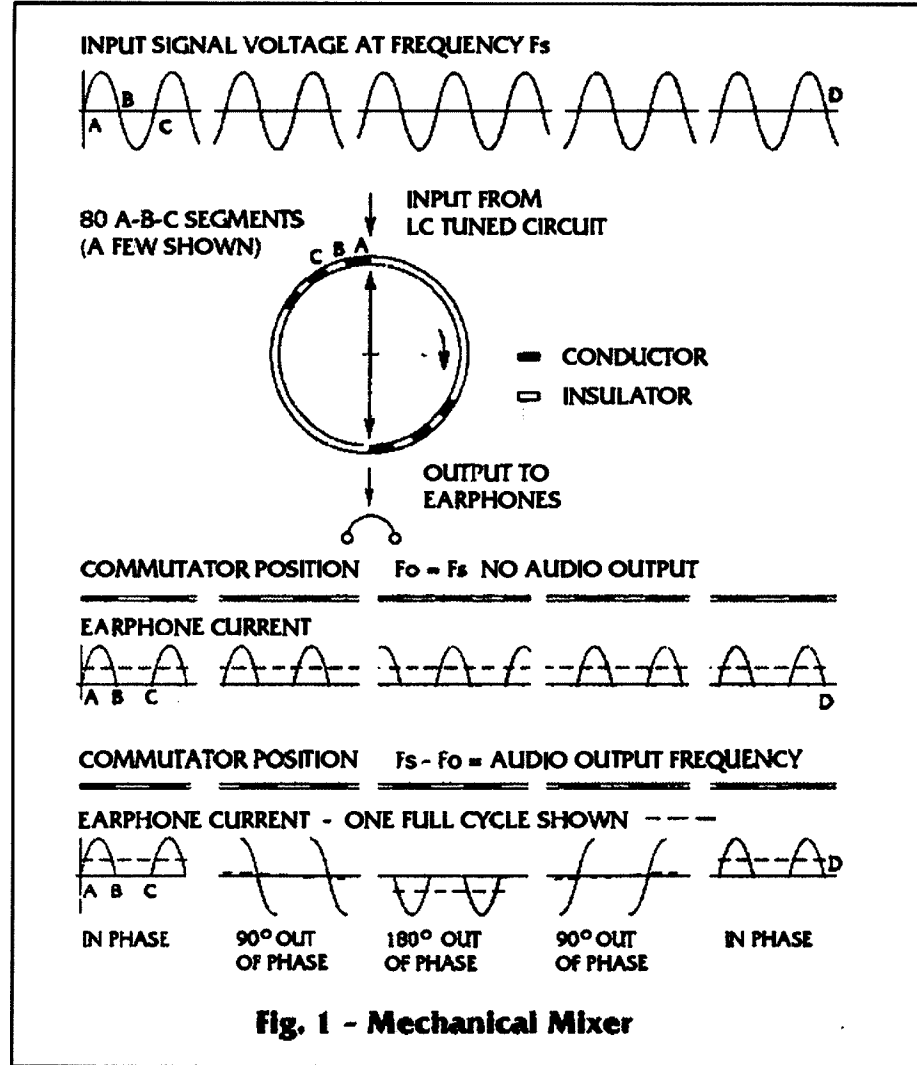

Fig. 1 - Mechanical Mixer

Remember also that we had mechanical rectifiers in the form of commutators and vibrating contacts long before we had solid state rectifiers.

A little later, Mr. Goldschmidt's system was modified to use a crystal detector as a mixer.

At about this time the Navies of the world were becoming very interested in this 'wireless' so as to be able to communicate with their ships at sea. Up

to that time, once a ship was out there on the deep blue sea, the crew were 'on their own'!

In 1913 the American Navy carried out some experiments to communicate with the vessel USS Salem on its voyage across the Atlantic, with 35 kW arc and 100 kW rotary spark transmitters located at Arlington in Virginia. On board the Salem were installed three different types of receivers for comparison testing.

## The revolutionary VK4VKD

# One Man Tower

## Freestanding Self-erecting 10m to 25m



Fully adjustable delta loop rotatable antenna  
1-2-3-4 element

D.I.Y. delta loop element to boom 'hubs'

350kg SWL 5:1 braking winches

Galvanised steel boom to mast clamps

VHF and UHF beams

High tensile 'U' bolts

Safety harnesses for above ground work

Arrays easily taken to ground level for maintenance and wind protection

Easily erected without cranes

(ideal for confined areas or

remote repeater sites)

proudly built in Australia by

**Australian Enterprise Industrial**

Unit 1/34 Tradellink Avenue

Hillcrest QLD 4118

(PO Box 1013 Browns Plains QLD 4118)

<http://homepages.ihug.com.au/~aitower>

[aitower@ihug.com.au](mailto:aitower@ihug.com.au)

Tel: 07 3800 0551 Mob. 0414 254 080

Fax 07 3800 8003

On board the US vessel as an observer was an English Naval Officer, Captain Willis RN from HMS Vernon.

Captain Willis' report says that the Heterodyne receiver was a crystal receiver with an oscillator loosely coupled to the receiver.

This Local Oscillator had to be placed as far away from the receiver as possible. Some difficulty was experienced due to the separation - the person tuning the oscillator could not hear the result at the receiver. Imagine having someone tuning the VFO 15 to 20 ft away from the receiver! Many hand signals would have to be given by the listener: 'up a bit', 'down a bit', 'too far' and a final nod of the head when it was correct!

According to Captain Willis this oscillator was a 100 W rotary arc! A bit like a Regenerative Receiver - you would bear the rec/osc better than the transmitter!

In his report to the Royal Navy Captain Willis said that he thought the system might work if the local oscillator was enclosed in a lead-lined room, to control the amount of oscillation mixed into the detector. Who amongst you put the VFO

for a DC Receiver in a tin box?

The article goes on to say that more experiments were carried out with the Heterodyne Receiver in the USA, UK and Europe, but the invention of the thermionic valve, diode and triode with its amplification enabled the TRF receiver, along with the valve oscillator for the transmitter, to be built and left the heterodyne behind on the path of technical development of radio.

It took Mr. Armstrong, who probably obtained and studied all of this information, to come up with the 'superheterodyne' we all know today.

So when you wire up your NE602 IC and associated components, you are not doing something new! Think of those early Amateurs who did it first, almost a century ago!

## Reference

*Wireless World* 'Whose Heterodyne?'  
T. O'Dell June 1995 p.496.

Reprinted from *Lo-Key* #52 December 1996

## Harry Angel Memorial Sprint

Friday 23 April, 2004

see page 50 this issue

# Cable and Connectors

**Belden**

- RG58C/U Belden 8259 @ \$0.90 per metre
- RG213/U Belden 8267 @ \$4.45 per metre
- RG8/U Belden 9913 Low Loss @ \$5.15 per metre
- RG8/U Belden 9913F7 High Flex Low Loss @ \$5.55 per metre
- RG8/U - RF400 Belden 7810 Low Loss Sweep Tested to 6000MHz @ \$6.30 per metre

**LINK**

- RG58: B80-006 UHF connector (M) @ \$7.65 each
- RG8/213: B80-001 UHF connector (M) @ \$8.80 each
- RG213: B30-001 N connector (M) @ \$9.10 each
- RG8: B30-041 N connector(M) @ \$14.00 each

**connektron** Pty Ltd

ABN 19 413 484 007

small sales@connektron.com.au or Phone (03) 9761-5220

connektron Pty Ltd, 45 - 49 Merrindale Drive, Croydon South, Victoria 3036

[www.connektron.com.au](http://www.connektron.com.au)

\* All prices include GST

\* Minimum order value \$50 payable by Visa, Mastercard, Bankcard or Money Order

\* Packing and Delivery \$15 within Australia (Outside Australia P.O.A.)

# Traps for multi band antennas

Lindsay Lawless VK3ANJ

Coaxial cable coiled on a plastic former is a popular form of "reactor circuit" trap for multi band aerials. The idea was first introduced to amateur radio by R H Johns in his paper published in QST May 1981. That paper was followed by several others giving construction ideas and methods but very little theory to assist designing from basic. This paper hopes to correct that deficiency.

The coiled coax and in fact any coiled twin conductor can simulate a transformer i.e. two coupled coils between which there is mutual inductance M and inter-wiring capacitance C. If the coils are connected series aiding the total inductance is,

$$L1 + L2 + 2M = La$$

If connected series opposing the total inductance is

$$L1 + L2 - 2M = Lb$$

The series aiding connection is the connection used for trap rejectors. That connection by transformer action (turns ratio = 2) multiplies the inter turns capacitive reactance by four. Thus the combined series aiding mutually coupled coils become an effective rejector circuit with inductance La and parallel capacitor C/4

The easy way to "design" a coaxial trap is to wind a reference trap (N turns) of sample cable on to a plastic plumbing pipe and measure the self resonant frequency (Fr) with a dip oscillator or Q meter. My reference trap is 6.5 turns of RG 58 on a 42 mm diameter plastic pipe; the coil length is 40 mm. The self resonant frequency is 11.7 MHz. The turns required on the same diameter former for traps for other frequencies are approximately:

$$Nr = (11.7/F) * N \text{ if } F \text{ is less than } 11.7 \text{ MHz}$$

$$\text{or } (F/11.7) * N \text{ if } F \text{ is more than } 11.7 \text{ MHz.}$$

Analysis of that reference trap with calculations based on dip oscillator measurements produced the following results;

$$\text{Outer conductor inductance} = 1.8 \mu\text{H}$$

$$\text{Inner conductor inductance} = 2.0 \mu\text{H}$$

$$C = 96 \text{ pF}$$

$$L1 + L2 + 2M = 7.7 \mu\text{H}$$

$$M = 1.95 \mu\text{H}$$

$$\text{Coupling coefficient } k \sim 0.97.$$

The justification for the above logic is contained in the relevant sections of the 80th edition of the ARRL Handbook and

the sixth edition of the RSGB Radio Communication Handbook. Note: Contrary to some opinions it is possible to measure the coax inner conductor inductance by dip oscillator method.

Coax cable traps are popular but the same principles apply to any twin conductor cable; I have made traps from figure 8 OFC speaker cable, a pair are now being weather tested on my 80/20 inverted Vee dipole. The characteristics of my reference figure 8 trap are;

6.5 turns on a 42mm diameter former  
Resonant frequency = 14.9 MHz

L of each coil = 1.8μH

C = 64pF ... (16pF effective)

L1 + L2 + 2M = 7.1 μH

M = 1.75 μH

k = 0.97

Armed with the measured values of L, C, M and k it is possible to design traps using any twin conductor cable and also other applications of the same principle such as balanced to unbalance transformers (baluns), variable inductors and etc. Many applications of the simple principle appear in the technical literature using "buzz word" names to disguise the fact that they are applications of basic principles dating back to the beginnings of radio technology.

Details of the traps constructed by VK3ANJ are:

Cable - twin 64/012 OFC conductors ex salvage bin (nearest equivalent DSE part No.W2016)

20 metre trap - 6.5 turns close wound on 42mm. OD plastic pipe.

40 metre trap - 14 turns ditto.

Trap construction ideas can be found at Fig.20.26 of the ARRL handbook 2003 edition and at section 7.9 of the ARRL Antenna book 18<sup>th</sup> edition.

## Other references :

Paul Duff VK2GUT : Amateur Radio October 1993

Tech Correspondence : QST August 1985.

## Australian Made ANTENNAS

### "Setting a New Standard" COM-AN-TENA

(Formerly a J and J coman)

6 Muir Court  
CHELSEA HEIGHTS 3198

All new 5/8 vertical 16 radials	\$160
Dual drive 26-30 5 ele yagi beam	\$315
4 ele 10-11m yagi beam	\$278
5 ele high gain antennas 11m	\$327
3 ele delta loop 10-11m	\$326
11m 5/8 vert./4-1/4 wave radials	\$175
Duoband 10-15 3 ele each band	\$385
Tri-band 5 ele HB35C s/steel fix	\$730
3 ele 20m computer opt	\$420
3 ele 15m computer opt	\$295
M B Vert Auto switch 10-80m	\$330
40m linear loaded 2 ele beam	\$595
6m 5 ele compt opt beam	\$268
6m 7 ele compt opt beam boom - 60mm	\$387
10 ele high performance 2m	\$145
17 ele high performance 70cm	\$125
2m vert 2-5/8 co-linear 4 rad	\$120
Log-periodic 9 ele 13-30 MHz 7.7m boom	\$990

## Guyed Masts

21 metres                      13 metres  
Winch-up & tilt-over. Aluminium and stainless steel three-sided construction. Auto-brake winches.

## Free Standing Masts

9.5 metres  
New Baluns  
1-1 to 16-1 to 3kW

### Our Masts

meet

Australian Standards.  
We supply all the computations and data you will need for a permit.



**03 9773 3271**  
**Mob: 0419 542 437**  
Andy VK3IV

Christine Taylor VK5CTY

vk5cty@vk5cty or geencee@picknowl.com.au

## The bad news first

The results of the ALARA Contest in August were so bad (only 6 logs were submitted though more people actually participated) the committee decided not to award the usual certificates. The Florence McKenzie Trophy was won convincingly by Pat VK3OZ – for the third year in a row!! Pat also had the highest overall score last year for which she was awarded a certificate. Well done, Pat. Perhaps we knew something when we physically gave the Trophy to Pat, in Murray Bridge in 2002.

The Florence McKenzie trophy is rather large so the usual practice has

been to send a certificate with a photo of the trophy, rather than the actual trophy, to the winner. For many years the actual trophy was on show in a glass case at the Burley Griffin Building in Adelaide. However, with the amalgamation of district councils which took place several years ago, the WIA(SANT) lost the Burley Griffin Building as a headquarters. Until a new permanent home is found we are glad to know the trophy is on display in the home of one of the most successful winners.

Other than the Florence McKenzie

Trophy and the winning score certificate, only one other certificate was awarded, to Mavis VK3KS for her all CW score. We were pleased to hear Mavis participating in the ALARA Contest again. For many years, Mavis and her OM Ivor VK3XB were very regular participants but it is more difficult for Mavis to operate her radio in her current QTH.

HINT: If we do not have a better response all round next year the ALARA Contest may cease to be. This would be a shame as it has been running since 1981.

## ...and the good news

Well, for most of Australia the drought has broken – with a vengeance if the pictures shown on TV recently of the downpour in Brisbane were anything to go by. Summer is here which always makes us feel more cheerful and, so far, there have not been any bad bushfires. (Hope this doesn't jinx us). There are some new voices on the HF bands now that CW is no longer required as an examination subject.

## Christmas

Some of us had more interesting than usual Christmases. Bev VK6DE went on a cruise to Antarctica for her Christmas treat. Dot VK2DB had a sad Christmas though. One son, with his wife and daughter (Dot's first grandchild) moved to VK4 on Christmas Eve and another son started packing up his room preparatory to moving out, on Boxing Day. Not a Christmas Dot (or John) will remember with joy.

For your correspondent Christmas was just the lead-up to the celebration of her Golden Wedding at the end of January. For a number of VK5 amateurs including Jeanne VK5JQ Christmas was only the prelude to operating the radio room for the 5,000 scouts attending the Jamboree in VK5. If you heard VK5BP during January they were probably there.

## Lunchtime problems

In VK3 where they decided to reduce the number of luncheons to occur only on alternate months, January presented a problem. When a couple of the YLs who travel a long way to attend, decided not to go to the city that day, several other regulars agreed to 'give it a miss' this time. However, there are one or two VK3 YLs who like to meet the others whenever they are in Melbourne. One of these planned to come in January but when she heard that there was not to be a meeting, she was disappointed but understood. How do we all let each other know what we are planning? Somehow the 'communicators' do not always communicate.

In VK5 the problem has been different. The venue used for the last three or four years has changed hands and the service is not as satisfactory as it was. So a new venue was chosen. There was a rush to inform the regulars of the change and a couple of us waited at the old venue – just in case. All OK. The new venue was also OK as far as food and cost were concerned BUT then there was a

glitch, as a consequence of which we decided to change venues once more. Let us hope that the February luncheon will be just right! We will meet on 13<sup>th</sup> February at the "Duke of York Hotel" in Currie Street.

In VK6 they do not have any problems. They still meet on the LAST THURSDAY of each month (except December) in the same hotel in North Perth.

Please get in touch with the State Rep or one of the local YLs if you are going to be in any capital city (or in some of the country towns where we are represented). It is often possible to arrange a lunch or visit. We would love to welcome you and show you "why we live where we live" to quote a well known radio program.



A VK5 ALARA Luncheon

## Adelaide Hills Amateur Radio Society

The Christmas Dinner was enjoyed by all. There were about 60 present. The highlight of the evening was the announcement of the "AHARS Amateur of the Year". This year the recipient, John VK5EMI, received the inaugural Denis Grieg Shield as a permanent reminder of the honour.

The Denis Greig Shield was presented to John by Denis' widow, Rosalind, in memory of Denis VK5PC who became an SK during 2003, and is to be an annual award. The names are to be engraved on the Shield and the recipient to have a replica.



John VK5EMI, winner of the inaugural Denis Grieg Shield for AHARS Amateur of the Year

In January, as we cannot use the school hall, we meet at the home of one of the members. This year we went to Myponga, to the home of two members who joined in 2003, Robin VK5ATT and Carol VK5KEY. It was rather cooler than usual for January in VK5 but this did not dampen the enjoyment of those present. The company was good, the barbecue was good and the view (360°) was magnificent. The house overlooks one of our beautiful reservoirs and is high enough that you can see the sea in one direction and the rolling hills in the other.

Some of us went for an invigorating walk. As you go downhill in all directions from the house, you finish the walk coming up hill. Definitely invigorating! Others inspected the contents of the very large shed or the radio shack. There was plenty to see everywhere. Thanks to Robin and Carol for an enjoyable evening.

Our President, Geoff VK5TY, had a special end-of-January. On 24th he



"Australia Day acknowledgement for Geoff Taylor VK5TY, who was named as "Citizen of the Year" for the City of Unley, for his efforts over more than 40 years in teaching amateur radio courses. Geoff is on the right."

celebrated his 50th Wedding Anniversary with family and friends, then on 28th he was presented with a certificate as "Citizen of the Year" for the District of Unley in which he has lived for over 70 years. As this Australia Day ceremony was close to the date of the party some of his interstate family were able to be there, along with a number of friends from within the amateur community.

As this recognition was largely due to Geoff's activities within amateur radio he feels that he represents all of us. Congratulations Geoff, from all your friends and from all the members of AHARS.

ar

## ALARA continued

### Congratulations

Deb VK5JT had a book of poems published at the end of 2003. Deb has been studying and writing English for a number of years as has been reported here, previously. To have a book published is a very satisfying result of all the hard work.

We hope this is just the first of many books, Deb. Our sincere congratulations to you.

### A sad occasion in North Queensland

In January 2004 Ann VK4MUM became an SK. She had been battling cancer for some time but eventually it won. Ann has been a stalwart of the Townsville ARC and a long time member of ALARA. She will be sadly missed. Our condolences to her family and friends.

### Don't forget to apply for your QSL cards

If you made contact with VK9XYL or VK9CYL in October 2003 do send your QSL cards to the QSL manager, Gwen VK3DYL for confirmation. Gwen, Elizabeth VE7YL and June VK4SJ were disappointed to only make 4,000 contacts during their time on Christmas Island and Cocos Keeling Islands but the QSL cards will be valuable to you towards your DXCC Award, or just because they are unusual.

Give Gwen something to do.

# Signor Marconi's Magic Box: How an amateur inventor defied scientists and began the radio revolution

Dr John Dawes VK5BJE

Gavin Weightman (2003), Harper Collins, London.

ISBN 0-00-713005-8; 312pp. Hardback, A\$32.75

Aspects of the life of Guglielmo Marconi have featured in *Amateur Radio* in recent years – see Ken Matchett's (2002/2003, pp. 32, 33) article about the call sign 2MT used by Marconi's Wireless Telegraph Company from February 1922 to January 1923. A mini biography of Marconi by Wolf Harrant (OE1WHC) (translated from the German by Ken Matchett, VK3TL) also appeared in *Amateur Radio* (1999, pp. 12–14). On page 15 in the same journal there is a one page extract from an article by Marconi that was published in the *London Magazine*, March 1902.

I have a QSL card in my collection from VK2IMD (International Marconi Day) confirming my contact on 23rd April 1994 on the 40 metre band with this station established to commemorate Marconi's achievements. The card especially celebrates the first direct wireless message transmitted from the United Kingdom to Australia on 22nd September 1918. Marconi transmitted the message himself for the Australian Prime Minister, Mr Billy Hughes, who was visiting his place of birth in Wales. As well many of us have built and used Marconi antennas for use on our high frequency bands. Orr and Cowan (1972, p. 92) describe the Marconi antenna as 'the simplest, least expensive and often most practical antenna for multi-band operation...'

So who was Guglielmo Marconi and why is he such an important figure in 20th Century history? Weightman's (2003) book is a substantial, sympathetic and gripping account of the brilliant and perhaps slightly eccentric Marconi. The book, of 44 lively chapters, also includes 16 pages of splendid historic photos of Marconi and key events in his life (25th April 1874 to 20th July 1937). The author begins his account of Marconi in 1896 as a 22 year old man travels with an older man to Toynbee Hall in London. The older man, William Preece, was Chief Electrical Engineer of the British Post Office. He gave a public lecture while the younger man, Marconi, demonstrated his wireless telegraphy equipment. This early patronage of

Marconi helped establish his reputation in England. Preece was, however, sceptical of Marconi's use of Hertzian waves for telegraphy (p. 26), perhaps as a result of the Post Office's investment in extensive underground cabling for that purpose. Preece through his invitation to a German scientist, Professor Adolphus Slaby, to be present that evening unwittingly enabled the Germans to benefit from Marconi's work, just a little over a decade before the Great War.

Weightman is an established author with a number of books to his credit. He makes no claim to being a wireless enthusiast but he writes with humour and a sense of history. He points out that young people today who send text messages using mobile phones are using wireless technology – but that they were all beaten by Queen Victoria who received and responded to a text message on 8th August 1898 (p. xvii, p. 39). 'Very anxious to have cricket match between *Crescent* and Royal Yachts Officers. Please ask the Queen whether she would allow match to be played at Osborne. *Crescent* goes to Portsmouth Monday'. The message was sent from the Royal Yacht *Osborne*, off the Isle of Wight, to a receiving station in the grounds of Osborne House. 'Queen Victoria's reply was tapped back across the sea: "The Queen approves the match between the *Crescent* and the Royal Yachts Officers being played at Osborne".'

As a social worker/criminologist I

chuckled at Weightman's telling of the story of the first use of wireless telegraphy to bring about the arrest of a fugitive. The *Montrose* was crossing the Atlantic in July 1910. On board was a Mr Robinson (p. 231) who engaged the captain in conversation about the merits of wireless telegraphy. While on board Robinson was changing his appearance by shaving off his moustache and growing a beard. Mr Robinson was travelling with his son, aged 20, who was described as being in poor health and they were intending to travel to California to a more helpful climate.

Before departing from Antwerp, newspapers carried stories of a hunt for a murderer, an American, called Crippen (p. 231). Crippen had killed his wife previously telling his friends and acquaintances that she was unwell. He placed a notice in the newspapers that she had died in California. However, his friends became suspicious of Crippen and the police became involved. But before their investigation was complete Crippen disappeared. After a few days as sea the captain became suspicious of Crippen AKA Robinson. Wireless telegraphy was used to alert the authorities and he was arrested by a Canadian police officer upon arrival of the ship in Canada.

Weightman tells this story masterfully and builds the tension sentence after sentence. He concludes by advising that film director Alfred Hitchcock used

Continued on page 41

## Discussion papers



# Looking Ahead

**The WIA Federal Convention and Annual General Meeting will be held in Brisbane on 2<sup>nd</sup>, 3<sup>rd</sup> and 4<sup>th</sup> April 2004 and will consider a proposal to restructure the WIA.**

Currently, every member is a member of a "division", representing a state or territory. The proposal is to convert the present federal body to a single national body, with every member becoming a member of that single national body.

That proposal suggests the adoption of a new Constitution to replace the current Memorandum and Articles of Association of the present federal body, The Wireless Institute of Australia.

The detail of the proposed Constitution is described in the Explanatory Memorandum.

The consent of the Victorian Attorney General is required to change the present Memorandum and Articles of Association of the WIA as proposed by the new Constitution and an application for that consent and the amendment of the Attorney

General's Licence has been lodged. When granted all aspects of the company will be subject to the Federal act, the Corporations Act, which is administered by the Australian Securities and Investments Commission, ASIC.

The draft "Ethics Policy" is a document that has been proposed for consideration and hopefully adoption by the new board of the national organisation if the Constitution is adopted.

Subject to the consent of the Victoria Attorney General, the Divisions will have the opportunity to adopt by a Special Resolution the new Constitution at the Federal Convention.

- - Yours in Amateur Radio,  
Ernie, VK1LK, WIA Federal President

**This document contains three papers for consideration**

## Proposed Constitution of The Wireless Institute Of Australia

### Index to clauses

1 Name	11 Proxies	21 Other Positions
2 Capacity	12 Directors	22 Seal
3 Objects	13 Powers And Duties Of Directors	23 Financial Records
4 Interpretation	14 Appointment And Removal Of Directors	24 Notices
5 Members	15 Disqualification Of Directors	25 Winding Up
6 Register Of Members	16 Directors' Contracts	26 Indemnity Of Officers
7 Annual Subscription	17 Directors' Conflicts Of Interest	27 Non-profit
8 General Meetings	18 Proceedings Of Directors	28 Limited Liability
9 Proceedings At Meetings	19 Minutes	29 Members' Guarantee
10 Votes Of Members	20 Secretary	30 Changing This Constitution

## Explanatory Memorandum

The purpose of this Memorandum is to provide an explanation of the proposed Constitution for the Wireless Institute of Australia.

It does not attempt to address every question that may arise, because that would make it a very long document indeed; rather it attempts to provide a general explanation of the approach adopted.

## Draft Corporate Ethics Policy

As part of the process leading to the reorganisation of the Wireless Institute of Australia from a federal body to a single national body, it was recognised that the Board of the single larger body would face new challenges.

It was suggested that the board consider adopting this policy to assist its directors and officers, its employees and consultants and its many volunteers.

Corporations Act 2001

# Constitution of The Wireless Institute Of Australia

A Company Limited by Guarantee

1	Name	16	Directors' Contracts
2	Capacity	17	Directors' Conflicts Of Interest
3	Objects	18	Proceedings Of Directors
4	Interpretation	19	Minutes
5	Members	20	Secretary
6	Register Of Members	21	Other Positions
7	Annual Subscription	22	Seal
8	General Meetings	23	Financial Records
9	Proceedings At Meetings	24	Notices
10	Votes Of Members	25	Winding Up
11	Proxies	26	Indemnity Of Officers
12	Directors	27	Non-profit
13	Powers And Duties Of Directors	28	Limited Liability
14	Appointment And Removal Of Directors	29	Members' Guarantee
15	Disqualification Of Directors	30	Changing This Constitution

## 1 Name

The name of the company is The Wireless Institute of Australia (the "Institute").

## 2 Capacity

Subject to the Corporations Act, the Institute has the legal capacity of a natural person including the capacity to exercise the powers set out in section 124 of the Corporations Act. It is the intention that this Constitution will not restrict or prohibit the exercise by the Institute of any of these powers.

## 3 Objects

The objects for which the Institute is established are:

- to promote, advance and represent in any way it thinks fit Amateur Radio and the interests of Radio Amateurs, and without limiting the generality of the forgoing,
- to protect and enhance the privileges of Radio Amateurs, to encourage an awareness of the value of Amateur Radio, to educate and encourage potential Radio Amateurs, to represent Radio Amateurs both nationally and internationally,
- to provide services for Radio Amateurs and those interested in Amateur Radio, and
- to do all other lawful things as are incidental or conducive to the attainment of these objects or any of them or which may be calculated to advance directly or indirectly the interests of the Institute.

## 4 Interpretation

### 4.1 Replaceable rules inapplicable

The replaceable rules in the Corporations Act do not apply to the Institute unless repeated in this Constitution or specifically made applicable to the Institute by a provision of this Constitution.

### 4.2 Definitions

In this Constitution, unless the context otherwise requires:

"Affiliated Club" means any club or similar organisation admitted as an Affiliated Club in accordance with clause 5.11.

"Amateur Radio" includes all activities by duly authorised persons interested in radio technique solely with a personal aim and without pecuniary interest and all other branches of knowledge and activity having application to amateur radio.

"Adoption Date" means the date that this Constitution is adopted.

"Business Day" means a day which is not a Saturday, Sunday or bank or public holiday in the state or territory in which the Institute's principal office is located.

"Board" means the board of Directors.

"Consent to Membership" means a notice to the Secretary agreeing to be bound by the Constitution in such form or forms as is determined by the Board from time to time, and including such other matters including but not limited to consents in accordance with privacy legislation and a resignation as a member of a Division, as may be considered by the Board to be appropriate.



“Constitution” means this constitution as amended from time to time.

“Corporations Act” means the Corporations Act 2001 (Commonwealth).

“Director” means any person occupying the position of a director of the Institute by whatever named called.

“Directors” means the Directors for the time being or such number of them as have authority to act for the Institute.

“Division” means a corporation that was a member of the Institute on the Adoption Date.

“Institute” means The Wireless Institute of Australia.

“Members” means persons who are, or who are admitted as, members of the Institute pursuant to clause 5 but does not include any Affiliated Club.

“Office” means the registered office for the time being of the Institute.

“Provisional Member” means any person who on the Adoption Date is a member of a Division, whether as a voting member or not.

“Radio Amateurs” means persons interested in Amateur Radio.

“Register” means the Register of Members to be kept pursuant to the Corporations Act.

“Seal” means the Common Seal for the time being of the Institute.

“Secretary” means any person appointed to perform all or any of the duties of a secretary of the Institute and or any person appointed to act temporarily as such.

“Special Resolution” has the meaning given to that term by the Corporations Act.

#### 4.3 Construction

In this Constitution unless the context otherwise requires:

- (a) words in the singular include the plural and vice versa;
- (b) any gender includes the other genders;
- (c) if a word or phrase is defined its other grammatical forms have corresponding meanings;
- (d) “includes” means includes without limitation;
- (e) a reference to:
  - (i) a person includes a partnership, joint venture, unincorporated association, corporation and a government or statutory body or authority;
  - (ii) any legislation includes subordinate legislation under it and includes that legislation and subordinate legislation as modified or replaced;
  - (iii) an obligation includes a warranty or representation and a reference to a failure to comply with an obligation includes a breach of warranty or representation;
  - (iv) a right includes a benefit, remedy, discretion or power;
  - (v) time is local time in the state or territory in which the Institute’s principal office is located;
  - (vi) “\$” or “dollars” is a reference to Australian currency;
  - (vii) writing includes any mode of representing or reproducing words in tangible and permanently visible form, and includes fax transmission;
- (f) if the date on or by which any act must be done under this document is not a Business Day, the act must be done on or by the next Business Day; and
- (g) where time is to be calculated by reference to a day or event, that day or the day of that event is excluded.

## 5 Members

### 5.1 Initial Members

The first Members will be:

- (a) the Divisions,
- (b) each of the persons who consents to be a Member of the Institute prior to the Adoption Date, and
- (c) each Provisional Member who after the Adoption Date and during such period as is set by the Board signs a Consent to Membership.

The first Members, other than the Divisions, whose membership of a Division accords with Honorary Life Membership shall be allocated that category of membership of the Institute, and all other first Members (whether or not a voting member of a Division) shall be ordinary Members of the Institute.

### 5.2 Further Members

- (a) The Institute may admit as a Member any person with an interest in Amateur Radio who applies for membership.
- (b) Every applicant for membership of the Institute (except the first Members and Non-Voting Membership) must be proposed by one and seconded by another Member.
- (c) The application for Membership (other than for Non-Voting Membership) must be:
  - (i) in writing signed by the applicant and his or her proposer and seconder; and
  - (ii) in the form including a Consent to Membership prescribed by the Board.
- (d) The application for Non-Voting Membership must be:
  - (i) in writing signed by the applicant; and
  - (ii) in the form including a Consent to Membership prescribed by the Board.
- (e) As soon as is practical after the receipt of the application for Membership, the Directors must consider the application and decide whether or not to admit or reject the applicant for Membership. The Directors need not give reasons for rejecting any application.

### 5.3 Membership Categories

The Institute shall have the following categories of membership:

- (a) Ordinary Member  
An ordinary Member is a duly elected and financial Member.
- (b) Honorary Life Member  
The Board may in consideration of special services rendered to the Institute or Amateur Radio by a Member nominate the Member as an Honorary Life Member of the Institute. If the nomination is approved by a majority of the Members at a General Meeting entitled to vote at the meeting, the nominated Member shall be elected an Honorary Life Member. Any Honorary Life Member shall enjoy all the rights and privileges and be bound by the Constitution of the Institute as from time to time in force.

The Institute may have the following categories of membership:

- (c) Life Members  
The Board may establish a category of Membership known as a Life Membership whereby any ordinary Member who having paid to the Institute, either by one or several payments within such period as is fixed by the Board, a sum of money which shall be decided by the Board at its absolute discretion (and any applicable Goods and Services Tax), shall, subject to the approval of the Board, be admitted as a Life Member of the Institute. Any Life Member shall not be required to pay to the Institute any further annual subscriptions but

notwithstanding such exemption shall enjoy all rights and privileges and be bound by the Constitution from time to time in force.

**(d) Non-Voting Members**

The Board may establish a category of Membership known as a Non-Voting Membership with such sub-categories with such privileges and at such rate of annual subscription as the Board shall determine from time to time. Non-Voting Members shall not be entitled to vote at any General Meeting of the Institute.

**5.4 Cessation of membership**

A person ceases to be a Member if the person:

- (a) resigns his or her Membership by written notice to the Directors; or
- (b) becomes an unfinancial member whose membership is terminated in accordance with clause 5.5; or
- (c) dies; or
- (d) becomes of unsound mind or a person who is or whose estate is liable to be dealt with in any way under a law relating to mental health; or
- (e) is expelled under clause 5.6; or
- (f) becomes an untraceable Member.

**5.5 Unfinancial Members**

A Member who has not paid his or her annual subscription, or any other fees or levies payable by the Member, within the time fixed by the Board, shall be deemed unfinancial and shall cease to be a Member if payment of the amount(s) in arrears is not made within 30 days of a final demand for payment of the arrears.

**5.6 Cessation of Provisional Membership**

Any Provisional Member who has not become a Member in accordance with clause 5.1 shall cease to be a Provisional Member at the end of the period fixed by the Board in accordance with clause 5.1(c).

**5.7 Expulsion**

- (a) The Board may by resolution expel a Member from the Institute if in its absolute discretion the Board decides that it is not in the best interests of the Institute for the person to remain a Member.
- (b) The Board must give the Member written notice of the meeting at which the resolution for his or her expulsion is proposed:
  - (i) stating the time, date and place of the meeting;
  - (ii) setting out the resolution and the grounds upon which it is based; and
  - (iii) informing the Member that he or she may attend the meeting and may give oral or written submission before the resolution is put to a vote.
- (c) At a meeting of the Board held in accordance with clause 5.7 (b), the Board:
  - (i) shall give to the Member, or his or her representative, an opportunity to be heard;
  - (ii) shall give due consideration to any written statement submitted by the Member; and
  - (iii) shall determine by resolution whether to expel the Member.

**5.8 Convening a Special General Meeting**

- (a) If at the meeting of the Board, the Board resolves to expel the Member, the Member may, not later than 48 hours after the meeting, give to the Secretary a notice to the effect that the Member wishes to appeal to the Institute at a Special General Meeting against the resolution.
- (b) If the Secretary receives a notice under clause 5.8(a), the Secretary must notify the Board and the Board must convene a Special General Meeting to be held within 40

days after the date on which the Secretary received the notice.

**5.9 Conduct of Special General Meeting**

At a Special General Meeting convened under clause 5.8:

- (a) no business other than the question of the appeal shall be transacted;
- (b) the Board may place before the Special General Meeting details of the grounds for the resolution and the reasons for the passing of the resolution;
- (c) the Member, or his or her representative, must be given an opportunity to be heard; and
- (d) the Members present shall vote by secret ballot on the question whether the resolution should be confirmed or revoked.

**5.10 Determination of Special General Meeting**

If at the Special General Meeting a majority of the Members vote in person or by proxy in favour of the confirmation of the resolution, the resolution is confirmed; and in any other case, the resolution is revoked.

**5.11 Affiliated Organisations**

- (a) The Board may from time to time make regulations defining the criteria for a club or similar organization to become an Affiliated Club of the Institute.
- (b) The Board may admit any club or similar organization as an Affiliated Club. The Directors need not give reasons for rejecting any application for admission as an Affiliated Club.
- (d) The Board may remove any club or similar organization as an Affiliated Club if in its opinion the club has ceased to comply with the requirements for an Affiliated Club. The Directors need not give reasons for removing any club or similar organization as an Affiliated Club.
- (d) An Affiliated Club:
  - (i) may describe itself on its letterhead and other material as an Affiliated Club of the Wireless Institute of Australia;
  - (ii) may be represented at any general meeting of the Institute;
  - (iii) may participate in any conferences or meetings conducted by the Institute for the benefit of Affiliated Clubs;
  - (iv) shall not be liable to pay any annual subscription; and
  - (v) shall not have any vote as a Member.

**6 Register Of Members**

The Secretary must keep the Register at the Office and must enter in the Register the:

- (a) full names and addresses of Members;
  - (b) date on which each Member becomes a Member; and
  - (c) date on which any Member ceases to be a Member.
- The Register is to be open for inspection by Members.

**7 Annual Subscription**

**7.1 Annual Subscription**

The annual subscription for ordinary Membership, and any sub-category of ordinary Membership established by the Board and any sub-category of Non-Voting Membership established by the Board shall be such amount as is fixed from time to time by the Board and is payable annually (or such other period as is determined by the Board) in advance on such date as the Board may determine.

**7.2 First Annual Subscriptions**

From the Adoption Date until otherwise determined by the Board the Annual Subscription for the following sub-categories of ordinary Membership shall be:

Sub-category	Annual Subscription
Member	\$
Overseas Member	\$
Concession Member	\$
Family Member	\$
Member – No magazine	\$

### 7.3 Annual Subscriptions of first Members

The Annual Subscription to the Institute of a first Member (other than an Honorary Life Member) shall not become payable before the subscription payable by that Member to the Division of which that first Member was a member would have been payable.

### 7.4 Board may Pro Rata Fees

The Board may in its absolute discretion pro rata the annual subscription and any other fees payable by a Member who joins the Institute during a year.

### 7.5 Fees are Debt Due

All subscriptions, fees and other moneys owing to the Institute by a Member at the time of the resignation or expulsion of the Member shall remain a debt due and owing to the Institute notwithstanding the Member's resignation or expulsion.

## 8 General Meetings

### 8.1 Annual general meeting

An annual general meeting of the Institute must be held in accordance with the Corporations Act.

### 8.2 Holding of general meetings

General meetings are to be held at the times and places as are determined by the Board.

### 8.3 Convening of general meetings

- (a) The Directors may whenever they think fit and must upon a requisition made in accordance with clause 8.3(b) convene a general meeting of the Institute.
- (b) The Directors must call and arrange to hold a general meeting of the Institute upon the request of at least 100 Members who are entitled to vote at the general meeting.
- (c) The request must:
  - (i) be in writing; and
  - (ii) state any resolution to be proposed at the meeting; and
  - (iii) be signed by the Members making the request; and be given to the Secretary.
- (d) Separate copies of a document setting out the request may be used for signing by Members if the wording of the request is identical in each copy.
- (e) The Board may change the venue for, postpone or cancel a general meeting, unless the meeting is called and arranged to be held by the Members or the Court under the Corporations Act.
- (f) If a general meeting is called and arranged to be held under clause 8.3 (b), the Directors may not:
  - (i) postpone it beyond 2 months after the request is given to the Secretary; or
  - (ii) cancel it without the consent of the requisitioning Members.

### 8.4 Notice of meetings

At least 21 days notice must be given of a meeting of Members unless the Corporations Act otherwise provides. The notice must specify the place, date and time of the meeting and in the case of:

- (a) special business, the general nature of that business; and
- (b) an election of Directors, the names of the candidates for election and their date of birth if over the age of 72 years.

### 8.5 Omission to give notice

The accidental omission to give notice of a meeting to or the non-receipt of notice of a meeting by any person entitled to receive notice does not invalidate the proceedings at the meeting.

### 8.5 Special business

All business will be special that is transacted at:

- (a) a general meeting not being an annual general meeting; or
- (b) an annual general meeting with the exception of:
  - (i) the confirmation of the minutes of the preceding meeting;
  - (ii) the receipt and consideration of the annual financial report and the reports of the Directors and the auditors;
  - (iii) the election of Directors; and
  - (iv) the transaction of any business which under the Corporations Act or this Constitution is required to be transacted.

## 9 Proceedings At Meetings

### 9.1 Quorum

At least 20 Members present in person or by proxy or representative and entitled to vote is a quorum for all general meetings. No business is to be transacted at any general meeting unless a quorum is present at the time the meeting proceeds to business.

### 9.2 Lack of quorum

If within 30 minutes after the time appointed for the meeting a quorum is not present, the meeting will stand adjourned to the same day in the next week at the same time and place or to such other day time and place as the Directors determine. If at the adjourned meeting a quorum is not present within 30 minutes after the time appointed for the meeting, 10 Members present in person or by proxy or representative is a quorum and if such reduced quorum is not then present the meeting will be dissolved.

### 9.3 Chairperson

The President may preside as chairperson at every general meeting. If the President is unable or unwilling or refuses to act as chairperson of a meeting the Vice President may act as chairperson of the meeting. If the President or Vice President is not present within 15 minutes after the time appointed for the meeting or is unable or unwilling or refuses to act as chairperson of the meeting, the Directors must choose another Director as chairperson. If no Director is so chosen or if all the Directors present decline to take the chair, the Members present must choose one of their own number to be chairperson.

### 9.4 Adjournment

The chairperson of a general meeting may with the consent of a meeting at which a quorum is present (and must if directed by the meeting) adjourn the meeting from time to time and place to place, but no business is to be transacted at an adjourned meeting other than the business left unfinished at the meeting from which the adjournment took place.

### 9.5 Notice of adjourned meeting

It is not necessary to give notice of an adjournment or of the business to be transacted at an adjourned meeting, unless the meeting is adjourned for 30 days or more, in which case notice of the adjourned meeting is to be given as in the case of an original meeting.

### 9.5 Declaration of resolutions

- (a) Subject to paragraph (b) of this clause, at a general meeting a resolution put to the vote of the meeting is to be decided on a show of hands unless a poll is (before

or on the declaration of the result of the show of hands demanded by the chairperson or (other than on the election of the chairperson of a meeting or the adjournment of a meeting) by not less than 5 Members having the right to vote at the meeting.

- (b) A question arising at a general meeting relating to the order of business, procedure or conduct of the meeting must be referred to the chairperson of the meeting, whose decision is final.

### 9.7 Minutes as evidence of result

Unless a poll is duly demanded, a declaration by the chairperson that a resolution has, on the show of hands, been:

- (a) carried;
- (b) carried unanimously;
- (c) carried by a particular majority; or
- (d) lost or not carried by a particular majority,

and an entry to that effect in the book containing the minutes of the proceedings of the Institute signed by the chairperson, is conclusive evidence of the fact, without proof of the number or proportion of the votes recorded in favour of or against the resolution.

### 9.8 Taking of poll

- (a) If a poll is duly demanded it must be taken in the manner and at the time and place as the chairperson of the meeting directs. The result of the poll will be deemed to be the resolution of the meeting at which the poll was demanded provided that a poll on the election of a chairperson of a meeting or on any question of adjournment must be taken at the meeting and without adjournment.
- (b) The demand for a poll does not prevent the meeting continuing for the transaction of any business other than the question on which a poll has been demanded.
- (c) The demand for a poll may be withdrawn.
- (d) In the case of a dispute as to the admission or rejection of a vote on a show of hands or on a poll, the chairperson must determine the dispute and the determination made in good faith will be final and conclusive.

## 10 Votes Of Members

### 10.1 Entitlement to vote

Subject to this Constitution and any rights or restrictions attached to any category or sub-category of Membership, at a general meeting every Member (other than a Non-Voting Member) present in person or represented by proxy or representative has one vote, whether on a show of hands or on a poll.

### 10.2 Casting vote

In the case of an equality of votes whether on a show of hands or on a poll, the chairperson of the meeting at which the show of hands is taken or at which the poll is demanded, is entitled to a casting vote in addition to any vote to which he or she is entitled as a Member.

## 11 Proxies

### 11.1 Appointment of proxy

Subject to section 249X(3) of the Corporations Act, a Member (other than a Non-Voting Member) may appoint one proxy only, who must be another Member or a representative of another Member, and that proxy is entitled to vote on a show of hands or on a poll.

### 11.2 Instrument of proxy

The instrument appointing a proxy must be in writing signed by the appointor or by his or her attorney duly authorised in

writing. An instrument appointing a proxy may direct the manner in which the proxy is to vote in respect of a particular resolution. Where an instrument contains such direction, the proxy is not entitled to vote on the proposed resolution except as directed in the instrument.

### 11.3 Proxy to be deposited at office

- (a) The instrument appointing a proxy and the authority (if any) under which it is signed or a certified copy of the authority must be received by the Institute not less than 24 hours before the general meeting or adjourned meeting or taking of the poll, at which the person named in the instrument proposes to vote. If this clause 11.3 (a) is not complied with, the instrument of proxy will be treated as invalid.
- (b) An instrument appointing a proxy is received when it is received at any of the following:
  - (i) the Office;
  - (ii) a facsimile number at the Office; or
  - (iii) a place, facsimile number or electronic address specified for the purpose in the notice of meeting.

### 11.4 Form of proxy

An instrument appointing a proxy is valid if it is signed by the Member making the appointment and contains the following information:

- (a) the Member's name and address;
- (b) the Institute's name;
- (c) the proxy's name or the name of the office held by the proxy; and
- (d) the meetings at which the appointment may be used.

An appointment of a proxy need not be witnessed and a later appointment revokes an earlier one if both appointments could not be validly exercised at the meeting.

An instrument of proxy in which the name of the appointee is not filled in is taken to be given in favour of the chairperson of the meeting to which it relates.

### 11.5 Power to demand poll

The instrument appointing a proxy is taken to confer authority to demand or join in demanding a poll.

### 11.6 Votes of proxies

A vote given in accordance with the terms of an instrument of proxy is valid despite the previous death or unsoundness of mind of the appointor or revocation of the instrument or of the authority under which the instrument was executed unless notice in writing of the death unsoundness of mind or revocation is received by the Institute before the meeting or adjourned meeting at which the instrument is used. A proxy is not revoked by the appointor attending and taking part in any meeting but if the appointor votes on a resolution either on a show of hands or on a poll the person acting as proxy for that appointor has no vote as proxy on that resolution.

### 11.7 Identification of proxy

The chairperson of a meeting may require a person acting as a proxy to establish to the satisfaction of the chairperson that he or she is the person nominated as proxy in the form of proxy lodged under this Constitution. If the person does not comply, that person may be excluded from voting either upon a show of hands or upon a poll.

### 11.8 Power of attorney

If a Member executes or proposes to execute an instrument or to act by or through an attorney the Member must produce to the Institute within the time prescribed by clause 11.3 the instrument appointing the attorney or a certified copy of the instrument.

## 12 Directors

### 12.1 Number

- (a) The number of Directors must not be less than five nor more than seven. If the number of Directors in office at any time falls below five, the Directors must not act in the affairs of the Institute (other than to appoint additional Directors) until the number of Directors is made up to at least five.
- (b) The Institute may by resolution:
  - (i) increase or decrease the minimum or maximum number of Directors; and
  - (ii) appoint or, in accordance with section 203D of the Corporations Act, remove a Director.

### 12.2 Directors must be Members

Directors must be Members but not Non-Voting Members.

### 12.3 Directors to elect President

- (a) Subject to clause 12.6 at the first meeting of the Board following an annual meeting the Directors shall appoint from their number a President and Vice President, who shall hold office until the next meeting of the Board following an annual meeting. A President and a Vice President is eligible for re-election.
- (b) The offices of President and Vice President becomes vacant if the President or the Vice President:
  - (i) ceases to be a Member
  - (ii) ceases to be a Director;
  - (iii) becomes an insolvent under administration within the meaning of the Corporations Law; or
  - (iv) resigns his office by notice in writing given to the Secretary.
- (c) If the office of President becomes vacant the Vice President shall become President for the remainder of the term of the President who vacated the office.
- (d) If the office of Vice President becomes vacant the Board shall appoint one of their number as Vice President for the remainder of the term of the Vice President who vacated the office.

### 12.4 No remuneration

Except as provided for in clause 27, no Director may receive any remuneration for his or her services as a Director or as a Member.

### 12.5 Vacancies

- (a) Subject to clauses 15 and 14.1, if any vacancy occurs in the Board for any reason, that vacancy must be filled within three calendar months (or such longer period as the Directors may otherwise resolve) by the remaining Directors. The person filling the vacancy is appointed for the remainder of the term of office of the Director who created the vacancy.
- (b) All such appointments must be made by instrument signed by all of the surviving or continuing Directors or the legal personal representatives of the last surviving or continuing Director.
- (c) The continuing Directors may act despite any vacancy in the Board. If however the number of Directors falls below the minimum number fixed under this Constitution, the Directors may only act:
  - (i) for the purpose of increasing the number of Directors to the minimum by summoning a general meeting of the Institute; or
  - (ii) in emergencies, but for no other purpose.

### 12.6 First Board

Upon the adoption of this Constitution:

- (a) the existing directors and other officers shall be deemed to have resigned; and

- (b) the following persons shall be appointed by force of this clause to be the Directors:

#### Group A

[name]  
[name]  
[name]  
[name]

#### Group B

[name]  
[name]  
[name]

- (c) Subject to clauses 15 and 14.1 the Directors in Group A shall hold office until the third annual general meeting following the Adoption Date, and the Directors in Group B shall hold office until the second annual general meeting following the Adoption Date. All of the Directors shall be eligible for re-election.
- (d) The following Director shall be appointed by the force of this clause to be President:
 

[name]  
who shall hold office until the first meeting of the Board following the second annual general meeting following the Adoption Date.
- (e) The following Director shall be appointed by the force of this clause to be Vice President:
 

[name]  
who shall hold office until the first meeting of the Board following the second annual general meeting following the Adoption Date.

## 13 Powers And Duties Of Directors

### 13.1 Management of the Institute

- (a) The management of the business and affairs of the Institute is vested in the Directors. In addition to the powers and authorities conferred on the Directors by this Constitution or otherwise, the Directors may exercise all the powers and do everything that the Institute may exercise or do and not required to be exercised or done by the Institute in general meeting. Without limitation, the Directors may exercise all the Institute's powers to:
  - (i) borrow or otherwise raise money;
  - (ii) charge Institute property; and
  - (iii) issue debentures or give any other security for a debt, liability or obligation of the Institute or (subject to clause 27) any other person.
- (b) The powers of the Directors are subject to the Corporations Act, this Constitution and to any regulations (not being inconsistent with this Constitution) from time to time made by the Institute in general meeting. No regulation made by the Institute in general meeting invalidates any prior act of the Directors which would have been valid if that regulation had not been made.
- (c) The Directors may:
  - (i) appoint or employ a person to be an officer, agent or attorney of the Institute with powers, discretions and duties, including those vested in or exercisable by the Directors;
  - (ii) authorise an officer to delegate powers and duties vested in that officer; and
  - (iii) dismiss or remove any agent, officer or attorney with or without cause.

### 13.2 Cheques, etc.

All cheques and other negotiable instruments and receipts for money paid to the Institute must be signed, drawn, accepted endorsed or otherwise executed by the persons and in the manner as the Board determines.

## **14 Appointment And Removal Of Directors**

### **14.1 Directors' retirement by rotation and filling of vacated offices**

- (a) At every annual general meeting one-half of the Directors (subject to clause 12.6) or if their number is not a whole multiple of two then the number nearest to but not exceeding one-half must retire from office provided that no Director may retain office for more than two years or after the second annual general meeting following the Director's appointment, whichever is the longer. A retiring Director must act as a Director throughout the meeting at which the Director retires. An election of Directors must take place each year.
- (b) In every year the Director or Directors to retire is the one-half or other number nearest to, but not exceeding, one-half of the number of the Directors who have been longest in office since their last election. As between two or more who have been in office an equal length of time the Director or Directors to retire will failing agreement between them be determined by lot in any manner determined by the President. A retiring Director is eligible for re-election.
- (c) The Institute at any annual general meeting at which any Director retires may fill the vacated office by re-electing the Director or electing some other person to fill the vacancy. The Board may determine that the election of Directors be conducted by postal ballot with the result of the election to be announced at the annual general meeting. A postal ballot shall be conducted in accordance with the regulations made by the Board from time to time.
- (d) No person except a Director retiring by rotation, a Director appointed by virtue of clause 12.6 or a person recommended by the Directors for election is eligible for election to the office of Director at any meeting unless the person (being a Member) or some Member intending to propose the person has at least 45 days before the meeting left at the Office a notice in writing duly signed by the nominee giving the nominee's consent to nomination and signifying the nominee's candidature for the office or the intention of such Member to propose. Notice of each and every candidature must be forwarded to all Members not less than 28 days (or such lesser period as is from time to time permitted by the Corporations Act) prior to the meeting at which an election is to take place.
- (e) Any Director may retire from office upon giving notice in writing to the Institute of the Director's intention to do so and such resignation takes effect upon the expiration of the notice or its earlier acceptance.

### **14.2 Removal of Directors**

- (a) Subject to clause 14.2 (b), the Institute in general meeting may by resolution remove any Director from office.
- (b) No resolution for the removal of a Director from office is to be put to a general meeting unless notice signed by a Member duly qualified to vote at that meeting and signifying the intention of that Member to propose that resolution is received by the Institute not less than 28 clear days before the date appointed for holding the meeting.

## **15 Disqualification Of Directors**

- (a) In addition to the circumstances in which the office of Director becomes vacant by virtue of the Corporations Act or this Constitution, the office of Director becomes vacant if:

- (i) the Director becomes of unsound mind or a person whose personal estate is liable to be dealt with in any way under the law relating to mental health;
  - (ii) the Director becomes an insolvent under administration or makes any composition or arrangement with his or her creditors or any class of them;
  - (iii) the Director is removed from office pursuant to this Constitution, resigns office by notice in writing to the Institute or refuses to act;
  - (iv) the Director is absent from the meetings of Directors for a continuous period of six months without special leave of absence from the Directors and the Directors resolve that the Director's office will be vacated;
  - (v) the period for which the Director is appointed expires;
  - (vi) the Director ceases to be a Member;
  - (vii) the Director resigns by written notice to the Institute or dies; or
  - (viii) the Director is removed from office pursuant to section 203D of the Corporations Act.
- (b) No proceedings of the Board, or any resolution passed at any meeting, will be invalidated by reason of any Director taking part or concurring in such meeting or resolution being then disqualified until an entry is made in the minutes of the Board of the Director's office having been so vacated.
  - (c) Any Director whose office becomes so vacant will be eligible for immediate re-election provided that the disqualifying conditions may be dispensed with, altered, varied or modified by a Special Resolution.

## **16 Directors' Contracts**

### **16.1 Directors' interests**

Subject to the Corporations Act:

- (a) no Director or proposed Director is disqualified by that office from:
  - (i) entering into a contract, agreement or arrangement with the Institute;
  - (ii) becoming or remaining a Director of any company in which the Institute is in any way interested or which is in any way interested in the Institute;
- (b) no contract, agreement or arrangement in which a Director is in any way interested, entered into by or on behalf of the Institute can be avoided merely because of that Director's interest; and
- (c) no Director who:
  - (i) enters into a contract, agreement or arrangement in which the Director has an interest; or
  - (ii) is a director of the other company with which the Institute has entered into the contract, agreement or arrangement,

is liable to account to the Institute for any profits or remuneration realised by that Director as a result of his or her being interested or being a director of the other company.

### **16.2 Declaration of interest**

The nature of a Director's interest in any contract, agreement or arrangement must be declared by that Director at a meeting of the Directors in accordance with the Corporations Act as soon as practicable after the relevant facts have come to his or her knowledge. A general notice that a Director is a member of any specified firm or corporation and is to be regarded as interested in all transactions with that firm or corporation is a sufficient declaration under this clause as regards the Director and the transactions. After giving the general notice it is not necessary for the Director to give any special notice relating to any particular transaction with that firm or corporation. The

Secretary must record in the minutes any declaration made or any general notice given by a Director under this clause.

### 16.3 Votes by interested Directors

Subject to the Corporations Act, a Director who has a material personal interest in a matter that is being considered at a meeting of Directors:

- (a) must not vote on the matter (or in relation to a proposed resolution in relation to the matter, whether in relation to that or a different Director); and
- (b) must not be present while the matter (or a proposed resolution of that kind) is being considered at the meeting, unless:
  - (i) the matter applies to an interest that the Director has as a Member in common with the other Members; or
  - (ii) the Directors have passed a resolution that identifies the Director, the interest and the matter, and states that the Directors voting for the resolution are satisfied that the interest does not disqualify the Director from considering or voting on the matter;
  - (iii) the interested Director is entitled to be present and vote as a result of a declaration or order made by the ASIC under section 196 of the Corporations Act; or
  - (iv) the interested Director is otherwise permitted by the Corporations Act to be present and vote.

### 17 Directors' Conflicts Of Interest

If a Director holds any office or possesses any property such that he or she might have duties or interests which directly or indirectly conflict with his or her duties or interest as Director, that Director must declare at a meeting of the Directors the fact, nature, character and extent of the conflict.

### 18 Proceedings Of Directors

#### 18.1 Procedure generally

The Directors may meet together for the dispatch of business and adjourn and otherwise regulate their meetings as they think fit.

#### 18.2 Quorum

- (a) The quorum for a meeting of the Board is the next whole number after one-half of the number of Directors in office, or such other number as determined by the Directors from time to time.
- (b) If the number of Directors in office at any time is not sufficient to constitute a quorum at a meeting of Directors, or is less than the minimum number of Directors fixed under this Constitution, the remaining Directors must act as soon as possible to:
  - (i) increase the Directors to a number sufficient to constitute a quorum and to satisfy the minimum number of Directors required under the Constitution;
  - (ii) convene a general meeting of the Institute for that purpose; or
  - (iii) appoint additional Directors,

and until that has happened the Directors may only act if and to the extent that there is an emergency requiring them to act.

#### 18.3 Calling of meetings

A Director may at any time convene a meeting of the Board by notice to the other Directors. Notice may be given to a Director either personally or by telephone, fax or other electronic means or by posting it in a prepaid envelope or wrapper addressed to the Director at any address within Australia to be supplied by him or her for that purpose.

### 18.4 Notice of meetings

- (a) Notice of a meeting of the Board is to be given to all Directors except to a Director whom the Secretary when giving notice to other Directors reasonably believes to be outside Australia.
- (b) A notice of meeting:
  - (i) must specify the time and place of the meeting; and
  - (ii) may be given immediately before the meeting.
- (c) Non-receipt of notice of meeting of Directors by, or a failure to give notice of meeting of Directors to, a Director does not invalidate any act matter or thing done by or resolution passed at the meeting if non-receipt or failure occurred by accident or error.

### 18.5 Chairperson of meetings

The President shall be chairperson of all meetings of the Board. If the President is not present within 15 minutes of the time appointed for the holding of the meeting or is unable or unwilling to act, the Vice President shall act as chairperson of the meeting. If the President or Vice President is unable or unwilling to act as chairperson, the Directors present must elect a chairperson of their meeting from among themselves.

### 18.6 Determinations

Subject to clause 18.10, questions arising at any meeting of the Board are to be decided by a majority of votes. Each Director has one vote and a determination by a majority of the Directors will for all purposes be deemed a determination of the Directors. If there is equality of votes at a meeting at which a quorum is present the chairperson has a second or casting vote in addition to a deliberative vote.

### 18.7 Delegation to Committees

The Board may delegate any of its powers to Committees consisting of one or more Directors or other persons as the Board thinks fit. Any Committee formed must comply with the regulations that may be imposed on it by the Board in exercising the Committee's delegated power.

### 18.8 Procedure of Committees

The meetings of Committees consisting of more than one person are governed by the clauses of this Constitution regulating the meetings of the Directors so far as they are applicable and are not superseded by any regulations made by the Directors under this Constitution.

### 18.9 Validation of irregular acts

Any act done by any meeting of the Board or by a Committee or by any person acting as a Director will be valid even if it is later discovered:

- (a) that there was some defect in the appointment or continuance in office of a Director or such other person; or
- (b) that any of them was disqualified or had vacated office or were not entitled to vote.

### 18.10 Written resolutions

A resolution in writing signed by all the Directors for the time being in Australia (not being less than a quorum) is as valid and effectual as if it had been passed at a meeting of Directors duly held. That resolution may consist of several copies of a document each signed by one or more Directors.

### 18.11 Voting authority

A Director who is unable to attend a meeting of the Board may authorise another Director to vote at that meeting and the Director authorised will have one vote for each Director by whom he or she is so authorised in addition to his or her own vote. Any such authority must be in writing (including by fax) and must be produced at the meeting at which it is to be used and be left with the Secretary for retention with the Institute's records.

### 18.12 Advisory Committees

- (a) The Board may appoint Advisory Committees in respect of matters previously the responsibility of a Division, to advise the Board from time to time in respect of such matters and on any other matters considered by the Board to be relevant to promoting the objects of the Institute.
- (b) The first members of each Advisory Committee shall be the members of the Council or other governing body of each Division on the Adoption Date who agree to be a member of an Advisory Committee.
- (c) The Board may from time to time appoint to an Advisory Committee any person whom the Board believes is interested in promoting the objects of the Institute, and may at any time remove a person from his or her position on an Advisory Committee.
- (d) The Board may impose such regulations as it thinks fit on the activities and proceedings of the Advisory Committees.

### 18.13 Meetings of Directors by Instantaneous Communication Device

For the purposes of this Constitution, the contemporaneous linking together by Instantaneous Communication Device of a number of consenting Directors not less than the quorum, whether or not any one or more of the Directors is out of Australia, is deemed to constitute a meeting of the Directors and all the provisions of this Constitution as to the meetings of the Directors will apply to such meetings held by Instantaneous Communication Device so long as the following conditions are met:

- (a) all the Directors for the time being entitled to receive notice of the meeting of Directors are entitled to notice of a meeting by Instantaneous Communication Device and to be linked by Instantaneous Communication Device for the purposes of such meeting. Notice of any such meeting may be given by the Instantaneous Communication Device or in any other manner permitted by this Constitution;
- (b) at the commencement of the meeting each of the Directors taking part in the meeting by Instantaneous Communication Device is able to hear each of the other Directors taking part;
- (c) at the commencement of the meeting each Director must acknowledge the Director's presence for the purpose of a meeting of the Directors of the Institute to all the other Directors taking part;
- (d) a Director must not leave the meeting by disconnecting the Director's Instantaneous Communication Device unless the Director has previously obtained the express consent of the chairperson of the meeting. A Director is conclusively presumed to have been present and to have formed part of the quorum at all times during the meeting by Instantaneous Communication Device unless the Director has previously obtained the express consent of the chairperson of the meeting to leave the meeting; and
- (e) a minute of the proceedings of a meeting by Instantaneous Communication Device is sufficient evidence of those proceedings and of the observance of all necessary formalities if certified as a correct minute by the chairperson.

### 19 Minutes

The Directors must cause minutes to be kept in accordance with the Corporations Act:

- (a) of the names of the Directors present at each meeting of the Board and of any Committee; and
- (b) of all resolutions and proceedings of general meetings

and of meetings of the Board and of Committees.

The minutes must be signed by the chairperson of the meeting at which the proceedings were held or by the chairperson of the next meeting.

### 20 Secretary

The Directors must appoint one or more Secretaries in accordance with the Corporations Act at the remuneration (if any) and on the terms and conditions as the Directors think fit. Any Secretary so appointed may be removed by the Directors.

### 21 Other Positions

The Directors may appoint one or more persons to undertake the tasks of a general manager and a chief financial officer with the responsibilities and at the remuneration (if any) and on the terms and conditions as the Directors think fit. Any person so appointed may be removed by the Directors.

### 22 Seal

The Directors must provide for the safe custody of any Seal. The Seal may only be used by the authority of the Directors or of a Committee authorised by the Directors for that purpose. Every instrument to which the Seal is affixed must be signed by a Director and countersigned by the Secretary or by a second Director or by some other person appointed by the Directors for that purpose.

### 23 Financial Records

#### 23.1 Financial and other records

The Directors must cause proper financial and other records to be kept and provide annual financial reporting to Members as required by the Corporations Act. The Directors must from time to time determine whether and to what extent and at what times and places and under what conditions or regulations any financial or other records of the Institute are to be open to the inspection of Members who are not Directors. No Member (who is not a Director) has the right to inspect any records of the Institute except as conferred by statute or authorised by the Directors or by the Institute in general meeting.

#### 23.2 Time for financial reports

The interval between the end of a financial year of the Institute and the annual financial reporting to Members must not exceed the period (if any) prescribed by the Corporations Act.

### 24 Notices

#### 24.1 Notices to Members

The Institute may give notice to a Member:

- (a) personally;
- (b) by sending it by post to the Member at his or her registered address;
- (c) by sending it to the fax number or electronic mail address (if any) nominated by the Member; or
- (d) in any other way allowed under the Corporations Act.

#### 24.2 Deemed service

- (a) If a notice is sent by post, service of the notice is taken to be effected by properly addressing, prepaying and posting a letter containing the notice and to have been effected at the time at which the letter would be delivered in the ordinary course of post;
- (b) A notice sent by fax is deemed to be received on production of a transmission report by the machine from which the fax was sent which indicates that the fax was sent in its entirety to the fax number of the recipient if produced before 5.00 pm on a Business Day, otherwise on the next Business Day.
- (c) (i) A notice sent by electronic mail is deemed to be received on the day of transmission, if transmitted



before 5.00 pm on a Business Day, otherwise on the next Business Day.

- (ii) A notice sent by electronic mail is deemed not to be served only if the computer system used to send it reports that delivery failed.

### 24.3 Persons entitled to notice of general meeting

Notice of every general meeting must be given in the manner authorised to:

- (a) every Member; and
- (b) the auditor for the time being (if any) of the Institute.

No other person is entitled to receive notices of general meetings.

## 25 Winding Up

If the Institute is wound up or dissolved and, after the satisfaction of all its debts and liabilities, any assets whatsoever remain, the remaining assets must not be paid or distributed to the Members but must be given or distributed to some other institution or company having objects similar to the objects of the Institute and whose constitution shall prohibit the distribution of its or their income and property among its or their members to an extent at least as great as is imposed on the Institute. Such institution or institutions to be determined by the members of the Institute at or before the time of dissolution and in default thereof by application to the Supreme Court of the state or territory in which the principal office of the Institute is located.

## 26 Indemnity Of Officers

- (a) The Institute must indemnify each Officer out of the assets of the Institute To The Relevant Extent against any Liability incurred by the Officer in or arising out of the conduct of the business of the Institute or a subsidiary of the Institute or in or arising out of the discharge of the Duties Of The Officer.
- (b) Subject to the Corporations Act, where the Board considers it appropriate, the Institute may execute a documentary indemnity in any form in favour of any Officer.
- (c) Subject to the Corporations Act, where the Board considers it appropriate, the Institute may:
  - (i) make payments by way of premium in respect of any contract effecting insurance on behalf or in respect of an Officer against any Liability incurred by the Officer in or arising out of the conduct of the business of the Institute or a subsidiary of the Institute or in or arising out of the discharge of the Duties Of The Officer; and
  - (ii) bind itself and amend any contract or deed with any Officer to make the payments;
- (d) In this clause:
  - (i) "Officer" means:
    - (A) a Director or Secretary or a director or secretary of a subsidiary of the Institute; or
    - (B) a person:
      - (i) who makes or participates in making decisions that affect the whole, or a substantial part, of the business of the Institute or a subsidiary of the Institute;
      - (ii) who has the capacity to affect significantly the Institute's or a subsidiary of the Institute's financial standing; or
      - (iii) in accordance with whose instructions or wishes the Directors or the directors of a subsidiary of the Institute are accustomed to act (excluding advice given by the person in the proper performance of functions attached to the person's professional capacity or their business relationship with the Directors or

the directors of a subsidiary of the Institute or the Institute or a subsidiary of the Institute),

- and includes a former officer;
- (ii) "Duties Of The Officer" includes, in any particular case where the Board considers it appropriate, duties arising by reason of the appointment, nomination or secondment in any capacity of an Officer by the Institute or, where applicable the subsidiary of the Institute, to any other corporation;
- (iii) "To The Relevant Extent" means:
  - (A) to the extent the Institute is not precluded by law from doing so;
  - (B) to the extent and for the amount that the Officer is not otherwise entitled to be indemnified and is not actually indemnified by another person (including, but without limitation, a subsidiary or an insurer under any insurance policy); and
  - (C) where the Liability is incurred in or arising out of the conduct of the business of another corporation or in the discharge of the Duties Of The Officer in relation to another corporation, to the extent and for the amount that the Officer is not entitled to be indemnified and is not actually indemnified out of the assets of that corporation; and
- (iv) "Liability" means all costs, charges, losses, damages, expenses, penalties and liabilities of any kind including, in particular, legal costs incurred in defending an action for a liability incurred as an Officer.

## 27 Non-profit

The income and property of the Institute must be applied solely towards the promotion of the objects of the Institute as set out in this Constitution and no portion of it is to be paid or transferred directly or indirectly by way of profit to Members. This does not prevent the payment in good faith:

- (a) of remuneration to any officers or servants of the Institute in return for any services rendered to the Institute, if such payment is approved by the Board and the amount payable is not more than an amount that would be commercially reasonable for the service;
- (b) for goods supplied in the ordinary and usual course of business;
- (c) of interest at a reasonable and proper rate on money borrowed from any Member;
- (d) of reasonable and proper rent for premises leased or licensed by any Member to the Institute; or
- (e) of out of pocket expenses approved by the Board incurred by a Director in performing Institute duties.

## 28 Limited Liability

The liability of the Members is limited.

## 29 Members' Guarantee

Every Member undertakes to contribute an amount not exceeding twenty dollars to the property of the Institute if it is wound up while he or she is a Member or within one year after ceasing to be a Member, for:

- (a) payment of the debts and liabilities of the Institute contracted before the time when he or she ceased to be a Member;
- (b) the costs charges and expenses of winding up; and
- (c) for an adjustment of the rights of contributories among themselves.

## 30 Changing This Constitution

This Constitution may only be changed by Special Resolution in accordance with the Corporations Act.

# Constitution of the Wireless Institute of Australia

## Explanatory Memorandum

### 1 Purpose of this paper

**The purpose of this Memorandum is to provide an explanation of the proposed Constitution for the Wireless Institute of Australia.**

**It does not attempt to address every question that may arise, because that would make it a very long document indeed; rather it attempts to provide a general explanation of the approach adopted.**

### 2 Background

The background to this Constitution is the result of a meeting in Sydney last December, attended by a number of people, many currently involved in the Institute at various levels, concerned by the challenges of a dropping amateur population and a dropping membership and the opportunity for growth presented by the abolition of morse as an HF licence requirement and the likely new licensing structure when the ACA completes its present investigations, and to meet those challenges and opportunities, concerned to improve the Institute by moving to a single, hopefully more efficient, national body, rather than the somewhat cumbersome federal structure we have at present.

Clearly there is no single, necessarily best, answer to the many options that this approach offers. There is one reality, however. If we debate every option, seeking to ensure our own personal preference on each issue is adopted, this will become a project without end. Each of us will have, on one issue or another, a preference for an option rejected in favour of another option. That is inevitable. But each of us must be prepared to accept that the most important object now is to achieve finality quickly, for unless we do we will leave the organisation destabilised and without clear direction.

That doesn't mean that obvious errors should not be identified and rectified.

### 3 The basis for change

Currently each WIA member is a member of a state or territory based "division", and each of the 7 divisions is a member of another company, the federal body, the Wireless Institute of Australia, which publishes the magazine, represents the amateur service to the administration (the ACA) and represents the Australian amateurs to the International Amateur Radio Union by participating in the Region 3 organisation. That federal body works by representatives of each Division meeting to decide policy, with a small executive and other volunteers to manage and undertake the tasks.

It is proposed to change the constitution of the federal body, so that each member of a division can become a member of the single national body, with the divisions either ceasing to exist, existing as a vehicle for the new national body or changing its name and becoming a radio club.

The Wireless Institute of Australia was incorporated in 1972 to take over the then existing unincorporated body that was the then divisions combined together for certain purposes. It is a company limited by guarantee, having the certificate of the Attorney General to dispense with word 'limited' in its title. It is restricted by that certificate and its constitutional documents in what it may do – essentially it cannot distribute assets or profits to its members, but must use its income and assets for the benefit of its continuing members.

Today the company law replaces the previous memorandum of association and articles of association of a company with a single "constitution", and so the draft Constitution that has been

prepared is intended to replace the present Memorandum and Articles of Association of the WIA, turning that company from the vehicle that is central to a federal structure to the entity that is the single national association of Australian amateurs, so that everyone may be a member of that single body.

An advantage of this approach is that the existing entities activities simply continue – no new national organisation has to apply to join the IARU and region 3, publication of AR continues, and the oldest radio society in the world continues, simply changing to meet today's world.

### 4 The transition for Divisions

A number of issues remain to be addressed, and so the Constitution does not deal with the changes necessary to the divisions. It is proposed that a separate Implementation Agreement be executed between the Divisions, setting out the particular changes necessary to bring each division into the total arrangement.

A particular issue will be the changes to each division's structure to enable all that is proposed to proceed with certainty.

### 5 The transition for members

Unfortunately, simply changing the constitution of the federal body so that it may become the single national body of which everyone is a member doesn't make everyone who is a member of a division a member of the national body instead. That is because the company is a company limited by guarantee and each member guarantees to pay a certain amount to meet the debts of the company if that ever became necessary. That is the guarantee. The amount involved is the great sum of \$20. But it does mean that to become a member a person must sign that they will abide by the Constitution from time to time. So the Constitution has been structured to allow that to happen as simply as possible.

### 6 The general approach of the draft Constitution

Remember, we are concerned with a company with a large membership and with today's duties and obligations imposed on officers and directors. That is a benefit for the members. In general terms, the draft Constitution seeks to provide detailed procedural rules, detailed guidance as to matters of good governance and to generally avoid debate as to the validity of actions, so that so far as possible, even at the expense of some extra length, the Constitution is as complete a guide as possible to the proper running of the company.

On the other hand, matters such as publications no longer appear, on the basis that the Constitution provides the framework for the entity, not the detailed rules as to what it does on a day-to-day basis.

So far as timing is concerned, I have used two dates. For many purposes I have used the date of the adoption of the new Constitution, that being, for example, the date that the new board replaces the existing executive. For subscription and the like purposes I have used 1 July 2004.

## 7 Name, capacity and objects

Because the memorandum and articles are replaced by a single document, the name and objects are set out. However, as the company law now allows a company to do anything a person can do, long and detailed objects and powers are not necessary. I have incorporated a reference to the relevant section of the act, and set out the broadest possible objects, simply to set out what the company is really all about. These are broad, for example to represent radio amateurs both nationally and internationally, covers any sort of representation, in the ITU, as part of the IARU, to the ACA, or to a local town planning authority. Immediately we start identifying particular areas, we have to go in for a long winded set of words to make sure that something new that we haven't thought of today is also covered when it arises.

## 8 The definitions and interpretation

The replaceable rules for companies found in the Corporations Act are made inapplicable to this company, so that all the provisions affecting the company can be found in one place, the Constitution, and reference to the Act is ordinarily unnecessary, which I think is desirable in a company such as this.

Many of the terms used in the current articles disappear, as we are now calling many aspects of the company by their usual name – for example, we have an Annual General Meeting, rather than a Federal Convention, and a Board rather than an Executive.

There is a definition of "Division" as a member of the company on the adoption of the Constitution.

## 9 First members and existing members

Clause 5 deals with members.

We need some members from the start. Obviously the divisions are already members, and they can stay there. But we need some individuals to be directors, and so they are dealt with by their consent to being a member prior to the adoption before we adopt the new Constitution.

As I have said, we cannot automatically make every present member of a division a member of the new national body.

To make it as seamless as possible, what the Constitution is written around is this; every member of a division on the day that the Constitution is adopted is a "provisional member", and really becomes a member when he signs a "Consent to Membership".

The Consent to Membership is defined, and is the paper that we need from members saying that they will abide by the Constitution. But it can also be the paper by which the members resign from a division or otherwise meets a need of their division.

That will have to be worked out with each division.

The members pay their subscription annually (or, more often, if the board wishes) and so what will happen is that when a subscription falls due after 30 June this year, it will be a subscription for the national WIA, and the members will be asked to send their subscriptions in with the form that enables them to become members of the national body.

Some divisions allow only licensed amateurs to be full members, and have non-voting associate membership, others allow anyone interested in amateur radio to be full members. Obviously, the transition to a national body will not be successful if the transition takes away rights, so every member, full or associate of any division becomes a voting member of the national body.

Honorary Life Members become the same in the national body.

## 10 Categories of membership

The Constitution is written so at the start there are two categories of membership, Ordinary Membership and Honorary Life Members.

As I say above, the Constitution is written so that every member of every division can be a member, so there is now no qualification for membership other than an interest in amateur radio.

So far as Ordinary Membership is concerned, the divisions have fee structures that allow overseas members, concession members, and other groups that I have called sub-categories. To enable the smooth transition, the Constitution identifies the sub-categories that will exist from the start, and the initial subscription rates.

The Constitution allows the Board to define new sub-categories and set the fees.

However, the Constitution also makes provision for two further categories of membership.

One is a "Life Member". Other amateur societies have successfully adopted Life Members, where you pay a sum of money, usually quite large, in one or more payments, so that as long as you live you are a member. If the society gets the sums wrong, it is a disaster. But the Constitution allows the Board to establish that sort of membership.

The other category the Board may establish is a non-voting membership. In the future, taxation consequences may make selling subscriptions to publications associated with membership attractive, and it may be the means by which special memberships for students and the like may be devised, perhaps even with a limited period.

The Constitution has been written on the basis that it should include provisions that may allow the Board the means to meet new needs in the future, even though the provisions may not, in fact, be used.

## 11 New members

New members having voting rights require nomination and seconding, intended to make becoming a member meaningful. However, given the intent of non-voting membership, the Constitution does not require more than an application form for that category of membership.

## 12 Cessation of membership and expulsion

If someone just disappears or just doesn't renew we need mechanisms that are simple to terminate their membership, such as the untraceable member and the unfinancial member provisions.

These are in provisions that deal with un-financial members and untraceable members.

The expulsion of members is a serious matter, and as so much power is given to the board, the provisions as to the obligation of the board to give notice, and to hear the members who may be expelled are quite ornate. The right to appeal to a general meeting is also set out.

The requirement to allow natural justice is, hopefully, met and more importantly, arbitrary or capricious actions by the board will be constrained.

Again, the Constitution is quite detailed on procedural matters.

### 13 Affiliated Clubs

Clubs and affiliated bodies are presently dealt with on a divisional basis, and so, naturally, there is no identical approach.

The draft Constitution (clause 5.11) allows the Board to define the criteria for clubs and the like to be "affiliated", but does not allow an affiliated club to have voting rights nor is it liable to pay any subscription.

The problem is this; the local clubs perform an essential role in the fabric of the amateur fraternity, and must be encouraged and supported by the WIA. But, on the other hand, we do not want potential members to say "I am a member of a club, it pays its fees, and so I am already supporting the WIA and don't need to be a member."

The effect of the Constitution, apart from these parameters is to leave it to the Board to manage and meet the needs of clubs.

### 14 Directors

As said above, we are using the common terms for the board and the directors. But the starting issue must be the structure for the election of directors. One option is to have each director elected by members in a particular area, another is to have a mixture of some directors elected by area and some elected by all members, and yet another option is to have all directors elected by all members.

What was desired was a small, effective board, largely free to organise its own affairs, clearly responsible for acting in the best interest of all members and with no special obligation to members in a particular area, with a structure to hopefully attract directors with a mix of commercial and professional backgrounds to best meet the needs of the Institute.

Accordingly, the Constitution is written on the basis that there are 7 directors, half retiring each year, each elected for two years, all available for re-election, with a President and Vice President elected by the Board annually, with the secretary and treasurers and general manager (if appointed) not directors but appointed by the board on terms determined by the board.

The first directors and the President and Vice President after the adoption of the new Constitution are appointed by name in the Constitution and hold office for 2 or 3 years respectively, demanding a real commitment from those so appointed.

Given the nature of a national body, the need for a postal ballot to appoint directors is obvious. The Constitution leaves it to the board to define the formalities of a postal ballot.

Usual provisions as to filling vacancies by the board for the balance of a resigning directors term are included.

A director may be removed by the members at a general meeting called for the purpose.

The directors can meet by phone or whatever other means so long as certain conditions are met, as set out in clause 18.13.

Other provisions deal with conflicts of interest and the like, and I deal with these under the heading Governance.

### 15 Advisory Committees

The Constitution allows the Board to appoint Advisory Committees "in respect of matters previously the responsibility of a Division". It contemplates that the first members shall be the council members of the former Division.

It is hoped that this provision will be useful for a new board to ensure continuity, provide useful guidance and at the same time not fetter the new board or look like we are instantly reverting to the current structure.

### 16 Meetings

The provisions as to meetings are standard, and hopefully provide sufficient detail as to calling a meeting and conducting a meeting, to be a proper and self-contained guide.

Most business at a general meeting, whether an annual general

meeting or another general meeting is special business, so that the general nature of the business must be included in the notice of meeting (Clause 8.4). Most special business does not require a special resolution, that is a 75% support to pass – such as changes to the Constitution.

One aspect of the national WIA is that its membership will be spread right across the country, and so attending a meeting in Sydney or Melbourne doesn't seem very realistic. That is one reason why the information provided in the notices of meeting is important, and the provisions for proxies are important.

Why cannot we allow members to participate by phone in a general meeting in the way the directors can? Simply because it would be impossible to verify participation by only those entitled to vote and to verify proxies for the purpose of a poll. The company's legislation does, however, allow a meeting to be held in more than one place, with electronic communication between the different centres where the meeting is being held.

If the need ever really arose, the directors would no doubt investigate these options.

### 17 Governance

A national WIA will be a much larger single entity than any of the present entities, with some 5,000 members. Both the members and those seeking to work for them are entitled to expect and offer proper conduct in the affairs of the Institute. Today the law sets out a number of obligations of directors, and it is important, I think, that the directors and officers are provided with proper guidance, and hopefully this will also provide a reassurance for members and potential members.

The particular provisions in the draft Constitution deal with director's contracts, allowing certain contracts, ensuring their validity and protecting the director, requiring directors to declare any interest in any contract or arrangement or in any office or property that could give rise to a conflict of interest, and restricting a director from voting on matters in which the director has a material personal interest. (Clauses 16.1, 16.2, 16.3 and 17.)

### 18 Other matters

This paper, at this time, does not address a number of important issues. Among them is the issue of what approvals are necessary because of the nature of the company, the changes that have been made to the Articles and apparently not made to the Memorandum.

If these affect what is being sought to be achieved, so be it. But they should be regarded as technical, and not obscure the broad thrust of what is the object of what is being done.

### 19 Conclusion

The problem with writing constitutions is that there is a great temptation to seek to legislate for today's perceived special needs. The problem with that is what is appropriate for today's problem may not be best for tomorrow's problem, and so the constitution has to be changed.

It is better is for the Constitution not to legislate for such things, but rather to establish a clear structure that enables the body to deal with whatever problems arise, facilitating the task of those undertaking the work and providing adequate ultimate protection for the members.

In the end, it is the quality of the people that we can attract to run the organisation that matters, and so, while a bad constitution may inhibit a good organisation, a good constitution will not guarantee that an organisation will work, as only people can do that.

I commend the draft Constitution for a national Wireless Institute of Australia.

Michael Owen

# Wireless Institute Of Australia

## Corporate Ethics Policy

### 1 Introduction

As part of the process leading to the reorganisation of the Wireless Institute of Australia from a federal body to a single national body, it was recognised that the Board of the single larger body would face new challenges, and it was suggested that the board consider adopting a policy to assist its directors and officers, its employees and consultants and its many volunteers.

The Board has adopted this ethics policy to provide guidelines that the Institute will follow in connection with its various activities. In doing so the Board has recognised that while fundamentally a voluntary organization, the Institute as a publisher and bookseller also engages in activities that are commercial in character, and so awareness of relevant legislation is essential.

The Policy expresses certain basic principles that each Board member and each officer and each of the employees and each of the many volunteers representing the Institute (collectively referred to in this Policy as the "Institute's people") should follow in all dealings related to the Institute. The Institute's people should be loyal to the Institute, should show the highest integrity and courtesy in their dealings with members and others, including preserving the confidentiality of other peoples' information and should conduct the Institute's business in accordance with law and principles of good practice.

The Board recognises that the Institute's reputation is an essential element of its success. The Institute's people must always act in a way that preserves and enhances the Institute's reputation.

While it is impossible to discuss every conceivable situation that might arise, the Institute believes that the examples contained in this Policy illustrate rules that should usually be followed to ensure that the actions of the Institute's people are not and will not be challenged for being unethical.

#### Scope

This Policy is intended to apply to all Institute people with respect to all actions taken and work performed, whether paid or voluntary, for the Institute.

No Institute person should act contrary to the Policy, even if directed to do so.

The Board is vested with ultimate authority and responsibility to determine the applicability of this Policy to any particular facts that may arise and to determine the steps that should be taken to correct any situation it believes is not in the best interest of the Institute, including, if appropriate, termination of contractual arrangements.

The Board is responsible for the constant review of this policy.

### 2 Policy

All of the Institute's people must preserve and, if possible, take all reasonable action to enhance, the Institute's interests and reputation, with its own members, the regulatory authorities, governmental agencies and suppliers and the general public.

Each of the Institute's people should avoid actual or apparent conflicts of interest with the Institute, which includes taking personal advantage from representing the Institute.

If circumstances involving a possible conflict of interest arise, they should be disclosed to the President in advance of the occurrence of the conflict, so that the Institute may, at the Institute's discretion, take appropriate steps to prevent the conflict or otherwise resolve or waive the conflict.

#### Secrecy

The representation of the Institute may bring the Institute's people into close contact with confidential information, including Board and management discussions and decisions on confidential matters, matters relating to members, their businesses, regulatory agencies and their current policy intents, and other

knowledge or information not available to the public.

All of the Institute's people are required to keep secret all such confidential matters and information, and may not use or disclose such to anyone outside of the Institute through any means at any time.

This is particularly important in the context of on air-discussions, where even casual speculation by any of the Institute's people can damage the Institute.

#### Conflict of interest

Each of the Institute's people has a responsibility to the Institute to be as free as possible from the influence of any interest which conflicts with that of the Institute when representing it in negotiations, or making recommendations with respect to policy or transactions with third parties, including contractors. This policy is to ensure that such decisions are made on the basis of unbiased and independent judgement and solely in the best interests of the Institute without favour or preference to third parties.

### 3 Ethics, integrity and courtesy in dealings with members and others policy

All the Institute's dealings must be conducted in accordance with the highest level of courtesy, ethics and good practice. This applies to dealings with governmental authorities, members, contractors and suppliers and the general public.

The Institute's policy is to cooperate in all reasonable ways with all governmental authorities and to comply with all applicable laws and regulations.

#### Dealing with confidential information of third parties

The Institute's people may have knowledge of or access to confidential information belonging to other people, particularly the members of the Institute. To ensure that the Institute is not compromised, the Institute's people must be careful to ensure that they do not breach any confidences.

#### Relationship with members

The members of the Institute are what the Institute is all about. Members must at all times be treated with courtesy and consideration by all of the Institute's people, including volunteers.

#### Relationships with suppliers

The Institute chooses its suppliers of goods and services on the basis of price, quality and performance.

#### Requests from the press, government officials or shareholders for information

Normally, requests from the press or governmental authorities for information about the Institute will be handled by the persons designated by the Board to deal with such requests, and failing that person, by the President. In those instances where this is not possible, the President should be informed as soon as possible of the inquiries and any responses which were given.

## 4 Good practice and compliance with laws policy

The Institute demands that its employees act with the utmost integrity and professionalism. Misrepresentation, dishonesty, deception, misleading and deceptive conduct and similar activities will not be tolerated.

### Anti-competitive conduct

The Institute will comply with all relevant provisions of the Trade Practices Act and Fair Trading Acts. Specifically, it will not become involved in any activity that involves an unfair trade practice or other anti-competitive activity.

This means that the Institute will not:

- enter into any arrangement designed to lessen competition; or
- attempt to fix the price of its products.

### The environment

The Institute will comply with the spirit and letter of its obligations to preserve and if possible improve the environment in which it operates.

### Dealing with security analysts, institutional investors and journalists

Elective disclosure of non-public information may result in a breach of the insider trading rules. A person in possession of non-public information who does not him or herself engage in a transaction but does transmit such information to someone who trades on the basis of the information may be just as liable as the person who made the trade. Thus, if a report containing material non-public information concerning the corporation were communicated only to local or trade journals and if full public disclosure of the information were not made at the same time, it is possible that this may give rise to breach of the Corporations Law provisions.

### Bribery

The Institute forbids any exchange of funds or assets between its people and officials of businesses and/or governmental agencies if the purpose of such exchange is to secure special concessions or consideration for that person or the Institute, such as, but not necessarily limited to, the following transactions:

- (a) payment of moneys, gifts, loans or other favours which tend to influence decisions or compromise independent judgement.
- (b) payment of rebates or kickbacks for obtaining information for the Institute.
- (c) payment of bribes to government officials in order to influence their judgement.

### Foreign corrupt payments

The Commonwealth Criminal Code Amendment (Bribery of Foreign Public Officials) Act 1999 prohibits payments to foreign public officials in the circumstances set out in the legislation and accordingly the Institute forbids all Institute people from ~~Group~~ making corrupt payments to foreign officials for the purpose of influencing the official to assist the Institute or amateur radio to obtain or retain privileges.

### Other Federal, State and local laws

The Institute's policy is to comply with all laws and regulations applicable to the Institute. In view of the complexity of the laws and government regulations there may be instances in which the Institute inadvertently violates applicable laws and regulations. If violations are discovered, they should be reported by the Institute people who discover the violation to the President or another director and corrected as promptly as practicable.

### Equal employment opportunity

The policy underlying the Institute's personnel practices is to extend equal opportunities to all qualified applicants for paid or unpaid positions without regard to race, creed, colour, sex, age or national origin, and to recruit, develop and retain individuals according to job related standards of education, training, experience, and personal qualifications.

### Drug Abuse Policy

The Institute believes that drug and alcohol use is highly detrimental to the safety and productivity of volunteers and employees. The Institute must remain drug-free.

### Email Etiquette

The informal nature of e-mail can create liability for the Institute because of the very nature of how e-mail is written and how it may be interpreted. Care should be taken that e-mails written on behalf of the Institute cannot cause offence to anybody, and cannot be misunderstood.

### Other Policies

The Board will develop other detailed policies dealing with employment, discrimination, harassment, privacy and the use of Institute facilities for e-mail.

## Book review ...continued (from page 24)

elements of this story in some of his films (p. 234).

Chapter 39 deals with the sinking of the *Titanic*. *CQD* was hammered out. Every amateur knows the general invitation to respond to a call, signal *CQ*, but the *D* on the end meant distress. This was the Marconi equivalent of *SOS*. There is not space to summarise the chapter. All I will say is that I found it hard to put down and hoped for a different ending to the one we all know!

The book provides many glimpses into the character of Marconi and Weightman states that Marconi 'was one of the great amateur inventors of all time' and that 'it is a remarkable testimony to the fragility of reputation that a man who should command such respect in his lifetime should now be relegated to comparative obscurity...' (p. xvii). This book should do much to refresh our

understanding of the life and work of Marconi. At a time when the ACA is reviewing our service and we are thinking about the future, stories of inspiration can be good for us all. I wholeheartedly recommend this book. I only found one mistake. On page 53 the letter H is shown in Morse code as dit dah dit dit dit rather than dit dit dit dit. This is either a mistake by Weightman or his publishers because one of the plates shows a love letter to Marconi's first great love, Josephine Holman, where the letter H is shown as dit dit dit dit. Weightman's book is well researched but I would like to see proper attribution of his sources in the text, making the book much more valuable to scholars. I ordered my copy through Matilda Books, Stirling, SA, but any good bookshop could obtain this book for you.

## References

- Harranth, W., 1999, 'Pioneer of the story of radio: Guglielmo Marconi', *Amateur Radio: Journal of the Wireless Institute of Australia*, 67, 9, pp. 12-14.
- Marconi, G., 1999, 'How I Thought of Wireless Telegraphy', first published in the London Magazine, 1902, *Amateur Radio: Journal of the Wireless Institute of Australia*, 67, 9, p. 15.
- Matchett, K., 2002/2003, 'A Truly Historic Event: 2MT', *Amateur Radio: Journal of the Wireless Institute of Australia*, Dec/Jan 2002/03, Vol 70, No 12, pp. 32, 33.
- Orr, W. & Cowan, S., 1972, *Simple Low Cost Wire Antennas for Radio Amateurs*, Radio Publications, Inc., Wilton, Conn.

ar

## Silent key

### W.S. (Bill) Walker VK5WW

Bill Walker was born in September 1911 in Tumby Bay, South Australia. In his childhood he lived in many country towns where his flour miller father found work. When Bill was old enough for high school the family moved to Adelaide where he attended the Adelaide High School. His interest in radio began in 1924 while still at school. This was the year that the B class station 5DN and A class station 5CL commenced operation. Before leaving school he built several crystal sets and a multi-valve receiver. His first job in 1928 was with the Adelaide Electric Supply Company. During his time with this organisation he worked on the conversion of the supply from 210 volts to 240 volts. In his spare time Bill studied the theory of radio and Morse Code. He passed the Amateur Operators Certificate of Proficiency in 1934 and was given the call sign VK5WW.

Because of his interest in radio he was given the job of modifying customer's

radio receivers and city broadcast equipment to operate on the new voltages in Adelaide. While doing this work he learned that the PMG's Department was conducting an examination for entry to the Department's Radio Section. He successfully sat for the exam and was offered an appointment in April 1940.

Bill was associated with the National Broadcasting Service from then until his retirement in 1976. Much of his early work was with the ABC Adelaide Hindmarsh Square studios in all the technical work associated with studio operations, and outside broadcasting work. He also worked on the operation and maintenance of the transmitters at 5CK, 5CL and 5DN along with the installation of the 5MV and 5PA transmitters.

When the studio technical facilities were transferred from the PMG to the ABC, Bill went to the ABC as Shift Supervising Technician, later becoming

Supervisor Radio Operations for the ABC in South Australia. In this last position he was involved with the construction of the Collinswood Studios.

Two of Bill's sons followed him into broadcasting; Bill jnr into ABC television in Adelaide and Ross (VK2ZWT) into transmitter maintenance and operation with Telecom's Broadcasting Division.

After his retirement Bill was active with the VK5 division of the WIA and the Prospect Lions Club. After his first stroke, two years ago, he relinquished his amateur license and membership of the WIA.

Bill passed away on 9 February 2004 and is survived by his wife, Marjorie, four children, six grandchildren and three great grandchildren.

Note to editor: Even though my father was not a member of the WIA at the time of his death, he would still be remembered by VK5 members.

Ross Walker VK2ZWT

## BPL (Broadband via Power Line)

**The on-going debacle regarding the distribution of Internet services via powerlines is hotting up in various parts of the world.**

Here is an item from a recent ANS posting that should be encouraging for everyone worried about this potential threat to all bands including of course weak signal segments like the satellite reservations. With the proliferation of "wireless" devices associated with computers - and the computer peripherals and processors themselves, the noise floor is growing as we speak in the cities and larger provincial centres. The last thing we need is BPL. You only have to switch off a few devices in your own home to realise how large concentrations of digital equipment can destroy our listening environment. "BPL" has the potential to be devastating and may well be "coming soon to a power point near you!" Here is the quote:

"The Austrian Amateur Transmitter Federation says that a Broadband over Power Line field test in the city of Linz has been cut short as a result of excessive radio interference. According to the national ham radio society, the Government Ministry for Commerce, Innovation and Technology closed

down Linz Power Company's BPL pilot project because it was generating interference on the HF bands".

This is a good omen for things in this country. It shows a very evenhanded policy on the part of the Austrian authorities. After all - they would not want to be swamped with interference reports, which would essentially be un-fixable. It's to be hoped that our ACA will view BPL in a similar light and monitor closely the amount of interference caused by radiation from the power lines and the ancillary apparatus. An unrestricted BPL system has the potential to make amateur radio operations impossible on most bands and very difficult on others. Satellite operators and other weak-signal buffs are urged to keep abreast of BPL developments in this country and be ready to support the WIA in any endeavours to counter this threat.

## AMSAT-VK monthly net - Echolink tests

**On Sunday 8th February 2004 another successful AMSAT-VK net was conducted via Echolink.**

A dozen or so stations took part and audio quality was good from all participants. There was very little evidence of any 'packet-loss' throughout the net. So far it looks like echolink will achieve our aim of having an Australia-wide net for exchange of ideas and experiences. This has not proved possible over the years that we've run the net on HF. Even changing bands from summer to winter has not allowed a

large group, particularly VK6 to take part. During the testing phase the echolink net has been meeting on the second Sunday of each month at 0500 UTC with stations connecting to the AMSAT conference server. The HF nets are still taking place in the evenings of the same day each month with the frequencies and times alternating as per the information in the box above.

### **The AMSAT group in Australia.**

The National Co-ordinator of AMSAT-VK is Graham Ratcliff VK5AGR. No formal application is necessary for membership and no membership fees apply. Graham maintains an email mailing list for breaking news and such things as software releases. Members use the AMSAT-Australia HF net as a forum.

### **AMSAT-Australia HF net.**

The net meets formally on the second Sunday evening of the month. In winter (end of March until the end of October) the net meets on 3.685 MHz at 1000 UTC with early check-ins at 0945 UTC. In summer (end of October until end of March) the net meets on 7.068 MHz at 0900 UTC with early check-ins at 0845 UTC. All communication regarding

### **AMSAT-Australia matters can be addressed to:**

AMSAT-VK,  
9 Homer Rd,  
Clarence Park, SA. 5034  
Graham's email address is: vk5agr@amsat.org

## Current Situation with AO-40

**The echolink net gave everyone the opportunity to hear the latest news directly from one of the control stations.**

Colin VK5HI filled us in on the latest news concerning the command team's efforts in trying to get AO-40 back on line. The best assessment from the team is that one of the main battery's cells failed and this caused a domino effect taking the battery voltage down to 14 volts. At that level the CPU should still be working and the team are trying to set some switching commands to prevent any further damage and hopefully put the satellite "S" band back into operation. The AMSAT-BB will be the best source of the latest information. Colin reminded everyone to keep a listening watch in case the "S" band middle beacon came back unexpectedly. The team members are anxious to receive any telemetry copied under these circumstances - so keep your ears to the sky everyone and have the log turned on. If you do hear any telemetry please zip it and send it to "ao40-archive@amsat.org".



# AMSAT-UK – Space Symposium 2004

**AMSAT-UK will be holding a Space Symposium at the University of Surrey in Guildford, England from 30 July - 1 August.**

This 3 day event always attracts Radio Amateurs from across Europe as well as North America, Africa, Asia and the Pacific. Over a third of those attending come from outside the UK. It provides a unique opportunity to rub shoulders with the designers of the latest Amateur satellites and find out the latest news.

As in previous years there will be special beginner's sessions to teach newcomers how to get started in the fascinating world of Amateur Radio Space communications. With some satellites you can communicate using little more than a standard dual-band FM handheld.

An antenna testing range will be available to enable you to check out the gain of your latest antenna, not all commercial antennas perform as well as you might think! Microwave experts will be on-hand with test equipment covering up to 24 GHz so you can have your equipment tested and receive professional advice.

There will be guided tours of the Surrey Space Centre with the satellite mission control centre and the satellite assembly facility. These tours have been very popular in previous years as they provide a unique opportunity to see satellites in various stages of construction.

The RSGB GB4FUN van, which has a fully equipped satellite station, will be available during the event for visitors to work the Satellites.

Throughout the event there is an extensive lecture programme ranging from highly professional technical presentations to basic down to earth "how to do it" type talks.

Guildford is 60 kilometres from

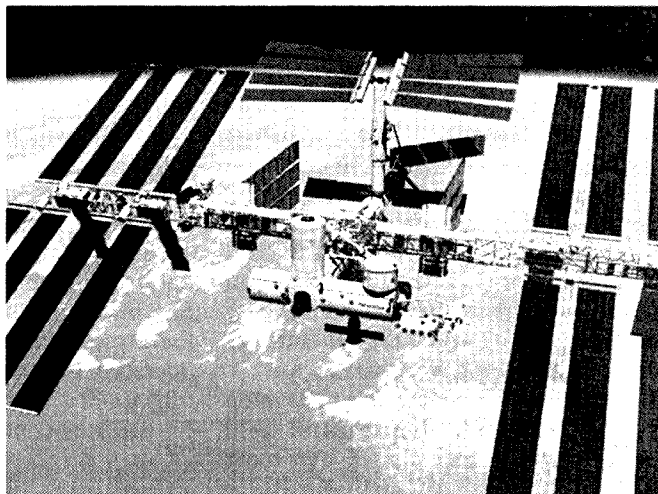

Central London and easily reached from both London-Heathrow and London-Gatwick airports.

Details of 2 or 3 day packages covering meals and accommodation in the University grounds are available from the secretary:

**Jim Heck G3WGM**

Tel: +44 1258 453959

E-mail: [g3wgm@amsat.org](mailto:g3wgm@amsat.org)

Website: [www.uk.amsat.org](http://www.uk.amsat.org)

## AMSAT continued

### Doppler Shift Correction - a software review

**So - what is there to know about Doppler shift? Hand up over there, "Yes you Jack".... "It's got something to do with a train whistle Sir".**

A predicable response. Yes, it has got something to do with a train whistle. It's also got something to do with "red-shift" and ancient galaxies rushing away from us across the cosmic void.

It's got something to do with a lot of things and some of those things impinge heavily on satellite communication. There you are sitting at your receiver, antenna trained on the horizon where a satellite is due to rise and orbit overhead. You tune to the beacon frequency and confidently expect to hear the signal as the satellite rises, right? Wrong! You will need to tune slightly higher in frequency than the true beacon, why? Doppler shift.

The satellite will be travelling towards you when it rises. Not directly towards you but close enough to give you and it

a relative motion of close to its orbital velocity. It's coming at you like a steam train! So fast in fact that the signal pulses which emanate from its antenna at (say) 145 900 000 cycles per second will pass you an appreciable amount faster (again say) 145 903 000 cycles per second. That's the frequency you'll have to tune to if you want to hear the beacon.

Fine, what's so complicated about that? Nothing actually but things don't stay that way for long. Soon the satellite will be almost overhead. It's still racing across the sky but not straight at you any more. So the Doppler shift will be less and less until it reaches its closest point to you and starts to move away. At that time, just for a moment you will be receiving the beacon on its assigned frequency. There will be no relative

motion and therefore no Doppler shift, but - only for a moment.

OK so far, but now it does start to get complicated. The Doppler shift has varied from a maximum value when the satellite rises to virtually nothing as it passes closest to you. The Doppler shift is varying. In fact it is never static. Neither is it linear in function. If you drew a graph of the Doppler shift you would see that it comes out sort of "S" shaped. It starts off high in frequency and drops until the satellite is overhead when the apparent frequency goes through nominal (at a very fast rate) and then the frequency falls below the nominal until the satellite goes out over the other horizon at which time the apparent (received) beacon frequency is

*continued next page*

## Oxley Region Amateur Radio Club

The Oxley Region Amateur Radio Club held its first meeting for the year on January 3 at the SES Building in Gordon Street, Port Macquarie. The club has 35 members, most of whom are active on HF and VHF. The January meeting reviewed the events of the past year that included their annual Field Day held over the Queens Birthday weekend in June and the many various community events, picnics and portable activity days. It has been a great year.

For 2004 they are planning to develop and manufacture simple hand held receivers that can be used by young

people to participate in their annual Field Day and possible take to various schools to explain Amateur Radio. Hands-on tools are always fascinating to schoolchildren. Visitors to the Hastings are more than welcome to visit at the meetings which are held on the 2nd and 4th Friday evenings (7pm) and the first Saturday (2pm), of each month at the SES building. For more information on their upcoming events, contact ORARC Secretary, Henry Lundell, VK2ZHE on 02 6582 2242 or on internet [lundell@tpg.com.au](mailto:lundell@tpg.com.au)

## Help wanted

VK2AYD - One of the projects my local club (ORARC) has tabled for 2004 is to build a number of simple DF receivers that can be used by school children at our annual Field Day or at School picnics and Amateur Radio demonstrations. Rather than re-invent the wheel, we wondered if any other club or person has developed a simple receiver that could be constructed, for say around \$20, and used for such purposes? Any help would appreciate, as we need to encourage the young. Please email me at [davpil@midcoast.com.au](mailto:davpil@midcoast.com.au) or snail mail.

Thanks de VK2AYD

## AMSAT continued

as low as you'll hear it on that pass and again only very slowly dropping in value. Note that it is always dropping in frequency. At no stage do you ever have to tune up in frequency to track the signal. It is always falling but never at a steady rate. Sometimes slowly like at the beginning and end of a pass. Sometimes quickly like in the middle of a pass but always moving downwards in frequency. The observed beacon frequency certainly changes from being above the nominal frequency to being below the nominal frequency as the satellite passes overhead but the change is always downwards and the rate-of-change is never steady.

Now the situation begins to get really complicated. Suppose you are listening to the passband and you hear a station you would like to contact. If you just listened you would find that his signal also moved in frequency, but in a different manner to the beacon. Why? Assuming of course that you are not operating from the same location - the satellite is moving towards or away from his station too and the satellite experiences a Doppler shift on his signal that makes its position in the on-board receiver's passband move as the pass progresses. It is then re-transmitted to you.

The signal you hear from him then will have two lots of Doppler variation

components impressed upon it. One resulting from the relative motion of the satellite and his station and another resulting from the relative motion of the satellite and your location. Depending on the position of your two locations in respect to the satellite's path these effects may add or tend to cancel each other out.

This is the rather frightening world of Doppler compensation that the newcomer encounters on first trying to "work the birds". For all the years that I have been working the oscars, we the unwashed have had to contend with compensating for this situation by manual tuning. Digital store and forward satellites are not so bad because no 'transponding' takes place. The uplink and downlink Doppler shifts are independent and easily accounted for with software like WiSP and the KCT/T. The high orbit satellites when around apogee are much easier to cope with than the LEOs but they all present a challenge, even to the nimble-footed operator.

Fear not, dear reader, help is at hand! The problem was one which cried out for a computerised solution and now such solutions are beginning to appear. I first mentioned this problem in an AR column in 1991 but in those days home computers weren't powerful enough to cope. It was left to Ron Parsons W5RJV to first come to grips with it in the May

1996 Amsat Journal.

Since then computers and operating systems have improved and great minds have been put to work on the problem. Now you have a choice of software to use. There are a number of programs available and listed on the AMSAT web site which all claim to totally compensate for all conditions of Doppler variation and tune your lovely new transceiver for you so that once you establish contact through a transponder you should never have to touch the dial again. Your uplink signal will be tuned to keep it on the same frequency in the satellite's passband.

That's the key to the whole idea. At the same time your receiver will be tuned to the Doppler corrected downlink frequency. If both stations are using such a system, the other station's frequency controls will be automatically adjusted in the same way so that the contact can proceed with no further tuning at either end. Wonderful! As an added bonus, because the QSO frequency is adjusted to stay the same on the satellite, there is no way that any two QSOs can overrun each other as can (and often does) happen when using manual control. If everyone was using such methods all QSOs would stay put in the passband and an old ogre would finally be put to rest.

ar

## **Division news**

### **VK2 News**

Tim VK2ZTM.

#### **Lightning strikes bring changes**

Lightning activity near VK2WI on 24th January knocked out a few of our services. Dural Station Engineer Mark, VK2XOF was able to restore some for the Sunday transmissions. Some problems were nuisance faults. Others were more involved and some older equipment had to be replaced due to obsolete components, including the callback transceiver on 80 metre, also the 7000 and 8525 repeaters where the microprocessor control expired. These systems were built in the late 1970s by Jeff VK2BYY and have provided sterling service. A new 7000 repeater was developed and installed in early February. It was talking well and relaying strong signals without problems. Weak signals however were being corrupted by local inband noise. On 70 cm, the second VK2RWI repeater on 8600 will be recrystallised to 8525. It will be replaced later by another unit on a new channel of 439.900 MHz. Sydney listeners should note that 2 metre coverage of the Sunday news sessions can also be heard on 145.600 MHz. Depending upon your location there is also coverage from services surrounding Sydney. VK2RMP on 146.850 in the south, VK2RDX on 146.650 in the west and VK2RAG on 146.725 in the north. Thanks to these groups for providing their facilities for the relay, also to many clubs and groups who provide a linked or manual feed to their local repeaters for the news. There are some holes in the State-wide transmission coverage; can your group assist?

The VK2RSY two metre beacon on 144.420 MHz also expired. This unit and its companion on 52 MHz were constructed early in the 1970s. They both have an RF line up of obsolete components and this is an opportunity for an upgrade. There are plans to shift the 6 metre beacon to the 50 MHz allocation, requiring a mode change to CW from the present FSK. With other

The 'Welcome to HF QSO' Party went off well in VK2 as it did in the rest of the country. VK2WI made over 150 contacts in the first 12 hours. Divisional President Brian VK2WBK and Norm VK2TOP came down from the New England area to be operators. They were assisted by Owen VK2AEJ, Mark VK2XOF and Tim VK2ZTM. VK2WI commenced on 80 metre and remained on 3595 kHz until dawn, such was the dog pile on the channel. There were some stations we missed contacting, sorry about that. During the morning, activity moved to 40 and 15 metre.

Brian donated a book prize to the NSW Division draw for a VK2 Limited or Limited Novice Amateur who made contact with VK2WI on New Years Day. Bill VK2ZZF was the name out of the hat and he chose the ARRL Antenna Handbook. Bill has a range of HF antennas to construct at his new QTH in the Snowy Mountains region. The darker sky will assist Bill in making up his monthly star report heard on VK2WI.

A commemorative QSL card for contacts with VK2WI during the Party has been sent to most contacts in the log. There are a few new call signs that do not appear in the 2004 callbook. If you made a contact with VK2WI on 1/1/04 and have yet to receive the QSL card, contact the Parramatta office with your address. Such was the success of the New Year Party, it is planned to conduct another QSO party [via VK2WI] next New Years Day.

#### **AGM**

Saturday 17th April will be the NSW Division AGM. During March the annual report will be assembled and posted early next month. AGMs are expensive operations so all members are invited to be involved in the AGM, either by attending the meeting or exercising their proxy. The meeting will be held at Amateur Radio House, Parramatta.

## **CLEARING SALE (private)**

**A leading manufacturer of electronic equipment is rationalising its operations and has for sale in total or separately the following items.**

- benches
- test instruments
- steel shelving
- pedestal drill
- grinder
- trolleys
- hand tools

**This offering affords the serious amateur radio constructor an opportunity to purchase 'industrial strength' equipment at an excellent price.**

**For inspection call  
Ernie on  
0417 039 145**

## **CLEARING SALE**

# Division news

work underway at VK2WI, it will be a while until anything can be done on the beacons. This is an opportunity for low end 6 and 2 metre operators to assist. Anyone able to design and construct transmitters for this purpose should contact the Parramatta office. They need to be rack mounted with about 25 watts output.

VK2WI needs a loan or gift of a circuit diagram or a manual for a Tait T198 UHF transceiver. If you can help please get in touch with the Parramatta office. If it is a loan, we will copy and return same to you.

## Some activity to note

The next Trash and Treasure is on Sunday 28th March at Parramatta, followed by the Homebrew and Experimenters meeting in the library.

The Homebrew Constructors night will be on Tuesday 6th April. There is currently a NAOCP class at Parramatta on Thursday evenings. It will conclude in July. The annual Urunga Convention on the North Coast is over Easter, April 10th and 11th.

Don't forget the local field day contests this month, an opportunity for HF operation by all. Check out the rules in the Contest Column. The next quarter roster for announcers and engineers at VK2WI will be drawn up this month. Contact the Parramatta office or John VK2JJV if you can assist. The recent annual Central Coast field day at Wyong was an opportunity for Members to meet some of the Council.

The annual Oxley Region field day will be held in Port Macquarie over the June long weekend. The Oxley Region

Club recently conducted training sessions for their H and Limited members on HF operating technique. There is a new 70 cm repeater operating near Dubbo. A 2 metre repeater - on 146.675 - has been established at Bathurst.

We must thank Jack VK2GJH for submitting a regular Six Metre report to the VK2WI news session. We would welcome other DX and activity reports for inclusion. These can be anywhere from 160 metre through to the microwaves. Simply make up a news item about recent events and send it by email - vk2wi@wiansw.org.au or fax to 02 9633 1525 to reach the office by 2 pm Friday.

Remember - next month is the Divisional AGM.

73, Tim VK2ZTM.

## VK6 News

### VK6WIA on air

Welcoming in the new operators onto the HF bands, due to the changes in the Morse requirement, was VK6WIA. Mal VK6LC, headed the station and operated 23 hours from 1300z 31st of December 2003 until 2400z on the 1st of January 2004. The total number of contacts was 211, with 118 of them being new callsigns to the HF bands. A more detailed report will appear in Amateur Radio magazine by Mal.

The VK6 WIA Council is pleased to see the changes to the Morse requirement allowing many grades to now operate on HF. The Council supported and worked towards the changes and feels the efforts put in by VK6, along with the other divisions, was time well spent.

### Radio Old Timers get together

The Christmas end of year lunch time get together for the Old Timers was held in early December and 15 Old Timers and 5 ladies came along to the get-together at the Bayswater venue, full of cheer. Get togethers are held most

months and for more detail contact Clem VK6CW.

### Quite short Council meeting.

January's VK6 council meeting was small, quite and short. Being the busy end of year for matters other than Amateur Radio, there was correspondence in and out, Treasurer's report and some general items. The meeting, which begins at 7.30 PM, was all over and done by 8.20 PM, perhaps a record. Our thanks to the Council for the past year. Meetings are held on the first Tuesday of each month and usually not ending much before 11 PM. All are welcome but please contact Neil VK6NE or Christine VK6ZLZ, as seating is limited. *Please book your sandwich if you are attending the AGM on April 17th. Email to vk6@wia.org.au*

### February Council Meeting

The VK6 WIA monthly council meeting was back in full swing with the meeting starting at 7.30 PM and not finishing till 22.30PM. Some of the items covered

were:

VK6 WIA assist WARG by paying some of the repeater licenses, as the VK6 WIA weekly broadcast is carried on several repeaters.

Due to a change of amateur radio course venue, a saving in the cost of renting premises has been achieved.

Correspondence from VK7 concerning possible frequency conflict between the existing Perth repeater and the proposed VK7 (Hobart) 29 MHz repeater. VK7 would be prepared to operate a repeater on a non-interference basis with the Perth repeater if there is no objection.

In all about twenty items were covered. The evening ended with Mal VK6LC giving a computer driven presentation of his DX-Vacation to the Maldives last year.

### Repeater License Costs

WARG, The West Australian Repeater Group, who have installed and operate 15 repeaters in VK6, have just paid the license renewal for all 15 repeaters for the next 5 years. The total cost \$3,894, of which \$1,509 was paid by VK6 WIA for use of 7 repeaters, which broadcast the weekly VK6 news.

## VK4 News

From Alistair Elrick VK4MV

### Qnews

#### RAT deprived of Electrons

A very active electrical storm associated with monsoonal activity decided that Mount Stuart near Townsville would be a great place to perform 600 plus electrical discharges during the evening of Friday January 9th 2004.

Unfortunately Mount Stuart is the location for the TARCinc repeater site which amongst other things houses the VK4RAT repeater systems, TAC08 UHF CB Repeater and the VK4RTL beacon systems. An inspection during Saturday January 10th on top of the mount revealed that ABC Radio National had been taken off air, there were many throbbing diesel emergency power units operating and that the entire top of Mount Stuart was without mains power supply. The only damage to the TARCinc site appeared to be that a set of lazy standby batteries had only held up the voice repeaters for 5 hours instead of the designed 200 hours. Replacing the dead batteries with a fresh one brought the repeaters back up on air.

The Sunday January 11th QNEWS transmissions in Townsville were announced on the VK4RAT VHF repeater and then undertaken on 146.500 MHz simplex so as to preserve the repeater batteries for other communications. A visit to VK4RAT on Sunday afternoon revealed that mains power had been restored to all the Mount Stuart sites and that the TARCinc site batteries were recharging nicely.

#### What caused the mains outage?

Lightning strikes ignited two power poles about two thirds of the way up Mount Stuart and caused the power lines to go to ground. Near the top of the mount, a branch was blown across the lines causing further mechanical damage. Difficult terrain and a soggy mountainside hampered the ERGON crews as they completed repairs to the vital electron lifeline.

#### Radio and Electronics School

Adam VK4KSS, Radio and Electronics School Course Manager reports 2004 is already shaping up to be a big year for the Radio and Electronics School. The school is approaching its 75th student since January 1st. Of this, over 70% of enrolments have been for the Novice Fast Track Multi Media Course. When you consider that in 2003 the total enrolments for the school were 565 students. You can appreciate how much of an effect the relaxation of the Morse code requirement has had. Many new students have indicated during the enrolment process, that the only reason they put off becoming a ham - was because of the CW requirement. Interestingly, those same students have said that they want to learn and use CW once they become licensed.

Another indicator to this phenomenal upturn in student enrolments, is the increase in visitors to the School web site. The school web site has enjoyed an average of 600 visits per week over the past 12 months. However, in the weeks leading up to January 1st, and the three weeks since, visits have increased to well over 1000. The student message board has also seen an increase in activity with over 850 members and an average of 300 messages per month being posted, with most messages having several responses within an hour or so - this has proven to be an excellent tool

for the students. This renewed interest in amateur radio has all come about because of the hard work put in by the WIA and many interested individuals. I think you will all agree that it is the best thing that has happened to the hobby in quite some time. Why not visit our web site at

<http://www.radioelectronicschool.com> and have a look at the courses we have on offer?

#### Northern Repeater News

Rain sprouts new Northern Repeaters and changes the frequencies of some too! The wet in the north not only has the grass growing into jungle at a rapid rate but has also brought on some new and changed repeater services.

From the TARCinc Technician Don VK4MC comes news of a new repeater at the clubs Mt Stuart site which will provide a challenge for all those in the region to suitably equip themselves with rigs and antennae to work. VK4RAT 23 cm Repeater Mt Stuart 1273.500 MHz with plus 20 MHz offset

From the Cairns Amateur Radio Club president John VK4JKL comes news that there has been a frequency change to the VK4RCA UHF voice repeater at Mt Yarrabah to prevent it being constantly triggered by so called "low interference potential devices" a good 10 km away in downtown Cairns. VK4RCA 70 cm Repeater Mt Yarrabah 439.850 MHz with neg 5 MHz offset

### Wireless Institute of Australia SA & NT Division Inc.

**The AGM will be held on Tuesday 27th April 2004 at St Johns Hall, Arthur Street, Unley commencing at 7:30 pm.**

Nominations are called for the position of President, Secretary, Treasurer and Minute Secretary.

Nominations are to be in writing and be received by the Secretary prior to the commencement of the meeting. Nominations may be sent to the Secretary, GPO Box 1234, Adelaide, SA 5001.

All nominations to be proposed and seconded by financial members and signed by the nominee as accepting the position.

Become involved and have your say in the running of the WIA!

Regards, 73, Peter Reichelt, VK5APR,  
Hon Secretary. SA & NT Division WIA.

# VK7 News

Justin Gies-Clark, VK7TW Email: vk7tw@wia.org.au  
Divisional Web Site: www.wia.org.au/vk7

## Divisional News

The Divisional Annual General Meeting will be held on 13 March 2004 at 11 am in the Alanvale TAFE College in Launceston. It will be followed by a special general meeting and by a buffet lunch. The AGM this year is hosted by the Northern Branch. Please make an effort to attend this very important event.

An analysis of the VK7 Divisional broadcast callback statistics for 2001-2003 has resulted in the following averages: 58 callbacks each broadcast (doesn't include Northern & NW repeaters) of which the average for Southern Repeaters = 28, UHF CB Channel 15 = 10 and all HF frequencies = 21.

## Branch Meetings

### North

The Northern Branch's AGM was held on 11 February 2004 and office holders will be reported in the April edition of AR Magazine.

### North West

The North West AGM was held on 4 February 2004 and was chaired by the Secretary, Ron, VK7RN. Ron comments "It was great to have some of the younger and newer members in attendance, unfortunately we could not get any nominations for President, Vice-President or Secretary and as the filling of these positions is vital to the running of the branch I had no other alternative than to move that this branch go into recess until people could be found to take on these positions".

### South

The AGM of the Southern Branch AGM was also held on the night of 4 February with about 25 members and visitors attending. Reports were received from most office holders and I thank those people for their efforts during the past year. As President I found my 2003 report very easy to write with all the things that members have done throughout last year. It is a credit to the Branch, thanks it makes my job so much easier!

The executive for 2004 is President, yours truly, Secretary, Dale, VK7DG and Richard, VK7RO. A full list of office holders is available on the Divisional web site. A vote of thanks was recorded for Brian, VK7RR and his tireless work on maintaining the VK7RIN, VK7RTC & VK7RAF repeaters.

Our guest speakers for the night were Barry McCann, VK7TBM and Mike Hooper, VK7CCX from the Tasmanian Small Marine Radio Group (TSMRG). For those who don't know the Southern Branch has a strategic partnership with TSMRG and they are about to start operating from the Domain clubrooms. In fact Wednesday night was an historic occasion as Mike did the first sked from the new operating room.

Barry outlined the formation of TSMRG from the old OTC/Telstra Marine Radio network. Yes, the Domain is returning to its original purpose! The

operating callsign is Coast Radio Hobart and they monitor 2182, 4125, 6215, 8291 kHz as well as the VHF marine bands.

TSMRG provide regular weather reports and have a sophisticated DTMF position logging safety system which logs radio ID, location and time on the computer at the operating position.

Mike then outlined the extensive technical work he has done on the computerised control system for the various radios they operate. This involved hardware control and visual basic written screen based control systems. Extensive use of packet radio is used to control remote transceivers at the various locations.

Thanks to Barry, Mike, Stu, Chris and Robert for coming along and sharing what TSMRG is all about.

ar

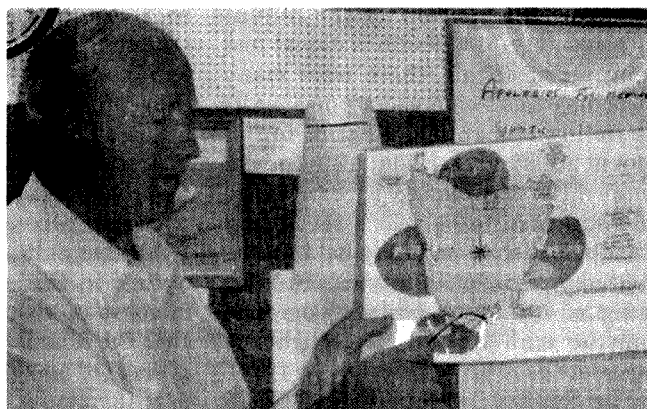

Barry McCann, VK7TBM explaining the coverage of the Marine VHF network around Tasmania

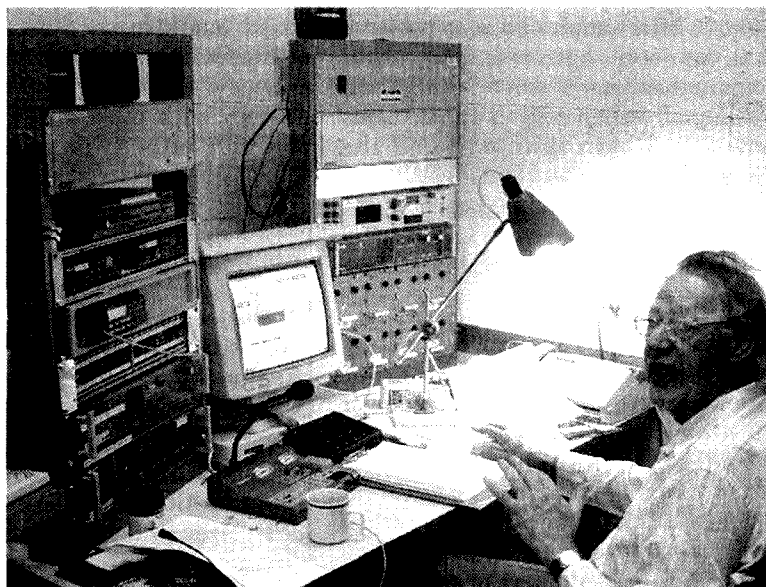

Mike Hooper, VK7CCX demonstrating the digital radio control system that he designed and built and TSMRG operators use.

## Contest Calendar March - May 2004

6/7	Mar	ARRL DX Contest	(SSB)
13/14	Mar	RSGB Commonwealth Contest (	CW)
20/21	Mar	John Moyle Field Day	(CW/SSB/FM)
20/22	Mar	BARTG HF RTTY Contest	(RTTY)
20/21	Mar	Russian DX Contest	(CW/SSB)
27/28	Mar	CQ WW WPX Contest	(SSB)
3-4	Apr	Elettra Marconi Contest	(CW/SSB/RTTY)
10/11	Apr	Japan International DX Contest	(CW)
17	Apr	Holyland DX Contest	(CW/SSB)
17/18	Apr	GACW CW DX Contest	(CW)
17/18	Apr	YU DX Contest	(CW/SSB)
23	Apr	Harry Angel Sprint	(CW/SSB)
24/25	Apr	SP DX RTTY Contest	(RTTY)
1-2	May	Ten-Ten Intl. Sprint QSO Party	(CW/Digi)
1-2	May	ARI Intl. DX Contest	(CW/SSB/Digi)
8/9	May	CQ-M Intl. DX Contest	(CW/SSB/SSTV)
15/16	May	King of Spain Contest	(CW)
22	May	VK/trans-Tasman Contest	(SSB)
29/30	May	CQ WW WPX Contest	(CW)

## Australian Contests 2004

### Please note the following in your diaries for 2004—

- As a result of suggestions about some of the VK contests, it has been decided to try some of the events at times other than Saturdays. Also, some of the contests will test new ground by expanding their rules to some extent.

Please read the rules carefully for these changes, especially (a) the change of addresses for sending logs for the John Moyle Field Day (see rules below), (b) change of dates for Harry Angel Sprint (see rules below) and QRP Day later in the year.

- The dates of the Remembrance Day Contest remains unchanged as the weekend nearest to the 15th August each year (Victory in the Pacific Day in World War II).

### Dates of VK Contests for 2004

(Some dates yet to be confirmed)

20/21	Mar	John Moyle Field Day	(CW/SSB/FM)
23	April	Harry Angel Sprint	(CW/SSB)
22	May	VK/trans-Tasman Contest	(SSB)
5	June	VK/trans-Tasman Contest	(CW)
12/13	June	<i>ANARTS Contest*</i>	(RTTY)
3	July	<i>Jack Files Contest*</i>	
17	July	VK/trans-Tasman Contest 160 metres	(CW/SSB)
6	Aug	QRP Day	(CW/SSB/FM)
14/15	Aug	RD Contest	(CW/SSB/FM)
21/22	Aug	<i>ALARA Contest*</i>	
2	Oct	Oceania DX Contest	(SSB)
9	Oct	Oceania DX Contest	(CW)
13/14	Nov	VHF Spring Field Day	(CW/SSB/FM)
26	Dec	Ross Hull Memorial VHF Contest	

*\*unconfirmed at time of writing*

# Harry Angel Memorial Sprint

1100z - 1246z Friday 23 April, 2004

This is the sixth year of a Contest to remember VK's oldest licensed operator, Harry Angel. Please note the time length of the Contest - 106 minutes, Harry's age when he died in 1998. It is open to all HF operators.

Object is to make as many contacts as possible on band 80 metres, using modes CW and SSB.

Categories: Single Operator (CW, Phone, Mixed) and SWL.

Frequencies: CW: 3500 - 3535 kHz, Phone: 3535 - 3700 kHz.

Contacts in DX window not permitted.

Exchange RS(T) and serial number starting at 001.

Score two points per CW QSO and one point per Phone QSO.

Stations may be worked once only per mode.

Logs must show time UTC, callsign worked (both callsigns for SWLs), mode, RS(T), serial numbers sent and received for each QSO.

Send summary sheet showing name and date of Contest, name and callsign of entrant, category entered, address, points claimed and a signed declaration that the rules and spirit of the Contest were observed.

Send logs to Harry Angel Sprint, 363 Nepean Highway, Chelsea, 3196, by Friday, 21 May, 2004. Logs may be sent via email to: vk3js@vkham.com

## Spring VHF-UHF Field Day 2003: Results

Contest manager: John Martin VK3KWA

The November 2003 Field Day didn't see the usual level of activity. Things were looking good in late October with good weather and even a major aurora. But by the time the Field Day came along, the weather was awful and the propagation had disappeared. So we had less than the usual number of stations in the field or operating at home, and only two stations on bands above 1296 MHz. Particularly hard hit were the multi-operator sections.

On the positive side, we had section winners from three different states, and the first VK7 log in some years.

As I compile these results, the Summer Field Day has also been and gone, and conditions and activity were very much better than in November. Considering the unreliable weather in early spring, it could be worthwhile to consider moving this event towards the end of the month. Any comments gratefully received. You can contact me QTHR or at jmartin@xcel.net.au.

Call	Name	Loc-ator(s)	6 m	2 m	70 cm	23 cm	12 cm	9 cm	6 cm	3 cm	TOTAL
<b>Section A: Single Operator, 24 Hours</b>											
VK4OE	D. Friend	QG52, 62	-	306	410	496	330	-	-	-	1542
VK3KAQ	A. Martin	QF21, 22, 23	69	375	315	352	-	-	-	-	1111
VK5AR	A. Raftery	PF94	21	219	355	-	-	-	-	-	595
<b>Section B: Single Operator, 6 Hours</b>											
VK5AIM	S. Mahony	PF95	43	192	320	344	-	-	-	-	899
VK3KAQ	A. Martin	QF21, 22, 23	56	327	235	256	-	-	-	-	874
VK3YDK	K. Allan	QF22	54	237	370	-	-	-	-	-	661
VK5AR	A. Raftery	PF94	21	216	355	-	-	-	-	-	592
VK7MO	R. Moncur	QE37	-	171	190	168	-	-	-	-	529
VK3HV	G. Francis	QF31	49	183	295	-	-	-	-	-	527
VK5ZUC	A. Russell	PF94, 95, QF04, 05	-	174	280	-	-	-	-	-	454
VK5OQ	K. Gooley	PF94	24	69	125	176	-	-	-	-	394
VK4EV	R. Everingham	QG62	-	105	115	-	-	-	-	-	220
VK5MX	M. Millar	PF95		Check log							
<b>Section C: Multi Operator, 24 Hours</b>											
VK3ATL	Geelong ARC	QF21	118	498	740	496	460	-	-	-	2312
			(Operators C. Gnaccarini VK3BRZ, L. Sim, VK3ZLS, D. Learmonth VK3XLD)								
<b>Section D: Multi Operator, 6 Hours</b>											
No entries											
<b>Section E: Home Station, 24 Hours</b>											
VK3HZ	D. Smith	QF22	51	375	555	464	-	-	-	-	1445
VK3ZUX	D. Johnstone	QF31	73	354	440	184	-	-	-	-	1051
VK3UH	L. Mostart	QF21	92	345	470	-	-	-	-	-	907
VK3AEF	J. Bywaters	QF03	22	105	190	184	-	-	-	-	501

Finally my apologies for taking so long to get these results out - the last couple of months have been quite hectic. I'll try to be more punctual next time.



# VHF/UHF - An Expanding World

David Smith VK3HZ - vk3hz@wia.org.au  
Leigh Rainbird VK2KRR - vk2krr@telstra.com

## Weak Signal

David Smith VK3HZ

After the bumper start to the year, the weather in the south of the country turned cold and band conditions went with it.

Several openings have occurred across the Bight from VK6 to VK5, but none have progressed as far as VK3. On the evening of 11/1, Bill VK5ACY and Colin VK5DK worked Wally VK6WG on 2 m at S9+. At the time, Colin was hearing the 70 cm beacon near Albany at S9.

There have also been a few of VK2 to

ZL openings. Gordon VK2ZAB reports that on the afternoon of 25/1, he worked into ZL via what may have been a sporadic E opening. He and Guy VK2KU worked Nick ZL1IU on 2 m at S9+, but nothing was heard on 70 cm. Adrian VK2FZ and Dave VK2AWD also managed to work Nick but signal strengths were up and down quite wildly. The opening lasted for only about 30 minutes.

Then on 6/2, this time in a tropo

opening, Gordon again worked Nick but this time on 2 m (S9), 70 cm (S5) and whistles heard on 23 cm. On 2 m, he also worked ZL3TY, ZL3TJZ and ZL2TAL. Then later that day and next morning, Ross VK2DVZ reports working ZL1IU, ZL3TJZ, ZL3TY, ZL2TAL, ZL2IP, ZL1TPH, ZL1BT and ZL1AOX on 2m; ZL3TY, ZL2TAL, ZL1TPH, ZL1BT, ZL1IU, ZL1AOX, ZL1TBG and ZL2IP on 70 cm; and ZL1IU, ZL1TPH and ZL1AOX on 23 cm.

## VHF/UHF Summer Field Day

The VHF/UHF Summer Field Day on January 17 and 18 saw a larger number of participants, in VK3 at least. The weather was a little better than during the Spring Field Day (no snow at least) but still fairly cold and rainy. Operating techniques seemed to be much improved also. Most stations used xxx.150 or xxx.200 as call frequencies and QSYed away to have a contact. At times, I was having difficulty finding a slot to have a contact. I operated from home and worked VK1, 2, 3, 5 & 7 on 2 m and VK1, 2, 3 & 5 on 70 cm. I counted 7 stations active on 23 cm too.

However, from reports received, it appears that activity in other states was fairly low. A number of stations report going portable and hearing not much

activity at all, even from home stations. Barry VK3BJM battled bad weather and equipment problems but, nonetheless, reports having a great time. He provides these words of wisdom: "If you are in VK2 or 4, and are thinking it's not worth the effort - don't be discouraged. You're in the vanguard of operators who, with persistence, could re-ignite portable activity in your region - and portable activity isn't just for Field Day contests. If things didn't go well for you in the Field Day, look at what exactly didn't work well. Then identify why those things didn't go well, and from there address how to change that in the future. Was your operating site not optimal? Was propagation lousy? Could

your operating window be better? Could more home stations have been encouraged to be on air? Could more stations have been encouraged to get out on a hill somewhere in your region - regardless of how good or bad their field station may be. Some things can be worked upon and improved - some cannot. Propagation (or perceived lack of it) will always be a challenging part of amateur radio, and a lack of troppo is simply a cue to start looking seriously at the other propagation modes available, and figuring out ways to exploit them." So keep up the portable activity or, if operating from home, please give the portable stations plenty of contacts for their efforts.

## Beacons

There's been lots of activity with beacons this month.

Chas VK3BRZ reports that he and David VK3XLD have installed the new VK3RGL 70 cm beacon on Mt Anakie near Geelong. It is running on 432.530 MHz using FSK ident at +700 Hz. Power is 20 W to each of two 5-element yagis, one pointing west and one to the northeast. The beacon switches transmission between the two antennas at 15 second intervals, adding either "W" or "NE" to the end of the ident depending on the active antenna. Thanks also to Lee VK3PK who wrote the ident. controller program. Chas is

looking for signal reports, which can be sent to him by email at CGNACCAR@gordontafe.edu.au.

Wally VK6KZ reports that the VK6RST Mt Barker beacon on 144.564 MHz has been installed, thanks to the assistance of Brian VK6YAU and Wally VK6WG. It uses FSK identification and 15 W of power into an omni-directional antenna. Thanks to Cec VK6AO for the antenna and Don VK6HK for the transmitter, on behalf of the WA VHF Group (Inc). Mt Barker is about 50 km north of Albany. Wally welcomes reports to him by email at wjhowse@bigpond.com.

Wally also advises easterners to listen

for VK6RSW Augusta on 144.562, 432.562 and 1296.562 MHz and for VK6RST from Mt Barker on 432.564 MHz and 10368.564 MHz, both with antennas favouring VK3/5. Don't overlook Perth 144.460, 432.460 and 1296.460 MHz and Bunbury 144.560 MHz. 5 and 10 GHz beacons are also on air from Perth but are unlikely to be heard in eastern Australia.

Rod VK2TWR reports that the VK2RSF Beacon on 144.414 MHz (FSK) is back on air. It is located on a very exposed site at Hudsons Peak, south east of Cooma, and the pair of big wheels on the mast have had a beating of late.

Reports are welcome to Rod by email at [marestails@bigpond.com](mailto:marestails@bigpond.com)

Jeff VK8GF has advised that the VK8RAS beacons at Alice Springs are working fine. The 2 m beacon on 144.485 MHz is about 300 Hz low and the 6m beacon on 50.046 MHz is also low. Both run Philips FM828s at 20 W into vertical whips.

Incidentally, Jeff also mentions that his 2 m station is still working, although he hasn't had any contacts now for several years - the last one was into Sydney. He has worked all states on Es except VK1, plus worked into Japan on evening TEP. He runs an Icom IC275 to a pair of 4CX250B's and 16 el ATN long yagi. He monitors 144.1 when in the shack.

In recent VK2 news, it was mentioned

that the 6 m and 2 m VK2RSY beacons at Dural have both been put out of action by a lightning strike. Apparently the 2 m beacon equipment is so old that it would be more feasible to build a new beacon than to repair the old one. The antennas are also rather sad. Therefore, the Dural Technical Committee is looking for volunteers to build a new beacon (and how about a 70 cm beacon while we're there).

Finally, there should shortly be a new beacon on 2.4 GHz in the Melbourne area. Alan VK3XPD has been rummaging in his extensive junk box and has put together a setup that should deliver 5 to 10 watt to an Alford slot at his QTH (also the site of the VK3RXX 23 cm beacon).

## GippsTech 2004

From Peter VK3KAI,

*a note about an event not to be missed by the serious VHF/UHF weak signal operator:*

The seventh annual Gippsland Technical Conference - GippsTech2004 - will be held on July 3 & 4, 2004, at the Gippsland Campus of Monash University, located at Churchill, Victoria.

Further details available from <http://www.qsl.net/vk3bez/>

Offers of presentations welcomed - contact Peter VK3KAI at [vk3kai@qsl.net](mailto:vk3kai@qsl.net)

## Digital Modes

Rex Moncur VK7MO

Congratulations to Charlie VK3FMD on completing the first VK EME digital contact on 432 MHz with Al, K2UYH. After much testing and many tries, Charlie found that JT44 worked much better than JT65b on 432 MHz EME. Following Chas, VK3BRZ, working HB9Q on CW, tests were run with HB9Q in February on JT65b and JT44. Rex VK7MO, (single 17 element yagi and 120 watt) and David VK3HZ (random) completed on JT44 with signal levels as good as -8 dB in an SSB passband. Again JT65b gave very poor performance with only one decode in 10 minute where-as JT44 gave almost perfect decodes for over half an hour. HB9Q runs a 15 metre dish and high power and these results

show he can be worked by single-yagi, 50 to 100 watt stations thus opening 432 MHz EME opportunities to many in VK.

Welcome, Ron, VK4KDD and Andy, VK2EAH to the 2 metre FSK441 activity sessions. Weekend activity sessions are held on 144.230 from 0700 to 0800 Vic/NSW time each Saturday and Sunday morning. New stations are encouraged to join in with VK7/3/5 transmitting first 30 second of each minute to the North and VK1/2/4 transmitting second and to the South. Typically one or two 2 metre contacts can be made over the range 800 to 1800 km during each session. After the session, come on 40 metre, 7085 kHz or nearby, and share your results.

During January, Bob ZL3TY and Rex

VK7MO have been testing FSK441 meteor scatter on 2 metres to look at the best hot spots. The hot spots are 10 to 15 degree either side of the direct path. It was found that by focussing on the same hot spot with Bob's high gain 4 yagi array, VK-ZL 2 metre contacts can be regularly completed in 5 to 10 minutes. Over 100 single tone pings were recorded in 30 minute on this 1941 km path. Interestingly the Southerly hot spot gave better results by a factor of around 2 to 1, which is the opposite of the advice provided by WSJT. Further tests will be carried out later in the year to see if the Southerly hot spot is consistently the best on this path.

## 2 m & 70 cm FM DX

Leigh Rainbird VK2KRR

After the fantastic openings of December in the south, January has been a big disappointment and far from what was anticipated for the FM DX scene. While the first half on January had some interesting occurrences, the second half of January was pretty well terrible in most areas of Australia.

The first half on January saw typical summer weather in the south, being very hot and at times over 40 deg C. But we are not really getting good high-pressure systems into the Great Australian Bight, they are all being mostly distorted and broken by cold weather fronts. The pressure maps were shocking in the

second half of January with small highs and lows all over the place. Good for rainfall, not good for DX. There has also been a low-pressure trough down the eastern side of NSW and the west of W.A. This has been causing unsettled weather, storms, rain and wind, not good for ducting. If you had looked at a lightning tracker map during the second half of January you would have noticed lightning strikes covering a great deal of area especially in the eastern half of Australia.

To get the ball rolling, on New Years Day there was an opening in the south

east of the country. I don't have too many notes written for this one, but conditions were open from here to the Adelaide area. Adrian VK5ZSN was worked on Summertown 438.125. Had an interesting chat via the Barossa Valley 438.425 with some new comers to AR, mainly Josh VK5HKS second operator and Sam, the owner of the callsign. Lets hope that Josh passes his next exam attempt and we will have another new callsign to try and work.

On the 2nd there were two separate openings, one in the southeast and the other from New Zealand across to the

Sydney area. From here conditions were not all that good, but a number of repeaters were worked from VK5. Ray VK2ZOR at Tocumwal was able to work 5RAD Crafers 2 m repeater @ 628 km.

Brian VK5UBC submitted the following great report:

This morning 2/1/04 conditions on 2 m were excellent from my portable QTH at Corny Point, southern Yorke Peninsula SA (PF85MC). I turned on at 7.30 am SA time and all the SE repeaters were S9 so I tried the Tasmanian repeaters. I could immediately hear Mt Barrow 7RAA and Mt Duncan 7RMD. 7RAA was noise free so I put out a call and VK7KY, 5 km east of Burnie answered. I then worked VK7LCW who was also readable 5 on reverse but Peter did not have time to make the simplex contact. Following these contacts VK7JG mobile in Launceston called and was worked.

At about 8.30am the repeaters faded but Tower Hill repeater VK7RNE was audible with VK7's talking on it. I could not break in but could hear them talking on the repeater for about 1/2 hour.

All the above Tasmanian repeaters are over 1000 km from my location.

Also worked VK5WCC at Millicent, VK3LY at Nhill and VK5ZAI via the Mt Gambier repeater (approx 500 km).

Various Victorian repeaters have been workable from here in the last couple of days and did work Leigh VK2KRR yesterday via several different repeaters.

I have 2 x 5 element yagis at 25 feet and running 20 watt.

Also on the 2nd we had a number of reports of FM contacts from the VK2 coast to New Zealand.

Brian VK2UBF in the Bulli area around Wollongong made it to the Greymouth 146.950 repeater in NZ. Brian's distance worked is around 1978 km. Brian was also heard unknowingly making it to the Canberra repeater on the same frequency at times. Bob ZL3ADH in Greymouth NZ, was heard working repeaters in the Wollongong area on 2 m. He had also made it to the Batemans Bay repeater on 146.675, around 1950 km. Later in the evening Bob was heard trying to call into one of the Sydney repeaters, which was connected to the IRLP Virtual Pub. A few overs were heard from Bob, but he was not able to hold in there, but it did impress the listeners of the Virtual Pub group all the same. Not sure if Brian and Bob linked

up for a simplex contact, but seems it would have been possible.

Vic VK2UVP, north of Newcastle also reported good conditions today along the coast. While Vic was unable to work across to NZ on his handheld, he did hear ZL3ADH on the Maddens Plains repeater near Wollongong. Vic was easily able to get to the Wollongong repeater from his 2 watt handheld and reported a 5/9 signal back from the repeater over the 250 km path.

Again on the 2nd, Steve VK2KFJ noted ZL1DK working VK2RHR 146.825 near Mittagong from 3 pm to 4.45 pm, ZL1DK was also on other Sydney 2 m repeaters after this.

On the 3rd, Steve also reports - approx 10 pm, coastal ducting between Sydney to far south coast VK2 and also inland to Goulburn, worked 438.325 at Goulburn using my h/held inside the house at S7. Also found 146.750 Ulladulla S1. Noted 146.650, VK2RDX, Mt Bindo, normally about S1 was way up to S9+20.

In addition to Steve's report, from here at The Rock I also noted a number of Sydney stations reaching the Canberra 146.950 device quite easily at around the same time.

On 14th January there was an opening in the south east of Australia. Wayne VK2PDW who was mobile in Wagga Wagga, decided to go to the top of Willans Hill, in the center of town. From

there Wayne was able to work as far as the Port Augusta repeater VK5RAE, at 929 km distant.

From The Rock I was able to get as far as Port Lincoln on 2 and 70 @ 1026 km. Port Augusta was very easy to work with only 2.5 watt @ 913 km.

Found on 146.500 and worked on simplex from here, were VK2FW, Ray from Orange, he was S9+30dB. And Brian VK5UBC at Gawler SA was a weak 4/4 signal @ 764 km.

Chris VK3VSW from Geelong went portable in the Grampians area during the mornings of the 17th and 18th of January, the Summer VHF Field Day weekend. Unfortunately for Chris conditions were terrible. Chris was running a handheld with 5 watts and small yagis on both 2 and 70. Chris made a number of shorter distance contacts and the furthest being to VK2KRR @ 456 km on both bands.

In the morning of the 25th January, Colin VK3LO in Melbourne was worked by VK2KRR on 146.500 simplex. Also a good jump by Graham VK3JGL in Bendigo into Canberra's 146.950 repeater where Graham worked VK2JSK in Orange. Distance for Graham was 425 km, while for VK2JSK it was quite a bit shorter.

That's about it for this month. Please remember to send through any 2 and 70 FM DX reports to Leigh VK2KRR at vk2krr@telstra.com.

ar

---

## Silent Key

---

### Franklyn Pain VK2DYP BE, FIE (Aust)

#### 1910-2004

Franklyn Pain's long life came to a peaceful end on the 17th January 2004. He was a chartered professional engineer and retired from the staff of the Sydney Water Board as chief mechanical engineer in 1970. He had a keen interest in radio communication from his boyhood but did not become a licensed amateur until 1979 - initially as VK2NAP. However he soon afterwards obtained his full call and for the remainder of his life amateur radio activities brought him many hours of pleasure and created for him a wide circle of friends.

He was a strong supporter of the WIA and the Central Coast Amateur Radio Club and a member of the RAOTC. He became a member of a group of veterans who would meet regularly over lunch at the Parramatta rooms. He was a faithful member of "Col's Net" (5 pm - 7.095 MHz) and greatly enjoyed acting as net controller occasionally. That his terminal illness was accompanied by an inability to speak was a source of much frustration to him.

Vale, OM.

ar

# Spotlight on SWLing

Robin Harwood VK7RH

## Cuts across the board

Further drastic cuts to shortwave broadcasting are due to come into effect when the new broadcasting period commences on 27th March. It was announced on February 3rd that the VOA will end regularly scheduled programs in Bulgarian, Estonian, Czech, Hungarian, Latvian, Lithuanian, Polish, Romanian, Slovak, and Slovenian, along with many of our broadcast feeds to affiliate stations in Central and Southeastern Europe. This action, which took effect on Friday, February 27, 2004, is in accordance with the recently passed 2004 federal budget, which endorsed the US Administration's proposal to close these services. As well the VOA News Now format will be further reduced from 19 hours to 14 hours as from the end of the current broadcasting period in October.

The religious broadcaster, Adventist World Radio, has been airing programs over shortwave for decades but from January dramatically reduced their output due to budgetary cuts. The future of WSHB in Cypress Creek also is doubtful. This station has programming on behalf of the Christian Science Movement in Boston. They have utilised

relay facilities from the Far East of the Russian Federation and also Taiwan but these ceased in December. WSHB has been on the market for some time.

External broadcasts from All India Radio may also be another shortwave casualty. A recent government evaluation of their effectiveness was very scathing. I also have wondered if AIR ever monitor their program output as the modulation or audio quality can vary wildly during the program. Relays of the domestic service and programming to the subcontinent will continue over shortwave.

The BBC News and Current Affairs programming came under the spotlight after a Royal Commission severely criticised a report by Andrew Gilligan on a statement relating to the Iraqi War and Weapons of Mass Destruction, after interviewing a top scientist who later committed suicide. The Hutton Inquiry findings led to the resignations of the BBC Chairman, its Director-General as well as Andrew Gilligan. Although it was primarily a domestic story, international ramifications saw this item extensively carried by many international broadcasters, with the

primary emphasis on the future of the BBC's independence and impartiality.

Incidentally the BBC World Service is now available here in my city from midnight to dawn over the ABC Newsradio Network as well a translator of 7RPH On 106.9 FM. The latter must be using a loop delay because it is between 10 to 30 seconds behind the ABC Newsradio feed. I also note that the Newsradio network uses other international radio broadcasters at various times.

My e-mail address of vk7rh@wia.org.au is active after some unexpected hiccups outside of my control. For some time I was puzzled my mailbox was empty but it was due to a change of the mailserver at the website. I must apologise for the delay in answering my e-mail but it has now been rectified and answered.

Don't forget that on the 27th of this month, most of the Northern Hemisphere Goes on to daylight summer time. This means that many HF stations will be altering their frequencies and transmission times. .

Well that is all for now. Until next time, good listening from VK7RH

ar

## Intruder watch

Henry VK8HA

**The 24 MHz CODAR interference has not changed, still very low level and no problems with working DX on the 24 MHz band.**

The 7 MHz CODAR/OHR has not been heard at Humpty Doo, PH57NK. Did have a 24 hour watch for 15 days, but NIL Codar heard. VK6WIA Sunday morning Broadcasts could be heard at very low level.

VK6XW, Karl, reports of logging 44 Indonesian SSB Stations on 14 MHz.

84 Chinese Stations on 14 MHz SSB.  
60 Other Asian SSB Stations.

The 14144 Frequency Has Chinese Language SSB all day.

VK4ZRT, Wayne, reports 10 unidentified SSB, Digital and Broadcast Stations on 14 MHz.

14250 North Korea still active from Pyongyang Broadcasting.

On 7100 Broadcast Station, possibly African, S9 + 40dB in VK4...

A2 and A7 D USA Stations with an S9 Signal or maybe Europe ??

On 28 7 unidentified Asian SSB Stations logged. (most likely Chinese??)

In Humpty Doo the Chinese Packet is very strong on 14015 and 14260.

Sometimes idling with a very NOISY Carrier, on 14260 it also sends some other bursts of Digital Info.

On 14370 Indonesians on SSB being 'Jammed Out' and it works as they have to stop transmission!

VK2BHO, John, reports Interference from 'Voice of Korea' on 10124 MHz on the 22nd of January 2004.

Good Luck Hunting and see you next month.

Cheers and all the best.  
vk8ha@octa4.net.au

ar

# Pileups are dangerous

HB9CIC Josef

Published in "Old Man" September 2002

Translated by Mike Krochmal, VK3KRO

According to a study by the Academy for Wireless Communication (AWC) of the University of Brainless (UK), which was published at the end of June 2002, the appearance of short-wave pileups results in a significant hazard for a fringe group of our society. This fringe group includes persons in the amateur fraternity who call themselves "DXers". The results of this study now show unequivocally that it is possible for a multitude of extremely disturbing behaviour disturbances, complex illnesses and massive personality changes to occur, independently of the age, origin, environment, culture and intelligence of the persons concerned. Material which hitherto has often been classified as baseless gossip has now been documented scientifically for the first time.

As an introduction, we will provide a definition of the concept of the "Pileup". This is a temporary phenomenon which may be of brief or extended duration, and may last for up to a day. If an amateur radio station from a very rarely activated country or from a newly constituted island commences transmissions, the mathematically normal distribution of the active stations on the band undergoes a profound shift. The number of stations in the vicinity of the frequency of the rare station rises instantly and massively. This effect is augmented by several orders of magnitude if the station concerned is reported in the so-called "DX-Cluster" systems.

It is precisely in this phase that the endangered fringe group now forms. As a result of an exothermic short-circuit in sector B2 of the cerebrum, the victims of this disease immediately forget all current and planned activities. Control over all such life-sustaining activities as, for example, hunger and thirst immediately ceases. The only thing which is judged to exist is the station which has just appeared. As a consequence, the situation escalates without control. Out of the 44 defects and illnesses which have now been recognised and listed, we are able to describe only the 10 most important ones here.

1. *Loss of knowledge of foreign languages.* Commonly used concepts such as "five up, split operating" etc. are no longer able to be translated into the mother tongue. This results in calling in simplex mode, directly on the transmission frequency of the rare station. The request "Full calls only please" is ignored totally, and the

DX station is bombarded with fragments of one's callsign.

2. *Dysfunction of speech recognition.*

This is a syndrome which appears in epidemic proportions. In the first stage, numbers are no longer recognised. The reply to the request "stations with number 7, please" is fundamentally one's own callsign, but only if this does not contain the number 7. In later phases of the illness, the request "the station whose call ends with Tango" results in all victims of the disease replying, regardless of their callsigns.

3. *Loss of coordination.* It is no longer possible to comprehend the basic principles of operating technique. "One talks, the other listens", the banal basis of amateur radio, is forgotten. The result is an uncontrolled calling such as "Eggoromeo, Eggoromeo" or "Sugaralfa, Sugaralfa" during the transmission times of the DX station.

4. *Deafness.* This defect is also observed on very frequent occasions. Patients with total loss of hearing can be very easily recognised by the utterances "is this frequency in use?" and "who's the dx?". Damage of long duration often occurs, which can be recognised by the inconsiderate operation of local QSOs on the frequency of the DX station.

5. *Deterioration of visual acuity.* The visual acuity of nearly all persons in the fringe group is more or less limited by approximately 80% through the appearance of an oscillating internal ocular pressure.

As a result of this, analog and digital S meters are no longer able to be read accurately. The remaining visual acuity is barely sufficient to read "five nine", and in the advanced stages „you are five nine“ can be observed, even though there is only one (1) other station.

6. *Paralysis of the vocal chords.* This type of deterioration is marked by the fact that the formulation of words fails completely, and only primitive sounds such as "Ooola ola oooooola", driven by instinct, are possible. These are exclusively transmitted in simplex mode. Often, only a whistling into the microphone is possible. In these cases, psychologists diagnose a very rare type of overestimation of personality (I am a bird!).

7. *Technical amnesia.* The operation of the short wave radio station, beloved above all, is no longer possible. Uncontrolled keying of the transmitter takes place. Tuning on the frequency of the DX station, lasting several minutes, replaces transmission technique. All fine technical feel has gone West, and energy is senselessly destroyed with all control elements at one's disposal set to their extremes. Signal bandwidths of more than 5 kHz are not uncommon.

8. *Loss of personality.* The capability for expressing oneself in a socially correct manner is lost. One's own personality suffers from total collapse, which expresses itself in the use of a vocabulary which leaves even seasoned radio amateurs with their mouths agape. In connection with this item, the

*Continued on page 59*

**Adelaide-London**

**58**

**Brisbane-Auckland**

**123**

First F 0-5 Short 16901 km

First 1F7-9 1E0 Short 2291 km

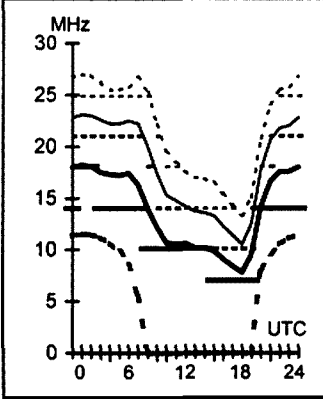
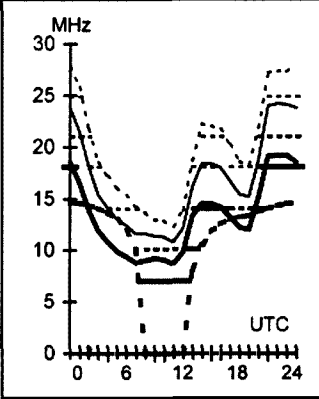

**March 2004**

T index: 52

**Legend**

Frequency scale  
 Time Scale

**HF Predictions**

by **Evan Jarman VK3ANI**  
 34 Alandale Court Blackburn Vic 3130

These graphs show the predicted diurnal variation of key frequencies for the nominated circuits.

These frequencies as identified in the legend are:-

- Upper Decile (F-layer)
- F-layer Maximum Usable Frequency
- E-layer Maximum Usable Frequency
- Optimum Working Frequency (F-layer)
- Absorption Limiting Frequency (D region)

Shown hourly are the highest frequency amateur bands in ranges between these key frequencies, when usable. The path, propagation mode and Australian terminal bearing are also given for each circuit.

These predictions were made with the Ionospheric Prediction Service program: ASAPS Version 4

**Adelaide-Singapore**

**311**

**Brisbane-Honolulu**

**49**

**Canberra-London**

**136**

**Darwin-Honolulu**

**65**

First 2F4-7 2E0 Short 5414 km

Second 4F3-7 3E0 Short 7569 km

First F 0-5 Long 23042 km

First 3F3-8 3E0 Short 8635 km

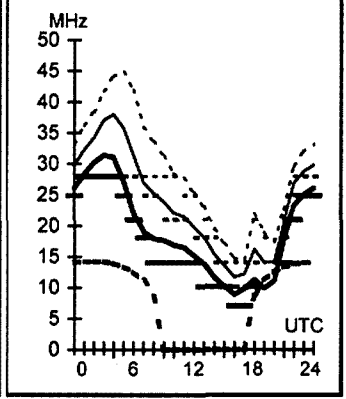
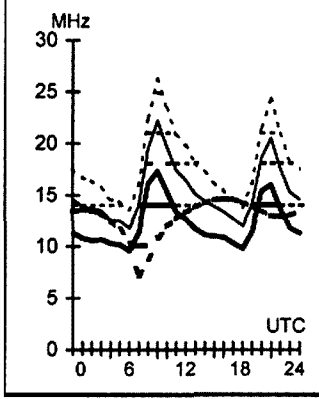
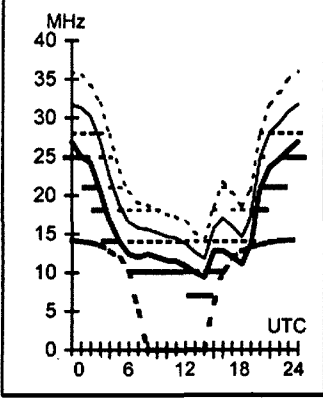
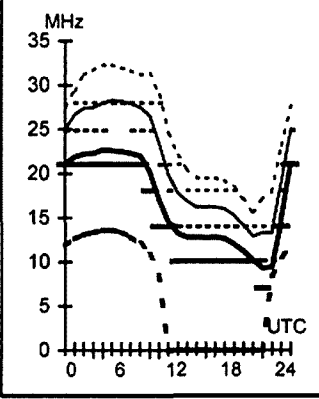

**Adelaide-Tel Aviv**

**291**

**Brisbane-Manila**

**320**

**Canberra-London**

**316**

**Darwin-Osaka**

**5**

Short F 0-5 Short 13125 km

Second 3F9-16 3E1 Short 5811 km

First F 0-5 Short 16982 km

Second 3F11-18 3E Short 5262 km

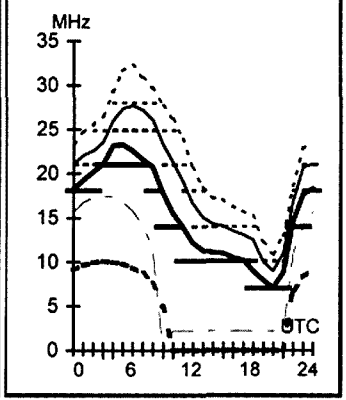
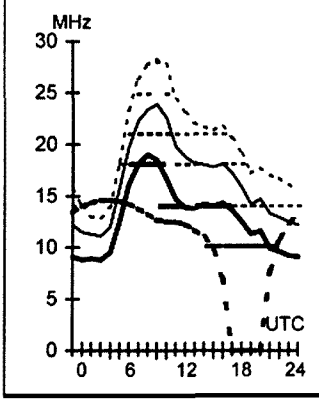
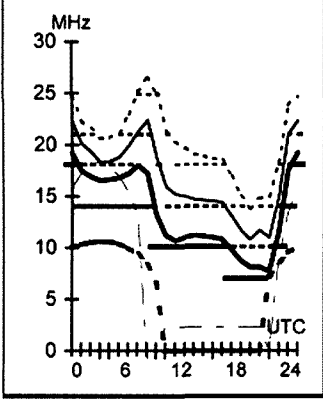
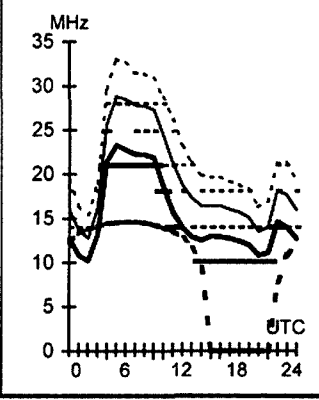

**Adelaide-Wellington**

**114**

**Brisbane-Rome**

**305**

**Canberra-Pretoria**

**231**

**Darwin-Seattle**

**44**

Second 2F13-17 2E Short 3214 km

First F 0-5 Short 16107 km

Second 4F4-7 4E0 Short 10824 km

First F0-5 Short 12262 km

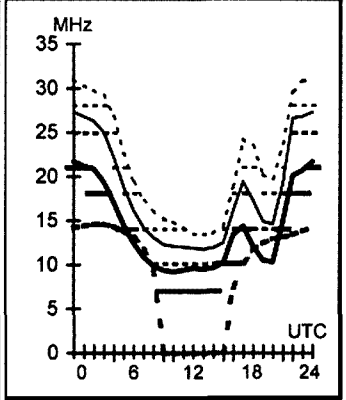
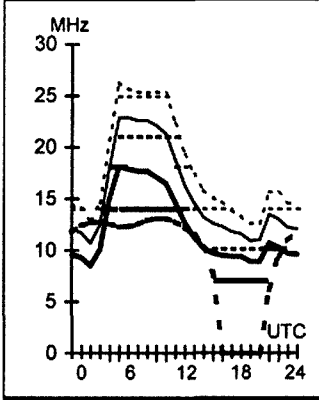
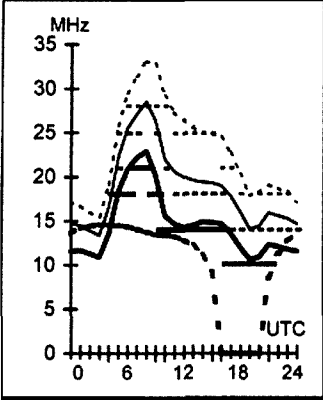
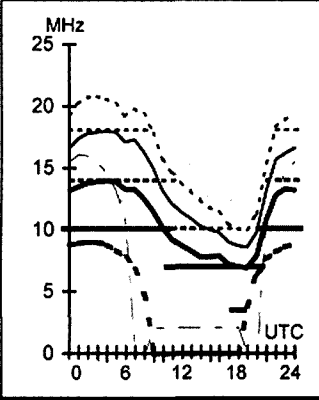

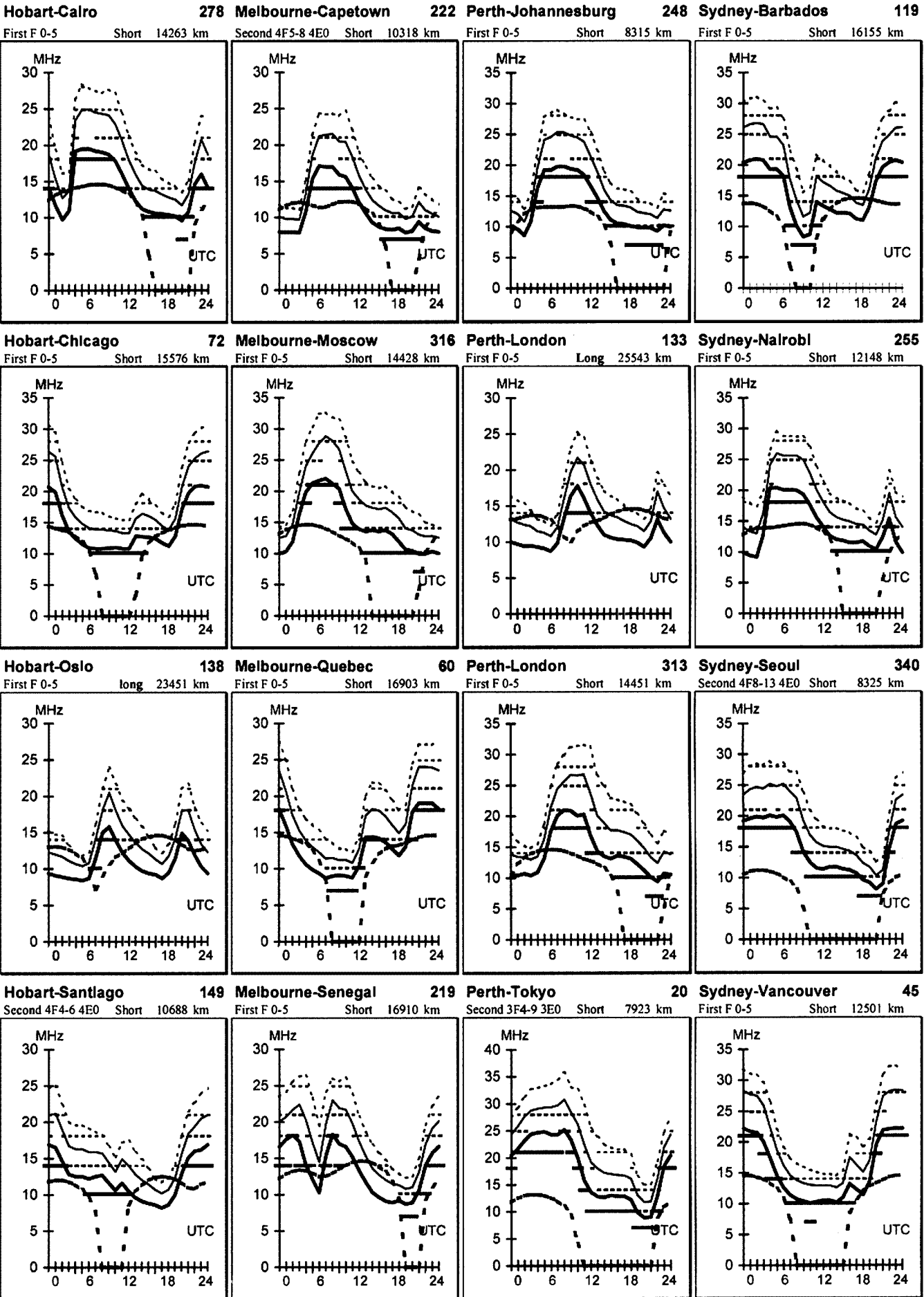

# Beyond our shores

David A. Pilley VK2AYD  
davpll@midcoast.com.au

## 5 MHz in Norway

Norwegian clubs have been experimenting on 60 metres for the past three years.

International Liaison Officer Ole Garpestad, LA2RR of NARL, reports that registered club stations there have enjoyed special permission to test on 5 MHz. Almost all of these club stations have one-letter call sign suffixes and, in some situations, they may use the LE prefix. The authorization is restricted for use in emergency communication or training, and Norwegian stations may not work stations outside of Norway on 5 MHz. Garpestad said Norway's elongated shape makes it impossible to communicate from one end of the country to the other on 80 metre, while 40 metre "has its shortcomings" during hours of darkness.

"We are only allowed to use the two frequencies 5.410 and 5.420 MHz, all modes, 100 W," he said, "but only for communication between Norwegian club stations engaged in emergency communication or training for such communication, so this does not include any station outside of Norway."

(ARRLN/L)

## Long Delay Echoes (LDE)

Have you ever heard this phenomenon? Long Delay Echoes were first documented in the late 1920's and since many occurrences have been reported. However, according to Alan Goodacre (VE3HX), there is still considerable scepticism about their existence. Alan has made a dedicated study of these and reports he has heard hundreds of LDE during his 50 years in Amateur Radio. Most of the LDE exhibit delays ranging from one or two to several seconds and very occasionally delays exceeding half a minute occur!

When studying LDE Alan has his antenna (4x4) pointing vertical and says he is trying to break the celestial pile-ups instead of the terrestrial ones! In order to ensure that any LDE originating

from his transmitter is not merely a hoax, he sends a coded signal. Much of his experiments are conducted on 10 metre. Pointing the antenna toward the auroral zone has produced interesting 'plasma' effects. Alan would be pleased to hear from anyone who observes LDE especially if he or she is able to record both the transmitted signals and echoes. QTHR or ve3hx@rogers.com

(FOC Journal 57)

## QRP in Europe

QRP Over the Christmas period, Richard Newstead, G3CWI, carried out tests with a transmitter running just under 3 microwatt. This small signal was positively identified by two stations in Germany, one in Holland and one in Belgium. The transmissions were on the 10 MHz band using very slow CW with 30-second dot lengths. This is a technique that has been widely used for LF communications at 136 kHz but is less common on the HF bands. Richard was encouraged to try this low power after receiving 'complaints' that earlier test transmissions using 150 milliwatt were "too strong"! There is an active group of HF QRSS experimenters in Europe and details are on the Internet [http://www.cnts.be/knights\\_qrss/](http://www.cnts.be/knights_qrss/)

(RSGB/Qnews)

## Sad news from Nepal

Some bad news about ham radio in Nepal. Charles Harpole, K4VUD, says that his efforts, along with those of 9N1AA, to expand ham radio in that nation and to establish a memorial club station for the late Father Marshall Moran, 9N1MM, are on an indefinite hold. This is due to the disturbed social and political conditions there.

Harpole says that all radios and other gear that was donated some years ago have been distributed to the currently licensed native 9N hams. Harpole says that the gear will come back to a club station someday. Harpole asks that everyone bear with this situation and extend understanding.

(OPDX/ARNewsline)

## United States propose new entry level

The ARRL will ask the FCC to create a new entry-level Amateur Radio license that would include HF phone privileges without requiring a Morse code test. The League also will propose consolidating all current licensees into three classes, retaining the Element 1 Morse requirement—now 5 WPM—only for the highest class. The entry-level license class—being called "Novice" for now—would require a 25-question written exam.

It would offer limited HF CW/data and phone/image privileges on 80, 40, 15 and 10 metre as well as VHF and UHF privileges on 6 and 2 metre and on 222-225 and 430-450 MHz.

Power output would be restricted to 100 W on 80, 40, and 15 metre and to 50 W on 10 metre and up, thus avoiding the need for the more complex RF safety questions in the Novice question pool.

(Qnews)

## USA DXCC rule change

At its January meeting, the ARRL Board of Directors removed paragraph 1.c) "The entity has a separate IARU member-society" from the criteria for determining a DXCC entity. This provision, implemented in 1998 as part of the DXCC 2000 Program, had provided that "An entity will be added to the DXCC List as a political entity if it . . . has a separate IARU member-society." Since then, the rule has allowed for the addition of four new DXCC entities and the retention of one existing entity. Unfortunately, the provision also had the unintended consequence of stimulating applications for IARU membership that do not further the objectives of the IARU, creating an unfortunate and unnecessary administrative burden. The rule change will have no effect on entities created by or as the result of the rule. According to DXCC Rule II, 5. C), "A change in the DXCC criteria shall not affect the status of any entity on the DXCC List at the time of the change." The other two criteria for the determination of a political entity for DXCC continue in effect.



## The BPL fight

Other than the removal of the Morse Code from the licence, the most discussed subject world wide is "Broadband over Powerlines". Recently in North Carolina USA, Progress Energy invited several Raleigh area Radio Amateurs to observe their new Phase II BPL trial in a rural subdivision south of the city.

On January 15th Progress Energy fulfilled their promise to North Carolina Amateur Radio operators and invited several Raleigh area hams to observe their new Phase II BPL trial in a rural subdivision south of the city. The following is a report from Gary Pearce, KN4AQ who, together with other Amateurs, took part in the observation. It was interesting to note that some of the Progress Energy engineers were also Radio Amateurs.

BPL – Broadband over Power Lines – is a system for delivering high speed Internet through neighborhoods and into homes and businesses via the power lines. The technology places radio frequency signals on the power lines in parts of the spectrum between 2 and 80 MHz. Those signals radiate to some extent, and can cause interference to a receiver in the vicinity of the power lines. Naturally this has become cause for great concern among hams worldwide.

The BPL trial consisted of a half-mile of overhead feeder along a highway, and a few dozen homes passed by buried power lines. A "repeater" amplified the signal about every other block.

We were particularly interested in the spectrum used. We learned that each run of BPL, from repeater to repeater, uses

two blocks of spectrum, 2.5 and 3.5 MHz wide. At each repeater, a different block of spectrum is required.

The overhead feeder segment in this trial used spectrum blocks around 25 and 29 MHz. We listened with mobile equipment driving on the road adjacent to the power line, and received S-9 signals in the immediate vicinity of the line. Audio recordings were made.

The signal fell off quickly when driving away from the line, but a ham at a home station almost a mile away heard the 10-meter BPL signal about S-6 using an 80-meter dipole antenna.

Amperion says a Network Operation Center can move any repeater to another block of spectrum, or notch part of a block by remote control, to eliminate interference, but they were unable to demonstrate that for the test.

Even with that flexibility, fitting 3.5 MHz wide blocks of energy in between ham bands would be a delicate jigsaw puzzle. That much "empty" spectrum exists only between the 30, 20 and 17-meter bands, and it's empty only from the perspective of Amateur Radio.

Skip could completely upset the equation. BPL signals, which are similar to very low power QRP Amateur signals, could reflect off the ionosphere and appear hundreds or thousands of miles away. The energy of one isolated trial area might not have much impact, but a mature nationwide system with hundreds or even thousands of installations using the same spectrum blocks could be a very different story.

Yet to come in BPL, is a comprehensive report from the NTIA; an FCC Notice of Proposed Rulemaking for changes in Part 15, based on last year's

Notice of Inquiry; and a decision by the local utility about getting involved in BPL.

The hams at the test included Wake County ARES E-C Tom Brown, N4TAB, Technical Specialist Frank Lynch, W4FAL, and reporter Gary Pearce, KN4AQ.

Here in Australia, both the WIA and ACA are concerned with BPL. If you know of any experiments being carried out by your local energy supplier, please contact your WIA Divisional office.

(ARNewsline)

## Ram QRM

A mysterious transmission that baffled British intelligence analysts for days was caused by a ram rubbing against an aerial mast. Radio operators at GCHQ Cheltenham were baffled by strange high frequency noises coming from an outstation at Scarborough. The noises were unlike anything encountered before and an investigating team initially thought they were coming from spies. Their investigation found the signal only happened during the day and went across all HF bands and were only received in Scarborough. The investigators eventually discovered that a Ram was rubbing its horns against the aerial mast "in between servicing some local Ewes". This (true) story appeared in a recruitment newspaper designed to attract graduates to GCHQ.

(RadCom Jan 04)

*If you have interesting news from overseas, why not share it with us. Email or Snail me. 73 de VK2AYD*

ar

## Pileups are dangerous *continued*

study by the AWC shows a most interesting anomaly. This defect is also frequency-dependent, and has been observed for years to occur prominently in Europe on several frequencies on the 80 m band.

9. *Partial loss of memory.* The patients suffer from a puzzling loss of basic knowledge. Appointments and obligations of all types are totally forgotten. Cases have occurred in which the victims only remembered after divorce that they had previously been married.

10. *Repetition compulsion.* If syndromes 1 to 3 occur simultaneously, then there is an extremely high risk of a so-called "repetition neurosis", and a special type of retrospective temporal jumps. Some poor victims have been observed to still be calling for the rare station after many hours, even though propagation conditions had collapsed a long time previously and the band was dead.

In its last section, this greatly

persuasive study by the AWC describes the range of therapeutic possibilities. The results of systematic experimental studies are, however, not very promising. The only effective cure was determined by means of extended tests in the field: only immediate disabling of the transmitting station seems to result in success.

A copy of the publication "Pileup Operating Influences", 2002 edition, Gloss Publishing, London, can be obtained by sending return postage by email to hb9cic@uska.ch.

ar

# Over to you

## Speaking with a single voice

If the morse code debate did anything, it certainly demonstrated that the amateur radio fraternity can speak with a predominantly single voice when the mood and the perceived cause is right. This particular occasion was made even more remarkable with the WIA joining the chorus of members and non-members alike in singing the praises of a world in which morse proficiency was no longer required. Still in tune, we are all moving on to plan "B", the introduction of an entry class of licence.

Both of these concepts have evolved from the world of the committee process, which, fresh from its success with the horse, must cause us to pause and review the planned objectives in the light of what has happened so far. The death of morse code will, unquestionably, be regretted in the future, but it no longer had a place in the mandatory requirements for HF access. Hopefully, the skill will be preserved in the special interest groups and/or contests. The entry class licence, on the other hand, is a very complex issue that has the potential to change the world of amateur radio forever; Whether it will be for the better or worse is really in the hands of our leaders and this is where serious concerns must be held.

Limited class amateurs who have gained HF privileges already had operating experience and technical skills, probably above the average of those already on HF, and the pooling of this talent will, no doubt, be seen as we inevitably move to new modes. Let there be no doubt that unless we devise some form of attractive entry standard we will soon enough join the other dinosaurs. However, if we get it wrong, we will create a Trojan horse situation that will see our activities subjected to draconian regulatory and cost changes. Keep in mind that the initial thinking in respect of the entry process was directed at the High Schools.

My problem is that I see 2004 as possibly the most important year ever for amateur radio as we jointly join the era of the great spectrum drought and the great expansion of all things wireless that can be sold to a world hungry for information exchange. The recent public

meeting with the ACA certainly revealed that our major problem is that we are essentially leaderless. The ACA saw the WIA as a mere 20% stakeholder in the proceedings and, if the official response from the WIA is examined, it must be perceived that this is the official view also. Positive proof of this situation was well demonstrated by the proceedings being devoted to discussion on the fait accompli morse situation to the exclusion of any discussion on matters such as BPL, class licencing and interference policy, let alone anything to do with spectrum retention.

Be very clear that the weary volunteers are not the problem. Nor are the clubs that are doing a sterling job at the workface. The real problem is with the divisional structuring of the WIA; Unless we can quickly get to some form of central body with the necessary status and legitimacy, and indeed ability, to speak for all amateurs we are literally leaderless.

Let us put the entry level licence on the back burner for the moment and put our total effort into the reforming of the WIA into some form of entity that can represent all amateurs in negotiations with the regulator, perform all administrative functions that can be devolved from the ACA, manage the spectrum allocated for amateur usage and control the activities of amateurs on these frequencies.

When we get to this stage the question of an entry licence, together with a host of other issues can be put back on the table.

**George McLeod VK2FF**

## Interference

I strongly agree with the comments made by Geoff Wilson VK3AMK in the February issue. I recently suffered a noise problem which caused S9+20db interference on HF. I contacted the ACA, who sent their local man round. His attitude was appalling, he claimed that such noise levels were normal for a suburban area and "I should think myself lucky I was ever able to use a radio in a town, and not be surprised that now I can't". He advised me that I should move house to cure the problem

and said the noise was coming from to far away for him to be able to do anything about it.

Even after I had located to noise source and informed him of the exact address, he ignored me and told me the noise was originating from out of town.

After a strongly worded letter of complaint to his managers, reminding them of the exact wording of the ACAs customer charter, the noise problem was repaired. And surprise surprise, he claimed to have "found" the noise source at the address I had told him it would be.

Later his managers claimed they had investigated my complaint, but stated he "had acted in accordance with the usual professional practices in response to a request to investigate interference to amateur frequencies". Sadly, they are probably correct.

What was even more disappointing was the reaction of other amateurs when I told my story to them. One friend summed up the general attitude by saying "you were asking a government employee to work, you can't expect much".

We are customers of the ACA. Their customer charter says they will investigate and assist in resolving inference. If we all lost our apathetic attitude towards the ACAs lack of customer service and complain when they refuse to help us, rather than assume they won't help and not bother contacting them, maybe they will be forced to remember their customer charter when faced with an amateur radio operator with a problem.

**Jack Cook VK2CJC**

**Views expressed in the 'Over to you' column are those of the authors, and do not necessarily reflect the policies of the Wireless Institute of Australia.**

**Send contributions to:**

**The Editor**

**Amateur Radio Magazine**

**34 Hawker Crescent**

**Elizabeth East SA 5112**

**or email:**

**edarmag@chariot.net.au**

# Over to you

## Directional antennae in Canberra circa 2004

Most building and associated work in the A.C.T requires "Development approval" and "Building approval".

Development approval is needed for "An antenna or aerial" if it exceeds 5 metre in height above ground level". Development approval will also be needed if "the aerial" is to be built in front of a residence.

Specific provision is made for exempting "a receiving satellite dish" and a "microwave receiving dish", "on a building".

A "Satellite Receiving dish" of up to 0.65 metre in diameter on a building in a residential area is exempt from development approval providing "the dish and its supports are not visible from the street at the front, or (from) an adjacent block, and it is 12 metre or more from an adjacent block".

"No part of the dish or its supports may project above the roof line of an adjacent pitched roof, and in a non commercial area the dish and its supports must not be conspicuous from an adjacent residential area".

In a non-residential area the "satellite receiving dish" may be up to 1.5 metre in diameter, but the dish and its supports must be colour matched to their background and have a matt finish.

A "receiving microwave antenna" of up to 0.65 metre diameter must be no more than 1 metre high and be colour matched to its background and have a matt finish.

There is no reference to transmitting antennae, or to typical antennae used throughout the Amateur Service.

The basis for these specifications is not known, but they appear as Exemption 7 on page three of the October 2003 ACT Planning and Land Authority Information Bulletin.

If similar criteria were to be enforced on antennae needed for operation in the International Amateur Radio Service, many amateur activities would cease.

Should W.I.A Federal bring this matter to a head, or should we let sleeping dogs lie?

Col Harvey VK1AU

## Echo Link Baghdad

I have just had a 90mins QSO with YI1SRA Laith in Baghdad using the echolink program

Laith was operating from an internet cafe as full internet access has yet to be widely restored in the city. With fellow members of the Baghdad Radio Club he is hoping to install a 2 m repeater in the city which could be linked up to echolink network via the internet allowing on-demand 24 x 7 contact with the city. Such a linked repeater could provide useful communications back home for any ham in Baghdad. Look out for Laith on Echolink, his email is laithtariq@yahoo.com

73 Ian Abel G3ZHI

Maltby Rotherham Yorkshire S66 8DY  
<http://www.qsl.net/g3zhi> - has many ham

radio links

G4NJI IRLP 5200 Echolink 135909

Rotherham simplex 145.2875MHz

GB3XN IRLP 5708 Echolink 153126

## ACA proposals re Licence classes

After reading the November edition of AR, I noticed that the VK1 News, mentioned the current topic on ACA submissions. The point on absorption of the Novice licensees into the body of the AOCPL licensees, is a very valid one.

There is a definite need to provide a realistic bridge between the proposed Foundation licence and the current AOCPL licences. The idea of rolling the Limiteds into the full privileges for each licence class, is a sound idea.

Regards,

Peter Scales VK6IS

## Ex-VK5 Ham honoured on Australia Day

### OAM (General Division)

Steven Norman JOHNSTON, Elizabeth: for services to the community, particularly residents and travellers in remote locations, through the Australian National Four-Wheel-Drive Radio Network.  
from *The Adelaide Advertiser*

- ★ Icom 706MK2G(Unused)\$1,399
- ★ Icom 706MK2G(Used) \$1,199
- ★ Icom 207H(Unused) \$ 479
- ★ Yaesu FT8900R (Unused)\$749
- ★ Kenwood TS2000(Immac) \$2,599
- ★ Kenwood TMD700(immac)\$799
- ★ Icom 910H \$1,999
- ★ Icom 718 \$799
- ★ Icom AH4 (Unused) \$525
- ★ Icom AT180 \$649

Guaranteed to be as described and in 100% working order or your money back.

## Computer interface

Icom and Yaesu \$69

Mobile Kit IC706 (unused) \$79

COD to anywhere in VK

Visit

[www.vk3ajj.com](http://www.vk3ajj.com)

to order online

or telephone Paul (03) 9504 2628

Licensed second hand dealer No.10229 (Vic.)

## radio and electronics school

## Become a Radio Amateur

Or study radio electronics to support your hobby

Australia's premier training institution for **AMATEUR RADIO AND HOBBYISTS**

courses available in radio & electronics technology for all ages

**COURSES AVAILABLE ONLINE**

Be guided through your course by one or more of our 20 experienced volunteer facilitators, email hundreds of other students

**IN A HURRY?**

Become a novice radio operator in 4 weeks with our computer-based

**NOVICE FAST-TRACK COURSE**

Courses for schools, youth organisations and seniors

**Australian Radio Certificate Scheme (ARCS)**

Use our accredited bridging program for radio amateurs to obtain a

**CERTIFICATE IN**

**ELECTROTECHNOLOGY**

Download all course materials free

(CD Rom has a small fee)

For Further Information visit

<http://radioelectronicschool.com>

or email

[manager@radioelectronicschool.com](mailto:manager@radioelectronicschool.com)

Tel: (07) 5573 2795 12-5 (EST)

# Hamads classifieds

# FREE

## FOR SALE ACT

• **SG-230 Auto coupler** \$450. TS-520 w/MC-50 mic, \$325. **Yaesu 290-R11** w/FL-2025 amp & 2 battery cases, \$450. **Yaesu FT-26** paging 2m h/h w/fast charger, speaker mic, MMB & soft case, \$425. **TR-9130** 2m all mode (25 W) \$225. **VHF/UHF amps** pis ring. All plus postage. VK1CJ. Phone 02 6251 1866.

## WANTED ACT

• **Collins radio equipment** including KWM-2/2A, 75S3/32S3/ 312B3/312B4/312B5, 55G1, 270G1/2/3, 30S1/30L1 Linears, 302C3, Directional Wattmeter, SM1/2/3, MM1 Microphones. 75A3, 75A4, 51J4, 51S1, R390A, 651S1, 851S1 Receivers, DL1 Dummy load, 516F2 and PM2 and MP1 Power supplies. PSE Chris VK5CC. Phone 02 6266 6684 (work), 0409 379 507 (mobile) or email christo@senet.com.au.

## FOR SALE NSW

• **Waltz coaxial switch** 2 off DC-900 MHz 1kW each \$100. **BC-221 freq meter** calibration book incl PS \$125. **Two Y type coaxial relays** incl PS control unit pair \$150. **Heavy duty 240 V Variac** \$95. **Heliac LDF4-50 connectors** 45 fit \$150. **G3RUH Mk2 PSK telemetry decoder** \$195. **ARRL UHF/micro manual**, as new \$25. **Attenuator 50 ohm** 7 switches 2-80 DB \$65. A Stowar VK2AS QTHR Phone 02 9416 7784.

• **Kenwood MC-50** mic \$50. **Valves** 6146B S2001A new \$80 pair. Seven 12BY7A (3 new) \$20. **PacComm Pactor controller** \$50.

**Micronta field strength SWR tester** \$30. **Micronta 7 range AC volt ammeter** \$30. **Dick Smith multimeter** model Q1136 \$30. **EA LCR bridge** large type full documentation \$50. **Revex 2 way S20 coax switches** \$20. **Weller soldering unit model TC202D** \$40. Soldering tips scope mini superspeed unit offer, **Oryx 6V 12 W Solderine** instrument \$15. **Power Pack 16 V DC 1 amp** output \$10. **Panel meters**. Various new \$10. **Maurie VK2OW**. Phone 02 9838 1834. Email maurieh@hotmail.com.

• As new **Kenwood TS-80**, purchased new from Mitchell Electronics, one owner from new, comes with microphone, original box, manual and packing. Very little use on air. \$1100.00 ONO. Never been mobile. Email vk2uw@iprimus.com.au, Phone mob 0413 114 953.

• **Triangular tower**, 20 metres to boom, hot dip galvanized. With rotator, and 20 metre spider quad. Dismantles into trailer-length sections for transport. Make an offer. Also **smaller tower**, angle iron unpainted, 8 metres high, in two trailer-length sections. Free to a good home. Roger (used to be) VK2AIV QTHR or email rogergraham@optusnet.com.au.

• **HP-7550 Plotter**, \$100; **Pace, NEC analogue** Sat. Rx's, \$20 ea; **FM-828 A**, \$50; **NEC 3D Monitor**, \$50; **Video Blaster**, \$20; **Grandtec VGA-Video Converter**, \$40; **Panasonic KX-P1180 Printer**, \$20; Various power and speaker transformers and chokes,

ask for list. Roger Woodward VK2DNX, Rogerwoodward10@hotmail.com, Phone 02 9547 2546.

## WANTED NSW

• **2BP1 small CRO tube** for monitor scope. Mick VK2BZE. Phone 02 4297 6406 or email mickh1@swiftsl.com.au..

• **Kenwood SP-950** external speaker. Email vk2uw@iprimus.com.au, Phone mobile 0413 114 953.

• **TH3-Jnr or similar for Net and emergency operations on Saipan**. Owen KH0EX, helps out on the Pacific Inter Island Net, also on emergency comms. If you have a TH3 lying around please let me know as I will ship it to Saipan. Chris, vk2uw@iprimus.com.au.

## FOR SALE VIC

• **Sig gen Marconi no 18**, model TF995/A/3/ S, range 1.5 MHz to 220 MHz AM-CW-FM \$85. Merv VK3AFO QTHR. Phone 02 6024 2537.

• **Morse key Japanese WWII**, 3 types, not too large, \$100, medium \$75, small \$75. VK3BK QTHR. Phone 03 9879 1896.

• **Magnum 10/11 m mobile** or base transceiver, new condition \$250. VK3AIQ, Phone 03 5352 1331.

• **Deceased estate: Tiltover windmill tower**, approx 55 feet high, self-supporting, also includes antenna TH3-Jnr 3el Triband rotatable beam with motor, \$800. Contact Phone 03 5821 6314.

## WANTED VIC

• **Kenwood TS-530s** transceiver in good condition. Please contact Bob VK3VCI. Phone 03 5358 1252, email hdddbob@hotmail.com

• **For a Wireless Set No 11** - One LP PSU box in any condition and/or any of the plugs or leads to suit this. An outer case to suit a No 11 set PSU. **For a Wireless Set No 62**, an aluminium handle assembly to suit the set's front panel. Clem VK3CYD. Phone 03 5126 2064 clem@dcsi.net.au

## FOR SALE QLD

• **Complete amateur radio station comprising: Yaesu FT-1000MP** serial # 61130192, includes operating and service manuals, **Yaesu MD-100** desktop dynamic microphone as well as a hand microphone MH-31, **Yaesu external speaker SP-8**, serial no 7C009, with selectable audio filters, all EC \$3750. **Yaesu FL-7000 HF Solid State**, auto tuning linear amplifier 400 watts, serial # 8M180092, includes instruction manual and **FAS-1-4R remote antenna selector**. All in excellent condition, \$1750. Harry VK4EL. Phone 07 5445 2647.

• **Sequencer for Preamp**, TR relay, Send and PA, homemade, all-new, fully assembled and tested, with 7 page loose leaf manual, 10 in use by amateurs since 1996. For photo and spec pdf send email titled Sequencer Spec. or phone. Firm price \$45.00 + P&P. Geoff VK4GWC QTHR, Phone 07 5445 9986, email geoffcom@powerup.com.au.

## About hamads....

- Hamads may be submitted by *email* or on the *form on the reverse of your current Amateur Radio address flysheet*. Please print carefully and clearly, use upper AND lower case.
- Separate forms for For Sale and Wanted items. Please include name, address STD telephone number and WIA membership number if you do not use the flysheet.
- Deceased estates Hamads will be published in full, even if the ad is not fully radio equipment.
- WIA policy recommends that the serial number of all equipment for sale should be included.
- QTHR means the address is correct in the current WIA Call Book.
- Ordinary Hamads from those who are deemed to be in general electronics retail and wholesale distributive trades should be certified as referring only to private articles not being re-sold for merchandising purposes.
- Commercial advertising (Trade Hamads) are pre-payable at \$25.00 for four lines (twenty words), plus \$2.25 per line (or part thereof), Forty word maximum, minimum charge of \$25.00. Cheques are to be made out to: WIA Hamads.
- Copy typed or printed clearly please, and received by the deadlines shown on page 1 of each issue of Amateur Radio.

Email: [newunltd@bigpond.net.au](mailto:newunltd@bigpond.net.au) Fax: 03 9756 7031

Postal: Newsletters Unlimited, PO Box 431, Monbulk Vic 3793

### TRADE PRACTICES ACT

It is impossible for us to ensure that the advertisements submitted for publication comply with the Trade Practices Act 1974. Therefore, advertisers and advertising agents will appreciate the absolute need for themselves to ensure that the provisions of the Act are strictly complied with.

### VICTORIAN CONSUMER AFFAIRS ACT

All advertisers are advised that advertisements containing only a PO Box number as the address cannot be accepted without the addition of the business address of the box-holder or seller of the goods.

### WANTED QLD

• **Article dealing with the Leader brand signal generator** converting it from valve operation to transistor, contained in the March edition of Amateur Radio 1970. Gladly pay any expenses. Please phone Geoff VK4MGB, Phone 07 46619209 or email: woodhill@halenet.com.au

### FOR SALE SA

• **Data Handbook ICa** for Telecom subscriber sets, mobile cellular radio pagers, \$10. Radio Handbook 9th edition, published 1942 by Editors and Engineers \$12. Radio Handbook 14th edition \$15. Motorola 1974 semiconductor data library \$15. Other data books, contact glmoore1@bigpond.com. Glenn Moore, 27 Wecoma Court, Craigmores SA 5114. Phone 08 8480 7550 BH.

• **Yaesu FT-707**, ideal rig to get on HF, mobile or base. All solid state, 80 to 10, including WARC bands, s/n OL121735, with manual and original packing \$350. **Yaesu FP-707** matching 20 amp P/S and speaker, s/n IC090155 \$150. Ron VK5VH, QTHR. Phone 08 8363 9008

• **Amateur UHF antennas**, used but in good condition: 1 x 88 element 70 cm Jaybeam \$30; 1 x 12 element 70cm Microlink yagi \$20; 1 x 14 element 50cm Microlink yagi \$5. For personal collection only. John Ingham VK5KG 37 Second Ave, Sefton Park SA 5083. Phone 08 8269 3130.

### WANTED SA

• **Coastwatchers complete 3B or 3BZ set** (receiver, transmitter, speaker) or units/parts thereof. Malcolm Haskard VK5BA QTHR, Phone/fax (08) 8280 7192, Email mhaskard@chariot.net.au

### MISCELLANEOUS

• **The WIA QSL Collection (now Federal) requires QSLs.** All types welcome, especially rare DX pictorial cards, special issue. Please contact the Hon Curator, Ken Matchett VK3TL, 4 Sunrise Hill Road, Montrose Vic 3765, tel. (03) 9728 5350

### TRADE ADS

**PSK-31, SSTV, RTTY, SOUNDBOARD**  
Interfaces Fully isolated, ready to plug in.  
<http://www.G3LIV.CO.UK>,  
johnny@melvin.com, G3LIV QTHR.

## Don't forget..

Eastern & Mountain District  
Radio Club Inc

## White elephant sale

Great Ryrie Primary School  
Heathmont Vic

Sunday March 21, 2004

## "Hey, Old Timer..."



If you have been  
licensed for  
more than 25  
years you are

## invited to join the Radio Amateurs Old Timers Club Australia

or if you have been licensed for **less than 25 but more than ten years**, you are invited to become an **Associate Member** of the RAOTC.

In either case a **\$5.00 joining fee plus \$8.00** for one year or **\$15.00** for two years gets you two interesting OTN Journals a year plus good fellowship.

Write to

RAOTC,  
PO Box 1100  
Sandringham VIC 3191

or call Arthur VK3VQ on **03 9598 4262** or  
Bill VK3BR on **03 9584 9512**,

or email to [raotc@raotc.org.au](mailto:raotc@raotc.org.au)  
for an application form.

## HAMADS ARE FREE!

John Moyle Field Day  
March 20 & 21st

Brisbane Amateur Radio Club  
**BARCFEST**  
8 May 2004

### AMIDON FERROMAGNETIC CORES

**For all RF/electronic applications.**  
See our website for complete data on all cores  
including prices.

[www.catchnet.com.au/~rjandusimports](http://www.catchnet.com.au/~rjandusimports)  
**RJ & US Imports**

**PO Box 431, Kiama NSW 2533.**  
**A 3.5" PC disk containing all data is  
available for \$5.00 incl. post.**

#### Agencies

Active Electronics, Tas  
Truscotts, Electronic World, Melb.  
TTS Systems, Tyabb (VIC)  
Tower Communications, Perth

### GROW WIA—MAKE IT YOUR JOB

#### RECRUIT A NEIGHBOUR\*, NON-MEMBER LICENSE HOLDER TODAY.

One to one approaches are very successful and it is in your interest to have a strong WIA.

If you need to know who your neighbouring operators are call John (03) 9756 7797 AH and he'll tell you.



## JACKSON BROS JACKSON OF THE UK IS BACK

Highest quality products  
made by UK craftsmen

Full range now off-the-shelf in Australia.  
Variable and trimmer capacitors,  
reduction drives, dials, ceramic standoffs

#### CATALOGUES, PRICE LISTS AVAILABLE

**CHARLES I COOKSON PTY LTD**

11-13 Port Rd  
Queenstown SA 5014

Tel: (08) 8240 3200 Fax: (08) 8240 3233

FreeFax 1800 673355 within Australia

Email: [jackson@homeplanet.com.au](mailto:jackson@homeplanet.com.au)

**ALL MAJOR CREDIT CARDS ACCEPTED  
SOLE AGENTS AUSTRALIA AND NEW ZEALAND**

### HF, VHF, UHF ANTENNAS & ACCESSORIES

Aluminium towers, guys etc  
Diamond VSWR/PWR meters.

HD copper antenna wire & insulators,  
TX tubes & pwr transistors, Create  
Rotators

Quality coax cables & connectors. Free  
advice & catalogue.

(Disregard the rumours, we are still here!)

#### ATN Antennas

Ph 03 6492 2224 Fax 03 5492 2666,  
email [atnant@iinet.net.au](mailto:atnant@iinet.net.au)

### ADVERTISERS INDEX

AEI .....	20	G & C .....	16
Benelec .....	IFC	Icom .....	OBC
Com-an-tena .....	21	Radio School .....	61
Computer Interface .....	61	TTS .....	8
Connektron .....	20	54s .....	63
EDL .....	45		

<http://www.hamsearch.com>

a not-for-profit site that is a search  
engine for hams



# Division Directory

*The Amateur Radio Service exists for the purpose of self training, intercommunication and technical investigation. It is carried out by amateurs who are duly authorised people interested in radio technique solely with a personal aim and without pecuniary interest.*

The Wireless Institute of Australia represents the interests of all radio amateurs throughout Australia. National representation is handled by the executive office under council direction. There is one councillor for each of the seven Divisions. This directory lists all the Divisional offices, broadcast schedules and subscription rates. All enquiries should be directed to your local Division.

## Broadcast schedules All frequencies MHz. All times are local.

VK1 Division Australian Capital Territory,  
GPO Box 600, Canberra ACT 2601  
President Alan Hawes  
Secretary Deane Walkington  
Treasurer Bob Howie

VK1WX  
VK1DW  
VK1HBH

VK1WI transmits each Thursday evening at 2000 hrs local time on VK1RGI 146.950 MHz and 438.375 MHz including the linked repeater system on VK2RGN Goulburn, VK2RHR High Range, VK2RMP Madden Plains and VK2RTW Wagga Wagga.  
VK1 Home Page <http://www.vk1.wia.ampr.org>  
Annual Membership Fees. Full \$80.00 Pensioner or student \$71.00. Without *Amateur Radio* \$48.00

VK2 Division New South Wales  
109 Wigram St, Parramatta NSW  
(PO Box 9432, Harris Park, 2150)  
(Office hours Tue., Thu., Fri., 1100 to 1400 hrs.)  
Phone 02 9689 2417  
Web: <http://www.wiansw.org.au>  
Freecall 1800 817 644 (NSW only)  
e-mail: [vk2wi@wiansw.org.au](mailto:vk2wi@wiansw.org.au)  
Fax 02 9633 1525

President Brian Kelly  
Secretary Owen Holmwood  
Treasurer Noel May

VK2WBK  
VK2AEJ  
VK2YXM

VK2WI transmits every Sunday at 1000 hrs and 1930 hrs on some or all of the following frequencies (MHz): 1.845, 3.595, 7.146, 10.125, 14.170, 18.120, 21.170, 24.950, 28.320, 29.170, 52.150, 52.525, 144.150, 147.000, 432.150, 438.525, 1273.500. Plus many country regions on 2m and 70cm repeaters. Highlights are included in VK2AWX Newcastle news Monday 1930hrs. on 3.593, 10 metres and local repeaters. The text of the bulletins is available on the Divisional website and packet radio. Continuous slow morse transmissions are provided on 3.699 and 145.650. VK2RSY beacons on 10m, 6m, 2m, 70cm and 23cm. Packet on 144.850.  
Annual Membership Fees. Full \$83.00 Pensioner or student \$66.00. Without *Amateur Radio* \$50.00

VK3 Division Victoria  
40G Victory Boulevard Ashburton VIC 3147  
(Office hours Tue 10.00 -2.30)  
Phone 03 9885 9261  
Web: <http://www.wiavic.org.au>  
Fax 03 9885 9298  
e-mail: [wiavic@wiavic.org.au](mailto:wiavic@wiavic.org.au)

President Jim Linton  
Secretary John Brown  
Treasurer Jim Baxter

VK3PC  
VK3JJB  
VK3DBQ

VK3BWI broadcasts on the 1st Sunday of the month at 20.00hrs Primary frequencies, 3.615 DSB, 7.085 LSB, and FM(R)s VK3RML 146.700, VK3RMM 147.250, VK3RWG 147.225, and 70 cm FM(R)s VK3ROU 438.225, and VK3RMU 438.075. Major news under call VK3ZWI on Victorian packet BBS and WIA VIC Web Site.  
Annual Membership Fees. Full \$87.00 Pensioner or student \$72.00. Without *Amateur Radio* \$55.00

VK4 Division Queensland  
PO Box 199, Wavell Heights, Qld. 4012  
Phone 07 3221 9377  
e-mail: [office@wiaq.powerup.com.au](mailto:office@wiaq.powerup.com.au)  
Fax 07 3266 4929  
Web: <http://www.wia.org.au/vk4>

President Ewan McLeod  
Secretary Bob Cumming  
Treasurer David Gulley

VK4ERM  
VK4YBN  
VK4DCG

EVERY SUNDAY, at 9am LOCAL (Sat 2300 UTC). From Far North Queensland On 7.070/2 MHz. From South East Queensland:- 1.825, 3.605, 7.118, 10.135, 14.342, 21.175, 52.525, 147.000, 438.500 MHz. Right throughout VK4 scan 146.6 to 148.0 MHz again at 9am local. SUNDAY 6:45pm hear LAST week's QNEWS broadcast 3.605 and 147.0 MHz from South East Queensland. MONDAY 7:00pm hear YESTERDAY's news again on 146.875 MHz broadcast from Brisbane's Bayside repeater, and then 7:30pm on 3.605 and 147.0 MHz from Stn East Queensland. Text editions on packet Internet and personal email, visit [www.wia.org.au/vk4](http://www.wia.org.au/vk4) News is updated 24/7 in both text and audio on this site. MP3 Audio from same website by 2300 hours each Saturday. Contact QNEWS, packet sp QNEWS@VK4WIE.BNE.QLD.AUS.OC email [qnews@wia.org.au](mailto:qnews@wia.org.au)  
Annual Membership Fees. Full \$95.00 Pensioner or student \$81.00. Without *Amateur Radio* \$63.00

VK5 Division South Australia and Northern Territory  
(GPO Box 1234 Adelaide SA 5001)  
Phone 08 8294 2992  
web: <http://www.sant.wia.org.au>  
email: [peter.reichelt@bigpond.com](mailto:peter.reichelt@bigpond.com)

President Trevor Quick  
Secretary Peter Reichelt  
Treasurer Trevor Quick

VK5ATQ  
VK5APR  
VK5ATQ

VK5WI: 1843 kHz AM, 3.550 MHz LSB, 7.095 AM, 14.175 USB, 28.470 USB, 53.100 FM, 147.000 FM Adelaide, 146.800 FM Mildura, 146.900 FM South East, 146.925 FM Central North, 438.475 FM Adelaide North, ATV Ch 35 579.250 Adelaide. (NT) 3.555 LSB, 7.065 LSB, 10.125 USB, 146.700 FM, 0900 hrs Sunday. The repeat of the broadcast occurs Monday Nights at 1930hrs on 3585kHz and 146.675 MHz FM. The broadcast is available in 'Realaudio' format from the website at [www.sant.wia.org.au/Broadcast](http://www.sant.wia.org.au/Broadcast) Page area.  
Annual Membership Fees. Full \$91.00 Pensioner or student \$76.00. Without *Amateur Radio* \$61.00

VK6 Division Western Australia  
PO Box 10 West Perth WA 6872  
Phone 08 9351 8873  
Web: <http://www.wia.org.au/vk6>  
e-mail: [vk6@wia.org.au](mailto:vk6@wia.org.au)

President Neil Penfold  
Secretary Roy Watkins  
Treasurer Bruce Hedland-Thomas

VK6NE  
VK6XV  
VK6OO

VK6WIA: 146.700 FM(R) Perth at 0930hrs Sunday relayed on 1.865, 3.564, 7.075, 10.125, 14.116, 14.175, 21.185, 29.120 FM, 50.150 and 438.525 MHz, Country relays 3.582, 147.200 (R) Cataby, 147.350 (R) Busseton, 146.900 (R) Mt William (Bunbury), 147.000 (R) Katanning and 147.250 (R) Mt Saddleback. Broadcast repeated on 146.700 at 1900 hrs Sunday relayed on 1.865, 3.564 and 438.525 MHz : country relays on 146.900, 147.000, 147.200, 147.250 and 147.350 MHz. Also in "Real Audio" format from the VK6 WIA website  
Annual Membership Fees. Full \$71.00 Pensioner or student \$65.00. Without *Amateur Radio* \$39.00

VK7 Division Tasmania  
PO Box 371 Hobart TAS 7001  
Phone 03 6234 3553 (BH)  
Web: <http://www.wia.org.au/vk7>  
email: [vk7tg@wia.org.au](mailto:vk7tg@wia.org.au)

President Phil Corby  
Secretary Dale Barnes  
Treasurer Dale Barnes

VK7ZAX  
VK7DG  
VK7DG

VK7WI: At 0930 hrs every Sunday on 146.700 MHz FM (VK7RHT, Hobart) and relayed on 147.000 MHz FM (VK7RAA, Launceston), 146.625 MHz FM (VK7RMD, Ulverstone), 146.750 MHz FM (VK7RNW, Ulverstone), 147.075 MHz FM (VK7RWC, Rosebery), 3.57 MHz LSB, 7.090 MHz LSB, 14.130 MHz USB and UHF CB Channel 15 in Hobart area.  
Annual Membership Fees. Full \$90.00 Pensioner or student \$77.00. Without *Amateur Radio* \$57.00

VK8 Northern Territory is part of the VK5 Division and relays broadcasts from VK5 as shown, received on 14 or 28 MHz. The broadcast is downloaded via the Internet.

# Bayside District Amateur Radio Society Inc

## *supporting the community*



Paddy VK4JPD (left), President of BDARS in the Redlands Shire is shown presenting a cheque to Darryl Humphries-the Cordinator, Resource Centre in the Library of the Alexandra Hills State High School. The proceeds will be used by Darryl to purchase suitable books which will have acknowledgement labels affixed to them. BDARS meet in one of the school classrooms free of charge. (Photo by Victor VK4WST)



The President of BDARS, Paddy VK4JPD is shown presenting our education award to Rod VK4VRD (formerly VK4HRD) at his home in Kenmore; a western suburb of Brisbane, for his success in upgrading his licence from Novice Limited to Novice. Rod accomplished this in spite of suffering a chronic illness and being severely vision impaired. Congratulations Rod! (Photo by Victor VK4WST, Secretary)

# ICOM'S GREAT CHAMPIONS



**NEW**

ICOM FLAGSHIP TRANSCEIVER

**IC-F7800 HF\*6m**

- Four 32-bit floating point DSP units • +40dBm ultra high intercept point
- Automatic tracking pre-selector • Two completely independent receiver circuits • 200W output power at full duty • Ultra high frequency stability • 7-inch wide color TFT LCD • Multi function spectrum scope
- RTTY / PSK31 operation without PC connection • Professional 6m receiver
- Digital Voice Recorder • CF memory card • Morse Free Package.



**IC-706MKIIG HF • VHF UHF**

**The amazing evolution of the legendary 706.**

Now includes 70cm @ 20W and 50W on 2m

- Standard feature dsp • Built in sub tone encoder & decoder
- Tone scan • Mosfet PA • You get base station performance and features in a mobile rig sized package • Morse Free Package.

**NO FILTERS REQUIRED**



**IC-7400**

- Sharp & soft IF filter shape • 100W HF /6m /2m • Digital twin PBT
- DSP • SSB / CW synchronous tuning • Built in antenna tuner
- RTTY demod / decoder • Digital RF speech processor
- Microphone equaliser • Morse Free Package.

**IC-T90A A new 5W Triband handheld**

- VHF/UHF FM 2M, 6M, & 70CM Wideband receive 495 KHz - 1 GHz
- 555 Alphanumeric memories • 13 Scan modes DTCS & CTCSS encode & decode DTMF encoder (10 memories) Wide/narrow transmit capability.



**NEW**



**IC-208H 2m FM Dual Band Transceiver**

Dual Band Features at a Single Band Price • 55W / 2m, 50W / 70cm

- Built-in CTCSS and DTCS Tone Squelch
- Detachable Front Panel (Req. OPC-600/601 Option)
- 9600 bps Packet Operation • 512 Memory Channel
- Standard Mic. Supplied:HM133.

**ICOM**  
Clearly Ahead

**2 YR WARRANTY**

find your nearest ICOM dealer at  
[www.icom.net.au](http://www.icom.net.au) or (03) 9387 0666



The magazine for  
**AUSTRALIAN**  
AMATEURS



April 2004  
Volume 72 No 4



# Amateur Radio

\$6.50  
incl GST

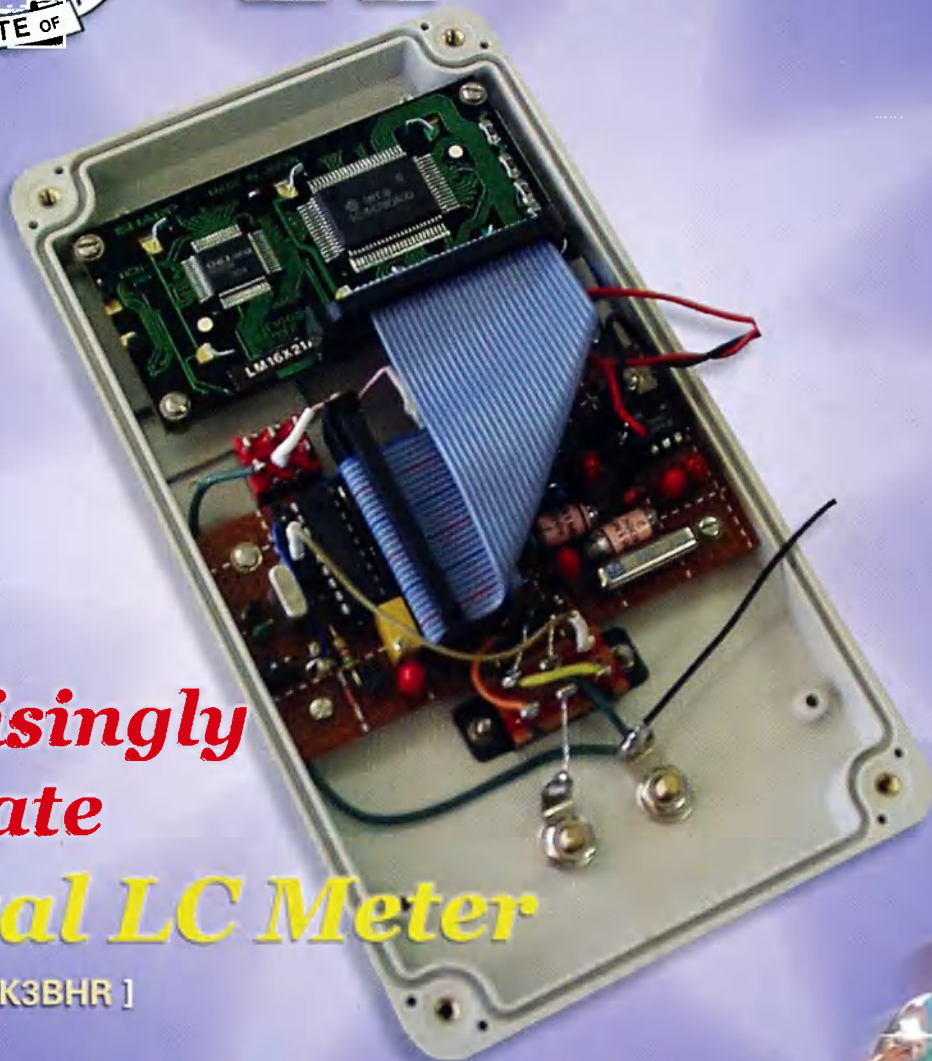

## *The surprisingly accurate Digital LC Meter*

[ Phil Rice VK3BHR ]

- **Many unqualified "Amateurs"** – the recruitment challenge  
[ Jim Linton VK3PC ]
- **A simple TV-aligned crystal frequency**  
[ Drew Diamond VK3XU ]
- **A dummy load and power meter for HF**  
[ Jim Tregellas VK5JST ]
- **PCI sound card interface**  
[ John Hodgkinson VK2BHO ]



*The pressure  
is ON  
2003 ARDF  
CHAMPIONSHIPS*





**NEW MODEL**

## FT-857D



**NOW includes DSP2 unit built-in**

- Ultra Compact + All Mode Transceiver
- 160-10m / 6m / 2m / 70cm
- 100W, 100W, 50W, 20W

**New Price \$1587.50**

**SUPER-SPECIAL PRICING**

## FT-897



**Now includes TXC09 Option Free**

- Portable / Mobile / Base All Mode Txr
- 160-10m / 6m / 2m / 70cm
- 100W, 100W, 50W, 20W

**New Price \$1690.90**

## FT-817



- Ultra Compact 135 x 38 x 165mm
- All Mode Portable Transceiver
- 160-10m / 6m / 2m / 70cm
- 0.5-5 Watts Selectable

**New Price \$1248.70**

## VX 1



**New Price \$343.10**

## VX 2



**New Price \$415.00**

## VX 5



**New Price \$693.50**

**BENELEC NOW OFFERS A '3 YEAR WARRANTY'**

for all radios including those sold in the last 12 months

**ALL OF OUR PRICES INCLUDE GST**

Colour brochures, Operating Manuals and full details on all Yaesu products can be found on our web site! Check it out...

[www.benelec.com.au](http://www.benelec.com.au)

NSW  
Andrews Communications Systems  
Tel 02 9636 9060 lee.andrews1@bigpond.com

Newcastle Pro Sound & Communications  
Tel 02 4965 6899 sales@newcastleprosound.com.au

Action Communications  
Tel 02 4732 2788 action@pnc.com.au

### Authorised Yaesu Retailers

VIC  
Strictly Ham P/L  
Tel 03 9729 7656  
sales@strictlyham.com.au

G&C Communications  
Tel 03 5996 3298  
gcomm@netspace.net.au

Qld  
Kyle Communications  
Tel 07 3857 4400  
mark@kyle.com.au

SA/NT  
POSNAV Systems P/L  
Tel 08 8342 4700  
brenton@posnav.com.au





# Amateur Radio

Volume 72, Number 4

April 2004

The Journal of the Wireless  
Institute of Australia

ISSN 0002-6859

## General

Many unqualified "amateurs" – the recruitment challenge .....	7
<i>Jim Linton VK3PC</i>	
IARU Region 3 ARDF Championships .....	13
<i>Jim Linton VK3PC</i>	
A bouquet for Echo Link .....	17
<i>Kingsley Savage VK5BHP</i>	
Never give up! .....	22
<i>(Name &amp; address supplied)</i>	
New ARRL DXCC Ruling February 2004 .....	25
<i>Wayne Mills N7NG</i>	
Book Review: Pure homebrew .....	47
<i>Chris VK2GV</i>	
Donated ham radios for Somalia .....	55
<i>Sam Voron VK2BVS</i>	

## Technical

A surprisingly accurate digital LC meter .....	4
<i>Phil Rice VK3BHR</i>	
A dummy load and power meter for HF .....	9
<i>Jim Tregellas VK5JST</i>	
A simple TV-aligned crystal frequency reference .....	18
<i>Drew Diamond, VK3XU</i>	
PCI sound card interface .....	24
<i>John Hodgkinson VK2BHO</i>	
More on solid-state lamps (Technical Abstracts) .....	26
<i>Peter Gibson VK3AZL</i>	
The load shedder (Technical Abstracts) .....	26
<i>Peter Gibson VK3AZL</i>	
A VHF/UHF discone antenna (Technical Abstracts) .....	51
<i>Peter Gibson VK3AZL</i>	

## Columns

ALARA .....	36	Gridsquare Standings .....	48
AMSAT .....	39	Hamads .....	54
Beyond Our Shores .....	35	HF Predictions .....	52
Book Review .....	47	Intruder Watch .....	38
Contests .....	41	Over to you .....	50
Club News .....	37, 38	Silent Key .....	15, 49, 50
WIA Division News		Spotlight on SWLing .....	33
VK1 News .....	31	Technical Abstracts .....	26, 51
VK2 News .....	31	VHF-UHF an expanding world .....	45
VK3 News .....	32	WIA Comment .....	3
VK6 News .....	33	WIA Division Directory .....	56
VK7 News .....	34	WIA Federal Directory .....	2
Editor's Comment .....	2		

## Our Cover this month

"With the aid of a little easily copied FREE software, you can have your own (possibly) accurate inductance and capacitance meter." See article on page 4 by Phil Rice VK3BHR

### Contributions to Amateur Radio

Amateur Radio is a forum for WIA members' amateur radio experiments, experiences opinions and news. Manuscripts with drawings and or photos are always welcome and will be considered for publication. Articles on disc or email are especially welcome. The WIA cannot be responsible for loss or damage to any material. A pamphlet, How to write for Amateur Radio is available from the Federal Office on receipt of a stamped self-addressed envelope.

### Back Issues

Back issues are available directly from the WIA Federal

Office (until stocks are exhausted), at \$4.00 each (including postage within Australia) to members.

### Photostat copies

When back issues are no longer available, photocopies of articles are available to members at \$2.50 each (plus an additional \$2 for each additional issue in which the article appears).

### Disclaimer

The opinions expressed in this publication do not necessarily reflect the official view of the WIA and the WIA cannot be held responsible for incorrect information published.

## Editorial

Editor: Colwyn Low VK5UE  
edarmag@chariot.net.au

Technical Editor: Peter Gibson VK3AZL

Publications Committee Members  
Brenda Edmonds VK3KT  
Ron Fisher VK3OM  
Don Jackson VK3DBB  
Evan Jarman VK3ANI  
Tom Potter VK3UBS  
Bill Roper VK3BR

## Submission of material to Amateur Radio Magazine

General and Technical articles to Secretary  
AR Publications Committee  
3 Tamar Court  
Mentone VIC 3194  
or armag@optusnet.com.au

Columns and Letters to the Editor to Editor  
AR Magazine  
34 Hawker Crescent  
Elizabeth East SA 5112  
or edarmag@chariot.net.au  
(Tel and Fax 08 8265 2138)

Hamads to "Hamads" Newsletters Unlimited  
PO Box 431  
Monbulk VIC 3793  
Pax 03 9756 7031  
newunltd@bigpond.net.au

Advertising  
All enquiries to Newsletters Unlimited  
PO Box 431  
Monbulk Vic 3793  
Phone: 03 9756 7797  
Fax: 03 9756 7031  
newunltd@bigpond.net.au

Registered Office  
10/229 Balaclava Road,  
Caulfield North VIC 3161  
Australia  
Phone: 03 9528 5962

## Production Deadlines

Advertising booking and articles for publication 10<sup>th</sup> of preceding month.

Hamads and advertising material deadline 18<sup>th</sup> day of preceding month

The contents of Amateur Radio are Copyright  
Wireless Institute of Australia © 2004

## Amateur Radio Service

A radiocommunication service for the purpose of self-training, intercommunication and technical investigation carried out by amateurs; that is, by duly authorised persons interested in radio technique solely with a personal aim and without pecuniary interest.

## Wireless Institute of Australia

The world's first and oldest  
National Radio Society  
Founded 1910

Representing

The Australian Amateur Radio Service

Member of the

International Amateur Radio Union

Registered Federal Office of the WIA

10/229 Balaclava Road  
Caulfield North Vic 3181

Tel: (03) 9526 5962 Fax (03) 9523 6191  
<http://www.wia.org.au>

All mail to

PQ Box 2175 Caulfield Junction VIC 3181  
Business hours: 9.30am-3pm weekdays

### Federal Secretary

Peter Nalsh VK2BPN

### Federal Office staff

June Fox Bookkeeper  
Rita Trebilco VK3IF Examinations Officer

### Council

President	Ernest Hocking	VK1LK
VK1 Federal Councillor	Gilbert Hughes	VK1GH
VK2 Federal Councillor	Terry Davies	VK2KDK
VK3 Federal Councillor	Jim Linton	VK3PC
VK4 Federal Councillor	Glenn Dunstan	VK4DU
VK5 Federal Councillor	David Box	VK5OV
VK6 Federal Councillor	Trevor Ward	VK6HTW
VK7 Federal Councillor	Phil Corby	VK7ZAX

### Executive

David Jones	VK4OF
David Pilley	VK2AYD
Don Wilschefski	VK4BY
Brenda Edmonds	VK3KT (ex officio)

### Federal Coordinators

AMSAT	Graham Ratcliff	VK5AGR
ARDF	Jack Bramham	VK3WWW
Awards	Mal Johnson	VK8LC
Contests	t.b.a.	
Education	Ron Smith	VK4AGS
FTAC	John Martin	VK3KWA
Historian	John Edmonds	VK3AFU
IARU	Nell Penfold	VK6NE
Intruder Watch	Harry Andersson	VK8HA
International Travel Host	John Miller	VK3DJM
ITU Conference and study group	Gilbert Hughes	VK1GH
QSL Manager (VKE, VKO)	Nell Penfold	VK6NE
Videotapes	VK2 Division	
Web	Joe Burford	VK5UJ
WICEN	John Welr	VK3ZR

### ACA Liaison Team

Peter Nalsh VK2BPN,  
Gilbert Hughes VK1GH  
Keith Malcolm VK1ZKM  
Glenn Dunstan VK4DU

## Editorial comment

Colwyn Low VK8UE

## The John Moyle Field Day had a great weekend!

I had an interesting expedition to my favourite Hill and some gear worked and some did not. The batteries kept up until I had had enough of the cold wind from the south. I hope the rest of you who ventured out had a good time. Some reports and pictures next month.

## Spirited debate

I have received several letters and documents which are too large to place in AR but I would bring to your attention the proposal on new amateur licencing from Sam Voron VK2BVS, 2 Griffith Ave, Roseville, NSW 2069, phone 02 94171066, Email svoron@hotmail.com.

## Interference problems

I also received a newspaper clipping from the Mansfield Courier describing problems with vehicle locking systems in proximity to shop barcode scanning equipment and a mobile phone tower which were presumably producing interaction product frequencies in the vehicle locking system passband.

## The big topic at the Convention

The Federal Convention is nearly with us and the big topic will surely be the proposal for a Federally based structure for the WIA. Already the state structures are feeling threatened and the problems of who will control what are being raised. Now to a degree the states which have worked hard to buy property should control and benefit from their diligence. I would have thought that as the Divisions were going to continue they could continue to hold the assets that they currently control. After all owning property is not WIA core business. This is the realm of local clubs. It would be a shame to see the chance of

creating a truly national Amateur Radio Society in Australia founder on these reefs of state rivalries.

## What to do about unlicensed operators

I have had several emails re unlicensed operation in Australia. It would appear that there are a number of people who think they can invent Australian calls and use them as they please and others who ignore the detailed requirements of our licensing system. The only way to deal with this problem is to ignore the operators when they appear on our bands. If they are operating their own private nets then log the information, call signs used, time, frequency, type of traffic and pass it to our Intruder Watch coordinators and the ACA.

## What all contributors should know!

One final thing we have changed the addresses for receipt of material for publication in Amateur Radio Magazine:

- Technical and general articles, that is the material which is mainly in the front of the magazine goes to "The Secretary, AR Publications Committee, 3 Tamar Court, Mentone, Victoria, 3194 or to [armag@optus.com.au](mailto:armag@optus.com.au). We can accept whole documents electronically. Hard copy should be accompanied by an electronic copy on disc if at all possible. We can only handle some drawing program formats so please check before sending circuit diagrams and drawings electronically.
- Short articles of immediate interest, club news, Over To You letters come directly to the Editor.
- Ham ads and all advertising go directly to Newsletters Unlimited. All addresses on page 1



<http://www.wia.org.au>

## Federal WIA AGM

I am writing this month's notes just a week or so before the 2004 WIA AGM. As such it is a very frustrating time to have to write them. At this time I really cannot predict the outcome of the current round of discussions amongst divisions and members of the institute on the question of whether we should move to a national body or remain in our current structure of a federation of separate divisions. Many of you will by now have had a chance to read and discuss the proposed National constitution. I also commend you to keep a close eye on the Federal web site for updates and additional discussion documents. Even if the

outcome of the AGM is to move towards a national WIA then there will be a large amount of work that needs to be performed in transitioning the current divisional structure into a national body so you can expect to see a constant flow of documents appearing on the web site.

Having performed the role of WIA Federal President for the last three years my own mind is firmly made up and for me a united national body is the only way to go. I say this for a number of reasons. These include the difficulties of financing the Federal group as well as finding the people to support the current Federal functions (this being in

addition to the volunteers needed to support the current WIA divisions and local radio clubs). However for me the main reason for seeking a national body is to enable us to get on with the business of promoting amateur radio as the hobby of choice for a range of aspiring engineers and professionals. A truly national WIA, in conjunction with an entry level licence, will be ideally placed to market amateur radio to a wide cross section of the community and demonstrate the immense value that the hobby has to contribute to the overall intellectual capital of Australia.

## Other activities

The last month has also kept me busy with a number of other matters. The month started with the annual trip to the Wyong Field day. This was for me as usual a great day out. This year was even more special in that I had the opportunity to take receipt of a Yaesu FT817 from David Benchoam of Benelec Electronics. David had kindly agreed to donate the FT817 to the WIA "Welcome to HF QSO Party". With both David and the winner, Norman Partridge VK2TOP, present at Wyong it was also a great opportunity to present the prize. Thanks once again to David and Benelec Electronics for offering the prize. I hope to have some pictures of the presentation in this or the next issue of AR.

At this time the last prize to be presented is on its way to John Sutton VK4TJS. John lives in Kelso in Far North Queensland and this ex-pom knows that as much as I might like to drop around to make the presentation myself; that Kelso is a little off the beaten track. I hope to be able to present John his FT100 from the Federal WIA at the AGM or failing that to arrange for the presentation to be made by a representative of the VK4 Division in the very near future.

Wyong was also an opportunity to meet up with John Dawes VK5BJE. John had approached me earlier this year to

examine options to develop a history of the WIA in preparation for its 100 year celebrations. In order to progress this matter I will be issuing a request for expressions of interest from anyone who would be prepared to undertake the research, data collection and writing of such an official history of the Institute.

## Further losses in the 70cm band

On a less optimistic front I met earlier this month with the ACA to discuss the migration of amateur repeater links out of the 420-430 MHz band. As I alerted you to before Christmas this in preparation for the implementation of an upgrade to the Victorian Metropolitan Police radio network. On 15 March 2004 the Victorian Government announced the outcome of its choice of provider for this new service (refer to [www.dpc.gov.au](http://www.dpc.gov.au) for a more detailed statement). This network upgrade is seen as a key part of the Australian preparations for the security of the 2005 Commonwealth Games in light of the current worldwide terrorist situation.

This loss of amateur spectrum continues a theme first encountered in VK6 where demand for spectrum for public protection purposes has entailed that the amateur community vacates part of the band to allow agencies such as the police, fire and ambulance access to

much needed spectrum to serve the increasing community demand for their services.

Finally this month I have been closely monitoring the situation with respect to various intruders on our bands. With the ever increasing pressure across Government to do more with less the ACA is finding it ever more difficult to keep up with the demand for investigations of violations to spectrum access. In order to ensure that the amateur spectrum receives a fair allocation of ACA investigation time the Federal WIA intruder monitoring group is investigating how we can better streamline the collection, analysis and reporting of intruder incidents. If we can collect this information in a consolidated manner and then ensure that when we approach the ACA that we only do so in cases where we are clear that a violation has occurred then we will be in a much better position to get results. If any of you are interested in this matter then I would be delighted to hear from you so that I can put you in touch with the group that is currently working on this.

Anyway I'd better bring this to a close since I still have a number of things to prepare for the 2004 AGM. 73s to you all and I look forward to hearing your comments, either directly or via the divisions. All the best in amateur radio

Ernie Hocking VK1LK

**Cover story**

# A surprisingly accurate digital LC meter

**Phil Rice VK3BHR**  
 Lot 601K Durston's Road, Maiden Gully Vic. 3551  
<http://ironbark.bendigo.latrobe.edu.au/~rice>

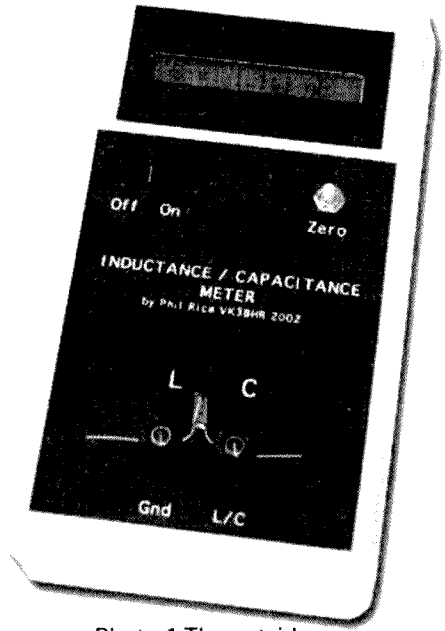

Photo 1 The outside

**Why?**

Several years ago, I built a "one transistor oscillator", which I used to measure small inductance values (by measuring the frequency of oscillation and applying the formula for resonant frequency of an LC circuit).

Following from the frequency meter project published in the September 2002 issue of AR, I wondered if I could combine the oscillator and frequency meter to make a direct reading inductance/capacitance meter.

I had seen an instrument that did exactly this on the web at <http://www.aade.com/lcmeter.htm> for \$120US and thought, "I'd like one of them".

**How?**

The AADE web site gave details of how their design worked and a circuit diagram. This led me to propose a design using their oscillator, but in a slightly different way. Like theirs, mine would measure the free running frequency of an LC oscillator, and then successively apply a known capacitance then the unknown inductor (or capacitor). After that, the maths used to calculate inductance or capacitance would be quite different. A brief play with the required formulas (see Fig 1) showed that it was COMPLICATED! At this time the maths all seemed too hard.

**A lucky find!**

Then I discovered Microchip Application Note - "AN575 IEEE754 Compliant Floating Point routines" (add subtract, divide and multiply). It didn't take long to load the code into a PIC 16F84, but the 32 bit floating point routines nearly filled the entire chip. This left no room for the frequency measuring, inductance/capacitance calculations and display formatting instructions.

At this stage, I found that I could use

Capacitance	Inductance
$F_1 = \frac{1}{2\pi\sqrt{LC}} \dots\dots(1)$	$F_1 = \frac{1}{2\pi\sqrt{LC}} \dots\dots(5)$
$F_2 = \frac{1}{2\pi\sqrt{L(C+C_{cal})}} \dots\dots(2)$	$F_2 = \frac{1}{2\pi\sqrt{L(C+C_{cal})}} \dots\dots(6)$
$F_3 = \frac{1}{2\pi\sqrt{L(C+C_u)}} \dots\dots(3)$	$F_3 = \frac{1}{2\pi\sqrt{(L+L_u)C}} \dots\dots(7)$
$C_u = \frac{\left(\frac{F_1}{F_3}\right)^2 - 1}{\left(\frac{F_1}{F_2}\right)^2 - 1} \times C_{cal} \dots\dots(4)$	$L_u = \left[ \left(\frac{F_1}{F_3}\right)^2 - 1 \right] \times \left[ \left(\frac{F_1}{F_2}\right)^2 - 1 \right] \times \frac{1}{C_{cal}} \times \left(\frac{1}{2\pi F_1}\right)^2 \dots\dots(8)$

Figure 1 The equations

the Microchip 24 bit Floating Point code and, by being a little careful, could fit it all in and achieve a numerical error of less than 0.1%. Overall accuracy would then be limited by the oscillator behaviour and one "calibration capacitor".

### The hardware!

This is a combination of two designs. The oscillator design originally came from the AADE LC meter web page. It uses an LM311 comparator with positive feedback to make a parallel LC oscillator with digital output. It seems to oscillate readily over a wide range of L and C values. Hopefully, it follows the "well known formula for resonant frequency". The frequency measuring part is a cut down version of the September 2002 Frequency Meter article. The original idea for this came from the web pages of Eamon Skelton, EI9GQ.

### The software

This was the hard part (and the fun part) of the project. Luckily, it's easy to duplicate and the copies work as well as the original. You can get copies of the "hex" code from the web page <http://ironbark.bendigo.latrobe.edu.au/~rice/lc/index.html>. The program takes two measurements when "zeroed". First the oscillation frequency is measured using only the internal inductor and capacitor (F1).

Then a standard capacitor (Ccal=1000 pF +/- 1%) is added in parallel and the frequency is measured again (F2).

The software then goes into a repeating loop where it measures the frequency of the oscillator using the internal inductor and capacitor and whatever unknown external inductor or capacitor is connected (F3).

Some serious maths (formulae 4 and 8) is performed each time to calculate the unknown external component value. This value is then scaled in engineering units and formatted for display.

As with the earlier frequency meter article, I can provide programmed chips for those people who don't want to get diverted into microcomputer programming.

### Getting started

To aid initial troubleshooting, the PIC program includes a test mode, which is entered by shorting link LK1 and pressing "zero". The PIC will now repeatedly count oscillator cycles for 0.1 second and display the result. With just the 82 mH inductor and 1000 pF in circuit (no external component, no calibration capacitor), the oscillator will run at about 550 kHz and the display will show around 55000. If the frequency is too high (anything over 655.350 kHz), the display will show "Over Range". If the oscillator isn't running, the display will show "0". For best accuracy, the free running

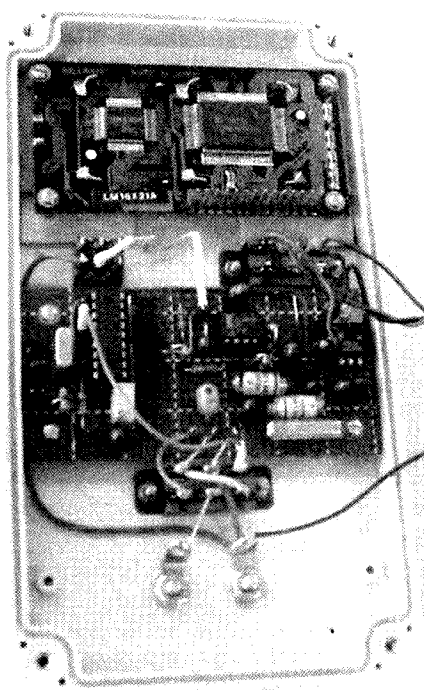

Photo 2 The inside without the ribbon cable to the display

frequency should be 10% to 15% below 655 kHz. If it is too close, it may accidentally overflow the PIC's internal 16 bit count. You may need to adjust the inductance to get the frequency right.

A second link, LK2, connects the calibration capacitor. The oscillator should then run at about 394 kHz.

Some LCD displays do not correctly display all 16 characters and need a little extra encouragement. When zeroed on

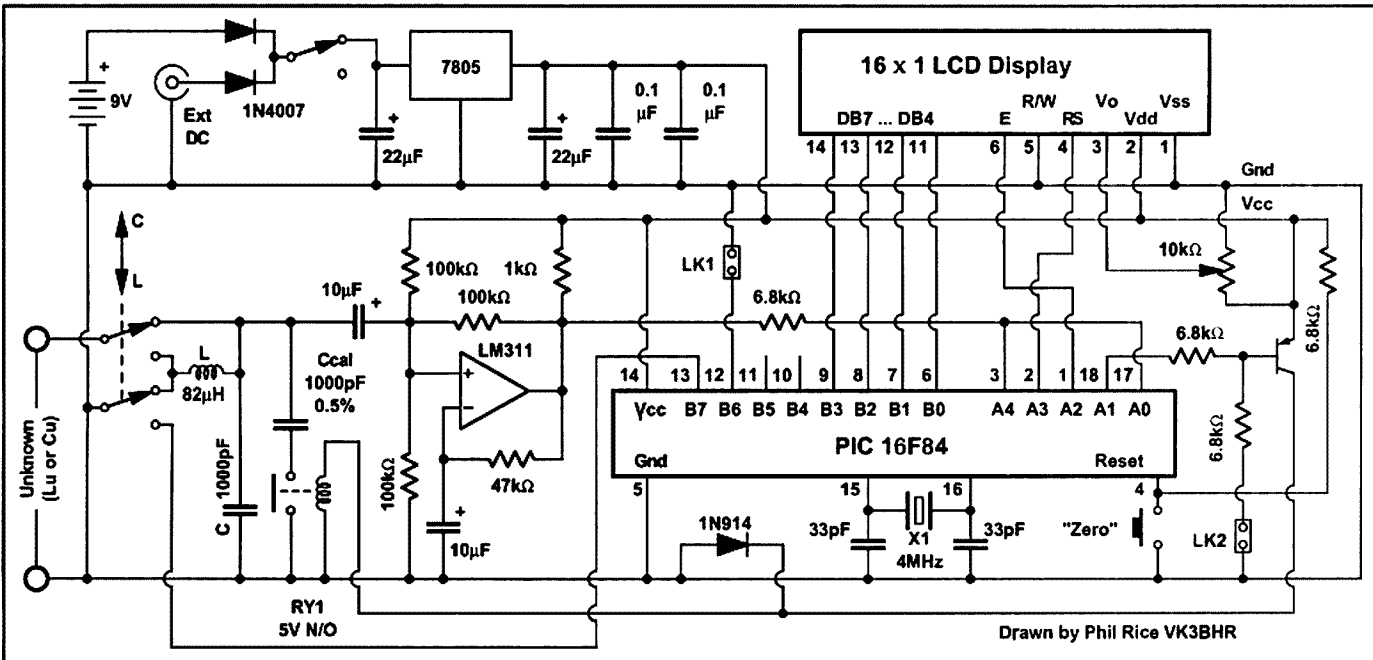

Figure 2 The circuit diagram

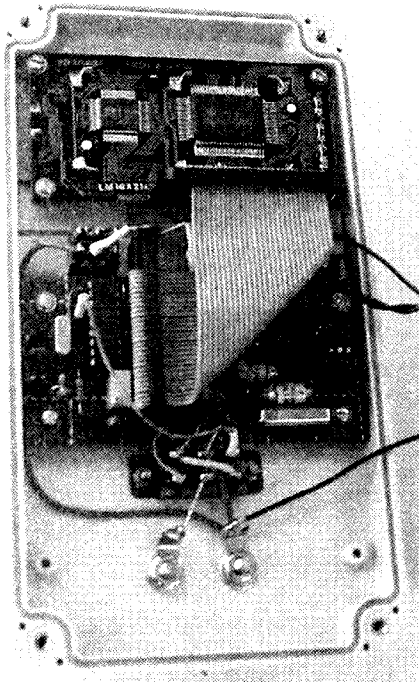

Photo 3 The complete inside.

The meter can be zeroed with an unknown component connected. For subsequent components, it then indicates the difference (+ or -) from the original component value. Great for matching parts!

## How accurate?

Accuracy depends on the user doing the "right thing" and on the unknown component being of fairly high Q. The PIC's internal program relies on the setting of the L/C switch being appropriate for the component. Since all the PIC is doing is measuring the frequency of the oscillator, any strange component that allows the oscillator to work will be reported as an inductor or a capacitor depending on the L/C switch. For example a 22 ohm resistor is reported as a 3.14 mH inductor or a 119 nF (0.119 mF) capacitor. This isn't even remotely correct!

When the unknown component has high Q (as you usually want in a tuned circuit) AND the L/C switch is set correctly, the prototype generally shows errors of less than 1%.

I checked the accuracy of the LC Meter against an old Marconi bridge, for capacitors of 33pF to 0.22 mF. For inductors, I only checked values from 475µH down to 60µH. Below that value, the Marconi bridge was a bit "cranky".

While the LC Meter is self calibrating, errors depend a little on the components used in the oscillator LC tank (L and C on the circuit diagram) and on the "standard" capacitor (Ccal), which should be 1000pF to within 1% or better.

The worst errors occurred when using a ferrite bobbin style choke from a

switchmode power supply for "L". Here the error was less than 1% for capacitors below 3300 pF and 2% for inductors less than 475 mH. The error climbed to 3% for 0.22 mF capacitors.

Surprisingly, the best accuracy used a "moulded" choke scrounged from an old TV. Here, the error was less than 1% for capacitors less than 0.22 mF and less than 1% for inductors less than 475 mH.

In all cases, I used a 1000 pF styroseal capacitor for the oscillator tank "C". A "greencap" would be a suitable substitute but a ceramic capacitor may not be a good choice. Some of these can have high losses.

I have no reason to suspect any strange non-linearities in the readings for low value components. Small component values are, in theory, directly proportional to frequency difference (when the part is added to the oscillator). The software inherently follows this proportionality. The only way I can verify this is to construct some small L/C tuned circuits and measure their resonant frequency - and I haven't got round to doing that yet.

## Conclusion

With the aid of a little easily copied FREE software, you can have your own (possibly) accurate inductance and capacitance meter. With the worst possible set of components from the junk box, accuracy should be better than 3%. If you are lucky, accuracy should generally be better than 1%.

It's now possible to design a tuned circuit, construct it and have it resonate on the right frequency first time, every time.

## References

1. The original idea and the oscillator came from  
<http://www.aade.com/lcmeter.htm>
2. The frequency measuring code came from "<http://ironbark.bendigo.latrobe.edu.au/~rice>"  
<http://ironbark.bendigo.latrobe.edu.au/~rice>  
also <http://homepage.tinet.ie/~ei9gq/stab.html>
3. Microchip's Web Site provided the Floating Point code essential to the working of the meter. See [http://www.microchip.com/-search for AN575](http://www.microchip.com/-search-for-AN575)

ar

ar

the capacitance setting, the display should show "C = 0.0 pF". If your display shows only part of this, then tie pin 10 to ground. If the display shows the value (0.0) and the units (pF) then pin 10 should be left floating. Pin 10 has an internal pull-up so no external resistor is needed.

## Operation

In practice, it's a bit like an Ohmmeter. For an inductor, just short the leads and press the zero button, then connect the unknown inductor. For a capacitor, zero it with the leads open, then connect the unknown capacitor.

## Something to look forward to in 2012

Christine Taylor VK5CTY

In June this year 2004, and again in 2012 there will be a transit of Venus. The planet Venus will cross the face of the sun. The transit this year will only be visible in the Northern Hemisphere but the one in 2012 will be visible in the Southern Hemisphere.

The transits of Venus only occur twice in about 8 years then not again for a hundred or so years but they are of significance to Australia because it was the Journey of Captain James Cook, to view such a transit that brought him to the Southern Ocean. Funding for

such an enormous journey, half way around the world was only available for a scientific expedition. There was no magical search for a 'path' across the oceans such as that which 'found' the Americas. Without the transit of Venus Australia might have remained mostly unoccupied for much longer.

If we are to 'view' a transit of Venus we must be careful to protect our sight, but there are safe ways to observe it. We have time to learn by the Northerners' experience later this year so we can do it even better.



# Many unqualified

# "amateurs"

## – the recruitment challenge

By Jim Linton VK3PC

email: wlavic@wlavic.org.au

**During discussion at both the IARU Region 3 Conferences In Darwin in 2000, and Taipei 2004, delegates considered the declining growth in radio amateur numbers that has been occurring in many countries.**

No-one had a solution, except to agree on a valid suggestion that if each existing radio amateur generated a new ham a lot could be achieved towards slowing or arresting the decline.

One delegate at the Darwin conference profoundly remarked that "we simply do not know where our next generation of radio amateurs is going to come from". He was right, at that time, but now in the Australian context at least, there are identifiable potential sources of new recruits that could find an Entry Level licence attractive.

There is little doubt that a new entry point into amateur radio is of benefit. The British Foundation licence in its first year has been hailed a success by the Radio Society of Great Britain (RSGB) in encouraging new entrants into amateur radio. There is also a healthy increase in the numbers seeking to upgrade to higher grades of licence.

The American Radio Relay League (ARRL) also recently announced its support for the introduction of an Entry Level licence in the United States.

### Wireless experimenters

The use of low powered licence-free 2.4GHz wireless LAN systems in Australia and overseas is relatively little known, yet quite amazing. In research for this article the author subscribed to two wireless email lists to see what was being discussed. The topics monitored included antennas, transmission lines, propagation and modulation.

Wireless hobbyists have set up microwave networks in capital cities and other major population areas, they hold meetings, share technical information and appear very much to have a self-help ethos. These groups are behaving not unlike amateur radio in many respects, and among their

members are in fact a few radio amateurs.

These are technically minded people and gauging by their email addresses many are employed in information technology or a similar field.

The existence of this strong group of wireless hobbyists throughout Australia is reflected in the WIA's proposed Entry Level licence including access to the 2.4GHz and 5.8GHz bands.

### HF radio clubs

A number of radio clubs specialising in HF radio for travellers, mainly four wheel drive enthusiasts, exist in Australia servicing thousands of members, many of whom could be interested in expanding their interest in radio communications through an Entry Level licence.

One such club, VKS737, established in 1993, has a national network of base stations, three paid staff and many volunteer base station operators. The primary role of the network is to provide safety orientated HF radio communications for travellers in remote areas.

It is licensed by the Australian Communications Authority (ACA) to use five HF channels, which are:

Channel 1: 5.455 MHz, Channel 2: 8.022 MHz, Channel 3: 11.916 MHz, Channel 4: 14.977 MHz, Channel 5: 3.995 MHz.

Membership of the club allows use of mobile radios on those channels and is available for around \$70 a year. VKS737 claims a growing membership of

thousands throughout Australia. Monitoring its activity is easy because VKS737 provides a broadcast schedule across 13 hours of each day starting at 7.30am (AEST).

These broadcasts provide an opportunity for mobile stations to check-in and log their location, as well as broadcast information on the weather, roads, and parks. There are parallels with VKS737 and the amateur radio Travellers Net.

### CB radio

Although not having the potential of providing a boom in new radio amateurs like it did in late 1970s and early 1980s, Citizen Band Radio could still easily provide a worthwhile yield of new radio amateurs.

CB radio consists of about 75% of operators who chase 27MHz DX, and many are quite serious communicators. The bad old days of widespread mindless "ratbags" on the 11 metre band is reported by a leading CB club in Victoria to be a thing of the past.

In fact there are some 35 active CB clubs throughout Australia and many more CBers who are not club members but enjoy being hobby communicators.

When the topic of amateur radio was discussed late last year at a major CB club meeting,

news about the removal of the Morse code requirement and the WIA's proposal for new Entry Level licence was met with much enthusiasm. All who were not already radio amateurs were eagerly awaiting the new licence.

**One delegate ...remarked that "we simply do not know where our next generation of radio amateurs is going to come from". He was right, at that time, but now...there are identifiable potential sources of new recruits that could find an Entry Level licence attractive.**

## Coax Cable & Connectors

### Low Loss 50 Ω

For  
2.4 GHz  
(WiFi) &  
Ham Radio

#### Cable

Type	CFD-200	CFD-400
OD (mm)	5	10
dB/m	150 MHz	0.130
	2400 MHz	0.550
\$/m	\$2.50	\$4.00
	(\$1.50 *)	(\$2.00 *)

#### Connectors

N-Type	\$7.00 (\$3.00 *)	\$7.00 (\$4.00 *)
RPSMA or RG-TNC	\$10.00 (\$5.00 *)	n/a
Pigtails	email	

\* = bulk price

Web: [www.freenel-antennas.com](http://www.freenel-antennas.com)  
Email: [sales@freenel-antennas.com](mailto:sales@freenel-antennas.com)  
Tel: +61 (8) 9319 1720

The end of mandatory code tests on 1 January, 2004, has also resulted in some CBers (and others) renewing their interest in amateur radio and studying for the Novice-Limited licence because of its HF privileges.

A new development called "eqso" is taking off overseas among users of low powered licence-free PMR (personal mobile radio) transceivers operating on UHF (not in Australia), and this too promises benefits for amateur radio.

The eqso system is a VOiP (Voice over internet protocol) similar to IRLP now widely used in amateur radio to link voice repeaters via the Internet. Two Australian CB repeaters, one in Melbourne and Brisbane, are included on an international list of eqso nodes.

Promoters in Britain claim that the exposure to long distance communications provided to PMR users through eqso has sparked additional interest in amateur radio.

## Potential recruits

Microwave wireless experimenters, HF radio hobbyists, CB operators, ocean-going yachtsmen, VHF/UHF scanner listeners and others could be very worthy targets of recruitment messages for the new Entry Level licence.

With the new licence, that could begin in 2005 to provide access right across the spectrum, it is likely to be seen as an attractive or desirable step for these "amateur" users of the airwaves to enter the world of ham radio.

They will of course need to hear about the "NEW AMATEUR RADIO". In the absence of strong marketing support from the Federal Government or the Australian Communications Authority, or corporate sector financial backing, it will be totally left to the Wireless Institute of Australia, radio clubs and individual radio amateurs to make it happen.

ar

# G&C COMMUNICATIONS

Authorised dealer for ● Kenwood ● Icom ● Barrett RFDS ● GME Electrophone ● Uniden ● YAESU

## KENWOOD

### TH-F7E Amateur VHF/UHF Transceiver

Freq: TX: 144-146 / 430-440 MHz  
RX: 0.1-1300 MHz  
Mode: TX: FM RX: AM/FM/SSB/CW  
RF Power output: Hi: 5/5 W  
Lo: 0.5/0.5 W EI: 50/50 mW  
Volt: Int: 5-7.5 VDC External: 12-16

Weight: 250 gr (inc lithium-ion batt. pack)

**TM-D700A** dual bander APRS, GPS and SSTV technologies. Built-in TNC, AX.25 protocol. Send and receive SSTV images using Kenwood's optional VC-H1. The TM-D700A makes the most of APRS - Automatic Packet/Position Reporting System. Wideband receive 118 MHz to 1.3 GHz (cellular blocked). Includes MC-53DM DTMF backlit hand mic.



Australia-wide orders welcome  
Credit card, cheque, Money order

## ICOM

### IC-208 Amateur VHF/UHF Transceiver

Freq: TX: 144-146 / 430-440 MHz  
RX: 118-1000 MHz  
Mode: TX: FM RX: AM/FM  
RF Power output:  
Hi: 50 / 50 W, Mid: 15 / 15 W, Low: 5 / 5 W  
Voltage: 13.8 VDC  
Weight: 1.2 Kg



### IC-706 MkII Amateur HF/VHF Transceiver

Freq: TX: 10-160 m +  
WARC / 50-54 / 144-146  
(148) MHz Europe (USA)  
RX: 0.03-200 MHz all-mode incl WFM Mode:  
AM/FM/SSB/CW/RTTY RF Power output: 100/100/20 W



Most popular mono/tri-banders  
TE series EMTRON HF ANTENNAS  
Storm tested - Call

## YAESU

### VX-7R 5 W Ultra-Rugged, Submersible Tri-Band Magnesium Handheld

Freq: RX: 0.5 - 999 MHz  
TX: 50, 144, 430 MHz Amateur Bds  
True Dual Receive: V-V/U-U/V-U/  
GEN-HAM

Power Output: 5 Watts 222 MHz:  
300 mW) 6 m AM: 1 W— MANY GREAT FEATURES



### FT-897 Multimode high-power base/mobile transceiver

Freq: RX: 100 kHz-56 MHz, 76 MHz-108 MHz (WFM only) 118 MHz-164 MHz 420-470 MHz TX: 160 - 6 m, 2m, 70 cm Amateur Bands; SSB/CW/AM/FM/FM-W/Dig.Modes 100 Watts Power Output (HF/6 m); 50 W (2 m); 20 W (70 cm) Opt. Int. Batteries: 4800 mAh x 2 Built-in - Digi.Signal Proc. - 3-Message Memory Keyer- VOX - AF Speech Processor. MANY MORE GREAT FEATURES



207 High St. Cranbourne VIC 3977  
Ph: 03 5996 3298 Fax: 03 5995 0184

Email: [gcomm@netSPACE.net.au](mailto:gcomm@netSPACE.net.au)  
[www.gcomm.com.au](http://www.gcomm.com.au)

# A dummy load and power meter for HF

Jim Tregellas VK5JST  
14 Sheringa Drive, Morphett Vale, SA 5162

Not everyone can (or wants to) afford that paragon of dummy loads, the Bird wattmeter, or for that matter the rather cheaper but still extremely good dummy load sold by Dick Smith. And getting your hands on the parts to build the dummy loads in the ARRL handbook isn't too easy either. But here is a dummy load and power meter, which you can build from standard parts, which covers the HF range and doesn't cost an arm or a leg.

Target specifications for the load/power meter were:

- (a) VSWR <1.25 from 1 to 30MHz
- (b) Power handling (50% duty cycle or 30 second max)  
500 watt RMS or 1kW PEP (two tone SSB testing only)
- (c) 50 ohm sampling output for a frequency counter or oscilloscope
- (d) PEP power indication

After a lot of thought it was decided that these specifications could be best met by the forced air-cooling of a multi resistor array. Although the fan necessary is an additional expense, in the author's opinion it is a far better proposition than the alternative of immersing the resistors in an oil bath with the attendant problems of spillage and fire hazard.

Initial testing showed that an array of 134 x 6800 ohm 1 watt carbon composition resistors would be satisfactory. These were formed into a roughly square array of resistors standing on end, and sandwiched between two conductive planes (epoxy PCB), one of which was drilled with large holes so that air could be forced past the resistors. The near square shape was selected because a large number of resistors could be mounted around its perimeter, while the stray capacitance could be minimized and the air flow maximized by drilling a large number of ventilation holes in the lower PCB. The stray inductance of this shape is also very low because the conductive planes are short and fat, and the resistors have near zero lead lengths. Best of all, the planes are also effective heat dissipaters. The fan used for cooling was a 240 V 14 watt 80mm diameter unit. A 12 Vdc fan was not used because its semiconductor driven motor will almost certainly misbehave in the high RF fields within the dummy load case. This set-up was

extensively tested at 80 metres and worked well.

The next design step was to establish how the design performed as the input frequency was varied. For this I am much indebted to Keith Gooley VK5OQ for his out of hours testing of the dummy load using a Hewlett Packard network analyser.

The results were interesting. As can be seen from figure 1, the VSWR linearly increases with frequency, reaching 1.5 at 30 MHz. Analysis shows this is due to the effect of a shunt capacitance of 48 pf (8 pf between the conductive planes and 40 pf due to the resistors).

Now if the dummy load is being used to test a conventional high power tube linear amplifier with its output tuning and loading capacitors, the 48 pf has no significance provided the leads between the amplifier and load are kept short. It simply becomes part of the loading capacitance at the amplifier output, which is never smaller than 150 pf at 30 MHz, even in amplifiers requiring quite high values of plate load resistance. The load therefore looks like a pure 50 ohm

resistance and is useful to well beyond 30 MHz unmodified.

The situation is entirely different if the load is attached to the wide band FET or transistor output amplifier found in a typical modern transceiver. Here there is no mechanism to swallow up the effects of the stray capacitance, and steps must be taken within the dummy load to compensate for it.

Now a parallel circuit can be mathematically transformed to an equivalent series circuit at any single frequency. Doing this at 50 MHz generates a circuit of 31.87 ohm in series with 132 pf, which is equivalent in its effects to the parallel circuit of 50 ohm and 48 pf. If we use a series inductor to resonate with the 132 pf at 50 MHz, we are left with a pure resistance of 31.87 ohm at 50 MHz and a nearly pure but somewhat larger value of resistor at frequencies lower than this. (At very low frequencies the equivalent series circuit is 50 ohm in series with a near infinite capacitance). Some work with a Smith chart shows the VSWR up to 30 MHz should not exceed 1.2, and a little

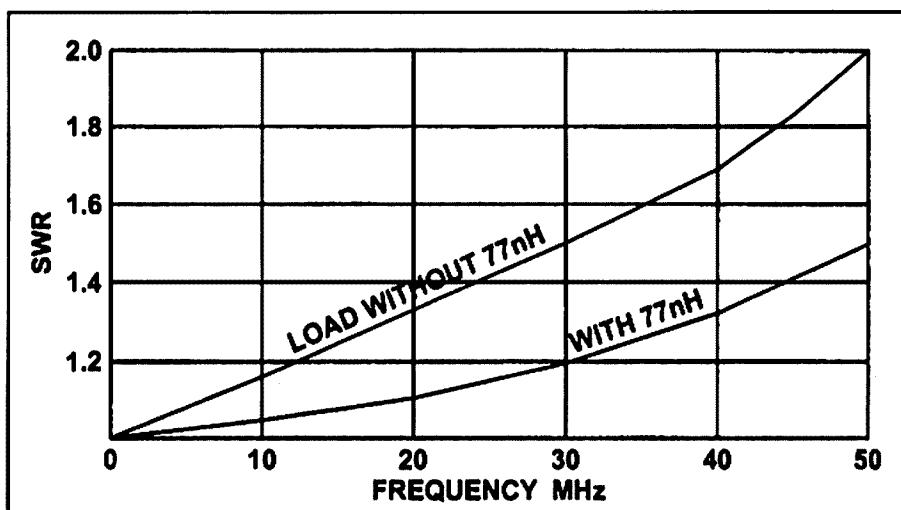

Figure 1

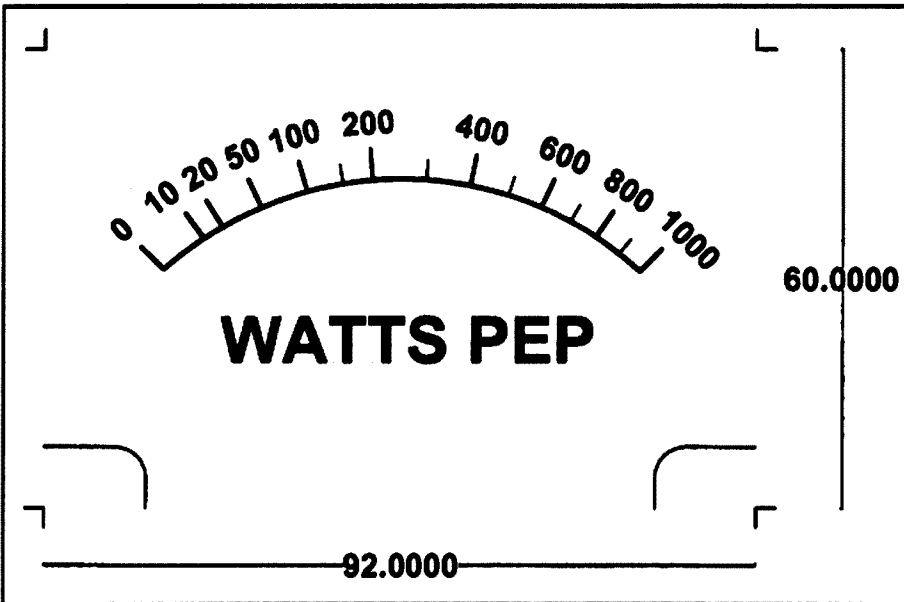

Figure 2

## Assembly and calibration

First drill both PCBs as per the drawings, and then drill the back panel of your metal box to match the hole pattern in the bottom PCB. Now solder the four brass nuts to the lower PCB using steel screws to temporarily hold the nuts in position while soldering occurs.

Next, bend the bottom lead of each 6k8 resistor at right angles to the resistor axis and as close to the body as possible. Form the inner rectangle of resistors by inserting the straight resistor lead of each 6k8 through the hole in the upper PCB. When this lead is soldered to the upper PCB surface, the resistor body should be hard up against the PCB. The bent lead should face outwards and all resistors should be equally spaced and at right angles to the PCB surface. This assembly is then soldered to the lower PCB, and the excess resistor leads trimmed off. Now add the outer row of resistors one at a time, soldering these into final position. Do not be tempted to assemble both resistor rows at once – it doesn't work. You should end up with a neat assembly where the resistors have virtually zero lead lengths and the PCBs are spaced 13 mm apart. The detector assembly and sampling resistor network for the CRO are added in space, at the edge of the resistor array. The only comment necessary on the remaining

calculation shows the inductor value required is 77 nano-henries. Further testing on the network analyser by VK5OQ showed that all this theory works! (see figure1). The engineering of our dummy load thus simply becomes making up the resistor array, and then frequency compensating it with an inductor which will resonate with 132 pf at 50 MHz. A dip meter is used to

make the inductor, and the NPO ceramic capacitors used to make up the 132 pf for inductor testing should have near zero lead lengths. The wire gauge selected for the inductor should reflect the 500 watt rating of the load (2.5mm). Also note that only the 1 watt resistors specified should be used, and the physical layout should be closely identical, as these two things determine the 48 pf of stray capacitance, which we are compensating with the inductor.

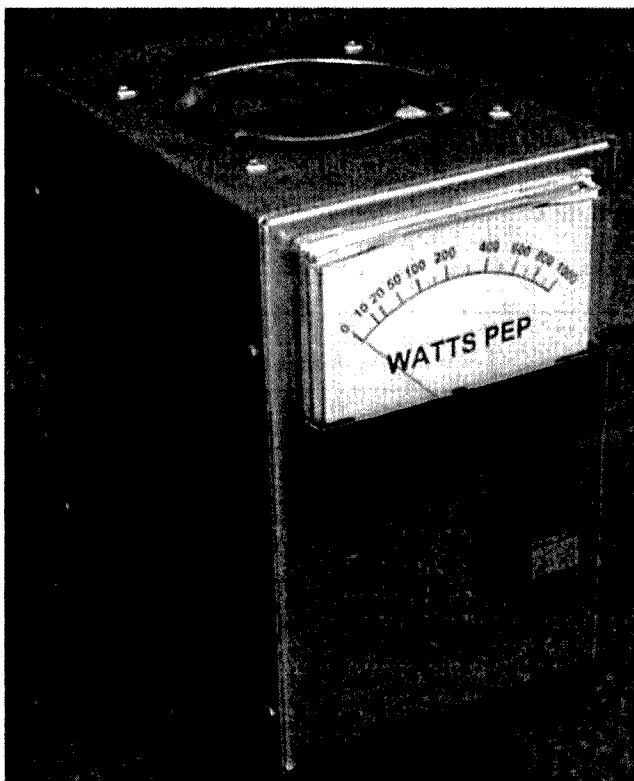

Photo 1

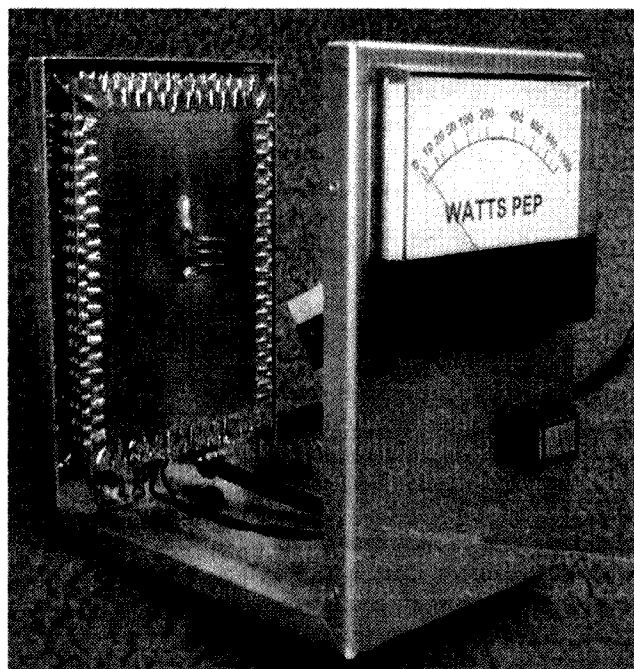

Photo 2

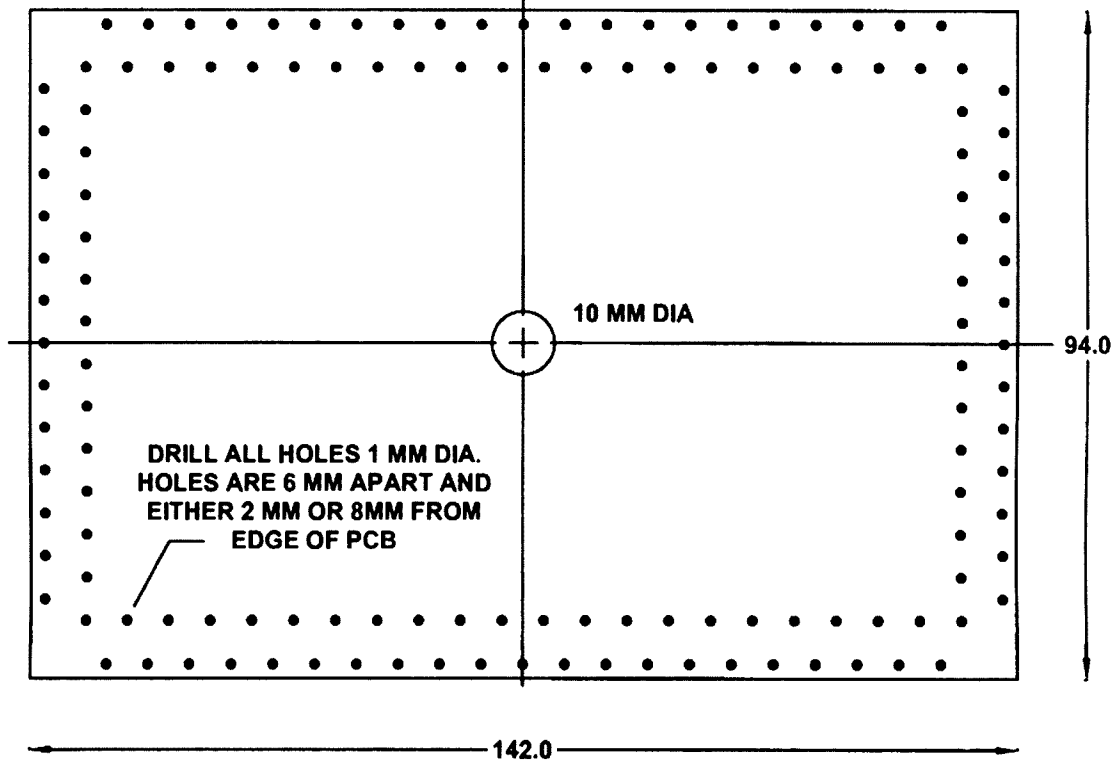

Figure 3. Upper PCB drilling details

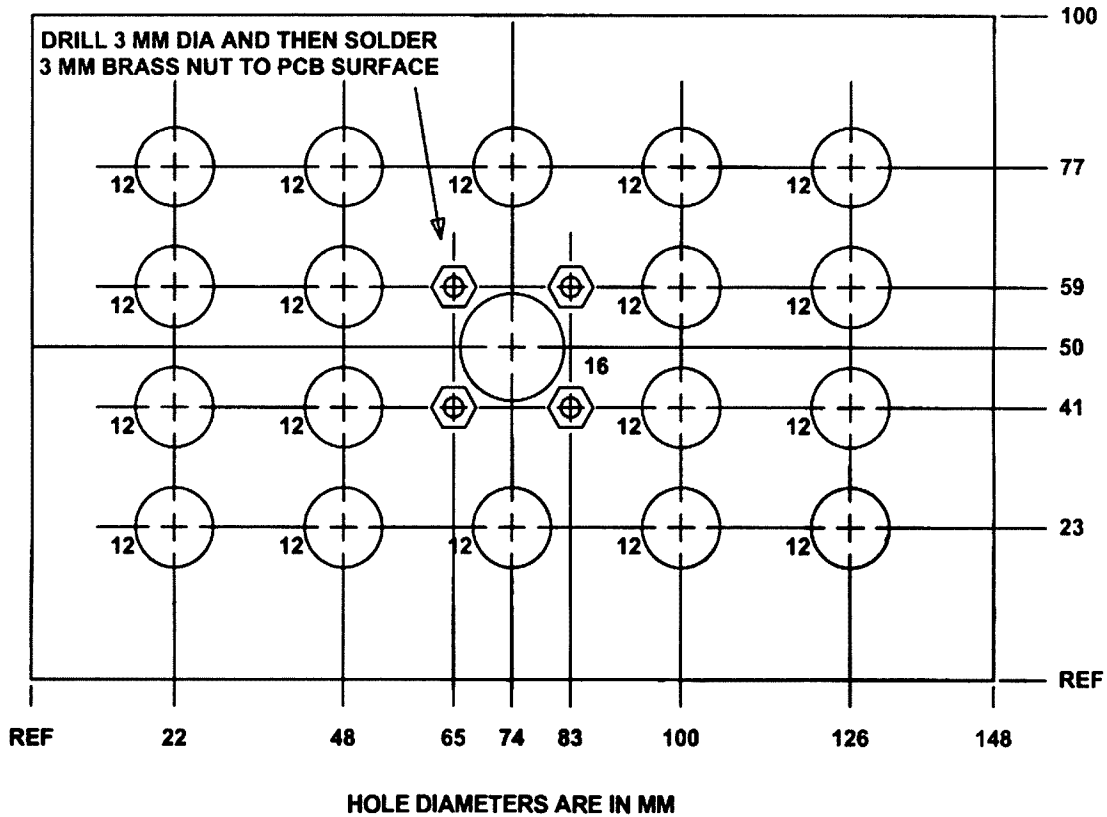

Figure 4. Lower PCB drilling details

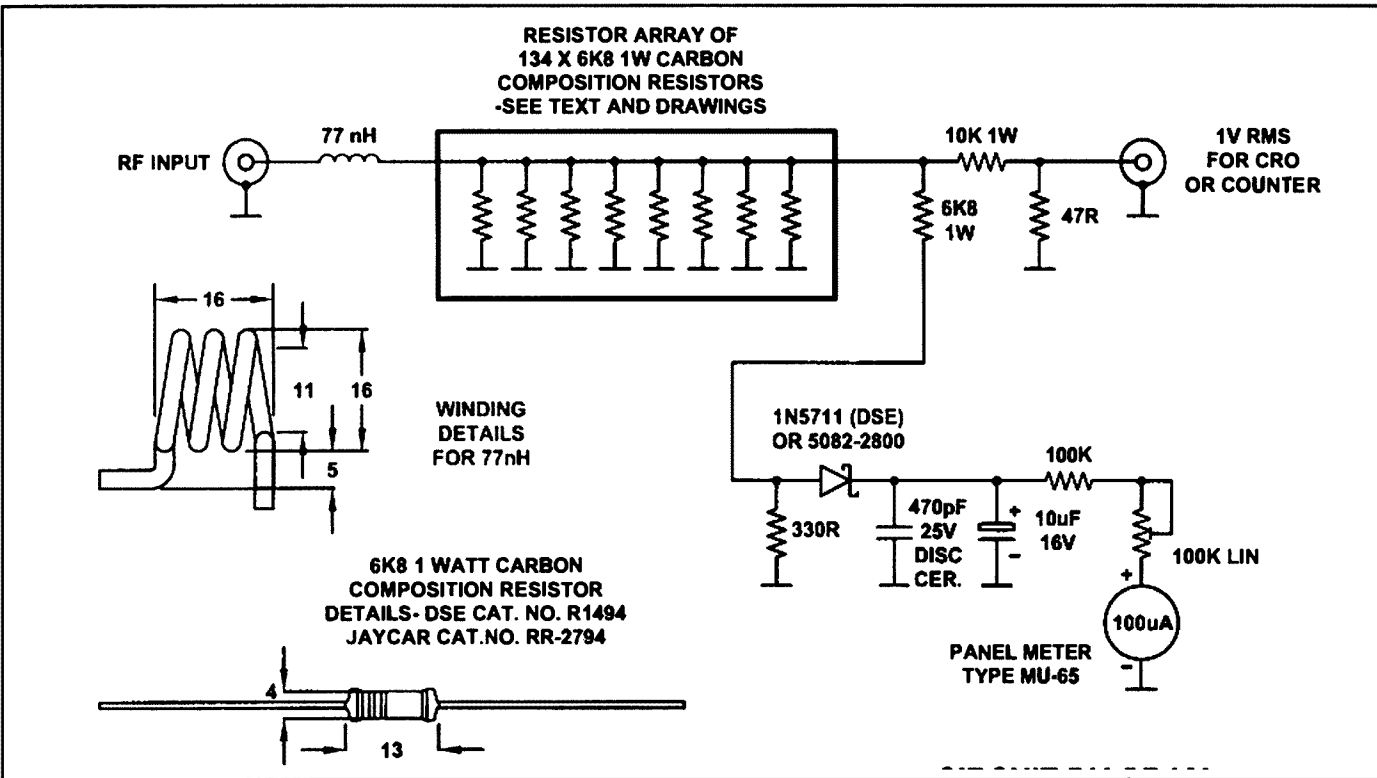

Figure 5. Circuit diagram 1kW PEP power meter and dummy load

assembly is to make sure that the mains supply to the 240 V fan is both safely wired and securely earthed to the metal case.

If the assembled array has a resistance lower than 50 ohm due to tolerances, adjust it to exactly 50 ohm by removing 6k8 resistors until the value is right. Replace the removed resistors with

physically identical 1 M ohm resistors, so that the air flow through the array is not upset. Alternatively, if the resistance is high, add a few resistors around the perimeter keeping their lead lengths short.

Calibration is simple. So the power meter will indicate watt PEP, a very long detector time constant is necessary. This is selected so that the carrier peak voltage in between modulation peaks is stored without much ripple, and the lowest frequency at which these peaks are likely to occur is 150 Hz for speech or 700 Hz or so for two tone testing. If we instead assume that peaks occur at a 50 Hz rate and lengthen the time constant accordingly, we can calibrate the load using conventional 50 Hz ac mains power and a DVM. To calibrate the load proceed as follows:

Find a reasonably heavy 50 Hz power transformer capable of

supplying an ISOLATED output voltage of between 50 VRMS (50 watt) and 120 VRMS (288 watt) to the 50 ohm load. Measure the AC voltage across the load terminals with your DVM, calculate the power in the load from  $V^2/50$  ohm, and adjust the trim pot until the meter reads correctly - DONE!

Finally, a few words on power measurements. This form of metering measures the RMS power existing at the peak of a modulation envelope (watt PEP) and consequently is useful for two tone SSB measurements, peak audio SSB measurements, modulated DSB envelopes, modulated AM, or any other measurement where the RF carrier envelope varies cyclically between a maximum and minimum e.g. Morse code. For transmission modes where the height of the envelope does not vary eg FM, un-modulated AM, single tone SSB, the metering simply indicates RMS power.

Note that the load has a maximum rating of 500 watt and can only be used to its 1 kW limit for two tones SSB testing where the average carrier power is one half of the peak envelope power. Single tone testing to 1kW has not been tried (PEP = average power) although the load will probably survive quite happily for brief periods.

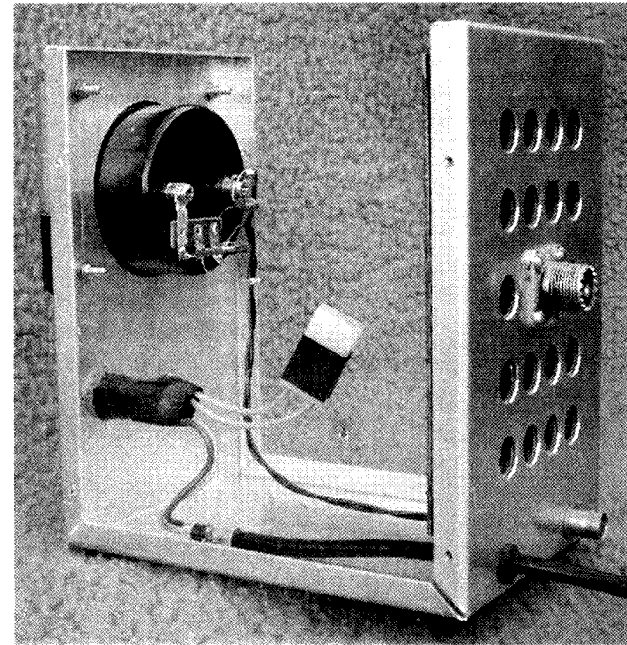

Photo 3

# IARU Region 3 ARDF Championships

By Jim Linton VK3PC  
email: wiavic@wiavic.org.au

**Amateur Radio Direction Finding (ARDF) also known as radio orienteering or radio sport has an active following of thousands throughout the world. Some enjoy it at a local level while others also participate in major championships.**

Each International Amateur Radio Union (IARU) Region holds its own regional championships. The latest such event was the 5th IARU Region 3 ARDF Championships hosted by the Wireless Institute of Australia late last year at Ballarat, Victoria.

Making the event not only possible, but a great success, was a team of some 40 volunteers who organised and ran the show. They included volunteers from the Victorian ARDF Group, Ballarat Amateur Radio Group and the Victorian Orienteering Association. WIA Victoria sponsored the championships.

Ballarat University's Mt Helen campus provided an ideal venue. The ARDF events were held in surrounding countryside while the campus provided accommodation and meals.

IARU Region 3 which encompasses

Asia and Oceania, had 59 male and nine female competitors from the Chinese Radio Sports Association (CRSA), Japan Amateur Radio League (JARL), Korean Amateur Radio League (KARL) and Wireless Institute of Australia (WIA).

Guest competitors are always welcome. This time they included a young team from Kazakhstan, and a senior competitor Robert Cooley KF6VSE (ARRL).

The Kazaks took out every division they competed in and won a swag of medals but were not eligible for medals in Region 3 events.

Robert KF6VSE, also ineligible for Region 3 events, won two gold medals in the Super Veteran category for men 60 years or older requiring the finding of three transmitters. In the 2m event he came in seven minutes ahead of the second place-getter and completed a 5.6km course in the 80m event in a blitting speed of 1:15:22.

There was disappointment that a team of 13 from the Mongolian Radio Sport Federation

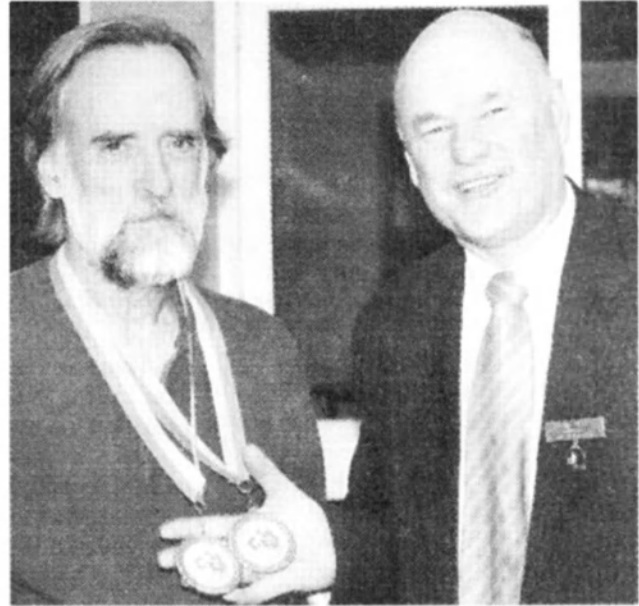

The Mayor of Ballarat, Cr David Vandy was amazed at the athletic ability shown by double gold medalist Robert Cooley KF6VSE.

(MRSF), who are known to be very competitive, did not arrive due to difficulties in obtaining visas.

In line with tradition the teams representing six radio societies (countries) carried flags and banners while marching in their colourful uniforms to the opening ceremony. Each was welcomed and subjected to much photograph taking.

Before the ARDF events begin all competitors had a briefing session. A key message given to them was to watch for holes in the ground – old gold mine shafts 50 metres deep.

Another no-go area during the competition was a rifle range. Although a few competitors strayed into it, there was no shooting practice happening.



*more pictures inside back cover*

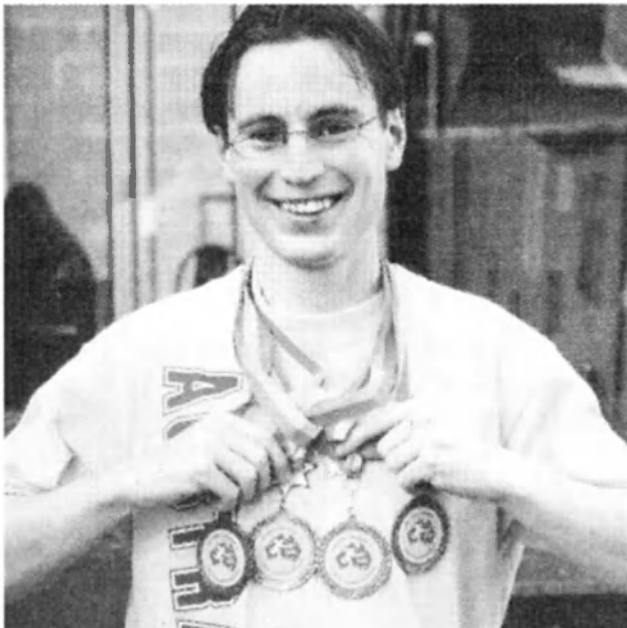

After a relatively short training session due to injury, nervousness and making a few mistakes during events, Adam Scammell VK3YDF is all smiles with four gold medals.



A few snakes were also out in the hot weather and the volunteers manning the transmitters for up to four hour shifts had to contend with mosquitoes.

Their job was to sit in the bush quietly with the well hidden transmitter, sense an approaching competitor by their footsteps, and usually only getting a glimpse of their antenna and face before heading off in search of the next transmitter.

ARDF requires knowledge and practice in radio wave propagation, taking precise bearings, map reading and the physical attributes of an athlete.

Each group of competitors was manoeuvred through a complex start before being permitted to escape at five minute intervals out a lengthy corridor that prevented them seeing the direction in which other competitors had headed.

Competitors in most events need to find up to five transmitting control points using direction finding techniques in a 140 minute time limit. If not all five points were found it was better to reach the finish within the time limit and not risk your team's score.

bush, or as he put it – "I went bush-bashing, the competitor followed, I escaped but he had difficulty getting out of the scrub."

A diverse range of DF receivers and antennas was used by the competitors. After the good showing by the WIA team some of our local ARDF experts were likely to be selling a few locally made units.

There also was plenty of social activity including boomerang throwing that thrilled the overseas visitors.

On a rest day during the championships, the visiting competitors were treated to a taste of local culture at the Ballarat Wildlife Park and Sovereign Hill. The day included an Aussie barbecue lunch.

A highlight of the whole event was the closing banquet with amusing entertainment indoors, and some whip-cracking demonstrations outside, from the Blackberry Jam Australian bush band.

A number of those at Ballarat have begun their plans to take part

One member WIA team member found the going hard with a fast competitor hot on his heels. His tactic on that occasion was to head for the

in the ARDF World Championships to be held in Brno in the Czech Republic September 7-12, 2004, and the next IARU Region 3 championships in 2005 to be organised by the JARL.

## Aussies win gold

Adam Scammell VK3YDF won two gold medals for both the Open Men's 2m and Open Men's 80m events. Adam's gold medal tally was four with the addition of WIA team wins in both of these events.

The open 2m men's event result was Adam VK3YDF first, Bruce Paterson VK3TJN second, and Tony Langdon VK3JED in 5th place. That won the team a gold medal.

The fiercely competed Open Men's event on 80m was another gold win for the WIA team of Adam VK3YDF who won individual gold, Mark Diggins VK3JMD silver, Tony Langdon VK3JED Bronze, and Doug Canning VK3JDO in 9th place.

The Veteran Men's 2m event team of Ian Sterling VK3MZ and Dennis Haustorfer VK3BQZ won the silver medal. Despite no placings in this event, the medal was still scored, with Dennis making the finish line by a narrow margin of only 21 seconds.

The Super Veteran Men's 80m event



IARU Region 3 Director, Peter Naish VK2BPN presenting a medal to Nikolay Tarassov of Kazakhstan (Jack Bramham VK3WWW and Mark Diggins VK3JMD in the background).



One of the WIA junior team Nathan Wyss checks out an ARDF sniffer ready for action.





Producing the results and allocating medals was a team effort with Greg Williams VK3VT on the computer, Jack Bramham VK3WWW (standing), Bruce Paterson VK3TJN in deep thought and Andrew McColm VK3KIR.

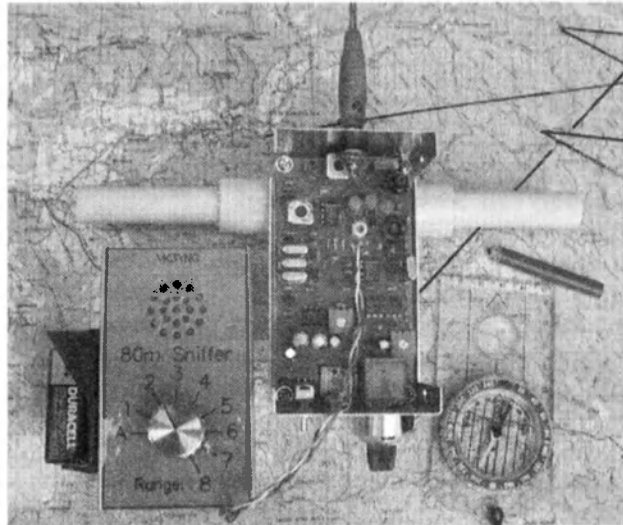

The 80m sniffer by Bryan Ackerly VK3YNG that has attracted international interest.



On the winner's dais, WIA team members Sue Diggins VK3LSL, Liliya Glashchenko.

achieved an individual bronze medal for Michael Hubbert (WIA).

The Senior Women's 2m event also saw WIA win gold, after Liliya Glushchenko winning individual silver and Sue Diggins VK3LSL scored 4th place.

The Senior Women's 80m event was another team gold medal for WIA – with, Liliya Glushchenko taking out silver and only 18 seconds short of a gold medal, and Sue Diggins VK3LSL in 4th place.

In the Junior 2m event, Rob Fell (WIA) who had only previously attempted one ARDF event, achieved a 14 minute lead from his nearest rival, Yuta Terui (JARL)

and won individual gold. This event required competitors to locate up to four transmitters.

Nathan Wyss (WIA) and David Hudson (WIA) came in 4th and 5th respectively. The WIA junior team won the silver medal based on the best two results of three team members.

The Aussie juniors could not compete in the 80m Junior event held on a weekday due to school commitments.

The full results can be found on the Victoria ARDF Group website [www.ardf.org.au](http://www.ardf.org.au)

ar

## Silent Key

### Ted (Edmund Charles) Roberts VK9QK, VK2QN, VK4QI, VK1QI

Ted Roberts passed away on 25th January 2004 following a long illness. I much regret not having met Ted a lot earlier than I did.

The circumstance of our meeting was that Merv Deakin, VK4DV, asked me to visit his old mate Ted who was now living in a retirement home in the ACT. Ted had recently relocated from Rockhampton to the ACT to be near his family. Ted was not in good health, he was on oxygen 14 hours a day but he

welcomed my invitation to attend our regular 2nd and 4th Tuesday Old Timers lunch time get togethers at the Farrer Ham Shack.

Several of us got to know Ted quite well at these meetings and we all enjoyed his tales and shared his technical knowledge. Ron Graham VK4 BRG tells me we all missed out on Ted's forte "Homo Brew manufacture of Ham gear". This made me more sorry I had not met Ted many years earlier.

Prior to joining the RAAF in 1938 Ted had served in the Militia. In the RAAF he was trained in a number of areas, including radio. When he was demobbed he re-entered the civilian workforce as a technician

The ACT Division of the WIA and its Old Timers Group wish to extend their heartfelt sympathy to Ted's family and friends.

John Clara VK1CJ

# The IPHG is two years old

On March 18, 2002 the International Pharmacists Ham Group (IPHG) was originated by two Italian pharmacists who were Amateur Radio Operators.

Their aim was to promote radio-initiatives and establish friendship among colleagues from different countries and to lend a hand when necessary and if possible to people who need help. Today, after two years the primary core of about 20 has grown to almost 200 Pharmacist Hams in over 40 countries and all the Continents.

The IPHG members co-operate with the Medical Radio Council and exchange information. Help via the radio has been extended to some African Missions. The Group has also created some awards, free of cost, for OM/YL and SWLers. If you are a Pharmacist and interested in learning more about this group look at: [www.malpensa.it/iphg](http://www.malpensa.it/iphg)



# Special callsign for PI4AA

to celebrate their 75th year of activity in the air

Remy F.G. Danker PA3AGF  
Evert Beitler, PA3AYQ  
Email PA3AGF@AMSAT.ORG

From May first till May 16th the clubstation of the VERON operating under the call PI4AA will celebrate 75 years of activity on the air. They are granted to use the special call PI75AA to commemorate this special event.

During the 1929 "Radio Salon" in Scheveningen a local club station was granted to use the callsign PA0AA. This was even before the official radio exams in The Netherlands took place.

This unique occasion will now be commemorated with many activities.

PI75AA will be on the air during this and transmissions in RTTY, PSK and Slow Scan will take place daily.

It is planned to broadcast the complete report as put together during the "Radio Salon". So you will now hear what happened 75 years ago. All photos taken at that time will be transmitted in slow-scan.

In the end you will have a very unique document transmitted in a very unique mode.

From May 1st onwards all previous co-workers of PI4AA and staff will be on the air with the special call PI75AA either on VHF or HF from their own

shack. Every QSO made will be confirmed with a special QSL card.

More information can be found on: [www.veron.nl](http://www.veron.nl).

## Schedule:

1 - 16 May 2004 PI75AA QRZ for reports. All modes, all frequency.

Special transmission PI75AA QTH LEUSDEN JO22QC

10 -16 May 2004 every day 20.30 - 21.30 GMT

For Europa: freq. 3.603 MHz

Outside Europa: freq. 14.120 MHz.  
Mode USB, PSK, RTTY

20.30 - 21.00 Antenna direction VE - W - PY

21.00 - 21.30 Antenna direction VK - JA

See you on the band.

# Cable and Connectors



- RG58C/U Belden 8259 @ \$0.90 per metre
- RG213/U Belden 8267 @ \$4.45 per metre
- RG8/U Belden 9913 Low Loss @ \$5.15 per metre
- RG8/U Belden 9913F7 High Flex Low Loss @ \$5.55 per metre
- RG8/U - RF400 Belden 7810 Low Loss Sweep Tested to 6000MHz @ \$6.30 per metre



- RG58: B80-006 UHF connector (M) @ \$7.65 each
- RG8/213: B80-001 UHF connector (M) @ \$8.80 each
- RG213: B30-001 N connector (M) @ \$9.10 each
- RG8: B30-041 N connector(M) @ \$14.00 each

# connektron Pty Ltd

ABN 19 413 484 007

email [sales@connektron.com.au](mailto:sales@connektron.com.au) or Phone (03) 9761-5220

connektron Pty Ltd, 45 - 49 Merrindale Drive, Croydon South, Victoria 3036

[www.connektron.com.au](http://www.connektron.com.au)

- All prices include GST
- Minimum order value \$50 payable by Visa, Mastercard, Bankcard or Money Order
- Packing and Delivery \$15 within Australia (Outside Australia P.O.A.)

# A bouquet for Echo Link

Kingsley Savage VK5BHP  
VK5BHP@blgpond.com

I feel impelled to pay a tribute to the superb program, Echo Link. When I first downloaded it, I was most impressed that it worked well immediately with no tweaking required. After the first "wow" reaction subsided, I realised that here is a program that opens a whole new dimension to my "ham" activities, and gave some thought to just where it would fit in with my on air pursuits.

I decided that because of its flexibility I would not use it in my ham shack, which I reserved for on air skeds only. Echo Link is a luxury I reserved for 2 or 3 nights a week while sitting comfortably in my lounge chair with my 15" laptop computer.

As I have prostate cancer, during the last few months I've been hospitalised twice, the last in an emergency situation, but I still had time to grab my "complete entertainment centre", (my laptop computer), as I left home. Before even undressing in my room, my first priority was to put a dual adaptor in the phone line for my Internet connection. At home I have Telstra ADSL Broadband, but in hospital I "borrow" my daughter's Telstra dial-in number and password, not forgetting to add a 0 and comma prefix. ("To get an outside line dial 0").

An hour after returning from "theatre" I was having a good chat with my friend Chris, VK5PN who at that time was in Perth on his way around Australia. I simply opened up Echo Link, connected to the VK6RLM repeater and there he was, speaking from his car, as though he was sitting on my bed. We both agreed that this was even better than our usual 20 metre daily sked! This repeater is obviously well monitored because I was hard pressed to even get time to eat my lunch. The first call was from a VK6 who was driving his mother to a hospital to visit his sister, and the next was WA7FMP who said it was 3am over there and as he couldn't sleep he decided to find someone "Down Under" to talk to!

For the 5 days I was in hospital I had a wonderful time with Echo Link talking each day to my friend Bob, VK3PT, and

I made many other new friends from every corner of the globe. It was difficult finding time for emails etc. Most were quite interested in the fact that I was talking to them from my hospital bed. The nurses were amazed at just how clearly the voices came in from people overseas, when I removed the earphones so they could hear. One question, which arose more than once, was "why doesn't Adelaide have a major repeater connected to Echo Link?" Now there's a challenge for someone!

If you wonder whether the hospital approved of computers on the Internet, I have to admit that my policy is, "if you don't ask, you won't get a refusal", and it has worked out well so far. The switchboard girl phoned one day and said, "here are several messages for you, because you seem to be on the phone quite a lot!"

Echo Link is the perfect communication solution for amateurs in locations where it is difficult to erect antennas, such as for those of us who, with advancing years, have moved into retirement villages, nursing homes, etc, and as I can certainly testify, also for those of us in hospital!

There are some who frown on Echo Link as "not radio", but I think we should all consider our wonderful hobby as "communication by any means possible".

Before closing I'd like to congratulate Alan Gibbs, VK6PG for his most informative articles in "Ham Shack Computers".

73, Kingsley, VK5BHP

## Australian Made ANTENNAS "Setting a New Standard" COM-AN-TENA (Formerly a j and j coman)

6 Mulr Court  
CHELSEA HEIGHTS 3198

All new 5/8 vertical 16 radials	\$160
Dual drive 26-30 5 ele yagi beam	\$315
4 ele 10-11m yagi beam	\$278
5 ele high gain antennas 11m	\$327
3 ele delta loop 10-11m	\$326
11m 5/8 vert./4-1/4 wave radials	\$175
Duoband 10-15 3 ele each band	\$385
Tri-band 5 ele HB35C s/steel fix	\$730
3 ele 20m computer opt	\$420
3 ele 15m computer opt	\$295
M B Vert Auto switch 10-80m	\$330
40m linear loaded 2 ele beam	\$595
6m 5 ele compt opt beam	\$268
6m 7 ele compt opt beam boom — 60mm	\$387
10 ele high performance 2m	\$145
17 ele high performance 70cm	\$125
2m vert 2-5/8 co-linear 4 rad	\$120
Log-periodic 9 ele 13-30 MHz 7.7m boom	\$990

### Guyed Masts

21 metres                      13 metres  
Winch-up & tilt-over. Aluminium and stainless steel  
three-sided construction. Auto-brake winches.

### Free Standing Masts

9.5 metres  
New Baluns  
1-1 to 16-1 to 3kW



**Our Masts**  
meet  
Australian Standards.  
We supply all the  
computations and data  
you will need for  
a permit.

**03 9773 3271**  
**Mob: 0419 542 437**  
Andy VK3IV

# A simple TV-aligned crystal frequency reference

Draw Diamond, VK3XU  
45 Gatters Rd  
WONGA PARK 3115

Since we lost our free-to-air time and frequency service VNG early in 2003, this region has been without a dedicated, accurate source of radio frequency. At least one method (Ref 1) has been described where signals from WWV (North America) and/or WWVH (Hawaii) heard on a short-wave receiver may be used to adjust an ovened crystal onto frequency. However, WWV's signal strength and phase is not usually steady due to propagation vagaries, so a fair degree of skill is necessary to achieve good setting accuracy.

Broadcast TV signals are an alternative. As far as can reasonably be determined, the video signals of our TV networks are referenced either to a rubidium standard, or an ovened crystal, whose accuracy is probably as good as, or better than the average amateur radio worker ever requires. Such highly accurate sources are constantly and freely available to any person with a TV receiver.

We can easily tap into this asset by maintaining an ordinary crystal, which is divisible down to some frequency, which equals, or is a multiple of the 15.625 kHz TV horizontal oscillator rate (Ref 2). An 8, 4, 2 or 1 MHz crystal, if repeatedly divided by 2 (modulo-2), will yield useful TV-comparable frequencies, such as 250, 125 or 15.625 kHz.

These square-wave signals, being rich in harmonics right up through VHF, may simply be applied to the antenna input of a TV receiver along with the off-air programme. An interference pattern is thus created upon the screen. When the crystal is oscillating at exactly 8.000 MHz, the interference pattern is stationary. More later.

## Circuit

A modulo-2 divider with internal oscillator; type HCF4080B CMOS chip (Fig 1), is used to divide an 8.000 MHz crystal by Q to the power of 4 ( $Q^4 = 32$ ) to 500 kHz, then by a factor of 2 again ( $Q$  to the 5th or  $Q^5 = 64$ ) and so on as far as  $Q^{14}$  if necessary. It is suggested that we only need the  $Q^4$  (500 kHz),  $Q^5$  (250 kHz),  $Q^6$  (125 kHz) and  $Q^9$  (15.625 kHz) outputs for radio work.

## Construction

The prototype is made using "paddyboard" ("Manhattan" in the USA) style construction (Ref 3). A suggested layout is pictured in Fig 2 and Photo 2. But any preferred wiring method, such as 'ugly' or 'dead-bug' may be used provided that the oscillator component leads are reasonably short.

Dimensions of the plain circuit board are 70 x 55 mm if the device is to be housed in the suggested 130 x 67 x 44 mm 'jiffy' box shown. The 4080B chip is inserted into a 18-pin I.C. socket, which is soldered into an 8 strip x 25 mm rectangle of Vero board- tracks upwards. The Vero must have a single shallow junior hacksaw cut placed down the middle to separate each side of the chip. The socket pins poke through, so the Vero substrate must be super-glued to a similarly sized scrap of single-sided circuit board (copper side down), which in turn is glued onto the circuit board, as shown in Fig 2. Note; super-glue in liquid

form is slightly conductive, so the chip must not be powered until the glue has set. Use it sparingly.

When planning the positioning of the front panel components (particularly your kHz rotary switch), make sure that these shall not clash with the board-mounted components beneath when the jiffy box lid is in place. The 25 pF crystal frequency trim capacitor should be soldered upon the board so that a tweaking tool may be easily applied. Photo 2 shows the top of the air-spaced 25 pF cap. just poking through a hole in the side of the box.

The "signal injector" may be made from scraps of double-side circuit board,

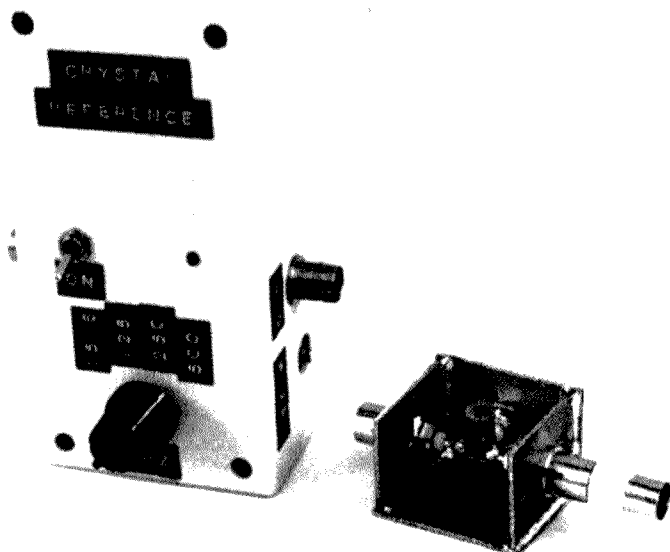

Photo 1 - Crystal reference and signal injector.

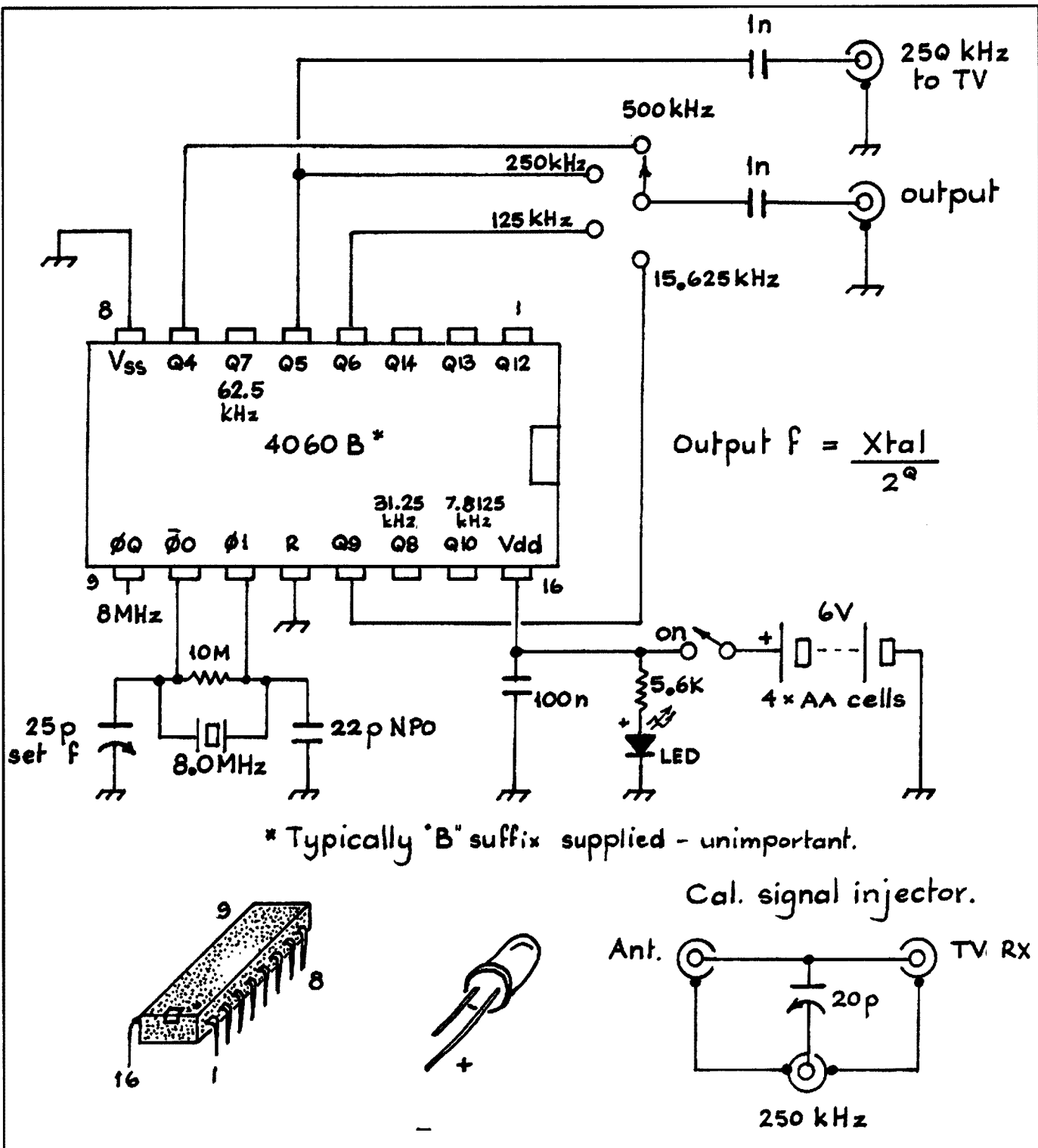

Figure 1

### Operation

Check your wiring and component polarities. Pay particular attention to the orientation of the 4060B chip and battery polarity. Interpose the signal injector between TV receiver and antenna, and connect the crystal reference to the '250

kHz' input of the injector with a short length of coax (about 1 m).

Switch on. There should be an interference pattern of vertical bars, or lines upon the TV screen similar to that shown in Photo 3. Adjust the 20 pF capacitor of the injector for a good clear pattern without "tearing" of the picture.

as pictured in photo 1. The 20 pF capacitor (which adjusts the strength of the interfering signal) may be soldered between the "250 kHz" connector, and a small length of bus wire connecting the other two.

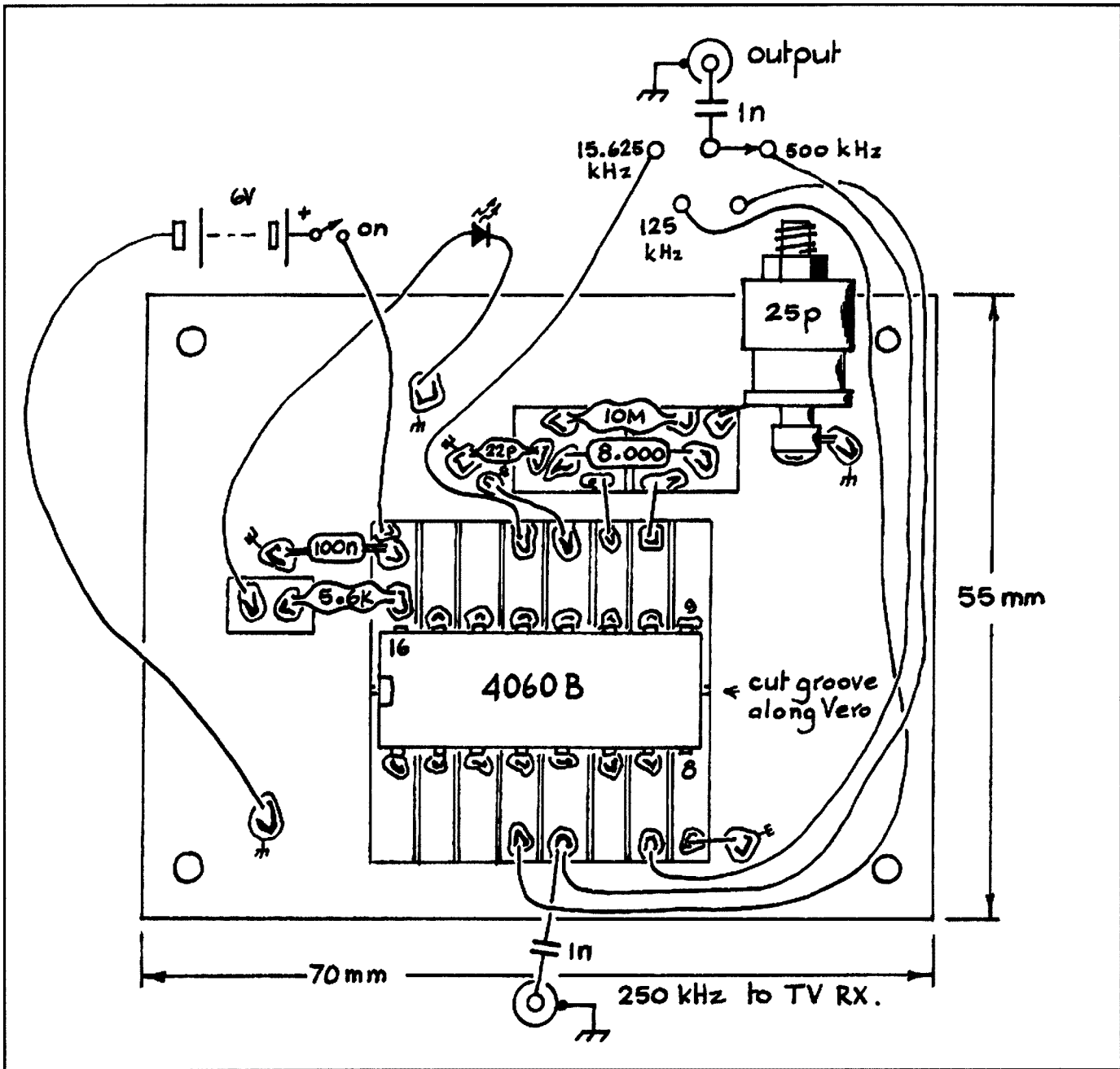

Figure 2

Now carefully adjust the trim capacitor so that the lines are stationary. Use the watermark logo- usually visible on the screen as a reference point.

Click to each TV station available to you, and observe that a good agreement is had in each instance. Interestingly (here near Melbourne) the only station that measurably differs from the bunch is SBS, due (possibly) to Doppler-shift produced by the satellite link. Nevertheless, very good congruence (and therefore low uncertainty) should be obtained between stations.

When used to check the accuracy of a digital counter for instance, the above is first performed. When the pattern is stationary (on most- or all local channels), the 500 kHz signal may be applied to your counter's input, where the display shall read 500.000 kHz plus or minus 1 count.

Similarly, the 125, 250 or 500 kHz signal may be applied to your receiver's input (a wire from the calibrator-wrapped around the receiver's antenna lead or coax should do) and the receiver's dial accuracy checked accordingly.

## Parts

All necessary components are quite common, and are collectively available from our usual parts suppliers. It happens that most of those used for the prototype were purchased from Jaycar, including the 4060B chip, 8 MHz crystal and jiffy box. The trim capacitor for the crystal should be an air-dielectric type, such as a "beehive" 25 or 30 pF, which are known to be available from Electronic World (03 9723 3860).

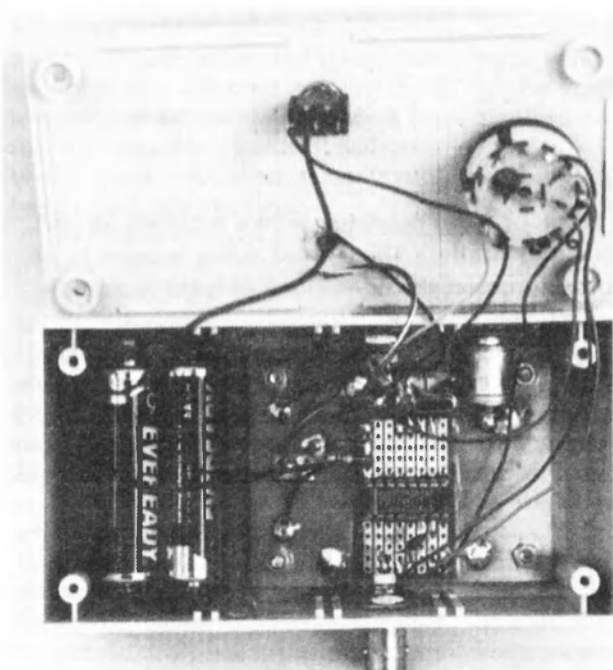

Photo 2 – Internal view.

## Summary

Our region is now without a dedicated free-to-air source of accurate radio frequency. However, by maintaining an ordinary crystal, which is easily divisible down to a frequency that is a convenient multiple of the TV horizontal frequency, the amateur may align the crystal's frequency against that of local TV transmissions, and thus exploit a rich source of accurate frequency at no cost.

A practicable circuit using an ordinary 4060B CMOS chip to generate relevant TV-related frequencies has been described, so that the amateur may use the device as an intermediary reference to check the accuracy of other frequency generating, or measuring instruments.

## References and Further Reading

1. "A Temperature-controlled Crystal Frequency Calibrator"; Diamond, AR, Dec/Jan '02/03.
2. "About Frequency References"; M. Greenman, ZL1BPU, Break-In, Jan/Feb. '03.
3. "Paddyboard Circuit Construction"; Diamond, AR, Feb. '95.

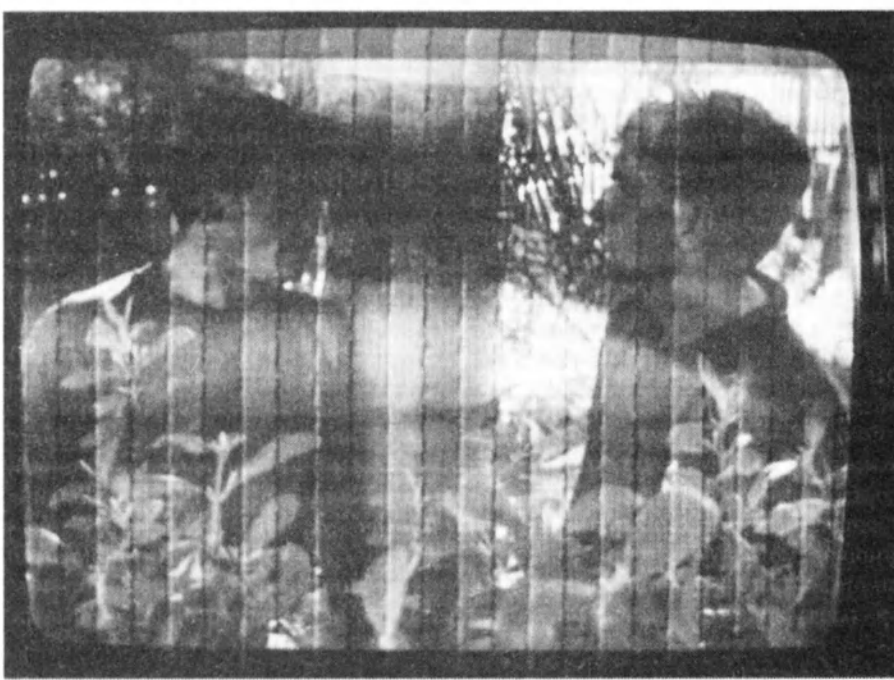

Photo 3 – Typical interference pattern, 250 kHz.

**radio and electronics school**

## Become a Radio Amateur

**Or study radio electronics to support your hobby**

Australia's premier training institution for  
**AMATEUR RADIO AND HOBBYISTS**  
courses available in radio & electronics technology for all ages  
**COURSES AVAILABLE ONLINE**

Be guided through your course by one or more of our 20 experienced volunteer facilitators, email hundreds of other students

**IN A HURRY?**

Become a novice radio operator in 4 weeks with our computer-based  
**NOVICE FAST-TRACK COURSE**  
Courses for schools, youth organisations and seniors

**Australian Radio Certificate Scheme (ARCS)**  
Use our accredited bridging program for radio amateurs to obtain a

**CERTIFICATE IN ELECTROTECHNOLOGY**  
Download all course materials free (CD Rom has a small fee)  
For Further Information visit  
<http://radioelectronicschool.com>  
or email  
[manager@radioelectronicschool.com](mailto:manager@radioelectronicschool.com)

**Tel: (07) 5573 2795 12-5 (EST)**

## EU Sprint April 2004

The first phone contest is on **Saturday 10th April** and the CW leg is the following **Saturday, 17th April**.

Software to use: DL2NBU's program has been written specially for this contest. It is very much like K1EA's CT, and it is FREE for download from the new Eu Sprint web site  
<http://www.qsl.net/ausprint>  
SD by EI5DI and TRlog by N6TR both

support the Eu sprint, and if you prefer to log on paper, that's fine as well. We accept any fixed column ASCII file, too. We hope you will give the sprints a try and then send your logs to [ausprint@kkn.net](mailto:ausprint@kkn.net)

73 from the EU Sprint Gang I2UIY, OK2FD & G4BUO

# Never give up!

Authors' names and call signs supplied

We recently had occasion to assist a friend, a visually impaired amateur radio operator, with a problem he had with alleged interference at his place of residence in a group housing situation. There were some lessons to be learned, particularly to be patient, to be firm but considerate, to be sure that the conditions of lease were fully understood by everyone, and, most important, to never give up.

It has been said that the resolution of an interference problem requires diplomatic as well as technical skills. In other cases, the technical solution has always been the more challenging. Well, not so in the case of our mutual friend.

Firstly, as our friend could not himself read the licence/lease agreement, he had his solicitor check it for him. There was a misunderstanding in that the legal person did not know or failed to appreciate that he was dealing with an amateur radio operator, and failed to

bring to his attention that there was a clause in the lease that effectively prohibited such activity. Certainly, if our friend had known, then it is doubtful whether he would have signed the lease to begin with.

However, being unaware of this restriction, our friend arranged for a magnetic mount dual band antenna to be placed on top of the window mounted external air conditioner, connected it to a dual band rig and he was on the air.

For about a week.

Some other residents apparently noticed the antenna, complained to management about it and that's when the trouble started. The conditions of his lease were quite unequivocal, and so our friend had to stop transmitting while we tried to sort things out. As you can appreciate, our friend has very limited opportunities to enjoy the rest of his life, and without amateur radio to occupy his mind, the future looked pretty bleak. But in the face of the direction, the dual bander came down and our friend was QRT.

We first approached the Residents' Committee for support, but this turned out to be a waste of time. One of the members had a son in law with apparently a decent sort of tower or mast in his back yard, and without listening to any discussion averred that there was no way that she would support any sort of activity involved with "such ugly structures". It did not matter that all we were proposing

was a simple vertical that would not have been visible from more than about 50 metre, no, she wasn't having any of that radio business there! They also used an argument that there were no other antennae of a similar type within the

residences, and they didn't want to start a precedent now. But that was one for us, because there were already four antennae similar to CB HF 1/4 wave verticals on the premises.

So thwarted by the Committee (which foolishly we thought were there to advance the interests of members) we then embarked on an exchange of letters with management that obviously did not appreciate the rules and regulations re amateur transmitters. But eventually they bent enough to say yes, he could operate subject to a number of conditions, amongst them being: -

- insurance being taken out on the antenna in case it fell and hurt someone or something, and
- the acceptance of all responsibility for any interference that may be caused, even to the extent of repairing or remedying any faults in the equipment being interfered with.

Now obviously the second of those conditions wasn't on, so a further exchange of letters with the head office took place, pointing out the facts of life and eventually reason was seen, and permission was given to install a gutter mount antenna. As a bonus, this worked much better than the dual bander, as it was considerably higher.

But then it was found that there was interference with quite a few TV sets, many of which were a bit ancient and so had minimal

rejection capabilities.

One resident became very aggressive, even ringing our friend at any time of the day but always hanging up the phone before our friend had a chance to talk to him about what should be done, ie involve the ACA straight away. But no,

**...as radio amateurs, we had the resources to remedy the situation but for one reason or another, we were prevented from implementing a solution**

The revolutionary VK4VKD

## One Man Tower Freestanding Self-erecting 10m to 25m



Fully adjustable delta loop rotatable antenna  
1-2-3-4 element

D.I.Y. delta loop element to boom 'hubs'

350kg SWL 5:1 braking winches

Galvanised steel boom to mast clamps

VHF and UHF beams

High tensile 'U' bolts

Safety harnesses for above ground work

Arrays easily taken to ground level for maintenance and wind protection

Easily erected without cranes

(Ideal for confined areas or remote repeater sites)

proudly built in Australia by

**Australian  
Enterprise  
Industrial**

(PQ Box 1013 Browns Plains QLD 4118)

<http://homepages.ihug.com.au/~aeltower>

[aeltower@ihug.com.au](mailto:aeltower@ihug.com.au)

Mob. 0414 254 080

Fax 07 3800 8003



according to the complainant there was no interference before the transmitter was set up (we found out later that there always had been interference there, but that's another story) and so it definitely was our friend's fault and he (our friend) had to fix it, now, not later.

This person also complained he had at his own expense, bought from a major electronics store, a filter to try and fix the interference, but not surprisingly, it didn't work. We thought that whilst salesmen were good at selling things, they didn't necessarily know much about technical matters or what sort of filter should be used and where it should be placed, particularly when they hadn't seen the actual problem.

An experienced TV antenna installer, who coincidentally also held an amateur licence, had been following progress with a great deal of interest. After a quiet inspection, he was of the opinion that all that was needed was a rejection filter installed at the main central TV antenna. But no, management was not having any of it, even though our friend had offered to pay for the filter.

So it dragged on a bit with management pursuing a course of action called "masterly inactivity". Finally however whilst a relieving manager was in charge, the ACA was called in with their equipment. It was quickly found that our friend's equipment was clean and operating within specifications on all amateur bands, and so he was cleared of all faults. The fault was found to be in the central distribution antenna serving all the TV's in the estate. It was quite coincidental of course that the antenna installer was there at the time, and even more coincidental that he had an appropriate filter on hand in his van. Curious, that!

So at the relieving manager's direction, the filter was installed, and lo and behold, all interference has stopped. The same result could have been achieved, without all the angst, if management had listened to us months before.

So our friend is now operating on two metres and 70 cm, IRLP and 20 metre CW, and everyone is happy.

Except the most vocal complainant who still has not conversed with our friend directly. Well, he may be happy, but at least he is now not aggressive to our friend.

It would have been very easy for us to have given up very early on. From the

time the dual bander was first spotted on the window mounted air conditioner, to the time that the ACA became involved and the problem fixed once and for all, was something like six months. It involved an amount of verbal intimidation and aggression by one person, extreme prejudice by a group, and ignorance on behalf of management, which would not take advice as to how to go about fixing the problem alleged to exist.

Now, our friend is a much relieved person, there is no stress and he sleeps a great deal better. Our friend never gave up and we know at times, he was prepared to "throw in the towel" but thankfully he held on and is now enjoying his amateur radio as much as he ever did.

So never give up, but in any case, read and understand the fine print first.

## Technical details

I was horrified when I had taken a casual glance at a television set while our friend was transmitting happily away on 70 cm IRLP at 5 watt output, to see an interference pattern. The premises have been the subject of many television reception complaints over the years but prior to this instance, the source has never been amateur radio. When people started complaining about interference, mainly on channel 9, it was put down to the same old problems of other times. I couldn't believe that at the frequency of operation and the output power involved, that we would get into any trouble. But our friend on this occasion was the unlucky one.

The problem, at a guess, was a mixing of 632.250 MHz vision carrier (WIN TV) and our friend's 433.725 MHz signal. The result was interference in the channel 9 picture. As our friend's transmitter was manipulated to bring the mixing product closer to the channel 9 vision carrier 196.250 MHz the interference became severe.

The solution was to provide a high pass filter so that only the UHF television signals entered the masthead amplifier input. Unfortunately for our friend, the politics of the situation took over and I could see that, as radio amateurs, we had the resources to remedy the situation but for one reason or another, we were prevented from implementing a solution.

# RippleTech Electronics

## Brand New Dxciting Products

RippleTech Electronics is providing a new service to hams in VK/ZL and the Pacific. With sunspot numbers declining, HF access for all and a bigger 80m DX window, grab a small footprint, high performance antenna and let loose on HF. We have excellent antennas for 30m/40m/80m and 160m. You may think that G5RV works, but you'll never look back once you've tried a RippleTech antenna!

Want to try something different, how about a WARC band 30/17/12m rotary dipole mounted above your tri-bander.

Got no space? Try a 10/15/20m or 12/17/30m vertical. Coming soon, automatic antenna switches for your modern Yaesu.... Wow!

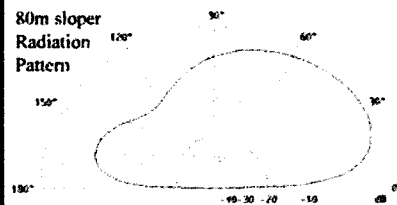

10/15/20m Vertical	\$199.00
10/15/20m Vertical	\$189.00
Radios kits	\$44.00
FT-100mp remote	\$33.00
30 or 40m Rotary Dipole	\$399.00
20m mobile whip	\$44.00

**RippleTech Electronics**  
3 Moyston Close  
Vermont South  
VIC 3133



**Phone or Fax**  
**03 9887 2917**

**WANT MORE INFO ?**  
**PICTURES-DESCRIPTIONS**  
**A FULL PRICE LIST**  
**OR AN ORDER FORM - see**  
[www.rippletech.com.au](http://www.rippletech.com.au)  
[sales@rippletech.com.au](mailto:sales@rippletech.com.au)  
[info@rippletech.com.au](mailto:info@rippletech.com.au)  
ABN 70 465 254 759

# PCI sound card interface

John Hodgkinson VK2BHO

Digital modes have steadily been increasing in usage by the Amateur Radio fraternity for some years now, the widespread usage of PCs has also impacted on Amateur radio. In the beginning dedicated systems were developed and marketed. The most dramatic impact took place when free software using a PC's Sound Card as an interface was released freely on the Net. In just the last few years we have seen a dramatic increase in usage of these new modes by many amateurs. Due to the fact that one simple hardware interface between the transceiver/radio and the PC sound card will support most if not all of the new modes, PSK31, MFSK16, SSTV, HELL and others.

Like many others, a fellow local amateur attracted me to this activity and about that time I was also developing an interest in things digital. I was trapped as they say. The scene was set, and also several other locals were taking the plunge. Then the horror happened: blown up sound cards. How did it happen? A lack of understanding and technical knowledge with interfacing and level control most likely. A little knowledge is dangerous as the saying goes.

An interface is described as *A common boundary between two objects.* In electrical/data terms this means that information can freely pass from one side of the boundary to the other, while at the same time providing complete

electrical isolation between the circuits on either side of the boundary, e.g. the amateur transceiver and the PC.

Early interface circuits (which are still being published in amateur magazines) are a hidden disaster to those who innocently try them. Variable resistors and transistor inverters do not an interface make. Next came audio transformer decoupling for send and receive data streams and opto isolator decouplers for the TX PTT line. This system needed a Comm. port output and a dc voltage source. For those with only two Comm. ports usually in use, it required cable swapping to access the amateur radio interface.

An article in Sept 2000 QST suggested a method of providing a complete

transformer isolated interface with the PTT generated from the send data stream. Using the principle involved, an interface was constructed using local parts which worked first time for me. Sharing this knowledge with other local club members was of some disappointment to some and I had no idea why. Well, in due course I updated my computer to improve my SSTV program capabilities. Suddenly my digital interface no longer worked and I was in the same position as the others who could not make it work.

## Solution

Investigation proved that sound cards are not sound cards as the saying goes, the original sound card was a Sound

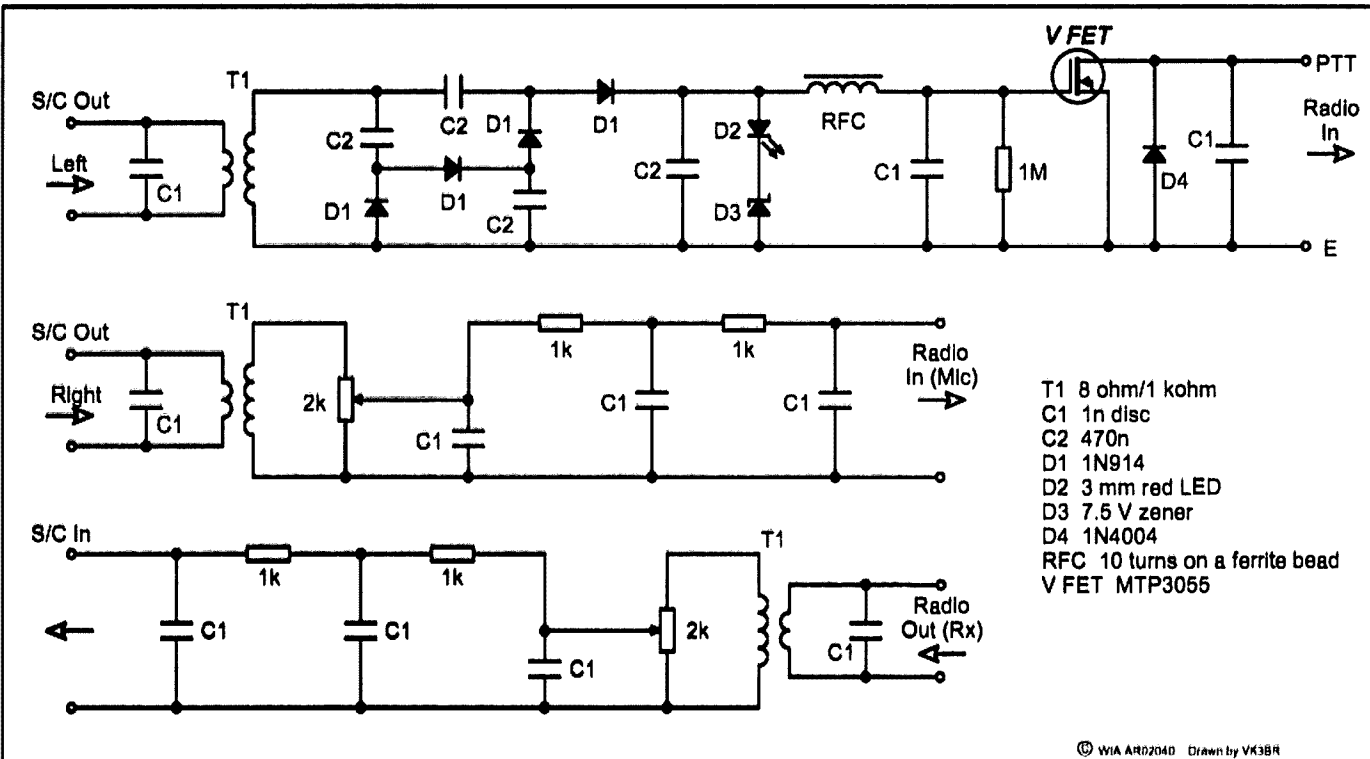

# New ARRL DXCC Ruling February 2004

Wayne Mills N7NG

225 Main Street, Newington CT USA 06111

Telephone: 860-594-0291 Telefax: 860-594-0259 Internet: [n7ng@arrl.org](mailto:n7ng@arrl.org)

At its January meeting in Windsor, Connecticut, the ARRL Board of Directors removed paragraph 1.c) from the criteria for determining a DXCC Entity. This provision, implemented in 1998 as part of the DXCC 2000 Program, had provided that "An Entity will be added to the DXCC List as a Political Entity if it ...has a separate IARU Member Society." Since that time, the rule has allowed for the addition of four new DXCC Entities and the retention of one existing Entity.

At the time it was not expected that this would create difficulties with the administration of the IARU. Unfortunately, the provision has had the unintended consequence of stimulating applications for IARU membership that do not further the objectives of the IARU, creating an unfortunate and unnecessary administrative burden.

The rule change will have no effect on those Entities created by or as the result of the rule. According to DXCC Rule II, 5. C), "A change in the DXCC Criteria shall not affect the status of any Entity on the DXCC List at the time of the change."

The other two criteria for the determination of a Political Entity for DXCC continue in effect:

- a) The entity is a UN Member State.
- b) The entity (except international organizations) has been assigned a callsign prefix block by the ITU.

The text of the Board resolution reads: *WHEREAS, the DXCC 2000 program adopted by the Board in 1998 included changes to the criteria for a DXCC entity, and*

*WHEREAS, one of the new criteria makes separate IARU membership the basis for determination of a "political entity," and*

*WHEREAS, this rule has served a constructive purpose with respect to existing IARU societies, but*

*WHEREAS, the rule also has had unforeseen consequences in creating an incentive for the creation of proposed IARU societies that do not further the objectives of the IARU, and*

*RECOGNIZING that elimination of the rule has no effect on the DXCC entities that already have been created as a result of the rule,*

*RESOLVED, that the DXCC rules are hereby amended by deleting IARU membership as a basis for determination of a "political entity."*

ar

---

## PCI sound card interface *continued*

Blaster 16 which has 2 x 2.5 watt amps capable of directly driving 8 W speakers. The new Multi Media PCI sound cards have much lower output intended to drive amplified speakers. At normal program fader settings there was not sufficient output to saturate the PTT power FET nor to turn on the indicating TX LED. The measured audio output was 600 millivolt ac, which produced just over 2.1 volt dc when rectified. This is well below the 10 volt needed to saturate the MTP3055 FET, the original SB 16 sound card being capable of producing 20 volt dc.

Since the FET is a voltage controlled device it draws no current. The voltage quadrupling rectifier was trialed and found to produce approx. 10.5 volt dc from the data stream using an 8  $\Omega$  / 1 k $\Omega$  transformer, this voltage saturated the FET, one down one to go. Several LEDs were tested and a 3mm red LED was found to provide a reasonable glow at 200 mA of current. The clamping Zener was reduced to 7.5 volt and the combination set the gate voltage at 9.6 volt with a reasonable LED glow. This being achieved at approx mid range slider settings.

## Construction

The modules can be enclosed in a suitable box. If a metal box is used "CARE" must be taken to ensure there is no dc continuity from input to output on any interface module. Shielded audio cable is recommended for connecting cables, other options are to use 8/1k ohm or 1:1 isolating transformers depending on the sound card in use and the audio signal source (see connection). All components were locally sourced and appear available through most usual electronic suppliers, cost (excluding box) approx. \$25 in March 2002

## Connection

Depending on your particular sound card and/or your radio you may need to use slightly different configurations. My HF transceiver has a line level audio output. I use a 1:1 transformer with this interface but my 2m VHF does not and I use a split of the 8  $\Omega$  speaker output and a 8  $\Omega$  : 1 k $\Omega$  transformer in this interface to achieve sufficient audio drive at the sound card Line In input. If you only

have a "Mic In" input to the sound card, dc blocking is required as normally +5 V for the electret microphone is supplied by the sound card. In the send direction, if you do not have a Line Out output from your sound card then separate the stereo outputs of the Speaker Out output. Using one to provide the send data stream and the other to drive the PTT interface ie. the Left and Right channels. This provides signal path isolation which was not provided in some versions of other published designs.

## Conclusion.

A PCI sound card interface with complete isolation between the radio and PC.

A passive device no external power source required.

Data stream generated PTT that frees the Comm port connection making the interface connection simpler.

Achieved at normal slider settings "not end stopped".

It worked for me, maybe it will for you.

ar

## More on solid-state lamps

Pat Hawker also referred to the article by Phil Sales AD5X (Tech Abstracts AR, April 2004) in the November 2003 issue of RadCom. In the February, 2004 issue of RadCom, he has published follow up correspondence from Dave Gordon-Smith, G3UUR.

He touches on a number of matters, starting with questioning the economics of using LEDs if it is still possible to purchase incandescent lamps at low cost at rallies or on special.

However, these bulbs do produce considerable heat and can distort or discolour plastic dials. Changing to LEDs may be beneficial in this respect, but they may well upset the thermal balance that the manufacturer intended when providing temperature compensation. Therefore, you should be aware that there may be unexpected consequences of wholesale replacement of incandescent lamps with new white LEDs.

Some of AD5X's figures for the voltage drop of bright LEDs are questioned. "White LEDs are usually blue LEDs with a phosphor coating the chip. The blue light excites states in the phosphor, producing light over a broad range of wavelengths. Good quality, White/Blue

LEDs have a forward voltage drop of about 3.6V at 20mA. By 'good quality' I refer to perfection of the material used – InGaN in this case although, in the technical press, it seems to be generically called GaN (there is some GaN as a buffer layer, just above the sapphire substrate).

"Beware of blue LEDs that are made from GaN (really InGaN and AlGaN epitaxial structures) and have a 4V forward drop at 20mA – they are much inferior, and their reliability and light output will be lower than the better devices. A general rule for the forward drop of an LED is that the shorter the wavelength, the higher the voltage. Green should be higher than amber and blue slightly higher than green.

"I also have a concern over the peak reverse voltage of the InGaN devices. For a 6.3V RMS filament supply, this can be as high as or higher than 9V. InGaN LEDs have a specified reverse breakdown voltage of only 5V. They are tough little critters, and will stand such abuse, especially with a current limiting resistor in circuit – but don't expect them to last for one million hours as specified for continuous forward operation at 20mA. In reality, they may

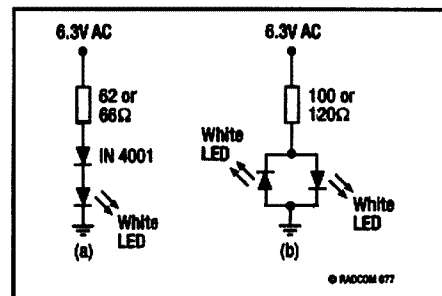

Figure 1

fail sooner than an incandescent lamp.

"There is a simple fix for this problem – put a diode (1N4001) in series with the LED and this will protect it in reverse bias. See (a) in the drawing. The series limiting resistor value needs to be reduced to get the same brightness. Alternatively, at extra cost, connect two LEDs back-to-back, so that one conducts on positive half-cycles, the other on the negative. That way, you get twice the light output with each LED protecting the other. See (b) in the drawing. This allows you to reduce the forward current for the same brightness as one running only half the time. Consequently, you get a longer life from the InGaN LED and this approach should work out cheaper in the long run.

## The load shedder

For those mobilers who have suffered from a flat battery, here is a project for you.

Rod Kreuter, WA3ENK (QST February 2003) describes a circuit that monitors the battery voltage and disconnects it from the load if it drops below a preset value.

This circuit monitors the battery voltage, and as the voltage drops (the battery discharges), a LED flashes and a Sonalert chirps out a warning (the warnings can be disabled). If the voltage continues to fall, the Load Shedder acts like a simple switch - it opens. This disconnects (sheds) the load, hopefully saving the battery whilst protecting the

equipment from under-voltage. It also saves the owner from a dead battery and a vehicle that will not start.

Both the warning voltage and the trip voltage are adjustable from about 11 to 13 V, the trip voltage always being lower than the warning voltage.

The drawing shows the complete circuit of the Load Shedder. The heart of the circuit is a precision voltage reference (U3). This diode is much more precise than a simple zener diode and provides a stable 2.5 V reference, even when powered from a severely discharged battery.

The voltage reference is compared to two other voltages, the warning and the

trip voltage, by comparators U1A and U1B. The warning comparator, U1A, enables a low frequency oscillator that drives the Sonalert. The pulsing tone is considered to be more 'attention getting' than a constant tone. The oscillator U2D does double duty. It generates the tone to drive the piezo noise maker as well as working as a charge pump, with diodes D2 and D3 and capacitors C7 and C8 to provide 24 V to drive the gate of the FET switch.

This voltage is required so that an N-channel MOSFET can be used in preference to a P-channel device. The N-channel has the advantage of having

*continued on page 30*

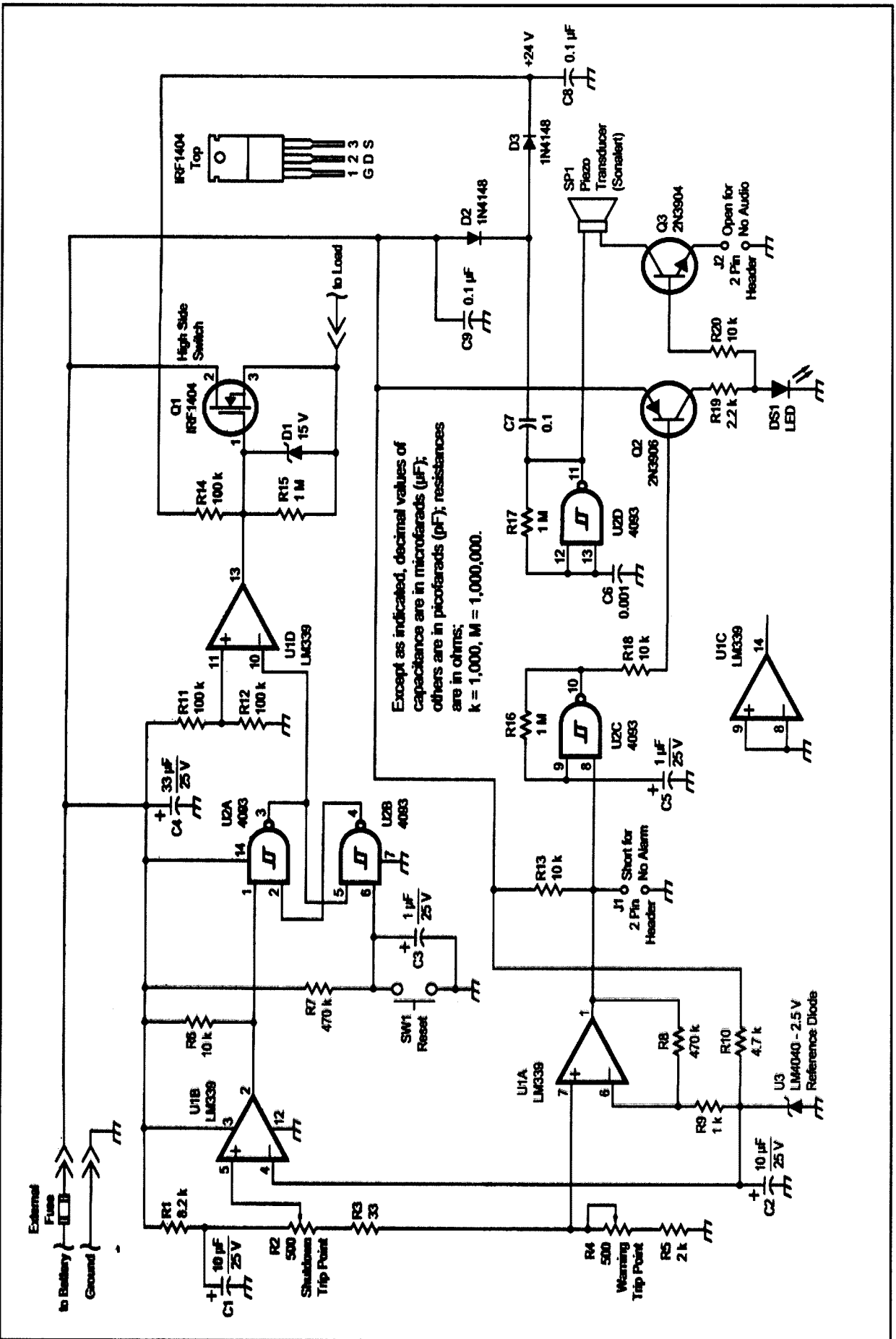

Figure 2



# TTS Systems Communications Equipment for t

www.ttssystems.com.au

FREE C

## Ten Tec Jupiter HF Transceiver

All Pegasus features plus a large LCD panel and controls. Can be used directly under PC control in Pegasus emulation Mode. The GUI software at no charge. With the command set for control of both the Pegasus and Jupiter you can write your own control software. **Frequency range:** 10-160 m + WARC Mode: All-mode (AM receive only) **RF Power output:** 5-100 W **Voltage:** 13.8 VDC **Current drain:** RX: Max 1.5 A TX: Max 20 A **Impedance:** 50 ohms **Dimensions:** 308\*127\*330 mm 5.3 Kg



## TEN-TEC KITS

We have these world famous kits, and remember, it sounds better on some-thing you built yourself. Start with a small kit and build up to a transceiver.

Check out the full list on the site.

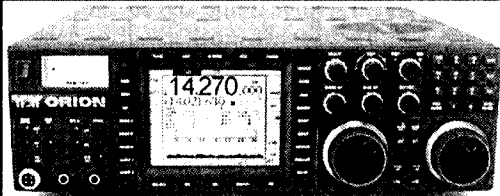

## Orion is here

We are working to separate the overjoyed owner from his new gear long enough to talk with us. When we do, we will bring you an assessment of how it all works. But until then, the list of primary benefits says it all:

- Dual 32-bit floating point ADI SHARC DSP processors
- Full dual receive capability
- Very high RX intercept points
- 590 receive IF-DSP bandwidth filters independently selectable on each of the main and sub receivers
- Adjustable receiver filter shape factors
- Programmable AGC response time for

- main receiver
- True diversity reception using both receivers
- Continuous real time spectrum display allows monitoring of band activity
- Instant Two Radio Mode" allows ORION to instantly QSY between two different bands
- Virtually indestructible 100-watt PA
- Superb SSB audio is yours at a touch of the AUDIO button
- Ten-Tec's

- new Panoramic Stereo receive feature
- Adjustable rise and decay times for transmitted CW waveform
- Nine adaptive DSP noise reduction filters
- Dual noise blankers
- Voice keyer and CW memory keyer built in
- On-the-fly reset button
- Flash ROM updatable

## TEN-TEC ARGONAUT V

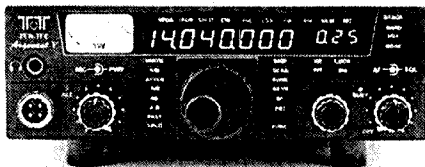

**Frequency range:** TX: 10-160 m + WARC

**RX:** 0.5-30 MHz

**Mode:** AM/FM/SSB/CW/AFSK

**RF Power output:** 1-20 W

**Sensitivity:** SSB/CW: 0.2-0.35 uV (10 dB SINAD @ 2.4 KHz bandwidth)

**AM:** 0.5-0.9 uV (10 dB SINAD @ 6 KHz bandwidth)

**FM:** 0.35-0.6 uV (12 dB SINAD @ 15 KHz bandwidth)

**Selectivity:** 35 built-in filters SSB/CW: 200-3000 Hz AM: 400-6000 Hz FM: 15 KHz

**Image rejection:** 80 dB **Voltage:** 13.8 VDC **Current drain:** RX: 950-? mA TX: Max 6 A

**Impedance:** 50 ohms, SO-239

**Dimensions (W\*H\*D):** 216\*70\*246 mm

**Weight:** 2.2 Kg

100 memories. Scanning. CTCSS encoder. PSK31-ready. IF-DSP.

"Software defined" radio.

Download new functions from your computer.

## Ten Tec RX350 Communications Receiver

- Modes AM/DSB, SAM/LSB, SAM/USB, AM, LSB, USB, CW, DIG, FM
- Tunes 100 KHz to 30 MHz.
- Stability +/- 90Hz at 25 deg C.
- Selectivity 34 inbuilt filters
- S Meter S9 calibrated to 50mV standard
- Spectrum Sweep Display • PC Interface

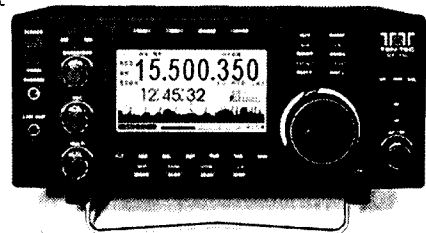

## TEN-TEC

## RX340

## Professional Communications Receiver

- Modes AM, SAM, LSB, USB, ISB, CW, FM
- Tunes 5 KHz to 30 MHz.
- +/- 1 ppm frequency stability.
- User programmable AGC
- Selectivity 57 bandwidths selectable from 0.1 KHz to 16 KHz.
- Meter Calibrated in both dBm and S Units
- External IF and digital (DSP data) outputs
- Both balanced & unbalanced audio outputs
- 100 memories that store frequency, bandwidth, AGC and Mode.
- Remote controllable via serial RS232 port.
- Rack Mount, 3U in height.
- Power 90 to 264 VAC 30 watts.
- Used by US and Australian Government Agencies

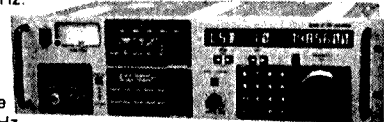

WE SPECIALIZE IN MAIL ORDER. VISA AND MASTER CARD ACCEPTED. CALL FOR A FREE CATALOG WITH PRICING.

## TEN-TEC 6n2



Model 526 "6N2" multi-mode 6m/2m transceiver. Amateur radios' first IF-DSP multi mode VHF rig. For a long time, there have been no affordable choices for either 6 or 2 meters in a single band VHF multi mode transceiver. Active hams planted the idea with us - why not offer a single rig that has BOTH 6 and 2 meters, without sacrificing

performance? Multi-mode HF/VHF rigs have been around for years, at over a thousand dollars and with compromised performance on the VHF bands at best. The 6N2 provides serious multi mode VHF performance in a small, take-anywhere package at a significantly lower price than HF+VHF multi mode transceivers.

## Re-sellers

International Comms Systems (SA)

Marcom-Watson Group (TAS)

all re-sell these famous products

Strictly Ham (Melb.)  
Tower Comms (Perth)  
Kyle Comms (QLD)

TTS Ph: 03 5977 4808. Fax 03 5977 4801

info@ttssystems.com.au

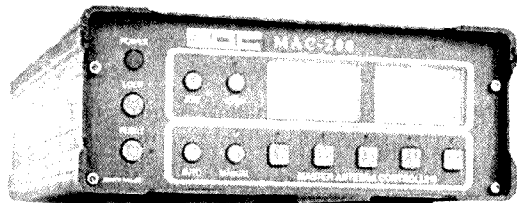

## MAC-200

### MASTER ANTENNA CONTROLLER (Smartuner Built-In)

The MAC-200 has a Smartuner and an Antenna Switch in one compact unit.

- Controls  
 5 ANTENNAS  
 3 SO239 COAXIAL CONNECTORS  
 1 BALANCED ANTENNA OUTPUT  
 1 END FED LONG WIRE

Displays Forward power on 20 and 200 watt scales and VSWR. Smart enough to do the job without operator attention.

The Mac-200 from SGC is THE answer for feeding multiple antennas from a single transceiver! It's more than a switch, it shares a tuner between all of the antennas. It knows which antenna you're on and remembers the last successful tunes on each antenna so it can get back there fast. All of this works in less

than 10ms for frequencies you've been on before, less than 2 seconds for randomly chosen frequencies with a no compromise Pi Network output. The Smartuner remembers everything for quick, perfect matching. The push of a button makes it work, everything else is automatic. Built in meters for easy monitoring, low power consumption, and rugged construction make it useful for complex field portable operation as well.

*"... reports I was given were from 5x5 to 5x9+ on eighty and forty meters QRP. I am told it sounds like 100 watts is being used ... my slogan now is 'the Box that brought my amateur radio hobby back to life'"*

(One of UK's most active low-power amateurs talking about the MAC-200)

Not only but also---  
**Autek Analysers & Power Meters**  
**Davis Weather Stations**  
**Amidon Cores.** Call for a stock/price list  
**Baluns and Transformers**

## SG 2020 ADSP<sup>2</sup>

Small, light, rugged, recessed face. Pre-set for 20 watts PEP with front panel power adjustments down to 1W for QRPers or up to 20W for serious USB or LSB "hamming". 20 pre-programmed memories preset to each of the 9 worldwide ham bands. Each memory position can be selected for a specific transmitter output power, specific amount of bandwidth filtering, mode and split VFO. Crystal clear.

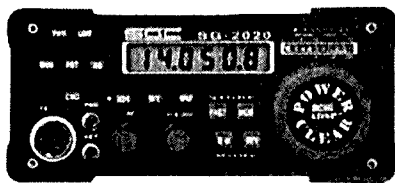

## ADSP2 Speaker

Works with the press of a button. You can select from three modes of operation: no noise reduction, the original ADSP, and the new ADSP2 noise reduction modes which provides up to 26 dB of noise reduction within the passband. The ADSP2 Speaker is "One Touch" simple to

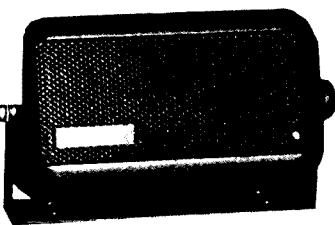

up to 26 dB of noise reduction

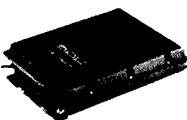

## SG-237 HF-VHF SMARTUNER®

Worlds Smallest  
 High Performance  
 Antenna Coupler  
 Finished Product  
 or PCB

- 100 watts
- 1.8 to 60 MHz

## Model SG-230 Smartuner™

Automatic microprocessor antenna coupler. Can be used within its power rating with any HF Transceiver in range of 1.6-30 MHz. Designed for marine, portable and fixed base applications. For antenna types: 23 ft marine whip for 1.6 to 30 MHz and with 9 ft minimum antenna for 3-30 MHz operation. memory channels: 170 Frequency range: 1.6-30 MHz Power rating: 200 watts PEP maximum: 12VDC operation

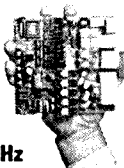

## The SG-239 Smartuner™ antenna coupler

With any transceiver get long distance communications. Great results with a longwire antenna or a coaxial fed multi resonant antenna at the unit window. Fits many low cost HF Transceivers: Scout, Yaesu FT-817, Kenwood TS-50, Icom IC-706, and the K2 kit. **Ideal with the legendary SG-2020 transmitter.** Silent receiver tuning or within 1.5 to 200 watts with a high power transceiver. 170 memory bins, independent sensors, inc. VSWR, phase, magnitude, low impedance, and forward sensing.

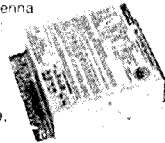

## SGC SG-211 MINI-Smartuner

SGC is announcing a new Mini-Smartuner, with zero power consumption. No DC wiring is necessary to power this Smartuner. It has a naturally balanced output for operation with whips, long wires and dipole antennas

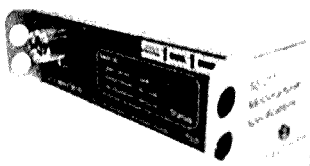

Due for release  
**April**

We will have  
**stock end of April**

## LDG-AT1000 High Power Antenna tuner

Microprocessor controlled  
 Switched L tuning network  
**Continuous coverage 1.8 to 54 MHz**  
**Power rating HF (1.8 to 30 MHz): 1000**  
**Watts Single Side Band 750 Watts CW 500**  
**Watts Digital (RTTY, Packet, etc.) Power rating 6 meters: 100 Watts**



## RT-11 Autotuner



A feature of the RT-11 is latching relays, which retain their settings so the RT-11 can be powered down once it is tuned. If you shut down after a night of operating, the next morning the tuner is in the same configuration. This power saving feature is very popular with our QRP Z-11 customers. The heart of the RT-11 is a 68HC11 Microprocessor which performs many hundreds of quick tests to determine the correct combination of capacitors and inductors to load your antenna system. Tuning is in 1 to 5 seconds. The tuner can handle 0.1 to 125 watts (100 watts continuous, 50 watts on 6 meters) of RF power. The water resistant case can be mounted on a tower, in a boat or car, outside the window of your shack ... almost anywhere. The case has 2 flange mounting brackets to facilitate ease of mounting. Since the unit is RF sensing, it will tune when it senses a band change (high SWR), thus it will operate with any HF radio

See it all on  
**www.ttssystems.com.au**

# Spotlight on SWLing

Robin L. Harwood VK7RH

## Programme reductions unearth buried treasures

As I predicted in last month's column, there certainly has been a dramatic reduction in programming output from 27th March. The Christian Science Society closed their 500 kW senders in Cypress Creek, South Carolina on February 29th and the senders are still on the market. Apparently the Society, publishers of the respected "Christian Science Monitor" daily newspaper, decided to permanently end their involvement with Shortwave, opting for Internet delivery and local programming.

The Governing Board of the IBB, which supervises official American government external broadcasters such as the VOA, R. Marti, R. Liberty, R. Sawa, R. Farda etc, decided also at the end of February to end broadcasts in certain central and eastern European languages over shortwave. One of the languages slated for closure was Ukrainian and arrangements were made for local relays of programming. However the Ukrainian government put pressure on the local stations to cease all relays of external stations. This pressure resulted in murder and some media owners fled

into exile into Western Europe. The immediate result, not surprisingly, was the rapid escalation of Ukrainian programming over shortwave and the deterioration in diplomatic relations between the US and Ukraine. Ironically Russian programming from Moscow goes into Ukraine uncensored as it does across the former Soviet Union giving news and commentary which has caused friction, particularly in Belorussia and Turkmenistan as well as in Ukraine.

The dramatic reduction has also allowed many low-powered signals to become audible after being buried under the major players. Funnily enough, many of these signals turn out to be harmonics of senders in the medium and tropical allocations. Monitors in the Americas are hearing second and third harmonics of Latin American MW stations whilst they cannot be heard at all on their fundamental channels. Another phenomenon is mixing products from major senders, especially when two transmitters from the same site operate close to each other. Spurs are usually plus or minus the difference between the senders. E.g. the Sackville

site of RCI.

I have previously mentioned that the BBC World Service is now locally available over ABC Newsradio as well as over a community FM radio station, in the wee small hours. As from the 1st of March, I now am able to access London on Austar as part of their so-called digital radio platform, with a 24-hour service. I wonder if other external stations will also become available via similar sources. An Australian ethnic station in Italian is also on Austar.

DRM, the HF digital signal, is certainly becoming noticeable. I hear it primarily from two sites, Sackville in Canada or Bonaire in the Netherlands Antilles. I also am informed that DRM is being utilised by various organisations and is being transmitted in blocks from senders such as the above instead of installing expensive hardware at numerous sites. However DRM should be on channels well away from the existing analogue signals as the digital signals are wider.

Well that is all for this month. If you have any news or comments please send them to [vk7rh@wia.org.au](mailto:vk7rh@wia.org.au).

ar

---

## Technical Abstracts

### The load shedder

*continued from page 27*

a much lower 'On' resistance than a P-channel, thereby, lower losses. The downside of this lower loss, is greater complexity where you need a gate voltage of about 10 volts greater than the supply voltage (to ensure full enhancement and hence complete turn-on). Therefore, the oscillator is pressed into double duty as described above.

The second comparator, U1B, is the trip comparator. If the voltage falls to the trip voltage, the output of the trip comparator sets the flip-flop formed by U2A and U2B. The flip-flop is required to ensure a positive switch off and stop

possible oscillation due to the battery voltage varying when disconnected.

The FET chosen is rated at 162 amp continuous, 650 amp peak current, with an 'On' resistance of only 4 milliohm (0.004 ohm). This translates to a 10 amp switch with no heat sink, to (at least) a 30 amp switch with a simple heatsink.

The only equipment needed to adjust the Load Shedder is an adjustable dc power supply, a dc load such as an incandescent 12 V lamp and an accurate digital voltmeter.

Place a jumper on J2 but leave J1 open during the following calibration. R2 and

R4 should be turned fully counterclockwise. Connect the load (12 V lamp) between the output and ground. Next apply a voltage equal to the warning voltage, say, 12.4 V. If the load is not on, push the 'Reset' button. At this point, the load should be on (lamp on) and the warning LED off. Adjust R4 until the warning LED blinks and the Sonalert sounds.

Next, lower the applied voltage to, say, 12.2 V. Adjust R2 until the load is switched off. Check the voltages again to confirm they are what you want. The Load Shedder is now calibrated.



## VK1 News

### Forward Bias

The Annual General Meeting for 2004 was held on Monday, February 23.

President, Alan Hawes, thanked all members for their help and assistance given during 2003 and handed out certificates of appreciation to those who had performed in an exemplary manner. After stand-down of the committee, Chris Davis, VK1DO, took on the role of Returning Officer, and conducted the election of the new committee members. However, as there were as many applicants for the various positions as there were positions, no voting was necessary and all applicants were declared elected.

The committee comprises the following persons: Alan Hawes, President; Phil Longworth, Senior Vice-

president, WICEN state coordinator, and chairman of ACT Technical Advisory Committee (ATAC); John Woolner, Vice-president, Bob Howie, Treasurer; Deane Walkington, Secretary; Graeme Wilson, Education; Peter Kloppenburg, Membership secretary; Colin Holmes-Clark, Broadcast officer; and Russell Manning. Graeme Wilson's first initiative is to make himself available on the second and fourth Tuesdays of the month at the Farrer hamshack to provide assistance to those pursuing private studies for any of the amateur licence examinations.

There will be two Trash & Treasure sales this year. The first one at 12 noon, on Sunday, May 16, together with a free

sausage sizzle, at the Parks & Garden compound in Longerenong St., Farrer, and the second one at 8.00 pm in Scout Hall, Longerenong St., Farrer, on Monday, August 23, 2004. During the T & T in May, Graeme Wilson will conduct VHF and UHF antenna tests for those who want to know the gain of their new or homebrewed Yagis.

During the months of January and February four membership applications were approved by the committee. They were: G.P. Wilson, VK4FXL; J.G. Bell; N.G. Chalmers, VK1ZNC; and W.P. Robertson.

The next general meeting will be held at 8.00 pm on Monday, April 26 at Scout Hall, Longerenong St. Farrer. Cheers.

By Peter Kloppenburg VK1CPK

## VK2 News

### The Annual General Meeting

By now members should have received by separate posting, the paperwork pertaining to this year's AGM, which will be held on Saturday 17th April. At the close of nominations on Saturday 6th March last, Returning Officer Peter VK2EMU had only received eight applications. As the Council requires nine members there will not be an election this year. A quorum of thirty five is required at an AGM and all members are urged to attend if possible. If unable to attend, then exercise your proxy so that you can still be involved. You will notice that a couple of the agenda items are suggested changes to the Articles to improve the operation of future meetings.

Also this month there will be the annual Urunga Convention. It will be held as usual at the North Coast village of Urunga, near Coffs Harbour. This is held over Easter and will be the 56th year of activities. If you need details

contact Arnold VK2ADA. Still on the Mid North Coast, this time in June, it will be the annual Oxley Region Field Day over the long weekend. It is held at the Sea Scouts hall in Buller Street, Port Macquarie.

Amateurs are being encouraged to take part in the 80 and 160 metre contests in May, June and July. An opportunity for Limiteds to take part in some short duration events.

The VK2 Bookshop is hard pressed at times to keep up with the demand for orders. No sooner does a shipment land on the office floor, than it is out the door again to fill a back order. Thank you for your support. There is a range of back issues of QST and the like on CD. There are also a few copies of the paper version of each month's QST, which, even if posted from the office, is still less than the newsagent cover price. You should check the VK2 Bookshop Web site for details of stock. There may still be some 2004 callbooks available.

The effects of the lightning strike at VK2WI in late January proved to be a

busy time for Station Engineer Mark VK2XOF. By now all the main faults and the strained components should have shown their hand. The repairs included the renewal of SSB callback operation on 80 metres and the replacement of the 2 and 70 metre repeaters. Twenty five years plus of faithful operation of the controllers and the RF side, which had been assembled by Jeff VK2BYY, has been retired. Even older was the 2 metre beacon, which used an old, now obsolete RF line up, it bit the dust. It will be out of service for a while until a new line up is created. As previously mentioned in these notes, an opportunity exists for those with design and construction ability to ease the work load. An application for mode and frequency change for the 6 metre beacon has been lodged with the ACA. We will move to join the others in the 50 MHz region on the frequency of 50.289 MHz, in CW mode. Currently as these notes were prepared, the 70 cm beacon was also being difficult and was out of service. A license application has also been lodged for a repeater on 70 cm, on 439.900 MHz

Tim Mills VK2ZTM.

# Division News

to join the Dural line up.

The roster for the second quarter at VK2WI has been drawn up by John VK2JJV. We welcome Peter VK2HC, joining the morning Engineering side of the operation. Anyone else wishing to join the team should get in touch with the Parramatta office. The lightning strike also knocked out the site alarms. The unit has since been replaced with a changed version. A reminder that new access cards are required and any old card is no longer operational.

Terry VK2UX, the Divisional Education Officer, is currently conducting a Novice class at the Parramatta rooms. He expects that the class will sit exams in July. In an allied field, those wishing a particular callsign will still need to sit a morse exam this year. The Bookshop has a special on the morse booklet and three cassettes. Any club or group conducting classes later this year might like to check out this special with the Bookshop.

A few weeks ago Kathy, XYL of

Michael VK2YC was involved in a motor vehicle accident. We wish you a continued speedy recovery Kathy.

The next Conference of Affiliated Clubs has been suggested for the end of May, on the same weekend as the Trash and Treasure. Clubs should watch their Email system for details.

Again a request and reminder that the AGM will be held on Saturday the 17 th April. If possible please attend so we can quickly reach the required quorum and transact the business without delay.

73 – Tim VK2ZTM.

## VK3 News

By Jim Linton VK3PC

WIA Victoria web site: [www.wiavic.org.au](http://www.wiavic.org.au)  
email: [wiavic@wlvic.org.au](mailto:wiavic@wlvic.org.au)

### GASS no more

**The annual Great Australian Science Show sadly has been discontinued. This public event had provided WIA Victoria a very good opportunity to promote amateur radio.**

A number of WIA Victoria affiliated clubs worked extremely hard to ensure that the amateur radio stand was manned by knowledgeable radio amateurs, and it included interactive components to interest and entertain both youth and adults alike.

Amateur Radio magazine on the front cover of its December-January holiday edition had a photograph of a youngster enjoying his first experience of our hobby. There were many others like him.

News from the promoters that falling attendances at GASS led to its demise has been greeted with disappointment by those involved. They can look back with some personal pride and sense of achievement about their role in promoting amateur radio.

GASS, held during Science Week, was visited by school groups and the general public. The experience gained by running the amateur radio stand will hopefully find another use in the future.

### WIA restructure

At the time of writing these VK3 Notes, discussions were continuing on a proposal to restructure the WIA by

replacing the WIA Divisions with a single WIA.

The WIA Victoria Council has discussed the proposal and could not support it for a number of reasons including the fact that only draft documentation had been provided. The extreme haste in seeking to make this major change is of concern.

Still many issues have to be sorted and WIA Victoria members need to be consulted and vote on this very important matter.

There are a number of significant impacts that adoption of the new WIA proposal would have on WIA Victoria and its members. Are there going to be benefits or disadvantages and what are they?

WIA Victoria has noted that discussion on the new WIA has been biased in favour of it going ahead, while there is a lack of balance that would be expected for such an important decision. It explains its view on that matter in a motion to the WIA Federal Convention which can be read on the WIA Victoria website.

The WIA Victoria Council has also noted that there is a well-prepared proposed new WIA Constitution and brief supporting notes. However, in the Council's opinion, these do not provide adequate information for it, or members, to properly consider a proposal of this importance.

### VK3BWI broadcast

The monthly broadcast is to be transmitted on the 30 m band (10.130 MHz) in addition to the 80 m, 40 m and VHF/UHF repeaters.

The new additional frequency followed liaison with interstate WIA broadcasts to avoid over-lapping broadcasts, particularly during daylight saving time.

Works are being carried out to fully restore the 80 m and 40 m transmissions of the broadcast which can now be heard three times, on the one weekend.

The broadcast continues its traditional 10.30 am and 8.00 pm time slots on the first Sunday of each month, and an advance transmission of the broadcast occurs at 8.00 pm on the Saturday night.

### Annual General Meeting

WIA Victoria members should find inserted in this edition of AR magazine, the formal notification of the Annual General Meeting on Wednesday, 26 May, and annual reports.

Copies are also being mailed to those members who do not subscribe to the magazine as part of the membership.

### QSL Bureau

The operation of the WIA Victoria Inwards and Outwards QSL Bureaux has been reviewed and found to be working very well.

After receiving a report on the review from the Treasurer, Jim Baxter VK3DBQ, the WIA Victoria Council resolved that the QSL Bureaux continue to operate in line with practices adopted some time ago.

This membership service is to remain free to members thanks to the dedicated work of the team of volunteers working from the WIA Victoria Office and at the various Distribution Points.

Members need to apply in writing to join the QSL Bureaux. Information sheets on how the system operates, the requirements including QSL card size and thickness, are available on request.

## VK6 News

Compiled by Will McGhie VK6UU

Input to: will2@ilnet.net.au, 08 9291 7165

### VK6WIA Council meeting

All of the VK6 notes this month comes from the April VK6 WIA Council meeting, which was a lengthy one, as considerable time was taken up with discussion about the next Federal WIA Convention. More about the Convention further down in the notes.

VK6 WIA Council minutes are released on Packet and are on the VK6 WIA web page and have been available for public scrutiny for several years. VK6 is the only division to do this.

On a sad note VK6CF, Chuck Farkas, passed away in February. Chuck was an amateur of note for many years in VK6 and had one of the best signals on HF, particularly 20 metres. See obituary on this page.

The VK6 WIA is to pay half of the VHF and above beacon license costs, taking up the 5-year option. The beacons are run by the VK6 VHF Group.

A letter from Graham, VK6BSL informed the council that he is running an Amateur Radio display at some libraries, mainly in the Northern suburbs.

It is VK6 council election time again and there were 10 nominations for 9 positions. In order to avoid a costly election process one of the nominated withdrew his application and will serve on Council in a non-voting capacity.

Standing down are long term Councillors Tony VK6TS and Eddie VK6ZSE. Two new Council members are Kathi VK6HKR and Roy VK6XV, although Roy has served on a non-voting basis for a number of years. The willingness of Council nominations shows a healthy interest in the VK6 WIA.

VK6NE our current VK6 WIA President has returned from the IARU

Region 3 convention with the news that Larry Price W4RA has been elected President and Timothy Ellam VE6SH/G4HUA Vice President.

There were 7 new members welcomed into VK6 WIA (6 AR students and 1 ex member returning). Financially the past year has been a good one for the VK6 WIA and there is no need to increase fees. VK6 WIA has the lowest fees of any division, a benefit that VK6 amateurs, and some non VK6 amateurs have enjoyed for many years.

A discussion was initiated about the under use of the Scout callsign block and the possibility of releasing some or all of this allocation for general use. No conclusion was reached at the Council

meeting but it is an area that could be discussed further on a national basis.

### Federal Convention

With the Federal Convention for 2004 soon, considerable discussion on how to vote on a variety of motions to be put at the convention took place. Of utmost importance is the discussion at the 2004 Federal Convention about future directions that the WIA may take towards a different structure, with a close eye on a National organization. Any decision that may be made at the Federal Convention on the WIA structure would be put to VK6 Amateurs before any decision is made by VK6.

## Silent Key

### Farkas, Charles (Chuck) VK6CF

Chuck who was born in NJ, USA died February 10th 2004 at his home in Kalamunda, Western Australia aged 64.5.

His love and interest in amateur radio began with building crystal sets at an early age and continued until two days before his death, his tower is a landmark in the Kalamunda area being some 100ft high.

He obtained his first licence W2IMX in the 1930s, and his present callsign VK6CF soon after the end of WW2 having been introduced to his first WIA meeting in January 1946 by VK6GM.

Chuck joined the USN in June 1939 and entered active service in the USNAF in March 1941. He was a Pear Harbour survivor, serving in the Asiatic Pacific area as a radioman/gunner in the Catalinas in Patrol Squadron 22, Patwing 10, Patrol Squadron 101, and Scouting Squadron 61. From 1942 until 1944 he

was based at Crawley Bay (Catalinas) in Western Australia and after the war returned to Australia to live.

Chuck being a retired electrician designed and built his own service lift that went up and down the full height of his tower. He was also the only person in Western Australia to fly a home made 20 m, 5 element yagi that was supported by a one wave length boom.

Chuck also was a WIA VK6 Division member dating from back around 1946.

He was very well liked all over the bands, both local and international. We will miss Chuck.

He is survived by his wife of 56 yrs Dorothy, daughter Carolyn, son-in-law David and grandchildren Melinda and Paul.

*Dorothy Farkas gave permission for the above.*

Mal Johnson VK6LC

## VK7 News

Justin Giles-Clark VK7TW

Email: vk7tw@wia.org.au

Divisional Web Site: www.wia.org.au/vk7

### Divisional Council meeting

A Divisional Council meeting was held in Launceston on 21 February 2004.

This meeting covered a range of topics including a good report on Divisional finances, a design for thank-you certificates to be presented at the AGM on 13 March and a Tasmanian Bicentenary Award to be investigated by the Southern Branch.

Notification was also given that a new location for the VK7RAE Beacons has been negotiated and it will be collocated at the SeaFM transmitter site at Don Heads in the North West of Tasmania.



Attendees from left to right: Reg VK7KK, Geoff VK7ZOO, John VK7KDR, Steve VK7ZSJ, Ron VK7RN, Phil VK7ZAX and Dale VK7DG at the Divisional Council Meeting. (Attendees not in photo were Allen VK7AN, Tony VK7YBG and Justin, VK7TW)

### Branch Meetings

#### North

The Northern Branch's AGM was held on 11 February 2004 and new executive is:

President: Allen Burke (VK7AN), Vice President: Geoff Wells (VK7ZOO), Secretary J McCulloch (VK7CCC) and Treasurer: Bob Richards (VK7KRR).

#### North West

In the words of a certain Monty Python film about the Holy Grail...."I'm Not Dead Yet". I have been assured that even though the North West Branch has gone into recess, it is definitely still alive and kicking! Watch this space for a new executive in the near future.

#### South

The Southern Branch meeting for March was a visit to the ABC TV studios in Hobart to have a guided tour through the new ABC outside broadcasting semi-trailer by Rod, VK7TRF who is a Technical Producer with the ABC TV.

Rod started the tour inside the vision control room where they had just put together the Tasmanian ABC TV News. Rod showed the group how they put together the 8:30 news update complete with teletext. He then ran through what each desk and control panel does including a demo of the remotely controlled TV camera that is fondly named Baldrick!

We then toured through the actual TV studio and on to the ABC garage where

the 14 metre long semi-trailer was parked and the three air conditioning plants were humming away. Just the audio, video and power patch bays were a sight for sore eyes and the trailer is fed by two three phase 40 amp per phase power leads.

The side of the trailer extends to give an additional 1-1.5 metre of space within the trailer. This provides four comfortable areas within the trailer that

cover the different functions - cameras, storage mixing/production and audio that Rod outlined earlier in the studio control room. Just the vision control area was mind boggling with a wall of 44 TV monitors each of which can be separately fed via the vision router from any number of different sources.

It was a very informative and entertaining evening, thanks Rod.

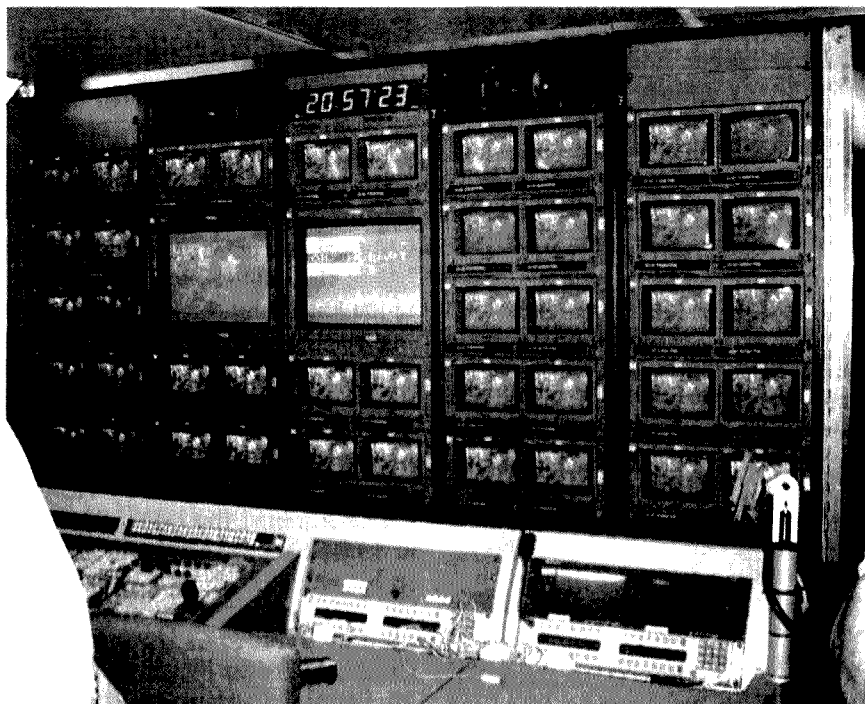

The production area of the OB semi-trailer and yes, the producers are looking at 44 TV monitors!

# Beyond our shores

David A Pilley VK2AYD  
davpl1@midcoast.com.au

## UK new Authority

The Radio Communications Authority has recently been replaced by OFCOM (Office of Communications) which is now the regulator for the UK Communications industry with responsibilities across Television, Radio, telecommunications and the wireless communications services.

OFCOM recently released the new Advanced Radio Amateur Examination. This new syllabus was developed with the help of a working group from the RSGB. Examinations for this new level of licence have been scheduled by the RSGB in February, April and June.

## USA licencing

The ARRL has asked the FCC to create a new entry level Amateur Radio licence that would include HF phone privileges without requiring Morse code.

## USA and BPL

The FCC has given notice of proposed rule making on Broadband Internet delivery over power line systems. The document (ET Docket 04-37) says the FCC is "cognizant that the possibility of widespread operation of Access BPL raises interference concerns that we must protect licensed radio services from any harmful interference that may occur". We hope the ACA will monitor this and follow a similar strong line.

## Croatia

Croatia radio amateurs are the first country in Region 1 to benefit from the 40 metre expansion proposed at WRC-03. They can now operate up to 7,200 kHz on a shared basis with a maximum power of 1,000 watts PEP. They no longer have to pass a Morse code test for access to the HF bands, and have only two classes of licence, Full and Beginners'. So look for lots of 9A stations on HF.

## RSGB and the RCF

The RSGB has set up a new foundation known as the Radio Communications Foundation. This is a charity to promote the awareness of the importance of Radio Communications in our every day life. The RCF will provide a channel through which funds can be raised for education projects such as school scholarships for young students, etc.

## Denmark

The Danish Information Technology & Telecom Agency has announced new regulations for Radio Amateurs in Denmark. The main feature of the new regulations that came into effect on 1<sup>st</sup> February, is the elimination of the Morse code examination for the HF bands. They have also been allocated parts of the 4 metre band (70MHz).

Information for this column was sourced from the RSGB & ARRL newsletters.

# Andrews Communications Systems

ESTABLISHED 1976

ACN 001 968 752



## YAESU FT-1000MP Mk V 200W ...\$4999

FT-1000MP V Field	...\$4,299	FT- 817 HF- 70cm	..\$999
FT- 897 HF-70cm	...\$1,499	FT- 7800R Dualband	..\$499
FT- 857 HF-70cm	...\$1,499	FT- 2800M 2m 65W	..\$349
FT- 847 HF-70cm	...\$2,499	FT- 1500M 2m 50W	..\$399
FT- 920 HF 100W	...\$2,499	VX-1R w/2 batteries	..\$329
FT- 8900R Quadband	..\$799	VX- 2R Tiny Dualband	..\$399
FT- 8800R Dualband	..\$699	VX- 5R Triband H/H	..\$499
FT- 90R Dualband	..\$499	VX- 7R Deluxe H/H	..\$599

★ 3 YEAR WARRANTY ★

★ 3 YEAR WARRANTY ★

## ICOM DISCOUNTED

IC-756 Pro II HF+6m	..\$4,999
IC-746 Pro HF+6m+2m	..\$3,299
IC-706 IIG HF-70cm	..\$1,499
IC-718 HF SSB 100W	..\$1099
IC-910H 2m+70cm SSB	..\$2,499
IC-208H 2m+70cm	...\$649
IC-V8000 2m 75W	...\$399

## ICOM SCANNERS DISCOUNTED

★ 3 YEAR WARRANTY ★



ALINCO DR-620 ..\$799  
NEW ALINCO SHIPMENT LANDED  
CALL

★ 3 YEAR WARRANTY ★

## KENWOOD DISCOUNTED

TS-2000X HF- 23cm	\$4,999
TS-480HX HF 200W+6m	\$2,799
TS-480SAT HF+6m+ATU	\$2,499
TM-D700A 2m/70cm	\$999
TM-G707A 2m/70cm	\$699
TH-F7 2m/70cm H/H	\$699

TOKYO HI-POWER, PALOMAR,  
TE SYSTEMS, YAESU LINEARS,  
bhi NES 10.2 DSP speaker \$249  
DIAMOND ANTENNAS from only \$49 ea  
HUSTLER + EMTRON ANTENNAS  
Avair SWR/RF wattmeters fr. \$99  
YAESU + EMOTATOR ROTATORS

FACTORY DIRECT IMPORTER  
OF HUNDREDS OF PRODUCTS

**MFJ** ANTENNA TUNERS  
ANALYSERS ETC

**CALL (02) 9636-9060 or 9688-4301 or FAX 9688-1995**

**SHOP 8, 41-51 BATHURST ST, GREYSTANES, NSW 2145**

Why pay more? MAIL ORDER TO PO BOX 240, PENDLE HILL, NSW 2145

Some items indent. Prices subject to change without notice - limited stock, some items.

E & OE

<http://www.andrewscom.com.au>

email: [lee.andrews1@bigpond.com](mailto:lee.andrews1@bigpond.com)

AR/4/4

# ALARA

Christine Taylor VK5CTY

vk5cty@vk5cty or gaencee@plcknowl.com.au

The AGM will be held on the first Monday in May – 3rd May 2004. It will be held at the normal time for the Monday Nete in winter, 1000Zulu, on 3580+/- MHz. Please call in. We are proud of the fact that we have a good attendance for our AGMs so make this one equally as good.

We do have a short General Meeting after the AGM but then there is time for a chat. We would love to hear your voice.

## The Gosford Field Day

Thanks to Dot VK2DB ALARA was represented at the Gosford Field Day, as usual. Dot sends this report:-

The Central Coast Field Day was held at Wyong Racecourse on 29th February and as normal was a beaut day.

My son Peter VK2ZCU always goes to Wyong early and sets up the table and banners for me. He is then there early enough to grab a bargain if something takes his eye. Nancy (XYL of John VK2EEH) assisted me at the ALARA table as she usually does but this time didn't have her knitting with her. It is usually an interesting talking point as she does such intricate patterns. I had my handcraft (crochet) with me and showed it to some of the ladies but didn't have time to work on it.

Visitors to the table included Karen VK2AKB and her OM Peter VK2EHQ, Agnes VK2GWI and her OM Henk VK2GWK and Nina VK2INZ who rejoined ALARA. She hopes to be back on air soon but at present is unable to set up a radio station in the flat.

Pat, XYL of Ian VK2ZIO who runs a Museum of Military Radios, told us of the perplexity, effort and humour of moving the museum from Castle Hill to Kurrajong. Ian always takes some interesting items from his museum to show at the field day.

There were many members and XYLS

of the Hornsby club who visited the table during the day. We have a 'bag and buys minding service' there for them as we have a large table and long bench seat where a lot of things can be tucked out of the way.

Ernie VK1LK came by to say hello with his warm friendly smile and told us that unfortunately Linden VK1LSO was unable to attend.

There were no ladies from Queensland this time and I missed having them there.

My OM John VK2ZOI took a long time to decide whether to buy a new rig or not and by the time he did decide (then ask my permission), they were all sold. We saw a lot of those radios tucked under other

peoples' arms.

One of the Hornsby club members, who bought one, was heard to comment that he would have to let his XYL get a new sewing machine now. We think the stand that sold them was almost cleared out of all stock, possibly because of the removal of CW.

I was lucky to have bought a new VK callbook early as they all went too..

It sounds as if a good time was had by all. A suitable amount of money changed hands as well as the opportunity for some renewed friendships, which is surely one of the functions of a Field Day.



(L-to-R) Nina VK2INZ, Dot VK2DB and Nancy at the ALARA table

## International YL Meet in Korea

If you are planning to travel, I hope you have included the upcoming YL International Meeting in Seoul. The official meeting runs from Oct 8 to 11 but several tours are arranged to follow, for those who wish to see more of the country.

I know Maria VK5BMT from Adelaide and Rajja SM0HNV have arranged to be there but I am sure there will be a number of others we will know from our own ALARAMEETS or from the International Meet in Hamilton.

Unfortunately we can't all go but wouldn't it be marvellous if we could?

## Luncheons

The "Duke of York" was quite a nice place for the VK5 Luncheon but it is a little bit out of town – well it is off the main drag of Rundle Mall – so we may be making another change.

HOWEVER, please note, if this comes out before Easter, there will be no April Luncheon in VK5 as that will be Good Friday. It is the first time this has happened since we started having regular lunches, but it had to happen sometime.

It is nice to know that people do read the column.

Thanks for taking up the challenge, Bill, VK2WJC. It was an interesting article and shows what fun you can have with kids and JOTA.



Myrna VK5YW, Meg VK5YG, Maria VK5BMT and Jean VK5TSX.

**International YL Meet  
October 8 to 11, 2004**

## Adelaide Hills Amateur Radio Society

The AGM had an unusual start this year. Finding ourselves temporarily locked out of our usual venue, the meeting began in the pleasant evening open air. With the meeting room finally unlocked, we adjourned there for a very interesting talk by John VK5EMI about his experiences working towards his DXCC.

He illustrated the talk with a powerpoint presentation of some of his QSL cards and stories about the people he had met either on the air or in person through his radio contacts.

## Fleurieu Group

Another pleasant luncheon and afternoon was spent at Goolwa with this group. There are only five or six active amateurs living in and around Goolwa. They speak to each other regularly on 20 metres and invite others with some connection to that area to share lunch with them, every three months.

One member, Garry VK5ZK, also a member of AHARS, had his name in the local paper recently. He is the technical expert for the Port Elliott IT Access Centre (PETAC). Garry services the computers including the virus software and recently installed a firewall in the network.

## North East Radio Club

The year has started off with some exciting events. January meeting we visited the Heights Observatory for some star gazing, in February the club made a visit to the Aviation museum at Port Adelaide. The March meeting was a visit to the Barossa club for a BBQ night. We showed a power point presentation of the removal of VK5RHO to its new site.

Meetings are held on the second Friday of each month at the Ardtornish Primary School, Saarinen Ave St Agnes. The club has undertaken a mail out to local Amateurs, inviting them to come along and join with our activities. Visitors and new members are always welcome.

The last Friday of January we started a course on use and programming of the Atmel microcontrollers. Rob Payne, VK5PR, is leading a group of 15 in learning of these devices. Possible projects are a shack clock, digital meters and an ATU. Norm VK5ZAH has

The election of committee members was simple as there were only as many nominations as required and the committee was unchanged. However, the club members were warned that there would be changes next year, and they were asked if they were prepared to offer their services, to do so before the end of the year.

The fees for the coming year have been set at \$25, but, to encourage prompt payment, all fees paid before the end of April will be discounted by \$5. to \$20.



PETAC has both IBM and Mac computers so both can be experienced by everyone. Negotiations with Telstra for its ISDN service have not long been concluded with special conditions available to locals who connect through it or to ADSL.

Christine Taylor VK5CTV

manufactured printed circuit boards for the programming interface and Atmel chip. These were constructed over two Saturdays, all worked fine when tested. These extra Friday nights will continue until mid year when it is hoped to start another series of courses.

Upcoming events for the club are,

- April 16th, Rob Gurr will speak on South Australian involvement with Sputnik 1 and then dipole antennas.
- Saturday April 17th is our Annual Buy and sell.
- May 14th, Alex McCallum will talk on the Pedal Prix.
- June 11th will be a presentation on computer log keeping.
- July 9th. Club AGM. Food and refreshments will be provided.

I can be contacted on 08 8396 1673 or vk5amk@chariot.net.au.

David Clegg, VK5AMK, NERC Secretary

By the time you read this the John Moyle Memorial Field day will have come and gone but AHARS is pleased to announce that again they won their section, (HF only Multi-operator) of the 2003 Contest and that they came 7th overall in the Summer UHF/VFH Contest. Why doesn't your club participate and give them competition. It is a lot of fun and a good practice at using equipment in the field in case of an emergency situation.

Christine Taylor VK5CTV

Brisbane Amateur Radio Club

## BARCFEST 2004

Saturday 8th May

at Holland Park Bowls Club

39 Abbotsleigh St

Holland Park, Qld

Opening time 0900

★ Club Displays

Disposals ★

Commercial Displays

★ and Sales

Computer Gear ★

Bar and Canteen by

★ Bowls Club

Entry Fee \$5

Contact Kev VK4ZR

07 3273 2738

or

Bryan VK4KWB work

07 3235 21231

# **WIA Intruder Watch**

Henry VK8HA

vk8ha@octa4.net.au

## **C O D A R**

Yes I found a new one. This one is down in the 13 MHz band, far enough not to interfere with our 14 MHz band!

According to our Local Darwin Radio Station, there will be more Codar Transmitters/Receivers to be installed 'later' this year between VK4 in the East and VK9 in the west. Here is hoping they will 'stay off' the Amateur Radio Bands.

During the first full weekend in February, the FOC Club has its annual; "Marathon Weekend" 14020—14030 and at approx 1200 a 'Grey Noise' signal appeared on 14025, S9 steady to the direction of Darwin. This blotted out all FOC Activity. At the time we had a visit from US Navy ships, so I left it at that. Did not hear the 'Grey Noise' after that. Another transmitter, upper and lower sideband, started transmitting just before 0800 for a couple of days, 2 x N0Ns up to 0800 when some sort of traffic was transmitted on both sidebands. Maybe

a test transmission as they were never heard again.

VOA has been a nuisance on 14.075 at VK6XW QTH. This seems to be a daily occurrence at 2200 when they are transmitting in Indonesian. This seems to be the 'old' problem with the Philippine transmitters which they did 'FIX' some time ago.

Mr Wilschefski VK4DU, could you PLEASE advise VOA about their straying transmitter.

Also could you please keep an 'EYE' on 14.025 as this would be a BIG disaster if CODAR were to be transmitting on the 14 MHz Band.

I have been monitoring the 10.1MHz band during the month.

The Indonesians in KUPANG, TIMOR, have set up base on 10.125 which they call MONITOR, (after the Big Goanna?) The base station is very strong here in Humpty Doo and calling in stations vary

in signal strength. They are very busy and completely blot out any amateur radio traffic.

There are other Indonesian intruders spread out every 5 kHz. If nothing can be DONE to remove these Intruders, it looks like the 10.1 MHz Band will be 'Lost' to amateur radio.

Karl VK6XW, reports 212 intruders on the 14 MHz Band. They are mainly Indonesians and Chinese dialect speaking (Northern Asians?). It seems that the lower end of 14 MHz, 14.000-14100, has less Indonesian intruders, maybe they have moved to lower bands??

Wayne, VK4ZRT, reports 4 UI intruders on 7 MHz band and 9 UI intruders on the 14 MHz Band.

That is it for this month... Wishing all the best

PS: anyone have a spare BroadBand?

## **Club News**

### **South Coast Amateur Radio Club Inc.**

SCARC held its Annual General Meeting on Wed 25th Feb 2004, where the Committee for 2004/05 were nominated and elected. The following members were elected into the following positions:

Chairman: Barry Bates VK5KBJ  
Secretary: Stef Daniels VK5HSX  
Treasurer: Neville Pudney VK5ZHP  
Committee: Sam Adcock VK5KSA  
Steve Callow VK5PCY  
Steve Harris VK5HBE

Thanks goes out to the previous Committee who contributed to the operation of 2003/04.

The AGM also saw the presentation of the Annual Russell Smith Memorial Award for 2003. The award is presented to the member who has contributed the most to Amateur Radio in the pursuit of the aims of the South Coast Amateur Radio Club judged annually by its members. This was awarded to Stef

Daniels VK5HSX, with a presentation of a Certificate and name engraved on a trophy displayed in the Clubrooms. The previous winners of this award were also presented with a Certificate. The past winners are:

1991	Bernie Samels VK5ABS
1992	Neville Thomas VK5XD
1993	Grant Willis VK5ZWI
1994	Peter Cockburn VK5TZX
1995	Peter Cockburn VK5TZX
1996	Barry Bates VK5UBJ
1997	Stef Daniels VK5HSX
1998	Grant Willis VK5ZWI
1999	Grant Willis VK5ZWI
2000	Barry Bates VK5KBJ
2001	Grant Willis VK5ZWI
2002-2003	Barry Bates VK5KBJ

Congratulations to those who received this award. It's quite an honour as it is decided by your fellow members.

One final award was presented to a member, who was one of the founding

members of the club, who has contributed enormous efforts to the club. This was recognised and felt it needed recognition in the way of "Life Membership" to the South Coast Amateur Radio Club Inc. This is the first of its kind and very deserving and the recipient was Bernie Samels VK5ABS.

Congratulations Bernie and thanks for your contributions over the years and it hasn't gone unnoticed.

The South Coast Amateur Radio Club Inc. can be contacted by the following methods:

Website: [www.scarc.org.au](http://www.scarc.org.au)

Email: [secretary@scarc.org.au](mailto:secretary@scarc.org.au)

Post: PO Box 333 Morphett Vale, SA 5162.

©2004 SCARC Inc.

Regards,

**Stef Daniels VK5HSX**  
SCARC Secretary & Publicity Officer.



## Satellite problems are not confined to amateur radio satellites

**Despite some recent unfortunate events, amateur radio satellites have a pretty good record for reliability.**

If you thought that only "amateur" satellites developed problems or experienced launch difficulties or battery failures, have a look at this website:

[www.sat-index.com/failures/](http://www.sat-index.com/failures/)

You will recognise many of the satellites in the list and be able to read

how in many cases they failed to live up to the hopes of the design team. Many total write-offs are listed but these are usually associated with launch vehicle failures as was the case with our own P3A, which unfortunately ended up on the ocean floor.

## AMSAT fund-raising for new satellites

**In case you haven't noticed, funding for the next batch of amateur radio satellites has just about bottomed-out.**

The barometer on the AMSAT web page is static at around half the amount required to launch the Echo satellite. The Eagle project cannot get into full swing until Echo is in orbit and working satisfactorily.

It's becoming more and more difficult to elicit funds from satellite users. There have been many suggestions how to address the problem of funding and everything from appeals to incentives have been used in the past, but in the end it comes back to the individual. You either consider it's worth your while contributing or it's not. This decision will often be an intensely personal one and can be affected by several factors. Some considerations may be - how much money you already have invested in the satellites in the form of your own satellite station. In some cases this will amount to many thousands of dollars.

It may well depend on just how serious the individual is about a long-term interest. Whether or not you can see a 'future' for amateur satellites. You may be a newcomer just having a dabble to see if it grabs you. It would be interesting to know how many amateurs have 'dabbled' in satellites and given it away for various reasons. My feeling is that they would outnumber by many times those who decide to stick with it - and of course they are hardly likely to

have ever considered contributing.

An individual's attitude can be influenced by their own geographic location. LEOs may not be viable if you live in a deep valley or are hemmed in by trees. Similarly elliptical orbiters may not be an option if you are a flat-dweller or don't have enough space (or funds) to put up tracking antennas. If you have only a southerly aspect the DX capability of the high orbiters will pass you by out of your view.

With research and determination all these difficulties can be overcome at least in part, but the degree of difficulty can often influence the user's inclination to support the future of AMSAT, particularly if the future plans don't suit the user's immediate interests.

The current debate regarding the relative merits of FM repeater style satellites or digital/analog transponders is a good indication of people's thinking. The planning and building of a new satellite is necessarily a long-term project. You can ask for input from users and this is usually forthcoming - in profusion. The decision though, generally has to go one way or another. It can never suit everyone and some sections of the user base will always be dissatisfied or feel left out of the picture. This too can lead to a reluctance to contribute to a satellite which can be

### The AMSAT group in Australia.

The National Co-ordinator of AMSAT-VK is Graham Ratcliff VK6AGR. No formal application is necessary for membership and no membership fees apply. Graham maintains an e-mail mailing list for breaking news and such things as software releases. Members use the AMSAT-Australia HF net as a forum.

### AMSAT-Australia HF net.

The net meets formally on the second Sunday evening of the month, in winter (end of March until the end of October) the net meets on 3.685 MHz at 1000UTC with early check-ins at 0945UTC. In summer (end of October until end of March) the net meets on 7.068 MHz at 0900UTC with early check-ins at 0845UTC. All communication regarding AMSAT-Australia matters can be addressed to:

AMSAT-VK,  
9 Homer Rd,  
Clarence Park, SA. 5034

Graham's e-mail address is:  
[vk5agr@amsat.org](mailto:vk5agr@amsat.org)

seen as not meeting one's own interests, particularly if you have expressed your views in a succinct, well documented manner through proper channels.

So - there are many reasons why NOT to contribute. Think about this. Virtually the whole AMSAT organisation worldwide is staffed by volunteers. Many, probably most of them also contribute financially. They are on the inside. They can see the worth and importance of contributing. They are the 'devotees' the 'party faithful' - but they simply can't do it all on their own. There are many, our own VK/ZL controllers included who give so freely of their time, expertise and energy that they are rarely heard on the satellites. They simply don't have the spare time. Most users will never have the opportunity - or like me - don't have the ability or background to act as a controller.

We may never get to helping in the planning or construction of an amateur radio satellite or produce a newsletter or give a talk on satellite communications at a club meeting. But we enjoy the fruits of the labour of those who can and do. Please consider this when making up your mind whether to contribute to the satellite building funds.

## Parkes radio telescope searches for AO-40

The "Parques Observatory" is operated by the "Australia Telescope National Facility (ATNF)" which is part of the "Commonwealth Scientific and Industrial Research Organisation" (CSIRO).

Here is a summary of a message which Peter Guelzow, DB2OS recently posted on the Amsat-BB. "With our attempts to restore AO-40 we have received today significant support from "Parques Observatory" in Australia. <http://www.parques.atnf.csiro.au/>

The radio telescope has a diameter of 64 metre and the system noise figure is approx. 25 K. From about 6:00 UTC, a 4 MHz wide spectrum with centre frequency of 1097 MHz was scanned with high level technique in order to find the LO frequency of the AO-40 L1 receiver. A band of approx. +/- 20 kHz

around the actual LO frequency was examined intensively. Three hours were needed to prepare the setup for AO-40 and to search.

Unfortunately nothing was heard which could be a signal of AO-40! The fact that nothing was heard of the L1 receiver's LO does not lead to the conclusion that AO-40 is completely dead. The receivers of Parques are not really fitted for frequencies below 1.25 GHz, and naturally one does not know how good the L1 receiver's LO is shielded or how much of the signal would go through the antenna to the

outside world. The L1 command receiver is continuously switched on, and it would have been good news if we had such a confirmation that the 10 V power source for the L1 receivers is still functioning. All receivers and also the IHU are supplied with the 10 V source.

All command stations are continuing to send commands to the satellite in order to switch the batteries. Peter went on to thank on behalf of AMSAT-DL, Brett Dawson VK2CBD and the team of Parques observatory, especially Dr. John Reynolds (Officer in Charge) and John Sarkissian (Operations Scientist).

## AMSAT turns thirty-five

From a recent posting on the BB by AMSAT-NA's President.

Congratulations to all AMSAT members past and present, and particularly to those far sighted individuals who 35 years ago brought AMSAT into existence. With the growth of AMSAT into international organisations based on all habitable continents, AMSAT is more than the sum of its technological parts, promoting peace, education, technology and communication skills.

I feel honoured to have had the opportunity to have taken a part in AMSAT's life. 73 Robin Haighton VE3FRH President AMSAT-NA

## Still nothing heard of AO-40

At the time of writing the control stations have published no further news of their attempts to re-activate AO-40. Keep up with their efforts via the AMSAT bulletin board or the web site.

## Two decades in space - UoSat-2 celebrates its 20th birthday

While we're on the subject of notable chronological events, UoSat-2, UO-11 passed a significant milestone on 1st March 2004.

To celebrate the event many operators all round the world made a special effort to listen for the beacon of UO-11 on both the 2 metre and 13cm band. From reports on the AMSAT-BB lots were successful and many were surprised that signals were so strong.

It seems to have sparked a renewed interest in listening for the telemetry from this veteran satellite. I have many wonderful memories of using UO-11 in my class work at school and weaving it into my year 11 and 12 electronics courses. Just after its launch I persuaded the keeper of the school purse strings to purchase a circuit board and set of components for the G3RUH UO-11 demodulator which we constructed during prac sessions and used for many years along with a 7 element 2 metre beam and tripod mount.

We used a hand-held transceiver to listen to UO-11's "digtalker" when it

was following an international group of skiers across the Arctic wilderness. They went from Cape Arktichevski in northern Russia via the North Pole to Ellsmere Island in northern Canada. The digtalker on UO-11 broadcast their latitude and longitude positions each day and we followed them on a large azimuthal map of the North Pole area by plotting their positions and sticking pins into the map each day. UO-11 also demonstrated the viability of 'packet' style store-and-forward communication, a mode that continues to be exploited today and will no doubt be included in future amateur radio satellites.

Alongside the digital telemetry and whole-orbit data collection files, plain text news bulletins were also uploaded to the satellite each week and broadcast around the world keeping radio amateurs informed in an era before the Internet!

UO-11 is surely one of the real success stories in amateur radio satellites and the design and launch team members at University of Surrey under Dr Martin Sweeting G3YJO are all to be congratulated. It is a constant reminder to us of the state of the art of amateur radio satellite communications of 20 years ago.

**Don't forget...**

**Harry Angel  
Sprint  
April 23**

**Brisbane Amateur  
Radio Club  
BARCFEST  
8 May 2004**

## Contest Calendar April - June 2004

3-4	Apr	Elettra Marconi Contest	(CW/SSB/RTTY)	
10/11	Apr	Japan International DX Contest	(CW)	
17	Apr	Holyland DX Contest	(CW/SSB)	
17/18	Apr	GACW CW DX Contest	(CW)	
17/18	Apr	YU DX Contest	(CW/SSB)	
23	Apr	Harry Angel Sprint	(CW/SSB)	(Mar 04)
web site - <a href="http://www.vkham.com/contests/">http://www.vkham.com/contests/</a>				
24/25	Apr	SP DX RTTY Contest	(RTTY)	
1-2	May	Ten-Ten Intl. Sprint QSO Party	(CW/Digi)	
1-2	May	ARI Intl. DX Contest	(CW/SSB/Digi)	
8/9	May	CQ-M Intl. DX Contest	(CW/SSB/SSTV)	
15/16	May	King of Spain Contest	(CW)	
22	May	VK/trans-Tasman Contest	(SSB)	
Web Site - <a href="http://home.iprimus.com.au/vktasman/rules.htm">http://home.iprimus.com.au/vktasman/rules.htm</a>				
29/30	May	CQ WW WPX Contest	(CW)	
5	June	VK/trans-Tasman Contest	(CW)	
<i>see Web Site above</i>				
12/13	June	(?) ANARTS Contest	(RTTY)	
12	June	Portugal day DX Contest	(SSB)	
12	June	Asia-Pacific Sprint Contest	(SSB)	
19/20	June	All Asian DX Contest	(CW)	
26/27	June	Marconi Memorial Contest	(CW)	
26/27	June	King of Spain Contest	(SSB)	

**NB:** Please see the web sites listed above for copies of rules. Any problems, please email [vk3js@vkham.com](mailto:vk3js@vkham.com)

### Greetings to all readers

This year I took on new duties in the area of ministry to aged people in Nursing Homes. It had been my hope that someone else may have volunteered to keep these Contest Notes up to date, but instead it almost fell to the lot of our good Editor. Col. has enough to do to compile the magazine each month without adding Contest Co-ordinator's tasks to his list.

Also, a few of you were kind enough to say that you had found the notes interesting even if you were not "into" contesting. This was very encouraging to me, so I take up my pen again to try to continue some comments for you all. However, please don't let that stop anyone offering to take over the job if you feel motivated!!

### DXing and Contesting – Same Thing?

We have all heard pile-ups and wondered who is calling. I have never been involved in too many, usually because I am not super-fast at picking up call signs and often because the station that caused the pile-up often gets drowned out by others hoping to get in before everyone else.

Recently I heard a DX station start to call and was able to listen to the pile-up begin. It took a few minutes, as the DX was on a band not terribly popular for such purposes. Almost at once I realized that there are stations monitoring just about every band, but they don't say anything until something "interesting" comes along.

It also occurred to me that the techniques for trying to get through a pile-up for a rare DX station and for a contest are rather similar – hence my title above. No, they are not the same thing, but when you remember that a DX station and a station in a contest can produce large numbers of others hoping to attract their attention, then there are similarities.

What do YOU do in a pile-up? Tune away from it, join in the noise, or try 'tricks' to get through? If you just join in the noise, then you have little hope of being heard; but if you 'tail-end' then there is an increased possibility. How many times have you heard a DX or contest station say "the Alpha Bravo station again, please"? This means that xxxAlpha Bravo managed to get part

of his callsign across, possibly by leaving it a fraction later to call. OK, he gets his contact and goes away. (By the way – I think it quite wrong and really inexcusable that stations do not give their *whole* callsign when calling. Perhaps that can be a future topic.)

However, have you considered calling off frequency? Seems contradictory to your aim of getting a contact? Not if you judge the frequency shift carefully. A slight offset by you in comparison with the calling station's centre frequency can often bring success, simply because the DX operator, like you, is also sick of the noise and is working hard to pick out callsings or parts thereof. He wants to give everyone a chance, but his ears do take a battering! Sometimes he retunes slightly in the hope of picking out a callsign.

This technique of shifting frequency

is one that I have used with a small amount of success, remembering too that I usually operate QRP. This presents its own challenges and teaches such operators that they had better get something up their sleeves, or they won't get many QSOs at all!

Many DX stations operate split-frequency, but the two suggestions here can work just as well for simplex as well as split. In other words it's just a matter of technique and patience.

## VK Contest Season

We are fast getting to the time of the VK contests again. I urge you all to keep an eye on the Calendar, especially as a few contests have had changes of days in the week. These are experimental in the hope that changing work patterns may still make it possible for hams to take part in our local contest events. Good luck and I hope to work you along the way.

### Diary Update

Please amend last month's VK Contest Calendar to read –  
28/29 August ALARA Contest (CW/SSB)

web site: [www.alara.org.au](http://www.alara.org.au)

### Results CQ WW DX 160 Metres Contest 2003

(VKs only Call\Score)

VK3IO 66,975

VK6VZ 44,198

## Ross Hull Memorial VHF-UHF Contest 2003 - 2004: Results

Contest manager: John Martin VK3KWA

This year's contest was not well supported, with a total of only 19 logs from 11 different entrants. The winner was again Rob Ashlin VK3EK, with a very high score of 4668 points. This shows that even though the number of logs was small, there are still plenty of stations to work - although of course Rob does a very good job of working anything that moves.

Of special note also is the second highest scorer - Rex Moncur, VK7MO. Rex is the first VK7 in some years to make a really serious effort in the contest, and he did exceptionally well with by far the highest score on 2 metres. This is a major achievement given his location in southern VK7.

In Section B, Rob also had a runaway win, with Peter Freeman VK3KAI coming second. Congratulations to all concerned, including all other entrants who made good scores in spite of indifferent conditions and low activity.

After some years with no rule changes, it is clearly time for an overhaul. Activity in VK2 is far lower than it

should be, and there were no logs from VK1 or VK5, and only one from VK6. And for the first time there was no log at all from VK4. I know that interest in VHF DX isn't as high as it used to be, but we must be able to do better than this.

One suggestion has been to take another look at 6 metres. The rules were designed to keep its scoring potential at about the same level as the higher bands, but most people aren't making any

serious use of the band. Several amateurs in the less populated states have pointed out that they can't be competitive unless they can get a reasonable score on 6 metres, so there isn't much incentive for them to make an effort on the higher bands either. A change to the 6 metre scoring might increase activity, and hopefully it might also have a flow-on effect for activity on the higher bands.

### Ross Hull Contest 2003 - 2004

Call	Name	6 m	2 m	70 cm	23 cm	12 cm	9 cm	6 cm	3 cm	TOTAL
<b>Section A: Best 7 Days</b>										
VK3EK	R. Ashlin	82	1139	1415	912	520	-	240	360	4668
VK7MO	R. Moncur	78	2906	653	144	-	-	-	-	3781
VK3ZUX	D. Johnstone	165	672	462	248	20	-	20	30	1617
VK3UH	L. Mostert	131	477	395	-	-	-	-	-	1003
VK3KAI	P. Freeman	9	114	170	200	140	40	90	100	863
VK2TG	R. Demklw	6	537	110	-	-	-	-	-	653
VK3HV	G. Francis	85	177	205	120	-	-	-	-	587
VK3CY	D. Clarke	-	414	-	-	-	-	-	-	414
VK2TWO	A. Scott	34	45	30	-	-	-	-	-	109
VK2CZ	D. Burger	9	6	5	48	-	-	-	-	68
<b>Section B: Best 2 Days</b>										
VK3EK	R. Ashlin	12	483	645	352	200	-	100	120	1912
VK3KAI	P. Freeman	5	84	110	120	70	30	60	70	649
VK3UH	L. Mostert	105	201	175	-	-	-	-	-	481
VK3HV	G. Francis	5	81	100	104	30	10	-	80	420
VK2TG	R. Demklw	2	288	26	-	-	-	-	-	316
VK3CY	D. Clarke	-	183	-	-	-	-	-	-	183
VK2TWO	A. Scott	26	42	26	-	-	-	-	-	93
VK8ADI	B. Burns	91	-	-	-	-	-	-	-	91
VK2CZ	D. Burger	2	8	6	32	-	-	-	-	46

Another possible change is to drop the two day section. It doesn't seem to have much purpose now that virtually all of the two-day entrants also enter the seven day section. If everyone had to put in at least seven days during the contest period, hopefully there would be more stations active on more days. Going even further, there is no doubt that activity was at its highest some years ago when every single day of the contest counted towards the final score.

There has also been some discussion of the scoring advantages of stations using microwave bands. One suggestion has been to create two new sections in place of the existing ones. One could be an all-band section, and the other could be confined to stations that used only three or four bands. I'm not completely convinced about this idea because I don't wish to discourage microwave activity, but I'd welcome any comments on it.

It could also be possible to try some more exotic incentives - for example, bonus points to everyone in call areas that got the lowest overall scores in the previous year's contest.

I'm happy to consider any comments or suggestions that could encourage more activity. I can be contacted by mail (QTHR) or by e-mail at [jmartin@xcel.net.au](mailto:jmartin@xcel.net.au).

# Summer VHF-UHF Field Day 2004: Results

Contest manager: John Martin VK3KWA

The Summer Field Day was a great improvement over the last Spring Field Day. Propagation was fair to average but the weather was much better and a far greater number of stations took to the field. Congratulations to all section

winners, and to all operators for making another successful field day.

Some logs had to be re-scored because the entrants had cheated themselves of points! Before you send in your log, please check against the sample scoring

sheet to make sure you haven't missed anything.

This event is steadily gaining support with a few new stations joining in each year, and I look forward to receiving a record number of logs next time.

Call	Name	6m	2 m	70 cm	23 cm	12 cm	9 cm	6 cm	3 cm	1.25 cm	TOTAL
<b>Section A: Single Operator, 24 Hours</b>											
VK3WRE	R. Edgar	-	456	680	832	750	610	580	580	-	4488
VK3KAI	P. Freeman	53	306	505	656	820	710	680	700	-	4430
VK3PK	L. de Vries	39	162	450	592	370	-	-	-	-	1613
VK4OE	D. Friend	44	264	365	568	320	-	-	-	-	1521
VK3HY	G. Brain	44	444	510	280	-	-	-	-	-	1278
VK5KFB	R. Mitchell	65	318	405	-	-	-	-	-	-	788
VK5AR	A. Raftery	-	291	190	-	-	-	-	-	-	481
<b>Section B: Single Operator, 6 Hours</b>											
VK3KAI	P. Freeman	53	306	505	560	700	700	560	580	-	3964
VK3HV	G. Francis	-	219	310	560	540	540	320	550	-	3039
VK4KZR	R. Preston	-	147	180	272	-	-	-	240	-	839
VK3DQW	K. Asplin	-	378	450	-	-	-	-	-	-	828
VK3BJM	B. Miller	34	321	455	-	-	-	-	-	-	810
VK3JS	I. Godsil	33	102	185	-	-	-	-	-	320	-
VK2TWO	A. Scott	8	42	25	-	-	-	-	-	-	75
VK4EV	R. Everingham	-	72	-	-	-	-	-	-	-	72
<b>Section C: Multi Operator, 24 Hours</b>											
VK3ATL	GARC (1)	163	633	855	920	500	240	-	210	-	3521
VK5SR	SERG (2)	65	548	650	520	-	-	-	430	320	2531
VK5ARC	SCARC (3)	75	585	670	-	-	-	-	-	-	1330
VK2TWR	(4)	-	402	435	384	-	-	-	-	-	1221
<b>Section D: Multi Operator, 6 Hours</b>											
VK3FRC	FAMPARC (5)	76	753	875	256	-	-	-	-	-	1960
VK3JA	CGARC (6)	67	252	390	-	-	-	-	-	-	709
VK3BSY	Bellarine SC (7)	-	222	250	-	-	-	-	-	-	472
<b>Section E: Home Station, 24 Hours</b>											
VK3FMD	C. Kahwagi	32	540	605	720	380	360	-	-	-	2637
VK3ZUX	D. Johnstone	21	180	315	376	-	-	-	-	-	892
VK3UH	L. Mostert	90	321	345	-	-	-	-	-	-	756
VK3CY	D. Clarke	-	354	-	-	-	-	-	-	-	354
VK3UBM	M. Borthwick	22	120	175	-	-	-	-	-	-	317
VK4EV	R. Everingham	-	72	110	-	-	-	-	-	-	182
VK2JHN	W. Munn	44	-	-	-	-	-	-	44	-	-

- (1) Geelong ARC: operators C. Gnaccarini VK2BRZ, D. Learmonth VK3XLD, K. Jewell VK3AKK, A. Gnaccarini (SWL).
- (2) South East Radio Group: operators T. Niven VK5NC, T. Aubrey VK5EE, M. Williamson VK5HMW, C. Hutchesson VK5DK.
- (3) South Coast ARC: operators B. Bates VK5KBJ, S. Callow VK5PCY, S. Daniels VK5HSX.
- (4) VK2TWR: operators R. Collman VK2TWR, D. Moore VK2XKE, N. Sandford VK2EI.

- (5) Frankston & Mornington Peninsula ARC: operators G. Werner VK3GER, A. Wilson VK3MUD, A. Watson (SWL).
- (6) Central Goldfields ARC: operators N. Laidlaw VK3JOO, C. Shaw VK3CJS, A. Greening VK3PA, D. Quirk VK3XDQ.
- (7) Bellarine Secondary College: operators D. Rolfe VK3TRD, L. Miller (SWL), C. Lewis (SWL).

# ALARA Contest Rules

## Eligibility:

All licensed operators throughout the world are invited to participate. Also open to SWLs.

## Object:

Participation: YL works everyone, OMs & Clubs work YLs only.

One contest (combined phone and CW) run over 30 hours.

## Starts:

Saturday 28th August 2004 at 0600 hours UTC

## Ends:

Sunday 29th August 2004 at 1159 hours UTC

## Suggested frequencies:

Bands to be used are 3.5, 7, 14, 21, and 28 MHz only.

The following are suggested frequencies for easier location of contacts:

28.380 to 28.410

21.170 to 21.200 and 21.380 to 21.410

14.250 to 14.280

7.070 to 7.100

3.560 to 3.590

## Operation:

- Every individual phone or CW contact may be counted.
- There must be an interval of greater than 1 hour between contacts with any one station on any one band and in the same mode.
- No net or list operations
- No crossmode operations.
- No crossband operations.
- All contacts must be made in accordance with operator and station licence regulations.

## Procedure:

Phone: call "CQ ALARA CONTEST"

CW: YLs call "CQ TEST ALARA"

OMs call "CQ YL"

## Exchanges:

ALARA member:

RS or RST, serial no. starting at 001, ALARA member, name.

YL non-member, OM or Club:

RS or RST, serial no. starting at 001, name, and whether Club station.

OMs, Clubs & SWLs work YLs only.

## Scoring:

- Phone:** 5 points for ALARA member contacted  
4 points for YL non-member contacted  
3 points for OM or Club station contacted
- CW:** All contacts made on CW count for double points
- OM, SWL, & Club:** 5 points for ALARA member logged  
4 points for YL non-member logged

## Logs:

Single log entry. Logs must show date/time UTC, band, mode, callsign worked, report & serial no. sent, report & serial no. received, name of operator of station worked, whether it is a Club station, and points claimed.

LOGS MUST BE SIGNED. Logs also to show full name, callsign and address of operator, and show final score (points claimed). Logs must be legible. No carbon copies. No logs will be returned. Decision of the Contest Manager will be final, and no correspondence will be entered into. Logs must be received by the Contest Manager by: 31st October, 2003.

## Contest Manager:

Mrs. Marilyn Syme VK3DMS  
99 Magnolia Ave.

Mildura. 3500 Vic. Australia

Or: [alaracontest@wia.org.au](mailto:alaracontest@wia.org.au)

## Certificates will be awarded for the following:

- Top score overall
- Top score phone only
- Top score Australian YL CW
- Top score ALARA member in each country and VK call area
- Top score YL non-member in each continent
- Top score OM in each continent
- Top score SWL in each continent
- Top score VK novice
- Top score overseas YL CW
- Top score VK Club station

## Trophies will be awarded to the following:

- Top scoring Australian YL
- Top scoring DX YL

## Club Stations:

Operators of Club stations may use the Club call only for contacts, and MUST identify each contact as with a Club station. Use of personal callsigns while operating as a Club member is not permitted.

## Sample Log:

Date	Time UTC	Band MHz	Mode MHz	Callsign	RS(T) & Serial No. Sent	RS(T) & Serial Rcd	Name	Points
30/08	0135	28	SSB	VK6DE	59001	58028	Bev	5
	0141	21	CW	VK3KS	599002	599045	Mavis	10
	0600	14	SSB	FK8FA	59025	59011	Aimee	5
	1100	3.5	CW	VK7LUV	599129	599004	Susan	10
	1103	3.5	SSB	VK3BSP	59130	59006	Joe (Club)	3

# VHF/UHF - An expanding world

David Smith VK3HZ – vk3hz@wia.org.au  
Leigh Rainbird VK2KRR – vk2krr@telstra.com

## Weak Signal

David Smith VK3HZ

The central east coast of Australia seems to be having a run of good conditions to the east, to the land of the ZL. According to Gordon VK2ZAB, there have been at least 19 days this season in which contacts from Australia to New Zealand, on bands 2 m and higher, have occurred.

On 14/2, Gordon VK2ZAB and Ross VK2DVZ worked Nick ZL1IU on 2 m. The Auckland 2 m beacon was audible to Gordon. John VK2TK could also hear the beacon, but couldn't hear Nick.

On 21/2, VK2DVZ worked ZL1IU on 2 m, 70 cm and 23 cm. VK2FG and VK2TG also worked ZL1IU on 2 m. VK2DVZ also worked ZL1TPH/P on 2 m.

On 22/2 Doug VK4OE portable on Mt Coot-ha using a halo on 2 m worked Nick ZL1IU. As he was departing, Ron

VK4KDD arrived with an IC-910 and 5WL(!) yagi and received a 5/7 report. Bill VK4LC, from his home QTH, also worked Nick.

On 4/3 VK2ZAB worked ZL1IU on 2 m and 70 cm, and Bob ZL3TY on 2 m. VK2TK also worked both ZL stations on 2 m, Nick several times during the day.

Things haven't been totally quiet in the south of the country either. On 16/2, a high-pressure cell settled over the Bight producing several days of good conditions from the southeast to the southwest of the continent.

On the morning of 16/2, the 70 cm VK6RST beacon near Albany was heard in Melbourne, peaking to S3. No sign of the 2 m beacon. Daryl VK6KDC worked Charlie VK3FMD and David VK3HZ on 2 m with attempts on 70 cm not

succeeding. Wally VK6WG also appeared and worked many Melbourne stations on 2 m. That evening, Wally re-appeared on the band having done some hasty repairs to his 70 cm setup, unfortunately without success.

On 17/2, the 2 m VK6REP beacon from Esperance was audible in Melbourne, reaching S5 at this QTH. Wally VK6WG was again working into Melbourne.

For the next 5 days, conditions between Adelaide and Melbourne were excellent with many stations working on 2 m and 70 cm.

On 19/2, Gordon VK2ZAB in Sydney worked Phil VK5AKK in Adelaide on 2 m. A contact of this sort is a rare event because of the difficult path between the two cities.

## Morning Activity/Aircraft Net

For some time, morning activity up and down the east coast utilising aircraft enhancement has been split between two frequencies. On weekdays, 144.1 MHz was the calling frequency while on weekends, this shifted to 144.2 MHz.

As the result of an informal poll on the VK-VHF email reflector, it was agreed by a large number of the operators involved that the calling frequency for this activity be changed to 144.2 MHz on ALL days.

As always, once a contact is established, operators are encouraged to QSY off the calling frequency for any sort of extended QSO. This is especially important with aircraft enhancement because of the short duration of the openings.

## Beacons

The VK3RLP beacon on 2403.532 MHz at Frankston, Victoria is back on air. It is running one watt into 4 corner reflectors on top of the South East Water storage tank overlooking Port Phillip Bay and Melbourne. The antennas are pointing towards Mt Gambier, Perth, Sydney and

East Gippsland. Signal reports are requested to John VK3YTV at [mlejohn@bigpond.com](mailto:mlejohn@bigpond.com)

It seems that a mysterious technical glitch is causing the new 70 cm VK3RGL beacon near Geelong on 432.530 to drift gradually upwards in frequency – 1.6

kHz in 6 weeks. Some adjustments have been made and Chas VK3BRZ would like reports, particularly from those who can accurately measure its frequency, by email at [CGNACCAR@gordontafe.edu.au](mailto:CGNACCAR@gordontafe.edu.au).

## Digital Modes

Rex Moncur – VK7MO

Joe Taylor K1JT has released a new version of WSJT (version 4.5.1) with enhancements for FSK441 and JT65. It can be downloaded at the following site: <http://pulsar.princeton.edu/~joe/K1JT/>

FSK441 now has Forward Error Correction (FEC) designed to reduce the number of false decodes. As well the

former single tone special messages for R26, R27, RRR and 73 are now produced by double tone messages that give around 6 dB improvement in decoding with a significant reduction in false decodes. The program now has three FSK441 sub-modes as follows:

FSK441A: the original mode that uses

three tones for each text character and has no provision for FEC. It uses single tones for special messages.

FSK441B: this uses four tones per text character to allow FEC and uses dual tones for special messages

FSK441C: this uses seven tones per text character and allows much more

robust FEC and also uses dual tones for special messages.

The penalty of the FEC sub-modes is that FSK441B requires a 66% longer ping and FSK441C 133% longer, but this can be offset by setting the detection levels lower as the FEC gives far fewer false decodes. Joe Taylor has suggested that FSK441B will be the best mode for 2 m where pings are short and that FSK441C might prove best for 6 m where pings are longer. Initial tests by VK operators indicate that the dual tone

messages are a significant improvement and support Joe Taylor's view that FSK441B has an advantage for 2 m but more extensive testing will be required.

JT65 has been up-graded with what Joe Taylor calls a "soft" decoder that provides a 1 dB improvement. 1 dB is significant on EME and well worth it. Leigh VK2KRR has been using the new version on EME and is impressed with its performance. JT65 also has sub-modes called JT65A, JT65B and JT65C.

JT65A is the more sensitive but requires very good frequency stability, JT65B is more tolerant of frequency instability and JT65C even more so at the expense of about 1 dB in sensitivity.

Joe Taylor is seeking feedback on the performance of the A, B and C of the sub-modes with a view to reducing the numbers of sub-modes in future versions or at least reaching a consensus as to which sub-modes should be used on each band.

## 2 m & 70 cm FM DX

Leigh Rainbird - VK2KRR

Thankfully, the conditions in February for Australia's southern FM DX stations were quite a bit better than the second half of January, which was a shocker. Things are still relatively quiet for our more northern counterparts in Queensland while they wait for the beginning of their dry season and a return to more stable weather.

There have been a number of longer distance paths in February as well as very strong shorter paths, and a monster duct, which was outstanding. There were a number of new stations not usually heard on the DX scene this month, which is good to see.

One issue of concern lately has been interference on the FM voice simplex frequencies by applications such as IRLP, Echo Link and other linking and repeating functions. This is particularly an issue on 146.500 and 439.000 the National FM Simplex Voice Calling frequencies. Could people please be aware of this and remind others in your club or locality.

February was a really good month for 2 & 70 FM DX and I am having to really cut back on many contacts and reports or it could go on for a number of pages.

On the 7th and 8th of February, a few simplex contacts noted, Les VK3TJ in Mildura worked VK2KRR on 146.5 @ 466 km. Graeme VK5GH near Mt Barker S.A worked VK2KRR on 146.5 @ 750 km, good signal from Graeme at a 5/7.

On the Sunday morning VK2KRR had an interesting QSO via the Canberra 146.950 repeater with John VK2FAD near Newcastle. Interesting because it is quite rare to hear a station on the coast north of Sydney getting into the Canberra repeater. John is approximately

350 km from Canberra and was running an omni directional antenna, and being down in a coastal area and having to come up over the mountains is a good effort.

But, meanwhile, the same morning, on the other side of the country, VK6 operators who were alert and awake were in for another morning of terrific DX action, courtesy of Brian VK5UBC in Gawler and also VK5KFB.

Brian was out to relive the magnificent effort from Boxing Day 2003. He did that and more! Not only did Brian work back into the Boddington repeater @ 2062 km on 147.250, he also worked to the Katanning repeater on 147.000 @ 1950 km. And later to the Mandurah 146.900 repeater on Mt William, which re set the VK5 Division repeater record to 2102 km, a great effort.

Eventually, as Western Australia got out of bed, Brian was able to work via the repeaters with VK6IQ, 6ZKO, 6KZ, 6HRC, 6ZCR, 6ZGU. VK5KFB believed to be near Adelaide was also able to work to Boddington. Again no signals were copied on reverse.

It certainly is amazing to hear a signal come in to your local repeater from a great distance away, a 2000+ km distance even more so. When you think of how far that signal has travelled, over a path that is rarely present, and that signal is preserved well enough along its travels to present itself just like a local signal to the repeater, its absolutely fascinating.

Further on into the month, a duct began to be workable, beginning on the 15th. This duct would hang around for almost a week and got better the longer it stayed. The conditions finished up around Saturday the 21st of February,

and have been described by some as the best conditions this summer season. Some massive signals were experienced, some very long paths worked by some, and some people were working to places they never thought possible.

I will just give a brief summary here as there was so much going on. Lucky I did not get many reports from others about this week's activities or they'd never fit in the magazine.

On the morning on the 16th, VK5UBC was able to work VK2KRR on 439.000 establishing new VK2 and VK5 Division FM DX records for 70 cm @ 764 km.

Later that evening VK5UBC worked to the Albany repeater on 146.725 a distance of 1900 km. First time to Albany for Brian, who worked John 6KJS and Brian 6YUA/m Albany via the repeater.

Showing just how good conditions were in the evening of the 17th of February were a group of operators who were all able to congregate on 147.275 the Otway Ranges repeater. These stations were VK3JNY, 3XOR, 3VTX, 3TJS, 2KRR, 5MM, 5KGP, 5ACY and 5UBC. Graham VK5KGP is located in Victor Harbor and was working the Otways repeater with an antenna mounted inside his house! The distance is around 550 km.

After this 5UBC made another series of contacts to the west. Brian worked to the Albany repeater with Frank VK6DM and then was able to easily work Frank on 146.500 simplex with up to 5/9 signals over the 1900 km path. New VK5 Division 2 m simplex record.

Morning of the 18th, big signals out there. A number of stations were worked simplex. Brenton VK5BJ at Meningie was a 5/6 on 2 m @ 702 km, 3.43 am.



## Pure homebrew

**Instruments of Amplification** by H.P. Friedrichs, ISBN 0-967 1905-1-7 is a recent release from the ARRL catalogue and is now being stocked in the Technical Bookshop.

Reviewed by Chris VK2QV, Technical Bookshop Manager

*You have not read a book like this before.* These are the final words of the Introduction and after becoming engrossed in this book I have to agree. This book is not homebrewing *a la* Diamond, the level is more basic, yet at the same time just as intricate - for here we shown to build projects completely *from scratch*.

The author painstakingly built "low tech amplifiers, vacuum tubes and semiconductors in his workshop and then observed the results. There have been failures and moderate successes. Don't expect to construct a high power linear amplifier from this book: that is not what it is about. The book is more about experimentation, the satisfaction

of building something and observing the results, the culmination of ideas put into practice.

The projects in the book may seem very low-tech in today's miniaturized, black-box push button culture. Electronics from days gone by are regarded as boatanchors, leg-warmers and curios. The author points out that, and he gives the "wagon wheel" as an example, something may appear low-tech until you actually try to build or repair it.

There are chapters on Basic Tools, Safety First and "What is an Amplifier"? before moving into some practical projects. There is an extensive list of references at the end of each chapter.

Explanations are straight-forward and not overly technical in nature. The amplifier experiments are a must-read!

The book contains seventeen chapters in all plus three appendices. It is softcover with 297 pages, photos are in black and white and there are numerous illustrations. Put it in your library, next to "How Things Work".

H.P.Friedrichs also happens to hold the callsign AC7ZL and he is the author of another book which he published himself, *Voice of the Crystal*.

I recommend this book as a good read for home brewers and experimenters in particular. The bookshop Catalogue number is TEC43-9163 and is priced at \$42.00 inc GST. Member price is \$37.80.

ar

## VHF/UHF an expanding world *continued*

Brenton was also worked on 70 cm also 5/6 signal. Rob VK5MM at Mt Barker was 5/7 on 2 m. Brian VK3UBC at Mildura was 5/5 on 2 m. Dion VK7YBI made it to the Barossa Valley 2 m repeater at around 11.45 am and made a new repeater distance record for himself @ 947 km. Amazingly conditions lasted till about 12.15 pm here!!, before it suddenly was lost and all was quiet again.

On Thursday 19th there was a Monster Duct! This would have to be the best duct opening I have worked. I won't go into how many repeaters were coming in, but lets just say, most repeaters in VK3 and VK5 on 2 m and 70 cm were full-scale signals or very close to it.

List of simplex FM contacts worked here before I went to work - VK5MM, Mt Barker @ 747 km on 2 & 70; VK3TJ, Mildura @ 466 km on 2 m; VK5JSR near Barossa Valley @ 770 km on 2 m; VK3MTV, Mildura @ 466 km on 2 & 70; VK5UBC, Gawler @ 784 km on 2 & 70; VK5ZLT, Keith @ 614 km on 2 m; VK3UBC, Mildura @ 466 km on 2 & 70; VK5XE, Claire @ 791 km on 2 & 70.

There was transmissions left right and centre and where to turn to next was a

problem. There were contacts I heard that I could not believe I was hearing. I noted VK3MTV, VK5UBC and VK3LY into Wagga 2 m. VK3MTV in Mildura and VK5UBC in Gawler made it to one of the highest repeaters in Australia being Canberra's Mt Ginini 146.950. I heard them both talking with VK1OD. I also heard stations in Wagga and Young NSW, getting to Barossa Valley SA.

The simplex contact on 439.000 between VK5XE and VK2KRR reset the 70 cm FM DX records again for VK5 and VK2 to 791 km.

In the morning of Friday the 20th there was a shift in conditions in eastern NSW. Steve VK2ZSZ in Queanbeyan worked Graham VK2GRB in Scone via the 2RDX repeater in the Western Blue Mountains. Steve was also able to get to Rylstone, Young, Grenfell, and Goulburn.

Ian VK2XB who was mobile near Young, was amazingly able to work to the Rylstone repeater over a mountainous 230 km path.

VK2KRR worked as far as the Walcha repeater @ 610 km, also to Knight's Hill near Wollongong, the Southern Highlands and Mt Bindo.

Alan VK2KAW in Wagga also had a

similar coverage area to VK2KRR. It was quite interesting to see the extent of the propagation.

On the final day Saturday the 21st, signals again were brilliant. Many stations were able to work each other simplex. Some of the more difficult simplex contacts into VK2KRR near Wagga were from Jim VK5AJW at Cowell, up to 5/9 on 146.500 @ 950 km. VK5KCX, 3LY, 3XQA/p were also worked on 2 m. Also 3AEF, 5UBC, 5MM, 3JGL were worked on both 2 & 70.

Well done to Rob VK1ZQR in Canberra who is always listening out to the west and finally got a path into Murray Bridge and possibly other repeaters around 900 km. VK5UBC also worked the Canberra 146.950 repeater but the two failed to make it on simplex.

No doubt there were a lot of other contacts that occurred that I did not have a chance to listen to or was never told about. Well done to everyone and keep up the good work.

That's about it for this month. Please remember to send through any 2 & 70 FM DX reports to Leigh VK2KRR at vk2krr@telstra.com.

ar

# Gridsquare Standings

at 22 February 2004

## 144 MHz Terrestrial

VK2FLR	Mike	108
VK2KU	Guy	102
VK3FMD	Charlie	84
VK2ZAB	Gordon	77 SSB
VK2KU	Guy	69 SSB
VK3BRZ	Chas	68 SSB
VK3KAI	Peter	63
VK2DVZ	Ross	62 SSB
VK3EK	Rob	62 SSB
VK2TK	John	58
VK3CY	Des	58
VK3XLD	David	55 SSB
VK2EI	Neil	54
VK3TMP	Max	53
VK3ZLS	Les	51 SSB
VK3BDL	Mike	50
VK2DXE	Alan	47
VK2KU	Guy	47 Digi
VK3BJM	Barry	47 SSB
VK7MO	Rex	47
VK3WRE	Ralph	46 SSB
VK3KAI	Peter	45 SSB
VK2DXE	Alan	43 SSB
VK3CAT	Tony	39
VK3KEG	Trevor	39
VK4TZL	Glenn	38
VK2TK	John	34 SSB
VK3HZ	David	33
VK4KZR	Rod	33
VK3ZUX	Denis	32 SSB
VK7MO	Rex	30 SSB
VK3KME	Chris	28 SSB
VK6HK	Don	28
VK2KRR	Leigh	27 FM
VK4DFE	Chris	26 SSB
VK2TK	John	25 Digi
VK7MO	Rex	24 Digi
VK2TG	Bob	23 SSB
VK3YB	Phil	23
VK5ACY	Bill	22 SSB
VK3KAI	Peter	21 Digi
VK6KZ	Wally	20
VK3BBB	Brian	19
VK3TLW	Mark	19 SSB
VK3AL	Alan	18 SSB
VK6KZ/p	Wally	16
VK3ZYC	Jim	14 SSB
VK3DMW	Ken	13
VK2CZ	David	12
VK7ZSJ	Steve	12
VK2EAH	Andy	11
VK2EI	Neil	11 Digi
VK2DXE/p	Alan	10
VK2EAH	Andy	10 SSB
VK3ANP	David	10
VK3BG	Ed	6 SSB
VK2TWO	Andrew	5
VK3ZDR	David	5 SSB
VK2AKR	Neil	3 Digi

VK2DXE	Alan	3 Digi
VK4TJ	John	3 SSB
VK2AKR	Neil	1 SSB
VK2EAH	Andy	1 Digi
VK3XLD	David	1 Digi

## 144 MHz EME

VK2FLR	Mike	110
VK2KU	Guy	83
VK3CY	Des	70
VK2KRR	Leigh	16
VK7MO	Rex	9
VK3KEG	Trevor	4
VK3FMD	Charlie	3
VK2DVZ	Ross	2
VK2DXE	Alan	2

## 432 MHz Terrestrial

VK2ZAB	Gordon	57 SSB
VK3BRZ	Chas	49 SSB
VK3XLD	David	46 SSB
VK3FMD	Charlie	45
VK3ZLS	Les	40 SSB
VK2KU	Guy	38
VK2KU	Guy	34 SSB
VK3EK	Rob	34 SSB
VK3CY	Des	31
VK2DVZ	Ross	30 SSB
VK3BJM	Barry	29 SSB
VK3KAI	Peter	28
VK3HZ	David	27
VK3KAI	Peter	27 SSB
VK3BDL	Mike	26
VK3WRE	Ralph	26 SSB
VK3TMP	Max	25
VK3KEG	Trevor	21
VK2TK	John	17 SSB
VK2TK	John	17
VK7MO	Rex	16
VK3CAT	Tony	14
VK3ZUX	Denis	14 SSB
VK4KZR	Rod	14
VK3TLW	Mark	13 SSB
VK6KZ	Wally	13
VK2KRR	Leigh	11 FM
VK4TZL	Glenn	11
VK3AL	Alan	10 SSB
VK3ANP	David	10
VK3YB	Phil	10
VK2TG	Bob	9 SSB
VK3BG	Ed	9 SSB
VK4DFE	Chris	9 SSB
VK3KME	Chris	8 SSB
VK6KZ/p	Wally	8
VK3BBB	Brian	7
VK2FLR	Mike	6
VK2KU	Guy	5 Digi
VK3BRZ	Chas	4 Digi
VK3XLD	David	4 Digi
VK3ZYC	Jim	4 SSB
VK2CZ	David	3

VK2TWO	Andrew	3
VK3KAI	Peter	3 Digi
VK7MO	Rex	3 Digi
VK2DXE/p	Alan	2
VK4TJ	John	2 SSB
VK2AKR	Neil	1 SSB
VK2TK	John	1 Digi
VK3DMW	Ken	1

## 432 MHz EME

VK4KAZ	Allan	14 CW
VK3FMD	Charlie	5
VK3HZ	David	1
VK7MO	Rex	1

## 1296 MHz

VK3XLD	David	33 SSB
VK3BRZ	Chas	32 SSB
VK3FMD	Charlie	32
VK2ZAB	Gordon	29 SSB
VK3ZLS	Les	26 SSB
VK2KU	Guy	25
VK2KU	Guy	22 SSB
VK3EK	Rob	20 SSB
VK3KWA	John	19
VK3KAI	Peter	16
VK3WRE	Ralph	16 SSB
VK2DVZ	Ross	15 SSB
VK3KAI	Peter	15 SSB
VK3BDL	Mike	12
VK3BJM	Barry	12 SSB
VK3TMP	Max	11
VK2TK	John	10 SSB
VK4KZR	Rod	10
VK7MO	Rex	10
VK3HZ	David	9
VK3TLW	Mark	8 SSB
VK3AL	Alan	7 SSB
VK2CZ	David	5
VK3ZYC	Jim	5
VK6KZ/p	Wally	5
VK3BVP	Shane	4
VK3YB	Phil	4
VK3ZUX	Denis	4 SSB
VK3ZYC	Jim	4 SSB
VK6KZ	Wally	4
VK2KU	Guy	3 Digi
VK3BBB	Brian	3
VK3BG	Ed	3 SSB
VK3KEG	Trevor	3
VK2DXE/p	Alan	2
VK2FLR	Mike	2
VK3CY	Des	2
VK3KAI	Peter	2 Digi
VK3KME	Chris	2 SSB
VK3XLD	David	2 Digi
VK4TJ	John	2 SSB
VK3DMW	Ken	1
VK3ZYC	Jim	1 Digi
VK4TZL	Glenn	1
VK7MO	Rex	1 Digi

## 2.4 GHz

VK3BRZ	Chas	11 SSB
VK3XLD	David	11 SSB
VK3WRE	Ralph	9 SSB
VK3FMD	Charlie	8
VK3KAI	Peter	7 SSB
VK3EK	Rob	5 SSB
VK6KZ	Wally	4
VK3BJM	Barry	3 SSB
VK3KAI	Peter	2 Digi
VK4KZR	Rod	2
VK3TLW	Mark	1 SSB
VK3ZUX	Denis	1 SSB
VK4TZL	Glenn	1

## 3.4 GHz

VK3FMD	Charlie	8
VK3WRE	Ralph	6 SSB
VK3KAI	Peter	5 SSB
VK3XLD	David	4 SSB
VK6KZ	Wally	4
VK3EK	Rob	3 SSB

## 5.7 GHz

VK3FMD	Charlie	10
VK3WRE	Ralph	9 SSB
VK3KAI	Peter	7 SSB
VK3XLD	David	5 SSB
VK6KZ	Wally	4
VK3BJM	Barry	2 SSB
VK3EK	Rob	2
VK6BHT	Neil	2
VK3KAI	Peter	1 Digi
VK3ZUX	Denis	1 SSB

## 10 GHz

VK3FMD	Charlie	9
VK6BHT	Neil	9
VK3WRE	Ralph	8 SSB
VK3KAI	Peter	7 SSB
VK3XLD	David	7 SSB
VK3EK	Rob	5 SSB
VK6KZ	Wally	5
VK3TLW	Mark	3 SSB
VK3ZYC	Jim	3 SSB
VK2EI	Neil	2
VK3BJM	Barry	2 SSB
VK3ZUX	Denis	2 SSB
VK7MO	Rex	2
VK3BG	Ed	1
VK4KZR	Rod	1
VK4TZL	Glenn	1

## 24 GHz

VK6BHT	Neil	3
VK2EI	Neil	2
VK6KZ	Wally	2
VK3FMD	Charlie	1

## 474 THz

VK7MO	Rex	1
-------	-----	---

Additions, updates and requests for the guidelines to Guy VK2KU, vk2ku@hermes.net.au, or by mail (QTHR 2002).

However note that the above email address will "die" in April 2004 when I move QTH.

The guidelines (and the latest League Table) are also

available on the website of the NSW VHF Dx Group at [www.vhfdx.oz-hams.org](http://www.vhfdx.oz-hams.org) - click on Gridsquares.

Next update of this table will be in May or June 2004.

Stations who do not confirm their status for more than 12 months may be dropped from the table.

## Charles H A Armstrong VK1WW

Charlie passed away on 7 Nov. 03 after a very long illness at the age of 83. He is survived by his wife Meg, who met Charlie during the war when she was a WREN signaller at Admiralty House London and Charles was a Radio Officer in the RN at sea. They could recognise each other's Morse code before they actually met, married and lived happily ever after. 50 years on Charlie and Meg taught me Morse so well that I passed 1st try After the war Meg and Charlie moved to Australia (Tasmania) where Charles took up a teaching position and amateur radio, building his own rig and antenna, and getting on the air on H.F.

Charlie was soon on the move again. He joined the RAAF and was posted to Wagga Wagga in the mid 50's to teach apprentices and National Service Trainees. Accommodation for married officers was very hard, so Charlie built his own house just outside the RAAF Wagga entrance gates. The first operational room in the house was the radio shack and he was soon on the air again with a VK2 callsign. In the small hours of the morning after a late mess

function Charlie would always scan the HF bands for late night contacts before bed.

Charles had regular skeds with contacts from many parts of the world and his shack was well lined with exotic QSL cards. Postings to RAAF bases in Victoria, the ACT and Butterworth qualified him for VK3 and VK1 callsigns. Not many members can claim to have had VK1, VK2, VK3 and VK7 callsigns.

During his posting to Butterworth in Malaya in the 70's Charles helped to establish the 'Radio Butterworth' service for the benefit of Service families. Charlie's silky smooth BBC accent is familiar to a great many radio amateurs all over the world and his cheery 'VK1 Whisky Whisky' will be sadly missed by all his many friends. Our deepest sympathy is extended to his family.

Submitted by Ted Holmes VK5ETH.



## Rolf A Hallamore VK3ARH

It is with regret that I record the passing of Rolf VK3ARH on the 27th February at Prince Alfred Hospital after a short illness. He was 89 years old.

By following family tradition Rolf had a very successful career in commercial banking and also maintained a keen interest in technical matters throughout his life. He was well adapted to building electronic apparatus and built the family's first TV set and many amateur radio projects of exceptional quality. It would be no exaggeration to state that he could have switched from his career path in banking to a successful one in electronics had he ever desired to do so. This was emphasized when Rolf joined the RAAF at the beginning of WWII and trained in the new technology of RADAR. His first posting sent him to assist setting up a station on Millingimpi, a small island off the coast of the Northern Territory. After a few months his expertise was recognised and he was posted South to become an

instructor on RADAR. This suited Rolf because Millingimpi was not a very pleasant place to be and had been getting the attention of Jap bombers for some time. The posting South with a promotion to Sergeant Instructor therefore had quite an appeal. He completed service in this role and particularly enjoyed lecturing and still remembered the technicalities of RADAR for the rest of his life.

While in the Air Force Rolf met my cousin Elva who was in the WAAF and so began the lifelong love affair, they became engaged and married soon after the war. They were infatuated with one another and enjoyed a common interest in their beloved golf.

At the end of war Rolf achieved his first class commercial radio licence but still returned to the banking business and began climbing the corporate ladder. A promotion transferred him from Victoria to Western Australia where he

continued with amateur radio and improved his golf average. The challenge of building equipment stayed with him and he was one of the first amateurs in VK to build his own SSB transmitter. Ultimately another career advancement returned him to Victoria and he continued with the same banking establishment until his retirement. Elva, the love of his life, passed away in January 1997 and it must have been a lonely time for him, but he kept his home going and was well supported by his "Troops"; his name for his children and grand children.

All who knew him will be saddened by the loss of Rolf, the consummate gentleman, always considerate of others, a great contributor to life who was modest of his own achievements.

Our sympathy is with his children Gillian, Margaret and Leigh and their children.

Allen O'Halloran VK5OH

# Over to you

## New Constitution

Re the proposed constitution as published in March 2004 AR, which seeks to establish a WIA, which speaks for all radio amateurs with a single voice. This to be achieved by all members of the state divisions being members of the one Federal WIA.

I am all for the WIA speaking with a single voice. Is that not the principle reason given for the Incorporation of the State-based WIA into the new federal structure in 1972? Normally I am in favour of centralised bodies and I thought that was what the Federated WIA was. Have I been wrong for the last 30 years of membership? How many voices has it been speaking with to the ACA, IARU on our behalf?

If the new constitution is not ratified by the Divisions, does the present Federal body not represent us with a single voice anymore?

Before we change anything we should carefully peruse this complicated document with particular attention to what happens to divisional property. Does clause 25, "Winding up" mean that if the WIA in the opinion of the Directors

becomes non-viable and the WIA is wound up with due process that the remaining property, say Dural in Sydney could be given to the Ballamakanka CB Club.

It appears to me that control of the WIA could pass to non-licensed amateurs if this constitution is adopted. Clause 5.2(a) states to be a member you only have to have an interest in amateur radio. Clause 5.3(d) states the Board may establish a non-voting membership category, it does not say it has to, nor does it say once established it cannot be removed.

Let us keep full membership with voting rights for licensed radio amateurs only.

I have listed just two matters of concern to me from reading the proposed constitution. There are many others I could have mentioned.

Please read the proposed constitution carefully and do not make any decision in haste. It seems to me that an urgent adoption is being sought. I have yet to be convinced that a change from the present structure of the WIA is needed.

**Neville Chivers VK2YO**

## Amateur Licence Exams

### I had a dream –

– we were at a radio Club meeting and a chap named Stephen was talking about future directions for bringing new members into our hobby. He had spoken of the lack of concern by some of the governing bodies and then he went on to some of the various entrenched attitudes members had.

He was especially concerned about the method used for examination of would-be amateurs. "It is difficult to understand," he said, "that we tend to ignore the developments made by some of our longstanding overseas compatriots. It seems that we are saying that countries like New Zealand, South Africa, Canada and the USA are not doing a good job of examining their applicants because they allow them to have access to relevant question banks beforehand". Food for thought.

**Neil Trainor VK3J**

Views expressed in the 'Over to you' column are those of the authors, and do not necessarily reflect the policies of the Wireless Institute of Australia.

Send contributions to: The Editor, Amateur Radio Magazine, 34 Hawker Crescent, Elizabeth East SA 5112 or email: edarmag@charlot.net.au

## Silent Key

### Brian Eccleston Cabena VK3BEC

It is with sadness that I note the passing of Brian Cabena VK3BEC on 25th February, 2004, after what the Melbourne newspaper described as "a difficult illness".

Although legally blind, radio was Brian's great interest all his life. He ran a repair business in the inner eastern suburb of Kew and as an Amateur was quite active in the 1960s and 70s on both HF and 2 metres. On air he called himself "Bec" — his initials.

Brian came from a musical family and it was in this context that my wife and I met him in the mid-1960s. Brian felt that there were serious shortcomings in the style of the ABC's presentation of its

classical music programmes. He went public with his idea of a classical music broadcasting station free of unnecessary talk and advertisements and formed The Music Broadcasting Society of Victoria.

As its Secretary in this 60s-early 70s period, Brian and I tackled the legislators of the day to change the structure of broadcasting in Australia and open up an FM band, as had happened overseas.

Thus, in July 1975, 3MBS began broadcasting on 92.7 MHz (later moved) with a transmitter designed by Brian and built by several of us as volunteers and installed over the radio repair shop in Kew.

So began the era not only of FM

broadcasting in this country, but the first radio station to be financed and staffed by volunteers — Community Radio.

Although my involvement was with administration and programming, Brian's enthusiasm for radio and broadcasting in general and his talks about AR rekindled in me an interest that I had as a boy, but did nothing about. Everyone who knew him would have to admit his determination to carry through his ideas in a patient, methodical way.

To his wife Mary and family, we extend our sympathy.

Vale Brian — a man who lived his dream!

**Ian Godsell VK3JS**

## A VHF/UHF discone antenna

In QST for May 2003, Bob Patterson, K5DZE describes a cheap and simple way of implementing the discone antenna design.

Whilst a discone antenna does not offer any gain over normal dipoles or verticals, it does offer unique characteristics of wide bandwidth, sometimes quoted as presenting acceptable VSWR over a 10:1 frequency range. If you consider this to be a little optimistic, assuming a lesser, 3:1 range with a VSWR of less than 2:1 will allow operation on 144 to 432 MHz and everything else in between.

Bob refers to having built quite serviceable discones for use under cover that consisted of foil covered cardboard

The design referred to in this article is made from 'hardware cloth' or very stiff galvanised steel 'chicken wire', manufactured as + inch square mesh. This design does not need a lot of extra support if the antenna is to be located inside a roof or attic. For outside use, a wood or PVC 'tree' can be placed inside the cone for extra support and rigidity.

To build the antenna, proceed as follows. Lay out a 5 foot length of hardware cloth. Tack the corners down so it won't roll up. Use a felt tip pen to mark out the cone and disc as per the drawing. The dimensions are calculated from the equation on the drawing

Carefully, cut out the shapes using heavy metal shears. Beware of the sharp edges. Roll the wire into the cone shape. Short lengths of wire or nuts and bolts can temporarily hold the shape together. Otherwise, fold some of the end wires into hooks to strengthen the join. Use a heavy soldering iron to spot solder the seam together. The drawing shows the general construction plus design equations. Whilst the drawing shows the top discs separated, in the final assembly, the PVC disc is glued to the PVC pipe and the coax is soldered to the top disc which is screwed to the PVC disc.

When mounted on a suitable outside support, the VSWR remained below 2:1 on both 144 MHz and 432 MHz. Whilst

any good VHF/UHF gain antenna will outperform this discone on a given frequency, none will operate consistently over such a wide bandwidth.

Note Conversions 1 inch = 25.4 mm, 1 foot = 308.4 mm Editor

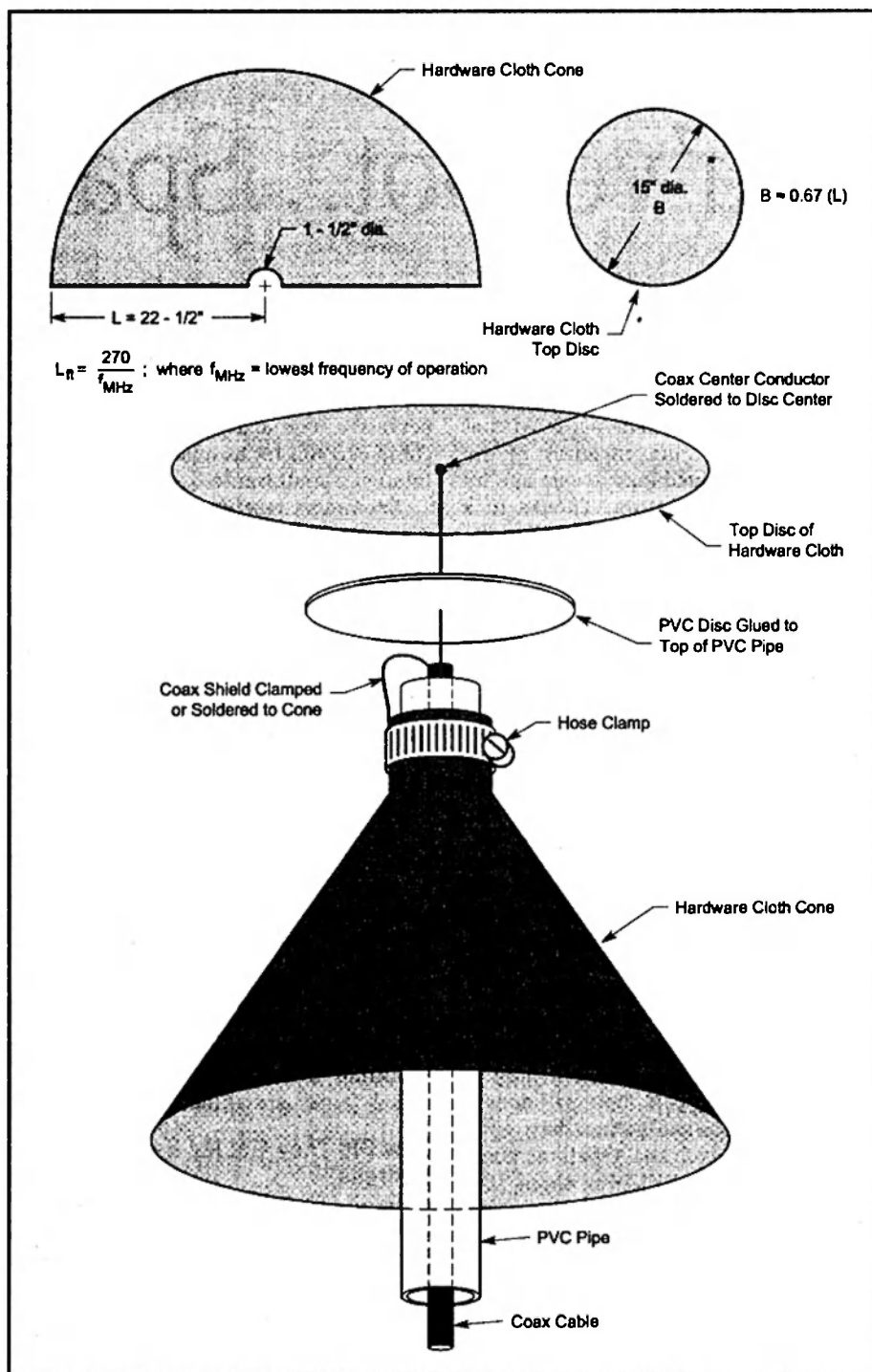

**Adelaide-Moscow 318**

First F 0-5 Short 13807 km

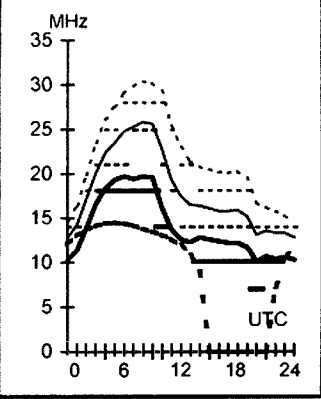
**Brisbane-Berlin 148**

First F 0-5 Short 15677 km

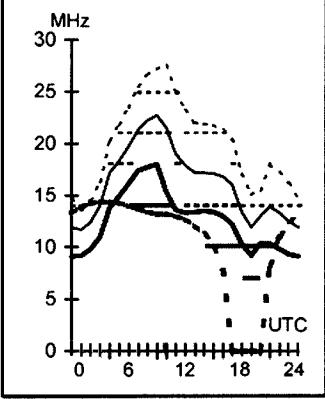
**April 2004**

T index: 46

**Legend**

Frequency scale

--- UD  
 - - - E-MUF  
 - - - OWF  
 - - - F-MUF  
 - - - ALF  
 - - - >10%  
 - - - >50%  
 - - - >90%

Time Scale

**HF Predictions**

by Evan Jarman VK3ANI  
 34 Alandale Court Blackburn Vic 3130

These graphs show the predicted diurnal variation of key frequencies for the nominated circuits. These frequencies as identified in the legend are:-

- Upper Decile (F-layer)
- F-layer Maximum Usable Frequency
- E-layer Maximum Usable Frequency
- Optimum Working Frequency (F-layer)
- Absorption Limiting Frequency (D region)

Shown hourly are the highest frequency amateur bands in ranges between these key frequencies, when usable. The path, propagation mode and Australian terminal bearing are also given for each circuit.

These predictions were made with the Ionospheric Prediction Service program: ASAPS Version 4

**Adelaide-Osaka 357**

Second 3F5-8 3E0 Short 7746 km

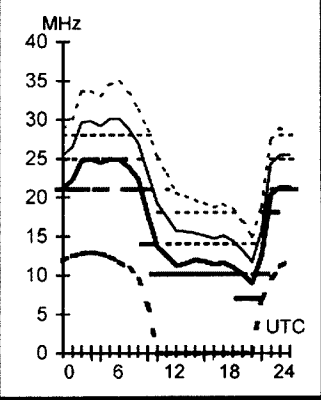
**Brisbane-Cairo 288**

First F 0-5 Short 14390 km

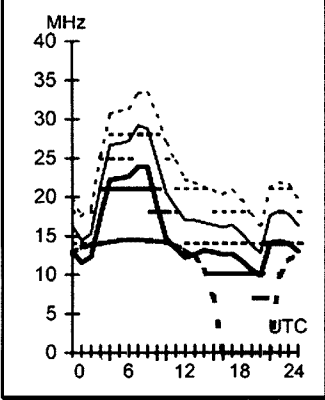
**Canberra-Auckland 102**

Second 2F20-22 2E Short 2300 km

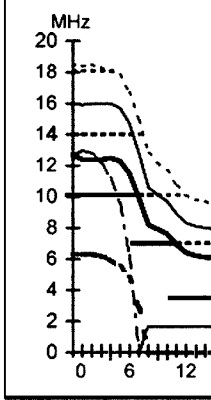
**Darwin-London 145**

First F 0-5 Long 26171 km

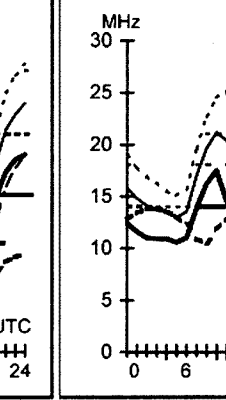
**Adelaide-Pretoria 238**

Second 4F5-6 4E0 Short 10064 km

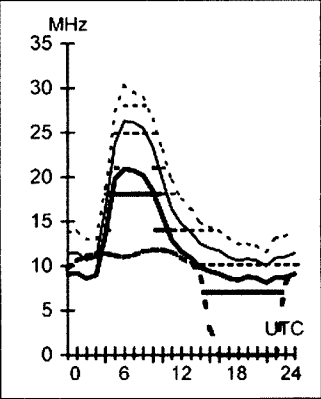
**Brisbane-Noumea 70**

First 1F15-17 1E3 Short 1473 km

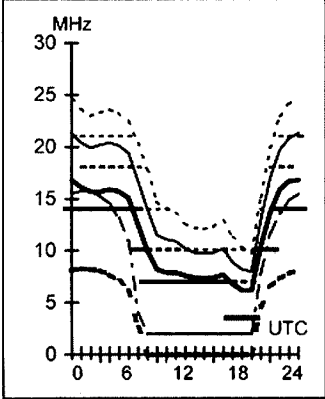
**Canberra-CapeTown 219**

Second 4F4-5 4E0 Short 10779 km

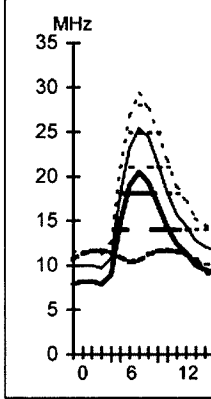
**Darwin-London 325**

First F 0-5 Short 13853 km

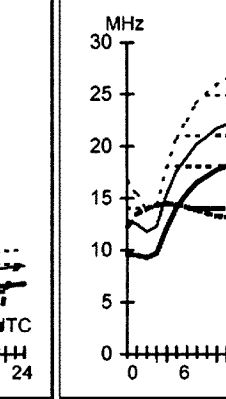
**Adelaide-Seattle 51**

First F 0-5 Short 13413 km

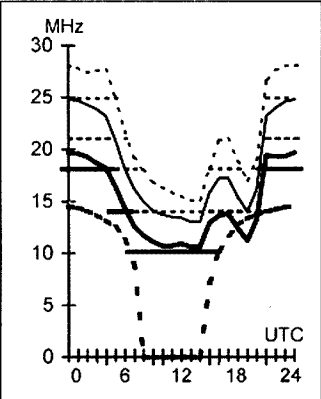
**Brisbane-Singapore 293**

Second 3F9-12 3E0 Short 6146 km

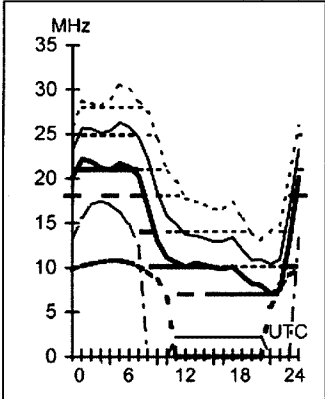
**Canberra-Manila 327**

Second 3F8-13 3E0 Short 6286 km

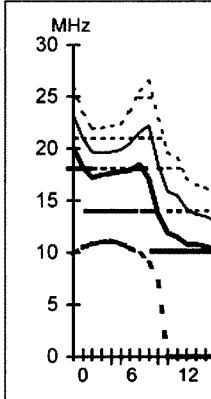
**Darwin-Riyadh 295**

Second 4F5-11 4E0 Short 10000 km

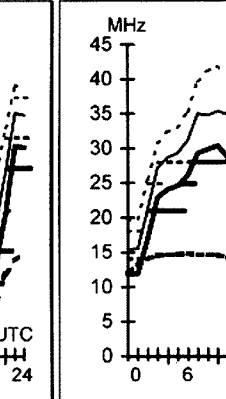

**Hobart-Dakar****209 Melbourne-Bangkok****312 Perth-Harare****257 Sydney-Miami****86**

First F 0-5 Short 16556 km

Second 3F5-10 3E0 Short 7372 km

First eF3-4 3E0 Short 8496 km

First F 0-5 Short 15026 km

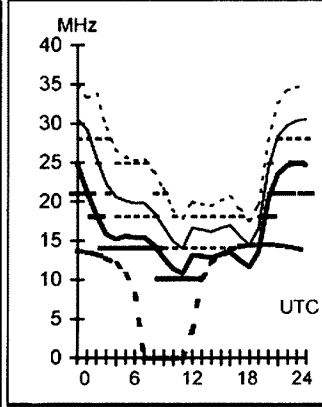
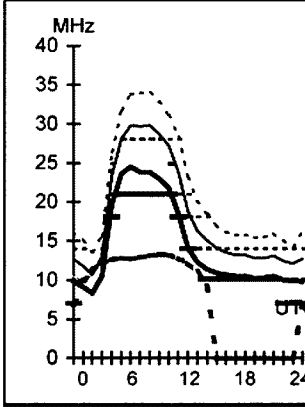
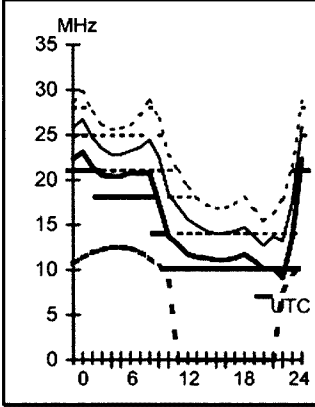
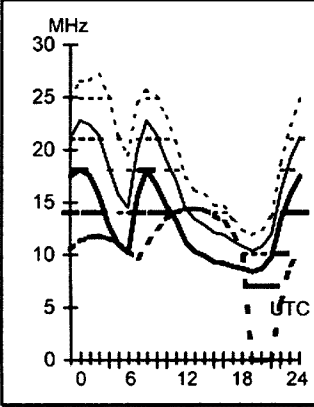
**Hobart-Lima****133 Melbourne-London****131 Perth-Port Moresby****59 Sydney-New Delhi****302**

First F 0-5 Short 12421 km

First F 0-5 Long 23118 km

First 2F9-10 2E0 Short 4073 km

Second 4F4-8 4E0 Short 10418 km

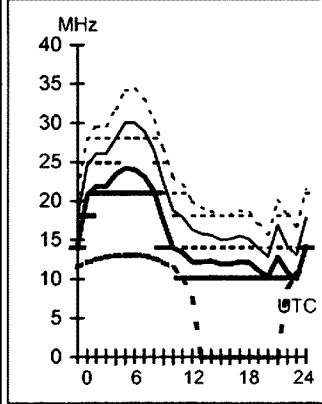
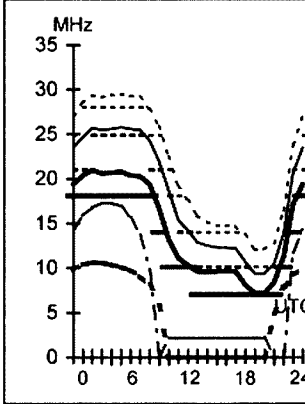
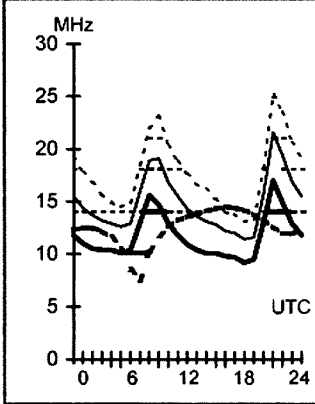
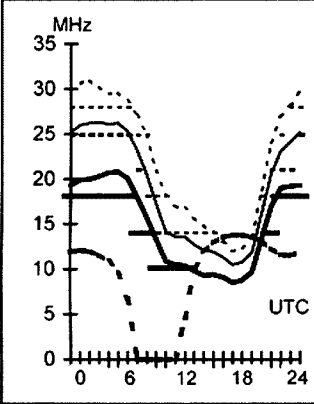
**Hobart-New York****80 Melbourne-London****311 Perth-Rome****123 Sydney-Rio De Janeiro****164**

First F 0-5 Short 16609 km

First F 0-5 Short 16906 km

First F 0-5 Long 26681 km

First F 0-5 Short 13519 km

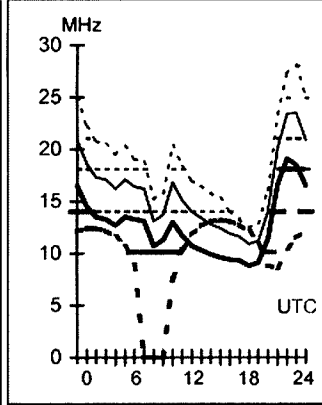
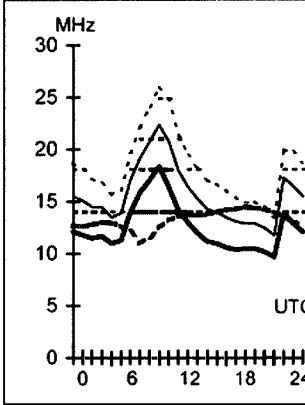
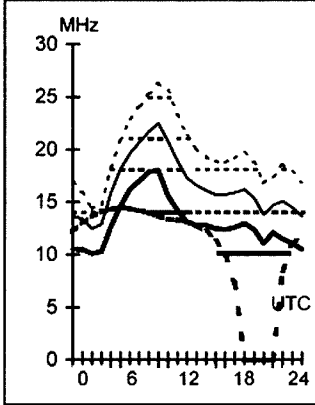
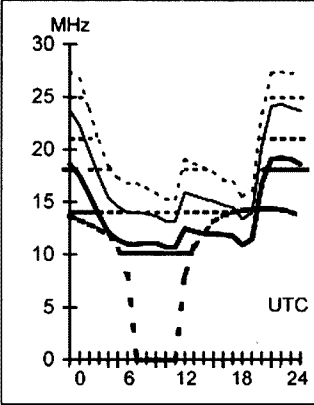
**Hobart-Seoul****344 Melbourne-Lusaka****241 Perth-Vancouver****50 Sydney-Tokyo****350**

Second 4F6-11 4E0 Short 9175 km

Second 4F3-4 4E0 Short 11153 km

First F 0-5 Short 14823 km

Second 3F4-8 3E0 Short 7825 km

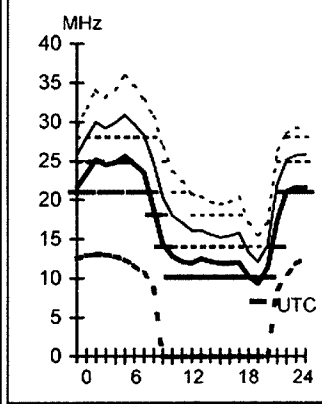
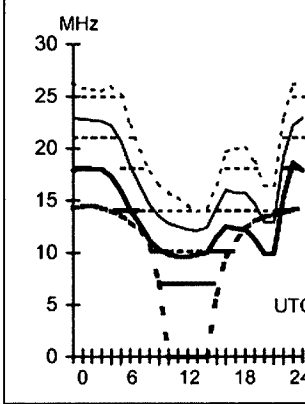
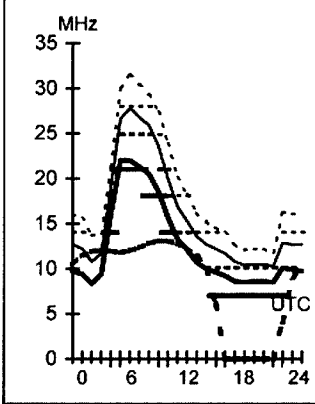
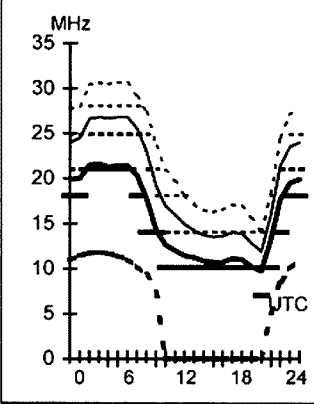

# Hamads classifieds

# FREE

## FOR SALE ACT

• **Kenwood TS-520** w/MC-50 mic \$325. **Yaesu FT-290II** w/FL-025 (25W amp), mobile bracket and 2 battery cases \$425. **Yaesu FT-26** 2 m h/h, w/fast charge, speaker mic, mmb and soft case \$400. **Collins 55G-1** \$50. All plus postage. VK1CJ, QTHR, Phone 02 6251 1816.

## WANTED ACT

• **COLLINS RADIO EQUIPMENT** including **KWM-2/A**, 75-S3/32-S3/312-B3/312-B4/312-B5, 55-G1, 270-G1/2/3, 30-S1/30-L1 Linears, 302-C3, Directional Wattmeter, SM-1/2/3, MM-1 Microphones. 75-A3, 75-A4, 51-J4, 51-S1, R-390A, 651-S1, 851-S1 Receivers, DL-1 Dummy load, 516-F2 and PM-2 and MP-1 Power supplies. PSE Chris VK5CC. Phone 02 6266 6684 (work), mobile 0409 379 507 or email christo@senet.com.au.

## FOR SALE NSW

• **Yaesu FT-ONE** deluxe solid state HF transceiver, split frequency IF shift, width notch, APF Vox, ac power supply and 12 V opps and workshop manuals \$550 ono, plus postage. VK2ZR Phone 02 6655 3190

• **CDs** over 400 megabytes digital and general amateur information, compiled and issued by ANARTS. \$10 PP. Cheque/money order VK2BQS, QTHR, Phone 02 4997 5068

• **SHACK CLEAROUT: Alinco 25 A power supply; Azden PCS-S000** (2 m) XCVR; **Daiwa CR4** rotator & controller; **Icom XCVRs IC-490**

(70 cm), **IC-505** (6 m), **IC-726** (HF 6 m), **IC-735** (HF) & **AT-150** tuner; **Kenpro az & el & controller**; **Kenwood TS-420S** HF XCVR & **PS-440S** power supply; **Racal RA17L** comms rcvr; **Tokyo Hi-Power Amps HL** (70 cm), **HL82V** (2 m), **HL86V** (6 m), **HL160V** (2 m), **HL180V** (2 m); **Tono 5000E** modem. Prices on application. Bob VK2CAN, Phone 02 9416 3727.

• **Yaesu FT-901DM** and matching VFO \$500. **Home brew ATU** \$100. **Kenwood QR-866** receiver \$60. Peter VK2DBI QTHR, Phone 02 6367 5095

• **Yaesu FL-2100B**, no WAARC bands, excellent order, little used, \$500. David VK2BDT Goulburn, Phone 02 4821 5036.

• **Have back issues of AR from mid 80s**, collect all THE LOT for free from QTH Jack VK2EJG. Phone mobile 0418 430 994.

• 2 off new **Type N right angle plugs for LDF4-50 Heliax** \$30 each. 6 off new **Type N plugs for half inch flexible FSJ4-50B Heliax** \$20 each. 2 off **Welz changeover coaxial switches** Type CH20A DC-900 MHz 1 kW SWR<1.15 Loss <0.1 dB \$100 each. Art VK2AS QTHR 02 9416 7784

## WANTED NSW

• **Kenwood R-600 manual and circuits** or copy. Will pay expenses. Peter VK2DBI Phone 02 6367 5095

• **Sub-mini valves** CK5672 (CV2238), CK5678,

CK6611. Also data on Acorn valve type CV1175 (NR 54) (Can find no data for this on internet). Pat Brennan VK2ABE PO Box 158, Tamworth 2340 or pmbrennan@bigpond.com.au

• **2 m transceiver** for base station. Must be CTCSS capable. Prefer DTMF mike and manual. Warwick VK2EDE, email wlake@nor.com.au

• **Power SWR meter VHF UHF and Azimuth indicator for rotator**, Iwasaki Ind. Co Ltd, or diagram for same. Ian VK2EYC, email alian@nlc.net.au, Phone 02 9416 1381

## FOR SALE VIC

• **Tower, 20 m, triangle**, self-supporting 160 km wind at 1m<sup>2</sup> load. Fully hot dip galvanised, comps available, tilting top, dismantled. Ring Keith VK3AFI Phone 03 5281 2264

• **Bargains: Icom IC-281H** Mobile 2 m transceiver s/n 001702 with manual (& home brew Slim Jim antenna). **Diamond F-23A antenna** - 2 m, 5/8 wave 3-element vertical. plus misc info & equipment, including **Kent hand key**. Any offers considered. **Free: Metal mast, 10 m**, hinged, guyed (galv. iron & aluminium, with timber top) & can be dismantled. Also miscellaneous fittings & wire. David VK3DNG QTHR Phone 03 9859 4698, email darodda@jeack.com.au

• **Kenwood TS-180S HF station** comprising: **TS-180S** transceiver \$250, **PS-30** power supply \$70, **AT-180** antenna tuning unit \$60, **VFO-180** external VFO \$30, **SP-180** external speaker \$30. All quote prices are negotiable. Terry VK3KBD phone 03 9315 0186 (evenings)

## WANTED VIC

• **Operators manual Yaesu FC-901** antenna tuner. Will pay for photocopy. Geelong Radio and Electronic Society. Contact Keith VK3XKS Phone 03 5243 5184

• **Service and/or maintenance manual for Marconi model TF-2700 universal bridge**. All costs cheerfully refunded. Drew VK3XU QTHR, Phone 03 9722 1620

• **Owner/operator Manual** or a copy of **Yaesu FT-890trans/rec**. Phone Lindsay VK3IQ at Phone 03 5672 2563 or email at vk3iq@nex.com.au

## FOR SALE QLD

• **GR Impedance bridge model 1650-B** \$100. **Signal generator** 300 Hz-612kHz -40 +10 dBm, Wandel Goltermann with matching level meter \$150. **100 W 50 ohm dummy load** \$50. Old transmitter crystals free. VK4AAF Phone 07 4936 3747

• One **Kenwood PS-30 power supply** in good order and condition but minus the dc power lead. Merv VK4DV QTHR, Phone 07 4928 5537 nights or leave a message please.

## WANTED QLD

• **DG5 readout** for use on a TS-520 XCVR. Merv VK4DV QTHR, Phone 07 4928 5537 nights or leave a message please.

## WANTED SA

• **Solid State HF general coverage Hamband XCVR** with damaged finals and or drivers that are no fixable. Transmitter and receiver sections must work up to the driver stage. **Yaesu preferred FT0747, FT-757, FT-77. An FT-817** would be lovely. Steve VK5AIM QTHR. Phone 08 8255 7379.

## About hamads....

- Hamads may be submitted by **email** or on the **form on the reverse of your current Amateur Radio address flysheet**. Please print carefully and clearly, use upper AND lower case.
- Separate forms for For Sale and Wanted items. Please include name, address STD telephone number and WIA membership number if you do not use the flysheet.
- Deceased estates Hamads will be published in full, even if the ad is not fully radio equipment.
- WIA policy recommends that the serial number of all equipment for sale should be included.
- QTHR means the address is correct in the current WIA Call Book.

Email: [newunltd@bigpond.net.au](mailto:newunltd@bigpond.net.au) Fax: 03 9756 7031

Postal: *Newsletters Unlimited, PO Box 431, Monbulk Vic 3793*

### TRADE PRACTICES ACT

It is impossible for us to ensure that the advertisements submitted for publication comply with the Trade Practices Act 1974. Therefore, advertisers and advertising agents will appreciate the absolute need for themselves to ensure that the provisions of the Act are strictly complied with.

### VICTORIAN CONSUMER AFFAIRS ACT

All advertisers are advised that advertisements containing only a PO Box number as the address cannot be accepted without the addition of the business address of the box-holder or seller of the goods.



**FOR SALE NT**

• Complete tower and antenna 10.5 metre ATN-320 tower (2 of the 3 each 6.5 m aluminium sections assembled), Yaaau G-8008DX Rotator, Force 12 CS88 antenna, 3 metre aluminium mast. Everything included: extra concrete stubs, hinged base plate, all cabling (rotator and coax), and Phillystran/wire rope guys. VG condition, 4-5 yrs old, have pictures, could deliver to Adelaide area. JJ, VK8JJ, QTHR, Phone 08 8953-0055, vk8jj@ozemail.com.au

**MISCELLANEOUS**

• The WIA QSL Collection (now Federal) requires QSLs. All types welcome, especially rare DX pictorial cards, special issue. Please contact the Hon Curator, Ken Matchett VK3TL, 4 Sunrise Hill Road, Montrose Vic 3755, tel. (03) 9728 5350

**TRADE ADS**

**PSK-31, SSTV, RTTY SOUNDBOARD**  
Interfaces Fully Isolated, ready to plug in.  
http://www.G3LIV.CO.UK,  
johnny@melvin.com, G3LIV QTHR.

**“Hey, Old  
Timer...”**

If you have been  
licensed for  
more than 25  
years you are



invited to join the  
**Radio Amateurs  
Old Timers Club  
Australia**

or if you have been licensed for less than 25 but more than ten years, you are invited to become an Associate Member of the RAOTC.

In either case a \$5.00 joining fee plus \$8.00 for one year or \$15.00 for two years gets you two interesting OTN Journals a year plus good fellowship.

Write to

RAOTC,  
PO Box 1100  
Sandringham VIC 3191

or call Arthur VK3VQ on 03 9598 4262 or  
Bill VK3BR on 03 9584 9512,

or email to raotc@raotc.org.au  
for an application form.

**Donated ham radios for Somalia**

Sam Voron VK2BVS

After a fantastic 6 months in Somalia last year it's about to happen again. My departure to Somalia is on 15 April 2004. I am looking for a team to work together to help Somali hams join the airwaves.

There are 13 Somali hams but none has a transceiver.

1. I can carry donated lightweight transceivers and power supplies (switch mode 20AMP), SWR meters and Morse code keys into Somalia.
2. If anyone can work on covering the airfreight for donated heavier transceivers then DHL can get those to Somalia in 8 days from anywhere including from Australia and the USA. Send them by DHL addressed to-Radio Galkayo, Amateur Radio Club, Galkayo, Somalia. That is the complete address. Send e-mail to me and I will watch for your item.
3. I will be taking digital photos and typing stories I can E-mail to anyone that wants to use their web site to find further help for Somali hams while I am there.
4. This is not a QSL expedition and no QSL will be issued. Please wait until the Somali people have their own stations and can QSL.

5. All my time and effort will go directly to helping the Somali people get on air themselves. This involves finding donated transceivers and people outside Somalia who want to help find and send donated equipment to get Somalia on air. It will also involve training the local people.
6. I am looking for help from aerial climbers to take down and put up a HF vertical aerial on my 50 foot Hills triangular mast at Roseville 6km north of Sydney's famous bridge. Call me anytime if you like climbing.
7. Donated transceivers, power supplies, Aerial systems, SWR metres and Morse code keys can be dropped in 24hours 7days or couriered or posted to Sam Voron 2 Griffith Ave, Roseville, N.S.W., Australia 2069.
8. If you want to help while I am in Somalia then E-mail svoron@hotmail.com

Thanks, Sam VK2BVS

**AMIDON FERROMAGNETIC CORES**

For all RF/electronic applications.  
See our website for complete data on all cores including prices.

www.catchnet.com.au/~rjandusimports

**RJ & US Imports**

PO Box 431, Kiama NSW 2533.

A 3.5" PC disk containing all data is available for \$5.00 incl. post.

**Agencies**

- Active Electronics, Tas
- Truscotts, Electronic World, Melb.
- TTS Systems, Tyabb (VIC)
- Tower Communications, Perth

**GROW WIA—MAKE IT YOUR JOB**

**RECRUIT A NEIGHBOUR\*, NON-MEMBER LICENSE HOLDER TODAY.**

One to one approaches are very successful and it is in your interest to have a strong WIA.

If you need to know who your neighbouring operators are call John (03) 9756 7797 AH and he'll tell you.

**JACKSON BROS**  
**JACKSON OF THE UK IS BACK**

Highest quality products made by UK craftsmen

Full range now off-the-shelf in Australia. Variable and trimmer capacitors, reduction drives, dials, ceramic standoffs



**CATALOGUES, PRICE LISTS AVAILABLE**

**CHARLES I COOKSON PTY LTD**

11-13 Port Rd  
Queenstown SA 5014

Tel: (08) 8240 3200 Fax: (08) 8240 3233

FreeFax 1800 673355 within Australia

Email: jackson@homeplanet.com.au



**ALL MAJOR CREDIT CARDS ACCEPTED  
SOLE AGENTS AUSTRALIA AND NEW ZEALAND**

**HF, VHF, UHF ANTENNAS  
& ACCESSORIES**

Aluminium towers, guys etc  
Diamond VSWR/PWR meters.

HD copper antenna wire & Insulators,  
TX tubes & pwr transistors, Create Rotators

Quality coax cables & connectors. Free advice & catalogue.

(Disregard the rumours, we are still here!)

**ATN Antennas**

Ph 03 8492 2224 Fax 03 8492 2066,

email atnant@llnet.net.au

**ADVERTISERS INDEX**

AEI .....	22	G & C .....	8
Andrews .....	35	Icom .....	OBC
Bansisc .....	IFC	Radio School .....	21
Coax Cable & Connectors .....	8	RippleTech Electronics .....	23
Com-en-tena .....	17	TTS .....	28/29
Connektron .....	18	54s .....	55



# Division Directory

*The Amateur Radio Service exists for the purpose of self training, intercommunication and technical investigation. It is carried out by amateurs who are duly authorised people interested in radio technique solely with a personal aim and without pecuniary interest.*

The Wireless Institute of Australia represents the interests of all radio amateurs throughout Australia. National representation is handled by the executive office under council direction. There is one councillor for each of the seven Divisions. This directory lists all the Divisional offices, broadcast schedules and subscription rates. All enquiries should be directed to your local Division.

**VK1 Division Australian Capital Territory,**  
 GPO Box 600, Canberra ACT 2601  
 President Alan Hawes VK1WX  
 Secretary Deane Walkington VK1DW  
 Treasurer Bob Howie VK1HBH

## Broadcast schedules All frequencies MHz. All times are local.

VK1WI transmits each Thursday evening at 2000 hrs local time on VK1RGI 146.950 MHz and 438.375 MHz including the linked repeater system on VK2RGN Goulburn, VK2FHR High Range, VK2RMP Madden Plains and VK2RTW Wagga Wagga.  
 VK1 Home Page <http://www.vk1.wia.ampr.org>  
 Annual Membership Fees. Full \$80.00 Pensioner or student \$71.00. Without *Amateur Radio* \$48.00

**VK2 Division New South Wales**  
 109 Wigram St, Parramatta NSW  
 (PO Box 9432, Harris Park, 2150)  
 (Office hours Tue., Thu., Fri., 1100 to 1400 hrs.)  
 Phone 02 9689 2417

VK2WI transmits every Sunday at 1000 hrs and 1930 hrs on some or all of the following frequencies (MHz): 1.845, 3.595, 7.146, 10.125, 14.170, 18.120, 21.170, 24.950, 28.320, 29.170, 52.150, 52.525, 144.150, 147.000, 432.150, 438.525, 1273.500. Plus many country regions on 2m and 70cm repeaters. Highlights are included in VK2AWX Newcastle news Monday 1930hrs. on 3.593, 10 metres and local repeaters. The text of the bulletins is available on the Divisional website and packet radio. Continuous slow morse transmissions are provided on 3.699 and 145.650. VK2RSY beacons on 10m, 6m, 2m, 70cm and 23cm. Packet on 144.850.  
 Annual Membership Fees. Full \$83.00 Pensioner or student \$66.00. Without *Amateur Radio* \$50.00

Web: <http://www.wiansw.org.au>  
 Freecall 1800 817 644 (NSW only)  
 e-mail: [vk2wi@wiansw.org.au](mailto:vk2wi@wiansw.org.au)  
 Fax 02 9633 1525

President Brian Kelly VK2WBK  
 Secretary Owen Holmwood VK2AEJ  
 Treasurer Noel May VK2YXM

**VK3 Division Victoria**  
 40G Victory Boulevard Ashburton VIC 3147  
 (Office hours Tue 10.00 -2.30)  
 Phone 03 9885 9261

VK3BWI broadcasts on the 1<sup>st</sup> Sunday of the month at 1030 and 2000 hours. Primary frequencies are 3.615, 7.085, 10.130, FM repeaters VK3RML 146.700, VK3RMM 147.250, VK3RWG 147.225, VK3RMU 438.075. The broadcast can also be heard on the Saturday night at 2000 hours before the 1<sup>st</sup> Sunday. Major news appears on the packet radio network under the callsign VK3ZWI, and the WIA Victoria website.  
 Annual Membership Fees. Full \$87.00 Pensioner or student \$72.00. Without *Amateur Radio* \$55.00

Web: <http://www.wiavic.org.au>  
 Fax 03 9885 9298

e-mail: [wiavic@wiavic.org.au](mailto:wiavic@wiavic.org.au)  
 President Jim Linton VK3PC  
 Secretary John Brown VK3JJB  
 Treasurer Jim Baxter VK3DBQ

**VK4 Division Queensland**  
 PO Box 199, Wavell Heights, Old. 4012  
 Phone 07 3221 9377  
 e-mail: [office@wiaq.powernp.com.au](mailto:office@wiaq.powernp.com.au)  
 Fax 07 3266 4929

EVERY SUNDAY, at 9am LOCAL (Sat 2300 UTC). From Far North Queensland On 7.070/2 MHz. From South East Queensland:- 1.825, 3.605, 7.118, 10.135, 14.342, 21.175, 52.525, 147.000, 438.500 MHz. Right throughout VK4 scan 146.6 to 148.0 MHz again at 9am local. SUNDAY 6:45pm hear LAST week's QNEWS broadcast 3.605 and 147.0 MHz from South East Queensland. MONDAY 7:00pm hear YESTERDAY's news again on 146.875 MHz broadcast from Brisbane Bayside repeater, and then 7:30pm on 3.605 and 147.0 MHz from Sth East Queensland. Text editions on packet internet and personal email, visit [www.wia.org.au/vk4](http://www.wia.org.au/vk4) News is updated 24/7 in both text and audio on this site. MP3 Audio from same website by 2300 hours each Saturday. Contact QNEWS, packet sp QNEWS@VK4WIE.BNE.QLD.AUS.OC email [qnews@wia.org.au](mailto:qnews@wia.org.au)  
 Annual Membership Fees. Full \$95.00 Pensioner or student \$81.00. Without *Amateur Radio* \$63.00

Web: <http://www.wia.org.au/vk4>

President Ewan McLeod VK4ERM  
 Secretary Bob Cumming VK4YBN  
 Treasurer David Gulley VK4DCG

**VK5 Division South Australia and Northern Territory**  
 (GPO Box 1234 Adelaide SA 5001)  
 Phone 08 8294 2992

VK5WI: 1843 kHz AM, 3.550 MHz LSB, 7.095 AM, 14.175 USB, 28.470 USB, 53.100 FM, 147.000 FM Adelaide, 146.800 FM Mildura, 146.900 FM South East, 146.925 FM Central North, 438.475 FM Adelaide North, ATV Ch 35 579.250 Adelaide. (NT) 3.555 LSB, 7.065 LSB, 10.125 USB, 146.700 FM, 0900 hrs Sunday. The repeat of the broadcast occurs Monday Nights at 1930hrs on 3585kHz and 146.675 MHz FM. The broadcast is available in 'Realaudio' format from the website at [www.sant.wia.org.au](http://www.sant.wia.org.au) Broadcast Page area.  
 Annual Membership Fees. Full \$91.00 Pensioner or student \$76.00. Without *Amateur Radio* \$61.00

web: <http://www.sant.wia.org.au>  
 email: [peter.reichelt@bigpondi.com](mailto:peter.reichelt@bigpondi.com)

President Trevor Quirk VK5ATQ  
 Secretary Peter Reichelt VK5APR  
 Treasurer Trevor Quirk VK5ATQ

**VK6 Division Western Australia**  
 PO Box 10 West Perth WA 6872  
 Phone 08 9351 8873

VK6WIA: 146.700 FM(R) Perth at 0930hrs Sunday relayed on 1.865, 3.564, 7.075, 10.125, 14.116, 14.175, 21.185, 29.120 FM, 50.150 and 436.525 MHz, Country relays 3.582, 147.200 (R) Cataby, 147.350 (R) Busselton, 146.900 (R) Mt William (Bunbury), 147.000 (R) Katanning and 147.250 (R) Mt Saddleback. Broadcast repeated on 146.700 at 1900 hrs Sunday relayed on 1.865, 3.564 and 438.525 MHz : country relays on 146.900, 147.000, 147.200, 147.250 and 147.350 MHz. Also in "Real Audio" format from the VK6 WIA website  
 Annual Membership Fees. Full \$71.00 Pensioner or student \$65.00. Without *Amateur Radio* \$39.00

Web: <http://www.wia.org.au/vk6>  
 e-mail: [vk6@wia.org.au](mailto:vk6@wia.org.au)

President Neil Penfold VK6NE  
 Secretary Roy Watkins VK6XV  
 Treasurer Bruce Hedland-Thomas VK600

**VK7 Division Tasmania**  
 PO Box 371 Hobart TAS 7001  
 Phone 03 6234 3553 (BH)

VK7WI: At 0930 hrs every Sunday on 146.700 MHz FM (VK7RHT, Hobart) and relayed on 147.000 MHz FM (VK7RAA, Launceston), 146.625 MHz FM (VK7RMD, Ulverstone), 146.750 MHz FM (VK7RNW, Ulverstone), 147.075 MHz FM (VK7RWC, Rosebery), 3.57 MHz LSB, 7.090 MHz LSB, 14.130 MHz USB and UHF CB Channel 15 in Hobart area.  
 Annual Membership Fees. Full \$90.00 Pensioner or student \$77.00. Without *Amateur Radio* \$57.00

Web: <http://www.wia.org.au/vk7>  
 email: [vk7dg@wia.org.au](mailto:vk7dg@wia.org.au)

President Phil Corby VK7ZAX  
 Secretary Dale Barnes VK7DG  
 Treasurer Dale Barnes VK7DG

VK8 Northern Territory is part of the VK5 Division and relays broadcasts from VK5 as shown, received on 14 or 28 MHz. The broadcast is downloaded via the internet



**5th IARU - REGION 3  
ARDF CHAMPIONSHIPS**

**BALLARAT - AUSTRALIA - 2003**

The pressure is on Tony Langdon VK3JED as he looks for the next hidden transmitter.



Learning new skills is Tatyana Karasheva of Kazakhstan, under expert instruction from Steve Dick VK3NMA of the Australian Boomerang Association.



Working CW from the special event station VI3ARDF is Yoshi Kaneshige JR1CHU.



At the busy registration desk is, from left, Susan Longayroux, John Longayroux VK3ZJH and Stephen Weiss.



On the hunt!



Showing the flag after being presented individual and team medals for the Open Men's 80m event are (left to right) Mark Diggins VK3JMD, Adam Scammell VK3YDF and Tony Langdon VK3JED.

# ICOM'S GREAT CHAMPIONS



**NEW**

**ICOM FLAGSHIP TRANSCEIVER**  
**IC-7800**

- Four 32-bit floating point DSP units • +40dBm ultra high intercept point
- Automatic tracking pre-selector • Two completely independent receiver circuits • 200W output power at full duty • Ultra high frequency stability • 7-inch wide color TFT LCD • Multi function spectrum scope
- RTTY / PSK31 operation without PC connection • Professional 6m receiver
- Digital Voice Recorder • CF memory card • Morse Free Package.



**IC-706MKIIG** HF • VHF UHF

**The amazing evolution of the legendary 706.**

Now includes 70cm @ 20W and 50W on 2m  
Standard feature DSP • Built in sub tone encoder & decoder  
Tone scan • Mosfet PA • You get base station performance and features  
in a mobile rig sized package • Morse Free Package.

**NO FILTERS REQUIRED**



**IC-7400**

- Sharp & soft IF filter shape • 100W HF /6m /2m • Digital twin PBT
- DSP • SSB / CW synchronous tuning • Built in antenna tuner
- RTTY demod / decoder • Digital RF speech processor
- Microphone equaliser • Morse Free Package.



**IC-T90A** A new 5W Triband handheld

VHF/UHF FM 2M, 6M, & 70CM Wideband receive 495 KHz - 1 GHz  
555 Alphanumeric memories • 13 Scan modes DTCS & CTCSS encode & decode DTMF encoder (10 memories) Wide/narrow transmit capability.



**NEW**



**IC-20SH** 2m FM Dual Band Transceiver

- Dual Band Features at a Single Band Price • 55W / 2m, 50W / 70cm
- Built-in CTCSS and DTCS Tone Squelch
- Detachable Front Panel (Req. OPC-600/601 Option)
- 9600 bps Packet Operation • 512 Memory Channel
- Standard Mic. Supplied:HM133.

**ICOM**  
Clearly Ahead

**2 YR WARRANTY**

find your nearest ICOM dealer at  
[www.icom.net.au](http://www.icom.net.au) or (03) 9387 0666

PH331\_AM02

The magazine for AUSTRALIAN AMATEURS

May 2004

Volume 72 No 5



# Amateur Radio

\$6.50  
incl GST

*Winter at  
Mt Barrow*

**This issue  
featuring**

**Ham radio internet  
repeater linking**  
Ian Abel G3ZHI

**Raft radio**  
Mike Patterson VK4M1K

**Elementary RF Vector  
Network Analysis  
using a HP8410B**  
Richard Sawday VK5ZLR

**An active receiving  
loop antenna  
for 1.8 MHz**  
Drew Diamond VK3XU

**The EH antenna**  
Lloyd Butler VK5BR

**Would you know  
what to do?**



**Helping a yacht  
in trouble**  
Jim Linton VK3PC

ISSN 0002-6859



# BENELEC



## FT-857D



**NEW MODEL**

**SUPER SPECIAL PRICING**

NOW includes DSP2 unit built-in

- Ultra Compact + All Mode Transceiver
- 160-10m / 6m / 2m / 70cm
- 100W, 100W, 50W, 20W

**New Price \$1587.50**

## FT-897



Now includes TCXO-9 Option Free

- Portable / Mobile / Base All Mode Txr
- 160-10m / 6m / 2m / 70cm
- 100W, 100W, 50W, 20W

**New Price \$1690.90**

## FT-7800



44/430 MHz Dual Band FM Transceiver

- High Power Output
- Wide Receiver Coverage
- Five One-Touch "Hyper Memory"
- Over 1000 Memory Channels
- WiRES Internet linking Compatibility

**New Price \$539.90**

**BENELEC NOW OFFERS A '3 YEAR WARRANTY'**  
for all radios including those sold in the last 12 months

## FT-817



- Ultra Compact 135 x 38 x 165mm
  - All Mode Portable Transceiver
  - 160-10m / 6m / 2m / 70cm
  - 0.5-5 Watts Selectable
- New Price \$1248.70**

**ALL OUR PRICES INCLUDE GST**

## VX 1



**New Price \$343.10**

## VX 2



**New Price \$415.00**

## VX 5



**New Price \$693.50**

Colour brochures, Operating Manuals and full details on all Yaesu products can be found on our web site! Check it out...

[www.benelec.com.au](http://www.benelec.com.au)

- NSW**  
Andrews Communications Systems  
Tel 02 9636 9060 lee.andrews1@bigpond.com
- Newcastle Pro Sound & Communications**  
Tel 02 4965 6899 sales@newcastleprosound.com.au
- Action Communications**  
Tel 02 4732 2788 action@pnc.com.au

- Authorised Yaesu Retailers**
- VIC**  
Strictly Ham P/L  
Tel 03 9729 7656 sales@strictlyham.com.au

- Qld**  
Kyle Communications  
Tel 07 3857 4400 mark@kyle.com.au
- G&C Communications**  
Tel 03 5996 3298 gcomm@netspace.net.au
- SA/NT**  
POSNAV Systems P/L  
Tel 08 8342 4700 brenton@posnav.com.au





# Amateur Radio

Volume 72, Number 5  
May 2004

The Journal of the Wireless  
Institute of Australia  
ISSN 0002-6859

## Editorial

Editor: Colwyn Low VK5UE  
edarmag@charlot.net.au

Technical Editor: Peter Gibson VK3AZL

Publications Committee Members  
Brenda Edmonds VK3KT  
Ron Fisher VK3OM  
Don Jackson VK3DBB  
Evan Jarman VK3ANI  
Tom Potter VK3UBS  
Bill Roper VK3BR

### Submission of material to Amateur Radio Magazine

General and Technical articles to  
Secretary  
AR Publications Committee  
3 Tamar Court  
Mentone VIC 3194  
or armag@optusnet.com.au

Columns and Letters to the Editor to  
Editor  
AR Magazine  
34 Hawker Crescent  
Elizabeth East SA 5112  
or  
edarmag@charlot.net.au  
(Tel and Fax 08 8255 2138)

Hamads to  
"Hamads" Newsletters Unlimited  
PO Box 431  
Monbulk VIC 3793  
Fax 03 9756 7031  
newunltd@bigpond.net.au

Advertising  
All enquiries to  
Newsletters Unlimited  
PO Box 431  
Monbulk Vic 3793  
Phone: 03 9756 7797  
Fax: 03 9756 7031  
newunltd@bigpond.net.au

Registered Office  
10/229 Balaclava Road,  
Caulfield North VIC 3161  
Australia  
Phone: 03 9528 5962

## Production Deadlines

Advertising booking and articles for  
publication 10<sup>th</sup> of preceding month.

Hamads and advertising material  
deadline 18<sup>th</sup> day of preceding month

The contents of Amateur Radio are Copyright  
Wireless Institute of Australia © 2004

## General

Helping a yacht in difficulty .....	8
<i>Jim Linton VK3PC</i>	
Raft radio .....	13
<i>Mika Patterson VK4MIK</i>	
New Honorary Life Member of the WIA .....	17
<i>Jim Linton VK3PC</i>	
Chip off the old block .....	26
<i>Jim Linton VK3PC</i>	
The solar cycle .....	51
<i>Bill Isdale VK4TWI</i>	
Battery packs for older handhelds .....	55
<i>Roy Yeats VK2BRY</i>	

## Technical

Ham radio Internet repeater linking .....	4
<i>Ian Abel G3ZHI</i>	
An active receiving loop antenna for 1.8 MHz .....	10
<i>Drew Diamond VK3XU</i>	
Elementary RF Vector Network Analysis using a HP8410B .....	14
<i>Richard Sawday VK5ZLR</i>	
The EH antenna .....	20
<i>Lloyd Butler VK5BR</i>	
An RF bridge for antenna measurements .....	24
<i>Roger Graham VK2AIV</i>	
The copper loop for 2 metre (Technical Abstracts) .....	46
<i>Peter Gibson VK3AZL</i>	
Temperature measurements (Technical Abstracts) .....	47
<i>Peter Gibson VK3AZL</i>	
A QRP ATU (Technical Abstracts) .....	49
<i>Peter Gibson VK3AZL</i>	

## Columns

ALARA .....	30	Hamads .....	54
AMSAT .....	38	HF Predictions .....	52
Beyond Our Shores .....	22	Intruder Watch .....	16
Contests .....	40	Over to you .....	37
Club News .....	16, 41, 42, 43	Silent Key .....	37, 48
WIA Division News		Spotlight on SWLing .....	21
VK1 News .....	32	Technical Abstracts .....	46
VK2 News .....	32	VHF-UHF an expanding world .....	44
VK3 News .....	33	WIA Comment .....	3
VK6 News .....	34	WIA Division Directory .....	56
VK7 News .....	36	WIA Federal Directory .....	2
Editor's Comment .....	2		

## Our Cover this month

The VK3RWG 2 metre repeater site at Mt Baw Baw in Gippsland in August last year. Photo courtesy of Chris Morley VK3KME, Secretary, WIA Eastern Zone Amateur Radio Club. See Chris's story and more photos inside back cover

### Contributions to Amateur Radio

Amateur Radio is a forum for WIA members' amateur radio experiments, experiences opinions and news. Manuscripts with drawings and or photos are always welcome and will be considered for publication. Articles on disc or email are especially welcome. The WIA cannot be responsible for loss or damage to any material. A pamphlet, How to write for Amateur Radio is available from the Federal Office on receipt of a stamped self-addressed envelope.

### Back issues

Back issues are available directly from the WIA Federal

Office (until stocks are exhausted), at \$4.00 each (including postage within Australia) to members.

### Photostat copies

When back issues are no longer available, photocopies of articles are available to members at \$2.50 each (plus an additional \$2 for each additional issue in which the article appears).

### Disclaimer

The opinions expressed in this publication do not necessarily reflect the official view of the WIA and the WIA cannot be held responsible for incorrect information published.

## Amateur Radio Service

A radiocommunication service for the purpose of self-training, intercommunication and technical investigation carried out by amateurs; that is, by duly authorised persons interested in radio technique solely with a personal aim and without pecuniary interest.

## Wireless Institute of Australia

The world's first and oldest  
National Radio Society  
Founded 1910

Representing

The Australian Amateur Radio Service

Member of the

International Amateur Radio Union

Registered Federal Office of the WIA

10/229 Balaclava Road

Caulfield North Vic 3161

Tel: (03) 9528 5962 Fax (03) 9523 8191

<http://www.wia.org.au>

All mail to

PO Box 2175 Caulfield Junction VIC 3161

Business hours: 9.30am-3pm weekdays

### Federal Secretary

Peter Naish VK2BPN

### Federal Office staff

June Fox Bookkeeper  
Rita Trabilco VK3IF Examinations Officer

### Council

President	Ernest Hocking	VK1LK
VK1 Federal Councillor	Gilbert Hughes	VK1GH
VK2 Federal Councillor	Terry Davies	VK2KDK
VK3 Federal Councillor	Jim Linton	VK3PC
VK4 Federal Councillor	Glenn Dunstan	VK4DU
VK5 Federal Councillor	David Box	VK5OV
VK6 Federal Councillor	Trevor Ward	VK6HTW
VK7 Federal Councillor	Phil Corby	VK7ZAX

### Executive

David Jones VK4OF  
David Pilley VK2AYD  
Don Wilschefski VK4BY  
Brenda Edmonds VK3KT (ex officio)

### Federal Coordinators

AMSAT	Graham Ratcliff	VK5AGR
ARDF	Jack Bramham	VK3WWW
Awards	Mal Johnson	VK6LC
Contests	t.b.a.	
Education	Ron Smith	VK4AGS
FTAC	John Martin	VK3KWA
Historian	John Edmonds	VK3AFU
IARU	Neil Penfold	VK6NE
Intruder Watch	Harry Andersson	VK8HA
International Travel Host	John Miller	VK3DJM
ITU Conference and study group	Gilbert Hughes	VK1GH
QSL Manager (vks, vkx)	Neil Penfold	VK6NE
Videotapes	VK2 Division	
Web	Joe Burford	VK5UJ
WICEN	John Weir	VK3ZRV

### ACA Liaison Team

Peter Naish VK2BPN,  
Gilbert Hughes VK1GH  
Keith Malcolm VK1ZKM  
Glenn Dunstan VK4DU

## Editorial comment

Colwyn Low VK5UE

## The New WIA

I suppose it was too much to expect all to be agreed at the first session of the 2004 WIA Federal Convention. I also believe it is better to wait a bit, even if it was a year, to let every one get their head around what is being suggested, what the benefits will be and what will change. We have also got to be sure we have a group of committed people to run the new organisation. It seems to me that the most important position in the new WIA will be that of a full time executive officer.

I cannot see how the organisation can be run efficiently, and properly, by volunteer managers and part time staff. The executive officer would have to be an amateur who has a broad-based background in management and a fair knowledge of amateur radio.

Where the national office should be, will be similar to the problem Australia had at federation in selecting a capital. I hope by the time you read this, we will have an idea of where we are going.

## Things 'amateur' we can all do now

No matter what happens to the structure, it is most necessary that we all try to recruit some new members to the hobby and also hopefully the WIA. There is no use telling young people or for that matter retirees that amateur radio will give them the same facilities as a mobile phone, it will not.

When I was young, amateur radio was the only way you and your friends could contact each other on the move. When I said to someone recently "What did amateur radio offer?" Their reply was the opportunity to make new friends from all over the world. This is certainly true and we all know of chance QSOs that ended up with frequent contacts

and a long-term friendship. We also have the chance to meet more people locally. I read a number of club magazines and some clubs have a very good social program so that our families can meet other members and their families.

There is also the facility to help your local community through WICEN and in some cases the amateurs are the SES or CFS radio operators. There are conditions where the amateur networks work better than the government

networks because they have knowledgeable operators and can flexibly reconfigure their networks to best suit the situation being served.

Finally there is the challenge of building up a station. Selecting the components which best suit

your interests HF -UHF, QRP - QRO, Digital - Analogue, big and bulky - small and neat the list goes on and on. There is the chance to talk to people on the ground close by or far away, to the Astronauts on the ISS or to listen to the signals from the Mars Rovers. Lots of challenges and lots of satisfaction and pleasure from taking them on and winning.

Lastly I did get things together and worked a few numbers for the Harry Angel Sprint. I really will have to do something with the 80 metre aerial systems. Then, if I can hear them better and radiate more efficiently, perhaps I can work more stations and win a section of the contest! But then the satisfaction is in the precipitation, not the possible trophy (well!).

Well now we are into winter it is a good time to refurbish some equipment, design new accessories and plan to do some operating on a new band in a new mode. Good luck in the quest.

73 Colwyn VK5UE



## Federal WIA AGM

I'd like to start this month's AR notes with a big "thank you" to all of the members of the VK4 division who helped to make the 2004 Federal WIA AGM a success. Thanks are due in particular to Ken Fuller VK4KF for offering to take the meeting minutes as well as helping out with a large amount of administrative support. And of course not to be forgotten is our own June Fox from the Federal Office who worked up until the last minute to ensure that the accounts, reports and all of the paraphernalia of the WIA AGM were ready on time. Thank you to Ken, June, and everyone who else who helped out.

So what happened? The main topic of discussion over the weekend was the question of whether we should become a National WIA rather than the federation of separate Divisions that it is at the moment. In other words the current Federal WIA has only 7 members who are the 7 Divisional councillors. Individual members are affiliated with a regionally based Division. There was strong support for the proposal but at this stage a number of outstanding questions remain. A significant amount of time was spent on the issue of the so called transition arrangements. How exactly will each of the current Divisions transfer it's membership and responsibilities to a national body? This discussion was led by Michael Owen VK3KI. There has been some comment that this transition document was not available before the meeting started. This was simply not an option since the transition plan is something that has to be agreed amongst all of the Divisions. As such the meeting was used as a forum to garner the views of each of the divisions so that everyone present could understand the intricacies involved in the transition arrangements. To have done this outside of the meeting or by email would have been almost impossible and extremely time consuming.

Having dealt with the complexities of the transition arrangements there was a strong feeling that Divisional councillors wished to discuss the details with their respective councils. As a result the AGM was adjourned until 1 May 2004.

This adjourned meeting will be held in Paramatta where the one outstanding AGM issue is the special resolution on the adoption of a new National WIA constitution.

The 2004 AGM was notable for a number of other reasons. Among these was the presence of David Wardlaw VK3ADW. David was present in an official, and sadly his last, IARU capacity. It was a fitting end to many years of effort on behalf of amateur radio and I'm sure that you will all join me in saying thank you to him for these efforts as well as wishing David well for the future.

Also present was Michael Owen VK3KI. Michael brought to the attention of the council the importance of the WIA contribution to WRC 2003. Michael was able to provide an invaluable insight into the role played by the both David Wardlaw VK3ADW and Keith Malcolm VK1AKM who presented the amateur radio viewpoint as part of the Australian delegation. It was heart warming to hear how important their contributions have been. Thanks also to all of you who contributed funds towards being able to send the WIA delegation to WRC 2003. It is good to be able to provide this sort of feedback to you to confirm the real value that these contributions have made to furthering the hobby.

Most of the other activities at the AGM seemed somehow much less momentous; partly I suspect because of the huge ramifications that the adoption of a National WIA would have upon future policy and operations.

The AGM did have its moments. This year saw David Jones VK4OF not being re-elected to his position on the executive as a director. I would like to ask you all to reflect on the immense efforts that David has put into AR both as a VK4 divisional councillor and over the last year as a director of the Federal body. His most recent *tour de force* was the petitioning of the Joondalup Council in respect of mast and covenants in the council area. So; thank you David on behalf of all of us at the Federal WIA.

Also sadly David Piley VK2AYD tendered his resignation at the AGM. David has indicated that he will continue to support the Federal body

and any national body that may arise in the future although not as a director. David has been acting as the Federal WIA treasurer for the last 3 years. He has made an immense behind the scenes contribution to the operation of the Federal body. Thank you David.

On a more upbeat note I am pleased to report that John Martin was made a life member of the Federal WIA for his contribution over many years as Chairman of the Federal Technical Advisory Committee. Well done John, you are another quiet achiever working behind the scenes to promote amateur radio. I am also delighted to announce that Gil Sones VK3AUI has been posthumously awarded the Higginbottom Medal in recognition of his contribution over many years.

## The future

As I write these notes the question upper most in my mind is where to next. At this time I am aware of a considerable amount of activity across Australia:

- In VK3 extensive debates are being held in conjunction with presentations by Michael Owen on the transition proposals at various clubs.
- The VK2 AGM was held on 17 April and initial analysis shows around 95% support for the national body. This confirms the general trends of reports that I receive from a range of quarters.
- In the west; the VK6 AGM appears to have voted against the proposed new constitution and implementation plan (although I have not heard this officially and I suspect we all need to look at exactly what they have voted for).

So the next few weeks and months look to maintain the interest and excitement of recent months. Hopefully, by the time I get to write AR notes for June, I will be able to report the outcome of the debate which ever way it goes.

I'll bring these notes to a close and wish 73s to you all. I look forward to hearing your comments, either directly or via the divisions. All the best in amateur radio.

# Ham radio internet repeater linking

Ian Abel G3ZHI

**It is now common for those on the Internet to communicate with friends and family around the world using voice and video, which requires their computer to have a camera, microphone and soundcard fitted.**

For radio hams the next step was to link their FM VHF or UHF transceiver to the computer sound card enabling audio from their transceiver onto the Internet. If a similar link was taking place on a remote computer and both computers were linked together via the Internet (in the UK or anywhere in the world) you could have a radio to radio QSO with the Internet providing the link in the middle.

The transceiver could be operating on either a local VHF or UHF repeater, or an FM simplex channel. All Internet linking on repeaters takes place in the shack of the ham providing the link, nothing is done at the repeater site. The audio quality is normally excellent. DX stations sound just like locals.

With the more liberal ham radio laws in the USA and Canada, Internet repeater linking has been in use there for more than 6 years. The first program used was Vocaltecs' IPHONE but any program that allows audio over the Internet e.g. MSN Messenger or Paltak can be used for linking and provide basic radio communication.

This would be done by holding the transceivers' microphone to the computer speaker and transmitting the

audio off the Internet over the air, then holding the computer microphone to the transceivers' speaker and transmitting the audio over the Internet.

The TX/RX change over would be made by manually pressing the PTT but with more sophisticated programs like IRLP the TX/RX change over is done automatically using an interface board and the transceivers 'COS' (carrier operated switch) data line, allowing repeaters to be connected to the Internet 24 x 7.

In the UK permission to link Ham radio to the Internet had to be obtained from the Radiocommunications Agency and a personal request was made by Ian Abel G3ZHI to David Hendon G8DPQ their Chief Executive at RA Road Show in Leeds October 1999. David Hendon gave his permission in January 2000.

There are currently four Internet linking systems in use IPHONE, iLINK, eQSO and IRLP. The first three run under Windows 95 and above and each program can be downloaded from my web site. IRLP runs under Linux Redhat 6.2 (this version only). For those not familiar with Linux the UKIRLP Group are willing to help with installing Linux and the IRLP software. Using Linux is straightforward when the Graphical User Interface (GNOME) is also installed, as the Desktop looks similar to the Windows Desktop.

As of April 2002 185 NoVs have been issued for simplex Internet gateways.

74 2m  
111 70cm  
1 70cm 7.6MHz split repeater

## Getting connected (UK specific)

If you wish to install an Internet gateway you first need to apply to the RA for a Notice of Variation (NoV) to your Amateur Radio Licence. For a simplex link the application can be made on line on the RSGB DCC web site. The site lists

all the 2m and 70cm frequencies available.

If you wish to put the link on a repeater you must first obtain the permission (in writing) of the keeper and then send a written application to the RSGB RMC Chairman Carlos Eavis G0AKI QTHR supplying all the information required for a simplex link, plus the callsign of the repeater you wish to put the link on, a copy of your licence validation document and the written permission of the keeper.

You could install your own 70cm 7.6 MHz split repeater and install an Internet link on it. 7.6 MHz repeaters are 'fast track' repeaters, as the application is processed quicker than a normal repeater application.

Some software changes will probably have to be made to the repeater logic as no repeater identification must be sent over the Internet, as it causes problems with the other repeaters that are connected producing a 'ping-pong' effect (repeaters continuously keying each other on and off). The logic must also be capable of operating CTCSS.

As Internet linking is worldwide, hams in many different time zones help to police the links 24 x 7 and any problems are reported to the stations providing the links.

## Contacts

Using an Internet link DX stations can be worked from home, while out walking, or bicycling using a hand-held. A typical example is to have a roundtable QSO with hams on repeaters in the U.S.A, Canada, South Africa, The Caribbean and Australia all in the same QSO.

Some American repeaters transmit simultaneously on multiple frequencies e.g. 2m 6m 10m 220MHz and 70cm so you can be transmitting on many different frequencies all at the same time.

### NOTE

***This article refers to systems set up under UK licences. Some frequencies etc are not available in Australia. Operating software which allows the possibility of unlicensed persons communicating over Amateur Radio Frequencies are not permitted in Australia.***  
Editor.

The most remote place on IRLP is the American Mc Murdo Base in Antarctica. The base has a 'live cam', <http://live7.truelook.com/nasa/mcmurdo/index.jsp> camera, which you can control, the picture quality is very good. For 6 months of the year the base is in 24-hour daylight so with a little organisation it would be possible to see the person you are talking to, if they stood in front of the camera. I have done this here from Sheffield and stood in front of one of the 'live cams' cameras on Sheffield University, while talking to hams on IRLP who were able to see me.

Some overseas repeater linked systems are very sophisticated with many repeaters linked together by RF. In New Zealand for instance they have the 70cm National System that has 19 repeaters linked together, providing nearly full coverage of both the North and South Islands. In 2001 when Tony Whitaker G3RKL was walking the length of the country (top to bottom 1,300 miles) I was able to keep in touch with him daily, while he was on his walk and patch him through to his local repeater GB3US in Sheffield (Tony is the keeper) to talk to his friends.

In the U.S.A. and Canada there are a number of linked systems. One example is the Winsystem in California which links San Diego to San Francisco via 17 mountain top repeaters (some over 8,000 feet high) all linked together.

Another repeater with excellent coverage is the Tram repeater in Palm Springs California, so called because the Tram goes to the top of the mountain where the repeater is. Also on the top of the mountain there is a 'live cam' which is next to the repeater site, which you can view from the Tram web site <http://www.pstramway.com/> and enjoy the beautiful scenery and see the repeater coverage.

In the future maybe all repeaters in the world will be linked to the Internet enabling hams to keep in touch with ham friends visiting any city in the world that has a repeater.

Internet linking is ideal for long QSOs making it possible to have in-depth discussions unaffected by QRM or QSB.

G3ZHI has given a number of talks to radio clubs in the U.K. and around the world using Internet radio linking. It could be used by any ham to give a club talk on any subject.

Contacts can be 'one to one' or in a

'round table' where many repeaters are linked together. Sometimes on IRLP 30 repeaters can be linked and all the users on each repeater are able to hear each other.

For elderly hams that are no longer able to look after their aeriels and towers, or hams that go into retirement homes, this is an excellent way for them to keep in touch with ham friends. I recently worked one ham in the USA who was 92 and using a handheld from a retirement home. Some retirement homes will permit computers and handheld radios but not a HF radio plus aeriels.

While you are at work, university, school or at an Internet café, providing the computer you are using has a microphone and soundcard you can talk or just listen to your ham friends without having access to a radio.

Internet linking will work on a 56k-dialup modem but a high-speed connection is best.

Repeaters represent a big investment in both time and money and the aim of the Internet radio-linking project is to increase activity on repeaters and simplex channels.

Using IPHONE 4.5 one of the memorable QSOs G3ZHI had was with the Motorola Museum club station in Chicago USA K9MOT. While talking to K9MOT over the N9EP-R repeater, a radio amateur passenger in a light aircraft joined the QSO, working aeronautical mobile (which is permitted in the USA). Just at that time the aircraft was flying above the Museum and the radio amateur in the plane was sending live video to the club, they then forwarded it via the IPHONE program, so G3ZHI was able to see the video from the plane.

G3ZHI has also worked another radio amateur passenger in a light aircraft, this time while out cycling and using a handheld on GB3DV, the 70cm repeater in Maltby, which was connected to N9EP-R in Chicago via IRLP.

A U.K. repeater system could be developed providing full coverage of each Motorway. e.g. The M1 motorway could have several repeaters all linked together providing continuous coverage from London to Leeds.

Check <http://www.dcc.rsgb.org/ShowGates.asp?call=ALL> to see if you have a local gateway near you. If you live within 10 miles of a gateway you should

be able to hear it when it is active. They are not all 24 x 7 and you may need to contact the keeper to check when the link is available.

You can listen on line to the Californian Winsystem 24 hours a day by following the link on their web site at <http://www.winsystem.org>

There are a number of 'egroups' on <http://groups.yahoo.com> which have discussions about Internet linking which you can join.

For sites on repeater Internet linking search using <http://www.google.com>

To use the Internet linking programs on a computer it must have a microphone, soundcard and speakers fitted. It is a good idea to first test that your microphone and soundcard are working correctly by using the sound recorder program located in Windows Accessories.

### **IPHONE (5Mb download)**

IPHONE has been used for ham radio linking since about 1996 and offers audio and video.

After downloading, the first chat room you connect to is the default 'General' room which can be deleted.

You need to join the 'ham radio' private chat room. To do this first click on the drop down menu 'Chat Room' on the 'Global On Line Directory' then click on 'New/Private' type in 'ham radio' - all lower case then click 'join'. You will then see a list of all the ham stations in the room. Click on a callsign to call the station, which could either be an individual, who is using a computer, a repeater, or a simplex link. Non-hams can also use the program enabling SWLs to talk to hams, this is fine provided there is no radio link involved.

You can link a transceiver to the Internet with the IPHONE program by using a VOX unit to operate the TX/RX function. Ready built VOX units are available from CPC <http://www.cpc.co.uk> part number HK00035 priced £16 pounds.

Vocaltec no longer sell the IPHONE program and therefore they will not allow you to register it. However it can be uninstalled and reinstalled, as many times as you wish (it only takes a couple of minutes) on 7-day free trial basis.

IPHONE also has a 'white board' facility that allows you to exchange text, photos and diagrams with the person you are talking to.

Unfortunately, if you are on a hand-

held which is connected to the Internet via iPhone, you have no way of knowing who has joined or left the room. Therefore you are not able to call stations, you must rely on hams that join the room, who are using their computer and can see the list, calling you. When hams click on your callsign and call on your link their audio triggers your VOX unit and puts your transceiver into transmit, when they stop transmitting your transceiver returns to receive and the transceivers audio is passed straight on to Internet. So when you transmit they hear your audio.

IPHONE used to support conference rooms but the facility is no longer available.

IPHONE provides little security so links need to be monitored when the program is being used.

**iLINK (300k download) <http://www.aacnet.net/>**

**Developed by Graham Barnes M0CSH in 2001.**

There are two iLINK program downloads one is for a PC user and the other is for someone providing a gateway and the iLINK interface board.

iLINK users can chat computer to computer, computer to radio, or radio to radio..

Before you can connect to iLINK you have to apply to the administrator for authorisation. To obtain this you have to provide a callsign and a password of your choice. Once your details are verified authorisation is granted but it can be removed at anytime, if there was a need to do so and you would be unable to connect to the server.

If you wish to link your computer to your radio you require an iLINK interface board which costs £25. Around 10,000 hams around the world have so far downloaded the iLINK program. There can be between 100 to 300 users on the iLINK list at any one time.

After installation when you run the program you are presented with a box. Click on BEGIN and a list of stations will appear. You can then call any station on the list or a station could call you. The station you call could be a ham sat at his or her computer using a headset, a repeater or a simplex radio link. There are also several different conference rooms and all stations in the room are able to hear each other.

When you have finished your QSO 'click' on 'END' which disconnects.

There is no SWL listen facility, you must be a licensed ham to download and use the program.

Each station is given a unique number and using DTMF on a radio you can call an individual station. However, when you are mobile and not able to see the list of stations connected on a computer screen, you do not know who is on line as stations come and go at random although some are on line 24x7. You have to use your experience to gauge which stations are likely to be on line at any particular time.

You can dial '00' that will connect randomly to any station that is on line at that time or '02' connects you to any free conference server. '#' disconnects. '0' checks the on air node status.

For those using computers there is also a text chat facility which is very useful if you are having audio problems or don't have a microphone.

The audio quality is very good and the servers are very reliable.

To transmit you press the space bar once and then press it again to listen.

There is an 'info text' file, which you can edit, when someone connects to you the information is displayed on his or her computer.

**eQSO (400k download) <http://www.eqso.net/>**

**Developed by M0ZPD in 2001.**

The eQSO program can be downloaded from the above web site and installation is straightforward.

When you join a server everyone in the room you select can all hear each other. You can change servers or change rooms on that server.

You can view the full list of all servers and rooms and who is in them.

eQSO can be installed on any computer, including a laptop, anywhere in the world, to have QSOs with fellow hams.

SWL stations are welcome to listen and should identify that they are SWLs. They must not speak unless they are in an SWL only room, which is off air and has no radio attached.

There are three levels of security in place and people can be 'kicked' 'banned' or 'muted' by controlling stations that are monitoring 24x7.

Hams over the world are using eQSO and some are in very remote areas, part of the fun is you never know who you will find on the system. Recently hams in China have started to use the program

and I have worked quite a number of them. One Chinese ham has just installed the first RF 70cm Internet gateway in China.

**Internet Radio Linking Project <http://www.irlp.net>**

**Developed by Dave Cameron VE7LTD in 1977**

<http://www.ve7ubc.ampr.org/dcameron/dchome.htm>

IRLP is primarily a worldwide Internet linked repeater network with over 400 repeaters connected together 24x7. The number grows almost daily.

It is a totally secure system running under Linux Redhat 6.2 (not later versions) and you cannot speak on the IRLP system from a computer, which is connected, to the Internet, like you can using the Windows programs. IRLP was designed just to link repeaters around the world although there are a few links that are on simplex channels.

You call a repeater by using DTMF tones and there is a directory list of all repeaters giving their individual 3-digit number. You use the number to connect and disconnect from the repeater you wish to call, adding a control digit '0' to turn a link 'on' and a '1' to turn a link 'off'.

e.g. To call VK2RBM in Sydney you would tune your radio to a local Internet linked gateway frequency and then dial 6000 to turn the link 'on' and 6001 to turn the link 'off'. You will hear a voice announcement identifying which repeater you are connected to. When you disconnect you get another voice announcement saying 'you are now disconnected' again identifying the repeater you have left.

You can use a 'touch tone' DTMF microphone costing about £50 or buy a DTMF keypad costing £2.50 inc. P&P available from UKIRLP.

You can call individual repeaters or connect to a Reflector, this is a 'conference room' which can have as many as 30 repeaters in the room. Anyone speaking on any one of the repeaters can be heard by all the other repeaters so it is vital that no CW indents or courtesy tones pass from a repeater on to the Internet as it would cause problems.

To connect your repeater to the IRLP network requires an IRLP interface board costing 60 USD plus 15 USD carriage making . To order an IRLP board please visit <http://www.irlp.net/>

UKIRLP (United Kingdom Internet Radio Linking Project) will help anyone unfamiliar with Linux to install the hardware and software.

You can view the 'live' status page of all the repeaters on the system by visiting <http://status.irlp.net>

Dialup connections can be used for IRLP and Linux will automatically reconnect if you are disconnected abruptly or if you get disconnected after every 2 hours. However, if you are using a dialup connection you are not able to connect to reflectors, so a high-speed connection is the best option.

Some repeaters connected to IRLP are connected to multiple linked systems e.g. the Winsystem in California which has 17 repeaters linked together and the New Zealand National System which has 19.

You can listen to the 'live' audio on reflector 2

<http://www.live365.com/stations/253404>

and on the Winsystem <http://www.winsystem.org>

For more information on Internet radio linking please contact the UKIRLP group or visit the web site <http://www.qsl.net/g3zhi/ukirlp.htm>

ar

## Bibliography

Radcom  
G3RKL April 2001  
G4CUI February 2002  
Ham Radio Today  
G3ZHI February 2000  
Radio Active  
G3ZHI January 2000

## Useful URLs

**G3ZHI**  
<http://www.qsl.net/g3zhi>

**UKIRLP**  
<http://www.qsl.net/g3zhi/ukirlp.htm>

**Radiocommunications Agency**  
<http://www.radio.gov.uk/topics/amateur/document/linking.htm>

**RSGB Data Communications Committee**  
<http://www.dcc.rsgb.org/>

**RSGB list of all simplex UK Internet gateways**  
<http://www.dcc.rsgb.org/ShowGates.asp?call=ALL>

**RSGB Repeater Management Committee**  
<http://www.coldai.org.uk/rmc.htm>

**RSGB Guidelines on Internet linking**  
<http://www.rsgb.org/extra/intlinks.htm>

**Yahoo egroups**  
<http://groups.yahoo.com/>

## iLINK links

<http://www.aacnet.net>

## IRLP

<http://www.irlp.net>  
VK2JTP iLINK FAQ  
<http://www.qsl.net/vk2jtp>

## eQSO

<http://www.eqso.net>  
eQSO FAQ  
<http://www.2e1ehm.freemove.co.uk/>

## Photographs

VOX unit  
I R L P board  
iLINK a board  
Diagram of a set up  
D T M F keypad  
Screen shots  
Iphone  
iLINK  
eQSO  
Winsystem map  
New Zealand National System map  
NoV Application form

## Lists

UK repeaters with repeater linking on them  
IRLP world-wide repeaters  
All UK Internet simplex gateways

# Join WIA today



## WIA is active in:

- QSL services
- Major role in amateur radio education
- Coordination of contests and awards
- Monitoring of illegal activity

“There is no denying that radio today still has all the magic that attracted people to the hobby all those years ago, when it first emerged onto an unsuspecting world.”

Ernie Hocking, President  
Amateur Radio April 2002

## How to join WIA

- Through your local amateur radio club
- Through your Division (contact details on page 56)
- Contact WIA Federal Office (03) 9528 5962

# Helping a yacht in difficulty

By Jim Linton VK3PC

Imagine you are in a QSO or just tuning around a band and hear a call for help. Would you know what to do as required under your regulatory obligations as a radio amateur?

A recent incident on the 40-metre band is an example of how amateur radio has a continuing role in providing assistance and saving lives at sea. Emergency calls are not confined to the oceans but can come from land too.

On Thursday 4 March this year Bernie Nicholson VK2ABN was chatting with Mike VK2ABT and John VK3ACA on 7070 MHz when Mike alerted him to "a very weak and distorted signal" on frequency.

Bernie asked the station to go ahead and it was Shawn (listed as Stanley S Gordon) KA7MWL on the Ukrainian registered schooner Bat'kivshchyna 'Fatherland' sailing from Wellington to Sydney with a crew of six.

She was located about 190 nautical

miles off the south coast of New South Wales with her sails blown out earlier after being lashed by the tail of a cyclone.

Slow progress was being made at about four knots. Concerns were held that fuel would run out before the vessel reached Sydney. The novice sailors on board were very seasick.

Bernie VK2ABN, located at Tuross Lakes between Batesmans Bay and Narooma, established contact with Shawn KA7MWL on 40-metres.

Shawn apparently amazed his fellow crew by the production of an Icom IC-706 transceiver from his personal belongings offering to contact land. Due to a flat battery output power was

limited to five watts. The Bat'kivshchyna's satellite communications system had stopped functioning.

After gathering the essential facts, Bernie VK2ABN then telephoned the Rescue Coordination Centre of the Australian Maritime Safety Authority in Canberra.

The Rescue Coordination Centre under the callsign VIC transmitting out of Charleville Queensland tried unsuccessfully to establish direct contact with the schooner on both the maritime frequency of 8176 kHz, and 7070 kHz.

Bernie VK2ABN set a sked with KA7MWL who closed down to conserve his battery. The next day news from the

## G&C COMMUNICATIONS

Authorised dealer for ● Kenwood ● Icom ● Barrett RFDS ● GME Electrophone ● Uniden ● YAESU

### KENWOOD TH-F7E

Amateur VHF/UHF Transceiver



Freq: TX: 144-146 / 430-440 MHz  
RX: 0.1-1300 MHz  
Mode: TX: FM RX: AM/FM/SSB/CW  
RF Power output: Hi: 5/5 W  
Lo: 0.5/0.5 W El: 50/50 mW  
Volt: Int: 5-7.5 VDC External: 12-16  
Weight: 250 gr (incl. lith.-ion batt. pack)

### ROTATORS

G450A (shown)  
G650C, G800DXA

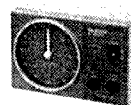

Australia wide orders welcome  
Credit card Cheque Money order

### ICOM

IC-208 Amateur VHF/UHF Transceiver

Freq: TX: 144-146 / 430-440 MHz  
RX: 118-1000 MHz  
Mode: TX: FM RX: AM/FM  
RF Power output:  
Hi: 50 / 50 W, Mid: 15 / 15 W,  
Low: 5 / 5 W  
Voltage: 13.8 VDC  
Weight: 1.2 Kg



IC-706 MkII Amateur HF/VHF Transceiver



Freq: TX: 10-160 m + WARC / 50-54 / 144-146 (148) MHz  
Europe (USA) RX: 0.03-200 MHz all-mode incl WFM  
Mode: AM/FM/SSB/CW/RTTY

RF Power output: 100/100/20 W

Most popular mono/tri-banders  
TE series EMTRON HF ANTENNAS  
Storm tested — Call

### YAESU

VX-7R 5 W Ultra-Rugged, Submersible Tri-Band Magnesium Handheld



Freq: RX: 0.5 - 999 MHz  
TX: 50, 144, 430 MHz Amateur Bds  
True Dual Receive: V-VU-UV-U/  
GEN-HAM  
Power Output: 5 Watts 222 MHz: 300 mW) 6 mAM: 1 W MANY GREAT FEATURES

**MFJ Antenna Tuners**  
MFJ 945E — MFJ949E

The auto MFJ 993



and the amazing  
MFJ 902 Travel Tuner



207 High St. Cranbourne VIC 3977  
Ph: 03 5996 3298 Fax: 03 5995 0184

Email: [gccomm@netspace.net.au](mailto:gccomm@netspace.net.au)  
[www.gccomm.com.au](http://www.gccomm.com.au)

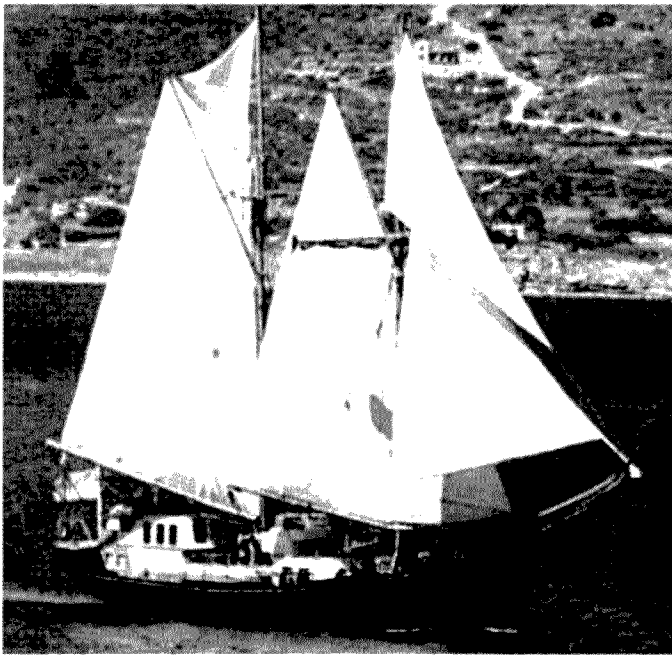

On arrival in Sydney on 6 March, Captain Birioukovych announced that the Discover Ukraine Expedition that began in 2001 had come to an end, due mainly to a lack of funds to replace both damaged main sails.

vessel was a lot more optimistic, the rough sea had abated, they had picked up speed to nine knots after restoring one sail and could now make Sydney.

The New South Wales Water Police had been alerted by the Rescue Coordination Centre and sought regular updates via the telephone from Bernie and his wife Rhonda, who likened it to the radio ham skit of the late comic genius Tony Hancock.

The Ukrainian Embassy was also on the telephone to monitor the situation. On board was the Ukrainian builder, owner and captain Dmytro Biriukovich, and crew who paid \$US200 a week on a cost sharing basis. They were a Russian, Swiss, German and two Americans.

The Bat'kivshchyna, a 34 metre schooner was on tour to raise awareness of Ukraine (previously part of the disbanded Soviet Union) as an independent European country

Bernie VK2ABN said, "Things eventually turned out OK. It showed once again that amateur radio can play a role in providing assistance during times of emergency."

The former merchant marine sailor who has been a radio amateur since 1967, also remembers a previous occasion in the 1980s when he heard a yacht calling Adelaide Radio on the 27MHz marine band.

Authorities were alerted to that vessel

in difficulty in the Great Australian Bight off Ceduna.

With the closure of the Australian Coastal Radio Service on 30 June 2002 after more than 90 years, reliance is now placed on an automatic Global Maritime Distress and Safety System (GMDSS) with frequencies being scanned by a computer looking for emergency or distress tones.

A key part of the licensing requirements for amateur radio stations is knowledge by radio amateurs about the use of the voice calls of "Pan Pan Pan" for an emergency or distress "May Day".

The recent incident off New South Wales involving amateur radio is one of those that occur from time to time around the world. Are you prepared?

ar

### 24 hours emergency contacts

#### Search and Rescue

Maritime 1800 641 792

Aviation 1800 815 257

Fax 1800 622 153

In case of emergency dial 000  
for Police, Fire & Ambulance



Australian Government  
Australian Maritime Safety Authority

## Australian Made ANTENNAS

### "Setting a New Standard" COM-AN-TENA

(Formerly a j and j coman)

6 Muir Court  
CHELSEA HEIGHTS 3196

All new 5/8 vertical 16 radials	\$160
Dual drive 26-30 5 ele yagi beam	\$315
4 ele 10-11m yagi beam	\$278
5 ele high gain antennas 11m	\$327
3 ele delta loop 10-11m	\$326
11m 5/8 vert./4-1/4 wave radials	\$175
Duoband 10-15 3 ele each band	\$385
Tri-band 5 ele HB35C s/steel fix	\$730
3 ele 20m computer opt	\$420
3 ele 15m computer opt	\$295
M B Vert Auto switch 10-80m	\$330
40m linear loaded 2 ele beam	\$595
6m 5 ele compt opt beam	\$268
6m 7 ele compt opt beam boom — 60mm	\$387
10 ele high performance 2m	\$145
17 ele high performance 70cm	\$125
2m vert 2-5/8 co-linear 4 rad	\$120
Log-periodic 9 ele 13-30 MHz 7.7m boom	\$990

### Guyed Masts

21 metres                      13 metres  
Winch-up & tilt-over. Aluminium and stainless steel  
three-sided construction. Auto-brake winches.

### Free Standing Masts

9.5 metres  
New Baluns  
1-1 to 16-1 to 3kW

#### Our Masts

meet

Australian Standards.  
We supply all the  
computations and data  
you will need for  
a permit.

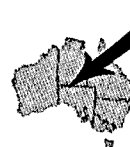

**03 9773 3271**  
**Mob: 0419 542 437**  
Andy VK3IV

# An active receiving loop antenna for 1.8 MHz

Drew Diamond VK3XU  
45 Gatters Road,  
Wonga Park, VIC 3115

**It is an unfortunate fact of radio life that towns and suburbs are increasingly polluted by spurious signals and noise from a host of domestic appliances. Our lowest band, 1.8 MHz, is perhaps the most affected by man-made electrical noise, so bad in some areas as to prevent satisfactory operation on "Top-Band".**

One popular and generally effective ploy is to use a loop antenna for receiving. A well-made loop has a relatively deep null running through the axis which, upon careful rotation usually allows the most troublesome noise sources to be placed "in the null", thus leaving the wanted signal substantially unaffected. The curious are pointed to Refs. 1 and 6 for lucid explanations of why this is so.

There are several types of loop; shielded coaxial (square, diamond, triangular and circular), pancake, frame and "loop-stick". Loop-stick antennas,

popular in portable broadcast receivers, abstract energy from the magnetic component (H field) of the wave (Refs 1 and 3), and are therefore mainly sensitive to ground-wave signals whose electric field is vertical (H field horizontal). Unfortunately, the indifferent material used in loop-sticks currently available does not provide a coil of sufficient Q and directivity for our purpose.

In long-distance work, the wave-front, particularly after ionospheric reflection, may be vertically or horizontally polarized, or it may vary between these two. In order to receive sufficient signal energy, a single-turn shielded coaxial loop made from (say) RG-8 cable must be reasonably large, one or two metres diameter, and a pre-amplifier is still usually required. If the antenna is to be used indoors, such a device is perhaps a little on the large side to be practicable.

Which brings us to the frame loop. According to the formulas cited in Refs 1, 2, 4 and 6, received signal energy is proportional to loop area and number of turns. We may therefore use a smaller, more practicable loop (for indoors) if more turns are added. It was found by experiment that 5 turns of #16 B&S copper wire wound upon a timber frame of just 400 x 400 mm yields a high Q inductance of 50 micro-Henries, which may be resonated, or "tuned", with a standard single-gang broadcast capacitor.

The prototype has given outstanding performance when used indoors, even inside my shack, which has a metal roof. DX signals, mainly from North America, have

been received under ordinary conditions, which (by switching rapidly between) compare well with those from my main 3/8 wave 160 m inverted-L antenna. Day-time reception of local amateur stations on the loop is as good as, and usually better than the inverted-L. The loop is also sensitive on 3.5 MHz, but with less "directivity".

## Circuit

A loop antenna has the classic "figure 8" directional pattern. Perhaps counter-intuitively, maximum response is obtained when the plane of the loop is parallel to that of the direction of wave travel (side-on), whereupon the wave front reaches the two halves of the loop at slightly different times, causing a phase difference between the voltages induced in each half, resulting in a net voltage that acts around the loop.

When the plane of the loop is at right angles to the wave direction, the voltages induced in the two halves of the loop are of equal amplitude and the same phase. Thus being directed around the loop in opposing directions, they cancel each other almost exactly (Refs 2 and 6).

A possibly simpler explanation is that: for a vertically polarized wave whose lines of magnetic flux are horizontal, maximum coupling occurs when the magnetic component of the wave passes through the opening of the loop, thus inducing maximum voltage in the loop.

Because our loop is physically small in terms of wavelength (and therefore obtains less energy from the passing wave), a pre-amplifier of moderate gain is usually necessary to bring the signal, as received on the loop, up to a level that is near equivalent to that obtained from a "full-size" antenna.

In order that the pre-amplifier shall handle strong in-band signals (which

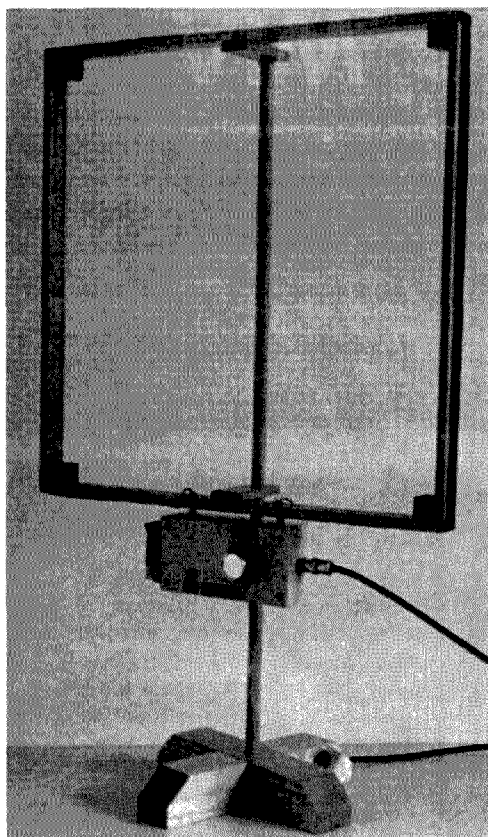

Photo 1 The finished Loop Aerial.



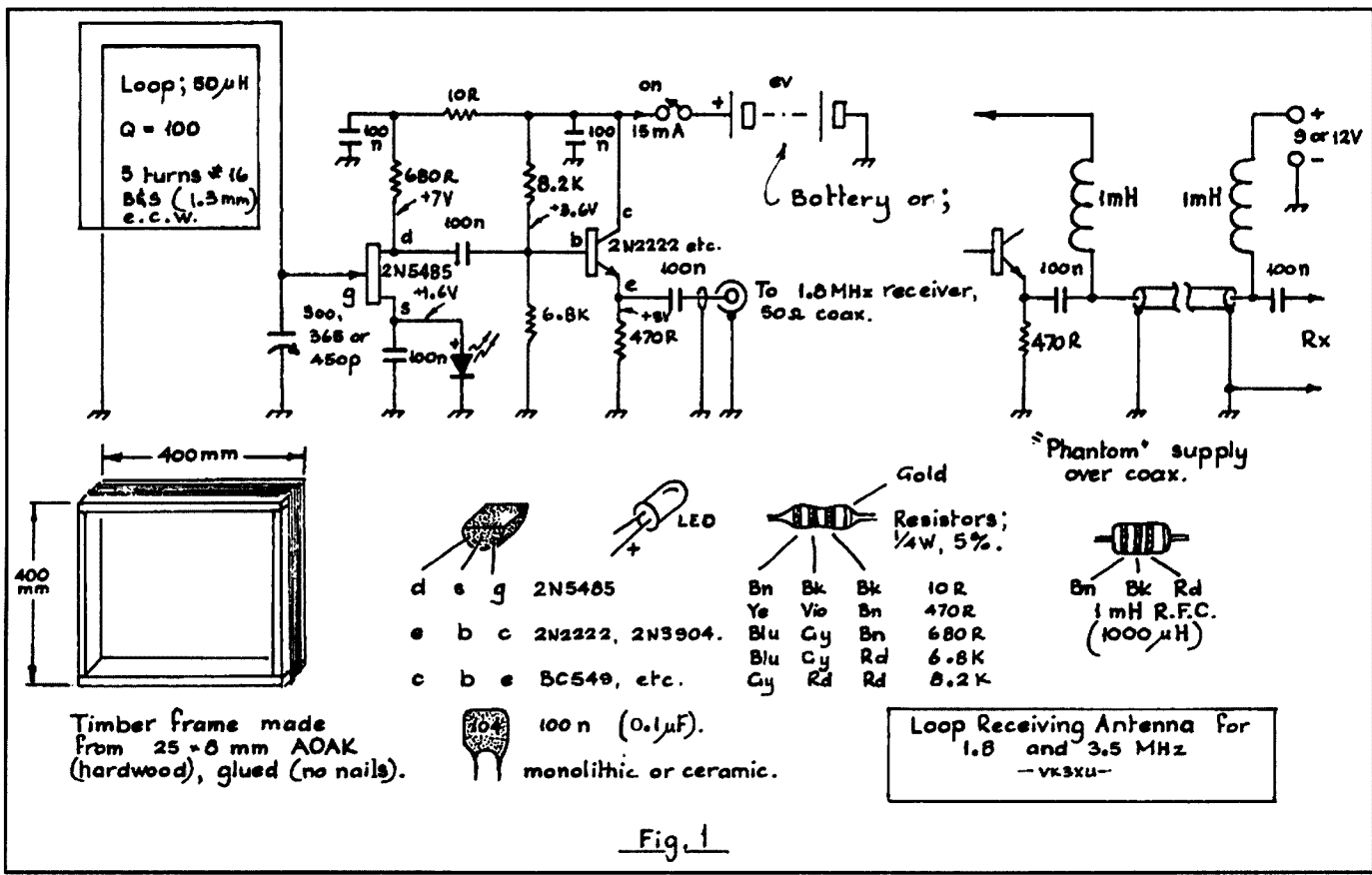

Figure 1 The Loop Aerial circuit

may be adjacent to a wanted signal for instance), a reasonably high amplifier dynamic range is desired. For an RF amplifier, high dynamic range and low noise are generally mutually exclusive, and so some sort of compromise is generally necessary. Additional noise contributed by the amplifier should not be so great as to mask weak signals, yet, by using moderate levels of bias current for the two stages, will remain substantially unaffected by strong in-band signals.

See Fig 1. The 50 µH loop inductance is tuned to 1.8 MHz (or 3.5 MHz) with a variable capacitor. Signal voltage thus obtained is presented to the high impedance gate of a 2N5485 FET, which provides some gain, but more importantly acts as a high to moderate impedance converter. An LED in the source lead establishes the gate bias at about 1.6 V.

The FET is followed by an ordinary NPN transistor, nominally a 2N2222 biased for class A operation in a conventional emitter follower configuration. The resulting overall voltage gain of the pre-amplifier is slightly greater than one. However, in

affecting a high to low impedance conversion, a useful power gain is obtained.

### Construction

The amplifier is made using "paddyboard" style construction (Ref 8). A suggested layout is pictured in Fig 2 and Photo 2. But any preferred wiring method, such as 'ugly' or 'dead-bug' may be used provided component leads are reasonably short. The amplifier circuit board and variable capacitor are housed in a "jiffy" box measuring 130 x 67 x 44 mm.

Any single gang variable capacitor of 300, 365 or 450 pF may serve as loop tuner. That shown in Photo 2 is a ubiquitous MSP 95 + 210 pF part. It is mounted upon a rectangle of circuit board material, which is a slide fit inside the little guide rails of the jiffy box.

The drawing in Fig 2 illustrates a suggested form for the frame, which is made from "square edge Tasoak, 25 x 8 mm" available in 1.8 m lengths from Bunnings. In addition to wood glue, 8 nails were used initially to fix the frame together. To satisfy a curiosity as to any effect that the nails may have on the coil's Q, their heads were left "proud" to ease their removal. Result; Q with

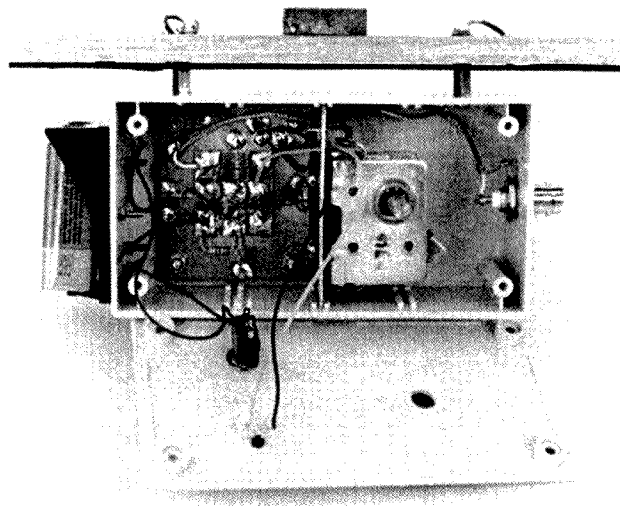

Photo 2 Inside the box.

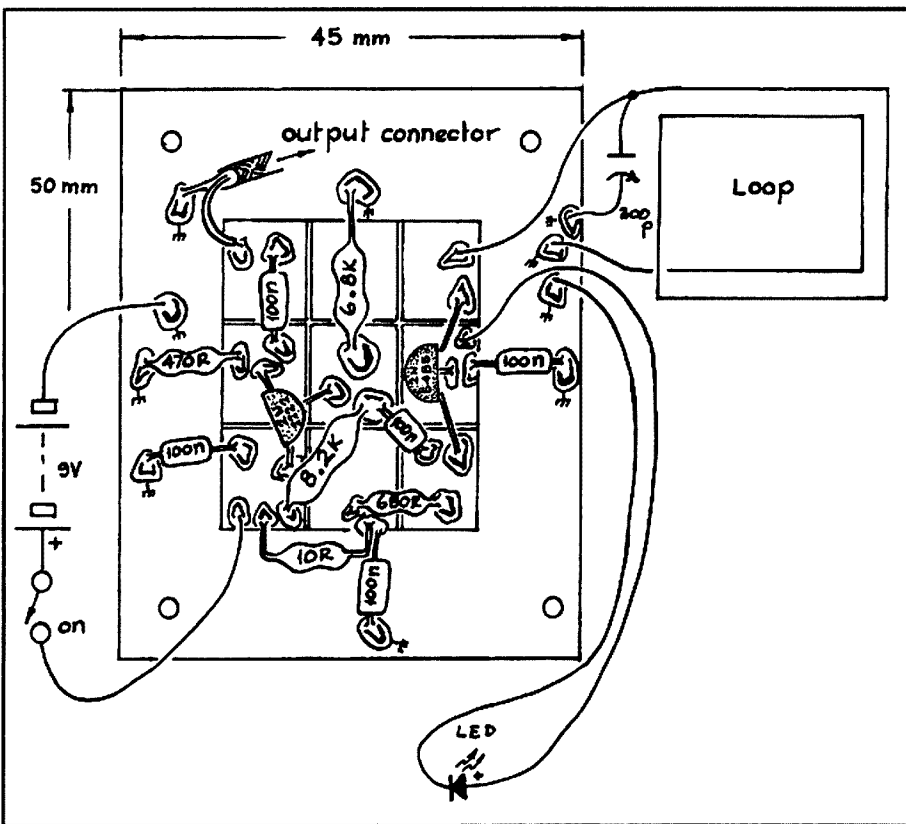

Figure 2 The circuit board.

nails in; 77, nails removed; 100. All-glue fixing is therefore recommended.

Using a triangular file, form 5 evenly spaced notches on each corner of the frame. Two 3 mm threaded hex spacers are ideal for mounting the jiffy box upon the underside of the frame. These also serve as solder-tag points for the loop connections (Photo 2). Wind 5 turns on #16 B&S (1.3 mm) enamelled copper wire onto the frame, ensuring that each turn beds down nicely into the notches (Photo 3).

For easy rotation of the frame, a wood rod may be installed into two wood lugs (Photo 1), which in turn may be fitted into a wood base, or allowed to hang

from a convenient sky-hook.

Supply current drawn is about 15 mA, which is a rather heavy drain on an ordinary 9 V "transistor" battery. Depending upon your operating set-up, consider making a "phantom" battery supply circuit along the lines of that shown in Fig. 1, where a regulated 9 or 12 V dc supply would be ideal. The red LED in the source lead of the FET may be mounted in the front panel to serve as "on" indicator.

## Operation

Check your wiring accuracy. Pay particular attention to FET and transistor connections. Connect the loop pre-amp

output to the receiver's input using any reasonable length of 50 ohm coax. Apply battery supply – the LED should glow.

Carefully adjust the tuning cap for a sharp peak in band noise. Tune your receiver to a troublesome spurious signal (e.g. 1843.750 kHz; 118th harmonic from a local TV line oscillator). You should be able to rotate the loop and place the interfering signal into a pronounced null.

## Parts

The electronic components are collectively available from our familiar suppliers, including Altronics, Electronic World and Jaycar. Do not substitute other FET types for the specified 2N5485. The 2N2222 is un-critical. I have a number of the MSP variable capacitors. Please drop me a line (at the address shown above) should you have trouble in locating something for the job.

## References and further reading

1. "The Loop Aerial Revived"; R. Schelel, *Wireless World*, July '79, pp 48 - 52.
2. *Radio Engineering*; F. Terman, 2nd ed., pp 722 - 725.
3. *Foundations of Wireless and Electronics*; M. Scroggie, 9th ed., pp 290, 291.
4. *Radio 2*; Australian Post Office; 1951, Paper 5, pp 13, 14.
5. "Active Magnetic Antennas"; J. Becker, DJ8IL, *Elektor Electronics*, 9/98, pp 22 - 27.
6. "Small Loop Receiving Antennas"; J. Carr, *Electronics World*, Nov. 00, pp 846 - 851.
7. "A Shielded Loop for 160 Metres"; I. Berwick, VK3ALZ, *Radio ZS*, Feb. '97, pp 6, 7.
8. "Paddyboard" Circuit Construction"; Diamond, AR, Feb. '95.

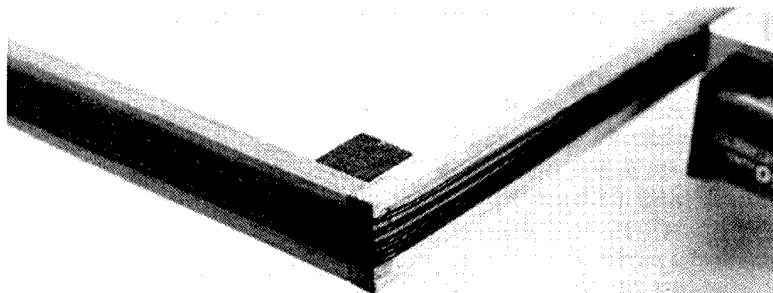

Photo 3 Corner detail



The WIA – in tune with  
amateur radio

ar

# Raft radio

Mike Patterson VK4MIK

**With the passing of Thor Heyerdahl many of us were reminded of the adventures of the 6 men on the balsa raft in 1947 or, perhaps, the RA on Rail expeditions in 1969 and 1970. There was a connection to Amateur Radio that played a vital role, some may say life saving, in the three expeditions.**

Prior to World War 2 Thor and his wife travelled to Fatuhiva Island where he studied the Polynesian race, saw rock carvings and heard the stories of the Tiki god. This led him to form his theory of the crossing of the Pacific Ocean by people from South America. During WWII he was in the free Norwegian Air Force and later an officer in a special parachute squad working in the Arctic region of Norway.

On the 28 April 1947 the balsa raft Kon-Tiki, 45 feet in length, sailed from Callao with 6 men aboard with the intention of sailing to Polynesia. To provide for communications two experienced radio operators were included, Knut Haugland and Torstein Raaby. They used a sabotage radio transmitter and NC173 receiver. Output power was 6 watt and mode was CW - call sign L1ZB.

Knut Haugland and Torstein had great difficulties with the transmitter at the beginning. After a few hours the crystal broke. A new crystal was put in and the same thing happened until the reserve crystals were all broken. This was a dramatic event. Then they discovered that the crystals broke because of the heat in the box. The lid was too tight giving no cooling for the crystals. To solve this problem, they took a crystal from a military radio set which they

carried to communicate with aircraft, and so lost this ability. The most important thing though was to keep the lid open during operation. This worked perfectly and the crystal at 13,990 MHz (see circuit diagram) worked consistently.

Regular contact was maintained with two radio amateurs in Los Angeles - Harold Kempel and Frank Cuevas who took it in turns to listen for signals from Kon-Tiki each night. Information was also passed to the US Weather Bureau.

The Kon-Tiki completed its voyage by grounding Raroia Reef in the Archipel des Tuamotu after 101 days on passage. Knut Haugland is the only crew member still alive and he still takes an interest in the Kon-Tiki Museum in Oslo.

Thor's next major expedition was the RAI and RAII in boats made of reeds from North Africa to the Carribean. This was a further test of Thor's migration theory.

Their radio was a Heath HW-32 and Richard W Ehrhorn W4ETO, general manager at Signal One in St Petersburg FL, carried out its modification to survive the salt air. The panel meter was replaced with a militarized, water and vibration proof unit and the circuit board was water- and fungus-proofed. The VFO was replaced with crystal oscillator and 3 switch selectable frequencies.

Cooling fans were installed on both the RF chassis and power supply and everything was mounted in a waterproof fibreglass transit case. A simple 20m coax-fed dipole was supplied, which ultimately was installed as a quarter-wave vertical hanging from RA's mast with the other half horizontal, along the deck as a sort of counter poise. Power was supplied by a small petrol generator.

After RAII failure in 1969 the transceiver was reconditioned but was found to be in good condition. Richard W4ETO handled day to day traffic from RAI and RAII. Chris Bockle LA5KG handled traffic from Thor's Norwegian contacts. The degree of appreciation by Thor Heyerdahl for Richard is shown by Thor's inscription inside Richard's copy of the RA book that reads, "To Dick Ehrhorn, RA's ghost voice."

The call sign LIZB was used by Kon-Tiki, RAI and RAII.

## References

- Hanne Rallag - Secretary KON TIKI Museum Oslo
- Transmitter diagram from Knut Haugland
- Correspondence from Richard W. Ehrhorn
- The KON TIKI Expedition - Thor Heyerdahl Penguin 1964
- The RA Expeditions - Thor Heyerdahl 1970

ar

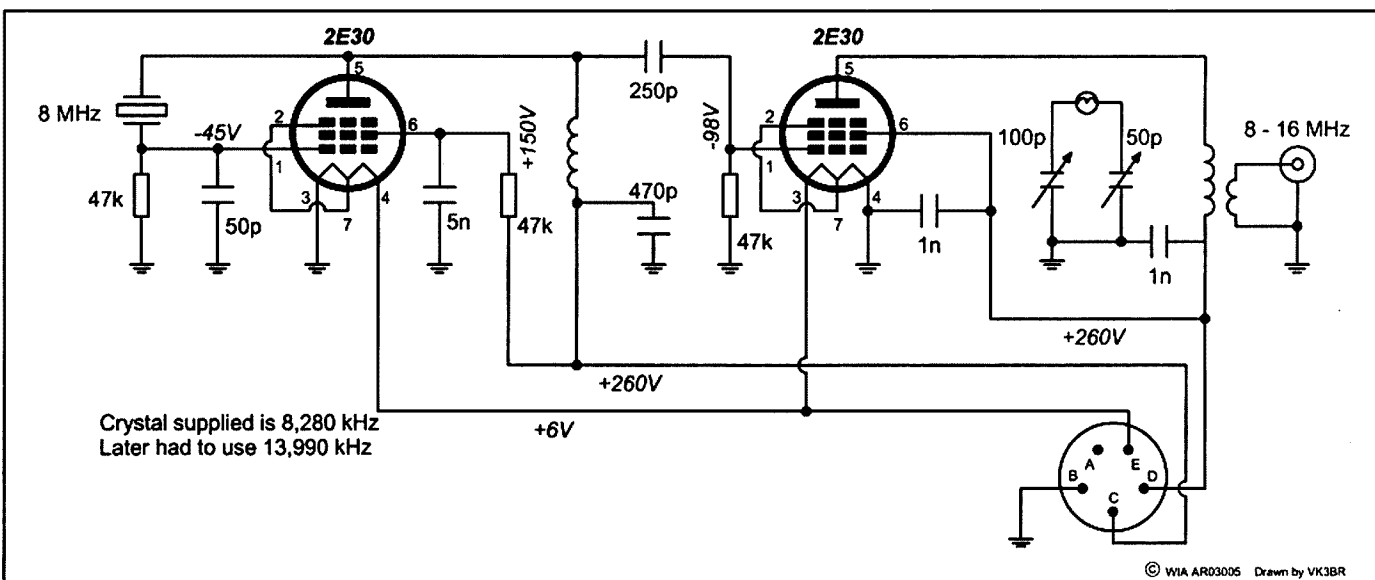

# Elementary RF Vector Network Analysis using a HP8410B

Richard Sawday VK5ZLR

Since HP released their 8410A in 1968, many amateurs have heard of RF Network analysers, few have the opportunity to roll up their sleeves and get in amongst them.

Simply, a Network Analyser compares a known RF signal with an unknown RF signal, so you can for example.

- compare input and output of a transistor,
- compare the forward and reflected power of an antenna,

- compare the loss and phase shift in a coaxial cable with a standard.

The applications to which a network analyser can be applied are limited only by the operator's imagination, from NASA, plotting the radiation pattern of a spacecraft antenna to an amateur, testing a dummy load.

There are two types of RF network analyser, the Vector Network Analyser (VNA), which provides the ability to compare the Phase and Magnitude of two RF signals, and the Scalar Network analyser which allows the comparison of the Magnitude of two RF signals.

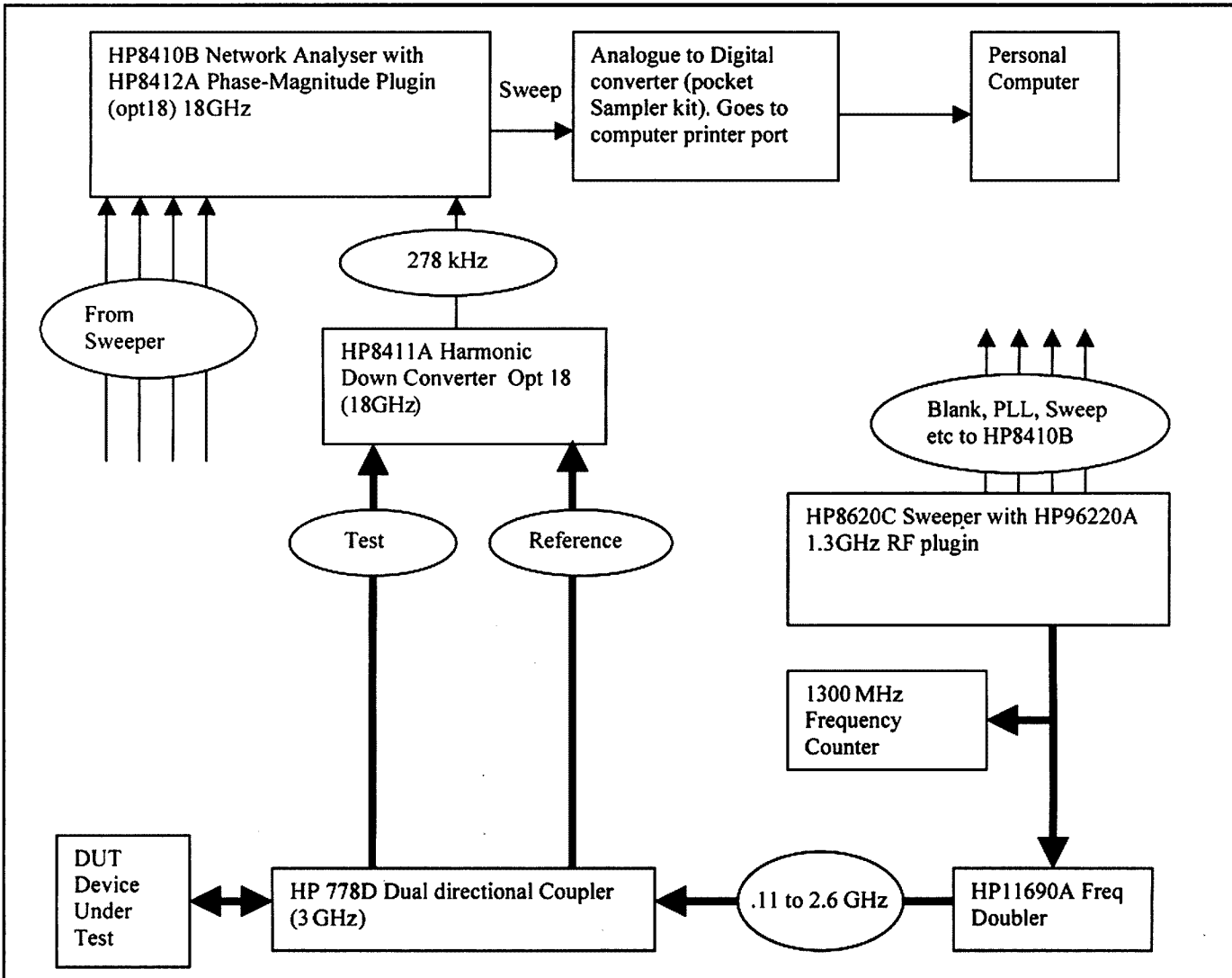

Basic HP8410 Vector Network Analyser Configuration  
Thick arrows indicate RF signal path at test frequency.

Further, more modern VNA's (eg HP8753) are microprocessor controlled with inbuilt signal source, along the lines of plug & play. These are a little expensive for amateurs.

- An Oscilloscope has Time on the X axis and Magnitude on the Y axis.
- A Spectrun Analyser has Frequency on the X axis and Magnitude on the Y axis
- A VNA has frequency on the X axis and Magnitude and/or Phase on the Y axis, also a VNA can display the output as a Smith chart, but we won't go there today.

The diagram below shows a test setup to measure, display, and log to a computer, for future reference and printing, the return loss of a 50 ohm coaxial device between 0.11 and 2.6 GHz. The device could be an antenna, antenna and cable assembly, or as in this example a dummy load.

The key to the test setup is the Sweeper. It is required to provide the swept frequency display on the X axis. The HP8620C has no direct frequency readout so a counter is optionally connected with a tee piece. The signal then goes to the optional doubler, this just extends the range of the sweeper,

it's quite lossy but as we are *comparing* levels the exact signal level is not important.

The signal then goes to the directional coupler, where the device under test is connected, the input reference (-20db) and the reflected power (-20db) are both then fed into the harmonic converter. These signals are then *compared* by the 8410B and the results displayed on the screen in the form of a plot, which is strikingly similar to a VSWR plot.

It is in fact a plot of *return loss* from this VSW can be derived by

$$VSWR = (10^{(RL/20)} + 1) / (10^{(RL/20)} - 1)$$

where RL = Return Loss

Conveniently the 8412A Phase/Magnitude display has analogue outputs for both phase and magnitude. If we take the magnitude output and put it into a digital-to-analogue converter (eg Oatleys Pocket Sampler Kit) then into a PC we can log the return loss plot. Then feed this data into Excel, do the manipulations, apply the formula above and hey-presto we have the VSWR plot of the device under test.

For further details email me [rsawday@bigpond.com.au](mailto:rsawday@bigpond.com.au)

Checkout the website [www.rfsup.com](http://www.rfsup.com).

ar

The *revolutionary* VK4VKD

## One Man Tower Freestanding Self-erecting 10m to 25m



Fully adjustable delta loop rotatable antenna  
1-2-3-4 element

D.I.Y. delta loop element to boom 'hubs'

350kg SWL 5:1 braking winches

Galvanised steel boom to mast clamps

VHF and UHF beams

High tensile 'U' bolts

Safety harnesses for above ground work

Arrays easily taken to ground level for  
maintenance and wind protection

Easily erected without cranes

(Ideal for confined areas or remote repeater sites)

proudly built in Australia by

**Australian  
Enterprise  
Industrial**

(PQ Box 1013 Browns Plains QLD 4118)  
<http://homepages.ihug.com.au/~aeltower>

[aeltower@ihug.com.au](mailto:aeltower@ihug.com.au)

Mob. 0414 254 080

Fax 07 3800 8003

**VSWR Plot Ericsson 50 ohm, 50 watt termination**

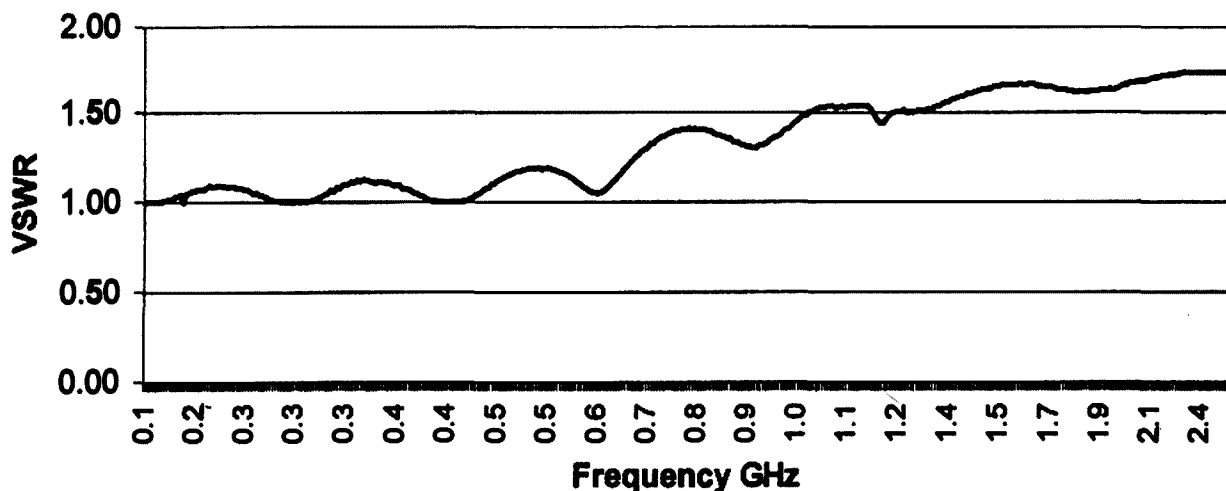

**WIA - putting YOUR interests**

**1st**

## Club News

# Port Macquarie Field Days

On 12, and 13th June, Queens Birthday long weekend the Port Macquarie Field Days are on once again.

Members of the amateur radio fraternity are invited to attend the venue being at the Sea Scout Hall in Bulla Street, on the western side of Kooloonbung Creek next door to the Country Comfort Motor Inn.

Early arrivals may wish to drop in to register and have a social chit chat or a snack comprising of a sausage or steak sandwich and a can of soft drink, tea or coffee.

There will be two practice Fox Hunts in the afternoon and a 2 m talk on Fox Hunts after the evening snack.

Sunday there will be a display by leading suppliers of amateur radio equipment and tables of used amateur radio equipment and other items for sale

Trade Displays, Fox Hunts, Raffles,

Disposals, Door Prizes, Prizes for the Best Amateur Radio Vehicle, Barbecue Lunch on the Sunday and Free Tea and Coffee with Fruit Salad and Ice-Cream included in the Registration Fee and Soft Drinks will be on Sale

Registration fee is \$10 for men \$7 for ladies and \$5 for school age children.

Contact details for any queries  
Bill Brooke V<sub>k2</sub> ZCW  
phone 02 6581 0547.  
or email Karen V<sub>k2</sub>HKW at  
vk2uw\_vk2hkw@iprimus.com.au  
or mobile phone 0413114953

So come and enjoy the beautiful sights of Port Macquarie and mix with the local amateurs of the Oxley Region Amateur Radio Club.

## Intruder Watch

Henry V<sub>k8</sub>HA

Box 619 Humpty Doo, N.T.0836

No reports received of interference from CODAR

Thanks to V.O.A. for fixing their 'straying' Transmitter on 14.075. Much nicer without them there. The RTTY Contest went off in great style without QRM.

The 366 Indonesian Intruders are still interfering on the 14MHz band as well as some 250 intruders from Northern Region 3.

Timor is still very active on 10.1 MHz and looks like we will have them there for some time unless a BIG JAMMER can be found.

The 7 MHz digitals in PY are a continuous nuisance.

Thanks to all observers who keep our Intruderwatch alive.

PS Still big problems with OCTA4-IINET—Telstra??

# Cable and Connectors

- RG58C/U Belden 8259 @ \$0.90 per metre
- RG213/U Belden 8267 @ \$4.45 per metre
- RG8/U Belden 9913 Low Loss @ \$5.15 per metre
- RG8/U Belden 9913F7 High Flex Low Loss @ \$5.55 per metre
- RG8/U - RF400 Belden 7810 Low Loss Sweep Tested to 6000MHz @ \$6.30 per metre

- RG58: B80-006 UHF connector (M) @ \$7.65 each
- RG8/213: B80-001 UHF connector (M) @ \$8.80 each
- RG213: B30-001 N connector (M) @ \$9.10 each
- RG8: B30-041 N connector(M) @ \$14.00 each

# connektron Pty Ltd

ABN 19 413 484 007

email sales@connektron.com.au or Phone (03) 9761-5220  
connektron Pty Ltd, 45 - 49 Merrindale Drive, Croydon South, Victoria 3036

[www.connektron.com.au](http://www.connektron.com.au)

\* All prices include GST

\* Minimum order value \$50 payable by Visa, Mastercard, Bankcard or Money Order

\* Packing and Delivery \$15 within Australia (Outside Australia P.O.A.)

# New Honorary Life Member of the WIA

By Jim Linton VK3PC

A radio amateur who has actively contributed to the WIA and amateur radio generally over three decades, John Martin VK3KWA, has been made Life Member of the Wireless Institute of Australia.

His first active involvement with WIA was when he became a member of the VHF Advisory Committee (VHFAC) in about 1974, which stemmed from his interest in the higher bands since 1968.

Soon after joining the VHFAC he also became a member of the WIA Federal Repeater Committee, mainly to facilitate contact between it and the VHFAC. It enabled him to build up knowledge and an historical perspective that continues to prove valuable to the WIA today.

Coinciding with the merging of the VHFAC into the WIA Federal Technical Advisory Committee (FTAC) in around 1981 he became inactive. Upon early retirement he resumed his involvement and ultimately after a few years inherited the position of FTAC Chairman from Rob Milliken VK1KRM in 1990.

Concurrently he has managed the WIA VHF/UHF Spring and Summer Field Days and the Ross Hull Memorial Trophy, plus adjudicating VHF/UHF/Microwave distance records and maintaining them.

He produced these records dating back to 1947 by searching through Amateur Radio magazine and other references to document the history of this activity.

Disputes over distance record claims or complaints about the running of the field days and the Ross Hull are unknown, due to the excellent stewardship he provides.

John's knowledge has been vital in other WIA activities including since 1990/91 WIA/ACA Liaison, writing of

assisting with submissions to the ACA, revision of the Amateur Licence Condition Determinations (LCDs), and other regulatory matters.

John Martin has been involved in the WIA responses to the major issues including planned restoration of the entire 6 m band to the Amateur Service, removal of the 50 cm band, Low Potential Interference Devices (LIPDs), Amateur Internet Linking Systems, Electromagnetic Radiation (EMR) requirements, and the changing amateur access to the 70 cm sub-band 420-430 MHz.

He has been the typical quiet achiever, always working in the background in a highly effective manner.

Attention to detail is a crucial part of his role. Maintenance of the repeater and beacon database on an annual basis has enabled them to be published in the Australian Radio Amateur Callbook, and available to all WIA websites.

A major achievement is gaining the respect of the Technical Advisory Committees in each state, working through issues with them and achieving a consensus. This includes the revision and publishing of 17 band plans.

The annual FTAC Report to the WIA Federal Council is also always informative. He has earned the respect of the amateur fraternity over the past 30 years, and is a most worthy recipient of WIA Honorary Life Membership.

## TET Emtron

### TE-33 3 ELEMENT 3-BAND BEAM

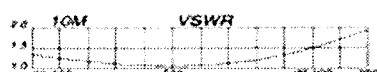
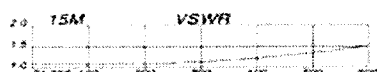
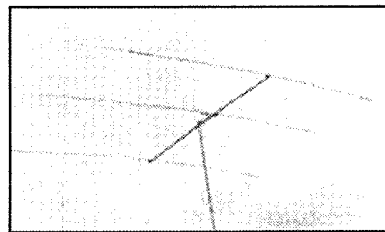

The TE-33 - the most popular tribander, has proven itself in the most severe storm conditions on the Pacific Islands. Its excellent performance and features on all 3 bands such as wide bandwidth, high gain, low SWR and high F/B ratio gives you all the features.

The antenna is manufactured from marine grade stainless steel hardware, 6063T83 aluminium tubing as well as specially machined heavy duty aluminium brackets.

#### Dealers

Vic  
LT Harris 78 Elgin Street Carlton Vic 3053  
Ph 03 93476264 Fax 03 93473629  
Email: ltharris@netscape.net.au  
G&C Comms 207 High Street Cranbourne Vic 3977  
Ph 03 5996 3298 Fax 03 5995 0184  
Email: gcomm@netscape.net.au  
NSW  
Emtronics 1/94 Wentworth Avenue Darlinghurst 2010  
Ph 02 9211 0988 Fax 02 9281 1508  
Email: Emtron@ozemail.com.au  
Andrews Comms Shop 8, 41-51 Bathurst St Greystanes, NSW,  
2145 Ph 02 9636 9060 Fax 02 9668 4301  
www.andrewscom.com.au  
WA  
Tower Communications 14 Mary Street  
Hazelmere 6055 Ph (08) 92741118 Fax (08) 92503734  
Email: tower@eon.net.au  
QLD  
Kyle Communications 668 Lutwyche Rd Lutwyche  
4030 Ph (07) 38574400 Fax (07) 38577825  
Email: mark@kyle.com.au  
SA  
International Communications - 8 Nile Street  
Port Adelaide 5015 Ph (08) 84473688 Fax (08) 83411453  
Email: intercom@picknowl.com.au  
New Zealand  
The Com Centre 400 Hillsborough Road  
Avondale Auckland Ph (64) 9 6270084 Fax (64) 9 6271613  
Email: comcent@radioinfo.co.nz

### RAWMAR ENTERPRISES

40 Blackburn Street

STRATFORD Victoria 3862 Australia

Ph: 61 3 5145 6179

Fax: 61 3 5145 6821

Email: rawmar@hotmail.net.au

www.tet-emtron.com

<http://www.wia.org.au>

Check out the website today

# The EH antenna

Lloyd Butler VK5BR

**Out of Balance Current or Longitudinal Mode Current in the Coaxial Cable causes radiation from the coax. But how large a proportion of the total power is radiated or lost from this Current?**

A lot has been said about radiation from the coax feeding the EH antenna. This occurs because a longitudinal or common mode current flows when the antenna is directly connected to the cable. There are those who have claimed that radiation from the coax is the primary means by which the EH antenna works. So let's take some measurements and really find out what proportion of the total power might come from the coax.

In this article, I describe how measurements were taken to determine the longitudinal mode current for a given transmitted power at certain points in the coax cable and the resistance component at those points. This enabled me to derive the proportion of power radiated or lost because of this current.

## What causes the out-of-balance current in the coax and why does it radiate?

The out-of-balance or longitudinal mode current will occur for any dipole arrangement fed by a coaxial cable without some means of isolating the antenna circuit from the unbalanced transmission feeder.

The result is current (the out of balance result) which can produce a magnetic field along a conductor which runs from the transmitter output to the extremities of the dipole antenna and acts as an antenna itself against ground.

To simulate this as an antenna itself, we have to model a conductor against ground which follows the route of the coaxial cable and ends at the extremities of the antenna.

Figure 1 has been prepared to illustrate how the out of balance currents occur when feeding a balanced antenna from an unbalanced source. The diagram shows a balanced dipole fed via 50 ohm coax cable. Matching elements are not shown and the load presented to the termination of the cable is a resistance of 50 ohm. The cable length, for the purposes of the discussion, is small compared to a wavelength to avoid complicating with varying current distribution due to standing waves. So current along the length of the line is assumed to be constant over the cable length.

At this point, I will also assume no radiation from the cable although the end point is resulting radiation.

I will feed 50 watt down the cable and because the load is 50 ohm, the current

is 1 amp. This is shown travelling in the outer conductor in the diagram.

I have assumed a reactance of 500 ohm from each half of the dipole elements to ground for the purposes of the demonstration.

Points B and C are at virtual ground potential and we can assume little current flows via the lower half dipole capacitance to earth. However the upper half dipole capacitance is across A and C and, in effect, is across the 50 ohm dipole load. Since its reactance is 500 ohm, a current will flow of around  $-j0.1$  amp and this is returned to the transmitter source via earth conduction.

The vector sum of the currents in the three conductors (inner coax, outer coax and earth) must be zero, and hence there is a difference current between the inner and outer conductors of the coax of  $j0.1$  amp.

Since there is a difference current, there is a magnetic field and the coax can radiate. Of course if there is radiation, there is radiation resistance and the difference current must become more complex than the simple reactive current I have used for the explanation. However I hope the diagram has filled the purpose to explain how radiation from the coax can occur.

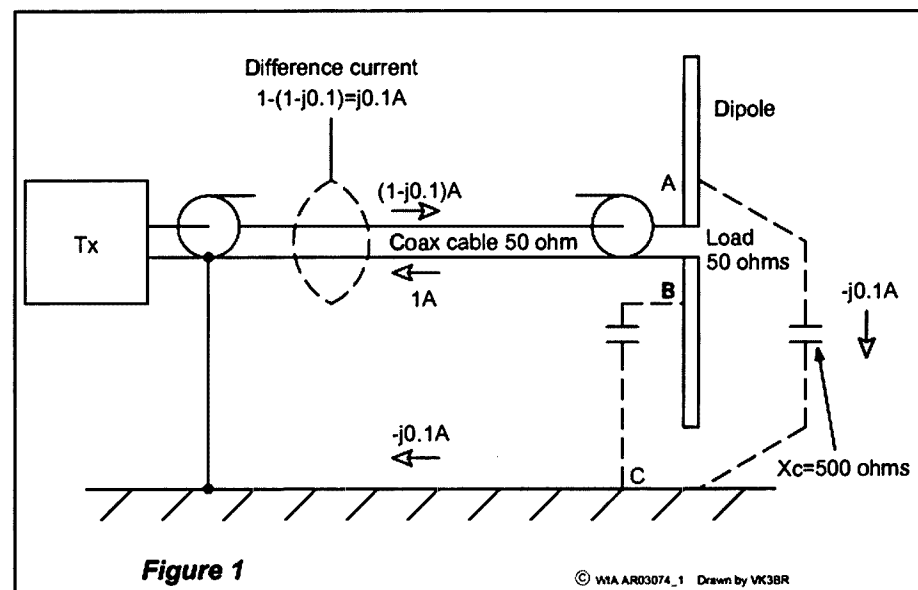

Figure 1 - Out of balance currents in coaxial cable.

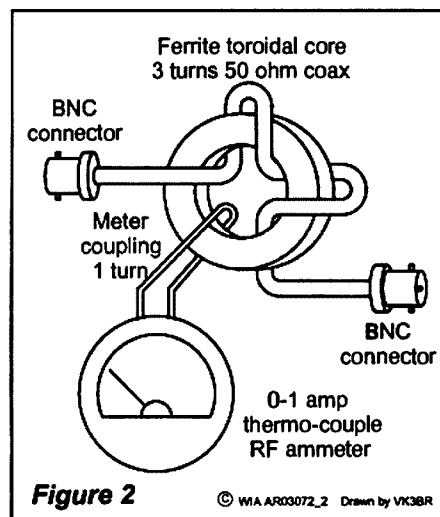

Figure 2 - Longitudinal current measuring device.



## Particular case of the EH antenna

In the previous example we depicted a current between a dipole element and ground of 0.1 amp. To do this we needed 500 ohm reactance and for 20 metre, this implies a capacitance to ground of around 20 pF. With such small sized elements, the EH antenna is not likely to exhibit such a high value. However, the effect is multiplied because of voltage gain in the resonant circuits of the EH matching system.

Take the case of the L+L matched antenna which I described in reference 1. The loaded Q of the matching system is around 7 and hence the voltage across each cylinder to reference ground is seven times that at the unbalanced 50 ohm input of the matching circuit. To achieve a current with this voltage, we only need a capacitive reactance of  $500 \times 7 = 3500$  ohm. This now implies a capacitance of less than 3 pf between the 20 metre EH antenna element and ground to produce 0.1 amp.

The matching circuits of the L+T and Star EH antennas are different (refer Appendix), but voltage multiplication, as referred to earth, between the top dipole element and the 50 ohm input can also be shown.

Of course we can stop the current out-of-balance with the right interface. The purpose of the balun choke or tuned trap in the coax line is to force equalisation of the two currents in the inner and outer conductors so that there is no magnetic field and radiation from the coax line is reduced or eliminated.

But how much power is radiated or lost from the coax when you don't use the interface? First the very short cable.

## Short coax cable lengths

For a coax feeder line within the length of 0.15 wavelength, its radiation resistance as a radiator is unlikely to be greater than 10 ohm. In fact not raised fully above the ground it will probably be much less.

Let's look at the possibility of such a feedline radiating. Take the case of 1 amp being fed up the cable differentially into its 50 ohm EH antenna load. Power =  $I^2 \times R = 1^2 \times 50 = 50$  watt.

Radiation from the coax can only occur from the magnetic field created

from the difference current of that of the inner and outer conductors. In making measurements of these currents, the worst case scenario I have seen is when the difference current is around half the current fed to the 50 ohm load. So for the case above, our difference current is 0.5 amp and fed into the radiation resistance of 10 ohm discussed above gives a power of  $0.5^2 \times 10 = 2.5$  watt. This represents a mere 5% of the radiated power of 50 watt.

So you can see that if your feeder cable is within 0.15 wavelength long you are not going to lose much power from feeder radiation. So for these short cable lengths, you do not need a balun choke or trap to reduce feeder radiation loss. In this case, the reasons you might decide to install one is because of too much RF in the shack or you are bugged because of interaction of the antenna tuning with the coax. Whilst these are nuisance things, they will not inhibit your antenna radiating most of the available power in the EH mode at the antenna.

But let's now turn to the longer cable. The antenna height and cable length is the same as I used for the 20 metre air tests described in a previous article. (At time of writing that article, we were describing the longitudinal current as



Demonstration of 10 metre and 40 metre EH Antennas by VK5BR at a meeting of the CW Operators QRP Club (Photo by Don Callow VK5AIL)

shield current whereas now I am saying the current is due to the out-of-balance between the inner and outer conductor currents).

## Longitudinal current tests

The following describes how measurements were carried out to measure the magnitude of longitudinal current on the coax line feeding several EH antennas operating without a choke balun or line trap. The tests were essentially concerned with the 20 metre antennas to derive information for power measurement. Tests were carried out on a 20 metre L+L matched antenna and a 20 metre Star matched antenna. The currents for a 40 metre L+L matched

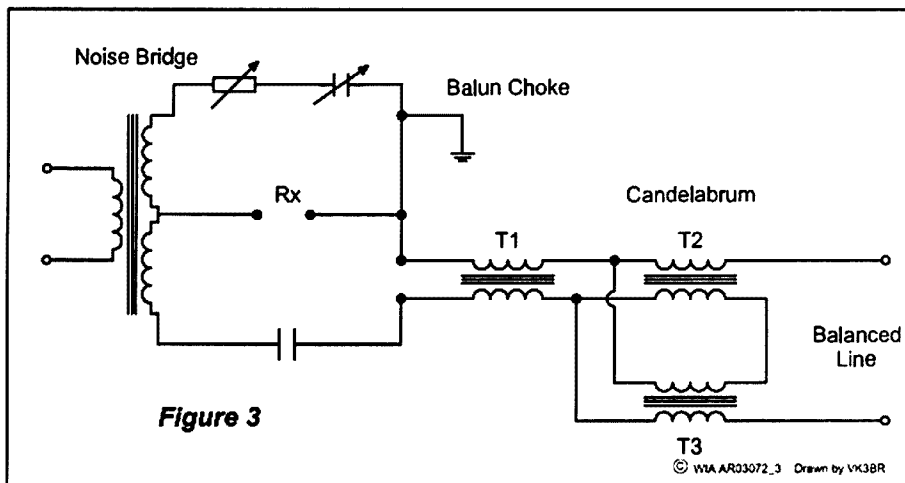

Figure 3 - Candelebra circuit to isolate unbalanced measuring instrument.

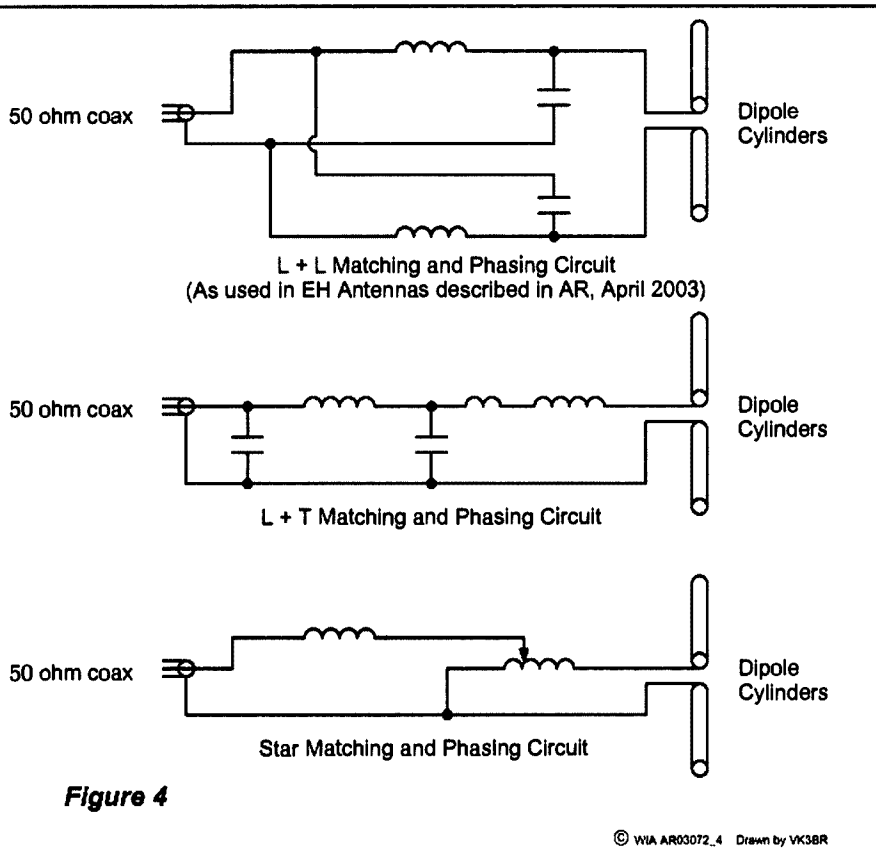

Figure 4

© WIA AR03072\_4 Drawn by YK38R

Figure 4 - EH antenna matching and phasing circuits.

antenna were also recorded but not processed further.

**Longitudinal current measuring device (Refer Figure 2)**

- Ferrite Core OD = 40mm
- ID = 20mm
- Width = 11mm
- Ferrite type - Not known

The device was calibrated by connecting to an RF source directly in series with another 0-1 Amp RF ammeter.

Reading = 1.2 x actual current (for 20 metre) & 2.5 x actual current (for 40 metre)

**Measurement Results**

Antennas fitted approximately 2.5 metre high.

- 50 ohm cable to antenna - 17.5 metre.
- Power fed to antenna - 50 watt.

Calculated differential line current for 50 watt - 1 amp

Longitudinal current measurements taken at:

- (1) 1.5 metre from antenna.
- (2) At transmitter end.

No choke balun or line trap is fitted for the tests.

**L+L Matched 20 metre Antenna**

- At 1.5 metre - 0.26A
- At Transmitter - 0.17A

**Star Matched 20 metre Antenna**

- At 1.5 metre - 0.25A
- At Transmitter - 0.2A

**L+L Matched 40 metre Antenna**

- At 1.5 metre - 0.6A
- At Transmitter - 0.08A

An interesting result is that despite the fact that the method of developing the two fields in the Star matched 20 metre antenna is quite different to that for the L+L matched 20 metre antenna, they produced similar results of longitudinal current. One might have expected that as only the secondary field of the L+L antenna operates in a longitudinal mode, a different reading might be recorded. The results give support to a theory which has been growing on me that the longitudinal current is more to do with the unbalance caused when you connect any dipole directly with an unbalanced line (without an isolating device to block the common mode currents) rather than due to the specific characteristics of the EH antenna.

**Resistance in the longitudinal circuit and the power consumed**

**Measurement Arrangement**

So that power radiated could be derived in the longitudinal mode, the coax was broken at the same points as the previous current measurement to measure the resistance component. The inner and outer conductors of each open coax end were paralleled and measurement was taken between these ends. A noise Bridge was used for the resistance measurement isolated by a series choke and candlebra circuit as shown in Figure 3. The coax break points were connected where "Balanced Line" is shown on the diagram.

Measurements were carried out on the 20 metre L+L antenna with the 17.5 metre coax feeder as described before. Measurements were taken at 1.5 metre down from the antenna and at the transmitter.

**Results of Measurements**

Resistance measured at 1.5 metre - 104 ohm

Current from previous measurement at 1.5 metre - 0.23 A

Power at 1.5 metre = 0.23 squared x 104 = 5.5 W

Resistance measured at transmitter - 252 ohm

Current from previous measurement at transmitter - 0.15 A

Power at transmitter end = 0.15 squared x 252 = 5.6 W

The previous current measurements were made with 50 watt of power fed from the transmitter. Hence close to 11% of the power is being consumed in the longitudinal circuit.

**Summary and conclusions**

I have described how a longitudinal current component can occur when you feed a balanced antenna from an unbalanced transmission line such as a coax cable. The phenomenon is dependent on current flowing through capacitance between the antenna elements and ground. In the case of the EH antenna, its elements are physically small, implying low capacitance to ground and low capacitive current. However in offset to this, the capacitive current is amplified by voltage gain in

## New period brings changes

The new broadcasting period, which commenced on March 28th, as predicted, had many changes to the bands. Some stations left shortwave altogether, such as WSHB, RTE in Dublin and a major programming reduction of the VOA "News Now" format in English. The VOA has axed programming to the Asia-Pacific region in the morning hours as well as cutting back on releases to Africa and Latin America. I believe further reductions are scheduled at the end of October.

The Americans seem to be increasingly concentrating on targeted broadcasting, particularly to the Middle East, China, North Korea and Indonesia. The various Radio Liberty stations such as Radio Sawa, Radio Farda, Radio Free Asia and Radio Marti all have had their allocations increased, whilst European languages have been reduced or eliminated altogether.

Swiss Radio International (SRI) ended their English language programming on April 12. This means that SRI will continue in French, German and Italian plus Swiss Music filling in the gaps, until it permanently closes down at the end of October.

Deutsche Welle in Bonn has reappeared on 9720 at 2200 in English, beamed to Asia and the Pacific from

Germany. Signal strength is very good. This brings News and information from a European perspective. I also can hear Radio Romania from Bucharest in English on 9725 at 2130. The rapid-fire delivery of the announcers coupled with their pronunciation could make comprehension difficult for people using English as a second language.

It is interesting that European signals propagate well at 2200 but they do fluctuate daily. I do expect that European signals will continue past 2300 simultaneously from both the long and short path, particularly on 9 and 11 MHz. Also expect that the higher bands of 15 and 17 MHz will not be as active this winter, as the Sunspot numbers have dramatically declined.

I have also been informed that Radio Slovakia from Bratislava, may be leaving shortwave for the Internet. No date has been announced so far.

Glenn Hauser has announced that he is taking a step back from editing his daily DX and shortwave news via the Internet and instead transferring it to a Yahooogroups list, where observations can be posted in real time.

Bob Padula also has introduced a fee paying private list for members to share loggings and observations. It indeed is time consuming compiling information

without getting any assistance with Internet costs.

The BBC World Service may have to do a rethink about local placement of programming via FM, after the Nigerian government banned local station rebroadcasting foreign stations, particularly the BBC. They hurriedly put up additional frequencies for West Africa and it is unclear whether other nations will also follow Nigeria's decision to ban foreign broadcasters being relayed via local transmitters. DW and Radio France International already extensively broadcast locally in Africa. Recently Paris had their programming curtailed in Rwanda, after that nation accused France of complicity in the horrific 1994 genocide.

The only commercial shortwave broadcaster in Japan, Radio Tanpa, from Tokyo, recently changed owners and format. It is now known as Radio Nikkei, concentrating on business and financial information. Radio Nikkei is on 3925, 6055 and 9595. The sender on 3925 is located at Sapporo whilst the others are near Tokyo.

Well that is all for this month. Don't forget you can email your news and comments to me via vk7rh@wia.org.au.

ar

### The EH antenna continued

the tuned matching circuits of the EH antenna.

For a short coax, the radiation resistance of the coax as a radiator in the longitudinal mode is too low to produce significant radiation. For a longer coax, the power radiated can increase and my tests show such a case where the longitudinal radiation resistance at the transmitter is a high 250 ohm. However multiplied by the current squared at that point, a mere 11% of the power is consumed due to the longitudinal current component.

Radiation from the coax of the EH antenna is a nuisance in that it has the effect of making the antenna tuning adjustment dependent on the length of the coax and its proximity to the

antenna. It is also a nuisance because of RF getting into the radio shack. If these things are a worry, then the coax radiation can be easily prevented by using a suitable trap as I have described in a previous article. However my tests show that coax radiation is hardly the primary source of radiation in the EH antenna (as some sources have claimed) and amounts to but a minor proportion of total power radiated.

### Other relevant articles in Amateur Radio magazine

- (1) *EH Antennas for 20 and 40 metre*, Lloyd Butler VK5BR, *Amateur Radio*, April 2003.

- (2) *The EH Antenna - More Information on how it works and how it has performed*, Lloyd Butler VK5BR, *Amateur Radio*, Nov. 2003

### On the Internet

- (1) Refer to articles on the EH Antenna by VK5BR at:  
<http://www4.tpgi.com.au/users/ldbutler/>  
Or link from:  
<http://www.qsl.net/vk5br/>
- (2) EH Antenna web site:  
<http://www.eh-antenna.com>

### Appendix

See Figure 4 - EH antenna matching and phasing circuits.

ar

# Antenna

'HomeBrew'

(with a lot of help from your Bushcomm kit)

## SWCS-KIT HF ANTENNA

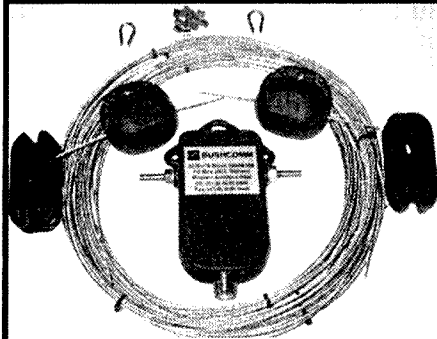

This is a kit version of our popular SWC-100S single wire model, but you have the great satisfaction of constructing your antenna.

Easy to follow, comprehensive instructions.

Common tools required.

You save money and have fun

Once completed correctly your antenna will be a replica of the SWC-100S model. This is a single-wire, base-situation antenna, constructed with stainless elements to give high resistance to corrosion. It has a length of 34m in total.

Trees, buildings or other structures can be used to suspend the antenna, (avoid running the antenna over iron-roofed buildings as this reduces the effective height above ground). The antenna can be mounted either horizontally between two supports, or as an inverted 'vee'

**Frequency Range:** 2-30 MHz  
**Impedance:** 50 OHM  
**Power Input:** 100 Watts, 250 Watts PEP

This kit contains:

Balun (x1) Load (x2) S/S Thimbles (x2)  
Copper ferrules (plus a few practice extras)  
Large egg insulators (x2) 4 cut lengths of wire.

**FULL and CLEAR**  
building and mounting diagrams

# Bushcomm

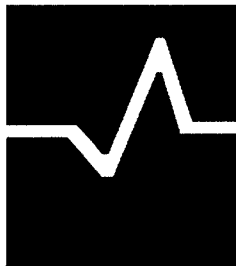

**PROUDLY AUSTRALIAN OWNED  
AND MANUFACTURED**

PO Box 2028, Midland DC 6936 Western Australia  
80 Stock Road, Herne Hill 6056 Western Australia

**PHONE: + 61 8 9296 0496**

**FAX: + 61 8 9296 0495**

**EMAIL: bushcomm@bigpond.com**

See more at

**www.bushcomm.com.au**

# Beyond our shores

David A. Pilley VK2AYD  
davpil@midcoast.com.au

## Rotarian convention

The ROAR (Rotarians Of Amateur Radio) will be holding their Convention between 22nd May and 26th May at Osaka, Japan. The special call, 8N3RI will be active on all bands during this period. The Chairperson of ROAR-J is Ken Noguchi, JA3LHL.

If you are a Rotarian or ex-Rotarian and interested in this Convention, information can be obtained from rotmem@yahoo.com or visit the web site at <http://www.2004kansai.jp/>

## Israel

### "Non-Ionizing Radiation"

Israel has proposed legislation on "Non-Ionising Radiation". The information is causing a lot of head-scratching and deliberation on the subject is underway. What can this mean for amateur radio? Will every ham have to have Ministry of the Environment inspectors OK his/her station? Will this cost a lot? Will stringent restrictions be imposed on our hobby?

Since the use of cell-phones has become widespread in 4X Land, there is much concern about the possible dangers of the radiation of these devices held adjacent to the brain, as well as the proliferation of cellular antenna systems on building-tops. Attention is shifting to other transmitting sites, and ham installations are now in the line of fire.

Quite a few years ago, Shalom 4Z4UT of Beer Sheva was taken to court by his neighbours on the grounds that he was subjecting them to dangerous radiation. With documentation provided by the IARC, Shalom won the case. Now the whole topic has resurfaced and in a big way.

(IARC via Q-News)

## Hong Kong

### Hong Kong to CANCEL ALL existing ham licences.

Hong Kong has announced they will drop the requirement for Amateur Radio applicants to pass a Morse code examination for access to frequencies below 30 MHz say they will also, in conjunction, CANCEL all existing

amateur station license classes (and/or authority to operate), replacing them with a new authorisation that does not carry a license class. Hong Kong have also opened the 430 to 440 MHz band for portable and mobiles and allocated 10.45 to 10.5 GHz to the Amateur Service. Changes would "come into effect soon."

(ARRL n/l)

## Gibraltar

### Gibraltar Amateur Radio Society

Amateur Radio started in Gibraltar shortly after the Second World War. The club organises a number of special events including operating once a year on National Day (September 10th) with the prefix ZG replacing the more familiar ZB.

Thinking of operating in Gibraltar? Non-residents can obtain a reciprocal call, not a ZB call and may be specifically restricted from operating from some areas of the rock. Maritime Mobile operation with a Gibraltar licence is restricted to operation in Gibraltar waters. Reciprocal licences for visitors are issued free of charge, just contact: THE WIRELESS OFFICER, Gibraltar Regulatory Authority, Europort, Gibraltar. Telephone: + 350 74636. Club meetings are held on Coaling Island and internationals are always warmly welcomed every Tuesday at 20.30 GARS Operates as ZB2LGT

([info@gibradio.net](mailto:info@gibradio.net))

## Germany – radio science

### DF5AI is heading up an Aurora probe and seeks help.

If you have contacted stations using Aurora during your ham career, you are invited to take part in a study on Auroral backscatter. Please submit your QSO data for analysis purposes to Volker Grassmann, DF5AI. Grassmann is heading up a scientific probe of this communications phenomena. He says that he is interested in any and all

Aurora QSOs hams have managed to make from the same geographical position.

Gassman says that the reason for the study is to compare the geographical distribution of DX stations with the theory of Auroral backscatter. He says that analyzing Aurora band openings provides him with a large base of individual observers to provide the needed data. DF5AI has placed a lot more information on his website. If this study interests you take your web browser over to [www.df5ai.net](http://www.df5ai.net) to view the details.

(DF5AI)

## South America - ham radio adventure

### Communicators needed for caving expedition.

Base stations are needed for communication on the ham bands with a scientific expedition. This, in July through August time frame. The 60 day expedition will explore deep caves in the high Andes mountains and jungle

in the western Amazon area of South America. Expedition access to the remote areas is via trekking on foot and pack animal. The expedition will use a solar and battery powered 20 watt backpack transceiver. Antennas will be a wire dipole or vertical. A miniature notebook computer will be along for digital operations. Communications will consist of position reports, some short messages with families of expedition members, and any possible emergency or medical messages. All operation will be non-commercial. Operators with good base stations, efficient antennas and low noise locations are needed on the 40 through 15 metre amateur bands. The operations will use SSB, CW and a variety of digital modes. If you are interested, e-mail Bonnie Crystal, KQ6XA, at [radioadventure@aol.com](mailto:radioadventure@aol.com)

## New Zealand

If you happen to be visiting the Land Of Long White Cloud in early June, you may like to attend the Marlborough 2004 NZART Conference, to be held at Marlborough Girls College, McLaughlan

Street, Blenheim, during the weekend of 5th & 6th June.

Now Marlborough is sometimes known as the gourmet province, which makes it even more enticing.

This year, the Conference will commence with a brief opening ceremony followed immediately by the AGM. Forum topics, detailed in the last issue of HQIL are virtually finalised and include something for everyone. In Sunday's lineup expect SPAM, AREC, WARO, OTC and AMSAT-ZL.

If you are interested in visiting check out their website: [www.zl2ks.com](http://www.zl2ks.com) or the Conference Secretary, Helen Harris, ZL2TPT. Email: [mt.adde@extra.co.nz](mailto:mt.adde@extra.co.nz)

Support the advertisers  
who support  
**Amateur  
Radio**

# Andrews Communications Systems

ESTABLISHED 1976

ACN 001 968 752



## YAESU FT-1000MP Mk V 200W ...\$4999

FT-1000MP V Field ...\$3,999	FT- 7800R Dualband .\$.499
FT- 897D HF-70cm...\$1,499	FT- 2800M 2m 65W .\$.349
FT- 857D HF-70cm...\$1,399	FT- 1500M 2m 50W .\$.399
FT- 847 HF-70cm ...\$2,499	VX-1R w/2 batteries ..\$329
FT- 8900R Quadband .\$.799	VX- 2R Tiny Dualband ..\$399
FT- 8800R Dualband .\$.699	VX- 5R Triband H/H ..\$499
FT- 817 HF- 70cm ..\$.999	VX- 7R Deluxe H/H ..\$599

★ 3 YEAR WARRANTY ★

★ 3 YEAR WARRANTY ★

## ICOM DISCOUNTED

IC-756 Pro II HF+6m	\$.4,999
IC-746 Pro HF+6m+2m	\$3,299
IC-706 IIG HF-70cm	\$1,499
IC-718 HF SSB 100W	\$1,199
IC-910H 2m+70cm SSB	\$2,499
IC-208H 2m+70cm	...\$649
IC-V8000 2m 75W	...\$399
IC-2100H 2m 50W	...\$349

## ICOM SCANNERS DISCOUNTED ★ 3 YEAR WARRANTY ★



ALINCO DR-620 Dualband...	\$.799
ALINCO DJ-V5 Dualband ...	\$.599
ALINCO DJ-X2000 Scanner...	\$.999

★ 3 YEAR WARRANTY ★

## KENWOOD DISCOUNTED

TS-2000X HF-23cm + ATU	\$4,499
TS-480HX HF 200W+6m	\$2,799
TS-2000 HF-70cm + ATU...	\$.3499
TM-D700A 2m/70cm	\$999
TM-G707A 2m/70cm	\$699
TH-F7 2m/70cm H/H	\$699

TOKYO HI-POWER, PALOMAR, TE SYSTEMS, YAESU LINEARS. bhi NES 10.2 DSP speaker \$249  
DIAMOND ANTENNAS from only \$49 ea  
HUSTLER + EMTRON ANTENNAS  
Avair SWR/RF wattmeters fr. \$99  
YAESU + EMOTATOR ROTATORS

FACTORY DIRECT IMPORTER  
OF HUNDREDS OF PRODUCTS

**MFJ** ANTENNA TUNERS  
ANALYSERS ETC

**CALL (02) 9636-9060 or 9688-4301 or FAX 9688-1995**  
**SHOP 8, 41-51 BATHURST ST, GREYSTANES, NSW 2145**

Why pay more? MAIL ORDER TO PO BOX 240, PENDLE HILL, NSW 2145

Some items indent. Prices subject to change without notice - limited stock, some items. E & OE

★ <http://www.andrewscom.com.au>

★ email: [lee.andrews1@bigpond.com](mailto:lee.andrews1@bigpond.com)

AR-54

# An RF bridge for antenna measurements

Roger Graham VK2AIV

**Making a whip antenna? You'll need some way to measure the resonant frequency. Various textbooks suggest coupling a dip oscillator into the antenna via a small loop of wire at the base. If you've ever tried it, you'll agree that it's difficult to do, and gives only approximate answers anyway. Make this small RF bridge, then a little DC amplifier to follow it, and find out how easy it can be. I have used it successfully on 80, 40 and 20 metres.**

The bridge circuit isn't original (I adapted it from an article in AR – see Ref.1). And the little DC amplifier which makes it work so well isn't new either

(adapted from a circuit in EA – see Ref 2.)

The idea of course is to connect the antenna, mounted on the vehicle as you intend to use it, directly to the SO239 socket of the bridge. Then you feed in some RF from a dip oscillator, coupled into the pickup coil of the bridge. Vary the frequency of the RF, and look for a dip on the meter of the oscillator).. More about this later.

The original bridge used a 100 micro-amp meter. I made mine using a 60-0-60 uA centre-zero meter salvaged from junk. It worked OK, but the null was rather broad due to the loading effect of the meter. This is where the little DC amplifier (Figure 2) created a magic improvement.

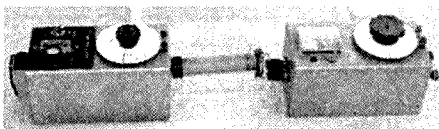

Photo 1 - Dip Oscillator (on the left) injecting RF into the bridge (right)

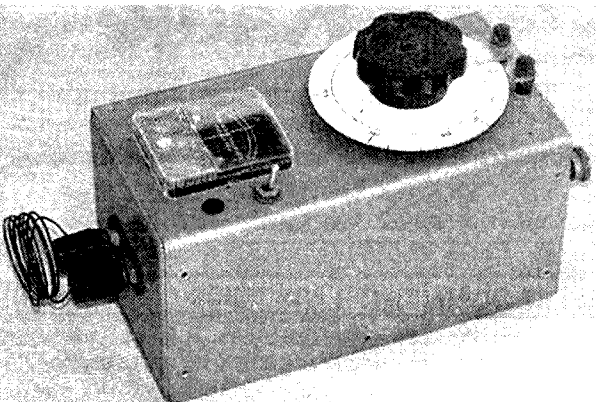

Photo 2 - The RF bridge.

## How it works

The small DC voltage from the RF bridge is applied to the inverting and non-inverting inputs of the op amp (pins 2 and 3) via two 10k resistors. The amplified DC voltage out (pin 6) is applied to the meter via a series resistor chosen to give a sensible value of deflection, nearly full scale, when the bridge is unbalanced. In my case, 6.8k was about right for the 60-0-60 uA meter used.

## What kind of diode?

I tried quite a number of germanium diodes, and some were much more sensitive than others. The one eventually selected was an ancient point-contact type, glass encapsulated, from a primitive computer board. Be prepared to experiment a bit here.

## Offset null

The 10k trimpot between pins 1 and 5 is for "offset null". Adjust it so the meter reads zero when there is no input signal.

## The battery

The battery is a 9-volt miniature type. In the excitement of tuning up your new antenna you'll forget to switch it off, so add a red LED in series with the positive lead to remind yourself. And it tells you the battery is still OK.

## The RF signal

The RF signal to operate the bridge is easily provided by a dip oscillator. I used a pickup loop of 7 turns, about 30 mm diameter, self supporting on short stiff leads held away from the box so the coil of the oscillator could be coupled into it. An RF signal generator could be used instead, or even your transmitter with the wick turned down very low.

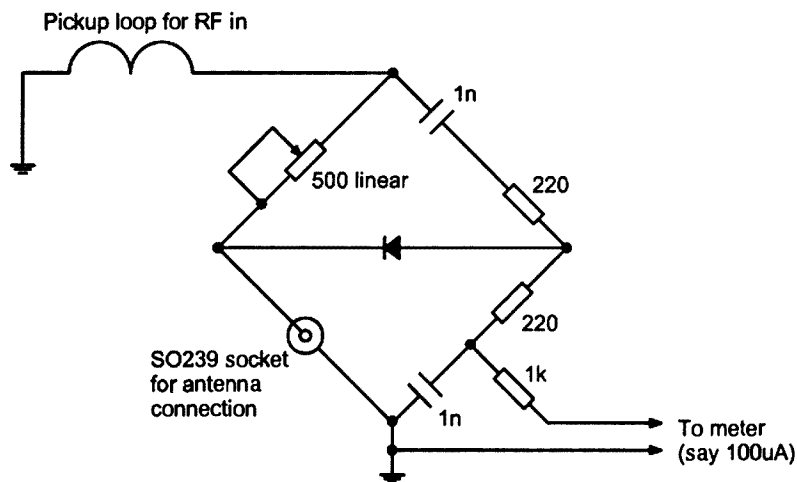

Figure 1

© WIA AR03077\_1 Drawn by VK3BR

Fig 1 - The basic RF Bridge without the DC amplifier.

# Calibrating the ohms scale of the bridge

Put a big generous pointer knob on the 500 ohm linear pot. Mark a scale directly in ohms, from 0 to 500. Either measure the resistance of the pot directly with a good ohm meter, or insert known values of resistor across the bridge at the antenna socket, and simply tune for a dip.

# Connecting the bridge to the antenna

You'll have provided a suitable socket on the base of the antenna, probably an SO239 type. And of course, there's a socket of similar type on the RF bridge. Simply join one to the other with a short coax lead with a plug on each end, and you can take measurements right at the base of the antenna. Switch on both the dip oscillator and the bridge. Couple some RF from the dip oscillator into the pickup loop of the bridge.

Vary the frequency by adjusting the dip oscillator. Look for a dip on the meter attached to the bridge (not the one on the oscillator). When you've found a dip, adjust the 500 ohm pot on the bridge for the deepest dip. This, we hope, will tell something about the impedance of the antenna. You'll probably be aiming for a nice sharp dip at a frequency in the middle of the band, with about 50 ohms impedance. Later, when it's all tuned up and the antenna is up in the air, join on a longer length of coax and take measurements from further away. Always keep the operator's body well clear of the field around the antenna to avoid erratic results.

# PC Boards

I made mine in two parts, because that's how the project grew. The RF bridge is on a little board (Figure 3) supported by soldering directly onto the lugs of the 500 ohm pot. The DC amplifier, added

*Continued on page 27*

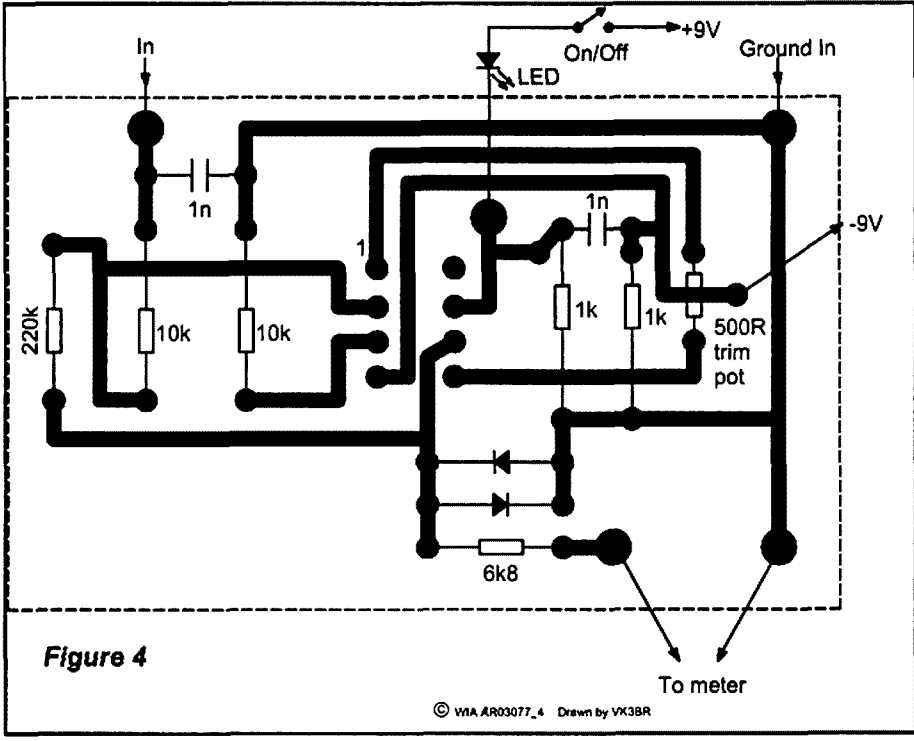
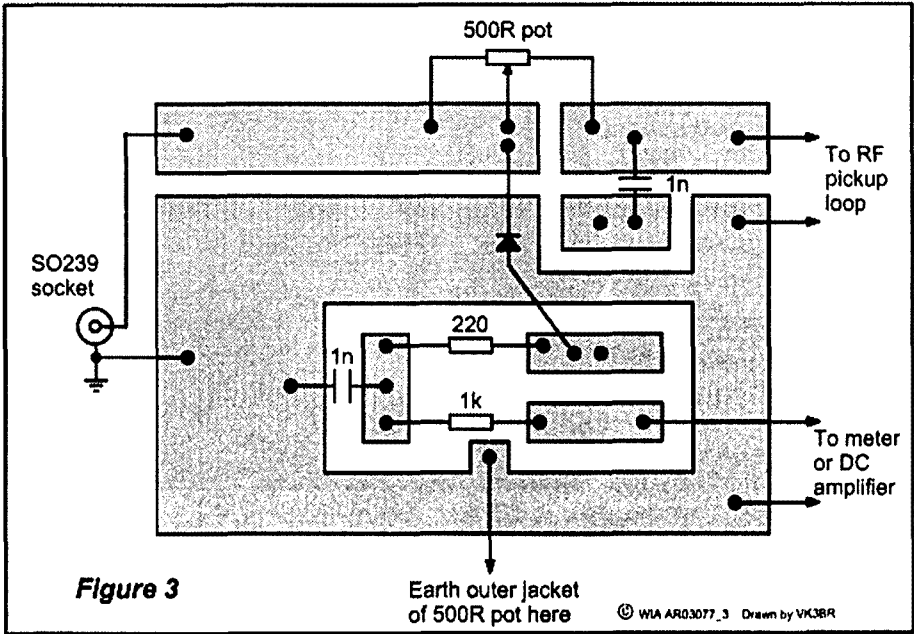
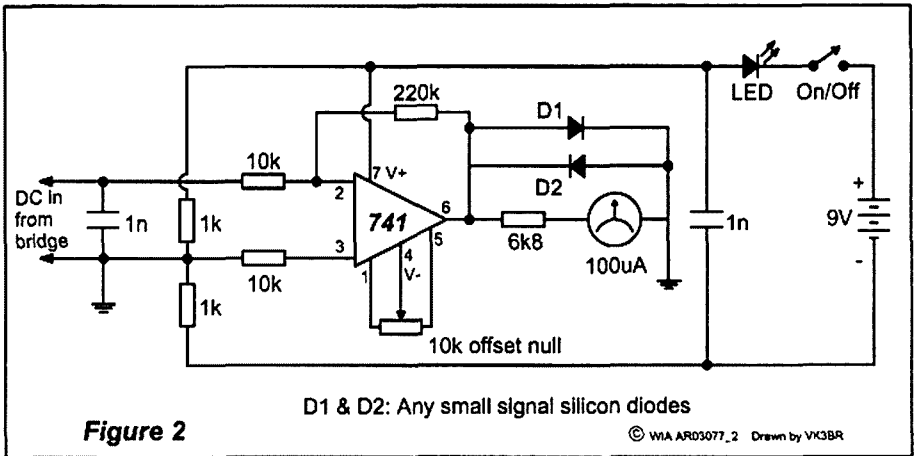

Fig 2 – DC amplifier for RF bridge.

Fig 3 - PC board for the RF bridge, to be mounted on the rear of the 500 ohm linear pot. Components are 'surface mounted' on the copper side of the board. Full size is approximately 55 x 35 mm..

Fig 4 - PC board layout for the DC Amplifier. This view is from the component side of the board.

# Chip off the old block

By Jim Linton VK3PC

**The prestigious WIA Ron Wilkinson Achievement Award has been awarded to a most worthy recipient, Rex Leonard Moncur VK7MO in recognition of outstanding achievements in the field of digital weak signal working on the VHF, UHF and microwave bands.**

The WIA Federal Council bestowed the award that included the citation that Rex "has consistently demonstrated the true spirit of amateur experimentation and imparted his knowledge for the interest of many others."

He is recognised by his peers as the leading exponent in Australia weak of signal digital modes on the higher bands using the WSJT suite of programs. Creator of the software, Joe Taylor K1JT shares that view.

To tell Rex's story it is best to begin with his late father Len Moncur VK3LN who was a pioneering radio amateur from the 1920s, experimented with television in the early 1930s using a flying spot disc and was on the 112 Megacycle band before the war.

He continued experimenting with television using an iconoscope for a number of years from 1948. The VK3LN station in the inner north-western Melbourne suburb of Ascot Vale became a local landmark with a five-element fully spaced 20m beam.

Rex remembers learning from his father. "I use to spend my time at his feet while he was working DX on 20 m. He was into everything and to that extent I've picked it up and run with it."

At the age of 18, Rex became VK3ZHI immediately exploring VHF on 2 m using amplitude modulation (AM), the mode of the day.

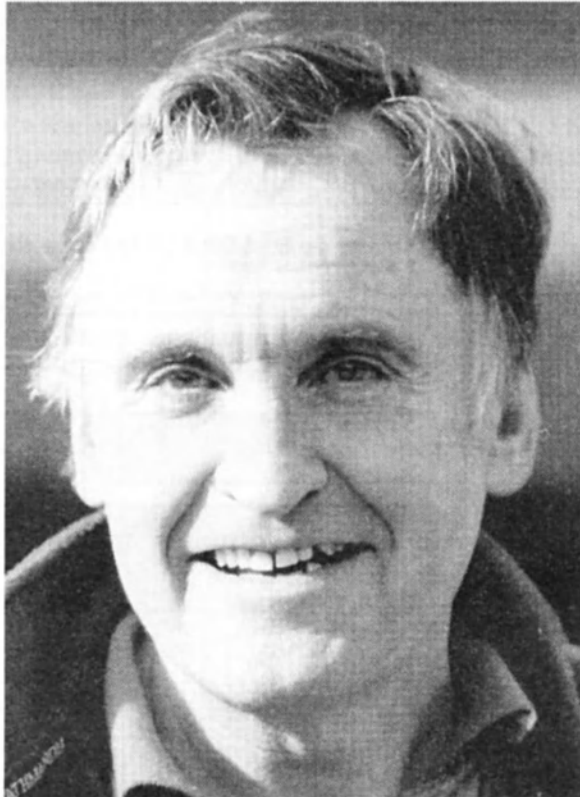

Rex Moncur VK7MO

After upgrading to an unrestricted licence with the callsign VK3OB he achieved a 70 cm distance record within a month of that band becoming available on 1 January 1964. Pushing the limits of the 1296 MHz bands he notched up another record in 1966. (In recent years he has set a handful of distance records on the higher bands.)

The next phase on Rex's life was working for the Bureau of Meteorology as an engineer developing radiosondes systems, gravitating to Canberra and became a bureaucrat ending up as the Director of the Antarctic Division in Hobart.

Rex has often explained to friends how he retired in 1998 and within months his wife Meryl died. That great loss

naturally caused him to think about his future, and remembering the good times he had as a young man enjoying amateur radio.

Speaking with emotion in his voice, Rex said, "All of that youthful enthusiasm I had was still there 40 years later. I really didn't believe I could get back into amateur radio and that it had gone beyond me."

However he had the time and enthusiasm to re-enter the hobby. His passion remained to be VHF and the 2 m band. Being in Hobart put him at a disadvantage with little activity on that band.

Rex's passion for the hobby and particularly the digital modes is unparalleled. His speciality is within the digital area using meteor-scatter and troposcatter modes.

Teaming up with Ian McDonald VK3AXH at Ballarat he explored meteor-scatter propagation using Hellscriber, a soundcard program that enables long distances to be achieved with weak signals.

Lots of fun was had until someone told Rex in 2001: "You're not doing this the right way. I've got a mate that can make a much better program. His mate turned out to be Joe Taylor K1JT."

Rex and Ian quickly replaced Hellscriber with the far superior WSJT FSK441 program for meteor-scatter.

His enthusiasm includes plenty of promotion of weak signal working including presentations at the 2000, 2001, 2002 and 2003 GippsTech

**Doug McArthur VK3UM, dual winner of the Ron Wilkinson Achievement Award:**

***Rex VK7MO has come to prominence in the VHF/UHF field and been almost solely responsible for promoting the new digital modes. He has spent considerable time in investigating the pros and cons for these modes and exploiting them to their maximum potential.***

t e c h n i c a l conference, writing a weekly email Digital DX News, and contributions to the VHF/UHF – An Expanding World column in Amateur Radio magazine.

VK7MO has mounted WSJT DXpeditions to

work from more than 60 grid squares.

"My objective has been to demonstrate to people that you can work 2 m at long distances up to 2,000 km at any time they like," he said.



The first DXpedition was to VK8 because VK3s find it very hard to work that call area on the 2 m. That trip resulted in VK7MO/8 making contact on that band with those in Sydney and Melbourne.

Another that occurred earlier in 2003 was to Cape Hauy a remote area on Tasmania's East Coast.

Rex and Eric Ferrier L70150 made two troposcatter (JT44) contacts with VK3, eight contacts on meteor scatter (FSK144) to VK1, 2 & 3 and 40 contacts on 2 m & 70 cm SSB & FM.

Rex's comment after the DXpedition was: "The exercise demonstrated that with the new digital modes one can make regular contacts in poor conditions up to 1600 km on 2 m with a back packed station comprising a small antenna and 60 watt."

Also in 2003 he went to Lord Howe

Island as VK9LS with Trevor, VK7TS. The island is around 780 km east of Sydney, working as far away as VK4, VK5 and VK7 on meteor-scatter on 2 m.

Rex comments: "The most unexpected result was the EME (moon bounce) contacts with just a 100 watt and a small yagi. These were fortuitous as while I did not plan it, the period 9-10 May was one of the best possible for EME in 2003."

He said, "Compared to those early days on 2 m in the 1950s, as a young man, getting really excited to make a contact a few suburbs away, this (WSJT) is really amazing."

The enthusiastic and often emotional manner in which Rex goes about being a radio amateur, exemplifies the essence of the amateur radio spirit and an outstanding record of achievement.

ar

## MOUNT GAMBIER CONVENTION 2004

June 12-13

(Queen's Birthday weekend)

### Amateur Radio Convention &

### Australian Fox Hunting Championship

Venue: A & H Halls  
Pick Avenue Showgrounds,  
Mount Gambier

For full program see:-  
<http://serg.mountgambier.org/>  
closer to the date.

For info or table bookings  
contact Wayne VK5ZX  
on

(08) 8725 4335 or 0407 718 908

## An RF bridge for antenna measurements *continued*

*Continued from page 25*

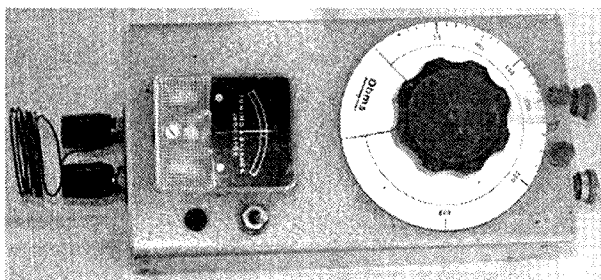

Photo 3 - Another view of the RF bridge.

later, is on a second board (Figure 4) held up on a little bracket inside the metal box. The diagrams show the general idea.

The little PC board for the DC amplifier is made in the conventional way, with components on one side and the copper tracks on the other. Some suggestions are in order here, for a painless way to make such a board.

- Lay out the positions of components on a piece of stiff cardboard, full size, from the component side of the board.
- Mark clearly where holes are to be drilled for component leads, especially for the IC where the pins have to be just so.
- Draw the copper tracks on the cardboard too, as seen from the component side.

- When it all seems OK, trim the card to size and cut a piece of blank PC board to match it. Tape the card onto the PC blank, with the copper side outwards.

- Now drill all the holes, using the accurate layout on the cardboard to get them just in the right place.

- Remove the cardboard, de-burr the holes, polish the copper with steel wool, etc then draw the tracks with a Dalo pen and etch in the usual way. The layout you made on cardboard helps get all the tracks where they should be without mistakes.

Much easier this way, with the holes pre-drilled before laying out the tracks.

## References

1. Amateur Radio, September 1965, reprinting an article titled "Antennascope-54" by Wilfred M. Scherer, W2AEF.
2. Electronics Australia, January 1977. Title and author are lost due to repeated copying.

ar

radio and electronics  
school

## Become a Radio Amateur

Or study radio electronics to  
support your hobby

Australia's premier training institution for  
**AMATEUR RADIO AND HOBBYISTS**  
courses available in radio & electronics  
technology for all ages

**COURSES AVAILABLE ONLINE**

Be guided through your course by one or more  
of our 20 experienced volunteer facilitators,  
email hundreds of other students

**IN A HURRY?**

Become a novice radio operator in 4 weeks  
with our computer-based

**NOVICE FAST-TRACK COURSE**

Courses for schools, youth organisations and  
seniors

**Australian Radio Certificate Scheme (ARCS)**  
Use our accredited bridging program for radio  
amateurs to obtain a

**CERTIFICATE IN**

**ELECTROTECHNOLOGY**

Download all course materials free  
(CD Rom has a small fee)  
For Further Information visit

<http://radioelectronicschool.com>

or email

[manager@radioelectronicschool.com](mailto:manager@radioelectronicschool.com)

Tel: (07) 5573 2795 12-5 (EST)



# TTS Systems Communications Equipment for

www.ttssystems.com.au

FREE C

## Ten Tec Jupiter HF Transceiver

All Pegasus features plus a large LCD panel and controls. Can be used directly under PC control in Pegasus emulation Mode. The GUI software at no charge. With the command set for control of both the Pegasus and Jupiter you can write your own control software. Frequency range: 10-160 m + WARC Mode: All-mode (AM receive only) RF Power output: 5-100 W Voltage: 13.8 VDC Current drain: RX: Max 1.5 A TX: Max 20 A Impedance: 50 ohms Dimensions ( 308\*127\*330 mm 5.3 Kg



## TEN-TEC KITS

We have these world famous kits, and remember, it sounds better on some-thing you built yourself. Start with a small kit and build up to a transceiver.

Check out the full list on the site.

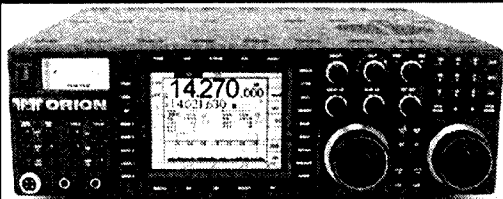

## Orion is here

We are working to separate the overjoyed owner from his new gear long enough to talk with us, When we do, we will bring you an assessment of how it all works. But until then, the list of primary benefits says it all:

Dual 32-bit floating point ADI SHARC DSP processors Full dual receive capability Very high RX intercept points 590 receive IF-DSP bandwidth filters independently selectable on each of the main and sub receivers Adjustable receiver filter shape factors Programmable AGC response time for

main receiver True diversity reception using both receivers Continuous real time spectrum display allows monitoring of band activity "Instant Two Radio Mode" allows ORION to instantly QSY between two different bands Virtually indestructible 100-watt PA Superb SSB audio is yours at a touch of the AUDIO button Ten-Tec's

New Panoramic Stereo receive feature Adjustable rise and decay times for transmitted CW waveform Nine adaptive DSP noise reduction filters Dual noise blankers Voice keyer and CW memory keyer built in On-the-fly reset button Flash ROM updatable

## TEN-TEC ARGONAUT V



Frequency range: TX: 10-160 m + WARC

RX: 0.5-30 MHz

Mode: AM/FM/SSB/CW/AFSK

RF Power output: 1-20 W

Sensitivity: SSB/CW: 0.2-0.35 uV (10 dB

SINAD @ 2.4 KHz bandwidth)

AM: 0.5-0.9 uV (10 dB SINAD @ 6 KHz

bandwidth)

FM: 0.35-0.6 uV (12 dB SINAD @ 15 KHz

bandwidth)

Selectivity: 35 built-in filters SSB/CW: 200-

3000 Hz AM: 400-6000 Hz FM: 15 KHz

Image rejection: 80 dB Voltage: 13.8 VDC

Current drain: RX: 950-7 mA

TX: Max 6 A

Impedance: 50 ohms, SO-239

Dimensions (W\*H\*D): 216\*70\*246 mm

Weight: 2.2 Kg

100 memories. Scanning. CTCSS encoder.

PSK31-ready. IF-DSP.

"Software defined" radio.

Download new functions from your computer.

## Ten Tec RX350 Communications Receiver

Modes AM/DSB, SAM/LSB, SAM/USB, AM, LSB, USB, CW, DIG, FM

Tunes 100 KHz to 30

MHz,

Stability +/- 90Hz at

25 deg C.

Selectivity 34 inbuilt

filters

S Meter S9

calibrated to 50mV

standard

Spectrum Sweep

Display PC

Interface



## TEN-TEC 6n2



Model 526 "6N2" multi-mode 6m/2m transceiver. Amateur radios' first IF-DSP multi mode VHF rig. For a long time, there have been no affordable choices for either 6 or 2 meters in a single band VHF multi mode transceiver. Active hams planted the idea with us - why not offer a single rig that has BOTH 6 and 2 meters, without sacrificing

performance? Multi-mode HF/VHF rigs have been around for years, at over a thousand dollars and with compromised performance on the VHF bands at best. The 6N2 provides serious multi mode VHF performance in a small, take-anywhere package at a significantly lower price than HF+VHF multi mode transceivers.

## TEN-TEC RX340

## Professional Communications Receiver

• Modes AM, SAM, LSB, USB, ISB, CW, FM

• Tunes 5 KHz to 30 MHz.

+/- 1 ppm frequency

stability. • User

programmable AGC

• Selectivity 57

bandwidths selectable

from 0.1 KHz to 16 KHz.

• Meter Calibrated in both dBm and S Units • External IF and digital

(DSP data) outputs • Both balanced & unbalanced audio outputs

• 100 memories that store frequency, bandwidth, AGC and Mode.

• Remote controllable via serial RS232 port. • Rack Mount, 3U in

height. • Power 90 to 264 VAC 30 watts.

• Used by US and Australian Government Agencies

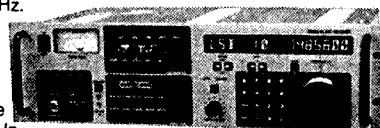

WE SPECIALIZE IN MAIL ORDER. VISA AND MASTER CARD ACCEPTED. CALL FOR A FREE CATALOG WITH PRICING.

## Re-sellers

Strictly Ham (Melb.)  
Tower Comms (Perth)  
Kyle Comms (QLD)

International Comms  
Systems (SA)  
Marcom-Watson Group  
(TAS)

all re-sell these famous products

TTS Ph: 03 5977 4808. Fax 03 5977 4801

info@ttssystems.com.au

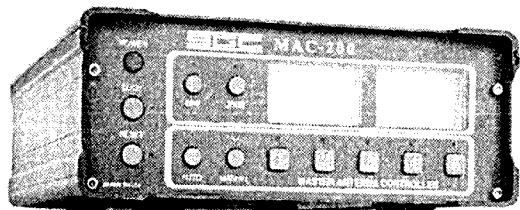

## MAC-200

### MASTER ANTENNA CONTROLLER (Smartuner Built-In)

than 10ms for frequencies you've been on before, less than 2 seconds for randomly chosen frequencies with a no compromise Pi Network output. The Smartuner remembers everything for quick, perfect matching. The push of a button makes it work, everything else is automatic. Built in meters for easy monitoring, low power consumption, and rugged construction make it useful for complex field portable operation as well.

*"... reports I was given were from 5x5 to 5x9+ on eighty and forty meters QRP. I am told it sounds like 100 watts is being used ... my slogan now is 'the Box that brought my amateur radio hobby back to life'"*

(One of UK's most active low-power amateurs talking about the MAC-200)

The MAC-200 has a Smartuner and an Antenna Switch in one compact unit. Controls

5 ANTENNAS

3 SO239 COAXIAL CONNECTORS

1 BALANCED ANTENNA OUTPUT

1 END FED LONG WIRE

Displays Forward power on 20 and 200 watt scales and VSWR. Smart enough to do the job without operator attention.

The Mac-200 from SGC is THE answer for feeding multiple antennas from a single transceiver! It's more than a switch, it shares a tuner between all of the antennas. It knows which antenna you're on and remembers the last successful tunes on each antenna so it can get back there fast. All of this works in less

Not only but also---  
**Autek Analysers & Power Meters**  
**Davis Weather Stations**  
**Amidon Cores.** Call for a stock/price list  
**Baluns and Transformers**

## SG 2020 ADSP<sup>2</sup>

Small, light, rugged, recessed face. Pre-set for 20 watts PEP with front panel power adjustments down to 1W for QRP'ers or up to 20W for serious USB or LSB "hamming". 20 pre-programmed memories preset to each of the 9 worldwide ham bands. Each memory position can be selected for a specific transmitter output power, specific amount of bandwidth filtering, mode and split VFO. Crystal clear.



### ADSP2 Speaker

Works with the press of a button. You can select from three modes of operation: no noise reduction, the original ADSP, and the new ADSP2 noise reduction modes which provides up to 26 dB of noise reduction within the passband. The ADSP2 Speaker is "One Touch" simple to



up to 26 dB of noise reduction



### SG-237 HF-VHF SMARTUNER®

Worlds Smallest  
 High Performance  
 Antenna Coupler  
 Finished Product  
 or PCB

100 watts  
 1.8 to 60 MHz

### Model SG-230 Smartuner™

Automatic microprocessor antenna coupler. Can be used within its power rating with any HF Transceiver in range of 1.6-30 MHz. Designed for marine, portable and fixed base applications. For antenna types: 23 ft marine whip for 1.6 to 30 MHz and with 9 ft. minimum antenna for 3-30 MHz operation. memory channels: 170 Frequency range: 1.6-30 MHz Power rating: 200 watts PEP maximum. 12VDC. operation.

### The SG-239 Smartuner™ antenna coupler

With any transceiver get long distance communications. Great results with a longwire antenna or a coaxial fed multi resonant antenna at the unit window, fits many low cost HF transceivers: Scout, Yaesu FT-817, Kenwood TS-50, Icom IC-706, and the K2 kit. Ideal with the legendary SG-2020 transmitter. Silent receiver tuning or within 1.5 to 200 watts with a high power transceiver. 170 memory bins, independent sensors, inc.VSWR, phase, magnitude, low impedance, and forward sensing.

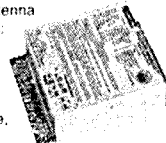

## SGC SG-211 MINI-Smartuner

SGC is announcing a new Mini-Smartuner, with zero power consumption. No DC wiring is necessary to power this Smartuner. It has a naturally balanced output for operation with whips, long wires and dipole antennas

Due for release  
**April**

We will have  
**stock end of April**



## LDG-AT1000 High Power Antenna tuner

Microprocessor controlled  
 Switched L tuning network  
 Continuous coverage 1.8 to 54 MHz  
 Power rating HF (1.8 to 30 MHz): 1000  
 Watts Single Side Band 750 Watts CW 500  
 Watts Digital (RTTY, Packet, etc.) Power rating 6 meters: 100 Watts

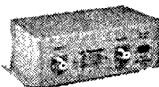
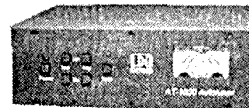

## RT-11 Autotuner

A feature of the RT-11 is latching relays, which retain their settings so the RT-11 can be powered down once it is tuned. If you shut down after a night of operating, the next morning the tuner is in the same configuration. This power saving feature is very popular with our QRP Z-11 customers. The heart of the RT-11 is a 68HC11 Microprocessor which performs many hundreds of quick tests to determine the correct combination of capacitors and inductors to load your antenna system. Tuning is in 1 to 5 seconds. The tuner can handle 0.1 to 125 watts (100 watts continuous, 50 watts on 6 meters) of RF power.

The water resistant case can be mounted on a tower, in a boat or car, outside the window of your shack, ... almost anywhere. The case has 2 flange mounting brackets to facilitate ease of mounting. Since the unit is RF sensing, it will tune when it senses a band change (high SWR), thus it will operate with any HF radio.

See it all on  
[www.ttssystems.com.au](http://www.ttssystems.com.au)

# ALARA

Christine Taylor VK5CTY

vk5cty@vk5cty or geencee@picknowl.com.au

## Home for a gift

Remember that donation of a complete radio station given to ALARA by Vic VK2EVK? We have found an ideal home for it, where young people already interested in radio will use it.

Leading up to and during the recent World Scout Jamboree held in VK5 last January the RIG came to be. RIG is the Radio Interest Group. It operates under the umbrella of the Scout movement, which these days includes boys and girls. It is lead by Leanne Adcock. She is supported by Dean VK5ZDW

Commissioner for Radio in VK5, her OM Luke VK5KSA, Jeanne VK5JQ, a member of ALARA and her OM Keith VK5OQ, Paul VK5PH and other amateurs, as well as by an enthusiastic groups of parents.

RIG operates from a Scout Hall in a beachside suburb of Adelaide and ran what was described as one of the best ever Radio Stations at the recent Jamboree. Many of the participants in the Jamboree came back several times to the radio shack or stayed for more than just long enough to have their cards

stamped!! One girl came almost every day to have a sked with her father (who is an amateur, of course).

It has taken some time to find the right "home" for Vic's station but RIG sounds like exactly the sort of group he had in mind when he donated his station to ALARA. We can expect updates of the activities of the group and the use made of the rig, from time to time, in this column.

## WARO and ALARA Awards

For the WARO Award, only 12 WARO licensees need to be contacted on HF (any mode or mixed modes but all from the same QTH) for VK and ZL operators, six HF contacts for other DX operators. If you are in ZL-land you could qualify for the VHF section of the WARO Awards with ten WARO Members contacted on VHF either directly or through repeaters.

There is a section for SWL which requires 20 contacts with WARO

members to be heard, listing callings of both stations as well as all other log details.

If you have made contact with 100 WARO members, including DX members from any QTH you have earned a WARO Century Award. The contacts can be on any mode or band, and from any location, including those made through repeaters and during contests and nets,

No QSL cards required, just an extract

from your log(s) signed by one other licensed amateur.

To obtain an ALARA Award only ten contacts with ALARA members are needed, any mode or band, as long as at least five States are represented. Log details, not QSL cards, signed by another licensed amateur.

For WARO Awards please contact Lynette ZL1LL QTHR the callbook. For the ALARA Award please contact Jean Shaw via email otterburn@maytel.net.au

## An interesting item from "New Scientist"

Way back in the 1770s, there were problems for all sailors who ventured out of sight of land, to identify their longitude with any degree of accuracy. To aid them in this endeavour an almanac was published every year, containing all the data a sailor needed to pinpoint his position – a sort of ready reckoner for longitude.

There were "lunars" which predicted the distance between the moon and the sun and certain stars calculated for each day at specific times at Greenwich i.e. at longitude zero. To navigate with these tables the sailor needed an accurate clock set on Greenwich time and a sextant to measure angles and distances of the stellar objects. For every hour of difference between Greenwich time and the time aboard ship the ship was 15 degrees around the globe from Greenwich.

On his own a sailor could do the calculations if he was very mathematically and astronomically skilled and had at least 4 hours to spare. With the tables it would not take him more than half an hour and needed only very simple calculations.

All the hard slog had already been done by "human computers" employed by the Astronomer Royal, Nevil Maskelyne. One of the people who took on this task for Maskelyne was a John Edwards, a curate with a hobby of telescopes. In fact it was Edwards' wife Mary who did the work. John's name was on the payroll but Mary did most of the computing right from the start.

We do not know if Mary had a particularly enlightened father or if she had brothers whose books she studied, but there is little doubt that she was an

able mathematician before she married. For each calculation Mary could have to look up 12 figures in astronomical tables and perform 14 additions or subtractions on the data – then repeat it for every day of a month. It was very boring work but Mary was very accurate and rarely made mistakes.

When, in 1784 John Edwards' passion for telescopes proved fatal (he inhaled a lungfull of arsenic fumes when experimenting with suitable metals for the reflecting surface of his telescope mirror), Mary and the children faced poverty unless the Board of Longitude would officially employ a woman. They did so because she was so good at the task.

In fact Mary Edwards was so quick and so accurate that she was employed and continued to do this work for another

forty years. She could complete a two-month chunk of tables in three weeks which took most other 'human computers' several months to complete.

History continues to show that women have done some extraordinary things behind the scenes. The book from which this information came is "Mary Edwards: Computing for a living in 18<sup>th</sup>-century England" by Mary Croaken as reviewed in "New Scientist" March 13 2004

## QSL cards for those YL DXpeditions

A note from Gwen VK3DYL tells us that the requests for confirmation of contacts for the 2003 (and 2001/2002) DXpeditions to those interesting Pacific Islands is slowing down, so maybe this is the time for you to send your QSL cards to her.

Gwen would rather have the cards now than in a couple of years time, as anyone who has been QSL manager can tell you does happen. So please apply for those special QSL cards NOW.

## Mini ALARA gatherings in VK5

At the recent meeting of AHARS there were five or six YLs clustered around Sue Mahony and her spinning wheel, as the photo shows. At the barbecue arranged as feedback to amateurs after the recent Jamboree there were again five or six YLs, members of both ALARA and AHARS. We really should stop meeting like this!!



YLs with Sue at the Buy and Sell Shirley, VK5JSH, Jenny Zeitz, a soon to be member, Meg VK5YG standing and Sue Mahony at the spinning wheel



The President Susan VK7LUV being pinned by Jean Shaw

## ALARA YLs really exist!

Recently our President Susan VK7LUV met a real ALARA YL. Jean Shaw, our Awards Manager and her OM were in Tasmania and took time to visit Susan to present her with her "President" badge.

The photo shows Jean pinning on the badge. Jean was the first actual member Susan has met.

## New "Dummies" Book

73 Richard VK2SKY

*Ham Radio for Dummies*  
by Ward Silver N0AX

I just spotted an interesting article at <http://www.eham.net/articles/8143>. It appears that the "... for Dummies" book series has just added a book on Amateur Radio. Don't know when it will be available here though it might be worth a mention in AR.

(Amazon.com has it in their catalogue)

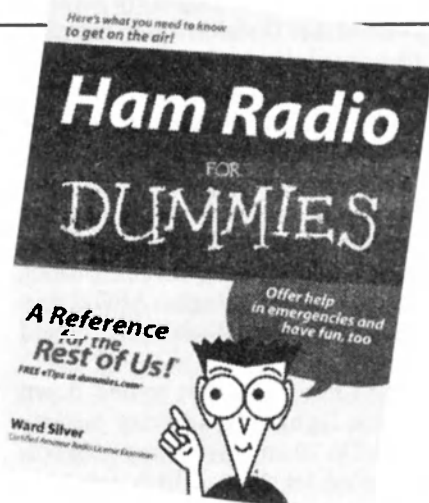

## VK1 News

### Forward Bias

#### Leslie A. Moxon, G6XN, silent key!

He died in England on March 3, 2004. He was 95 and among the oldest Amateur Radio operators in the UK. Licensed in 1928, Les was well-known among the amateur community for his writings on antennas, in particular his 1982 book *HF Antennas for All Locations*, now in its second edition. His book set the standard for practical antenna books and is still referred to by amateurs today. His son, David, said that his father grew antennas in the backyard the way others grew plants and shrubs, and a new antenna design was always taking shape. Of his many antenna designs, one was published in QST of

July 1952 entitled "Two-element Driven Arrays". And another will appear in April 2004 entitled "A 6 Meter Moxon Antenna". Several other of his articles appeared during the 1970s and 1980s in Ham Radio Magazine.

#### New licence

A brand new licence has been issued to W. (Bill) Robertson with callsign VK1WPR, who also became a member of the Division recently.

#### National WIA

During the last general meeting of the ACT Division it was decided by the members present that the WIA transforms itself from a federally based organisation into a National entity. For

those of us who like to try a different band with different operating parameters, try 160 metre. To get on top of the topband, log on to the topband reflector at [www.contesting.com](http://www.contesting.com) and make some preparations for the various topband contest. Two popular ones are the trans/Tasman contest on July 18 and the ARRL contest on December 4/5.

#### Reminders

**Trash & Treasure on Sunday, May 16** at noon in the compound of the Parks & Garden Depot, Longerenong St, Farrer. Sellers and buyers welcome.

**Another T & T on Monday, August 23** at 8 pm in the Scout Hall, same address. Next general meeting on Monday, May 24 at 8 pm. Cheers.

## VK2 News

Tim Mills VK2ZTM.

Hello there. When these notes were being compiled it was before the AGM and there is little that can be reported until the June notes. The Sunday news sessions at 10 am and 7.30 pm will keep you informed in the meantime. As reported in the April notes, there were only eight nominations received for the nine Council positions. Some arm twisting will no doubt go on for the ninth position. Until any changes are perhaps introduced, the Division has to function on its normal day to day basis. Sydney based assistance is always welcomed.

This month it is planned to hold the Conference of Clubs on Saturday 29th at Parramatta. Next day, Sunday 30th will be the usual Trash and Treasure at Parramatta, followed by the Home Brew meeting. On June 12th and 13th, the long weekend, the Oxley Region ARC at Port Macquarie conduct their annual field day.

VK2WI has just about settled down after the lightning activity in late January. On 70 cm., a new repeater was constructed for 8525, which left 8600

operational. An additional licence has been applied for, for a system on 9900. One of these repeaters will be assigned to the linked network when development reaches Dural. Currently both the 2 metre and 70 cm VK2RSY beacons are off air due to faults and their age. A licence is also being requested for a 6 metre beacon on 50.289 MHz in the CW mode. The slow morse transmissions continue whenever the computer decides to start after a power down. It too is old and an update is planned. The 80 metre transmitter is now running about 30 watt to a low inverted vee dipole. It had a minor fault in that the output power would slowly increase, which was finally too much for the power supply and it kept expiring. A new, matched power supply has corrected the problem. There is still some interest in morse, or at least this transmission, it would appear. Whenever it would go missing, there were calls to the Parramatta office inquiring as to its status. We know that some use is made of the signal as a

propagation indicator. The latest lightning induced problem appears to have been with the 30 pair Telstra cable, which is underground on the Dural property. Several circuits developed earth faults due to water. It is in the process of being replaced as we write.

As the winter conditions develop, the Sunday evening news session is providing good coverage in eastern Australia. Often, the 80 metre callbacks equal or exceed the morning 40 metre reports. The AM transmission on 40 metres - 7146 kHz - still has a [almost] clear channel in our time slot. As the evening advances and it gets dark in the Middle East, there is considerable traffic near the channel. Hopefully it stays that way. There are few evening reports on 30 and 20 metre. It would appear that most HF listening at that time is to the 80 and 40 metre transmissions. The 160 metre AM transmitter has been off for a while as tree growth encased the antenna. While the site is extensive, finding a path longer than 80 metres,

clear of trees is proving a challenge for the dipole. It is almost as though trees are attracted to RF. The antenna is a dipole hung as an inverted vee. Poor rocky ground has not helped in considering a vertical system. We would be interested in hearing about or

receiving details of easily constructed 160 metre antennas with a ground wave component.

Those readers into constructing antennas and guying masts and needing insulators should check out the rural supply stores that handle electric

fencing. Nowadays the range is usually confined to various plastic versions, rather than the older ceramic or porcelain models. The price is usually attractive compared to the more traditional sources at the electronic stores.

Regards - 73, Tim VK2ZTM.

## VK3 News

Jim Linton VK3PC

WIA Victoria web site: [www.wiavic.org.au](http://www.wiavic.org.au)

email: [wiavic@wiavic.org.au](mailto:wiavic@wiavic.org.au)

### WIA restructure proposal update

The WIA Federal Convention (AGM) held in Brisbane 2-4 April has provided considerably more detail of an evolving plan to restructure the WIA into a National Body. This was the very first occasion at which the WIA has met to discuss the restructure proposal.

There was concern by the majority of the delegates representing the seven WIA Divisions at the Federal Convention about an implementation agreement. A binding contract requiring two signatures from each WIA Division. This agreement, still in draft form, was only produced during the Federal Convention, following extensive discussion involving all in attendance. It has since undergone further changes.

The WIA Victoria delegates in Brisbane were unable to commit on-the-spot to that agreement or a new constitution for the proposed National Body, due to it only being previously available in various draft forms.

WIA Victoria reaffirmed its commitment to the membership that it would work cooperatively with those seeking a national body. This has occurred before, during and following the Brisbane convention.

The other part of the commitment to members was that the WIA Victoria Council would seek legal and other professional advice on documents provided, and have the members make the final decision about the proposed restructure once all of the relevant material was available.

In recognition that WIA Victoria is a public company limited by guarantee,

its councillors (directors) need to act in accordance with the current WIA Victoria constitution, and Corporations Law.

Michael Owen VK3KI, who is assisting with the key documentation for the proposed restructure, stated at the Federal Convention that control of the VK3 and VK2 assets was required to make a National body viable and give it an appearance of having "substance". He also firmly believes that WIA Victoria and WIA NSW must remain in existence as companies.

WIA Victoria considers that the draft National Constitution provides a basis for discussion. However, in its present form, it does not adequately address the enormous contribution expected from VK3 and VK2 in terms of membership numbers or assets.

WIA Victoria acknowledges the changes introduced so far by Mr. Owen to the draft National Constitution, which are in response to input provided by WIA Victoria.

Further negotiation is needed on the issue of adequate local representation, protection of the membership and assets, which need to be locked into any national constitution and implementation agreement. This requires legal advice to be obtained on the documentation that is now available. The WIA Victoria Council will then call a meeting of members for a decision.

### New Honorary Life Member

A radio amateur who has actively contributed to the WIA and amateur radio generally over three decades, John

Martin VK3KWA, has been made Life Member of the Wireless Institute of Australia.

His first active involvement with WIA was when he became a member of the VHF Advisory Committee (VHFAC) in about 1974, which stemmed from his interest in the higher bands since 1968.

Soon after joining the VHFAC he also became a member of the WIA Federal Repeater Committee, mainly to facilitate contact between it and the VHFAC. It enabled him to build up knowledge and an historical perspective that continues to prove valuable to the WIA today.

Coinciding with the merging of the VHFAC into the WIA Federal Technical Advisory Committee (FTAC) in around 1981 he became inactive. Upon early retirement he resumed his involvement and ultimately after a few years inherited the position of FTAC Chairman from Rob Milliken VK1KRM in 1990.

Concurrently he has managed the WIA VHF/UHF Spring and Summer Field Days and the Ross Hull Memorial Trophy, plus adjudicating VHF/UHF/Microwave distance records and maintaining them.

He produced these records dating back to 1947 by searching through Amateur Radio magazine and other references to document the history of this activity.

Disputes over distance record claims or complaints about the running of the field days and the Ross Hull are unknown, due to the excellent stewardship he provides.

The knowledge of John has been vital in other WIA activities including since 1990/91 WIA/ACA Liaison, writing or assisting with submissions to the ACA, revision of the Amateur Licence

## Coax Cable & Connectors

**Low Loss 50 Ω**

**For  
2.4 GHz  
(WIFI) &  
Ham Radio**

### Cable

Type	CFD-200	CFD-400
OD (mm)	5	10
dB/m	150 MHz	0.130
	2400 MHz	0.220
\$/m	\$2.50 (\$1.50 *)	\$4.00 (\$2.00 *)

### Connectors

N-Type	\$7.00 (\$3.00 *)	\$7.00 (\$4.00 *)
RPSMA or RG7NC	\$10.00 (\$5.00 *)	n/a
Pigtails	email	

\* = bulk price

Web: [www.freenet-antennas.com](http://www.freenet-antennas.com)  
Email: [sales@freenet-antennas.com](mailto:sales@freenet-antennas.com)  
Tel: +61 (8) 9319 1720

## Division News

Condition Determinations (LCDs), and other regulatory matters.

John Martin has been involved in the WIA responses to the major issues including planned restoration of the entire 6m band to the Amateur Service, removal of the 50 cm band, Low Potential Interference Devices (LIPDs), Amateur Internet Linking Systems, Electromagnetic Radiation (EMR) requirements, and the changing amateur access to the 70cm sub-band 420-430 MHz.

He has been the typical quiet achiever, always working in the background in a highly effective manner.

Attention to detail is a crucial part of his role. Maintenance of the repeater and beacon database on an annual basis has enabled them to be published in the Australian Radio Amateur Callbook, and available to all WIA websites.

A major achievement is gaining the respect of the Technical Advisory

Committees in each state, working through issues with them and achieving a consensus. This includes the revision and publishing of 17 band plans.

The annual FTAC Report to the WIA Federal Council is also always informative. He has earned the respect of the amateur fraternity over the past 30 years, and is a most worthy recipient of WIA Honorary Life Membership.

## Annual General Meeting

WIA Victoria members are reminded of the Annual General Meeting on Wednesday, 26 May.

Formal notification was inserted in the April edition of AR magazine, and posted to members who do not subscribe to the magazine as part of the membership.

See you at the AGM!

## VK6 News

Will McGhie VK6UU

Input to: [will2@inet.net.au](mailto:will2@inet.net.au) 08 9291 7165

## Post-Federal WIA Convention 2004

The VK6 WIA council met on the Tuesday after the WIA Federal convention to discuss outcomes of the convention. It was a baptism of fire for the new VK6 Federal Councilor Trevor VK6HTW, as at the very last minute, Neil VK6NE could not accompany Trevor as planned. The main issue at the VK6 Council meeting was the proposed change from a Federal WIA to a National WIA. What this means in simple terms is to do away with one level of the WIA structure, namely the Divisional WIA. It is believed by some that a single National structure would better serve Australian amateurs. No decisions were made about this important proposal but Trevor returned with considerable information and a written structure for the change. It is this structure that was discussed at the April VK6 council meeting and the discussions are on going. Even though the VK6 Division is

in favor of change, the detail is complex and will require considerable discussion. VK6 WIA members will be consulted before any decision is made.

## A little History

At April's VK6 council meeting Neil, VK6NE read out an email he had received from Mick VK6FP. Mick goes back a long way with Amateur radio (early 60s) and the short bit of history makes for interesting reading. For those who do not know much about VK6 there is a large amount of sparse population and the North West Kimberly region (very top of VK6) is one of the sparsest.

## Time: early 70s

"Charlie Power OIC Derby Radio Telephone Station was easy to get along with. He had his own private aircraft, a two seater Piper, and being an Amateur Radio Ham, VK6CP, we had a lot in common. I used to have regular skeds with Keith VK6KC at Kuri Bay, and Father Basil at Kalumburu, who had a

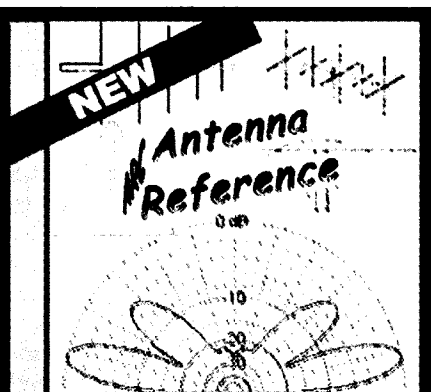

## Antenna Reference CD

Antenna basics, Radiation patterns, Transmission lines, Impedance matching, Built-in calculators and more!

**Only A\$35.00 (approx US\$25.00)**  
plus p&h

**ENQUIRIES WELCOME**

Discounts for upgrades & club members

**Michael Todd Computers & Communications**

15 Conifer Street, Maddington  
Western Australia 6109  
Ph: 0407-089-308

E-mail: [sales@arcompanion.com](mailto:sales@arcompanion.com)  
<http://www.arcompanion.com>



## Division News

limited call sign, so we could only work cross-band, Father Basil using the Flying Doctor frequency. When Father Basil was ready to sit for his full call, he had to sit for it in Wyndham, the Morse test being conducted by The Postmaster. Charlie and I flew up to Kalumburu in the Piper. I stayed at the Mission to set up a transceiver for Amateur bands, while Charlie and Father Basil went to Wyndham. The Morse test was passed and the results wired through to the Commissioner for Post and Telegraphs, a chap I knew in the Signals Section of my Battalion during the War. A call sign was allocated VK6NA. By the time, they returned to the Mission the Amateur Station was ready for action. We received quite a write up in Amateur Radio Magazine. After returning to Derby, I had regular skeds with Father Basil and Keith on 40 metre."

**Mick Paget VK6FP**

### New 10 GHz beacon

A new (refurbished) 10 GHz directional beacon for VK6 at Busselton, 200 kilometre south of Perth. This beacon constructed by The VHF Group joins a 1296.560 MHz beacon at the same site under the callsign VK6RBS. The 10 GHz beacon is on 10368.560 MHz and was installed by Terry VK6ZLT and Luigi VK6YEH. Both beacons point towards Perth over a largely water path.

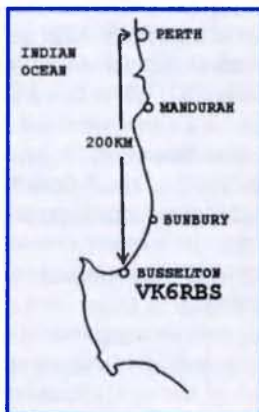

Luigi and 10GHz

**International YL Meet**  
**October 8 to 11, 2004**  
**in Seoul**  
**YLs, start planning your trip**  
**now**

# RippleTech Electronics

## Brand New Dxciting Products

Rippletech Electronics is providing a new service to hams in VK/ZL and the Pacific. Our quarter wave slopers will outperform a quarterwave ground mounted vertical by several dB. You can have access to a DX antenna on 80m and 160m with as little as 15m of ground space (provided you have an existing 15m tower-nally or equivalent).

Our best selling combined 40/80m sloper requires even less space. Alternatively, the TZ-V3 and TZV3w will give you access to 10/15/20m or 12/17/30m with a small budget or small backyard. Mount on your metal garage roof for a surprising signal. New novice operators, what about a rotary dipole for 10/15m only - \$129.00 plus p&p

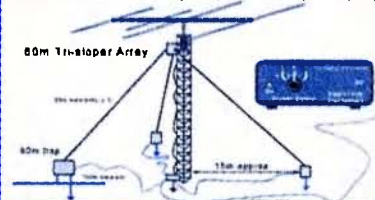

1:1 & 4:1 HF 1kW Baluns	\$59.00
Single 80m sloper	\$109.00
Single 40 & 80m sloper	\$179.00
WARC Rotary dipole	\$289.00
10/15/20 Rotary Dipole	\$279.00
12/17/30 Vertical	\$199.00
10/15/20m Vertical	\$189.00
Radials kits	\$44.00
FT-1000mp remote	\$33.00
30 or 40m Rotary Dipole	\$399.00
80m Sloper Array (3 ele)	\$499.00

### RippleTech Electronics

3 Moyston Close  
 Vermont South  
 VIC 3133



**Phone or Fax**  
**03 9887 2917**

WANT MORE INFO ?  
 PICTURES-DESCRIPTIONS  
 A FULL PRICE LIST  
 OR AN ORDER FORM - see  
[www.rippletech.com.au](http://www.rippletech.com.au)  
[sales@rippletech.com.au](mailto:sales@rippletech.com.au)  
[info@rippletech.com.au](mailto:info@rippletech.com.au)

ABN 70 465 254 759

## VK7 News

Justin Giles-Clark, VK7TW

Email: vk7tw@wia.org.au

Divisional Web Site: www.wia.org.au/vk7

### Divisional News

The Tasmanian Division Annual General Meeting was held on the 13 March 2004 at the Allenvale TAFE College, Launceston. The Divisional Councillors for 2004 are:

From the North West - Ron Churcher, VK7RN and Steve Jones, VK7ZSJ. From the North - Phil Corby, VK7ZAX, Tony Eagling VK7YBG and Geoff Wells, VK7ZOO and from the South - Reg Emmett, VK7KK, Martin Luther, VK7GN and Dale Barnes, VK7DG.

The Divisional Executive is President, Phil Corby, VK7ZAX and Secretary/Treasurer, Dale Barnes, VK7DG. Further information about ex-officio office holders can be found on the divisional website.

Congratulations to Rex Moncur, VK7MO who was awarded the prestigious Ron Wilkinson Award at the WIA Federal Convention in Brisbane. The award was for Rex's work in VHF and UHF communications and in pioneering VHF digital communication modes in Australia. Well done Rex, congratulations from all of us in the Division.

### Branch Meetings

#### North

There is a new Northern 6 Metre Repeater now on test on Mt Barrow. The callsign is VK7RAA. Frequencies are receive on 53.875 MHz and transmit on 52.875 MHz FM.

The March meeting was held on the 10th and a record attendance was witnessed with fine cuisine presented by TAFE cafeteria, wines by Sterling Heights vineyard via Geoff, VK7ZOO and a major fundraising raffle sponsored by Sanitarium Aust via Kevin, VK7KVN.

The evening lecture was by Mick Dennis of Australian Customs and covered all facets of our border controls and major drug trafficking detection. The lecture convincingly proved that drug trafficking has no gains with the current technology that Customs use.

#### South

The Southern 6 metre repeater VK7RAD on the Queen's Domain now has a trial output on 146.850 MHz FM (Ch 5). It is running 60 W into a 6 dB vertical antenna. Please send signal reports to Dave VK7DM or Bob VK7KRW.

At the April meeting held on the 7th it was resolved to open the Domain clubrooms from 7-9pm each Wednesday night for anyone interested in radio and electronics experimentation. This is an invitation to members and non-members to attend.

It was also suggested that the Southern Branch hold business only meetings on one of those Wednesday evenings and leave the other evenings for experimentation and/or presentations, visits, etc.

There were two video presentations after the business meeting that started with a short talk from Rob Gurr, VK5RG, on computer interference to and from radio communications equipment and the second video presentation was given by Geoff Taylor, VK5TY. This talk covered lead/acids, nickel cadmium/nickel iron batteries, the care, maintenance and dos and don'ts. These presentations were provided by the Adelaide Hills Amateur Radio Society and I express my sincere gratitude to Geoff, VK5TY and the club for being allowed to show them.

### PLC/BPL Pilot in Hobart, Tasmania

The main energy authority, Aurora is in the process of implementing a small pilot of Power Line Communication (PLC) by providing broadband Internet to 4 houses and to the 1st and 2nd floors of the Aurora office building. Mitsubishi engineers

from Japan have installed the pilot and it will run for two months.

The system uses the DS2 chipset, which uses multiple carriers between about 4 MHz and 20 MHz. Multiple carriers can usually be heard on the 40 and 20 metre band in the form the system is normally configured. The signal should sound like multiple carriers approximately 5 kHz apart as you tune across the band. When the system is idle you will hear a click, click approximately every second. This has already been heard in the Hobart area on the 80 metre band.

Please keep your ear out for BPL/PLC type interference on the HF bands and keep a log of the interference that includes time/date/band/strength, etc.

### Targa Tasmania

Targa Tasmania is Australia's premier tarmac rally. This year it runs from 27 April to 2 May 2004 and is staged all around Tasmania. The Southern WICEN group and many other helpers provide the radio communication support during this event. This is a major training experience for this team of highly dedicated enthusiasts. This group is well respected by the event organisers.

ar



Targa Tasmania, providing training and experience for amateurs in portable/mobile operation as well as a great promotional opportunity. Photo courtesy of Roger, VK7XRN.

## Kenya has made licensing much quicker and easier

I thought you might like to know that our Licensing authority CCK has just dropped the requirement for reciprocal agreements, Police checking and Security vetting. They now want diplomatic relations between the applicant's country and Kenya, but this might be eased if circumstances dictate. CCK will verify all licenses with the originating office by e-mail.

Applicants must complete the new form, which will be on the CCK website ([www.cck.go.ke](http://www.cck.go.ke)) quite soon, and submit photocopies of the license and passport certified by a Commissioner for Oaths - no other will do. The fee is still K.Shs.3,000, about US\$39 at present. Anyone interested can look up details on our website at [www.qsl.net/arsk](http://www.qsl.net/arsk). We are now looking at issues in a few hours or a day or two. A far cry from the five and a half years it took one of ours and the more usual 6 - 18 months! It has been a 14 year battle to achieve this, and the relief is terrific!

You may care to pass the news around - I have told New Zealand, PNG and a number of hams who have asked for help in the past, as well as putting it over the IARU reflector. Maybe QST (ARRL) and RadCom (RSGB) may publish it if they have space!

Morse has also been dropped as a requirement, the rules are being brought up to date and documentation revised.

73 from Nairobi

**Ted E.H.M. Alleyne 5Z4NU**  
Chairman/Secretary ARSK

## EchoLink Adelaide

Hi Kingsley,

I have just read your letter, "A bouquet for Echo Link" in April AR and I was quite surprised that you said that there is no Adelaide repeater on echolink, I have been providing the echolink service on VK5RNE for nearly 18 months now, and wonder why you did not see it on the list of stations. The repeater is operated by the North East Radio Club in Adelaide.

The repeater is on every day and the frequency is 439.875, input is 434.875. Node Number 41479. I agree with you it is a wonderful programme The repeater is situated at Ansty's Hill.

I am sorry to read that you have not been too well and had a spell in the hospital.

Wishing you a speedy recovery.

**Alan Mallabone VK5KAM.**

## Ham Advertising

A recent unexpected bonus from the ATO coupled with the new "no Morse code" condition has me shopping for a portable HF/6m rig to complement my VHF set up.

Who would think the money would be so difficult to spend?

I live in an isolated area of NSW, so comparison-shopping is done via the www and magazine(s). So, why is it that so few Ham stores put prices in their print or web advertising? Print, with its relatively long lead-time I can *almost* understand, although Lee Andrews manages, but not having up to date prices on a website is inexcusable!

Speaking of which, here's an open question to all Ham and/or retail radio stores. Why do so few have an "effective" website? A wealth of IT talent abounds in the Ham fraternity, one only has to look at a few of the Amateur Radio websites, including the various WIA sites, to see that. I don't expect the full e-shopping bit, just an effective site, easy to navigate with all the required information including tech-specs and price!

Perhaps the IT industry has spoiled me!

**Norm McMillan VK2XCI**

## Info wanted

I have a Multi Band Quad Hub marked "CLARK VK3AS" with some parts missing. There was article in "Amateur Radio" way back in the early 1970s if I remember correctly. Could someone help me with some info, please.

**Craig S. Martin VK2ZCM**

Views expressed in the 'Over to you' column are those of the authors, and do not necessarily reflect the policies of the Wireless Institute of Australia.

Send contributions to:

The Editor, Amateur Radio Magazine, 34 Hawker Crescent, Elizabeth East SA 5112 or email: [edarmag@chariot.net.au](mailto:edarmag@chariot.net.au)

## Silent Key

### Col Wright, VK7LZ

The 22 March 2004 saw the passing of Col Wright VK7LZ, Tasmania's oldest amateur and patron of the Wireless Institute in Tasmania at age 92.

Col built his first crystal set about 1925 when he was 12 and listened to amateur station 7BC on Sunday afternoons. He obtained his amateur license in 1933 and became active on the HF bands. Later, he had a regular program for broadcast listeners on the 200 metre band.

Following service in the RAAF during World War 2, Col became very active on

the VHF bands, 50MHz and 144MHz. He even managed to contact Melbourne on 288MHz. Later on 432MHz with his 64 element array he regularly contacted Victorian stations from Launceston. Col held records on 50 MHz, 144 MHz, 288 MHz and 432 MHz.

Col became very active on amateur satellites when they first started and obtained one of the first certificates for working 1000 stations via satellite. In between all this VHF and UHF activity he managed to contact 300 different

countries on HF.

Col was very active in the WIA, being the main organiser of the Northern Zone when it started in 1938 and reformed in 1947. Col was a life member of the WIA.

In recent years Col attended the Wednesday lunch time get-togethers at the Queen's Domain and was always interested in and encouraged technical developments and the construction activities of others.

Vale Col.

**Richard VK7RO & Rex VK7MO**

## Meanwhile, back at the farm, it's time to take stock

Right now you could be forgiven for thinking things have been better in the amateur radio satellite game.

The prospects of getting AO-40 back are getting slimmer by the week. Despite the on-going efforts of the worldwide group of control stations, it has not responded to any commands for a couple of months. On one occasion several weeks ago Colin Hurst VK5HI heard what sounded like a peak in the noise level around the beacon frequency when certain commands were given. This report caused everyone to re-double their efforts but unfortunately other control stations have been unable to duplicate the situation and hear the noise. AO-40 may be lost or at best it could take a long time for the battery problem to clear, perhaps in the same fashion that gave us back AO-07.

So, what's the state of the high orbit birds at present? AO-13 de-orbited and burned up a few years ago due in part to a malfunction during its launch making the orbit unstable. So the high orbit contingent now numbers only one and that old campaigner, AO-10 has been out of control for many years and is semi-operational to put the best face on it.

### The AMSAT group in Australia

The National Co-ordinator of AMSAT-VK is Graham Ratcliff VK5AGR. No formal application is necessary for membership and no membership fees apply. Graham maintains an email mailing list for breaking news and such things as software releases. Members use the AMSAT-Australia HF net as a forum.

### AMSAT-Australia HF net

The net meets formally on the second Sunday evening of the month. In winter (end of March until the end of October) the net meets on 3.685 MHz at 1000 UTC with early check-ins at 0945 UTC. In summer (end of October until end of March) the net meets on 7.068 MHz at 0900 UTC with early check-ins at 0845 UTC. All communication regarding AMSAT-Australia matters can be addressed to:

AMSAT-VK,  
9 Homer Rd,  
Clarence Park, SA. 5034  
Graham's email address is:  
vk5agr@amsat.org

Good contacts over long distances are reported from time to time but it is by no means regular in operation and can no longer be relied upon. Similarly our digital satellite "fleet" which at one stage numbered three 9600 baud and two 38k4 satellites all built in the Surrey mould, is now down to one semi-operational 9600 baud satellite and ironically that too is the oldest in the fleet, UO-22. It goes into eclipse for long periods but when it is in full sunlight the performance is just as good as ever. The remaining 38k4 bird, MO-46 is only partially active and is often turned off for long periods. That has struck a discouraging blow to the large number of digital satellite operators who some years ago made up the keenest core of satellite users. We were looking forward eagerly to faster baud rates and higher resolution cameras but those ideals seem to have been put on hold indefinitely.

AO-7, which came to life again after almost two decades of silence, is struggling along and providing some irregular communications when in sunlight. PCsat has been kept partially alive for about two years now by a dedicated group of controllers but in essence it too is virtually dead from an operator's point of view. The last of the Russian RS series, RS-15 is not responding to commands and it seems to be dead or damaged. FO-20 is listed as semi-operational but is far from reliable. The last of the 1200 baud BBS type satellites IO-26 has problems and the control team is trying without success to upload new software for the BBS so at present no uplinks are available. Even the old faithful UO-11, now in its 21st year has been sluggish in operation lately. It never did have any communication facility being one of the early "beacon-only" satellites but it did have a large following of dedicated users, particularly among educators.

The International Space Station's ARISS project is listed as operational but in fact has been very unreliable since the

Shuttle accident. I guess the crew have been pretty busy one way and another and are concentrating on scheduled school contacts rather than general amateur radio chatting. The digipeater is turned on sometimes but is off for long periods. It's hoped this situation will improve as time goes on and operations return to normal on ISS and to this end the ARISS equipment has received some welcome upgrades in recent months. It is approaching full functionality. AO-16 is listed as semi-operational but is really only in APRS digi mode.

Now, looking back, that's not a very encouraging overall situation, so it may be time to take stock of what is around and what is on the horizon. FO-29 is listed as being in mode JA. That means analog operation so SSB and CW stations can use the transponder. I have no experience myself but reports on the AMSAT-BB seem to indicate that the JA mode provides good communication.

The Fuji web site is notorious for being out of date with its information so it's better to look on the BB for late status reports on this satellite. AO-27 always seems to be listed as operational but its schedule only applies to its time orbiting over the USA and environs. It has never been turned on down this way so don't be fooled. Again SO-41 is listed as operational but I have yet to hear any activity from this bird. In similar vein SO-50 is listed as operational as a mode-J FM repeater. I have not had any reports of contacts recently but some people claim that it's up and running. It requires a 67Hz tone for operation on demand. There are frequent reports on the BB of it being unworkable. My last information is that there are stations in VK authorised to turn on this bird when it's over this part of the world.

If your taste turns to digipeating UI frames (packets) through satellites then you have a couple of choices. AO-16 is listed as turned on for digipeating UI frames and I guess this would be of interest to the APRS gang. NO-45 fills a

similar role and is also listed as operational. Although not in very good shape PCsat NO-44 is also listed as being in APRS digi mode.

The latest information on the condition of these birds is available by looking up the latest Amateur Satellite Report on the AMSAT-NA web site. You can subscribe to this service by following instructions on the web site. Remember though, it's only as good as the incoming information. The list managers are always on the lookout for up to date information. If you know of any

variations from the listed information please let them know. Your reports will be welcome and will be included in the list.

That's about the current situation and it doesn't paint a pretty picture, but there are some good things in the pipeline. If you visit the web site of KD4APP at <http://kd4app.webhop.org/> you will see a compact list of current and projected satellites. The list of projected satellites looks a bit too good to be true and some of the birds listed as being in the pipeline

may never get off the ground. Some are University projects and may or may not have an amateur radio component when launched. The only ones I have been able to get any firm information on are ECHO which will be launched later this year, EAGLE which is slated for launch in 2006 and PCsat-2 which is also listed for launch in the near future and has undergone most testing already. Full information on all these satellites is available on the AMSAT-NA website by following the various links.

## AMSAT-DL's Mars mission is moving right along

**This ambitious project, at present named "phase 5A" is centred around the University of Marburg in Germany and is largely the brainchild of Dr Karl Meinzer DJ4ZC.**

With Karl's close involvement you can be sure it will have some amateur radio content. The exact nature of that content has not yet been divulged but it is virtually certain that it would not include transponders of any kind. The communications link budget will be taxing enough but the timing problems caused by the vast distances would render anything approaching "real-time" operation right out of the means of ordinary amateurs and would tax even the keenest operators with state-of-the-art gear. The most any amateur satellite

operator could hope for would be some sort of telemetry system, probably 400 baud or lower. A number of tests have already been made from the Bocham test site of the proposed earth station for P5A using the telemetry signals from various Mars missions currently in progress.

Surprisingly good results have been achieved by other amateurs using dishes as small as 3 metres and more or less standard EME class receiving gear coupled to DSP soundcard software. Detecting such a signal from a

commercial satellite is one thing but actually decoding telemetry from P5A may well be another kettle of fish. It may come to pass that the job will be beyond the resources of operators with even quite good Oscar class or EME class stations.

It will be a fantastic challenge for those able to 'tool-up' for the job but would hardly be of consuming interest to the vast bulk of satellite operators. We'll certainly be watching developments with great interest.

## Another worrying threat to satellite bands

**A recent posting to the AMSAT-BB pointed out that repeater frequencies in Sweden had recently been changed and some were now listed as having uplink channels in the satellite bands.**

It appears that this situation has been brought about to avoid ISM interference, which is a particular problem in Europe and becoming critical in Scandinavia. It can render repeaters unusable and it seems that juggling uplink frequencies is the only way out. The situation is to be brought to the notice of the Swedish amateur radio band planners in the hope some changes can be made.

It just goes to show how closely intertwined these matters can be. We can only hope similar situations don't arise here and that something can be done to reach a solution to the problem. I can remember Scandinavian amateurs being very active back in the early days of AO-10 and AO-13 when footprints dictated

that antennas at both ends of the contact point close to the horizon.

With repeater DX-ing gaining in popularity, increasing numbers of operators will be using high gain arrays and high power to access distant repeaters. It has the potential to become a big problem to satellite operators if not addressed in the planning stage. Satellites by design carry very sensitive receivers. One only has to recall the problems from Asian taxi-phones and fishing boat radios pirating on 2 m and 70 cm when satellites rise to our north. And they are only running low power and omni antennas.

ar

**Plan ahead...**

**GippsTech**

July 3rd and 4th

**Remembrance Day Contest**

August 14th and 15th

**International Museum activation**

August ?

**International Lighthouse activation**

August 21st and 22nd

**JOTA**

October 16th and 17th

# Contests

Ian Godsil VK3JS

## Contest Calendar May – July 2004

1-2	May	Ten-Ten Intl. Sprint QSO Party	(CW/Digi)
1-2	May	ARI Intl. DX Contest	(CW/SSB/Digi)
8/9	May	CQ-M Intl. DX Contest	(CW/SSB/SSTV)
15/16	May	King of Spain Contest	(CW)
22	May	VK/trans-Tasman Contest	(SSB)
		<i>Web Site - <a href="http://home.iprimus.com.au/vktasman/rules.htm">http://home.iprimus.com.au/vktasman/rules.htm</a></i>	
29/30	May	CQ WW WPX Contest (CW)	
5	June	VK/trans-Tasman Contest (CW)	
		<i>see Web Site above</i>	
12/13	June	ANARTS Contest (RTTY)	
12	June	Portugal day DX Contest (SSB)	
12	June	Asia-Pacific Sprint Contest (SSB)	
19/20	June	All Asian DX Contest (CW)	
26/27	June	Marconi Memorial Contest (CW)	
26/27	June	King of Spain Contest (SSB)	

*Greetings to all readers*

## Are you methodical and dedicated?

Recently I picked up a free magazine whilst shopping. Its tenor was towards being organised and being positive. These concepts are certainly still very valid for those wanting to make a successful career. I think we all know that little effort brings little serious reward.

Are these ideas valid for hobbies? Yes, I think they are. Certainly, if you are taking part in an hobby there is not normally pressure to be the tops, unless you are in a competition – swimming, bowls, best roses or whatever. If we apply this to our AR hobby, is not a contest a competition? Therefore, being organised and positive in our approach is most relevant.

How many of us seriously prepare for a coming contest? Do we know the rules? Have logging materials prepared in advance? Check that our equipment is in good working order (isn't it amazing how little things can go astray once a contest is under way)? Make sure that we have had plenty of rest in the week

leading up to the contest?

These seem to be self-evident, but how many of us take them seriously? We don't have 48-hour contests in Australia, but some USA DX events are. Many serious US contesters go off to DX sites with huge amounts of equipment. All very fine and interesting, but sleep then becomes a priority. It is not normal to sit up for 24 or 48 hours. The risk of making mistakes probably increases exponentially as the hours pass. So we can help ourselves by getting to bed early on the nights preceding the contest weekend. It certainly does help.

So as we enter the 2004 VK/ZL contest period I commend to you the time-honoured principles of being organised and positive. Keep your actions positive because your actions become your values.

### Jack Files Contest

Last year a request was made for suggestions for enhancing this VK4-based event and I know that ideas were

put forward. I have received a note from John Spooner VK4AJS that this year's contest will follow the same lines as last year and that any changes will be introduced in 2005. Please see [vkham.com](http://vkham.com) contest page for details and rules will be published here next month.

**Good luck in the contests.**

73, Ian Godsil VK3JS

### CORRECTION

#### Summer VHF-UHF Field Day

A log was accidentally omitted from the results for the last Summer VHF-UHF Field Day. The details are:

**Section B - Single operator, 6 hours**

VK5ZUC - Andrew Russell  
Score: 6m 43, 2m 237, 70cm 110, total 390 points.

# Rules Summary: VK/trans-Tasman Contests

(Summary only. Full details available on web site

<http://home.iprimus.com.au/vktasman/rules.htm>)

From Bruce Renn VK3JWZ, Contest Manager

Dates: Sat 22 May 80 metre Phone  
Sat 5 June 80 metre CW  
Sat 17 July 160 metre CW/Phone  
Time: 0800 - 1400 UTC  
Frequencies: 80 m Phone 3.535 - 3.625 MHz  
80 m CW: 3.500 - 3.550 MHz  
160 m CW: 1.810 - 1.835 MHz  
160 m Phone: 1.840 - 1.875 MHz  
Categories: Single Operator, Multi-operator, QRP, SWL  
Callsigns: VK4s north of Tropic of Capricorn to add "Central" after callsign. QRP stations to add "Quebec" or "/Q".

Scoring: See detailed rules for individual scores. Final Score will be sum of five (5) highest scoring hours.

Logs: Separate log for each Category entered. New log sheet for each separate hour, with hourly totals at bottom. Each contact to show time (UTC), callsign worked, exchange. Summary Sheet shall accompany each log showing operator's callsign, name and address, email (if applicable), categories entered and points claimed.

Send Logs by mail to: VK/trans-Tasman Contest, 28 Crampton Crescent, Rosanna, 3084. Logs may be sent via email to: [vktasman@hotmail.com](mailto:vktasman@hotmail.com)

Closing Dates:

19 June (80 m Phone/SWL)

3 July (80 m CW)

15 August (160 m Phone/CW)

Awards: Various awards available. See detailed rules.

ar

## Club News

### Fort Queenscliff – Telegraph Station

The Geelong Amateur Radio Club have undertaken to assist the Friends of Fort Queenscliff in their effort to turn the 150 year old Telegraph Station within the Queenscliff fort into a display area which will be included in the tours of the Fort.

To quote from the letter from Major General Mike O'Brien. In one room "We are working towards four to six story boards that have about 200 words of text

and include photographs where we can find them. In the other room we would plan to display hardware such as Morse keys and similar telegraph equipment (of the period)."

In view of the worthiness of this idea and the need to preserve the history of the telegraph station and its very important role in shipping, the GARC asks for assistance from anyone who can provide

- 1 any information
- 2 any photos (even for copying)
- 3 hardware either as a gift or on extended loan

Any offers -please contact initially David Godfrey

[jadlgod@ozemail.com.au](mailto:jadlgod@ozemail.com.au) OR Mike O'Brien [MikeOBrien@bigpond.com](mailto:MikeOBrien@bigpond.com)

David Godfrey VK3AZX

### North East Radio Club

Saturday March 20th several members of the club ventured out for the John Moyle Field Day. A station was set up at Mt Gawler and operated for the first 6 hours of the contest. Quite a few contacts were made on 20 and 40 metres. The 6m, 2m, 70cm and 23cm VHF and UHF bands were used with over 100 contacts made. The weather was fine and warm; all operators had a great day.

- The May meeting of NERC will be on the 14th and will be a presentation on the Pedal Prix. Alex McCallum will speak on his involvement in this activity.
- June 11th will be a presentation on computer log keeping.

- July 9th is the Club AGM. Food and refreshments will be provided on the night. Time now to volunteer for the committee.

I will report on our annual buy and sell next month. This was held on April 17th.

The nights on Atmel processors held on the last Friday of each month are continuing, it is expected these will run until the end of the year. This will allow members to construct their own projects as they become familiar with programming.

The North East Radio Club meets on the second Friday of each month at the Ardtornish Primary School, Saarinen Ave St Agnes. Doors open at 1930.

David Clegg VK5AMK

### Waverley Amateur Radio Society - Annual Club Auction

The club will be holding its annual auction on Saturday, June 19th at the clubhouse in Vickery Avenue, Rose Bay, Sydney. Gates open 8:30 and the sale starts at 10:30. Goods consist of useful ham radio, computer and electronic gear and it is open to all wishing to buy or sell. Full details are available on the club's web site at [www.vk2bv.org](http://www.vk2bv.org) or by phone from Simon VK2UA, on 02 9328 7141.

## Adelaide Hills Amateur Radio Society

Christine Taylor VK5CTY

The March meeting was a members' Buy and Sell. As usual it was well attended and some money changed hands as one person's junk became another person's treasure. Many more members took the opportunity to renew their subscriptions at the old rate rather than have to pay more after the end of April. By the time you read this it will be too late to 'get in early'.

A week or so later about 20 AHARS members went to the 'wind-up' barbecue where we heard about the recent Scout radio activities associated with the Jamboree and about the changes under consideration for the 'remaking' of the WIA. We were reminded that the proposed constitution for the new company was included in the March issue of AR and it was recommended that we read it to understand what changes were coming.

Everyone (not only the YLs) also enjoyed the Ikebana style flower arranging demonstration given by Alicia and the winners of the raffle were delighted to be allowed to take home the finished products. Next time a certain amateur talks about not having room for his amateur gear because of the 'pots' in the house, it could be one we know. Beware of garage sales!!

As usual VK5BAR was busy during the John Moyle Memorial Field Day. This year was the 'year of the LED'S'. Geoff used several LEDs to light the outside of the building during the night hours (it was during the dark of the moon, which has a close resemblance to the inside of a cow). Later, the kitchen was 'invaded' by Daleks. Three members each with a LED 'headlamp'.

We also hope a high score will earn its just reward.

Anyone in Adelaide on the third Thursday of a month is very welcome to attend an AHARS meeting. Contact Geoff VK5TY or Paul VK5PH for more details.



A general view of the members Buy and Sell AHARS



Leanne Adcock (RIG) in front of a display about the Jamboree station.



Shirley VK5JSH with her winning flower arrangement



"The Daleks" Steve VK5ZHT, Paul VK5ZRT, and Chris VK5YME



## Geelong Amateur Radio Club

### President's Report

Looking back over the last year from June 13th 2003 I find much for the GARC to be satisfied, even pleased about. The committee took the suggestions put forward at the meeting on June 13th and worked their way through them. They have worked consistently in your interest to ensure a better GARC. You each received a copy of those suggestions and of the 14 points needing action only two were not discussed or acted upon. They were 'Visit other clubs to gather ideas' and 'Some possible association with amateurs in the Werribee/ Hoppers Crossing area' This is not to say that more could not have been done, but in general members should be well satisfied with the effort put in by their elected committee.

Meetings have been better attended, but it is a great pity that more members have not taken advantage of the excellent quality of the presentations the club has enjoyed, and the camaraderie offered by people of like interest. A look at the syllabus items illustrates the range of topics, all with a distinctly amateur bias and many at the cutting edge of electro-technology.

Some highlights of the year were

- Field operations Black Lighthouse, Ross Hull, VHF field day, RD contest, John Moyle (15 callsigns in the field);
- Christmas breakup at Barbara and Mike's place;
- Club dinner.

I'm sure that you will agree that the degree of activity indicates that GARC is in robust good health. Our premises and equipment are excellent and in good repair, and our finances are sound.

BUT

Too much still revolves around too few. Certainly the number of presenters has increased and as a result the topics covered will diversify – look at the 2004 syllabus; but we need more people prepared to contribute. We all have a story so please share yours with other members. It does not need to have a radio content. It could be a holiday,

another hobby, riding a bicycle, catching crocodiles – the list of possibilities is endless. Please see David VK3XLD, our syllabus convener, to register your presentation.

For the incoming committee there are some matters that will need attention viz.:

- Black Lighthouse, and Friends of the Fort development of the old signal station
- Marconi anniversary
- JOTA
- The new club emergency vehicle
- The need for another club project (to follow the huge success of the antenna project)

Finally I wish to thank everyone for their support of the GARC, the committee and myself. There has been so much active support that I am reluctant to single out special efforts but, as in all things, some do more than others. These are:-

Lee VK3PK and his helpers with the training class- the future of AR  
Mike VK3ASQ and Barbara for duplication, newsletter distribution –at their cost

Regular presenters Chas VK3BRZ  
David VK3XLD  
Lee VK3PK

Syllabus David VK3XLD

Minute secretary Ken VK3AKK

Minutes to web Doug VK3TRD

The rising enthusiasm and interest among members both old and new is tangible and can only assure better outcomes for the GARC in 2004/5.

The Committee as elected at the A.G.M. on 2nd April 2004 is

President David VK3AZX

Secretary Ken VK3AKK

Treasurer Bob VK3HFL (also President nominee 2004/5)

Committee Kelvin VK3ZPK, Lee VK3PK, David VK3AZX

David Godfrey VK3AZX  
ar

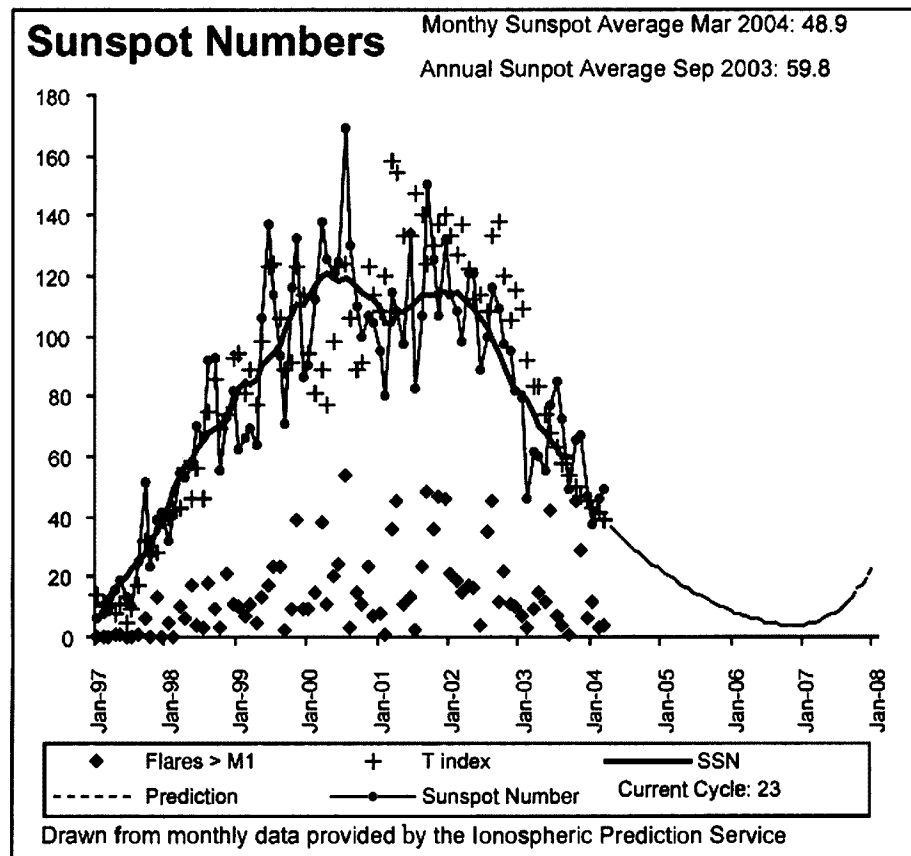

# VHF/UHF - An Expanding World

David Smith VK3HZ - vk3hz@wia.org.au  
Leigh Rainbird VK2KRR - vk2krr@telstra.com

## Weak Signal

David Smith - VK3HZ

There's been a bit of action across the Bight during March - possibly the last for the season. On the evening of March 22nd, Wally VK6WG worked VK5ZBK, VK5DK, VK3ZQB, VK3II and VK3AUU on 2 m. He also worked VK5ZBK, VK5DK and VK3ZQB on 70 cm. The following morning, Wally again appeared and worked VK3II, VK3HZ, VK3ZUX, VK5DK, VK5ZPS and VK5NY on 2 m. He also worked VK3HZ and VK3ZUX on 70 cm - a distance of around 2,600 km. At the time, the VK6RST Mt Barker 70 cm beacon and the VK6REP Esperance 2 m beacon were both audible at good strength in Melbourne. To add to the action, VK6EWI, a DXpedition station on Woody Island off the coast of WA near Esperance (and, needless to say, a very rare gridsquare on 2 m), popped up and worked VK5NY, VK5KNB, VK3AUU, VK3II and VK3ZUX. The DXpedition guys couldn't believe their luck in having a good opening on 2 m while out on the island (Murphy usually strikes and the bands all close down). Meanwhile, Wally VK6WG spent over an hour on 70 cm ragchewing with VK5NY, VK5ZPS and VK5DK with signals consistently S8 to 9 before the band closed down at around 0400Z. That evening, VK6EWI worked VK5AKK,

VK5DK and VK5NY but nothing heard of them in VK3.

Then on the morning of March 26th, Leigh VK2KRR, near Wagga Wagga, heard the Mt Barker 2 m beacon at about S2. He telephoned Wally VK6WG who came up on 2 m and contact was made at S8 to 9. An attempt was made on 70 cm but, with antennas cross-polarised, nothing was heard. The path remained for about an hour before Wally had the call to breakfast. The distance between them is 2645 km, but with a difficult path over land. It was interesting to note reports from VK5NY and VK5ZK in Adelaide, in the same line to Albany as Leigh, both hearing the Esperance beacon but not Mt Barker, whereas Leigh could hear Mt Barker but not Esperance.

Barry VK3BJM reports that he has been travelling again, from Kyneton, Vic, to Fowlers Gap, NSW, to continue exploring Aircraft Enhanced Propagation (AEP) possibilities in far western NSW, and to activate QF08UV over the weekend of 3-4th of April. Whilst there, he had contacts with VK2KRR (684 km), VK2EMA (on 2 m and 70 cm) (551 km), VK5ZK (560 km), VK1DO (860 km), VK3AFW (813 km), VK2ZAB (923 km), VK3II (882 km), and VK5UBC (474 km). Some of these contacts were via troposcatter, some via

AEP. Mobile 2 m contacts were also had with VK3GOM, VK2KRR, VK3CY, and VK5ZK, whilst enroute to Fowlers Gap.

Fowlers Gap is located 114 km north of Broken Hill, on the Silver City Highway. Equipment used was an IC706MkIIg to (on 2 m) a 150 W PA, with inbuilt 21 dB pre-amp, then 6 m LDF4-50 to a 10 element DL6WU yagi. On 70 cm, a 100 W PA, with inbuilt 12 dB pre-amp, via 6 m of LDF4-50 to a 15 element DL6WU yagi. Thanks to John VK2TK and Ron VK3AFW for extended assistance via the HF liaison frequencies, and to all who listened and attempted contacts.

Jim VK3II reports some success in the reduction of interference at his QTH. When conditions are reasonable to the west, he has been suffering from "crud" between 144.295 MHz and 145.300 MHz, effectively wiping out the beacon segment. The source of the interference was narrowed down to the Colac ABC TV translator on channel 5A (sound carrier 143.724 MHz). He contacted the ABC about the problem who then passed the complaint on to Broadcast Australia (they operate the ABC transmitters). They called back to say that they know about the problem and are waiting on a bandpass filter which will be fitted to the translator in the near future.

## EME

Doug VK3UM has been busy on the PC, working on some of his software that is widely used throughout the EME world. Significant upgrades have been made to the EME Calculator and the Site and Radiation Calculator, while new programs include the Transmission Line Calculator and Four Pole Interdigital Filter designer. The programs and details of the changes can be found at [www.qsl.net/sm2cew/download.htm](http://www.qsl.net/sm2cew/download.htm).

Please remember to send through any 2 & 70 FM DX reports to Leigh VK2KRR at vk2krr@telstra.com

## Beacons

The Melbourne 2 m beacon, VK3RTG on 144.430 MHz, is currently off air. Building renovations at the site have resulted in the power being removed. This will be the situation for many weeks. The beacon may be temporarily relocated, pending an upgrade.

The Auckland 6 m beacon, ZL1VHF on 50.0433 MHz has been QRT since the start of April after the antenna pole was felled by chainsaw, cut off at ground level. The beacon will be recommissioned once several paperwork issues have been taken care

of, and a replacement antenna pole has been installed. In the meantime, all equipment has been removed from the site.

Finally, congratulations to our "Digital Modes" man, Rex VK7MO, who has been awarded the WIA Ron Wilkinson Achievement Award in recognition of his achievements and contributions to the knowledge of other radio amateurs in relation to weak signal working on VHF/UHF and microwave bands.

Please send any Weak Signal reports to David VK3HZ at vk3hz@wia.org.au.

# Digital modes

## Rex Moncur - VK7MO

Joe Taylor K1JT, continues to improve WSJT with version 4.6.3 including AFC for JT65 to allow it to cope with less stable rigs. He has also joined up with Alberto I2PHD, to combine WSJT with Spectran. From some initial tests it is particularly useful to identify a very weak signal on Spectran and then lock down the band in which WSJT looks to just a few Hz and sort out the desired signal from birdies.

Since JT44 came out with the ability to give perfect decodes at around -19 dB in a single line and around -22 dB with an average over 4 cycles, Joe has advanced things so that JT65A will produce perfect decodes at around -24

dB and perfect averages over 4 cycles at -26 or -27 dB (all with reference to the noise in a 2.5 kHz passband). A note of caution about WSJT signal reports—they are based on the average in the channel with the maximum level and if the signal drifts outside the channel (just a few Hz) during a cycle then WSJT signal reports can be quite misleading. For example Ian VK3AXH, has had problems with a wonkie crystal in his FT-847 that resulted in signal reports being up to 10 dB less than on a second more stable rig.

Rex VK7MO, will be on a DXpedition to VK6 in early May during the Eta Aquarids meteor shower and initially intends to operate from around Eucla on

the WA/SA border. Rex will TX on 144.330, FSK441B in the first period and use the DXpedition procedures outlined on the NSW VHF Group DX site - <http://www.vhfdx.oz-hams.org>. He will work to the East Coast from 0630 to 0830 EAST. He will beam half way between Melbourne and Sydney so VK2/4 should use the southerly hot spot and VK3/7 the Northerly hot spot. Operations will commence on 1 May for a few days at Eucla and depending on progress a number of grid squares should be available on the way back up to mid May. Skeds to other areas will be possible at other times if you can catch his mobile within range on 0408 147 808.

## 2 m & 70 cm FM DX

### Leigh Rainbird - VK2KRR

March has really pulled up the FM DX scene down south, with the change of seasons coming on and the shortening of daylight hours, things are really taking a dive, still some interesting contacts are being made though. Nice to see conditions returning to the Queensland coast after a wet and windy few months.

John VK2FAD has been able to repeat his interesting path into the Canberra 146.950 repeater again. This is an approximate 350 km trip across the mountains to Mt Ginini from Budgewoi. Good clean signal from John.

A freak change in conditions occurred along the VK4 coastal areas from 6th to 10th March and saw some great conditions down the coast from up north as indicated by the Hepburn charts.

Felix VK4FUQ at Ingham reports that the Mackay repeater was accessible most evenings and mornings. On Monday 8th the Mackay repeater was almost full scale at Felix's QTH and he was able to contact VK4LH, 4OG and 4DJC. Felix reports he was also able to work the Hayman Island repeater.

Later Felix made it to VK4RGA, Gladstone area repeater, and made contact with VK4JIN at Maryborough and VK4KKN in Gladstone. The distance to this repeater for Felix is 797 km and this contact just knocked Mike VK4MIK off top spot in the VK4 Division Repeater Distance Records by a mere 4 km. Well done to Felix for grabbing the top spot.

Later that evening Mike VK4MIK was able to work to the Townsville repeater

and also made a simplex contact with VK4FNQ at Charters Towers on 146.500.

On Wednesday 10th Felix was able to work back to the Gladstone repeater again @ 797 km and also to the Springsure repeater @ 639 km and to the Hodgson Range repeater @ 491 km, which gave Felix 3rd and 4th spots in the VK4 Repeater Distance Records.

Felix also reports that while the Gladstone repeater was coming through, he copied VK4LC from Mt. Tamborine and amazingly, VK2MHB at Murwillumbah. Distance was 461 and 504 km respectively to the repeater.

Sat 13th March, small opening to Melbourne from south VK2. Colin in Melbourne worked VK2KRR twice simplex on 146.500, once in the morning once in the evening. Colin was a good signal up here at a 5/8 @ 334 km. Ian VK3ZZG also put in a very nice signal up here from Bendigo on both 2 & 70. Distance is around 300 km and Ian was 20 dB over on 2 m and a 5/5 on 70 cm.

The John Moyle Field day was held on 20th and 21st March. For a change, there appeared to be more SSB stations on air in comparison to FM stations. Admittedly the conditions were quite poor. The only DX FM stations worked here were VK3SAA near Ballarat @ 359 km and VK3CNE on Mt Macedon @ 320 km. Gavin VK3VTX was also heard in the noise at one stage, along with a number of other stations.

We welcome a new member to the FM DX ranks, Karl VK3HDX in Launceston.

Karl recently passed his exams and is very keen on the VHF DX scene. With only a limited set up Karl has already managed to work right across Bass Strait into the Mt Macedon repeater @ 504 km.

While we're on the subject of VK7, one of the top FM DX stations out of northern Tasmania right now would have to be Dion VK7YBI near Burnie. Dion gets out very well with his new twin yagi array, and is heard at locations you would not believe. On Monday evening 22nd March, Dion reports that the conditions were quite exceptional, all stations heard on repeaters were also being copied on simplex and many repeaters were 60 dB+ with no pre-amp! Dion worked simplex on 146.500 with VK5HAY and VK5HCF mobile (Mt Gambier?). Dion continued to work VK3 stations and then, turning the antenna back to VK5, he worked John VK5DJ on Mt Gambier repeater, then John VK5NJ on the same repeater, as well as on simplex 146.500 where John gave Dion a 5/7 report. Dion was running only 2 watt over 573 km.

The following morning Dion VK7YBI found Shane VK5NRV on an Adelaide repeater and they both tried 146.500 simplex and made it through! Shane is at Woodside and signal reports were 5/3 both ways over the big 921 km path.

Interestingly, on 27th March Dion VK7YBI made a rare trip into the Cooma repeater 147.375 VK2RSE @ 630 km and was able to contact VK2DE and VK2HFM.

That's about it for this month.

# Technical abstracts

Peter Gibson VK3AZL

## The copper loop for 2 metre

This would have to be the ultimate 'plumbers delight' antenna.

In QST for December 2002, Dick Stroud, W9SR describes his experience in constructing a heavy-duty square halo (Squalo) antenna for 2 metre, using all copper components. This antenna is very sturdy, easily reproduced, performs well and is quite economical to make. In addition, it can be operated either vertically or horizontally.

Although construction is fairly easy, some basic plumbing techniques are required. The copper tubing is standard 3/4 inch thin walled tubing, available

from nearly any hardware or plumbing supply store.

Carefully cut the tubing into the lengths shown in Figure 2 and assemble into the copper elbows. Make sure the sides are parallel and the two top sections are in line. Clean the ends of the tube that will engage the elbows with steel wool and apply a paste soldering flux to the area. Solder the corners with a propane torch, remembering that it takes time to get this much copper hot enough to properly flow the solder. After

soldering, remove any excess flux and polish the antenna using steel wool.

The Figure 1 shows details of the connector mounting bracket, mounting plate and gamma match rod. All screws and other fittings unless otherwise specified should be stainless steel. The antenna mounting plate is not symmetrical to allow clearance between the gamma rod and the U-bolt.

The gamma match shorting strap is made of 0.020-inch brass stock and is 1/2 inch wide. It is held in place with

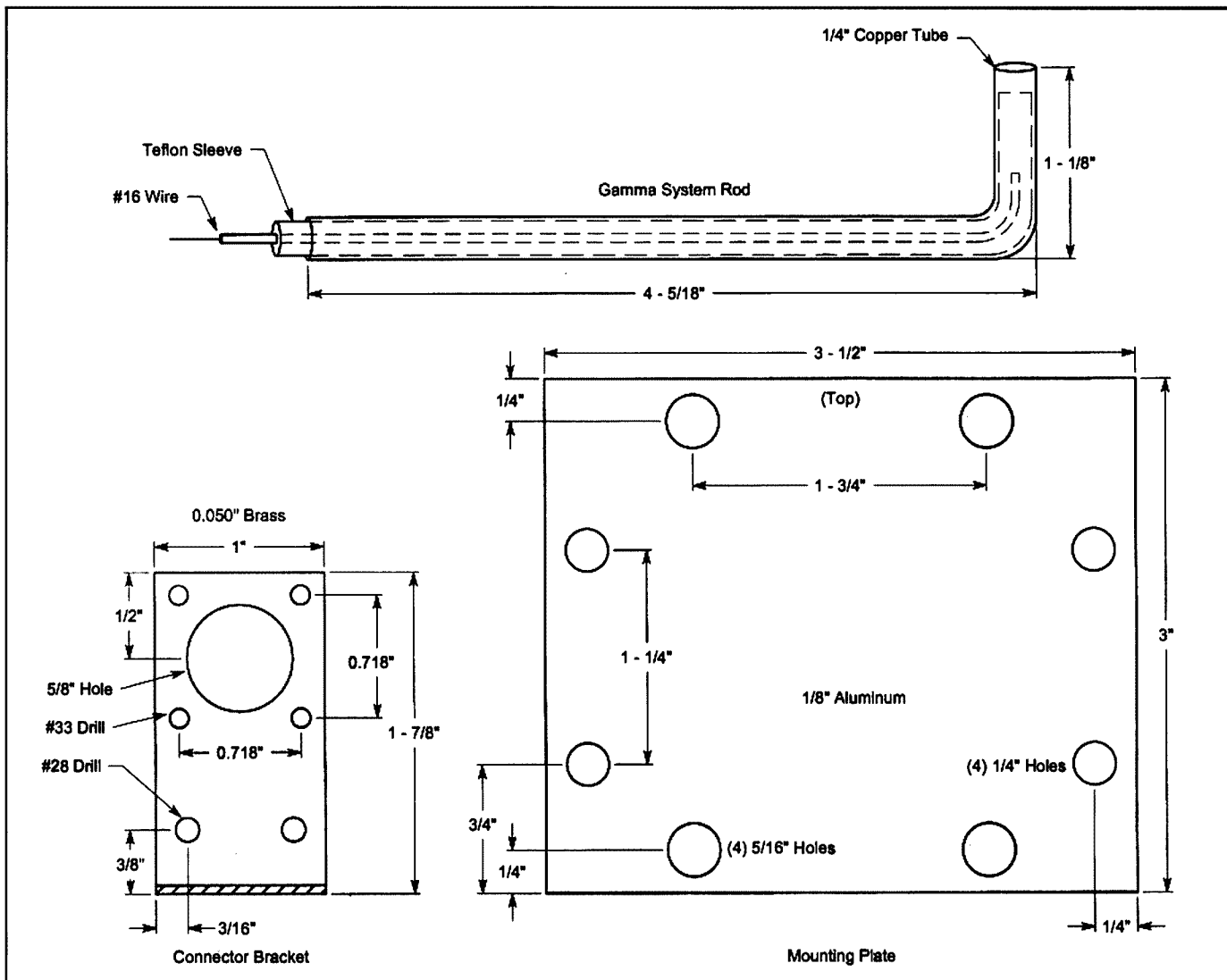

Figure 1. Gamma match, connector bracket and mounting plate details

stainless hardware. The gamma section is formed, as shown, from a 5 5/8 inch length of 1/4 inch OD soft copper tubing. A 5 1/2 inch length of 5/32 inch OD Teflon sleeving is inserted into the copper tube and a 5 1/2 inch length of #16 vinyl insulated wire is placed inside this sleeving. See the drawings for details of the gamma section assembly. The wire end of the gamma match is soldered to the coaxial connector centre pin.

With the gamma rod and connector in place, the two end caps can now be installed. With both caps fully seated, mark the positions with a felt tip pen as the reference points. All adjustments of the end caps should be equidistant from these marks.

For tuning, the antenna should be mounted at least 6 feet off the ground and clear of surrounding objects. The centre frequency can be adjusted by sliding both end caps in and out, equally. Moving them closer together will lower the centre resonant frequency by increasing the length of the loop as well as increasing the capacity across the loop.

On the example described, the 2:1 VSWR bandwidth was about 4 MHz at a centre frequency of 147.000 MHz. If the constructional details have been followed closely, the VSWR should be quite low. If necessary, the gamma strap position can be changed slightly and the wire length can also be changed in small increments to bring the VSWR to 1:1.

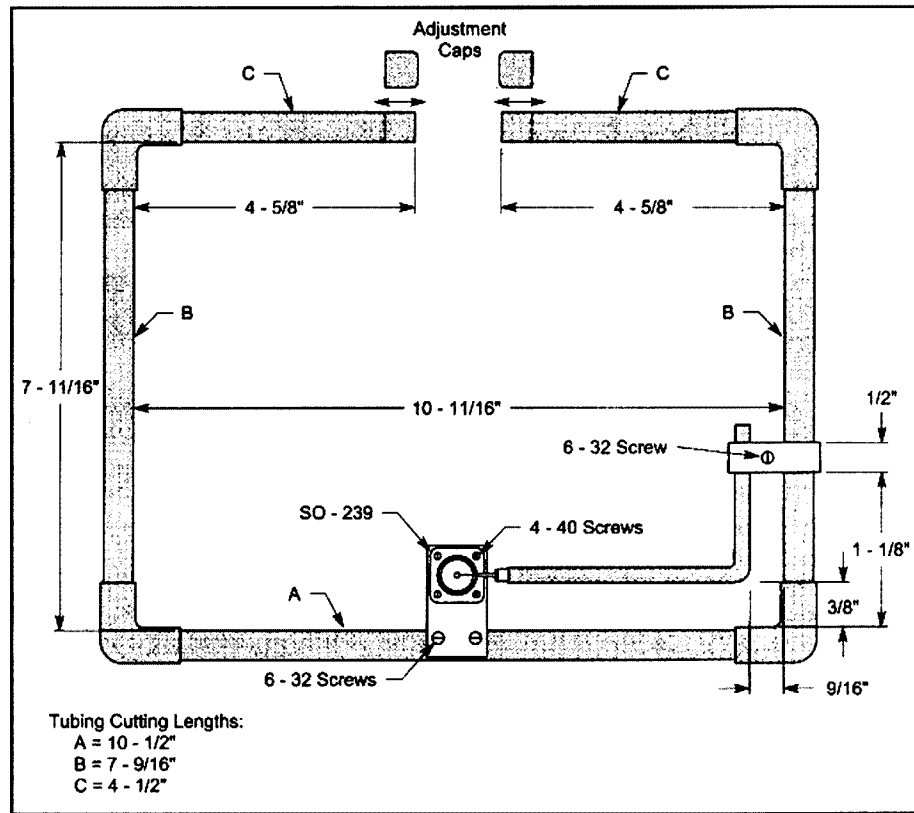

Figure 2. Construction details of main antenna assembly

After the adjustments are completed, both end caps should be secured to the end elements with stainless steel self-tapping screws. A low loss sealant should be placed over the back of the coax connector and the end of the

gamma rod, to prevent entry of moisture. To preserve the finish and stop the copper from oxidising, the antenna can be coated with a clear protective finish, such as Krylon 1301.

ar

## Temperature measurements

In Maths Notes (CQ September 2003), Irwin Math, WA2NDM describes some experiments in electronic temperature measurement. A digital/electronic thermometer can provide a valuable addition to the experimenter lab, and fortunately there exist devices that are simple to use and do not require elaborate additional circuitry to make them work.

One of these is the National Semiconductor LM335. This component is described by the manufacturer as a "precision temperature sensor", and it is ideally suited to our needs. The version recommended comes in a TO-

92 package (the common plastic transistor package with which we are all familiar), although a surface-mount package as well as a metal version are also available. The LM335 is actually a specialised integrated circuit that can be thought of as a temperature-varying zener diode. The TO-92 version of this IC is linear and usable over a range of -40 degree to +100 degree C while other versions can operate from -55 degree to +125 degree C.

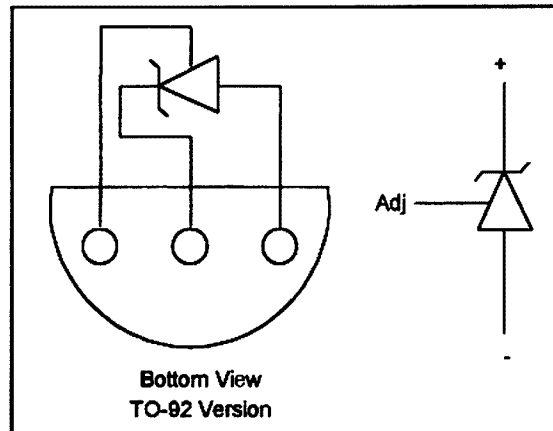

Figure 3 - Pin connections and symbol for LM335

# Technical abstracts

continued

Accuracy is within 1 degree C over the entire range, certainly close enough for most experimental measurements. Figure 3 shows the symbol and pin connections for the TO-92 version.

Figure 4 is the basic circuit of a centigrade thermometer. A reference diode and op-amp are used to provide a calibrated offset voltage for the LM335, and a digital voltmeter (DVM) provides a direct indication of temperature. (Any of the standard op-amps, ranging from 741 to the later FET input units should be suitable for this circuit. The pin connections refer to the standard 8-pin package.)

To set up the circuit, adjust the 2k pot for a voltage reading of 2.732 volt between pin 6 of the op amp and ground with a DVM. Next, place the LM335 in a known temperature and adjust the 10k pot for the correct reading on the DVM used for the measurements. If you do not have access to an accurate thermometer to determine the correct temperature at which to calibrate the circuit, simply prepare a mixture of crushed ice and water. Stir the mixture so that you have a good slurry of both ice and water. The temperature of such a slurry is very close to 0 degree C, and as a result, can be used to calibrate the thermometer at this point.

For ease of using the thermometer it is a good idea to enclose the LM335 in a probe-type housing. Figure 5 is a diagram of the details of such a probe. To make the probe, obtain a common plastic drinking straw and cut it to a length of about 6 inches. Next, close one end of the straw with a small piece of masking tape. Solder wires to the LM335 using a 3 foot length of two-conductor shielded wire. Connect the wires to the Adj ("emitter"), the + ("base") and the shield to the - ("collector") lead. Be sure that the leads do not short to one another. Now liberally coat the entire assembly with epoxy and slide it into the open end of the straw until the top of the TO-92 just makes contact with the masking tape. If necessary, fill the rest of the straw with epoxy so you have a totally enclosed assembly. When the epoxy hardens, remove the masking tape

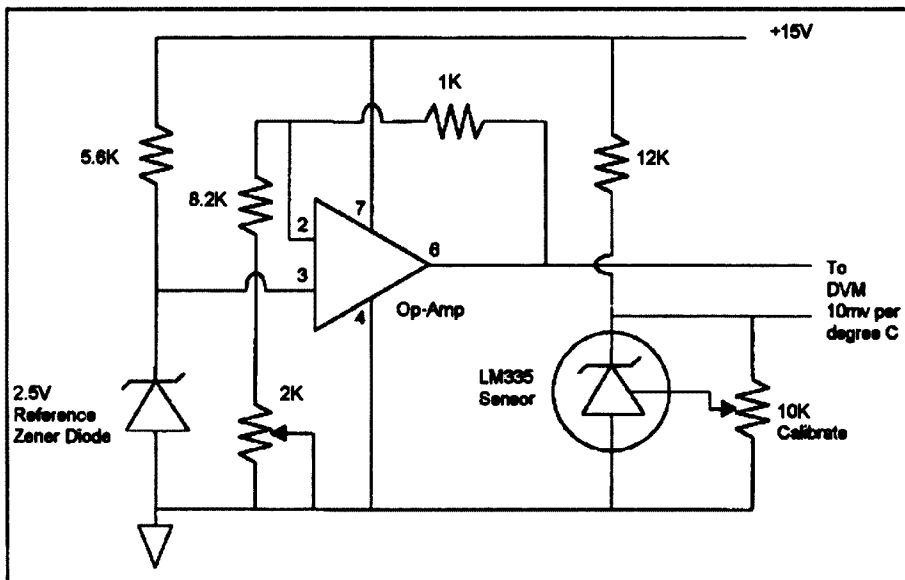

Figure 4 - Centigrade electronic thermometer

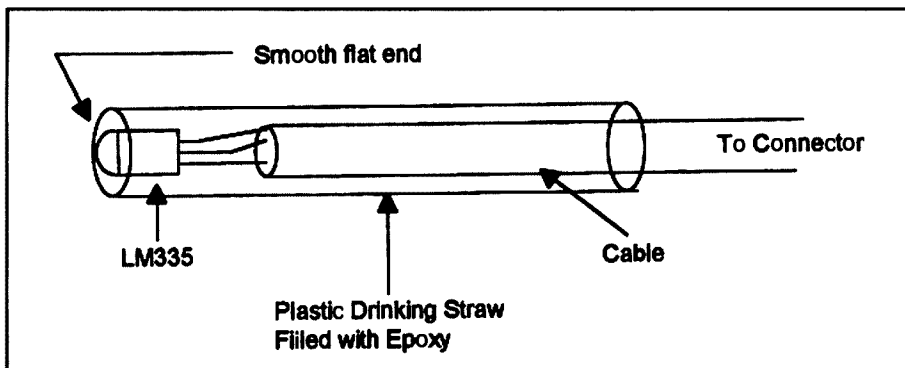

Figure 5 - Details of temperature probe

and clean the end. If needed, add a bit more epoxy and then lightly sand the end to obtain a smooth, flat finish. The result should be a reasonably rugged probe that will be waterproof and insulated. A three pin connector on the cable and a mating three pin connector on the thermometer enclosure is now all that is necessary to complete the project.

To make a measurement, lightly press the tip on the component you wish to check and wait for the reading to become stable. A bit of silicon grease on the probe will often make better contact and result in a more accurate reading

For additional circuits and more details regarding the versatile LM335, visit the National Semiconductor website at 'www.national.com'.

## Silent key

### John Bugler VK4AJR

John Bugler VK4AJR, passed away at his home at Riverside Brisbane on 18th March 2004.

He had come through a triple by-pass well, but passed away peacefully at home about a month later.

Until recently, John held callsigns VK2AJB and VK2JRB when he lived at Gordon, and was a member of several nearby clubs.

Submitted by Bob VK2CAN

## A' QRP ATU

David Littlewood, M3DCT describes a QRP ATU to use on the HF bands after acquiring his new M3 licence, in RadCom for May 2003.

This ATU was initially built to match a half size G5RV antenna. A pi-configuration was chosen to cope with the range of VSWR levels encountered on all HF bands from 80 m to 12 m. It can cope with a wide range of load impedances, from a few tens of ohms, up to several kilohms, even when these include significant levels of reactance. It is thus suitable for end fed wires as well as the half size G5RV. Figure 6 shows the complete circuit.

The construction is not critical, and the unit can be mounted in any suitably sized box. The box should ideally be of metal construction to provide some RF screening, but the prototype was built in a partially plastic box with no adverse effects.

The six coils are wound on six, separate T68-2 iron dust toroids, each of which provides its own closed magnetic path. Therefore, very little RF radiation is emitted from the cores.

The circuit shows some extra circuitry that allows transverters to be selected, as well as a 30 W to 1 W, 15 dB attenuator. This attenuator doubles as an acceptable 50 ohm dummy load as it provides a reasonable match to 50 ohms. All or part of this part of the circuit can be omitted if desired.

Calculations determined that a maximum inductance value of 30  $\mu\text{H}$  would be required. This value is built up by using 6 separate inductors, increasing in a binary sequence from 0.5  $\mu\text{H}$ . This sequence gives a range of 0.5  $\mu\text{H}$  to 31.5  $\mu\text{H}$  in 0.5  $\mu\text{H}$  steps. The

inductors are wound on Amidon T68-2 iron dust toroids of 0.68 in diameter and colour coded red. Table 1 shows the number of turns required for each toroid.

Coils 1-4 are wound with single layer 0.8 mm enamelled copper wire. Coils 5 and 6 are wound with 0.5 mm wire with coil 6 requiring two layers.

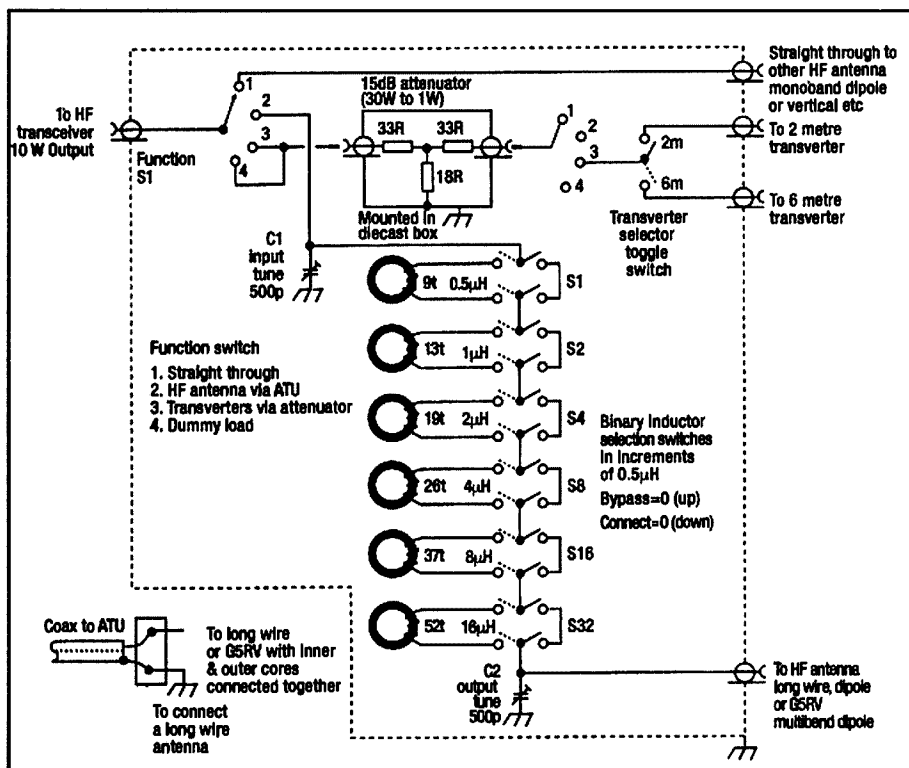

Figure 6 – Complete circuit of complete circuit of QRP antenna tuning unit

Coil	Number of turns	Inductance ( $\mu\text{H}$ )
1	9	0.5
2	13	1.0
3	19	2
4	26	4
5	37	8
6	52	16

Band	S1	S2	S4	S8	S16	S32
80*	1	1	1	0	0	0
40	0	1	0	0	0	0
30	0	1	0	0	0	0
20	0	0	0	0	0	0
17	0	1	0	0	0	0
15	1	0	0	0	0	0
12	1	0	0	0	0	0
10	0	0	0	0	0	0

Band	S1	S2	S4	S8	S16	S32
160	0	1	1	1	0	0
80	0	1	0	0	1	0
40	0	0	0	1	0	0
30	0	0	1	0	0	0
20	0	1	0	0	0	0
17	1	0	0	0	0	0
15	1	0	0	0	0	0
12	1	0	0	0	0	0
10	0	0	0	0	0	0

\*assumes that half sized G5RV is used with normal coaxial cable, and run as quarter wave dipole. As this is not very efficient, it may be better to use it as Marconi longwire tuned against earth on this band

# The solar cycle

Bill Isdale VK4TWI

We have become used to seeing the data of solar activity put together by the Commonwealth Government Ionospheric Prediction Service. This organization has observatories monitoring solar activity and from the observations, carried out several times a day, are produced such things as the sunspot numbers graph we see each month in Amateur Radio magazine. The I. P. S website provides an up to date display of the results of their observations and calculations in various forms including maps showing what frequencies are going to work to reach particular destinations.

The observations of solar activity are essentially telling us how much energy is pouring out of the huge continuous thermonuclear fire that is the sun. A vast ball of hydrogen gas, condensing under the pull of its own gravity until the pressure on the hydrogen gas atoms is so great that some of them, those which happen to be under the greatest pressure, fuse together to form one atom of a slightly heavier gas and release a whole lot of energy in the process. This has been going on for a few billion years and will continue for some billions of years to come as the hydrogen is used up. Then the process will continue with the next gas, manufactured in the engine that is the sun, until progressively heavier elements are created and used up. This, by the way, is how every element has been manufactured. The iron in a magnet was made in a star a very long time ago and has been recycled into space when the star which made it went nova and blew up, scattering the results of its cooking far and wide. Some drifted into a cloud that condensed under gravity. Too small to form another star, it became the Earth which now provides a home for radio amateurs.

Some of the energy which is lost from the sun as it cooks away goes into space in the form of light in the ultraviolet part of the electromagnetic spectrum. This high energy radiation breaks the molecular bonds of the gas molecules that are up in the highest levels of the atmosphere and they become ions, no longer an atom in which the electrical charges of the particles which they are made of are equal and cancel each other out; there is an imbalance and the ions are electrically charged and subject to magnetic influence.

Electromagnetic radiation of certain frequencies, when encountering this area of the ionosphere, energized by the rays of the sun, will reflect off of it and

bounce back down again.

When a ray of light or electromagnetic energy of whatever frequency strikes something which acts as a mirror to it the angle of incidence of the energy to the reflector is equal to the angle at which it bounces off. So if we send a flow of electromagnetic energy up to the ionosphere at a low angle of incidence, right down low to our horizon, it will bounce off that reflective layer, which is very high up and therefore quite far away, at the same small angle as it strikes it and reflect back to earth even further away. The radio amateur, who happens to be listening at that far away place can tune to the frequency of the reflected energy and, all being well, hear our signal. If we can reach them then they should be able to call us back by the same path until the reflectivity breaks down due to the instability of the atmosphere which at high altitude, as at the lower levels, is always swirling about.

The activity of the sun has been systematically observed only since as recently as about 1750. In the life of the sun we have been making and recording scientific observations for a brief time. This middle-aged star has, during that time, been exhibiting an 11 year cycle of increasing and decreasing sunspots.

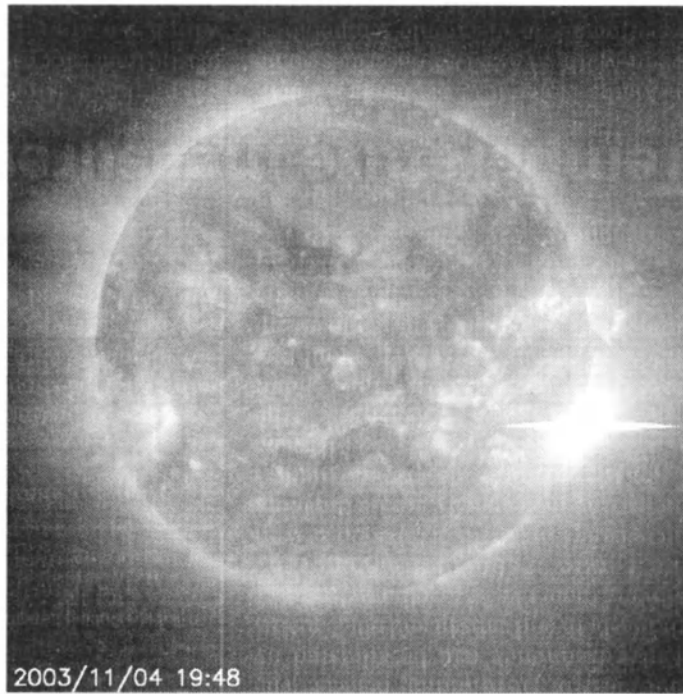

Our unpredictable sun launches another mega-flare

Sunspots are bubbles of gas from below the surface of the sun. A bit cooler than the surface, they appear as dark spots. The first cycle that was recognized and recorded as cycle 1, started in 1755. The cycles are, on average, of 11 years duration, but have varied from 7 to 17 years. We are now in the downswing of cycle 23 and the average number of sunspots per month at the start of 2004 is about 60 and decreasing. Despite this, we have recently seen some quite major solar eruptions with not only sunspots but also ejections of gas many times larger than the Earth. Although these occur mostly around the peak of a cycle, they may be observed at any time, indicating that the sun does not feel obliged to obey some rules of behaviour that we have thought up for it, based on our relatively brief observations.



This is a large and ancient system and we may have been observing for such a relatively short time that there are longer-term cycles we have not yet identified.

Recent research, now in press and probably published in *Physical Review Letters* by the time you read this, indicates that the sun is now more active than it has been for a thousand years. In October and November, 2003, the sun was extremely active and was putting out such an amount of energy that those operators of large antenna systems called power grids had to adjust their protective systems to stop the circuit breakers from tripping out when the moving magnetic field encountered their wires and induced a current in the wire just as Michael Faraday demonstrated. In this case it was an increased current, perhaps an overload of the system such as occurred in Canada in 1989 when major blackouts resulted. The cause of the Canadian blackouts was eventually identified and it was realized that the long wire runs in that part of the world made the grid there especially vulnerable.

A group of scientists led by Ilya Usoskin at the University of Oulu in Finland, in cooperation with the Max Planck Institute for Aeronomy in Katlenberg-Lindau, Germany has concluded that there have been more sunspots since the 1940s than for the past 1150 years.

Since sunspot observations only go back about 250 years, they needed to come up with a method to find out what

the sun was doing back 900 years before records are available. What they did was ingenious.

Ice cores taken in Greenland and Antarctica provide a preserved sample of what was in the atmosphere when new ice layers formed each winter. The cores provide a record of the concentration of beryllium-10 in the atmosphere. This is produced when high-energy particles hit the upper atmosphere. When the sun is more active, its increased magnetic field protects the Earth from these particles and levels of beryllium-10 are reduced.

Beryllium-10 is scarcer in recent times than it has been for a very long time. This indicates that the sun has been more than usually active since 1750, with

a dip in output about 1850.

It seems that we have been observing an active stage of the sun that happens to have been occurring since people started recording sunspot activity.

The big question is how long will it continue? It would be unrealistic to assume that there will be another upswing starting in 2007 just because that is when our recent observations suggest that is when it is "due". It may come or it may not. If it does, well and good. If not, there may be a steep drop-off of solar output, as occurred in the

1650s and 1660s, when 1665-66 was a year described as being "without a Summer" and the river Thames froze in London. Such minimums were found in 1450 and 1050 as well. Solar minimums in 1050, 1450, 1650 and 1850 are suggestive of a longer cycle. There is a gap with a double-dip in the period 1250 to 1350 that perhaps shows only that there is no totally consistent pattern.

Whether these oscillations correlate with cold weather or not is the subject of a major scientific debate and it is too soon to know the answer. What we do know is that high frequency radio propagation would be diminished with reduced solar output.

The message is that we cannot be confident that the period of high solar activity of the last 250 years is not at an end. We are due

for a major downturn. Whatever it may do to the climate, to the potential annoyance of those warning of global warming, we do know that high frequency radio communication would be adversely affected.

We cannot control the sun, perhaps we cannot really predict its activity based on the last 250 years of observation either. If the evidence from the ice cores is being correctly interpreted, it may be that our hobby will need to evolve to suit the changing circumstances.

ar

## Technical Abstracts *continued*

### A QRP ATU

*continued from page 49*

The completed inductors were soldered directly to the panel mounted toggle switches. Remember that this ATU is only intended for relatively low powers of 10-25 W maximum. Saturation and/or overheating of the cores may take place if higher powers are used. Six small DPDT toggle switches are used to select any combination of inductors in a binary sequence. The switches are arranged so that in the UP position they open circuit the coil and bypass it. In the DOWN position, they connect the associated coil in series with the circuit.

Input and output tuning capacitors, (C1 and C2) are air-spaced AM tuning capacitors of 500 pF range (30-530 pF). If available, it may be better to use dual or triple gang capacitors to extend the range of impedance matching. For the rated power levels of, say, up to 25 W, normal plate spacing should be adequate.

Tables 2 shows the typical switch settings for each of the HF bands for the half-sized G5RV. Table 3 show the switch settings for the same antenna used as a Marconi antenna tuned against ground.

Most modern transceivers have solid state output stages with adjustable power output and also have VSWR sensing circuits which reduce power output as the VSWR rises. Therefore, the tuning of the ATU should be carried out with the minimum power levels that will give a display of the VSWR value. The tune up procedure involves progressively increasing the inductance value by operating the associated toggle switch and adjusting the input and output capacitances for lowest VSWR.

ar

**Adelaide-Moscow**

**318**

**Brisbane-Berlin**

**148**

First F 0-5 Short 13807 km

First F 0-5 Short 15677 km

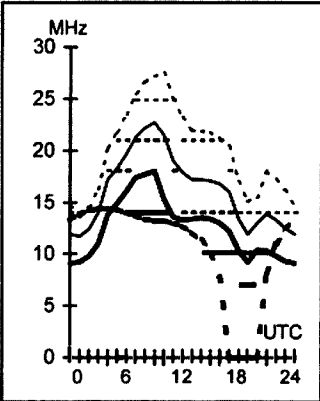
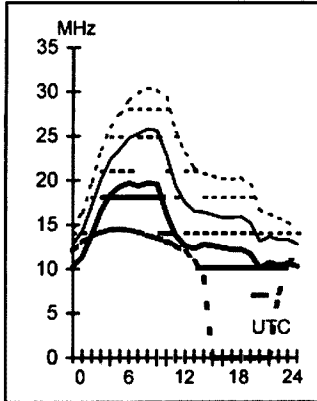

**May 2004**

T index: 43

**Legend**

- Frequency scale
- UD
  - - - E-MUF
  - OMF
  - F-MUF
  - ALF
  - >10%
  - >50%
  - >90%
- Time Scale

# HF Predictions

by **Evan Jarman VK3ANI**

34 Alandale Court Blackburn Vic 3130

These graphs show the predicted diurnal variation of key frequencies for the nominated circuits.

These frequencies as identified in the legend are:-

- Upper Decile (F-layer)
- F-layer Maximum Usable Frequency
- E-layer Maximum Usable Frequency
- Optimum Working Frequency (F-layer)
- Absorption Limiting Frequency (D region)

Shown hourly are the highest frequency amateur bands in ranges between these key frequencies, when usable.

The path, propagation mode and Australian terminal bearing are also given for each circuit.

These predictions were made with the Ionospheric Prediction Service program: ASAPS Version 4

**Adelaide-Osaka**

**357**

**Brisbane-Cairo**

**288**

**Canberra-Auckland**

**102**

**Darwin-London**

**145**

Second 3F5-8 3E0 Short 7746 km

First F 0-5 Short 14390 km

Second 2F20-22 2E Short 2300 km

First F 0-5 Long 26171 km

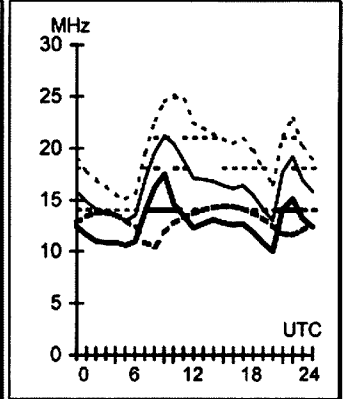
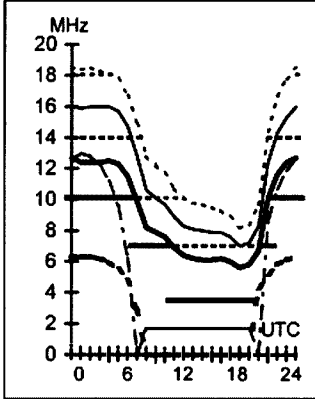
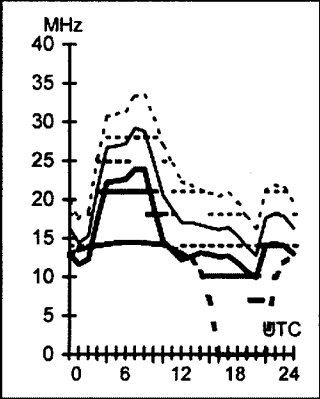
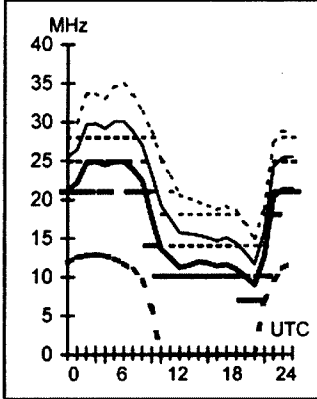

**Adelaide-Pretoria**

**238**

**Brisbane-Noumea**

**70**

**Canberra-Capetown**

**219**

**Darwin-London**

**325**

Second 4F5-6 4E0 Short 10064 km

First 1F15-17 1E 3 Short 1473 km

Second 4F4-5 4E0 Short 10779 km

First F 0-5 Short 13853 km

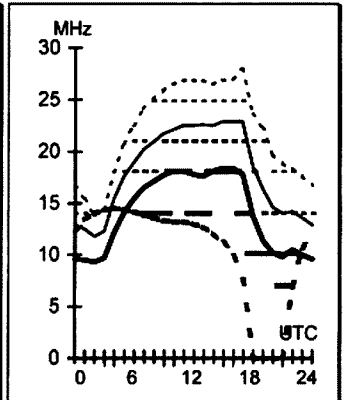
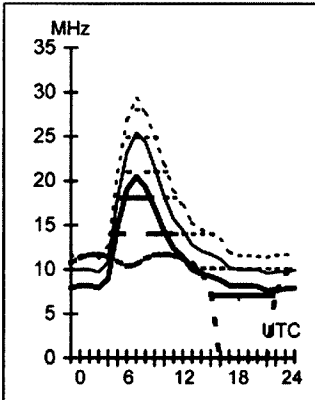
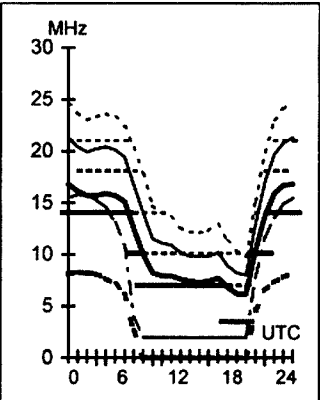
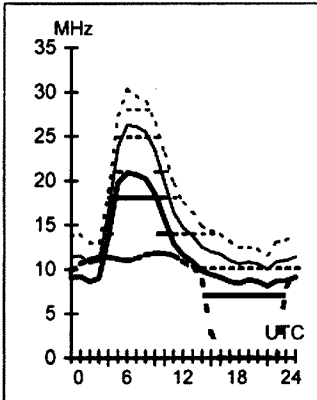

**Adelaide-Seattle**

**51**

**Brisbane-Singapore**

**293**

**Canberra-Manila**

**327**

**Darwin-Riyadh**

**295**

First F 0-5 Short 13413 km

Second 3F9-12 3E0 Short 6146 km

Second 3F8-13 3E0 Short 6286 km

Second 4F5-11 4E0 Short 10000 km

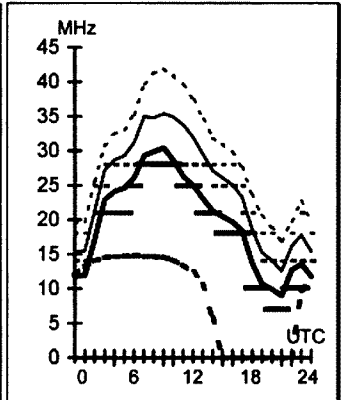
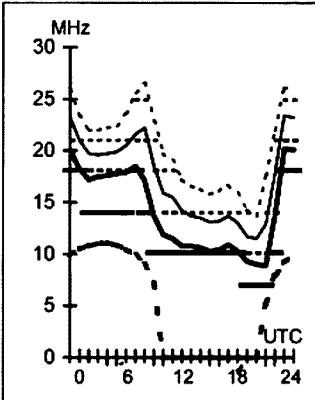
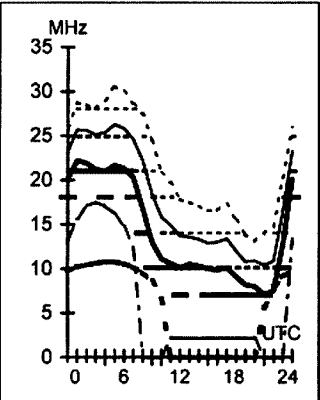
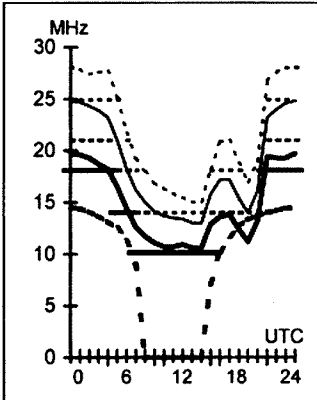

**Hobart-Barbados****134 Melbourne-CapeTown****222 Perth-Buenos AiresHarari****185 Sydney-Budapest****306**

First F 0-5 Short 15825 km

Second 4F4-5 4E0 Short 10318 km

First F 0-5 Short 12591 km

First F 0-5 Short 15779 km

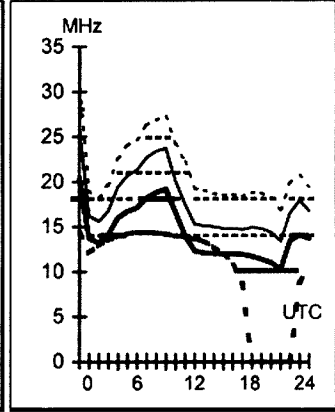
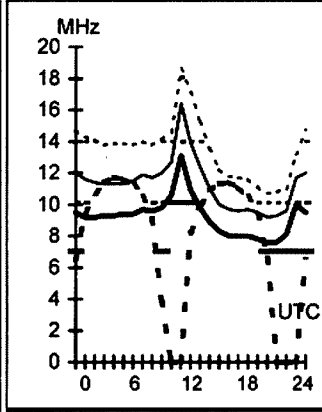
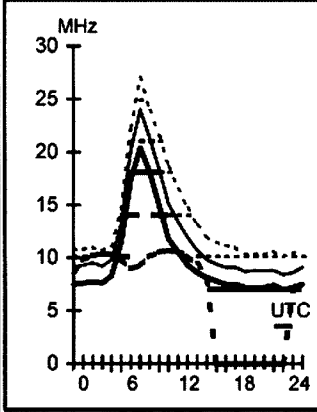
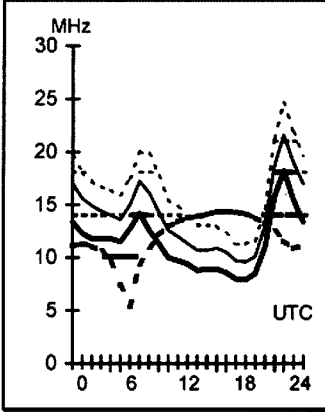
**Hobart-Lima****133 Melbourne-Miami****94****Perth-Columbo****312****Sydney-Chicago****62**

First F 0-5 Short 12421 km

First F 0-5 Short 15584 km

Second 3F10-13 3E Short 5798 km

First F 0-5 Short 14876 km

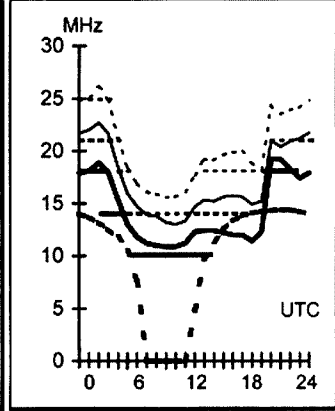
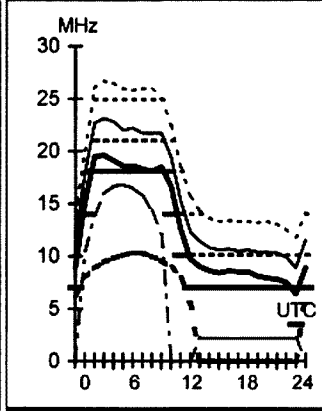
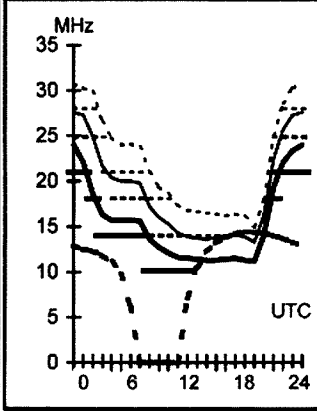
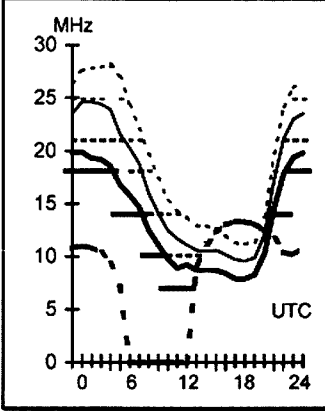
**Hobart-London****123****Melbourne-Senegal****219****Perth-Osaka****17****Sydney-Jakarta****294**

First F 0-5 Long 22620 km

First F 0-5 Short 16910 km

Second 3F5-8 3E0 Short 7684 km

Second 3F10-12 3E Short 5496 km

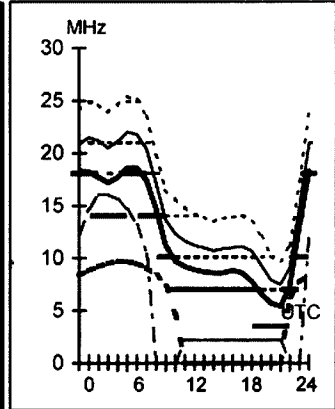
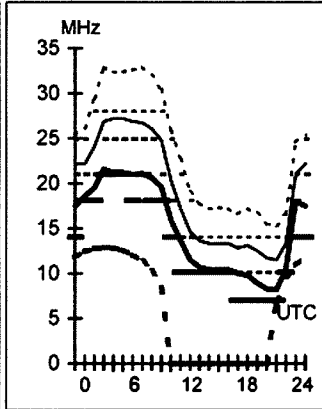
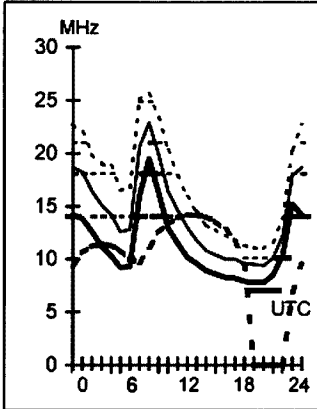
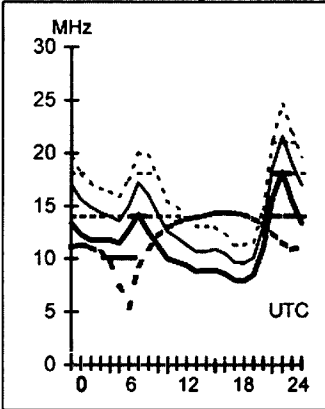
**Hobart-London****303****Melbourne-Suva****65****Perth-Wellington****119****Sydney-Pretoria****230**

First F 0-5 Short 17404 km

Second 2F9-11 2E0 Short 3914 km

Second 3F11-13 3E Short 5255 km

Second 4F3-4 4E0 Short 11063 km

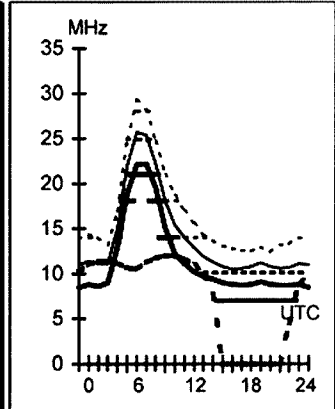
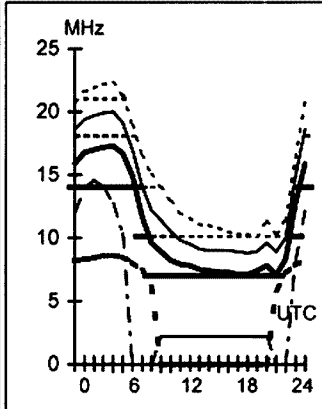
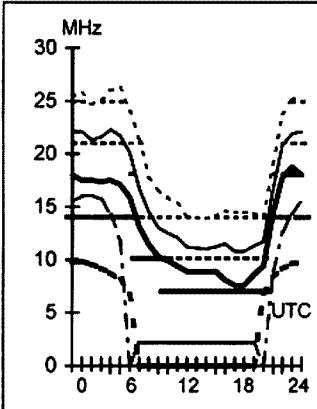
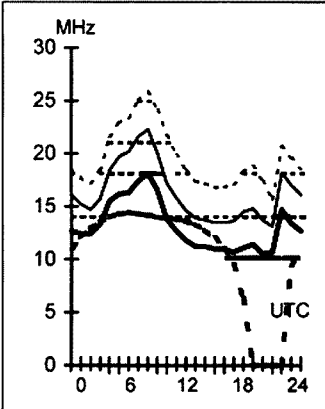

## WANTED ACT

• **Icom IC-471/475A** 70 cm base xcvr, **Yaesu FBA-120** battery case, handbook for **Alinco ELH-230** for THP HL-110V amp, **Yaesu FL-110** HF amp. VK1CJ Phone 02 6251 1816.

• **Collins Radio Equipment** including KWM-2/2A, 75-S3/32-S3/ 312-B3/312-B4/312-B5, 55-G1, 270-G1/2/3, 30-S1/30-L1 Linears, 302-C3, Directional wattmeter, SM-1/2/3, MM1 Microphones. 75-A3, 75-A4, 51-J4, 51-S1, R-390A, 651-S1, 851-S1 Receivers, DL-1 Dummy load, 516-F2 and PM-2 and MP-1 power supplies. PSE Phone Chris VK5CC 02 6266 6684 (work), 0409 379 507(mobile) or email christo@senet.com.au.

• **Valve socket type Eimac SK-410** or similar. 5-pin ceramic for use with 4-125A valve. Also valve type **6146B** new or near new. Peter VK1CPK Phone 02 6231 1790. pkloppen@austarmetro.com.au

## FOR SALE NSW

• **Icom IC-761** HF base xcvr, internal power supply, auto antenna tuner, factory service and operator's manuals, \$800 ono. **IC-471A** 2 m VHF, all mode xcvr \$300. Both xcvs in mint cond. Tony Phone 02 9487 3383

• **Transceiver Yaesu FT-901D**, s/n 94081386, inbuilt keyer and dc/dc converter, cables & manual \$550. **Desk mike \$30. 6 ele 10 m Yagi** partially assembled \$250. VK2VZB QTHR, Phone 02 9449 7548

• **Shack clearout: Alinco 20A** pwr supply, \$350. **Azden PCS-5000** 2 m FM xcvr, \$450. **CD-100W** HF amp, \$100. **Daiwa CR4** rotator

and controller \$400. **Emtronics 25A pwr supply**, \$400. **Emtronics EAT-300 ATU**, \$150. **HF amp & pwr supply**, 2 X 3/500Z, 1kW, \$650. **Icom IC-490** 70 cm all-mode xcvr, \$350. **Icom IC-505** 6 m all-mode xcvr, \$450. **Icom IC-726** HF, 6 m xcvr, \$800. **Icom IC-736** HF xcvr & **AT-150 ATU**, \$800. **Kenpro KR-5600A** Az, El, controller, \$850. **Kenwood TS-430S** HF xcvr, \$450. **Kenwood TS-440S** HF xcvr & pwr supply \$850. **Kenwood TR-9130** 2 m all-mode xcvr, \$300. **Racal RA-17L** Comms rcvr \$350. **Tokyo high power HL-60U** 70 cm amp \$300. **Tokyo high power HL-82V** 2 m amp, \$250. **Tokyo highpower HL-86V** 6 m amp, \$350. **Tokyo high power HL-160V** 2 m amp \$600. **Tokyo high power HL-180V** 2 m amp, \$650. **Vono 5000E** Keyer/Modem, \$600. Bob VK2CAN, Phone 02 9416 3727

• **Test equipment: DSE AG2600A AF oscillator**, \$75. **DSE/EA spectrum analyser**, 50-870 MHz, \$100. **Hitachi V212** 20 MHz CRO, \$200. **Leader LSW-250** sweep & marker generator, \$150. **LT PC1200** 1250 MHz counter, \$150. **Nemic Lambda 20 A** pwr supply, \$40. **Nemic Lambda 43 A** pwr supply, \$75. **Trio SG-402** signal generator, \$100. Bob VK2CAN Phone 02 9416 3727

• **KLM antenna KT-34XA** partly disassembled with manual, \$600 neg. **Drake L-4B** linear amplifier, new filters with manual, around \$1400. Both plus shipping. Ted Baker VK2ABW Phone 02 6337 1219, fax 02 6337 1572, baker@ix.net.au

## WANTED NSW

• **Wanted urgently: High frequency transceiver**, valve or solid state, working or not, by pensioner wanting to become active on air again! Anything considered, even old AM transmit/receive equipment. Must be inexpensive, or one that with work I might be able to get going. Not working, desk or old dynamic microphone sought also! Please contact Norm VK2ZG QTHR Phone 02 4341 1736 or email normv2za@optusnet.com.au.

• **Flexible exhaust pipe** for ex-army **Onan Genset 2kVA model OTC-5B. Circuit/handbook Zenith Trans-Oceanic Royal 7000. Handbook/circuit National** portable tape/radio/TV model **TR-5000A**. VK2S1G@macben.id.au QTHR.

• **Collins KWS-1** transmitter and/or **75A-4** receiver. Will collect locally or interstate. Phone Glen VK2FC on Phone 0427 624 028 or 02 4988 6565 or email to vk2fca@hotmail.net.au

• **HF solid state transceiver** Kenwood TS-430S, TS-140S or Icom IC-738, IC 737A cash buyer for right radio. James VK2UN vk2un@wia.org.au or Phone 0417 410 503

• **Free standing tower**, approx 60 ft or higher. Leigh VK2KRR Phone 0419 631199

## FOR SALE VIC

• **Transceiver, Kenwood TS-130S**, HF 80 m, 10 m (including WARC bands) \$299. **HF communications receiver, Yaesu FRG-7**, \$99. All quoted prices are negotiable. Phone Terry VK3KBD Phone 03 9315 0186 (evenings only).

## FOR SALE QLD

• **Yaesu FT-101B** and **FV-101** ext VFO **Kenwood TS-120S** with PSU \$200. Paul Phone 07 4775 7998

## WANTED QLD

• **Information and circuit diagrams for YU3UMV 23 cm transverter** and **Netset PRO-2028 scanner**. All costs repaid. Wayne VK4WDM. Email melrosew@optusnet.com.au Phone 07 4788 8781

• **For Townsville RAAF Museum: Donations of military comms equipment and an amateur SSB transceiver for our memorial station VK4KG**. Older rig in GWO OK. Wayne VK4WDM. Email melrosew@optusnet.com.au Phone 07 4788 8781

• **Geiger counter and TV transponder**. Please phone 07 5543 7212 or email nicholaschantler@yahoo.com.au

## FOR SALE WA

• **Yaesu Classic FT DX-400** transceiver immaculate will demonstrate, with **3 band quad antenna, 35 ft tower**, motor cables etc, also **Ameritron AL-811x** 400 watt linear amplifier and other items all with manuals. Tom VK6TL Phone 08 9386 7692 QTHR

## FOR SALE TAS

• **Yaesu FT-857** new in box built in DSP unit offers \$. **Yaesu MH-59A8J** DTMF mic, suit FT-857, \$95, new in box unused. Allen VK7AN Phone 0417 354 410

• **Deceased estate: Icom IC-22A** 2 metre transceiver with magnetic base whip antenna, serial no 3981. Make good mobile rig \$100. Phone 03 6431 2164 vk7kh@southcom.com.au

## About hamads....

- Hamads may be submitted by *email* or on the *form on the reverse of your current Amateur Radio address flysheet*. Please print carefully and clearly, use upper AND lower case.
- Separate forms for For Sale and Wanted items. Please include name, address STD telephone number and WIA membership number if you do not use the flysheet.
- Deceased estates Hamads will be published in full, even if the ad is not fully radio equipment.
- WIA policy recommends that the serial number of all equipment for sale should be included.
- QTHR means the address is correct in the current WIA Call Book.

- Ordinary Hamads from those who are deemed to be in general electronics retail and wholesale distributive trades should be certified as referring only to private articles not being re-sold for merchandising purposes.
- Commercial advertising (Trade Hamads) are pre-payable at \$25.00 for four lines (twenty words), plus \$2.25 per line (or part thereof), Forty word maximum, minimum charge of \$25.00. Cheques are to be made out to: WIA Hamads.
- Copy typed or printed clearly please, and received by the deadlines shown on page 1 of each issue of Amateur Radio.

Email: [newunltd@bigpond.net.au](mailto:newunltd@bigpond.net.au) Fax: 03 9756 7031

Postal: Newsletters Unlimited, PO Box 431, Monbulk Vic 3793

### TRADE PRACTICES ACT

It is impossible for us to ensure that the advertisements submitted for publication comply with the Trade Practices Act 1974. Therefore, advertisers and advertising agents will appreciate the absolute need for themselves to ensure that the provisions of the Act are strictly complied with.

### VICTORIAN CONSUMER AFFAIRS ACT

All advertisers are advised that advertisements containing only a PO Box number as the address cannot be accepted without the addition of the business address of the box-holder or seller of the goods.

**MISCELLANEOUS**

• **The WIA QSL Collection (now Federal) requires QSLs.** All types welcome, especially rare DX pictorial cards, special issue. Please contact the Hon Curator, Ken Matchett VK3TL, 4 Sunrise Hill Road, Montrose Vic 3765, tel. (03) 9728 5350

**TRADE ADS**

**PSK-31, SSTV, RTTY SOUNDBOARD**  
Interfaces Fully isolated, ready to plug in.  
<http://www.G3LIV.CO.UK>,  
johnny@melvin.com, G3LIV QTHR.

**“Hey, Old  
Timer...”**

**If you have been  
licensed for  
more than 25  
years you are**



**invited to join the  
Radio Amateurs  
Old Timers Club  
Australia**

or if you have been licensed for **less than 25 but more than ten years**, you are invited to become an **Associate Member** of the RAOTC.

In either case a **\$5.00** joining fee plus **\$8.00** for one year or **\$15.00** for two years gets you two interesting OTN Journals a year plus good fellowship.

Write to

RAOTC,  
PO Box 1100  
Sandringham VIC 3191

or call Arthur VK3VQ on **03 9598 4262** or Bill VK3BR on **03 9584 9512**,

or email to [raotc@raotc.org.au](mailto:raotc@raotc.org.au) for an application form.

# Battery packs for older handhelds

Roy Yeats VK2BRY  
16 Eungella Place  
Orange 2800

The battery pack for a sixteen year old FT208R was well past its “use by” date and would not hold its charge. A new pack was unavailable. The original pack FNB-2 uses nine half AA NiCad cells in series giving 10.8 volts with a 450 mAH capacity.

I had no wish to use a pack rebuilder or try to source half AA NiCads after an unsatisfactory result. Perusing the local electronics catalogues showed that nine AAA size NiCads cells would fit. Also an acceptable voltage (11.25 volts) and a gain in capacity from 450 mAH to 550 mAH would be achieved. Using blank PCB material, a suitable box with an etched terminal arrangement was soldered together. The nine AAA cells stacked to fit the dimensional criteria of the original box.

Care is needed to accurately duplicate the critical dimensions of the original pack. To ensure proper fit in the handheld, no specific dimensions are given, as each situation would be different.

The overall cost would be somewhat less than a new pack if it were available.

The philosophy of the exercise may give new life to other models of handhelds with battery problems, by using a little ingenuity with readily available cells and easy mechanics.

**AMIDON FERROMAGNETIC CORES**

**For all RF/electronic applications.**

See our website for complete data on all cores including prices.

[www.catchnet.com.au/~rjandus/imports](http://www.catchnet.com.au/~rjandus/imports)

**RJ & US Imports**

**PO Box 431, Kiama NSW 2533.**

**A 3.5" PC disk containing all data is available for \$5.00 incl. post.**

**Agencies**

Active Electronics, Tas  
TTS Systems, Tyabb (VIC)  
Tower Communications, Perth



**JACKSON BROS  
JACKSON OF THE UK IS BACK**

Highest quality products  
made by UK craftsmen

Full range now off-the-shelf in Australia. Variable and trimmer capacitors, reduction drives, dials, ceramic standoffs



**CATALOGUES, PRICE LISTS AVAILABLE**

**CHARLES I COOKSON PTY LTD**

**11-13 Port Rd  
Queenstown SA 5014**

Tel: (08) 8240 3200 Fax: (08) 8240 3233

FreeFax 1800 673355 within Australia

Email: [jackson@homeplanet.com.au](mailto:jackson@homeplanet.com.au)



**ALL MAJOR CREDIT CARDS ACCEPTED  
SOLE AGENTS AUSTRALIA AND NEW ZEALAND**

**GROW WIA—MAKE IT YOUR JOB**

**RECRUIT A NEIGHBOUR\*, NON-MEMBER LICENSE HOLDER TODAY.**

One to one approaches are very successful and it is in your interest to have a strong WIA.

If you need to know who your neighbouring operators are call John (03) 9756 7797 AH and he'll tell you.

**HF, VHF, UHF ANTENNAS  
& ACCESSORIES**

Aluminium towers, guys etc

Diamond VSWR/PWR meters.

**HD copper antenna wire & insulators,  
TX tubes & pwr transistors, Create  
Rotators**

**Quality coax cables & connectors. Free  
advice & catalogue.**

(Disregard the rumours, we are still here!)

**ATN Antennas**

Ph 03 5492 2224 Fax 03 5492 2666,

email [atnant@iinet.net.au](mailto:atnant@iinet.net.au)

**ADVERTISERS INDEX**

AEI .....	15	G & C .....	8
Andrews .....	23	Icom .....	OBC
Benelec .....	IFC	Radio School .....	27
Coax Cable & Connectors .....	34	RippleTech Electronics .....	35
Com-an-tena .....	9	Todd .....	34
Connektron .....	16	TTS .....	28/29
Emtron .....	17	54s .....	55



# Division Directory

*The Amateur Radio Service exists for the purpose of self training, intercommunication and technical investigation. It is carried out by amateurs who are duly authorised people interested in radio technique solely with a personal aim and without pecuniary interest.*

The Wireless Institute of Australia represents the interests of all radio amateurs throughout Australia. National representation is handled by the executive office under council direction. There is one councillor for each of the seven Divisions. This directory lists all the Divisional offices, broadcast schedules and subscription rates. All enquiries should be directed to your local Division.

## Broadcast schedules All frequencies MHz. All times are local.

VK1 Division Australian Capital Territory,  
GPO Box 600, Canberra ACT 2601  
President Alan Hawes  
Secretary Deane Walkington  
Treasurer Bob Howie

VK1WX  
VK1DW  
VK1HBB

VK1WI transmits each Thursday evening at 2000 hrs local time on VK1RGI 146.950 MHz and 438.375 MHz including the linked repeater system on VK2RGN Goulburn, VK2RHR High Range, VK2RMP Madden Plains and VK2RTW Wagga Wagga.  
VK1 Home Page <http://www.vk1.wia.ampr.org>  
Annual Membership Fees. Full \$80.00 Pensioner or student \$71.00. Without *Amateur Radio* \$48.00

VK2 Division New South Wales  
109 Wigram St, Parramatta NSW  
(PO Box 9432, Harris Park, 2150)  
(Office hours Tue., Thu., Fri., 1100 to 1400 hrs.)  
Phone 02 9689 2417

Web: <http://www.wiansw.org.au>  
Freecall 1800 817 644 (NSW only)  
e-mail: [vk2wi@wiansw.org.au](mailto:vk2wi@wiansw.org.au)  
Fax 02 9633 1525  
President Brian Kelly  
Secretary Owen Holmwood  
Treasurer Noel May

VK2WBK  
VK2AEJ  
VK2YXM

VK2WI transmits every Sunday at 1000 hrs and 1930 hrs on some or all of the following frequencies (MHz): 1.845, 3.595, 7.146, 10.125, 14.170, 18.120, 21.170, 24.950, 28.320, 29.170, 52.150, 52.525, 144.150, 147.000, 432.150, 438.525, 1273.500. Plus many country regions on 2m and 70cm repeaters. Highlights are included in VK2AWX Newcastle news Monday 1930hrs. on 3.593, 10 metres and local repeaters. The text of the bulletins is available on the Divisional website and packet radio. Continuous slow morse transmissions are provided on 3.699 and 145.650. VK2RSY beacons on 10m, 6m, 2m, 70cm and 23cm. Packet on 144.850.  
Annual Membership Fees. Full \$83.00 Pensioner or student \$66.00. Without *Amateur Radio* \$50.00

VK3 Division Victoria  
40G Victory Boulevard Ashburton VIC 3147  
(Office hours Tue 10.00 -2.30)  
Phone 03 9885 9261

Web: <http://www.wiavic.org.au>  
Fax 03 9885 9298  
e-mail: [wiavic@wiavic.org.au](mailto:wiavic@wiavic.org.au)  
President Jim Linton  
Secretary John Brown  
Treasurer Jim Baxter

VK3PC  
VK3JJB  
VK3DBQ

VK3BWI broadcasts on the 1<sup>st</sup> Sunday of the month at 1030 and 2000 hours. Primary frequencies are 3.615, 7.085, 10.130, FM repeaters VK3RML 146.700, VK3RMM 147.250, VK3RWG 147.225, VK3RMU 438.075. The broadcast can also be heard on the Saturday night at 2000 hours before the 1<sup>st</sup> Sunday. Major news appears on the packet radio network under the callsign VK3ZWI, and the WIA Victoria website.  
Annual Membership Fees. Full \$87.00 Pensioner or student \$72.00. Without *Amateur Radio* \$55.00

VK4 Division Queensland  
PO Box 199, Wavell Heights, Old. 4012  
Phone 07 3221 9377  
e-mail: [office@wiaq.powerup.com.au](mailto:office@wiaq.powerup.com.au)  
Fax 07 3266 4929

Web: <http://www.wia.org.au/vk4>  
President Ewan McLeod  
Secretary Bob Cumming  
Treasurer David Gulley

VK4ERM  
VK4YBN  
VK4DCG

EVERY SUNDAY, at 9am LOCAL (Sat 2300 UTC). From Far North Queensland On 7.070/2 MHz. From South East Queensland:- 1.825, 3.605, 7.118, 10.135, 14.342, 21.175, 52.525, 147.000, 438.500 MHz. Right throughout VK4 scan 146.6 to 148.0 MHz again at 9am local. SUNDAY 6:45pm hear LAST week's QNEWS broadcast 3.605 and 147.0 MHz from South East Queensland. MONDAY 7:00pm hear YESTERDAY's news again on 146.875 MHz broadcast from Brisbane's Bayside repeater, and then 7:30pm on 3.605 and 147.0 MHz from St East Queensland. Text editions on packet internet and personal email, visit [www.wia.org.au/vk4](http://www.wia.org.au/vk4) News is updated 24/7 in both text and audio on this site. MP3 Audio from same website by 2300 hours each Saturday. Contact QNEWS, packet sp QNEWS@VK4WIE.BNE.QLD.AUS.OC email [qnews@wia.org.au](mailto:qnews@wia.org.au)  
Annual Membership Fees. Full \$95.00 Pensioner or student \$81.00. Without *Amateur Radio* \$63.00

VK5 Division South Australia and Northern Territory  
(GPO Box 1234 Adelaide SA 5001)  
Phone 08 8294 2992

web: <http://www.sant.wia.org.au>  
e-mail: [peter.reichert@bigpond.com](mailto:peter.reichert@bigpond.com)  
President Trevor Quick  
Secretary Peter Reichelt  
Treasurer Trevor Quick

VK5ATQ  
VK5APR  
VK5ATQ

VK5WI: 1843 kHz AM, 3.550 MHz LSB, 7.095 AM, 14.175 USB, 28.470 USB, 53.100 FM, 147.000 FM Adelaide, 146.800 FM Mildura, 146.900 FM South East, 146.925 FM Central North, 438.475 FM Adelaide North, ATV Ch 35 579.250 Adelaide. (NT) 3.555 LSB, 7.065 LSB, 10.125 USB, 146.700 FM, 0900 hrs Sunday. The repeat of the broadcast occurs Monday Nights at 1930hrs on 3585kHz and 146.675 MHz FM. The broadcast is available in 'RealAudio' format from the website at [www.sant.wia.org.au](http://www.sant.wia.org.au) Broadcast Page area.  
Annual Membership Fees. Full \$91.00 Pensioner or student \$76.00. Without *Amateur Radio* \$61.00

VK6 Division Western Australia  
PO Box 10 West Perth WA 6872  
Phone 08 9351 8873

Web: <http://www.wia.org.au/vk6>  
e-mail: [vk6@wia.org.au](mailto:vk6@wia.org.au)  
President Nell Penfold  
Secretary Roy Watkins  
Treasurer Bruce Hedland-Thomas

VK6NE  
VK6XV  
VK6OO

VK6WIA: 146.700 FM(R) Perth at 0930hrs Sunday relayed on 1.865, 3.564, 7.075, 10.125, 14.116, 14.175, 21.185, 29.120 FM, 50.150 and 438.525 MHz. Country relays 3.582, 147.200 (R) Cataby, 147.350 (R) Busselton, 146.900 (R) Mt William (Bunbury), 147.000 (R) Katanning and 147.250 (R) Mt Saddleback. Broadcast repeated on 146.700 at 1900 hrs Sunday relayed on 1.865, 3.564 and 438.525 MHz : country relays on 146.900, 147.000, 147.200, 147.250 and 147.350 MHz. Also in "Real Audio" format from the VK6 WIA website  
Annual Membership Fees. Full \$71.00 Pensioner or student \$65.00. Without *Amateur Radio* \$39.00

VK7 Division Tasmania  
PO Box 371 Hobart TAS 7001  
Phone 03 6234 3553 (BH)

Web: <http://www.wia.org.au/vk7>  
e-mail: [vk7dg@wia.org.au](mailto:vk7dg@wia.org.au)  
President Phil Corby  
Secretary Dale Barnes  
Treasurer Dale Barnes

VK7ZAX  
VK7DG  
VK7DG

VK7WI: At 0930 hrs every Sunday on 146.700 MHz FM (VK7RHT, Hobart) and relayed on 147.000 MHz FM (VK7RAA, Launceston), 146.625 MHz FM (VK7RMD, Ulverstone), 146.750 MHz FM (VK7RNW, Ulverstone), 147.075 MHz FM (VK7RWC, Rosebery), 3.57 MHz LSB, 7.090 MHz LSB, 14.130 MHz USB and UHF CB Channel 15 in Hobart area.  
Annual Membership Fees. Full \$90.00 Pensioner or student \$77.00. Without *Amateur Radio* \$57.00

VK8 Northern Territory is part of the VK5 Division and relays broadcasts from VK5 as shown, received on 14 or 28 MHz. The broadcast is downloaded via the Internet.

# Seasons at Mt Baw Baw

Chris Morley VK3KME

Secretary

WIA Eastern Zone Amateur Radio Club



The winter photos were taken in July and August 2003 (see also photo on front cover) when I travelled by cross-country skis to the summit to replace the transceiver. It took two trips spread over a couple of weeks to achieve this, as I was not successful gaining access on the first attempt. The summer photo (below) was taken in February 2004 on another repeater maintenance trip.

The VK3RWG 2 metre repeater site at Mt Baw Baw in Gippsland.

The Mt Baw Baw repeater, which operates on 147.225 MHz, provides good radio coverage over virtually all of West Gippsland (hence the RWG call sign), much of Central and South Gippsland and well into Melbourne. Repeater output power is about 15 watt into a 3 dB collinear antenna. The repeater is co-located with a number of other services near the summit of Mt Baw Baw in an air-conditioned hut, previously used for pay TV and now owned by a phone carrier.

Mt Baw Baw, at 1564 metre above sea level, is one of the highest amateur radio repeater sites in the country, and stands well above any other nearby mountains, except for Mt Erica at the eastern end of the Baw Baw plateau. The alpine climate provides snow cover for a good deal of winter much to the delight of both cross country and alpine skiers. Many day-trippers from Melbourne make the 2 – 3 hour journey to the ski resort in winter.

The repeater is maintained by the WIA Eastern Zone Amateur Radio Club which is based in the Latrobe Valley. Other devices maintained by the WIAEZARC include the 2 metre and 23 cm Mt Tassie repeaters (VK3RLV), the Carrajung 70 cm repeater VK3RGU, and beacons on 2 metre, 70 cm and 23 cm also at Carrajung. Most of the repeater and beacon work is undertaken by the Club's Repeater Officer, Ralph Edgar VK3WRE.



# ICOM'S GREAT CHAMPIONS



## IC-208H 2m FM Dual Band Transceiver

Dual Band Features at a Single Band Price • 55W / 2m, 50W / 70cm  
 • Built-in CTCSS and DTCSS Tone Squelch Detachable Front Panel (Req. OPC-600/601 Option) • 9600 bps Packet Operation  
 • 512 Memory Channel • Standard Mic. Supplied: HM133.



## IC-2720H The new dual band FM Transceiver

2M / 70CM • Remote head operation • Dual VFO with independent control for each band • 212 Memory channels • Wideband receiver  
 • CTCSS & DTCSS encode & decode • 9600 bps packet operation  
 • Standard HM133 remote control microphone



## IC-718 A compact HF all band transceiver.

A superior performer with simple, straightforward operation with keypad • Optional AF DSP capabilities, including noise reduction & auto notch function • It's versatile, compact & loaded with features • **Morse Free Package**



## IC-7400

**NO FILTERS REQUIRED**

Sharp & soft IF filter shape • 100W HF /6m /2m • Digital twin PBT  
 • DSP • SSB / CW synchronous tuning • Built in antenna tuner  
 • RTTY demod / decoder • Digital RF speech processor  
 • Microphone equaliser • **Morse Free Package**



## IC-706MKIIG HF • VHF UHF

**The amazing evolution of the legendary 706.**  
 Now includes 70cm @ 20W and 50W on 2m  
 Standard feature dsp • Built in sub tone encoder & decoder  
 Tone scan • Mosfet PA • You get base station performance and features in a mobile rig sized package • **Morse Free Package**



## IC-T90A A new 5W Triband handheld

VHF/UHF FM 2M, 6M, & 70CM  
 Wideband receive 495 KHz - 1 GHz  
 555 Alphanumeric memories • 13 Scan modes DTCSS & CTCSS encode & decode DTMF encoder (10 memories) Wide/narrow transmit capability.



**ICOM**

Clearly Ahead

**2 YR WARRANTY**

find your nearest ICOM dealer at

[www.icom.net.au](http://www.icom.net.au) or (03) 9387 0666

PH353 ANK 2



The magazine for AUSTRALIAN AMATEURS

June 2004  
Volume 72 No 6



# Amateur Radio

\$6.50  
incl GST

## The Dish: *detecting signals from MARS*

Now The  
**NATIONAL  
WIA**

also featuring

- **Waldegrave Islands**  
- IOTA OC-261
- **Sherlock Holmes** and  
the 50-year mystery
- **SSB back to basics transmitter**
- **A basic GPS unit**
- **The No Code influence**  
on amateur bands
- \* **In Charlie's way, Part 2**

ISSN 0002-6859



9 770002 685062 06



## Mobile Antennas

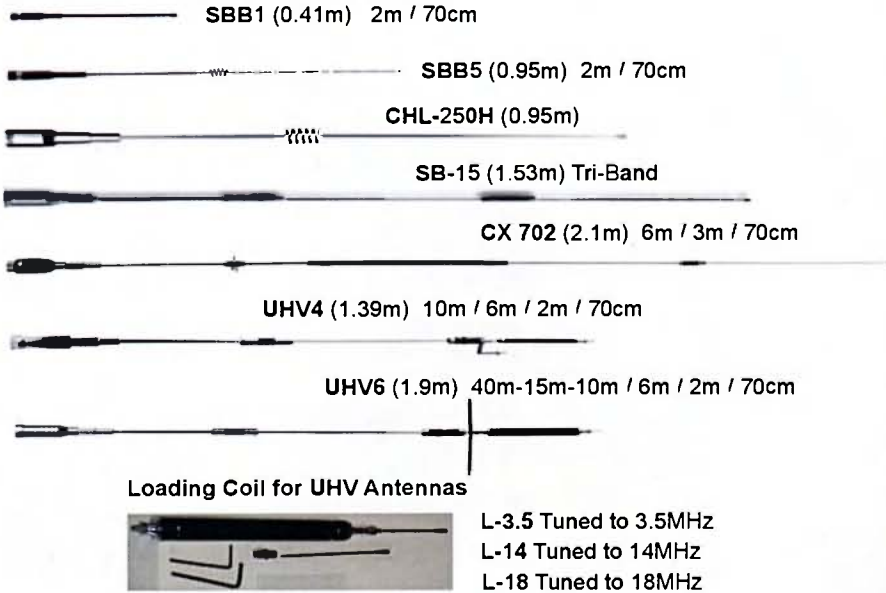

## Base Antennas

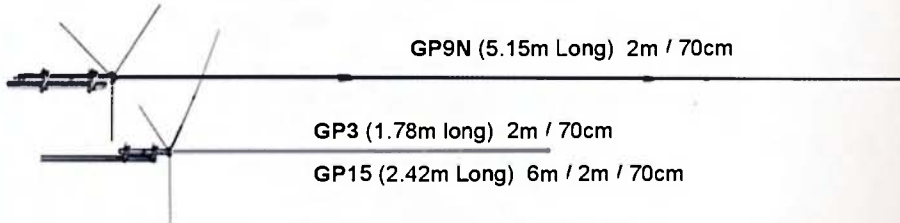

## Portable Antennas



Made in Japan

[www.benelec.com.au](http://www.benelec.com.au)

Authorised Yaesu Retailers

NSW  
Andrews Communications Systems  
Tel 02 9636 9060  
lee.andrews1@bigpond.com

Newcastle Pro Sound  
& Communications  
Tel 02 4965 6899  
sales@newcastleprosound.com.au

Action Communications  
Tel 02 4732 2788 action@pnc.com.au

VIC  
Strictly Ham P/L  
Tel 03 9729 7656  
sales@strictlyham.com.au

G&C Communications  
Tel 03 5996 3298  
gcomm@netspace.net.au

Qld  
Kyle Communications  
Tel 07 3857 4400  
mark@kyle.com.au

SA/NT  
POSNAV Systems P/L  
Tel 08 8342 4700  
brenton@posnav.com.au

## Accessories



0301 BENELEC VSWR / Power  
1.8-520MHz 200/400 Watts



172001205 50ohm Load UHF  
100 Watts PFP DC-600MHz



Revex Switch Ns  
DC-1500 MHz



CSW-210G  
UHF Manual Coaxial Switch  
DC-600 MHz



CF 706 Duplexer  
1.3 - 57 MHz/75-550 MHz



CFX-514N Triplexer  
1.3-90 / 130-200 / 380-200 MHz



# Amateur Radio

Volume 72, Number 6  
June 2004

The Journal of the Wireless  
Institute of Australia  
ISSN 0002-6859

## Editorial

Editor: Colwyn Low VK5UE  
edarmag@chariot.net.au

Technical Editor: Peter Gibson VK3AZL

Publications Committee Members  
Brenda Edmonds VK3KT  
Ron Fisher VK3OM  
Don Jackson VK3DBB  
Evan Jarman VK3ANI  
Tom Potter VK3UBS  
Bill Roper VK3BR

## Submission of material to Amateur Radio Magazine

General and Technical articles to  
Secretary  
AR Publications Committee  
3 Tamar Court  
Mentone VIC 3194  
or armag@optusnet.com.au

## Columns and Letters to the Editor to

Editor  
AR Magazine  
34 Hawker Crescent  
Elizabeth East SA 5112  
or  
edarmag@chariot.net.au  
(Tel and Fax 08 8255 2138)

Hamads to  
"Hamads" Newsletters Unlimited  
PO Box 431  
Monbulk VIC 3793  
Fax 03 9756 7031  
newunltd@bigpond.net.au

Advertising  
All enquiries to  
Newsletters Unlimited  
PO Box 431  
Monbulk Vic 3793  
Phone: 03 9756 7797  
Fax: 03 9756 7031  
newunltd@bigpond.net.au

Registered Office  
10/229 Balaclava Road,  
Caulfield North VIC 3161  
Australia  
Phone: 03 9528 5962

## Production Deadlines

Advertising booking and articles for  
publication 10<sup>th</sup> of preceding month.

Hamads and advertising material  
deadline 18<sup>th</sup> day of preceding month

The contents of Amateur Radio are Copyright  
Wireless Institute of Australia © 2004

## General

Waldegrave Islands IOTA OC-261 .....	4
<i>Peter Forbes VK3QI</i>	
Detecting signals from the Mars Global Surveyor .....	8
<i>Doug McArthur VK3UM</i>	
In Charlie's Way.....	13
<i>Ross Fraser VK2WN</i>	
Sherlock Homes and the 50-year mystery .....	18
<i>Frank Shaw VK6ALF</i>	
The No Code influence on amateur bands .....	24
<i>Chris Wright VK2UW &amp; Karen Wright VK2HKW</i>	

## Technical

A basic GPS unit .....	14
<i>Dale Hughes VK2DSH</i>	
SSB back to basics transmitter .....	19
<i>Neville Chivers VK2YO</i>	
Delayed turnoff fan control (Technical Abstracts) .....	22
<i>Peter Gibson VK3AZL</i>	
Easy to build 50:300 ohm and 50:450 ohm transformers (Technical Abstracts) .....	39
<i>Peter Gibson VK3AZL</i>	

## Columns

ALARA .....	34	Hamads .....	54
AMSAT.....	38	HF Predictions .....	42
Beyond Our Shores .....	38	Intruder Watch .....	28
Contests .....	37	Know your 2nd hand equipment .....	40
Club News .....	31	Over to you .....	37
WIA Division News		Silent Key .....	21, 23
VK1 News .....	29	Spotlight on SWLing .....	36
VK2 News .....	25	Technical Abstracts .....	22, 39
VK4 News .....	27	VHF-UHF an expanding world .....	44
VK6 News .....	28	WIA Comment.....	3
VK7 News .....	30	WIA Division Directory .....	56
Editor's Comment .....	2	WIA National Directory .....	2

## Our Cover this month

The Doug McArthur VK3UM responds to a challenge. He poses here with his dish designed to receive signals from Mars. See story page 8

## Contributions to Amateur Radio

Amateur Radio is a forum for WIA members' amateur radio experiments, experiences opinions and news. Manuscripts with drawings and or photos are always welcome and will be considered for publication. Articles on disc or email are especially welcome. The WIA cannot be responsible for loss or damage to any material. A pamphlet, How to write for Amateur Radio is available from the Federal Office on receipt of a stamped self-addressed envelope.

## Back Issues

Back issues are available directly from the WIA Federal

Office (until stocks are exhausted), at \$4.00 each (including postage within Australia) to members.

## Photostat copies

When back issues are no longer available, photocopies of articles are available to members at \$2.50 each (plus an additional \$2 for each additional issue in which the article appears).

## Disclaimer

The opinions expressed in this publication do not necessarily reflect the official view of the WIA and the WIA cannot be held responsible for incorrect information published.

## Amateur Radio Service

A radiocommunication service for the purpose of self-training, intercommunication and technical investigation carried out by amateurs; that is, by duly authorised persons interested in radio technique solely with a personal aim and without pecuniary interest.

## Wireless Institute of Australia

The world's first and oldest  
National Radio Society  
Founded 1910

Representing  
The Australian Amateur Radio Service

Member of the  
International Amateur Radio Union

Registered Office of the WIA

10/229 Balaclava Road

Caulfield North Vic 3161

Tel: (03) 9526 5962 Fax (03) 9523 8191

<http://www.wia.org.au>

All mail to  
PO Box 2175 Caulfield Junction VIC 3161  
Business hours: 9.30am-3pm weekdays

### Office staff

June Fox Bookkeeper  
Rita Trebilco VK3IF Examinations Officer

### Board of Directors

President	Michael Owen	VK3KI
Vice President	Ernie Hocking	VK1LK
	Glenn Dunstan	VK4DU
	Trevor Quick	VK5ATQ
	Ewan McLeod	VK4ERM
	Ted Thrift	VK2ARA
	Phil Wait	VK2DKN
Secretary	Peter Nalsh	VK2BPN
Treasurer	David Pilley	VK2AYD

### Coordinators

AMSAT	Graham Ratcliff	VK5AGR
ARDF	Jack Bramham	VK3WWW
Awards	Mai Johnson	VK6LC
Contests	t.b.a.	
John Moyle Memorial		
FD Manager	Denis Johnstone	VK3ZUX
Editor "AR"	Colwyn Low	VK5UE
Education	Ron Smith	VK4AGS
EMC/EMR	Gilbert Hughes	VK1GH
	Keith Malcolm	VK1ZKM
Standards	Gilbert Hughes	VK1GH
	Peter Nalsh	VK2BPN
FTAC	John Martin	VK3KWA
Historian	t.b.a.	
IARU Region 3	Neil Penfold	VK8NE
Liaison Officer		
Intruder Watch	Henry Andersson	VK8HA
International	John Miller	VK3DJM
Travel Host		
ITU Conference and		
study group	Gilbert Hughes	VK1GH
	David Wardlaw	VK3ADW
	Keith Malcolm	VK1ZKM
QSL Curator	Ken Matchett	VK3TL
QSL Manager (VK8/0)	Neil Penfold	VK6NE
Videotapes Curator	VK2 Division	
Web page co-ordinator	Colin Thompson	VK2TRC
WICEN	John Weir	VK3ZRV

### ACA Liaison Team

Peter Nalsh VK2BPN,  
Gilbert Hughes VK1GH  
Keith Malcolm VK1ZKM  
Peter Mill VK3APO  
Glen Dunstan VK4DU

## Editorial Comment

Colwyn Low VK5UE

## At last. A National WIA

The new dawn of the WIA has arrived. At the conclusion of the Federal Convention on 16th May 2004 the constitution for a national Wireless Institute of Australia was accepted and implemented.

Now we can truly say that the WIA is an Australian National Institute.

Like all new organisations, formed from previously federated bodies, there are a number of procedural processes to be gone through, but the benefit to Amateur Radio in Australia will be immense.

One thing we as members will see will be the transfer of our membership from a Division to the National body. This will be quite seamless, but we will have to formally accept membership in the National WIA. This will be processed when our current Divisional membership comes up for renewal.

The day-to-day things will not change the repeaters will still operate and the clubs will still meet.

A copy of the new constitution as adopted by the WIA Federal Convention is enclosed with members mailed out copies. Others can request a copy from the National WIA Office in Melbourne or read it on the National WIA web site [www.wia.org.au](http://www.wia.org.au). Also see WIA comment in this issue.

I am glad we now have an opportunity to progress Amateur Radio in Australia on a National basis for the good of all Australian Amateurs and ask you all to support the National body.

### Amateur activity

With the winter setting in some of our outside activities will be curtailed. I do hope you have done all the necessary maintenance on your aerial systems, as there is nothing worse than having to take antennas down and handle cold metal in the wind and rain. We also have the chance to sit in the warm and talk to friends catch up on recent events and plan the next project.

I have been caught up in some of this with my WICEN commitment to support the Coopers Pale Ale Rally of SA. This is a dirt road rally similar to those run in other states and also supported by WICEN. Making sure all the gear works is important. This is best done by having a trial run away from home base. This ensures we have all the microphones, patch leads, aerials clips, power distribution boards, guys and pegs, etc. When I worked in a trials environment we had check lists for even the simplest activities because in the pressure of doing the real job you could easily miss an important action or forget a necessary piece of equipment, which "Some One" should have done or brought. A list made at a practice is a necessity. Ask any DXpedition organiser. The one thing I find useful in these circumstances is to start with an empty tool box and every tool I use is put in this box as it is used. Then you add those might be useful items at the end.

Remember—hobbies for relaxation and enjoyment!

73 Colwyn

## Michael Owen VK3KI, 1st President of WIA National

Michael Owen VK3KI has been licensed for over 40 years, has been a member of the VK3 Division Council, and its Federal Councillor. He became a member of the Federal Executive, and was Federal President at the time the federal body was incorporated, having been largely responsible for writing the constitution. He has been a WIA delegate to a number of Region 3 Conferences, and was a Director of Region 3 for many years. He was IARU Vice President for 10 years until 1999. He was the Chairman of the IARU committee responsible for formulating the

global policy in respect of Article 25, the international regulations governing the amateur services. He represented the IARU at the Special Committee on Regulatory /Procedural Matters, Geneva, July 2 to 12, 2002. and was a member of the IARU WRC 2003 observer team, responsible for coordinating Article 25 matters. By profession he is a lawyer, until 1997 a partner in Corrs Chambers Westgarth, was resident partner in London for 6 years from 1988, and more recently has been General Counsel for Quiksilver.



## The National Society for Australian Radio Amateurs

**On Sunday afternoon, 16 May 2004, the Federal Council of the Wireless Institute of Australia made one of the most important decisions it has made for many years when it passed a special resolution that adopted a completely new Constitution for the WIA.**

The Federal Council comprised the representatives of the 7 Divisions, which were the 7 members of the WIA. The federal body of the WIA was a federation of state organisations, with the federal body having primary responsibility for representing Australian amateurs at a national and international level.

The Federal Council "was", because with the adoption of a new Constitution it no longer exists, and a new, single, national WIA is created by the new Constitution.

Every individual is now entitled to become a member of the single WIA. The existing members of the Divisions are Provisional Members of the national WIA, and when they are next invited to renew their membership, they will be able to renew it as a member of the national WIA.

The new company is structured on very simple lines, with a board of 7 directors, the first board appointed for two years by the Constitution, thereafter the directors will be elected for two year terms, with half retiring each year.

Elections will be by postal ballot, and every member will be entitled to vote.

The new board is as follows:

Michael Owen VK3KI, President  
Ernie Hocking VK1LK, Vice President,  
Glenn Dunstan VK4DU  
Trevor Quick VK5ATQ  
Ewan Mcleod VK4ERM  
Ted Thrift VK2ARA, and  
Phil Wait VK2DKN.

Peter Naish continues as Secretary, and David Pilley continues as Treasurer.

A couple of the Divisions are still considering how to manage their interests, but others are clear what they wish to do, and the national WIA will have the responsibility of ensuring that the services that members are used to at a local level continue to be available.

We are going through a period of transition, and the directors and officers and the WIA office are now very busy struggling to come to grips with the new structure.

The new Constitution is available on the Institute's website.

There are 5 categories of membership, and with the same fee all across Australia.

The categories and subscription rates are:

Member	\$75
Overseas Member	\$85
Concession Member	\$70
Member – No magazine Member	\$50
Honorary Life Members	

A Concession Member is either a person holding a Pensioner Health Benefits Card or a full time student.

Because the WIA is a company limited by guarantee, each member undertakes to contribute up to \$20 to meet the debts of the Institute, if the company is wound up and the member is called upon to make a payment. So, members on renewing their membership after 1 July 2004 will be asked to sign and return a form with their subscription. Even though the amount is very small, that is the formality that is required as it is the members guarantee that limits the company, the requirements of the Corporations Act for this type of company, the type that has been used for many years for these purposes and the type of company that is allowed to have a name that does not include the word "Limited".

This is a dramatic move. Why? The WIA has over recent years suffered as many national radio societies have suffered, with a dwindling and ageing amateur population and declining membership.

I am told that in 1990 some 41% of all

licensed amateurs were members of the WIA. Today the figure is around 27%.

But while there are threats, there are opportunities. The removal of the Morse requirement for HF may make amateur radio more attractive. A new entry-level licence may attract new amateurs, particularly younger amateurs. The increasing awareness of the shortage of trained radio technicians, and the perception of amateur radio as one of the possible tools to meet that need may lead to growth. The currently perceived advantage of amateur radio as an educational tool in schools may also lead to growth.

To use the opportunities to overcome the threats requires a single, strong organisation, speaking with one voice, and using its resources effectively, not in performing duplicated functions. That was the reason that a new national WIA was proposed and ultimately adopted.

I make no apology for stating firmly that I believe that the role that the WIA undertakes as the representative voice of Australian amateurs, nationally and internationally, is the most important thing that the WIA does. The critical issues of amateur radio at the WRC last year amply illustrate that, and the importance of Australia in that ITU forum, and the importance of the WIA being in a position to nominate two members of the Australian delegation cannot be overstated.

But the WIA does much more than that; it publishes this magazine, and provides member services and assistance at every level. That must continue.

The WIA must be effective. How can the WIA be taken seriously if it only represents less than one in every three

# Waldegrave Islands IOTA OC-261

April 17 to 21, 2003

By Peter Forbes, VK3GI

After our successful and exciting OC-251 Lady Julia Percy Island operation of September 2002, Tom VK3ZZ and I scanned the IOTA directory. In southern Australia, we found two groups, one in far eastern Western Australia and the other South Australia State West Centre. The only problems were the distance to the area from Victoria (VK3), 1400 kilometres plus, and the small amount of information on the area.

The largest island in the SA group is Flinders Island, which is privately leased as a sheep station of some 8000-hectare and lies approximately 35 kilometre off shore. Tom was able to make contact with the owner, Peter Woolford, who graciously offered to allow access to the island. We could fly to the island by light plane and our equipment could be barged from Elliston. Peter Woolford also suggested we contact an abalone diver, Jeff Grocke.

Jeff Grocke runs a very successful enterprise, including two 8 metre Shark Cat boats, which can operate in virtually any weather. Jeff was also the designated emergency boat rescue person for the Elliston area, which made the safety/emergency requirements placed on our access permit by the Parks and Wildlife officials, much easier to negotiate.

## The choice is made

Waldegrave Islands were chosen as the most accessible of the islands in the

group and Jeff was asked to select a suitable operating point on the islands.

Waldegrave Islands lie some 3 kilometres off the coast and are separated by a body of water that can be very rough at times. East Island is the larger. It is 9 kilometres in circumference, relatively flat on top, with saltbush vegetation, drifting sand and a 25 metre high sandstone cliff almost entirely around its edge. There are three beach areas where one can land and each has a small area near the cliff face, which remains dry at high tide. The day we arrived at Elliston there was a good 3 metre swell running, with spectacular waves crashing onto the southern end of the island. Jeff had chosen an area at the north end with a beach landing, somewhat better sheltered from the prevailing south-westerly swell.

The islands are a conservation park and the South Australian Parks and Wildlife permit states, "The island has

a population of Eastern Brown Snakes and Bush Rats, which may cause concern when camping".

Jeff Grocke chose an area, which was absolutely perfect for our operation – large enough to spread out antennas, generator and tents, sheltered from the prevailing winds and with relatively safe access up the cliff face at one end of the beach. We were able to erect the tri-band beam antenna some 30 metres high, directly overlooking our operating position. The beam had a 270 degree salt-water take-off from south through east to west and a relatively clear take-off over the island in the south to west direction. Our other main antenna was a Hy-Gain AV-640 "Patriot" vertical, which was mounted on the beach at the high water mark and had a 140 degree clear take-off from south-east through north to west over salt water, but was shielded in the south-west direction by the island's cliff.

The droopy dipole was erected some 100 metres along the cliff top and fed with open wire line to a 4:1 balun before a coaxial cable run down the cliff face.

The conservation park has several small penguin colonies, resident seals and dolphins who patrolled the water next to the beach in search of food, and many bird species, including Cape Baron Geese.

Being a conservation area, we had to undertake not to disturb the flora and fauna and remove rubbish and waste on departing. The only thing we left behind were hundreds of footprints on the beach.

## Why use the special callsign, VI5WCP?

The period 1802 to 1804 was a watershed time in the coastal exploration of Australia. In 1802 the English explorer Matthew Flinders and the French explorer Nicolas Baudin met

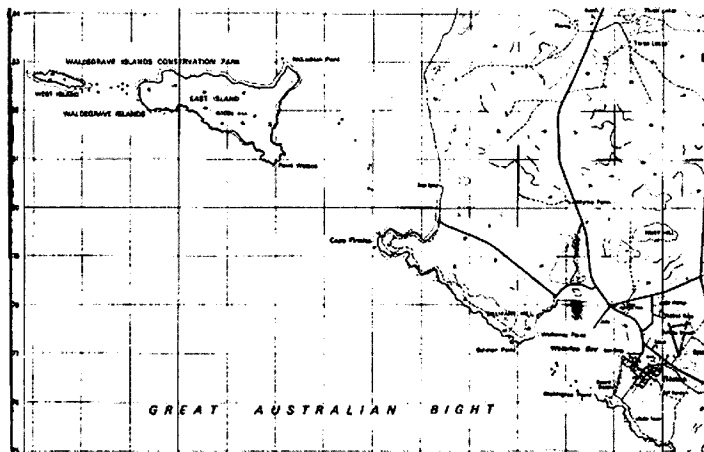



in Encounter Bay off the South Australian coast. Both were searching unsuccessfully for an entrance to the great inland sea that was believed to exist in central Australia. England and France were at war, but in the spirit of scientific discovery, relations between the two explorers were cordial, at least.

Most of the islands and coastal features were named at this time and in South Australia especially, many of the original French and English names remain.

Waldegrave Island was named by Flinders on 10th February, 1802 after Sir Richard Waldegrave, who was the Lincolnshire representative of the House of Commons in the British Parliament and Flinders' local member. This operation commemorated its 200th year anniversary.

## Operators

It was decided to limit the number of persons to four. Keith VK3FT, Jack Bramham VK3WWW, Peter Forbes VK3QI and Tom Marlowe VK3ZZ (also VK3OK). If you worked us any time from 1600Z till 2100Z (1.30 a.m. till 6.30 a.m. local time) on SSB, it was sure to be Tom, as he is an avid "night owl" operator.

## Planning the Operation

We decided on one vehicle and a trailer for the 24 hour trip to Elliston. Weight was not going to be an issue like our previous operation. Jeff Grocke said his boat was capable of carrying a 2 tonne abalone diving outfit and lengths up to 6 metres could easily be accommodated. So we had to decide how much equipment was really necessary. As the equipment would need to be landed by dinghy and the landing could be quite wet, we planned to package the equipment in watertight plastic drums

of approximately 60 litres. These could easily house the transceivers, power supplies and most small items that should be protected from the elements.

This put the total weight at 700 kilogram, which fitted in the trailer and rear of the Jeep vehicle.

Our basic equipment was:

- IC-706 and MA-1000 solid-state 12 volt amplifier, MFJ 4245 switch mode power supply to 3 element Hidaka tri-band yagi on a 5 metre mast with a small rotator.
- FT-100 and TX-5500 solid state 12



Peter Forbes VK3QI

volt amplifier, MFJ 4245 switch mode power supply to a Hy-Gain AV 640 "Patriot" vertical

- IC-706 to a tuned feeder 13 metre per side droopy dipole on a 10 metre telescoping mast.
- Various MFJ antenna tuning units as required.
- Power source was a Honda EU20i generator with an EU10i as backup. Fuel use for the Honda EU20i is stated as 1 litre per hour, so 100 litres of fuel was needed.
- We decided against computer logging. You can't beat a paper log and clipboard when the wind is

blowing, salt spray is all around and the power goes off suddenly due to running out of fuel. The other important issue is looking for broken calls etc. We have already had several instances where the claimed contact was found on the paper logs, not correctly recorded, or at the wrong time, but clearly the actual one. This would not have been possible on a directly entered computer log.

- Equipment for shelter consisted of low wind resistance/low profile tents for sleeping, a large touring tent for the main operating position and a second smaller touring tent for the other operating position.

## Getting it all there

We left Melbourne midday on Tuesday 15th April and, by all four sharing the driving, drove non-stop overnight. This allowed 23 hours to discuss our plans for the operation.

We arrived at

Elliston around 11 a.m. on Wednesday 16th and stayed overnight at the Elliston Caravan Park.

The weather forecast for the Easter period was excellent. Fine conditions, 28 degrees maximum, 15 degrees minimum overnight, winds variable, strong at first and moderating.

First light Thursday, we loaded all our equipment into the Shark Cat at Jeff Grocke's boatshed, before towing the boat by tractor 4 kilometres to the boat ramp. The boat was launched and, towing a 4-metre dinghy, we quickly arrived off the island and anchored about 100 metre off shore around 11 a.m.

In four trips we were able to transfer the operators and equipment by dinghy to shore without incident, save a few wet operators from re-launching the dinghy in the 1 metre waves.

Assembling the station went smoothly, due in no small part to having set up the antennas and tents before. Precautions were taken to avoid snakes both in climbing the cliff and moving around on the cliff. Pulling the beam antenna and two support poles up the cliff by rope took some time, but by 5 p.m. local time (0730Z), we were ready to hit the airwaves.

## Up and running

Despite extra filters and separation of the antennas, we still had some mutual interference problems, especially where the two bands were adjacent to each other. For example, the 17 m and 15 m bands share the same low pass filter ranges on both the FT-100D and the IC-706. This means that 17 m oscillator phase noise when operating on 15 m is also transmitted and that causes reception problems on 17 m. Fortunately, one combination that works well is transmit CW on 40 m on the FT-100 and receive SSB on 20 m on the IC-706. This was one of the main operating configurations, that netted us so many contacts. For our next operation, we plan even better bandpass filtering.

Many operators in typical urban and semi-rural high noise areas would be unaware of the sort of interference we are talking about, but on Waldegrave, the noise floor was essentially zero. NO noise from the Honda generator (which we have been able to eliminate with appropriate filters and earthing), and receiving conditions such that we could detect the weak ignition noise from passing fishing boats at up to 10 kilometres distance.

The first night was quite windy and around 11 p.m. (1330Z) after 180 SSB contacts, the beam appeared to go dead. Never mind! Three operators were tired and retired to bed for some well earned sleep. VK3QI, continued on all night on CW on the dipole, firstly 40 m (1130Z - 1230Z), then 30m (1245Z - 1630Z), then 20 m (1700Z - 2000Z) and finally 30 m (2000Z - 2100Z), netting some 420 CW contacts.

First thing on Friday morning, Jack, Tom and I climbed up to the cliff top and lowered the beam to check it out.

Clearly there was continuity on the coaxial cable, but no signals getting through. Dismantling the driven element soon revealed a break in the connection on the "hot side" of the 10 m trap coil, hence only the short bit of aluminium between the balun and the trap was active. Jack, whose day job is a locksmith, carries a toolkit for every eventuality. In short order we had oversized self-tapping screws installed to fix the problem and while we were at it, we checked over all the traps and added extra oversized screws where appropriate. The whole exercise took less than an hour and soon the beam was up again and working like new.

Meanwhile, Keith had been operating on the beach mounted vertical, amassing contacts on 20 and 15 m.

The Honda EU20i was simply brilliant, running continuously for 104 hours before getting a break of 3 hours on the final night, and then a final 6 hours of running. To hear the generator inverter go under load when sending CW was fascinating. All the while the output voltage remaining at a steady 242 volts. Despite being run in normal mode, consumption was only 80 litres. (Note: even though the generator has an Economy mode, which uses half the fuel, experienced Honda service people advised us that it is better all round to run the engine at normal speed when running for long periods continuously. This has been borne out by our own experience.)

## The Bands

We planned to use the IOTA frequencies exclusively and split frequency operation as the norm. Our aim was 5000 contacts in the planned 100+ hours of operation. The emphasis was on working European stations, who have the largest number and are the keenest of the IOTA chasers, especially long path on 20, 17 and 15 m from 0500Z to 1000Z. We knew from experience, that

this was the prime time for European DX.

Our strategy worked better than expected. The following contact breakdown was achieved.

### CONTACTS:

2 m	PHONE	4	CW	0
6 m	PHONE	2	CW	0
10 m	PHONE	458	CW	0
15 m	PHONE	785	CW	40
17 m	PHONE	312	CW	447
20 m	PHONE	2709	CW	266
30 m	PHONE	16	CW	1165
40 m	PHONE	40	CW	454

Number of countries worked: 95

### CONTACTS WORKED BY REGIONS OF THE WORLD:

Continent	SSB	CW	Com-bined
Africa	18	5	23
Asia	1267	819	2086
Europe	1733	994	2727
North America	904	527	1431
Oceania	388	23	411
South America	16	4	20
Total	4326	2372	6698

Total number of hours of radio's setup on island:

113 hours

Total number of hours an actual operator on deck and listening/operating:

Total = 110 hours

Average QSOs: 61 Contacts per hour

The pleasing figure was the relatively larger number of JA contacts compared with our LJP operation. We believe the three reasons were:

- Better north/south propagation
- Our targeting the early morning JA



Keith VK3FT



opening on SSB, just after sunrise on 20 and later 15 m

- The use of the much rarer VI5 prefix on CW, compared with the VI3 prefix, which is activated every year by our local radio club for the Australian Grand Prix, as VI3GP.

## Timing

Good timing always makes for a successful operation.

Being on the descending side of Solar Cycle 23, radio conditions can often be quite disturbed for long periods of time. Certainly on the first day of operation, there was evidence of a geomagnetic disturbance with the A index running at 30 and above.

Over the next four days, the A index ran at 20, 12, 16 and 22 and the solar flux at 112, 120, 125 and 130. Conditions were stable on all bands from 40 through 10 m.

The operation was within one month of the equinox and summer absorption over the important North American and European paths was still relatively low.

Conditions were very good across the Pacific on 10 and 15 m with excellent openings to North and Central America. Long-path conditions on 17 and 20 m were very good to Europe and the Middle East and short path on 20 m to Europe was reliable, if not too strong.

30 m and 40 m provided excellent conditions for CW operation. Around 1430 Z each evening, (midnight local time) it was possible to contact right across the Northern Hemisphere on 30 m. e.g. consecutive contacts from 1437 Z were, UA3SKV, HL1AV, AK7G, N9US, DL1SDN and OH7RJ.

Weather conditions were excellent, with wall-to-wall blue sky every day and a gentle sea-moderated breeze during the night.

## Operating and living conditions

Both the FT100 and IC706 rigs performed faultlessly, with the FT100 far superior to the IC706 for CW contacts. This is not a biased comment, as I own and regularly operate both rigs. Even with both having 500 Hz filters, the "CW feel" with the Yaesu is superior.

The MA1000 amplifier was used in conjunction with the MFJ 4245 switch-mode power supply, which is a light weight 45 amp/13.8 volt power house.

Although the MA1000 is capable of 500 W PEP output, the power supply would overload at that level, so we adjusted exciter drive to run around 300 W PEP output. In this way, the amplifier and exciter were running cool.

The use of a small antenna rotator on the beam worked very well over a 60 metre distance and made antenna rotation possible, without climbing a 25 metre high cliff!

It is always difficult to judge the performance of antennas in such conditions, but our experience suggested that they were sufficiently good enough to maintain order on the operating frequencies.

By far the most interesting aspect was the relative performance between the 3 el tri-band beam on 20, 15 and 10 m (at a height of 30 metre and with a perfect takeoff) and the Hy-Gain AV640, mounted at sea level. Sometimes the vertical OUTPERFORMED the beam on direct A/B switching, and at other times the beam was far superior, depending on angle of arrival and time of day.

Given that the AV-640 vertical works all bands from 6 to 40 m and works REALLY well on all of them, it is now our first choice for any future expeditions. The ground independent feed with the counterpoise mounted 2 metre above the sand, remained perfectly tuned under all tide conditions. Prior to the expedition, we had figured out a way of assembling and disassembling the antenna into two bundles of 4 metre length, with the various aluminium stubs and stainless steel counterpoise rods stored inside one of the vertical sections. With no traps involved in the tuning process, the bandwidth is superior and the antenna does not suffer from detuning in wet weather like some trapped verticals have in the past. All in all, the AV-640 is an antenna really worth considering.

## Packing up

Our last contacts were on Tuesday 22 April, 11 a.m. (0030 Z)

The weather was fine and sunny and the sea was almost smooth. It took us two hours to dismantle the tents. The trip back to Elliston was uneventful. We left early Wednesday morning for the 24 hour non-stop drive, arriving Melbourne 10 am Thursday, happy with the success of the operation and looking forward to the computer logging and QSLing chores!

## Helpers

No expedition can be successful without the assistance of helpers.

David VK3EW, acted as our unofficial pilot. We had access to him via both mobile (CDMA) phone and via satellite phone and could get him to spot us on various frequencies quickly and accurately. This meant maximizing the chances of operators working us when the bands were open.

Ross Keogh VK3MY, from Strictly Ham Pty. Ltd. graciously provided us with the Hy-Gain AV640 antenna at a discount.

Jeff Grocke and his son, Jethro, who transported us safely to and from the island and provided us with much useful advice on the location.

Troy and Andrea Taylor, proprietors of the Elliston Caravan Park, who provided us with advice and brand new on-site accommodation.

Parks and Wildlife, Department for Environment and Heritage, South Australia and in particular, Ross Belcher and Ross Allen, for their friendly cooperation.

Alan VK3BF, for lending us his trailer wheels at the last minute after we found problems with the existing spare wheel on the trailer.

Ian, from Motorola, for the loan of a satellite phone at no charge and Sue VK3LSL for the loan of her CDMA phone.

And to all the operators around the world, who made our experience such a pleasurable one. The kind comments of praise on the incoming QSL cards really made the adventure worthwhile.

## QSL Information

Direct with SAE and postage to QSL manager:

Tom Marlowe VK3ZZ  
P.O. Box 368  
Leongatha  
Australia 3953 or  
Via the VK3 bureau

ar

**more pictures  
inside back cover**

# Detecting signals from the Mars Global Surveyor

Doug McArthur VK3UM  
"Tikaluna" 26 Old Murrindindi Rd  
Glenburn 3717 Victoria

The following posting on the EME reflector caught my eye and after missing the earlier experiment I was anxious to see if I could detect the signal from the Mars Global Surveyor.

During the period August 26-29 2003, NASA's Jet Propulsion Laboratory (JPL) in cooperation with the Stanford Research Institute (SRI) will be conducting a test of the Mars Relay transmitter aboard the Mars Global Surveyor (MGS) spacecraft currently in orbit around Mars. The test involves the spacecraft transmitting a 1 watt 437.1 MHz CW carrier for reception by the 46 metre dish at SRI. Amateurs with 70cm EME class stations using DSP techniques may be able to detect this signal also.

**Here was a challenge. This is how I went about it and the results I achieved.**

I should initially explain that I have been actively involved with EME (Earth Moon Earth) for over 20 years and have, after considerable effort and with the help of close friends, erected a 10 metre fully steerable (computer controlled) parabolic reflector.

In brief it has a repeatable tracking resolution of 0.5 degree (limited by of my home brew Gray code position indicators). It is mounted on a 1+ ton Centurion Tank planetary ring gear. The azimuth drive requires 24 volts at 85 amps. The proportional speed control power supply is sizable! The elevation drive consists of two 12-ton hydraulic rams driven by a 3 HP single-phase motor. All up it weighs just over two tons and is held on to the hill with 18 ton of concrete! It does not move nor is there any backlash! At 437.1 MHz it has a gain of 30.5dBi. The dish surface is fully specified to 7.5 GHz and usable to 10.3GHz. (Kennedy reflector, all aluminium welded construction, installed on a home brew mount)

The first thing I needed to establish was the feasibility of actually detecting the MGS signal. Given the 1 watt transmitter output to a unity gain antenna at a distance of 55,770,000 kms it is fair to say, that even with what you may consider is a large antenna, the signal would not exactly "blow your head off"! In fact the free space loss at that distance is 240.08 dB. Mind you this is some 20 db less than the EME path on 432 MHz but the MGS was not running

the power or antenna gain of my fellow EMERs!

Using my EMCalc software (obtainable from [www.qsl.net/vk3bez/vk3bez.htm](http://www.qsl.net/vk3bez/vk3bez.htm)) it could be seen that given my receiver capabilities, I could only expect to receive MGS at a S/N equivalent to  $-1.2\text{dB}$  in a 1 Hz bandwidth. This was based upon my receive system temperature of  $97^\circ\text{K}$ . (degrees Kelvin) In fact this figure was not correct as I failed to account for another 3dB loss due to the space craft radiating right hand circular polarisation. I am only capable of receiving linear horizontal or vertical polarisation. At the time I believed I should be able to detect the signal and pressed ahead to check and confirm my systems capability.

The receive antenna feed system (and used for transmit) consists of two sets of folded dipoles in an H configuration, remote switchable for both horizontal or vertical polarisation. The spacing has been designed to align the radiation pattern at the 10dB point corresponding to the rim of the dish. This provides a reasonable compromise between antenna gain and antenna temperature. The pre amplifier or low noise amplifier (LNA) at the feed consists of a home brew cavity with a FHX35 HEMFET. Y factor and noise figure measurements indicate it has a noise figure of better than 0.35dB and, with the relay

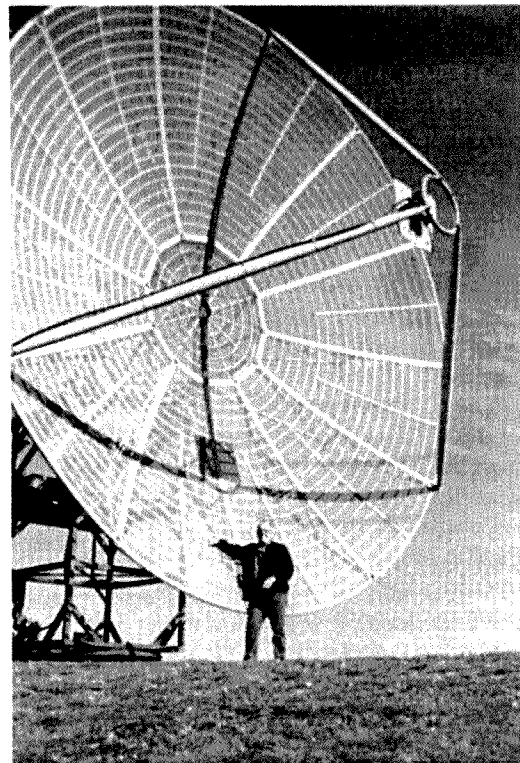

VK3UM and his dish

switching and feed losses, provides a receiver noise figure of about 0.7 dB or  $51.5^\circ\text{K}$ . Given a Sky temperature of  $15^\circ\text{K}$  (hopefully Mars would be in the quiet part of the sky) and ground noise (dish spill over) the actual system noise temperature is about 1.25dB or  $97.2^\circ\text{K}$  for elevation angles above  $4^\circ$ . The preamplifier at the feed is followed up at the shack end with an identical LNA which then passes through a 3 cascaded precision stepped attenuators. (10, 1.0 and 0.1 dB steps). These attenuators form the key element to my measuring capability. At this point I have two down converters 432-28 MHz and 432-15 MHz. The former I use to feed my DL9BV automatic noise figure meter whilst the latter feeds a W & G Peglemesser (SPM6 precision tuneable selective voltmeter). This output also feeds sound card and another accurate HP AF voltmeter. The output of the down converters also feeds

an Icom 751 (receive only) whilst at 432 MHz (switched attenuator output) I also feed the receive section of Icom IC910H. Other test equipment allows for signal generation and frequency measurement when required.

I should explain what Y factor measurements are and how they are used. Y factor measurements (in this case) are simply the difference between two noise source level measurements. One of these sources should be known or the level derived from another source. The Y factor, measured generally in dB, is simply the difference between the two sources. If you know one then you can derive the other. I prefer to use the substitution measurement and you will note that my precision attenuator is placed in the 432 MHz signal path. The reference indicator is the 2.5 dB (full scale) analogue level meter which is part of the precision selective voltmeter.

As an example, to measure Sun noise, I would first direct the array at the quiet area of the sky (Aquarius) and note the level meter reading. I would then direct the antenna at the Sun and add attenuation until the previous level is again obtained on the meter. The Y factor is the amount of added attenuation inserted. This value can then be entered in my software and knowing the Solar Flux Index (SFI) at the time you can derive your Receive System noise temperature. The Sun is not always a good choice of a noise source as its level can vary significantly. Those fortunate to have a large array may choose a known noise source like Cygnus A as a better and a more accurate noise source. Sagittarius is not a good choice either as it is not a point source which may impact adversely on your measurement. You can see that by using the substitution method you do not require a heap of expensive test equipment. There is so much you can achieve by the simple substitution method and I get some enjoyment in deriving the SFI from my measurements and then checking the results off the web. It is rare to be more than 10 SFI units out and if there is a discrepancy you have a problem Houston!

If all of the above seems just too complicated and the figures difficult to

understand, then download the software and you will find that by substituting your figures all the hard work and calculations are done for you. Moreover the software provides for "reverse engineering" calculations to derive other unknowns. It is better than the average game programs as it has a large number of buttons and variables you can play with even if you don't know what you are doing!!

Back to checking out the system. Given that my normal operation is at 432 and the MGS is transmitting on 437.1

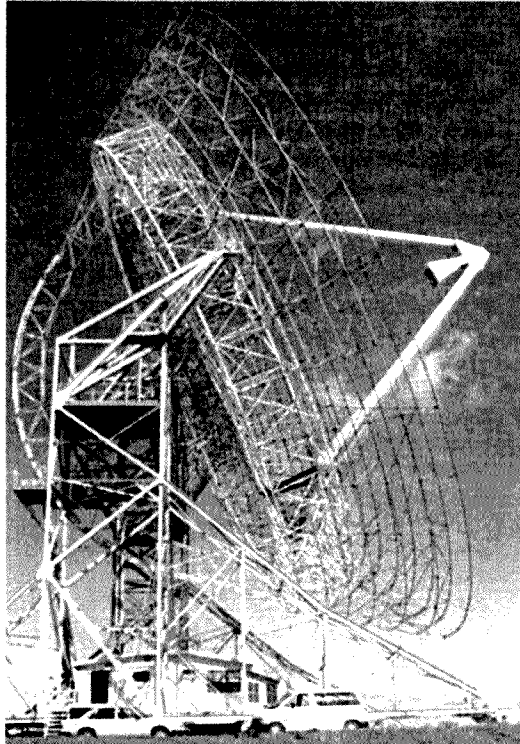

SRI 46 metre dish

MHz it was essential to know just how much degradation may occur at the higher frequency. By using the Sun Noise measurement procedure, as described above, the system gain was found to be 10 dB less (due to fixed tuning inherent with the down converter). The Y factor however was within 0.2 dB and totally acceptable. The difference I normally see between the horizontal and vertical dipoles (impedance variation at LNA input) was also much the same (0.25 dB) so I was fairly confident that the higher frequency, that would not be detrimental to the receive performance. I also performed a quiet sky to Cygnus A check at the time and confirmed that the

System Noise Temperature was normal as expected. (Y factor measured at 3.5dB)

The only way I believed I would be able to detect the Spacecraft was by use of DSP software. Spectran, written by I2PHD and IK2CZL is simply brilliant. I have used it for several years observing Aircraft Doppler Shift and Meteor Activity on both 144 and 432 MHz. The simplest description I can give here is that it takes the receiver audio input to a sound card and displays the signal in an amplitude time domain format on the screen as a white trace or line. Its main feature is to digitally reduce the bandwidth down to 0.032 Hz (selectable) and thus realise a most significant signal to noise improvement. (refer [www.qsl.net/padan/spectran.html](http://www.qsl.net/padan/spectran.html))

When the bandwidth is narrowed the "signal window" is narrowed as well. In this case the viewable signal window at 0.032 Hz is only 10 Hz and at 0.125Hz it is 80Hz wide. That is fine if you know the exact frequency, and have the time to allow for the overhead processing required to resolve and then display the signal. With a 1GHz processor, it takes about 10 seconds to display a signal in a 0.125 Hz bandwidth. In other words, when you vary your tuning the displayed signal is delayed by 10 seconds. Remember of course that you have to be within 80 Hz of the signal frequency to even see the signal display!

The problem we face with the MGS is that the frequency is not constant as the Doppler Shift between you and the spacecraft is varying rapidly for most of the viewable time. It is rotating around Mars, and Mars and Earth are also moving at differing relative speeds. To calculate the Doppler shift requires some pretty smart mathematics to derive just where you should be tuned. As was described earlier, the space craft antenna (in use) is pointing towards the Martian surface and will be blocked by the body of the spacecraft except for a 5 -15 minute period as it enters (ingress in spacecraft tracking parlance) or exits (egress) "occultation" or blockage by the planet.

During the approach to us the Doppler shift is positive (occultation egress ..received frequency is higher than the signal frequency) and as it heads away

from us it is negative. (occultation ingress.. received frequency is lower than the signal frequency) In round figures it is in the order of 4 kHz but varies from orbit to orbit! MGS will be entering and exiting occultation (blockage by Mars with respect to Earth) with each 118-minute orbit. Again remember that the UHF antenna (with about 0 dBi of gain, EIRP~30 dBm) will only be viewable from Earth for a few minutes (5 to 15 minutes) just before ingress and just after egress during each orbit.

As you can see, given the combination of varying Doppler Shift, the narrow bandwidth with a very narrow signal display window, it is vital that you know just where to tune at any given time. Fortunately I was supplied with one-minute predictions accurate to the Hz. I was somewhat taken aback when I first received them in an email. After a cursory glance I then hit the print button only to find there was 81 pages! I learnt to edit what I wanted first after that!

The next thing I had to do was to relocate my main computer down to the EME shack some 200 metres distant. This was necessary to run Spectran as the maximum speed I could muster was essential for fast decoding. My dish tracking and house keeping is done on a small IBM Notebook where speed is not important.

When I tuned on the computer and tuned to the appropriate frequency, lo and behold, Murphy had already predicted my actions and was producing the weakest of weak signal precisely where I did not want it! After removing the covers from the computer the source was traced to one of the Crystal Oscillators on the video card. Grabbing a bare alligator clip (no lead) I attached it to the Crystal case and the birdie moved outside the desired frequency range! Be aware that when using Spectran it is essential to keep audio leads well shielded with no current loops etc as its sensitivity is extreme and it loves to display 50Hz traces!

Now to check out the antenna tracking. Not a problem expected here, just click on Mars and away we go. This is my own tracking software that I (and many others) have been using for years. I was using it only the previous weekend

looking at Jupiter's IoB pulses and "working a few off the moon". Clicked on Mars and away hummed the motors. Hang on, Mars is not setting it is rising! A day later I finally tracked the tracking error to the 2000 Epoch Ephemeris data having a 12-hour right ascension error! All the other planets were spot on — of course only Mars was wrong! Murphy again!

Now we were tracking Mars and JPL was about to turn on MGS at 1200 UTC on August 25th 2003. Incidentally, given its distance from Earth, the transit time for the signal to reach Earth is 3:05 minutes. Thus when commanding the "bird" it takes 6:10 minutes for you to know that your actions worked!

My first attempt to detect the MGS signal (CW only) was from 1221 UTC, (some 20 minutes after switch on) and at 1226 I "painted" a very weak signal

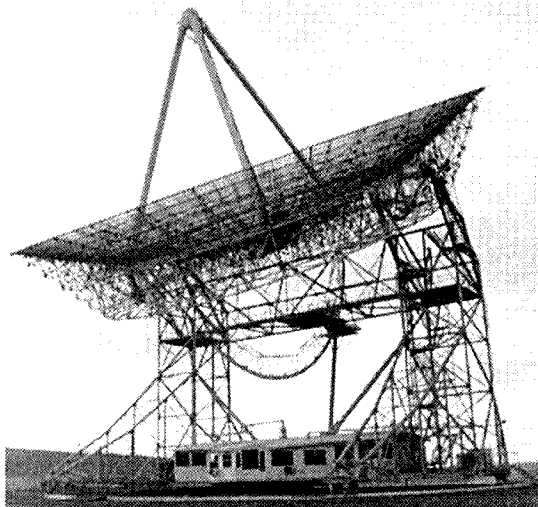

SRI dish

at 437.103.500 (in a 1Hz BW) for 25 seconds. At this time I had not received the accurate Doppler calculations for my location and was relying upon the predicted "4 kHz shift". What immediately appeared suspicious was that the observed signal was not exhibiting the characteristic Doppler Shift as expected. MGS at that time would have exhibited about a 1.5Hz per second downward shift. The signal I was "painting" showed little shift at all. Over the next few days I saw this very same signal on many occasions and finally deduced it was as a result of aircraft reflection from a source unknown. During the first night I listened to 3 orbits from 5 to 15 minutes just before ingress and after egress. Unfortunately no

signals were detected.

The following day, 26th August 2003, I received the Doppler predictions for my location. This allowed me a greater degree of confidence to know exactly where and when to tune. As a consequence it allowed me to narrow the bandwidth to the maximum possible. Alas still nothing, although at times one was becoming "line happy" thinking you could see a coherent line in the snow. This is very similar to "hiss happy" that many of us are familiar with but in a visual format!

It was not until 28th August (after monitoring many orbits) that at 1328 I noticed (0.5Hz BW) a broken trace exactly where I expected to find the signal. The trace indicated that the signal's amplitude was varying at about a half second rate. I switched polarisation from Horizontal to Vertical

and it seemed to "paint in" the missing signal for that time period. In other words it appeared that the signal might have been the result of the spacecraft spinning. I watched it for about 90 seconds and during that time the Doppler shift appeared to follow the identical signature as predicted. At 1356 I again saw a similar signal for another 15 seconds or so in the right Doppler "ball park area". I saw nothing after that time until I ceased tracking at 1410.

I reported my findings and asked about the possibility of the signal variation and received the following response. *The spacecraft is 3 axis stabilized, so signal variations cannot be explained by spin modulation. Also, the antenna on*

*the spacecraft is circularly polarized ... which to me indicates that what I was seeing may not in their opinion have been the signal in question? (All I was really saying is that the amplitude variation could not be explained by spacecraft spin ... what you saw certainly could have been the spacecraft ... particularly since the Doppler signature seemed to match well.) All the same I do feel fairly confident that it was the MGS given the exact Doppler signature it exhibited. Why I had not seen the signal in earlier orbits? I believe it was due to the background sky noise. It was lower on the 28th and would have remained that way for the next few days. Unfortunately I was unable to track MGS on the following night prior to JPL*

turning it off at 1956 on the 29th due to 80 kph winds. I would dearly like to have confirmed categorically the received signal was MGS. Murphy again!

During this time we were being given most valuable feedback and confirmation that the SRI 46 metre dish was copying the signal just fine! It really

puts you back into reality, as by amateur standards, there are not too many larger dishes around but it felt so inferior compared with the "big boys"! 12.8 dB does not sound much (that's the difference in antenna gain between VK3UM and the SRI dish) but it really is breathtakingly large by comparison!

It was a fun exercise commensurate with our Amateur radio pursuits and if nothing else showed just what can/can not be achieved. A bit like proving Ohms Law I suppose? The result is known before hand .. but achieving it can be challenge.

## Over view of the Mars Global Surveyor

Refer <http://mars.jpl.nasa.gov/mgs/>

### MGS Role with the Landing Craft and Earth Control

(much edited but courtesy of JPL)

The Mars Relay system provides a simple low to medium rate (8,000 and 128,000 bits per second) UHF link (approx. 405 MHz) between a Mars orbiter and any ground station.

The Orbiter transmits an FM beacon at 437.1 MHz with one of three Request Command (RC) subcarriers (to trigger specific landers) when the Orbiter's guidance system determines that a Lander is within view.

If Lander receives beacon (with appropriate RC subcarrier), the Lander transmits approx. 2 seconds of pure carrier followed by approx. 0.5 seconds of pseudo-random numbers to allow the Orbiter receiver Viterbi decoder to synchronize.

The Orbiter determines if Lander-Orbiter link is satisfactory (greater than -126 dBm for 8000 bits per second data rate), if so it sends the telemetry command (TC) signal to the Lander. After receiving the TC, the Lander transmits its science telemetry to the Orbiter until either loss of signal (at the Orbiter) or the end of the 16 second Balloon Telemetry Time Slot (BTTS). The time available for telemetry transmission is approx. 13 seconds (if the Orbiter is in range).

The data and control with the Earth stations is provided at X-band where the Downlink is 8400 - 8450 MHz and the Uplink: 7145 - 7190 MHz

The launch of the *Mars Global Surveyor* from the Cape Canaveral Air Station took place on November 7, 1996. After a ten-month cruise to Mars, the MGS spacecraft executed its orbit insertion manoeuvre on September 12, 1997. The period of the initial orbit of Mars was nearly two days. The mission plan called for a three- to four-month aerobraking sequence to modify the orbit

to one suitable for mapping the red planet. The mapping phase of the mission was then scheduled to begin in the spring of 1998, and to continue for one complete Martian year (687 days).

Unfortunately, problems with one of the two MGS solar panels forced the aerobraking sequence to proceed more slowly than planned. MGS executed its final aerobraking pass through the upper Martian atmosphere on February 4, 1999, and successfully performed its aerobraking exit manoeuvre later that day. MGS executed its transfer to mapping orbit on February 19, 1999, and since then has been in the desired mapping orbit with a period just under two hours and an altitude of approximately 250 miles. The primary mapping phase of the MGS mission began in March, 1999, and was completed in January, 2001 after one Martian year. An extended mapping mission began on January 31, 2001 and is expected to continue into the year 2002. The extended mission will permit study of year to year changes on Mars.

The two rovers, Spirit and Opportunity, arrived three weeks apart in January at opposite sides of Mars. They bounced and rolled inside cocoons of inflated airbags. Unlike the much smaller Sojourner

rover of the Mars Pathfinder mission in 1997, each Mars Exploration Rover will be independent of its stationary lander, capable of communicating directly with Earth and carrying a full set of cameras for scouting locations to explore. At selected rocks it will extend an arm bearing geological tools for close-up analysis. The landing sites were selected as places likely to hold geological clues about the history of water on Mars.

### Acknowledgement

Joe Fitzgerald (KM1P) provided the most valuable liaison and information flow with John Callas, Ph.D. Mars Exploration Rover Project Science Manager, Jet Propulsion Laboratory Pasadena, California.

ar

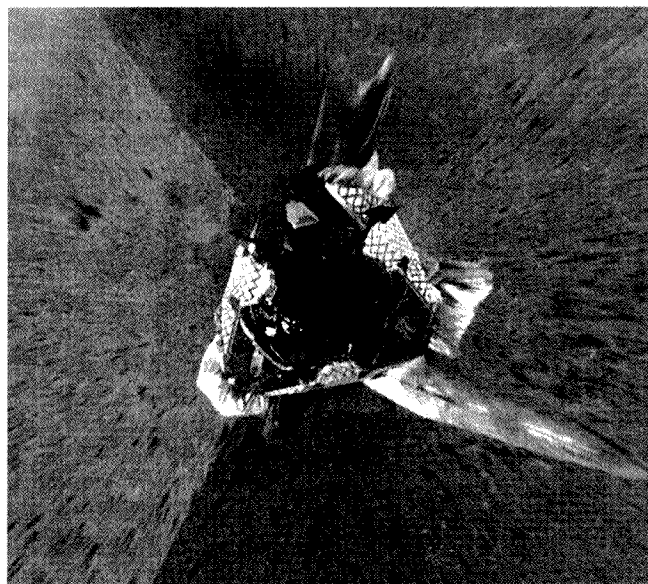

The Mars Exploration Rover Spirit on its way to the Martian surface in January 2004  
NASA/JPL/Arizona State University

## Test Equipment

Autek WM1 2 KW  
peak reading  
wattmeter

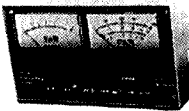

Autek RF1 HF  
Antenna  
Analyzer

Autek RF5 VHF/  
UHF Antenna  
Analyzer



Autek VA1 MF/HF  
Vector Antenna  
Analyzer

Ten Tec HF/VHF  
Dummy Load Kit

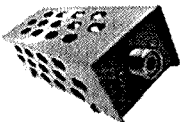

Ten Tec HF/VHF SWR  
Power Meter Kit

Lutron Bench  
top 2.7 GHz  
Frequency  
Counter

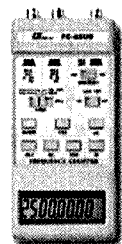
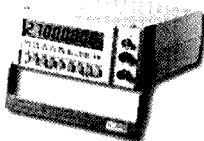

Lutron Handheld 2.5 GHz  
Frequency Counter

### WE SUPPORT WHAT WE SELL!

If you have a problem, our strong relationship with the support divisions of our US suppliers combined with our professional service lab will get your unit quickly up and working to original specs.

We specialise in mail order. Visa and Master Card



## HF Radios



Orion



Jupiter



& Argonaut HF  
Transceivers

Ten Tec  
Commercial  
and  
Professional Communications  
Receivers



SGC2000 150W  
Professional HF  
Transceiver

SGC 2020  
Portable  
20W HF  
Transceiver

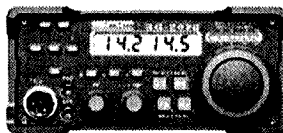

SG 500 HF Mobile 500W Power  
Amplifier



build  
yourself  
kits

(Call for your free  
catalog)

Amidon Iron Powder and Ferrite Products  
(Call for an Amidon product guide)

SGC ADSP<sup>2</sup> Noise Reduction Speakers  
SGC ADSP<sup>2</sup> Noise Reduction Boards (High  
power and low power versions available)

Power Source switch mode power  
supplies (a wide range of outputs)

Davis Weather Stations

Professional Grade Coax Feed lines and  
Connectors

Custom RF Patch leads and cables made  
to order

## Antenna

### Couplers/Tuners

SGC Mac 200

5 Position  
Antenna  
Switch/Tuner



SGC SG235,  
SG230, SG237,  
SG239 and SG211  
Automatic Antenna Couplers



Z100



and AT1000  
Automatic  
Antenna Tuners

## Antenna

SGC QMS Quick Mount  
Mobile antenna system  
with built-in tuner



SGC Stealth Kit. All you  
need to get HF on air  
quickly.



SGC SG 307  
7 foot Mobile/Marine  
Antenna

SGC SG 303 9 foot Mobile Antenna

## RE-SELLERS

Tower Communications, Perth

International Communications  
Supplies, Port Adelaide

Strictly Ham, Bayswater

Marcom Watson, Launceston

Nixon Communications, Gladstone,  
Rockhampton & Mackay

Seabourne Electronics, Townsville

Brian Swinton Electronics, Cairns

DETAILED DATA SHEETS ARE AVAILABLE ON REQUEST FOR MOST PRODUCTS.



# TTS Systems Communications Equipment

Systems

FREE CATALOGUE

[www.ttssystems.com.au](http://www.ttssystems.com.au)

HF and VHF Transceivers, Autotuners and Kits

Phone 03 5977 4808. Fax 03 5977 4801 [info@ttssystems.com.au](mailto:info@ttssystems.com.au)

# In Charlie's Way

A short story about a ham, his mates and the CW receiving exam.

Ross Fraser VK2WN

## Part 2 - 'The kindness starts'

Colin put on his thinking cap for the rest of the day and tried to come up with some ideas to discuss with Charlie the following morning. All day at work he tried to focus on what he was doing but his mind kept wandering back to finding a way to help his friend pass the exam. As he drove home he had more time to think and came up with a few ideas.

'What about me sending him some morse over the air?' 'What about if I get him to come over to my shack and we can practice some receiving exams?'

Colin was deep in thought when suddenly the speaker, near the two metre radio produced a loud blurring sound. It sounded like eggs sizzling in a frypan. Colin nearly jumped out of his skin. 'Damn pagers' he said out loud. Just then he heard his callsign followed by Charlie's. Charlie was calling him.

Colin announced Charlie's and then his own callsign before adding 'How're y' going mate?'

'Good' said Charlie.

Colin explained to Charlie some of the ideas that he had and then Charlie came back with 'I'm not sure if I want to sit another damn exam'.

'Fair enough' said Colin trying to encourage Charlie 'but I have a master plan that I think will get you through. The three Ps'.

'What's that' said Charlie sounding sceptical, 'panic, panic and more panic?'

Just before Colin responded another blurt of pagers crackled through. 'Damn fried eggs! No, not quite, but you're close. Practice, practice and more practice! And I'll be able to help you so you won't be doing it on your own. What do you think?'

Even though the QSO hadn't been going for a full 10 minutes Charlie announced Colin's callsign before giving his own and then continued with: 'Sounds good but if I did any more practice I think I'd be hearing CW in my sleep. These bloody diddly-dahs give me the good and propers. I want to pass it so I can get my full-call but listening to it for too long gives me the willies. In fact, just thinking about it is starting to give me a headache!'

Colin knew only too well what he meant. He'd been in the same situation a few years ago. 'I know what you mean. You're going to have to take some headache tablets after this question. When's the next exam, the twelfth?'

'My headache's getting worse now. No, it's the sixteenth.'

'Hang on' Colin said, slightly sarcastically 'I thought you said you weren't sure about sitting another exam'

'It pays to cover all bases in case I find inspiration,' said Charlie a bit despondently.

'That's fair enough. Okay, that gives us, gives you, just over three weeks till the exam. So how about we give you a few days to get over your headache and then start preparing, eh?'

'Okay, sounds like I don't have any choice. I suppose I'll give it another go. And this better be the last time!'

Colin hoped it would be too. 'I can't promise anything except that we'll have you one hundred prepared for the exam. You'll be receiving at twenty-five words-per-minute by the exam'.

Charlie knew Colin's humour. 'What ever you reckon. Ten will more than do.'

Colin and Charlie said their good-byes and organised to chat on 80m in the morning.

to be continued

## RippleTech Electronics

### Brand New Dxciting Products

Rippletech Electronics is providing a new service to hams in VK/ZL and the Pacific. Our quarter wave slopers will outperform a quarterwave ground mounted vertical by several dB. You can have access to a DX antenna on 80m and 160m with as little as 15m of ground space (provided you have an existing 15m tower-nally or equivalent).

Our best selling combined 40/80m sloper requires even less space. Alternatively, the TZ-V3 and TZV3w will give you access to 10/15/20m or 12/17/30m with a small budget or small backyard. Mount on your metal garage roof for a surprising signal. New novice operators, what about a rotary dipole for 10/15m only - \$129.00 plus p&p

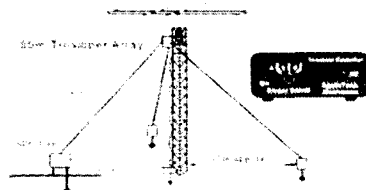

11 & 41 HF I/F Baluns	\$59.00
Single 80m sloper	\$109.00
Single 40 & 80m sloper	\$179.00
WAPC Rotary dipole	\$289.00
10/15/20 Rotary Dipole	\$279.00
12/17/30 Vertical	\$199.00
10/15/20m Vertical	\$189.00
Radials kits	\$44.00
FT-1000mp remote	\$33.00
30 or 40m Rotary Dipole	\$399.00
80m Sloper Array (3 ele)	\$499.00

RippleTech Electronics  
3 Moyston Close  
Vermont South  
VIC 3133



Phone or Fax  
03 9887 2917

WANT MORE INFO?  
PICTURES-DESCRIPTIONS  
A FULL PRICE LIST  
OR AN ORDER FORM - see  
[www.rippletech.com.au](http://www.rippletech.com.au)  
[sales@rippletech.com.au](mailto:sales@rippletech.com.au)  
[info@rippletech.com.au](mailto:info@rippletech.com.au)  
ABN 70 465 254 759

# A basic GPS unit

Dale Hughes VK2DSH

**This article describes a basic Global Positioning System (GPS) unit that displays time, latitude and longitude. It uses the Trimble Lassen SQ GPS receiver and magnetic mount patch antenna that is readily available for a relatively low price. This article is intended to generate ideas and interest, so no circuit board artwork or software for micro-controller is presented. However these can be supplied to interested readers.**

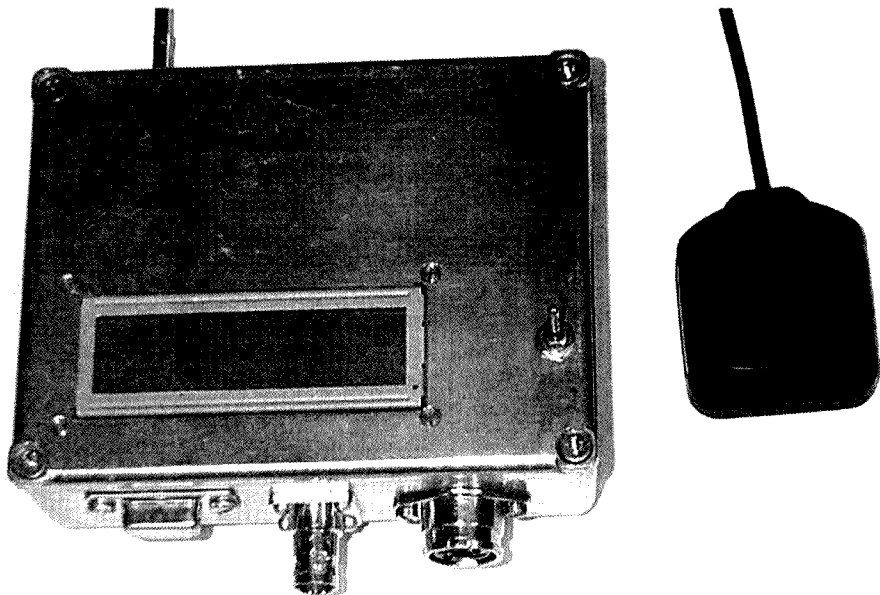

Figure 1: The complete GPS receiver and antenna. The switch on the right hand side of the receiver box selects which information is to be displayed; either the time and date, or latitude and longitude.

Accurate time keeping and navigation has a long history and mankind has expended much intellectual effort in establishing methods for keeping track of the time and accurately determining position. Clocks have progressed from pendulum types to Hydrogen Masers. Navigation has progressed from clocks, sextants and charts to the Global Positioning System. Instead of requiring skillful use of a sextant to measure position accurate to one or two kilometers, portable GPS receivers can display their position anywhere on earth with an accuracy of a few metres.

The GPS system consists of a constellation of 24 satellites and five ground stations, operated and maintained by the US Department of Defense. Each of the satellites transmits on two frequencies. Civilian GPS receivers operate on the so-called L1 frequency of 1575.4 MHz. The L2 frequency (1227.6 MHz) is not available to the general public, however sophisticated receivers make use of both frequencies so that transmission delays caused by the ionosphere can be corrected.

The stated horizontal accuracy of the Lassen SQ GPS receiver is better than 9 metres for 90% of the time, this can be

improved by averaging the measured position over time.

In the device described here, data from the GPS receiver is displayed on a 16 character by 2 line Liquid Crystal Display (LCD) driven by a separate micro-controller. The data is also transmitted in serial form from the RS 232 interface. Direct access to the GPS receiver is available via the RS 232 interface. This allows the user to access much more information than is displayed on the LCD; amongst other things, information regarding each satellite currently visible by the GPS receiver is displayed, or the user can configure the GPS receiver in various ways. This software, SQ-monitor (for Windows) and TSIPCHAT (for DOS), is available for free download from Trimble. See reference (1) for details.

The Lassen SQ GPS receiver module and antenna is available from Step Global, see reference (2) for details.

## Circuit description

Figure 2 shows the schematic diagram of the complete unit. Signals to and from the GPS receiver are via a serial interface (connector J3), these signals are at CMOS levels and require conversion to RS 232

levels for communications with an external computer or terminal. A MAX 232 (IC3) converts the logic level signals to RS 232 levels. Jumper block J2 allows the user to connect the GPS receiver serial I/O to either the local micro-controller (IC1) or to the RS 232 (IC3) converter, or both in the case of the GPS transmit line. In normal use, the serial output from the GPS receiver is connected to both the micro-controller and the RS 232 interface as this allows time and position data to be displayed on the LCD and be transmitted to a host computer via the RS 232 interface. Sending commands to the GPS receiver is only possible via the RS 232 interface as the user must be able to set the GPS receiver to the correct configuration. (Described later)

The micro-controller (IC1) is an Atmel AT90S8535P device, it is available at low cost and offers many advantages for a project of this type. It contains inbuilt serial communication facilities, adequate program and data memory and fast operation. In this application it reads the ASCII data output from the GPS receiver, extracts the required information and displays time, date and position on the local LCD.



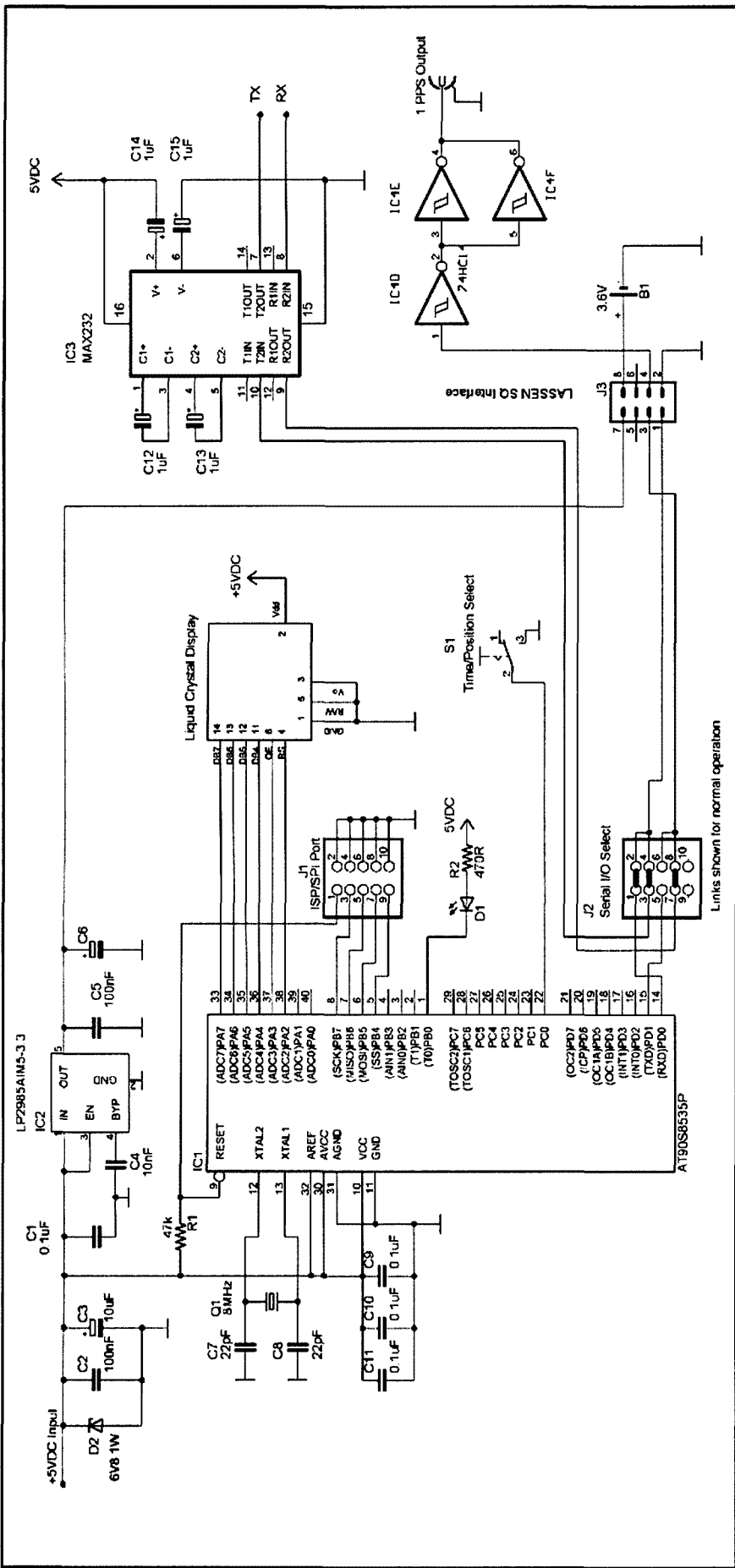

Figure 2: Schematic diagram of the GPS unit.

For accurate timing purposes, a 1 pulse per second (1 PPS) output is available. When the GPS receiver is receiving data from the constellation of GPS satellites, the 1 PPS signal is locked to the orbiting atomic clocks and provides a signal pulse that is locked to UTC (100 ns).

Power to the unit is via a 5 Vdc input which drives the micro-controller, the RS 232 interface, the 1 PPS buffer (IC4), the LCD and 3.3 Vdc regulator (IC2) for the GPS receiver and antenna. Current consumption is approximately 80 mA, so operation from a battery is entirely feasible. As the GPS receiver contains its own real time clock, a 3.6 Vdc Lithium battery is provided to keep the GPS real time clock running when the external power supply is removed. This ensures a rapid acquisition of satellite data with a consequent rapid display of time, date and position when power is re-applied. If the battery is not fitted, the GPS receiver has to 'cold start' every time it is used and time and position data will not be available for several minutes.

A 'mode' switch allows the user to display time and date or latitude and longitude on the liquid crystal display. As my main purpose for building the device was time keeping, I set the default display to be time and date.

### Construction

The complete unit is housed in a small die-cast box. A double-sided printed circuit board contains all the circuitry, with the GPS receiver being mounted on the underside of the printed circuit board. With the exception of some bypass capacitors and the GPS receiver, all the other components are mounted on the upper side of the circuit board. Figure 3 shows the circuit board and the GPS receiver module.

Construction of the unit is straight forward and the only slightly difficult part is soldering the 8 way surface mount connector for the GPS receiver and several of the surface mounted components. This requires a steady hand and good eyesight!

The printed circuit board artwork was created using EAGLE. An evaluation version of the software is available for free download, see reference (3) for details of obtaining EAGLE software.

It would be feasible to construct the circuitry on 'Vero board' or similar

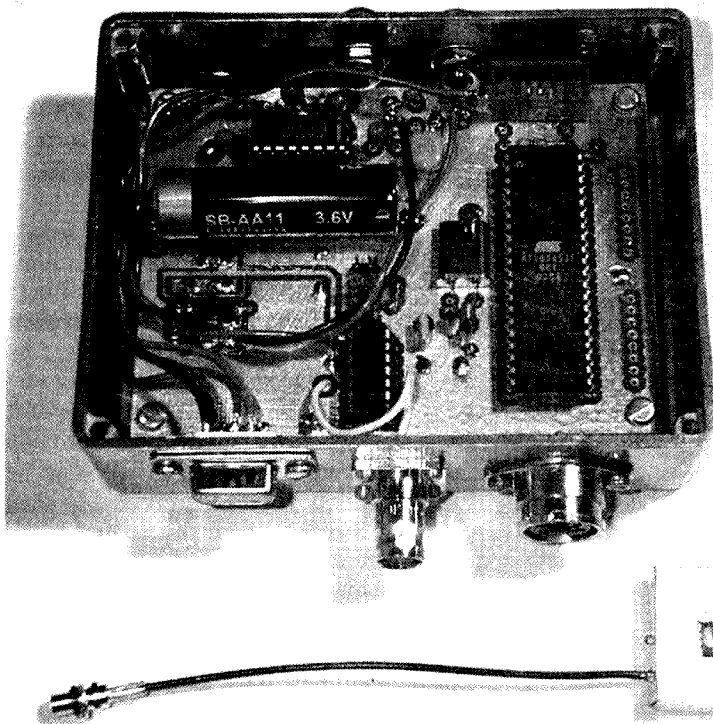

Figure 3: The printed circuit board and GPS receiver. The photograph was taken before the liquid crystal display, mode switch and GPS receiver were fitted. The GPS receiver mounts underneath the circuit board and isn't visible after the circuit board is mounted inside the box. The DIN connector on the right hand side is for a high-speed serial interface and is optional.

prototype boards, in which case surface mounted components would not be necessary. With care, it would be possible to solder fine wires to the GPS receiver connector to provide power and communications.

All of the parts used in this project are readily available, Table (1) lists the major items:

Other components such as resistors, capacitors, connectors etc, are available from various suppliers.

## Software

Evaluation software is available for users to configure the GPS receiver and to extract time, position and other data. Figure 4 is the main screen of the SQ\_Monitor software. It shows various status messages, as well as time, position and velocity. The software also shows what satellites are currently visible from the location of the antenna. In the case shown, four satellites are visible. Data from the GPS receiver can be sent in two different formats:

- Trimble Standard Interface Protocol (TSIP, a binary protocol), or
- NEMA messages (An ASCII or plain text protocol).

When using SQ\_Monitor, TSIP must be used. The interface to the micro-controller uses NEMA messages, as it is easier to extract information from the ASCII string, instead of the floating point binary numbers used by TSIP. A nice feature of SQ\_Monitor is that it allows the user to set the PC clock to GPS time, which ensures that it is accurate. A number of GPS receivers can be connected to a PC running SQ\_Monitor, so that differential positioning is possible.

The micro-controller software takes the NEMA message from the GPS receiver and extracts time, date and position. This information is then displayed as two screens of information on the liquid crystal display. If an insufficient number of satellites is visible an error message is displayed. The time and position are updated each second as long as at least three satellites are visible. The micro-controller code is written in assembler using Atmels Studio4 development system. See reference (4) for more information. The existing micro-controller software accepts only the NEMA RMC message, so the GPS receiver must be configured to transmit the RMC message before using it with the micro-controller and local display. This is easily achieved using the TSIPCHAT software that is available from Trimble.

## Performance

A clear view of the sky is required for best performance of the unit, however even if the antenna is on an inside window sill and enough sky is visible, time and position data will be available for much of the time. When the antenna has a clear view of the sky, time and position data is available for 100% of the time. Time and position is updated every second and, when using SQ\_Monitor, the receiver velocity in three dimensions is also available, making it ideal for mobile applications.

## Conclusion

A basic GPS receiver unit has been described which offers a good level of performance. Artwork for the printed circuit board in EAGLE CAD format can

Description	Supplier	Part or catalogue number
Lassen SQ receiver	Step Global Pty Ltd	
Diecast box	Jaycar Electronics	HB-5067
Liquid Crystal display	Dick Smith Electronics	Z-4170
IC1 ATMEL AT90S8535P	Dick Smith Electronics	Z-9205
IC2 LP2985AIM5-3.3	Farnell Components	121-812
IC3 MAX232	Jaycar Electronics	ZK-8824
IC4 74HC14	Jaycar Electronics	ZC-4821
B1 3.6 V Lithium battery	Dick Smith Electronics	S-3368

Table 1

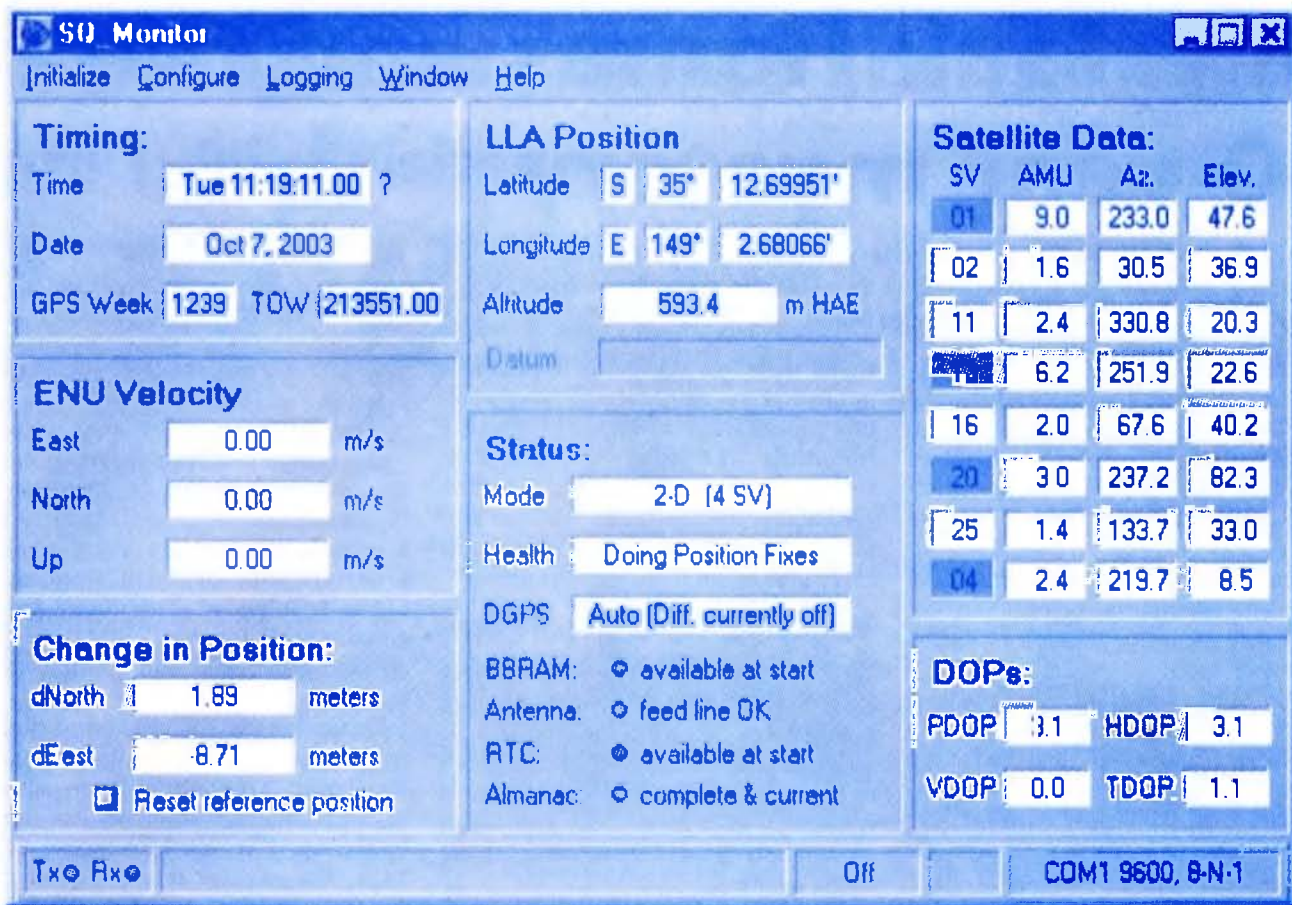

Figure 4: SQ Monitor screen.

be provided to interested readers. Also, a hex file of the micro-controller software can be provided so that interested readers can program their own device. Please contact me via email at Dale\_E\_Hughes@bigpond.com.au

## References:

(1) See <http://www.trimble.com/> for a range of information on GPS

products and software. SQ\_monitor and TSPCHAT.exe are available for free download. The site also has a tutorial on GPS systems.

(2) The Lassen SQ GPS receiver is available from STEP Global Pty Ltd, PO Box 355, Bayswater, Victoria 3153. Telephone 03 9720 2892. See their web site at <http://www.stepgps.com>

(3) A basic version of the EAGLE CAD package can be downloaded from <http://www.cadsoft.de> Note: The software is free for hobby use only.

(4) See <http://www.atmel.com> for information on the AT90S8535 micro-controller and the Studio4 development system.

## WIA Comment

*Continued from page 3*

amateurs in Australia?

I know that there are people who have been in the past members of the WIA but who are not members today.

For whatever reason they have ceased to be members, I urge them to consider rejoining.

To those who are amateurs and who have never been members, I urge them to now consider joining.

To our existing members I say this: please consider whether you are in a position to encourage someone else to be a member. And please make the time

to do something about it.

A downloadable membership application form is available on the Institute's website.

Many people over many years have argued that a single national WIA was necessary. It has been a matter for discussion for many years, perhaps for too many, perhaps raising doubts as to the credibility of the WIA.

I hope that new members and former members rejoining will support the move that has been taken.

I know that with such a fundamental restructure there will be times when the transitions and tasks are not as efficient

or as smooth as we would have liked. But I hope that everyone will appreciate the enormity of what is being undertaken.

The WIA must have the strength and the wisdom to make the most of the opportunities that are emerging, and to overcome any perception that amateur radio is the interest of an ageing and dwindling group. We must work to attract new amateurs, and younger amateurs. The Institute must have younger people active in its affairs.

I am sure that with your support, and the support of a majority of Australian amateurs, the WIA will succeed.

# Sherlock Homes and the 50-year mystery

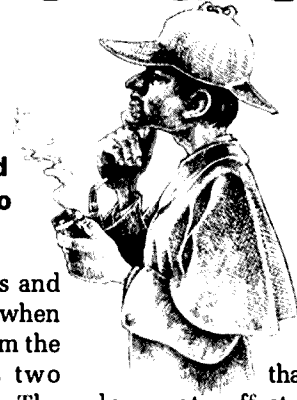

Frank Shaw VK6ALF

About 80 years ago the greatest mystery of electronics was stumbled upon: the dreaded super regenerative detector. So many have tried to solve its operation, and so many have failed.

My name is Sherlock Homes and along with my assistant, I shall illuminate the long darkness of the theory of the dreaded mystery. Please follow this story carefully and you should be much clearer on the operation of this wonderful little design. It does not suffer certain dreaded symptoms as many have claimed: like it radiates a strong interfering signal or it has too wide a selectivity etc.

These allegations simply relate to how the circuit should be used properly. The simple fact is that a self-quenched super regenerative receiver is a dual conversion detector amplifier superheterodyne receiver. A small triode is usually used as a self-oscillating modulated oscillator, operating on the frequency of the signal to be received.

## The First Conversion

Let's first drop the term quench. No quenching takes place to be quenched. Let that term be called the conversion oscillator/modulator.

To the circuit. It will be noted in the representative circuit of operation that the triode is self-oscillating at 10 MHz and is generating a second component at 10 kHz. This produces a 10 MHz

signal with two sidebands of plus and minus 10 kHz - an AM signal. Now when this combination is subtracted from the incoming AM signal that has two sidebands plus and minus 1 kHz. The resultant is the first IF, in this case two signals of 9 kHz and 11 kHz, plus the 10 kHz modulation frequency (quench).

## The Second Conversion

To continue from the above First Conversion. The lower sidebands components that form the first IF - 9/10/11 kHz are simply subtracted from one another and the lower sideband frequency of 1 kHz is the recovered modulation signal of the incoming signal to the receiver.

## Detection and Amplification

The recovered 1 kHz modulation signal appears between the grid and cathode of the triode, and is detected as a grid leak detector, and is amplified by the triode. A RF filter is provided at the output of the valve, to block the quench frequency, in particular, from appearing at the output, where it would badly overdrive the following amplifier stages

at the rate, in this case, of 10 kHz. The filter also ensures that the following stages do not affect the RF operation of the 10 kHz circuits. As all functions are achieved with only one grid bias valve, a certain amount of distortion is normally tolerated. The circuit works equally well for AM/PWM, and has almost perfect AGC and ignition noise limiting.

To receive PM the method of tuning is detection by slope detection. Example The Bendix radio radar altimeter as used in the Mirage fighter aircraft once used by the RAAF is called the model APU-141v. The receiver is a self-quenched super regenerative receiver that receives nanosecond pulses from the ground to indicate altitude. To process these very narrow pulses requires a receiver bandwidth of 200 kHz, with lots of amplification. The super regenerative receiver is ideally suited to the task. The output video bandwidth is easily achieved, along with high amplification. Try to do this task with any other receiver. Many light aircraft used in their VHF radio IF section, a super regenerative detector complete with its

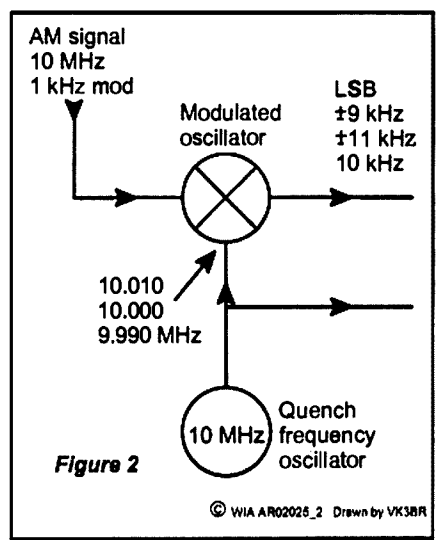
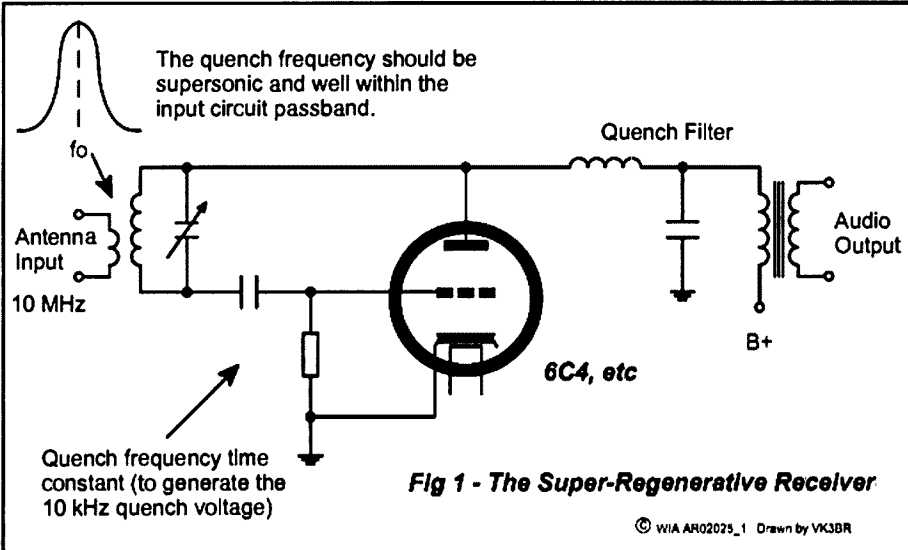

# SSB back to basics transmitter

## April 1995 revisited

By Neville Chivers VK2YO

### Why revisited?

Let me explain. I originally produced these "Back to Basic" articles - the receiver published in January 1995, the transmitter in April 1995, and the VXO in August 1995 issues of *Amateur Radio* magazine - to prove to some skeptics that it was still possible to home brew a simple amateur station from components available from the most common suppliers such as Dick Smith, Jaycar, and Tandy, etc.

I had quite good feedback from these articles.

I finished the transmitter at about one watt output from a 2N3866 and I had a few contacts at that power level to prove the point. But I must admit that one watt of PA power was a bit weak, so I mostly operated into an old amplifier I built as a transverter, with parallel 807s for finals, originally to work the "new" WARC bands in 1980.

Eventually the filter choke in the power supply shorted its turns and, as I didn't need to operate my home brew 40 m rig, I put it away in the cupboard where it stayed until another amateur (VK2AUS, now SK) visited me last year and asked me about it.

At about that time I read an article in an American journal about the popularity of QRP operation, defined as transmitter power up to five watt.

So I thought why not add a small solid state PA to my original 1995 home brew SSB transmitter and complete the original series of articles, but broadband the PA so that it could be used with any low powered transmitter on most HF bands, not just 40 m.

As built with a crystal oscillator feeding into the front end, and a resonant antenna after a tuner at "C" in the circuit, output power was substantially the same

on 80, 40, 30, 20 and 17 m. I could not go higher for want of more crystals for those bands.

Using only the Dick Smith catalogue, this is what evolved. First of all, what transistors were available? There was only one, really, the BD139 rated at 8 W, I would guess in class C. As a linear amplifier it produces about 5 W on 40 m with about one watt drive from the preceding stage, a 2N3866.

As you can see, the circuit is quite straight forward. Mine was built on perforated board and hard wired. The output transformer needs some explanation, perhaps. It is made of two F34 toroids - the only ones available from Dick Smith - stacked one on top of the other. Take 250 mm of 27 SWG enamelled wire and wind on nine turns for the primary. This should leave about 20 mm for each lead, one to the transistor collector and one to B+ via the 68 ohm resistor.

If instability is experienced when first tried out, reverse the secondary connections at A and B as indicated on

the circuit diagram.

Output from "C" goes to a harmonic filter for whichever band is selected. I can do no better than refer you to Drew Diamond VK3XU's excellent tabulation of low pass filters in his article on page 17 of the February 2000 issue of *Amateur Radio* magazine. The filter is particularly important if the PA is issued without a tuner direct to the antenna.

If you use an antenna tuner between this PA and your antenna, you may find any unwanted harmonics are suppressed by the tuner at this power level.

The project is now completed after all this time!

Parts List	Dick Smith Cat No
BD139	Z1443
6.8 v Zener diode	Z3531
5 k potentiometer	R1769
2 x F43 toroids	R5400
27 SWG wire	W3126
Dual prototype board	H5607

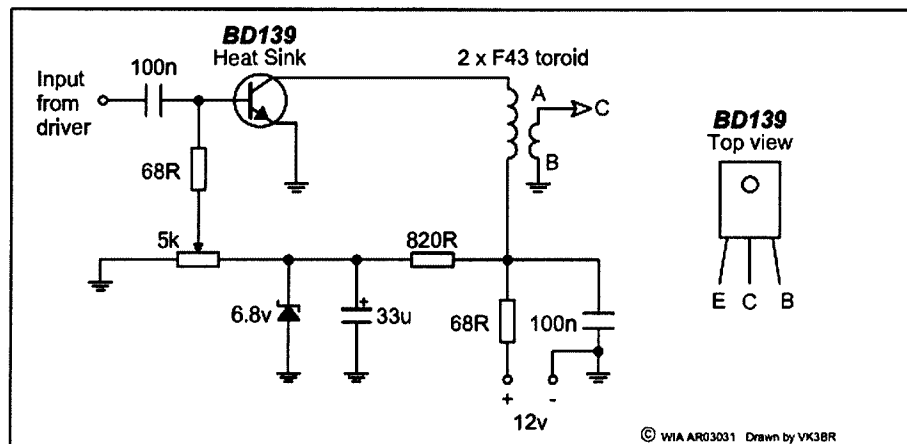

Output Transformer - primary nine turns of 27 SWG enamelled wire on two stacked F43 toroids - total length of wire 250 mm - secondary return loop of insulated hook-up wire through toroids.

### Sherlock Holmes continued

own squelch. Remember these radios are narrow band AM.

### Technical Editor's Note

A recent discussion of the operation of the super regenerative receiver by

Charles Kitchen appeared in Communications Quarterly Fall 1994 edition.

The original article was by Edwin Howard Armstrong in 1922 published in Proc IRE Vol 10 No 4 Aug 1922.

Another historical article was by Hikosuburo Ataka in Proc IRE Vol 23 No 8 Aug 1935.

Super regenerative receivers have been used recently in some consumer wireless devices.

# ALARA

Christine Taylor VK5CTY

vk5cty@vk5cty or geencee@picknowl.com.au

## Annual General Meeting

The AGM of May 3rd was well attended and had quite fabulous conditions. There was a little QRM at the beginning but once the meeting really started the interference disappeared. Almost everyone could hear almost everyone else. Most amazing and very helpful.

The new committee is not very different from the old one with

President Susan VK7LUV  
Vice President Judy VK3AGC  
Jnr Vice President Bev VK6DE

Secretary Margaret VK4AOE  
Treasurer/Souvenir Bev VK4NBC  
Minute Secretary Bron VK3DYF  
Publicity Officer Christine VK5CTY  
Editor Dot VK2DB  
Awards Custodian Jean Shaw  
Contest Manager Marilyn VK3DMS  
Sponsorship Sec. Maria VK5BMT  
Librarian Kim VK3CYL  
Historian Christine VK5CTY  
VK1/2 Rep Dot VK2DB  
VK3 Rep Gwen VK3DYL

VK4 Rep Dawn VK4HER  
VK5/8 Rep Jean VK5TSX  
VK6 Rep Bev VK6DE  
VK7 Rep Susan VK7LUV

The old members were thanked and the new members were welcomed and the meeting proceeded without problems so there was time for a chat afterwards. We all hope the conditions on 80 metre will continue to be as good.

Why not join us and find out if they are as good?

## The International YL Meet in Seoul

At latest information there will be at least nine ALARA members in Seoul. We have Gwen VK3DYL, June VK4SJ, Maria VK5BMT, Unni LA6RHA, Mio JR3MVF, Carol WD8DQG, Ruth IT9ESZ, Evelyne F5RPB and Walli DJ6US. I believe Raija SM0HNV plans to be there, too, so altogether it looks as if ALARA will be well represented.

We wish you all well and wish we could join you.

Gwen has been asked to talk about the Dxpeditons she has organised so she is preparing a PowerPoint presentation of those very successful excursions to interesting places. Hope that all goes well, Gwen.

There will be a special radio station with the callsign of DT0YL so listen out for it between 8th and 11th October 2004. Probably it will be operating on

most of the HF bands and it is sure to be using both CW and phone.

The QSL card will be interesting, I'm sure.

## Update on those radios

Well there has been some sickness around so things have been delayed but by this time next month the radios should be in VK5 and in use. Watch this space!

# Cable and Connectors



- RG58C/U Belden 8259 @ \$0.90 per metre
- RG213/U Belden 8267 @ \$4.45 per metre
- RG8/U Belden 9913 Low Loss @ \$5.15 per metre
- RG8/U Belden 9913F7 High Flex Low Loss @ \$5.55 per metre
- RG8/U - RF400 Belden 7810 Low Loss Sweep Tested to 6000MHz @ \$6.30 per metre



- RG58: B80-006 UHF connector (M) @ \$7.65 each
- RG8/213: B80-001 UHF connector (M) @ \$8.80 each
- RG213: B30-001 N connector (M) @ \$9.10 each
- RG8: B30-041 N connector(M) @ \$14.00 each

# connektron

ABN 19 413 484 007

email sales@connektron.com.au or Phone (03) 9761-5220  
connektron Pty Ltd, 45 - 49 Merrindale Drive, Croydon South, Victoria 3036

[www.connektron.com.au](http://www.connektron.com.au)

- \* All prices include GST
- \* Minimum order value \$50 payable by Visa, Mastercard, Bankcard or Money Order
- \* Packing and Delivery \$15 within Australia (Outside Australia P.O.A.)

## Did you catch this?

From 17th Nov to 2nd Dec there was an International DXpedition in Tunisia, to the Kerkennah Islands, north of Jerba IOTA AF-073.

There were YL and OM operators. Each radio station had a laptop with a WLAN-card and the CTWIN log of K1EA so records could be kept very easily. There were 6 different radios in 4 different shacks.

During the expedition the operators took part in the CQ WW DX CW Contest with 9,999 QSOs and a final score of 25,000,000 points WOW!

Altogether there were 53,042 QSOs in SSB, CW and digital modes on 10 different bands. There were 18 OMs and 4 YLs. They were busy little bees. But they had fun! I do hope all those keen DXers made some good contacts, just to keep the QSL manager busy. Conditions are improving all the time

Now that winter is here and daylight saving on the other side of the world makes the time of the net so much more convenient for YLs to call into the net.

We love to hear them and they are just as excited to hear us.

The net is controlled either by June VK4SJ or Dave ZL1AMN who both have good antennas and receivers. Officially

the net starts at 0530 UTC but the keen operators are usually on frequency anything up to half an hour earlier.

Don't be surprised if the YLs using the special station in Seoul join the 222 net, just as the DXpeditioners do.

The frequency is 14.222 so let us see you there, soon.



Our April luncheon at TG's on North Terrace.  
L to R Christine VK5CTY, Myrna VK5YW, Tina VK5TMC, Maria VK5BMT, Shirley VK5JSH and Sue Mahony.

## John Elton VK3ID

John Elton VK3ID became a silent key on the 18th April 2004, after a short but severe illness.

John was born in Melbourne on 30th October 1917. He attended Canterbury State School, and later 5 years at Scotch College. Though his great love at school was chemistry, he was unable to continue that passion as a career, due to the uncertain job prospects caused by the depression, and the threat of war.

Instead he worked for his father in the paper merchant business of Tullis Hunter and Co, a paper importer and wholesaler. He later went on to be General Manager of that Company, and after early retirement in 1972, he went on to manage the Marketing Department at Brown Brothers Winery until his second retirement in 1989.

In 1940 he enlisted with the CMF, and later in 1942 transferred to the AMF. In June 1940 he was sent as a member of the 54th company in the AASL (Anti-Aircraft Searchlight Co, R.A.E.) division to Darwin, where he was an important member of the team which installed around Darwin anti-aircraft searchlight facilities at Dripstone, McMillans, Talc Cove, Flagstaff Hill, amongst others.

On 9th February 1942, Dad was in the ration boat, returning from one of their many trips to the outlying searchlight stations, bringing food and supplies. I quote from his memoirs – "... the ration boat was returning from a run to Flagstaff Hill. It was quite a sight to see the Neptunia explode before our eyes and to see the USS Peary sink with her guns ablazing. Just before the finish of the raid, two Japanese aircraft took a pot-shot at us too, but fortunately they missed. ...Amongst the ships sunk were the SS Mauna and the USAT Meigs. Their crews had manned their lifeboats and we took them in tow, making very slow progress to our jetty". Many people in Darwin that day, and during later raids, were not that lucky nor so brave.

Not long after returning to civilian life in 1945, Dad became interested in radio and amateur radio in particular. After a long struggle trying to pass the CW exam, he finally became licensed in 1952, and began what was to become a lifelong love of amateur radio.

He was a keen operator on 40 and 20 metre, loved DX, and later on was active on 2 metre AM. He was a keen home brewer, and built all his own test gear

including CROs, GDOs, noise bridges, signal generators, etc. SSB exciters, linear amplifiers, a Deltahet receiver, were some of the many projects which he built over the years. He was on the Amateur Radio Publications Committee in the 1960's.

At the young age of 80 (1997) he discovered the world of computers, and this opened up a whole new world of discovery for him. Over his last 7 years he immersed himself in computer related projects such as AR digital modes, digital photography, probing and utilising the Internet and emails, restoring and recording on CDs, old 78s and 33s, (particularly Jazz) and of course his last great passion, studying the genealogy of his family.

Just prior to the onset of his illness in January, he was preparing to restore, digitise and archive all of the super 8 films he had taken back in the '60s.

Dad, John VK3ID, was an inveterate enthusiast, meticulously documenting all the work he undertook in all his many hobbies, and passionate in what he did until the last.

To my mentor, peer, Dad and mate, thanks and 73.

Peter Elton VK3KG

Peter Gibson VK3AZL

## Delayed turnoff fan control

Proper ventilation of electronic equipment has been a design issue for professional engineers and radio amateurs for many years. In QST for July 2003, Glen Thomas, N8AKS describes a delayed turn off fan control to keep equipment cool, but only when required.

Adequate cooling has become more important with the advent of solid state devices and the resultant miniaturisation of equipment. In many cases, natural convection proves to be inadequate and it is necessary to resort to forced air cooling to remove the heat. Every solution carries its own disadvantages. In the case of forced air cooling, the introduction of a fan adds audible noise, increased power consumption and reduced reliability as it is expected that mechanical devices will fail before the other system components.

The fan control circuit described here was designed and built for use at a repeater site. Whilst noise was not much of a problem in this case, reliability and power consumption were important.

The fan controller circuit is shown in Figure 1. It consists of a retriggerable monostable oscillator (one-shot) controlled by an op-amp used as a comparator that senses the state of the push-to-talk (PTT) signal generated by the repeater controller. The output of the one-shot gates a power MOSFET into conduction or cut-off, which, in turn, applies or removes power to the fan. An internal power supply provides filtered and regulated voltages for the various active devices. Two LEDs are included to provide POWER ON and FAN RUNNING indication.

During idle times, the PTT signal

applied to the positive input of comparator U1 is higher than the reference voltage applied to the negative input (3 V). Under this condition, the output of U1 is high, and, when applied to the input of the 555 (U2), holds its output low. This corresponds to the fan being turned off.

When the repeater is keyed, the PTT signal goes low, forcing the output of U1 high. Timer U2 responds by going high and causing the MOSFET Q4 to turn on and power the fan. Whilst the transmitter is keyed and the output of U1 is low, transistor Q2 is biased on which stops capacitor Q10 from charging. This causes the monostable to be continuously retriggered, resulting in the fan running whilst this state exists.

When the transmitter is unkeyed, the output of U2 goes high, transistor Q2 is

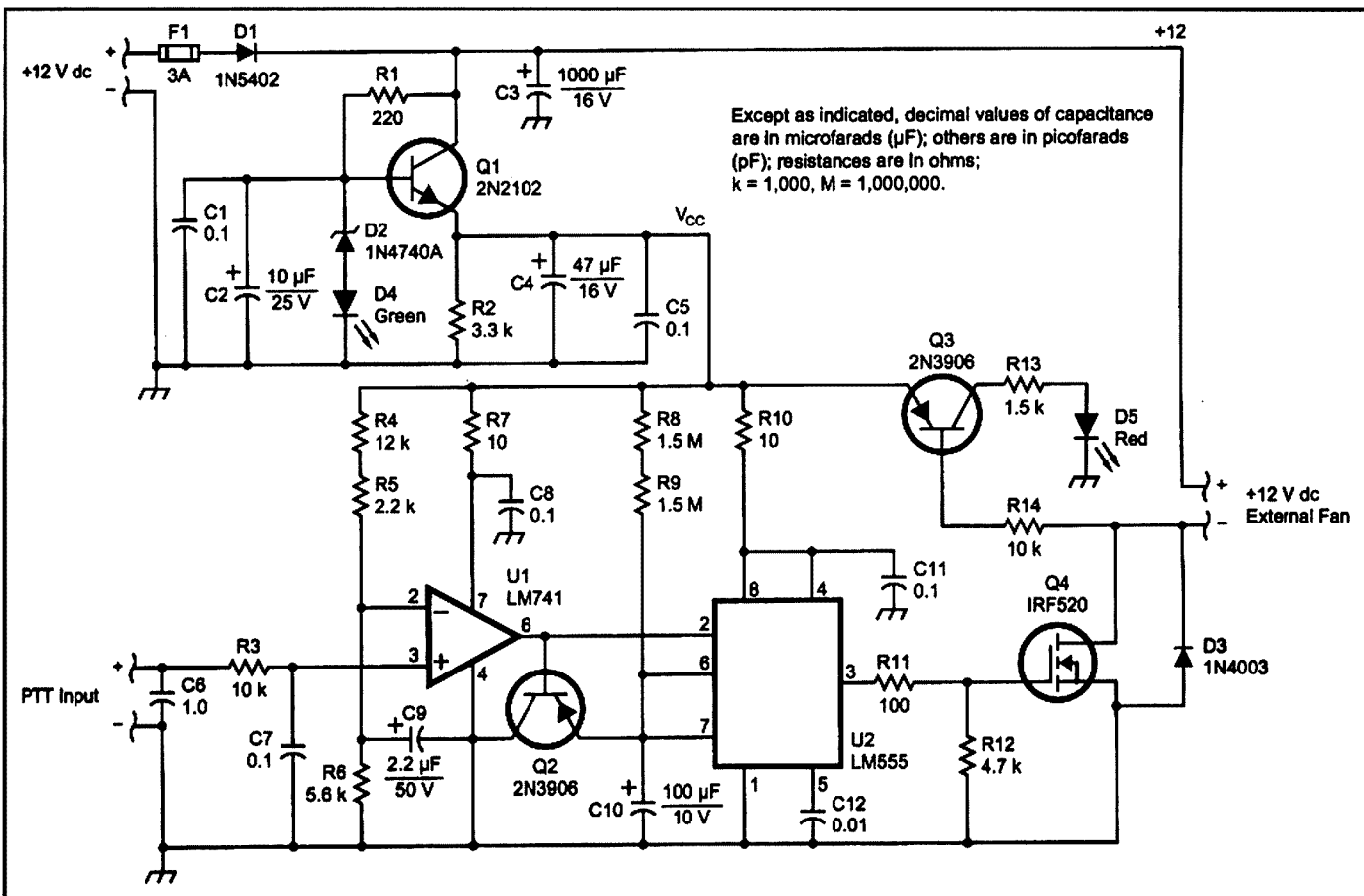

Figure 1 - Delayed fan controller schematic



biased off, which allows C10 to charge via resistors R8 and R9. The values of these components were chosen to allow a time out period of 4-5 minutes, after which the output of the monostable goes low, turning Q4 and the fan off. Because of the long period involved, C10 should

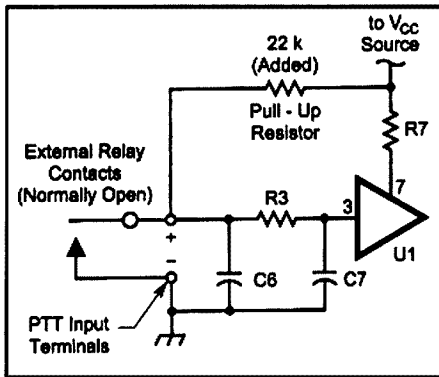

Figure 2 - Additional 22k resistor for 'Dry' input

be a tantalum capacitor as it exhibits lower leakage. Additionally, 1% tolerance metal film resistors were used for R8 and R9.

The internal power supply consists of Q1 and D2 and provides a stable 10 V supply for U1, U2 and Q3.

The layout and construction is not critical, with the original being built on a small piece of perforated board. The heat dissipation of Q1 and Q4 should be low enough to not require heatsinks. However, if the system is expected to operate in high temperatures, it may be useful to install small heatsinks on each transistor.

If the PTT output of the transmitter is a 'dry' contact, it will be necessary to add a 22k resistor as shown in Figure 2. Likewise, if it is required to operate a fan that is other than 12 V, such as a

mains unit, an alternate output circuit is shown in Figure 3 where Q4 operates a relay instead of the fan directly.

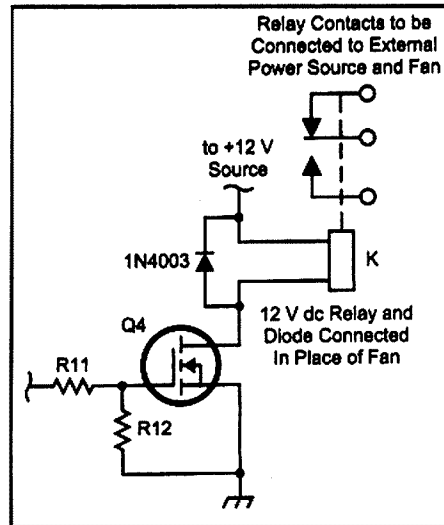

Figure 3 - Relay output for other than 12 V fan"

## Mike Walton VK2MJ

Mike Walton VK2MJ passed away on 22 April 2004

He was born on the 28th May 1945 in Yorkshire in the United Kingdom.

As Mike put it, he arrived here as a 10 Pound Pom on the 10th September 1969. He married Prue Budden on the 4th April 1975 and the two of them recently celebrated their 29th wedding anniversary at Darling Harbour. They have 3 sons Gavin, Julian and Stewart.

Mike was very community minded as he was a member of:-

Westleigh Rural Fire Service  
WICEN Sydney North Region

Mike also was a member of a group which maintained the Dural site of the Wireless Institute of Australia

He also provided a service so that country and interstate HF packet radio operators could tap into the Sydney 2 metre packet network and thereby access overseas packet operators via The Macquarie University gateway.

He also made many friends when helping the Scout movement with their Jamboree On The Air in October each year.

Mike obtained his licence with the Sydney Radio Group who used the Ron



Bertrand Video Tapes. Mike was pleasantly surprised that he obtained his full call at his first attempt. He was not that impressed with Morse code and after he passed the exam, he nailed the Morse key to the wall of his radio shack.!

Mike was very technically minded even though he was not a technocrat like many Amateur operators, and he put them to shame the way he got stuck into and mastering NOS and then Linux!

He was a member of the Hornsby and District Amateur Radio Club as well as the Sydney Radio Group (now defunct)

I have never seen Mike without a smile on his face and he also had his familiar

## Silent Key

infectious laugh. Mike should have been born with a wooden spoon in his hand as he was always the "eternal stirrer"

My wife caught him at it, at a Sydney Radio Group DXpedition at Hampton in the Blue Mountains. Some one had said some thing and Mike, always the stirrer, put his tuppence-worth in. When Rose picked him up on this he said "I like dropping a stone into a still pond and watching the ripple effect!" Most of us were not even aware that he was doing this!

He was always helping others, and if a newly licensed amateur had no radio gear, Mike would lend him a transceiver until the new amateur had saved up to buy his own. Mike was a bricklayer by trade and built his own house on the side of a picturesque gorge in the Hornsby area. He was always hard working and his family always came first, last and foremost.

Thankfully Mike's illness was quite short with a minimum of suffering, and he passed from this life with his characteristic minimum of fuss.

Farewell, Mate!

Garry Barker VK2TSR

# TET-EMTRON

TE-33

3 ELEMENT  
3-BAND BEAM

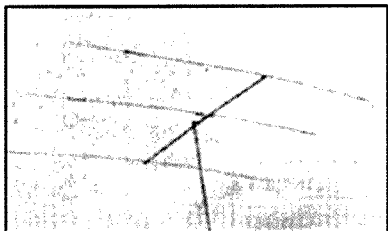

The TE-33 - the most popular tribander, has proven itself in the most severe storm conditions on the Pacific Islands. Its excellent performance and features on all 3 bands such as wide bandwidth, high gain, low SWR and high F/B ratio gives you all the features.

ED52c

Wire dipole for 80 and 40.

This antenna can be used as an "inverted V" or just a straight dipole. It is resonant on 80 and 40 but can also be used on 20, 15 and 10 meters. It comes with 30.5 meters of cable.

## Dealers

VIC

LT Harris 78 Elgin Street Carlton Vic 3053  
Ph 03 93476264 Fax 03 93473629

Email: lharris@netscape.net.au

G&C Comma 207 High Street Cranbourne Vic 3977  
Ph 03 5996 3298 Fax 03 5995 0184

Email: gccomm@netspace.net.au

NSW

Emtronica 1/94 Wentworth Avenue Darlinghurst 2010  
Ph 02 9211 0988 Fax 02 9281 1508

Email: Emtron@ozemail.com.au

Andrews Comms Shop 8, 41-51 Bathurst St  
Greystanes, NSW, 2145 Ph 02 9636 9060

Fax 02 9688 4301

www.andrewscom.com.au

WA

Tower Communications 14 Mary Street Hazelmera 6055  
Ph (08) 92741118 Fax (08) 92503734

Email: tower@eon.net.au

QLD

Kyle Communications

668 Lutwyche Rd Lutwyche 4030

Ph (07) 38574400 Fax (07) 38577825

Email: mark@kyle.com.au

SA

International Communications -

8 Nile Street Port Adelaide 5015

Ph (08) 84473688 Fax (08) 83411453

Email: Intercom@plcknowl.com.au

New Zealand

The Com Centre

400 Hillsborough Road Avondale Auckland

Ph (64) 9 6270084 Fax (64) 9 6271613

Email: comcent@radiolinfo.co.nz

## RAWMAR ENTERPRISES

40 Blackburn Street

STRATFORD Victoria 3862 Australia

Ph: 61 3 51 45 6179

Fax: 61 3 51 45 6821

Email: rawmar@hotmail.net.au

www.tet-emtron.com

# The Newbridge Group: The No Code influence on amateur bands

Chris Wright VK2UW & Karen Wright VK2HKW

The Newbridge Amateur Radio Group was formed on 17th September 2003 in order to obtain a licence for a 2 metre and 70 cm voice repeater at Newbridge to enhance the coverage that amateur radio Repeaters have in the area.

The licence, VK2RLH, also covers the facility of linking the repeater at Grenfell via a 70 cm link and has an allocation for a 2 metre packet digipeater.

Following the opening of HF bands to limited licence holders on 1st January 2004 two of the Newbridge Amateur Radio Group members, Lindsay VK2TLH and Tom VK2TDM, who had been trying various means to establish an afternoon discussion with Greg VK2TGP decided to give 40 m a try. With distances between of well over 100 km, it looked like 40 m might be the best at 4 pm.

The first day, 6th January 2004 at 4.00 pm, on 7.085 MHz, there was Tom, Greg and Lindsay. The trio had success with their yarn for a few days, then on the fourth day, 9th January, James VK4XJB joined in and asked if this was a net/group. On the spur of the moment Tom VK2TDM said it was the Newbridge Amateur Radio Group discussion time, and it was from this day that the 4 pm discussion continued. During the next week the original group was joined by on average ten other amateurs and on 17th January this had grown to seventeen.

To keep some order it was decided to have a Group Controller and young Tom VK2TDM happily volunteered for this very important job. He has kept things rolling every weekday since. The group runs at 4 pm every weekday. Weekends are for Tom to regain his voice.

After running for 14.2 weeks there had been 1,318 call-ins: 116 full calls, 36 combined calls and 60 limited calls.

Considering that it was conceived just so a few limited calls could take advantage of the newly gained privileges on HF, it has been an unqualified success, with now well over 211 individual stations calling in. The greatest number in one afternoon has been 34. On the Newbridge Group on the 16th April on Frequency 7.085, we had the pleasure of Ron Bertrand VK2DQ who gave a brief but very informative talk on the Radio Electronics School.

This was well received and found very informative by all that attended the net.

It is good to note the operators are receiving feedback from SWLs by SMS, mobile phone and QSLs.

Ron VK2DQ explained the intentions of the Radio Electronics School and the rewards for those interested in amateur radio. He included talks on certificates that are and have been available to those willing to give up an hour each day to study.

Ron compared costs of doing classes with going to TAFE to do a similar course, also the length of time needed to achieve the same results.

The Newbridge Group hope Ron VK2DQ can do this on a regular basis, as when Ron was talking there was complete silence from all those listening with great interest.

Past students came up after Ron's speech and thanked Ron very much for helping them obtain a licence. Others took down the contact details so as to pass on to mates etc, to be part of the school.

ar

## VK2 News

Tim Mills VK2ZTM.

Hello there. The VK2 AGM was held, as scheduled, on Saturday 17th April 2004, at Amateur Radio House, the Parramatta based offices of the NSW Division. Fifty members were in attendance and 156 proxies received. The meeting opened on time and quickly dispensed with the minutes of the previous meeting and the various reports for the past year. Returning Officer Peter VK2EMU reported to the meeting that only eight nominations were received for the nine Council positions. They were Adrian Clout VK2BFN, Michael Corbin VK2YC, Chris Flak VK2QV, Terry Davies VK2KDK, Brian Kelly VK2WBK, Noel May VK2YXM, Norman Partridge VK2TOP and Terry Ryeland VK2UX.

Peter O'Connell VK2EMU was re-appointed Returning Officer with Kevin Dawson VK2CKD as alternate Returning Officer. The present Auditors, Casey Bates, were re appointed.

The meeting then dealt with the two Special Resolutions and one motion. The first special resolution, to amend the Memorandum and Articles of Association to allow the use of email to distribute annual reports and notices of general meetings, was agreed to by the meeting. The second special resolution to fix the quorum of a meeting as a percentage of the membership (3%) was agreed to with the lower limit being ten members. A break was then taken.

After the meeting resumed the President Brian VK2WBK presented awards to members with 40 or more years with the NSW Division. They were John Bishop VK2ZOI, Col Christensen VK2BCC, Dean Davidson VK2ZID, Stan Dogger VK2KSD, Owen Holmwood VK2AEJ, Aub Topp VK2AXT and Brian Warren VK2BX. Members of the NSW Division with 40 or more years of membership are reminded that they may apply for these awards by writing to the Division, outlining when they joined and activities during their period of membership. A register is maintained and presentations are made at intervals.

A Federal award, Certificate of Thanks, was presented to Barry White

VK2AAB, for services to Amateur Radio by Federal Secretary, Peter Naish VK2BPN.

Certificates of Appreciation were also presented to

Max Bowey VK2AFE for services to the Parramatta office.

Aub Topp VK2AXT for the library and historical display at Amateur Radio House.

Mark Blackmore VK2XOF for technical services to the Dural installation.

Tim Mills VK2ZTM for services to the Division and the Dural property. Owen Holmwood VK2AEJ, retiring Councillor, for 5 years on Council and recently as Secretary.

John Vettors VK2JVV, retiring Councillor and Dural Officer.

Seppo Ahlstedt VK2SMA, retiring Councillor and Trash & Treasurer Officer.

Pat Leeper VK2JPA for general services to the Division and Past Secretary.

Jo Harris VK2KAA for services to the Historical Records of Amateurs.

The meeting then went on to the motion "that the NSW Division supports the single national WIA organisation". There was some discussion before the lunch break. After the meeting resumed, Jim Linton VK3PC, who was present as a visitor, was invited to address the gathering. The members then resumed debate on the motion (for some time) and added to the wording to give the Divisional Council authority to finalize negotiations. This national WIA topic is extensively reported elsewhere in 'Amateur Radio' magazine. Informal polling indicated that the VK2 membership, in general, favours a single national WIA, but there are reservations concerning the property and asset aspects of the Division. This appears to be a concern in some other Divisions who also have assets and/or property. The motion was passed. The new Council is continuing to address this

## Antenna 'HomeBrew'

(with a lot of help from your Bushcomm kit)

### SWCS-KIT HF ANTENNA

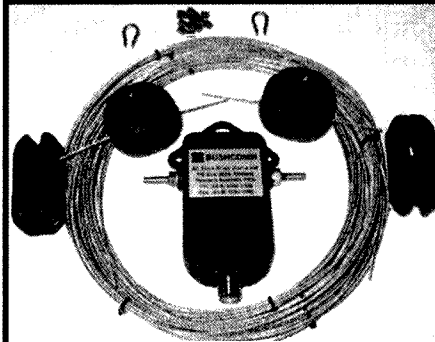

This is a kit version of our popular SWC-100S single wire model, but you have the great satisfaction of constructing of your antenna. Easy to follow, comprehensive instructions. Common tools required.

You save money and have fun. Once completed correctly your antenna will be a replica of the SWC-100S model. This is a single-wire, base-situation antenna, constructed with stainless elements to give high resistance to corrosion. It has a length of 34m in total. Trees, buildings or other structures can be used to suspend the antenna, (avoid running the antenna over iron-roofed buildings as this reduces the effective height above ground). The antenna can be mounted either horizontally between two supports, or as an inverted 'vee'.

Frequency Range: 2-30 MHz  
Impedance: 50 OHM  
Power Input: 100 Watts, 250 Watts PEP

This kit contains:  
Balun (x1) Load (x2) S/S Thimbles (x2)  
Copper ferrules (plus a few practice extras)  
Large egg Insulators (x2) 4 cut lengths of wire.

FULL and CLEAR  
building and mounting diagrams

## Bushcomm



PROUDLY AUSTRALIAN OWNED  
AND MANUFACTURED

PO Box 2028, Midland DC 6936 Western Australia  
80 Stock Road, Herne Hill 6056 Western Australia

PHONE: + 61 8 9296 0496

FAX: + 61 6 9296 0405

EMAIL: [buaahcomm@bigpond.com](mailto:buahcomm@bigpond.com)

See more at

[www.bushcomm.com.au](http://www.bushcomm.com.au)

# Division News

matter. The meeting concluded with a short period of general business. Eric Fossey VK2EFY raised the position and status of the Dural Consolidation Committee, who had reported back to the Council. It was considered that the committee should remain in view of the present discussion re the future of the WIA. Peter Naish VK2BPN spoke to the meeting on his role in the IARU and Region 3. He had recently been re elected as a Region 3 director and had also become Chairperson of Directors for Region 3. The 2003/4 AGM concluded just after 3 pm.

At the new Council's first meeting at the end of April the following positions were filled.

President	Chris Flak VK2QV
Senior Vice President	Norm Partridge VK2TOP
Junior Vice President	Terry Ryeland VK2UX
Secretary	Michael Corbin VK2YC
Treasurer	Noel May VK2YXM
Federal Councillor	Chris Flak VK2QV
Alt Federal Councillor	Michael Corbin VK2YC
Affiliated Clubs Officer	Terry Davies VK2KDK
Deceased Estates Officer	Michael Corbin VK2YC
Education Officer	Terry Ryeland VK2UX
Publicity Co-ordinator	Chris Flak VK2QV
Dural Officer	Brian Kelly VK2WBK
Trash & Treasure Co-ordinator	Terry Ryeland VK2UX
QSL Bureau Liaison	Norm Partridge VK2TOP
NTAC Officer	Adrian Clout VK2BFN
Bookshop Officer	Chris Flak VK2QV
Membership Secretary	Terry Davies VK2KDK

There are various other workers and helpers within the Division. There is need to fill the ninth position on the Council. The Parramatta office also needs assistance from members, able to access the location. Please check with the office on how you could help.

The next Parramatta based exams will be on Sunday 20th June, with the closing date on Tuesday 8th June. Contact the office. The next Trash and Treasure is at the end of July. The present spacing of the T & Ts is every two months. Some are questioning whether this should be altered to perhaps every three months. Comments please to the T & T Co-ordinator, Terry VK2UX. The Conference of Clubs, scheduled for a May meeting, has been deferred until there is more finalization in the national WIA debate. Don't forget the Oxley Region field day at Port Macquarie during this month's long weekend. The Divisional Bookshop is scheduled to attend on Sunday. In late April, the Division's web site came under a 'spam' attack, which may have caused some mail to be lost. If you have difficulties by email, remember the other methods of contact with the Division.

Check the Directory at the back of this issue of AR for details.

We are always saddened to hear of 'Silent Keys'. If you are reporting a Silent Key please send it to the Parramatta office so that the details may be included in the VK2WI news sessions, as well as adjusting records. We ask that you also send a copy of the details to this magazine, 'Amateur Radio' for inclusion.

The VK2 BOOKSHOP has placed an ad in the May issue of 'Silicon Chip' to expand the reach of its operations. The ad will run for a couple of months. For a catalogue of the Bookshop, check out the VK2 web site. You may have noticed the article in the May issue of "AR", re the EH Antenna. The Bookshop has a few, Italian made, EH Antennas. They are single band units and those available, as these notes were prepared, cover 160, 80, 40 or 20 metre. Make inquiries. While on the Bookshop, there are still a few copies of the 2004 Callbook. Also WIA log books, keyrings, watches and blank QSL cards for those 'rare' contacts that you wish to confirm. Those items are in addition to the many titles and CDs now being carried. There are monthly issues of the ARRL - QST magazine, which even with postage from the bookshop, is better than the newsagent price. Use email or call during office hours as shown in the Divisional Directory.

VK2WI is hopefully out of the lightning season for a while. The VK2RSY beacons on 2 and 70 remain off. Some recently acquired equipment may assist the 70 cm beacon to co-exist with the repeaters. We are still looking for a designer/builder for a 2 metre beacon. Work is being planned to overhaul the antenna systems. They have weathered well, but need some TLC to extend their useful life. Anybody into 'qualified' tower climbing? If so, please contact the office. The overall coverage from VK2WI is going well. The evening transmissions on both 80 and 40 are reaching many parts of the country with callbacks at times on 80 exceeding the morning roundup on 40. Keep listening, we have the news.

73, Tim VK2ZTM.

## GippsTech 2004 3-4 July

GippsTech 2003, which had amateurs in attendance from VK1, 2, 3, 4, 5 & 7, was the sixth successive symposium; the event has been organised by the WIA Eastern Zone Amateur Radio Club each July since 1998, and yes, it will be on again this year.

GippsTech 2004 is being held on 3-4 July and promises to be another successful meeting of those amateurs who are interested in the top half of the spectrum. We are still looking for further speakers for this year's event so if you would like to present a topic, please email either Peter Freeman (peter.freeman@sci.monash.edu.au) or



Avid Microwave operators at GippsTech 2003 the club through its website at [www.qsl.net/vk3bez](http://www.qsl.net/vk3bez) with details of your proposal. Look forward to seeing you one and all at this year's conference.

# Division News

## VK4 News

### Qnews

From Alistair Elrick VK4MV

#### Gold Coast Q5

The Gold Coast Club has been presenting an Education Hour, called Q5, consisting of segments of interest to radio amateurs and general audiences. This is a group effort, led by Ron Bertrand VK2DQ, and Gold Coast listeners may catch it on the 146.950 Repeater VK4RGG each Wednesday evening at 2000 hours. Subjects covered so far include histories of the Marconi School of Wireless, the telephone and amateur radio; the search for extra-terrestrial intelligence and famous women in science. There have been discussions on amateur radio technology, such as Antenna theory, and Radio interference. Some interstate listeners may listen through their Club repeaters, as it has now been syndicated to various clubs in NSW, Tasmania and Western Australia.

#### Mount Pleasant Comms Report

The Mount Pleasant Horse Endurance ride was held recently under excellent weather conditions and good radio communications. Six operators from Townsville - Steve VK4JUS, Phil VK4HSV and Jan, Wayne VK4YWG and Kate, John VK4KN and Ray VK4LU helped in the smooth running of the endurance ride of 25 participants from Townsville, Bowen and Mackay.

Communications support was provided on VHF with most stations also having backup HF transceivers. Unlike previous years most operators slept off base prior to the event but most had to wake at 3 am to receive the competitors list. Stations were battery powered with most sporting omnidirectional antennae.

The Riders Safety Briefing was pretty impressive with the emphasis being the well being of the horses. Everything went well at Mount Pleasant Station, no riders or operators were lost and the Townsville operators were invited to meld with the Mackay operators at the next Pioneer Valley Endurance Riders event.

#### Quoll Adventure Race Comms Report

In May 104 competitors slogged through soggy rainforest, boggy tracks, slippery slopes and alpine lakes during the 2004 Quoll Adventure Race. The on-course medical teams only had to deal with minor injuries, no teams got horribly lost and the communications support supplied by Far North Queensland WICEN operators was second to none. Operators included Dale VK4DMC, Chris VK4ANI, John VK4JKL, Bill VK4WL, Lyndall VK4ZM and Gavin VK4ZZ at checkpoints over the 3 days and Dale VK4DMC, John VK4TL, Ron VK4ZJR, Nick VK4YT, Dave VK4ADW, Mike VK4AMO, Ross VK4AQ, Bill VK4WL, John VK4DJS and Adrian VK4NAL manning Quoll Base.

To quote Quoll Communications Leader Dale VK4DMC: "...The Quoll management team were extremely grateful for our assistance and have asked me to pass on their thanks. Good comms helped to make the event the success it was. On a personal note I would also like to thank all who participated for input and help, it made my task as organiser just so much easier..."

WICEN communications shone when a number of service vehicles got horribly bogged on Glen Gordon Station and Co-ordination between recovery vehicles, a helicopter and people on scene was required. This and the myriad other communications tasks kept the WICEN operators busy from 6am on Saturday May 1st until 4pm Monday May 3rd.

Field operations were battery powered with most operators raising dipoles to ensure reliable communications, which - due to the terrain and vegetation - had to be mainly conducted on 80 m and 40 m HF. Closer range communications to the west of Quoll Base were also conducted on VHF.

Dale VK4DMC asks that if participants have any ideas on improvements to the communications support for the next Quoll to please contact him.

73s from Alistair

## Australian Made ANTENNAS "Setting a New Standard" COM-AN-TENA (Formerly a j and j coman)

6 Muir Court  
CHELSEA HEIGHTS 3196

All new 5/8 vertical 16 radials	\$160
Dual drive 26-30 5 ele yagi beam	\$315
4 ele 10-11m yagi beam	\$278
5 ele high gain antennas 11m	\$327
3 ele delta loop 10-11m	\$326
11m 5/8 vert./4-1/4 wave radials	\$175
Duoband 10-15 3 ele each band	\$385
Tri-band 5 ele HB35C s/steel fix	\$730
3 ele 20m computer opt	\$420
3 ele 15m computer opt	\$295
M B Vert Auto switch 10-80m	\$330
40m linear loaded 2 ele beam	\$595
6m 5 ele compt opt beam	\$268
6m 7 ele compt opt beam boom - 60mm	\$387
10 ele high performance 2m	\$145
17 ele high performance 70cm	\$125
2m vert 2-5/8 co-linear 4 rad	\$120
Log-periodic 9 ele 13-30 MHz 8.4m boom	\$990
Wire Dipole 10-20-40-80 MHz	RING

#### Guyed Masts

21 metres 13 metres

Winch-up & tilt-over. Aluminium and stainless steel  
three-sided construction. Auto-brake winches.

#### Free Standing Masts

9.5 metres

#### New Baluns

1-1 to 16-1 to 3kV

#### Our Masts meet

Australian Standards.  
We supply all the  
computations and data  
you will need for  
a permit.



03 9773 3271

Mob: 0419 542 437

Andy VK3IV

## VK6 News

Compiled by  
Will McGhie VK6UU

Input to: will2@iinet.net.au, 08 9291 7165

Colour original inserted

### VK6 and the National WIA

The VK6 council has for the past few months been deep in discussion about the move towards a National WIA. At the moment, the WIA is a Federal structure and many feel it would be better if the WIA became a National organisation. The VK6 Council has long supported the move to a National WIA, and the VK6 council believes that the majority of VK6 amateurs, both WIA members and non-WIA members, support a change to a National organisation. However at the VK6 AGM, members voted against the proposals as presented. The vote was not against the concept but the detail. A great deal of work has gone into drawing up a new constitution and other documents that work through just how such a complicated change would take place.

What has taken many VK6 amateurs by surprise is the speed at which the proposed changes would take place. The proposed timetable is to dissolve the Federal Divisions with members resigning and joining the National organization all by midyear. The VK6 council has had to work through many issues. There are a considerable number of activities that the VK6 council performs that members may not be aware of. Many of these tasks are "housekeeping" such as administering club insurance, educational classes,

invigilators, licences, news broadcasts, our web site etc. It is important that we do not wind up the existing structure before we all understand just how the new structure would take over.

The intention is for there to be local advisory councils throughout Australia that report to the National WIA board. These local councils (committees) advise the board (directors) on local issues. It could be said that the new structure is much like the existing structure but the difference is the National board is not state based.

Amateurs elected to the WIA board are so elected on the business skills they can offer to the WIA and Amateur Radio. Yes, we may end up with a WIA board made up of Eastern Staters, but if that is where the best skills are then that is what is best for amateur radio in Australia. It would not make any sense, once we acknowledge the need for change, to have a board that acts other than in the best interests of all Australian amateurs.

Michael Owen, who is largely responsible for writing up the proposed constitution and other documentation, flew to Perth to talk to all VK6 amateurs.



Meeting with Michael Owen and VK6 Amateurs

This meeting took place at the Westrail building in East Perth (see photograph). The attendance by VK6 amateurs was poor considering the importance of such a meeting. The meeting directed the VK6 Council to accept the new National structure, even though there were still many outstanding issues. There were some at the meeting that had reservations about the move and the VK6 council is discussing their concerns. There is a deadline to have a vote on this important issue and this will have taken place by the time you read this.

From the VK6 council's position, this has proved to be far more complex than perhaps first thought. With council being faced with nuts and bolts issues, sorting through the mechanism for such a radical change has required a lot of discussion and thought.

In passing, the VK6 AGM was held and Neil Penfold VK6NE was narrowly re-elected as Divisional President. Congratulations Neil, perhaps our last Divisional President.

## Intruder Watch

Henry VK8HA  
Box 619, Humpty Doo, NT 0836.

### The 24 MHz Codar is still at very low level and no interference to DX Work in Humpty Doo..

The 14 MHz Intruder problem is on the improve. First week in the month, the "Chinese Packet / OHR?" shut down the transmitters on 14.025 MHz and 14.045 MHz and were still not heard at the end of April.

There was a 'new type' of packet heard on 14.025 MHz for a couple of days. Did sound like packet with short bursts of traffic every five or ten minutes or so. No identification heard. After he finished, the frequency was left in a 'no

interference' mode.

The 'Asian CW' is still around and can be heard on 13.999 MHz moving up to 14.004 MHz. Good CW Practice !

On 14.084 and 14.098 MHz multi channel digitals from PY still very strong in PH57NK on 14.1 and 14.105 MHz Indonesian SSB intruders, but generally the band is free from Indonesian Intruders, generally they will be found on the 10.1 and 7 MHz bands which is a 'great joy' to radio amateurs on 14 MHz

band.

Due to problems at octa4 / iinet , no incoming email has been received for a couple of months, so no reports from VK6 and VK4 this month either. Tried to join the BIGPOND, but they are also 'cluttered up' with viruses and their machines can not accept any 'work'. No Logs have been received via Australia Post either.

Hoping this will find the right spot.

ar

## VK1 News

### Forward Bias

Peter Kloppenburg VK1CPK

In addition to the second and fourth Tuesdays of the month, when the Farrer hamshack is open to visitors, it will also be open on the following Wednesdays evenings when Graeme Wilson, VK1FXL, provides help and assistance to aspiring radio amateurs studying for their NAOCP and AOCPP examinations.

Those who are using Ron Bertrand's on-line study course or Graeme Scott's text books can get assistance from Graeme with the theory and practical aspects of amateur radio using the whiteboard or radio equipment available in the hamshack. Graeme can be contacted by phone on 6291 2101 or mobile on 0419

342 555, or email on [fxl@fxl.com.au](mailto:fxl@fxl.com.au)

It is always useful and interesting to visit the ACA Website, [www.aca.gov.au](http://www.aca.gov.au) While browsing through the various sections of the amateur services section, I came across newly specified definitions of Spurious Emission Limits for Amateur Stations

**Amateur operators must also comply with International Telecommunication Union (ITU) requirements for amateur stations. The maximum permitted spurious emission power level is calculated by subtracting the following values of "attenuation" from the transmitter power supplied to the antenna transmission line.**

Type of service	Attenuation (dB) below the power supplied to the antenna transmission line
Amateur services operating below 30 MHz (including those using SSB)	43 + 10 log (PEP), or 50 dB, whichever is less stringent
All other amateur services	43 + log (P), or 70 dBc, whichever is less stringent

where  $P$  = mean power in watt supplied to the antenna transmission line.

PEP = peak envelope power in watt supplied to the antenna transmission line.

*continued next page*

## Andrews Communications Systems

ESTABLISHED 1976

ACN 001 968 752



### YAESU FT-1000MP Mk V 200W ...\$4999

FT-1000MP V Field ...\$3,999	FT- 7800R Dualband ..\$499
FT- 897D HF-70cm...\$1,499	FT- 2800M 2m 65W ..\$349
FT- 857D HF-70cm...\$1,399	FT- 1500M 2m 50W ..\$399
FT- 847 HF-70cm ...\$2,499	VX-1R w/2 batteries ..\$329
FT- 8900R Quadband ..\$799	VX- 2R Tiny Dualband ..\$399
FT- 8800R Dualband ..\$699	VX- 5R Triband H/H ..\$599
FT- 817 HF- 70cm ..\$999	VX- 7R Deluxe H/H ..\$699

★ 3 YEAR WARRANTY ★

★ 3 YEAR WARRANTY ★

### ICOM DISCOUNTED

IC-756 Pro II HF+6m	..\$4,999
IC-746 Pro HF+6m+2m	..\$3,299
IC-706 IIG HF-70cm	..\$1,499
IC-718 HF SSB 100W	..\$1,199
IC-910H 2m+70cm SSB	..\$2,499
IC-208H 2m+70cm	....\$649
IC-V8000 2m 75W	...\$399
IC-2100H 2m 50W	...\$349

### ICOM SCANNERS DISCOUNTED

★ 3 YEAR WARRANTY ★

ALINCO DR-620 Dualband...\$799

ALINCO DJ-V5 Dualband ...\$599

ALINCO DJ-X2000 Scanner...\$999

★ 3 YEAR WARRANTY ★

### KENWOOD DISCOUNTED

TS-2000X HF- 23cm + ATU	..\$4,499
TS-480HX HF 200W+6m	..\$2,799
TS-2000 HF-70cm + ATU...	..\$3,499
TM-D700A 2m/70cm	..\$999
TM-G707A 2m/70cm	..\$699
TS-4805 AT	..\$2,499

TOKYO HI-POWER, PALOMAR, TE SYSTEMS, YAESU LINEARS. phi NES 10.2 DSP speaker \$249  
DIAMOND ANTENNAS from only \$49 ea  
HUSTLER + EMTRON ANTENNAS  
Avair SWR/RF wattmeters fr. \$99  
YAESU + EMOTATOR ROTATORS

FACTORY DIRECT IMPORTER OF HUNDREDS OF PRODUCTS

**MFJ** KEYS, TUNERS, ANALYSERS ETC

**CALL (02) 9636-9060 or 9688-4301 or FAX 9688-1995**

**SHOP 8, 41-51 BATHURST ST, GREYSTANES, NSW 2145**

Why pay more? MAIL ORDER TO PO BOX 240, PENDLE HILL, NSW 2145

Some items indent. Prices subject to change without notice - limited stock, some items. E & OE

★ <http://www.andrewscom.com.au>

★ email: [lee.andrews1@bigpond.com](mailto:lee.andrews1@bigpond.com)

AR/64

# Division News

## VK1 News *continued*

Spurious emissions from any part of the installation, other than the antenna and its transmission line, shall not have an effect greater than would occur if this antenna system were supplied with the maximum permitted power at that spurious emission frequency.

It is not easy to measure these power levels unless you have access to a spectrum analyser, a tuneable RF voltmeter, or a spare communications receiver. Given a transmitter output

power of 100 watt,  $\log 100 = 2$ . Adding this to 43 equals 45. This means that the spurious level should be at a level of 45 dB below the level of 100 watt. That is, it should be less than 3.162 mW or 0.398 volts RMS in the coax feeder.

Another interesting item on the ACA's home page is the heading 'Review of Amateur Service Regulation'. Clicking on the heading presents all the details of the responses received last year from

radio amateurs around the country. There were 1300 of them, all having widely different views about how amateur radio should progress in the future, and how the ACA should respond to the changes and challenges presented to it.

The next general meeting will be held on Monday evening, 28 June '04 at the Scout Hall, Longerenong St. Farrer, at 8.00 pm. Cheers.

## VK7 News

Justin Giles-Clark VK7TW

Email: vk7tw@wia.org.au

Divisional Web Site: [www.wia.org.au/vk7](http://www.wia.org.au/vk7)

### Divisional News

Just a quick reminder that the VK7 Divisional news broadcast is not only available on Sunday mornings at 0930 EST on a variety of HF, VHF and UHF frequencies but it is also available on the Internet at [www.wia.org.au/vk7](http://www.wia.org.au/vk7) and the text can even be sent to you via email.

The email mailing list allows anyone to register their email address and receive the Divisional Broadcast text and relevant Divisional news items free, via email. The easiest way to subscribe and receive the email, is to send a blank email to: [vk7divisionalnews-subscribe@yahoo.com](mailto:vk7divisionalnews-subscribe@yahoo.com)

Once you become a member of the group you can view and search the archived broadcasts. Membership is open to anyone and messages sent to the list are moderated.

### Branch Meetings

#### North

The evening of the 14th of April saw a record roll up to our meeting held at the Launceston TAFE College. The evening's guest speaker was Trevor Briggs, VK7TB who is a former senior lecturer at TAFE. Trevor presented a very educational lecture on electronics and antenna theory fundamentals. Thanks for your informative lecture during the evening. Attending were several of Trevor's former novice class students and a credit they are to you Trevor!

#### South

##### *BPL/PLC Trail in Hobart*

On May 3rd, a group of interested and concerned Southern Branch amateurs attended the Aurora Energy building in Hobart, to hear about the small Broadband over Power Line (BPL) trial that is currently being undertaken by Aurora Energy.

A presentation was given by Piero Peroni, the Business Manager for the BPL trial and Adrian Wild, the Corporate Affairs Manager within Aurora Energy.

After the presentation an open, frank and positive discussion was held where, we as amateurs expressed our concern about BPL technology and Aurora expressed their reasons for trialing the technology. Fortunately, Aurora is happy to keep us informed about developments, futures trials, etc.

We expressed our disappointment in the limited trial that consists of 7 users in a small area serviced by underground cables and they acknowledged the limitations and that this trial is not the decision maker for their BPL business case. They are also investigating

wireless technologies and fibre optics as strategies for delivering the last mile of broadband to consumer and are still assessing the options.

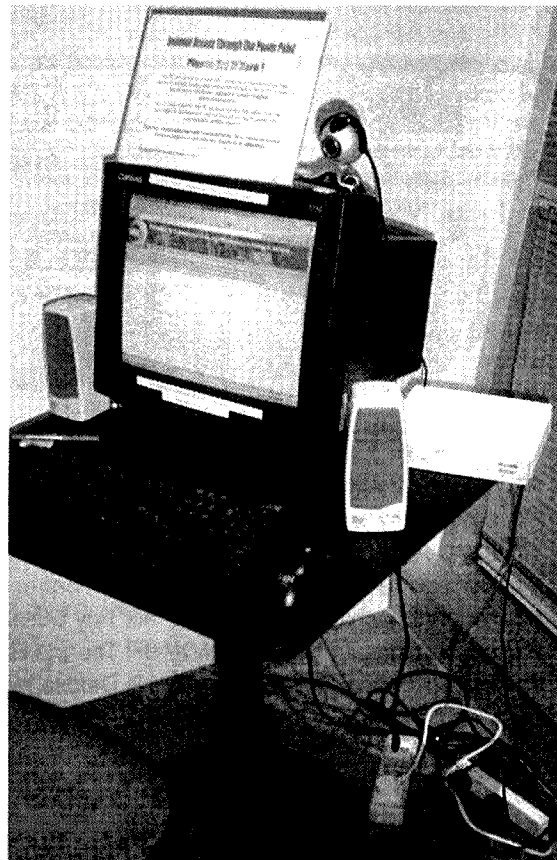

BPL Interface (white box) connecting a PC to the power socket and providing megabits of bandwidth. It brought up the NTIA Report on screen in milliseconds!



We were shown the boxes that connect the PC network card to the power socket and also inside the switch board where there is a distribution/repeater box. Unfortunately we couldn't get a look inside the substation!

Martin, VK7GN gave us an audible demonstration of the horrific interference on his portable HF receiver and I think all present agreed it wasn't good!

Just a reminder for those amateurs in Hobart, please keep your ear out for BPL/PLC type interference on the HF bands and keep a log of the interference that includes time/date/band/strength, and if possible record it.

## Targa Tasmania and Subaru Safari

Targa Tasmania has finished for another year and the 20 WICEN members and friends from across the state made up the eleven teams that provided communications services at 41 locations around the state for the event this year. Jobs included mobile equipment installations, stage repeaters, SOS points and a stage start. Distances travelled by some teams exceeded 1,600kms, including snow covered highland roads on the final day!

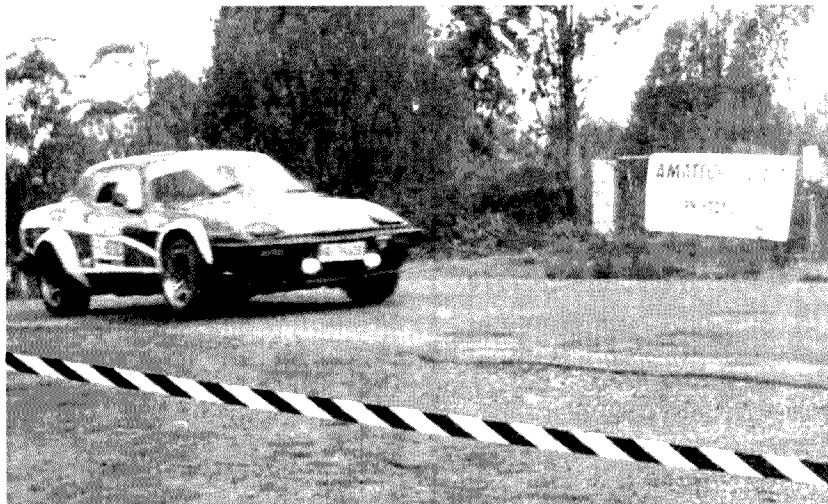

One of the Targa Competitors at the Woodbridge Stage. The WICEN team never losing an opportunity to promote the hobby! Photo courtesy of Roger VK7XRN.

Planning has already started for the next major car rally event that the WICEN team helps with - Subaru Safari. It starts in Hobart on Friday 25th June and then heads into the forests for two days of rallying.

An additional challenge has been presented with a move at short notice from the usual location of the Plenty Valley to the deep Southern Forests

around Geeveston. The WICEN team are looking at integrating internet technologies into the system to get communications back to Rally HQ at the Grand Chancellor hotel in Hobart, maybe with a radio link back-up via Bruny Island. The forest stages are not repeater coverage friendly, so some fancy linking will almost certainly be required.

ar

## Club News

### North East Radio Club

The April meeting of NERC was a talk by Rob Gurr VK5RG, firstly on Sputnik 1 and then on wire antennas. This was well received by all in attendance. We thank Rob for his informative talk. Saturday 17th was the Club's annual Buy and Sell. This was a great success, with lots of equipment and money changing hands. Adrian VK5ZBR won the door prize of a \$50 food and drink voucher from the Bombay Bicycle Club. Congratulations Adrian. The May meeting was a talk by Alex McCallum on the Pedal Prix. This is a cycling endurance event aided by Solar power. More on this next month.

The Club has obtained a supply of old telephones. The main item of interest in these is the LCD display. These are a 2 line, 16 character, large digit display. We will sell the complete phone for \$5. There are many other useful items on the PCBs. This fits with our courses on the Atmel micro controllers. Possible uses for the LCDs are a volts / current display, SWR bridge or a shack clock.

The June meeting will be held on Friday 11th and will be a talk on Computer log keeping. July will be the club AGM. Please consider helping out on the committee if you have the time. Nominations need to be in by the June meeting.

Check the club web site for the latest on meetings and activities. <http://nerc.vk5bbs.ampr.org>

Once again we will be involved with the two Car Rallies in Adelaide. Rally SA over the weekend of July 31st and August 1st, and the Classic Adelaide November 17th to 21st. NERC and many other Clubs and volunteers help out with communications for these events.

NERC meets at the Ardtornish Primary School, Saarinen Ave St Agnes on the 2nd Friday of each month. Doors open at 7.30 pm.

David Clegg  
VK5AMK Secretary

## OZGEAR

### Ozhelph Services

Doug Hunter VK4ADC  
Brisbane

Ph **07 3273 7203**

Fax **07 3272 1000**

sales@ozgear.com.au

# ICOM

- **HF Transceivers** - 7800, 756Pro2, 7400, 706Mk20, 710
- **VHF/UHF Transceivers** - V8000, 200H, 2720H, 910H, V8, T90A
- **Receivers** - R3, R6, R10, R20, R8500, PCR100, PCR1000
- **Accessories** - wide range of options and parts

# YAESU

- **HF Transceivers** - Base & mobile FT-1000MP, 817, 847, 857, 897
- **VHF/UHF Transceivers** - Base, mobile and handhelds FT-1500M, 2800M, 7800R, 8800R, 8900R, VX-1, 2R, 5R, 7R, VX150
- **Receivers** - VR-500, 120D, 5000
- **Accessories** - Yaesu rotators, thrust bearings plus equipment options

**Plus...** OzGear balun kits, **Diamond** HF, VHF & UHF antennas & accessories, **MFJ** & **IDG** tuners, **Autek** antenna measurement, **Dahua** cross-painter SWR meters, **RFI, Mobile One, GME, Scalar** & **TET** Antennas, Coax connectors, cables and hardware from **Andrews, RFI & Benelec**

**With...** More brands available and new products being listed all of the time...

CB, Marine, Airband and Land Mobile equipment and accessories are also available.

**Product not listed above?**  
Phone or email to see if we can help or visit us on the web at <http://www.OzGear.com.au> for the latest product info plus on-line ordering

## Club News

### Geelong Amateur Radio Club (GARC)

The GARC band invasion has commenced! By the time you read this the first monthly GARC band invasion will have occurred. May 23rd was marked as the day that members of the Geelong Amateur Radio Club (GARC) would come up in force in an effort to activate the many listeners. The band chosen on this occasion was 40 meter between 1030 hrs and 1200 hrs. after the various WIA and associated broadcasts. I hope you were lucky enough to work a participating station. If not listen for the next GARC band invasion. Members will invade a selected frequency band from 80 metre through to 70 centimeter once a month or thereabouts.

The club station will be active (VK3ATL a call sign well known on VHF) and stations will be home, portable, and mobile so join in meet some new ops. And there will be recognition of any station contacting 20

or more GARC stations during any 90-minute invasion.

April meetings were again well attended some highlights being an excellent presentation and demonstration by Doug (VK3TRD) from the Bellarine Secondary College of the work done by students in robotics and human powered vehicles and the GIGANTIC white elephant sale. The auctioneer Mike (VK3ASQ) was hard pressed for over two hours (190 lots) to redistribute 30% of the preloved goodies. At least two more sessions will be needed to move the rest, which includes some excellent rigs, parts, cabinets and more. The club also took the opportunity to express our approval of the National WIA plan to the Victorian and Federal bodies by both email and snail mail.

Look forward to meeting many of you on the next GARC band invasion

Dave Godfrey VK3AZX

## Port Macquarie Field Days

**On 12th and 13th of June, Queens Birthday long weekend the Port Macquarie Field Days are on once again.**

Members of the amateur radio fraternity are invited to attend, the venue being at the Sea Scout Hall in Bulla Street, on the Western Side of Kooloonbung Creek next door to the Country Comfort Motor Inn.

Early Arrivals may wish to drop in to register and have a social chit chat or a snack comprising a sausage or steak

sandwich and a can of soft drink, tea or coffee.

There will be two practice Fox Hunts in the afternoon and a 2m talk on Fox Hunts after the evening snack.

Sunday there will be a display by leading suppliers of Amateur Radio Equipment and tables of used Amateur Radio

### Equipment and other items for sale

**Trade Displays, Fox Hunts, Raffles, Disposals, Door Prizes, Prizes for the Best Amateur Radio Vehicle,**

**Barbecue Lunch on the Sunday and Free Tea and Coffee with Fruit Salad and Ice-Cream included in the Registration Fee and Soft Drinks will be on Sale**

**Registration Fee is \$10 for Men \$7 for Ladies and \$5 for School Age Children**

**Contact Details for any queries Bill Brooke VK2ZCW phone 02 65810547, email cabrooke@tsn.cc**

**So come and enjoy the beautiful sights of Port Macquarie and mix with the Local Amateurs of the Oxley Region Amateur Radio Club.**

## Adelaide Hills Amateur Radio Society

The talk given by Jim VK5JST will have inspired a number of members to get busy with their circuits and soldering irons. He showed us just what could be done using Pickaxe chips. These are clearly designed to be used simply. Instead of trying to make things seem as difficult as possible to show off their cleverness, the designers of these chips have gone out of their way to make them cheap, simple to use and to have many applications.

There was an interesting and interested guest at this meeting, Norman M0CRM. He is the vice president of RSGB for his area, a local councillor of long standing and a radio amateur – quite a few ‘hats’ to juggle. He had been contacted by Shirley VK5JSH on Echolink and invited to come to the meeting while he was in Adelaide. In fact I understand he visited several other clubs in VK5 on which he will, no doubt, report when he returns to the UK.

He also attended the AGM of the VK5/8 Division just before his flight, so he will be well and truly up-to-date with VK doings.

At the end of the AHARS meeting Norman presented the club with a plaque to commemorate the occasion. This will be hung where it will be seen

at all future meetings and whenever the club participates in any outside activities. I believe similar plaques will be on show at other club activities. A nice gesture by a pleasant visitor to our shores.

Another activity for AHARS was the removal of the tower for Clem VK5GL. Clem will be very well-known to amateurs for his skill in crystal making and for his achievements in long distance contacts on VHF. He held the first QSO on 2 metre between VK5 and VK6 with Rolo VK6BO back in 1951. This contact was 2164 km, just short of



The AHARS one is of the plaque with the RSGB badge on it, given to the club by Norman M0CRM

the world record of 2253 km. Over the next few years, whenever the weather front was suitable similar contacts across the Bight were made.

Clem has been very active over many years in VK5 on ATV and although the club members (at least 15 turned up!!) have now removed Clem's tower and all the DX and VHF/UHF beams from the tower, he has still retained his verticals, so he will still be in touch and be able to watch ATV, as usual. Listen out for him, he would love a contact.

Christine Taylor VK5CTY

## Waverley Amateur Radio Society Annual Club Auction

The club will be holding its annual auction on Saturday, June 19th at the clubhouse in Vickery Avenue, Rose Bay, Sydney. Gates open 8:30 and the sale starts at 10:30. Goods consist of useful ham radio, computer and electronic gear and it is open to all wishing to buy or sell. Full details are available on the club's web site at [www.vk2bv.org](http://www.vk2bv.org) or by phone from Simon VK2UA, on 02 9328 7141.

## GippsTech Ladies' Program

Pauline Corrigan

### Ladies, it's the time for me to plan our days.

My name is Pauline Corrigan and I organise a tour of the Gippsland area for the wives who accompany their husbands to GippsTech every year.

As our group grows every year and husbands joke about coming too, I believe it is an important aspect of GippsTech.

Well this year is coming up fast, and plans are well in hand for our tour. I don't think Mike will decline the offer to be our driver as he appeared to enjoy our company last year, although we may need a bigger bus due to the popularity of our group. So ladies, please if you could let me know in advance that

would be excellent. My email is [tcorrigan@vic.australis.com.au](mailto:tcorrigan@vic.australis.com.au) Last year we had a full bus.

Also is there anything else YOU would like to see or do. I thought you might like to do a visit to Rosedale on the Sunday, as there are a lot more interesting shops now, and Wendy T's serve a lovely morning tea. Also Sunday market. Anyway I am open to suggestions, so let me know what you would like and I will attempt to provide the best time yet. It will be good to catch up with you all, and some new faces too.



Last year's happy throng

Let's hope the weather is nice to us. I'll try to book any rain for Monday.

Okay. Hope to see you for tea at the top pub on Friday night. For the campers I have spoken to the council re caravan parks, so hope for positive feedback this year..... See you soon

## Interesting new projects scheduled for ISS

Development of the ARISS systems has been more or less put on hold until the resumption of the Space Shuttle flights, hopefully in 2005. This does not mean that things are stagnant however. Planning continues apace. It has been reported recently that a meeting of the International ARISS committee at the European Space Agency in the Netherlands has given a starting approval for two new projects involving amateur radio on the International Space Station. The first is a Russian project called "Shadow". It is an experiment that is designed to test the possible ill effects on radio signals of a plasma propulsion unit. The outcome of this experiment could be influential in the

future planning of plasma propulsion systems on deep space probes. If the plasma units are shown to have deleterious effects on radio communications it could mean a total re-design of the systems which are being touted as the way to the future for deep space exploration. Hopefully amateurs will be able to contribute through the collection of telemetry data from the experimental package. The "Shadow" project is fully explained on the web site of the Russian Central Research Institute for Machine Building at: [http://www.tsniimash.ru/Shadow/default\\_eng.htm](http://www.tsniimash.ru/Shadow/default_eng.htm)

You can register your interest in the project at the site. The second project

involves the installation of a number of colour, fast-scan digital TV cameras on the exterior of ISS. The cameras will be capable of panning, tilting and zooming and will be controllable from a satellite ground station. This system will be coordinated in the UK. No information is yet available on the frequencies to be used for transmitting the TV pictures to earth. The encoding arrangements and the development of suitable specialised software for control of the TV camera(s) will be undertaken in the next stage of planning. Satellite users who have ground systems already operating on 70 cm and 23 cm will be ideally placed to take part in both these experiments.

## Good news on VUSAT

Here is a clip from a message sent to the AMSAT-BB by William PE1RAH who was responsible for designing and building one of the mode-U/V transponder to fly on VUSAT.

"I just wanted to let the AMSAT-world know that testing has been resumed to get VUSAT 100% working and ready for launch. During the final testing last year

some minor problems were found and the satellite could not be launched. I am back at ISRO in Bangalore to help with testing and to get the satellite in best shape for its launch summer this year. I cannot give any technical details and date of launch, but I want the AMSAT world to know that in the background a lot of work is in progress. The satellite

will give hams two new linear mode-U/V transponders in an 800 km LEO orbit. 73 de VU/PE1RAH William Leijenaar in Bangalore, India".

VUosat or "Hamsat", as it is also known, will provide a most welcome boost to the fleet of satellites available for amateurs when it is launched later this year (hopefully).

## The AMSAT group in Australia.

The National Co-ordinator of AMSAT-VK is Graham Ratcliff VK5AGR. No formal application is necessary for membership and no membership fees apply. Graham maintains an e-mail mailing list for breaking news and such things as software releases. Members use the AMSAT-Australia HF net as a forum.

### AMSAT-Australia HF net.

The net meets formally on the second Sunday evening of the month. In winter (end of March until the end of October) the net meets on 3.685 MHz at 1000 UTC with early check-ins at 0945 UTC. In summer (end of October until end of March) the net meets on 7.068 MHz at 0900 UTC with early check-ins at 0845 UTC. All communication regarding AMSAT-Australia matters can be addressed to:

AMSAT-VK,  
9 Homer Rd,  
Clarence Park, SA. 6034  
Graham's e-mail address is:  
[vk5agr@amsat.org](mailto:vk5agr@amsat.org)

## Coping with extreme Doppler shift

We may have to review our traditional methods of coping with Doppler shift variations when working with amateur radio satellites in the future. As transponder frequencies move ever higher to escape interference from non-amateur services we will be faced with a very different situation to that existing with the lower VHF/UHF modes.

In the early days of 10 metre downlinks Doppler shift would amount to just a few kilohertz during a satellite pass. The maximum rate of change, around the time of closest approach was relatively easy to counteract and signals were easy to keep in tune. Seventy centimetre downlinks introduced a situation where one had to be more attentive when conducting a satellite contact. Total Doppler shift variation amounted to 10 or more kHz and it made tuning that much more difficult.

With the advent of high orbit satellites

like AO-10/13 many operators chose to limit their operating times to a period around apogee when the relative velocity of the satellite and your station made the Doppler variations easier to control. Indeed downlinks like modes "L" and "S" were scheduled "on" only around apogee to help this situation along. Mode "S" on a LEO is quite a difficult problem. You can see for yourself just how difficult by tuning your "S" mode receiver to the beacon on UO-11, which is still providing a weak signal source for those wishing to "tweak", their "S" mode apparatus.

The rate of change of Doppler is quite savage and would make the manual tuning of SSB signals impossible around close approach. It's even a challenge to maintain "zero-beat" when you first hear the beacon signal. The beacon is rather weak now but I can remember standing at my back door, holding up a 2.4 GHz

## Technical Correspondence re "A Simple TV-aligned crystal frequency reference", AR April 2004.

An astute reader has pointed out that; for the device to produce strong harmonics through VHF, the 4060 CMOS chip must be of the fast variety, such as a prefix HC or HCT4060. That used in the prototype is a Philips HEF4060BP, which was purchased from Electronic World. An ordinary CD4060 may not do the job.

Bill Roper VK3BR

## Publishing exam questions? (a)

If I navigated my way correctly through the circumlocution, Neil Trainor VK3IJ is suggesting we should publish the Amateur exam question banks ("Amateur Licence Exams - I had a dream", Over to you, April 2004.) Are we becoming so desperate for new blood that we want to make Amateur licences available to those too lazy to learn the basic theory, in favour of rote learning a

predefined list of questions and answers?

It seems like only yesterday that we removed the Morse test requirement, certain that it was killing the hobby; now we want to dumb it down by removing the need to learn any theory as well? Neil's "food for thought" is giving me indigestion!

By all means issue sample papers that allow prospective amateurs to become familiar with the *style* of the exams they will face, but let's leave the parrot-style shortcuts to others. After all, does anyone not interested in learning even the basics of radio theory really deserve to call themselves a Radio Amateur?

## Publishing exam questions? (b)

Since submitting my original letter, I came across an article by John Portune W6NBC, entitled *Is Your Club's Amateur Radio License Class Efficient?* which had appeared briefly on the ARRL web site, but which was removed after a few days. The article subsequently appeared on the FCC web site, at <http://gullfoss2.fcc.gov/>

[prod/ecfs/retrieve.cgi?native\\_or\\_pdf=pdf&id\\_document=6516089602](http://prod/ecfs/retrieve.cgi?native_or_pdf=pdf&id_document=6516089602) (or email me at [rmurnane.1@optusnet.com.au](mailto:rmurnane.1@optusnet.com.au) for a copy.)

The article details the "work" of W6NBC, who achieves an 85% pass rate on his one-day Amateur licensing course, not by teaching anything about Amateur Radio (he openly admits that he doesn't even try). Rather, his "students" cram the published question and answer pools for six hours and are then given the exams before they have a chance to forget what they have "learned." More details can be found at [www.w6nbc.com](http://www.w6nbc.com).

The article at the FCC site is prefixed by the comment, *The following article is proof that the practice of releasing the test pool is a huge mistake ... The testing system is a farce.* While it is not clear whose opinion within the FCC is being expressed here, it's plain that parrot-learning question pools does nothing to improve the image of Amateur Radio in government circles.

73 Richard Murnane VK2SKY

Views expressed in the 'Over to you' column are those of the authors, and do not necessarily reflect the policies of the Wireless Institute of Australia.

Send contributions to:

The Editor, Amateur Radio Magazine, 34 Hawker Crescent, Elizabeth East SA 5112 or email: [edarmag@chariot.net.au](mailto:edarmag@chariot.net.au)

## AMSAT continued

converter above my head with a 3.5 cm long piece of wire plugged into the "N" connector. The beacon was loud enough then to hear the signal nearly all the way across the sky on an overhead pass. Clearly something will need to be done in the future, as transponder downlink frequencies are forced higher by circumstances beyond our control. Several auto-tune solutions are available but it behoves us to gain our experience

with these right here and now and not wait until we are confronted with a fleet of satellites that present a seemingly insurmountable problem.

A check of the AMSAT-NA web site and its links will reveal a number of systems to try and these should enable us to cope with most 2.4 GHz situations. Those operators contemplating a new radio should check the specs to see if they are compatible with the software

or hardware approaches to this problem. Features like access to the radio's CPU and the degree of control over the "mic-click" increments can impact on your decision. An excursion into the 5 or 10 GHz bands (or even higher) will mean that even they are inadequate and a reversion to wideband modes and the introduction of exotic techniques may be the order of the day in the future.

## AMSAT Phase 3E on track

Things are still moving along nicely with the planning of P3E at AMSAT-DL. The AMSAT-Phase 3E satellite (P3E) is dedicated as a communication and scientific platform for a highly elliptical orbit around Earth. The spacecraft will be created in a joint process together with the P5A Mars mission by an international team under leadership of AMSAT-DL and continues the successful series of AMSAT-Phase 3

satellites. Additionally the spacecraft will be a test bench for technology developed for the Mars mission.

The main task of P3E is to act as communication platform for radio amateurs worldwide. A launch is planned in the period 2004 to 2006. P3E will look rather like the AO-10/13 satellites in that it is being planned around the triangular platform pioneered in those satellites. Its many

features are too numerous to detail in this column but you can see it all laid out on the AMSAT-DL web site. It will be a high orbiter like AO-10/13 but it will have a different kick motor. There will be transponders and beacons right through the range we have come to expect. The drive to complete this satellite is coming from AMSAT-DL's planned Mars mission, P5A and much of its technology will be tested on P3E.

ar

# Spotlight on SWLing

Robin L. Harwood VK7RH

Winter has certainly arrived with a vengeance here in northern Tasmania, which means I am spending more time indoors, listening to daytime propagation. One thing is noticeable, the buzzing noise that has plagued my listening ever since I moved in here, has disappeared. It looks as if the likely culprit was my next door neighbour's TV set, probably the switch-mode power supply. She died a few weeks ago and the offending TV set has been removed and the noise has also departed.

There has been a lot of comment about broadband Internet via Powerlines, (BPL) particularly within the USA. Elsewhere you will read that our sole electricity supplier here in Tasmania has been conducting experiments within their headquarters and in a street within Battery Point, adjacent to the office.

I believe the Southern Branch of the WIA recently inspected the experiment and you can find out the results elsewhere. However I do notice that the normal line noise here seems to resonate on certain frequencies, but I think has more to do with the impedance of my temporary antenna that the actual power wires in the street.

Radio Slovakia was originally scheduled to cease shortwave broadcasting on the first of May, but then it was announced that it would cease in July. Then the Media committee of the Slovak Parliament weighed in and stated that it was not a good idea to stop shortwave transmissions on the first day Slovakia became a full member of the European Union (EU).

The confusion continues regarding Kol Israel's shortwave transmissions. Most of us have heard it all before that Jerusalem will leave HF completely. This seemed to happen one day but it turned out to be one of the labour disputes that often happens within the Israeli public sector. I personally think Kol Israel will continue over shortwave.

I notice that at 1100 UTC, there is a broadcaster on 9408 kHz in an Asian language and the Far Eastern Broadcasting service from either Saipan or the Philippines on 9405 in Chinese. It certainly is an unusual channel 9408 and I wonder is it because Merlin is

testing DRM on 9410 from a site in the UK. DRM does indeed need a wider than normal channel and it was originally proposed that transmissions in the digital mode would be on channels well away from the normal analogue senders. Incidentally DRM receivers are still not readily available, although I have seen that they might be at the end of this year on in the middle of 2005.

"VOA News Now" can be heard to East Asia on the VOA at 2200 UTC, although the VOA no longer targets Australasia. Radio New Zealand International is now on 15720 from 2200 to 0459. I did hear a station on 9515 kHz at 1150 with selections from Opera and identifying as "China Business Radio" in English and Chinese. This apparently is the normal domestic network.

On 30th June, Iraq is scheduled to regain their sovereignty from the Coalition Provisional Authority, although coalition troops will remain there to supervise security. I would expect that eventually we could hear Iraq return broadcasting via shortwave, particularly to the region. Incidentally the American sponsored "Radio Free Iraq" disappeared from shortwave on 24th April.

The Olympic Games commence on 13th August in Athens, Greece and this will be extensively covered over shortwave from a variety of broadcasters. Look out for special programming.

I am hearing a broadcasting station on 9330 at 2145 on Lower sideband (LSB) with reduced carrier with an assortment of religious and political programming. It identifies as WBCQ "the Planet" from Monticello Maine.

There is a rumour on the Net that Sony may be discontinuing manufacturing shortwave receivers. This does not seem to be correct as Sony is involved with the development of DRM receivers. Shortwave analogue transmissions will continue for some time, especially to Africa and Asia, although programming hours have been slashed to Europe, the Americas and Australasia.

Well that is all for this month. Don't forget you can email me <mailto:vk7rh@wia.org.au>

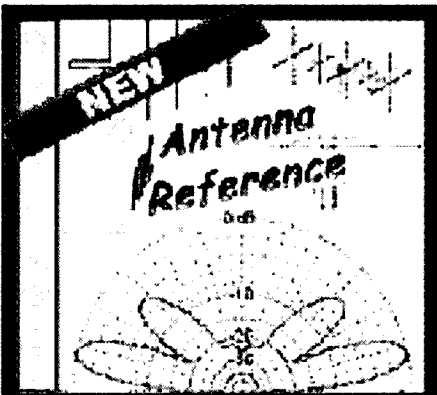

**Antenna Reference CD**

Antenna basics, Radiation patterns, Transmission lines, Impedance matching, Built-in calculators and more!

**Only A\$35.00 (approx US\$25.00)**

**ENQUIRIES WELCOME**

Discounts for upgrades & club members

**Michael Todd Computers & Communications**

15 Conifer Street, Madingleton  
Western Australia 6109  
Ph: 0407-089-308  
E-mail: [sales@arc.com.au](mailto:sales@arc.com.au)  
<http://www.arc.com.au>

**Low Loss 50 Ω**

**For 2.4 GHz (WIFI) & Ham Radio**

Type	CFD-200	CFD-400
ØØ (mm)	5	10
dB/m @ 1.50 MHz	0.130	0.050
2400 MHz	0.550	0.220
\$/m	\$2.50 (\$1.50 *)	\$4.00 (\$2.00 *)
N-Type	\$7.00 (\$3.00 *)	\$7.00 (\$4.00 *)
RFSMA or RG7MC	\$10.00 (\$5.00 *)	n/a
Features	email	

\* = bulk price

Web: [www.freeantennas.com](http://www.freeantennas.com)  
Email: [sales@freeantennas.com](mailto:sales@freeantennas.com)  
Tel: +61 (8) 9310 1720

## Contest Calendar June – August 2004

5	June	VK/trans-Tesman Contest <i>see Web Site</i>	(CW)
12/13	June	ANARTS Contest	(RTTY)
12	June	Portugal Day DX Contest	(SSB)
12	June	Asia-Pacific Sprint Contest	(SSB)
19/20	June	All Asian DX Contest	(CW)
26/27	June	Marconi Memorial Contest	(CW)
26/27	June	King of Spain Contest	(SSB)
3	July	Jack Files Contest	(CW/SSB)
11/12		IARU HF World Championship	(CW/SSB)
17	July	VK/trans-Tasman 160 metre Contest	(CW/SSB)
17	July	Colombian Independence Day Contest	(CW/SSB/RTTY)
24/25	July	Russian RTTY Contest	
24/25		RSGB IOTA Contest	
8/9	Aug	Worked All Europe DX Contest	(CW)
14/15	Aug	RD Contest	(CW/SSB/FM)
21/22	Aug	TOEC WW Grid Contest	(CW)
28/29	Aug	SCC RTTY Championship	(RTTY)
28/29	Aug	YO DX HF Contest	(CW/SSB)
28/29	Aug	ALARA Contest	(CW/SSB)

### Greetings to all readers

### Manners maketh the Man?

When I was growing up my parents and the school would present us with sayings or adages from time-to-time. At first these seemed strange, such as the one above, because of the unusual wording. However, we were told that they were sayings that would help to guide our thinking and actions as we matured. After a while the wording was not all that strange, because it was obvious what the words meant; it was just that the second person singular of verbs had gone out of use; but this did not seriously detract from the *meaning* of the word and the sentence.

I quote the above adage because (a) the purpose of such sayings has not changed, just that they may have dropped out of current usage; (b) a lack of manners in any aspect of life quickly makes itself evident and tends to induce a negative attitude toward the person/s exhibiting the bad manners.

As I wrote in this column recently, by all means devise techniques to get your

signal across and log that extra station, but please not at the expense of you being regarded as showing no manners or concern for others also trying to call that station.

Recently in the John Moyle Field Day Contest I heard and worked on several VHF bands a club station in an outer area of Melbourne. On the one hand I was delighted to know that my signal was travelling across a large city (this is part of the function of a contest to test the efficiency of one's station), but I was far from happy about the method of calling employed by the station in question. In subsequent weeks some other hams commented that they thought xxxxxx "should learn some manners".

This is sad and need not be.

There is, I believe, a fine line between being motivated to do well and even being determined to achieve your end versus being bull-headed and giving the wrong impression to those listening.

Any activity has its code of practice, and AR contests are no exception; but the philosophy of "if you don't like the rules, then get in there and change them" will not bring about your wish to do things your way without a good deal of antagonism being created among your colleagues. Worse still would be the idea of just barging in without any knowledge of the accepted protocol for that activity.

Please let us not lose our good name as amateur radio operators just because of a few changes in the rules governing the hobby. Please let us not forget that it is only a hobby, but courtesy and a continuation of time-honoured practices in conducting QSOs, whether in contests or in general, still are the mark of a well-balanced, concerned operator. This is known as "self-regulation" and is a duty of all of us. This way, we shall all continue to enjoy our hobby and help the less-experienced to come into our ranks too.

*Continued next page*

# Beyond our shores

David A. Pilley VK2AYD  
davpll@midcoast.com.au

## Iraq

A widely publicized email from Laith Adhary YI1SRA in Baghdad asks the world's radio amateurs for support in keeping ham radio a part of a new Iraq. This, as the June 30th date for handover of the government to local authorities approaches.

Adhary is a member of the Iraqi Association for Radio Amateurs and works at the University in Baghdad. He says that it is urgent that Iraq establishes a viable ham radio program in the country before the shift of governing takes place.

To accomplish this, Laith and Iraqi Association for Radio Amateurs President Diya Sayah, YI1DZ, are asking hams around the globe and their national societies to send a letter of support for the future of the hobby in Iraq. Both men indicate that this is a time-sensitive issue and request support right away.

The best way to make sure your letter of support arrives is to send it by email. We have two addresses. Sayah can be reached at yi1dz@hotmail.com and Adhary is at laithtariq@yahoo.com.

(ARNewsline 16/4)

## Jordan

Robin Bellerby GM3ZYE is in the early stages of planning an amateur radio trip to Jordan. The excursion will take place either in May or September of 2005 and will be mainly - but not exclusively - for members of the United Kingdom's Royal Signals, Royal Naval, and Royal Air Force Amateur Radio Societies. Between 20 and 60 people are expected to make the trip.

(GB2RS)

## CONTESTS *continued*

### Remembrance Day Contest

As I write these notes I am aware that it will not be all that long until this year's Remembrance Day (RD) Contest. I hope that now you will all start to check your stations ready for the "big night".

I have also heard that there may have been a delay in the issuing of certificates for last year, 2003. I am attempting to learn what has happened here and hope

## Kenya

Ted Alleyne 5Z4NU, the Chairman and Secretary of the Amateur Radio Society of Kenya ARSK, has informed P29KFS that the Communications Commission of Kenya (CCK) announced on 2nd April a new and more relaxed policy towards amateur radio licensing. "Until now it was 'practically impossible' for most visitors to obtain an amateur radio licence in Kenya. All applicants' countries must have diplomatic relations with Kenya, at any level. The previous stumbling blocks for reciprocal agreements, Security and Police vetting, have been dropped entirely. Ted says that the ARSK will be happy to supply the new licence application forms and further information will be published on the ARSK website as soon as possible". CCK will verify all licences with the originating office by email.

Applicants must complete the new form on the CCK website [www.cck.go.ke](http://www.cck.go.ke) and submit photocopies of the licence and passport certified by a Commissioner for Oaths - no other will do. The fee is still K.Shs.3,000, about US\$39 at present. Details on ARKS website at [www.qsl.net/arsk](http://www.qsl.net/arsk) It has been a 14 year battle to achieve this, and the relief is terrific! You can operate within weeks, not the 18 months to 5 years plus which was quite common. And Morse has also been dropped as a requirement. The rules are being brought up to date and documentation revised.

(Qnews 15/4)

## U.A.E.

Kenya may have eased restrictions but in the UAE they still only license UAE nationals. Several US and European hams have tried to obtain a licence but that was in vain. Many travelers in the region hope that one day things get a little bit easier regarding the issuance of ham licences but most have given up hope.

(Qnews 15/4)

## Ham Radio For Dummies

Yes it has arrived!

We've all seen the famous yellow books such as DOS for Dummies, Windows for Dummies, etc. Well now we have *Ham Radio For Dummies* written by Ward Silver N0ZAX. *Ham Radio For Dummies* extols the belief that hams do cool things like talking to folk around the world and helping with communications in emergencies. An ideal gift to give your neighbour who wonders about your tri-band yagi and why it rotates. Or of course, perhaps more important, a gift to yourself. On sale in the USA, no doubt the bookstalls in Australia will soon have copies available. More information can be obtained from [www.rainreport.com](http://www.rainreport.com).

(ARNewsline)

## Rodrigues Island

Is Amateur Radio really on the decline?

The Rodrigues Island DXpedition topped 150,000 contacts before closing down on April 12. For their most excellent effort they received the ARRL Colvin Award. If you were one of the many VKs that worked 3B9C you may like to check out their web site at <<http://www.fsdxa.com/3b9c/online-logs.html>>. This DXpedition was sponsored by the Five Star DXers Association (FSDXA), with assistance from many others. QSL direct to FSDXA, PO Box 73, Church Stretton SY6 6WF UK or via the RSGB QSL Bureau. Much more information plus a form to request bureau cards is available on the 3B9C Web page <<http://www.fsdxa.com/3b9c>>.

(ARRL N/L)

ar

## Result Jock White Memorial Field Day 2004

VK section 1st VK2LCD 83 points



## Easy to build 50:300 ohm and 50:450 ohm transformers

Simple wire antennas often have high resistive impedances, typically from 200 to 500 ohm. It is desirable to match these impedances to 50 ohm to take advantage of the convenience of 50 ohm coaxial cable.

Zack Lau, W1VT, in his RF column in QEX for Jan/Feb 2003 describes the design, construction and testing of such transformers.

If an impedance transformation as described above is required over a wide frequency range, a popular solution is to use a transformer with a ferrite core. The high permeability of ferrite allows less wire to be used for a given inductance, increasing the transformer bandwidth. However, increasing the permeability too far results in excessive loss. A balance needs to be struck for best performance. As transformers for 50:200 ohm are relatively common, the description here is for a 50:300 or 450 ohm transformer.

Other important characteristics of any transformer are its power handling capacity and loss. Both of these characteristics will result in core

heating. If the core gets hot enough, its impedance will change, but it may be cooked in the process. The impedance change is easily detected as a slow rise in VSWR. Some cores will not survive this abuse. Their permeability may be permanently changed and the VSWR will not return to normal.

Figure 6 shows a broadband HF design. It has 9 trifilar turns of #22 AWG, PVC covered wire on an FT-140-61 core. It is tapped five turns from the high impedance output to provide transformations to both 300 and 450 ohm. The return loss is better than 16 dB from 3.5 to 30 MHz (1.4:1 VSWR). The return loss for a pair of back to back 50:450 ohm transformers at 30 MHz is just 0.33 dB. One method of calculating the toroid power rating is based on surface area and allowable temperature rise. For a 25 degree temperature rise a properly matched transformer as described above should be able to handle 45 W

A smaller transformer design uses 10 trifilar turns of 22 gauge PVC covered wire on an FT-114-61 core. The tap for

the 300 ohm connection is 6 turns from the output. It has better than 19dB return loss from 7 to 30 MHz (1.25:1 VSWR) and 12.5 dB return loss at 3.5 MHz. The worst case insertion loss was at 3.5 MHz: 0.6 dB for a pair of 50:450 ohm transformers back to back.

Both designs are intended to be used with a 1:1 choke balun. A design that works well from 1.8 to 54 MHz is 16 turns of RG-58C on an FT-240-43 core.

The cores are wound with ordinary PVC hookup wire. The outer diameter of the #22 AWG wire is 0.058 inches, the #20 AWG measured 0.062 inches. The thickness of the insulation is important as it helps determine the impedance of the windings. Thicker insulation spaces the windings more, raising the impedance. Conversely, you can use thinner insulation for lower impedance windings. A recommended winding method involves winding and labelling each wire, one at a time. Assuming the labels don't fall off, it is then relatively easy to connect the windings in phase.

Once built, the transformers should be tested with an antenna analyser to measure VSWR. Suitable value carbon resistors can be used as the high impedance loads. The VSWR should be low from 3.5 to 30 MHz. A 4 or 5:1 VSWR usually means that the wrong tap point has been chosen for the 50 ohm input. If the optimum frequency range is too high, you need to add turns. If it is too low, remove turns.

You can measure insertion loss by hooking two transformers back to back, terminating them into a 50 ohm dummy load and measuring the power lost in the pair.

## Correction

to Figure 3, page 25 May AR - An RF bridge for antenna measurements

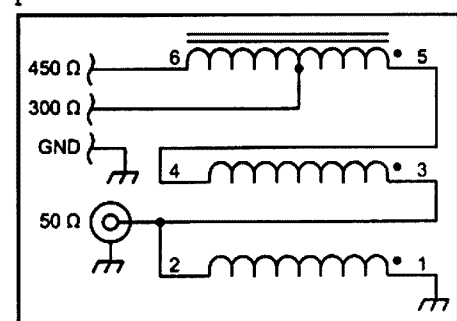
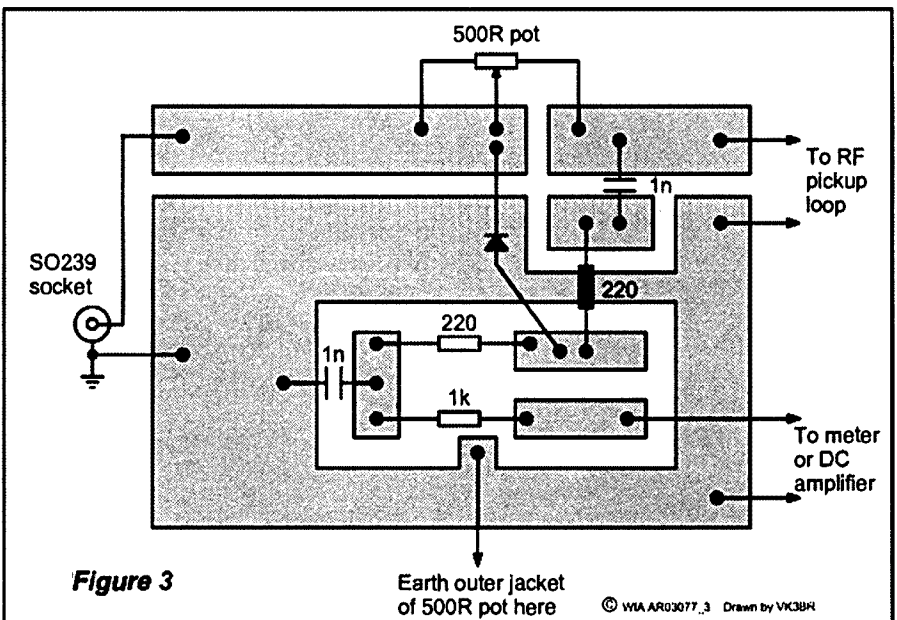

Figure 6 - Schematic of the matching transformer

# Know your second-hand equipment

Ron Fisher VK3OM.

ronlyn@nex.net.au. Phone 035944 3019.

This month I intend to look at a couple of popular transceivers, again from the Kenwood stable. The TS-120V/S and its later incarnation the TS-130V/S. But before going into detail I want to thank those readers who have been in touch with me. I have noted your suggestions and will act on them as soon as possible. By the way, don't think that I am only going to look at Kenwood. I have plans to discuss a couple of Yaesu models in the next instalment, so stand by.



Photo 1 - A TS-120V with matching PS-20 power supply.

thing to have. The "V" versions were not fitted with fans, which were not required with the lower power output.

Operating features included an illuminated "S" meter switchable from ALC to RF output on the "V" version or ALC to final current on the "S" version when in transmit mode. A very effective IF shift control gives excellent rejection against close-in interference. The RIT control gives a +/- shift of 2 kHz and has a red LED indicator to show when it is in use. There are separate RF and audio gain controls. One nice feature is that there is no frequency shift when changing sidebands. Quite a few contemporary transceivers required a retune of about 3 kHz when changing sidebands.

## Now to the differences

The TS-120 only covered the old HF allocations from 80 to ten metre, whereas the TS-130 has those plus the WARC bands of 10, 18 and 24 MHz. Both, by the way, have a band-switch position for reception of WWV on 15 MHz, which is handy to check the calibration of the digital read-out. The TS-130 added a speech processor. This was a fairly simple audio compressor,

Please note that I am always happy to give my opinions on equipment either via email or on the phone. I prefer the phone, as it's easier to exchange ideas. My phone number is listed above. I am also happy to make skeds on any HF or VHF frequency. It's up to you.

## The Kenwood TS-120 and TS-130 HF transceivers

As you can see from the illustrations, the two models look very much alike. So let's firstly look at what they have in common. They both come in two versions. The "S" runs 100 watt output, the "V" being the low power version with about 15 watt output. From this, you might think that the "S" version would be worth quite a bit more. Not so. The "V" versions are very popular with low power operators and often sell at a premium, particularly if they are in mint condition.

They require a 13.8 volt power supply with a four amp rating for the low power version and a twenty amp rating for the 100 watt model. Kenwood did produce matching power supplies for each, the PS-30 with 20 amp output and the PS20 with 4.5 amp output. They have both an analogue and a very clear digital frequency readout. This puts them in a

class above the TS-520 that we discussed last time. They also have fully solid state final amplifiers, which require no tuning but do require a 50 ohm load with a low VSWR.

From the front, the "S" and "V" of both versions look identical but the rear tells the difference with the "S" sporting a very heavy heat sink and a cooling fan. However, a word of warning. A version of the TS-130S, labelled the TS-130SE, did not include a fan as standard. These are not very common, but a few do pop up from time to time. Some were later fitted with fans as an option but watch out. The fan is definitely a desirable



Photo 2 - A TS-130SE.

## Second-hand equipment *continued*

not up with the later RF clippers but nonetheless useful to have. It also had provision to install a narrow CW filter with front panel wide/narrow switching. Both models were fitted with an effective noise blanker and a receiver front end RF attenuator.

### A few points to note

Both models have analogue VFOs so, of course, they do drift from switch on. However Kenwood VFOs were well designed and, after a 15 minute warm up, drift should not be a great problem. Expect to see around 300 Hz drift over the first twenty minutes. Even some of the early synthesised transceivers were not completely stable. Early versions of the TS-120 had a few problems with instability in the RF driver and final stages; however, these problems should have been long fixed.

Watch that the meter and dial lights

are working. It takes quite a while to replace them.

### What are they worth?

Now down to the nitty gritty. What are they worth? First keep in mind that these transceivers are getting on to twenty five years old and some are now in deplorable condition. However, they were well built, so even rusty and battered versions might still be working fine.

I have seen battered TS120-S transceivers sell for under \$200, but for one in excellent condition expect to pay around \$275. For a TS-130S in very good condition expect to pay around \$300 to \$325. As mentioned earlier, a "V" version might sell for around the same figure. Overall condition is really the determining factor.

Several optional accessories were produced and these include an external

VFO to allow split operation. This is the VFO-120. There was also a matching speaker, the SP-120, and two sets of headphones, the HS4 and the HS-5. A mobile mounting bracket, the MB-100, helped out with mounting the transceiver in the car. The supplied hand microphone was the MC-35S, a 50 kilohm unit with a selectable noise cancelling feature. Perhaps the most interesting of the options was the DFC-230. This allowed remote operation of the TS-130. These are scarce and not easily found.

These really are very nice little rigs, usable at home, mobile or portable. They have excellent receivers and the transmitters are capable of producing very good quality audio, particularly if you can find an MC-50 microphone to go with it.

Good luck with your hunting on the second-hand market. More in a couple of months.

ar

# G&C COMMUNICATIONS

Authorised dealer for ● Kenwood ● Icom ● Barrett RFDS ● GME Electrophone ● Uniden ● YAESU

## KENWOOD TH-F7E

Amateur VHF/UHF Transceiver

Freq: TX: 144-146 / 430-440 MHz  
RX: 0.1-1300 MHz  
Mode: TX: FM RX: AM/FM/SSB/CW  
RF Power output: Hi: 5/5 W  
Lo: 0.5/0.5 W Et: 50/50 mW  
Volt: Int: 5-7.5 VDC External: 12-16  
Weight: 250 gr (inc lith-ion batt. pack)



## ICOM IC-208 Amateur VHF/UHF Transceiver

Freq: TX: 144-146 / 430-440 MHz  
RX: 118-1000 MHz  
Mode: TX: FM RX: AM/FM  
RF Power output:  
Hi: 50 / 50 W. Mid: 15 / 15 W.  
Low: 5 / 5 W  
Voltage: 13.8 VDC  
Weight: 1.2 Kg



## IC-706 MkII Amateur HF/VHF Transceiver

Freq: TX: 10-160 m + WARC / 50-54 / 144-146 (148) MHz  
Europe (USA) RX: 0.03-200 MHz all-mode incl WFM  
Mode: AM/FM/SSB/CW/RTTY  
RF Power output: 100/100/20 W

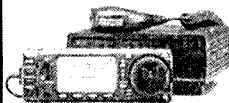

Most popular mono/tri-banders  
TE series EMTRON HF ANTENNAS  
Storm tested — Call

## YAESU

VX-7R 5 W Ultra-Rugged, Submersible Tri-Band Magnesium Handheld

Freq: RX: 0.5 - 999 MHz  
TX: 50, 144, 430 MHz Amateur Bds  
True Dual Receive: V-V/U-U/V-U/  
GEN-HAM  
Power Output: 5 Watts 222 MHz: 300 mW) 6 m AM: 1 W. MANY GREAT FEATURES

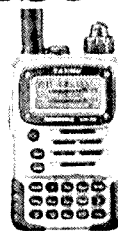

## Antenna Tuners MFJ 945E — MFJ949E

The auto MFJ 993



and the amazing MFJ 902 Travel Tuner



## ROTATORS G450A (shown) G650C, G800DXA

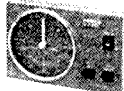

Australia wide orders welcome  
Credit card Cheque Money order

207 High St. Cranbourne VIC 3977  
Ph: 03 5996 3298 Fax: 03 5995 0184

Email: [gccomm@netspace.net.au](mailto:gccomm@netspace.net.au)  
[www.gccomm.com.au](http://www.gccomm.com.au)

**Adelaide-Anchorage****30****Brisbane-Berne****316**

First F 0-5 Short 12466 km

First F 0-5 Short 16321 km

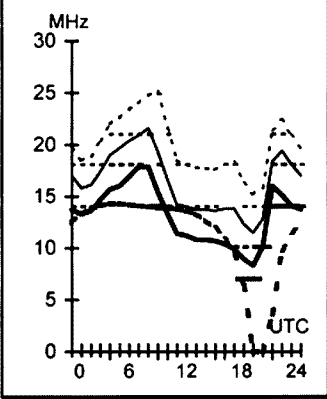
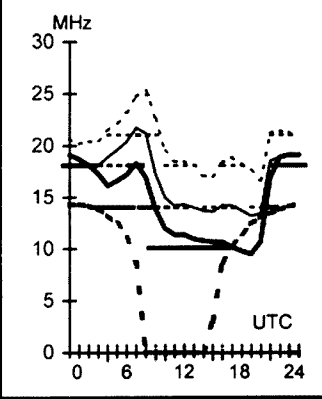
**June 2004**

T index: 40

**Legend**

Frequency scale

- UD
- - - E-MUF
- OWF
- F-MUF
- ALF
- >10%
- >50%
- >90%

Time Scale

**HF Predictions**

by Evan Jarman VK3ANI  
34 Alandale Court Blackburn Vic 3130

These graphs show the predicted diurnal variation of key frequencies for the nominated circuits.

These frequencies as identified in the legend are:-

- Upper Decile (F-layer)
- F-layer Maximum Usable Frequency
- E-layer Maximum Usable Frequency
- Optimum Working Frequency (F-layer)
- Absorption Limiting Frequency (D region)

Shown hourly are the highest frequency amateur bands in ranges between these key frequencies, when usable. The path, propagation mode and Australian terminal bearing are also given for each circuit.

These predictions were made with the Ionospheric Prediction Service program: ASAPS Version 4

**Adelaide-Dakar****233****Brisbane-Los Angeles****59****Canberra-London****136****Darwin-Capetown****321**

First F 0-5 Short 16724 km

Second 4F3-6 4E0 Short 11564 km

First F 0-5 Long 23042 km

Second 4F3-4 4E0 Short 11221 km

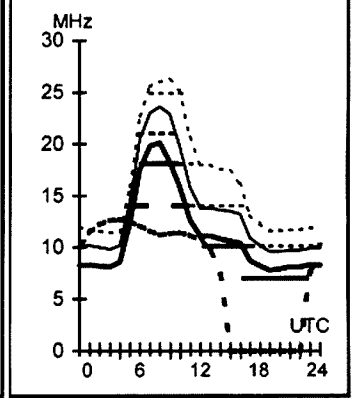
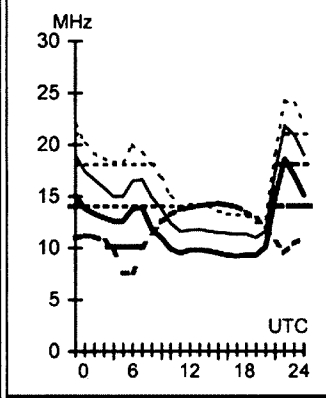
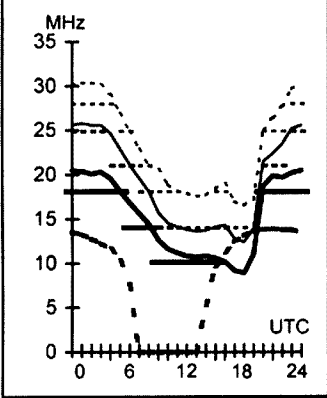
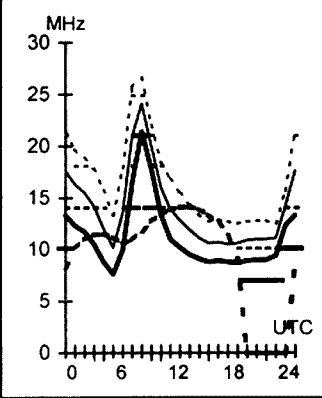
**Adelaide-Ottawa****58****Brisbane-Osaka****344****Canberra-London****316****Darwin-Tokyo****10**

First F 0-5 Short 16901 km

Second 3F6-11 3E0 Short 7148 km

First F 0-5 Short 16962 km

First 2F4-8 2E0 Short 5436 km

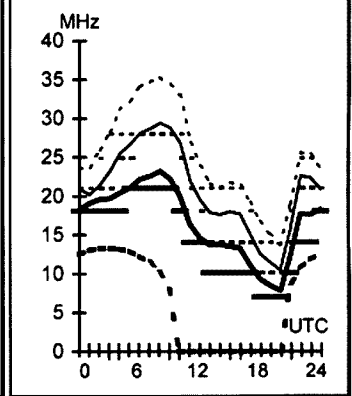
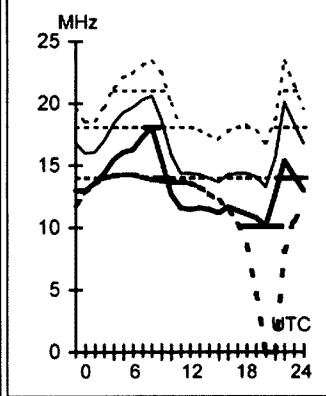
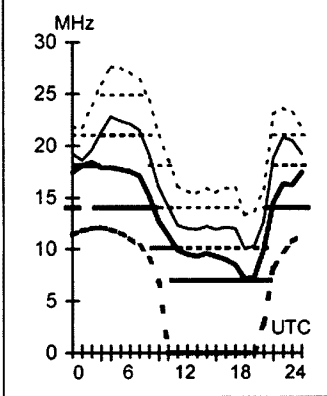
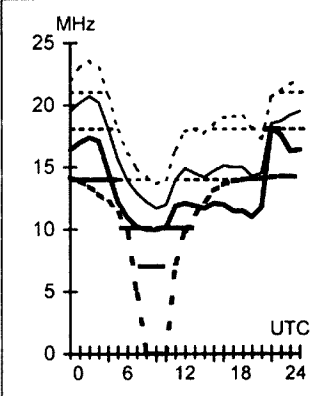
**Adelaide-Stockholm****142****Brisbane-Singapore****293****Canberra-London****317****Darwin-Vancouver****42**

First F 0-5 Short 25029 km

Second 3F8-11 3E0 Short 6146 km

First F 0-5 Short 14481 km

First F 0-5 Short 12212 km

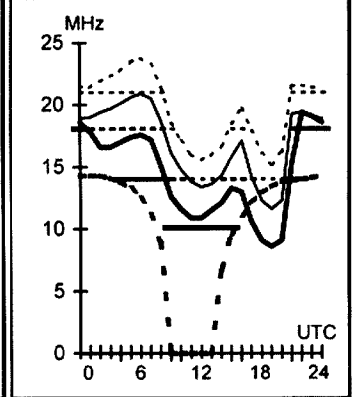
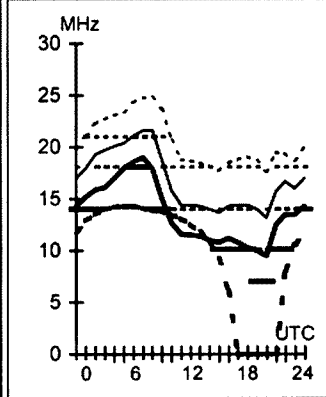
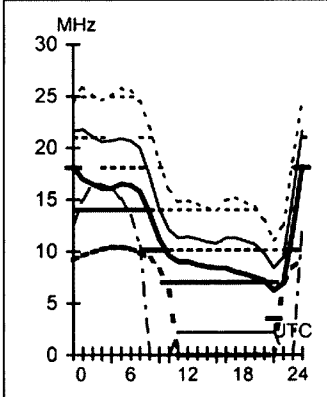
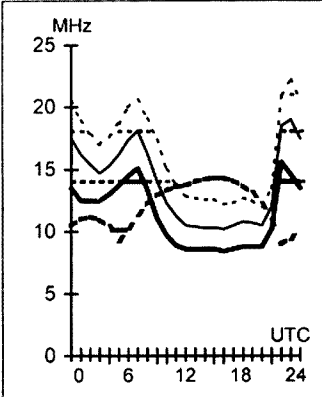

**Hobart-Boston****78****Melbourne-Auckland****97****Perth-Honolulu****70****Sydney-Miami****86**

First F 0-5 Short 16895 km

First 1F4-5 1E0 Short 2623 km

Second 4F4-7 4E0 Short 10905 km

First F 0-5 Short 15026 km

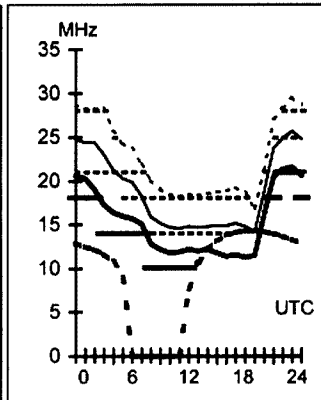
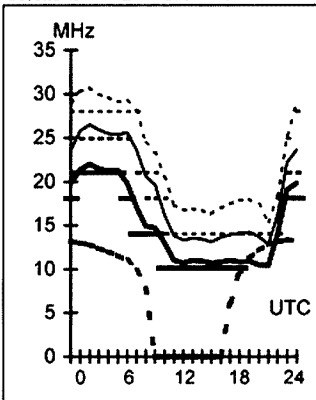
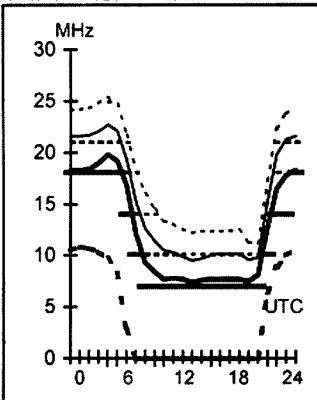
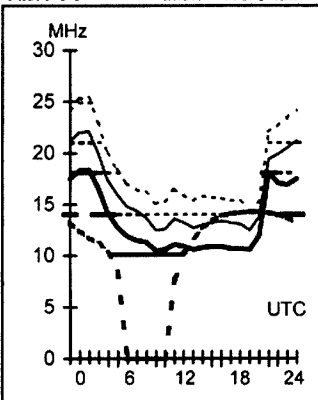
**Hobart-Christchurch****101****Melbourne-Lima****133****Perth-Johannesburg****248****Sydney-Pretoria****230**

First 1F8-10 1E0 Short 2040 km

First F 0-5 Short 12950 km

First 3F4-9 3E0 Short 8315 km

Second 4F3-4 4E0 Short 11063 km

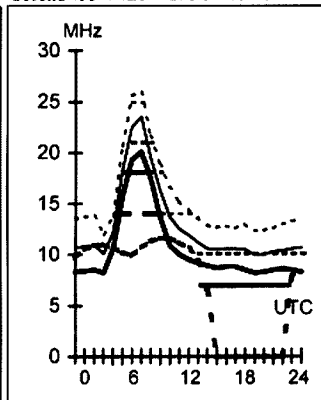
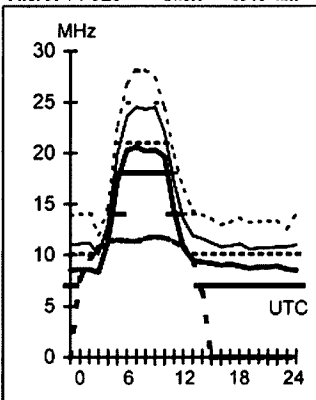
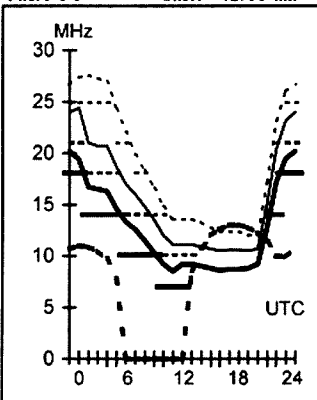
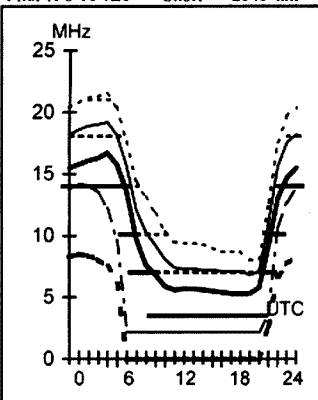
**Hobart-Lusaka****239****Melbourne-Montreal****62****Perth-London****133****Sydney-Seattle****47**

Second 4F3-4 4E0 Short 11045 km

First F 0-5 Short 16731 km

First F 0-5 Long 25543 km

First F 0-5 Short 12470 km

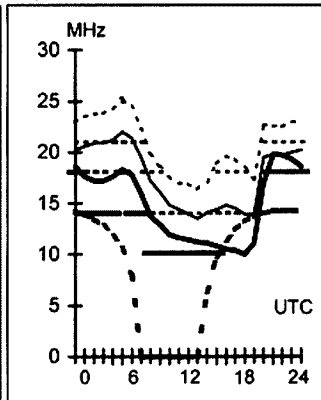
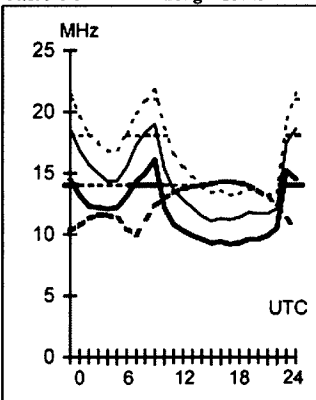
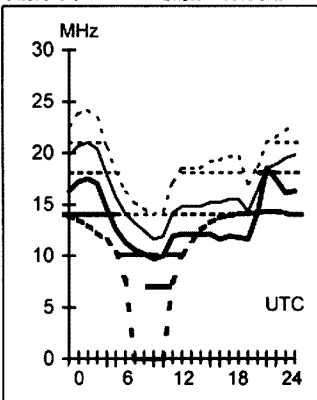
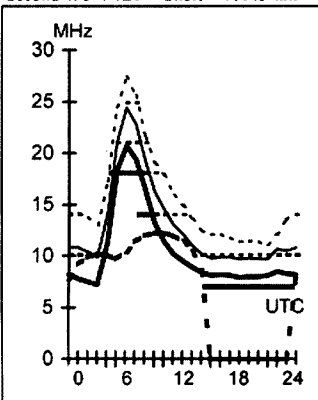
**Hobart-Port Moresby****360****Melbourne-Papeete****90****Perth-London****313****Sydney-Tel Aviv****267**

Second 2F10-12 2E Short 3710 km

Second 3F7-8 3E0 Short 6687 km

First F 0-5 Short 14481 km

First F 0-5 Short 14173 km

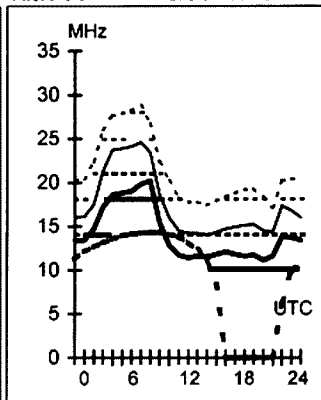
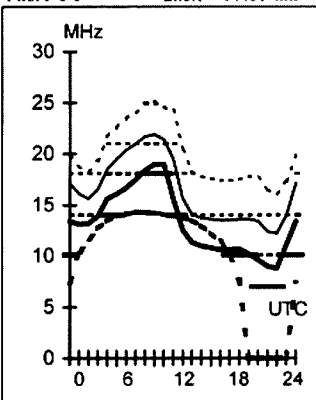
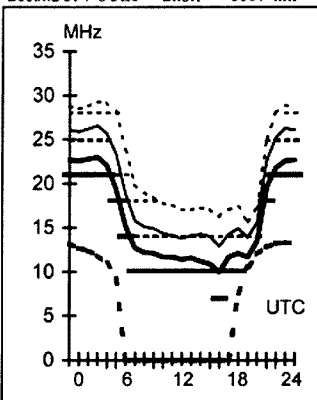
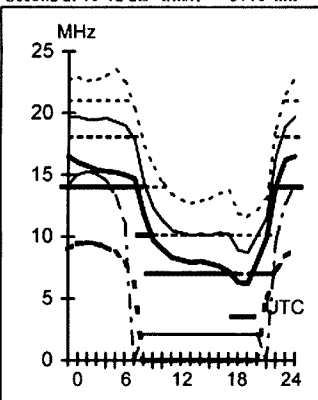

☀ ICOM 706MK2G(NEW)	\$ 1,399
☀ ICOM 706MK2G(USED)	\$ 1,249
☀ ICOM 207H(NEW)	\$ 499
☀ ICOM 208H (IMMAC)	\$ 599
☀ ICOM 2720H (IMMAC)	\$ 699
☀ YAESU FT8900R (NEW)	\$ 749
☀ YAESU FT100D (IMMAC)	\$ 1,249
☀ KENWOOD TS2000(IMMAC)	\$ 2,450
☀ KENWOOD TMD700(IMMAC)	\$ 849
☀ ICOM 910H (NEW)	\$ 2,199
☀ ICOM 756PR02 (IMMAC)	\$ 3,499
☀ ICOM AH4 (NEW)	\$ 525
☀ ICOM AT180 (IMMAC)	\$ 599

PRICES SUBJECT TO CHANGE – CHECK WEBSITE FOR LATEST BARGAINS.

PLENTY OF OTHER CURRENT MODEL GEAR AVAILABLE

WILL CONSIDER TRADE-IN OF ANY CURRENT MODEL GEAR.

COMPUTER INTERFACES  
ICOM AND YAESU \$69

MOBILE KIT IC706 (UNUSED) \$85

FREIGHT TO ANYWHERE IN VK / ZL.

ORDER ONLINE AT [WWW.VK3AJJ.COM](http://WWW.VK3AJJ.COM)

OR TEL: PAUL (03-9504 2628)

Licensed second hand dealer No. 10229 (Vic.)

The revolutionary VK4VKD

## One Man Tower Freestanding Self-erecting 10m to 25m

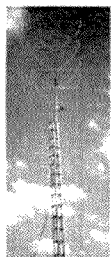

Fully adjustable delta loop rotatable antenna  
1-2-3-4 element

D.I.Y. delta loop element to boom 'hubs'

350kg SWL 5:1 braking winches

Galvanised steel boom to mast clamps

VHF and UHF beams

High tensile 'U' bolts

Safety harnesses for above ground work

Arrays easily taken to ground level for  
maintenance and wind protection

Easily erected without cranes

(ideal for confined areas or remote repeater sites)

proudly built in Australia by

**Australian  
Enterprise  
Industrial**

(PO Box 1013 Browns Plains QLD 4118)

<http://homepages.ihug.com.au/~aejtower>

aejtower@ihug.com.au

Mob. 0414 254 080

Fax 07 3800 8003

## VHF/UHF - An Expanding World

David Smith VK3HZ - vk3hz@wia.org.au  
Leigh Rainbird VK2KRR - vk2krr@telstra.com

### Weak Signal

David Smith - VK3HZ

There's not been a great deal of long distance propagation to report about this month. Time to pull down the tower, clean the cobwebs out of the matching harnesses and get ready for the next season.

At the start of May, a high-pressure cell settled over the southeastern part of the country, giving some enhancement from Adelaide over to the east coast. On the evening of 5/5, Roger VK5NY worked Rob VK1ZQR along a difficult path over the mountains. Rex VK7MO/5 in Port Lincoln managed some good digital contacts into Melbourne and beyond. (More in the "Digital Modes" section.) Then on the morning of 6/5, VK5NY's keyer was heard at good strength by a multitude of stations in Canberra and Sydney, but no contacts resulted.

The morning activity (aircraft net) on 144.200 continues unabated with a number of stations (re)appearing with big signals. In particular, for the Melbourne stations, Chris VK2DO is putting a big signal into Melbourne on 2 m from his new QTH in the hills to the east of Canberra. Chris is currently "planting" a number of towers and so the signal could become even louder, and on higher bands, in the near future. Guy VK2KU is unpacking his station at

his new QTH in QF55. He now has fewer neighbours and a good outlook to the east for EME. His path to VK3 is shielded by hills and so we in VK3 probably won't hear anything like the good signal that came from his old QTH.

The Wednesday evening net (144.150 at 2030 EST) run by Robbie VK3EK in Bairnsdale is attracting a larger crowd each week. Stations recently participating include VK3GOM and VK3KQB from Bendigo; VK3AXH, VK3IDL and VK3JTM from Ballarat/Ararat; VK3AJN, VK3KEG and VK3BG from northern Victoria; VK3XDK, VK3HZ and VK3AMD from Melbourne; and VK3ZYC, VK3RS, VK3WRE, VK3KAI, VK3HV, VK3YDK and VK3ZUX from the Gippsland area.

Russell VK3ZQB is testing new 70 cm and 23 cm beacons for Mt Gambier (VK5RSE) at the moment. All that is missing is a 10 W PA module for 23 cm. The current 70 cm beacon suffers from frequency stability problems, but is heard constantly in Melbourne – a distance of 410 km. Hopefully, the 23 cm beacon will also put out a strong signal.

Please send any Weak Signal reports to David VK3HZ at vk3hz@wia.org.au.

### Digital Modes

David Smith - VK3HZ

The usual contributor to this section of the column, Rex VK7MO, has been travelling back and forth across the south of the continent, creating the Digital Modes news for this month.

As advised last month, Rex travelled to Perth to give a presentation on "Weak signal DSP Techniques" to the WA VHF group, which, by all reports, was very well received – twice the normal turnout of people. At the same time, he was taking advantage of the Eta Aquarids meteor shower and attempting Meteor Scatter contacts back to the east from a number of locations, using his remarkably compact, but very capable,

portable setup.

Based on the results of contacts on his outgoing trip, where he was getting strong, regular pings at 1800 km from Melbourne, Rex decided that, on his return trip, he would see how far he could achieve a contact. After Perth, he headed back to Bremer Bay on the south coast between Albany and Esperance – 2336 km from Melbourne – where he succeeded in working VK3HZ and VK3FMD. Following that success (at one stage, there were 4 strong "pings" within 10 minutes), Rex moved 115 km further west to Albany to the location used by Wally VK6KZ to set the world 10 GHz

## Geoff Page VK2BQ

Geoff was born on 2nd May 1917 in Melbourne.

After army service he worked as a civil engineer for Lockhart and later Tumut councils.

It was while he was at Tumut that he obtained his amateur licence VK2BQ in 1950. Geoff moved to Melbourne in 1960 to work as site engineer for ESSO Oil.

While in Melbourne his callsign was VK3ABQ.

Geoff retired to Warrabee around the time Hornsby and Districts Amateur Radio Club, HADARC, was formed, so Geoff was an early member of the club and for many years was our auctioneer.

Geoff was a keen CW operator right up to the early 1990s.

Geoff was an early member of Australian Amateur Packet Radio Association, AAPRA, and was a committee member until his death. Geoff

was a keen packet radio user and was publicity officer for AAPRA for most of the time.

Geoff had a sardonic sense of humor and always had a retort for any situation that arose. Geoff in the last year or two had heart problems and spent a few episodes in hospital.

Geoff is survived by his wife Thelma and two sons.

**Barry White VK2AAB**

## VHF/UHF - An Expanding World *continued*

record. Unfortunately, nothing was heard from there despite 2 + hours of trying. With the help of local Wally VK6WG, Rex found another location, still 86 km further west than Bremer Bay, for another attempt. Here, he worked VK5DK and was heard by VK3FMD. He also received a ping containing "FMD". However, no contact was made back to Melbourne. It seems that there is a "brick wall" for Meteor Scatter at about the 2400 km mark. The contact from Bremer Bay to VK3HZ is a new national digital record for 2 m and is believed to be the furthest FSK441 digital contact ever achieved.

Rex headed back east with a number of goals in mind. One of those, to work

into Sydney from VK6, was achieved at Eucla where he completed with VK2FZ and VK2FLR. From Eucla, he also worked VK7JG, back to the home state.

On 5/5, a stop at Port Lincoln coincided with very good conditions between SA and the eastern states. That evening, Rex worked a number of long distance tropo contacts using JT44, including VK3ZYC at Longford in eastern Victoria on 2 m, and VK3FMD and VK3HZ in Melbourne on 70 cm.

One of Rex's other goals was to work from Adelaide into Perth. Rex had stirred up quite a bit of enthusiasm for digital modes and both VK6AO and VK6HK were working him regularly, when he had the beam pointing that way.

In Perth, Rex parked his setup near the QTH of Roger VK5NY at Mt Wilson and looked west for contacts. He completed with VK6AO – a distance of 2140 km – and was heard by VK6HK in a "burn" more than 20 seconds long. VK6KZ also received a number of pings. Hopefully, this will spur the Perth stations on to working into further locations like Mt Gambier, and perhaps Melbourne (although no pings were received from the VK6 stations during monitoring of the VK7MO/VK6AO QSO at this QTH).

Rex would like to thank the stations that he worked during his trip including: VK2KRR, VK2FLR, VK2TK, VK2FZ, VK2EAH, VK3FMD, VK3HY, VK3HZ, VK3ZYC, VK3AFW, VK3KAI, VK3UM, VK5DK, VK6AO, VK6HK and VK7JG.

## 2 m & 70 cm FM DX

**Leigh Rainbird - VK2KRR**

2 & 70 FM DX has been very quiet during April, with only one opening in the south east and also north QLD coast.

On Wednesday morning 7th of April, good conditions were present in the south east of the country from around 6 am till almost 2 pm. This duct occurred the morning after rainfall across the SE area.

Conditions were very good from here across to Adelaide with good strong signals both 2 m and 70 cm main repeaters.

Interesting call in on the Willunga Hill 146.675 repeater, south of Adelaide. Stations copied were VK5ZK, VK5ZPS, VK5KBJ, VK5YX, VK5AUE and VK5ACY. It was good to hear VK5ACY back in there after a return trip from Hospital, hope you're recovering OK Bill.

Garry VK5ZK at Goolwa and myself tried simplex. Nice copy from Garry up to 4/5 on 146.500 and Garry was running only a 5/8th wave stick at 30 ft with 30 watt. Garry is 754 km from here.

Amazingly, conditions lasted till about 1.50 pm.

On Monday 12th April, Garry VK3KYF in Mildura was worked here at 5/7 on 146.500 @ 466 km.

Still deprived of much in the way of conditions, slight relief was provided for some VK4 operators on Monday evening the 19th of April. Mike VK4MIK at Butchers Creek, 60 km south of Cairns, was able to make it to the Townsville repeater VK4RAT where he was able to work Phil VK4JOK, Felix VK4FUQ and Garry VK4ADW. Mike had a good S8 signal from the repeater and Garry had

a good S5 signal from Mike direct.

If you're looking for FM DX resources on the Internet, you may have noted the VK VHF FM DX Group website has not had an update for a while and the email group of the same name no longer exists. The site's activities have been incorporated into the Australian National VHF DX Group site [www.users.bigpond.com/anvdg/](http://www.users.bigpond.com/anvdg/). The existing FM DX email group has also been relocated to the ANVDG email group, which covers FM along with other modes. More details can be found on the website.

That's about it for this month. Please remember to send through any 2 & 70 FM DX reports to Leigh VK2KRR at [vk2krr@telstra.com](mailto:vk2krr@telstra.com).

ar

## WANTED ACT

• **Military type plugs and sockets** mostly made by **Cannon MS-3102E 14S-6P** 6 pin chassis mount plug. **MS-3102E 14S-6S** cord mounted socket with threaded ferrule, two or more of each required. Glen VK1GL Phone 02 6254 8002.

## FOR SALE NSW

• 2 off **Kuranishi model RW-100L** Thru-line watt meters, dual meter, switchable bands 50/144/430 MHz 50 ohms, input 100 W or 20 W, output 20 W or 5W, N connectors, \$95 each ono. **Homebrew Pi network antenna tuner**, rotary inductor with turns counter, slow motion tuning dials, \$135 ono. Art VK2AS Phone 02 9416 7784.

• 2 m **VK5 preamp**, type N connectors, \$65 ono. **ICOM AG-35 70 cm preamp** type N connectors, \$100 ono. **Oskerblock SWR 200** power SWR bridge, \$125 ono. Two data switch boxes, one changeover, one 3 position, each \$35. Art VK2AS Phone 02 9416 7784.

• **GME Electrophone TX-6000** x 2 (new cases), one wall plug charger and one spare battery pack. Excellent working order. \$525. Geoff, VK2KPK. Phone 02 6845 4203

• 3 x **Morse keys** as follows: **Bug Hi-Mound BK100**, straight **YA1860** and **Keyer, ARRL Iambic Accu.** Phone Herman VK2IXV Phone 02 4237 5201 email hermanw@smatchat.net.au

• **Linear Amplifier Kenwood TL922** Serial No.750092. Very little used, in fact the covers have never been off. Complete with manual. **HF Transceiver TS930S** Serial No. 2110680. In fine condition, serviced by Kenwood

complete with operating AND service manuals, mike and power cable. **HF Transceiver YAESU FT101E** also in fine condition complete with manual, mike and power cable. Enquiries/offers to VK2MW Ian, phone 02 9488 5219

## WANTED NSW

• **Copy of manual and/or circuit diagram Marconi LCR bridge type TF 2700** also **Rola filter choke type 14/60** replacement. S Dogger, 116 Tunnel Road, Stokers Siding 2484. Phone 02 6677 9292.

## FOR SALE VIC

• **Transverter Microwave Mmodules MMT-144/28-R** 2 metre multimode 25 watt, \$140. Adam VK3JRR QTHR Phone 03 5464 2214 AH.

• **ANTENNA 3 el 10 m Yagi** \$80. David VK3MED 03 5952 5940.

• **Linear power amplifier for 144.000 - 148.000 MHz band, PV-85R.** Phone Terry VK3KBD 03 9315 0186 (evenings)

• **70cm Yagi Antenna ATN model 432-16LB** 16 el 17.2 dBi gain, 3.7 m boom c/w 1/4 wave sleeve balun, N conn. \$60 Terry VK3ZXY. QTHR Phone 03 9592 3514 email vh3zxy@leithy.com

• **Deceased Estate:** Quality equipment. **FT-1000** XCVR c/w MD-1 mic, BPF-1 b/pass Filter, **SP-5** spkr, paddle key, \$3000. **T5-4305** XCVR c/w FM bd, N/B filter, mike, \$750. **Analogue Multimeter AS-1000D/P**, \$60. **DX-88 8-Band Vert Ant**, \$450. **Beckman 3020 Dig. M/meter**, Rf & HV probes, \$200. **Icom IC-271H VHF xvcr** S/N 04073, \$500. **Icom IC-**

**PS15 Power Supply** 13.8V @ 20A, \$125. **RF pwr meter 6 W-120 W**, 1.8-500MHz, \$80. **SWR/Pwr Meter CN-620** S/N C-01021, \$120. **Freq. Counter 60-612 MHz, 5800A**, \$120. **TNC Demodulator Packratt 232**, \$250. **TNC for Radio-Data Engine V.2.0**, \$60. **TR Dip Meter** c/w 6 coils 1.5-250MHz, \$75. **Yaesu VX-5R Triband H/H XCVR**, \$600. **VHF Packet Modem B2F, KPC-3**, \$120. **Universal HF Ant. Coupler 1000 W**, \$100. **Mobile Whips**, full set of 8, various, \$500. Stan VK3JSS. Rosebud. Phone 03 5986 6817.

## WANTED VIC

• **Battery box for TX475 Electrophone.** Either Ni-cad or dry cell type, or information where I can possibly find one would be appreciated. David VK3DBD QTHR Phone 02 6027 0570 email vk3dbd@rm.quik.com.au

## FOR SALE QLD

**IC-720A HF all band transceiver IC-PS20** AC Power supply **YAESU** receiver - FRG-100. **MFJ Deluxe Versa Tuner II** - MFJ-949B Regulated 13.8 VDC Power supply 2 amp continuous M9540 Kamodan 360-TRCX. Mob 0412 031 759 (Dec estate VK4CKF)

## WANTED QLD

• **Manual (or copy) for HP audio oscillator type 208A.** All costs refunded. Gwen VK4CB QTHR Phone 07 3202 7137

• **RF HV capacitors**, suit medium power VHF tube amplifier tank circuit. Doorknob or similar type, 500 to 1500 pF, 5 kV min. Send size and ratings to Geoff VK4GWC, All costs covered. Phone 07 5445 9986, email geoffcom@powerup.com.au

## WANTED WA

• **BWD 830 oscilloscope service manual** or copy, cost refunded. Jim VK6CA QTHR or Phone 08 9622 2804

## MISCELLANEOUS

• **Elizabeth Amateur Radio Club Inc.** Collect your property! Do you have any property at the Club? Do you wish to donate these goods to EARC? Please reply ASAP to Secretary M V Millar VK5MX QTHR Callbook.

• **The WIA QSL Collection (now Federal) requires QSLs.** All types welcome, especially rare DX pictorial cards, special issue. Please contact the Hon Curator, Ken Matchett VK3TL, 4 Sunrise Hill Road, Montrose Vic 3765, tel. (03) 9728 5350

## TRADE ADS

**PSK-31, SSTV, RTTY, SOUNDBOARD** Interfaces Fully isolated, ready to plug in. <http://www.G3LIV.CO.UK>, johnny@melvin.com, G3LIV QTHR.

# About hamads....

- Hamads may be submitted by **email** or on the **form on the reverse of your current Amateur Radio address flysheet**. Please print carefully and clearly, use **upper AND** lower case.
- Separate forms for For Sale and Wanted items. Please include name, address STD telephone number and WIA membership number if you do not use the flysheet.
- Deceased estates Hamads will be published in full, even if the ad is not fully radio equipment.
- WIA policy recommends that the serial number of all equipment for sale should be included.
- QTHR means the address is correct in the current WIA Call Book.

- Ordinary Hamads from those who are deemed to be in general electronics retail and wholesale distributive trades should be certified as referring only to private articles not being re-sold for merchandising purposes.
- Commercial advertising (Trade Hamads) are pre-payable at \$25.00 for four lines (twenty words), plus \$2.25 per line (or part thereof), Forty word maximum, minimum charge of \$25.00. Cheques are to be made out to: WIA Hamads.
- Copy typed or printed clearly please, and received by the deadlines shown on page 1 of each issue of Amateur Radio.

Email: [newunltd@bigpond.net.au](mailto:newunltd@bigpond.net.au) Fax: 03 9756 7031

Postal: Newsletters Unlimited, PO Box 431, Monbulk Vic 3793

### TRADE PRACTICES ACT

It is impossible for us to ensure that the advertisements submitted for publication comply with the Trade Practices Act 1974. Therefore, advertisers and advertising agents will appreciate the absolute need for themselves to ensure that the provisions of the Act are strictly complied with.

### VICTORIAN CONSUMER AFFAIRS ACT

All advertisers are advised that advertisements containing only a PO Box number as the address cannot be accepted without the addition of the business address of the box-holder or seller of the goods.

# HAMADS ARE FREE!

<http://www.hamsearch.com>

a not-for-profit site that is a search engine for hams



## "Hey, Old Timer..."



If you have been licensed for more than 25 years you are invited to join the

### Radio Amateurs Old Timers Club Australia

or if you have been licensed for less than 25 but more than ten years, you are invited to become an Associate Member of the RAOTC.

In either case a \$5.00 joining fee plus \$8.00 for one year or \$15.00 for two years gets you two interesting OTN Journals a year plus good fellowship.

Write to

RAOTC,  
PO Box 1100  
Sandringham VIC 3191

or call Arthur VK3VQ on 03 9598 4262 or Bill VK3BR on 03 9584 9512,

or email to raotc@raotc.org.au for an application form.

### GROW WIA—MAKE IT YOUR JOB

#### RECRUIT A NEIGHBOUR\*, NON-MEMBER LICENCE HOLDER TODAY.

One to one approaches are very successful and it is in your interest to have a strong WIA.

If you need to know who your neighbouring operators are call John (03) 9756 7797 AH and he'll tell you.

## Sunspot Numbers

Monthly Sunspot Average Apr 2004: 39.3

Annual Sunspot Average Oct 2003: 58.4

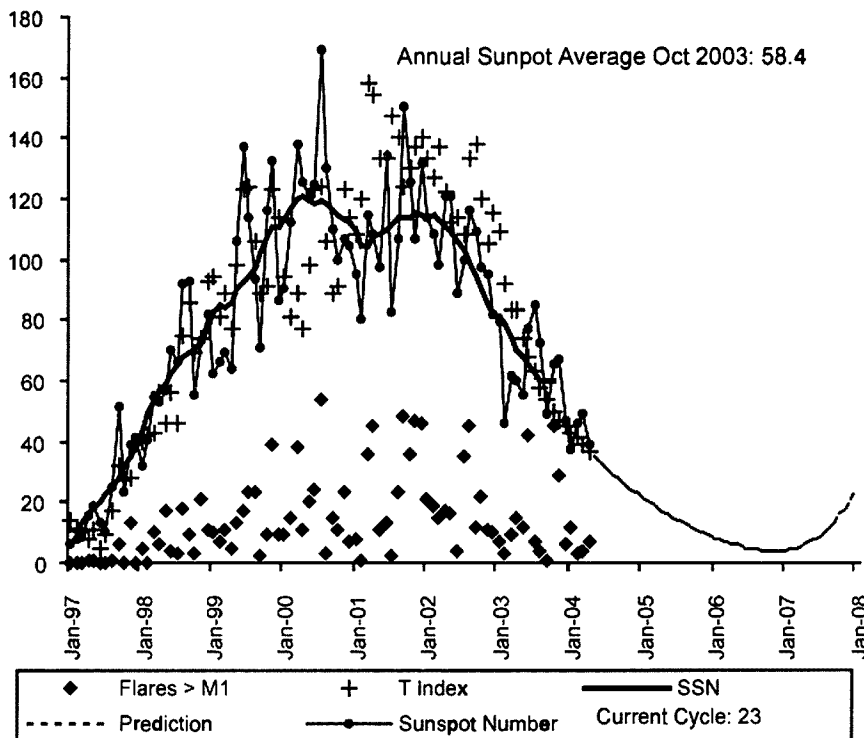

Drawn from monthly data provided by the Ionospheric Prediction Service

### AMIDON FERROMAGNETIC CORES

For all RF/electronic applications. See our website for complete data on all cores including prices.

[www.catchnet.com.au/~rjanduslimports](http://www.catchnet.com.au/~rjanduslimports)

#### RJ & US Imports

PO Box 431, Kllama NSW 2533.  
A 3.5" PC disk containing all data is available for \$5.00 incl. post.

#### Agencies

Active Electronics, Tas  
TTS Systems, Tyabb (VIC)  
Tower Communications, Perth



## JACKSON BROS

JACKSON OF THE UK IS BACK

Highest quality products made by UK craftsmen

Full range now off-the-shelf in Australia. Variable and trimmer capacitors, reduction drives, dials, ceramic standoffs

#### CATALOGUES, PRICE LISTS AVAILABLE

#### CHARLES I COOKSON PTY LTD

11-13 Port Rd  
Queenstown SA 5014

Tel: (08) 8240 3200 Fax: (08) 8240 3233

FreeFax 1800 673355 within Australia

Email: [jackson@homeplanet.com.au](mailto:jackson@homeplanet.com.au)

ALL MAJOR CREDIT CARDS ACCEPTED  
SOLE AGENTS AUSTRALIA AND NEW ZEALAND

## Plan ahead

3 July Jack Files Contest

3-4 July GippsTech 2004

17 July VK/trans-Tasman  
160 metre Contest

14/15 August  
Remembrance Day  
Contest

### ADVERTISERS INDEX

AEI .....	44	Emtron .....	24
Andrews .....	29	G & C .....	41
Benelec .....	IFC	Icom .....	OBC
Bushcomm .....	25	Radio School .....	27
Coax Cable & Connectors .....	36	RippleTech Electronics .....	13
Com-an-tena .....	32	Todd .....	36
Computer Interface .....	44	TTS .....	12
Connektron .....	20	54s .....	55

### HF, VHF, UHF ANTENNAS & ACCESSORIES

Aluminium towers, guys etc  
Diamond VSWR/PWR meters.

HD copper antenna wire & insulators,  
TX tubes & pwr transistors, Create Rotators

Quality coax cables & connectors. Free advice & catalogue.

(Disregard the rumours, we are still here!)

### ATN Antennas

Ph 03 5492 2224 Fax 03 5492 2666,  
email [atnant@iinet.net.au](mailto:atnant@iinet.net.au)



# Division Directory

The Amateur Radio Service exists for the purpose of self training, intercommunication and technical investigation. It is carried out by amateurs who are duly authorised people interested in radio technique solely with a personal aim and without pecuniary interest.

The Wireless Institute of Australia represents the interests of all radio amateurs throughout Australia. National representation is handled by the executive office under council direction. There is one councillor for each of the seven Divisions. This directory lists all the Divisional offices, broadcast schedules and subscription rates. All enquiries should be directed to your local Division.

## Broadcast schedules All frequencies MHz. All times are local.

VK1 Division Australian Capital Territory,  
GPO Box 600, Canberra ACT 2601  
President Alan Hawes  
Secretary Deane Walkington  
Treasurer Bob Howie

VK1WX  
VK1DW  
VK1HBB

VK1WI transmits each Thursday evening at 2000 hrs local time on VK1RGI 146.950 MHz and 436.375 MHz including the linked repeater system on VK2RGN Goulburn, VK2RHR High Range, VK2RMP Madden Plains and VK2RTW Wagga Wagga.  
VK1 Home Page <http://www.vk1.wia.ampr.org>  
Annual Membership Fees. Full \$80.00 Pensioner or student \$71.00. Without *Amateur Radio* \$48.00

VK2 Division New South Wales  
109 Wigram St, Parramatta NSW  
(PO Box 9432, Harris Park, 2150)  
(Office hours Tue., Thu., Fri., 1100 to 1400 hrs.)  
Phone 02 9689 2417

Web: <http://www.wiansw.org.au>  
Freecall 1800 817 644 (NSW only)  
e-mail: [vk2wi@wiansw.org.au](mailto:vk2wi@wiansw.org.au)  
Fax 02 9633 1525  
President Chris Flak  
Secretary Michael Corbin  
Treasurer Noel May

VK2QV.  
VK2YC.  
VK2YXM

VK2WI transmits every Sunday at 1000 hrs and 1930 hrs on some or all of the following frequencies (MHz): 1.845, 3.595, 7.146, 10.125, 14.170, 18.120, 21.170, 24.950, 28.320, 29.170, 52.150, 52.525, 144.150, 147.000, 432.150, 438.525, 1273.500. Plus many country regions on 2m and 70cm repeaters. Highlights are included in VK2AWX Newcastle news Monday 1930hrs. on 3.593 , 10 metres and local repeaters. The text of the bulletins is available on the Divisional website and packet radio. Continuous slow morse transmissions are provided on 3.699 and 145.650. VK2RSY beacons on 10m, 6m, 2m, 70cm and 23cm. Packet on 144.850.  
Annual Membership Fees. Full \$83.00 Pensioner or student \$66.00. Without *Amateur Radio* \$50.00

VK3 Division Victoria  
40G Victory Boulevard Ashburton VIC 3147  
(Office hours Tue 10.00 -2.30)  
Phone 03 9885 9261  
Web: <http://www.wiavic.org.au>  
Fax 03 9885 9298  
e-mail: [wiavic@wiavic.org.au](mailto:wiavic@wiavic.org.au)

President Jim Linton  
Secretary John Brown  
Treasurer Jim Baxter

VK3PC  
VK3JJB  
VK3DDB

VK3BWI broadcasts on the 1<sup>st</sup> Sunday of the month at 1030 and 2000 hours. Primary frequencies are 3.615, 7.085, 10.130, FM repeaters VK3RML 146.700, VK3RMM 147.250, VK3RWG 147.225, VK3RMU 438.075. The broadcast can also be heard on the Saturday night at 2000 hours before the 1<sup>st</sup> Sunday. Major news appears on the packet radio network under the callsign VK3ZWI, and the WIA Victoria website.  
Annual Membership Fees. Full \$87.00 Pensioner or student \$72.00. Without *Amateur Radio* \$55.00

VK4 Division Queensland  
PO Box 199, Wavell Heights, Qld. 4012  
Phone 07 3221 9377  
e-mail: [offices@wiaq.powerup.com.au](mailto:offices@wiaq.powerup.com.au)  
Fax 07 3266 4929

Web: <http://www.wia.org.au/vk4>  
President Ewan McLeod  
Secretary Bob Cumming  
Treasurer David Gulley

VK4ERM  
VK4YBN  
VK4DCG

EVERY SUNDAY, at 9am LOCAL (Sat 2300 UTC). From Far North Queensland On 7.070/2 MHz. From South East Queensland:- 1.825, 3.605, 7.118, 10.135, 14.342, 21.175, 52.525, 147.000, 438.500 MHz. Right throughout VK4 scan 146.6 to 148.0 MHz again at 9am local. SUNDAY 6:45pm hear LAST week's QNEWS broadcast 3.605 and 147.0 MHz from South East Queensland. MONDAY 7:00pm hear YESTERDAY's news again on 146.875 MHz broadcast from Brisbane's Bayside repeater, and then 7:30pm on 3.605 and 147.0 MHz from St East Queensland. Text editions on packet internet and personal email, visit [www.wia.org.au/vk4](http://www.wia.org.au/vk4) News is updated 24/7 in both text and audio on this site. MP3 Audio from same website by 2300 hours each Saturday. Contact QNEWS, packet sp QNEWS@VK4WIE.BNE.QLD.AUS.OC email [qnews@wia.org.au](mailto:qnews@wia.org.au)  
Annual Membership Fees. Full \$95.00 Pensioner or student \$81.00. Without *Amateur Radio* \$63.00

VK5 Division South Australia and Northern Territory  
(GPO Box 1234 Adelaide SA 5001)  
Phone 08 8294 2992  
web: <http://www.sant.wia.org.au>  
email: [peter.reichelt@bigpond.com](mailto:peter.reichelt@bigpond.com)

President Trevor Quick  
Secretary Peter Reichelt  
Treasurer Trevor Quick

VK5ATQ  
VK5APR  
VK5ATQ

VK5WI: 1843 kHz AM, 3.550 MHz LSB, 7.095 AM, 14.175 USB, 28.470 USB, 53.100 FM, 147.000 FM Adelaide, 146.800 FM Mildura, 146.900 FM South East, 146.925 FM Central North, 438.475 FM Adelaide North, ATV Ch 35 579.250 Adelaide. (NT) 3.555 LSB, 7.065 LSB, 10.125 USB, 146.700 FM, 0900 hrs Sunday. The repeat of the broadcast occurs Monday Nights at 1930hrs on 3585kHz and 146.675 MHz FM. The broadcast is available in 'RealAudio' format from the website at [www.sant.wia.org.au](http://www.sant.wia.org.au) Broadcast Page area.  
Annual Membership Fees. Full \$91.00 Pensioner or student \$76.00. Without *Amateur Radio* \$61.00

VK6 Division Western Australia  
PO Box 10 West Perth WA 6872  
Phone 08 9351 8873  
Web: <http://www.wia.org.au/vk6>  
e-mail: [vk6@wia.org.au](mailto:vk6@wia.org.au)

President Neil Penfold  
Secretary Roy Watkins  
Treasurer Bruce Hedland-Thomas

VK6NE  
VK6XV  
VK6OO

VK6WIA: 146.700 FM (R) Perth at 0930hrs Sunday relayed on 1.865, 3.564, 7.075, 10.125, 14.116, 14.175, 21.185, 29.120 FM, 50.150 and 438.525 MHz, Country relays 3.582, 147.200 (R) Cataby, 147.350 (R) Busselton, 146.900 (R) Mt William (Bunbury), 147.000 (R) Katanning and 147.250 (R) Mt Saddleback. Broadcast repeated on 146.700 at 1900 hrs Sunday relayed on 1.865, 3.564 and 438.525 MHz : country relays on 146.900, 147.000, 147.200, 147.250 and 147.350 MHz..Also in "RealAudio" format from the VK6 WIA website  
Annual Membership Fees. Full \$71.00 Pensioner or student \$65.00. Without *Amateur Radio* \$39.00

VK7 Division Tasmania  
PO Box 371 Hobart TAS 7001  
Phone 03 6234 3553 (BH)  
Web: <http://www.wia.org.au/vk7>  
e-mail: [vk7dg@wia.org.au](mailto:vk7dg@wia.org.au)

President Phil Corby  
Secretary Dale Barnes  
Treasurer Dale Barnes

VK7ZAX  
VK7DG  
VK7DG

VK7WI: At 0930 hrs every Sunday on 146.700 MHz FM (VK7RHT, Hobart) and relayed on 147.000 MHz FM (VK7RAA, Launceston), 146.625 MHz FM (VK7RMD, Ulverstone), 146.750 MHz FM (VK7RNW, Ulverstone), 147.075 MHz FM (VK7RWC, Rosebery), 3.57 MHz LSB, 7.090 MHz LSB, 14.130 MHz USB and UHF CB Channel 15 in Hobart area.  
Annual Membership Fees. Full \$90.00 Pensioner or student \$77.00. Without *Amateur Radio* \$57.00

VK8 Northern Territory is part of the VK5 Division and relays broadcasts from VK5 as shown, received on 14 or 28 MHz. The broadcast is downloaded via the Internet.

# Waldegrave Islands

## IOTA OC-251

April 17 to 21, 2003

By Peter Forbes, VK3QI



The team on the beach with the Hy-Gain AV-640 Vertical



VK3WWW with the paper work



VK3ZZ working the DX

**A**FTER OUR SUCCESSFUL and exciting OC-251, Lady Julia Percy Island operation of September 2002. Tom VK3ZZ and I scanned the IOTA directory. In southern Australia. We found two groups, one in far eastern Western Australia and the other South Australia State West Centre. The only problems were the distance to the area from Victoria (VK3) — 1400 kilometre plus — and the small amount of information on the area.

Waldegrave Islands were chosen as the most accessible in the SA group. A Conservation Park, the islands lie some 3 kilometres off the coast and are separated by a body of water that can be very rough at times. East Island is the larger. It is 9 kilometres in circumference, relatively flat on top, with saltbush vegetation and drifting sand and a 25 metre high sandstone cliff almost entirely around its edge. There are three beach areas where one can land and each has a small area near the cliff face, which remains dry at high tide. The day we arrived there was a good 3 metre swell running, with spectacular waves crashing onto the southern end of the island. We chose an area at the north end with a beach landing, sheltered from the prevailing south-westerly swell.

Jeff Grocke chose an area, which was absolutely perfect for our operation...

*see page 4 for the rest of our story.*

# MEET ICOM'S CHAMPIONS

NEW  
ARRIVAL



THE NEW  
IC-R20 RECEIVER

**Check out the Icom specials at the South East Radio Group Convention 2004 & Far North & North Qld Amateur Radio Get Together**

**Venue:** South East Radio Group Convention 2004  
Pick Ave Showground, Mt. Gambier, SA

**Date:** 12-13th June 2004

**Venue:** Far North & North QLD Amateur Radio Get Together  
Beachcomber Coconut Village, South Mission Beach,  
Far North QLD **Date:** 12-13th June 2004

**ICOM**  
2\_YR WARRANTY

find your nearest ICOM dealer at

[www.icom.net.au](http://www.icom.net.au) or (03) 9387 0666

The magazine for AUSTRALIAN amateurs

Volume 72 No 7

July 2004



# Amateur Radio

\$6.50  
incl GST

## VK women take on Antarctica

*This issue  
featuring...*

How to stop your  
bug from walking  
[ Ted Miles VK2FLB ]

Trying to read digital  
SW (DRM) broadcasts  
[ Brian Tideman VK3BCZ ]

An SSB generator  
from JUNK PARTS  
[ Donald Howarth VK6JDM ]

The EH Antenna - Part 4  
[ Lloyd Butler VK5BR ]

ISSN 0002-6859



9 770002 685079 07

# BENELEC

# YAESU

## FT-857D



Now includes DSP2 unit built-in

- Ultra Compact + All Mode Transceiver
- 160-10m / 6m / 2m / 70cm
- 100W, 100W, 50W, 20W

**Ideal Antenna:**

ATAS 25 / ATAS120 / Comet UHV6

**Price \$ 1,587.50**

## FT-897D



Now includes TCX0-9 Built-in

- Portable / Mobile / Base All Mode Txr
- 160-10m / 6m / 2m / 70cm
- 100W, 100W, 50W, 20W

**Ideal Antenna:**

ATAS 25 / ATAS120 / Comet UHV6

**Price \$ 1,690.90**

## FT-7800



2m / 70cm Dual Band FM Transceiver

- High Power Output
- Wide Receiver Coverage
- Five One-Touch "Hyper Memory"
- Over 1000 Memory Channels
- WiRES Internet linking Compatibility

**Ideal Antenna:**

Comet SBB5 / CHL 250H SB15

**Price \$ 539.90**

## FT-8900



Quad Band FM Mobile

- 29 / 50 / 144 / 430 MHz Quad Bander
- V+U Full Duplex Operation
- High Power 50 W and Heavy Duty PDA
- 50 Tone CTCSS / 104-Code DCS Tone Systems
- Huge 800 Ch memory Capacity

**Ideal Antenna:**  
Comet UHV4

**Price \$ 901.20**

## FT-817



Now includes FNB72 Internal Battery

- Ultra Compact 135 x 38 x 165mm
- All Mode Portable Transceiver
- 160 - 10m / 6m / 2m / 70cm
- 0.5-5 Watts Selectable

**Price \$ 1,248.70**

## VX-1



**Price \$343.10**

## VX-2



**Price \$415.00**

## VX-5



**Price \$963.50**

## VX-7



**Price \$759.30**

**Does Your Radio Need Fix?  
- We FIX YAESU Radios!**

[www.benelec.com.au/yaesu/yaesu.htm](http://www.benelec.com.au/yaesu/yaesu.htm)

# www.benelec.com.au

Authorised Yaesu Retailers

**All Price includes GST**

**NSW**  
Andrews Communications Systems  
Tel 02 9636 9060  
lee.andrews1@bigpond.com

**VIC**  
Strictly Ham P/L  
Tel 03 9729 7656  
sales@strictlyham.com.au

**Qld**  
Kyle Communications  
Tel 07 3857 4400  
mark@kyle.com.au

**Newcastle Pro Sound & Communications**  
Tel 02 4965 6899  
sales@newcastleprosound.com.au

**G&C Communications**  
Tel 03 5996 3298  
gcomm@netspace.net.au

**SA/NT**  
Hamtronics  
Tel 08 8342 4700  
brenton@posnav.com.au





# Amateur Radio

Volume 72, Number 7  
July 2004

The Journal of the Wireless  
Institute of Australia  
ISSN 0002-6859

## Editorial

Editor: Colwyn Low VK5UE  
edarmag@chariot.net.au

Technical Editor: Peter Gibson VK3AZL

Publications Committee Members  
Brenda Edmonds VK3KT  
Ron Fisher VK3OM  
Don Jackson VK3DBB  
Evan Jamman VK3ANI  
Tom Potter VK3UBS  
Bill Roper VK3BR

## Submission of material to Amateur Radio Magazine

General and Technical articles to  
Secretary  
AR Publications Committee  
3 Tamar Court  
Mentone VIC 3194  
or armag@optusnet.com.au

Columns and Letters to the Editor to  
Editor  
AR Magazine  
34 Hawker Crescent  
Elizabeth East SA 5112  
or  
edarmag@chariot.net.au  
(Tel and Fax 06 8265 2138)

Hamads to  
"Hamads" Newsletters Unlimited  
PO Box 431  
Monbulk VIC 3793  
Fax 03 9756 7031  
newunltd@bigpond.net.au

Advertising  
All enquiries to  
Newsletters Unlimited  
PO Box 431  
Monbulk Vic 3793  
Phone: 03 9756 7797  
Fax: 03 9756 7031  
newunltd@bigpond.net.au

Registered Office  
10/229 Balaclava Road,  
Caulfield North VIC 3161  
Australia  
Phone: 03 9528 5962

**Production Deadlines**  
Advertising booking and articles for  
publication 10th of preceding month.  
Hamads and advertising material  
deadline 18th day of preceding month  
The contents of Amateur Radio are Copyright  
Wireless Institute of Australia © 2004

## General

Talking Lighthouses: EGARC at Point Hicks.....	11
Linda Stanford VK3VLS	
Talking Lighthouses: Working in the Light.....	13
Carl Schlink VK3EMF	
In Charlie's Way. Part 3, 'Battler's test'.....	20
Rosa Fraser VK2WN	
The ACA Review of Amateur Service Regulation: a look at the outcomes (Opinion)...	25
Jim Linton VK3PC	
Women, radio and Antarctica.....	27
Christine Taylor VK5CTY	

## Technical

The EH antenna - Part 4 .....	4
Lloyd Butler VK5BR	
Trying to receive the digital SW (DRM) broadcasts .....	9
Brian Tideman VK3BCZ	
An experimental SSB generator from junk parts .....	15
Donald Howarth VK6JDM	
Simple home brew PCB artwork .....	18
Malcolm Heakerd VK5BA	
How to stop your bug from walking .....	21
Ted Miles VK2FLB	
Winding a helical whip antenna .....	23
Roger Graham (used to be) VK2AIV	

## Columns

ALARA.....	46	WIA Comment.....	3
AMSAT.....	48	WIA Regional Directory.....	56
Beyond Our Shores.....	51	WIA National Directory .....	2
Contests .....	41	WIA National News .....	30
Club News .....	38	WIA State News	
Editor's Comment .....	2	VK1 News .....	31
Gridsquare .....	47	VK2 News .....	32
Hamads .....	54	VK3 News .....	33
HF Predictions .....	52	VK6 News .....	32
Silent Key .....	37, 40	VK7 News .....	36
Spotlight on SWLing .....	50		

## Our Cover this month

"Radio has been an important part of just about all Antarctic expeditions since Sir Douglas Mawson took a spark radio station to Macquarie Island in 1911". Women are now very much part of the team. The cover picture shows Donna Simpson at Casey station (AAD photo 35589C1, Copyright C of A 1994). The background shows the VHF Antenna array at Davis, February 2003. (Photo by N. Storey. First published in "Aurora", the ANARE Club Journal Vol 22 No 4 page 8, in an article on VHF Radars at Davis.) See story page 27.

## Contributions to Amateur Radio

Amateur Radio is a forum for WIA members' amateur radio experiments, experiences opinions and news. Manuscripts with drawings and or photos are always welcome and will be considered for publication. Articles on disc or email are especially welcome. The WIA cannot be responsible for loss or damage to any material. A pamphlet, How to write for Amateur Radio is available from the Federal Office on receipt of a stamped self-addressed envelope.

## Back issues

Back issues are available directly from the WIA Federal

Office (until stocks are exhausted), at \$4.00 each (including postage within Australia) to members.

## Photostat copies

When back issues are no longer available, photocopies of articles are available to members at \$2.50 each (plus an additional \$2 for each additional issue in which the article appears).

## Disclaimer

The opinions expressed in this publication do not necessarily reflect the official view of the WIA and the WIA cannot be held responsible for incorrect information published.

## Amateur Radio Service

A radiocommunication service for the purpose of self-training, intercommunication and technical investigation carried out by amateurs; that is, by duly authorised persons interested in radio technique solely with a personal aim and without pecuniary interest.

## Wireless Institute of Australia

The world's first and oldest  
National Radio Society  
Founded 1910

Representing

The Australian Amateur Radio  
Service

Member of the  
International Amateur Radio Union

Registered Office of the WIA

10/229 Balaclava Road  
Caulfield North Vic 3161

Tel: (03) 9528 5962 Fax (03) 9523 8191  
<http://www.wia.org.au>

All mail to

PO Box 2175 Caulfield Junction VIC 3161  
Business hours: 9.30am-3pm weekdays

### Office staff

June Fox Bookkeeper  
Rita Trebilco VK3IF Examinations Officer

### Board of Directors

President	Michael Owen	VK3KI
Vice President	Ernie Hocking	VK1LK
	Glenn Dunstan	VK4DU
	Trevor Quirk	VK5ATQ
	Ewan Mcleod	VK4ERM
	Ted Thrift	VK2ARA
	Phil Walt	VK2DKN
Secretary	Peter Nalsh	VK2BPN
Treasurer	David Pilley	VK2AYD

### Coordinators

AMSAT	Graham Ratcliff	VK5AGR
ARDF	Jack Bramham	VK3WWW
Awards	Mal Johnson	VK8LC
Contests	i.b.a.	
John Moyle Memorial		
FD Manager	Denis Johnstone	VK3ZUX
Editor "AR"	Colwyn Low	VK5UE
Education	Ron Smith	VK4AGS
EMC/EMR	Gilbert Hughes	VK1GH
	Keith Malcolm	VK1ZKM
Standards	Gilbert Hughes	VK1GH
	Peter Nalsh	VK2BPN
FTAC	John Martin	VK3KWA
Historian	t.b.a.	
IARU Region 3	Nell Penfold	VK8NE
Liaison Officer		
Intruder Watch	Henry Andersson	VK8HA
International	John Miller	VK3DJM
Travel Host		
ITU Conference and study group	Gilbert Hughes	VK1GH
	David Wardlaw	VK3ADW
	Keith Malcolm	VK1ZKM
QSL Curator	Ken Matchett	VK3TL
QSL Manager (VK9/D)	Nell Penfold	VK8NE
Videotapes Curator	VK2 Division	
Web page co-ordinator	Colin Thompson	VK2TRC
WICEN	John Weir	VK3ZRV

### ACA Liaison Team

Peter Nalsh VK2BPN,  
Gilbert Hughes VK1GH  
Keith Malcolm VK1ZKM  
Peter Mill VK3APO  
Glen Dunstan VK4DU

## Editorial Comment

Colwyn Low VK5UE

# How things are done in the real world

### Greetings to all our readers.

The WIA is now working on the details of how it will operate. There are still lots of things to be ironed out and there is still a lot to be understood about how things can be done in the real world.

The ACA review outcome is being worked on. I have had a few comments from readers about how the privileges can be appropriately distributed between the proposed three licence grades. Please pass all comments to the Directors, but please also make some suggestions as to how your personal view of the licence grades could be implemented.

I have also had brought to my attention some of the problems of buying equipment either through the Ham Ads in AR or on the Internet. The advertiser has a responsibility to those who answer their advertisements. There needs to be a commitment to being civil and to appreciate the fact that the prospective purchaser is interested in purchasing your equipment, so if it is already sold just pleasantly say "Sorry it has gone" and thank them for their enquiry.

Further if you offer to sell a Deceased Estate remember you are going to get a lot of calls which can get irritating. One final point you have to be very clear about the conditions of the sale, if you say it works then you could be up for fixing it if it does not work when received by the purchaser. So make sure the items are carefully packed with foam or bubble wrap to reduce shock and vibration in transit.

This month I have had the perennial problem of what to put on the cover. I am always on the hunt for good clear pictures, which have a bit of equipment and possibly some people with it. This month I am grateful to the Department of Environment and Science, Antarctic Division in Kingston, Tasmania for the cover picture. Next month's cover comes from the Department of Veterans' Affairs.

So please see if you have a good picture for the cover preferably in Portrait orientation and either a photograph for me to scan or a digital picture at 300 dpi, a jpeg or tiff file about 500 kb should do. With any scanned or digital original please let me have the original as well as any processed image you think presents better. In cooking terms we cannot unscramble the egg if there are problems in the preparation.

My activities this month, the few spare moments I have are on my FM-828 conversion to 50 MHz. Ordered the crystals for 52.525 MHz and then on receipt found I had used a divide by 6 for the TX crystal instead of 8 !!!!!!!!. So back to Beacon Crystals, at Craigmore, up the road from me for the correct crystal and sort out a X3 +X2 oscillator unit circuit to use as a marker/beacon with my surplus crystal.

Finally, the change to the national WIA from the federated WIA is still poorly understood by some members. We could have continued the discussions at grass roots level for a few more years or as we did, have the Divisional Councillors at the Federal Convention decide to bite the bullet and get on with an agreed constitution and a general set of aims. We are now on the way. Some things are easily done, others are much harder than at first thought. However Australia needs a NATIONAL Amateur Radio body. In 2006 we will have a better idea of how things are and for the first time members will have a national ballot to elect the Directors. We will continue to publish each month in AR comment on current WIA activities. News from Q-News and state news broadcasts will bring weekly reports. So please pass your concerns to the Directors and stick with us through the initial teething problems.

Colwyn VK5UE



## WIA adopts revised position in response to the ACA "outcomes of the review of amateur service regulation"

### The following statement is made on behalf of the Board of the WIA:

On 17 June 2004 the WIA Board published a statement in response to the ACA paper "Outcomes of the Review of Amateur Service Regulation".

The Board was very careful to acknowledge in its statement the consultation process adopted by the Authority, and generally supported the outcome.

It did however express concern at the extent of the differentiation between the privileges of the new standard level (novice) and the advanced level licenses and the incentive to up-grade, and at the same time pointing out the difficult position it found itself in, probably offending either the novice licensees or other licensees, depending on whatever it did or did not do.

In the end, the Board decided to advocate the removal of the 14 MHz band from the proposed standard (novice) licence privileges.

This decision, published through broadcasts and various web sites has caused considerable comment, both in favour of and against the proposal. The comments are appreciated, and helpful.

The Board has accordingly reviewed that decision, having regard to the various comments it has received.

The following matters are seen by the Board as being particularly relevant to its considerations:

- The WIA has been informed by the ACA that it sees no reason to review its basic policy decisions, for example its decision to adopt a three-tier licence structure for the amateur service rather than a two-tier structure as suggested by the WIA;
- In any event, a significant number of amateurs support the basic three-tier structure proposed by the ACA;
- The extent of the differentiation between the standard and advanced

licence remains a matter of concern to the Board;

- However, the position suggested by the WIA in respect of the 14 MHz band is, on the face of it, inconsistent with the position it adopted in its original submission, though that position was adopted in the context of a two-tier structure;
- While views are split, there are many full and novice licensees who do not support the proposal.

In light of the ACA position, the Board does not consider it either useful or appropriate to seek to reopen the basic policy issues, though it is confident that it will have adequate opportunity to make submissions on the many very important implementation issues and the issues left open in the Outcomes paper.

The Outcomes paper proposes that the small WARC bands and the 1.8 MHz band continue to be restricted to the advanced licensees, as it is understood that they are viewed by the ACA as being bands appropriate for access by more highly qualified licensees. The Board sees that approach as providing some differentiation, but in itself not enough.

The Outcomes paper also proposes that Australia participates in CEPT Recommendation T/R 61-01, and when that occurs, it can be assumed that the visiting advanced licensee will have privileges that the other classes of Australian licence do not have.

At the same time the Board will lodge a further and expanded application for spot frequencies around 5 MHz, building on the application initially lodged last February by the Council of the Victorian Division. The Board believes that given a strong proposal from the WIA this suggestion will be seriously considered by the ACA.

In addition, the allocation of a LF band, as in New Zealand, is also being

pursued, and other privileges may from time to time be identified for the advanced licensee, furthering the differentiation.

The Board believes that this approach would be more acceptable to many than the original approach in respect of the highly attractive 14 MHz band.

Accordingly, the Board has decided to accept the ACA position, which provides 14 MHz band privileges for the standard (novice) licensee.

In this statement, as with its earlier statement the Board has addressed only what it perceives as the major issue flowing from the outcome. There are very many other issues of detail that have been drawn to its attention.

As it said previously, the Board is confident that it will have the opportunity to address these issues in an ongoing process of consultation with the ACA as part of the process of preparing a new LCD and generally addressing the detail of the implementation of the restructure.

## A Comment

**This revised Statement made by the Board represents the product of much consideration and discussion. It sets out a position supported by all Directors.**

**I acknowledge that others may have different opinions. Indeed, in this issue of AR, Jim Linton expresses his own and different views.**

**However, I hope that the fact the Board of the WIA was prepared to listen to constructive comment, and no doubt to the disappointment of some, change its position will be seen as being constructive, and a step along the path of reinvigorating our hobby.**

# The EH antenna

## - Part 4

### The EH dipole antenna with the L+T and Star type of matching and phasing networks

Lloyd Butler VK5BR

In my previous articles on the EH antenna, I have mainly concentrated on the antenna which uses a matching and phasing circuit network defined as the L+L network.

I will now discuss two other methods of matching and phasing used by the EH Antenna inventor, Ted Hart W5QJR. Ted has called these methods the L+T system and the Star system.

In the L+L antenna, I described how two E fields were formed, the primary field from a voltage developed differentially and a secondary field from a 90 degree phase shifted voltage developed longitudinally. (Displacement current from the secondary E field generates the H field in phase with the primary E field). In the L+L antenna the two dipole cylinders are fed by the balanced form of the L+L network. However in the L+T and Star antennas, the lower cylinder is connected directly to the 50 ohm coax shield and the system is unbalanced. Clearly, the idea of one field voltage developed differentially

and the other longitudinally does not apply to these antennas and a different explanation must apply.

### The L+T System

Figure 1 shows a typical L+T network with component values taken from the EH Antenna Calculator on the EH Internet site. The values were set for a 14.1 MHz EH dipole with 9pf of capacitance. The L+T name becomes apparent when L1 is considered as two separate inductors for the L and the T sections combined. The network is particularly applicable to an EH antenna which Ted Hart has called the Backpacker and which he and an associate have distributed in kit form throughout USA. The series antenna radiation resistance for this antenna has been defined by Ted as around 30 ohm.

Photo 1 - 40 metre Star EH Antenna manufactured by Arno Electronica (Photo courtesy Of Julie Fubbri & Steve Galastri of Arno

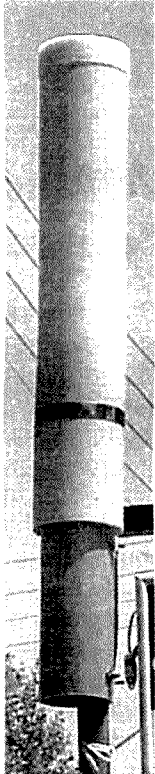

To understand the network better, I have broken down the complete network into individual L sections which are coupled together. (See figure 2). To do this, L1 and L2 are each split into two separate inductive reactances in series and C2 is split into two separate capacitive reactances in parallel. (The reactance values when combined closely fit the reactances derived from original form of Figure 1.)

The first L network, C1-L1A forms a match from the 50 ohm input to 25 ohm at A. The second L network L1B-C2A forms a match from the 25 ohm to 200 ohm at B. The third L network C2B-L2A forms a match from the 200 ohm to 34.5 ohm at C. (Reactance values are easily calculated from formulae in the VK3IY article, reference 5). If the source at the input looking back into the coax cable is 50 ohm resistance, then looking back from C into the network will be 34.5 ohm resistance.

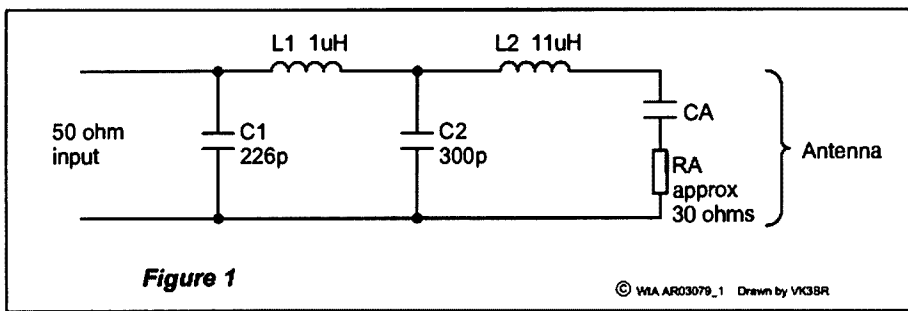

Figure 1 - The L+T matching and phasing network.

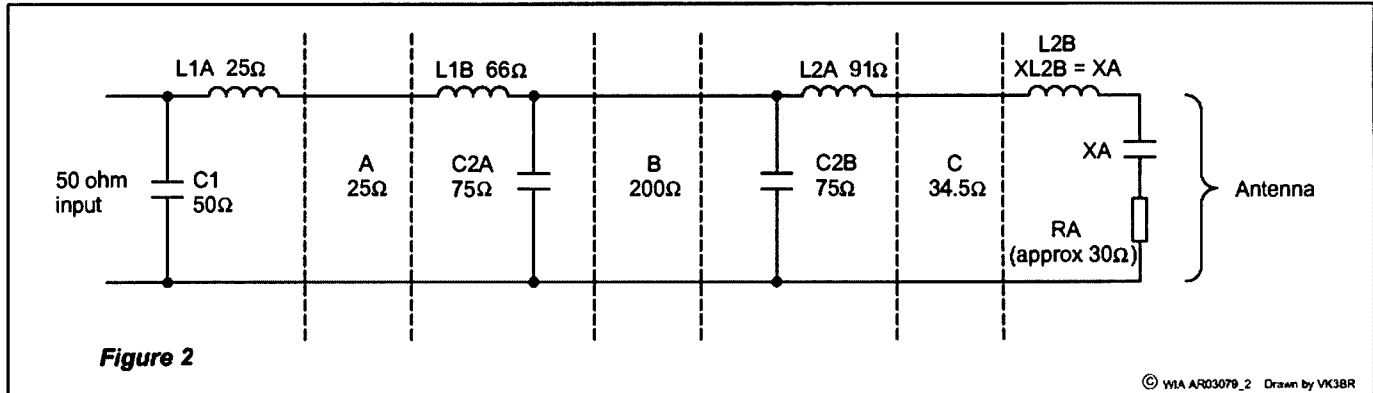

Figure 2 - The L+T network broken down into separate L networks and last antenna resonating inductor.

Now we come to L2B. The reactance of L2B is simply made equal to the antenna capacitive reactance XA so the antenna is then resonated and the output of the network at C sees a resistance equal to the sum of the radiation resistance and any loss resistance (mainly in the inductor).

## The secondary E field

The next question is how do we get a 90 degree phase shift and how is a secondary E field applied. As the network at C looks as a resistance, we can substitute it for a resistive source feeding a series resonant circuit formed by L2B and XA as in figure 3.

A characteristic of this circuit is that there is a 90 degree phase shift across the inductor. There is clearly a primary E field developed by the potential between the top cylinder and the general common reference of the bottom cylinder and coax shield. My theory is that there is also a 90 degree phase shifted secondary E field formed between the potential on the inductor around the vicinity of the C junction to the common reference. As in the L+L antenna, the displacement current from this secondary field generates the H field in phase with the primary E field.

In using this method of generating a 90 degree phase shift, an interesting characteristic is that it only works if the source is resistive. In figure 4 an inductive reactance has been added to the source. Observe that to bring the circuit to resonance, the inductive reactance of L2B must be less and the phase shift across it must be less than 90 degrees.

I have tried operating the tuned antenna directly from the 50 ohm coax cable. It seemed to me that as the

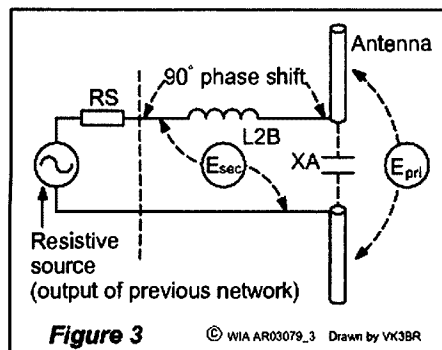

Figure 3 © WIA AR03079\_3 Drawn by VK3BR

Figure 3 - 90 Degree phase shift developed across series resonating inductor and resultant potentials to develop two E fields 90 degrees phase separated.

antenna resistance was about 30 ohm, the mismatch would not be that great. This actually worked but the interaction between antenna tuning and movement of the cable (as experienced on other EH antenna systems) was particularly high. I formed the opinion that the preceding elements of the L+T network were needed to provide a coupling buffer to reduce this effect. However, even with the buffer, reactance at the source can reflect through to cause some shift of phase in the series tuning inductor.

Concerning source reactance, one interesting bit of history concerns field tests carried out on a Backpacker EH antenna by Adam Macdonald N1GX. He found that when he eliminated the coax feed to the antenna and substituted a local battery powered oscillator at the antenna, the radiated field strength dropped dramatically. He (and others) concluded that this showed most of the radiation from the EH antenna was due to its feeder coax. However, Ted Hart strongly argued that the antenna was phase sensitive to the source and that the local oscillator had a reactive source impedance which upset its operation. The difference of opinion was never resolved except that results from my own tests, with out-of-balance current on the coax inhibited, did not support Adam's conclusion. (Refer to my previous articles in AR).

## The Star antenna

Ted Hart's more recent version of matching and phasing of the EH dipoles is illustrated in figure 5. He has called this the Star. Basically it works much the same as in figure 3 except that instead of injecting the source signal in series with the resonating inductor, the signal is coupled in by magnetic induction and the coupling to set the matching is controlled by the position of the input

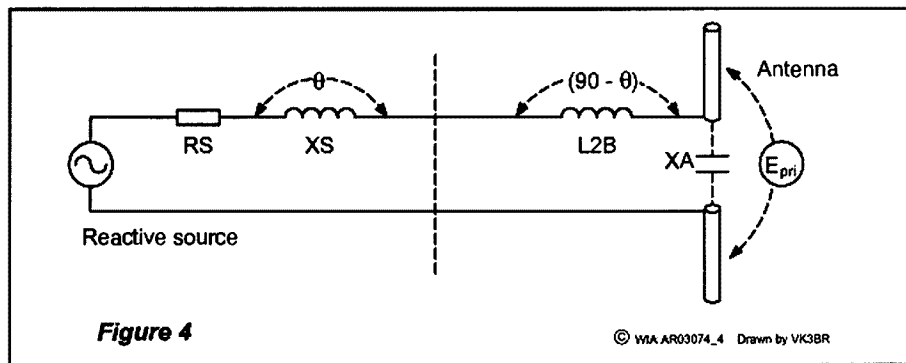

Figure 4 © WIA AR03074\_4 Drawn by VK3BR

Figure 4 - Effect of reactance added to source series resonating inductor now has less than 90 degrees across it.

tap. As in figure 3, the primary E field across the dipole cylinders is 90 degrees phase shifted to that at the inductor input and there is a 90 degree phase shifted secondary E field between that point and reference common connected to the lower cylinder.

To get the thing working with the 90 degrees phase shift and low SWR reflected to the 50 ohm coax cable, there seems to be a need to add a small amount of inductive reactance in series with the input tap and a small coil is added as shown in figure 6. I haven't tried to evolve a theoretical explanation but I have confirmed the need for this on my own test antenna with SWR meter connected and monitoring of phase with the CRO across input and output of the network.

## An experimental 20 metre Star matched antenna

To carry out some tests on the Star matching idea, I assembled a rough model for the 20 metre band as shown in figure 7. More detail is given in the following text:

I put to use 600 mm length of 62 mm diameter PVC tube which I had on hand. Over this I fitted two metal sleeves 65 mm in diameter and 70 mm long to form the dipole cylinders. These were spaced 70 mm apart.

An open wound coil from the junk box was fitted at the bottom of the PVC tube, 130 mm down from the bottom of the lower cylinder. The coil, with a diameter of 50 mm, was wound with 22 turns of 18 SWG tinned copper wire space to a length of 80 mm. The spacing enabled it to have sufficient room between turns to tap the coil where required with crocodile clips. To obtain a good match, I found that 15 turns for the top tap and

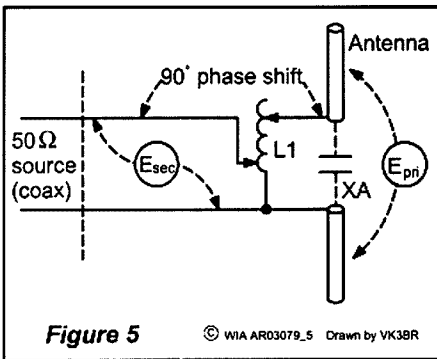

Figure 5 - The Star EH matching system showing 90 degrees phase shift and the two E field potentials developed.

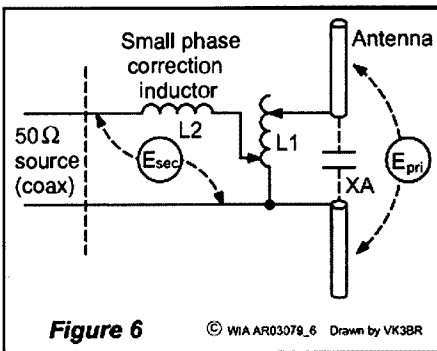

Figure 6 - The Star antenna matching with additional series phase correction coil added.

4 turns for the lower input tap was close to the mark.

To locate the coil in place, a second PVC tube, 45 mm in diameter was fed as a tight fit through the centre of the coil and into the main PVC tube. The two PVC tubes were held together with the aid of three wood spacing pieces and self tapping screws. The coax input connector was located at the bottom of the smaller and lower tube.

The input series coil (a later addition not originally planned) was made up of 8 turns of 20 SWG tinned copper wire open wound to a length of 30 mm and with a diameter of 20 mm. The coil was left to float in space with one leg soldered to the 4 turn tap on the main coil. I found best matching was achieved with the other end tapped at 6 turns.

As an engineered example, my matching assembly would hardly take a prize but it enabled me to adjust the coil taps and carry out operational and performance tests as I needed to do.

### The Star preference

Ted Hart seems to be concentrating on the Star method of feeding the EH antenna as the now preferred method for amateur radio use. Both the L+L and

of the L+T models include two variable capacitors which are adjusted to tune up the antenna. In the Star method, resonance is with the self capacitance of the antenna and there are no tuning capacitors used. Ted has stated that he considers this less difficult for the radio amateur to get the antenna working. However it does seem to me that unless the design information is tied down to very rigid specifications, there is a need for some means to easily adjust the position of coil taps to tune the antenna right on the dot. Tying down adjustments to fixed positions is also made more difficult if the out of balance current in the coax is not inhibited with a trap and tuning is allowed to interact with the placement of the coax.

So there is a challenge here. What is the design of a coil with accessible taps which can be fitted around the supporting PVC tube and which can be easily assembled by the radio amateur with limited workshop facilities?

### For those who may wish to purchase an assembled EH antenna or a kit

I asked Ted Hart the market situation for supply of ready made EH antennas or kits for the amateur bands as at the date of preparation of this article (December 2003). The following is information he supplied:

George Jones KA4Q in USA continues to supply kits for the 20 metre Backpacker (L+T) antenna. George believes it is easier for a Ham to adjust the screws on the capacitors than to adjust the inductance of the \*STAR\* version. Although George is associated with EH Antenna Systems, he is doing this on the side from that company. However information on his antennas can be found at the EH Antenna Web site sponsored by the company (reference 6).

Steve Galastri IK5IIR of Arno Elettronica in Italy (Reference 7) now supplies Star type EH antennas for the 40, 80 and 160 metre band. With no tuning capacitors needed, they handle powers of 2 kW of SSB and 500 W of continuous power. However he still makes L+L type antennas for the higher frequency bands. A typical Star antenna for 40 metre is shown in figure 8. Observe the metal sleeve on the outside

of the protective cover used to fine tune the adjacent coil inside.

A new company (yet to be named) led by JA3FR in Japan will introduce \*STAR\* versions for the 80, 40 and 20 metre bands very soon. The 80 metre version contains a small motor and tuning slug to allow coverage over the range of 3.5 to 4 MHz and it has the

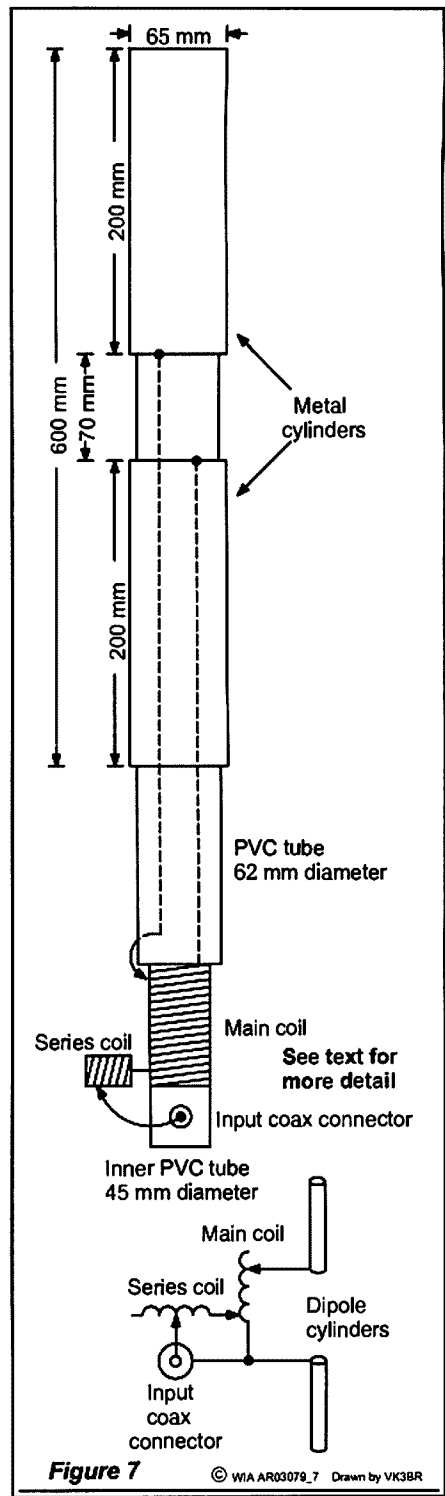

Figure 7 - An experimental 20 metre EH star antenna.

## The National WIA and the clubs

On 16 May 2004, when the Federal Council adopted the new Constitution for the Wireless Institute of Australia, there were about 69 clubs that were members of the WIA, that is, members of a Division.

Let me make my position in respect to clubs quite clear, a position that has not really changed for very many years. I believe that a strong national amateur society is essential. That is why I have done what I have done to help develop a new national WIA. But, at the same time, I believe that clubs are essential, as they can do what an organisation such as the WIA (whether structured nationally, or as it was, federally) cannot do. The club provides a meeting place, a place for projects, a place to participate in amateur radio as it should be, a place to attract new amateurs, a place where the voice of amateurs can be heard, and listened to.

Indeed, in this country, there are clubs in the far north Queensland, in the Northern Territory, and in other parts of Australia where the only focus for amateurs is the radio club, and where the WIA is about as remote as it can be.

While I accept that the WIA may be physically remote, it should not be meaningless, and that is what the Board of the WIA has identified as a need. It is

an area for which I am taking personal responsibility.

What is the position of clubs under the new Constitution?

The rights of "affiliated clubs" are set out as follows:

"An Affiliated Club:

- (i) may describe itself on its letterhead and other material as an Affiliated Club of the Wireless Institute of Australia;
- (ii) may be represented at any general meeting of the Institute;
- (iii) may participate in any conferences or meetings conducted by the Institute for the benefit of Affiliated Clubs;
- (iv) shall not be liable to pay any annual subscription; and
- (v) shall not have any vote as a Member."

To treat a club as an ordinary member doesn't make sense. If there are 4,000 members of the national WIA, a club with 150 members having one vote is not meaningful. Anyway, we want clubs with 150 members to make sure that their 150 members are also members of the WIA.

Hopefully, this approach will not encourage individual amateurs to say that they did not need to be a member of the WIA as they were a member of a

club that was a paying member!

However, we do want affiliated clubs to be in a special position.

But what is an "affiliated club"?

That is where it gets hard, because the Constitution says that the Board of the WIA shall define the criteria for a club to become an "Affiliated Club" of the Institute. We have to define the criteria. And we haven't. And, we can't. At least, not now.

We need the clubs, but we don't really know what the clubs need from us.

That is why I hope to be invited to visit as many clubs as possible over the next months, to hear what the members of clubs say about the national WIA, what it should do and particularly, how the clubs and the WIA should relate to one another, and what should be the criteria for affiliation.

But what about clubs until we do work out that relationship?

The new Constitution does not simply cast aside the clubs that were members of a Division on 16 May 2004. The clubs that were members of a Division on 16 May 2004 are now "Provisional Members" of the WIA. That means that they will continue with a relationship with the WIA, until we have addressed and resolved the issue.

ar

## The EH antenna *continued*

extended cylinders to allow high angle radiation. Ted says these antennas have very high efficiency and he is very impressed with the prototypes he has received.

### Summary

The article follows on from my previous articles in Amateur Radio to include some theory on how the L+T and Star versions of the EH Antenna work.

I am sure that if you contemplate making one of these forms of antennas, or even purchasing one, you will ask which one should I choose. All of the antennas generate out of balance current on the coax feeder which, if you desire, can be stopped with a trap. Personally, I like the L+L version as it is the nearest arrangement to a balanced antenna. It goes against my grain to see one leg of a dipole directly connected to the shield of an unbalanced transmission line as in the L+T and Star versions. However

the dipole legs are isolated if you use a trap as I have discussed in a previous article.

Clearly the inventor (Ted) sees an advantage in getting rid of tuning capacitors and the problems of capacitor breakdown when using high power. (This is particularly important to him for work he is doing on antennas for high power broadcasting). Hence his more recent concentration on the Star antenna development.

However from an amateur constructor's point of view, I favour the opinion of George KA4Q that it is easier for the radio amateur to adjust some capacitor screws than taps on a coil. Furthermore, there is the construction problem of how to easily make the coil with adjustable taps.

### References

1. *Construction of an EH Antenna for 20 & 40 metre* - Lloyd Butler VK5BR - 'Amateur Radio', April 2003.

2. *More Information on the EH Antenna & how it has performed* - Lloyd Butler VK5BR - 'Amateur Radio', November 2003
3. *How much power is actually radiated from Longitudinal current in the EH Antenna?* Lloyd Butler VK5BR - 'Amateur Radio', Date??
4. Various Articles on the EH Antenna by Lloyd Butler VK5BR - Web site <http://www4.tpgi.com.au/users/lbutler> or link from <http://www.qsl.net/vk5br>
5. Graham Thornton VK3IY - *An L of a Network* - 'Amateur Radio', March, April and May 1995.
6. The EH Antenna Web Site (Sponsored by Ted Hart W5QJR) - <http://www.eh-antenna.com>
7. Stefano (Steve) Galastri IK5IIR - Arno Elettronica - <http://www.eheuroantenna.com>

ar

## Test Equipment

Autek WM1 2 KW  
peak reading  
wattmeter



Autek RF1 HF  
Antenna  
Analyzer

Autek RF5 VHF/  
UHF Antenna  
Analyzer

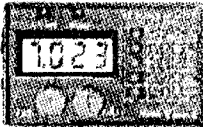

Autek VA1 MF/HF  
Vector Antenna  
Analyzer

Ten Tec HF/VHF  
Dummy Load Kit



Ten Tec HF/VHF SWR  
Power Meter Kit

**LF** Lutron Bench  
top 2.7 GHz  
Frequency  
Counter

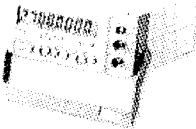

Lutron Handheld 2.5 GHz  
Frequency Counter

### WE SUPPORT WHAT WE SELL!

If you have a problem, our strong relationship with the support divisions of our US suppliers combined with our professional service lab will get your unit quickly up and working to original specs.

We specialise in mail order. Visa and Master Card



## HF Radios



Orion



Jupiter



& Argonaut HF  
Transceivers

Ten Tec  
Commercial  
and  
Professional Communications  
Receivers

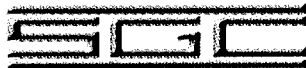

SGC2000 150W  
Professional HF  
Transceiver

SGC 2020  
Portable  
20W HF  
Transceiver



SG 500 HF Mobile 500W Power  
Amplifier



build  
yourself  
kits

(Call for your free  
catalog)

Amidon Iron Powder and Ferrite Products  
(Call for an Amidon product guide)

SGC ADSP<sup>2</sup> Noise Reduction Speakers  
SGC ADSP<sup>2</sup> Noise Reduction Boards (High  
power and low power versions available)  
Power Source switch mode power  
supplies (a wide range of outputs)

Davis Weather Stations  
Professional Grade Coax Feed lines and  
Connectors

Custom RF Patch leads and cables made  
to order

## Antenna Couplers/Tuners

SGC Mac 200

5 Position  
Antenna  
Switch/Tuner



SGC SG235,  
SG230, SG237,  
SG239 and SG211

Automatic Antenna Couplers

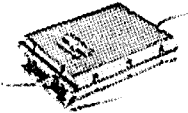

Z100

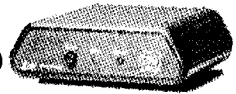

and AT1000  
Automatic  
Antenna Tuners

## Antenna

SGC QMS Quick Mount  
Mobile antenna system  
with built-in tuner



SGC Stealth Kit. All you  
need to get HF on air  
quickly.



SGC SG 307  
7 foot Mobile/Marine  
Antenna

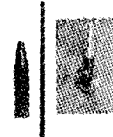

SGC SG 303 9 foot Mobile Antenna

## RE-SELLERS

Tower Communications, Perth  
International Communications  
Supplies, Port Adelaide  
Strictly Ham, Bayswater  
Marcom Watson, Launceston  
Nixon Communications, Gladstone,  
Rockhampton & Mackay  
Seabourne Electronics, Townsville  
Brian Swinton Electronics, Cairns

DETAILED DATA SHEETS ARE AVAILABLE ON REQUEST FOR MOST PRODUCTS.



# TTS Systems Communications Equipment

Systems **FREE CATALOGUE**

[www.ttssystems.com.au](http://www.ttssystems.com.au)

HF and VHF Transceivers, Autotuners and Kits

Phone 03 5977 4808. Fax 03 5977 4801 [info@ttssystems.com.au](mailto:info@ttssystems.com.au)

# Trying to receive the digital SW (DRM) broadcasts

By Brian Tideman VK3BCZ  
24 Baird Street  
Mulgrave Victoria 3170

In the Feb 2003 issue of AR, there was a brief report "Digi Radio Experiment" encouraging amateurs to monitor the continuing DRM test transmissions. As I seem to be the only registered user in Australia providing reports to the web page of Global Reception reports, I thought that it might be useful to report on my findings so far.

## What is DRM?

DRM stands for Digital Radio Mondiale which is the new digital radio standard recently accepted at WARC for use by SW Broadcasters. (Unfortunately, the USA is trialling an alternative system called IBOC and so may not be very interested in the project.) Test transmissions commenced in earnest early in 2003. The February report said that "Radio Amateurs and serious broadcast-band listeners have been invited to become part of the DRM Software Radio Project."

My interest had originally been aroused by reading an article about DRM reception methods in the December 2002 issue of Elektor magazine. Participation required a modest outlay (about \$100) for the decoding software which runs in the sound card of a PC. The difficult part for many is that the receiver needs to have an IF bandwidth with a flat response to at least 10kHz and an outboard converter fitted to convert the usual 455 kHz IF down to 12 kHz +/- 5 kHz, for processing and demodulating in the sound card.

I decided that I would not purchase the software until I knew that I could receive the DRM "noise" signal and had a suitably modified receiver available. After deciding that the FT100 was not suitable for modification to the IF, I decided that the 1986 vintage Yaesu Musen FRG 9600 VHF/UHF receiver was probably easier to modify. It also appeared to have a wideband AM filter which made it attractive. I subsequently found that the width of the wide IF was only 6 kHz. However, I then realised that I could switch out all the 455 kHz IF filters and rely on the 15 kHz filters in the 10.7 kHz section to define the bandwidth. This has worked out well, although

giving slightly too much bandwidth. The next problem was constructing an up-converter using a 53 MHz crystal together with a simple transistor mixer and the broadband RF amplifier from Drew Diamond's HF receiver/converter published in June 2002 AR. The final change was to arrange for the 12 kHz IF. I think I managed this more neatly than using the recommended outboard converter. I simply replaced the USB ceramic oscillator with an LC network (the L was from a Toyo IF transformer) substituted for the ceramic resonator and tuned to 443 kHz to provide the required 12 kHz offset. A reduction in the value of filter capacitor on the output of the ring demodulator was all that was required to finish the conversion to ensure that the output response was flat to about 19 kHz.

After downloading the software and running the set-up every Saturday and Sunday when the 15400 kHz signal was beamed especially to VK and ZL, I found that I could only demodulate the data channel "RNWB English - Information - Audio AAC mono 14.5 kbps". The DRM software gives a spectrum display (12 kHz wide approximately centred on 12 kHz) and also displays the measured signal to noise ratio. This was typically 8 to 10 dB. Decoding to program audio seemed to be occurring at a SNR of about 10 dB. Meanwhile a log file is generated showing the number of synchronising and audio frames recovered per minute together with the measured SNR.

The good news was that I finally achieved 18 dB SNR thereby ensuring a much needed "fading" margin, but only after making several more changes. First, I obtained a better sound card. (I found that the recommended Sound Blaster 5.1 card realised about 2 dB better SNR than

the original CMI card) Then I wired up a manual RF gain control. This improved the SNR by a notable 5 or 6 dB. From reading about some of the other stories of receiver conversions for DRM on the DRM web pages, I found that a slow AGC response was required to avoid distortion of the phase of the multi-carriers (the FRG 9600 AGC response much too fast at about 1 msec) and that the attainable SNR is limited if the local oscillator has

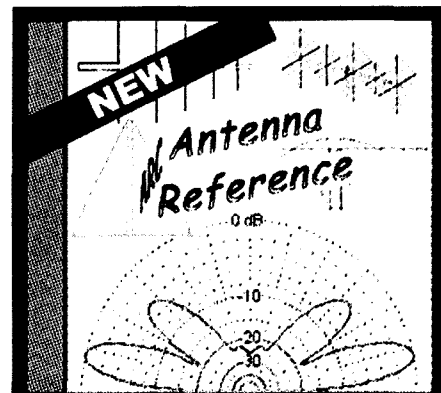

## Antenna Reference CD

Antenna basics, Radiation patterns,  
Transmission lines, Impedance matching,  
Built-in calculators and more!

**Only A\$35.00 (approx US\$25.00)**  
plus p&h

**ENQUIRIES WELCOME**

Discounts for upgrades & club members

**Michael Todd Computers &  
Communications**

15 Conifer Street, Maddington  
Western Australia 6109  
Ph: 0407-089-308

E-mail: [sales@arcompanion.com](mailto:sales@arcompanion.com)  
<http://www.arcompanion.com>

a poor sideband phase noise response. I was not surprised to find when I used an audio spectrum display program to look at the IF output when receiving a test crystal oscillator, that there were hum and other low frequency sidebands present only 35 dB down. The hum components could be eliminated using a DC power supply. However, the residual phase noise (due to the older design of the frequency synthesiser) seems to be the main contributing limiting factor. I have therefore had to be content with the performance obtained so far with this receiver.

At one stage, I realised that my amateur multi-band antenna was end on to the Antilles in the Caribbean where the Radio Netherlands transmitter site is located. I decided to try a temporary dipole cut for 15400 kHz. Certainly the signal was then more than 10 dB stronger and mostly strength nine. However, tests with an external attenuator proved that changing the incoming signal by as much as 20 dB did not make much change to the measured SNR. This seemed to confirm that the deficiencies in my old receiver were responsible. Consequently, I am now testing a more conventional crystal locked HF down-converter which will drive directly into the 10.7 MHz filter stage of the VHF receiver. I am confident that eventually this receiver set-up will at least enable maximum DRM decoding performance (and SNR) to be obtained by eliminating

the sources of local oscillator noise.

Examples of reception can be found at <http://www.drmtx.org/analysis.html> and clicking on "view reception results."

Another interesting site for reception reports is the one run by a New Zealander, Chris Mackerell at <http://www.owdjim.gen.nz/chris/radio/DRM/DRM.html>

Here you can see his DRM spectrum screen dumps, his reception comments, audio and log files. He is certainly a very keen monitor of the DRM test broadcasts. His results have been excellent when the received signals have been of adequate strength.

## What does the recovered audio sound like?

When the SNR is above the demodulator threshold of about 10 dB (when the digital stream of 14.5 kbps is being used in a 10 kHz bandwidth), the audio response is crisp and noise free. There seems to be a buffer of about two seconds being employed. When the signal fades below the threshold, the audio gracefully "shudders" on its way out. Other transmitting services use rates of up to 20 kbps which can support either stereo or mono and sometimes multi-channel data services. Several of these can be selected, when available, using the supplied software.

## What is the future for DRM?

As for DAB and Digital TV, it all depends on what additional services the new system will provide. It is difficult to see how, in the countries where SW radio is depended upon for alternative world news, users will be willing to pay very much for new good performance radios that include the DSP for DRM reception built-in. It is understood that the DSP chips and radios will start to become available by the end of 2003. It is hoped by the DRM consortium and others, that mass production of cheap receivers will usher in this "new age of digital broadcasting" which eliminates the old bug-bears of phase distortion accompanying fading of the signal. However, I suspect that unless there is a considerable signal margin, that this distortion will at least partly be substituted with drop-outs. This might at least be more pleasing to the ear than the old analogue system. Only time will tell. And then there is IBOC from USA which is intended to be more "compatible" because of its mix of analogue with digital on the one signal!

If you are interested, look up the DRM web pages, or satisfy your curiosity as I did listening for the DRM "noise" signals according to the published broadcasting test schedules. The best signals in Australia and New Zealand are on 15400 kHz every Saturday and Sunday from 0430 to 0530 UTC. If you can afford to purchase the software, then find a suitable wideband receiver that can be modified to provide the 12 kHz IF output and have a listen.

If you are serious enough to try decoding a DRM broadcast on the HF bands and do not have a receiver with relatively flat 10 kHz bandpass, I have several 12 kHz bandwidth ceramic filters type CFW455F available. Please enquire by email to [bgtideman@hotmail.com](mailto:bgtideman@hotmail.com).

Also interesting is that digital broadcasters in Australia might soon be allowed to use the digital systems' multi-channel capabilities. You can see from the screen dump that the DRM system also allows for, and is indeed sometimes utilising, multiple programme channels and even stereo audio. There is usually a text message visible when the SNR is sufficient (greater than about 11 dB) to allow audio decoding.

Happy DRM-ing!

The screenshot shows the DRM Software Radio 1.0.21 interface. On the left is a spectrum display with a vertical axis for dBFS (0 to -100) and a horizontal axis for Hz (-4000 to 4000). The display shows a noisy signal centered around 0 Hz. To the right of the spectrum are control buttons for 'Start Record', 'Setup', and 'About'. Below these are three service selection boxes, each currently showing 'no service'. At the bottom left, contact information for Mr Brian G Tideman is displayed. At the bottom right, a status bar shows '<< waiting for text message >>'. The interface also includes a volume control slider and a status section with radio type (RNWB), language (English), and audio format (AAC mono 14.5 kbps).



# EGARC at Point Hicks

By Linda Stanford VK3VLS

East Gippsland Amateur Radio Club made the journey to Point Hicks Lighthouse on the weekend of August 16th and 17th, 2003 to participate in the International Lighthouse Weekend. During the weekend, amateur radio operators all around the world travelled to various lighthouses and attempted to make as many contacts as time and conditions permitted. There were operators working in approximately 45 different countries at over 290 lightstations, including 25 lighthouses in Australia.

The trip to Point Hicks was a new venture for the club and proved to be very successful. Six members and one very junior member made the trip to Point Hicks. The first to arrive, Rob VK3EK, set up an inverted L on two squid poles with an auto tuner and established communications on 80 metre. This was followed by a J pole which gave communication on 2 m FM through the local FM repeater at Mt Nowa Nowa. Using the club call sign of VK3EGC, Rob attempted to make contact with operators who were also setting up for the Lighthouse Weekend as well as other club members who were still on the road to Point Hicks. Battling poor atmospheric conditions, communication was at times very difficult and all members hoped that Saturday would show an improvement.

***One highlight of the weekend was spotting a passing whale that obligingly approached within a few hundred metres of the tip of the Point, giving members a clear and close-up view of a mature humpback whale.***

The base was at one of the historic assistant lighthouse keepers' quarters literally in the shadow of the towering Point Hicks lighthouse. This lighthouse, built in 1890, is the tallest concrete lighthouse in Australia and is positioned at the point where Captain Cook's lieutenant, Zachary Hicks, first sighted Australia in 1770. EGARC members set up two workstations in the enclosed north-facing veranda that proved to be a wonderfully comfortable and sunny spot, handy to the kitchen and all civilised amenities.

At midday Saturday, the event officially started. By this stage, members had set



Point Hicks Lightstation: EGARC base was in the house on the right-hand side.



East Gippsland Amateur Radio Club members at Point Hicks: L – R Melanie, Des VK3DMP, Rob VK3EK, Maurie VK3VLR, Mark VK3MOA with Andrew in front.

# Talking Lighthouses

Looking back at ILLW 2003



Des VK3DMP making some running repairs

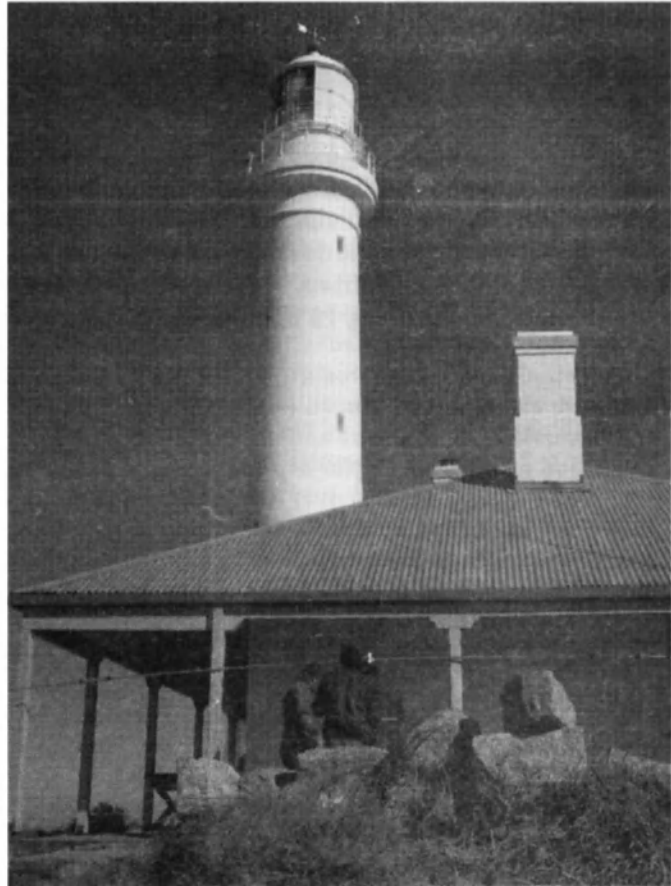

Point Hicks Lighthouse and EGARC base for International Lighthouse Weekend.



Rob VK3EK operating at Point Hicks Lighthouse base



Setting up antennas at the EGARC base at Point Hicks Lighthouse



Rob VK3EK and Maurie VK3VLR solving a small technical difficulty

# Working in the Light

**The East McCrae Lighthouse – AUS-067**

**The Cape Schanck Lighthouse – AUS-045**



Carl Schlink VK3EMF  
September 2003

Two years ago, whilst scouting around for lighthouses with suitable venues to operate from, I came across the East McCrae Light and was immediately drawn to it as a candidate for activation.

The unpredictability of the weather and our reluctance to brave the elements should the worst conditions eventuate ruled out an open air operation, so the field of "candidates" was somewhat narrowed and it looked to me that McCrae would suit our needs admirably. Its proximity to the McCrae Yacht Club, with all the potential attributes that it had to offer, providing of course the Club was amenable to our proposal, had nothing whatsoever to do with its selection. Although cynics among you may beg to differ after reading of our expedition.

Glenn VK3CAM and I had already decided to team up for our third ILLW, and Marty VK3MF and Joe VK3BKI (both veterans of the Troubridge Island Light expedition last year) joined us for McCrae/Cape Schanck.

With our arrangements confirmed I registered two lighthouses on the ILLW participants' website – the McCrae Light (AUS-067) under my call VK3EMF and the Cape Schanck Light (AUS-045) under Marty's call VK3MF.

The two Cushcraft R5s were erected at opposite ends of the building, one fixed to some scaffolding and the other perched on top of Marty's Land Cruiser and guyed. The G5RV was strategically raised up as high as we could get it, initially using a squid pole as the support mast, but as the wind picked up it

tended to bend and roll around considerably so we moved it from the car park onto the lawn in front of the Club. The vertical for 2 metre was mounted on the balcony handrail and all the cabling was channeled into the club rooms... we were ready to roll.

*continued next page*

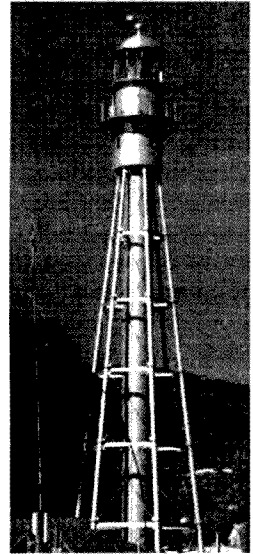

East McCrae Lighthouse

## EGARC at Point Hicks *continued*

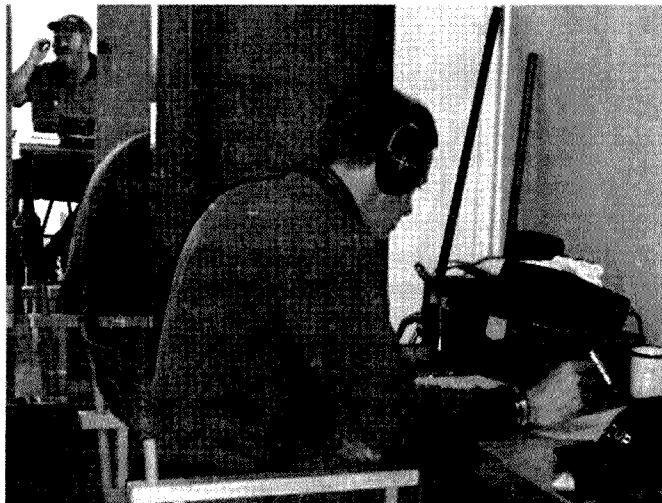

Des VK3DMP operating at the base with Rob VK3EK reflected in background

up two triband HF antennas to work 20 m, 15 m and 10 m. The rigs used were Icom 706 Mark 2Gs and, thankfully, conditions on 80 m had improved vastly from the difficult conditions experienced the previous night. The world boomed in from lighthouses all over the world.

By the close of the weekend, contact had been made with light stations in all states of Australia except Western Australia and the ACT. International contacts were made with Lithuania, France, New Zealand, Cuba, Israel, Japan, Asiatic Russia, Denmark, Algeria, Slovenia, Estonia, Hungary, Switzerland, Portugal, Germany, Austria and the USA. Most of these contacts were participants in the International Lighthouse Weekend but some were interested home station contacts who became involved in the Weekend although they were not stationed at a lighthouse. Two operators worked simultaneously, with frequent changeovers to enable everyone to enjoy the glorious weather and the unique environment at Point Hicks. One highlight of the weekend was spotting a passing whale that obligingly approached within a few hundred metres of the tip of the Point, giving members a clear and close-up view of a mature humpback whale.

Members who participated were Rob VK3EK, Des VK3DMP, Mark VK3MOA, Linda VK3VLS and Maurie VK3VLR together with Melanie (Mrs Des) and Andrew (junior Des).

Following the success of this venture, members are already planning a return to Point Hicks to participate in the 2004 International Lighthouse Weekend.

ar

# Talking Lighthouses

## Looking back at ILLW 2003

**"Will we do it again? You bet we will, it's just a matter of which lighthouse we select to activate next year."**

Two metre checked out OK, as did the FT7 and the FT757 and last, but by no means least, Glenn's "Big Bertha" IC 775 was operational too.

What an experience day one was, the weather was quite splendid, the hospitality superb, the company was great with the added bonus that band conditions were pretty good as well. Four out of four isn't too bad! It was as close to perfection as we could've hoped for.

Glenn, Marty and myself shared the microphone while Joe worked the key. It was a pleasure to see an ex merchant marine radio officer in action – almost poetry in motion.

The day wore on and we had to make the best of the bands before the RD Contest began, as we knew from past experience that once it got started it was going to be tough going for the ILLW participants. During the day several members of the Yacht Club dropped in for a chat and showed a lot of interest in what we were up to. Interestingly, a couple of them were not only hams but ex members of the EMDRC whom Joe knew.

As dusk approached, the yacht club working bee wound up for the day and so did we. It was great to be told that if we wanted another crack at it in the morning someone would be on deck to open up for us. We accepted the offer, indicating it would only be for a couple of hours as we planned to activate the Cape Schanck Lighthouse on the way back to Melbourne.

On the recommendation of the Commodore we booked into the Admiralty Motel for the night.

The next morning as hunger pangs set in, the little café across the street raising its shutters for the day's trading looked mighty attractive. We sat down to a large breakfast with some very good coffee to go with it.

With the batteries recharged we traipsed back to the Yacht Club, which by now was open, and set everything up again for a couple more hours operating. Not a great deal of activity took place in the morning session and pretty soon we were packing up again and looking forward to Cape Schanck.

By the time we got to the yacht club,

the wind was stronger and actually blowing a little sand around. However, undaunted, we got the FT7 and the FP4 power supply set up on Marty's tail gate and fired up the Honda generator. One of the Cushcraft R5s was again mounted and guyed atop Marty's beast and in no time we were ready for another session. This time it was the "real McCoy" as far as field operations are concerned. We soon found out that no operation is as simple as it should be; the generator was not only generating, but also producing a hash problem in the FT7. We tried moving it further away, two extension leads away in fact, but there was still no change. We realised that there was nothing else we could do and switched it off, resorting to a 24 AH battery that Marty had had the foresight to include.

After a few hours we moved on to Cape Schanck. We had trouble making contacts from Cape Schanck and in the end resorted to CW only, and even that was very marginal. Two hours of wind and worsening conditions forced us to pack up yet again, this time for the trip home.

I guess you could sum up the weekend away by saying we had a lot of fun, met some terrific people and had a great time. The fact that the ILLW is not a competition, but a get-together of like-minded amateurs around the world to celebrate centuries of the great work done by lighthouses and their keepers in keeping mariners safe, made it all the more enjoyable.

We finished the ILLW having contacted eighteen lighthouses around the world



**The Gruesome Foursome**  
This was taken inside the McCrae Yacht Club  
L to R in the pic: Joe VK3BKI, Carl VK3EMF, Glenn VK3CAM & Marty VK3MF.



Carl VK3EMF presenting Guy Bancroft, Commodore of the McCrae Yacht Club, with an EMDRC Banner as a token of our appreciation.

as well as many "ordinary" amateur operators. This year (2003) there were some 370 registered lighthouse stations participating in around 48 countries, up slightly on last year.

Will we do it again? You bet we will, it's just a matter of which lighthouse we select to activate next year.

Our thanks go to Commodore Guy Bancroft and members of the McCrae Yacht Club for the hospitality and assistance that their members extended to us. We were made to feel most welcome and were given the full, unconditional use of their facilities.

ar

# An experimental SSB generator from junk parts

Donald Howarth VK6JDM

While preparing for the AOC examination I set out to build a single side band transmitter and receiver that could be used as my station once I obtained a licence. One of the aims of the project was to recycle a 1.65 MHz crystal filter I had from a long dead commercial transceiver. Now that H.F. is becoming a little outdated in the eyes of many in the bush and with the RFDS no longer taking radio-phone calls such transceivers seem to be piling up in rural communications equipment repair shops and go quite cheaply.

Another aim was to be able to experiment with modifications to each section of the circuit and to compare various circuits with each other as I went. This meant that all the circuits were developed in ugly construction style making modification quick and easy and eliminating the need for production of printed circuit boards. The transmitter was developed

in modules each of which had a copper clad box and each of which joined its neighbours via B.N.C. connectors and coaxial cable, this enabled rapid swapping of modules and enabled a module to be tested on the bench independent of the rest of the circuit. Only the V.F.O. was made without a box of copper clad circuit board as this

made it easier to arrange the mechanics of tuning the variable capacitors. As all the other modules were enclosed in boxes any stray V.F.O. was kept out of the rest of the circuit without physically enclosing the V.F.O..

The heart of a single side band transmitter is the balanced mixer. Various standard mixer circuits were tried but

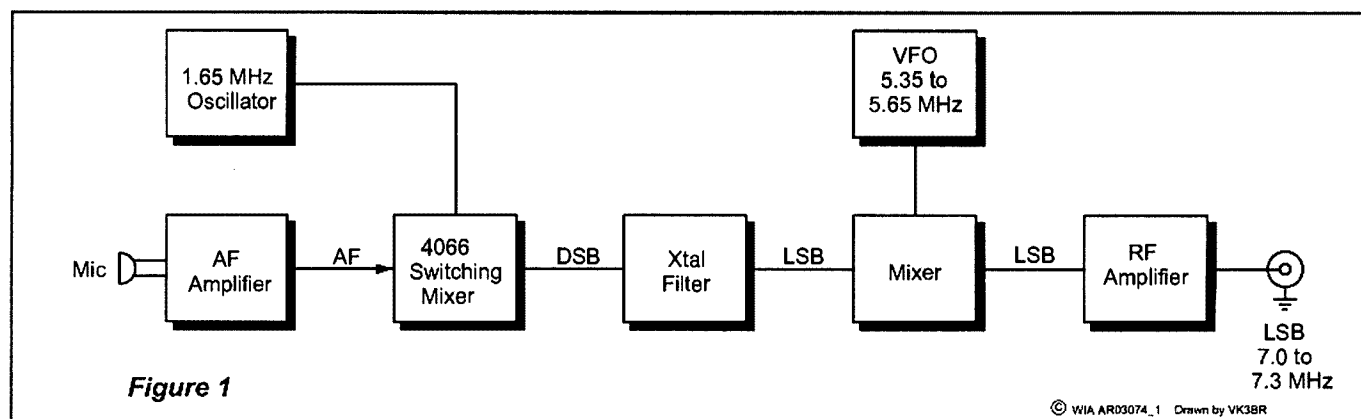

Fig 1 – Block diagram of the SSB (LSB) transmitter.

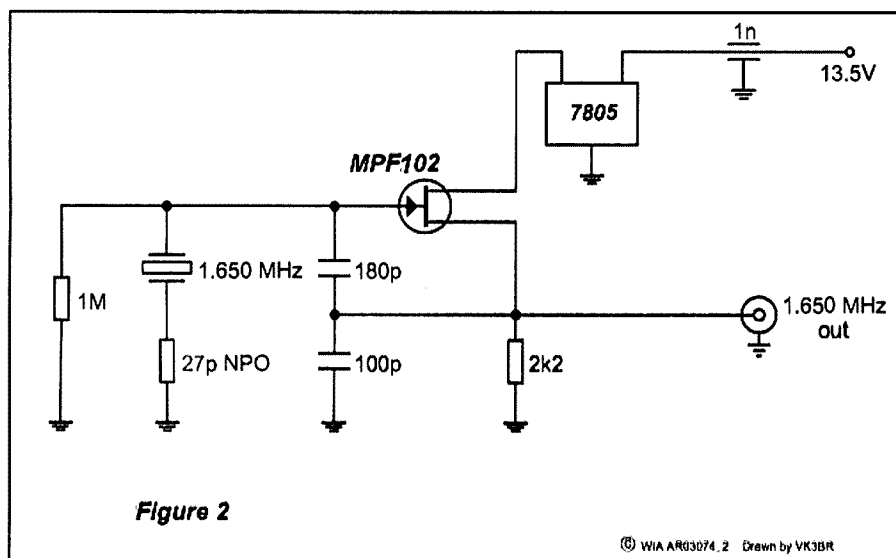

Fig 2 – Module 1 – 1.65 MHz oscillator.

all tended to produce a signal with an easily detectable carrier component. I did not want howls of derision when going to air with a single side band plus reduced carrier as a signal. I had already produced a couple of switching type frequency converters for a receiver. These were of the type used in recent circuits by Diamond and Parker in A.R. over the last two years. By running one of the circuits back to front with audio being applied at one end a very clean double side band signal was obtained. After running that D.S.B. signal through the crystal filter no carrier frequency could be detected on a receiver pushed to its dynamic limit by the power of the S.S.B component of the signal. After a few teething problems, on-air reports confirm a clear clean signal with no apparent carrier.

The circuits of the modules used to generate the 1.65 MHz lower side band signal are set out in the diagrams. The power supply for the circuit is a 12 volt car battery. The 1.65 MHz signal is mixed with a 5.35 to 5.65 MHz signal to produce a 7 to 7.3 MHz final signal. The circuits for this mixer and the subsequent linear amplifier are still undergoing refinement and may be published later.

Module 1 is a straightforward crystal oscillator that uses the original crystal salvaged from the dead transceiver. This circuit is built in a small box of soldered-together pieces of copper clad circuit board. Likewise the audio amplifier is a very conventional circuit. The microphone is from an old Yaesu

FT 301. The third module is the double side band mixer. This uses a 74HC04 chip to convert the sine wave output of the oscillator into two 180 degree out-of-phase square waves. These square waves operate the switches in the 74HC4066 chip and result in the audio signal being applied to the output transformer alternately as a positive and negative signal 1.65 million times a second. The result is a D.S.B. signal with no carrier. No problem was found with mounting the two 74HC chips on their backs with the leads pointing up, those leads that were to be earthed were simply gently bent down and soldered to the copper clad board.

The output transformer of the D.S.B. mixer consists of two 37-43 toroid cores

stacked on top of each other with the windings consisting of 30 turns of trifilar wound 30 AWG enamelled wire twisted at a rate of about one twist per cm.

The crystal filter module uses a Hy-Q QF01602 crystal filter from an old Codan 6924 transceiver. That filter was popular in many SSB transceivers produced 15 to 40 years ago. The Hy-Q website does not list this filter which is clearly obsolete so it was not possible to determine in advance the correct terminating impedance. The arrangement shown in module 4 however worked satisfactorily provided the L.S.B. output was fed into a high impedance following stage such as the gate of a field effect transistor. When tested with a sweep generator and oscilloscope the filter displayed

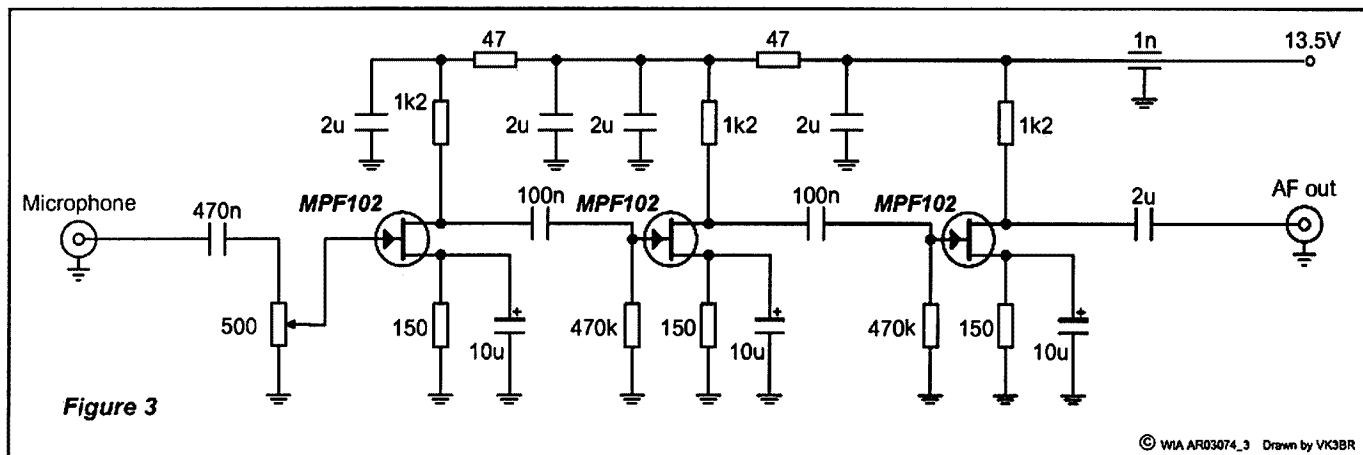

Figure 3

© WIA AR03074\_3 Drawn by VK3BR

Fig 3 - Module 2 - AF amplifier.

# Cable and Connectors



- RG58C/U Belden 8259 @ \$0.90 per metre
- RG213/U Belden 8267 @ \$4.45 per metre
- RG8/U Belden 9913 Low Loss @ \$5.15 per metre
- RG8/U Belden 9913F7 High Flex Low Loss @ \$5.55 per metre
- RG8/U - RF400 Belden 7810 Low Loss Sweep Tested to 6000MHz @ \$6.30 per metre



- RG58: B80-006 UHF connector (M) @ \$7.65 each
- RG8/213: B80-001 UHF connector (M) @ \$8.80 each
- RG213: B30-001 N connector (M) @ \$9.10 each
- RG8: B30-041 N connector(M) @ \$14.00 each

## connektron

ABN 19 413 484 007

email [sales@connektron.com.au](mailto:sales@connektron.com.au) or Phone (03) 9761-5220

connektron Pty Ltd, 45 - 49 Merrindale Drive, Croydon South, Victoria 3036

[www.connektron.com.au](http://www.connektron.com.au)

- All prices include GST
- Minimum order value \$50 payable by Visa, Mastercard, Bankcard or Money Order
- Packing and Delivery \$15 within Australia (Outside Australia P.O.A.)

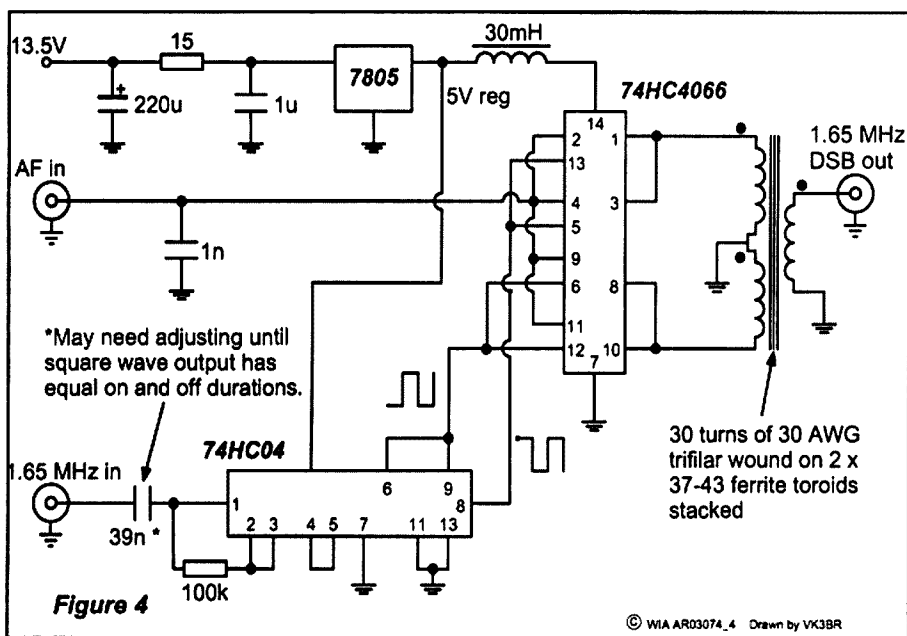

Fig 4 - Module 3 - DSB mixer.

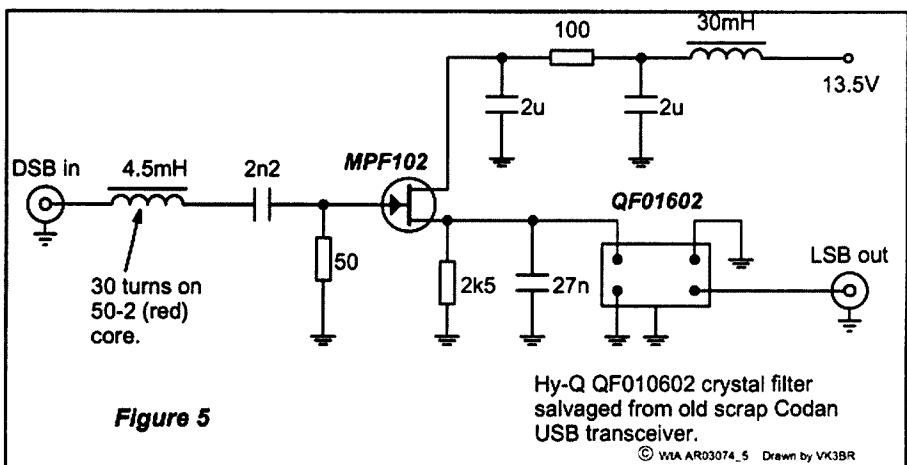

Fig 5 - Module 4 - Crystal filter.

steep sided response with about 1 dB of ripple.

The QF01602 was used in upper side band equipment and this transmitter, being for the 40 metre band is a lower side band device. The equipment it came out of generated a 1.65 MHz lower side band signal then mixed that with a frequency 1.65 MHz higher than the final signal. This process turned the lower side band signal into an upper side band signal. By mixing the 1.65 MHz lower side band signal with a frequency 1.65 MHz below the final frequency the final signal remains lower side band.

The photographs show the modular construction with coaxial interconnections. The parts for this part of the transmitter are all readily available from Truscott's Electronic World in Melbourne except for feed through capacitors, which were taken

from old junked equipment. With careful decoupling of the stages using radio frequency chokes and capacitors they are probably not needed. In the rig I am using the circuit described above is housed along with the second mixer and V.F.O in an aluminium cabinet. The output of the second mixer is connected by coaxial cable to a second cabinet, which contains a valve driver and power amplifier stage. These two cabinets are separate to prevent heat from the valve stages heating the oscillators and so causing drift.

I would like to thank Drew Diamond whose articles inspired me to take the plunge and make my own gear, and Peter VK6APZ who proved a great source of old parts and who patiently listened for my initially feeble signals as the project progressed.

# TET-EMTRON

## TE-33 3 ELEMENT 3-BAND BEAM

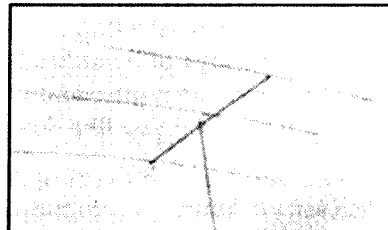

The TE-33 - the most popular tribander, has proven itself in the most severe storm conditions on the Pacific Islands. Its excellent performance and features on all 3 bands such as wide bandwidth, high gain, low SWR and high F/B ratio gives you all the features.

### ED52c

### Wire dipole for 80 and 40.

This antenna can be used as an "inverted V" or just a straight dipole. It is resonant on 80 and 40 but can also be used on 20, 15 and 10 meters. It comes with 30.5 meters of cable.

## Dealers

### VIC

LT Harris 78 Elgin Street Carlton Vic 3053  
Ph 03 93476264 Fax 03 93473629  
Email: ltharris@netscape.net.au  
G&C Comms 207 High Street Cranbourne Vic 3977  
Ph 03 5996 3298 Fax 03 5995 0184  
Email: gccomm@netspace.net.au

### NSW

Emtronics 1/94 Wentworth Avenue Darlinghurst 2010  
Ph 02 9211 0988 Fax 02 9281 1508  
Email: Emtron@ozemail.com.au  
Andrews Comms Shop 8, 41-51 Bathurst St  
Greystanes, NSW, 2145 Ph 02 9636 9060  
Fax 02 9688 4301  
www.andrewscomm.com.au

### WA

Tower Communications 14 Mary Street Hazelmere 6055  
Ph (08) 92741118 Fax (08) 92503734  
Email: tower@eon.net.au

### QLD

Kyle Communications  
668 Lutwyche Rd Lutwyche 4030  
Ph (07) 38574400 Fax (07) 38577825  
Email: mark@kyle.com.au

### SA

International Communications -  
8 Nile Street Port Adelaide 5015  
Ph (08) 84473688 Fax (08) 83411453  
Email: intercom@picknowl.com.au

### New Zealand

The Com Centre  
400 Hillsborough Road Avondale Auckland  
Ph (64) 9 6270084 Fax (64) 9 6271613  
Email: comcent@radioinlo.co.nz

## RAWMAR ENTERPRISES

40 Blackburn Street

STRATFORD Victoria 3862 Australia  
Ph: 61 3 5145 6179  
Fax: 61 3 5145 6821

Email: rawmar@hotmail.com

www.tet-emtron.com

ar

# Simple home brew PCB artwork

by Malcolm Haskard VK5BA

Age often reduces the ability to see fine detail and to hold a soldering iron or any tool steady Thus it becomes more difficult and frustrating to correctly hand wire electronic circuits on general purpose prototype boards (consisting of arrays of holes on 0.1" spacing) and fault find them. Personal experience has shown that the success rate is much higher and the frustration less when a circuit specific PCB is used. This means you are restricted to kits or if you like designing your own circuits you have to produce your own boards.

Some years ago I decided to check out the Microsoft Works drawing program on my computer to see if it would suffice for home PCB design. Although a primitive drawing tool it can produce acceptable quality single and double sided PCB artwork at scale and further, is very simple to use. Here is how it is done!

## Requirements

Five potential problems need to be solved, namely available grid size, how to draw both pads and tracks, adding lettering and generating a simple library of devices.

### a) Grid size

You can select Metric or Imperial (US) units (Control panel; Regional settings; Measurement system), but I normally use the latter. Here the grid size available is in thousands of an inch increments although 10 thou steps is more realistic when a hand mouse is used. If snap to grid is switched on then the grid is much coarser, typically 1/12 inch steps (0.083"). I tend not to use snap to grid, but simply place the viewed X and Y grid lines on the spot where a pad is

needed, much like cross hairs, and the pads will lock to that grid line position. With text, spacing depends upon the font used and this fact can be put to good use as will be seen next.

### b) Pads

The easiest way of doing pads is to use fonts type where the letter "o" (upper and lower cases) or zero is the desired shape (text instruction set). I found four possible fonts of interest and these are shown in Figure 1. You may find others more suitable in the font file on your computer.

The shape and size of the pad may be changed using lower or upper case, plain or bold print or font size. Often I select Newfoundland for it gives a circular pad with a largish hole in the centre for drill positioning, even though there is no difference between upper and lower case "o". As a shortcut, using 12 font size pads can be placed on approximately 0.2" spacing if a space is placed between letters, appropriate spacing for when artwork is done at x 2 size. Gilbert Ultra Bold provides more pad copper area. The other two fonts give greater spaces

for between pins of an IC. To solve the larger oval shaped drill hole, simply place a smaller size Newfoundland "pad" over the top. When laying out pads it is more convenient to set the (text) cursor set to the centre position rather than the usual left side for text.

### c) Tracks

Lines of various styles and points are available (draw instruction set). At x 2 size artwork 4 point is used for tracks in the X and Y direction with 2 point for any diagonal lines (Figure 1). Earth and other large copper areas can be undertaken using the draw rectangle shape and then fill in. When actually laying out the board I initially use the hair line track width option and only when happy with the layout go to the 2 and 4 point track widths.

### d) Lettering

Simply select a font to your liking. I normally use Arial size 10 font, going to size 12 for board identification details.

### e) Library

Very few shapes are required. My library consists of 8 pin DIL package, transistor packages of 3 and 4 pin as well as several two lead component pads of different spacing (Figure 2). These I keep in a separate file called PCB\_LIB.wps and using the copy instruction they can be transferred from this file to any new file containing the layout being undertaken. The horizontal DIL packages are made up of a row of pads using either the Text instruction (Newfoundland font of size 12) alternately typing in an "o" and a

Font type	Printed, lower case "o", Upper case "O", and Zero			
	Font size 12	Font size 14	Font size 18	Font size 24
Bahamas Heavy	o o o	o o o	o o o	o O 0
Gilbert Ultra Bold	● ● ●	● ● ●	● ● ●	● ● ●
Kabana Bold	o o o	o o o	o o o	o O 0
Newfoundland	● ● ●	○ ○ ○	● ● ●	● ● ●

Figure 1 - The easiest way of doing pads is to use fonts type where the letter "o" (upper and lower cases) or zero is the desired shape (text instruction set). Here are examples of four possible fonts of interest.



single space or individually placing them using the grid lines. The latter is a more accurate method. After doing one line of pins, this is duplicated using the Copy and Paste instructions, the second line spaced at 0.6" distance away. A "1" can be typed by pin 1 (Arial font size 10) for identification, but it is sometimes simpler to add this later while undertaking a particular board layout. The two pad lines and "1" are grouped by highlighting the three simultaneously (Point and click to each with the shift key down) and using the Group instruction. If the Text instruction method is used it is difficult to have a vertical DIL package (Text instruction giving 0.2" spacing only works in the x direction) so the rotate instruction for DIL packages does not work correctly.

The art work does not have to be drawn at x 2 size. Many have been undertaken at x1 and while there is a reduction in precision, it does allow direct transfer of the layout to a PCB.

### Printouts and "Negatives"

The output from the drafting phase depends on the board process that has to be interfaced into. Where a positive photo resist is employed a positive artwork is required (copper is printed black). Various grades of tracing paper are available so if x1 artwork is drawn then this tracing paper printout may be adequate to use as the positive. Likewise there are now overhead transparency materials for direct printing from inkjet or laser printers and again positives can be printed direct onto a clear film. The method I normally used was do

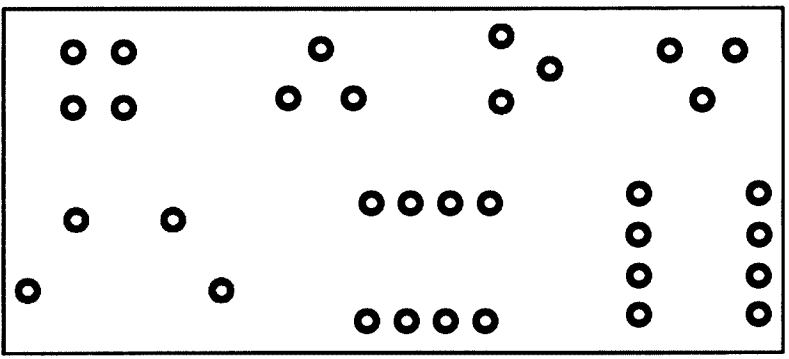

Figure 2 Simple library for circuits drawn at x2 size. Two terminal devices various pad spacing, 4 and 3 pin transistors and 8 pin ICs

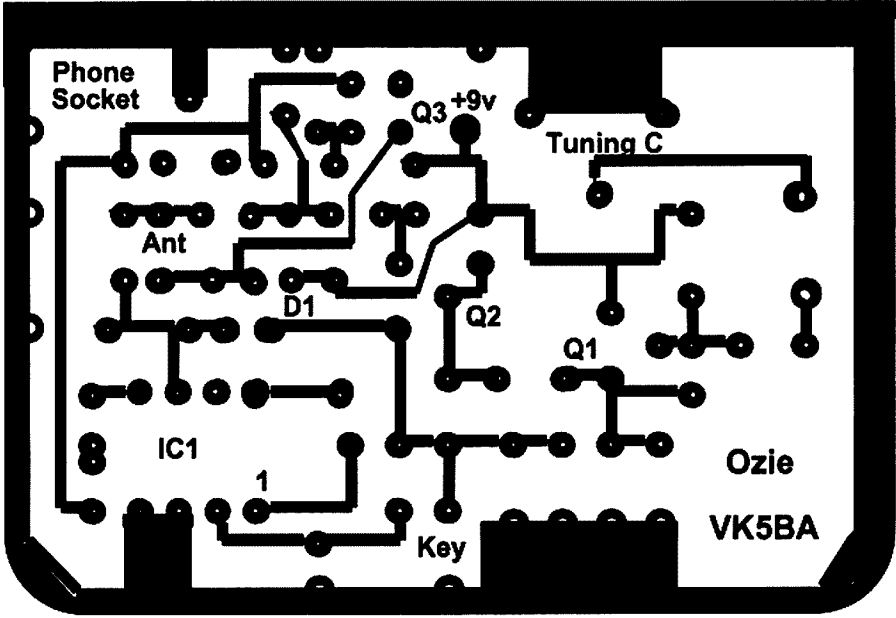

Figure 3 - Ozie, the Australian version of SPRAT magazine's QRP rig called "Pixie". Side tone and frequency crystal pulling features have been added. The phone socket and tuning capacitor mount directly on the card. Trial layout is at x 2 size. Circuit fits into half of a "Strepsils" tin. Layout is viewed from the copper side.

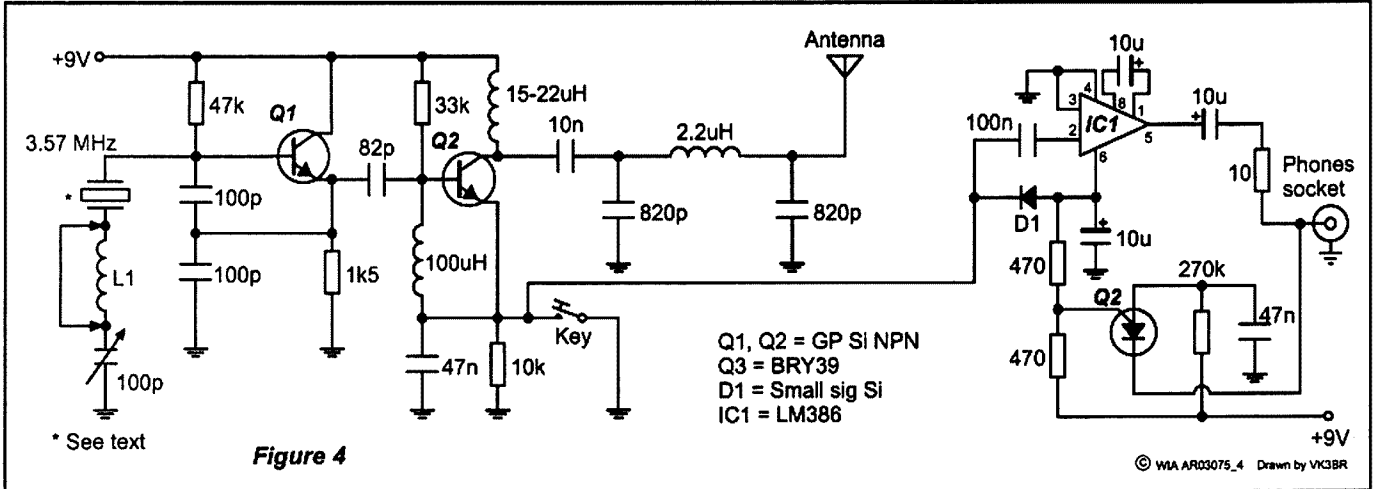

Figure 4 - Circuit details of trial QRP 80 m transceiver, Ozie.

# In Charlie's Way

A short story about a ham, his mates and the CW receiving exam

Ross Fraser VK2WN

## Part 3. 'Battler's test'

The next morning Colin woke up bright and early – before the alarm went off, so it must have been before a quarter to six. The day looked promising, the sun was shining and the magpies were carolling outside. He walked into his kitchen and turned on the kettle and leaned against the kitchen bench yawning and scratching himself. His second operator, Tiger the cat, meowed outside to be let in. As Colin opened the door to let Tiger in the cool morning air struck him suddenly and made him shiver. Almost robot-like he went to the cat biscuit tin and poured some biscuits into Tiger's feed tin.

With his coffee made he wandered into his shack, actually a sunroom adjacent to the kitchen, and switched on his HF radio and also the heater switch. The frequency was still on the early morning chat frequency, where it had

been left, but there were no voices, just a gentle hissing and crackling sound. Colin wandered back to make his coffee and cereal and heard some one talking on the radio. But there was something different about the voice. He recognised it, but it was too clear to be coming from the shack. He shook his head and wondered what was going on. Then he looked down and saw Tiger wandering off to the door.

The figure of Charlie was emerging through the door and his very presence took Colin by surprise.

'Charlie what the hell are you doing here at this hour? You frightened ten years growth out of me....and you scared Tiger...' At that moment Tiger was affectionately rubbing against Charlie's leg.

Colin started to smirk and said: 'Well nothing would frighten that cat....a

pair of 6146s could blow up when he's sleeping on the chair in the radio-room and he wouldn't even flinch'

'Well I thought we could get started with the Morse practice'

'You know I've got to be at work in a few hours'

'You work too hard' Charlie said sarcastically, before saying 'Today is Sunday'.

Colin looked shocked and realised that he was still half-asleep. 'Oh' he said.

It was then that it dawned on Colin that it actually was Sunday - and that was why the radio was so quiet this morning - the net doesn't start till 7am on a Sunday. Colin sheepishly sipped on his coffee and then wandered over to the kettle to make one for Charlie.

**to be continued**

## Simple home brew PCB artwork *continued*

a printout. Most copy shops will do overhead transparencies on a Xerox copier and the x2 reduction can be done at this stage. The process is crude and there are gaps in the black section of the transparency which could give a hair line gap in a track. Consequently two copies of the transparency are used (if a small board then multiple copies can be on the same page so only one transparency is made), one on top of the other, fixed together with sticky tape at the edges. The assumption is that it is unlikely that two gaps will occur at the same location so by combining two there will be no gaps in tracks. Looking through the combined positive at a light to check this is always a wise move.

Where a negative is required a layout using reverse fills must be used. While you can reverse a positive image on the screen I have not been able to get a negative print out. Therefore the simplest thing is to do the artwork with fills reversed. Initially make the whole board black and draw with white objects.

A further and final step is to print an additional copy of the positive and in red Biro free hand draw where components go adding their values or parts number. This helps later with loading a board while it also provides a check of the layout prior to making the board.

## Example

As an example Figure 3 shows the layout of a QRP rig based on the PIXIE circuit from the UK QRP magazine SPRAT (Spring 1996). The circuit here has been modified to include a side tone circuit and tuning, while the PCB has been made of a size to fit into half of a "Strepsils" tin. Called Ozie the circuit is given, with component values for 80 m, in Figure 4. The layout is viewed from the copper side.

With a 3.57 MHz ceramic resonator instead of a crystal no inductor is needed (a shorting link is required) as it can cover a large frequency shift - several tens of kilohertz. However, should a quartz crystal be used then you can

only pull such a crystal a few hundreds of Hertz below its stated frequency. Thus an inductor is needed to maximise the pull range. The inductor allows one to go higher in frequency than the crystal's stated frequency.

## Conclusions

Although primitive, the Microsoft Works drawing routine can readily be used for producing single sided PCB artwork. With lateral thinking double sided boards can also be produced, eg group all pads so you can transfer the whole to produce a pad layout for the second board side to which tracks need only be added.

## Technical editor's note

*Several of the more useful fonts referred to in this article may not be initially available on some of the newer software versions in use today. To achieve the results described above, you will need to install the fonts needed, if not already available.*

ar

# How to stop your bug from walking

Ted Miles VK2FLB

I'm pretty heavy handed when using my bug and for more years that I'd like to say, I've been sometimes holding it with my left hand when sending, or applying a little bit of spit under the rubber feet to get a better grip on the desk.

So I came up with a simple idea (which may also be in use by others) that would enable my bug to act as if it was screwed to the desk, yet remain as if it were floating.

Whichever medium you use as a base, it should be of minimum size but enough coming away from the bug area for the edge of your wrist to rest on and bear weight. Since most bugs will have wiring and screws on the underside, don't make the holes to suit the largest diameter of the tapered round feet, as the screw heads may not let the unit settle fully into the holes and would let the unit slop around when in use. Allow for a smaller hole initially, then ream out or drill larger holes until the unit sinks down and the tapered feet rest firmly in the holes, or drill holes in the base to clear the screw heads. **Note:** In all cases, the feet in the holes must be firm; no slop.

Cutting to size some black 'rubbery/plasticity' material for a mat under the base works well. This 'floating base' will allow you to use your bug 'single handed' comfortably, even on the front seat of a (stationary) vehicle.

ar

Desk 'Floating anchor' bases for bug keys

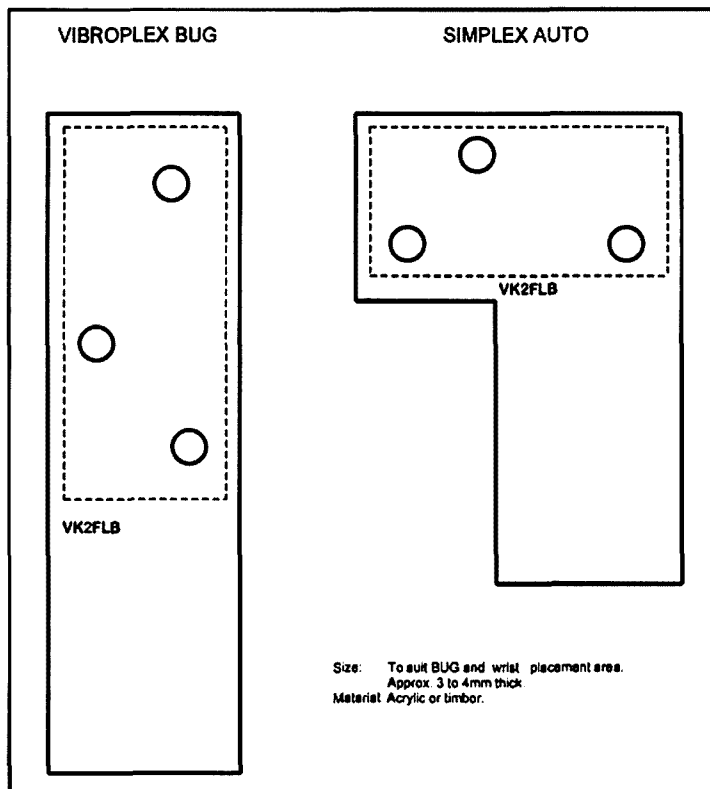
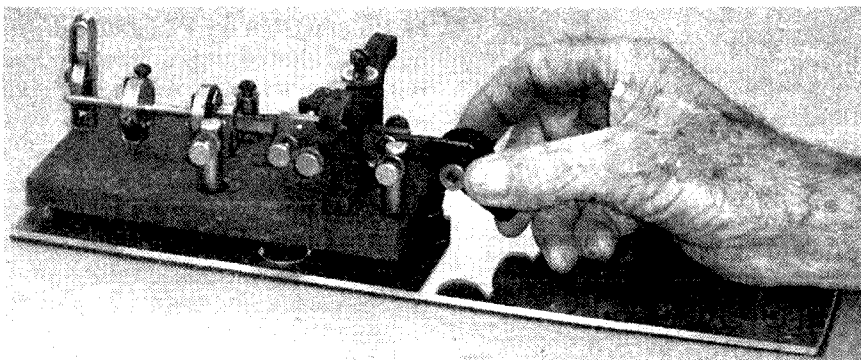
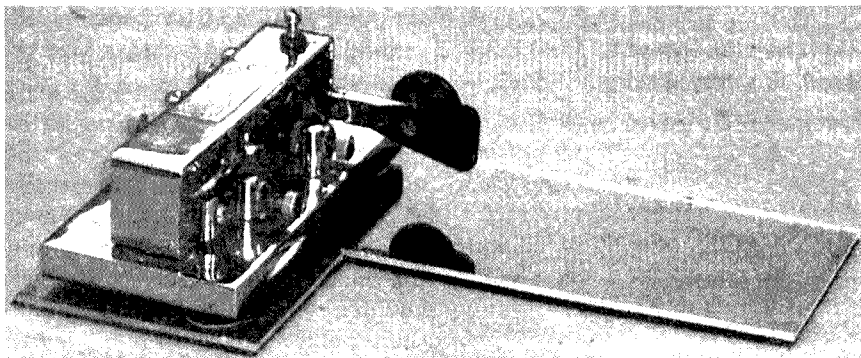

**Send articles to:**  
 AR Publications Committee  
 armag@optusnet.com.au

**Send columns & letters to:**  
 Editor  
 AR Magazine  
 edarmag@chariot.net.au  
 (Tel and Fax 08 8255 2138)

Australian Made  
**ANTENNAS**  
 "Setting a New Standard"  
**COM-AN-TENA**

(Formerly a j and j coman)  
 6 Mulr Court  
 CHELSEA HEIGHTS 3196

All new 5/8 vertical 16 radials	\$160
Dual drive 26-30 5 ele yagi beam	\$315
4 ele 10-11m yagi beam	\$278
5 ele high gain antennas 11m	\$327
3 ele delta loop 10-11m	\$326
11m 5/8 vert./4-1/4 wave radials	\$175
Duoband 10-15 3 ele each band	\$385
Tri-band 5 ele HB35C s/steel fix	\$730
3 ele 20m computer opt	\$420
3 ele 15m computer opt	\$295
M B Vert Auto switch 10-80m	\$330
40m linear loaded 2 ele beam	\$595
6m 5 ele compt opt beam	\$268
6m 7 ele compt opt beam boom - 60mm	\$387
10 ele high performance 2m	\$145
17 ele high performance 70cm	\$125
2m vert 2-5/8 co-linear 4 rad	\$120
Log-periodic 9 ele 13-30 MHz 8.4m boom	\$990
Wire Dipole 10-20-40-80 MHz	RING

**Guyed Masts**

**21 metres**      **13 metres**  
 Winch-up & lift-over. Aluminium and stainless steel  
 three-sided construction. Auto-brake winches.

**Free Standing Masts**

9.5 metres

**New Baluns**

1-1 to 16-1 to 3kW



Our Masts meet Australian Standards. We supply all the computations and data you will need for a permit.

**03 9773 3271**  
**Mob: 0419 542 437**

Andy VK3IV

# Winding a helical whip antenna

Roger Graham (used to be) VK2AIV

**Can you wind up a home-brew HF whip antenna that really works? Yes indeed. And it's easier than you think.**

First there are some decisions to make. How long do you want the whip to be? Common sense says that a long whip will probably perform better than a short one (and it's true). But a 3 metre long antenna is a complete nuisance on the vehicle, and you may be surprised how well you can get out with a much shorter one.

The idea of course is to wind a suitable length of wire in some kind of spiral or helix, all the way up a fibreglass rod. But, how much wire? And how do you arrange for it to be resonant at your chosen frequency? And wouldn't it be nice if the impedance at the base was a neat 50 ohm?

The easiest place to start is with a discarded CB antenna, since it already has the usual metal screw fitting on the bottom (5/16 inch, 26 TPI) The tapered rod makes the calculations a bit slower, but the finished whip looks (and works) like a bought one. An alternative is one of those bright yellow fibreglass rods sold for supporting electric fence wires. They're 10 mm in diameter, and 1500 mm long. Cost about \$2 each when I bought some from a rural co-op store. Less convenient, because you have to make your own brass screw fitting for the bottom end, and glue it on with epoxy cement.

Now, how much wire? The basic formula is  $(256/f)$  metre of wire, where  $f$  is the operating frequency in MHz, provided that the wire is wound onto the rod in the manner described below (see Ref 1). The procedure will give an antenna with a base impedance of about 50 ohm, and resonant very close to the design figure you choose.

How thick should the wire be? Thicker is better, We'll get to that in a minute.

Now pay attention and get this right. Measure the available length of fibreglass rod, and divide it into 9 equal parts. Mark the 9 portions clearly on the rod with a felt-tip pen. Let's agree to call the sections A, B, C, D, E, F, G, H and

I, starting at the bottom. The bottom section (that's A) will end up with only 1% of the total wire on it. The next section (that's B) will have 2%. Section C gets 4%, then D gets 6%. Section E has 7%, and section F gets 9%. Add these up and the total is only 29% of the wire. That leaves 71% of the wire, which will be close wound to fill the top three sections G, H and I.

With that understood, you can now calculate the thickest possible wire to use. It's easiest to explain with actual figures. Suppose you choose to make your 20-metre whip resonant in the middle of the band, about 14.18 MHz. The basic formula gives the required length of wire a  $(256/14.18)$  metre, which is very near 18 metre of wire. And 71% of this will be  $(18 \times 0.71)$  which is 12.8 metre. Suppose further that your fibreglass rod was one of the electric fence kind, 1500 mm long, and you decided that the available length for winding was say 1450 mm.

When you mark off the rod into 9 equal parts, each one will be  $(1450/9) = 161$  mm long, so the top three sections G, H and I will total  $(3 \times 161) = 483$  mm. And since the rod is 10 mm in diameter, the circumference will be  $(10 \times 3.14) = 31.4$  mm. For now, take this figure as the length of 1 turn of wire.

See it coming? You have to wind 12800 millimetre of wire, close wound, onto sections G, H and I. And since each turn is 31.4 mm long, that means  $(12800 / 31.4) = 408$  turns to be fitted into a length of 483 mm. That means each turn can occupy  $(483/408) = 1.18$  mm, and that is the thickest wire you can use. (For example, 18 AWG wire is 1.02 mm diameter.)

If you're a maths whiz, you'll realize that the length of one turn using wire of this thickness will not be the figure we calculated (31.4 mm) since the diameter of each turn, measured to the centre of the wire, will be  $(10 + 1.18) = 11.18$  mm,

Section Number	Length of section (mm)	% of wire in this section	No of turns in this section	Pitch mm
G, H and I (top three sections)	161 x 3 = 483	71	370	Close wound
F	161	9	47	3.5
E	161	7	36	4.5
D	161	6	31	5
C	161	4	21	8
B	161	2	10	16
A (bottom)	161	1	5	32

Table 1

So the close-wound section will end up with fewer turns than you expected, and less inductance too, and the finished whip will resonate a bit higher than you planned. (Sure enough, it does too. Mine came out at 14.9 MHz.) So be prepared for a bit of cut-and-try at the end of the job. I'll explain later.

Table 1 above gives the actual figures for construction of a 20 m whip wound on a simple cylindrical rod.

In real life, you'll probably be using enamelled wire salvaged from your junk box, and making do with the nearest practical size available. Before you go out and buy expensive wire, try dismantling various brush-type motors (a vacuum cleaner is a good place to start). The field coils yield lots of top-

quality undamaged wire, and you may be lucky.

Now for the actual winding. Rule up a little table like the one given, and work out the number of turns you'll need in each section of the rod. The figures given in the table are worked out for the same example that we began with, but using available wire of diameter 1.0 mm. Knowing the number of turns to go in each section, you can work out the pitch of the winding and mark little dots on the fibreglass rod to guide your wind on the wire. It's a fiddly job, but much better than trying to guess the spacing then spreading the turns out

later. If you wind the wire on tightly, as you should, it's hard to push the turns about afterwards.

All ready? Measure out the length of wire. Solder one end onto the metal base of the whip. Tie the other end to some suitable object 18 metre away. Have a few lengths of sticky tape on hand, and some spring clothes pegs, to anchor the winding when the phone rings. Now hold the rod horizontally from left to right in front of your body, and rotate it slowly with fingers and thumbs as you advance along the wire while you wind the turns firmly and neatly into place. Add a bit of sticky tape every so often in case things come unstuck.

All the whips I've made (maybe five or six) have come out near to, but not

# G&C COMMUNICATIONS

Authorised dealer for ● Kenwood ● Icom ● Barrett RFDS ● GME Electrophone ● Uniden ● YAESU

## KENWOOD

### TH-F7E

Amateur VHF/UHF Transceiver



Freq: TX: 144-146 / 430-440 MHz  
RX: 0.1-1300 MHz  
Mode: TX: FM RX: AM/FM/SSB/CW  
RF Power output: Hi: 5/5 W  
Lo: 0.5/0.5 W E1: 50/50 mW  
Volt: Int: 5-7.5 VDC External: 12-16  
Weight: 250 gr (incl lith.-ion batt.)

## ICOM

### IC-208 Amateur VHF/UHF Transceiver



Freq: TX: 144-146 / 430-440 MHz  
RX: 118-1000 MHz  
Mode: TX: FM RX: AM/FM  
RF Power output:  
Hi: 50 / 50 W,  
Mid: 15 / 15 W,  
Low: 5 / 5 W  
Voltage: 13.8 VDC  
Weight: 1.2 Kg

## YAESU

### VX-7R

5 W Ultra-Rugged,  
Submersible Tri-Band  
Magnesium Handheld



Freq: RX: 0.5 - 999 MHz  
TX: 50, 144, 430 MHz Amateur Bds  
True Dual Receive: V-V/U-U/V-U/  
GEN-HAM  
Power Output: 5 Watts 222 MHz:  
300 mW) 6 m AM: 1 W MANY GREAT FEATURES

## ROTATORS

### G450A (shown) G650C, G800DXA



Australia wide orders welcome  
Credit card Cheque Money order

## IC-706 MkII Amateur HF/VHF Transceiver



Freq: TX: 10-160 m + WARC / 50-54 / 144-146 (148) MHz  
Europe (USA) RX: 0.03-200  
MHz all-mode incl WFM  
Mode:  
AM/FM/SSB/CW/RTTY  
RF Power output:  
100/100/20 W

Most popular mono/tri-banders  
**TE series EMTRON HF ANTENNAS**  
Storm tested – Call

## Antenna Tuners

### MFJ 945E – MFJ949E

The auto MFJ 993



and the amazing  
**MFJ 902 Travel Tuner**



207 High St. Cranbourne VIC 3977  
Ph: 03 5996 3298 Fax: 03 5995 0184

Email: [gccomm@netspace.net.au](mailto:gccomm@netspace.net.au)  
[www.gccomm.com.au](http://www.gccomm.com.au)

exactly on, the design frequency. So how do you make adjustments?

- (1) A short brass upstand added at the top of the whip will lower the frequency. A 10 mm upstand lowers the frequency of a 20-metre whip by about 150 kHz. If you've provided a little threaded socket at the top of the rod, you can solder the end of the wire to it, and screw in various lengths of extra metal for fine tuning.
- (2) What if the initial frequency is too low? Removing turns is surprisingly ineffective. You have to take off lots and lots to raise the frequency just a little, but it does work. So you can remove turns at the top.
- (3) Much more effective, if the frequency is too low, is to slacken off the tension a little and slide the close-wound portion towards the top, if there's room. If your fibreglass rod is tapered, this process will tend to loosen the windings, so be prepared with the sticky tape.

## Twin Cities Radio and Electronics Club inc.

### The Riverina Field Day

**Sunday 8th August 2004**

Held at Murray High School on the corner of Kaitlers road and Kemp Street Lavington.

It will be located in the assembly hall.

*There will be a talk on computer technology.*

**Opening times will be 10 am.  
Closing time is 3 pm.**

Food will be supplied by caterer's on site at reasonable prices

Tea and Coffee will be free to everyone.

There are a number of reasonable motels located nearby and in Albury/Wodonga.

On Saturday evening some of the club members will be having an informal dinner at the Albury Commercial Club Bistro where the prices are \$12.00 a head for a very good 3 course meal of your choice.

Contact Patar Praautti VK2CJM  
02 6040 3210 [presutti@tpg.com.au](mailto:presutti@tpg.com.au)

Greg Sargeant VK2EXA 02 6021 6436  
[sarge@ilinet.net.au](mailto:sarge@ilinet.net.au)

Fred Armstrong VK3XLV 02 6026 7360  
[nameat@bigpond](mailto:nameat@bigpond)

If you're trying to measure the resonant frequency of the whip with only your transmitter and a SWR bridge; well, good luck. But if the resonant frequency is somewhere well outside an amateur band, it isn't easy. Much simpler with a dip oscillator and a little RF bridge, as described in an earlier AR article ("An RF Bridge for Antenna Measurements").

When most of the adjustments are made, set the whip up on the vehicle and connect it to the XCVR via a SWR meter. Measure the SWR at various points across the band. (The helical coil of wire at this stage is still stuck down with sticky tape. The heat-shrink tubing comes later). There are some traps for the unwary here. If you make the final adjustments under an overhanging tree, expect the resonant frequency to be a bit higher when you come out into the open later (less top capacitance). If the whip is mounted on the top of a camper-van "pop top", the resonant frequency will be different with the pop-top up. And if you adjust the whip on vehicle A, then move it to vehicle B, the resonant frequency may be different. For example, a whip measured at 14.35 MHz on my Mitsubishi van roof, measured 14.1 MHz on a Toyota bull-bar.

If you make the original whip resonant near the high end of the band, you can easily add little screw-in upstands to the top to bring its frequency down, spot on, to wherever you choose to operate. I have a set of little screw-in pieces, each 10 mm longer than the next, to a total of about 40 mm maximum. Expect SWR values of about 1.2:1 or 1.3:1 at resonance. If you don't provide any adjustments, a 20 metre whip set up for minimum SWR at 14.2 MHz will have an SWR of about 2:1 before you reach the band edge on either side. So providing a range of little upstands seems a good idea.

The whip I've used most was set up for 14.116 MHz, the frequency of the Australian Travellers' Net. In practice, for operation from the CW end of the band up to about 14.25 MHz, it wasn't necessary to fiddle with the tuning at all.

Adding the heat-shrink tubing comes last. It comes in 1-metre lengths in a variety of colours and diameters (DSE and other places). It doesn't seem to alter the resonant frequency much, and in any case you can adjust it with those little screw-in bits, can't you?

Oh yes.. What if your fibreglass rod is tapered, not cylindrical? The calculations for the close-wound sections are much the same, but this time measure the diameter of the rod in the centre of the close-wound part (that is, the middle of section G) and take that as the average diameter for those three sections (G,H and I). And when working out the number of turns for each of the sections A to F, measure the diameter of the rod at the centre of that section, then calculate the average length of a turn for that section. A tapered rod looks much neater and more professional, as you'd expect.

## Case history: an actual example

The table shows actual calculations made when winding a whip on an electric fence spreader of diameter 10 mm, using wire of diameter 1.0 mm. The length of 1 turn was taken as  $(11 \times 3.142) = 34.56$  mm, so the total number of turns would be  $(18000 / 34.56) = 520$

With an available rod length of 1450 mm, each of the 9 sections was  $(1450 / 9) = 161$  mm long.

Wire of diameter 1.0 mm was used because that was what I had on hand, though 1.3 mm diameter would have been ideal for the close-wound section. And sure enough, the extra inductance due to having the turns spaced too closely at the top made the whip resonant somewhere near 12 MHz. The top section was spread gently until the wire was no longer close-wound, but about 1.3 mm centre-to-centre. The whip was now resonant at 14.1 MHz. Spread the turns just a little more... now 14.3 MHz. An adjusting screw of length 15 mm at the top lowered the frequency to 14.1 MHz.

## References

1. Amateur Radio 1977, in a "Forward Bias" feature. Title and author details have not survived the successive photocopying.

I have adapted the original design for my requirements, ie. single band, with 50 ohm impedance to eliminate any need for a coupler.

AR

# The ACA Review of Amateur Service Regulation: a look at the outcomes

A personal view by Jim Linton VK3PC

**The biggest ever reshaping of amateur radio is set to occur early in 2005 following an exhaustive inquiry by Australian Communications Authority (ACA) which released its 'Outcomes' report a month ago.**

The ACA in making its findings public is welcoming comments before moving to the next step of implementation that mostly requires amendments to the Amateur Licence Condition Determinations.

A major victory for the amateur radio fraternity through the review was to have the ACA seriously re-think its proposed draconian "no interference policy". More about that later in the article.

The ACA is still to announce exactly how it intends to move towards the outsourcing of amateur certificates, examinations, the issuing of call signs and other administrative tasks.

The ACA began its inquiry in August 2003 by issuing a discussion paper and holding a series of public meetings. The exercise was primarily aimed at addressing the changes to the International Radio Regulations that resulted from the World Radiocommunications Conference in June and July 2003.

The end to mandatory Morse code tests for amateur licensing meant that the current five licence types had to be restructured. This was an ideal time to also consider the WIA's request for the introduction of a new entry level licence.

Some two-thirds of respondents to the ACA inquiry supported a new licence type for the benefits it promises in stimulating the declining interest in amateur radio. It needs to be made more relevant to today's society and attractive to a wider range of people.

## Foundation licence lacks attractiveness

The ACA has proposed a new licence that is likely, in the opinion of the author of this article, to create a sub-group of people who will not be 'true' radio amateurs in accordance with the ITU definition of the Amateur Service.

The Foundation Licence, as currently proposed by the ACA, is starting to be

seen by some sceptics as a telephony operator's permit.

To market amateur radio it must be treated like a product that can compete with other recreational activities on offer. We live in a digital age and restricting the new licence to voice and hand-key Morse code does not face reality.

A straw poll of secondary school students has found little interest in the proposed Foundation Licence. Why? They are a digital generation into email, mobile phone text and images, and computing generally.

A highly restrictive Foundation licence is unlikely to be an attractive entry point and stepping stone to a higher grade of licence. The failure of the Australian Novice-Limited licence is a lesson of history. The now discontinued Novice licence in New Zealand, introduced later than in VK, also failed for much the same reason.

The non-radio amateurs who responded albeit in small numbers to the ACA inquiry, and others showing interest want a licence that gives them a "taste" of what the wonderful hobby of amateur radio has to offer.

The ACA, rather than specifying voice and Morse code for the Foundation Licence should have stated maximum bandwidth that would allow various transmission emission types or operating modes.

Even the Citizen's Band licence seemingly gives more scope for experimentation. CBers are transmitting data and have a higher transmit power than the proposed 10 W for the Foundation Licence.

While on the issue of power, the ACA

rejected the call for a 100 W PEP level for the new licence, although the power level had majority support. This misses the opportunity to market the hobby to current HF radio users in 4-wheel drive groups and the yachting fraternity who are using similar power levels.

The 10 W limit for Foundation licence holders will also restrict their use of mobile and portable radio transceivers. The experience with 10 W mobile into voice repeater is often inferior due to lower signal strength and flutter.

In an HF mobile operation that universally requires the use of a compromise antenna system 10 W is not sufficient. Taxis, couriers, emergency services and a host of land mobile users run higher power – so why can't the Foundation licensees?

Sure there is new amateur radio equipment that has

10 W output, but to use its availability as part of the justification to relegate the Foundation licence to low power is not justified.

The ACA has not heeded the arguments in support of 100 W. The average amateur station now runs 100 W and, on the ACA admission at its public hearings, only a few hams are involved in alleged interference claims a year.

There are also family implications. Why should the parent of a Foundation licensee have to buy a 10 W rig for their

**Radio amateur rage**  
In excess of 99% of the 1300 submissions to the ACA inquiry said "no" to the ACA's proposed 'no interference policy'. Some 19% only talked about the proposed policy and nothing else, while probably a total of five or six said it was a good policy and urged the ACA to introduced it.

### NOTE

**The views expressed in this article are those of the author, and do not necessarily reflect official WIA policy**

child instead of sharing their existing station transceiver?

The common way of getting on air is to buy a second hand transceiver and the predominately used rig is the standard up to 100 W HF transceiver, with very few of the modern 10 W sets available.

If there are genuine concerns about the potential for interference and EMR issues held by the ACA, then why not a 50 W limit? Inadequate justification has been put by the ACA in support of its rejection of 100 W, which is not high power.

Lifting the restriction on modes, and the power level for the Foundation licence, will open new horizons of experimentation for the entry level licence, and strengthen the amateur radio fraternity by providing it a new generation of radio amateurs.

## ACA's no interference policy

Feeling the full force of "radio amateur rage" the ACA has stepped back from its "original" no interference policy that could have shut down blameless radio amateurs involved in lengthy disputes over alleged interference.

The ACA has conceded that its original approach lacked fairness. Rather than concentrating on the Amateur Service it will now take a general interference management approach across all radio services.

The ACA's Radio Consultative Council (RCC) will task a sub-committee to examine the issue in greater detail and make recommendations.

In theory the ACA still wants to be able to restrict the operation or close down an amateur station because of an unresolved interference complaint. But it is indicating a generally less rigid approach than its original proposal.

The RCC, which includes a representative of the WIA, will develop interference resolution guidelines for inclusion in the Amateur Licence Condition Determinations by the second quarter of 2005.

## ACA review outcomes at a glance

### Licence restructure

Three tier licence system – Foundation, Standard (Novice-Limited and Novice), Advanced (Limited, Intermediate and Unrestricted)

- Foundation licence to have six frequency bands - 3.5, 7, 21 and 28 MHz plus 2 m and 70 cm, 10 W transmit power, phone and CW only. Commercial transmitting equipment only
- Standard licence – the Foundation licence bands plus 20 m, 6 m and three microwave bands, 100 W and all modes
- Advanced licence – as for the current Unrestricted licence

### Syllabus and assessments

- Licence syllabuses to be restructured in line with international practice
- Licence syllabuses to be updated to include electromagnetic radiation (EMR) and more emphasis on interference avoidance, cures and resolution practice
- Foundation licence to have a combined multi-choice exam paper covering safety, operational and regulation issues
- Practical assessments to be passed by candidates for all three licence types
- Either written examinations or progressive assessment method by accredited bodies will be allowed
- The knowledge of Morse code will be deleted from licence syllabuses
- No (minimum) age limit will apply to holders of any of the three licence types
- The ACA will continue to verify the operational and technical qualifications of any person wishing to operate an amateur station

### Callsigns

- Continuance of callsign suffix blocks that identify licence type, and generally maintain the system of state-based geographic numeral indicators
- Introduction of four-letter callsign suffixes
- Australia to adopt the CEPT Recommendation T/R 61-0-1 to allow visitors with a CEPT licence to operate in Australia using their home callsign portable without the need to take out a temporary VK licence
- Advanced licensees can have two-letter suffix callsigns when available

### Operational

- ACA to free up the use by amateur stations of the public telecommunications network and Internet linking, and address in the regulations the potential for non-amateur access to an amateur station via the Internet or a telephone
- A beefing up of awareness of the ACA's method of dealing with interference issues, the responsibilities of those affected by it, and the resolution actions to be undertaken by radio amateurs
- Third party communications to an amateur station in another country will be permitted unless that country seeks a prohibition
- The ACA will continue to impose limits on the purity and stability of emitted frequencies, and maximum power limits
- Reduced station identification requirements for WICEN or similar networks providing emergency communications
- The Advanced licence will have a maximum transmit power of 400 W PEP (no change from the Unrestricted licence), although the ACA will more widely publicise the conditions under which it will issue higher power permits
- Encoded transmissions to be permitted for control signals from amateur satellite command stations, command and control signals for amateur stations, communications during emergency services operations and training

A copy of the ACA inquiry 'Outcomes' document was mailed to all radio amateurs. It can be found on the ACA website at <http://www.aca.gov.au/aca>

Comments about it can be mailed to Review of Amateur Service Regulation, ACA, PO Box 78 Belconnen ACT 2616, faxed to 02 6219 5353 or emailed to [amateurs@aca.gov.au](mailto:amateurs@aca.gov.au).

### About the author:

*Jim Linton VK3PC has spoken and written about licence restructure for more than 20 years. He co-authored two seminal discussion papers in 1984 and 2003 with Roger Harrison VK2ZRH – both of them being published in the WIA journal 'Amateur Radio magazine.'*

ar



# Women, radio

Christine Taylor VK5CTY

Let us start in the reverse order:

## Antarctica

Antarctica is a cold and desolate place. However it is a very important place to investigate, to help us understand world meteorology and geology.

The early explorers on their sailing ships saw glimpses of the ice. Captain Cook circumnavigated the continent in 1772-5. A Russian, Bellingshausen in 1819-21 sighted the Antarctic coast. The first party to winter over was the British Antarctic Expedition of 1898-1900. They pitted themselves against the harsh environment to explore and to study the geography, the geology, the flora and fauna and the weather. Later expeditions added to the list and the ionosphere became important as radio communications developed and the influence of the upper atmosphere on world climate was better understood. Initially getting to the South Pole and the South Magnetic pole were the goals, but once this was achieved, bases were established for long term study both on the continent itself and the offshore islands. Until 1958 Antarctica was for men only but from then on women have worked at Antarctic bases both for summer expeditions and wintering over.

Current investigations require a variety of skills in the team members, explorers, science investigators, observers, communicators and maintenance/construction.

## Radio

Radio has been an important part of just about all Antarctic expeditions since Sir Douglas Mawson took a spark radio station to Macquarie Island in 1911. As time went by radios became more efficient, worked on more bands and were able to be taken on expeditions by sledge and vehicle. It became very important that most of the team members were able to operate the communication equipment. The specialists maintained it but every one needed to know how

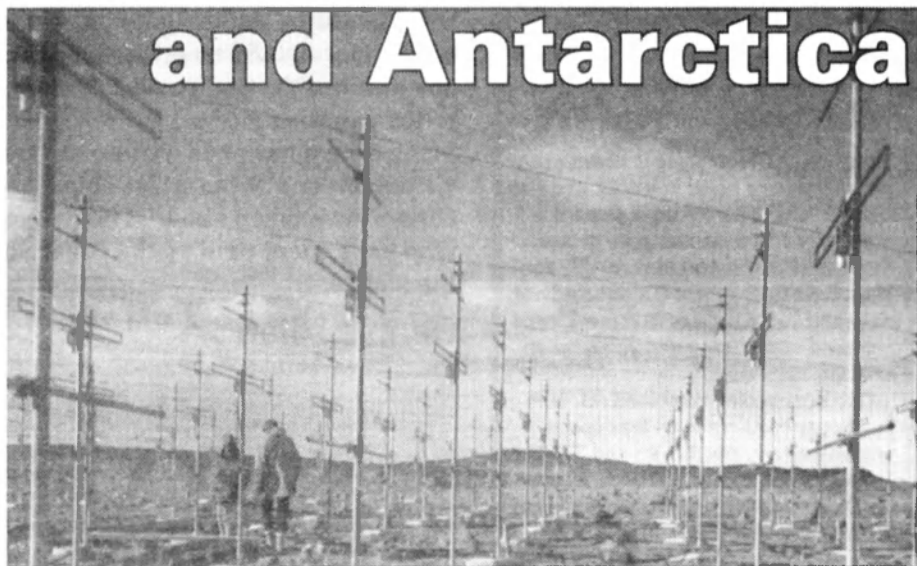

VHF Antenna array at Davis, February 2003.

Photo by N. Storey. First published in "Aurora", the ANARE Club Journal Vol 22 No 4 page 8, in an article on VHF Radars at Davis.

Used by permission from ANARE

to operate it. Electronic and radio skills are required for many of an expedition's activities. One activity which requires both these skills is in ionospheric investigations. The picture, Photo 1, shows a VHF array used for these investigations, from "Aurora" Volume 22, No 4, June 2003.

The radio operator is almost as important as the doctor. Even today with IMARSAT; he/she has a role to fill. The radio operator can also be an amateur because it is from the field of those who have been interested enough in radio and electronics to do the exams that those with the requisite skills are found. Naturally, on the ice, each person has many tasks to perform, their professional jobs as well as taking their turn at all the normal duties like cooking and dishwashing, even the radio operator!

Radio contact in all its forms has been the link between the expeditioners and their families. Birthdays have been celebrated, and anniversaries remembered. Even romances have been nurtured and marriages arranged through those radio contacts.

Radio is important in many places as the only means of communication with the outside world. Until the advent of IMARSAT telephone communications in 1988, the radio in all its forms was the most important means of keeping the

ANARE (Australian National Antarctic Research Expeditions) members and their families in contact.

Many amateurs have done as my husband, Geoff, VK5TY did and acted as liaison for the amateur operators 'Down South' by having regular skeds and having family members come to their home so they could each hear the voices of their loved ones.

## Women

Women have played a part in most expeditions since the early 1970s. Louise Holliday has the honour of being the first woman to winter on the Antarctic continent. Women have played many roles on expeditions, for example they have been doctors, scientists, technicians and expedition loaders. The short biographies which follow tell us something of women's activities with the Australian Antarctic Division. The material draws from "Aurora" the journal of the Australian National Antarctic Expedition Club, Volume 23 Number 1, 2003, and also Elizabeth Chipman's 'Australians in the Frozen South', Nelson, 1978

The photographs have all been released by the Australian Antarctic Division, Kingston, Tasmania and "Aurora".

*continued next page*

# RippleTech Electronics

## Brand New Dxciting Products

Rippletech Electronics is providing a new service to hams in VK/ZL and the Pacific. Our quarter wave slopers will outperform a quarterwave ground mounted vertical by several dB. You can have access to a DX antenna on 80m and 160m with as little as 15m of ground space (provided you have an existing 15m tower-nally or equivalent).

Our best selling combined 40/80m sloper requires even less space.

Alternatively, the TZ-V3 and TZV3w will give you access to 10/15/20m or 12/17/30m with a small budget or small backyard. Mount on your metal garage roof for a surprising signal. New novice operators, what about a rotary dipole for 10/15m only - \$129.00 plus p&p

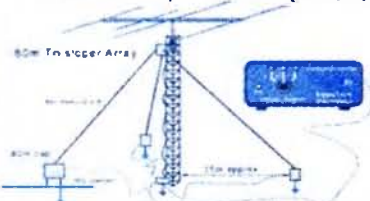

1:1 & 4:1 HF 1kW Baluns	\$59.00
Single 80m sloper	\$109.00
Single 40 & 80m sloper	\$179.00
WARC Rotary dipole	\$289.00
10/15/20 Rotary Dipole	\$279.00
12/17/30 Vertical	\$199.00
10/15/20m Vertical	\$189.00
Radials kits	\$44.00
FT-1000mp remote	\$33.00
30 or 40m Rotary Dipole	\$399.00
80m Sloper Array (3 ele)	\$499.00

## RippleTech Electronics

3 Moyston Close  
Vermont South  
VIC 3133



Phone or Fax  
03 9887 2917

WANT MORE INFO ?  
PICTURES-DESCRIPTIONS  
A FULL PRICE LIST  
OR AN ORDER FORM - see  
[www.rippletech.com.au](http://www.rippletech.com.au)  
[sales@rippletech.com.au](mailto:sales@rippletech.com.au)  
[info@rippletech.com.au](mailto:info@rippletech.com.au)

ABI1 70 465 254 759

# Women, radio and Antarctica

continued

Ulla Knoxlitttle, Denise Jones, Kerrie Hindle and Kim Harrington have worked for ANARE as professional licensed radio operators. If you know any of these YLs and could ask them to contact me I would be delighted to tell you their stories.

Many others have had a true, but fleeting, Antarctic experience by visiting on one of the cruise ships, as Bev VK6DE did at Christmas 2003. Others have taken a tourist flight over the region. For every one of those who have spent time on the Great Southern Continent, radio has been the lifeline.

## Denise Allen



Denise Allen  
AAD Photograph 44691.  
Copyright C of A 1987

DENISE ALLEN first went south as a meteorology observer for the Bureau of Meteorology at Macquarie Island for the winter of 1985. She was the first woman employed by the Bureau of Meteorology to winter on the Antarctic Continent.

Denise was the first woman to become a Senior Observer with the Bureau of Meteorology (in 1988) and one of the two first women (with medical officer Lynn Williams) to be awarded the prestigious Antarctic Medal for outstanding service to the Antarctic. She also was the first woman to complete postings to all four of Australia's Antarctic bases, Macquarie Island, Casey, Davis and Mawson.

She gained her amateur licence and held the callsign VK0YL for the year of 1986. She says she didn't use the microphone very often once she realised just how popular she was with all the keen DXers. One call and she was smothered under an avalanche of calls. All those QSL cards!

Denise is not the only woman meteorological observer to go to Antarctica. Christine Spry is currently doing her 8th or 9th winter as a Meteorological Observer. How about that! And several other women have been employed as Meteorological Observers with the Bureau of Meteorology.

## Elizabeth Chipman



ELIZABETH CHIPMAN worked for the AAD nearly all her working life and was one of four women who visited Casey in 1976. Her book "Australians in the Frozen South" Nelson 1978 was used in the preparation of this article.

(Left) Elizabeth Chipman at Macquarie Island  
Photo by Jutta Hosel.  
AAD Photo 1769C6  
Copyright C of A 1979.

## Shelagh Robinson



SHELAGH ROBINSON was one of the radio links. For fourteen years she was the Welfare Officer for ANARE. She would receive cables or telexes (usually in a special code) from men and women in the Antarctic and from family members at home. She would transcribe these and either send them on to addressee or telephone them with the messages. On a few occasions she actually knocked on doors and passed on messages personally.

Shelagh undertook this task because

(Left) Shelagh Robinson  
AAD Photograph 224D3 by Martin Betts  
Copyright C of A 1979

she realised just how isolated you feel down there, from personal experience. Shelagh was one of the first three women (with Elizabeth Chipman and Jutta Hösel) to go to the Antarctic continent with ANARE. She was a Science specialist at Casey in the summer of 1975-76.

Like all those who have gone to the Antarctic with ANARE Shelagh still has strong bonds with that world. She acts as occasional correspondent to the ANARE in-house magazine, "Aurora", telling some of those stories that may not have got into the official reports.

## Patchwork quilt in honour of women who held firsts in their field of endeavour

If you should go to Alice Springs, make a point of visiting the National Pioneers Women's Hall of Fame. There is a signature quilt in this museum recognising the work of women in many fields of endeavour including Antarctica. Two quilts were made. One is in Alice Springs the other was raffled to raise money for the museum. The quilts have been signed and the names embroidered with coloured panels that recognise the particular field of interest of each of the women. As you can see the quilt is very exciting and worth spending time over.

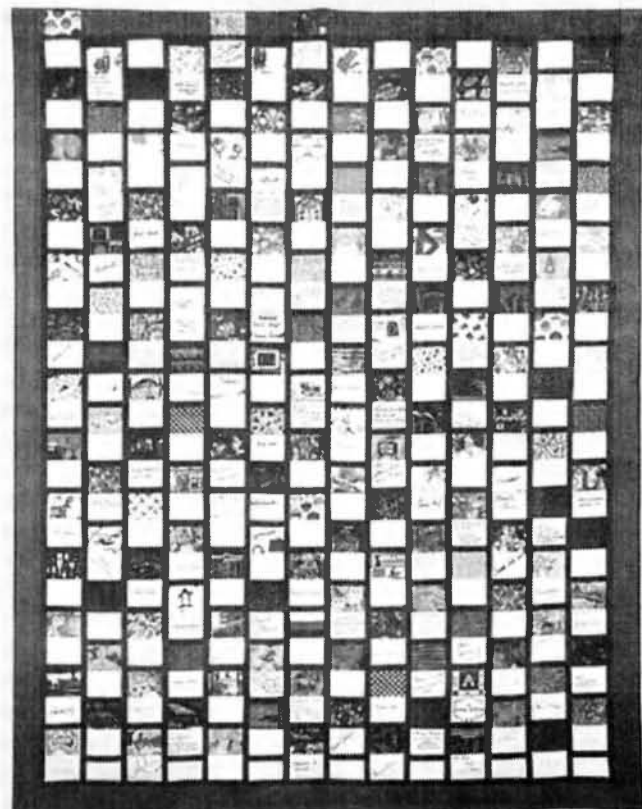

The Signature Quilt.

The quilt was installed in the NPWHF on March 7th 2003 to celebrate International Women's Day. There are over 300 names of which more than 30 apply to women who have spent time in Antarctica. The activities of the women cover a very wide range of activities. The book that was to be written telling all these women's stories has probably been published if you would like to know more about the quilt.

(Left) One of the squares

ar

## First Board meeting of new national WIA

**On 16 May 2004 the then Federal Council adopted a new Constitution for the WIA, and the Board appointed by that Constitution met for the first time on Saturday 29 May 2004.**

The members of the new Board are:

Michael J. Owen	VK3KI	President
Ernest S. Hocking	VK1LK	Vice President
Glenn C. Dunstan	VK4DU	Director
Ewan R. McLeod	VK4ERM	Director
Trevor M. Quick	VK5ATQ	Director
Edward C. Thrift	VK2ARA	Director
Philip J. Wait	VK2DKN	Director
Peter J. Naish	VK2BPN	Company Secretary
David A. Pilley	VK2AYD	Treasurer

The meeting lasted all day, with all directors and Peter Naish, VK2BPN, Company Secretary and David Pilley, VK2AYD, Treasurer, also present.

The Board undertook a number of formalities, including recording any potential conflicts of interests of directors, and a protocol to deal with conflicts. It reviewed and up-dated the cheque signatories for the Institute's bank accounts. It also adopted a Code of Corporate Ethics, to guide not only the directors and employees, but also the many volunteers who represent the Institute, one way or another. That Code is almost the same as the draft published in March AR, changed only to remove an incorrect reference to shareholders, and enhanced to include a reference to Institute conducted examinations.

The Code stresses the imperative of courtesy in all dealings with anyone representing the Institute.

The transition to a single, national body created many new tasks, and directors were given responsibility for particular areas.

The need for a national broadcast structure was identified, with QNEWS recognised as a potential core facility, and on the basis that news be disseminated as widely as possible, including where possible, through the clubs. Ewan McLeod was given this responsibility.

The Board noted that the Institute was represented on a number of committees

and the like, and it was agreed that the Institute's need for corporate knowledge required that all WIA representatives provide a report to the Board after every meeting.

It was agreed that the new board needed to know more about the Institute's publications, including AR. Ted Thrift was given this responsibility, and both he and President Michael Owen would attend the next Publications Committee meeting.

Ernie Hocking and David Pilley are to develop a plan for the immediate marketing of items such as books and badges, while Ernie Hocking and Phil Wait will develop a separate strategy for other marketing opportunities.

The Board noted that insurance, particularly liability insurance, was an important issue, particularly as the divisions had various policies, some covering clubs and members of clubs, and Peter Naish was given the responsibility of investigating the present position and possible cost savings with a single national cover, seeking assistance from others and preparing a report for the Board.

It was also noted that membership certificates were needed, and this was linked to the search for a new corporate image.

The Board agreed that the radio clubs were particularly important, and that it seemed that the relationship between the clubs and the Institute might differ from state to state. It was recognised that the Institute needed the support of the clubs, and it was not clear what the clubs needed from the Institute. President, Michael Owen, accepted responsibility

for this, saying he hoped to visit as many clubs as possible.

It was agreed that a FAQ section would be placed on the WIA website. Ewan McLeod is coordinating this, as well as the updating of the website.

All the appointments made at the Brisbane Convention were reconfirmed by the new Board, which also considered the ACA response to the review of the amateur service. The possible impact on the examination system, the possibility of the Institute tendering for work outsourced by the ACA was considered at length. Many tasks associated with this area were identified, and primary

responsibility for coordinating this effort was accepted by Phil Wait.

The importance of the role of the Technical Advisory Committees was identified and it was agreed that the directors responsible for coordinating with the Advisory Committees would also address the issue of a national Technical Advisory Committee.

The directors taking responsibility for particular areas are Ewan McLeod for

Queensland, Trevor Quick for South Australia and the Northern Territory and Tasmania and Glen Dunstan for New South Wales, with Michael Owen continuing to liaise with Western Australia and Victoria.

Ewan McLeod will liaise with all states regarding a national QSL bureau.

A number of other matters were reviewed and addressed.

It is likely that future meetings will include telephone meetings, with a further face to face meeting as needed, possibly in a few months time.

## VK1 News

by Peter Kloppenburg VK1CPK

### Looking at "Outcomes"

The publication of "Outcomes of the Review of Amateur Service Regulation" by the ACA early in June was eagerly greeted by the Amateur Radio Community. All the concerns expressed during the review period were addressed and dealt with. Most importantly, the entry level, aka Foundation Licence, into the amateur radio service is now becoming a reality and will be modelled on the one in use in the UK.

However, there is one detail of the licence specification that needs to be looked at again. That is the maximum output power level of 10 watt Peak Envelop Power (PEP). Of the low-power transceivers readily available in Australia i.e. Yaesu FT-417, Icom IC-703, Ten-Tec Argonaut V model 516, SGC-2020, and the Alinco DX-801, none of them quote output power levels in PEP. They all quote an 'average' power level of between 5 and 20 watt.

To measure a power level in PEP you would need a two-tone audio oscillator, an accurate RF power meter and an oscilloscope. Hardly the type of test equipment readily available to Foundation Licence holders. Radio Amateurs are invited to express any of their concerns re Outcomes on the ACA Website [amateur@aca.gov.au](mailto:amateur@aca.gov.au).

### Next meeting

The next General meeting will be held on Monday evening, July 26, 2004 at Scout Hall, Longerenong St. Farrer at 8.00 pm. Cheers.

**WICEN  
(ACT)  
volunteer today**  
email:  
[wicen@vk1.wia.ampr.org](mailto:wicen@vk1.wia.ampr.org)  
website:  
<http://www.vk1.wia.ampr.org/WICEN/>

Brindabellas, Southern NSW, South-East NSW, Canberra, and ACT. The new name could also indicate who the members are: i.e. licensed radio amateurs, hobbyists, CB operators, and experimenters. Lastly, the name could indicate the type of organisation, such as Club, Union, Association, or Society.

Following are a few suggested names:

- *Canberra and Region Amateur Radio Club (CARARC).*
- *The Monaro and Southern Districts Radio Club (MSDARC),*
- *Canberra and Region Electronics and Radio Club (CRERC),*
- *Canberra Amateur Radio Society (CARS),*
- *Amateur Radio Society of the ACT (ARSA), and*
- *Association of Amateur Radio Operators (AARSA).*

If you have any suggestion for the Division's new name, send them to the Secretary, Deane Walkington: [deanew@pcug.org.au](mailto:deanew@pcug.org.au).

### Hams may be needed for Disaster Relief

Our WICEN coordinator for the ACT, Phil Longworth, VK1ZPL, is looking for volunteers to help out with providing communications on VHF/UHF (with hand-helds) at various sporting venues. This is a rewarding activity, as you get to know other ACT radio amateurs, as well as becoming familiar with the radio hardware that is used to conduct and supervise the activity. You also become more familiar with the layout of the ACT, and services provided by the State Emergency Services (SES). It is also more than likely that volunteers with radio communications experience will be required for a future Disaster Relief organisation to be organised by the Government. This may occur in response to ITU S25.9A "Administrations are encouraged to take the necessary steps to allow amateur stations to prepare for and meet communication needs in support of disaster relief".

### Forward Bias

#### National WIA: What the change will mean

The speaker at the May general meeting was Alan Hawes, VK1WX. Alan spoke to the subject of the Division's changeover to a local club. He said that as the WIA is about to change from a federal organisation to a national one, the state-based divisions would no longer exist and should become local clubs. Members of divisions will have a choice of joining the new national WIA and/or becoming members of the local club. The new fees for WIA membership will be \$75 for full members (F grade), \$70 for pensioners and students (G and S) grade, and \$50 for membership without 'Amateur Radio' (X grade). The new ACT based club will charge \$20 for annual membership. The 'Division' will no longer receive the Divisional Component of the WIA membership fee. This amounted to \$24 for each member. The WIA will keep the total amount of the fees, and thereby be able to employ salaried staff and provide more services to the members.

The ACT Division will therefore have to make a few drastic changes. These will include a change of name and a change in its constitution. Financially, this means that more reliance will be placed on fund-raising activities, and grants from the WIA. It is expected that the WIA will establish a QSL bureau at its headquarters, wherever that may be.

#### Naming the baby

The name change for the Division is something that all of us can contribute to, and various suggestions have already been made. The new name should indicate what our interests and activities are: communications, amateur radio, ham radio, radio operators, radio enthusiasts, radio and electronics, radio and hobbies, contesters, radio hams, ham operators, radio research & development, and transmitting and receiving.

It should also give an idea of where the organisation is located: ACT & District, Monaro District, Southern Tablelands,

## VK2 News

Tim Mills VK2ZTM.

Hello there. In this time of change - much has been reported in this magazine and elsewhere. These notes have to be compiled and submitted more than a month before you get to read them. More up to date reporting is achieved by the spoken word in news bulletins and the written word via the web pages. In the meantime, some items with a longer lead time.

The next exam being conducted at Parramatta will be early August with the closing date for applications later this month. Inquire via the Internet or the office.

A couple of decades ago there was an extensive WIA video library maintained in VK5. It has since moved a couple of times and unfortunately has not been updated. There were several lectures given to the VK5 Division in the 1980's and recorded on video. While the technology described in the lectures may be old, the theory and background is still relevant today. VHS copies of some of the material are available for loan from the Parramatta office. Check with them if you have an interest in borrowing same. They are available Australia wide for a two week period. You will have to cover the postage both ways. By now, a list of the titles may be on the Internet - follow the links to the VK2 section.

The next scheduled Trash and Treasure at Parramatta will be on the last Sunday

of this month - the 25<sup>th</sup>. It will be followed by the regular Home Brew gathering. Following a lecture given at the May meeting by Gordon VK2ZAB on construction techniques used in making [mainly VHF & UHF] antennas, it was decided to devote the next meeting to the practical side of the talk. Most interest was for 70 cm antennas, so it was decided to make a Yagi at the July Meeting. If you would like to take part in the construction afternoon, get in touch with Peter VK2EMU in sufficient time to add your name to the material purchase list.

At Dural, the morse transmissions came to a halt when the rather old computer refused to start. Just as old is the program used to run the morse. It requires a slow computer to handle and maintain the speed. By now it should be back on air. What we would like to source are some more modern programs that could be run on later model computers. If anyone could point us in the right direction please email Dural via the Parramatta office or contact Mark VK2XOF. The long term plan is to utilize non-mechanical memory so that it does not have to rely on floppies or hard drives as the source.

Another aspect of Dural is the tree growth. Many have now exceeded the height of the HF antennas and

recently permission was given by local authorities to trim some of the growth. This, along with dead wood created by the various high winds in recent times will need to be removed. If there are any readers around the Sydney region who have wood fires and need to source wood, you might care to register your interest with the Parramatta office.

June is a time for field days and gatherings around the country, judging by the details in recent "AR's". In this State, the Oxley Region ARC conducted their annual event over the long weekend. Next month, NSW WICEN will be conducting their AGM. Like many groups they seek new members for fill positions on their management committee.

Until another time,

73, Tim VK2ZTM.

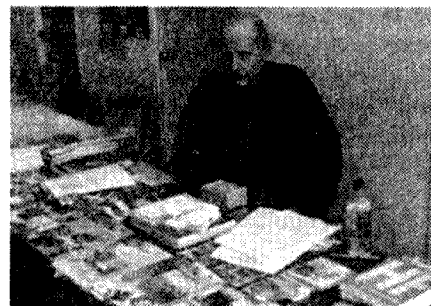

VK2 President Chris Flak VK2QV in his role as the bookshop manager, selling books at the Port Macquarie Field Day.

## VK6 News

Compiled by Will McGhie VK6UU

Input to: will2@iinet.net.au 08 9291 7165

and the various WIA web sites and in particular the VK6 WIA Web page <http://members.iinet.net.au/~vk6wia/>.

### Support the change

Just how different the new national WIA will be from the old Federal WIA is yet to be seen. Many have spoken about its benefits and few about what may be a new name with the same problems. However there are many talented Amateurs who have skills that are desperately required. The list of the new board members contains many of the people we need. They

### Towards a National WIA

Having just returned from a sailing holiday in Shark Bay, 850 km north of Perth, I'm a little out of touch with the detail towards the change to a National WIA. However, as the changes are taking place so quickly and due to the lead-time from writing this to appearing in Amateur Radio magazine, there is little point in trying to write about the changes other than in general terms.

As you should be aware, it is happening. The VK6 division has agreed in principle for a National WIA and is deep in discussion about the future of

the VK6 division. At the time of writing, several options are being considered as to the future of the VK6 WIA division.

There has been ongoing debate within the VK6 Council. Not all Councillors have been in agreement over several issues. The robust discussion has been essential, as what may have seemed a simple process, has many small but important issues. This has been the busiest time for Council with many meetings taking place over the last few months.

In order to keep in touch with this rapid transition listen to the VK6 news

## WICEN WA

**As a radio amateur, are you able to provide communication facilities in time of need?**

WICEN WA is seeking names and call signs of licensed amateurs, metro or regional based, who are able to perform as part of a communications network that could be used in an emergency situation.

You will need to have portable, mobile or base station equipment operational from power sources other than the normal domestic power supply and be able to operate for an indefinite period of time. Your equipment can be HF, VHF or UHF, or a combination of these.

**Rob VK6PO,**

email vk6po@eon.net.au,

tel 08 9341 3939

7 Anne Place Scarborough WA 6019

**Jim VK6JP**

email jimmaree@webace.com.au,

tel 08 9364 1779

14 Henley Rd, Mt Pleasant WA 6153

Please indicate your interest by contacting Jim, VK6JP or Rob, VK6PO and we will send you a form to complete which will outline your capabilities.

You will not be requested to join WICEN, nor will there be any other activities other than your normal operating practices. This is simply a quick contact list of operators who can fulfill a need should the occasion arise.

## VK3 News

By Jim Linton VK3PC

WIA Victoria web site: [www.wiavic.org.au](http://www.wiavic.org.au)

email: [wlavlc@wlavlc.org.au](mailto:wlavlc@wlavlc.org.au)

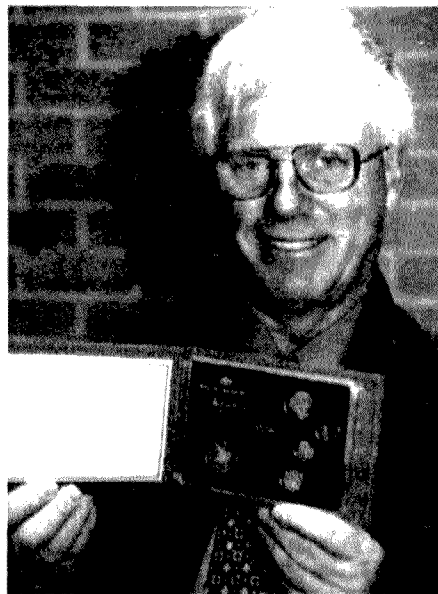

With the 2004 Australian Mint coin set received as part of the WIA Victoria President's Commendation, is Peter Forbes VK3QI who was recognised for his key role in the WIA gaining expansion of the 80m DX window.

President's Commendations which included a 2004 mint coin set were presented to:

- Rob Carmichael VK3DTR for his service which included being a councillor, class instructor, providing publications relations opportunities for amateur radio, and long-time broadcast announcer and contributor.
- Peter Forbes VK3QI for the excellent work he did that created a compelling argument for the WIA to present to the ACA and obtain an expansion of the 80m DX window.

The fifteenth inductee into the WIA Victoria Elmer Hall of Fame is Keith Proctor VK3FT, nominated by Paul Ashby VK3MR. The Elmer Hall of Fame is hosted on the WIA Victoria website and has been updated to include the citation for Keith VK3FT.

The President Jim Linton VK3PC

*continued next page*

have a range of skills that is the best chance we have of revitalizing amateur radio in Australia. The old WIA had a proportional declining membership over a long time. Many saw the WIA as an argumentative slow moving organization and would not belong. The old structure has responded and now is your chance to give the new national organization a go. If you were not a member, for whatever reasons, of the old Federal WIA, now is the time to support the new structure. If you firmly believed in not supporting the old WIA then most if not all of your reasons should now be gone. Join, support the new National WIA. At least give it a go and make a judgment down the track. Lack of support will continue the decline. Your support will give all Amateurs in Australia a strong single voice. Without it, we all will be on the receiving end of other forces hungry for spectrum and reduced privileges for Radio Amateurs in Australia.

## WIA Victoria AGM

About 60 members attended the WIA Victoria Annual General Meeting held on Wednesday 26 of May with many eager to learn more of the developments occurring in relation to the new WIA.

The reports from the President, Treasurer and Secretary were adopted (these had been issued to members and can also be found in the Member's Section of the WIA Victoria website). Appointments were made of both the auditor and returning officer.

With the formal and statutory requirements completed, a series of presentations was made including recognition of those WIA Victoria members who have made significant contributions.

Three new Honorary Life Members were created - they are Bill Trigg VK3JTW, Gary Furr VK3KKJ and Ron Cook VK3AFW. Congratulations on receiving this high recognition for your meritorious contributions and service.

# Antenna

## 'HomeBrew'

(with a lot of help from your Bushcomm kit)

### SWCS-KIT HF ANTENNA

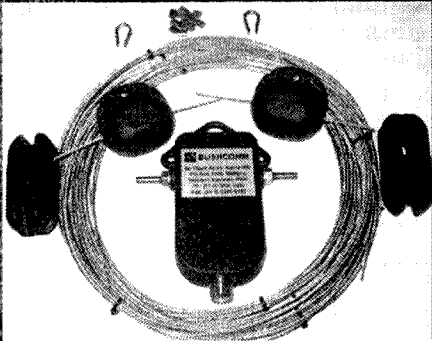

This is a kit version of our popular SWC-100S single wire model, but you have the great satisfaction of constructing your antenna.

Easy to follow, comprehensive instructions. Common tools required.

You save money and have fun

Once completed correctly your antenna will be a replica of the SWC-100S model. This is a single-wire, base-situation antenna, constructed with stainless elements to give high resistance to corrosion. It has a length of 34m in total.

Trees, buildings or other structures can be used to suspend the antenna, (avoid running the antenna over iron-roofed buildings as this reduces the effective height above ground). The antenna can be mounted either horizontally between two supports, or as an inverted 'vee'

Frequency Range: 2-30 MHz  
Impedance: 50 OHM  
Power Input: 100 Watts, 250 Watts PEP

This kit contains:

Balun (x1) Load (x2) S/S Thimbles (x2)  
Copper ferrules (plus a few practice extras))  
Large egg insulators (x2) 4 cut lengths of wire.

**FULL and CLEAR**

building and mounting diagrams

## Bushcomm

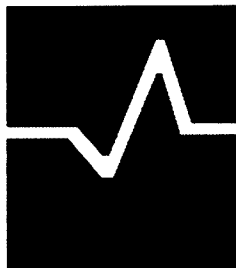

**PROUDLY AUSTRALIAN OWNED  
AND MANUFACTURED**

PO Box 202B, Midland DC 6936 Western Australia  
80 Stock Road, Herne Hill 6056 Western Australia

PHONE: + 61 8 9296 0496

FAX: + 61 8 9296 0495

EMAIL: bushcomm@bigpond.com

See more at

[www.bushcomm.com.au](http://www.bushcomm.com.au)

# State News

*continued from previous page*

surprised the President of the Moorabbin and District Radio Club Ken Morgan VK3CEK with a physically large cheque as a contribution towards the restoration and upgrading of the club's historic honour board.

The WIA Federal ARDF Coordinator, Jack Bramham VK3WWW presented both Jim VK3PC and WIA Victoria with certificates of participation in the IARU Region 3 ARDF Championships held in Ballarat. Jack VK3WWW acknowledged the support received that made the running of that international event possible.

After closing the formal AGM a discussion session was held about the restructure of the WIA.

President Jim Linton VK3PC addressed the gathering to provide information on how the WIA Federal structure had not worked for some time, and reaffirmed that the Victorian body is in support of a national membership WIA.

Alternative Federal Councillor, Peter Mill VK3APO answered a series of questions from the floor and valuable assistance was given by David Wardlaw VK3ADW who has very good knowledge about the topic.

In the end a much greater understanding of the restructure was gained by those in attendance, and the session has been widely described as

being very positive and beneficial to members.

The WIA Victoria Council is working through the necessary legal and administrative steps to reach a stage when a recommendation will be put to members for a vote.

There are still some reservations among the membership about this enormous change. We can all look forward to further developments in the time ahead.

For those unable to attend the AGM, it was captured on video. To inquire about obtaining a copy please email Bruce Bathols VK3UV [wiavic@wiavic.org.au](mailto:wiavic@wiavic.org.au) and state whether you want it in VHS or DVD format.



Rob Carmichael VK3DTR expressing his appreciation on both receiving the WIA Victoria President's Commendation and being able to have provided support for the Institute.

## Bill Trigg VK3JTW LMWIA(Vic)

Bill served on the WIA Victoria Council under three Presidents. Held the positions of Vice President and Alternate Federal Councillor for parts of his term.

When the WIA Victoria Office relocated from Brunswick Street Fitzroy to Taylor Street Ashburton in the mid 1980s he was heavily involved in making it happen.

His friendly disposition made him an asset at the WIA Federal Conventions that more than occasionally in those days involved lobbying between the delegates on motions and decisions.

While living at Surrey Hills he joined the broadcast team in about 1989 and

later volunteered to fill the position of Broadcast Officer, producing and announcing the weekly VK3BWI broadcast.

Starting from a base of very little word processing skills, Bill mastered a computer that did at times crash losing parts of the broadcast text that had to be retyped.

In mid 1998 Bill moved initially to the Geelong suburb of Hamlyn Heights before setting up home at St Leonards on the Bellarine Peninsula.

His fellow councillors thought that would be the end of Bill's involvement with the broadcast, but not so.

Without a grumble he produced the



## State News

broadcast and put it to air. That involved two hours of travel and somewhere close to 150kms each way.

He teamed up with the late George Hunt VK3ZNE who took over as Broadcast Officer for a number of years.

Bill resumed broadcast duties in April 1999 and continued until his resignation from both the broadcast and Council about September 2000, ahead of his relocation to Balmoral.

He is not known to have missed an Annual General Meeting and has in many ways continued to provide support WIA Victoria.



Bill Trigg VK3JTW and Gary Furr VK3KKJ at the AGM with their WIA (Vic) Life Membership Certificates.

### Gary Furr VK3KKJ LMWIA(Vic)

Gary is a former WIA Victoria Councillor who did not seek re-election after two years so he could concentrate on the position of Internet Project Development Officer. In that role he has made enormous contributions.

Through this behind-the-scenes role, Gary has contributed greatly since 1998 to the well-being of WIA Victoria as a result of its website and online enhancements. Gary comes from a technical background and has used a lot of natural creative flair that can be seen on the website.

He has developed it from a basic site to one of the best websites of its type. It is actually two websites when you take into account the Members Sections. Nothing is any bother to Gary. He has been able to meet any demands with enthusiasm.

He has made himself readily available to post urgent material, and reports filed from major events at Darwin, Melbourne, Adelaide, Brisbane and Taiwan.

### Ron Cook VK3AFW LMWIA(Vic)

Ron is one of our quiet achievers. His activities can be traced back to the defunct WIA Victoria VK3 VHF Group. He has been a regular columnist for the WIA journal monthly, Amateur Radio.

Ron is one of a relatively small number of radio amateurs who have a professional engineering background, which when combined with an amateur interest makes them valuable members

of the community, helping to broaden the understanding of most aspects of amateur radio.

His involvement with the website is consistently 15 hours a week, but in the earlier years it was 20 hours a week or three hours each night. The education section with its interactive trial examinations has been linked to many club websites around Australia, and is the leading resource of the material it provides.

The WIA Victoria Council recognises that the work and dedication of Gary Furr VK3KKJ has contributed greatly to the retention of members, attracted new ones, and improved the image of WIA Victoria.

The flow of membership application forms received that were downloaded from the website is one evidence of its success.

Through Gary's efforts WIA Victoria is able to communicate via email with at least half of the membership and it has enabled otherwise impossible consultation with members.

His technical knowledge and ability to explain difficult topics in simple terms has educated many thousands of radio amateurs throughout Australia over the past decades. His lectures at

*continued next page*

## OZGEAR

### Ozhelph Services

Doug Hunter VK4ADC

Brisbane

Ph 07 3273 7263

Fax 07 3272 1800

sales@ozgear.com.au

## ICOM

- **HF Transceivers** - 7800, 756Pro2, 7400, 706Mk2G, 718
- **VHF/UHF Transceivers** - V8000, 208H, 2720H, 910H, V8, T90A
- **Receivers** - R3, R5, R10, R20, R8500, PCR100, PCR1000
- **Accessories** - wide range of options and parts

## YAESU

- **HF Transceivers** - Base & mobile FT-1000MP, 817, 847, 857, 897
- **VHF/UHF Transceivers** - Base, mobile and handhelds FT-1500M, 2800M, 7800R, 8800R, 8900R, VX-1, 2R, 5R, 7R, VX150
- **Receivers** - VR-500, 120D, 5000
- **Accessories** - Yaesu rotators, thrust bearings plus equipment options

**Plus...** OzGear balun kits, Diamond HF, VHF & UHF antennas & accessories, MFJ & LOG tuners, Autek antenna measurement, Daiwa cross-pointer SWR meters, RFI, Mobile One, GME, Scalar & TET Antennas, Coax connectors, cables and hardware from Andrews, RFI & Benelec

**With...** More brands available and new products being listed all of the time...

CB, Marine, Airband and Land Mobile equipment and accessories are also available.

**Product not listed above ?**  
Phone or email to see if we can help or visit us on the web at <http://www.OzGear.com.au> for the latest product info plus on-line ordering.

# State News

*continued from previous page*

the GippsTech technical conference and radio clubs are always well received.

Ron is a mild-mannered likeable person. He has always been willing to help others in their amateur radio activities, and provided counsel and valued advice to the WIA Victoria Council.

When the WIA Victoria 2-metre propagation beacon VK3RTG in Melbourne failed, Ron offered to fix it. He has maintained the beacon for many years as part of his continuing involvement and support for activity on the higher bands.

He answered the WIA Victoria call for volunteers to set up a display at cinemas showing the movie "Frequency" - with Ron representing our hobby at a Brighton movie house.

Most recently Ron was the initiator of the WIA Victoria VI3BVS special event station for the 150th anniversary of the first European settlement in Victoria.

Ron Cook VK3AFW takes a moment out of busy retirement to receive his WIA (Vic) Life Membership Certificate.



## VK7 News

Justin Giles-Clark VK7TW

Email: vk7tw@wia.org.au

Divisional Web Site: www.wia.org.au/vk7

### Divisional News

The change to a National body will see a number of changes in the VK7 Division and the Implementation Agreement is the instrument that will assist this transition and in VK7 it will include:

- Appointment of a VK7 regional WICEN Coordinator
- Lease of the OTC Radio Station/clubrooms
- Transfer of WIA repeaters and beacons and
- Administration of the Tassie Devil award.

Once this agreement has been settled then a Special General Meeting of the VK7 Division will be held to agree and vote on the agreement.

The change to the National Body will require the VK7 Division to decide on a future structure and decide whether to stick with the current Division/branch structure or move to three separate clubs with affiliation with the new national body. There is much work ahead for this Division!

### Branch Meetings

#### North West News

Tony, VK7ZX has let me know that both Q5 and Spectrum broadcasts will be recommencing following the short break

due to health problems. Spectrum will be heard on a Monday night at 7.30 PM on 2 metre repeaters around Tasmania and Q5 features on a Thursday night at 8.00 PM on Northern repeaters. Great to hear the medical problems have been sorted out and we look forward to the Q5 and Spectrum broadcasts again.

#### Northern News

Two successful meetings have been held in the Northern Branch and Al, VK7AN reports there was outstanding attendance of members and non-members at both meetings.

The May 12 meeting saw guest speaker Bill, VK7AK with an interesting biography of Grote Reber. Al reports "Many members were left in awe at his un-proclaimed achievements, Bill was at his utmost glory regarding these explicit details. Congratulations on a fine, well prepared lecture"

The June 9 meeting heard an excellent speaker Rex, VK7MO describe his digital modes experimentation and his recent DXpedition across the Nullabor Plain to Perth. The night continued on a

practical note with a group discussion on the construction of his antennas for 144 & 432 MHz. "Many new members were delighted with such a creative meeting, culminating in our speaker receiving a standing ovation from the floor." Al said.

#### Southern News

##### BPL/PLC Trial in Hobart

Aurora Energy has let me know that the BPL trial equipment was removed at the end of May and that the ACA continues to monitor the situation. We eagerly await the outcome of the trial and I will keep you posted on any developments.

##### Southern Meetings

May 20, saw a group of interested members and visitors watch and discuss

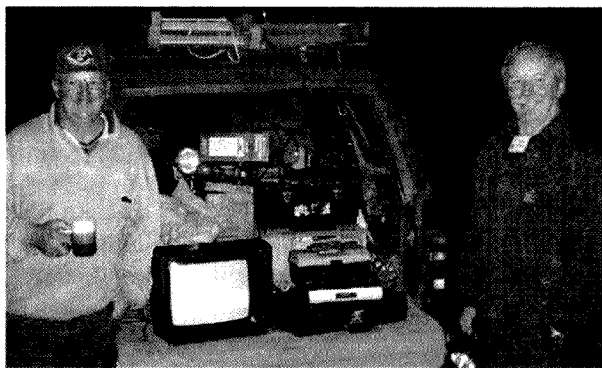

Ken, VK7DY and Gary, VK7JGD demonstrating digital TV



ar Peter, VK7TPE using the satellite alignment meter with the big dish!

the video presentation by the President of the RSGB, Bob Whelan G3PJT, when he spoke to the NSW Division in March 2003 about the introduction of the Foundation Licence within the UK.

May 27, Branch members and visitors were treated to a demonstration of digital and satellite TV & Radio. Gary, VK7JGD demonstrated digital TV and Ken, VK7DY and Martin, VK7ZBG demonstrated digital TV via satellite.

Ken and Martin set up and aligned two dishes - an offset feed satellite dish of about 80cm on Optus C1 at 156.0°E and a bigger dish of about 1.2m to the Optus B3 satellite at 152.0°E. Martin gave an interesting demo of just how critical alignment is using both the satellite alignment box and the set-top box and at 12GHz it doesn't take much to lose that signal and Peter, VK7TPE can attest!

Thanks to Gary, Ken and Martin for giving us the demonstration, I think we all learnt something, thanks guys.

June 2 was an address by Phil, VK7ZAX our Divisional President on the new National Constitution and the implementation agreement. Phil ran through many aspects of the new national body and some important aspects of the implementation agreement for VK7.

June 9, members and visitors watched a video presentation on the Mobile Phone Network given by Grant Willis, VK5ZWI to the Adelaide Hills Amateur Radio Society (AHARS). This was a great in-depth technical look at the mobile phone network in Australia. Thanks to AHARS for lending us the presentation.

ar

## Silent Key

### Wilfred David Butler Smith VK2DAL

#### Better known as "Dave"

We were saddened by the passing of David, VK2DAL on May 16th at the age of 73. Although David had been fighting with Muscular Dystrophy over the past years he maintained his daily skeds with his friends overseas.

David, as a young school boy, found electronics interesting, and built his first crystal set. After getting 'the bug', he built battery powered one and two valve receivers using his pocket money. From there he moved on to building his first transmitter using a Geloso VFO and a 6146 valve.

He was apprenticed as a fitter and turner. In 1958 he joined the NSW Police Force on general police work, but with his love of radio he was quickly transferred to the Communications Branch where he obtained his Commercial Wireless Operator's Certificate of proficiency at the Marconi School of Wireless. His technical skills soon put him in charge of technical maintenance, and in 1988 he was promoted to the rank of Superintendent in charge of NSW Police



Communications and Operations.

He took early retirement and ran a computer systems consultancy, managing the installation and commissioning a computer based Pathology System for all the hospitals in the central Sydney

area Health Service. On completion of this project he retired and moved to Wauchope.

David was first licensed in the 50s as VK2IS, but never did like the call sign and eventually changed to VK2DAL. His station at Wauchope was one to be admired, especially his antenna system. (Which was written up in "Amateur Radio"). Through the local Electrical Supply Company, he acquired a 18m pole, built rail tracks on it, and motorized it so that the antenna could be raised or lowered as required.

He was an active member of the Oxley Region Amateur Radio Club and had served as their President in 1995.

David is survived by his wife Roma.

Now an "SK", his key is silent, but the memory of VK2DAL will linger on. He will be sadly missed. His funeral service on 20th May 2004 at Port Macquarie was attended by a large number of amateur radio operators.

Submitted by David A. Pilley VK2AYD

## Adelaide Hills Amateur Radio Society

Christine Taylor VK5CTY

### A simple but effective lecture.

The talk in May was a very useful one. Rob VK5RG told the members how they could recover useful components from 'junk'. Rob has obtained many trimpots, LEDs, toroids and crystals from the things discarded at garage sales. Occasionally the memory chips are worth retrieving but it is more often the small components that are most worth while.

The most useful device in your workshop when you are hoping to get some bits and pieces is a heat gun. As long as the components have not had their wires folded, the application of a nice hot heat gun, followed by a thump on the bench will produce a veritable 'rain storm' of things.

After that all you need is a collection of the sort of boxes to be found in these 'cheapie' shops to put your treasures

into and you can turn to the next circuit board. Remember, not only resistors are colour coded or have their values written on them, capacitors are usually labeled these days, too. All of them will be useful if they are sorted into sizes as they come off the boards.

To get everyone started Rob had a couple of boxes for Lucky Dips.

Most members went home with some treasures.

Any visitors in Adelaide on the third Thursday of a month (except July and December) are welcome to come to an AHARS meeting. Contact Geoff VK5TY or Paul VK5PH for more details. Both are QTHR in the callbook.

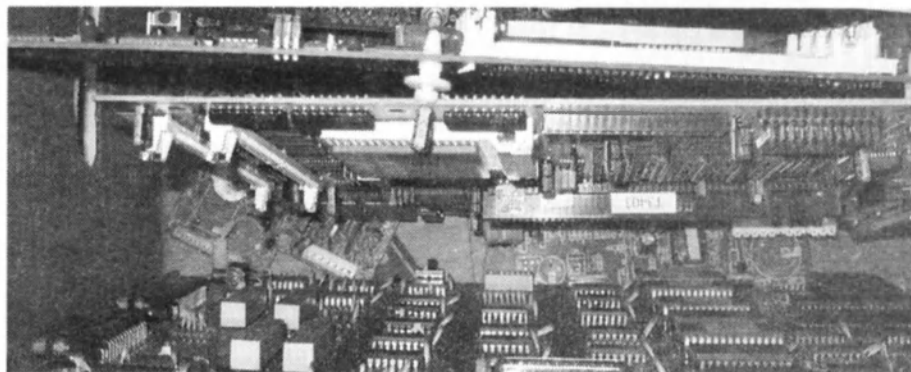

Some useful junk

## Fleurieu Group Luncheon

Christina Taylor VK5CTY

One of the largest groups gathered in May for the regular get-together of the Fleurieu Group of radio amateurs and their partners. As usual the luncheon was held in the Goolwa Hotel and as usual the weather was lovely.

Everyone was delighted to see the President, Frank VK5FJ and his wife Marilyn arrive as Frank has been quite ill recently. Let us wish him a speedy recovery.

Another unexpected attendee was Tony VK5ZAI and his XYL Judy. Many people in the amateur world know of Tony and his exploits into space communications. Tony was the anchor communications with Andy Thomas during his months on MIR and his shuttle flights. Since that time Tony initiated regular skeds between school children and the various shuttles as they passed overhead.

Hopefully when the shuttles again are flying, these and other children will be able to 'talk' to space men through the programs Tony has started.

Tony and Jill are now living down in the South East of VK5, having moved back to where they started from before they moved to the Riverland. If you go to the SERG Convention over the June long weekend you are almost sure to see Tony there.



Tony ZAI and his wife Judy

## Eastern and Mountain Districts Radio Club (EMDRC)

# Celebrating the ITU's 139th birthday

A tradition in amateur radio is to celebrate World Telecommunications Day, May 17 each year to mark the formation of the International Telecommunications Union (ITU) in Paris in 1865.

Callsigns with the ITU prefix appear on the amateur bands during the 24 hours of the day, and a regular participant in this exercise is WIA Victoria's AX3ITU.

The Eastern and Mountain Districts Radio Club (EMDRC) operated the special event station on behalf of WIA Victoria as it has enthusiastically for a number of years.

The EMDRC had a good mixture of SSB and CW operators on HF participating on most bands, with some electing to operate in multiple sessions to fill the gaps.

The ten operators in roster order are: Peter VK3DI, Tony VK3TZ, Carl VK3EMF, Don VK3MNZ, Gwen VK3DYL,

Dave VK3KAB, Peter VK3KG, Gavin VK3VTX, Mark VK3ZMF and "tail end Charlie" was Dick VK3LN.

A special QSL card for 2004 has been printed and is available. QSL is via VK3ER, or the bureau.

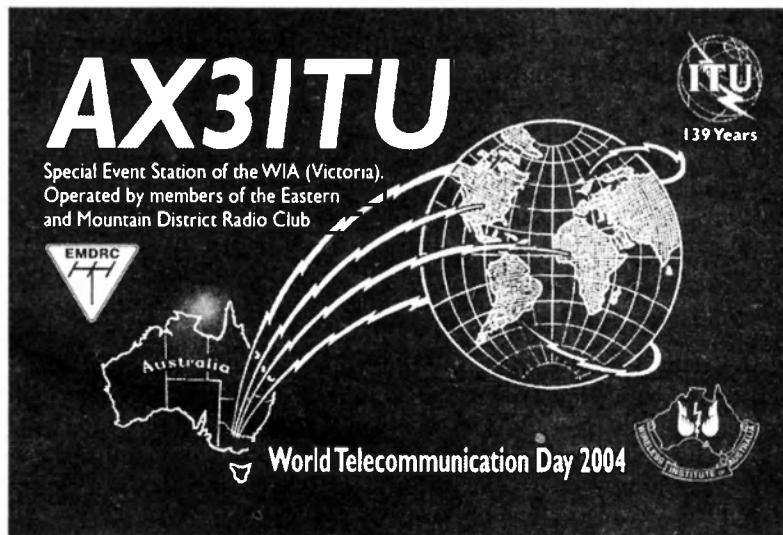

Tony VK3TZ

## Geelong Amateur Radio Club (GARC)

A big thank you to all those amateurs who helped make the first GARC band invasion such a success. On the morning of May 23rd forty metres sprang to life with GARC members at 1030 hrs. Contacts were continuous with many interstate amateurs participating. Well done all! Again by the time you read these notes the GARC will have invaded forty meters on July 2nd. I hope many of you were able to join the fun. While on this topic, maybe some other clubs could invade a band at some suitable time and so increase activity. If we as amateurs want to keep our bands we must populate them with talkers NOT listeners.

The monthly meetings were again well attended and it is interesting to note that none of the presentations had to do with radio related topics. The month started with a most interesting and well researched presentation by Don Bainbridge on the Australian involvement in atomic bomb testing in the Australian interior. The following week Bob VK3HFL told us how to make a small fortune- take a large fortune and refurbish a 40ft boat. Members are now anxiously awaiting the launch. The last week of the month David Paterson gave a fascinating presentation displaying and demonstrating aids for the visually impaired. The presentation was the more

interesting because David is seriously impaired. The ease with which David was able to carry out various tasks was astounding. David attends the Gordon TAFE and is studying electronics—he also attends the GARC class each Friday night and it is safe to say that within the next couple of months you will hear him under his own callsign calling CQ CQ CQ VK3 — calling CQ.

That's the lot for this month. Don't forget to listen for the next GARC band invasion—when? --- who knows-- but a hint would be to listen to the callbacks to the Sunday morning broadcasts

73 Dave VK3AZX

## Coax Cable & Connectors

**Low Loss 50 Ω**

**For  
2.4 GHz  
(WiFi) &  
Ham Radio**

### Cable

Type	CFD-200	CFD-400
OD (mm)	5	10
dB/m	0.130	0.050
150 MHz	0.550	0.220
2400 MHz		
\$/m	\$2.50 (\$1.50 *)	\$4.00 (\$2.00 *)

### Connectors

N-Type	\$7.00 (\$3.00 *)	\$7.00 (\$4.00 *)
RPSMA or RGTC	\$10.00 (\$5.00 *)	n/a
Pigtails	email	

\* = bulk price

Web: [www.freenet-antennas.com](http://www.freenet-antennas.com)  
Email: [sglas@freenet-antennas.com](mailto:sglas@freenet-antennas.com)  
Tel: +61 (8) 9319 1720

**"Hey, Old  
Timer..."**

If you have  
been licensed  
for more than  
25 years you  
are invited to  
join the

**Radio Amateurs  
Old Timers Club  
Australia**



or if you have been licensed for less than 25 but more than ten years, you are invited to become an Associate Member of the RAOTC.

In either case a \$5.00 joining fee plus \$8.00 for one year or \$15.00 for two years gets you two interesting OTN Journals a year plus good fellowship.

Write to

RAOTC,  
PO Box 1100  
Sandringham VIC 3191

or call Arthur VK3VQ on 03 9598 4262 or  
Bill VK3BR on 03 9584 9512,

or email to [raotc@raotc.org.au](mailto:raotc@raotc.org.au)  
for an application form.

## Club News

### Gippsland Gate Radio & Electronics Club

The GGREC members are at it again. On July 17 they shall be conducting their Annual Hamfest Sale at the Cranbourne Community Hall on the Corner of Clarendon and High streets in central Cranbourne. (High Street is part of the Sth. Gippsland Highway, Melway 133 K4).

Some 40 tables of goods will be presented at this large venue, but stallholders should book early as demand is expected to be very high following the great success of last year's event. Reservations for stallholders may be made by contacting Dianne Jackson VK3JDI on (03) 5625 2545. Doors open from 8:30 am. for stallholders and 10:00 am for buyers. Profits from the \$20 per table seller fee and the \$5 buyer

admittance fee will go towards the construction of a "Club Shack" building at our Club meeting site in Cranbourne. Take-away food with free tea and coffee will be available. The entry fee includes a ticket in the Door Prize competition that will be drawn at around 1:00pm for all who register upon entry. First prize is a 12 channel hand-held GPS unit.

Visitors are also welcome to attend our Club meetings that are conducted on the first and third Fridays of each month at the Girl Guide hall in Grant Street Cranbourne. Check out our comprehensive web site at: [www.ggrec.org.au](http://www.ggrec.org.au) for more information on the Club and its events.

**Albert Hubbard**  
0418 339 779

### Maryborough 150th Anniversary

The sesquicentenary of the naming of the central Victoria town of Maryborough is being celebrated by a range of activities including special event amateur radio station VI3JA.

The Central Goldfield Amateur Radio Club (CGARC) Secretary Allan Greening VK3PA said VI3JA will be activated from 8 July to 8 September.

Look for it mainly on the 80 m DX window 3.789 MHz, 20 m SSB, RTTY and CW, 144.125 MHz SSB or CW. QSL

to VK3JA or via the bureau.

The Maryborough 150 Celebrations Committee is welcoming visitors, residents and past residents to celebrate 150 Golden Years in Maryborough.

The birthday will include reunions, exhibitions, entertainment, historic vehicle display, tours of historic buildings, a photograph record of today's residents and business people, and the release of a history book.

## Silent Key

### Abe Deitch

It is with regret that I announce the passing of Abe Deitch age 82 years old on 5-03-2004 at Lane Cove Sydney.

Abe was the youngest of 5 brothers Solomon, Louis, Barney and Myer and 2 sisters Rebecca and sole surviving sister Gertrude

Abe was the last remaining brother associated with Deitch Brothers army disposals store at 74 Oxford St Darlinghurst known as the store in the middle of Oxford St, well known amongst hams for ex military radio equipment from the fifties till the late nineties, the store being run by Sol and Abe Deitch. Abe was the quieter and younger of the brothers working in the

store while Sol would attend the various Military Auctions held around Australia after the second World War. The store was well known for the mountains of disposal equipment with only enough room for one person at a time to navigate the narrow maze inside the shop at Oxford St. and warehouse at Mascot .

It was often joked that upon the closing and subsequent removal of items at both stores a skeleton would be found of a customer buried or lost under the mountain of equipment.

He will be sadly missed by his three daughters, son and close family members

**Norman Deitch VK2ZXC**

## Contest Calendar July - September 2004

3 July	Jack Files Contest	(CW/SSB)
11/12 July	IARU HF World Championship	(CW/SSB)
17 July	VK/trans-Tasman 160 Metres Contest	(CW/SSB)
17 July	Colombian Independence Day Contest	(CW/SSB/RTTY)
24/25 July	Russian RTTY Contest	
24/25 July	RSGB IOTA Contest	
6 Aug	QRP Day	(CW/SSB/FM)
8/9 Aug	Worked All Europe DX Contest	(CW)
14/15 Aug	RD Contest	(CW/SSB/FM)
21/22 Aug	TOEC WW Grid Contest	(CW)
28/29 Aug	SCC RTTY Championship	(RTTY)
28/29 Aug	YO DX HF Contest	(CW/SSB)
28/29 Aug	ALARA Contest	(CW/SSB)
4/5 Sep	All Asian DX	(SSB)
11/12 Sep	Worked All Europe DX Contest	(SSB)
25/26 Sep	CQ/RJ WW RTTY DX Contest	(RTTY)

# Andrews Communications Systems

ESTABLISHED 1976

ACN 001 968 752

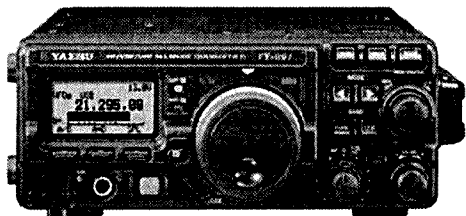

### YAESU FT-897D .....\$1699

FT-1000MP MkV 200W \$4,999	FT- 2800M 2m 65W ..\$349
FT- 857D HF-70cm...\$1,499	FT- 1500M 2m 50W ..\$399
FT- 847 HF-70cm.....\$2,699	VX-1R w/2 batteries ..\$369
FT- 8900R Quadband ..\$899	VX- 2R Tiny Dualband..\$399
FT- 8800R Dualband ..\$699	VX- 5R Triband H/H ..\$549
FT- 817 HF- 70cm ..\$999	VX- 7R Deluxe H/H ..\$699
FT- 7800R Dualband ..\$499	★ 3 YEAR WARRANTY ★

**Yaesu rotators in stock... Call**

### ICOM DISCOUNTED

IC-756 Pro II HF+6m	..\$4,999
IC-746 Pro HF+6m+2m	\$2,999
IC-706 IIG HF-70cm	\$1,399
IC-718 HF SSB w/DSP	\$1,199
IC-910H 2m+70cm SSB	\$2,499
IC-208H 2m+70cm	....\$649
IC-V8000 2m 75W	...\$399
IC-R5 Handheld scanner.	...\$399

### ICOM SCANNERS DISCOUNTED

★ 3 YEAR WARRANTY ★



ALINCO DR-620 Dualband...	\$799
ALINCO DJ-V5 Dualband ...	\$599
ALINCO DJ-X2000 Scanner...	\$999
★ 3 YEAR WARRANTY ★	

### KENWOOD DISCOUNTED

TS-2000X HF-23cm + ATU	\$4,499
TS-480HX HF 200W+6m	\$2,799
TS-2000 HF-70cm + ATU	\$3,499
TM-D700A 2m/70cm	\$999
TM-G707A 2m/70cm	\$699
TS-480SAT HF+6m+ATU	\$2499

TOKYO HI-POWER, PALOMAR, TE SYSTEMS, YAESU LINEARS. bhi NES 10.2 DSP speaker \$249  
 DIAMOND ANTENNAS from only \$49 ea  
 HUSTLER + EMTRON ANTENNAS  
 Avair SWR/RF wattmeters fr. \$99  
**DIAMOND - Why pay more?**

**FACTORY DIRECT IMPORTER OF HUNDREDS OF PRODUCTS**

**MFJ** KEYSERS, TUNERS, ANALYSERS ETC

## CALL (02) 9636-9060 or 9688-4301 or FAX 9688-1995

### SHOP 8, 41 BATHURST ST, GREYSTANES, NSW 2145

Why pay more? MAIL ORDER TO PO BOX 240, PENDLE HILL, NSW 2145

Some items indent. Prices subject to change without notice - limited stock, some items. E & OE

★ <http://www.andrewscom.com.au>

★ email: [lee.andrews1@bigpond.com](mailto:lee.andrews1@bigpond.com)

AR7/4

# Contests

## Greetings to all readers

### That raises the question...

Below are the results of the Wadda Cup for 2003. You may recall that this was held on 21 June, 2003, and it was the second year that the event had been held. It is an SSB-only event and one that should be able to take its place in the annual VK Contest Calendar – certainly the type of contest that could do much to encourage newer operators on the HF bands.

Normally I would not seek to be critical of Contest Managers and the time that they take to release results; but in this case I feel that comment must be made about what has taken the sponsors so long to publish the results and the modus operandum of the rules.

The sponsor of this event is the Central Highlands Amateur Radio Club of Tasmania (CHARCT), but an unusual feature of the rules is that the winner in any year becomes the Contest Manager for the following year. This, I feel, is a mistake and may be at the root of why it has taken so long for the 2003 results to appear.

Contest Management is not something that can be done by just anybody without knowledge, serious thought and planning. One would hope that this approach is brought to everything that we do in Life, but we all know that it is not so.

I would like to suggest that the objects of the Manager of any contest are (1) to collect all logs, (2) to check as carefully and as accurately as possible one log against another, (3) to compile an accurate list of names and scores of those who submitted entries, (4) to prepare and send any certificates and/or trophies, (5) to publish the results within a reasonable time after the event. In fairness to this latter point, some leeway should be allowed for late entries, but we all know of the advertised closing date for a contest and a question could be raised as to why should there be any leeway, especially in these days of electronic log submission??

At time of starting these notes (mid-May), there has been no indication

as to whether the Wadda Cup will be held this year or not. Perhaps many of you don't care one way or the other, but I suggest that the image that this approach projects is a "she'll be right, mate" approach and not a good image for either the sponsor concerned or for the contesting community in Australia. Certainly we may wish to do things our way, but that raises the question just how far do we go trying to be uniquely Australian?

If you would like to run a contest, fine; but please be organized and consistent in your approach to its management.

### Another question

Something else on which I would value YOUR opinion, please.

From time to time I have been told that I should not take part in any contest for which I am the Manager. Presumably these critics would wish to apply that to any manager. Some critics are quite adamant that "administrators should not be users".

Against this I could argue that ours is a hobby, not a professional presentation, therefore we are all entitled to enjoy our hobby in the ways that give us interest and pleasure.

On this issue I would be most interested to hear discussion, either directly to me or via the 'Over to You' columns in this magazine.

### RD and ALARA times...

The two main contests for August are coming round again, so please, as I ask each year, check your stations to see that they are in good shape for these occasions.

### ... plus QRP Day

The annual QRP Day contest has been presented by the CW Operators' QRP Club for several years now. It has never been a hugely popular event, but this year the Club has decided that it is time to let everyone know that the emphasis is not solely on Morse code – it is a QRP Club! This year the contest will embrace both CW and voice (SSB and FM), so there should be something for everyone. Please read the rules below and join in. Note that the event is scheduled for a FRIDAY night!!

73, good contesting and hear you on air.

Ian Godsil VK3JS

Acting Federal Contests Co-ordinator

## Results Wadda Cup 2003

VK5SR	29 pts
VK3MGZ	22
VK2BPL	22
VK3EK	20
VK2LCD	20
VK7JGD	20
VK7KZ	20

VK4KSS	19
VK7VH	19
VK3MSW	18
VK3GER	16
VK3JSS	16
VK3FH	15
VK3KMB	15

VK5GX	14
VK4MIA	12
VK3MMM	12
VK2JHN	7
VK3JKY/7	6

SWL Ben Henderson  
26 points

**Amateur Radio** for **100% amateur radio**



# 2004 Remembrance Day Contest

14/15 August 0800z Sat - 0759z Sun

Presented by Alek Petkovic VK6APK

**This contest commemorates the amateurs who died during WWII and is designed to encourage friendly participation and help improve the operating skills of participants. It is held close to 15 August, the date when hostilities ceased in the south-west Pacific area.**

It is preceded by a short opening address by a notable personality transmitted on various WIA frequencies during the 15 minutes prior to the contest. During this ceremony, a roll

call of amateurs who paid the supreme sacrifice is read.

A perpetual trophy is awarded annually to the WIA Division with the best performance. The name of the

winning Division is inscribed on the trophy, and that Division then holds the trophy for 12 months. The Division also is given a certificate, as are leading entrants.

## Rules

### Objective:

Amateurs in each VK call area will endeavor to contact amateurs in other VK call areas, ZL and P2 on

### Bands:

1.8 - 30 MHz (no WARC). On 50 MHz and above amateurs may also contact other amateurs in their own call area.

Contest Period: 0800z Saturday, 14 August to 0759z Sunday, 15 August, 2004. As a mark of respect, stations are asked to observe 15 minutes' silence prior to the start of the contest, during which the opening ceremony will be broadcast.

### Rules:

- Categories:
  - High Frequency for operation on bands below 50 MHz;
  - Very High Frequency for operation on and above 50 MHz;
  - Single Operator;
  - Multi-operator;
- Within each Category the Sections are:
  - Transmitting Phone (AM, FM, SSB, TV);
  - Transmitting CW (CW); Note: Digital modes such as Packet, RTTY, AMTOR, PSK31 etc are excluded from the contest.
  - Transmitting Open (a) and (b);
  - Receiving (a), (b) or (c).
- All amateurs in Australia, Papua New Guinea and New Zealand may enter the contest, whether their stations are fixed, portable or mobile.
- Cross-band and cross-mode contacts are not permitted.
- Call "CQ RD", "CQ CONTEST" or "CQ TEST".
- On bands up to 30 MHz stations may be contacted once per band using each mode, ie twice per band using CW and Phone. No points will be awarded for contacts between stations in the same call area on HF.
- On 50 MHz and above, the same station in any call area

may be worked using any of the modes listed at intervals of not less than two hours since the previous contact on that band and mode.

- Both single and multi-operator entries are permitted. To be eligible as a single operator, one person must perform all operating and logging activities without assistance, using his or her own callsign. More than one person can use the same station and remain a single operator providing that each uses his or her own callsign, submits a separate log under that callsign and does not receive operating or logging assistance in any way during the contest.
- 8b. Holders of more than one licence or callsign may submit a separate entry for each callsign held.
- 9a. Multi-operator stations are only allowed one transmitter per band/mode at any one time. Simultaneous transmissions on different bands are permitted. Simultaneous transmissions on the same band but different modes are permitted.
- 9b. Automated operation is not permitted. The operator must have physical control of the station for each contact. CW and voice keyers are permitted, as is the use of computers for logging.
10. For a contact to be valid, numbers must be exchanged between stations making the contact. Exchange RS for phone and RST for CW, followed by three figures commencing at 001 and incrementing by one for each successive contact.
11. Contacts via repeater (including satellite) are not permitted for scoring purposes. Contacts may be arranged through a repeater. Operation on repeater frequencies in simplex is not permitted.
12. Score: on 160 m two points per completed valid contact; on all other bands one point; on CW double points.
13. Logs should be in the format shown below and accompanied by a Summary Sheet showing

- callsign;
- name;
- address;
- category;
- section;
- for multi-operator stations a list of the operators;
- total score;
- declaration: I hereby certify that I have operated in accordance with the rules and spirit of the contest;
- signed; date.

14. Entrants operating on both HF and VHF are requested to submit separate logs and summary sheets for both areas.
15. VK entrants temporarily operating outside their allocated call area, including those outside continental Australia as defined for DXCC, can elect to have their points credited to their home Division by making a statement to that effect on their summary sheet(s).
16. Send logs and summary sheets to: RD Contest Co-ordinator, A Petkovic VK6APK, 26 Freeman Way, Marmion, WA 6020, by Friday 19 September, 2003. Endorse envelope "Remembrance Day Contest" on front outside. Late entries will not be eligible.
17. Certificates will be awarded to the leading entrants in each section, both single and multi-operator; in each Division; P2 and ZL. Entrants must make at least 10 contacts to be eligible for awards, unless otherwise decided by the Contest Manager.
18. Any station observed as departing from the generally accepted codes of operating ethics may be disqualified.

### Determination of Winning Division:

Unless otherwise elected by the entrant concerned, the scores of VK0 stations will be credited to VK7, and the scores of VK9 to the mainland call area which is geographically closest. Scores of P2, ZL and SWL stations will not be included in these calculations.

For each Division, an "improvement factor" will be calculated as follows:

- (a) For transmitting logs only, HF and VHF "Benchmarks" for each Division will be established, against which its performance for the current year is judged. The same formula will be used for HF and VHF, inserting the appropriate figures:

$$B = 0.25P + 0.75L$$

where B = this year's benchmark, P = last year's total points, and L = last year's benchmark.

- (b) For each Division, HF and VHF Improvement Factors will then be calculated. Once again the same formula will be used for both HF and VHF, inserting appropriate figures:

$$I/F = \text{Total points (this year)}/\text{Benchmark}$$

where I/F = improvement factor.

- (c) For each Division, the HF and VHF Improvement Factors will then be averaged:

$$\text{Overall I/F} = (\text{HF I/F} + \text{VHF I/F})/2.$$

- (d) The Division which achieves the highest overall improvement factor will be declared the winner.

### 2004 Benchmarks

Div'n	HF	VHF
VK1	586	158
VK2	3909	131
VK3	2978	4581
VK4	3203	1687
VK5/8	3234	1711
VK6	2189	5583
VK7	1584	829

### Receiving Section Rules

1. This section is open to all SWLs in Australia, Papua New Guinea and New Zealand. No active transmitting station may enter this section.
2. Rules are the same as for the Transmitting Section.
3. Only completed contacts may be logged, i.e. it is not permissible to log a station calling CQ.
4. The log should be in the format shown below.

### Example Summary Sheet

#### Remembrance Day Contest 2004

Callsign: VK3VP  
 Name: Ian Godsfil  
 Address: 363 Nepean Highway, Chelsea, 3196  
 Category: HF/Single Operator  
 Section: Transmitting CW  
 Total Score: 1000  
 Declaration: I hereby certify that I have operated in accordance with the rules and spirit of the Contest.  
 Signed: Ian Godsfil  
 Date: 30 August 2004

### Example Transmitting Log

#### Remembrance Day Contest 2004

Callsign: VK1XXX  
 Category: HF/Multi Operator  
 Section: Transmitting Phone

Time (UTC)	Band	Mode	Call	Nr Sent	Nr Rcvd	Pts
0801	14	SSB	VK2QQ	58001	59002	1
0802	14	SSB	VK6LL	59002	59001	1
0806	14	SSB	VK5ANW	59003	59001	1
0808	14	SSB	ZL2AGQ	58004	57004	1
0811	14	SSB	VK4XX	59005	59008	1

### Example Receiving Log

Name/SWL Nr: L33071  
 Category: HF  
 Section: Receiving Phone

Time (UTC)	Band	Mode	Calling	Calling	Nr Sent	Nr Rcvd	Pts
0801	14	SSB	VK1XXX	VK2QQ	58001	59002	1
0802	14	SSB	VK1XXX	VK6LL	59002	59001	1
0806	14	SSB	VK5ANW	VK1XXX	59001	59003	1
0809	14	SSB	VK7AL	VK2PS	59007	58010	1

# COQC QRP Day Contest 2004

0800z - 1400UTC Friday, 6 August

Sponsored by the CW Operators' QRP Club in Australia and open to all AR operators, the objects are --

1. To work as many stations as possible in each hour,
2. To encourage contacts between VK, ZL and P29 stations,
3. To encourage the use and enjoyment of low power equipment, whether commercial or home-brewed,
4. To test the efficiency of your station under QRP conditions,
5. To compete for a certificate for best hour and/or best four hours,
6. (in VK) to prepare for the Remembrance Day Contest.

Entrants are encouraged to compete for all six hours, but to submit their logs on the basis of "best four hours". Logs will also be considered for highest score in any individual hour.

## SECTIONS: HF and VHF

### CATEGORY: Single Operator only.

#### HF

MODES: CW, SSB, PSK31, Mixed.

BANDS: All HF bands (no WARC) may be used, although it is envisaged that the bulk of operations will be on 80 and 40 metres.

EXCHANGE: RS(T) plus serial number beginning at 001 and incrementing by one for each contact.

REPEAT CONTACTS: In order to make greater use of available band space and time, repeat contacts with the same station will be allowed once each hour of the contest.

SPECIAL EVENT STATION: In 2004 VK3JS/QRP will act as a Special Event Station. It will operate on all HF bands in CW and SSB modes, but will submit a Check Log only. It is anticipated that VK3JS/QRP will work CW during the first half-hour and SSB during the second half-hour, but this will depend upon conditions on the night. VK3JS/QRP may be worked once only for the contest, and stations may claim 20 POINTS for the contact.

#### VHF

BANDS: 6 metres, 2 metre and 70 cm.

MODE: FM only.

EXCHANGE: RS plus serial number beginning at 001 and incrementing by one for each contact.

REPEAT CONTACTS: In order to make greater use of available band space and time, repeat contacts with the same station will be allowed once each hour of the Contest.

SCORE: One point per contact.

LOGS: Entrants may use separate logs for each band if they wish, but this is not a requirement. However, please arrange logs so that each hour is clearly distinguishable. Logs must show full details of time UTC, station worked,

band, mode, exchange and points claimed. Logs should be submitted for "best four hours" and scores will be considered for highest score for each separate hour.

### Scoring:

Stations within VK/ZL/P29 score as follows --

VK-VK 1 point	ZL-ZL 1 points	P29-P29 1 point
VK-ZL 3 points	ZL-VK 3 points	P29-ZL 3 points
VK-P29 3 points	ZL-P29 3 points	P29-VK 3 points

Any DX stations (outside VK/ZL/P29) score 5 points.

Contact with Special Event Station VK3JS/QRP: 20 points

A BONUS of 20 POINTS may be claimed if the QRP station operated with an homebrew transmitter or transceiver.

FINAL SCORE is the sum of the total QSO points. Except for the use of homebrew equipment (see above), no multipliers apply.

LOGS: PLEASE USE SEPARATE LOGS FOR CW, SSB, PSK31 or MIXED MODES. Logs must show full details of time UTC, station worked, band, mode, exchange and points claimed. Arrange logs so that each hour is clearly distinguishable. Logs should be submitted for "best four hours" and scores will be considered for highest score for each separate hour. Please indicate clearly if you claim the 20 points bonus for homebrew equipment (once only for the Contest).

CERTIFICATES: Certificates will be awarded to the following:

- (i) first three placegetters in each mode who submit "best four hours" entries,
- (ii) the highest scorer in each hour in each mode in each call area.

#### GENERAL:

- (i) A SUMMARY SHEET, showing operator's callsign, name, address and points claimed should accompany the Log.
- (ii) Any station claiming to operate QRP MUST NOT exceed a maximum of five watt carrier to the antenna and should add /QRP after its callsign.

SEND Logs and Summary Sheet by mail to --

Ron Everingham VK4EV,

30 Hunter Street, Everton Park, Queensland, 4053, Australia.

Logs may also be sent via email to [vk4ev@computerguru.com.au](mailto:vk4ev@computerguru.com.au)

All entries to be received no later than Friday, 20 August, 2004.

ar

Find Contest information at  
<http://www.wia.org.au/contests/>

## A visitor for lunch

The YLs at the VK5 luncheon in May were delighted to have an addition to their number. Val VK4VR and her OM, Brian VK4RX decided to book a trip on the "Ghan" so they timed the trip to allow them to attend the luncheons in Adelaide. While Val was in the City, Brian was at the AHARS luncheon in Blackwood.

Unfortunately Myrna VK5YW was unable to join us but Meg VK5YG, Maria VK5BMT, Jean VK5TSX and Christine VK5CTY (all old friends of Val) with Shirley VK5JSH, and Jeanne VK5JQ (new friends from the ALARAMEET in Murray Bridge) made up a good sized group.



Back row Maria VK5BMT, Jean VK5TSX, Meg VK5YG and JEANNE VK5JQ  
Seated l-r Val VK4VR and Shirley VK5JSH.

## A warning to us all

(this was sent to me recently by an ALARA member in VK4 – but there was a similar incident in VK5 - I think it contains a message for us all)

### From: Red Cross Blood Service

A few weeks ago in a movie theatre in Melbourne a person sat on something that was poking out of one of the seats. When she got up to see what it was she found a needle sticking out of the seat with a note attached saying "You have just been infected by HIV". The Disease Control Centre in Melbourne reports many similar incidents have occurred in many other Australian cities recently. All tested needles are HIV Positive.

The Centre also reports that needles have been found in the cash dispensers in ATMs. We ask everyone to use

extreme caution when faced with this kind of situation. All public chairs/seats should be inspected with vigilance and caution before use. 17 people have been tested positive in the Western suburbs alone in the last 2 months!!! A careful visual inspection should be enough.

## To a more frivolous world

Did you know that, for the first time in 160 years a new symbol has been added to the official Morse Code.

There is now a real code for the "@" sign as it is used in email addresses.

The code is dit dah dah dit dah dit.

Thought you would like to know about this, now that Morse Code is no longer an examination subject.

Have you discovered, as many people have done: now that it is not REQUIRED, more people want to learn and use CW? Strange, isn't it?

## The story of Dot and John's trip to Queensland

As many of us heard about this trip I thought you would like to hear the whole story. It is interesting when you come and go between two places using different highways.

"In early May John and I visited our eldest son Ian and his family in their new home in southern Queensland.

We left in two cars, John drove Mandy's small manual car with absolutely no mod cons, but the company of Ian's two (snoring) pugs in the back. I drove the bigger automatic car with air con, cruise control, etc. etc. We had radios set up on a simplex frequency so we could keep in contact and, as we had to do the trip in the one day, to keep each other awake.

The drive up was via the New England Hwy to Tenterfield then the Bruxner Hwy to somewhere just past Tabulam where we turned into another road north through a mountain range until we met the Mount Lindesay Hwy. Now if you ever want to pretend you are in a grande prix, drive the southern end of

the Mount Lindesay Hwy, but not if your passengers get car sick! Ian's road joins the Mount Lindesay Hwy at Jimboomba. At Muswellbrook and north of Moonbi we had some pleasant company on 2m with 2 OMs who were scanning the bands. John and I kept up quite a stream of chatter between us reminding each other about speed and school signs.

Ian has 5 lightly treed acres and it would make a beautiful antenna farm, although they want to grow chooks and alpacas. The thought of moving up there crossed our minds but we would need to experience a summer before making a decision, autumn was lovely. Of course seeing Ian, Mandy and our granddaughter Imogen was great.

Graham VK4BB lived quite close so during one of our drives, we popped a note into his letterbox and very soon we had a phone call inviting us for morning tea. At his home we chatted about many subjects - radio and non radio while enjoying some home-made cookies.

Travelling home was down the Pacific Hwy and was a much faster trip but not as pretty. Both highways had roadworks which slowed us down. I can see us making the trip up there regularly from now on."

From Dot VK2DB and OM, John VK2ZOI

## Other means of communication

Recently a number of YLs have been using Echolink and IRLP for some of the nets, with some success. To be able to have a radio conversation (these modes are only available to those who have legal radio licences) that is as clear as a telephone conversation is quite amazing.

They will never replace 'proper' radio contacts but they have their place as new 'toys'. Why don't you investigate and participate? There are several regular nets and many people whose call signs are listed as 'listening'. They are just waiting for your call.

# Gridsquare Standings at 5 June 2004

## 144 MHz Terrestrial

VK2FLR	Mike	111
VK2KU	Guy	102
VK3FMD	Charlie	94
VK2ZAB	Gordon	78 SSB
VK2KU	Guy	69 SSB
VK3BRZ	Chas	68 SSB
VK3KAI	Peter	63
VK2DVZ	Ross	62 SSB
VK2TK	John	62
VK3EK	Rob	62 SSB
VK3CY	Des	68
VK3XLD	David	55 SSB
VK2EI	Neil	54
VK3TMP	Max	53
VK3ZLS	Les	51 SSB
VK3BDL	Mike	60
VK2DXE	Alan	47
VK2KU	Guy	47 Digi
VK3BJM	Barry	47 SSB
VK3HZ	David	47
VK7MO	Rex	47
VK3WRE	Ralph	46 SSB
VK3KAI	Peter	45 SSB
VK2DXE	Alan	43 SSB
VK3CAT	Tony	39
VK3KEG	Trevor	39
VK4TZL	Glenn	38
VK2TK	John	35 SSB
VK3ZUX	Denis	33 SSB
VK4KZR	Rod	33
VK8HK	Don	33
VK3ZYC	Jim	31
VK7MO	Rex	30 SSB
VK3KME	Chris	28 SSB
VK2RRR	Leigh	27 FM
VK2TK	John	27 Digi
VK4DFE	Chris	26 SSB
VK7MO	Rex	24 Digi
VK2TG	Bob	23 SSB
VK3YB	Phil	23
VK5ACY	Bill	23 SSB
VK3KAI	Peter	21 Digi
VK3TLW	Mark	20 SSB
VK8KZ	Wally	20
VK3BBB	Brian	19
VK3AL	Alan	18 SSB
VK2EAH	Andy	18
VK8KZ/p	Wally	16
VK3ZYC	Jim	14 SSB

VK3DMW	Ken	13
VK2CZ	David	12
VK2EAH	Andy	12 SSB
VK7ZSJ	Steve	12
VK2EI	Neil	11 Digi
VK2DXE/p	Alan	10
VK3ANP	David	10
VK3BG	Ed	10
VK8HK	Don	6 Digi
VK2TWO	Andrew	5
VK3ZDR	David	5 SSB
VK2EAH	Andy	4 Digi
VK2AKR	Neil	3 Digi
VK2DXE	Alan	3 Digi
VK4TJ	John	3 SSB
VK2AKR	Neil	1 SSB
VK3XLD	David	1 Digi

## 144 MHz EME

VK2FLR	Mike	110
VK2KU	Guy	89
VK3CY	Des	70
VK7MO	Rex	29
VK2RRR	Leigh	22
VK3KEG	Trevor	4
VK3FMD	Charlie	3
VK2DVZ	Ross	2
VK2DXE	Alan	2
VK3HZ	David	1

## 432 MHz Terrestrial

VK2ZAB	Gordon	57 SSB
VK3BRZ	Chas	49 SSB
VK3FMD	Charlie	47
VK3XLD	David	46 SSB
VK3ZLS	Les	40 SSB
VK2KU	Guy	38
VK2KU	Guy	34 SSB
VK3EK	Rob	34 SSB
VK3HZ	David	32
VK3CY	Des	31
VK2DVZ	Ross	30 SSB
VK3BJM	Barry	29 SSB
VK3KAI	Peter	28
VK3KAI	Peter	27 SSB
VK3BDL	Mike	26
VK3WRE	Ralph	26 SSB
VK3TMP	Max	26
VK3KEG	Trevor	21

VK2TK	John	18
VK2TK	John	17 SSB
VK7MO	Rex	16
VK3ZUX	Denis	15 SSB
VK3CAT	Tony	14
VK4KZR	Rod	14
VK3TLW	Mark	13 SSB
VK8KZ	Wally	13
VK2KRR	Leigh	11 FM
VK4TZL	Glenn	11
VK3AL	Alan	10 SSB
VK3ANP	David	10
VK3BG	Ed	10 SSB
VK3YB	Phil	10
VK2TG	Bob	9 SSB
VK4DFE	Chris	9 SSB
VK3KME	Chris	8 SSB
VK8KZ/p	Wally	8
VK3BBB	Brian	7
VK2FLR	Mike	6
VK2KU	Guy	5 Digi
VK3BRZ	Chas	4 Digi
VK3XLD	David	4 Digi
VK3ZYC	Jim	4 SSB
VK2CZ	David	3
VK2TWO	Andrew	3
VK3KAI	Peter	3 Digi
VK7MO	Rex	3 Digi
VK2DXE/p	Alan	2
VK4TJ	John	2 SSB
VK2AKR	Neil	1 SSB
VK2TK	John	1 Digi
VK3DMW	Ken	1

## 432 MHz EME

VK4KAZ	Allan	14 CW
VK3FMD	Charlie	5
VK3HZ	David	1
VK7MO	Rex	1

## 1296 MHz

VK3XLD	David	33 SSB
VK3BRZ	Chas	32 SSB
VK3FMD	Charlie	32
VK2ZAB	Gordon	29 SSB
VK3ZLS	Les	26 SSB
VK2KU	Guy	26
VK2KU	Guy	22 SSB
VK3EK	Rob	20 SSB

VK3KWA	John	19
VK3KAI	Peter	16
VK3WRE	Ralph	16 SSB
VK2DVZ	Ross	15 SSB
VK3KAI	Peter	15 SSB
VK3BDL	Mike	12
VK3BJM	Barry	12 SSB
VK3TMP	Max	11
VK2TK	John	10 SSB
VK4KZR	Rod	10
VK7MO	Rex	10
VK3HZ	David	9
VK3TLW	Mark	8 SSB
VK3AL	Alan	7 SSB
VK2CZ	David	5
VK3ZUX	Denis	5 SSB
VK3ZYC	Jim	5
VK8KZ/p	Wally	5
VK3BG	Ed	4 SSB
VK3BVP	Shane	4
VK3YB	Phil	4
VK3ZYC	Jim	4 SSB
VK8KZ	Wally	4
VK2KU	Guy	3 Digi
VK3BBB	Brian	3
VK3KEG	Trevor	3
VK2DXE/p	Alan	2
VK2FLR	Mike	2
VK3CY	Des	2
VK3KAI	Peter	2 Digi
VK3KME	Chris	2 SSB
VK3XLD	David	2 Digi
VK4TJ	John	2 SSB
VK3DMW	Ken	1
VK3ZYC	Jim	1 Digi
VK4TZL	Glenn	1
VK7MO	Rex	1 Digi

## 2.4 GHz

VK3BRZ	Chas	11 SSB
VK3XLD	David	11 SSB
VK3WRE	Ralph	9 SSB
VK3FMD	Charlie	8
VK3KAI	Peter	7 SSB
VK3EK	Rob	6 SSB
VK8KZ	Wally	4
VK3BJM	Barry	3 SSB
VK3KAI	Peter	2 Digi
VK4KZR	Rod	2
VK3BG	Ed	1 SSB
VK3TLW	Mark	1 SSB

VK3ZUX	Denis	1 SSB
VK4TZL	Glenn	1

## 3.4 GHz

VK3FMD	Charlie	8
VK3WRE	Ralph	6 SSB
VK3KAI	Peter	6 SSB
VK3XLD	David	4 SSB
VK8KZ	Wally	4
VK3EK	Rob	3 SSB

## 5.7 GHz

VK3FMD	Charlie	10
VK3WRE	Ralph	9 SSB
VK3KAI	Peter	7 SSB
VK3XLD	David	5 SSB
VK8KZ	Wally	4
VK3BJM	Barry	2 SSB
VK3EK	Rob	2
VK8BHT	Neil	2
VK3KAI	Peter	1 Digi
VK3ZUX	Denis	1 SSB

## 10 GHz

VK3FMD	Charlie	9
VK8BHT	Neil	9
VK3WRE	Ralph	8 SSB
VK3KAI	Peter	7 SSB
VK3XLD	David	7 SSB
VK3EK	Rob	5 SSB
VK8KZ	Wally	5
VK3TLW	Mark	3 SSB
VK3ZYC	Jim	3 SSB
VK2EI	Neil	2
VK3BJM	Barry	2 SSB
VK3ZUX	Denis	2 SSB
VK7MO	Rex	2
VK3BG	Ed	1 SSB
VK4KZR	Rod	1
VK4TZL	Glenn	1

## 24 GHz

VK8BHT	Neil	3
VK2EI	Neil	2
VK8KZ	Wally	2
VK3FMD	Charlie	1

## 474 THz

VK7MO	Rex	1
-------	-----	---

Additions, updates and requests for the guidelines to Guy VK2KU, vk2ku@tsn.cc, or by mail (QTHR 2005).  
 The guidelines (and the latest League Table) are also available on the website of the NSW VHF Dx Group at [www.vhfdx.oz-hams.org](http://www.vhfdx.oz-hams.org) - click on Gridsquares.  
 Next update of this table will be in September 2004.  
 Stations who do not confirm their status for more than 12 months may be dropped from the table.

## Six-monthly update of operational amateur radio satellites

In consideration of the diminishing list of truly "operational" satellites at present, I have decided to change the format of this segment a little. I'll begin with a detailed list of the satellites that can reasonably be expected to be there for the working when you decide to have a go. The rest will be broken up into those with known restricted access and those listed as "semi-operational" as this last category seems to imply that they will not be there when you decide to have a go!

### ARISS

The ARISS station on board the International Space Station is turned on but direct contact with the crew has been quite rare in recent months. The packet radio digipeater is turned on but my latest information is that the Mailbox is off.

Worldwide packet uplink:	145.990 MHz FM
Region 1 voice uplink:	145.200 MHz FM
Region 2/3 voice uplink:	144.490 MHz FM
Worldwide downlink:	145.800 MHz FM

Russian callsigns	RS0ISS, RZ3DZR
USA callsign	NA1SS
Packet station mailbox callsign	RS0ISS-11
Packet station keyboard callsign	RS0ISS-3
Digipeater callsign	ARISS

### FO-29 (JAS-2) is operational

but may be operating in either mode.

#### Voice/CW Mode JA

Uplink:	145.90 to 146.00 MHz CW/LSB
Downlink:	435.80 to 435.90 MHz CW/USB
Beacon:	435.795 MHz

#### Digital Mode JD

Uplink:	145.850 145.870 145.910 MHz FM
Downlink:	435.910 MHz 1200-baud BPSK or 9600-baud FSK
Callsign:	8J1JCS
Digitaltalker:	435.910 MHz

### SO-50 is operational.

(See detailed notes below).

Uplink: 145.850 MHz (67.0 Hz PL tone)

Downlink: 436.795 MHz (Note the correction to this frequency in the notes below).

SO-50 is in good health and it is easy to access the satellite. However, SO-50 needs to be opened by a control station before you can operate. The repeater is available to amateurs worldwide as power permits, using a 67.0 hertz tone on the uplink, for on-demand activation. (See detailed notes below).

### UO-11 is operational

But remember it was never designed as a transponder satellite. Being a "beacon only" satellite it is of prime interest to telemetry fans.

Downlink: 145.826 MHz FM (1200-baud AFSK)

Mode-S Beacon: 2401.500 MHz

The beacon operates under control of the watchdog timer, approximately 10 days ON followed by 10 days OFF. A new cycle is scheduled to begin on 1st June so you can do your sums from then on (give or take a day or two). Users of OSCAR-11 should note that the date in the telemetry is now advanced by FOUR days. The time is advanced by 19.8 minutes, and this error is increasing by about one minute per year. The mode-S beacon is ON continuously, even when the VHF beacon is OFF, nominally transmitting an unmodulated carrier on 2401.5 MHz. This beacon is a useful weak signal source for those testing mode-S converters. Users should note that the polarisation of OSCAR-11 is left circular so if you are testing your Oscar-40 downlink you will need to change the antenna to LHCP for the test. If your "S" mode gear is working very well you may be able to hear some very low level modulation on the carrier. Go to the top of the class if you can hear the modulation!

### UO-22 is going well

and is providing good strong signals and high download efficiencies. The bulletin board is busy with new files appearing daily.

Uplink: 145.900 FM 9600-baud FSK

Downlink: 435.120 MHz FM

Broadcast Callsign: UOSAT5-11

BBS Callsign: UOSAT5-12

That ends the list of reliable satellites. Those listed in the following group are restricted in operation.

- AO-7 switches on when in sunlight.
- FO-20 is listed with a question mark. I'm not sure what that means but I would not be optimistic in looking for it.
- NO-44 (PCsat) is very restricted in operation due to a solar cell failure. You really need to be watching the AMSAT-BB to keep up with this one. It is often listed as being OK but a day or two later it will fail.
- NO-45. Again Sapphire is listed as operational but users are requested not to use the bulletin board as it locks out ground access to the satellite's CPU. The UI digipeater is reported to be available on 145.945 MHz.

The following (sadly) rather long list shows those satellites that have either partially or permanently failed or have been turned off or resumed commercial service - but are still in orbit.

AO-10, RS-12/13/15, UO-14, LO-19, KO-23, KO-25, PO-34, SO-33, UO-36, AO-40, SO-41, SO-42, MO-46, AO-49.

### The AMSAT group in Australia

The National Co-ordinator of AMSAT-VK is Graham Ratcliff VK5AGR. No formal application is necessary for membership and no membership fees apply. Graham maintains an email mailing list for breaking news and such things as software releases. Members use the AMSAT-Australia HF net as a forum.

### AMSAT-Australia HF net.

The net meets formally on the second Sunday evening of the month. In winter (end of March until the end of October) the net meets on 3.685 MHz at 1000 UTC with early check-ins at 0945 UTC. In summer (end of October until end of March) the net meets on 7.068 MHz at 0900 UTC with early check-ins at 0845 UTC. All communication regarding AMSAT-Australia matters can be addressed to:

AMSAT-VK,  
9 Homer Rd,  
Clarence Park, SA. 5034  
Graham's email address is:  
vk5agr@amsat.org

## Interference from long-range cordless phones

The old problem of non-amateur operation on satellite frequencies has reared its head again. Once upon a time it could be attributed to the illegal use of amateur radio gear by untrained and largely unaware operators. The easy availability of "long-range" cordless phones in some countries has lifted the bar to a new level. These units have a base station running some 4 watt, often into high gain omni-directional antennas. The remotes run around 2 watt. The legality or otherwise of

importing and distributing these devices may still be a matter of debate, but there are some sections of the community that seem only too willing to take up the technology if it is offered, and ask no questions. In many cases the users would not be aware of any restrictions on spectrum use. The frequencies used by many of the devices in question make interference to LEO satellites with 2 metre uplinks very likely. There have already been instances of these phones being found in use here in Australia but

we are fortunate in this part of the world to have authorities who would view this situation very dimly indeed and insist on users meeting our high standards. Our relative isolation helps too. Many countries have to put up with "over-the-border" activities falling into the above categories. Most LEOs these days are in relatively low orbits so interference from outside Australia is less likely. Satellites in orbits like AO-7 however are much more susceptible to this kind of interference.

## Insertion loss in co-ax adaptors at higher frequencies

I've often wrestled with this question so I thought it might be worth a mention. Not being an electronics technician by calling, I have always tried to err on the side of caution when "connecting things up" in the realm of VHF and UHF. I did however have the enormous advantage of counting a number of experienced technicians among my friends. They too, I noted, erred on the side of caution.

So, what are the rules? First, use as few connectors or adaptors as possible. A little foresight comes in handy here. Make sure you fit the correct 'gender' of connector to the gear when it is being constructed or choose the right ones if you are buying. Otherwise you could be reaching for otherwise unnecessary adaptors to connect things up. I've seen the time when I've had to go right down from "N" type to "UHF" to "BNC" when connecting up someone else's bit of gear to something of mine. You can easily end up with a string of adaptors where proper planning could have made the connection with no adaptors at all.

The second rule is to stick with "N" type connectors if at all possible and certainly in critical circuits. BNC are next best but they are not waterproof and are more easily damaged. Don't discount PL-259s and SO-259s if they are of good quality. They will do the job at 145 MHz and can be pressed into service without too much fuss at 435 MHz but forget them after that. There are more exotic connectors than "N" type of course but they are usually more expensive or

restrict the user to small or odd diameter co-ax cable.

The third rule is to learn how to discriminate between good and not-so-good connectors and adaptors, especially if you are in the habit of stocking up at hamfests. Avoid bright, shiny, nickel or chrome plated units. They may have inferior insulation and losses could be intolerable above 70cm. Pay a little extra and go for silver plated connectors and adaptors. This is particularly important if you are going to use PL / SO series at UHF. Go for the silver plated ones every time. The better units will have good quality insulation - and in the case of "N" type and BNC - they should also sport gold plated centre pins and sockets. Fourthly, learn to tell the difference between 50 ohm and 75 ohm units. The only outward difference is in the diameter of the pins and sockets. Make a wrong choice here and you can easily ruin a perfectly good connector by plugging in a 'wrong-un'. If in doubt - ask before you commit yourself to the purchase.

Now, as a former Prime Minister used to say, having said that, now let me say this: Don't overdo the caution business to the stage of paranoia. The average UHF or microwave satellite receive or transmit set up may only involve two or three such connectors or adaptors in the critical circuitry - and you generally have a few dB up your sleeve. The critical circuitry is that between the

antenna and the first RF amplifier in the receive chain and between the final RF amplifier and antenna on the transmit side. In both these situations make a practice of using as few connectors and adaptors as possible and using the best quality you can afford. Piping the whole thing up with the most expensive machine-crimped "N" types may well be called for in commercial airport radar installations but you could waste a lot of money chasing a rainbow in amateur practice.

Most good quality connectors and adaptors have losses measured in the low or fractional dB range up to several GHz and you may need just a few of these to make a very efficient installation. Losses are not the only consideration. Connectors immediately on either side of a sensitive receive pre-amplifier need careful selection. The losses may only amount to a fraction of a dB but the possibility of a wrong choice upsetting the impedance and thence the noise figure can be devastating to an otherwise good installation. Unlike EME where the operator is always chasing the errant dB, the satellite game is not usually as stringent. That may change as frequencies rise higher into the microwave region, 5.6 or 10 GHz is a different story to 145 or 435 MHz. Just keep the above few rules at the back of your mind when planning your station or collecting for your odds-'n'-ends box.

*continued next page*

# Spotlight on SWLing

Robin Harwood VK7RH

You may recall that I reported that the former Christian Science shortwave senders in Cypress Creek, South Carolina, were switched off in late March. Well they are back on-air with new owners and not surprisingly, World Harvest Radio (WHR) in South Bend, Indiana now uses these senders in addition to their sites in Noblesville, Indiana, Maine and Hawaii. The Maine senders also were originally part of the World Service of the Christian Science Monitor and now have been linked up again through the evangelical World Harvest Radio Network. WSHB is heard well here on 7535 up to 1200 UTC. WHRA is in Maine and WHRI in Indiana. KWHI is in Hawaii.

Recently I was tuning across the 19-metre band and heard a station with an evangelical Christian program in English. It was on 15748 and my initial thought it was an off-channel American gospel station. The time was just before 0200, which corresponded to the local midday here but I was somewhat surprised to find that it was the Asian Service of the Sri Lankan Broadcasting Corporation in Colombo. They had a

very interesting regional news bulletin in English, at 0200. However the signal did drop rather quickly after 0215.

I also note that Australian Christian evangelical station HCJB-Australia, based in Kununurra WA, recently received approval to acquire adjoining land as well as additional towers. The ABC reported that there was some limited local opposition because of the fear that broadcasting to Islamic nations and populations may make Kununurra a possible terrorist target. However this objection was not upheld and the approval motion was passed comfortably by the local shire council.

HCJB-Australia has made some alterations to their broadcasting times and they now broadcast to the South Pacific from 0700 to 1000 UTC on 11750 and to Asia from 1000 to 1200 on 15425. I also came across the release to South Asia on 15560 at 0225 and the signal level here was superior to that at 0700. I also am informed that they are only running 50 kW on 11750, whilst on 15 MHz they are running almost the full 100 kW.

Thanks to the assistance of Mark,

VK7KMA, I am once again back on 2 metre and on the local repeater. It has been many years and I certainly got a shock, hearing Canadian stations come via the IRLP node. I have yet to work them myself, being just content to talk to the locals at this stage.

A Catholic network recently commenced operations in Niugini and recently opened a small shortwave sender in Vanimo on 4960. It is rated at a kilowatt and they hope to run skywave and not broadcast outside of the nation. However shortwave signals do propagate well, if conditions do permit. I am informed that the Vanimo sender has already been observed on the West Coast of the United States. The main Nuiguini station on 4890 also from Vanimo, carries the Government network with a 100 kW sender which is heard throughout the world.

Well, that is all for this month. Don't forget you can forward your news and comment to me at vk7rh@wia.org.au or via Australia Post to 20/177 Penquite Road, Norwood, Tasmania 7250.

73 from VK7RH.

ar

---

## AMSAT continued

### BlueSat latest

The BlueSat team at the University of New South Wales have produced a very informative web site. Point your browser at <http://www.bluesat.unsw.edu.au/>. The presentation is worth downloading even if you have a slow

dial-up connection like mine so don't be tempted to hit the "skip movie" button. The site contains many links that are worth following and you can get a pretty good idea of what this satellite will do

for amateur radio and for University research. The list of sponsors make interesting reading. The project deserves our support.

### SO-50 over Australia

I received a letter from Noel VK3FGN with the latest information regarding SO-50. Noel is one of a group of VKs who work this satellite regularly. Noel activates SO-50 on 90% of daylight passes and some nighttime passes. He listed more than a half-dozen VK stations and a couple of ZLs who are regular operators on this bird. Signals can peak as high as S 9 with averages around S 4 when the bird is out over the Tasman Sea and in a good position for VK/ZL contacts. Noel reports that 10 minute contacts between his QTH in Mildura

and Melbourne are not uncommon. He confirms my own experience with UO-14 and similar satellites that a good tracking antenna is almost essential for consistent results, a mast-mounted pre-amp also contributing to good results. I certainly echo that. If you are going to have a serious look at SO-50, Noel cautions that the downlink frequency is approximately 4 kHz low. Please be sure to make this offset adjustment to any auto-tune facility you use or remember to take it into account if you manually tune the radios. An error of

4 kHz is enough for you to miss the signal completely if it is weak. Noel also mentions that - depending on the gain of your antenna system - the pointing accuracy is a vital component of success. Check your system regularly and make sure it tracks to a degree or two over the whole of a pass. Plus/minus 5 degrees should be considered a minimum. Thanks for the very comprehensive report Noel. Let's hope it results in some increased interest in SO-50.

ar



# Beyond our shores

David A. Pilley VK2AYD  
davpil@midcoast.com.au

## Germany

### Propagation studies

Volker Grassmann, DF5AI, says over the VHF Reflector that he recently updated his "Amateur Radio Propagation Studies" web site. Features now include a countdown for the 2004 sporadic E season, a discussion of thunderstorm effects on the ionosphere, notes on the people behind VHF DXing and much, much more. The page is in cyberspace at [www.df5ai.net](http://www.df5ai.net). Volker says come over and spend some time at the site.

(ARNewsline)

## Greece

### 2004 Summer Olympics Award Series from Greece.

The Greek R.A.A.G. has the certificates featuring historic images of Greek statuary/friezes of sports events from the country which originated the Olympics. Check out [www.dxawards.com/inet2004.htm](http://www.dxawards.com/inet2004.htm) A special "countdown on the air" program will be active from many Greek radio amateur until 13 Aug the starting day of the OLYMPIC GAMES 2004. Nine (9) Multi operators special Event Stations as SX9A, SX8A, SX7A, SX6A, SX5A, SX4A, SX3A, SX2A and SX1A from the nine (9) Greek regions are active now until 12 Aug. These stations will be on the air every 10 days one by one, to celebrate GAMES. NO QSL manager, QSL via Greek Bureau ONLY. More info, calendar and on-line logs for the "2004 OLYMPIC GAMES Countdown on the air program" you will find at: <http://www.qsl.net/sv2ngct/sx.htm>

### Olympic Prefixes for Foreign Hams

The Greek Communications Authority has announced that Greek radio amateurs may use the optional SX2004 or SY2004 call sign prefix from 1 June 2004 until 15 November 2004 to commemorate the Athens Olympic Games and Paralympic Games 2004. Also foreign radio amateurs, as visitors in Greece, from CEPT countries or from countries with reciprocity (U.S.A., Canada, Cyprus, Switzerland and Australia) can use the special prefix J42004 from 1 Aug 2004 until 15 November 2004 without any licence from Greek authorities. All others need communicate with Greek

authorities for special permission. Note that you can find the official website of ATHENS OLYMPIC GAMES 2004 at: <http://www.athens2004.com> (SV1CNS-VASSILIS - (Author SV2AEL-SAVAS))

## Iran

### IARU presents an amateur radio administration course in Iran

In response to an invitation from the administration of the Islamic Republic of Iran, Fred Johnson ZL2AMJ representing the IARU Region 3 and Daniel Lamoureux VE2KA representing the IARU International Secretariat visited Iran to present a three-day Amateur Radio Administration Course, 26 to 28 April 2004.

Since the early 1980s this course has been conducted by IARU in various forms in countries all over the world and in response to invitations from administrations to train regulators and prospective regulators in the administering of the amateur service and amateur satellite service. Related objectives include managing disaster relief communications and organising an amateur radio society.

The course in Tehran was arranged by Mr T. Shafiee and Mr M. Zomorodi of the Directorate General of Telecommunications. An excellent training room was provided with full support facilities including a data projector and access to a photocopier. The course was presented using PowerPoint displays prepared by IARU and each of the 16 participants received printed copies of the displays, documents and two CD-ROMs with documentation about amateur radio.

The two IARU visitors had discussions with many radio amateurs in Tehran, some of whom attended the course. The course participants visited EP3PTT, a station established in the Ministry's office premises in Tehran. The equipment in this station was received by Iran from the IARU Region 3 Stars\*\*\* programme. Licensed Iranian operators may operate it by arrangement.

There have been earlier amateur radio societies in Iran but there has not been an IARU member society. An amateur radio "club", a social meeting group, presently meets in Tehran.

The course has been a memorable experience for the two IARU visitors who have been very warmly received. Contact between IARU and the amateurs and the administration of Iran is to continue and further amateur radio information is to be provided.

(NZART News)

## Europe

### More countries drop CW

More restructuring has taken place in Europe. The RSGB News Service reports that Finland has now officially dropped the Morse code requirement for that nation's hams to have access to the high frequency bands. RSGB says that Finland actually deleted the Morse requirement on 1st November, 2003. Now, with the latest rules revisions there are now only two classes of amateur licence in that European nation.

Also from RSGB word that former French Class 2 licensees with F1 and F4 callsign prefixes are now being heard on the High Frequency bands.

According to the French national amateur radio society, this change was implemented on May 16th.

But CW is far from dying or dead on the other side of Europe.

In fact the fourth European High Speed Telegraphy Championships takes place 15th through 19th September in Montenegro and Serbia.

(GB2RS)

## New Zealand

### Goodbye to Morse

Finland and France are not alone in saying goodbye to Morse code testing. So has a nation down-under.

On June 4th New Zealand's Telecommunications regulators issued a decree that says Morse proficiency testing has ended and that New Zealand Limited Class operators will soon have access to the high frequency bands. In fact, regulators have decided to upgrade Limited Class operators to the New Zealand General Class.

According to the notice, operators will not be required to change their callsigns or take any other action. The new rules went into effect on June 17th.

(ZL2BHF)

ar

**Adelaide-London**

**132**

First F 0-5 Long 23755 km

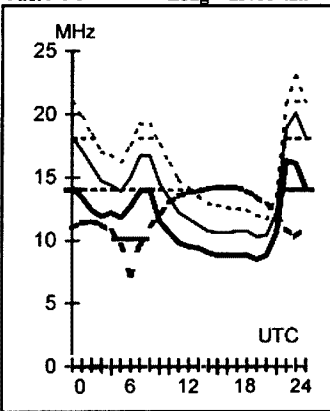

**Brisbane-Honiara**

**21**

First 1F7-10 1E0 Short 2131 km

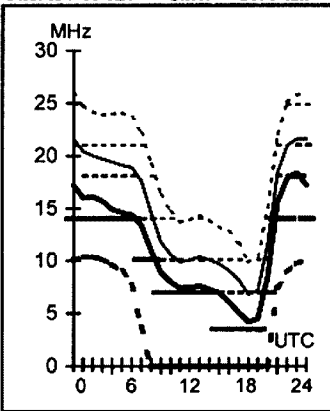

**July 2004**

T index: 39

**Legend**

Frequency scale

- UD
- - - E-MUF
- OMF
- F-MUF
- ALF
- >10%
- >50%
- >90%

Time Scale

**HF Predictions**

by **Evan Jarman VK3ANI**  
34 Alandale Court Blackburn Vic 3130

These graphs show the predicted diurnal variation of key frequencies for the nominated circuits.

These frequencies as identified in the legend are:-

- Upper Decile (F-layer)
- F-layer Maximum Usable Frequency
- E-layer Maximum Usable Frequency
- Optimum Working Frequency (F-layer)
- Absorption Limiting Frequency (D region)

Shown hourly are the highest frequency amateur bands in ranges between these key frequencies, when usable. The path, propagation mode and Australian terminal bearing are also given for each circuit.

These predictions were made with the Ionospheric Prediction Service program: ASAPS Version 4

**Adelaide-London**

**312**

First F 0-5 Short 16269 km

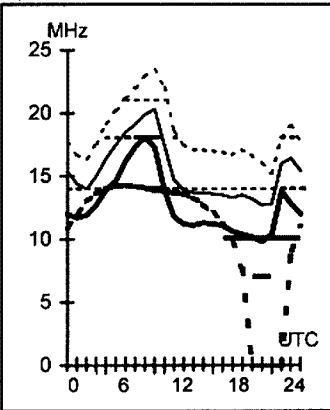

**Brisbane-Montevideo**

**154**

First F 0-5 Short 12432 km

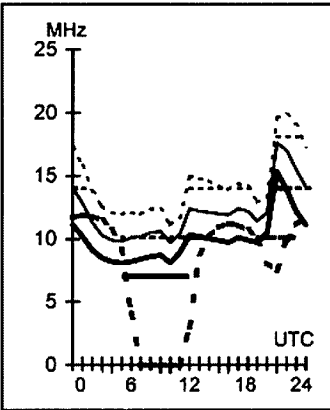

**Canberra-Auckland**

**102**

First 1F6-8 1E0 Short 2300 km

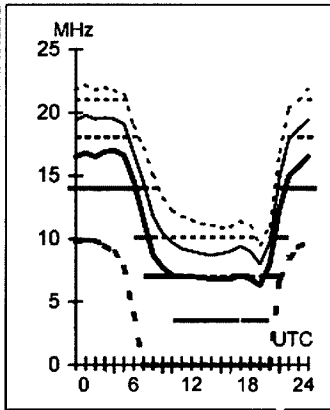

**Darwin-Seattle**

**44**

First F 0-5 Short 12282 km

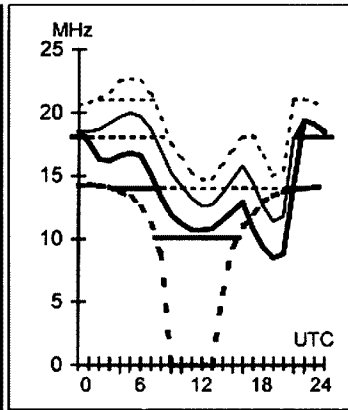

**Adelaide-Los Angeles**

**66**

First F 0-5 Short 13159 km

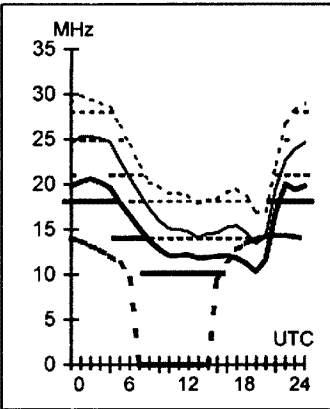

**Brisbane-Tokyo**

**346**

Second 3F6-11 3E0 Short 7159 km

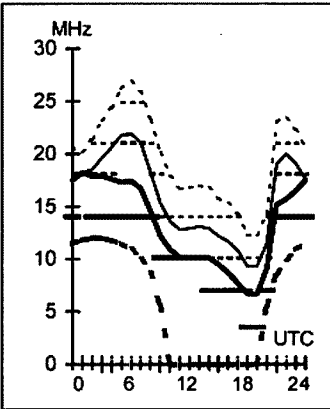

**Canberra-Honolulu**

**50**

Second 4F8-13 4E0 Short 8407 km

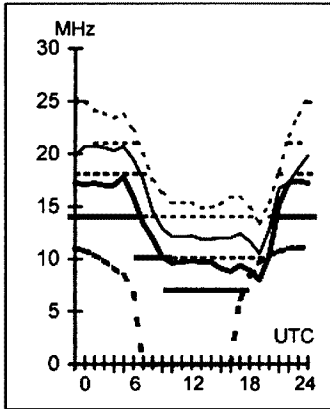

**Darwin-Singapore**

**295**

Second 2F12-18 Short 3351 km

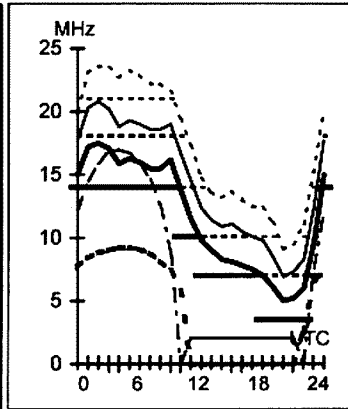

**Adelaide-Pretoria**

**238**

Second 4F5-6 4E0 Short 10064 km

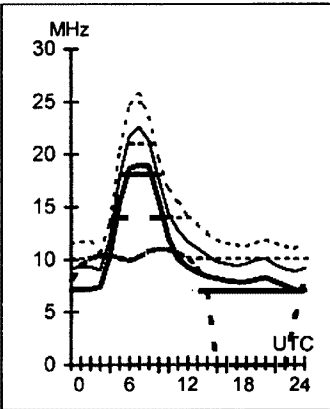

**Brisbane-Wellington**

**133**

First 1F5-6 1E0 Short 2508 km

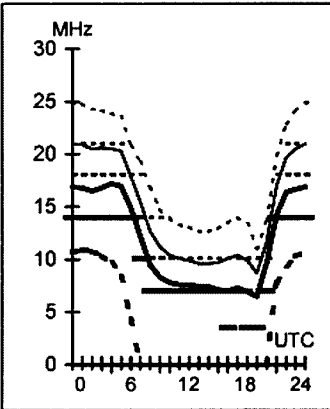

**Canberra-Paris**

**130**

First F 0-5 Long 23100 km

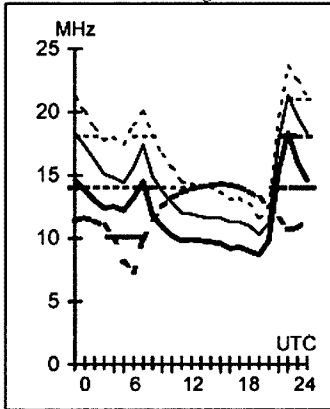

**Darwin-Vancouver**

**42**

First F 0-5 Short 12212 km

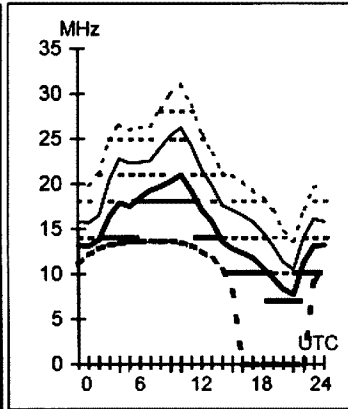

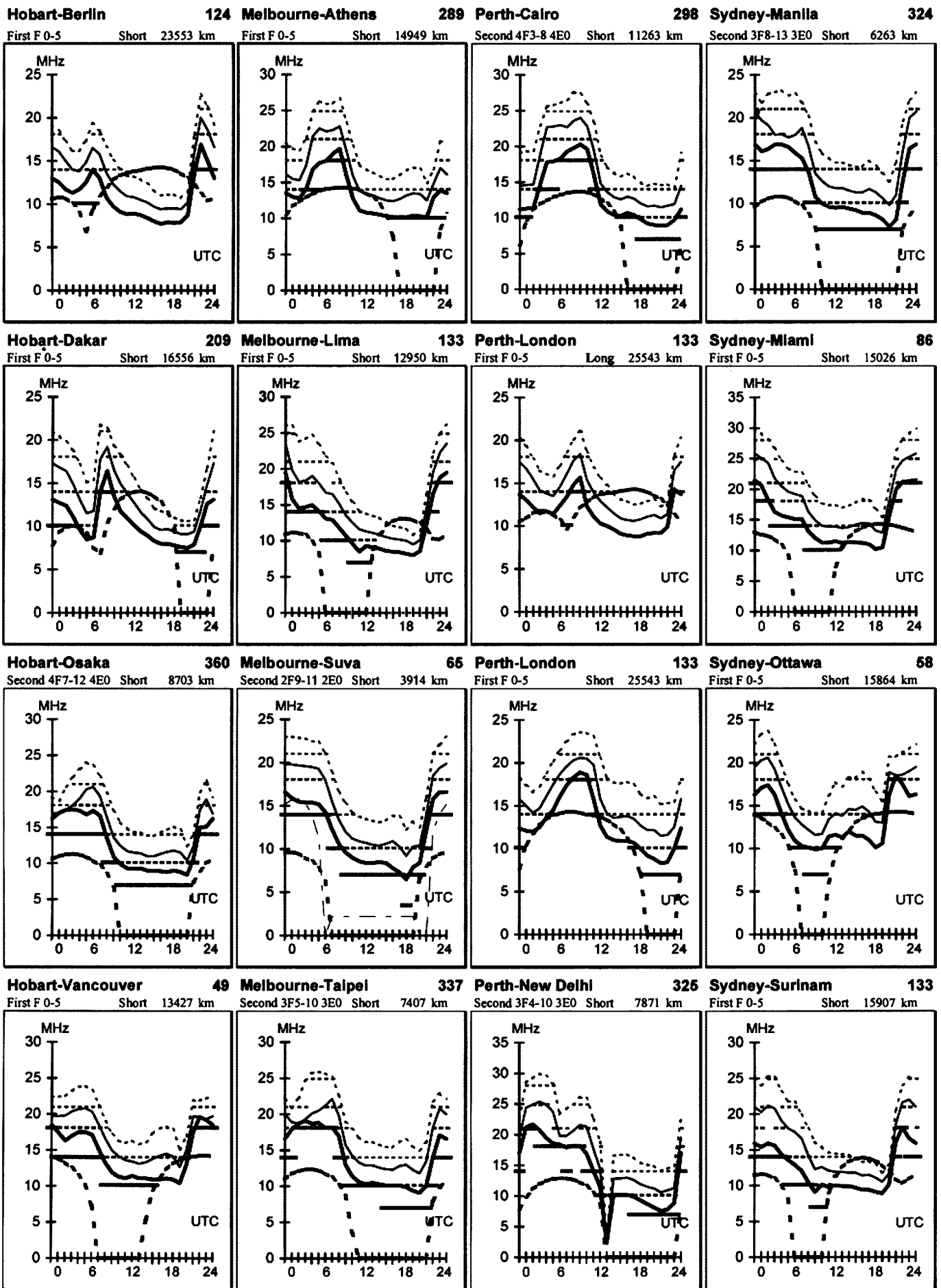

## FOR SALE ACT

• Linear 2 m suit h/h \$70. Workshop manual and handbook Kenwood TS-440 \$50. Yaesu FRG-9600 VHF/UHF receiver \$350. Yupiteru 7000 scanner \$275. Kenwood TS-520 \$280 (w/2 new tubes \$320). Kenwood SP-820 \$85. Military amplifier AM-4306/GRC \$40. All plus postage. VK1CJ QTHR Phone 02 6251 1816

## WANTED ACT

• 70 cm base station 10 watt out on SSB consider any brand. ICOM IC-1296 multi-mode transceiver. VK1CJ QTHR Phone 02 6251 1816

## FOR SALE NSW

• Complete package satellite station, ICOM IC-271A ICOM IC-471A, Sattrak 3 controller, Tiny 2 1200/9600 baud TNC, G5400B Az/EI ant control, 60 cm dish & SSB 2.4 GHz converter, 2 m/70 cm ants, G3RUH 400 baud PSK decoder, 7 m tiltover tower, anyone interested? ART VK2AS Phone 02 9416 7784.

• Yaesu FT-920, new in box, transceiver plus 6 metre, price \$2000. Jeff, Phone 0415 287 145,

• Yaesu FT-847 HF 6 m/2 m/70 cm, DSP, New with manuals \$2500 ono. 25 amp supply \$220 ono. Dot, Phone 02 6766 6649

• Shack clearout: Alinco 20 A power supply \$350. Azden PCS-5000 2 m FM Xcvr \$450. DSE AG-2600A AF oscillator \$75. DSE/EA spectrum analyser \$100, ICOM IC-490 70 cm all-mode Xcvr \$350. ICOM IC-505 6 m all-mode Xcvr \$450. ICOM IC-726 HF 6 m Xcvr \$800. ICOM IC-735 HF Xcvr & AT-150 ATU \$800. Kenpro KR-5600A Az, EI, controller \$850. Kenwood TS-430S HF Xcvr \$450. Kenwood TS-440S HF Xcvr & power supply \$850. Kenwood TR-9139 2 m all-mode

Xcvr \$300. LT PC-1200 1250 MHz counter \$150. Nemic Lambda 22 A pwr supply \$40. Tokyo Hi-Power HL-82V 2 m amp \$250. Tokyo Hi-Power HL-160V 2 m amp \$600. Tokyo Hi-Power HL-180V 2 m amp \$650. Tono 5000E keyer/modem \$600. Trio SG-402 signal generator \$100. 2 X 4/400A 2kW HF linear home brew \$600. Bob VK2CAN, Phone 02 9416 3727

• HEATHKIT SB-200 80 m to 10 m HF 400 W linear amp. has 2 x 572B triodes. Working cond \$550 ono. Dave VK2AWD, QTHR, Phone 02 9487 1840, dave0005@bigpond.net.au

• Quantity of 6 ft Deeko triangular tower sections \$50.00 each or near offer +freight if required. Colin MacKinnon VK2DYM, 104 Pebbly Hill Rd, Maraylya 2765. Phone 02 4573 6276, email cmac@zip.com.au

• Swan MK II Linear Amplifier. 80 m to 10 m. Loafs along at Australian (and USA) power limits. Comprises a fan cooled power supply and a separate fan cooled RF unit using two 3-500Z tubes. Note: This is a serious amplifier with potentially dangerous voltages inside so must be treated with respect. Weight of PSU 15 kg, RF unit 9 kg. \$800 or near offer plus freight. Colin MacKinnon VK2DYM, 104 Pebbly Hill Rd, Maraylya, Phone 02 4573 6276

• Triangular, galvanised, tiltover/windup mast. Approx. 15 m. very good condition: Deceased estate VK2EHT. Offers invited. Ron VK2GPS Phone 02 9525 8035, vk2gps@hotmail.com

## WANTED NSW

• Collins ART-13 parts or complete radio for restoration project. Phone 02 4473 9010 or 0427 624 028

• Seeking any information on transmitter/radio Marconi CNY2. Contact Herman VK2IXV, Phone 02 4237 5201 or herman@smartchat.net.au

## FOR SALE VIC

• Garage Sale Radio Station: ICOM IC-737 HF transceiver & manual. DSP-9 timewave. Emtron antenna tuner EAT-3000A. Emtron power supply. Keyer MFJ-401B. Vibroplex iambic paddle. SWR/wattmeter MFJ-815B. Drake low pass filter. Nally tower 1 stage, with 6.5 metre aluminium scaffolding pipe. Antennas, baluns, coax, connectors, etc. Diamond F-23A antenna - 2 m 5/8 wave 3-element vertical. David VK3DNG QTHR Phone 03 9859 4698, email darooda@jeack.com.au

• Kenwood R-5000 HF communications receiver, good condition, \$290. Phone Terry VK3KBD Phone 03 9315 0186 (evenings).

• Yaesu FT-990 HF transceiver, 100 W 160-10 MHz gen cov RX, Modes LSB USB CW AM FM RTTY Pkt. Auto ant tuner, internal electronic keyer, extra SSB filter, operating and workshop manuals. 240 V ac operation ser.no 1L090215. With Yaesu MD-1 Dynamic desk mic. Excellent condition. Suit upgrading amateur \$1350 ono. vk3amh@datafast.net.au QTHR Phone 03 5562 3335.

## FOR SALE SA

• Codan 8528 remote head transceiver serial number B9209, with auto tune 855a antenna. Fitted with amateur bands 80,40,30,20,17,15 metre: All VKS 737, RFDS, Radtel and CB frequencies. \$1500 ONO. VK5HRS Phone 0418 895 090.

## WANTED SA

Digital ICs 74HC 4060B and 74HCT4060B MUST be PHILIPS. A small quantity of each required but prepared to buy a "tube" if necessary. Eugenio Muratore. Phone 08 8337 6887 AH

## FOR SALE WA

• Yaesu FT-1000MP deluxe 100 W HF transceiver. 1.8 to 28 MHz amateur bands, plus general coverage. Built-in ac power supply. Serial no. 6G110031. Fitted with dual 2.4 kHz and 500 Hz IF filters and Inrad noise reduction/improved sensitivity IF board. FH-1 remote control keypad. Complete with microphone and manual. Immaculate. \$2,300. Steve VK6VZ, Phone 08 9298 9330 or email: sire@iinet.net.au

## WANTED WA

• Power transformer for Yaesu Y0-901 multiscope or a complete unit. Also a 9 MHz HC49/U crystal. VK6ABS Bob, Phone 08 9075 4136 QTHR

## MISCELLANEOUS

• The **WIA QSL Collection (now Federal)** requires QSLs. All types welcome, especially rare DX pictorial cards, special issue. Please contact the Hon Curator, Ken Matchett VK3TL, 4 Sunrise Hill Road, Montrose Vic 3765, tel. (03) 9728 5350

## TRADE ADS

**PSK-31, SSTV, RTTY SOUNDBOARD** Interfaces Fully isolated, ready to plug in. <http://www.G3LIV.CO.UK>, johnny@melvin.com, G3LIV QTHR.

## About hamads....

- Hamads may be submitted by email or on the form on the reverse of your current Amateur Radio address flysheet. Please print carefully and clearly, use upper AND lower case.
- Separate forms for For Sale and Wanted items. Please include name, address STD telephone number and WIA membership number if you do not use the flysheet.
- Deceased estates Hamads will be published in full, even if the ad is not fully radio equipment.
- WIA policy recommends that the serial number of all equipment for sale should be included.
- QTHR means the address is correct in the current WIA Call Book.
- Ordinary Hamads from those who are deemed to be in general electronics retail and wholesale distributive trades should be certified as referring only to private articles not being re-sold for merchandising purposes.
- Commercial advertising (Trade Hamads) are pre-payable at \$25.00 for four lines (twenty words), plus \$2.25 per line (or part thereof), Forty word maximum, minimum charge of \$25.00. Cheques are to be made out to: WIA Hamads.
- Copy typed or printed clearly please, and received by the deadlines shown on page 1 of each issue of Amateur Radio.

Email: [newunltd@bigpond.net.au](mailto:newunltd@bigpond.net.au) Fax: 03 9756 7031

Postal: Newsletters Unlimited, PO Box 431, Monbulk Vic 3793

### TRADE PRACTICES ACT

It is impossible for us to ensure that the advertisements submitted for publication comply with the Trade Practices Act 1974. Therefore, advertisers and advertising agents will appreciate the absolute need for themselves to ensure that the provisions of the Act are strictly complied with.

### VICTORIAN CONSUMER AFFAIRS ACT

All advertisers are advised that advertisements containing only a PO Box number as the address cannot be accepted without the addition of the business address of the box-holder or seller of the goods.

- Icom 706mk2g (NEW) \$1,299
- Icom 706mk2g (IMMAC) \$1,199
- Icom 207H (NEW) \$499
- Icom 910H (IMMAC) \$1,699
- Icom 756PRO2 (IMMAC) \$3,399
- Kenwood Ts2000 (IMMAC) \$2,399
- Kenwood TS480HX (IMMAC) \$1,799
- Kenwood TS480SAT (IMMAC) \$1,699
- Yaesu FT8900R (USED) \$699
- Yaesu FT100D (IMMAC) \$1,249
- Icom AH4 ATU (NEW) \$499
- Icom AT180 (USED) \$579
- Atas 120 Antenna (USED) \$449

FULL RANGE OF NEW HEIL PRODUCT  
PRICE SUBJECT TO CHANGE - CHECK  
WEBSITE FOR LATEST  
BARGAINS.

PLENTY OF OTHER CURRENT MODEL  
GEAR AVAILABLE.

WILL CONSIDER TRADE IN OF ANY  
CURRENT MODEL GEAR.

## Computer Interfaces

- Icom and Yaesu \$69
- Mobile Kit IC706 (NEW) \$85

Freight to anywhere in VK / ZL

ORDER ONLINE AT  
WWW.VK3AJJ.COM

OR TEL: PAUL (03-9504 2628)

LICENSED SECOND HAND DEALER NO 10229 (Vic)

## Plan ahead

14/15 August:  
Remembrance Day  
contest

21/22 August:  
international  
Lighthouse/Lightship  
Weekend

28/29 August  
ALARA contest

<http://www.hamsearch.com>

a not-for-profit site that is a search  
engine for hams

### ADVERTISERS INDEX

Andrews .....	41
Benelec.....	IFC
Bushcomm .....	35
Coax Cable & Connectors .....	40
Com-an-tena.....	22
Computer Interface.....	54
Connextron .....	16
Emtron .....	17

## Sunspot Numbers

Monthly Sunspot Average May 2004: 41.5

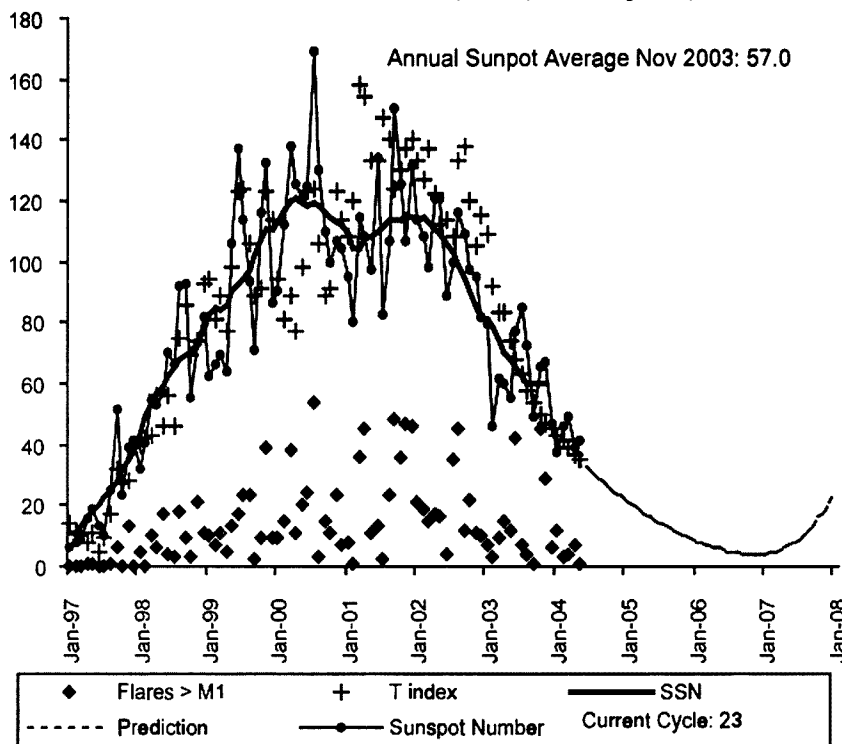

Drawn from monthly data provided by the Ionospheric Prediction Service

### AMIDON FERROMAGNETIC CORES

For all RF/electronic applications.  
See our website for complete data on all cores  
including prices.

[www.catchnet.com.au/~rjandusimports](http://www.catchnet.com.au/~rjandusimports)

RJ & US Imports  
PO Box 431, Kiama NSW 2533.  
A 3.5" PC disk containing all data is  
available for \$5.00 incl. post.

Agencies  
Active Electronics, Tas  
TTS Systems, Tyabb (VIC)  
Tower Communications, Perth

GROW WIA—MAKE IT YOUR JOB  
RECRUIT A NEIGHBOUR\*, NON-  
MEMBER LICENCE HOLDER TODAY.

One to one approaches are very  
successful and it is in your interest to  
have a strong WIA.  
If you need to know who your  
neighbouring operators are call John  
(03) 9756 7797 AH and he'll tell you.



## JACKSON BROS

JACKSON OF THE UK IS HERE

Highest quality products made by  
UK craftsmen

Full range now off-the-shelf in Australia.  
Variable and trimmer capacitors, reduction  
drives, dials, ceramic standoffs

CATALOGUES, PRICE LISTS AVAILABLE

CHARLES I COOKSON PTY LTD  
11-13 Port Rd  
Queensdown SA 5014

Tel: (08) 8240 3200 Fax: (08) 8240 3233

FreeFax 1800 673355 within Australia

Email: [jackson@homeplanet.com.au](mailto:jackson@homeplanet.com.au)

ALL MAJOR CREDIT CARDS ACCEPTED  
SOLE AGENTS AUSTRALIA AND NEW ZEALAND

## HF, VHF, UHF ANTENNAS & ACCESSORIES

Aluminium towers, guys etc  
Diamond VSWR/PWR meters.

HD copper antenna wire & insulators,  
TX tubes & pwr transistors, Create  
Rotators

Quality coax cables & connectors. Free  
advice & catalogue.

### ATN Antennas

Ph 03 6492 2224 Fax 03 6492 2666,

email [atnant@inet.net.au](mailto:atnant@inet.net.au)

PO Box 80, Birchip Vic 3483



# State/Division Directory

The Amateur Radio Service exists for the purpose of self training, intercommunication and technical investigation. It is carried out by amateurs who are duly authorised people interested in radio technique solely with a personal aim and without pecuniary interest.

The Wireless Institute of Australia represents the interests of all radio amateurs throughout Australia. All enquiries should be directed to your local Division.

The new fees for WIA membership will be \$75 for full members (F grade), \$70 for pensioners and students (G and S grade), and \$50 for membership without 'Amateur Radio' (X grade)

## Broadcast schedules All frequencies MHz. All times are local.

**VK1 Australian Capital Territory,**  
GPO Box 600, Canberra ACT 2601  
President Alan Hawes  
Secretary Deane Walkington  
Treasurer Bob Howie

VK1WX  
VK1DW  
VK1HBH

There is no longer a VK1 Broadcast but the VK1 Email News is available by request to [president@vk1.wia.ampr.org](mailto:president@vk1.wia.ampr.org)

Revised arrangements for membership of the new Canberra Region Amateur Radio Club will be advised in due course

**VK2 New South Wales**  
109 Wigram St, Parramatta NSW  
(PO Box 9432, Harris Park, 2150)  
(Office hours Tue., Thu., Fri., 1100 to 1400 hrs.)  
Phone 02 9689 2417  
Web: <http://www.wiansw.org.au>  
Freecall 1800 817 644 (NSW only)  
e-mail: [vk2wi@wiansw.org.au](mailto:vk2wi@wiansw.org.au)  
Fax 02 9633 1525

President Chris Flak  
Secretary Michael Corbin  
Treasurer Noel May

VK2QV.  
VK2YC.  
VK2YXM

VK2WI transmits every Sunday at 1000 hrs and 1930 hrs on some or all of the following frequencies (MHz): 1.845, 3.595, 7.146, 10.125, 14.170, 18.120, 21.170, 24.950, 28.320, 29.170, 52.150, 52.525, 144.150, 147.000, 432.150, 438.525, 1273.500. Plus many country regions on 2m and 70cm repeaters. Highlights are included in VK2AWX Newcastle news Monday 1930hrs. on 3.593 , 10 metres and local repeaters. The text of the bulletins is available on the Divisional website and packet radio. Continuous slow morse transmissions are provided on 3.699 and 145.650. VK2RSY beacons on 10m, 6m, 2m, 70cm and 23cm. Packet on 144.850.

**VK3 Victoria**  
40Q Victory Boulevard Ashburton VIC 3147  
(Office hours Tue 10.00 -2.30)  
Phone 03 9885 9261  
Web: <http://www.wiavic.org.au>  
Fax 03 9885 9298  
e-mail: [wiavic@wiavic.org.au](mailto:wiavic@wiavic.org.au)

President Jim Linton  
Secretary John Brown  
Treasurer Jim Baxter

VK3PC  
VK3JJB  
VK3DBQ

VK3BWI broadcasts on the 1<sup>st</sup> Sunday of the month at 1030 and 2000 hours. Primary frequencies are 3.615, 7.085, 10.130, FM repeaters VK3RML 148.700, VK3RMM 147.250, VK3RWG 147.225, VK3RMU 438.075. The broadcast can also be heard on the Saturday night at 2000 hours before the 1<sup>st</sup> Sunday. Major news appears on the packet radio network under the call sign VK3ZWI, and the WIA Victoria website.

**VK4 Queensland**  
PO Box 199, Wavell Heights, Qld. 4012  
Phone 07 3221 9377  
e-mail: [office@wiaq.powerup.com.au](mailto:office@wiaq.powerup.com.au)  
Fax 07 3266 4929  
Web: <http://www.wia.org.au/vk4>

President Ewan McLeod  
Secretary Bob Cumming  
Treasurer David Gulley

VK4ERM  
VK4YBN  
VK4DCG

EVERY SUNDAY, at 9am LOCAL (Sat 2300 UTC). From Far North Queensland On 7.070/2 MHz. From South East Queensland:- 1.825, 3.605, 7.118, 10.135, 14.342, 21.175, 52.525, 147.000, 438.500 MHz. Right throughout VK4 scan 146.6 to 148.0 MHz again at 9am local. SUNDAY 6:45pm hear LAST week's QNEWS broadcast 3.605 and 147.0 MHz from South East Queensland. MONDAY 7:00pm hear YESTERDAY's news again on 146.875 MHz broadcast from Brisbane Bayside repeater, and then 7:30pm on 3.605 and 147.0 MHz from Sth East Queensland. Text editions on packet Internet and personal email, visit [www.wia.org.au/vk4](http://www.wia.org.au/vk4) News is updated 24/7 In both text and audio on this site. MP3 Audio from same website by 2300 hours each Saturday. Contact QNEWS, packet sp QNEWS@VK4WIE.BNE. QLD.AUS.OC email [qnews@wia.org.au](mailto:qnews@wia.org.au)

**VK5 South Australia and Northern Territory**  
(GPO Box 1234 Adelaide SA 5001)  
Phone 08 8294 2992  
web:<http://www.sant.wia.org.au>  
email: [peter.reichelt@bigpond.com](mailto:peter.reichelt@bigpond.com)

President Jim McLachlan  
Secretary Peter Reichelt  
Treasurer Trevor Quick

VK5NB  
VK5APR  
VK5ATQ

Every Sunday at 0900h Local. In VK5, VK5WI: 1.843 LSB, 147.000 FM Adelaide. Relays: 3.550 LSB, 7.095 AM, 14.175 USB, 28.470 USB, 53.100 AM, 146.800 FM Mildura, 146.825 FM Barossa Valley, 146.900 FM South-East, 146.925 FM Central North, 147.925 FM Riverland, 438.475 FM Adelaide North. In VK8, Relays: 3.555 LSB, 7.065 LSB, 10.125 USB, 146.700 FM Darwin. In VK5, a repeat of the broadcast occurs Monday nights at 1930h Local on 3.585 LSB and 146.675 FM Willunga. The broadcast is available in "Real Audio" format from the website [www.sant.wia.org.au](http://www.sant.wia.org.au) Broadcast Page area.

**VK6 Western Australia**  
PO Box 10 West Perth WA 6872  
Phone 08 9351 8873  
Web: <http://www.wia.org.au/vk6>  
e-mail: [vk6@wia.org.au](mailto:vk6@wia.org.au)

President Neil Penfold  
Secretary Roy Watkins  
Treasurer Bruce Hediand-Thomas

VK6NE  
VK6XV  
VK600

VK6WIA: 146.700 FM(R) Perth at 0930hrs Sunday relayed on 1.865, 3.564, 7.075, 10.125, 14.116, 14.175, 21.185, 29.120 FM, 50.150 and 438.525 MHz, Country relays 3.582, 147.200 (R) Cataby, 147.350 (R) Busselton, 146.900 (R) Mt William (Bunbury), 147.000 (R) Katanning and 147.250 (R) Mt Saddleback. Broadcast repeated on 146.700 at 1900 hrs Sunday relayed on 1.865, 3.564 and 438.525 MHz : country relays on 146.900, 147.000, 147.200, 147.250 and 147.350 MHz..Also in "Real Audio" format from the VK6 WIA website

**VK7 Tasmania**  
PO Box 371 Hobart TAS 7001  
Phone 03 6234 3553 (BH)  
Web: <http://www.wia.org.au/vk7>  
email: [vk7dg@wia.org.au](mailto:vk7dg@wia.org.au)

President Phil Corby  
Secretary Dale Barnes  
Treasurer Dale Barnes

VK7ZAX  
VK7DG  
VK7DG

VK7WI: At 0930 hrs every Sunday on 146.700 MHz FM (VK7RHT, Hobart) and relayed on 147.000 MHz FM (VK7RAA, Launceston), 146.625 MHz FM (VK7RMD, Ulverstone), 146.750 MHz FM (VK7RNV, Ulverstone), 147.075 MHz FM (VK7RWC, Rosebery), 3.57 MHz LSB, 7.090 MHz LSB, 14.130 MHz USB and UHF CB Channel 15 in Hobart area.

VK8 Northern Territory is part of the VK5 Region and relays broadcasts from VK5 as shown, received on 14 or 28 MHz. The broadcast is downloaded via the Internet.

# Working in the Light

## International Lighthouse Lightship Weekend 2003

ILLW is not a competition, but a get-together of like-minded amateurs around the world, celebrating centuries of great work done by lighthouses and their keepers in looking after the safety of mariners.

We finished the ILLW having contacted 18 lighthouses around the world as well as many "ordinary" amateur operators.

This year (2003) there were some 370 registered lighthouse stations participating in around 48 countries, up slightly on last year.

Will we do it again? You bet we will, it's just a matter of which lighthouse we select to activate next year.

(see complete story inside)



East McCrae Lighthouse, with McCrae Yacht Club in foreground

East McCrae Lighthouse

Below: L to R, Joe VK3BKI, Carl VK3EMF, Glenn VK3CAM & Marty VK3MF.



## McCrae Lighthouse



The original McCrae Lighthouse was a timber structure built in 1854 and following years of service was dismantled in sections and transported by bullock wagon to the top of nearby Arthurs Seat to be used as a look out.

The present day lighthouse, built in England in 1874 by Chance Brothers & Co of Birmingham, was transported to Australia by sea and erected on this site in 1883.

The structure, which is listed on Victoria's Historic Buildings Register, is one of two such types remaining in Australia and at 33.5 metres is the tallest lighthouse in Port Phillip Bay.

The lighthouse comprises of a central circular column, housing a 120 step spiral staircase which ascends to the lantern housing. The central column is 1.5 metres in diameter and is constructed of riveted steel plate. The small brick portico at the base of the lighthouse has been added in more recent times.

The lantern housing located 30.8 metres above sea level is constructed of steel and timber and is protected by a glass surround and a lead dome roof. A narrow steel balcony surrounds the lantern housing.

The lighthouse was decommissioned in 1994, following modernisation of other navigational aids in Port Phillip Bay.

In 1998 the Victorian Government's Department of Natural Resources and Environment undertook significant restoration works to ensure the lighthouse's structural condition will be preserved well into the next century. The restoration which included the repair of corroded sections of the steelwork, the removal of existing coatings of paint and application of new coatings to the external structure will ensure its ongoing historical importance to the community.

# ICOM BASE STATIONS SOLUTIONS



**IC-756PROII**

Sharp & soft IF filter shape • Improved 3rd IMD & wide dynamic range  
 • One-touch record/play Digital voice memory • Extended 1/4 Tuning step & BPF functions for SSB-D mode • 32-bit floating-point DSP and 24-bit AD/DA converter • SSB/CW synchronous tuning • 4.9-inch color TFT LCD  
 • Built-in antenna tuner.



**IC-7400**

Sharp & soft IF filter shape • 100W HF /6m /2m • Digital twin PBT  
 • DSP • SSB / CW synchronous tuning • Built in antenna tuner  
 • RTTY demod / decoder • Digital RF speech processor  
 • Microphone equaliser • Morse Free Package.



**IC-718** A compact HF all band transceiver.

A superior performer with simple, straightforward operation with keypad • Optional AF DSP capabilities, including noise reduction & auto notch function • It's versatile, compact & loaded with features.



**IC-706MKIIG** HF • VHF UHF

The amazing evolution of the legendary 706.  
 Now includes 70cm @ 20W and 50W on 2m  
 Standard feature dsp • Built in sub tone encoder & decoder  
 Tone scan • Mosfet PA • You get base station performance and features in a mobile rig sized package • Morse Free Package.

## Base Station Solutions Antenna Tuner Options



**AT180**  
Antenna Tuner



**AH4**  
Antenna Tuner



**AH710**  
Folded Dipole Antenna

**ICOM**  
Clearly Ahead

2 YR WARRANTY

find your nearest ICOM dealer at  
 or (03) 9387 0666

[www.icom.net.au](http://www.icom.net.au)



The magazine for AUSTRALIAN amateurs

Volume 72 No 8  
August 2004



# Amateur Radio

\$6.50  
incl GST

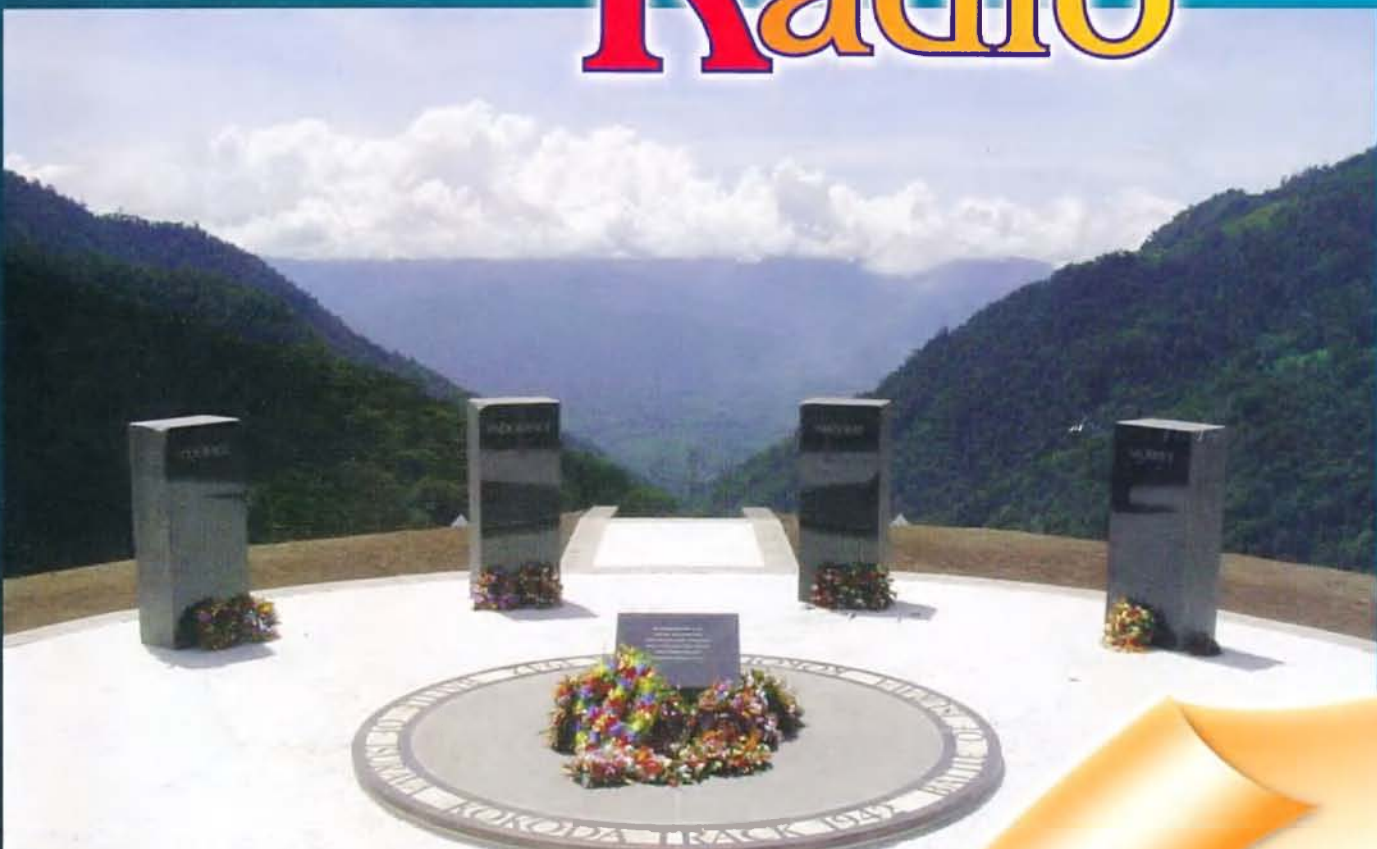

*Remembrance Day  
Contest 2004*

*Band-pass  
filters for  
the IIF  
bands*

*RSQ: an improved  
signal reporting  
system for PSK*

*A direct reading  
inductance meter for  
radio coils*

*The Secret War of Wireless*

*Radar band designations,  
old and new*

*Edison and his contribution  
to wireless*

*A visit to the Cardwell Bush  
Telegraph Heritage Centre*

ISSN 0002-6859



9 770002 685086 08

# BENELEC



## FT-857D



### Now includes DSP2 unit built-in

- Ultra Compact + All Mode Transceiver
- 160-10m / 6m / 2m / 70cm
- 100W, 100W, 50W, 20W

**Price \$ 1,693.40**

### Ideal Antenna:

ATAS 25 / ATAS120 / Comet UHV6

## FT-897D



### Now includes TCX0-9 Built-in

- Portable / Mobile / Base All Mode Txr
- 160-10m / 6m / 2m / 70cm
- 100W, 100W, 50W, 20W

### Ideal Antenna:

ATAS 25 / ATAS120 / Comet UHV6

**Price \$ 1,803.60**

## FT-7800



### 2m / 70cm Dual Band FM Transceiver

- High Power Output
- Wide Receiver Coverage
- Five One-Touch "Hyper Memory"
- Over 1000 Memory Channels
- WiRES Internet linking Compatibility

**Price \$ 575.90**

### Ideal Antenna:

Comet SBB5 / CHL 250H SB15

## FT-8900



### Quad Band FM Mobile

- 29 / 50 / 144 / 430 MHz Quad Bander
- V+U Full Duplex Operation
- High Power 50 W and Heavy Duty PDA
- 50 Tone CTCSS / 104-Code DCS Tone Systems
- Huge 800 Ch memory Capacity

### Ideal Antenna:

Comet UHV4

**Price \$ 961.30**

## FT-817



### Now includes FNB72 Internal Battery

- Ultra Compact 135 x 38 x 165mm
- All Mode Portable Transceiver
- 160 - 10m / 6m / 2m / 70cm
- 0.5-5 Watts Selectable

**Price \$ 1,331.90**

### Does Your Radio Need Fix?

- We FIX YAESU Radios!

[www.benelec.com.au/yaesu/yaesu.htm](http://www.benelec.com.au/yaesu/yaesu.htm)

NSW

Andrews Communications Systems  
Tel: 02 9636 9060 lee.andrews1@bigpond.com

Newcastle Pro Sound & Communications  
Tel: 02 4965 6899

sales@newcastleprosund.com.au

Action Communications

Tel: 02 4732 2788 action@pnc.com.au

### Authorised Yaesu Retailers

VIC

Strictly Ham P/L  
Tel: 03 9729 7656  
sales@strictlyham.com.au

G & C Communications

Tel: 03 5996 3298  
gccomm@netspace.net.au

Qld

Kyle Communications  
Tel: 07 3857 4400  
mark@kyle.com.au

SA/NT

POSNV Systems P/L  
Tel: 08 8342 4700  
brenton@posnav.com.au

**All Price includes GST**

## VX-1



**Price \$364.70**

## VX-2



**Price \$441.40**

## VX-5



**Price \$738.50**

## VX-7



**Price \$808.50**

[www.benelec.com.au](http://www.benelec.com.au)





# Amateur Radio

Volume 72, Number 8  
August 2004

The Journal of the Wireless  
Institute of Australia  
ISSN 0002-6859

## Editorial

Editor: Colwyn Low VK5UE  
edarmag@chariot.net.au

Technical Editor: Peter Gibson VK3AZL

Publications Committee Members  
Brenda Edmonds VK3KT  
Ron Fisher VK3OM  
Don Jackson VK3DBB  
Evan Jarman VK3ANI  
Tom Potter VK3UBS  
Bill Roper VK3BR

## Submission of material to Amateur Radio Magazine

General and Technical articles to Secretary  
AR Publications Committee  
3 Tamar Court  
Mentone VIC 3194  
or armag@optusnet.com.au

Columns and Letters to the Editor to Editor  
AR Magazine  
34 Hawker Crescent  
Elizabeth East SA 5112  
or  
edarmag@chariot.net.au  
(Tel and Fax 08 8255 2138)

Hamads to  
"Hamads" Newsletters Unlimited  
PO Box 431  
Monbulk VIC 3793  
Fax 03 9756 7031  
newunltd@bigpond.net.au

Advertising  
All enquiries to  
Newsletters Unlimited  
PO Box 431  
Monbulk Vic 3793  
Phone: 03 9756 7797  
Fax: 03 9756 7031  
newunltd@bigpond.net.au

Registered Office  
10/229 Balaclava Road,  
Caulfield North VIC 3161  
Australia  
Phone: 03 9528 5962

**Production Deadlines**  
Advertising booking and articles for publication 10th of preceding month.  
Hamads and advertising material deadline 18th day of preceding month

The contents of Amateur Radio are Copyright  
Wireless Institute of Australia © 2004

## General

The Secret War of Wireless ..... 14
<i>David A. Pilley VK2AYD</i>
Edison and his contribution to wireless ..... 19
<i>Malcolm R Haskard VK5BA</i>
A visit to the Cardwell Bush Telegraph Heritage Centre ..... 24
<i>Felix Scerri VK4FUQ</i>
PNG amateurs remember at the Kokoda gateway ..... 28
<i>P29KFS Rick</i>
PLC/BPL in Australia: progress, or a cause for concern? ..... 37
In Charlie's Way. Part 4 'Charlie's quality' ..... 51
<i>Ross Fraser VK2WN</i>

## Technical

Band-pass filters for the HF bands ..... 4
<i>Peter Kloppenburg VK1CPK</i>
RSQ: an improved signal reporting system for PSK ..... 6
<i>Graeme Harris VK3BGH</i>
A direct reading inductance meter for radio coils ..... 10
<i>Drew Diamond VK3XU</i>
Radar band designations, old and new ..... 15
<i>Richard Sawday VK5ZLR (Dip. Eng. Electronics)</i>
Technical Abstracts
<i>Peter Gibson VK3AZL</i>
The copper loop for 2 metres – addendum ..... 16
A parallel wire dipole ..... 17
YS1AG 40 metre two element beam ..... 22
An easy to build, dual-band collinear antenna ..... 26

## Columns

ALARA ..... 34	Silent Keys ..... 23,27, 35, 45
AMSAT ..... 36	Spotlight on SWLing ..... 39
Awards ..... 46	State news ..... 30
Beyond our shores ..... 38	VK1 news ..... 30
Club news ..... 40	VK2 news ..... 30
Contests ..... 41	VK6 news ..... 31
Directory ..... 56	VK7 news ..... 32
DXCC listings 30 June, 2004 ..... 47	VK3 news ..... 33
Editorial Comment ..... 2	Technical Abstracts ..... 16, 17, 22, 26
HF predictions ..... 52	VHF/UHF – an expanding world ..... 48
Hamads ..... 54	WIA comment ..... 3

## Our Cover this month

see page 2

### Contributions to Amateur Radio

Amateur Radio is a forum for WIA members' amateur radio experiments, experiences opinions and news. Manuscripts with drawings and or photos are always welcome and will be considered for publication. Articles on disc or email are especially welcome. The WIA cannot be responsible for loss or damage to any material. A pamphlet, How to write for Amateur Radio is available from the Federal Office on receipt of a stamped self-addressed envelope.

### Back Issues

Back issues are available directly from the WIA Federal

Office (until stocks are exhausted), at \$4.00 each (including postage within Australia) to members.

### Photostat copies

When back issues are no longer available, photocopies of articles are available to members at \$2.50 each (plus an additional \$2 for each additional issue in which the article appears).

### Disclaimer

The opinions expressed in this publication do not necessarily reflect the official view of the WIA and the WIA cannot be held responsible for incorrect information published.

## Amateur Radio Service

A radiocommunication service for the purpose of self-training, intercommunication and technical investigation carried out by amateurs; that is, by duly authorised persons interested in radio technique solely with a personal aim and without pecuniary interest.

## Wireless Institute of Australia

The world's first and oldest

National Radio Society

Founded 1910

Representing

The Australian Amateur Radio Service

Member of the

International Amateur Radio Union

Registered Office of the WIA

10/229 Balaclava Road, Caulfield North Vic 3161

Tel: (03) 9528 5962 Fax (03) 9523 8191

email: nationaloffice@wia.org.au

http://www.wia.org.au

All mail to

PO Box 2175 Caulfield Junction VIC 3161

Business hours: 10am – 4pm weekdays

### National Office staff

June Fox	Office Coordinator
Emma Trebilco	Examinations Officer
Brenda Edmonds	Office Assistant

### Board of Directors

President	Michael Owen	VK3KI
Vice President	Ernie Hocking	VK1LK
	Glenn Dunstan	VK4DU
	Trevor Quick	VK5ATQ
	Ewan Mcleod	VK4ERM
	Ted Thrift	VK2ARA
	Phil Wait	VK2DKN
Secretary	Peter Naish	VK2BPN
Treasurer	David Pilley	VK2AYD

### Coordinators

AMSAT	Graham Ratcliff	VK5AGR
ARDF	Jack Bramham	VK3WWW
Awards	Mal Johnson	VK6LC
Contests	t.b.a.	
John Moyle Memorial		
FD Manager	Denis Johnstone	VK3ZUX
Editor "AR"	Colwyn Low	VK5UE
Education	Ron Smith	VK4AGS
EMC/EMR	Gilbert Hughes	VK1GH
	Keith Malcolm	VK1ZKM
Standards	Gilbert Hughes	VK1GH
	Peter Naish	VK2BPN
	John Martin	VK3KWA
FTAC	t.b.a.	
Historian		
IARU Region 3	Neil Penfold	VK6NE
Liaison Officer		
Intruder Watch	Henry Andersson	VK8HA
International	John Miller	VK3DJM
Travel Host		
ITU Conference and		
study group	Gilbert Hughes	VK1GH
	David Wardlaw	VK3ADW
	Keith Malcolm	VK1ZKM
QSL Curator	Ken Matchett	VK3TL
QSL Manager (VK90)	Neil Penfold	VK6NE
Videotapes Curator	VK2 Division	
Webpage co-ordinator	Colin Thompson	VK2TRC
WICEN	John Weir	VK3ZRV

### ACA Liaison Team

Peter Naish	VK2BPN,	Peter Mill	VK3APO
Gilbert Hughes	VK1GH	Glen Dunstan	VK4DU
Keith Malcolm	VK1ZKM		

## Editorial Comment

Colwyn Low VK5UE

### Remembrance

The Remembrance Day contest is with us and our thoughts turn to those Amateurs who died in the services during the 1939 - 1945 war. We should also remember all those who served in other conflicts both past and present. The front cover comes from the Australian War Graves Commission and I thank them for their prompt response to my request to use the picture.

### Antarctic operator

The July cover had an incorrect identification of the radio operator in Antarctica, two people have pointed out the young lady is Denise Jones. As occasionally happens in archives, the original picture must have had incorrect annotation. I apologise to Denise Jones and Donna Simpson for any problems this mistake may have caused.

### State Advisory Committees

The WIA is progressing towards the finalisation of the national organisation as Divisions sign the necessary documents and the references in Amateur radio magazine are being changed from Divisions to States and State Advisory committees. I will now start to group all news from each state under a State heading.

### Somalia now on air

I was pleased to learn that Sam Voron in Somalia has received a transceiver donated by the wife of an Australian SK. It is now on the air. Listen on 14.285,

21.295 and 28.475 MHz for SIX OSCAR ZERO ALPHA.

### WICEN

The WICEN support of community and sporting events continues. The north east of Australia has a number of horse, car, cycle and human trials, which they support loyally, each year and the Tasmanian and South Australian Amateurs are critical to the operation of major car rallies in those states and local events. I really wonder why anyone would want to get up at 4 am drive through the fog and rain in the dark to set up radio links on voice and packet ! Is it just to see the cars go by ? All these WICEN activities provide an opportunity to advertise Amateur Radio and we should exploit them to the full. However please try and get all age groups and genders into the support otherwise "Amateur Radio a hobby for all ages etc" is a bit hollow.

The Technical Abstracts on page 26 show how to build a 144 MHz and 430 MHz vertical with ground independent feed. I have built one of these and used it on WICEN exercises and FD operation I think it was a good investment of my time. Without too much trouble it has 20 W out and 1 W back. I used 15 A single solid core mains cable for the elements with the insulation left on.

### Have fun!

Well that is it for another month. Keep enjoying your hobby and please keep talking about it to all ages and genders. Good DX, good chats, good support for community activities and have fun.

73 Colwyn VK5UE

## August cover

### Isurava Memorial, Papua New Guinea

The Memorial was constructed by the Office of Australian War Graves and dedicated on 14 August 2002 by the Prime Minister of Australia, the Rt Hon John Howard MP, and the Prime Minister of Papua New Guinea, the Rt Hon Sir Michael Somare GCMG CH MP.

The Isurava Memorial commemorates those Australians and Papua New Guineans who fought and those who died on the Kokoda Track in 1942. Isurava is the site of some of the most intense fighting on the Kokoda Track during WWII. It was here that Private Bruce Kingsbury performed an act of valour for which he was posthumously awarded the Victoria Cross - the first VC on what was then Australian administered soil.

The photograph is courtesy of Hewitt Pender Associates and was supplied by the Office of Australian War Graves, Department of Veterans' Affairs.



## Who is doing what?

**As I write this, it is just two months since the former Federal Council voted to pass the Special Resolution that gave the WIA a new Constitution and a single national WIA with a new board of directors.**

**I would like to tell you something about what we are doing, and how we are doing it.**

### The Office

On the administrative side, the national office at 10/229 Balaclava Road, Caulfield is now working from 9 am to 4 pm, though we do ask that phone inquiries be made between 10 am and 4 pm.

The subscription year starts each July, and on 12 July we started posting the renewal notices for July. Usually they would have been posted in June, but they were delayed this year because of the changes to the WIA structure.

A number of people have contacted the office, concerned that they had not received their renewal notices. We are sorry, but we hope that by the end of the month we will have sent out renewal notices for everyone whose subscription became due in July or will become due in August.

One further problem this year is that we do need the slip that is the bottom half of the renewal notice signed and returned to the office. Many are sending them back unsigned, and that means we have to write another letter asking for a signature. It is all taking a lot of time, so please help us this year by returning that slip with your signature.

Apart from the office, who is doing what?

### Publications

On many important matters, a particular director has been identified as having primary responsibility.

Responsibility for publications, Amateur Radio and the Callbook, has been given to Ted Thrift, VK2ARA. I am sure that a good flow of information in both directions between the Publications Committee and the Board will help everyone, so Ted's role is very much a liaison role, but making sure that the Publications Committee is given as much help as possible.

### Broadcasts and website

The Board recognises that information on what is happening is extremely important, not only through this magazine, but also through the broadcasts and the WIA web site.

The Director given broad responsibility for broadcasts and the web site is Ewan McLeod, VK4ERM, though he has been helped by a small number of people who have given a great deal of time to bringing our web site, [www.wia.org.au](http://www.wia.org.au) to a new standard, and placing all sorts of information on it in a timely way.

Our inaugural truly national broadcast took place on 25 July, with QNews changing its role and name to WIANews. The response was really encouraging.

The broadcast is carried under our new call sign, VK1WIA. As I said in the broadcast, it is very hard to think of a more appropriate call sign, with the WIA becoming a single, national body, than VK1WIA. VK1 is also significant, as with the adoption of the new Constitution, the last link of the WIA as a company with a state was lost, as the company

is now administered completely under Commonwealth legislation.

I would particularly thank Graham Kemp, VK4BB, and his team, not only for their totally professional approach but also for their enthusiasm for helping us make a "one WIA".

### QSL Bureau

The WIA has made a promise to the Divisions that it will provide a QSL Bureau service at no charge to members, and Ewan McLeod has responsibility for this project. Ewan is consulting with the various people involved in the QSL services in the different states, and is developing a plan as how to use the existing resources to best advantage, and at the same time see if there are any economies or efficiencies that can be used.

### BPL

One very important issue is BPL, or broadband over powerlines. Phil Wait, VK2DKN, is the director primarily responsible for this. In fact, as I write, Phil is in the UK, and has visited the RSGB at Potters Bar, and some prominent members of the RSGB and Region 1 to discuss that issue, as well as to learn more about the UK experience of the foundation licence, and of the progression of those licensees.

Phil is working with a small group on this important matter, and making sure that up to date information about the issue is placed on the web site.

### Contests

Trevor Quick, VK5ATQ, is the director responsible for contests and the like. He has been busy with the upcoming RD contest.

### Spot frequencies

The director taking responsibility for developing the WIA case for spot

**...This issue of AR in fact marks the next step in the evolution of a truly national WIA,...**

**With the support of so many people of goodwill we have every chance of securing a better future for amateur radio.**

# Band-pass filters for the HF bands

By Peter Kloppenburg VK1CPK

Band-pass filters are most efficiently and effectively used when two or more transceivers are used in close proximity to each other such as at field days and contests<sup>3</sup>. Each nearby transceiver's output contains broadband phase noise<sup>2</sup>, harmonics, and other RF distortion products that interfere with another receiver's input circuits. Band-pass filters provide discrimination against these unwanted signals by steep-skirted selectivity while achieving a flat-topped frequency response.

Skirt selectivity is specified as shape factor that is the ratio of -6 dB to -60 dB bandwidth. Shape factors can be as low as 1.2 to 1. These filters are designed for one amateur band only, such as the 80-, 40-, or 20-metre band. The pass bandwidth ranges from 750 kHz on the 160-metre band, to 11 MHz on the 10-metre band, with less than 0.5 dB of insertion loss. Rejection, or insertion loss, at the adjacent bands is usually greater than 30 dB. These band-pass filters are designed for 50 ohm input and output impedance, and are connected between the transceiver and the feedline to the antenna. If a linear amplifier is used, the filter is connected between the transceiver and the linear amplifier. The filters discussed here can easily handle 100 watt of thru-power.

Band-pass filters provide protection against many types of interference caused by nearby transmitters, which would otherwise result in desensing, imaging, third-order harmonic distortion, and overloading at the input circuit of a receiver.

There are many different types of band-pass filters<sup>5</sup>. Some are easier to construct than others. But, when used with transceivers, the insertion loss of the filter must be at an absolute minimum. An insertion loss of less than 0.5 dB is acceptable in most circumstances. The Butterworth type of filter is easy to construct, has a flat pass-band, and with careful selection of components results in having an insertion loss of less than 0.5 dB at the centre of the pass-band

The type selected is a three-pole,  $\pi$ -section. Three-pole means that there are three tuned circuits in the filter. The  $\pi$ -symbol means that one of these is oriented horizontally, the other two are vertically oriented. Refer to Figure 1.

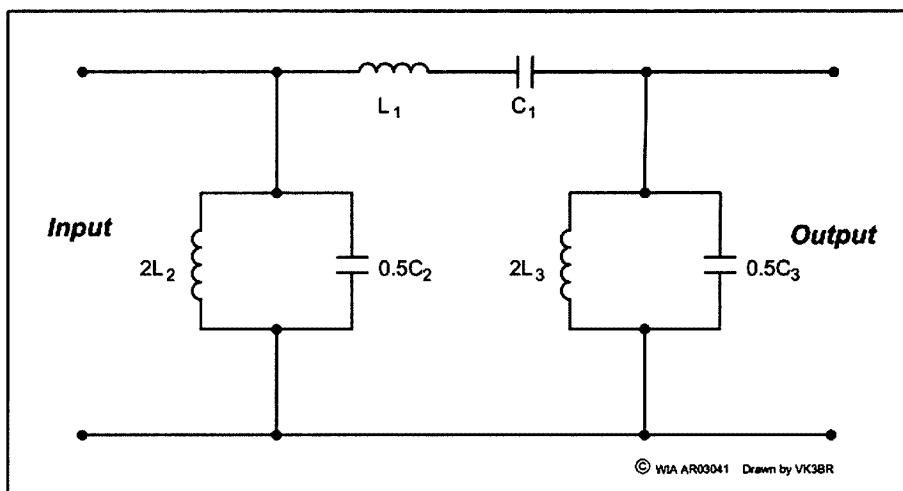

Figure 1. Circuit diagram of the 3-pole,  $\pi$ -section band-pass filter.

The more poles, the steeper are the pass-band skirts and the higher the insertion losses.

## Project Construction

All the components of the filters fit within a small die-cast aluminum box. The preferred type is the Eddystone Radio model 6809P, which has dimensions of 120 x 95 x 55 mm. The inside is divided into three chambers using panels made of brass or aluminum sheeting. This is necessary to prevent capacitive coupling between the tuned circuits, and thereby broadening of the pass-band skirts. A tiny hole is made in each dividing panel to allow a connecting wire to pass through.

All the coils are hand-wound, preferably with silver-plated wire (B&S 16). Tinned copper wire is an alternative, but enameled wire is least desirable, as it is lossy at HF frequencies. The wire diameter should be between 1 and 2 mm, so that the coils can be self supporting within the circuitry. Turns are spaced about one wire diameter

and the coil shape should be square i.e. length = width, to obtain the highest possible Q.

When the filter input is 100 watt, the capacitor and the coil in the series resonant circuit operate at about 350 volt, and should have a rating of 500 volt. The capacitors and coils in the parallel circuit have circulating currents of 3 amp. These high voltages and currents appear only across and within these components, not at the input or output of the filter.

## Formulas and Calculations

Below are the formulas<sup>5</sup> for calculating the values of Ls and Cs for the different bands:

$$\begin{aligned}L_1 &= R/\pi(F_2 - F_1) \\L_2 &= R(F_2 - F_1)/4\pi F_2 F_1 \\C_1 &= (F_2 - F_1)/4\pi R F_1 F_2 \\C_2 &= 1/\pi R(F_2 - F_1)\end{aligned}$$

These formulas apply equally to constant-K,  $\pi$ -section and T-section filters. However, the component values

obtained from these formulas are either halved or doubled, depending on which type of section is used<sup>5</sup>. The resonant frequency ( $F_R$ ) and the bandwidth ( $F_2 - F_1$ ) at the -3 dB levels have been selected so as to provide nominal values for  $C_1$ ,  $C_2$ , and  $C_3$ .

The result of calculations for the components in Figure 1 are given in Table 1.

## Tuning and testing

The minimum test equipment required for aligning the tuned circuits of each filter is a Gate-, or Grid-dip Oscillator<sup>6</sup> (GDO). Such a device will indicate the resonant frequency of a tuned circuit while the coil in the device under test (DUT) is being squeezed or stretched. Provided that the tolerance of its associated capacitor is within 5%, the coil and capacitor (LC) combination can be made to resonate very close to the required frequency.

To prevent interaction between the three tuned circuits, each LC combination should be disconnected from the others while it is being tuned to resonance. The series LC combination should be connected as a parallel LC combination while it is being tuned to resonance. When all three LC combinations are tuned to resonance, they can be connected as per Figure 1.

Band (MHz)	$C_2/C_3$ (pF)	$C_1$ (pF)	$L_1$ ( $\mu$ H)	Turns	$L_2/L_3$ ( $\mu$ H)	Turns	$F_R$ (MHz)	$F_2 - F_1$ (MHz)
1.8	4000	400	2.2	20	22	95	1.75	0.723
3.5	2000	200	1.1	10	11	48	3.38	1.44
7	1000	100	0.55	5	5.5	27	6.78	2.89
14	500	50	0.28	4	2.8	16	13.56	5.68
21	330	33	0.18	2.5	1.8	11.5	20.65	8.84
28	250	25	0.14	2	1.4	9	27.39	11.37

Note:  $R = 50 \Omega$ . All capacitors are silvered mica types, 500 volt working, available from Radio Spares in preferred values.  
Coil diameter: 18 mm

Table 1

A final alignment test is to measure the insertion loss of the filter. This should be no more than 0.5 dB. With 100 watt of input power, output should be no less than 89 watt.

Tuning and testing is much easier and accurate when a signal generator and an RF voltmeter are available.

A visual image of the pass-band can be obtained by using a sweep generator, a detector, and an oscilloscope. A set-up like that will show the width of the pass-band, and how much rejection is provided at other frequencies.

## References

1. L. Gordon, "Band-pass filters for HF transceivers" QST September 1988

2. J. Grebenkemper, "Phase noise and its effects on amateur communications" QST March/April 1988
3. T. Moliere, "Band reject filters for multi/multi contest operation" CQ Contest, Feb. 1996
4. ARRL Handbook 1995/6/7 Chapter 16
5. RSGB 'Radio Communications Handbook' 5th Edition Vol. 2, Page 23.10
6. D. Diamond, "Kalitron" Gate Dip Oscillator/crystal checker. Amateur Radio, March 2003

ar

## WIA comment *continued*

### Who is doing what?

*continued from page 3*

frequencies around 5MHz is Glenn Dunstan, VK4DU.

### New syllabus

Glenn is also helping Phil Wait and Ernie Hocking to develop the WIA's proposals and position for a new syllabus and the vitally important opportunity for outsourced work from the ACA.

### Insurance

Secretary, Peter Naish, VK2BPN, is responsible for investigating the insurance issue, another promise made by the WIA to the Divisions, to, if possible, find a cost effective policy that will adequately cover the WIA, and its volunteers and also be available for the clubs.

## Marketing

Treasurer David Pilley, VK2AYD, and Vice President Ernie Hocking, VK1LK, have the task of developing a marketing plan for publications, badges and the like, and Ernie with Phil Wait has the task of developing a much broader marketing plan, addressing other marketing opportunities to enhance the future role of the WIA.

### Last but not least...

When I started to write this, I attempted to mention, where I thought it appropriate, some of the many people who give their time and expertise to benefit us all though the WIA, but then I rapidly realised that I was simply going to overlook more people than I would mention. It is really staggering how many people give their time for amateur radio.

So, this note is really to give you some idea of the areas of responsibility of the different directors.

It is also very appropriate, as this issue of AR in fact marks the next step in the evolution of a truly national WIA, with a directory on the last page of the Advisory Committees and the broadcast time and frequencies of the national WIA broadcasts from VK1WIA.

Finally, a personal note. To all of you who taken the trouble to send us your good wishes and to let us know that we have your support in what we are doing in establishing a single WIA, I thank you.

With the support of so many people of goodwill we have every chance of securing a better future for amateur radio.

ar

# RSQ: an improved signal reporting system for PSK

By Graeme Harris, VK3BGH

Narrow band digital modes have become more popular on the HF bands in recent years and have seen an increase in more casual keyboard style QSO's. Today, PSK31 leads the way with keyboard chatting, RTTY remains popular, and an increasing number of other PC sound card based digital modes are seen on the bands. This article suggests that Readability, Signal Strength and Tone (RST) no longer provides a meaningful signal report for these newer modes and is particularly unsatisfactory for PSK. An improved signal reporting process is now needed to keep pace with the evolving digital revolution in Amateur radio, and the popular PSK modes are seen to provide an opportunity to springboard a change.

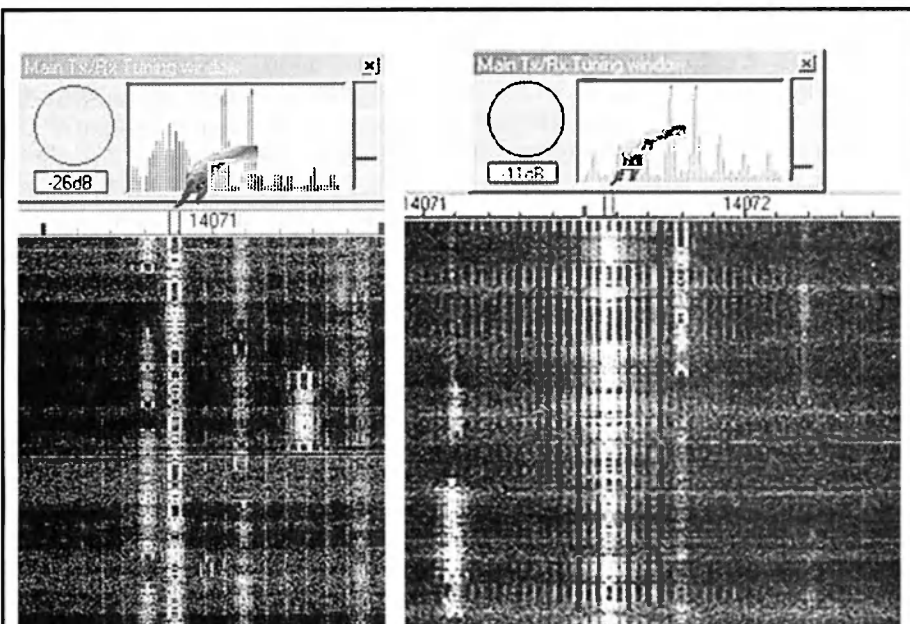

## Good quality BPSK31 transmission

The image above shows a range of signals, with the chosen signal highlighted by the pointer and two parallel lines. The waterfall display shows the clean profile of this signal. The related spectrum display extends +/- 500 Hz from the selected trace.

This trace would rate a Q9 report according to the RSQ reporting table.

There is a total of six traces to be seen in this waterfall display with some only just visible, and most occupying the normal bandwidth of approx 60Hz. However, the short trace to the centre-right is starting to exhibit an additional unwanted sideband pair.

Although these screen images do not reproduce particularly well in black and white, the quality of PSK traces is easily observed on normal colour screen waterfall displays.

## Poor quality transmission

This image demonstrates a bad signal, unfortunately all too commonly seen!

The signal is generating multiple sidebands, taking up more bandwidth than necessary, and causing interference to fellow amateurs.

The spectrum display (+900Hz and -600Hz) clearly shows the multiple signals emitting from this station.

This trace would rate a Q1 report. There are four traces in this display and the traces on either side of the (indicated) poor signal are being subjected to its multiple sideband QRM.

Any DX traces within 100 to 200Hz of the poor signal would be almost impossible to decode. The gross distortion of this signal would also be very audible on the band.

"Your report is 5 and 9 OM - please repeat name and QTH!"

There seems little value in receiving a 59 or 599 report when the other station is obviously struggling to hear you. Despite the lack of meaning in such reports for SSB and CW, a further situation exists for PSK where the traditional RST format is clearly inadequate to describe the error content of received text, signal strength on a busy band, or quality of the actual transmission itself. A particularly unhelpful aspect is where operators with poor quality transmissions receive T9 reports as a matter of course even though their signals are broad and distorted with the potential to QRM adjacent QSOs.

So what really constitutes a readability of 3, 4 or 5 for PSK text decoding on your screen? How do you interpret signal strength when there are several other signals within your passband or when a local station has pinned your S meter? And what is a meaningful and reliable measure for the quality of a transmitted PSK signal? These are the questions that have been the basis of most debate since PSK31 was introduced in 1998. Various solutions have been proposed but unfortunately none has produced any serious new direction for change.

Late 2002, a small group of operators decided to propose a new signal reporting system for PSK and assemble a website in support of its implementation. "PSB" (Print, Strength, Bandwidth) reporting was developed, advertised and used on-air by the development team, during which time it also underwent peer review via a list of dedicated mailing subscribers and the PSK31 group site at Yahoo.

"RSQ" (Readability, Strength, Quality) is a subsequent development of the PSB



system. It provides the same improved reporting outcome as PSB and uses terminology more closely aligned to that of traditional RST.

Just as RST describes the tone of a CW signal in terms of the presence of unwanted modulation heard as hum, key clicks, chirping etc, so RSQ describes the quality of a PSK signal in terms of the presence of unwanted modulation observed as additional unwanted sidebands. This is the most significant departure of RSQ from traditional RST.

## RSQ Reporting Table

Readability is the percentage of decipherable text.

Strength is a visual measure of the waterfall trace.

Quality attempts to describe visible unwanted sidebands.

S meters measure the average strength of all signals in the receiver passband. So for regular situations where multiple signals are present, and narrow band IF filtering is not applied, then a *visual* measure of waterfall trace or spectrum amplitude is more meaningful for the *strength* of the decoding signal.

When viewing the quality of very strong signal traces, well-suppressed additional sidebands may be seen above the noise floor. In this case, an intermodulation distortion (IMD) reading may assist in determining their status. If the IMD reading is about -25dB or better, then any additional sidebands can be assumed as below the interference threshold, disregarded, and a Q9 report given. If the IMD reading is about -20dB or worse, then the additional sideband modulation is undesirable, may cause interference to other stations, and an appropriate value from the quality table can be applied to the report.

PSK software usually provides the facility to measure IMD, however many operators are unaware of the limitations of its practical use. The measurement of very strong signal IMD mentioned above is reliable providing the measurement is taken when the signal is at idle, as occurs during a pause at the keyboard or during the brief tail at the end of each PSK transmission - and even then, only after careful adjustment of receiver gain settings.

It is therefore suggested however that IMD readings only be given to the

other operator when requested, and then only as a supplementary report. The following explanation is from Howard (Skip) Teller KH6TY who developed the first panoramic PSK31 transceiver and Digipan software: "IMD is the measurement of the first pair of unwanted sidebands to the desired ones, and if the signal to noise ratio is not around 26 db, you will start to measure the noise instead of the unwanted sidebands, which will be under the noise threshold. Also, if there is any distortion in the receiver, you create a false IMD reading. Whenever I measure a station's IMD, I have to be sure the S/N is good, and then I reduce the RF gain of my transceiver until the IMD stops falling and starts rising. At this point, I believe I have almost eliminated IMD caused by the receiver distorting the signal".

Further information about the RSQ scheme can be found at the [http://www.psb-info.net/\\_website](http://www.psb-info.net/_website) which also outlines the original PSB report and supporting information. Here you will find a station setup checklist to assist operators to achieve a clean PSK signal and a PSK31 signal modeling treatment as a basis for that checklist. Colour screen shots and audio clips of a range of signal traces of differing quality are also provided for reference.

Since PSK IMD readings are difficult to reliably measure at the receiving end, a simple test bed has been described to allow operators to measure the IMD and bandwidth of their own transmitted signals. There are also pages for News, Future Plans and links to information on digital mode sound card interfaces and related topics.

The website was revised November 2003 to make the reporting process independent of the PSK baud rate and to introduce the new RSQ development.

It is recommended that operators mention the site URL for reference and

## READABILITY

R5	95%+	Perfectly readable
R4	80%	Practically no difficulty
R3	40%	Considerable difficulty
R2	20%	Occasional words distinguishable
R1	0%	Undecipherable

## STRENGTH

S9	Very Strong trace
S7	Strong trace
S5	Moderate trace
S3	Weak trace
S1	Barely perceptible trace

## QUALITY

Q9	Clean signal - no visible unwanted sideband pairs
Q7	One barely visible pair
Q5	One easily visible pair
Q3	Multiple visible pairs
Q1	Splatter over much of the spectrum

further information when providing RSQ reports during a QSO until the new reporting scheme is more widely understood.

The format of the 3 data elements of an RSQ report continue to satisfy the traditional RST requirements for manual and computer logs, QSL cards and PSK software. RSQ is not recommended however for chasing elusive DX or regular contesting until wider acceptance is achieved.

RSQ can improve the value of PSK signal reports and help reduce excessive bandwidth and distortion. The reporting process is intuitive and provides more useful information for stations wishing to better understand the overall status of their signal.

This article has described RSQ as an attempt to improve signal reporting for the various PSK modes, and offers it as an alternative to the traditional RST report. Your comments on this proposal and the best way to promote it would be appreciated. Please provide feedback to <http://www.psb-info.net/Feedback.htm>.

73 from the development Team:  
Bob K6MBY, Graeme VK3BGH, Ian  
GM4KLN, Milton W8NUE

ar



# TTS Systems Communications Equipment

www.ttssystems.com.au

FREE CATALOGUE

## Ten Tec Jupiter HF Transceiver

All Pegasus features plus a large LCD panel and controls. Can be used directly under PC control in Pegasus emulation Mode. The GUI software at no charge. With the command set for control of both the Pegasus and Jupiter you can write your own control software. **Frequency range:** 10-160 m + WARC **Mode:** All-mode (AM receive only) **RF Power output:** 5-100 W **Voltage:** 13.8 VDC **Current drain:** RX: Max 1.5 A TX: Max 20 A **Impedance:** 50 ohms **Dimensions ( 308\*127\*330 mm** 5.3 Kg

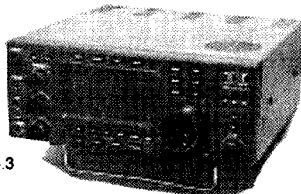

## TEN-TEC KITS

We have these world famous kits, and remember, it sounds better on something you built yourself Start with a small kit and build up to a transceiver Check out the full list on the site.

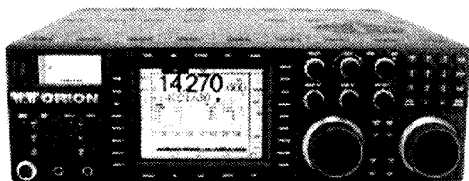

## Orion is here

We are working to separate the overjoyed owner from his new gear long enough to talk with us, When we do, we will bring you an assessment of how it all works. But until then the list of primary benefits says it all:

- Dual 32-bit floating point ADI SHARC DSP processors
- Full dual receive capability
- Very high RX intercept points
- 590 receive IF-DSP bandwidth filters independently selectable on each of the main and sub receivers
- Adjustable receiver filter shape factors
- Programmable AGC response

- time for main receiver
- True diversity reception using both receivers
- Continuous real time spectrum display allows monitoring of band activity
- "Instant Two Radio Mode" allows ORION to instantly QSY between two different bands
- Virtually indestructible 100-watt PA
- Superb SSB audio is yours at a touch of the AUDIO button

- Ten-Tec's new Panoramic Stereo receive feature
- Adjustable rise and decay times for transmitted CW waveform
- Nine adaptive DSP noise reduction filters
- Dual noise blankers
- Voice keyer and CW memory keyer built in
- On-the-fly reset button
- Flash ROM updatable

## TEN-TEC ARGONAUT V

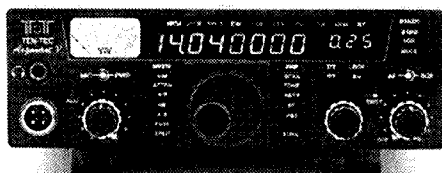

**Frequency range:** TX: 10-160 m + WARC

**RX:** 0.5-30 MHz

**Mode:** AM/FM/SSB/CW/AFSK

**RF Power output:** 1-20 W

**Sensitivity:** SSB/CW: 0.2-0.35 uV (10 dB SINAD @ 2.4 KHz bandwidth)

**AM:** 0.5-0.9 uV (10 dB SINAD @ 6 KHz bandwidth)

**FM:** 0.35-0.6 uV (12 dB SINAD @ 15 KHz bandwidth)

**Selectivity:** 35 built-in filters SSB/CW: 200-3000 Hz AM: 400-6000 Hz FM: 15 KHz

**Image rejection:** 80 dB **Voltage:** 13.8 VDC

**Current drain:** RX: 950-? mA TX: Max 6 A

**Impedance:** 50 ohms, SO-239

**Dimensions (W\*H\*D):** 216\*70\*246 mm

**Weight:** 2.2 Kg

100 memories. Scanning. CTCSS encoder.

PSK31-ready. IF-DSP.

"Software defined" radio.

**Download new functions from your computer.**

## Ten Tec RX350 Communications Receiver

- Modes AM/DSB, SAM/LSB, SAM/USB, AM, LSB, USB, CW, DIG, FM
- Tunes 100 KHz to 30 MHz,
- Stability +/- 90Hz at 25 deg C.
- Selectivity 34 inbuilt filters
- S Meter S9 calibrated to 50mV standard
- Spectrum Sweep Display • PC Interface

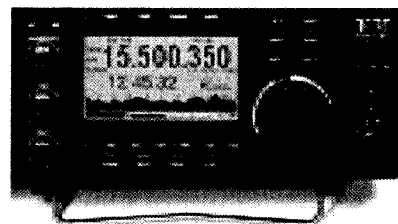

## TEN-TEC 6n2

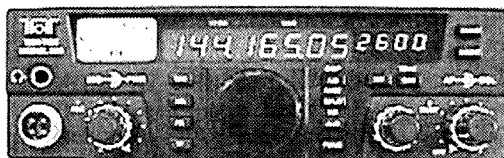

Model 526 "6N2" multi-mode 6m/2m transceiver. Amateur radios' first IF-DSP multi mode VHF rig. For a long time, there have been no affordable choices for either 6 or 2 meters in a single band VHF multi mode transceiver. Active hams planted the idea with us - why not offer a single rig that has BOTH 6 and 2 meters, without sacrificing

performance? Multi-mode HF/VHF rigs have been around for years, at over a thousand dollars and with compromised performance on the VHF bands at best. The 6N2 provides serious multi mode VHF performance in a small, take-anywhere package at a significantly lower price than HF+VHF multi mode transceivers.

## TEN-TEC RX340 Professional Communications Receiver

- Modes AM, SAM, LSB, USB, ISB, CW, FM
- Tunes 5 KHz to 30 MHz. +/- 1 ppm frequency stability. • User programmable AGC
- Selectivity 57 bandwidths selectable from 0.1 KHz to 16 KHz.
- Meter Calibrated in both dBm and S Units • External IF and digital (DSP data) outputs • Both balanced & unbalanced audio outputs
- 100 memories that store frequency, bandwidth, AGC and Mode.
- Remote controllable via serial RS232 port. • Rack Mount, 3U in height.
- Power 90 to 264 VAC 30 watts.
- Used by US and Australian Government Agencies

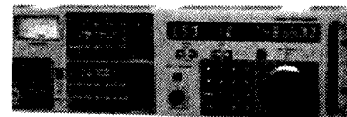

WE SPECIALIZE IN MAIL ORDER. VISA AND MASTER CARD ACCEPTED. CALL FOR A FREE CATALOG WITH PRICING.

## Re-sellers

Strictly Ham (Melb.)  
Tower Comms (Perth)  
Kyle Comms (QLD)  
Brian Swinton Marine Electronics - Cairns

Qzhelph Services - Qld  
International Comms Systems (SA)  
Marcom-Watson Group (TAS)  
all re-sell these famous products

TTS Ph: 03 5977 4808. Fax 03 5977 4801  
info@ttssystems.com.au

# HF and VHF Transceivers, Autotuners and Kits

Ph: 03 5977 4808. Fax 03 5977 4801 info@ttssystems.com.au

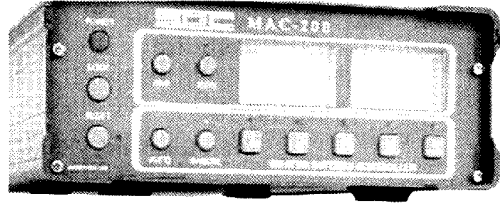

## MAC-200 MASTER ANTENNA CONTROLLER (Smartuner Built-In) The MAC-200 has a Smartuner

10ms for frequencies you've been on before, less than 2 seconds for randomly chosen frequencies with a no compromise Pi Network output. The Smartuner remembers everything for quick, perfect matching. The push of a button makes it work, everything else is automatic. Built in meters for easy monitoring, low power consumption, and rugged construction make it useful for complex field portable operation as well.

and an Antenna Switch in one compact unit.

Displays Forward power on 20 and 200 watt scales and VSWR. Smart enough to do the job without operator attention. The Mac-200 from SGC is THE answer for feeding multiple antennas from a single transceiver! It's more than a switch, it shares a tuner between all of the antennas. It knows which antenna you're on and remembers the last successful tunes on each antenna so it can get back there fast. All of this works in less than

*"... reports I was given were from 5x5 to 5x9+ on eighty and forty meters QRP. I am told it sounds like 100 watts is being used ... my slogan now is 'the Box that brought my amateur radio hobby back to life'"*

(One of UK's most active low-power amateurs talking about the MAC-200)

- Controls  
5 ANTENNAS  
3 SO239 COAXIAL CONNECTORS  
1 BALANCED ANTENNA OUTPUT  
1 END FED LONG WIRE

Not only but also---

- Autek Analysers & Power Meters  
Davis Weather Stations  
Amidon Cores. Call for a stock/price list  
Baluns and Transformers

## SG 2020 ADSP<sup>2</sup>

Small, light, rugged, recessed face. Pre-set for 20 watts PEP with front panel power adjustments down to 1W for QRP'ers or up to 20W for serious USB or LSB "hamming". 20 pre-programmed memories preset to each of the 9 worldwide ham bands. Each memory position can be selected for a specific transmitter output power, specific amount of bandwidth filtering, mode and split VFO. Crystal clear.



## ADSP2 Speaker

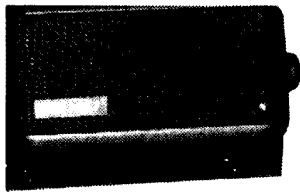

Works with the press of a button. You can select from three modes of operation: no noise reduction, the original ADSP, and the new ADSP2 noise reduction modes which provides up to 26 dB of noise reduction within the passband. The ADSP2 Speaker is "One Touch" simple to operate.

up to 26 dB of noise reduction



## SG-237 HF-VHF SMARTUNER®

Worlds Smallest  
High Performance  
Antenna Coupler  
Finished Product  
or PCB

- 100 watts
- 1.8 to 60 MHz

## Model SG-230 Smartuner™

Automatic microprocessor antenna coupler. Can be used within its power rating with any HF Transceiver in range of 1.6-30 MHz. Designed for marine, portable and fixed base applications. For antenna types: 23 ft marine whip for 1.6 to 30 MHz and with 9 ft. minimum antenna for 3-30 MHz operation. memory channels: 170 Frequency range: 1.6-30 MHz Power rating: 200 watts PEP maximum: 12VDC. operation.

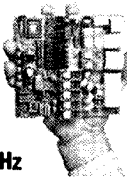

## The SG-239 Smartuner™ antenna coupler

With any transceiver get long distance communications. Great results with a longwire antenna or a coaxial fed multi resonant antenna at the unit window, fits many low cost HF transceivers: Scout, Yaesu FT-817, Kenwood TS-50, Icom IC-706, and the K2 kit. Ideal with the legendary SG-2020 transmitter. Silent receiver tuning or within 1.5 to 200 watts with a high power transceiver. 170 memory bins, independent sensors, inc.VSWR, phase, magnitude, low impedance, and forward sensing.

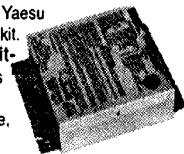

## SG-211 MINI-Smartuner

SGC has a new Mini-Smartuner, with zero power consumption. No DC wiring is necessary to power this Smartuner. It has a naturally balanced output for operation with whips, long wires and dipole antennas

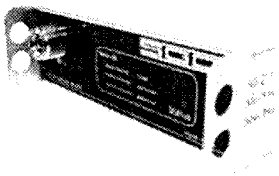

## LDG-AT1000 High Power Antenna tuner

Microprocessor controlled  
Switched L tuning network  
Continuous coverage 1.8 to 54 MHz  
Power rating HF (1.8 to 30 MHz): 1000  
Watts Single Side Band 750 Watts CW 500  
Watts Digital (RTTY, Packet, etc.) Power rating 6 meters: 100 Watts



## Hand Held & Test Measurement instruments available

Check on our website under 'test gear'  
for full details

See it all on  
[www.ttssystems.com.au](http://www.ttssystems.com.au)

# A direct reading inductance meter for radio coils

Draw Diamond, VK3XU  
45 Gatters Road,  
Wonga Park, 3115.

**Of all the electrical quantities that the experimental amateur must measure, that of inductance is possibly the most problematic. To get an accurate idea of the inductance and quality (Q) of a coil, particularly where a magnetic core is involved, it is desirable that we test the coil at or near the intended operating frequency.**

The ideal tool (for the amateur) remains the "Q" meter, where the coil is generally examined at a suitable frequency, but these are extremely rare and highly prized items. "Laboratory" LCR bridges and digital meters generally make the measurement at some frequency (often 1 kHz) far removed from the application frequency, and so significant errors may occur. Furthermore, the popular digital meters seldom provide sufficient resolution below about 20  $\mu\text{H}$  (micro-henries) for serious radio work.

A much better approach is to use the 'resonance' method where the unknown inductance is resonated at an appropriate

frequency with a variable capacitor whose dial is directly calibrated in terms of inductance. Measuring range is increased if a choice of two or more test frequencies is available.

In recent years we have seen, in Amateur Radio and other journals, details of inductance meters using bridge (Ref 1), resonance (Refs. 2–5) and digital methods. Bridge and resonance meters require some means of calibrating the instrument, generally a pretty good collection of chokes and coils of (hopefully) known value. And cheap digital meters (in my experience) have poor resolution as we get down into the micro-henries.

The problem of calibration can be overcome if a variable capacitor of the ubiquitous 95 + 205 pF type is used, the prototype's calibration being sufficiently accurate for amateur work. Measuring range is from less than 0.33  $\mu\text{H}$  (micro-henries) to 150  $\mu\text{H}$  (micro-henries) in three ranges, which should cover just about any coil encountered in high-frequency work. Although not offering direct Q measurement, the meter provides a very useful indication (by comparison, for instance) of the "Q-iness" of a coil, as shown by the sharpness and amplitude of the meter deflection.

Unfortunately, practical coils of larger than (about) 150  $\mu\text{H}$  (micro-henries) become increasingly difficult to measure accurately by this method because the unwanted (but real) inter-winding capacitance cannot easily be separated from the resonating capacitor's value.

## Circuit

A crystal of 2, 6 or 20 MHz (being ranges 3, 2, and 1 respectively) is made to oscillate with a 2N5484 FET (see Fig 1). The near sine-wave signal at the source is coupled via a 1 pF capacitor to the 300 pF variable capacitor, across which the unknown inductor "LX" is connected. When the capacitor and inductor are "in resonance", the RF signal voltage developed across the circuit will increase enormously.

A second 1 pF capacitor couples this voltage into a simple two-diode detector, where the 10 nF capacitor charges to a level roughly proportional to the signal voltage obtained. The dc voltage developed is applied to the 100 K (sens)itivity pot, where a manually

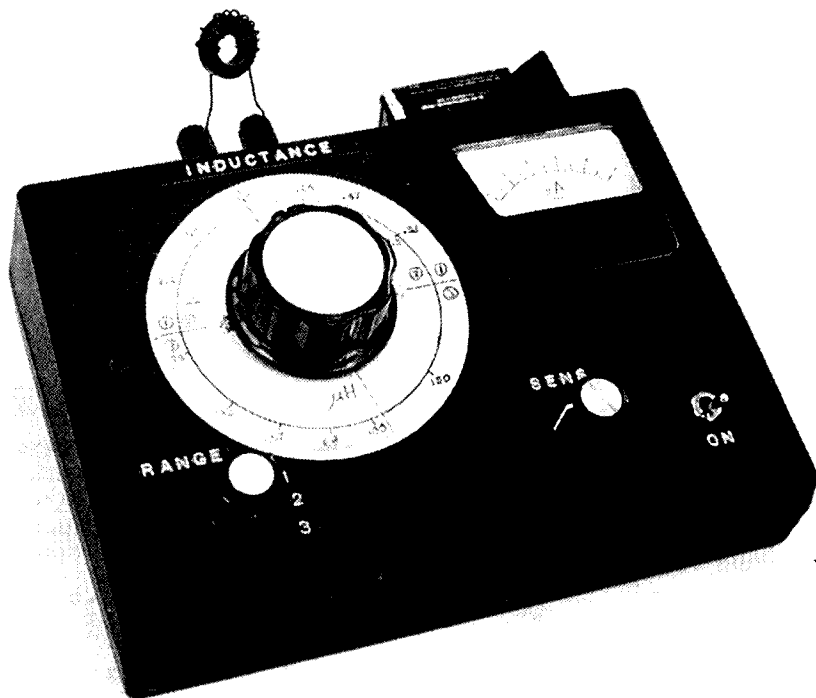

Photo 1—Direct reading inductance meter.

adjustable portion may be applied to the input of a popular LM-386 chip, configured as a dc (or servo) amplifier. The '386 thus provides us with a handy dc amplifier without need of a dual polarity supply. A 1 mA meter is connected in a virtual bridge circuit. With no dc signal applied to the (+) input pin 3, the output (pin 5) rests at about half supply (4.5 V), the bridge is "balanced". When a small dc signal is applied (as a result of resonating a coil), pin 5 moves in a positive direction, so unbalancing the bridge and proportionately driving the meter.

**Construction**

My prototype model is housed in a black plastic sloped "console" enclosure measuring 189 x 134 x 32 mm, but any metal or plastic case of similar dimensions would do. A suggested "paddyboard" (Ref. 6) layout is shown in Fig. 2 and Photo 2. Layout is not particularly critical, just about any preferred wiring method will suffice, provided that RF signal carrying connections are reasonably short, especially those to and from the LX terminals and variable capacitor.

The '386 chip is fitted into an 8-pin DIL socket, which is soldered upon a substrate, tracks upwards, made from a 25 mm x 4-strip Vero off-cut. The 'lands' of the substrate must be divided down the middle with a single junior hacksaw cut. The pins of the socket poke through the Vero, so a similarly sized rectangle of plain circuit board should be sandwiched between, foil side down, and super-glued to the circuit board.

If you use the same capacitor type as in the prototype, the calibrations shown in Fig. 3 may be photocopied and affixed to the front panel. The cursor shown in Photo 1 was cut from 3 mm Perspex sheet using a rod-saw, then cleaned up in a poor man's lathe; drill a 1/4" (6mm) hole dead centre, insert a 1/4" (6mm) Wh bolt and nut, fix in the chuck of an ordinary electric drill which in turn is held in a vice. Gently apply a smooth file to the rotating disc and thus smooth up the disc's perimeter.

Using a sharp scribe and steel rule, carefully scribe a line across the diameter for your pointer line, which may be filled with black crayon then polished to improve contrast. The disc may now be attached, with epoxy or hot-melt glue, to

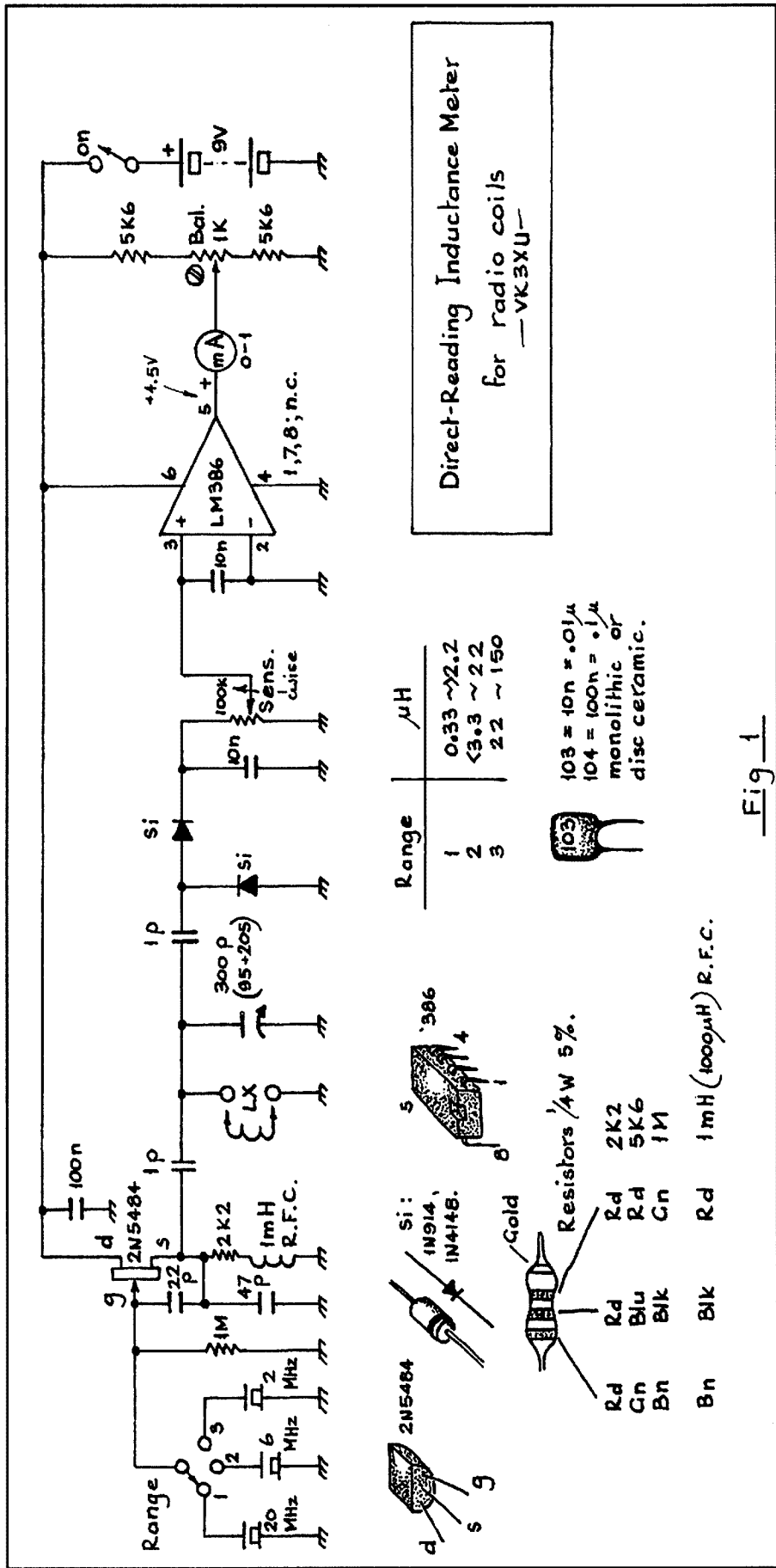

Fig 1

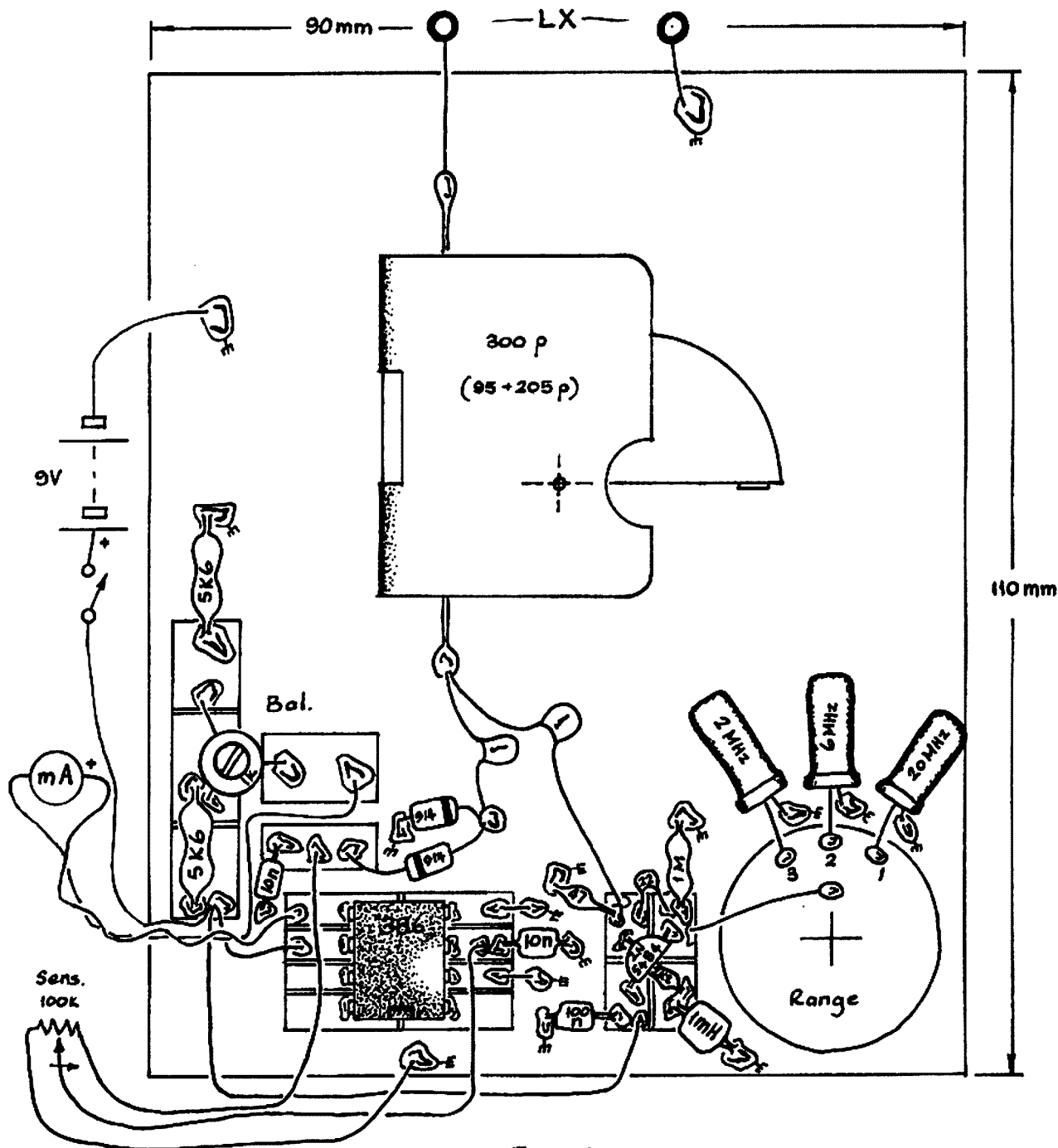

Fig 2

the skirt of a suitable knob, temporarily insert a scrap of 1/4" (6mm) rod (eg a pot shaft off-cut) through the disc and into the knob to assure correct alignment.

### Operation

Before you apply battery power, do a thorough parts placement, polarity (particularly the '386) and wiring check. If an oscilloscope or counter

is available, apply a high impedance probe to the source of the FET and observe a fair sine wave and/or correct crystal frequency. Otherwise, tune to the crystal's frequency on a general coverage receiver. Adjust the (bal)ance pot for zero deflection on the meter.

Connect a known good inductance to the LX terminals, set the sens. pot to about mid travel, select an appropriate

range, and then sweep the capacitor's dial around the estimated value of the inductance. For moderate to high Q coils, you should obtain a sharp, pronounced peak, whereupon the coil's inductance may be read (or interpolated) from the calibrated scale. The meter's deflection may be adjusted to a convenient level by use of the sens. pot.

## Summary

The experimental amateur often needs to measure the value of inductance coils. However, popular, cheap LCR meters generally lack the necessary resolution as we get down into the microhenries, typical in HF radio work. Furthermore, most accurate results are obtained when the coil is tested at some frequency that is near its intended operating frequency.

A practical model has been outlined which employs the 'resonance' method, whereby one of three crystal frequencies is used for the measurement of inductances from about 0.3 to 150  $\mu\text{H}$  (micro-henries), and also provides an indication as the "Q-iness" of a coil. The need for individual calibration is dodged by specifying a common variable capacitor type for the resonating component.

## Parts

Most of the electronic components are available from our familiar parts suppliers, including Altronics, Electronic World and Jaycar. The case may be a Jaycar HB 6094 or similar. For convenience, it is suggested that the 9 V battery be installed in a PH 9235 battery holder mounted upon the outside of

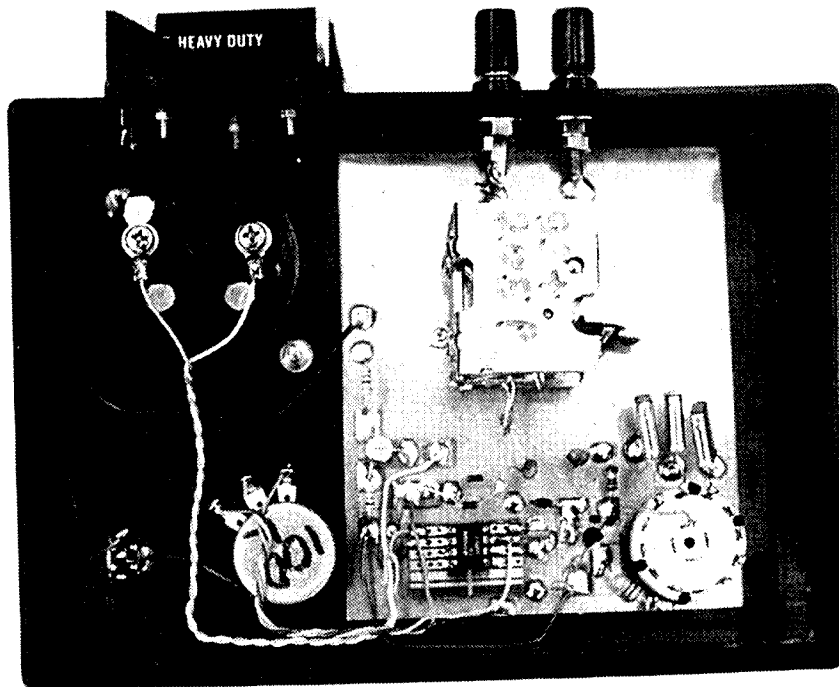

Photo 2 – Internal view.

the case. The range switch may be 3-position rotary type SR 1210 or similar. The variable capacitor is of a kind often seen at ham-fest sales and swap meets.

However, if you cannot locate a suitable capacitor, drop me a line at the address shown above, and I will be pleased to send you one for the cost of postage.

## References and Further Reading

1. "Little-L" Inductance Meter"; AR Nov. '92, pp 11,12.
2. "An RF Inductance Meter"; Butler, VK5BR, AR June '97, pp 7-9.
3. "The G4HUV Inductance Meter"; Scott, G4HUV, Rad Com Nov. '93, pp 40, 41.
4. "Nano-L" Inductance Meter"; AR May '97, pp 6-8.
5. "An Inductance Meter for Radio Coils"; AR Feb. '99, pp 12, 13.
6. "'Paddyboard' Circuit Construction"; AR, Feb. '95, pp 4-6.

ar

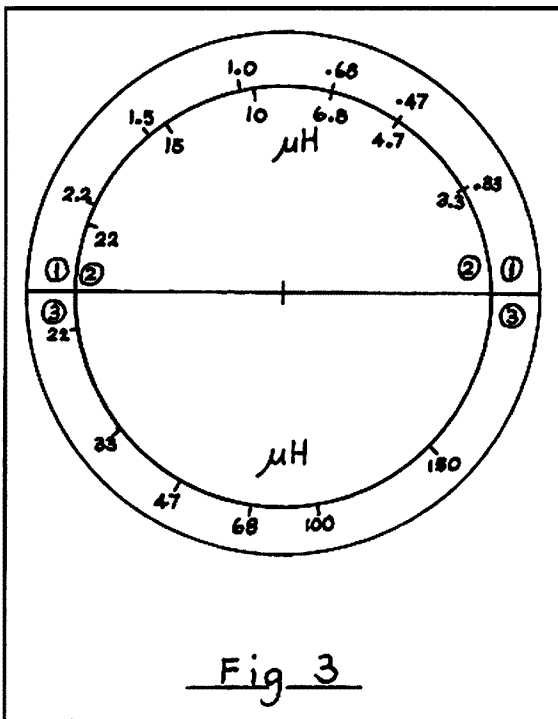

## Vintage Radio Club

of North East Victoria Inc

The club was founded in 1989 and currently has 35 members aged from 16 to 90. It meets monthly, alternately in Benalla and Shepparton. Approximately half the members have amateur call signs. Interests of members cover radio in general and the restoration of old radios in particular.

Applications for membership and other inquiries to :-

Geoff Coats,  
Club Secretary  
25/67 Samaria Road  
Benalla Victoria 3672

# The Secret War of Wireless

David A. Pilley VK2AYD

**Have you ever wondered what your value as a Radio amateur is to your community and to your country? Let me tell you true stories of your importance during WW II.**

You have probably all heard of Bletchley Park – the home of the Code Breakers. It is located NW of London in the county of Buckinghamshire. It was established by MI6 (Military Intelligence Division 6) and, prior to WW II comprised a small wireless section for communicating with overseas operatives and a group known as the Government Code & Cypher School (GC&CS).

At the outbreak of WWII the communications department was moved to Whaddon Hall (also in Buckinghamshire) and Bletchley dedicated itself to Code Breaking. The entire operations now became known as Section VIII.

There is a Trilogy that needs to be appreciated.

- (a) Obtaining the coded message
- (b) Breaking the code into intelligence and
- (c) Distributing the intelligence to those concerned.

It is (a), Obtaining the messages, where the Radio Amateur played a very important role.

At the outbreak of war, all Radio Amateur transmitters in the U.K. were impounded, but not the receivers. Wireless communications in these times were strictly

telegraphy and anyone having knowledge of Morse code was immediately seconded. All Radio Amateurs knew Morse code as it was a requirement to obtain a licence.

Across the board you had young Amateurs who were ready to be conscripted into the military, those that were in reserved occupations and of course the "golden oldies".

Those ready to be conscripted were sent to Section VIII, the remainder were broken into various divisions around the country and asked to monitor certain

frequencies and pass the messages they received to a designated address in London. These people were known as Voluntary Interceptors (VIs) under a section called Illicit Wireless Intercept Organisation (IWIO). Their initial task was to listen on designated frequencies looking for enemy agents that may have landed in the U.K. They never ever found any and were soon given other tasks to listen to and record.

(Did enemy agents ever land in the UK? – As far I can find out they were captured on arrival and some turned to use their capabilities to assist the allies. There is a story of one notable

Intercept (WI)" was too much to write!

There were quite a few incidents with the VIs, especially with their neighbours who were reporting them as spies. Eventually they all carried special documents that explained that they were on special duty.

One of the problems realised was the equipment the VI's were using was not efficient and in many cases the receivers were of their own construction. Section VIII went to the USA and purchased a multitude of HROs, some SX 28s and a few AR 88s. Not just for the VIs, but for their entire operation. Incidentally, in 1942 an HRO cost \$US360 each.

"Y" stations and D/F stations were scattered around the world. In 1943 Beaumanor in England was the largest "Y" station, employing 900 ATS and 300 civilians manning five set rooms.

Most operators had two receivers. This was necessary as not every group of stations they listened to was on the same frequency!

In the UK alone Section VIII had 5 major communications centres with over 120 listening posts supported by 9 active D/F stations.

As well as recording the coded messages they also became familiar with the various operators. Like we

all have different voices, so did the German operators have different fists for sending Morse code. Consequently these operators could be followed as they moved around Europe. This today is known as "finger printing" and voice recognition.

Those Radio Amateurs that were conscripted into the services and sent to section VIII to work were given special privileges and were not just on the basic military pay. Although they wore the uniform of the Royal Signal Corps, there

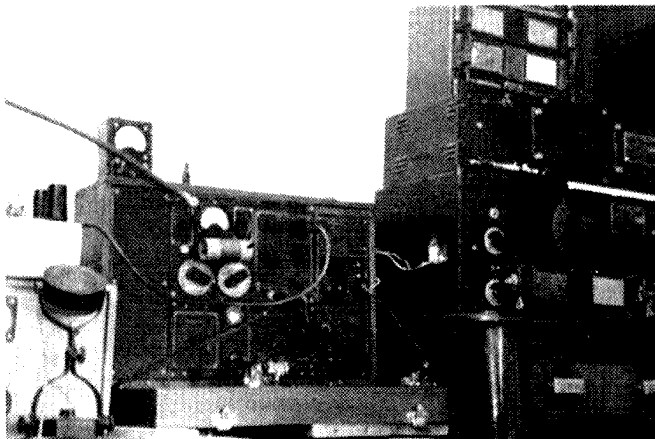

A B2 spy transceiver, in its original wooden case, that the writer used on the Amateur bands back in the early 50s. It was modified for voice and had a VFO.

agent that was dropped by parachute near Aylesbury in England, on landing he was knocked out by his radio that landed on his head!).

As far as I can determine from reading various books, over 1,500 Radio Amateurs were used for intercept work. Incidentally the IWIO name was changed to the Radio Security Service (RSS) and the operators were known as "Y" operators.

Where did the "Y" come from – typical government – the words "Wireless



# Radar band designations, old and new

Richard Sawday VK5ZLR (Dip. Eng. Electronics)

There always seems to be confusion about the band designations used for higher frequencies. This is a brief description of WW2, and post-war radar band designations.

Search radar was developed and called L-band (L for long wavelength)

Then when shorter wavelengths were used they were called S-band (S for short wavelength)

X-band radar was then developed for fire control (X marks the spot). These fire control and ranging systems reached a high level of sophistication during WW2 with automatic servo-controlled gun laying of multiple heavy guns. The US designed radar was the SCR-584, and the analog computer was the M-9 Gun Predictor. One radar and M-9 could control a battery of four guns.

Further development saw the introduction of C-band which was designed to have a combination of X and S band features (C=compromise)

K-band was introduced, however it was absorbed by water vapour, rain and fog. K=kurtz (German for short)

Ku-band and Ka-band got around the water problem. Ku = frequencies under K-band. Ka = frequencies above K band.

The first radars operated with metre-long wavelengths. The German Wuerzburg operated on a wavelength of 53 cm and Freya operated on a 1.8-2.0 metre wave length. These are called P-band (P for Previous). P-band radar is seeing a resurgence of interest, and currently being used for EW (electronic warfare) systems.

A new naming system has since been introduced, however it has only created confusion, because of similar alphabetical labels. Many people just stick to the old system.

## Radar band designations, old and new

Old P-band	=	New A band	0-250	MHz
Old P-band	=	New B band	250-500	MHz
Old L-band	=	New C band	500- 1000	MHz
Old L-band	=	New D band	1 -2	GHz
Old S-band	=	New E band	2 -3	GHz
Old S-band	=	New F band	3 - 4	GHz
Old C-band	=	New G band	4 - 6	GHz
Old C-band	=	New H band	6 - 8	GHz
Old X-band			8 - 12.4	GHz
		New I band	8 -10	GHz
Old J & Ku-bands			12.4 - 18	GHz
		New J band	10 - 20	GHz
Old K-band			18 - 26.5	GHz
		New K band	20-40	GHz
Old Q & Ka-bands			26.5 - 40	GHz
Old U-band			33 - 60	GHz
		New L band	40-60	GHz
Old V-band			50 - 75	GHz
		New M band	60-140	GHz
Old E-band			60 - 90	GHz
Old W-band			75 - 110	GHz
Old T-band			110 - 170	GHz

## The Secret War of Wireless *continued*

was really no rank or direct military discipline forced upon them.

Some Amateurs were involved with the mobile units known as SCUs. These mobile units were initially built in Packard sedans. They travelled in reasonable comfort! These units were used as forward listening posts and in many cases, employed overseas in such places as North Africa.

Many Amateurs were responsible for designing and constructing the various "spy" transmitters and receivers used by agents. Most of these were crystal controlled and with power outputs of just a few watt. You can imagine an agent, surrounded by the enemy,

having to put up an antenna, then transmitting as fast as he could before the enemy D/F got them. There were terrible fatalities. The most saddening story was in Holland where the Germans had turned the agents and 47 of the 51 agents dropped were executed as well as members of the Dutch Underground. 12 aircraft and 84 crew members that flew the special missions were also lost.

However, back to the Section VIII. You may be interested to know that in 1941 decrypts rose from 30 to 70 a day. By December 1942 to 260 and in May 1944 it peaked at 282. A total of 268,000 RSS decrypts was made during 39-45.

There are many stories to be told. For those of you interested in this great story, you will find most of what is written above in a wonderful book "The Secret Wireless War", the story of MI6 Communications 1939-1945 written by Geoffrey Pidgeon. ISBN 1-84375-252-2

Did "Y" work carry on after the war. Yes, but that's another story.

Think about it. In a time of hostilities you could be of extreme value to your country. Keep the Morse up; it's another language that, in time, only the elite will be able to read!

ar

# Technical Abstracts

Peter Gibson VK3AZL

## The copper loop for 2 metres - addendum

Since we published the article on the Copper loop in Technical Abstracts in *Amateur Radio* May 2004 (page 46), we have had an inquiry from a reader as to the correct way of mounting the loop to the support pole. The text as published gives all that was written in the original article. The additional mounting details were contained in the accompanying pictures, which we are not able to adequately reproduce here.

The only practical location to mount the loop is about the centre, where the coax connector is mounted as shown in Figure 2. The mounting plate is detailed in Figure 1, with the word 'top' defining

the top of the plate when mounted on the support pole. When the loop is in the vertical plane, this plate is attached to the loop with a pair of U bolts in the smaller holes. The plate is mounted on the other side of the loop tube to the plate holding the connector with the gamma rod in the middle. In Figure 2, the connector plate seems to be shown on the wrong side of the tube. If it is located on the other side of the tube, the gamma rod will be parallel with the main tube and it will leave clearance for the support plate to be mounted opposite it. Unfortunately the pictures were required to show all of this clearly.

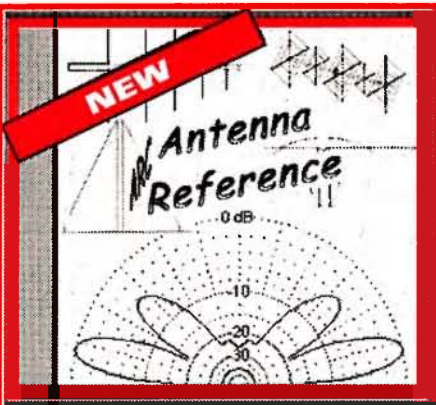

### Antenna Reference CD

Antenna basics, Radiation patterns, Transmission lines, Impedance matching, Built-in calculators and more!

Only A\$35.00 (approx US\$25.00)

ENQUIRIES WELCOME

Discounts for upgrades & club members

**Michael Todd Computers & Communications**

15 Conifer Street, Maddington  
Western Australia 6109  
Ph: 0407-089-308

E-mail: [sales@arcompanion.com](mailto:sales@arcompanion.com)  
<http://www.arcompanion.com>

# Andrews Communications Systems

ESTABLISHED 1976

ACN 001 968 752

### ICOM DISCOUNTED

- IC-756 Pro II HF+6m \$4,299
- IC-746 Pro HF+6m+2m \$2,999
- IC-706 IIG HF-70cm \$1,399
- IC-718 HF SSB w/DSP \$1,199
- IC-910H 2m+70cm SSB \$2,199
- IC-208H 2m+70cm ...\$649
- IC-V8000 2m 75W ...\$399
- IC-R5 Handheld scanner. ...\$399

### ICOM SCANNERS DISCOUNTED

★ 3 YEAR WARRANTY ★



- ALINCO DR-620 Dualband...\$799
- ALINCO DJ-V5 Dualband...\$599
- ALINCO DJ-X2000 Scanner...\$999

★ 3 YEAR WARRANTY ★



### YAESU FT-7800R.....\$499

- |                              |                             |
|------------------------------|-----------------------------|
| FT-1000MP MkV 200W \$4,999   | FT- 2800M 2m 65W ..\$349    |
| FT- 857D HF-70cm ...\$1,399  | FT- 1500M 2m 50W ..\$399    |
| FT- 847 HF-70cm .....\$2,499 | VX-1R w/2 batteries ..\$369 |
| FT- 8900R Quadband ..\$799   | VX- 2R Tiny Dualband..\$399 |
| FT- 8800R Dualband ..\$699   | VX- 5R Triband H/H ..\$549  |
| FT- 817 HF- 70cm ..\$999     | VX- 7R Deluxe H/H ..\$699   |
| FT-897D HF~70cm ...\$1499    | ★ 3 YEAR WARRANTY ★         |

COMET ANTENNAS & ACCESSORIES DISCOUNTED

### KENWOOD DISCOUNTED

- TS-570SG HF + 6m + ATU \$2499
- TS-480HX HF 200W+6m \$2,999
- TS-2000 HF~70cm+ATU \$3,499
- TM-D700A 2m/70cm \$999
- TM-G707A 2m/70cm \$699
- TS-480SAT HF+6m+ATU \$2499

### TOKYO HI-POWER, PALOMAR, TE SYSTEMS, YAESU LINEARS.

- bhi NES 10.2 DSP speaker \$249
- DIAMOND ANTENNAS from only \$99 ea
- HUSTLER + EMTRON ANTENNAS
- Avair SWR/RF wattmeters fr. \$99
- DIAMOND - Why pay more?**

BINOCULARS & TELESCOPES DISCOUNTED  
DIGITAL SCANNING RECEIVER ..\$1199

**MFJ** KEYS, TUNERS, ANALYSERS ETC

CALL (02) 9636-9060 or 9688-4301 or FAX 9688-1995

SHOP 8, 41 BATHURST ST, GREYSTANES, NSW 2145

Why pay more? MAIL ORDER TO PO BOX 240, PENDLE HILL, NSW 2145

Some items indent. Prices subject to change without notice - limited stock, some items. E & OE

★ <http://www.andrewscom.com.au>

★ email: [lee.andrews1@blgpond.com](mailto:lee.andrews1@blgpond.com)

AR714

# Technical Abstracts

Peter Gibson VK3AZL

## A parallel wire dipole

In the 'Hints and Kinks' section in QST for October 2003, Bob Schetgen, KU7G, describes a multiband dipole he has been building for others. It can be used in either the flat top or inverted V configuration. Figure 1 shows the overall layout of the antenna.

The centre insulator (no balun) used in this case is from a supplier in the US called 'Wireman' (#800 at [www.thewireman.com](http://www.thewireman.com)) but other similar units are available elsewhere. This one is as shown in Figure 1 with the SO-239 connector on the bottom. An alternative would be to use a combined centre insulator/balun at this point. All of the other components are fairly conventional and should be available from a number of sources. The weed trimmer line is stiffer and therefore neater than the lighter alternatives, although they could be used if necessary. The bare stranded 80 metre wire serves as the 'messenger' cable and supports the rest of the antenna.

When purchasing the wire, check the diameter of both sizes before buying the drills to drill the spreaders. The sizes need to be as close in diameter as possible; you'll see why below. The bottom wires are spaced a bit from the top one (see Figure 2) to lower the centre of gravity of the assembly and stop it from twisting.

After drilling and cleaning the holes, cut two wires for each band, remembering to allow a little for terminations and trimming later. The lengths are given in Table 1. Note that these lengths are for US phone bands and allowance should

be made for where you want to use the antenna on each band.

It is best to cut the wires and thread them through the spreaders first. Lay out the wires as per Figure 1, with 80 metre on top and the higher bands below in succession. Thread the first spreader on, making sure you are using the top hole and the bare wire for 80 metre. Once you have all of the wires started through all of the spreaders on one side, pull about 2 feet of the wires through the spreaders. When this is done, strip about 4 inch of insulation off each of the bottom wires. If you are not using thimbles, it is recommended that one be used as described below as they reduce wire fatigue.

Place the thimble through one of the eyes on the centre insulator. Tin about 6 inch of the bare 80 metre wire using a suitable high powered soldering system, then let it cool. Wrap the tinned wire around the thimble but leave about 3 inch extra from the thimble junction before starting the wrap (see Figure 3). Start a tight wrap for 3 or 4 turns. When finished, apply more heat and solder to the junction to fill any voids, although don't apply too much heat, otherwise you may soften the wire.

Next, place all the wires flat as they would hang from the top. Make sure

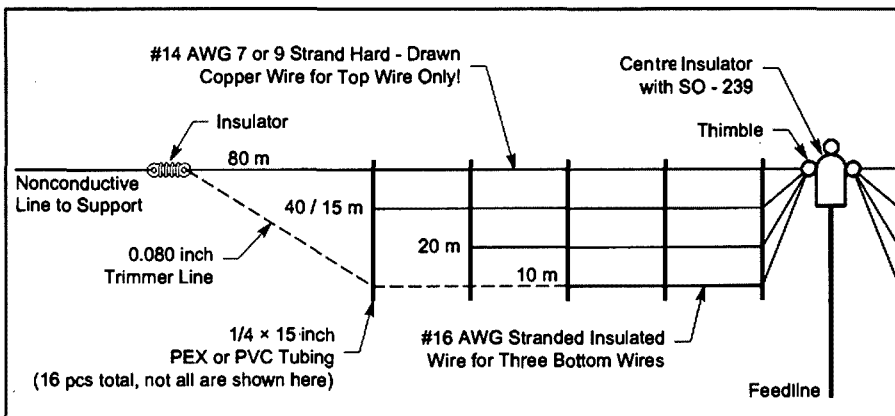

Figure 1 - The parallel wire dipole.

## Australian Made ANTENNAS "Setting a New Standard" COM-AN-TENA

(Formerly a j and j coman)  
115 John Street  
GLENROY 3046

All new 5/8 vertical 16 radials	\$160
Dual drive 26-30 5 ele yagi beam	\$315
4 ele 10-11m yagi beam	\$278
5 ele high gain antennas 11m	\$327
3 ele delta loop 10-11m	\$326
11m 5/8 vert./4-1/4 wave radials	\$175
Duoband 10-15 3 ele each band	\$385
Tri-band 5 ele HB35C s/steel fix	\$730
3 ele 20m computer opt	\$420
3 ele 15m computer opt	\$295
M B Vert Auto switch 10-80m	\$330
40m linear loaded 2 ele beam	\$595
6m 5 ele compt opt beam	\$268
6m 7 ele compt opt beam boom - 60mm	\$387
10 ele high performance 2m	\$145
17 ele high performance 70cm	\$125
2m vert 2-5/8 co-linear 4 rad 8.4m boom	\$120
Log-periodic 9 ele 13-30 MHz	\$990
Wire Dipole 10-20-40-80 MHz	RING

## Guyed Masts

21 metres      13 metres  
Winch-up & tilt-over. Aluminium and stainless steel  
three-sided construction. Auto-brake winches.

## Free Standing Masts 9.5 metres

New Baluns  
1-1 to 16-1 to 3kW



Our Masts meet Australian Standards. We supply all the computations and data you will need for a permit.

03 9773 3271  
Mob: 0419 542 437

Andy VK3IV

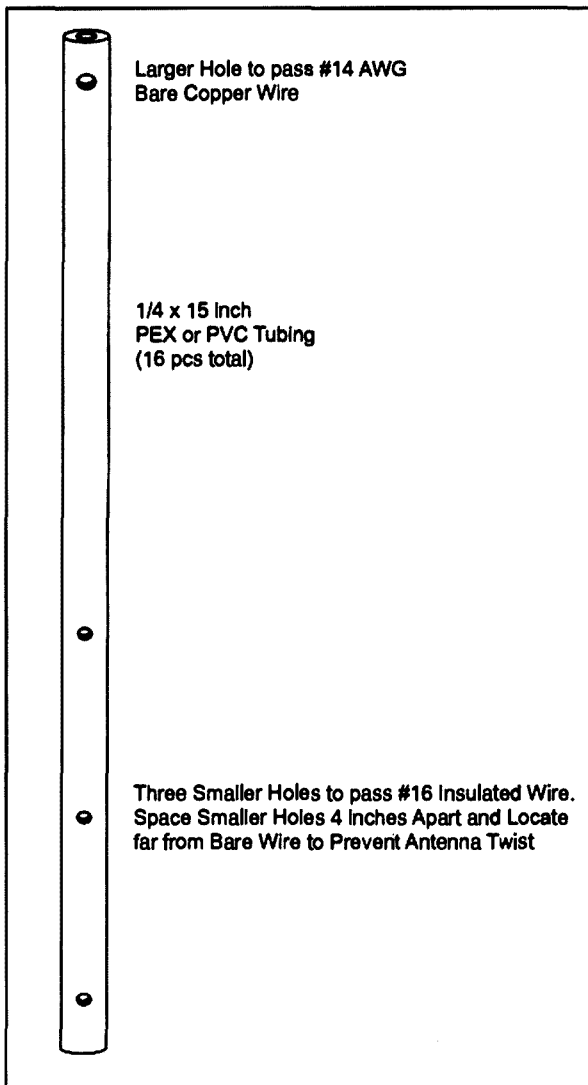

Figure 2 – Spreader holes are drilled to space shorter wires well below the 80 metre wire. This places the centre of gravity well below the point of support and prevents the antenna from twisting.

the thimble and insulator are oriented properly before you start, with the PL 259 at the bottom as it would be in use. Hold the bottom wires by the insulation, keeping them flat, perpendicular and underneath the end of the 80 metre wrap. The 40 metre wire should be the first and outermost wire, next to the beginning of the 80 metre wrap. Do a flat spiral wrap from each wire around the double wire leading back to the thimble. Snip any surplus and solder. Repeat this for each of the other band wires on one side and then repeat it all on the other side of the centre insulator. Finally, attach and solder the pigtail from the centre insulator to each side.

It is now time for testing. Ensure that the lengths of both antenna sides

are equal. Now, find a pair of end insulators and install them on the ends of the 80 metre wires. Pull 18 inch of wire through the insulator and loosely wind it back on itself. Do this on both sides. Connect the feedline and you are ready to test it. If you are not using a balun, and are using coax, make a shield choke near the transmitter by wrapping 6 loops of the coax and taping them together. A diameter of 8 inch is OK for small diameter coax, otherwise, use whatever diameter is suitable to the minimum bending radius of the coax you are using.

Hoist the dipole to operating height and test. When testing, measure the VSWR on all bands and record the results after each test. You need to keep track of how much the wires interact before final trimming for resonance. Leave an extra 1.5 inch on the outer end of each of the insulated wires. This is to allow for securing the wire end at the spreader. To do this, strip the insulation from 1.5 inch of the wire as above, twist the bare wire into a ball and apply some solder.

When adjustments are complete. It's time to run the trimmer line and glue everything together. Lower the antenna, and position the spreaders evenly. Fire up the 80 W hot glue gun while you are

feeding the trimmer line through the holes in the spreaders. Allow extra line for tying off at the insulator end. At the 10 metre end insulator, either make a loop around the spreader or drill another hole about 1 inch above the 10 metre wire, pass it through, make a knot and glue it.

Now, using the heavy-duty glue gun, get to work on the spreaders. You will need lots of glue sticks. Wear work gloves for the next bit as things can get hot. Start with the first spreader near the centre, on either side. Hold the spreader from the top, horizontally with your covered hand between the 80 and 40 metre wire or lay it on a table. Tilt it slightly upward so the 10 metre end is slightly elevated. Be careful not to let the wires slip from side to side as this will cause one or more wires to go slack. Insert the glue gun nozzle firmly into the top of the spreader. Squeeze the trigger, filling the entire length of the tubing. Don't stop until you see the glue coming out the other end and don't move it until the glue cools and starts to solidify.

Some of the glue will be squeezed out the holes where the wires and stringer line are passing through the insulator. This is OK. In fact, it's the reason why the bare wire was used for the 80 metre span. The glue forced into the wire strands help it stay in place

Table 1  
Parallel Dipole Data

Band (m)	Leg Length	Fo (MHz)
80	60'8"	3.880 MHz
40	33'6"	7.225 MHz
20	17'0"	14.260 MHz
15	(see 40 m)	
10	8'7"	29.000 MHz

1' = 1 foot = 304.8 mm  
1" = 1 inch = 25.4 mm

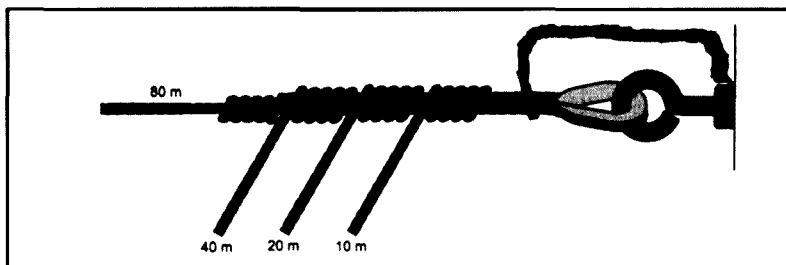

Figure 3 – Details of the wire connection and thimble at the centre insulator. The 80 metre wire is wrapped about 3 inch from the centre insulator, and the shorter wires are wrapped around the double wire in that 3 inch space

# Edison and his contribution to wireless

by Malcolm R Haskard VK5BA

**Thomas Alva Edison (1847-1931), was one of the greats in experimental technology. Even though he had only three months of schooling, and had an acute hearing problem, he devised and perfected many items that we take for granted today. In fact he may still hold the record for taking out the largest number of patents by a single individual (over 1,000).**

It is therefore not surprising that Edison made a number of contributions towards the field of broadcasting. This would include his efforts in recording sound, in producing motion pictures and in the generation of electric light (the last two items relevant to TV). However in this paper, we will examine his three contributions which have been of importance to wireless. They are the :-

- a) use of a raised antenna
- b) discovery of a phenomena later to be called the Edison effect
- c) invention of the carbon microphone.

## The use of a raised antenna

During the nineteenth century men dreamed of sending electrical signals from one place to another without wires.

For example, Sir Samuel Morse in 1840 sent electrical impulses for a mile or so through water and for several feet through the earth without wires.

In November 1875 Edison claimed to have discovered a "new force" which he later named "etheric force" because it seemed to diffuse itself through the air. There was considerable discussion in engineering and scientific journals of the day on this discovery. Figure 1 shows diagrammatically the equipment used in one of Edison's experiments demonstrating this discovery. On operating what might be called today a buzzer, sparks could be seen in the black box showing the passage of a current and yet there was no return path for the current. Edison and Dr George Beard independently showed that it was due to a very high frequency oscillation.

It was not until 12 years later in 1887



Thomas Alva Edison

when Professor H Hertz proved the existence of electro magnetic waves in free space that the situation became clear and Edison realised that the fundamental principle of aerial telegraphy had been in his grasp. Without reducing the importance of Hertz's work it has been noted that Edison's staff demonstrated the "etheric force" experiment at the Paris Exposition in 1881 and that Hertz used equipment similar to Edison's, especially his dark box with a micrometer adjustment.

Two years before Hertz, Edison with Ezra T Gilliland devised a device to allow someone traveling across the Western Prairies by train to telegraph out and receive messages whilst still in motion. This they called the Space Telegraph or Grasshopper Telegraph. The system was shown to work, patented (May 14th, 1885), but never put to any practical use. A variation of this system allowed Edison to send telegraphic messages without wires a distance of 2 1/2 miles. (His notes actually indicate that as far back as 1880 he had used a similar inductive telegraph system to send messages over 580 feet of free space.) He employed 100 feet high masts

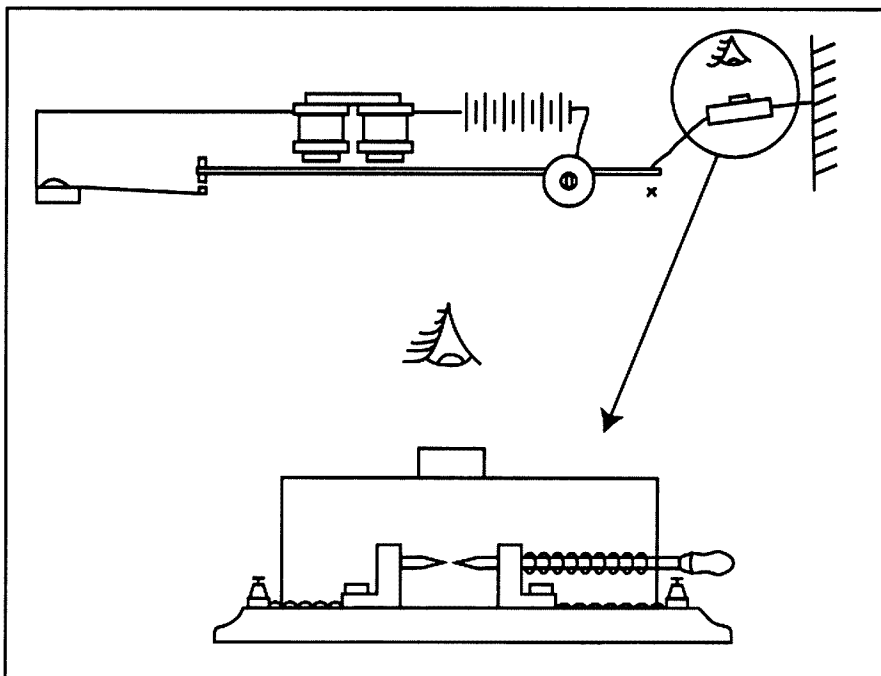

Figure 1

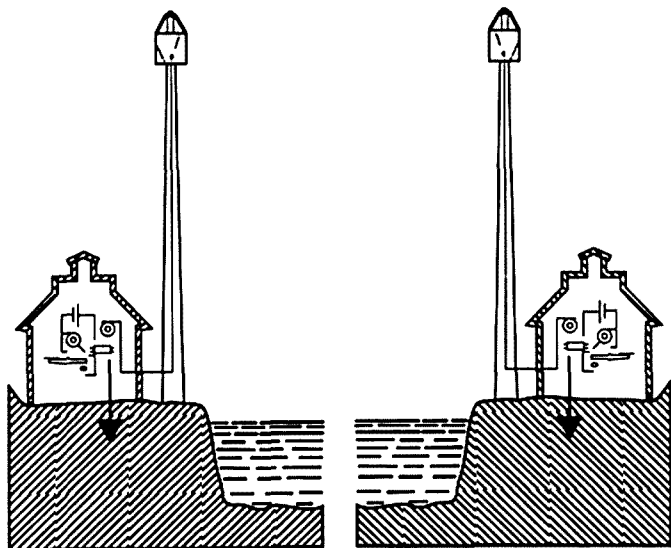

Figure 2

to overcome the curvature of the earth, with a large metallic plate located at the top (Figure 2). The system has been called an electro static generator, the plates on the masts acting as a condenser, the air between the dielectric. Confusion exists today as to whether the system worked or not - the problem lying not on the transmitter side, but in the receiver. It is interesting to note that in May to July 1901, an engineer E Guarini took Edison's system, replacing the telegraph receiver by a coherer and worked distances of 26 miles between Brussels, Mechlin and Antwerp. Comparing the transmitters of Marconi and Edison there was little difference except that Edison used much lower frequencies.

Perhaps the important aspect of Edison's system and patent was the aerial masts. Marconi in 1903, as did several of his opposition experimenters, approached Edison to buy his patent. Edison who had a deep admiration for Marconi, stipulated that the patent was to go to him rather than any of the others and so in 1904 the patent was sold to the Marconi Telegraph Company.

## The Edison effect

Turning now to Edison's second contribution. Whilst studying the physical and chemical reactions which took place in an evacuated glass bulb containing a glowing carbon filament, Edison noticed a blackening of the bulb by a deposit. This he records on February 13th and 18th 1880. Further, he also noted that the bulb in the plane of the filament connected to the positive side was not blackened, leaving a clear patch

as if a shadow had been cast.

Following the matter further, Edison, in July 1882 designed a two element bulb where he inserted a platinum wire between the horseshoe shaped filament. This wire was brought out separately so that the electrical condition of the inside of the bulb could be examined. To his surprise he found

a current flowed

when this wire was connected to the positive polarity, but not the negative (Figure 3 (a)). Other shaped electrodes were used giving the same result. This was a discovery of great importance, that a current could flow through a vacuum! In true Edison fashion he immediately set out to apply his discovery and designed an electrical regulator. This he patented on 15th November 1883 (see Figure 3 (b)). The device was not really successful, probably due to difficulties in producing consistent vacuums, and being over-worked with his electric light system he had no time to follow things through. However, his device was the first electronic instrument - a voltage regulator and he exhibited it at the International Electrical Exposition in Philadelphia in September 1884. The British engineer, Sir William H Preece saw the display and out of curiosity took back to England several models. In 1885 he presented a paper to the Royal Society calling the phenomena discovered by Edison the "Edison Effect".

Professor Ambrose Flemming in London (it appears Edison may have asked his help at this time), tried to improve Edison's two element bulb so that it could reliably be used as a regulator. In 1888 he replaced the metal plate electrode with a cylinder surrounding the filament. It worked far better as a rectifier, but again it appears problems in achieving a consistent vacuum limited its use as a regulator and Flemming gave up.

Marconi, in the years 1895-6, when experimenting with his primitive wireless

used the coherer of Edouard Branly to detect his signals. The discovery of the electron and work of Sir J J Thompson in 1897 gave Flemming, who was now a consultant to Marconi, the idea of using Edison's device or the Flemming valve as he himself called it, as a detector. It proved to be a far more sensitive and reliable detector than the coherer and so after 1904 the Marconi Telegraph Company standardised on this detector, obtaining a greatly increased range of communication.

In just 20 years Edison's two electrode bulb had come into its own and until the advent of the transistor in 1948 was the basic element in all electronic communications.

## The carbon microphone

Edison's third major contribution to wireless, the carbon microphone, was really developed for the telephone industry. In June 1875, Alexander Graham Bell first heard the feeble voice of his assistant from his telephone. He patented it and made it public in March 1876. At this time, Edison re-examined a similar device that he had made (in fact he had lodged a note of intent to patent on 14th January 1876), and found that it was capable of transmitting sound, though crudely. If only he had had good hearing he would have heard the faint sound as Bell did. (To "hear", Edison used to bite the instrument with his teeth allowing the vibrations to be conducted through the bones of his head to the inner hearing nerve).

Bell's magneto telephone, constructed around transducers similar to today's dynamic microphone and earphone, had no amplification and so was limited in the distance that it could be used to about two miles. Edison, who had been approached by Western Union to devise an alternative telephone, looked at ways in which the telephone volume could be raised. On 20th January 1877 he succeeded using platinum points into carbon granules. From here he produced the carbon microphone and by including a step up transformer found that he was able to increase the volume still further. A patent was filed on April 27th 1877. In March 1878 using the Edison transmitter with a Bell receiver a conversation over a distance of 107 miles was demonstrated to the Western Union directors. All were impressed with the loudness of the signal.

With the advent of wireless telephony, it was quickly discovered that the carbon microphone was ideally suited for modulating a valve oscillator. Even with the development of more exotic electronics the carbon microphone stayed and it was not until the 1950s that this type of microphone was finally superseded in communication systems.

## Conclusions

While Edison will always be remembered for his inventions of the phonograph and electric light bulb, his contributions made to wireless are no less significant.

## Bibliography

- 1 Dyer F L and Martin T C, (1910), "Edison his life and inventions", Harper and Brothers.
- 2 Miller F T, (1932), "Thomas A Edison", Stanley and Paul
- 3 Joseph M, (1961), "Edison", Eyre and Spottiswoode
- 4 White W C, (1943), "Electronics", General Electric Review, October, p537-541
- 5 US Patent No. 465971, "Means for transmitting signals electrically", Edison T A, 1891 (Drafted 23rd May 1885)
- 6 US Patent No. 307031. "Electrical Indicator", Edison T A, 15th November 1883
- 7 "The new force", (1876), The Telegraphic Journal, 15th January, p29-30
- 8 Guarini E, (1903), "Wireless Telegraphy in the United States", The Electrical Review, Vol. 52, p643-644

ar

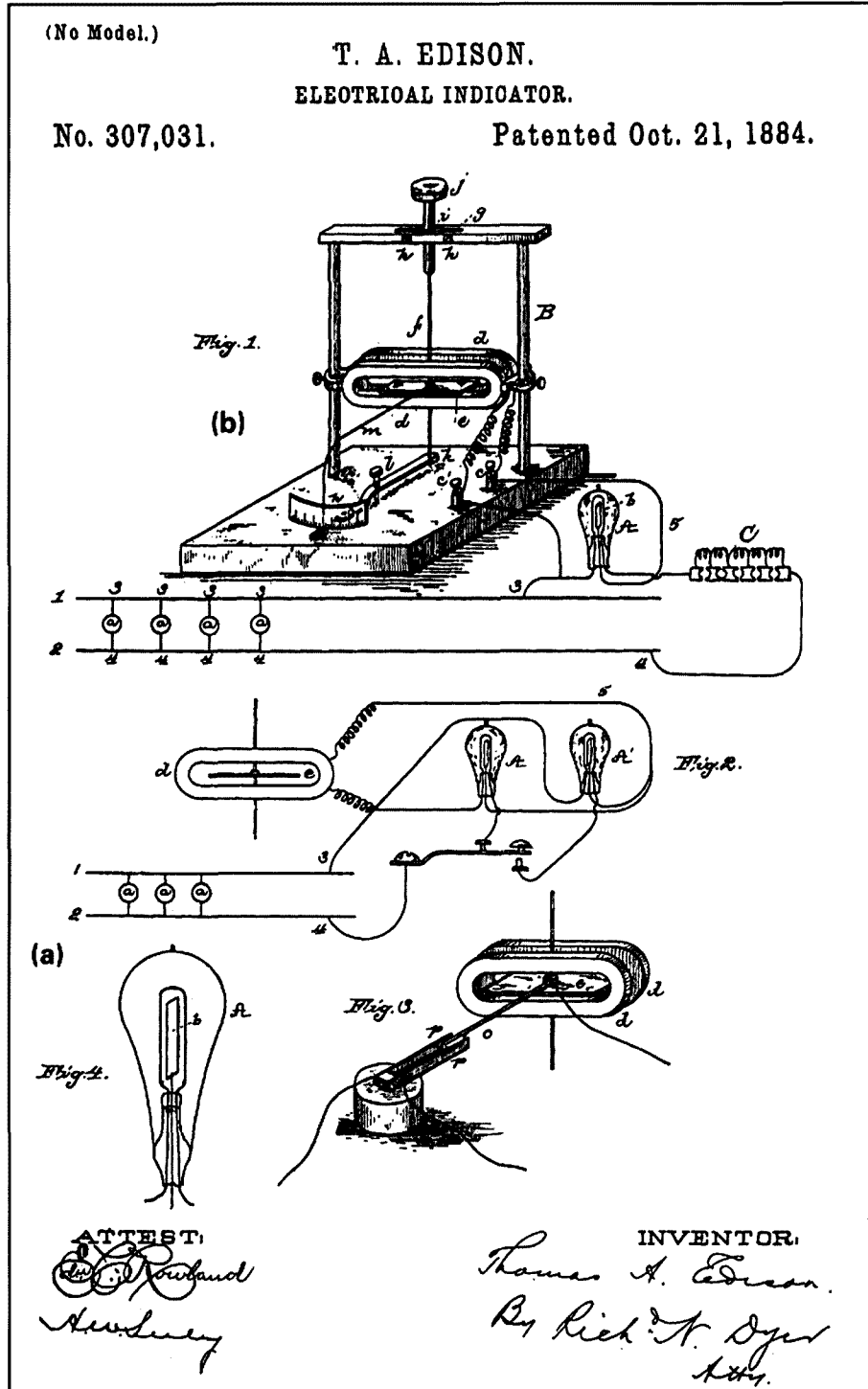

Figure 3

# NEW NODE #6391

Repeater: VK3RIR located Arthur's Seat, Mornington Peninsula, Victoria

## Bass Amateur Radio IRLP Group Inc

Specialising in IRLP mode of operation

Frequency 438.150 MHz (-) offset

3 Hakea Avenue, West Rosebud Vic 3940

Phone/Fax: 61 3 5982 0315, email: kennith2@optusnet.com.au

www.qsl.net/vk3irl

# TET-EMTRON

TE-23M  
2 ELEMENT  
MINI-BEAM

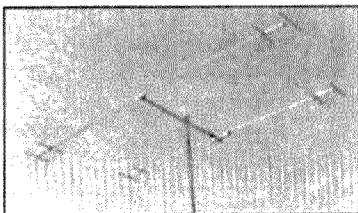

## SPACE A PROBLEM?

Don't give up! This mini antenna can be installed almost anywhere, especially where space is at an absolute premium and you still get superb performance on the 10, 15 and 20 metre bands.

It has a 30% space saving when compared to a standard 2 element beam, light weight and rotatable even with a TV rotator.

All stainless steel hardware, 6063T83 aluminium tubing and all standard features which go with every TET-EMTRON ANTENNA.

## Dealers VIC

LT Harris 78 Elgin Street Carlton Vic 3053  
Ph 03 93476264 Fax 03 93473629  
Email: lharris@netscape.net.au

G&C Comma 207 High Street Cranbourne Vic 3977  
Ph 03 5996 3298 Fax 03 5995 0184  
Email: gccomm@netspace.net.au

## NSW

Emtronics 1/94 Wentworth Avenue Darlinghurst 2010  
Ph 02 9211 0988 Fax 02 9281 1508  
Email: Emtron@ozemail.com.au

Andrews Comms Shop 8, 41-51 Bathurst St  
Greystanes, NSW, 2145 Ph 02 9636 9060  
Fax 02 9688 4301  
www.andrewscom.com.au

## WA

Tower Communications 14 Mary Street Hazelmere 6055  
Ph (08) 92741118 Fax (08) 92503734  
Email: tower@eon.net.au

## QLD

Kyle Communications  
668 Lutwyche Rd Lutwyche 4030  
Ph (07) 38574400 Fax (07) 38577825  
Email: mark@kyle.com.au

## SA

International Communications -  
8 Nile Street Port Adelaide 5015  
Ph (08) 84473688 Fax (08) 83411453  
Email: intercom@picknowl.com.au

## New Zealand

The Com Centre  
400 Hillsborough Road Avondale Auckland  
Ph (64) 9 6270084 Fax (64) 9 6271613  
Email: comcent@radioinfo.co.nz

## RAWMAR ENTERPRISES

40 Blackburn Street

STRATFORD Victoria 3862 Australia

Ph: 61 3 5145 6179

Fax: 61 3 5145 6821

Email: rawmar@hotmail.com

www.tet-emtron.com

## Technical Abstracts

Peter Gibson VK3AZL

# YS1AG 40 metre two element beam

Very few of us are able to erect full size beam antennas for the lower frequencies. Some designs for reducing the size of an antenna use loading coils. Other designs achieve a reduced turning circle by folding the ends of the elements.

Peter Dodds, G3LDO reports in his Antenna column in RadComm for January 2004 on one approach to making a compact, two element 40 metre parasitic beam.

Andy Goens, YS1AG/G5AVU has achieved a small element size by folding the ends of the elements back on themselves, as shown in Figure 4. The turning circle is about one third that of a full size 40 metre beam. Its measured performance on the air is claimed to be 2-3 S units above another local operator using a vertical. The front to back ratio is about 12dB. It is not the ultimate antenna, but it is better than a dipole and quite compact.

Analysis of the antenna using EZNEC3 indicates a maximum free space gain of just over 4 dBi and a front to back of about 10 dB, which agrees with the measured performance. Increasing the

boom length from 0.078 wavelength to 0.1 wavelength results in an increase in gain to 5 dBi and front to back ratio of about 12 dBi. This would increase the boom length from 3.3 m to 4.26 m.

As the feed impedance of such an antenna will be quite low, the feed arrangement consists of a gamma match where the gamma rod is 1.3 m long, made of 5 to 6 mm OD tubing and spaced 180 mm from the driven element. The series compensating capacitor comprises two tubes, one sliding inside the other to make up a variable capacitor with a maximum value of 180 pF. A 100 pF, doorknob capacitor is connected in parallel to make up the required total capacitance. The measured VSWR, using such an arrangement with 50 ohm feeder, is 1.8:1 at 7.0 MHz, less than 1.2:1 over the range of 7.04 to 7.1 MHz, rising to 1.8:1 at 7.2 MHz.

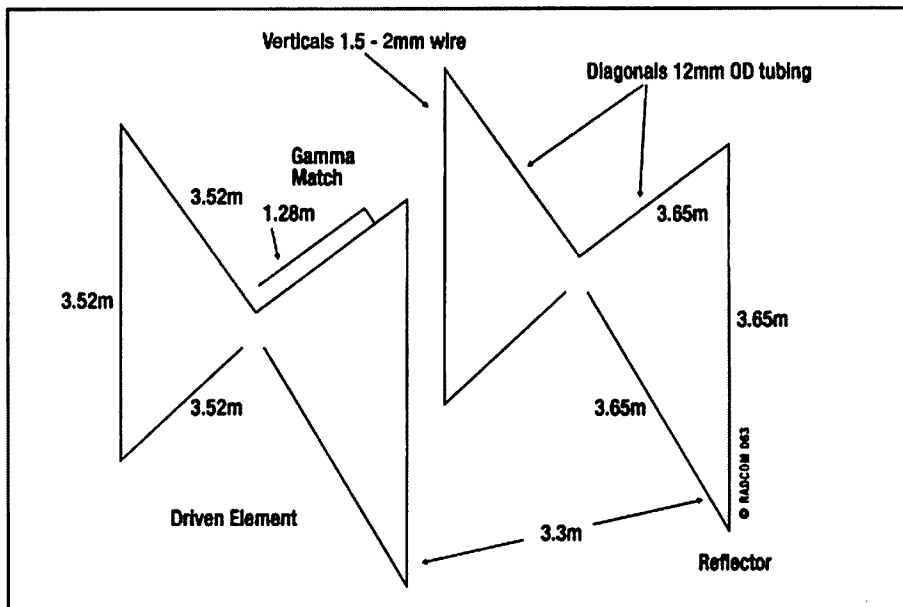

Figure 4 - YS1AG 40 m minibeam



# Silent Key

## Robert (Bob) Wheeler 1917 to 2004 (Previously VK5NH)

I first met Bob in 1956 at the tender age of 14 years. I had left school and applied for a job at his radio repair shop (Wheeler's Radio Service) in Hutt Street on the rim of the City of Adelaide. Having previously developed an interest in radio, Bob employed me and so I spent an interesting year in his workshop doing the easier repair jobs. Bob was a keen sailor and, being then the distributor of "Vaughan" transceivers, equipped many a vessel with radio communications. He also was at the cutting edge of television when it was established in Adelaide. Being young and not very smart, I left his employ and after a few dead-end jobs joined the Army, and ended up in the Signal Corps and trained as a wireless operator.

Some 30 odd years later I bumped into him at a local electronics store and began a fruitful friendship, Bob encouraging me

to obtain my "Ham" licence. His advice and assistance to me was invaluable. His three element quad and telescopic mast was to be admired at his residence in Modbury its performance being amazing. His two metre phased Yagi array guaranteed daily skeds with an operator on Hindmarsh Island. A few years ago with failing health Bob ceased his "Ham" activities and so I became the recipient of his mast and quad. I remember the day I, with a taxi truck, went to his place to pick up the already dismantled mast and quad; but it just happened to be that day that his water heater blew up, so when I handed him payment for the mast and antenna he handed it straight on to the repairman. It became our habit to say to people who wondered where his mast etc had gone that it turned into a water heater.

Bob is survived by his widow, Mona, son Noel and daughter-in-law Ashly.

Submitted by Godfrey Williams VK5BGW

more Technical Abstracts on page 26

# G&C COMMUNICATIONS

Authorised dealer for ● Kenwood ● Icom ● Barrett RFDS ● GME Electrophone ● Uniden ● YAESU

## KENWOOD TH-F7E

Amateur VHF/UHF Transceiver

Freq: TX: 144-146 / 430-440 MHz  
RX: 0.1-1300 MHz  
Mode: TX: FM RX: AM/FM/SSB/CW  
RF Power output: Hi: 5/5 W  
Lo: 0.5/0.5 W EI: 50/50 mW  
Volt: Int: 5-7.5 VDC External: 12-16  
Weight: 250 gr (inc lith.-ion batt. pack)



## ICOM

### IC-208 Amateur VHF/UHF Transceiver

Freq: TX: 144-146 / 430-440 MHz  
RX: 118-1000 MHz  
Mode: TX: FM RX: AM/FM  
RF Power output:  
Hi: 50 / 50 W,  
Mid: 15 / 15 W,  
Low: 5 / 5 W  
Voltage: 13.8 VDC  
Weight: 1.2 Kg



## YAESU VX-7R

5 W Ultra-Rugged, Submersible Tri-Band Magnesium Handheld

Freq: RX: 0.5-999 MHz  
TX: 50, 144, 430 MHz Amateur Bds  
True Dual Receive: V-V/U-U/V-U/  
GEN-HAM  
Power Output: 5 Watts 222 MHz:  
300 mW) 6 m AM: 1 W MANY GREAT FEATURES



## ROTATORS

G450A (shown)  
G650C, G800DXA



## IC-706 MkII Amateur HF/VHF Transceiver

Freq: TX: 10-160 m + WARC / 50-54 / 144-146 (148) MHz  
Europe (USA) RX: 0.03-200 MHz all-mode incl WFM  
Mode: AM/FM/SSB/CW/RTTY  
RF Power output: 100/100/20 W

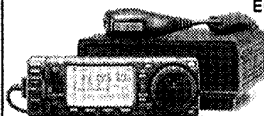

Most popular mono/tri-banders

TE series EMTRON HF ANTENNAS  
Storm tested - Call

## Antenna Tuners MFJ 945E - MFJ949E The auto MFJ 993

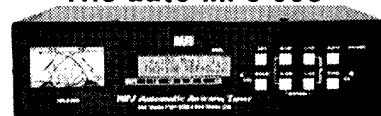

and the amazing  
MFJ 902 Travel Tuner



Australia wide orders welcome  
Credit card Cheque Money order

207 High St. Cranbourne VIC 3977  
Ph: 03 5996 3298 Fax: 03 5995 0184

Email: [gccomm@netspace.net.au](mailto:gccomm@netspace.net.au)  
[www.gccomm.com.au](http://www.gccomm.com.au)

# A visit to the Cardwell Bush Telegraph Heritage Centre

by Felix Scerri VK4FUQ.

Recently, while on one of my routine trips to Cardwell where I conduct regular VHF path tests with amateurs further north on the Atherton Tablelands, I decided to visit the newly opened Cardwell Bush Telegraph Heritage Centre situated at 53 Victoria Street, in the main street of Cardwell. Actually the main street is the highway called "Bruce". As a person with a long background in telecommunications, (I worked for Telstra from 1981 to 2000 in the technical area), I was looking forward to seeing the various displays at the Centre. The whole Centre has been open since early in 2003. There are several buildings on the site, being the old post office, the old courthouse and another most interesting "building". There are lots of interesting displays throughout and reminders of the good?(but hard) old days.

I was met at the entrance by the charming and vivacious Renne who is the Museum Coordinator paid by the Cardwell Shire Council and also one of several volunteers at the Centre and she showed me around the various buildings and provided enlightening commentary. By the way, entry is free. The old post office building was in use from 1870 to 1983, and as such, has seen quite a lot of local history. It is interesting to note that the township of Cardwell, now a quaint, quiet town by the sea, was in earlier days an important Centre providing vital commercial infrastructure for the local and not so local area. The various displays feature quite comprehensive collections of the various equipment seen throughout the time of the post

office's existence, including telephone equipment. Some of this I was quite familiar with, but some was just a little before my time, such as early operator assisted manual switchboards, magneto telephones and other allied telephone equipment from the days before modern automatic telephone exchanges such as we have today. I guess there was plenty of social interaction and gossip on the party lines of the day! There were also some nice displays of actual hand keys sourced from telegraph stations around

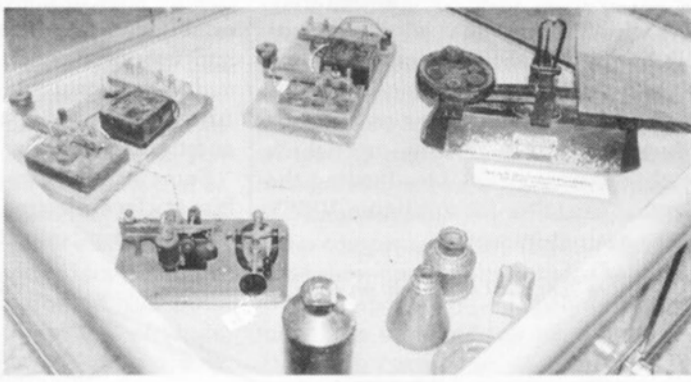

Selection of telegraph keys

the area. Also to be seen were constant reminders of the overhead open wire aerial lines that carried the few telephone and telegraph trunk circuits that existed at the time, in the form of beautifully made glass and porcelain insulators. They were a very common sight on telephone poles! Apparently as related to me by Renne, the breakage



Renne the Museum Coordinator



The Museum Building

of insulators was quite common for the lead contained in the insulators.

Of particular interest to me, in different rooms of the post office building, was a setup of telegraph keys and tone oscillators, allowing visitors to send "Morse code" to each other for a bit of fun. In my conversation with Renne, I mentioned my hobby of Ham Radio and my interest in "Morse code". Inevitably I guess, I eventually found myself seated at one of the keys, sending a little text in Morse code and explaining a little about Morse code and its use in Ham Radio. I also mentioned its sad (to me anyway) decline in Ham Radio, at least as a requirement for licensing, and its decline in areas such as shipping communications systems. Incidentally, the hand keys used in this display were quite modern "hi mound" keys.

One of the other buildings on the reserve, associated with the courthouse is the "lock up". It is not a building I would like to end up in, being a fairly cramped and very solid small wooden room with enough space for a bed of sorts (it didn't look very comfortable to me!) and a grating for a window that let in a mere glimmer of sunlight. A very solid looking wooden door complete with a large barrel type lock, obviously designed to prevent escape, completed the structure. I was reminded of that famous scene in the "Great Escape" of the Steve McQueen character in solitary confinement! As one would expect, Renne told me that apparently there were no successful escapes from this lock up. Things were tough in those days with definitely no luxuries, for those who transgressed the law! But life was tough for all. Throughout all the displays, evidence of this is

everywhere. The old time laundry, complete with wash board, is but one example.

All up, I found the Centre quite fascinating. I think, as a general rule, it is important to remember things of the past and just how lucky we are today. I found it particularly interesting to reflect on the evolution and development of telecommunications over the years, from the simple telegraph key and basic open wire aerial feeders and single wire earth return systems to early telephony to modern digital switching and the present state of the art digital telecommunications. The next time

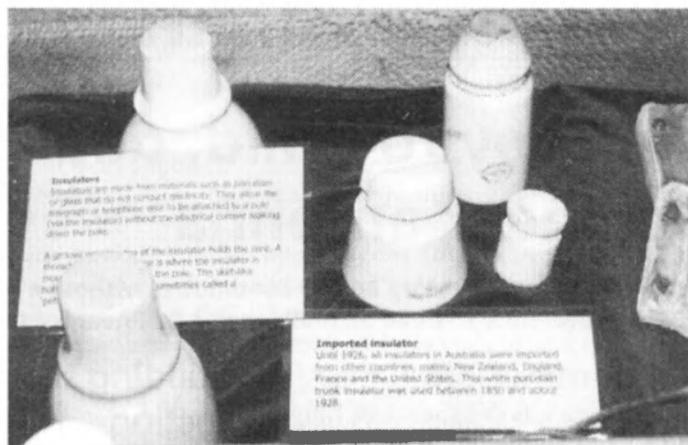

Porcelain insulators from the telephone lines

you're in Cardwell, drop by and have a look. The Centre is not open every day. It is advisable to ring the Cardwell Shire Council on 07 4043 9100 for opening times.

Highly recommended.

73 Felix VK4FUQ.

ar



Clothing and household nostalgia

Be part of a dynamic global community

Join  
**WIA**  
today



**WIA**  
is active in:

- Being an strong advocate for amateurs' place in communications
- QSL services
- Major role in amateur radio education and innovation
- Coordination of contests and awards
- Monitoring of illegal activity

10/229 Balaclava Road, Caulfield North Vic 3161

Tel: (03) 9528 5962 Fax (03) 9523 6191

email: nationaloffice@wia.org.au, website: http://www.wia.org.au

# Technical Abstracts

Peter Gibson VK3AZL

## An easy to build, dual-band collinear antenna

Get some gain on 2 metre and 70 centimetre, without a beam. In QST for September 2003, Dan Friedrichs, K0IPG shows how to build an inexpensive Collinear for the amateur bands..

### Bill of materials

This antenna was designed to be simple and inexpensive to build. All you need is the following components:

- 10 foot length of 3/4 inch PVC pipe
- 3/4 inch PVC end cap for top of PVC tube.
- 1/2 inch wood dowel, 1 1/2 inches long.
- 4 feet of 20 SWG solid, insulated copper wire
- 7 feet of 12 SWG solid, insulated copper wire
- 20 inches of 300 ohm twin-lead (not foam type)
- small piece of copper-clad printed circuit board material

### Building the matching section

The matching section is shown in Figure 5. This will require the 20 inches of twin lead and whatever coaxial cable you intend to use (RG-58 would fit into the tube). Remove 1/2 inch of insulation from the bottom of the twin lead. Twist the two wires together and solder. From this point, measure up 1 1/2 inches and mark the spot. Strip off 1/8 inch of insulation above this point, taking care not to damage the conductors.

Strip about 1 inch of insulation off one end of the coaxial cable to be used and separate the braid and centre conductor. The coax may be of any suitable length and be terminated as needed at the other

end. Solder both parts of the coax cable as shown in Figure 5.

Measure up 16-11/16 inches from the bottom of the twin-lead and cut off any excess. Finally, at the top of the twin-lead, remove 1/2 inch of insulation from the same side of the twin-lead that is connected to the centre conductor of the coax cable. The matching section is now complete.

### The radiating element

The layout of the radiating section is shown in Figure 6. Start by cutting two pieces of the 12 SWG wire to 38 1/2 inches long. These will form the top and bottom of the radiating elements.

For the coil, take the section of 1/2 inch dowel and the 20 SWG wire. Drill two 1/8 inch holes in the dowel, 1 1/8 inch apart. Insert one end of the wire through one of the holes with about 1 inch sticking out. Wind 13 turns tightly

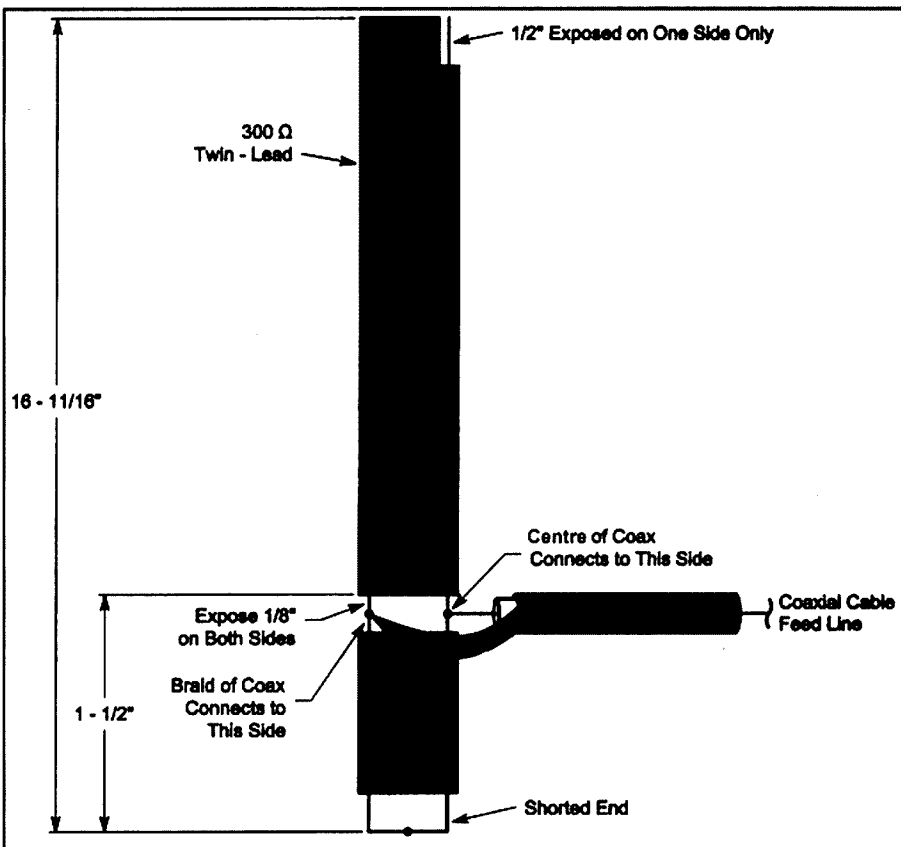

Figure 5 - The matching section for the dual-band collinear

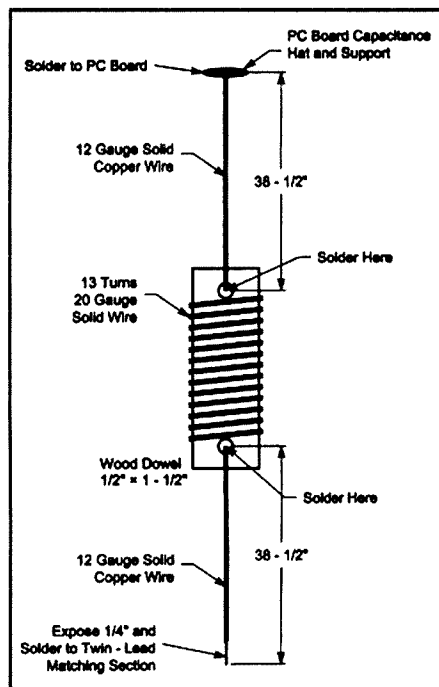

Figure 6 - The collinear radiating element and decoupling choke.

## Charles (Chuck) Farkas VK6CF

Chuck who was born in NJ, USA died February 10th 2004 at his home in Kalamunda, Western Australia aged 84.5 yrs.

His love and interest in amateur radio began with building crystal sets at an early age and continued until two days before his death. His tower is a landmark in the Kalamunda area being some 100ft high.

He obtained his first licence W2IMX in the 1930s, and his present callign VK6CF soon after the end of WW2 having been introduced to his first WIA meeting in January 1946 by VK6GM.

Chuck joined the USN in June 1939 and entered active service in the USNAF in March 1941. He was a Pearl Harbor survivor, serving in the Asiatic Pacific area as a radioman/gunner in the Catalinas in Patrol Squadron 22, Patwing 10, Patrol Squadron 101, and Scouting Squadron 61. From 1942 until 1944 he was based at Crawley Bay (Catalinas) in Western Australia and after the war returned to Australia to live.

Chuck, being a retired electrician, designed and built his own service lift that went up and down the full height of his tower. He was also the only person

in Western Australia to fly a home made 20 m, 5 element yagi that was supported by a one wave length boom.

Chuck also was a WIA VK6 Division member dating from back around 1946.

He was very well liked all over the bands, both local and international. We will miss Chuck.

He is survived by his wife of 58 yrs Dorothy, daughter Carolyn, son-in-law David and grandchildren Melinda and Paul.

*(Dorothy Farkas has given permission for the above).*

Mal Johnson VK6LC

## Arthur Johnson VK4PX

Arthur Johnson went silent key March 2004 aged 88 years. All those who knew him will mourn his passing.

Arthur was born August 1916. By 1936 he was busy working as a salesman for Music Masters, a Brisbane company that manufactured and sold these new radio things. The new radio things bug struck Arthur and he obtained his amateur radio licence on 28th February 1938. Not too many years later his radio training found him a place in the Australian army as a signaller.

Posted to Milne Bay, Arthur soon

demonstrated what friends referred to as interest and enthusiasm. He discovered that army radio works just as well as amateur radio and soon had his own net operating for friends in Australia. The army took a very dim view of this and Arthur found himself back in Australia teaching Morse code to new recruits.

Post-war, Arthur found employment with the P.M.G. in Alice St Brisbane. At that time the building was shared by the P.M.G. and A.B.C. radio. No one knows how but Arthur was soon seconded to the A.B.C.

In 1960 he moved with the A.B.C. to the new T.V. studios in Coronation Drive and worked in studio 41 till his retirement in 1976.

On retirement Arthur and wife Coral moved to the Sunshine Coast, living in a caravan for two years while they built a house in Kawana. Arthur was an active member of the Sunshine Coast Amateur Radio club, a supporter and volunteer for Meals On Wheels and a man who would go out of his way to help when help was needed.

Arthur is survived by his daughter who lives in Scotland.

David Eyles

10 Coolibah St., Mujimba Qld 4564

## Technical Abstracts *continued*

onto the dowel and insert the other end through the hole at the other end, leaving about 1 inch free. Bend the wire at 90 degrees at both ends to stop the coil unwinding. Strip the insulation off both wire ends. Now strip about ¼ inch off the end of each of the 12 SWG radiators (top and bottom). Wrap and solder each of the coil ends to the top and bottom of the 12 SWG radiators.

## Connecting it all together

Remove ¼ inch of insulation from the bottom of the bottom 12 SWG radiator. Solder it to the exposed ¼ inch section of the twin lead matching section.

Cut a circle of the circuit board material, slightly larger than the inside diameter of the PVC pipe, but smaller

than the outside diameter. Drill a hole in the centre of the disc and solder the top of the top radiator.

Insert the entire assembly into the PVC tube from the top, (twin lead first) so that it is supported by the circular PC section.

If it is necessary to tune the antenna to frequency, the 38½ inch sections may need to be trimmed up or down. Be sure to adjust both equally. It may also be necessary to adjust the matching by moving the position of the coax up or down on the matching section

If all is well and you are happy with the performance of the antenna, the top cap can be glued on and the bottom of the pipe can be filled with sealant to make it fully waterproof. The antenna is now completed.

ar

**This month**

**Remembrance  
Day Contest**  
August 14th and 15th

**International  
Lighthouse  
activation**  
August 21st and 22nd

**ALARA Contest**  
August 28th and 29th

# PNG amateurs remember at the Kokoda gateway

P29KFS, Rick Warnett



## RD 2003 Contest station P29AIF, Papua New Guinea

Amateurs in PNG have long wanted to provide a station for the RD Contest that offered a closer link to the past history that makes Remembrance Day important.

For the last five years, it has been a personal aim of the author to establish and operate a field station from either the start of the Kokoda Trail or the Bomana War Cemetery.

Unfortunately, this has not been the simple task it sounds, there being many factors that prevented a station from being organized, manned and operated.

At last, with the help of some amateurs just new to the PNG AR scene, sufficient interest was generated and equipment put together to make it all happen on at least one day of the weekend.

Previously, individual stations have operated from PNG and have managed to do quite well in the overall contest, giving out more than 300 contacts in 2002. However, this did not meet the special station rating that could be expected from PNG, a place where activity during the last war was high and



of great importance to Australia. More effort was needed to put to air a station closer to the places where Australian soldiers fought and died preventing an invading army from reaching a position where they could strike directly at our Australian shores.

Activity was hoped for from the Kokoda Trail, Owers Corner or even part way along the track itself.

A real field station out in the bush was hoped for, but several aspects of operation stopped this from becoming a reality in the 1990s. Security problems, work commitments and the number of

people available to operate the station were all against such a station being created.

An upgrade to the War Cemetery security, fencing and the appointment of a permanent guard service for the protection of the area made operation from the location possible this year.

In late 2002 it started to look as though the station could be established and used to provide many interested people with a contact. Efforts were re-doubled to make it happen.

In 2003 plans firmed and a small group was formed to push for the collection of equipment, building of aerials and scheduling of operators.

Simple aerials were the order, it being necessary that they be erected and taken

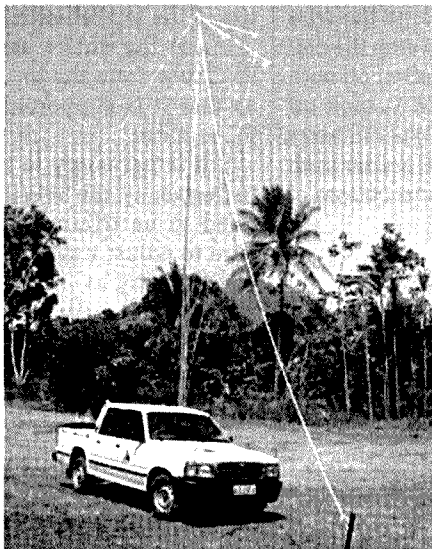

### Coax Cable & Connectors

Low Loss 50 Ω

For  
2.4 GHz  
(WiFi) &  
Ham Radio

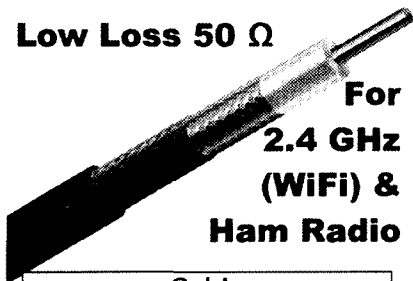

Cable		
Type	CFD-200	CFD-400
OD (mm)	5	10
dB/m 150 MHz	0.130	0.050
2400 MHz	0.550	0.220
\$/m	\$2.50 (\$1.50 *)	\$4.00 (\$2.00 *)

Connectors		
N-Type	\$7.00 (\$3.00 *)	\$7.00 (\$4.00 *)
RPSMA or RG7NC	\$10.00 (\$5.00 *)	n/a
Pligtalle	email	

Web: [www.freenet-antennas.com](http://www.freenet-antennas.com)  
Email: [sales@freenet-antennas.com](mailto:sales@freenet-antennas.com)  
Tel: +61 (8) 9319 1720

down in a short time to maximize operating time. Dipoles with baluns were made and tested prior to their use at the site. A planned long wire was never used because of the difficulty in climbing the only coconut tree in the right location.

The station was to operate from mains power, very conveniently provided in the small building we were given access to. Battery backup was also available in case the supply authority performed as expected and "pulled the plug" at a critical time. On the day, the mains power never faltered.

As it turned out, three radios were

His group takes people over the trail in some 10 days, time he says, to see what it was all about. You need time to look into the historic places, get a feel for the terrain and the jungle and develop some appreciation of just how hard it was to do anything and move about.

I recall walking up the Golden Staircase on a hike from Port Moresby, remembering that then it was actually a river of mud two feet deep and that men were carrying 70 pound packs loaded with ammo and rations one way and their wounded mates back the other way.

A BBQ lunch was put on by Gary P29NW and it was enjoyed by all present.

Operations continued through the early afternoon and contacts tapered off after about 14.00 local time (04.00 UTC).

Later in the day, a visiting amateur operated for a period using CW and gave contacts to some of the many who hoped to hear P29AIF on code.

Vladimir had just returned from a flying trip around PNG, during which he carried a radio and delta loop aerial tuned for 40 m and above.

He had managed to visit Rabaul, Manus, Madang, Karkar Island, Ukarumpa, Goroka, Mount Hagen and was now back in Port Moresby after 8,000 QSOs mainly on CW.

As the afternoon passed and contact rates fell, it was decided to drop most of the aerials and continue only on 15 m.

A few last QSOs were made and it was then time to pack up and head for home.

By the time we were ready to go the contest was drawing to a close and we left hoping we had provided some highlights for those that



P29NW Gary cooks lunch

have a special link to Bomana, Kokoda and PNG.

Support, operation and technical assistance was provided by ;

P29NW, Gary  
P29CQ, David  
P29ZTC, Terry  
P29VVB, Vladimir

Peter, John, Greg, Geoff and others.

Radios used on the day were an ICOM 7400 and 706Mk2 and Kenwood TS-690.

Aerials – dipoles at about 10 m for 40 m, 20 m and 15 m all fed with coax via baluns.

It's hoped we can manage to do it all again next year, perhaps we will even manage to operate overnight for the Saturday.

Best 73, P29KFS Rick

**(more pictures inside back cover)**



Operators enjoying the hospitality of station P29AIF



available on the day, we managed to erect aerials for 40, 20 and 15 and some 100+QSOs were made.

Six amateur operators and several other interested people attended the site from about 0800 and operated through the day until 1600. Most contacts were made on 20 m SSB.

One visitor was an organizer of Kokoda Trail Trekking and some of his soon to be trekkers were also on site. He gave some first hand accounts of the trail as it is now and advised that the correct history of many battlefield sites is still being discovered.



P29NW Gary, P29GQ David, P29ZTC Terry, P29VVB Vladimir

## VK1 news

### Forward Bias

by Peter Kloppenburg VK1CPK

**Being in the middle of an earthquake, strength 6.8 on the Richter scale, and with only a Hand-Held to communicate with, is not much fun, especially when you are in a foreign country.**

But this is exactly what happened to Michael Walkington, VK1CK, who, as a member of the RAAF, spent 4 years in Seattle, Washington, USA, ensuring that Boeing converted six regular production models 737 into the 'Wedgetail' Radar platforms in accordance with Australian specifications. Mike's technical background and experience as a licensed radio amateur came to the fore when he carried out checks on performance specifications of communication systems and simulators in these aircraft.

Mike said that the four years in the USA were a wonderful experience for him and his family. Using a laptop-driven projection apparatus, he showed still pictures and a slow-motion movie of how Boeing put the 737 aircraft together, and then proceeded by dismantling the aft section of it and replacing that with a fully functional Radar system including a flattened torpedo-shaped radome (Radar Dome). One day, an earthquake struck the area around Seattle. Mike decided to get out of the building he was in and drive home to look after his family, as telephone and mobile services had dropped out. It appeared that other people had the same idea at the same time and, as a consequence, all the

roads leading to Seattle were blocked with traffic. It took Mike four hours to drive a distance of 40 km. Mike said that during disasters such as earthquakes, floodings, fire storms, or tornadoes, you don't want to be stuck in traffic with nowhere to go. His only means of communications at the time was his Hand-Held with which he logged in at the Seattle based amateur radio club. Mike said that precisely at times like that amateur radio clubs around the USA spring into action to pass messages and provide emergency communications to individuals and other service-based organisations. Luckily for the manager of the Boeing assembly plant, he was able to talk to his staff from Seattle using the facilities of the "Boeing Employees Amateur Radio Society" aka BEARS. Mike said that BEARS does things a little different from the Canberra Region Amateur Radio Club. At the start of each monthly meeting, a pledge of allegiance is made. After that, the agenda comprises business items, reports from members with special responsibilities such as Propagation, Packet, HF, Beacon reports, Repeaters, etc. A guest speaker then follows this. Near the end of meetings, a lucky door prize is handed

out, doughnuts and coffee are served, and the junk box with donated items such as components or discarded radio projects is made available to members for free.

But, before Mike made his delivery on Monday, June 28, 2004, our President, Alan Hawes, VK1WX, dealt with three important items of business: The new name of the Division was first. Alan proposed, and it was agreed, that the new name of the Division will be "Canberra Region Amateur Radio Club", (CRARC). The second agenda item was setting the membership fee. Again, Alan proposed, and it was agreed, that the membership fee of CRARC would be \$20.00 per year, payable on July 1 of each year. The last item of business was the signing of the draft agreement with the WIA. This was merely an announcement to the effect that the members of the Division's executive committee intend to sign the agreement. This agreement formalises the break between the WIA and the ACT Division.

The next General Meeting, together with a Trash & Treasure sale, will be held on Monday, August 23, at 8.00 pm at the Scout Hall, Longerenong St. Farrer. Cheers.

## VK2 news

Tim Mills VK2ZTM.

**Hello there. Everyone is aware that this is a major turning point for the Institute as the various Divisions look at the ways of making changes from separate State bodies to one single structure.**

It is 94 years since the Wireless Institute was formed in New South Wales, in March 1910. It is 49 years since the serious work began to develop the "Home for VK2WI" at the Dural site. It is 84 years since the committee of the day recorded an interest in seeking property to house the Institute. This was realized in 1959 when a property was obtained at St. Leonards. That was sold in 1982 when the present Parramatta property was purchased.

The assets of the NSW Division is giving the NSW Council much to ponder at this time.

In late June, members of the NSW Division were sent a letter by the Membership Secretary, Terry VK2KDK, outlining the positions and options of future membership. The Council has extended the membership of NSW members subject to renewal in July, August or September, to 30th September 2004. By then, it is expected that the

direction being taken will have been determined. The options available to NSW members are:- [a] to join only the national body; [b] join only the NSW Division or [c] join both bodies. Each body will attract a fee and while not finally determined as these notes were being written, it could be round \$10 for the NSW portion. The national fees have been announced elsewhere. Some members were confused as to the total value of membership of both bodies. It



would in fact be the sum of both fees being asked. Thank you to all who returned the form. If you have not yet returned the form, Terry VK2KDK would be pleased to hear from you.

The ninth position on the NSW Council was filled at the June Council meeting by the co-option of Chris Devery VK2XCD. Chris comes from Goulburn. Consideration is being given to holding the deferred Conference of Clubs in September, most likely Saturday the 11th. The August Council meeting is scheduled for Friday the 13th. For much of the year a Novice class has been conducted at Parramatta by Terry VK2UX. With the opportunity at intervals to sit an examination, most of the class did so and were successful. Most are now on air. The July Council meeting discussed reports and actions pertaining to the changeover of the Institute structure, along with the routine department reports from the various Councillors. Council meetings

in recent times have been held on Friday afternoons. With the finish timed for late afternoon, it enables the country Councillors to return home the same day.

The packet group AAPRA, closed down their operations last year, following a decline in interest in this mode. They recently dispersed their remaining funds and included the NSW Division in the distribution. The donation will be put towards the continued operation of the Packet facility at Dural. Thank you AAPRA.

The proposed workshop - reported in last month's notes - to construct a 70 cm Yagi antenna was deferred from the July gathering to a later date. The morse facility at Dural was restored late June after surgery was performed on the computer. It should last a little longer. The VK2RSY beacons on both 2 and 70 remain off air waiting for a kind soul to assist in the rebuild of same. An interim

beacon source on 2 metre is the morse transmission on 145.65 MHz, an FM signal with about 20 watt to a vertical antenna.

The Bookshop reports an interesting fact about morse. Now that it is no longer a subject for examination, there has been a big increase in inquiries for the Morse Code Kit as well as for morse cassettes. There is currently a good stock of both. Keeping up with demand in the Bookshop has the office busy. No sooner is stock in the door, it is out again, filling a back order. Check out the web site for the latest titles. With the continuing demand, please note that there may be a few weeks delay on some titles. Do you have an interest in 'fox hunting'? A recent arrival in the Bookshop was a CD on the art of same. It could be worth the viewing if it gives you the edge over the other competitors - providing they don't get to see it also.

73 - Tim VK2ZTM.

## VK6 news

Compiled by Will McGhie VK6UU

Input to: will2@iinet.net.au

08 9291 7165

### Lots of meetings

As reported over the past few months, the move from the old WIA Federal structure to the New WIA National structure is taking up large amounts of the VK6 Council's time. Many people have provided considerable input as to how such a change may take place in VK6, but one person who has brought much of it together deserves a special

mention and that is Wally Howse VK6KZ. Many thanks to all on the VK6 Council including ex-officios and co-opted, who have debated the pros and cons and dealing with what has been a fair bit more involved than at first thought.

At time of writing, a Special General Meeting is planned for mid/late August. A Motion was passed by the VK6

Council to the effect that membership subscriptions (for the VK6 Division) be \$0.00 (zero) for the year 2004/2005 for financial members at June 30th 2004. This extension of VK6 membership is for the purpose of having financial members to be legally able to vote at the Special General Meeting /Ballot. Note: This does not include AR magazine or any other service now provided by the National WIA, so continue your membership with the WIA by joining the National body.

This is a historic time for the WIA, so the VK6 Council asks you all to make the effort to attend the meeting but if you can't attend in person, please send your vote to the questions asked by post or by giving your proxy to a member who is attending the meeting in person. Details on the VK6 news and the VK6 web site. <http://members.iinet.net.au/~vk6wia/>

The accompanying photograph shows the VK6 Council and visitor at a typical meeting at CWA House West Perth.



VK6 Council

# State news

## VK6 News continued

### Meteor trail reflections

Several amateurs in VK6 have been experimenting with the digital mode WSJT mode JT6M. Don VK6HK, Wal VK6KZ and Cec VK6AO come to mind. Cec tows a caravan every year from Perth to Broome (long way) and amateur radio goes along as well. Don supplied the following information.

Meteor scatter tests with Cec VK6AO portable in Broome have been a bit limited so far but we plan to do more

before he returns to Perth around the end of September. So far we have trialed WSJT mode JT6M on 50.230 MHz with some success. Usually it can be expected that QSOs like this can take more than an hour to complete if things aren't optimum and so far we have only been able to allocate half an hour per session. Therefore, we have been using the opportunity to get some practice with the mode rather than seeking to make lists of fully complete contacts with

each other! Not unexpectedly, there have been some spectacular "burns" from meteor trail reflections. On one occasion for longer than 30 second over the 1600 km path. We have yet to try 144 MHz although that will be more difficult given greater path attenuation and lower power available at Cec's end.

14 MHz has come in handy for liaison and we have been keeping regular skeds there, although not always conducting WSJT tests on VHF.

## VK7 news

Justin Gilis-Clark, VK7TW

Email: vk7tw@wia.org.au

Advisory Committee Web Site: [www.wia.org.au/vk7](http://www.wia.org.au/vk7)

### Branch Meetings

#### Northern Branch Meetings

June 9 saw a record number of attendees at the Northern Branch meeting to hear Rex Moncur, VK7MO speak about the digital modes he is currently experimenting with and about his recent DXpedition across the Nullarbor Plain to Perth.

The night moved into a practical group discussion on the construction of Rex's antennas for 144 & 432 MHz. The Northern Branch has also formed an IRLP working liaison committee to work with Tony, VK7AX.

#### Southern News

##### APRS now operating

Ken, VK7KRJ, let me know that the APRS digipeater is now operating on Guy Fawkes Hill. The digi is on 145.175 MHz FM which is the national APRS frequency. There are a growing number of mobile stations operating APRS in Southern Tasmania.

##### IRLP - Canadian School

##### Contact

Ken, VK7DY, let me know that on 24 June, repeater 2 and IRLP was used in a QSO with Brian, VE6JBJ in Calgary Canada and the Chestermere Lake Middle School. The class did a project on Tasmania and Australia and were asked to answer a number of questions

finishing up with "What is black and white, has a very nasty growl, sleeps all day and stays up all night, and lives in Tasmania?". At the completion of the QSO we were treated with the "Yeah for the day" from all the kids.

##### Repeater Updates

The new repeater relay system on 146.850 MHz is now operational. The system uses a commercial scanning receiver supplied by Brian, VK7BW. It continuously scans the output of three 70 cm repeaters, VK7RBH, Launceston, VK7RIN, Barren Tier and VK7RTC, Mt Nelson (as well as the 6 m repeater) and relays their output on 146.850 MHz. VK7RAF is now up and running again courtesy of Brian, VK7RR and Clayton, VK7ZCR informs me that there is now a simplex frequency of 439.300 MHz that is linked to the Echolink repeater VK7RBW on 147.850 MHz. This overcomes the issue for some of the older rigs with the 1.8 MHz offset on VK7RBW.

##### Southern Meetings

June 16, we were treated to a very interesting talk from visitor, Peter Parker, VK3YE who was touring the state with Mum, Lesley. Peter's talk was on his latest experiments with a 1.8-21 MHz

magnetic loop antenna made from 19 mm soft copper pipe. Thanks for coming along Peter and sharing some of your vast knowledge.

June 23 saw a very interesting "hands-on" demonstration of the



Richard VK7RO talks about his experiences with PIC Microcontrollers.



(L to R) Stu VK7NXX, Nick VK7HAF and Phil Grundy - host of the Bruny Island VHF repeater linked by UHF to the Mt Nelson VHF repeater. Photo courtesy of Roger, VK7XRN.

use of oscilloscopes by Eric, VK7TAS. Eric followed this with a demonstration of his home brew Time Domain Reflectometer. We then had a demonstration of spectral analysis fast fourier transform software demonstrating the frequency domain. Thanks to Eric for an excellent demonstration.

June 30 we were asked whether tube-type rigs still have a place in amateur radio and I think after the broad ranging discussion we had the answer was a resounding YES!

We took a look at the FT101 and TS520 series transceivers.

July 7 the Branch was treated to a night of microcontroller madness with Richard, VK7RO who demonstrated a number of PIC projects and yours truly demonstrating a number of Z8 projects.

Thanks Richard for sharing your knowledge.

### WICEN News - Subaru Safari

Roger, VK7XRN has let me know that WICEN South's contribution to this year's Subaru Tasmanian Safari brought multiple thanks from the organisers, commenting on WICEN's reliability and professionalism over many years.

Over two thousand messages were passed by WICEN, between eighteen locations, over the two days. Over 30 radios, excluding backups, were used. 3 VHF repeaters with 2 UHF links were deployed, connecting locations bounded by Dover, the Tahune Air Walk, South Bruny Island and Hobart.

The WICEN team can be justifiably proud of their achievement. A special tribute to those who designed, built or deployed equipment, participated in surveys, supplied additional equipment or put in an extra day for set up.

## VK3 news

By Jim Linton VK3PC

WIA Victoria web site: [www.wiavic.org.au](http://www.wiavic.org.au)  
email: [wiavic@wiavic.org.au](mailto:wiavic@wiavic.org.au)

### WIA restructure adopted in Victoria

WIA Victoria has become the first WIA Division to complete all of the necessary procedures required of it under the restructure of the WIA after receiving the strong endorsement of its membership.

The signing of the implementation agreement between WIA Victoria and the new WIA National occurred on Wednesday, 21 July, immediately after a well-attended membership consultation meeting.

The outcome of months of work is a very simple implementation agreement that underpins the arrangements between WIA National and WIA Victoria.

The approach taken was to carefully consider the WIA restructure including the seeking of legal advice, numerous meetings of the WIA Victoria Council and its sub-committee engaging in

frequent discussion with the WIA National President Michael Owen VK3KI. The issue was also vigorously

vote at the 21 July consultative meeting was 66 in favour and three opposed to the recommendation of the WIA Victoria Council.

WIA Victoria will continue as a statewide membership organisation, providing services to members, charge a separate membership subscription, and support WIA National. It has registered the business name Amateur Radio Victoria that is expected to be phased in over the next year, while use of the names Wireless Institute of Australia Victorian Division and WIA Victoria can continue under certain circumstances.

The 1,100 WIA Victoria members, when their memberships are due for renewal, will receive invitations asking them to agree to be members of WIA National and invited to continue their membership with WIA Victoria.



VK3 signing off on the National WIA

discussed at the WIA Victoria AGM on 26 May.

Paramount at all times was that the ultimate decision by WIA Victoria would be made by the membership. The

ar

## OZGEAR

### Ozhelph Services

Doug Hunter VK4ADC

Brisbane

Ph 07 3273 7263

Fax 07 3272 1800

sales@ozgear.com.au

**ICOM**

#### • HF Transceivers -

7800, 756Pro2, 7400, 706Mk2G, 718

#### • VHF/UHF Transceivers -

V8000, 208H, 2720H, 910H, V8, T90A

#### • Receivers - R3, R5, R10, R20,

R8500, PCR100, PCR1000

#### • Accessories - wide range of options and parts

**YAESU**

#### • HF Transceivers - Base & mobile

FT-1000MP, 817, 847, 857, 897

#### • VHF/UHF Transceivers -

Base, mobile and handhelds

FT-1500M, 2800M, 7800R, 8800R,

8900R, VX-1, 2R, 5R, 7R, VX150

#### • Receivers - VR-500, 120D, 5000

#### • Accessories - Yaesu rotators, thrust bearings plus equipment options

### Plus... OzGear balun kits,

Diamond HF, VHF & UHF

antennas & accessories, MFJ &

LDG tuners, Autek antenna

measurement, Daiwa cross-

pointer SWR meters, RFI, Mobile

One, GME, Scalar & TET

Antennas, Coax connectors,

cables and hardware from

Andrews, RFI & Benelec

**With...** More brands available and new products being listed all of the time...

CB, Marine, Airband and Land Mobile equipment and accessories are also available.

### Product not listed above ?

Phone or email to see if we can help or visit us on the web at

<http://www.OzGear.com.au>

for the latest product info plus on-line ordering.

## ALARA

Christine Taylor VK5CTY

### The Contest

August is the most important month in the VK amateur radio calendar for contests. The Remembrance Day Contest comes first and I hope all of you will participate in that for the honour of your state and in respect for those who helped to make Australia such a great and safe place to live.

At the end of the month, 28th and 29th August, to be precise, we have the ALARA Contest. As usual the contest runs for 36 hours so we have two 80-metre opportunities.

All the details are in the ALARA Newsletter and in AR so there is no excuse not to know when it all happens.

Please try to make some contacts. Last year the response was terrible. Conditions on air were not good but they were better than the results suggest. Let us all be there sometime, either on 80-metres on the Saturday or Sunday evening or on one of the other HF bands during the day. There will be people listening for you.

OMs and Clubs and SWLs are more than welcome. Please participate and please send in your logs. If you would like a very attractive Award to put up on your brag wall, you can make the required number of contacts during the Contest. You need ten ALARA members from at least five VK call areas. Send applications to the Awards Custodian Jean Shaw 10 Huntingfield Drive, Hoppers Crossing, Vic 3029.

After the contest do remember to send in your log. Let's give Marilyn some work to do. No matter how small the number of contacts you have, please do send in the log. They can be posted, or emailed. Details in the Newsletter and AR.

### 222 Net

Propagation is very good at the moment on 20-metres so why not call into the 222 DXYL Net on 14.222 MHz one Monday afternoon from 0530 Zulu (officially) or before that, from about 0500 Zulu (unofficially).

The net is again being run most often by Dave ZL1AMN and usually has three or four ZL stations and four or five VK

stations as well as several regular DX stations. The chatter is informal and pleasant when conditions are as good as they are at the moment.

Go on. Have a go!

### Vic's marvellous gift to ALARA

Dot VK2DB has had the housing of the radio equipment so kindly donated by Vic VK2EVK, last years, well it has reached its new home at last. As I told you there is a new interest in amateur radio among the scouts and guides, especially after the big Jamboree in the Adelaide Hills in January this year. The following is an item from the ALARA Newsletter that gives a bit of background and contains a report from Leanne Adcock the Coordinator of RIG.

"The HF radio which was donated to ALARA by Vic VK2EVK last year is going to a very good home in South Australia. The Scouts have a Radio Interest Group called RIG at Glenelg.

"The coordinator is Leanne Adcock, her OM is an amateur and she has a number of people assisting, including Jeanne VK5JQ and OM Keith VK5OQ. Many of our ALARA ladies have helped the Scouts and Guides for many years and as the Foundation Licence is not far away, the interest is building among the young people.

"The RIG group recently had a long hike with 420 children looked after by the Scout leaders and 18 amateurs including some YLs.

"After Christmas (at the World Jamboree) they held a JOTA with amateurs bringing their own equipment. Eleven hours a day for nine days, fifteen amateurs manned the stations using HF, VHF, UHF, IRLP, SSTV, Echolink and even CW. About 5,500 of the 11,000 Scouts and their Leaders visited the radio site and took part in many contacts. They were all very keen and there were long queues outside.

"The Leaders and Scouts will be erecting aerials (at the new home of Vic's radios) in a few weeks so hopefully all should be ready for the ALARA Contest in August."

We look forward to hearing from them at the end of August.

## Silent Key

### Charles John Robinson VK7KP

It saddens me to inform you that Chas (my OM) passed away peacefully in his sleep during the early hours of June 23rd, 2004, at the age of 96.

Chas was born in Launceston, Tasmania, and became a Saddle Maker by trade. His primary interests were Photography and Amateur Radio.

In 1936, Chas passed the AOCIP and issued VK7KR as his first call sign.

During WWII, he was an aerial photographer with the RAAF (Rank of Sergeant). Chas was seconded to the NEI 18<sup>th</sup> Squadron operating in New Guinea, and he took many reconnaissance photographs from B-25 Mitchell Bombers.

After WWII, Chas's career was with Kodak in Victoria until his retirement at sixty-five.

In 1947 he was issued his VK3 license, VK3ACR.

Chas loved the challenge of constructing and using homebrew gear. Home brew equipment was used on 2 meters, HF, and 160 meters. Around 1965 he began using commercial equipment for HF SSB and modified commercial car phones for the FM band on 2 metre.

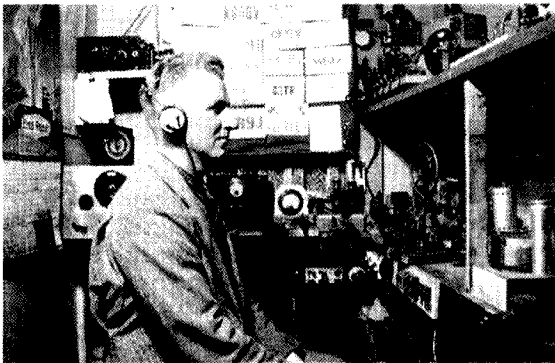

When OSCAR-6 was launched in the early 1970s, Chas became intrigued with amateur satellite communications. Also in the early seventies, Chas ran the AMSAT-VK net, and was awarded a lifetime membership of AMSAT. This facet of Ham radio led him into RTTY and computing. Chas also loved packet radio.

In 1989, after retirement, Chas and XYL returned to Launceston. Here he established a new radio shack, with the final call sign of VK7KP.

He continued with his passionate love of Amateur Radio, Computers, Internet and electronics, remaining active with regular Schedules on 80 meters until his health deteriorated in the last few weeks of his life.

Murray Robinson VK7YBE (son)

### ALARA continued

#### Luncheons, especially birthday luncheons

July is ALARA's birthday month so usually special luncheons are arranged if possible. The VK6 girls had their special luncheon at the end of June. VK3 and VK5 luncheons are in July, in VK3 the usual day is designated special, in VK5 we are greedy, we have the usual one on the second Friday and another one on the last Sunday of the month when the OMs associated with the YLs also have an extra luncheon.

We make them sit separately for their meal but they are allowed to join us for coffee! Cheeky aren't we?

Although the photos from the

actual occasions will be too late for this bulletin we do have a photo from the May luncheon in VK3-land, sent to us by a newly rejoined member Kathy VK3XBA. Welcome and thank you Kathy. HINT HINT! I LOVE PHOTOS

ar



The VK3 group: Kathy VK3XBA, Carol ZL2VQ Gwen VK3DYL, Mavis VK3KS and Muriel May. Not in photo Wayne ZL2VN and Niel May VK3KNM.

## Antenna

'HomeBrew'

(with a lot of help from your Bushcomm kit)

### SWCS-KIT HF ANTENNA

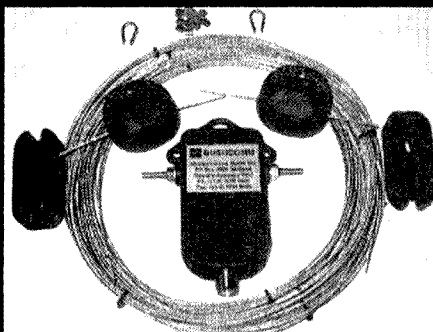

This is a kit version of our popular SWC-100S single wire model, but you have the great satisfaction of constructing your antenna.

Easy to follow, comprehensive Instructions.

Common tools required.

You save money and have fun

Once completed correctly your antenna will be a replica of the SWC-100S model. This is a single-wire, base-situation antenna, constructed with stainless elements to give high resistance to corrosion. It has a length of 34m in total. Trees, buildings or other structures can be used to suspend the antenna, (avoid running the antenna over iron-roofed buildings as this reduces the effective height above ground). The antenna can be mounted either horizontally between two supports, or as an inverted 'vee'

Frequency Range: 2-30 MHz

Impedance: 50 OHM

Power Input: 100 Watts, 250 Watts PEP

This kit contains:

Balun (x1) Load (x2) S/S Thimbles (x2)  
Copper ferrules (plus a few practice extras)  
Large egg insulators (x2) 4 cut lengths of wire.

FULL and CLEAR

building and mounting diagrams

## Bushcomm



PROUDLY AUSTRALIAN OWNED  
AND MANUFACTURED

PO Box 2028, Midland DC 6936 Western Australia  
80 Stock Road, Herne Hill 6056 Western Australia

PHONE: + 61 8 9296 0496

FAX: + 61 8 9296 0495

EMAIL: bushcomm@bigpond.com

See more at

[www.bushcomm.com.au](http://www.bushcomm.com.au)

## Alternative approach to the "Mode-J" de-sense problem

**Going way back to Oscar-8 days the problem of receiver de-sensing on "J" mode was an added complication to operating this mode.**

Its root cause is the third harmonic of the 2 metre transmit frequency falling close to the 70cm down-link frequency. The people charged with designing satellite frequency plans are aware of this of course, and the frequencies are chosen so that no direct relationship exists between the two frequencies. That would make full duplex operation well nigh impossible.

In practice, however, most installations will involve highly sensitive pre-amplifiers and high gain antennas in close proximity. Receiver de-sensing can be a real problem due to the proximity of the third harmonic and can ruin an otherwise good station's performance. It's a depressing experience to see the receiver "S" meter fall to zero when you press the talk button. You can kiss full duplex operation goodbye.

The conventional wisdom in the early days was to construct an "inter-digital filter", a device which had been pioneered in this part of the world by the ATV gang. The filters were first made in a 3 or 4 section die-cast box with tuned rods made from 1/8" bronze welding rod. They worked well but were eventually superseded by printed circuit board versions using strip-line techniques. I made and used both kinds when AO-8 was in its prime.

When the digital satellites appeared

on the scene and full duplex operation became essential rather than just desirable for maximum download efficiency, more isolation was required and the day of the cavity filter was upon us. I made my cavity filter from 3" diameter copper tube with brass tuning parts and "N" connectors. It was machined accurately and soft welded together using low-temperature eutectic methods. It is still in operation at the mast-head after more than 12 years of operation and still gives such good isolation that the 70cm "S" meter barely moves when the 2 metre transmitter keys up. About the only improvement would have been to silver plate the inside surfaces. At the time some purists did that but the likely improvement was only a dB or so and in most cases it wasn't warranted.

However if you do not have engineering facilities at your disposal the successful construction of such a device could be beyond your means. Many people have avoided mode-J as a result. An alternative approach was aired in a recent discussion on the AMSAT-BB. As my satellite antenna system is more or less cast in concrete and works well I have not tried out these suggestions but they seemed well-founded and a number of people attest to their effectiveness. The first suggestion was to

use a Diamond MX-72N duplexer in line with the 70 cm side, and terminating the 2 metre side into a 50 ohm load.

Another similar approach was to use a Comet CF-416C duplexer as the de-sense filter. It was claimed in that article that you do not need to terminate the VHF port, just use the UHF port as a high-pass filter. I have not checked to see if the above mentioned duplexers are available in VK but it should be possible to find a similar unit on the market.

There is obviously room for experimentation in this area. I know of operators who have made co-ax cable duplexer devices for this purpose (we used to call them *diplexers*) but the test gear and expertise required has worked against their widespread adoption. The availability of multi-band antennas for VHF/UHF radios has resulted in their companion duplexers being available at a reasonable cost. It may well prove to be a permanent solution to this sticky problem on mode "J".

This mode became popular with satellite builders as the 2 metre band became more and more chaotic in many parts of the world with rising ambient noise levels and piracy running rife. For most operators it is still a viable mode so it is still being built in to new satellites today.

## Echo successfully launched, becomes AMSAT-OSCAR-51 (AO-51)

**On June 29th Chuck Green N0ADI, reported from the Baikonur Cosmodrome that the launch of AMSAT Echo and several other satellites occurred on time at 6/29/2004 0630 UTC.**

Chuck reported that he watched the rocket climb out and said it appeared to be flying straight and true. In a second phone call some 18 minutes later he confirmed that the launch carrying AMSAT OSCAR Echo was successful and that all spacecraft had separated successfully.

There was a flurry of activity on the AMSAT-BB with old timers confirming the telemetry and newcomers peppering the BB with questions regarding setting

up their station for this new bird. Mike Kingery KE4AZN quickly published a web site for forwarding telemetry files to the command team. It was pleasing to note the number of VK stations who had downloaded the telemetry decoding program "TlmEcho" from the web site and began almost immediately to send in captured data.

From day to day we watched the telemetry data as the controllers proceeded with uploading software to

the satellite. The WOD (Whole Orbit Data) software was loaded and the controllers began to analyse files as they came in. As a result adjustments were made to the on-board settings resulting in increased power availability from the solar panels.

On Wednesday 7th July, Bill Tynan W3XO announced that Echo had been allocated an Oscar number and it became AMSAT-OSCAR-51 or AO-51. Look for keplerian elements under this

# PLC/BPL in Australia: progress, or a cause for concern?

**Proposals for Power Line Communications or Broadband over Power Lines (BPL) in Australia concern many users of the radio frequency spectrum, including radio amateurs.**

WIA President, Michael Owen, VK3KI said recently that the WIA's position in relation to BPL is that it supports increasing broadband access and broadband competitiveness in Australia, but in a way that does not cause interference to legitimate users of the High Frequency spectrum. The WIA supports the development by the ACA of policies for BPL that protect existing users.

The WIA believes that one of the

problems associated with BPL is that trials on a limited basis are not good indicators, and that the full effects of a problematic technology will not be seen with such trials. The WIA considers that BPL will not really serve the community's long run needs because of its limited bandwidth.

A deep fibre network is to be preferred to using long runs of power lines.

The WIA has appointed a team to deal with this issue.

WIA President has appointed Phil Wait, VK2DKN the director responsible for developing and advocating the WIA's position in relation to BPL.

He has asked Owen Duffy, VK1OD Barry White, VK2AAB and David Wardlaw, VK3ADW to assist Phil, as the WIA's BPL Team.

A report on a recent small trial in Hobart of BPL to some 4 houses and 2 floors of the Aurora building is on the WIA website.

ar

## AMSAT continued

designation on the Celestrak web site.

At the time of writing this column the new satellite is still being commissioned. By the time you read this it should be well and truly in use by the amateur radio satellite community. Details are available on the recently revamped AMSAT-NA web site. Follow the links to Project Echo.

There's talk of bringing back the "experimenter's days". They were fun. In the early days of Oscars 10 and 13 Wednesdays were often scheduled to run more exotic modes and to have QRP days when one could make contacts with a few tens of milliwatts of power. With modes like high speed data and bands like 13 cm, AO-51 promises to be an exciting addition to the Oscar fleet.

## The AMSAT group in Australia.

The National Co-ordinator of AMSAT-VK is Graham Ratcliff VK5AGR. No formal application is necessary for membership and no membership fees apply. Graham maintains an email mailing list for breaking news and such things as software releases. Members use the AMSAT-Australia HF net as a forum.

## AMSAT-Australia HF net.

The net meets formally on the second Sunday evening of the month. In winter (end of March until the end of October) the net meets on 3.885 MHz at 1000utc with early check-ins at 0945utc. In summer (end of October until end of March) the net meets on 7.088 MHz at 0900utc with early check-ins at 0845utc. All communication regarding AMSAT-Australia matters can be addressed to:

AMSAT-VK,  
9 Homer Rd,  
Clarence Park, SA. 5034

Graham's email address is:  
vk5agr@amsat.org

ar

## SO-50 can now be switched on by users

Robin Haighton VE3FRH, President of AMSAT-NA recently released details of how users may turn on the 10 minute timer on SO-50. This will take a big load off the control stations who have been turning it on each time it rises at their locations. The power budget is such that this precaution is no longer necessary. Here is the sequence for switching the repeater on.

- 1) Transmit on 145.850 MHz with a tone of 74.4 Hz to arm the 10 minute timer on board the spacecraft.
- 2) Now transmit on 145.850 MHz (FM Voice) using 67.0 Hz to PT the repeater on and off within the 10 minute window.
- 3) Sending the 74.4 tone again within the 10 minute window will reset the 10 minute timer.

The spacecraft repeater consists

of a miniature VHF repeater with a sensitivity of -124 dbm, having an IF bandwidth of 15 kHz. The receive antenna is a 1/4 wave vertical mounted in the top corner of the spacecraft. The receive audio is filtered and conditioned then gated in the control electronics prior to feeding it to the 250 mW Transmitter. The downlink antenna is a 1/4 wave mounted in the bottom corner of the spacecraft and canted at 45 degrees inward.

Thank you Robin, this will be welcome news for SO-50 users.

Plan ahead...

# JOTA:

**Jamboree On The Air  
October 16th and 17th**

---

# Beyond our shores

---

David A. Pilley VK2AYD  
davpil@midcoast.com.au

**This month's BOS is dedicated to our near neighbour, New Zealand. Whilst our ACA is proposing new changes to our hobby, so are our friends across the water.**

## New Zealand

### New Directions in Amateur Radio Licensing in New Zealand

There are new directions in Amateur Radio Licensing in New Zealand. The changes started on 17 June when a new revised Schedule 3 attached to the ZL licence came into effect with other changes taking effect over the next 18 months or more. The news is all good. Many long-standing problems are being eliminated. Some of the changes are believed to be world firsts.

The following is a summary of essential points from the report by Fred Johnson MNZM ZL2AMJ, NZART Administration Liaison Officer, given at the NZART Conference, Blenheim, 5 June 2004.

There has been a complete review of the conditions for the Amateur Radio Licence in New Zealand, the most thorough review ever. It commenced with a letter on 18 July 2003 from NZART to the Ministry of Economic Development, Radio Spectrum Management group (RSM), asking for the many successful outcomes for the Amateur Service from the World Radiocommunications Conference 2003 to be implemented in New Zealand. Your NZART ALO has been working with RSM to develop these new requirements. NZART Council has been kept apprised of the developments.

The Ministry is changing its licensing software system to SMART (Spectrum Management and Registration Technology) and this system is expected to come on-stream in about 18 months. Some changes may have to wait for this new system to be operating as explained in the following notes.

Some of the new 'rules' to come into effect are:

1. A callsign must be transmitted at least once every 15 minutes during communications.
2. The permitted maximum transmitter power output for an amateur station is quoted with one figure: 500 watt

PEP. This is defined in the ITU RR 1.157. With only one figure, it is now mode-independent.

3. Third-party traffic, which since 1988 has been permitted nationally within New Zealand, is now permitted internationally with any country. (Subject to the other country being permitted third-party traffic).
4. Licensed overseas visitors, i.e. persons holding a current amateur certificate of competency, authorisation, or licence issued by another administration, may operate an amateur station in New Zealand under a General User Radio Licence (GURL) with similar privileges to a ZL resident station for a period not exceeding 90 days, provided the certificate, authorisation or licence meets the requirements of Recommendation ITU-R M.1544, or CEPT T/R 61-01, or CEPT T/R 61-02, and is produced at the request of the Chief Executive.
5. The present country-to-country reciprocal licence agreements will disappear in time as more countries directly recognise the licences issued by other administrations. Cross-border travel by radio amateurs will become easier.
6. The callsign to be used by a visitor from overseas will be the home-country callsign as allocated by the other administration with an added prefix "ZL" or an added suffix "ZL" which is to be separated from the national callsign by the character "/" (telegraphy), or the word "stroke" (telephony).
7. Encoded transmissions by radio amateurs remain prohibited but are now permitted for the licensees of remotely operated stations, for example repeater and beacon trustees and for satellite control.
8. The present unwanted emission limit figure for amateur stations -56dbW is being discarded. The

ETSI standard ETS 300 684 is being adopted to apply to any emissions falling outside amateur bands.

9. Licensees are now encouraged to prepare for, and to meet, the communication needs of national and international disaster relief. In New Zealand this has been an agreed and understood arrangement for decades but any written authorisation seems to have been lost in history. This international provision is now reflected in the new licence schedule.
10. To demonstrate competency in the Morse code is no longer a requirement for an amateur radio licence. There is no mention of Morse code in the new licensing provisions.
11. Morse testing by NZART will continue, voluntary for persons who wish to take a test for challenge purposes. NZART's Examinations Division could issue speed-achievement certificates. Some overseas countries are retaining a mandatory Morse requirement so a testing facility will be required for some overseas travellers for reciprocal-licensing purposes.
12. There is only one grade of amateur operator licence in New Zealand, the GENERAL AMATEUR LICENCE. The word "General" must continue meantime because it is hard-entered in the Ministry's existing database. This may change with the new SMART system expected in 2005 but is undecided.
13. All existing Limited Amateur licensees will automatically become General Amateur licensees on 17 June 2004 irrespective of what is written on their existing licences.
14. The very few present legacy Novice licensees and their separate conditions will continue and will be manually processed outside the database by the Ministry until extinction. No new Novice licences are possible. Novice Licensees



## Midwinter conditions better than 2003

Propagation was better, particularly on the lower frequency bands, although the higher bands have been not as good as then. This is primarily due to rapid descent of the sunspot numbers. It also helped that the offending switch-mode power supply on my next door neighbour's television is no longer there.

The precarious situation with Iraq continues, although sovereignty was restored on 28th June. I expect a shortwave service will emerge soon, although satellite based television seems to be the preferred delivery mode. The American backed "Radio Free Iraq" disappeared from shortwave in February with the emergence of an independent media within Iraq. Neighbouring Iran has increased their Arabic output of the external service, for Iraq and the adjoining Gulf States.

There definitely has been an escalation in the number and frequency of Arabic language transmissions since the restoration of Iraqi sovereignty. As I previously mentioned, satellite television is very influential within the region and extremely graphic. However, it is worth remembering that car radios, fitted with shortwave bands, are sold in the Gulf States.

The VOA in Washington has changed the focus of their news broadcasts, to

reflect the editorial priorities of the current Administration. This has caused industrial and political conflict between the staff and the IBB. Apparently the editorial independence of the VOA has been an ongoing issue over many decades between the Administration and the news staff.

Finland has stated that they have no plans to leave shortwave, despite speculation that Helsinki was closing at the end of this year. It is the only shortwave station with a non-religious weekly news bulletin in classical Latin. It currently only broadcasts in Finnish, Swedish and Russian, in addition to the weekly Latin bulletin.

This month, the Summer Olympic Games are being staged in Athens. Many broadcasts will be live. I expect that ERT, the Greek broadcaster will be in the forefront. They certainly were excited when Greece unexpectedly won the European Soccer championship in Portugal. Athens is best heard here on 9420 at 2100 and later at 0500 onwards. Broadcasts are in Greek but short news bulletins in either Spanish or English are heard towards the end of the targeted transmissions.

Croatia is being easily heard here on 9925 at 2200 with broadcasts in Croatian. At 2230, there is a Spanish program for

Latin America. Signal strength has held up surprisingly well throughout the day. Broadcasts for Australasia are on 13820 at 0700 via senders in Juelich, Germany. I often hear English programming, complete with Australian accents, which is not surprising as there are quite a number of Australians with a Croatian heritage.

World Harvest Radio has indeed purchased WSHB, the former Christian Science senders in South Carolina. They also own former senders of the Christian Science church in Maine. WHRI in Noblesville, Indiana has consequently been closed and the 500 kW senders in Maine and South Carolina are being run at quarter- to half-power. KWHR in Hawaii has two senders but apparently is no longer running Radio Free Asia programming, concentrating on religious output.

Don't forget Remembrance Day is on this month and since the January 1st deregulation, I expect that activity will be more intense on HF. 40 metre activity has dramatically increased, especially at night. 80 metre has become thinner, although there is considerable interest in the DX window between 3775 and 3800, especially at greylines peaks from various DX locations.

ar

## Beyond our shores *continued*

require a pass in the examination to attain General grade and are encouraged to do so.

- Existing Limited and Novice callsigns will be retained.
- A change of callsign can be requested following the existing rules. There being only one licence grade, licences will no longer indicate a grade.
- All amateur bands remain the same but the LF band is being listed for the first time as an allocated amateur band and is extended from 130 to 190 kHz.
- The band 7.1 to 7.2 MHz is to become amateur exclusive worldwide in 2009 - but that's a future excitement.

There continues to be only one amateur radio examination, computer-generated, administered by NZART. The 600-question question-bank is being revised for the new conditions. New exam-generating software will soon be available for exam supervisors. Exams conducted after 17 June should be for the new conditions.

The present generally-established entry route into amateur radio is to pass the one examination and then spend some time on the VHF bands gaining operating experience. The future entry path into amateur radio continues this pattern. A pass in the examination is followed by access to several HF bands and to VHF for a 3-month period to gain practical operating experience and with

at least 50 contacts logged. Then access is permitted to all amateur bands. This requirement is only for new amateurs licensed after 17 June 2004.

## Finally

These changes are being introduced over a lengthy period. It is suggested that remits for further changes or tinkering be held off for several years until the new system settles down and is properly studied and understood.

With one examination, with only one licence grade, and with new and simplified procedures, New Zealand Amateur Radio is positioned for an exciting future.

(sourced to Jim Meachen ZL2BHF Editor 'infoLine')

ar

# RippleTech Electronics

## Brand New Dxciting Products

Rippletech Electronics is providing a new service to hams in VK/ZL and the Pacific. Our quarter wave slopers will outperform a quarterwave ground mounted vertical by several dB. You can have access to a DX antenna on 80m and 160m with as little as 15m of ground space (provided you have an existing 15m tower-nally or equivalent). Our best selling combined 40/80m sloper requires even less space. Alternatively, the TZ-V3 and TZV3w will give you access to 10/15/20m or 12/17/30m with a small budget or small backyard. Mount on your metal garage roof for a surprising signal. New novice operators, what about a rotary dipole for 10/15m only - \$129.00 plus p&p

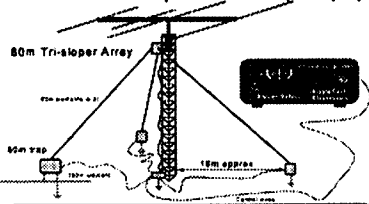

1:1 & 4:1 HF 1kW Baluns	\$59.00
Single 80m sloper	\$109.00
Single 40 & 80m sloper	\$179.00
WARC Rotary dipole	\$289.00
10/15/20 Rotary Dipole	\$279.00
12/17/30 Vertical	\$199.00
10/15/20m Vertical	\$189.00
Radials kits	\$44.00
FT-1000mp remote	\$33.00
30 or 40m Rotary Dipole	\$399.00
80m Slopers Array (3 ele)	\$499.00

RippleTech Electronics  
3 Moyston Close  
Vermont South  
VIC 3133



Phone or Fax  
03 9887 2917

WANT MORE INFO ?  
PICTURES-DESCRIPTIONS  
A FULL PRICE LIST  
OR AN ORDER FORM - see  
[www.rippletech.com.au](http://www.rippletech.com.au)  
[sales@rippletech.com.au](mailto:sales@rippletech.com.au)  
[info@rippletech.com.au](mailto:info@rippletech.com.au)  
ABN 70 465 254 759

## Club news

### Adelaide Hills Amateur Radio Society

The June meeting was addressed by Geoff VK5TY with the story of the first Australia amateur radio satellite, Australis OSCAR 5 (Orbiting Satellite for Communication through Amateur Radio).

Before 1957 the only satellite of the earth was the moon. Then Sputnik appeared and the race was on.

As you would expect, it was not long before the amateurs became involved in the new technology.

Then, in 1967 Australian amateurs decided to 'have a go'. A group in Melbourne was already working on the idea when it was presented to the Federal Convention in 1967 where it was given the 'go ahead.'

It was several years before the prototype was shown at another convention just before it was shipped to the USA for launch.

An interesting talk about a typical

example of Aussie ingenuity. To save space and cost the antenna of our Australis Oscar used a Stanley steel tape measure. If you have ever had one of these in which the spring failed you will recognise the folded tape easily.

The July meeting is the Mid-year Dinner, but if you are in Adelaide for the third Thursday of a month, please come to a meeting at the Blackwood High School at 7.30pm.

### The Lower Murray Mid-year Dinner

This was held in Tailem Bend this time and was very well attended. As the photo shows there were 16 people there that night when a good time was had by all.

These regular dinner meetings are a good way to get everyone together and to involve the 'other halves' so they feel part of the scene.

Christine Taylor VK5CTY



The Lower Murray Mid-year Dinner

### NERC

Friday July 10th was the club AGM. 35 members and family were treated to a meal of chicken, pizza, salads and delicious sweets. Drinks were consumed liberally and a good night was had by all. The formal part of the evening was conducted by Geoff Glynn-Roe. Geoff, a retired bank manager audits the club accounts and presided over the AGM. The following people were elected to the committee. Peter Watts, John Butler, Brian Roberts, Eric Whittington, David Clegg, Trevor Quick, Warren Frost and Alex McCallum.

By the time you read these notes the Rally SA will be over, Thanks to all

volunteers. I will give more information at a later date.

The August 13th meeting will be a talk by David Woolford on video editing and production. September meeting will be a talk on CPR by John McCallum. This will include demonstration of CPR techniques on the mechanical "dummies". This is a technique that we should all be aware of.

Meetings are held on the second Friday of each month at the Ardtornish Primary School, Saarinen Ave St Agnes. Meetings start at 1930 hours.

David Clegg Secretary.

## Contest Calendar August - October

6	Aug	QRP Day	(CW/SSB/FM)
8/9	Aug	Worked All Europe DX Contest	(CW)
14/15	Aug	RD Contest	(CW/SSB/FM)
21/22	Aug	TOEC WW Grid Contest	(CW)
28/29	Aug	SCC RTTY Championship	(RTTY)
28/29	Aug	YO DX HF Contest	(CW/SSB)
28/29	Aug	ALARA Contest	(CW/SSB)
4/5	Sep	All Asian DX	(SSB)
11/12	Sep	Worked All Europe DX Contest	(SSB)
25/26	Sep	CQ/RJ WW RTTY DX Contest	(RTTY)
2/3	Oct	Oceania DX Contest	(SSB)
2	Oct	Psk 31 Rumble	
3	Oct	RSGB 21/28 MHz Contest	(SSB)
9/10	Oct	Oceania DX Contest	(CW)
16/17	Oct	JARTS WW RTTY Contest	
16/17	Oct	Worked All Germany Contest	(CW/SSB)
17	Oct	Asia-Pacific Sprint Contest	(CW)
17	Oct	RSGB 21/28 MHz Contest	(CW)
23/24	Oct	CWQ WW DX Contest	(SSB)

## Cable and Connectors



- RG58C/U Belden 8259 @ \$0.90 per metre
- RG213/U Belden 8267 @ \$4.45 per metre
- RG8/U Belden 9913 Low Loss @ \$5.15 per metre
- RG8/U Belden 9913F7 High Flex Low Loss @ \$5.55 per metre
- RG8/U - RF400 Belden 7810 Low Loss Sweep Tested to 6000MHz @ \$6.30 per metre



- RG58: B80-006 UHF connector (M) @ \$7.65 each
- RG8/213: B80-001 UHF connector (M) @ \$8.80 each
- RG213: B30-001 N connector (M) @ \$9.10 each
- RG8: B30-041 N connector (M) @ \$14.00 each

# connektron

ABN 19 413 484 007

email [sales@connektron.com.au](mailto:sales@connektron.com.au) or Phone (03) 9761-5220  
connektron Pty Ltd, 45 - 49 Merrindale Drive, Croydon South, Victoria 3036

[www.connektron.com.au](http://www.connektron.com.au)

\* All prices include GST

\* Minimum order value \$50 payable by Visa, Mastercard, Bankcard or Money Order

\* Packing and Delivery \$15 within Australia (Outside Australia P.O.A.)

# Contests

## Greetings to all testers,

Thank you for taking part in the recent group of VK/ZL contests. Without your participation there would be no contests at all.

However, please prepare NOW for the RD Contest in just a week or so, also QRP Day Contest (see rules for both of these in July column).

For those interested in the "big" ones, the Oceania DX Contest is coming round again in October. This is an opportunity

for VK/ZLs to give times for DX stations to make contacts with us "down under". Please support this event, even though it is a big job assessing all the logs. Believe me, the overseas stations are very happy to have contacts with us, as propagation is not always favourable to them.

## Linux anyone?

Is there anyone out there who is using Linux for AR work? I have just switched over, but as yet have found little in the AR field to run under that platform. Please let me know.

73, Ian Godsll VK3JS

## Results Harry Angel Sprint 2004

### CW

1st	VK5NJ	38 points	John Nieuwenhuizen	7TH	VK2LCD	28	Chris Meagher
2ND	VK4BUI	16	Les. Styles	8TH	VK4KNN	26	Barry Molkentin
3RD	VK2CTN	14	Chris. Thompson	9TH	VK5AIC	20	Ian Clayton
				10TH	VK7JGD	18	Garry Duence
				11TH	VK3DBQ	16	Jim Baxter
				12TH	VK2JHN	9	Walter Munn

### SSB

1ST	VK5AY	55 points	Bronte Wood				
2ND	VK5SR	48	SERG (SA) Club Station				
3RD	VK5UBC	34	Brian Cleland				
4TH	VK5USB	33	Richard Pipe				
5TH	VK6LG	31	Ron Hartley				
6TH	VK6ZN/2	30	John Howlett				

### Mixed

1ST	VK3JS	58 points	Ian Godsll
2ND	VK2BPL	46	Paul Linsley
3RD	VK8AV	34	Alan Viegas
4TH	VK2YN	28	Lindsay Collins

Total Logs: 19

## Manager's comments

The QRN on the night was very strong, one of the worst that I had heard for some time. Nevertheless it was most pleasing to tune around and hear the level of activity. It was very heartening to hear some of the more recent comers to HF taking the opportunity to try a simple, straightforward contest. The

emphasis was certainly on phone work, so that we dedicated CWers have now to turn more and more to the Mixed Mode section.

No-one mentioned anything about the change of day for this event, so I take it that it was not such a dreadful thing as may have been imagined. Next year,

2005, ANZAC Day will be on a Monday, so which will be the better day for the contest - Friday or Saturday night? Any suggestions most welcome.

I thank everyone who took part and sent in a log.

73, Ian Godsll VK3JS

## 2003 Oceania DX Contest results

27 June 2004

The report and full results for the 2003 Oceania DX contest are now available for you to view on-line at the Oceania DX Contest web site - go to <http://www.oceaniadxcontest.com>.

CONGRATULATIONS to all of the 2003 winners and thank you to everyone who participated to make this contest a success.

Special congratulations go to KH7X (op KH6ND) who hit the jackpot by winning both the PHONE and CW sections in the Oceania SOAB category. Despite the depressed solar conditions, overall activity was similar to 2002 and

a number of new records were set. There was also a good turn out from Oceania DX stations outside VK or ZL, including prefixes such as 3D2, 4W, AH2, KH6, DU, FK, ZK and YB/YC.

We are currently in the process of arranging the production and distribution of the various certificates and awards.

## Please note:

The 68th Oceania DX contest will be held on the first two weekends of October 2004 as follows:

PHONE Section: 0800 UTC Saturday 2 October to 0800 UTC Sunday 3 October 2004

CW Section: 0800 UTC Saturday 9 October to 0800 UTC Sunday 10 October 2004

The full 2004 rules are available at <http://www.oceaniadxcontest.com>. In order to further reduce the amount of effort required from volunteers and get the results out more quickly, the following rule changes are being introduced for the 2004 contest:

1. All logs with more than 50 QSOs are to be submitted via email;
2. All email logs are to be submitted in the required Cabrillo format;
3. Only logs with more than 10 valid QSOs will qualify for an award.

Finally, thank you to the members of the Oceania DX Contest Committee and the additional log checking volunteers (ZL2AOV and ZL2AOH) who carried out the work behind the scenes for the 2003 contest. We also acknowledge the support provided by NZART, WIA and the various sponsors of the awards.

We look forward to seeing you all again in the 2004 contest. Let's hope for some good conditions and encourage plenty of activity to make it the biggest and best event so far.

73 from

Oceania DX Contest Committee (VK3TZ, VK4EMM, VK2FHN, VK2AYD, VK1JDX, VK2CZ, ZL1AZE, ZL3GA, and ZL2BSJ)

*continued next page*

## Continent: Oceania

### Australia

Call sign	Category	Bands	QSOs	Points	Multi	Score
VK4EMM	SINGLE-OP	ALL	993	2433	581	1413573
VK4AN	SINGLE-OP	ALL	1057	2114	423	894222
VK7GN	SINGLE-OP	ALL	686	1200	369	442800
VK2FHN	SINGLE-OP	ALL	377	793	240	190320
VK8AV	SINGLE-OP	ALL	250	458	199	91142
VK4BAY	SINGLE-OP	ALL	281	470	184	86480
VK4TI	SINGLE-OP	ALL	230	455	171	77805
VK4BUI	SINGLE-OP	ALL	234	429	180	77220
VK2CZ	SINGLE-OP	ALL	110	814	87	70818
VK3TZ	SINGLE-OP	ALL	139	276	127	35052
VK3JS	SINGLE-OP	ALL	80	435	59	25665
VK3EVG	SINGLE-OP	ALL	41	103	38	3914
VK3KTO	SINGLE-OP	ALL	34	78	33	2574
VK2IT	SINGLE-OP	ALL	11	15	11	165
VK5UE	SINGLE-OP	ALL	12	12	12	144
VK3IO	SINGLE-OP	40M	302	1510	143	215930
VK4FJ	SINGLE-OP	15M	434	868	211	183148
VK2XT	SINGLE-OP	15M	375	750	148	111000
VK2VZQ	SINGLE-OP	15M	189	378	106	40068
VK6ANC	MULTI-ONE	ALL	1018	1757	552	969864

# Riverina Field Day

## 8th August

Twin Cities Radio and Electronics Club inc.

The Riverina Field Day, Sunday 8th August 2004

held at

*There will be a talk on  
computer technology*

**Murray High School**

on the corner of Kaitlers Road and Kemp Street Lavington.

It will be located in the assembly hall.

Opening times will be 10 am.

Closing time is 3 pm.

Food will be supplied by caterers  
on site at reasonable prices

Tea and Coffee will be free to  
everyone.

There are a number of reasonable motels  
located nearby and In Albury/Wodonga.

On Saturday evening some of the club  
members will be having an informal  
dinner at the Albury Commercial Club  
Bistro where the prices are \$12.00 a head  
for a very good 3 course meal of your  
choice.

### Contact:

Peter Presutti VK2CIM 02 6040 3210  
[presutti@tpg.com.au](mailto:presutti@tpg.com.au)

Greg Sargeant VK2EXA 02 6021 5438  
[sarge@iinet.net.au](mailto:sarge@iinet.net.au)

Fred Armstrong VK3XLV 02 6026 7350  
[namsat@bigpond.com](mailto:namsat@bigpond.com)

## RADIO AMATEURS OLD TIMERS CLUB OF SA

**The ANNUAL LUNCHEON will be held on Thursday 21 October 2004 at 12 noon for  
12 30pm lunch at Marion Hotel, Marion Road, Mitchell Park, Adelaide.**

RSVP Ray Deane VK5RK Phone 08 8271 5401

# 2004 80 Metre VK/ trans-Tasman Contests

## Complete Results:

### "Participation factor":

**PHONE:** 25 ZLs, and 182 VKs participated.  $25/182 = 0.137$ . All ZL "overseas call-area" group bonus points were reduced by multiplying by 0.137.

**CW:** 28 VKs, and 28 ZLs participated.  $28/28 = 1.00$ . Therefore, the Participation Factor was not applied.

#### Category 1 (Phone) /1

Call sign	Score	Contacts
1st VK5AY	2968	268
2nd VK2CZ	2346	247
3rd VK2WT	2328	214
4. VK6LG	2162	159
5. VK3IO	2113	239
6. VK3FRC multi	2099	239
7. VK2HZ	2031	235
8. VK4SN	1977	219
9. ZL1ALZ	1928	185
10. VK3TZ	1848	206
11. ZL4AL multi	1784	170
12. VK2EP	1732	203
13. ZL2AUB	1723	168
14. VK2UW	1660	210
15. VK6DXI	1607	140

#### Category 1 (Phone) /2

Call sign	Score	Contacts
16. VK7GN	1578	194
17. VK2AKB	1489	191
18. VK2KVA/Q	1382	150
19. VK2LCD/Q	1307	120
VK3JWZ*	1298	174
20. ZL4AA	1236	120
21. ZL4IM	1230	113
22. VK5KBH	1214	161
23. VK5MH	1210	146
24. ZL1AAR	1125	115
25. ZL4PW	1080	108
26. VK3UMB/Q	1075	149
27. VK2BPL	938	133
28. ZL2AOV	762	75
29. VK1WJ	709	102
30. VK3AVV	700	113
31. VK2LEE	700	99

#### Category 1 (Phone) /3

Call sign	Score	Contacts
32. VK5KMC	663	105
33. ZL2TW	636	73
34. VK4HDX	579	89
35. VK4AQD	532	80
36. VK2QV	523	56
37. VK6ADI	482	59
38. VK4BAY	451	73
39. VK3XAT	440	73
40. ZL2BSJ	419	43
41. VK6HST	375	50
42. VK2JHN	362	60
43. VK2VRM	194	41
44. VK7XRN	118	23
45. VK3JS/Q	118	18
46. VK2ZZ	114	27
47. VK4KML	58	14
48. VK8HPB	12	4

#### Category 2 (QRP Phone)

Call sign	Score	Contacts
1st VK2KVA	1382	150
2. VK2LCD	1307	120
3. VK3UMB	1075	149
4. VK3JS	118	18

#### Category 3 (CW) /1

Call sign	Score	Contacts
1st. VK4SN	1415	119
2nd. ZL6FF	1358	102
3rd. VK7GN	1333	111
4. ZL4OL	1305	85
5. ZL2CD	1232	95
6. ZL1ALZ	1173	91
7. ZL2BSJ	1167	91
8. VK2GR	1148	90
9. VK4BCM	1147	107
10. VK2BPL	1070	81
11. ZL1TW	951	81
12. VK3MV	920	76
13. ZL2ALV/Q	848	77
14. VK3BBT	721	65
15. VK1WJ	564	45
16. ZL4PW	493	47
17. VK5BLS/Q	407	32
18. VK2AKB	401	35

#### Category 3 (CW) /2

Call sign	Score	Contacts
19. VK2FDU	384	45
20. ZL2TX	376	37
21. VK8AV	270	31
22. VK3JWC/Q	111	16
23. VK4CEU/Q	76	10
24. VK1BL	48	10

#### Category 5 (SWL)

Call sign	Score	Contacts
ZL149	1346	

#### Category 4 (QRP CW)

Call sign	Score	Contacts
1st ZL2AVL	848	77
VK5BLS	407	32
VK3JWC	111	16
VK4CEU	76	10

\*Note: VK3JWZ (Contest Manager)  
Cat 1 Phone score of 1298, is ineligible

ar

## Jack Hazlewood VK2AAT

Passed away Tuesday afternoon July 6th 2004 His funeral was held on Friday July 9th 2004

Jack was one of the original WIA NSW members who spent many hours at working bees during the construction the Dural premises.

Submitted by Trevor Huntley VK2TM

## Ian Leslie Pogson VK2AZN

Ian Pogson, VK2AZN passed away peacefully at his Wentworth Falls home on Saturday morning, 26th June 2004. Ian was born on 1st October 1917 at West Pennant Hills and passed his A.O.C.P on 15th March 1938.

Ian was a very inventive and knowledgeable person. He was also very helpful in giving advice on technical matters and would always listen to, and was interested in, what others were doing technically or otherwise.

His first place of technical employment was S.T.C during the years of the Second World War and into the 1950's. He worked at A.B.C radio during the late 1950s and Radio, Television and Hobbies / Electronics Australia during the 1960s and 1970s.

Ian's major interests were precise timekeeping (he kept V.N.G's clocks running on time), antennas and astronomy. Amongst many other things, he built three large pendulum clocks during 1949 / 1950 and they are still running strong.

He designed and built many projects at Electronics Australia, the most notable ones being the Deltahets Mk 1 and Mk 2, both of which are still running perfectly.

Ian suffered a severe heart attack approximately three months ago and he never fully recovered.

Ian will be sadly missed by his many friends and acquaintances. He is a great loss to the amateur fraternity. To his wife Dorothy, our sincere condolences and sympathy.

73s Mate.

Submitted by Errol Trimmingham VK2BET.

## Geoff Page VK2BQ

Geoff was born on 2nd May 1917 in Melbourne.

After army service he worked as a civil engineer for Lockhart and later Tumut councils.

It was while he was at Tumut that he obtained his amateur licence VK2BQ in 1950. Geoff moved to Melbourne in 1960 to work as site engineer for ESSO Oil.

While in Melbourne his callsign was VK3ABQ.

Geoff retired to Warrawee around the time Hornsby and Districts Amateur Radio Club, HADARC, was formed so Geoff was an early member of the club and for many years was our auctioneer.

Geoff was a keen CW operator right up to the early 1990s.

Geoff was an early member of Australian Amateur Packet Radio Association, AAPRA, and was a committee member until his death. Geoff was a keen packet radio user and was publicity officer for AAPRA for most of the time.

Geoff had a sardonic sense of humor and always had a retort for any situation that arose. Geoff in the last year or two had heart problems and spent a few episodes in hospital.

Geoff is survived by his wife Thelma and two sons.

Barry White VK2AAB

## John Kennard VK2GJK

It is with great regret I advise John became a silent key on 15th June, 2004. He became an amateur during the 1970s and met and spoke to amateurs worldwide. During his travels he made a point of meeting many of those contacts, one of them being me and we remained great friends. Apart from Amateur Radio John (originally from England) had many other attributes including Marine Commando (UK), member of the Coffs Harbour Coastal Patrol and regular disc jockey for Belligen Community Radio 2BBB.

John went to England earlier this year to visit friends and relatives and shortly after his return, was diagnosed with a

very rare form of cancer. Fortunately he didn't suffer for too long, having wonderful support from his family, friends and Dorrigo Hospital staff. A celebration of his life was held at Dorrigo on 17th July at which money was raised for the Westpac Rescue Helicopter Appeal, which was his choice.

My sympathy and love go to his loving wife Brenda and family.

88 John

Submitted by Anne Benson VK4FAB

## Geoff Bower VK2OI

Geoff Bower VK2OI passed away on Thursday 8 July 2004 following a short illness. Geoff served as a WW2 Signaller in New Guinea. He was a keen CW DX operator often heard in recent years working DX on 160 metres from his retirement home near Lismore.

Submitted by Allan Mason VK2GR.

ar

radio and electronics school

## Become a Radio Amateur

Or study radio electronics to  
support your hobby

Australia's premier training institution for  
**AMATEUR RADIO AND HOBBYISTS**  
courses available in radio & electronics  
technology for all ages

**COURSES AVAILABLE ONLINE**

Be guided through your course by one or more  
of our 20 experienced volunteer facilitators,  
email hundreds of other students

**IN A HURRY?**

Become a novice radio operator in 4 weeks  
with our computer-based

**NOVICE FAST-TRACK COURSE**

Courses for schools, youth organisations and  
seniors

**Australian Radio Certificate Scheme (ARCS)**  
Use our accredited bridging program for radio  
amateurs to obtain a

**CERTIFICATE IN  
ELECTROTECHNOLOGY**

Download all course materials free  
(CD Rom has a small fee)

For Further Information visit

<http://radioelectronicschool.com>

or email  
[manager@radioelectronicschool.com](mailto:manager@radioelectronicschool.com)

Tel: (07) 5573 2795 12-5 (EST)

# Awards

Mal Johnson VK6LC

We have developed our Award Program using the standard intelligent Microsoft xp. Excel smart spreadsheet documents. These can be saved to a common file that will run on Excel 5.0/95 & 97-2002 versions.

For those that are on internet email system we recommend you enjoy the fast service offered by our new computerised awards system. One document is used repetitively for the life of the DXCC award.

Check out our "new" 2004 release "Quad Management" DXCC award file that will take care of four awards in any mode combination. i.e. Phone, CW, RTTY and Open all in the one package, available only in Microsoft xp.

Awards information and downloadable files are available on our WIA website <http://www.wia.org.au> or by email to: [awards@wia.org.au](mailto:awards@wia.org.au) or W.I.A. Awards Manager P.O.Box 196. Cannington. Western Australia. 6987.

Mal. VK6LC

## DXCC Certificate comments

★ Mal VK6LC has sent me the draft of the new DXCC Certificate and it's a welcome change. As I'm sitting on the WIA Honor Roll with all entities worked I certainly give it my stamp of approval and will apply for the new format when it becomes available.

Regards VK3SX Bob Robinson

★ I had the opportunity to view your latest new generation Federal DXCC certificate.

I can say nothing but praise for a very well designed certificate. Colours are just great and anyone applying for this certificate should be very proud to own one or more.

Best wishes, Russ. VE6VK

★ Mal Johnson, Awards Manager for the WIA, has just sent a few copies of the latest DXCC certificates. They look good and any DXer would be proud to have them in his shack.

Hope you are able to fit them in the awards section of AR magazine in the near future.

73 Austin Condon VK5WO

★ Having read in AR that a "New" Federal Awards Website was available I attacked it with enthusiasm and have now applied for a number of VK WIA awards. My recent experiences have been most pleasing. The navigation of the website was easy. Finding the specific award, its rules and paperwork/computer data entry was self explanatory. The comprehensive set of Excel spreadsheets was very professionally constructed along with an easy to use interface. Having 35 years of IT experience I can fairly say that those involved in the development of the WIA Federal Awards Website and facilities are to be commended on their professionalism and dedication in bringing forward much fine piece work that puts our award system up with the best around, if not the best. The system allows the applicant to complete the form online and has all the country information required to that as part of the country and prefix cell. On acceptance the spreadsheet is emailed back to you with data in unchangeable form so you review DXCC status without changing those entities that have been

accepted. I cannot speak highly enough of the prompt, friendly and business like manner in which the service was provided.

During this exercise I was afforded the opportunity to look over the new 2004 award certificate. It was found to be very appropriate for current times being green and gold which is very much representative of Australia. It states its purpose, from whom it comes and for what it is presented. Thus another fine piece of work any amateur operator would be proud to display. I recommend to all amateurs that these WIA Federal Awards are truly valued and will enhance walls of any shack or office.

Jim Baxter VK3DBQ

★ I would like to express my thanks to Malcolm Johnson VK6LC for his work for the WIA.

The new DXCC certificate is another step forward in the WIA awards program.

Thanks Mal (VK6LC) for putting Australia on the world map of DXers.

73 de Ted VK2UK

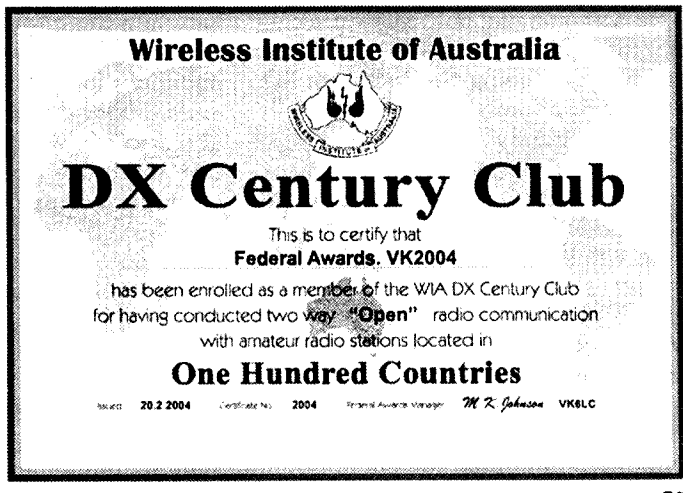
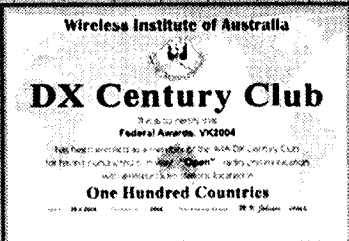
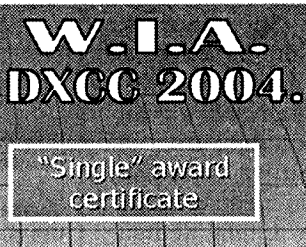

ar



# DXCC listings 30 June, 2004

Call sign	Countries	Call sign	Countries	Call sign	Countries	Call sign	Countries	Call sign	Countries		
<b>Honour Roll(326)Phone</b>											
VK6MS	335/389	VK2CSZ	286/289	VK5ATU	126/128	VK5UO	171/172	VK3VQ	276/293		
VK4LC	335/382	VK7TS	285/286	VK6HZ	126/000	DK6AP	168/000	VK3DBQ	276/279		
VE8VK	335/372	VK6ANC	276/280	VK2IRP	125/101	VK4UA	151/164	VK6MK	256/259		
VK4UA	335/370	VK3DP	274/277	TG8NE	125/000	VK4AAR	144/146	VK8NSB	256/000		
VK5WO	335/368	VK2CA	271/000	SM6PRX	121/126	VK8AM	138/000	VK5UO	251/255		
VK6LK	335/360	VK3UY	264/266	VK4EZ	119/125	N0TM	135/000	VK2CWS	251/253		
VK3AMK	335/354	VK3VQ	261/278	VK2MH	116/118	VK7DQ	131/132	VK3DQ	246/275		
VK3QI	335/349	VK3DBQ	260/263	VK5UO	112/115	DL6UGF	126/000	VK2FHN	243/000		
VK3AKK	335/348	VK2XH	257/000	VK3MRG	108/000	K5QNM	110/113	VK3JMB	239/000		
VK2FGI	335/341	VK8NSB	255/000	AX4EJ	105/000	VK5BWW	110/113	VK4DA	237/239		
VK3DYL	335/341	VK3CIM	254/258	VK9RS	104/000	SM6GZN	110/111	VK8AM	236/000		
VK3SX	335/341	<b>General listing- Phone</b>		VK6ISL	102/000	VK3DBQ	110/000	VK2BQS	183/186		
VK3EW	334/340	VK8DK	249/250	SV1GYG	102/000	PY2DBU	106/109	VK4CXQ	179/000		
VK6NE	333/349	VK4AO	240/000	SV1FTY	102/000	UR5BCJ	103/105	VK4CHB	177/179		
VK2AVZ	333/344	VK2FHN	238/000	3W2LC	102/000	SM6PRX	101/102	9A4KA	168/000		
VK1ZL	333/339	VK3JMB	237/000	VK3PA	102/000	<b>Honour Roll(326)Open</b>					
VK6HD	332/358	VK8KTC	231/233	VK2EJM	101/103	VK4LC	335/382	VK5ATU	158/160		
VK2DEJ	332/338	VK8AM	226/000	VK3KTO	101/102	VE6VK	335/380	VK3VB	153/155		
VK3OT	331/345	9V1RH	216/218	VK1PRG	101/000	VK4UA	335/372	VK3JXO	146/000		
VK4OH	330/337	PY2DBU	212/213	HS1NGR	101/000	VK5WO	335/372	VK2SPS	144/145		
VK6APK	330/335	VK4IL	212/000	VK5JAZ	100/000	VK3AMK	335/354	SV1XV	142/144		
VK4AAR	330/334	VK3DVT	206/209	<b>Honour Roll(326)CW</b>						VK4EZ	140/147
CT1EEN	330/000	VK6BH	200/000	VK3QI	334/346	VK3AKK	335/348	ON9MCR	129/140		
VK3CSR	329/338	PY2DBU	195/197	VK6HD	333/354	VK3OT	334/348	VK3OZ	126/127		
VK3YJ	327/333	VK6RZ	187/190	VK5WO	331/347	VK7BC	334/343	VK7CQ	123/125		
<b>General listing- Phone</b>											
VK7BC	324/329	VK7JAB	186/000	VE6VK	326/353	VK6HD	333/360	N0MSB	117/000		
EA3AKN	323/331	G0VXX	184/000	<b>General listing- CW</b>						VK9RS	111/000
VK5FV	323/326	VK6EH	170/000	VK6RZ	315/320	VK2AVZ	333/344	VK2AJE	109/000		
VK3EUZ	323/324	VK4CHB	167/168	VK3AKK	312/317	VK3UY	333/336	VK3MRG	109/000		
VK4SJ	321/322	VK2BQS	166/169	VK3KS	307/335	VK4AAR	332/336	<b>General listing- RTTY</b>			
VK4LV	319/321	VK4BP	164/000	VK4LV	299/306	<b>General listing- Open</b>					
VK1TX	319/000	VK5EMI	160/000	VK4ICU	291/000	VK2UK	325/330	VK3EBP	253/255		
VK6ABS	316/000	VK4ARB	159/160	VK3JI	274/299	VK4LV	323/331	VK3AMK	200/202		
VK2UK	313/318	JA6KTY	156/000	VK6MK	249/252	<b>General listing- Open</b>					
VK6RO	312/319	VK2EJK	153/000	VK7BC	246/255	VK6RZ	323/329	VK3DBQ	127/000		
VK3JI	310/325	VK2GSN	152/000	VK2CWS	245/247	VK4LV	323/331	VK2BQS	126/128		
VK6LC	309/312	VK7LUV	148/000	VK3DP	245/247	<b>General listing- Open</b>					
VK4ICU	303/305	VK2SPS	143/145	VK4DA	237/239	VK6RO	320/327	SP3CUG	124/000		
VK3IR	302/308	VK2QV	141/000	VK3CIM	235/236	VK4DV	313/328	VK5RY	100/102		
VK6DY	297/301	VK3JXO	141/000	VK3DQ	234/261	VK6LC	311/314	<b>Gen-listing 6m. Open</b>			
JA3EY	286/300	VK8LC	137/000	RD3AF	233/000	VK4ICU	311/313	VK4FNO	137/000		
VK4EJ	291/293	OK1ZSV	136/000	VK7TS	219/000	VK3DP	305/308	VK4ABW	109/000		
VK2HV	288/000	VK2JAU	135/000	IK1ZOD	210/000	VK7TS	295/296	VK6JQ	103/104		
VK4BAY	287/290	VK3DQ	133/147	DL7PA	203/000	VK2HV	289/000	VK4CXQ	101/000		
		SV1XV	130/131	VK6RO	190/192	VK3CIM	284/288	<b>Gen-listing- Satellite</b>			
		VK4FNO	130/000	VK4CXQ	174/000	VK6ANC	278/282	VR2XMT	112/114		
		VK4VIS	127/129			PY2DBU	278/282	VK3XDQ	106/000		

# VHF/UHF - an expanding world

David Smith VK3HZ - vk3hz@wia.org.au  
Leigh Rainbird VK2KRR - vk2krr@telstra.com

## Weak signal

David Smith - VK3HZ

My apologies that, owing to a production error, the July column didn't appear. So, this month, a combination of news from the last two months is included.

It seems that most of the weak signal activity at present is happening during the morning aircraft nets. Peter VK2BIT has been operating portable from a hilltop near Young on 2 m on several weekends recently, putting a good signal into Melbourne.

Mark VK2EMA in Tottenham in central NSW is being worked regularly by a number of stations in Melbourne on both 2 m and 70 cm. It appears that flights from Melbourne to Brisbane pass along the ideal path for aircraft enhancement between these two locations. Recently, VK2WWV at Trangie, northwest of Dubbo, was also heard in Melbourne.

Peter VK5ZLX has recently moved to the eastern side of the range near the Barossa Valley. With only a small yagi on a pole off the side of the shed on 144 MHz, he has already been able to work VK3II, VK3BG and VK2KRR. Look out when Peter gets the tower up.

Since returning home from a successful Meteor Scatter Dxpediton, Rex VK7MO has quickly racked up an extra 10 grid

squares on 144 MHz EME bringing his current total to 31 squares.

There were several periods of tropo enhancement in the south of the country during the month of June, but it appeared to be a case of "the lights are on, but no-one's home" for the most part. It's a little frustrating to hear the beacons pounding in, but be unable to raise anyone at the other end.

Leigh VK2KRR reports that on June 5th, he worked Peter VK5ZLX near Barossa Valley - a distance of 735 km - with signals up to S9+20 dB. He also worked Barry VK5KCX at Gawler - 764 km - at good strength.

During the evenings of June 16th and 17th, Peter VK5ZLX and Leigh VK2KRR tried some tropo scatter tests over the 735 km path. There was no tropo duct enhancement and general conditions were poor with no beacons heard. Contacts were completed with reasonable ease, with signal reports noted at VK2KRR's end on the 16th up to S4 and on the 17th up to S7. At both ends single yagis were used with around 150 watts.

On June 21st, a slow-moving high-

pressure cell settled over western NSW, producing some good conditions. On the morning of the 21st, Leigh VK2KRR worked Terry VK3ATS in Mildura and Garry VK5ZK in Gawler. In the evening, he worked Phil VK5AKK - S9+10 at 763 km, Bill VK5ACY - S3 at 894 km, Peter VK5ZLX - S9 at 735 km and Garry VK5ZK - S7 at 754 km.

On the morning of the 22nd, the high had moved across favouring north/south paths from Melbourne. Mark VK2EMA in Tottenham worked Ron VK3AFW and David VK3HZ in Melbourne - a distance of 650km - on both 2 m (S9+20) and 70 cm (S6). Signals were steady for quite a while indicating tropo rather than aircraft enhancement. Phil VK5AKK was worked by VK3HZ at S5, although enhancement to the west had dropped right off. Unfortunately, Phil had been getting strong signals from the Melbourne area beacons and calling for most of the morning, without any takers. That evening, Peter VK5ZLX was S9+ in Melbourne. Norm VK2XCI was also worked at S3. Leigh VK2KRR worked Colin VK5DK in Mt Gambier (630km) with signals up to S9+10 dB.

## ACA changes

By now you should all have received a letter from the ACA regarding the outcomes of the review of amateur service regulation. There are a significant number of changes that will affect us all, but much has already been said about that. But what changes are important to the VHF/UHF weak signal operator?

The most significant change is that all classes of licence will be given access to all of the 2 m and 70 cm bands. The

Standard licence class (formerly Novice) will also be able to use the 6 m, 23 cm, 13 cm and 6 cm bands. (In what appears to be an anomaly, Foundation licensees will be able to use all "Voice" modes - including SSB - but Standard will be limited to the current Novice modes - not including SSB). Thus we should look forward to an increased number of active stations on the low ends of those bands.

The ACA did back away from proposals to allow us parity with our US brethren regarding maximum power limits, arguing that EMR problems were highly likely in the urban environment. However, for the Advanced licence class, they are proposing a maximum power of 400 W PEP for ALL modes, not just SSB. That means 400 W RMS for modes like CW, FM and WSJT.

## Beacons

Paul VK2YVG in Broken Hill reports that new beacons have been installed on Mt Darling, about 20 km east of Broken Hill in far western NSW. They are on 52.525, 144.525 and 432.525 MHz. The beacons are on a time cycle, running through all 3 bands in about 50 seconds. Each beacon is active for about 14 seconds

and transmits in CW "VK2RBH Broken Hill". On 2 m & 70 cm the beacons run 10 watts to a pair of crossed folded dipoles. There is a catch though. Only the 2 m beacon is running at the moment. The 70 cm beacon is suffering from RF feedback, but should be fixed soon. The 6 m beacon has been held up waiting for

the licence to be issued. The 2 m beacon is getting out quite well and has been heard several times in Melbourne.

The VK3RGL 70 cm beacon's frequency has been reset and now appears to have stabilised somewhat. It is now approximately 30 Hz lower than its assigned frequency of 432.530 MHz.

# GippsTech 2004

The annual GippsTech conference has just concluded. The 70 people who attended once again experienced an event that should not be missed by anyone interested in weak-signal operating. There were 15 excellent presentations given by 11 amateurs on a wide variety

of topics, some of them practical, some theoretical, some historic and many of them intended simply to stimulate the thought processes. I'll bet there are many attendees now back in their workshops hatching new project plans (I know I am). Thanks to Peter VK3KAI and his

many tireless helpers for making the event again a huge success.

The date has already been set for the next conference – July 9th and 10th 2005 – so put that in your diary now.

Please send any Weak Signal reports to David VK3HZ at vk3hz@wia.org.au.

## Digital modes

Rex Moncur - VK7MO

The new version of WSJT (v 4.7.0), which includes Spectran, is a winner for small station EME as one can detect stations on Spectran that are well below the level that can be decoded, and wait for them to come out of the noise (set Spectran to 1.3 or even 0.67 Hz bandwidth). While contacts might take an hour or more, it is amazing to see the occasional peaks in signal give a perfect decode in the average. Possibly the prime advantage of Spectran is psychological, in that if you can see a signal you are more inclined to wait around for it to peak sufficiently to decode. The technical advantage is that once you see a signal you can narrow the tolerance to 25 or even 10 Hz and avoid birdies and stronger noise peaks on adjacent frequencies. The use of Spectran makes it practical for single yagi stations to work other small or medium stations and greatly increases the numbers of possible contacts. To work the smaller stations it is best to use JT65A and this in turn requires very good stability at both ends (better than 2 Hz over a minute). JT65A is 1 dB better than JT65B and while 1 dB does not sound much it is equivalent to reducing

the time to make a contact from say three hours to two. For those with limited patience this can be the difference between making a contact or not. Before trying JT65A, do some test transmissions with single tone R27 on FSK441A set to 60 second TX period with a local station who has good stability and can watch for you on Spectran in a bandwidth of around 0.2 Hz.

It is good to see the AGA will allow the Digital modes the same power limit as SSB (400 watts PEP), subject to EMR assessment.

Garry VK5ZK and Leigh VK2KRR have regularly been working 754 km on JT44 using less than 10 watts and single yagis. Gavin VK3HY was excited to get perfect copy from a Czech station on EME using JT65. Rod VK2TWR has sorted out his computer and is working into Hobart on JT44. Cec VK6AO is going to the North of the state and will run some meteor scatter tests with Don VK6HK.

Something not mentioned in last month's report is that VK2KRR was able to copy VK7MO/6 on a 1731 km direct tropo path while Rex was on his DXpedition from Eucla in May. Rex's

144 MHz FSK441 signal was weak but audible at times.

During the morning FSK441 session on June 19th, a huge "burn" from a large meteor was experienced by most of the stations involved - VK1CJ, VK2AWD, VK2EAH, VK2FZ, VK2XCI, VK3AXH, VK3HY and VK7MO.

The burn was at least one minute and 3 seconds long. It is by far the longest burn we have had during our normal meteor activity sessions in around 3 years of running tests, although there were many similar long burns during the Leonid peak a few years ago that produced great SSB contacts.

The fact that the signals were seen by Waldis VK1CJ in Canberra and also by Gavin VK3HY in Melbourne suggests it was somewhere between these two locations. Gavin received Norm VK2XCI first and then Adrian VK2FZ second suggesting that the meteor was going from west to east. Therefore, a large, hot rock might have hit the ground in Eastern Victoria somewhere, up to the Snowy Mountains.

## 2 m & 70 cm FM DX

Leigh Rainbird - VK2KRR

Out of one DX season and into another, the 2003 / 2004 season was filled with excitement.

I'd like to announce two end-of-season awards for Outstanding Achievement in FM DX for 03 / 04. I feel that the two stations that stand out as making some amazing contacts and made for some great reading to this column during the past season were – Brian VK5UBC from Gawler, and Dion VK7YBI from Burnie.

Brian and Dion made some jaw dropping FM DX contacts during the

year. Here is a quick look back at a few of these beauties.

Dion made a number of contacts into the Adelaide area from his home QTH near Burnie in Tasmania. These included a 913 km trip to the Murray Bridge repeater on 146.875, a 925 km trip to the Crafers repeater 147.000 and also a 947 km trip to the Barossa Valley repeater on 146.825. Dion also worked simplex on 2 m with Shane VK5NRV in Woodside at 921 km. Many people mentioned the rarity of hearing VK7s into Adelaide. Dion has his sights set

on cracking the 1000 km mark so watch this space.

Over the period of only a single season, one quick look at the ANVDG FM DX Records list tells you that Brian VK5UBC holds 7 of the 8 records for VK5 on 2 m; five of these are near or in excess of 2000 km! Brian's top two simplex contacts were - 1900 km from his home QTH at Gawler to VK6DM in Albany, and 1044 km from a portable location at Corny Point to VK7LCW in Penguin, Tasmania. Brian's top two repeater distances were to sites in Western

Australia – 2102 km from Gawler to VK6RMW at Mt William and 2062 km to Mt Saddleback VK6RMS.

Thanks also go to everyone who made an effort in the search for 2 & 70 FM DX during the past season. It's been fascinating. Let's see now what the new season has in store for us. I'm sure it will be even better.

On to current activity reports. June was quite good in the south east providing a good end to the season. Conditions from VK4 remained poor.

On the 5th of June in the SE conditions came up in the evening after around 6.30 pm. From here the path was initially to Mount Gambier, which faded and then some good signals were noted from the Adelaide and Port Augusta directions. The Port Augusta repeater was up to S9 at 913 km. Conditions into Adelaide were rather poor.

Around 9.10 pm the VK5RMN Port Pirie repeater came in and I had a few good overs with Arnie VK5NEX and Daryl VK5HBK both in Whyalla, also Jim VK5AJW called in from Cowell, their locations are on the west side of the Spencer Gulf, and the Port Pirie repeater is 867 km from here.

The big one for the month ran from the morning of the 21st to the afternoon of the 23rd of June. A lovely big high-pressure cell loomed on the weather maps and was drifting east. From about 4.30 am on the Monday signals began coming in. I was initially woken by the Adelaide beacon on 144.450 and then checked the Adelaide repeaters and found Murray Bridge, Crafters, Lobethal and Barossa Valley. The Mildura repeater was also present and Terry VK3ATS was worked on 146.500 at 466 km. Bill VK3LY in Nhill was able to work to the Crafrers repeater VK5RAD.

That evening things were looking good. At 7 pm the Adelaide beacon was S7 and a number of Adelaide repeaters were coming in OK. Also present was the Central North repeater, Port Pirie and Port Augusta.

I noted some slight enhancement to

the north, and at about 8 pm a very noisy signal was heard opening the Canberra 146.950 repeater. This lasted around 2 overs of a one sided QSO and I am quite sure I heard the station sign as a VK4. There is a repeater at Glen Innes, far NE NSW on the same frequency as Canberra. So if there was a VK4 station somewhere in QLD beaming south into the Glen Innes repeater around 8 pm on Monday the 21st of June, you may not know it but you were also getting to Canberra.

Helping confirm the possibility of this VK4 to VK1 path was Alan VK2KAW in Wagga who was able to work David VK2AYO in Dubbo via the Coonabarabran VK2RCC repeater at a similar time. This is a good 480 km trip for Alan and an interesting path.

A little later, on the Canberra repeater, around 10.30 pm while speaking with Steve VK2ZSZ about the VK4 station, we had a couple of interesting stations call in. Initially Noel VK3ANW at Kyabram was able to call in and say g'day. This is around 345 km for Noel over the mountains. After this a noisier

small signals from some parts of VK2.

Colin VK3LO and Laurie VK3AW were worked here on 146.500 via aircraft enhanced tropo. Good signals were also showing from the Melbourne repeaters, extending even to the 70 cm band, where some pretty awesome signals were noted, especially from Mt Macedon 439.275 up to S9+40 and the Grampians 438.675 up to S9+50dB at 471 km.

At around 9 pm conditions took an interesting twist and let the Broken Hill repeater through. The Broken Hill repeater on 147.000 peaked at a fantastic S9+10 dB signal at 638 km and held in there for about an hour. I had a good chat with Paul VK2YVG and Steve VK2SRN, both in Broken Hill. Was also able to contact Steve on simplex up to 5/5 signal, which was nice to see.

Good to hear of Greg VK3MTV lurking about the bands from Mildura. On the same night, Greg was able to get into the Canberra repeater and to the Wagga repeater, as well as a few from VK5.

In the morning on the Wednesday there were good signals into VK3 including Mildura, but all VK5 signals were totally gone. Signals were still good even on 70 cm, and Mt Macedon 2 m was running at 60dB+. The rarely present Warrnambool repeater was up to S9 at 512 km and even Broken Hill was still available but weak.

Terry VK3ATS was doing well from Mildura this morning and was also able to get to Broken Hill, we gave simplex a try and Terry was S9+40 here, Terry could also access the Wagga repeater and

Canberra, but Terry did comment that he was not hearing anything down Melbourne way, which was interesting to note.

That afternoon, everything was gone and conditions were back to their usual quiet state.

That's about it for this month. Please remember to send through any 2 & 70 FM DX reports to Leigh VK2KRR at vk2krr@telstra.com.

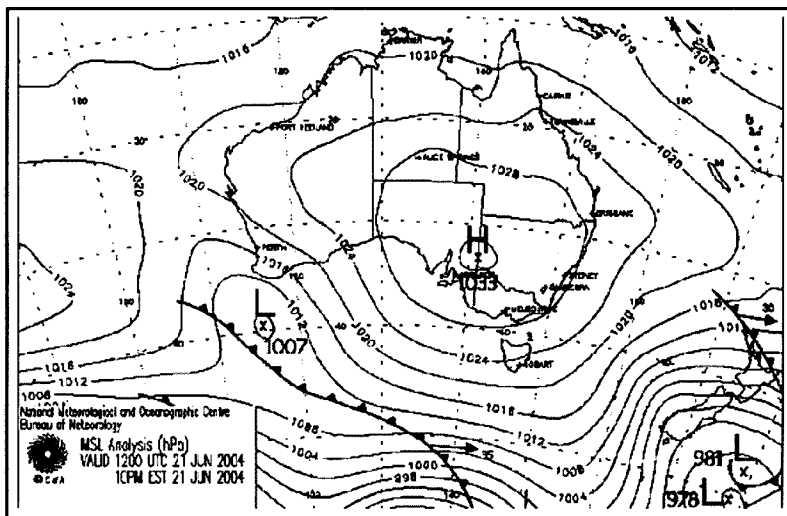

The isobars on June 21 at noon UTC

signal came through from Ian VK3IDL at Ballarat. Very surprised to hear Ian call in from down south at 493 km considering he was only using an omni vertical.

On the Tuesday, conditions seemed to be running along OK for most of the day. Reasonable signals in the morning from the west. In the evening though, signals appeared to be getting weaker from the Adelaide area and slowly picking up from the VK3 direction, there were also

# In Charlie's Way

A short story about a ham, his mates and the CW receiving exam.

Ross Fraser VK2WN

## Part 4 - 'Charlie's quality'

COLIN'S RADIO ROOM looked like a bomb had hit. He tried cleaning it up a few times but it always managed to get disorganised again. Life's too short, he figured so he rarely tidied it up. Every now and then he would give the room a quick clean up just to make it look okay. His former girlfriend, Susie had refused point blank to enter the room – the mess was just too much for her to cope with – and that was after a tidy up!!

Charlie walked into the room and thought to himself that he often stirred Colin about the mess but thought it would be best not to comment this morning. Colin leaned over his desk and switched on the '520s and pointed to the pad and pen lying nearby.

'OK' said Colin authoritatively 'it's time for the exam to begin'.

Charlie went as white as a ghost. Colin could tell that Charlie was nervous in this simulated exam situation.

'Just relax' Colin said soothingly. 'It's not something to be frightened of'.

Charlie clearly wasn't convinced and said 'If I could get these butterflies out of my stomach I could start a farm!'

The computer chirped into operation and the monitor made a brief swooshing sound before a picture slowly formed on the screen. The picture on the monitor flashed as various start-up stages were passed. Eventually the Morse-sending program was activated and some pleasant sounding Morse emanated from the radio speaker.

'See, it's not so bad' said Colin pointing to the speaker and smiling. 'It's okay here but it's not so good in the exam room' wailed Charlie painfully. Charlie and Colin eventually got down to some Morse practice. Colin would type in some text and then press a button and the machine would generate it. Colin would copy it down. He mostly got them right.

Colin said with a cheeky grin, 'Do you wanna cup of tea?' Charlie nodded, and before he could speak Colin said, 'We'll copy this lot down and then we'll have a

cuppa okay'. Charlie nodded again.

Colin waited till Charlie had his pen poised and then asked 'okay?'. Again Charlie nodded. Colin started to type – it looked and sounded as though he was typing, anyway. He pressed a button on the keyboard and Morse was produced again. Charlie started to write the Morse down. While Charlie copied the Morse, Colin read an article from an old electronics magazine. The magazine article was titled 'The Origins of Morse'.

A few minutes passed and Charlie shuffled in his chair uncomfortably. A minute later he groaned – this was the longest exam-style copying he'd done in a while. About thirty seconds later the Morse ended with a welcome and pleasant sounding 'AR'.

'What the hell was that?' asked Charlie, angry, but more relieved than anything. Colin avoided answering the question. He read out the text that had been sent and asked Charlie how he went. 'Well bloody hell, I only got three ...no four wrong, but that's all'.

The grin returned to Colin's face. He explained to Charlie that the text he'd just copied was sent at twelve words-per-minute and lasted just over seven minutes.

'You just passed your first exam' said Colin happily and then corrected himself by adding '...well a simulated exam'. Charlie started to say something, maybe to downplay what he had just achieved, but Colin wanted him to know that he was doing well and to encourage him at the same time.

'That text was longer than you'll get in the exam, and also faster. You did very well'.

'I suppose I didn't make many errors' Charlie said somewhat positively and then continued by saying 'I'm going to pass this damn exam'.

'Yes you will. Keep practising for about twenty minutes a day with text sent faster and longer than the exam and you won't have any problems'.

Tiger the cat walked into the room, first rubbing against Charlie's leg and then against Colin's.

Charlie leaned forward and put his hand down, and when Tiger came to him he rubbed the back of his neck. Charlie looked up at Colin and said 'Thanks mate'.

There was not much more to be said but Colin smiled and said confidently 'You'll do it'.

to be continued



**International YL Meet**  
**October 8 to 11, 2004**  
**in Seoul**  
**YLS, start planning your trip now**

**Adelaide-Amman****292**

First F 0-5 Short 13022 km

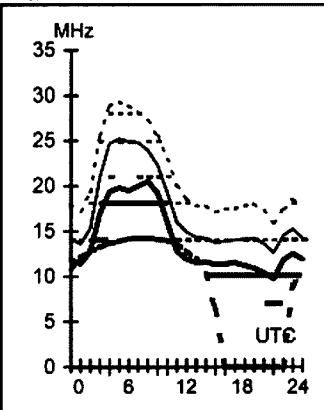
**Brisbane-Auckland****123**

First F 1F7-9 IE0 Short 2291 km

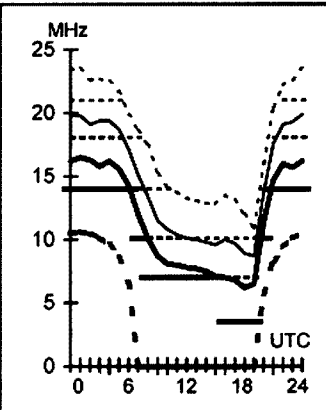
**August 2004**

T index: 37

**Legend**

Frequency scale

--- UD  
 - - - E-MUF  
 - - - OWF  
 - - - F-MUF  
 - - - ALF  
 - - - >10%  
 - - - >50%  
 - - - >90%

Time Scale

**HF Predictions**

by Evan Jarman VK3ANI  
 34 Alandale Court Blackburn Vic 3130

These graphs show the predicted diurnal variation of key frequencies for the nominated circuits.

These frequencies as identified in the legend are:-

- Upper Decile (F-layer)
- F-layer Maximum Usable Frequency
- E-layer Maximum Usable Frequency
- Optimum Working Frequency (F-layer)
- Absorption Limiting Frequency (D region)

Shown hourly are the highest frequency amateur bands in ranges between these key frequencies, when usable. The path, propagation mode and Australian terminal bearing are also given for each circuit.

These predictions were made with the Ionospheric Prediction Service program: ASAPS Version 4

**Adelaide-Invercargil****126**

First F 3-5 IE0 Short 2796 km

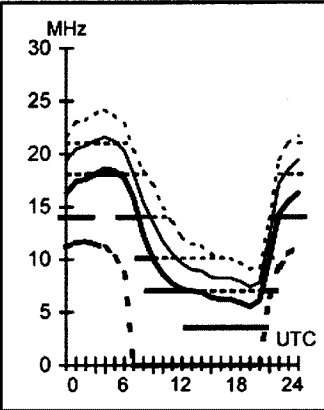
**Brisbane-Dakar****217**

First F 0-5 Short 18279 km

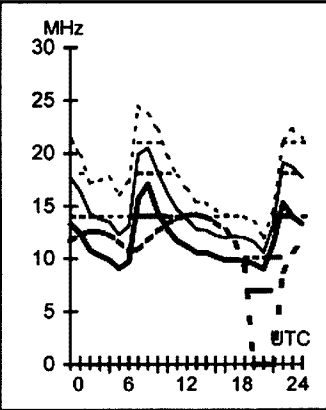
**Canberra-Lusaka****239**

Second F 4F2-4 E0 Short 11620 km

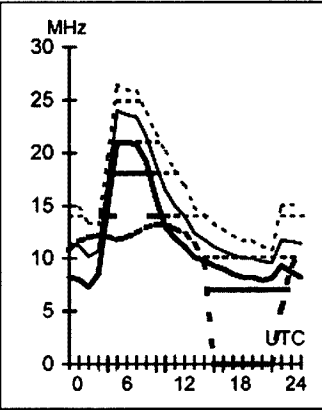
**Darwin-London****145**

First F 0-5 Long 26171 km

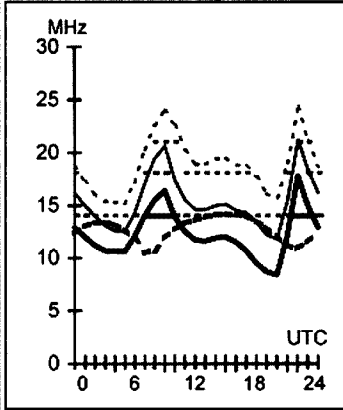
**Adelaide-New York****67**

First F 0-5 Short 17092 km

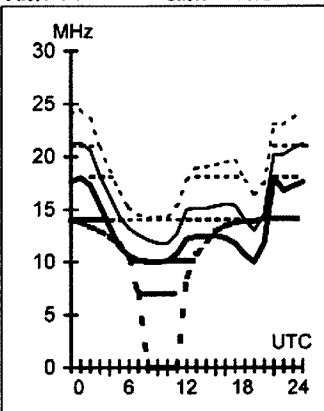
**Brisbane-Honolulu****49**

Second F 3F5-9 3E0 Short 7569 km

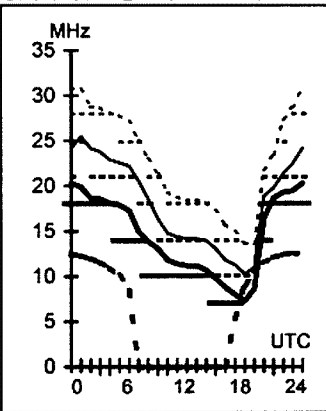
**Canberra-Moscow****317**

First F 0-5 Short 14481 km

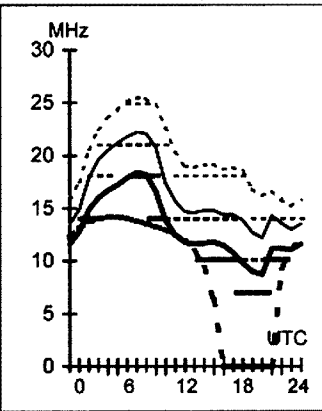
**Darwin-London****325**

First F 0-5 Short 13853 km

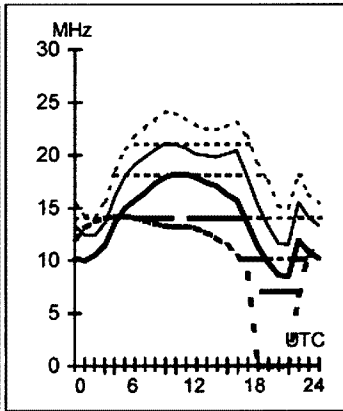
**Adelaide-Rome****296**

First F 0-5 Short 15337 km

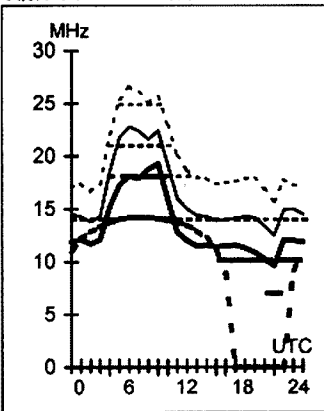
**Brisbane-Singapore****293**

Second F 3F8-12 3E0 Short 6146 km

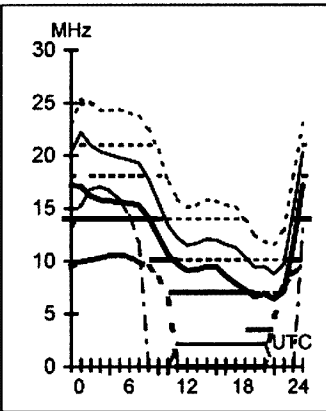
**Canberra-Tokyo****352**

Second F 3F4-8 3E0 Short 7948 km

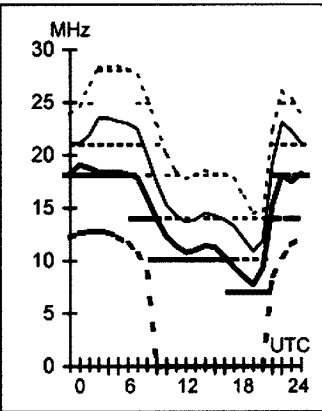
**Darwin-Pretoria****242**

Second F 4F4-5 4E0 Short 10639 km

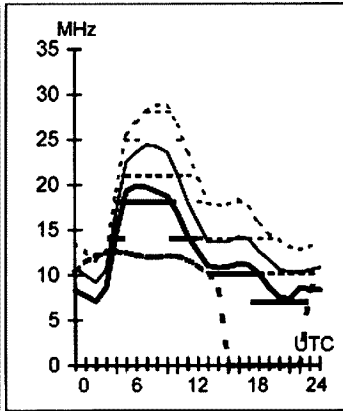

**Hobart-Montevideo**

**161**

**Melbourne-Budapest**

**302**

**Perth-Capetown**

**237**

**Sydney-Chicago**

**62**

Second 4F3-4 4E0 Short 11044 km

First F 0-5 Short 15558 km

Second 4F7-9 4E0 Short 8704 km

First F 0-5 Short 14876 km

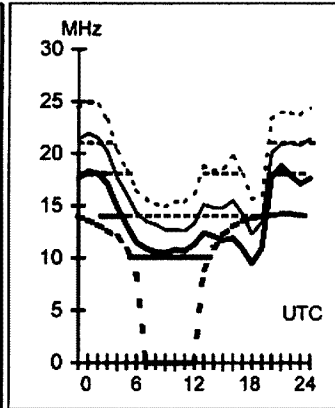
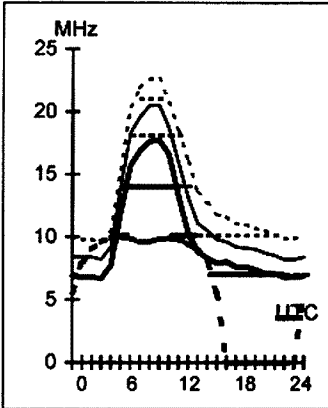
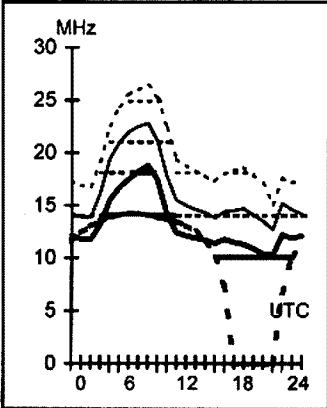
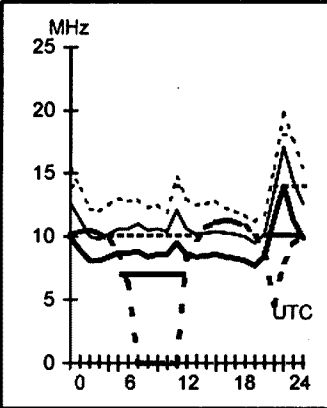

**Hobart-Stockholm**

**136**

**Melbourne-Jakarta**

**303**

**Perth-Osaka**

**17**

**Sydney-London**

**139**

First F 0-5 Long 23871 km

First 2F4-6 2E0 Short 5214 km

Second 3F5-9 3E0 Short 7684 km

First F 0-5 Long 23032 km

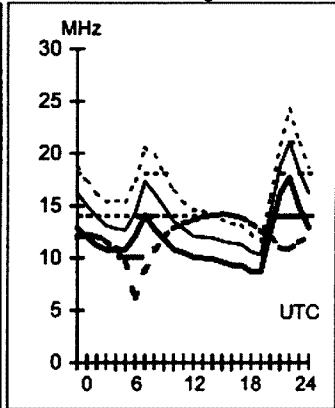
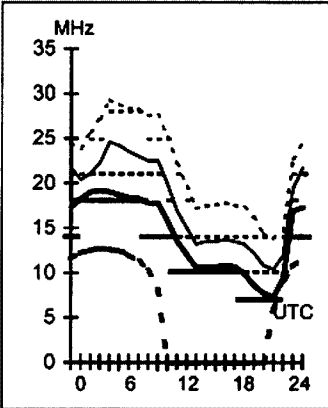
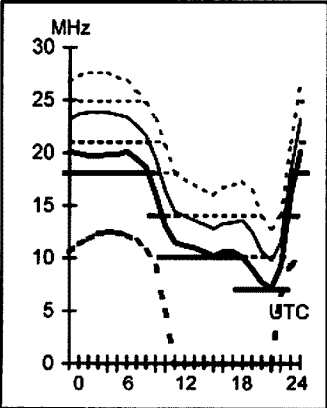
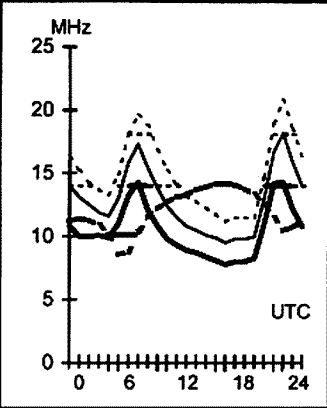

**Hobart-Suva**

**56**

**Melbourne-Manila**

**332**

**Perth-Santiago**

**174**

**Sydney-London**

**319**

First 2F9-11 2E0 Short 4012 km

Second 3F8-13 3E0 Short 6341 km

First F 0-5 Short 12709 km

First F 0-5 Short 16992 km

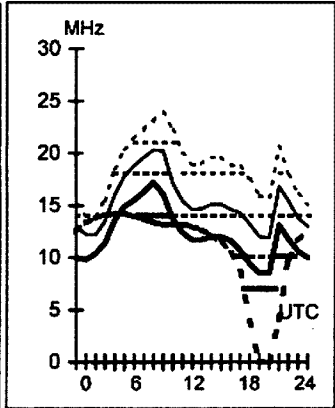
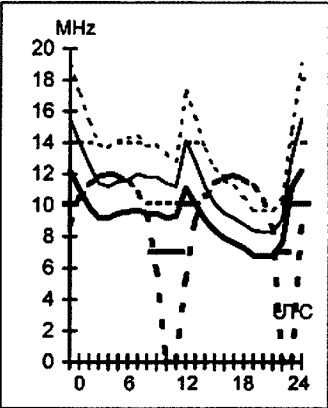
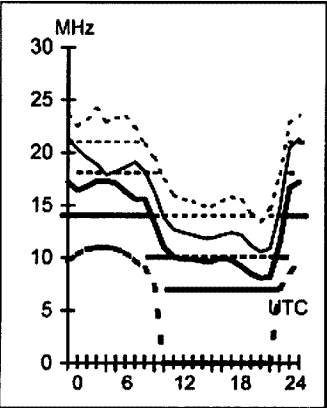
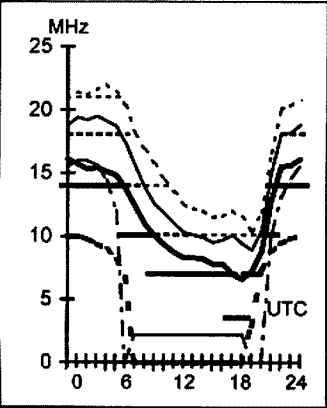

**Hobart-Vancouver**

**49**

**Melbourne-New Delhi**

**306**

**Perth-Tel Aviv**

**302**

**Sydney-Rio de Janeiro**

**164**

First F 0-5 Short 13427 km

Second 4F5-9 4E0 Short 10200 km

Second 4E3-8 4E0 Short 11091 km

First F 0-5 Short 13519 km

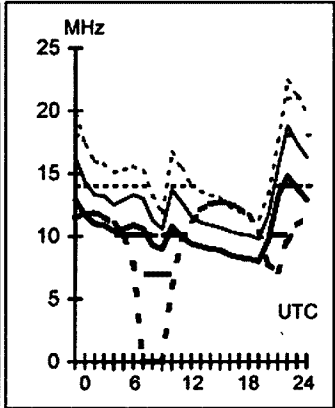
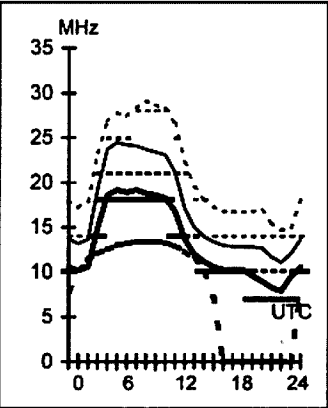
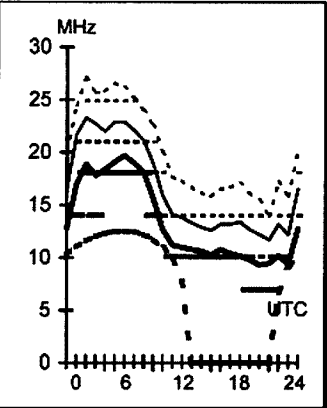
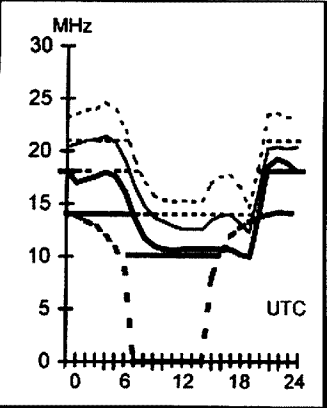

## FOR SALE NSW

• Wilson System SY-1 4 element beam \$350, Prop Pitch Motor \$250, DX-2 amplifier with QSK \$3000. Tom VK2OE@arrl.net or 2/25 Andrew St. Inverell NSW 2360 or Phone 0413 796 851 8-9 PM

• 16x2 backlit LCD displays AC-162D-YJLY57H. These have the industry standard interface. For more information, data sheet and constructional articles see <http://vk2bak.no-ip.com/>. Asking \$9.80 + \$3.20 post. Email [markweb@bigpond.com](mailto:markweb@bigpond.com) VK2BAK QTHR, Phone 02 4997 3173

## WANTED NSW

• Circuit and handbook THP HL-166V 6 metre power amp. Will pay costs. Ted VK2ARA QTHR Phone 02 4272 9521.

• Copy of owner's manual Yaesu FT-757 GX II. VK2AEW John Robinson QTHR, Phone 02 4344 7191.

• Copy of book, "Radiotron Designer's Handbook", compiled by Langford-Smith, published 1950's by Amalgamated Wireless Valve Company. Price and condition of book please to John, VK2SIG, QTHR; or [vk2sig@macben.id.au](mailto:vk2sig@macben.id.au)

• FDK multi 750 2 metre rig for parts only. Need not be working. Phone 02 4297 6406 [mickh1@swiftdsl.com.au](mailto:mickh1@swiftdsl.com.au) Mick VK2BZE

## FOR SALE VIC

• Ameritron AL-811 linear amplifier 10-160m, as new \$975. Bob VK3PT QTHR, Phone 03 5439 6314.

• 100 W, 2 m linear microwave modules \$120. MFJ-934 ATU \$150. VK powermaster 20 A supply \$120. Ken VK3DQW, Phone 03 5251 2557 (AH), 1300 133 526 (W).

• Antenna HF-5B Butternut 2 element mini-beam 10-20m, \$250 dismantled. Antenna AM-42 4 element 10m and 15m, \$70 dismantled. Franz VK3DVD Phone 03 9879 8804.

• Boat Anchors, FT-101s. Two FT-101s, both need a fix. One needs a second mixer box rebuild, all parts intact, the other has lost low level carrier. Incl. FV-101 Ext. VFO. condition good. Two for the price of one say \$200. Kenwood TS-520S serviceable, no DC leads, spare finals, \$250. Test Gear: Two Heathkit 30 MHz valve Sig Gens plus Heathkit VTVM, all goers, with 110 V. Jaycar auto xformer. Palec ET3 Valve Tester. \$250 the lot. All at the gate in Sale or meet Morwell. VK3VI, Max [gooloo@netspace.net.au](mailto:gooloo@netspace.net.au), Phone 03 5144 2687

## WANTED VIC

• CW filter YG-455C-1 or YK-455C-1 for Kenwood TS-140S or TS-680S. Peter VK3DU QTHR, Phone 03 9379 3626.

• WWII Reception Set No 4, No 19 set complete or power supply, cables, junction boxes, any WWII radios 101, 22, 122, 38, no 11 or any associated parts. Instruction books for these or any sets. An ARN-6 radio compass for Vampire Jet being restored at Moorabbin air museum. Phone 03 9789 9580 or email [emschem@techinfo.com.au](mailto:emschem@techinfo.com.au). Roger VK3HRS.

• Retired pensioner in his 70s would like to obtain some amateur radio gear to start a basic HF CW station on a pensioner budget. Roy, VK3BAM, QTHR, Phone 03 5263 2032.

## WANTED QLD

• Wanted for Townsville RAAF museum. Collins 427D psu for 618F VHF receiver, top cover for AWA C6770 RX, psu and speaker units for AR7, R115, T1154. Other donations welcome. Wayne VK4WDM, phone 07 4788 8781, [melrosew@optusnet.com.au](mailto:melrosew@optusnet.com.au).

## WANTED TAS

• KVG 9 MHz xtal filters XF-9A and/or XF-9B or any 9.0 MHz filters with an approx. 2.4 kHz BW. Email Trevor VK7TB [cabriggs@optusnet.com](mailto:cabriggs@optusnet.com), or Phone 03 6398 2118.

## MISCELLANEOUS

• The WIA QSL Collection (now Federal) requires QSLs. All types welcome, especially rare DX pictorial cards, special issue. Please contact the Hon Curator, Ken Matchett VK3TL, 4 Sunrise Hill Road, Montrose Vic 3765, tel. (03) 9728 5350

## TRADE ADS

PSK-31, SSTV, RTTY SOUNDBOARD Interfaces Fully isolated, ready to plug in. <http://www.G3LIV.CO.UK>, [johnny@melvin.com](mailto:johnny@melvin.com), G3LIV QTHR.

## About hamads....

- Hamads may be submitted by email or on the form on the reverse of your current Amateur Radio address flysheet. Please print carefully and clearly, use upper AND lower case.
- Separate forms for For Sale and Wanted items. Please include name, address STD telephone number and WIA membership number if you do not use the flysheet.
- Deceased estates Hamads will be published in full, even if the ad is not fully radio equipment.
- WIA policy recommends that the serial number of all equipment for sale should be included.
- QTHR means the address is correct in the current WIA Call Book.
- Ordinary Hamads from those who are deemed to be in general electronics retail and wholesale distributive trades should be certified as referring only to private articles not being re-sold for merchandising purposes.
- Commercial advertising (Trade Hamads) are pre-payable at \$25.00 for four lines (twenty words), plus \$2.25 per line (or part thereof), Forty word maximum, minimum charge of \$25.00. Cheques are to be made out to: WIA Hamads.
- Copy typed or printed clearly please, and received by the deadlines shown on page 1 of each issue of Amateur Radio.

Email: [newunltd@bigpond.net.au](mailto:newunltd@bigpond.net.au)

Fax: 03 9756 7031

Postal: Newsletters Unlimited, PO Box 431, Monbulk Vic 3793

### TRADE PRACTICES ACT

It is impossible for us to ensure that the advertisements submitted for publication comply with the Trade Practices Act 1974. Therefore, advertisers and advertising agents will appreciate the absolute need for themselves to ensure that the provisions of the Act are strictly complied with.

### VICTORIAN CONSUMER AFFAIRS ACT

All advertisers are advised that advertisements containing only a PO Box number as the address cannot be accepted without the addition of the business address of the box-holder or seller of the goods.

"Hey, Old Timer..."

If you have been licensed for more than 25 years you are invited to join the

**Radio Amateurs Old Timers Club Australia**



or if you have been licensed for less than 25 but more than ten years, you are invited to become an Associate Member of the RAOTC.

In either case a \$5.00 joining fee plus \$8.00 for one year or \$15.00 for two years gets you two interesting OTN Journals a year plus good fellowship.

Write to

RAOTC,  
PO Box 1100  
Sandringham VIC 3191

or call Arthur VK3VQ on 03 9598 4262 or Bill VK3BR on 03 9584 9512,

or email to [raotc@raotc.org.au](mailto:raotc@raotc.org.au) for an application form.



## TRADE ADS

Dear Amateur Community

I am currently having specials on the following coax cables. As follows -

**Hellax LDF-450 @ \$485 per 100 m qty (4.85 P/M)**

**LMR 400 (BEL 9913) @ \$390 per 100 m qty (3.90 P/M)**

**RG-58CU @ \$66 per 100 m qty**

**RG-213 @ \$166 per 100 m qty**

**LDF-450 male & female N type connectors @ \$40 ea**

**BEL 9913 N type connectors @ \$11 ea**

Freight anywhere in VK \$18.50

For any further inquiries on these cables, or any other cables you may require, please don't hesitate to contact me, as we are able to supply anything you can think of!

Regards Rob Long VK2XZ

rob\_vk2xz@hotmail.com

- Icom 706mk2g (NEW) \$1,299
- Icom 706mk2g (IMMAC) \$1,199
- Icom 207H (NEW) \$499
- Icom 910H (IMMAC) \$1,699
- Icom 756PRO2 (IMMAC) \$3,399
- Kenwood Ts2000 (IMMAC) \$2,399
- Kenwood TS480HX (IMMAC) \$1,799
- Kenwood TS480SAT (IMMAC) \$1,699
- Yaesu FT8900R (USED) \$699
- Yaesu FT100D (IMMAC) \$1,249
- Icom AH4 ATU (NEW) \$499
- Icom AT180 (USED) \$579
- Atas 120 Antenna (USED) \$449

FULL RANGE OF NEW HEIL PRODUCT

PRICE SUBJECT TO CHANGE - CHECK WEBSITE FOR LATEST

BARGAINS.

PLENTY OF OTHER CURRENT MODEL GEAR AVAILABLE.

WILL CONSIDER TRADE IN OF ANY CURRENT MODEL GEAR.

## Computer Interfaces

Icom and Yaesu \$69

Mobile Kit IC706 (NEW) \$85

Freight to anywhere in VK / ZL

ORDER ONLINE AT  
[WWW.VK3AJJ.COM](http://WWW.VK3AJJ.COM)

OR TEL: PAUL (03-9504 2628)  
LICENSED SECOND HAND DEALER NO 10229 (Vic)

<http://www.hamsearch.com>

a not-for-profit site that is a search engine for hams

## ADVERTISERS INDEX

Andrews .....	41
Benelec.....	IFC
Bushcomm .....	35
Coax Cable & Connectors .....	40
Com-an-tena.....	22
Computer Interface.....	54
Connektron .....	16
Emtron.....	17

## Sunspot Numbers

Monthly Sunspot Average June 2004: 43.2

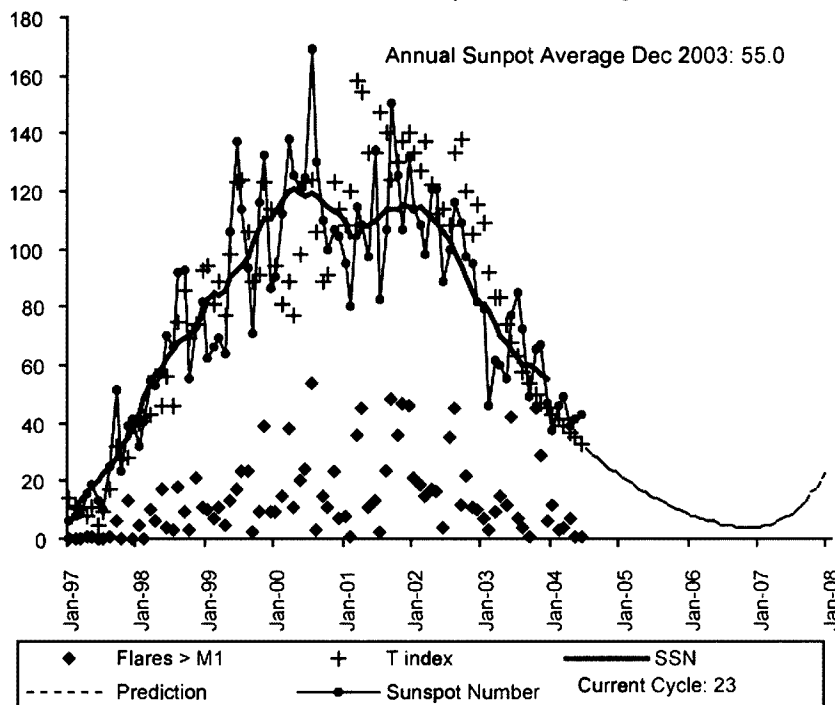

Drawn from monthly data provided by the Ionospheric Prediction Service

## AMIDON FERROMAGNETIC CORES

For all RF/electronic applications.

See our website for complete data on all cores including prices.

[www.catchnet.com.au/~rjandusimports](http://www.catchnet.com.au/~rjandusimports)

RJ & US Imports

PO Box 431, Klama NSW 2533.

A 3.5" PC disk containing all data is available for \$5.00 incl. post.

Agencies

Active Electronics, Tas  
TTS Systems, Tyabb (VIC)  
Tower Communications, Perth

## GROW WIA—MAKE IT YOUR JOB RECRUIT A NEIGHBOUR\*, NON-MEMBER LICENCE HOLDER TODAY.

One to one approaches are very successful and it is in your interest to have a strong WIA.

If you need to know who your neighbouring operators are call John (03) 9756 7797 AH and he'll tell you.

## JACKSON BROS

JACKSON OF THE HAM IS RAGE

Highest quality products made by UK craftsmen

Full range now off-the-shelf in Australia.

Variable and trimmer capacitors, reduction drives, dials, ceramic standoffs

CATALOGUES, PRICE LISTS AVAILABLE

CHARLES I COOKSON PTY LTD

11-13 Port Rd  
Queenstown SA 5014

Tel: (08) 8240 3200 Fax: (08) 8240 3233

FreeFax 1800 673355 within Australia

Email: [jackson@homeplanet.com.au](mailto:jackson@homeplanet.com.au)

ALL MAJOR CREDIT CARDS ACCEPTED  
SOLE AGENTS AUSTRALIA AND NEW ZEALAND

## HF, VHF, UHF ANTENNAS & ACCESSORIES

Aluminium towers, guys etc

Diamond VSWR/PWR meters.

HD copper antenna wire & insulators, TX tubes & pwr transistors, Create Rotators

Quality coax cables & connectors. Free advice & catalogue.

**ATN Antennas**

Ph 03 5492 2224 Fax 03 5492 2666,

email [atnant@inet.net.au](mailto:atnant@inet.net.au)

PO Box 80, Birchip Vic 3483



# Directory

The Amateur Service:- a radio communications service for the purpose of self training, intercommunication and technical investigation carried out by amateurs, that is, by duly authorised persons interested in radio technique with a personal aim and without any pecuniary interest. 1.56 ITU Radio Regulations.

The Wireless Institute of Australia represents the interests of all amateurs throughout Australia.

WIA membership fees are \$ 75 for full members ( F grade ), \$ 70 for pensioners and students ( G and S grade ), and \$ 50 for membership without 'Amateur Radio' ( X grade ). Payment direct to National office.

## National Office

10/229 Balaclava Road,  
Caulfield North VIC 3161,  
Australia

## Contact

Phone 03 9528 5962,  
Fax 03 9523 8191,  
10am to 4pm daily,  
nationaloffice@wia.org,  
www.wia.org

## News Bulletin Schedule

Subject to change see [www.wia.org](http://www.wia.org), follow national news prompts.  
Contact [nationalnews@wia.org.au](mailto:nationalnews@wia.org.au),  
VK1WIA to National repeaters,  
HF VK1WIA 7.128 MHz,  
Sundays at 11.00 am

## Advisory Committees

## Contact

## News Bulletin Schedule

VK1 Australian Capital Territory

Sundays at 11.00 am  
VK1WIA 7.128, 146.950, 438.050  
Tuesday at 8.0pm 146.750, 147.375, 438.025

VK1WX Alan Hawse  
VK1ZPL Phil Longworth  
VK1ET John Woolner

VK2 To be advised

VK3 Victoria

Phone 03 9885 9261  
[advisory@wiavic.org.au](mailto:advisory@wiavic.org.au)

VK1WIA Sunday 11.0am via HF and major VHF / UHF rpters

VK3JJB John Brown  
VK3PC Jim Linton  
VK3APO Peter Mill

VK4 Queensland

Phone 07 3221 9377  
[qac@wia.org.au](mailto:qac@wia.org.au)  
[ewan.mcleod@bigpond.com](mailto:ewan.mcleod@bigpond.com)

VK1WIA, Sunday 9.0am via HF and major VHF/UHF rpters

VK4ERM Ewan McLeod  
VK4ZZ Gavin Reibelt  
VK4KF Ken Fuller

VK5 South Australia and Northern Territory

Phone 08 8294 2992

VK1WIA via major VHF/UHF rpters Sunday 9am 145.000, 147.000  
HF bands as shown on the web  
Darwin 146.900 and HF

VK5NB Jim McLachlan  
VK5APR Peter Reichelt  
VK5ATQ Trevor Quick

[jimac@picknowl.com.au](mailto:jimac@picknowl.com.au)  
[peter.reichelt@bigpond.com](mailto:peter.reichelt@bigpond.com)  
[vk5atq@chariot.net.au](mailto:vk5atq@chariot.net.au)

VK6 Western Australia

Phone 08 9351 8873  
[vk6ne@upnaway.com](mailto:vk6ne@upnaway.com)  
[vk6xv@bigpond.net.au](mailto:vk6xv@bigpond.net.au)  
[vk6kz@bigpond.com](mailto:vk6kz@bigpond.com)

VK1WIA Sunday 9.0am via WIA network

VK6NE Neil Penfold  
VK6XV Roy Watkins  
VK6KZ Wally Howse

VK7 Tasmania

Phone 03 6234 3553  
[phil.corby@tassie.net.au](mailto:phil.corby@tassie.net.au)  
[vk7dg@wia.org.au](mailto:vk7dg@wia.org.au)  
[regemm@ozemail.com.au](mailto:regemm@ozemail.com.au)

VK1WIA via Tony, VK7AX 8.55am

VK7ZAX Phil Corby  
VK7DG Dale Barnes  
VK7KK Reg Emmett

## Notes

1. Only three members of the state advisory committees are listed.
2. All listings are preliminary. They will be updated each month as required.
3. Membership application forms are available from the WIA web site [www.wia.org.au](http://www.wia.org.au) or the national office address above.

# PNG amateurs remember *at the Kokoda gateway*



Amateurs in Papua-New Guinea have long wanted a station for the RD Contest that offered a closer link to the past history that makes Remembrance Day important.

It has been the aim of Rick P29KFS to establish and operate a field station from either the start of the Kokoda Trail or the Bomana War Cemetery.

This has not been a simple task but at last, with the help of some amateurs new to PNG AR, sufficient interest was generated and equipment put together to make it all happen on at least one day of the 2003 weekend.



P29NW Gary, P29GQ David, P29ZTC Terry, P29VVB Vladimir

*"I recall walking up the Golden Staircase on a hike from Port Moresby, remembering that then it was actually a river of mud two feet deep and that men were carrying 70 pound packs loaded with ammo and rations one way and their wounded mates back the other way"*



A real field station out in the bush was hoped for, but security problems, work commitments and the number of people available to operate the station were all against such a station being created. In late 2002 it started to look as though the station could be established.

In 2003 a small group was formed to push for the collection of equipment, building of aerials and scheduling of operators.



P29ZTC Terry



P29VVB Vladimir

*see page 28 for full story*

# ICOM'S GREAT CHAMPIONS

**NEW**



## IC-208H 2m FM Dual Band Transceiver

- Dual Band Features at a Single Band Price
- 55W / 2m, 50W / 70cm
  - Built-in CTCSS and DTCSS Tone Squelch Detachable Front Panel (Req. OPC-600/601 Option)
  - 9600 bps Packet Operation
  - 512 Memory Channel
  - Standard Mic. Supplied.HM133.



## IC-T90A A new 5W Triband handheld

- VHF/UHF FM 2M, 6M, & 70CM  
Wideband receive 495 KHz - 1 GHz  
555 Alphanumeric memories • 13 Scan modes DTCSS & CTCSS encode & decode DTMF encoder (10 memories) Wide/narrow transmit capability.



## IC-718 A compact HF all band transceiver.

- A superior performer with simple, straightforward operation with keypad • Optional AF DSP capabilities, including noise reduction & auto notch function • It's versatile, compact & loaded with features • Morse Free Package.



## IC-706MKIIG HF • VHF UHF

The amazing evolution of the legendary 706.

- Now includes 70cm @ 20W and 50W on 2m  
Standard feature dsp • Built in sub tone encoder & decoder  
Tone scan • Mosfet PA • You get base station performance and features in a mobile rig sized package • Morse Free Package.



## IC-7400

**NO FILTERS REQUIRED**

- Sharp & soft IF filter shape • 100W HF /6m /2m • Digital twin PBT  
• DSP • SSB / CW synchronous tuning • Built in antenna tuner  
• RTTY demod / decoder • Digital RF speech processor  
• Microphone equaliser • Morse Free Package.



find your nearest ICOM dealer at  
[www.icom.net.au](http://www.icom.net.au) or (03) 9387 0666



The magazine for  
**AUSTRALIAN** amateurs

Volume 72 No 9  
September 2004

# Amateur Radio

\$6.50  
incl GST

**An EH antenna  
for 10 metres**  
A companion to the 20 and  
40 metre L+L EH Antennas  
published in the April 2003 issue  
of Amateur Radio  
[ Lloyd Butler VK5BR ]

**Two tone testing**  
[ Jim Mellis VK5IST ]

**Operating a 5 Band  
HF Amplifier on 10, 18  
and 24 MHz**  
[ Neville Chivers VK2YO ]

**Understanding  
phase-locked loops**  
[ Elmo Jansz VK7CJ ]

**VK3AIR - 417SQN**  
**Australian Air Force Cadets**  
[ Theo Kalkafitis VK3AP 417SQN AAFC ]

**Brilliant  
harmonics**  
at the  
**SERG Convention**

ISSN 0002-6859



9 770002 485093 109

# BENELEC

# YAESU



## FT-1000MP Mark V



### 200 W All Mode HF Transceiver

- High Power Output
  - Wide Receiver Coverage
  - High-Speed Automatic Antenna Tuner
  - TX Microphone Equalizer
  - RX Speech Processor
- Price \$ 5,774.90**

## FT-1000MP Mark V Field



### 100 W All Mode HF Transceiver

- High Power Output
  - High-Speed Automatic Antenna Tuner
  - RX Speech Processor
- Price \$ 5,008.30**

## FT-857D



### Now includes DSP2 unit built-in

- Ultra Compact + All Mode Transceiver
  - 160-10m / 6m / 2m / 70cm
  - 100W, 100W, 50W, 20W
- Ideal Antenna:**  
ATAS 25 / ATAS120 / Comet UHV6

**Price \$ 1,628.30**

## FT-847



### Multi-Mode HF/VHF/UHF Satellite Transceiver

- Full Duplex Satellite Operation
- 160-6m / 2m / 70cm
- 100W, 50W, 20W

**Price \$ 2,744.10**

## FT-817



### Now includes FNB72 Internal Battery

- Ultra Compact 135 x 38 x 165mm
- All Mode Portable Transceiver
- 160 - 10m / 6m / 2m / 70cm
- 0.5-5 Watts Selectable

**Price \$ 1,334.00**

### Ideal Antenna:

ATAS 25 / UHV6

**All Price includes GST**

## FT-897D



### Does Your Radio Need Fix?

**- We FIX YAESU Radios!**

[www.benelec.com.au/yaesu/yaesu.htm](http://www.benelec.com.au/yaesu/yaesu.htm)

### High Performance All in One Portable Base Transceiver

- Portable / Mobile / Base All Mode Txr
- 160-10m / 6m / 2m / 70cm
- 100W, 100W, 50W, 20W

**Price \$ 1,734.30**

### Ideal Antenna:

ATAS 25 / ATAS120 / Comet UHV6

# www.benelec.com.au

## Authorised Yaesu Retailers

### NSW

Andrews Communications Systems  
Tel: 02 9636 9060 [lee.andrews1@bigpond.com](mailto:lee.andrews1@bigpond.com)

### Newcastle Pro Sound & Communications

Tel: 02 4965 6899 [sales@newcastleprosund.com.au](mailto:sales@newcastleprosund.com.au)

### Action Communications

Tel: 02 4732 2788 [action@pnc.com.au](mailto:action@pnc.com.au)

### VIC

Strictly Ham P/L  
Tel: 03 9729 7656  
[sales@strictlyham.com.au](mailto:sales@strictlyham.com.au)

### G & C Communications

Tel: 03 5996 3298  
[gccomm@netspace.net.au](mailto:gccomm@netspace.net.au)

### QLD

Kyle Communications  
Tel: 07 3857 4400  
[mark@kyle.com.au](mailto:mark@kyle.com.au)

### SA/NT

POSNAV Systems P/L  
Tel: 08 8342 4700  
[brenton@posnav.com.au](http://brenton@posnav.com.au)





# Amateur Radio

Volume 72, Number 9  
September 2004

The Journal of the Wireless  
Institute of Australia  
ISSN 0002-6859

## Editorial

Editor: Colwyn Low VK5UE  
edarmag@chariot.net.au

Technical Editor: Peter Gibson VK3AZL

### Publications Committee Members

Brenda Edmonds VK3KT  
Ron Fisher VK3OM  
Don Jackson VK3DBB  
Evan Jamman VK3ANI  
Tom Potter VK3UBS  
Bill Roper VK3BR

### Submission of material to Amateur Radio Magazine

General and Technical articles to Secretary  
AR Publications Committee  
3 Tamar Court  
Mentone VIC 3194  
or armag@optusnet.com.au

Columns and Letters to the Editor to Editor  
AR Magazine  
34 Hawker Crescent  
Elizabeth East SA 5112  
or  
edarmag@chariot.net.au  
(Tel and Fax 08 8255 2138)

Hamads to  
"Hamads" Newsletters Unlimited  
PO Box 431  
Monbulk VIC 3793  
Fax 03 9756 7031  
newunltd@bigpond.net.au

Advertising  
All enquiries to  
Newsletters Unlimited  
PO Box 431  
Monbulk Vic 3793  
Phone: 03 9756 7797  
Fax: 03 9756 7031  
newunltd@bigpond.net.au

Registered Office  
10/229 Balaclava Road,  
Caulfield North VIC 3161  
Australia  
Phone: 03 9528 5962

**Production Deadlines**  
Advertising booking and articles for publication 10th of preceding month.  
Hamads and advertising material deadline 18th day of preceding month

The contents of Amateur Radio are Copyright  
Wireless Institute of Australia © 2004

## GENERAL

VK3AIR-417SQN Australian Air Force Cadets <i>Theo Kalkandla VK3AP</i>	12
Our next big adventure: DXpedition to Baudin Rocks (VI5BR) <i>Peter Forbes VK3QI</i>	19
Charlie's Way, Part 5 - 'Stop kidding!' <i>Ross Fraser VK2WN</i>	26
Special Event Radio Station ON60CLM	27
Horse Endurance Ride 2004 <i>Mika Patterson VK4MIK</i>	32
JOTA for Scouts in SA <i>Les Adcock</i>	33
Home Brew Competition <i>John Draw VK5DJ</i>	34
The Gulag files <i>Richard Sawday VK5ZLR</i>	35

## TECHNICAL

Two tone testing <i>Jim Tregallas VK5JST</i>	4
Operating a 5 Band HF Amplifier on 10, 18 and 24 MHz <i>Neville Chivers VK2YO</i>	9
Understanding phase-locked loops <i>Elmo Jansz VK7CJ</i>	10
Technical Abstracts <i>Peter Gibson VK3AZL</i>	14
Own your own Enigma machine - almost	14
Simple sound-card-to-radio interface circuits	14
An EH antenna for 10 metre <i>Lloyd Butler VK5BR</i>	16

## COLUMNS

ALARA	38	Silent Keys	2, 29, 41, 47, 50
AMSAT	45	State News	30
Beyond our shores	28	VK1 News	30
Contests	41	VK2 News	30
Club News	37	VK7 News	31
Directory	56	Over to you	36, 40
Editorial Comment	2	Technical Abstracts	14
Hamads	54	VHF/UHF - An Expanding World	48
HF Predictions	52	WIA comment	3
Know your secondhand equipment	50		

## Our Cover this month

Mark Diggins VK3JMD with his 4 year old son, Nathan, who was attempting his first sniffer hunt under his Dad's guidance. The photo was taken at the SERG Convention at Mount Gambier on the June long weekend during the Australian Fox Hunting Championships.

### Contributions to Amateur Radio

Amateur Radio is a forum for WIA members' amateur radio experiments, experiences opinions and news. Manuscripts with drawings and or photos are always welcome and will be considered for publication. Articles on disc or email are especially welcome. The WIA cannot be responsible for loss or damage to any material. A pamphlet, How to write for Amateur Radio is available from the Federal Office on receipt of a stamped self-addressed envelope.

### Back issues

Back issues are available directly from the WIA Federal

Office (until stocks are exhausted), at \$4.00 each (including postage within Australia) to members.

### Photostat copies

When back issues are no longer available, photocopies of articles are available to members at \$2.50 each (plus an additional \$2 for each additional issue in which the article appears).

### Disclaimer

The opinions expressed in this publication do not necessarily reflect the official view of the WIA and the WIA cannot be held responsible for incorrect information published.

## Amateur Radio Service

A radiocommunication service for the purpose of self-training, intercommunication and technical investigation carried out by amateurs; that is, by duly authorised persons interested in radio technique solely with a personal aim and without pecuniary interest.

## Wireless Institute of Australia

The world's first and oldest  
National Radio Society

Founded 1910

Representing

The Australian Amateur Radio Service

Member of the

International Amateur Radio Union

Registered Office of the WIA

10/229 Balaclava Road, Caulfield North Vic 3161

Tel: (03) 9528 5962 Fax (03) 9523 8191

email: nationaloffice@wia.org.au

http://www.wia.org.au

All mail to

PO Box 2175 Caulfield Junction VIC 3161

Business hours: 10am - 4pm weekdays

### National Office staff

June Fox	Office Coordinator
Emma Tröbilco	Examinations Officer
Brenda Edmonds	Office Assistant

### Board of Directors

President	Michael Owen	VK3KI
Vice President	Ernie Hocking	VK1LK
	Glenn Dunstan	VK4DU
	Trevor Quick	VK5ATQ
	Ewan McLeod	VK4ERM
	Ted Thrift	VK2ARA
	Phil Wait	VK2DKN
Secretary	Peter Nalsh	VK2BPN
	David Pilley	VK2AYD

### Coordinators

AMSAT	Graham Ratcliff	VK5AGR
ARDF	Jack Bramham	VK3WWW
Awards	Mal Johnson	VK6LC
Contests	t.b.a.	
John Moyle Memorial		
FD Manager	Denis Johnstone	VK3ZUX
Editor "AR"	Colwyn Low	VK5UE
Education	Ron Smith	VK4AGS
EMC/EMR	Gilbert Hughes	VK1GH
	Keith Malcolm	VK1ZKM
Standards	Gilbert Hughes	VK1GH
	Peter Nalsh	VK2BPN
	John Martin	VK3KWA
FTAC		
Historian	t.b.a.	
IARU Region 3	Neil Penfold	VK6NE
Liaison Officer		
Intruder Watch	Henry Andersson	VK8HA
International	John Miller	VK3DJM
Travel Host		
ITU Conference and study group	Gilbert Hughes	VK1GH
	David Wardlaw	VK3ADW
	Keith Malcolm	VK1ZKM
	Ken Matchett	VK3TL
QSL Curator	Ken Matchett	VK3TL
QSL Manager (VK9/0)	Neil Penfold	VK6NE
Videotapes Curator	VK2 Division	
Webpage co-ordinator	Colin Thompson	VK2TRC
WICEN	John Weir	VK3ZRV

### ACA Liaison Team

Peter Nalsh	VK2BPN,	Peter Mill	VK3APO
Gilbert Hughes	VK1GH	Glen Dunstan	VK4DU
Keith Malcolm	VK1ZKM		

# Editorial Comment

Colwyn Low VK5UE

## Looking to the future

The RD has been and gone and from what I heard on Saturday evening the contest operating conditions were noisy in the eastern states and quieter in the west. I worked 20 stations around the country in the time I had available and enjoyed the time. Thank you all for the contacts.

The RD issue cover was well received, so I had a good month!

The National WIA is settling down and the Divisions are proceeding with the procedures to wind up and sort out the structure needed to maintain the facilities for Amateurs they used to run as Divisions.

We are now pushing on to JOTA and this issue has an emphasis on youth. Scouts, Guides and now military cadets are all interested in wireless communication as are many young computer enthusiasts. Some of these groups have amateurs as leaders and some need every assistance they can get. So please try and provide assistance if you are asked to help.

On Thursday 19th August I was able to attend the Adelaide Hills Amateur Radio Society meeting to present the Amateur Radio Magazine Technical Award to Lloyd Butler VK5BR for his articles on EH antennas published in AR in 2003. I have been made aware that AR Magazine awards for 2002, which should have been made in 2003, have not reached the awardees. Drew Diamond VK3XU, The Higginbotham Award for contributions to AR magazine

and Dale Hughes VK2DSH, the Technical Award. The Publications committee is working on rectifying the situation and I hope to post the certificates and cheques in the next few weeks.

I have had some complaints about the lateness of notice in Amateur Radio Magazine for events. This arises from two things, date of receipt of the notice from the organisers by AR and receipt of the magazine by members and readers. Unfortunately AR is not received in some locations until about the 14th of the month of issue and the closing date for material for that issue is about 4 weeks before that. So please ensure your notice is available to AR to be published in the issue before the event takes place. For example: - All November events should have been advertised in this issue September, with a follow up in October. Advertising in October only would do, but events in early November would only have 2 weeks notice to some members and readers. Advertising only in November would mean some people would hear about your event when it was over.

Apology. I have done it again. When I went looking for the ALARA Contest rules on Saturday 28th August 2004 I could not find them. They were in the April AR and I did not go back far enough. I hope those who needed them were able to refer to the WIA web site or found them in April 2004 AR

73 Colwyn VK5UE

## Silent Key

### Harley Davison VK2AHD

Wagga and District Amateurs were very saddened to hear of the passing of Harley Davison VK2AHD. Harley passed away suddenly during the evening of Sunday 14th August. Vale Harley VK2AHD

Submitted by John Eyles VK2YW

## Erratum

### A Direct-reading Inductance Meter for Radio Coils by Drew Diamond VK3XU in Amateur Radio August

The word "microhenries", used in several places, is incorrect. The correct spelling is microhenrys.



# Clearing the air

**The Editor has drawn my attention to a couple of letters that he has received that contain some seriously wrong statements of fact, and I am aware of some equally wrong statements that have been made, including on air.**

My instinct has been to ignore them, mainly because some are so wrong that even repeating them seems unnecessary.

However, the Editor has suggested that I should "clear the air" and "set the record straight".

I am not going to take what one person has said, and pull it part. What I am going to do is to express, in my own words some of the thoughts that I am referring to as being wrong.

**"The national WIA wants the assets of the Divisions, particularly the VK2 Dural site."**

This has been repeated and repeated. It is just not the fact. My own view and the view of the other directors is that Dural could be developed as an Australian W1AW, under the control of New South Wales, or even only Sydney amateurs. I have even suggested that it be placed in a trust, with whatever restrictions are desired. Of course, the problem with that approach, if taken too far, is that no one gets any benefit from the asset!

It is my belief that the national WIA must survive as a separate service organisation, with a service to attract members and with an income to meet its expenses, and just cannot be structured to depend on surviving by spending capital.

One single, strong national WIA will not emerge from disputes about assets.

The national WIA is careful to respect the right of the members of each division to decide what to do with the assets of their division for the betterment of amateur radio.

**"The new company has cast aside the Divisions, who founded the WIA as we know it."**

It was the Divisions who, through their Federal Councillors, passed a special resolution (a resolution requiring at least 75% majority) that adopted a new constitution for the WIA.

It was the 7 Divisions, each with one

vote, who voted the Federal Council out of existence, and who started the period of transition from a federal structure to a single national structure, and so that every member of every division could have an equal vote in one single body.

They did so because they believed that a single national body, with a single board, and a simple structure and with cost savings from avoiding duplicated services, could be more efficient and more effective. A single national body, speaking with one voice is in the best interests of amateur radio in Australia.

While the Divisions have continued to exist as a company structure they can never exist again as part of a federal hierarchy as they were, as that has gone forever. Accordingly, it has been for each division to decide what it should do or what would be in the best interests of amateur radio. Some have decided to continue as a state or local group, under a different name and some have decided to wind up. The different name is important, because no one is helped by any risk of confusion, where someone could think that by continuing to belong to what had been a division they were supporting the WIA. Where a division has continued, it has done so because its Council and its members have believed that it can meet a particular need, such as the provision of repeaters or a special role in WICEN, not as a substitute for the WIA.

I would have thought it obvious that it would not be consistent with the view of the majority or in the best interests of amateur radio in Australia for what had been a division to now seek to act as an alternative or substitute organisation to the WIA. No one has seriously suggested such a course.

**"Nobody is remaining a member of the WIA and it is doomed."**

After three months of operation as the national WIA, the number of new members is growing by around 25% when compared with membership

growth last year. It is still too early to determine if the number of members renewing is different from last year, though no alarming trend has been detected. The different pattern is no doubt due to the delayed mailing of July and August renewals. It is expected that the September renewals will also be mailed later than usual, because as the situation of the divisions' change, what needs to be said to members being offered renewal needs to change.

**"The national WIA is heading for inevitable bankruptcy, particularly as it is about to employ a new manager at \$70,000 per year."**

The fact is that the WIA's expenses can be closely controlled and national WIA treasurer David Pilley undertakes a detailed review at the end of each month and constantly monitors the financial situation of the WIA.

Renewals and new membership applications are reviewed weekly.

Oh, the new manager? Well, we haven't heard of that. Much as we would like it to be true, that is a figment of someone's imagination at this stage. We must grow, and then we will go down that path.

**"There have been threats of legal action by the new company."**

That is just untrue. To seek the resolution of disagreements by resort to the courts seems to me to be totally contrary to the spirit of amateur radio. Yes, I am aware of veiled threats to litigate, but they certainly have not been made on behalf of the national WIA.

**"Despite not financing divisions, fees have increased."**

Until 1 July this year, the fees for "WIA membership" comprised two components, one for "federal", to meet

*continued on page 7*

# Two tone testing

Jim Tregellas VK5JST

In these amazing days where one can go out and buy a state-of-the-art transceiver for just a little less than the cost of a good second hand car, much is written about such features as price and the number of bells and whistles.

Unfortunately, almost nothing is written about transceiver testing, which is the only way for the amateur to gain a "feel" for the really important front panel features such as audio AGC, audio compression, RF power output, and metering BEFORE a signal is put to air.

For beginners this is particularly important, because a huge gap exists between the knowledge required to pass the amateur "ticket", and practical transceiver operation. If you are actually constructing equipment then this knowledge is mandatory.

As the major mode of operation on HF is SSB, two tone testing needs to be clearly understood. With a two tone tester, a dummy load and an oscilloscope, a transmitter can be really put through its paces.

Two tone testing consists of applying two clean non-harmonically related sine waves of approximately equal amplitude to the audio input of an SSB transmitter. The sine waves are typically around 600 - 700Hz and 1800 - 2000Hz i.e. about 300Hz from either end of the audio pass band. The result, in a properly adjusted transmitter, is an RF output that varies from zero to maximum at a rate determined by the difference in frequency between the two audio inputs. Consequently, overdrive (which causes splatter), non-linearity, instability and a host of other problems are easily visible on the CRO.

This thorough testing of the transmitting system becomes even more important when the transmitter is followed by a linear amplifier, if only to avoid rock throwing, obscene language and other similar behaviour by understandably irate neighbours.

Other test modes can be used for SSB but they are not very realistic. For example, a single audio tone can be applied to the microphone input of an SSB transceiver. The oscilloscope display that results is a carrier envelope which does not vary in amplitude. Overdrive and other problems are not easily detected unless a spectrum analyser is available (and only a very fortunate few have one of these). Furthermore, the average RMS output power is equal to the peak envelope power, which is

definitely not the case for speech, where the relationship between these two is probably around a 1:5 or 1:6 ratio. At full rated output, power supplies and heat sinks in the typical transceiver generally cannot cope as they are not designed for

conditions (probably 5 - 15% larger) simply because the power supply rails rise due to the light demands and poor supply regulation.

So, in summary, intelligent two tone testing of a transmitting system and application of its results will give the amateur all he needs to operate a transceiver correctly, and put a clean signal on air to the benefit of the entire amateur fraternity.

Single tone testing is also provided by the generator described later in this article, and should generally be reserved for AM, double sideband, and FM. The dummy load and oscilloscope can be used for the first two modulation modes with the same excellent results as for SSB. FM however, requires different test gear to analyse the transmitter output. None of these three modes will be discussed in this article.



Photo 1 - The Single and Two Tone Generator.

this type of operation, and transceiver damage is a distinct possibility.

In two tone testing, the average power output is one half of the peak envelope power, and this represents the most severe conditions ever likely to be encountered in amateur operation, which is the continuous sending of a stream of Morse code dots (50% duty cycle). And this is a pretty savage test. For phone operation, heat liberated from power supplies and RF power amplifiers is very much less than that caused by two tone testing. Further, the PEP measured during typical speech will usually be significantly larger than that measured under two tone testing

## How it works

Operation of the generator is quite simple. The two oscillators are based around a low pass phase shift network which provides a 180 deg. phase shift at the frequency of oscillation. The circuit is unique, and is the reverse (dual) of the high pass network normally used in phase shift oscillators. It has the major advantage that the gain around the oscillator loop does not have to be critically adjusted to obtain a sine wave. In fact, the whole circuit operation simply relies on the amplifier having a very high gain to produce a square wave at its output, which is then low pass filtered to generate a sine wave at the amplifier input. Both oscillators are run for two tone operation, while one or the other is stopped for single tone work.

The sine voltages existing at pins 6 and 9 of the op amp are current summed at pin 2, which is a virtual earth due to the negative feedback from pin 1 of the output amplifier.

In order to get a good sine wave, the

Figure 1

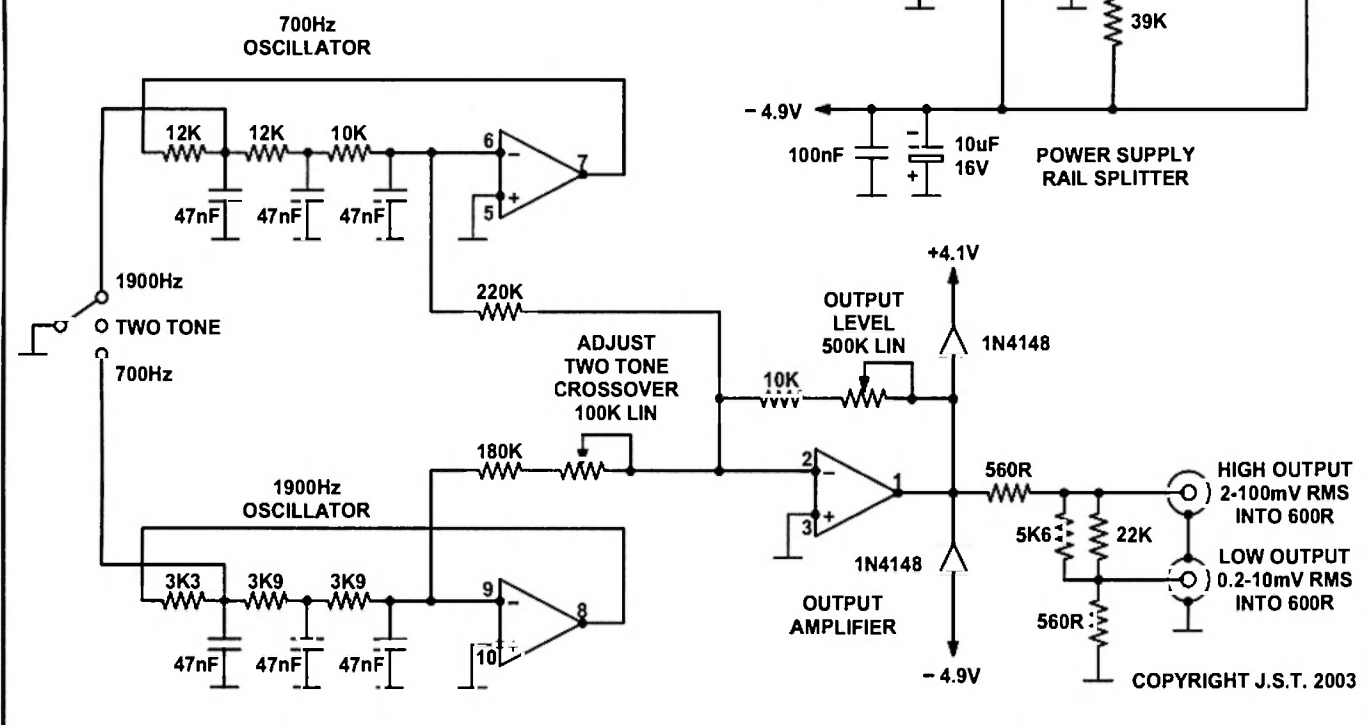

Fig 1 – Single and Two Tone Generator for transceiver testing.

positive and negative half cycles of the square waves existing at either pin 7 or 8 must be closely symmetrical (better than 2%), and to cause this to happen a slightly larger negative supply is generated by the power supply splitter circuit section. This compensates for the fact that the op amp output swings closer to the positive rail than to the negative rail, and places the op amp inputs exactly at the centre of the output swing.

Note that the current swing into pin 2 can be varied by the 100 k pot. This is an important feature sometimes omitted from two tone testers, and allows the amplitude of one audio sine wave to be adjusted relative to the other. This feature compensates for the fact that the transmitter audio response is usually not flat, and allows perfect zero crossings to be obtained in the RF output (see CRO photos).

The last stage is simply an inverting

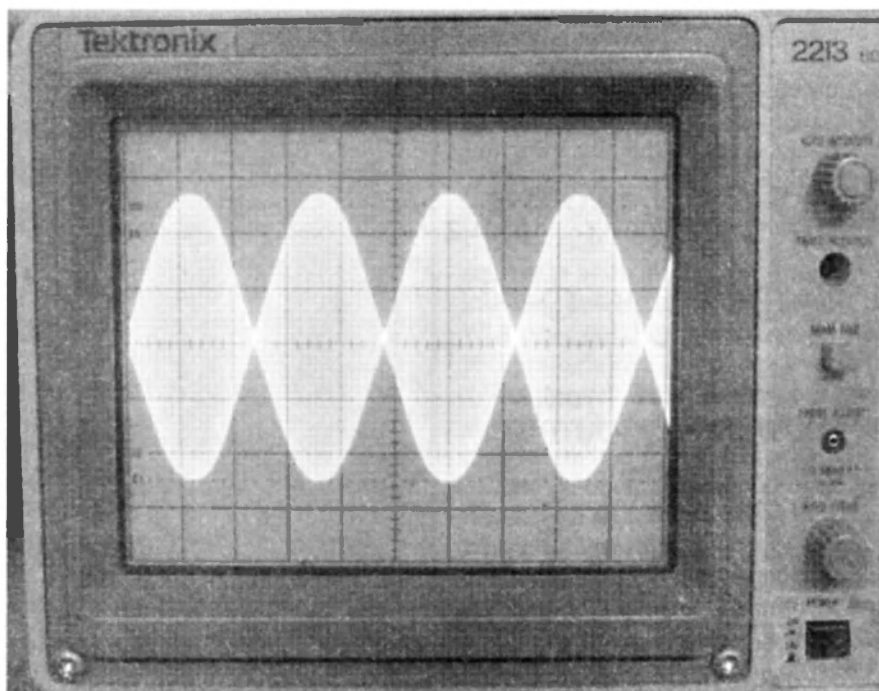

Photo 2 – A properly adjusted SSB transmitter with two tone audio levels correctly set.

Figure 2

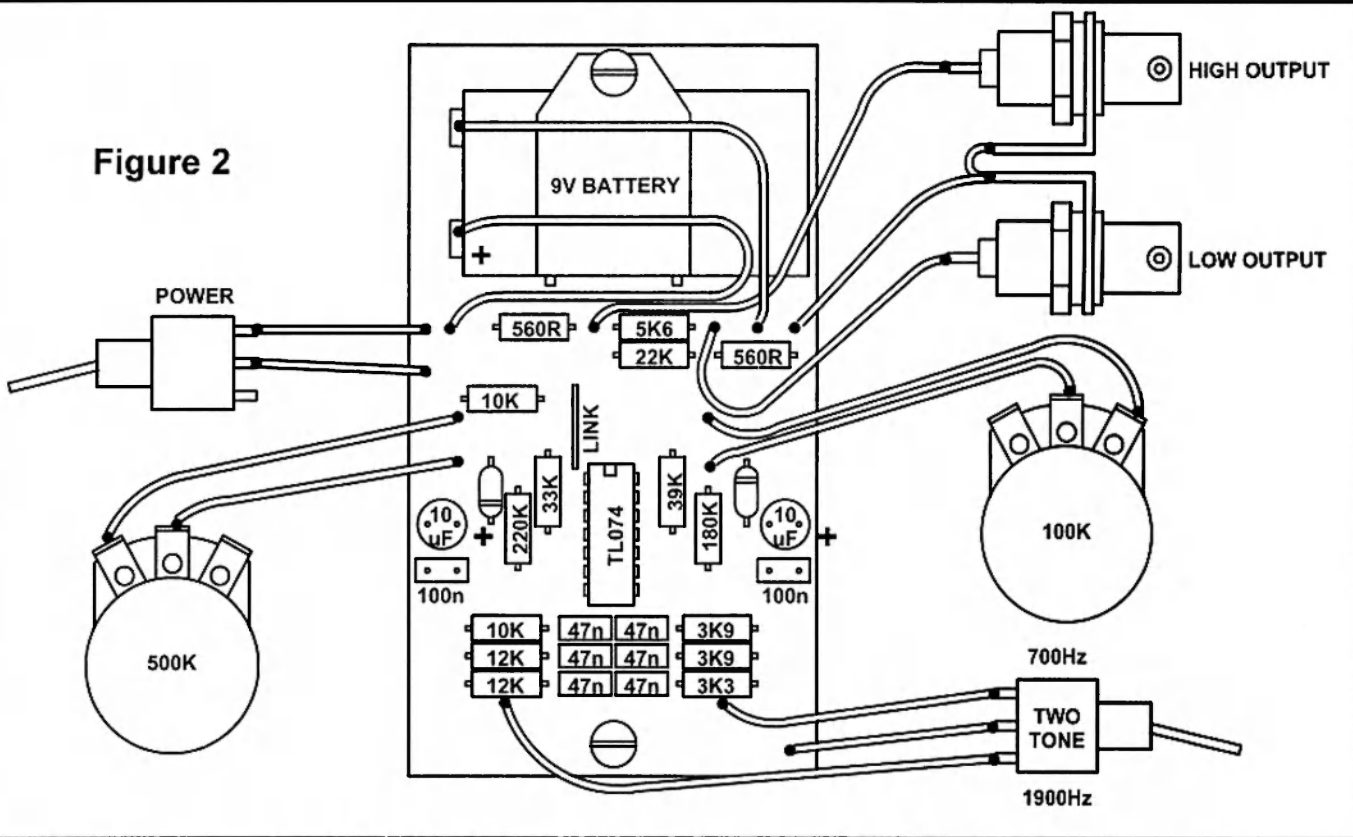

Fig 2 – Component overlay for the two tone generator.

amplifier providing a gain which can be varied over a 50:1 range. The output impedance of this stage is approximately 600 ohm allowing transmitter low impedance microphone inputs to be driven. If

the transmitter microphone input is high impedance (47K) then the generator output voltage will be approximately twice that shown on the circuit. Two diodes are included to protect the op amp output, so that it cannot be dragged

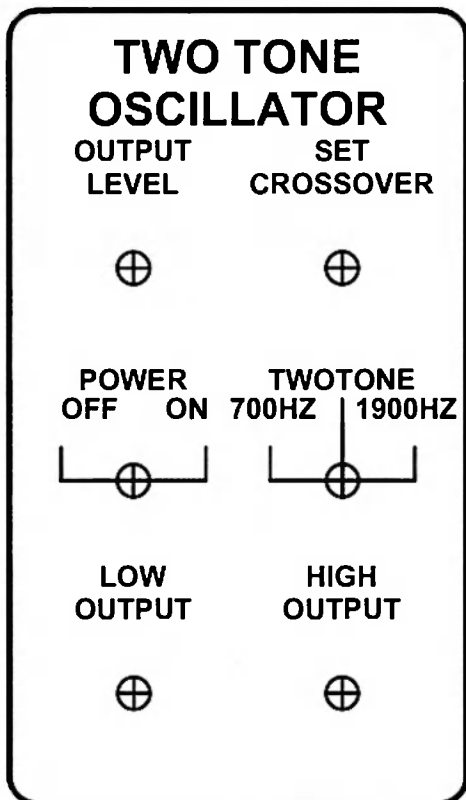

Fig 3 – Front panel label (actual size).

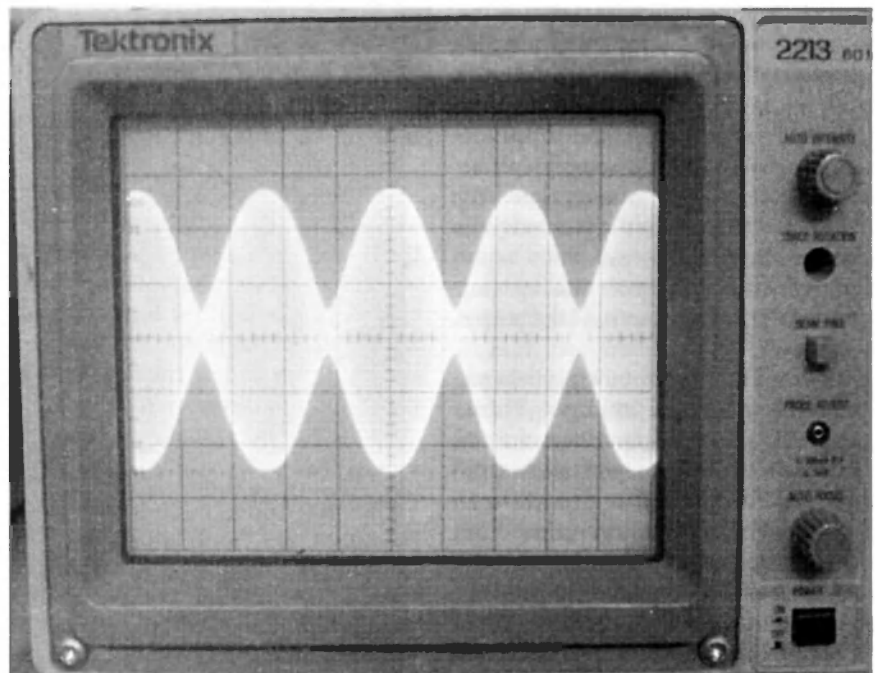

Photo 3 – The same SSB transmitter with two tone audio levels incorrectly set.

either above the positive or below the negative rails by an external voltage. Finally high and low voltage outputs are provided.

## Construction

Construction is so simple almost no description is required. Make the PCB

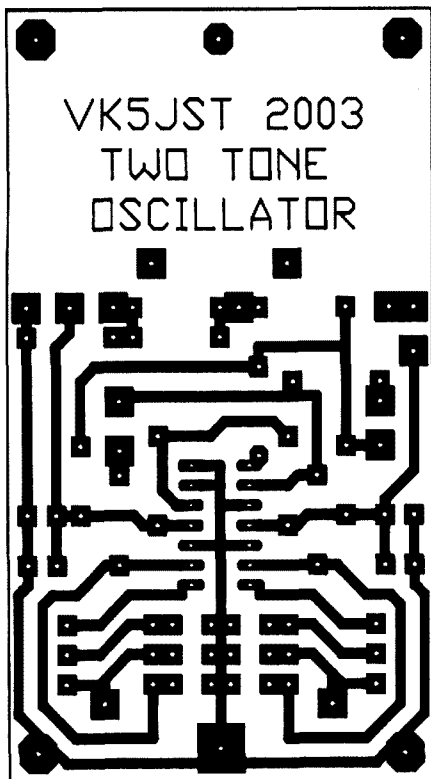

Fig 4 - The PCB artwork for the two tone generator (actual size).

(if you feel so inclined) and follow the component overlay using the components specified. Make sure all wiring is kept well away from the pin 7/8 end of the IC so that no glitches appear in the output sine waves due to stray capacity coupling of the fast square wave transitions. USE A METAL BOX to avoid RF feedback during testing, and coaxial cable between the generator output and transmitter microphone input for the same reason. The battery is retained by

a U loop of heavy copper wire which passes through the two holes provided in the PCB (do not solder these). The copper wire is then soldered to the piece of tin plate shown on the component overlay on top of the battery, through which the battery hold down screw passes. Before switching on, check battery polarity and the orientation of electros and the IC. There isn't much to go wrong.

ar

## Parts list

### Capacitors

- 2@ 10  $\mu$ F 16V aluminium electrolytics
- 2@ 0.1  $\mu$ F 100V MKT caps.
- 6@ 0.047  $\mu$ F 100V greencaps

### Resistors

All resistors are 0.25 Watt 5%

- |         |         |
|---------|---------|
| 2@ 560R | 1@ 22K  |
| 1@ 3K3  | 1@ 33K  |
| 2@ 3K9  | 1@ 39K  |
| 1@ 5K6  | 1@ 180K |
| 2@ 10K  | 1@ 220K |
| 2@ 12K  |         |

### Potentiometers

- 1@ 100K linear pot
- 1@ 500K linear pot

### Semiconductors

- 2@ 1N4148
- 1@ TL074 or TL084

### Miscellaneous

- 1@ box - DSE Catalogue No. H2305 or equivalent
  - 2@ potentiometer knobs
  - 1@ 9V battery clip
  - 2@ BNC panel mount connectors
  - 1@ SPDT switch (on-none-on) DSE. P7654 or Jaycar ST0335
  - 1@ SP3T switch (on-centre off-on) Jaycar ST0336
  - 1@ 14 pin DIL IC socket
  - 2@ 19 mm long standoff pillars tapped 3 mm both ends
- miscellaneous screws, hookup wire, cable clips, scrap tinplate

## WIA Comment *continued*

the cost of AR, the cost associated with representation, the office and the like, and then, a different amount for each division, a "divisional" component, covering divisional activities, in some cases repeaters, licences, repeater site rental, and the like. So, where a division has elected to continue, such as Victoria as Amateur Radio Victoria, or in the ACT, as the Canberra Region Amateur Radio Club, they charge a fee, to meet the cost of the services they continue to provide, such as the repeaters.

For members in most states, the new national WIA fee is less than the composite fee charged until July this year. That does present a problem, as more and more the national WIA needs to ensure that local services are not lost.

**"I don't like AR, it is a VK3 thing, and so the WIA doesn't do anything for me."**

And that is the heart of it.

In the last week or so, I have visited clubs in Newcastle, Townsville, Rockhampton and the Gold Coast, and attended the last WIA Queensland Division Council meeting.

I have talked about the importance of Australia in last year's ITU conference in relation to the agenda item relating to the 7 MHz amateur band, and the importance of two amateurs as members of the Australian delegation representing the amateur service and how it was vital that there was a WIA to nominate those delegates.

I have talked about the national WIA addressing the problem of BPL, a very difficult and potentially dangerous issue.

Yes, national WIA membership does give the member AR, yes through our web site [www.wia.org.au](http://www.wia.org.au) we continuously tell everyone what we are doing, (have a look at the site about BPL) yes, through WIANews we hope we are providing amateurs with much information of interest, but I suggest that to say the WIA does nothing is to ignore the fact of representation.

The local club may finance a repeater and I don't have to be a member of the club to use it.

The union complains that it gets benefits for all workers, including those who are not members.

The WIA may protect my bands but I don't have to be a member. But, I am a member. I guess I realise how important that representation is.

ar

# 450 Ohm Ladder Line

Copper coated 7  
core steel conductors

VERY LOW LOSS



## High Power Variable Inductor

from Ten-Tec.  
Silver Plated Coil, Max Inductance is 20  
microHenry.

An Ideal  
companion  
to the Ten-  
Tec variable  
capacitor kit.

Perfect for that  
high power  
antenna tuner  
project

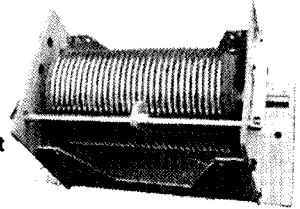

## Test Equipment

Auttek WM1 2  
KW peak reading  
wattmeter



Auttek RF1  
HF Antenna  
Analyzer



Auttek RF5 VHF/  
UHF Antenna  
Analyzer



Auttek VA1 MF/HF  
Vector Antenna  
Analyzer

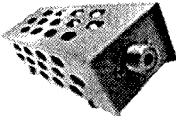

Ten Tec HF/VHF  
Dummy Load Kit



Ten Tec HF/VHF  
SWR Power  
Meter Kit

Lutron  
Bench top 2.7 GHz  
Frequency Counter

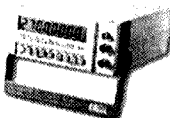

Lutron Handheld 2.5 GHz  
Frequency Counter



### WE SUPPORT WHAT WE SELL!

if you have a problem, our  
strong relationship with the  
support divisions of our US  
suppliers combined with our  
professional service lab will  
get your unit quickly up and  
working to original specs.

We  
specialise  
in mail  
order.  
Visa and  
Master  
Card



Check us out for all RF cables and  
connectors.

## TEN-TEC HF Radios

Orion  
Jupiter  
& Argonaut  
HF Transceivers

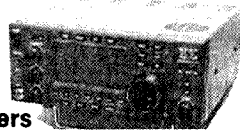
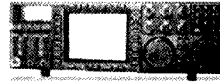

Ten Tec  
Commercial &  
Professional  
Communications  
Receivers



## SGC



SGC 2020 Portable  
20W HF Transceiver  
SG 500 HF Mobile  
500W Power

SGC2000 150W  
Professional HF  
Transceiver

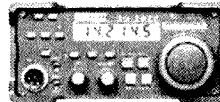

## TEN-TEC

build  
yourself  
kits

(Call for your free  
catalog)

Amidon Iron Powder and Ferrite Products (Call for  
an Amidon product guide)

SGC ADSP<sup>2</sup> Noise Reduction Speakers

SGC ADSP<sup>2</sup> Noise Reduction Boards (High power  
and low power versions available)

Power Source switch mode power supplies (a  
wide range of outputs)

Davis Weather Stations

Professional Grade Coax Feed lines and Connectors

Custom RF Patch leads and cables made to order

## Antenna Couplers/Tuners

SGC Mac 200

5 Position Antenna

Switch/Tuner

SGC SG235,

SG230,

SG237, SG239

and SG211

Automatic Antenna Couplers

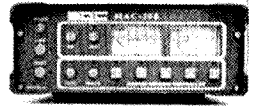

Z100



## Antenna

SGC QMS Quick Mount  
Mobile antenna system  
with built-in tuner



SGC Stealth  
Kit. All you need to get  
HF on air quickly.



SGC SG

307 7

foot Mobile/Marine  
Antenna

SGC SG 303 9 foot Mobile Antenna

## RE-SELLERS

Tower Communications, Perth

International Communications  
Supplies, Port Adelaide

Strictly Ham, Melbourne

Marcom Watson Group (Tas)

Kyle Comms (QLD)

Ozhelph Services — (QLD)

Brian Swinton Marine Elect. Cairns

DETAILED DATA SHEETS ARE AVAILABLE ON REQUEST FOR MOST PRODUCTS.



# TTS Systems Communications Equipment

FREE CATALOGUE

[www.ttssystems.com.au](http://www.ttssystems.com.au)

HF and VHF Transceivers, Autotuners and Kits

Phone 03 5977 4808. Fax 03 5977 4801 [info@ttssystems.com.au](mailto:info@ttssystems.com.au)

# Operating a 5 band HF amplifier on 10, 18 and 24 MHz

Neville Chivers VK2YO  
57 Vulcan Street,  
Kingscliff, NSW 2487

If you have an old five band, 80 through 10 m, HF amplifier such as the Yaesu FL2100B series and you would like to operate it on 12, 17 and 30 metre, as well as the original 80 to 10 m bands, without modification, then please read on. This may interest you.

Some years ago I acquired a Yaesu FL2100B amplifier, second hand. These amplifiers were compatible with the Yaesu FT101, FT200 vintage transceivers of the valve final type.

My current transceiver is all solid state with 50 ohm unbalanced output. No problem here as the FL2100B is 50 ohm unbalanced input so it was not hard to match them up once the switching arrangements had been figured out. However, only the five bands that the FL2100B was designed for were available.

A look at the circuit diagram of the FL2100B convinced me that major surgery was required to accommodate the extra three bands at 10, 18 and 24 MHz that became available after this type of amplifier was built.

Is there another way? Yes, there is! But it requires a tuner between the exciter and the amplifier. How does that help? Let me explain.

With the amplifier switched to 20 m and the output connected to a resonant 30 m antenna, I tried feeding the amplifier with a tuning signal direct from the transceiver. The result was very little output on 30 m from the amplifier and very little output from the transceiver to drive the FL200B. In fact, there was less than 20 W indicated. As the amplifier requires 100 W drive, this was not nearly enough.

The transceiver's final transistors are protected by internal circuitry against damage by mismatch at the output and will not produce full power of 100 W unless the SWR is below 1.5 to 1.

I next placed an SWR bridge between the transceiver and the amplifier still connected to the 30m antenna. I tuned again and observed that the SWR

was off the scale! Obviously a severe mismatch and nowhere near the 50 ohm impedance that the TS680S transceiver likes to work into.

I have a Kenwood AT-130 antenna tuner and, when it was placed between the transceiver and the amplifier, interconnected with 50 ohm coax, the tune up procedure was reactivated. A few trial settings of the Receive Tune and Transmit Tune knobs produced an SWR of 1 to 1 and full 100 W drive indicated into the amplifier. Then, with adjustment of the amplifier plate and loading controls, hey presto!, full output from the FL2100B into the resonant 30 m antenna was indicated.

The same procedure was then tried on the 17 and 12 m bands with the amplifier switched to 15 m for 17 m operation, and to 10 m for 12 m operation, with equally pleasing results.

I only tried this with the units I have available, but I can see no reason why it would not work with some other combinations. I suspect it would be easier with a transceiver that incorporates an automatic antenna tuner.

Just for reference, for anybody with an AT-130 ATU available, these are the settings that worked for me:

TS680S transceiver	AT-130 tuner	FL2100B amplifier
30 m band	10 - Rx-tune 0 Tx-tune 5	20 m band-switch
17 m band	18 - Rx-tune 0 Tx-tune 9	15 m band-switch
12 m band	24.5 - Rx-tune 9 Tx-tune 10	10 m band-switch

Ensure that the amplifier is connected to a resonant antenna for each of the 10, 18 and 24 m bands, then adjust the plate and loading controls for maximum output, not exceeding the published IC for the tube finals.

Give it a try. It works for me. And when you wish to use the amplifier on any of its original bands there is no need to remove the tuner - just turn its band switch to the through position.

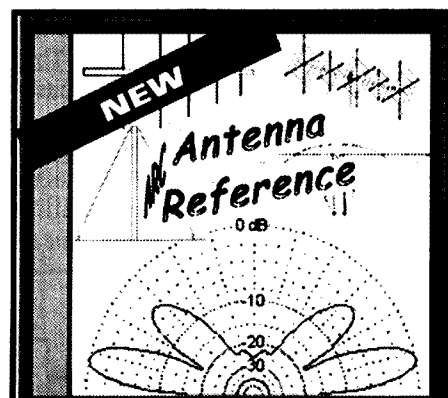

## Antenna Reference CD

Antenna basics, Radiation patterns,  
Transmission lines, Impedance matching,  
Built-in calculators and more!

Only A\$35.00 (approx US\$25.00)

ENQUIRIES WELCOME

Discounts for upgrades & club members

Michael Todd Computers & Communications

15 Conifer Street, Maddington  
Western Australia 6109  
Ph: 0407-089-308

E-mail: sales@arcompanion.com  
http://www.arcompanion.com

# Understanding phase-locked loops

Elmo Jansz VK7CJ

## Early beginnings

Phase-locked loops (PLL) came into existence in the early 1930s to overcome some of the problems associated with superheterodyne receivers, particularly the large number of tuned circuits present in conventional receivers. A new concept of receiver was conceived, called a Homodyne and later, a Synchrodyne.

The input signal and a local oscillator were mixed (actually multiplied together) and after filtering, an exact replica of the original audio could be recovered - assuming that the phase and frequency of the two signals were identical. Unfortunately the oscillator tended to drift with time and reception became impaired. The problem was overcome by comparing the local oscillator frequency with that of the incoming frequency in a phase detector to produce a 'correction' voltage sometimes called an 'error voltage' which could be applied to the oscillator to pull it back on track. This was the early beginning of the phase-locked loop.

Phase-locked loops are now used in FM and AM demodulators, in Frequency Synthesizers, in Low Noise Satellite Receivers, in Industrial Motor Speed

Controllers, in Frequency Shift Keying Decoders and in TV Receivers to lock the horizontal and vertical oscillators to the Sync. Pulses, to name but a few applications.

## General principles

A phase-locked loop (from now on we shall call it the PLL) consists of the following blocks as shown in Fig 1 below.

1. A phase detector
2. A low-pass filter
3. A voltage controlled oscillator

Observe that the PLL has a forward and a feed-back path. The VCO is a free running oscillator, the frequency of which can be set by an external RC or LC combination. The output frequency of the VCO is fed back to the input of the phase detector where it is compared with that of the input signal. The output of the phase detector, that is, the 'error voltage', is the average DC voltage that is proportional to the phase and frequency difference between the VCO and input signals. This voltage is filtered by the low pass filter to remove any high frequency components present such as noise and is

applied to the VCO to complete the loop. The 'error voltage' forces the frequency of the VCO to change in a direction that reduces the frequency difference between that of the VCO and the input signal. When the VCO starts to change frequency it is said to be in the Capture State. This process continues until the input and VCO frequencies are identical, when the loop is said to be phase-locked. During phase-lock the VCO frequency is identical to that of the input except for a finite phase difference. This phase difference is necessary to generate a small voltage to keep the loop operating. After this state is reached the loop follows changes in the input frequency. That is, if the input frequency changes the loop follows these changes. We now have a system that can follow changes in a given frequency precisely.

A PLL has three distinct states as defined below.

1. Free running
2. Capture
3. Phase-lock

When no input signal is applied to the PLL, or when the input and VCO are far apart, the VCO maintains a constant frequency which is called the free running frequency. This frequency is set by the external RC or LC components mentioned above.

When the input and VCO frequencies are close enough the loop can acquire phase-lock. The PLL is now in its capture state or capture range. That is, the capture range is the range of frequencies over which the loop will acquire phase-lock. The range of frequencies over which the loop will follow changes in the Input after lock is called the lock range. The capture range is always smaller than the lock range. We need to distinguish between the two clearly.

**Capture Range** - The range of frequencies over which the loop will acquire lock.

**Lock Range** - The range of frequencies over which the loop will remain locked once captured.

Let us now examine the blocks making up the PLL.

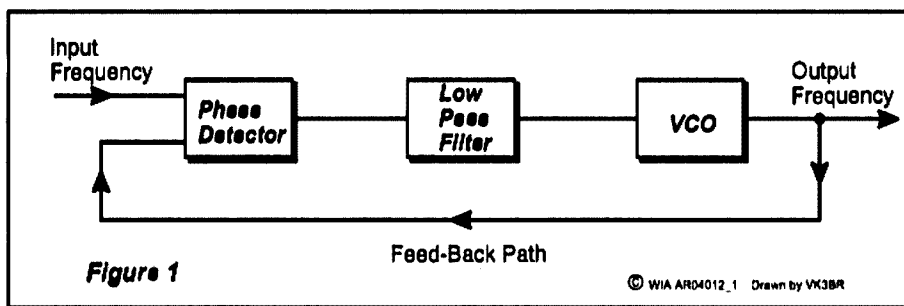

Figure 1 - Basic components of a phase-locked loop

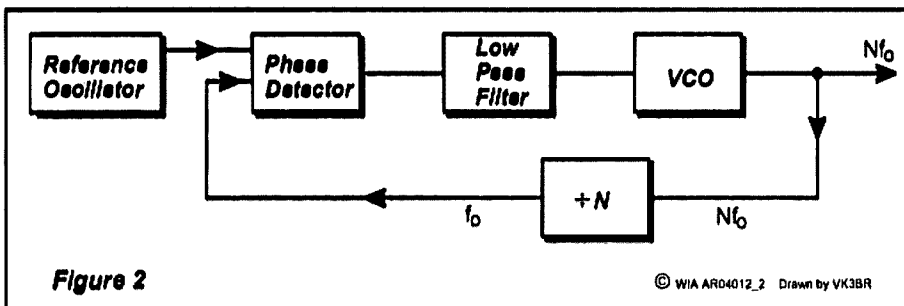

Figure 2 - Basic frequency synthesizer



## 1. Phase detector.

The phase detector is sometimes called the phase comparator. It gives an average DC voltage proportional to the phase difference between the input signal and the VCO output. Phase difference is measured in degrees but in PLLs it is more commonly measured in radians. Pi radians is equal to 180 degrees, which makes one radian equal to about 57.3 degrees. There are analog and digital PLLs. Analog PLLs use a Balanced Mixer as the phase detector while digital PLLs use an Exclusive OR or an Edge Triggered circuit. Most modem PLLs use digital phase detectors.

## 2. Voltage controlled oscillator

The voltage controlled oscillator or VCO is a circuit which gives an output frequency proportional to the voltage applied to the input. There are a large number of VCOs in Integrated Circuit packages, eg the MC4024 which is a 14 pin device made by Motorola Semiconductors. It consists of two square wave generators with output buffers. The output frequency can be controlled by an external capacitor. It has a maximum frequency of about 25 MHz. Another device is the MC 1648. This requires an external LC combination and can operate up to frequencies of about 225 MHz.

## 3. Low pass filter

The low pass filter has two functions; first to remove high frequency noise components as already mentioned above and secondly as a control for the dynamic performance of the loop. In other words the speed with which the loop responds to external changes. The filter could be active or passive. That is consisting of passive components such as resistors, capacitors, etc or built around an operational amplifier.

## Practical applications

At this point we shall consider a few common applications of PLLs

### 1. Frequency Synthesizer

Refer to Fig 2. The frequency synthesizer is essentially a PLL with the output going to a load and also to a binary counter, which divides the output frequency by an integer N. The number N is programmed into the counter. Observe that the other input to the phase detector

is from a stable reference oscillator ( $f_0$ ). The loop is locked when the two inputs are identical. At this point the DC error voltage from the phase detector will be the exact value required to tune the VCO to a frequency  $Nf_0$  which, when passed through the counter, will be reduced to  $f_0$  which will be identical to the reference frequency. The output frequency can now be adjusted by changing the value of N.

### 2. FM demodulator

Refer to Fig 3. The input FM signal is compared with the VCO signal in a phase detector. The phase detector 'error voltage' is proportional to the frequency and phase difference of the two signals. The signal is passed through a low pass filter to remove any high frequency noise, then amplified and applied to the VCO. The loop is designed so that this voltage moves the VCO frequency closer to that of the incoming signal. If the incoming frequency is close enough to that of the VCO, ie it is in the capture range of the VCO, the VCO will change frequency and become equal to that of the incoming frequency. The loop is now in lock and the incoming signal and the VCO are identical in frequency but maintain a small phase difference. This

is required to generate a small voltage to keep the VCO at its new frequency. When the input signal frequency changes due to the modulation on the original carrier, the VCO follows it and the two frequencies are equal. The control voltage required to follow the changes in the instantaneous frequency of the FM signal will now be proportional to that of the original information signal, that is, the modulating signal. We have assumed that the VCO operation is linear, which to all intents and purposes it is.

### 3. AM demodulator

Refer to Fig 4. The basic idea is similar to that for the FM demodulator. The input AM signal is applied to the PLL and the multiplier. The PLL produces a frequency identical to the unmodulated carrier. This is multiplied with the frequency of the VCO which is the same as the original AM when the loop is locked. The output of the multiplier contains the information signal as well as a number of sum and difference frequencies of the carrier and the information signal. The low pass filter isolates the information signal. The entire system is available in an integrated circuit package.

ar

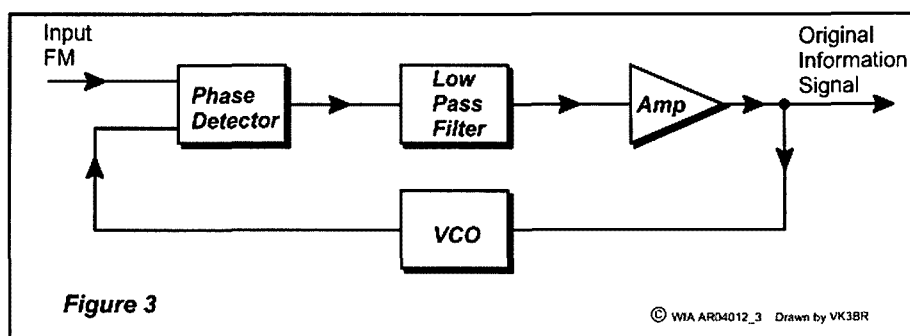

Figure 3

© WIA AR04012\_3 Drawn by VK3BR

Figure 3 – Phase-lock FM demodulator

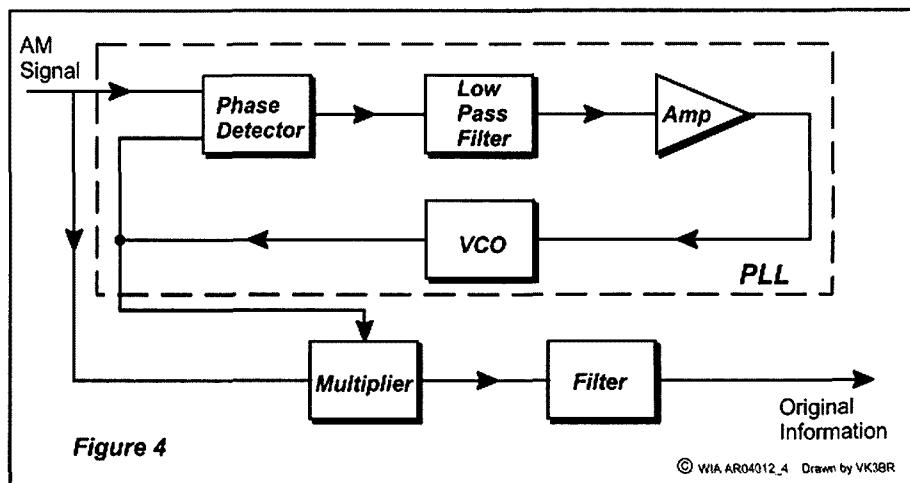

Figure 4

© WIA AR04012\_4 Drawn by VK3BR

Figure 4 – Phase-lock AM demodulator

# VK3AIR-417SQN

## Australian Air Force Cadets

Theo Kalkandis VK3AP  
417SQN AAFC

**After a very successful Radio Communications field exercise over the Queen's Birthday long weekend, members of 417SQN Australian Air Force Cadets have now formed their own squadron radio club with the callsign VK3AIR.**

Sixteen cadets took part in the Radio Telephony exercise comprising basic antenna theory, propagation, and radio operational procedures.

The equipment comprised sophisticated military HF backpack systems, amateur HF gear, various tuners and wire antennas of all descriptions and a number of UHF CB handhelds for onsite operational duties and procedural training.

The first exercise of the weekend was to erect an antenna system capable of covering our deployment area. A Bushcomm all band dipole was chosen for its simplicity and ease of tuning over the range of frequencies assigned over the weekend.

A suitable pair of trees was located in close proximity to the command post. The cadets formed their own little competition to see who could throw the pulley to the highest branch. After many attempts, the weight finally scored a nice branch at approximately 20 metre high. One leg of the stainless steel dipole was drawn up and tied off. The other side was much easier as many had now been gifted with the art of throwing that difficult piece of lead.

After further radio instruction the cadets were tasked with navigating to a predetermined area, setting up radio equipment including antenna, making contact with the command post, dismantling, changing location, and repeating the procedure to keep their operational skills at a high standard.

The next task guided 2 teams (sections) some distance from the command post. A Scenario was given, resulting in both teams having to find an imaginary downed pilot some distance away, over some very difficult terrain. The cadets navigated by map and compass having to give location reports via HF radio every 30 minutes. The command post operator,

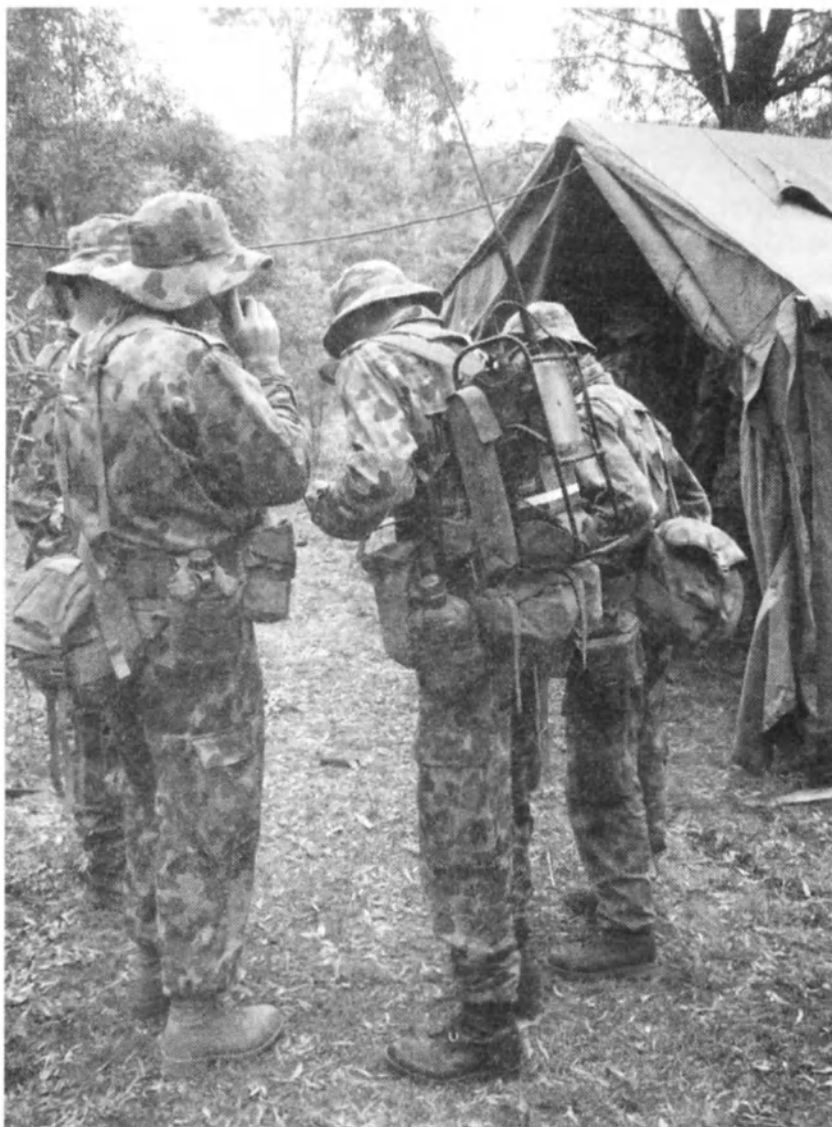

Radio here is a Racal BCC39B HF Manpack. It has a 2.3 metre copper whip antenna mounted into an integrated automatic ATU

also a first time radio operator, had the difficult job of recording all the details and relaying any relevant information to their respective officers.

Most of the cadets had such a great time operating radio equipment they now feel at ease with a microphone in their hand. This is the major obstacle in

most youth operations including JOTA, so great emphasis is put on building and instilling confidence in our younger generations to continue with such a fantastic hobby and maybe even make a career of it. Our squadron now has 6 cadets wanting to join a signals unit as first preference, where prior to the

weekend they wouldn't even think of holding a microphone. The majority are also enquiring and very eagerly awaiting inception of the foundation licence in 2005.

Next year will see us starting another Ratel course with the possibility of encompassing other squadrons. I believe the Australian Air Force Cadets provide a fantastic environment for encouraging future amateur radio operators.

If you hear our club call VK3AIR please break in for a chat, we may even contemplate a club QSL card.

ar

*Below:* Two cadets satisfied with the communications link back to base. Note the coil of wire on the operator's belt. This was a reserve long wire with attachments for the Racal TRA906 HF Manpack in use. The 906 has a manual ATU.



Cadets under instruction in the Command Post.



## radio and electronics school

# *Become a Radio Amateur*

or study radio electronics to  
support your hobby

Australia's premier training institution for **AMATEUR  
RADIO AND HOBBYISTS**  
courses available in radio & electronics technology for  
all ages

### **COURSES AVAILABLE ONLINE**

Be guided through your course by one or more of our  
20 experienced volunteer facilitators, email hundreds  
of other students

### **IN A HURRY?**

Become a novice radio operator in 4 weeks with our  
computer-based

### **NOVICE FAST-TRACK COURSE**

Courses for schools, youth organisations and seniors  
**Australian Radio Certificate Scheme (ARCS)**  
Use our accredited bridging program for radio  
amateurs to obtain a

### **CERTIFICATE IN ELECTROTECHNOLOGY**

Download all course materials free  
(CD Rom has a small fee)

For Further Information visit

<http://radioelectronicschool.com>

or email

[manager@radioelectronicschool.com](mailto:manager@radioelectronicschool.com)

Tel: (07) 5573 2795 12-5 (EST)

# Technical Abstracts

Peter Gibson VK3AZL

## Own your own Enigma machine – almost

There can't be too many people who haven't read about or seen documentaries about the Enigma cipher machines used by the German military during World War 2 and the success of the allied cracking of the codes generated by the machine.

In RadCom for June, 2004, John Alexander, G7GCK gives a brief history of the machine and describes his experiences in purchasing and building a modern electronic version of the Enigma machine.

The German Enigma machine is perhaps the best known of many mechanical cipher systems developed during the 20th century. It was originally developed in 1923 and was intended as a cipher machine for commercial use by banks, insurance companies, or any other organisation that needed security in business communications. Many countries purchased commercial versions of the machines, including the UK and the USA. From 1935, the British used a very similar type of machine, called the Typex. It was so similar, that supposedly one German operator converted an incomplete captured Typex as a spare for his Enigma machine.

Original Enigma machines, in good

condition, are expensive to buy, so an electronic version is a reasonable alternative, – illustrating the original working system, and is more interesting (tactile) than a computer simulation.

John purchased a kit from Bletchley Park and constructed it in a relatively short time. It worked first time when switched on.

The Electronic Enigma emulates the German M4 (four rotor) Naval Enigma as well as the three-rotor version used by the Luftwaffe and Army. All settings can be made as for the real Enigma machine. Rotors, rotor order and other settings can be selected by pressing 'up' and 'down' buttons on the board. You can even store several settings in memory to allow ultra fast switching between settings. There is also a fully functional plug board. This option was unique to the military machines.

There are some important additions

to the electronic version that never appeared in the mechanical version, for obvious reasons. The kit can be connected to a PC via a standard serial port or can be configured to send Morse automatically. You can also encipher plain text, send it to a text editor and insert it into e-mails. An interesting variation on adding a degree of security to your e-mails.

Anyone who has seen a real Enigma would know that they came in a wooden box. Similarly, a nice wooden box would set this unit off, and John discusses some options.

The Enigma-E kit is available from the Bletchley Park shop or their website and costs 119.99 pounds.

The relevant web sites are:-  
[www.bletchleypark.org.uk](http://www.bletchleypark.org.uk)

[www.xat.nl/enigma-e](http://www.xat.nl/enigma-e)  
<http://frode.home.cern.ch/frode/crypto/CSG>

## Simple sound-card-to-radio interface circuits

Have you ever wanted to try those digital modes that require connecting your computer sound card to your transceiver, but you have been put off by the cost of commercial interfaces.

In RadCom for April, 2004, Peter Homer, G4KQU describes three solutions – a fully isolated interface, a simpler interface without isolation and an even simpler one for hand-held radios. You can use them for RTTY, PSK31, SSTV, CW etc.

For digital transmission modes, you need to be able to connect your computer to your transceiver in an effective and consistent way, allowing signal levels to be correctly set and maintained.

### General requirements

Three interface circuits of varying complexity are described below. They will also work well if you intend to run an Internet gateway using eQSO or EchoLink software.

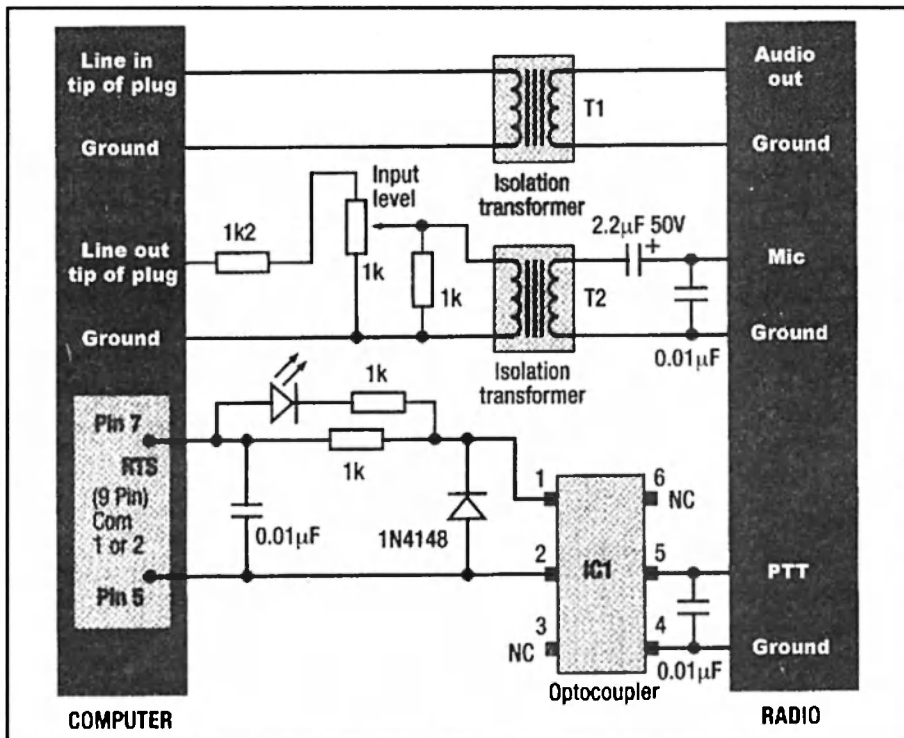

Figure 1 – The fully isolated Interface circuit

Some PTT techniques make use of the transceivers VOX circuits – but don't forget to disconnect it, otherwise you may get some surprises with the odd computer beep, or worse. The circuits described avoid using VOX switching, but as many new PCs have no RS-232 port, we may have to find new ways to switch our radios in the future.

Digital modes can have quite high duty cycles, much higher than speech. Try to keep your output power to 10-20 % of the maximum rated power. Also disable all of the compressors, DSP noise reduction etc.

## The fully isolated interface

Figure 1 incorporates two 600 ohm transformers (T1, T2) and an RS-232 driven optocoupler, IC1 (4N25 or similar). Preferably use a socket for IC1, just in case.

As the reason for the transformers and coupler is to isolate the radio and computer, ensure the screening from each end is also kept separate. Stereo 3.5 mm plugs are commonly used. Use only tip and sleeve (no ring) in this case as we are not using stereo.

To control the radio PTT, an isolated RS-232 RTS line is used. If you use a DE9 connector, RTS is on pin 7 and earth is on pin 5. If you use a DB25 connector, RTS is on pin 4 and earth is on pin 7. Remember to configure your computer to use the RTS line for PTT.

To control the audio going to the microphone input on the transmitter, a 1 kohm potentiometer varies the input to T2, converting the line signals (0.5 V) to microphone (10 mV) levels. The 1.2 kohm resistor can be varied to put the pot in a 'comfortable' position in its travel.

Once set, the operation levels can be trimmed by adjusting the computer level controls. The high sensitivity LED is used as an indicator when the interface is in the transmit mode. The finished interface should be put in a shielded enclosure with the ground taken from the radio side.

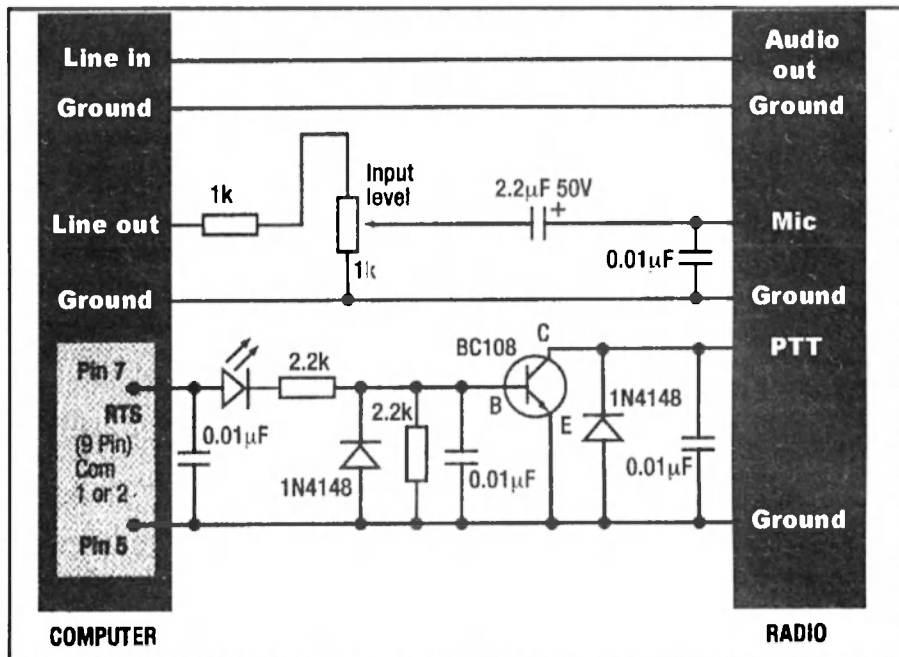

Figure 2 – Interface with same electrical performance as Fig1, but without isolation elements

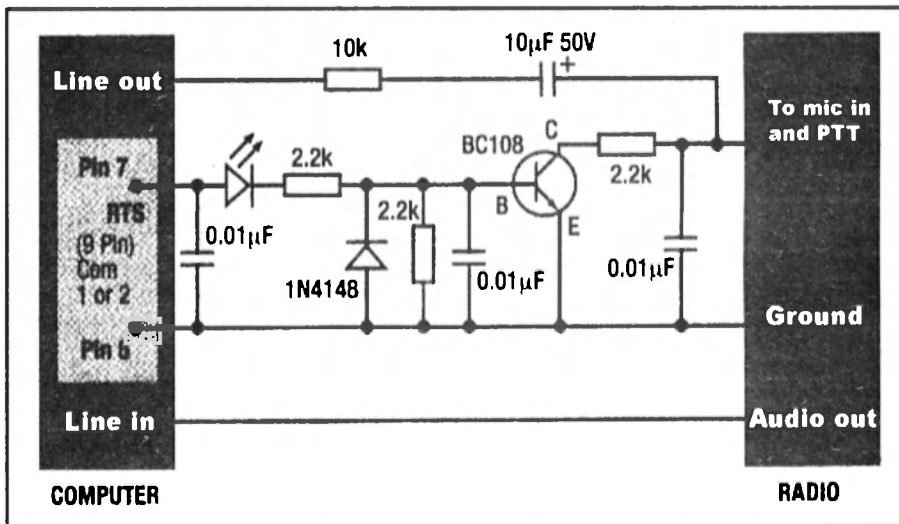

Figure 3 – Interface for handheld radios where PTT and microphone lines are combined

## The simple interface

The circuit shown in Figure 2 is similar to Figure 1 except it does not use the transformers or optocoupler, but performs well. In this circuit, the RTS signal drives an open collector transistor for PTT. The transistor type is not critical.

## The simple interface for handheld radios

The microphone and PTT lines in a handheld are normally combined, hence the circuit in Figure 3 was designed.

Audio levels can only be adjusted by the computers level control. Stereo 3.5mm plugs connect the 'line in' and 'line out' sockets on the computer sound card. As before, use the tip and sleeve only, the ring is not used.

# RippleTech Electronics

## Brand New Dxciting Products

Rippletech Electronics is providing a new service to hams in VK/ZL and the Pacific. Our quarter wave slopers will outperform a quarterwave ground mounted vertical by several dB. You can have access to a DX antenna on 80m and 160m with as little as 15m of ground space (provided you have an existing 15m tower-nally or equivalent).

Our best selling combined 40/80m sloper requires even less space. Alternatively, the TZ-V3 and TZV3w will give you access to 10/15/20m or 12/17/30m with a small budget or small backyard. Mount on your metal garage roof for a surprising signal. New novice operators, what about a rotary dipole for 10/15m only - \$129.00 plus p&p

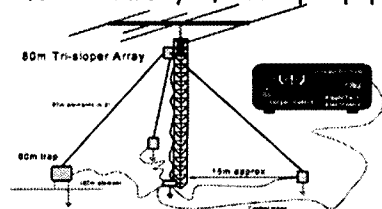

1:1 & 4:1 HF 1kW Baluns	\$59.00
Single 80m sloper	\$109.00
Single 40 & 80m sloper	\$179.00
WARC Rotary dipole	\$289.00
10/15/20 Rotary Dipole	\$279.00
12/17/30 Vertical	\$199.00
10/15/20m Vertical	\$189.00
Radials kits	\$44.00
FT-1000mp remote	\$33.00
30 or 40m Rotary Dipole	\$399.00
80m Slopser Array (3 ele)	\$499.00

## RippleTech Electronics

3 Moyston Close  
Vermont South  
VIC 3133



Phone or Fax  
03 9887 2917

WANT MORE INFO ?  
PICTURES-DESCRIPTIONS  
A FULL PRICE LIST  
OR AN ORDER FORM - see  
[www.rippletech.com.au](http://www.rippletech.com.au)  
[soles@rippletech.com.au](mailto:soles@rippletech.com.au)  
[info@rippletech.com.au](mailto:info@rippletech.com.au)  
ABN 70 465 254 759

# An EH antenna for 10 metre

This is a companion to the 20 and 40 metre L+L EH Antennas published in the April 2003 issue of Amateur Radio

Lloyd Butler VK5BR

Here is a 10 metre version of the EH antennas published the April 2003 issue of Amateur Radio and which was assembled at around the same time. However it was put aside because of the problem encountered with interaction between the antenna tuning and the coaxial feeder. At that time I had not learned how to prevent this with a coax trap. The antenna has now been fitted with a tuned trap at its base and this has stabilised the tuning to the extent that any interaction is now negligible.

## Circuit diagram

The antenna has the same basic circuit arrangement as the 20 and 40 metre versions previously published and which use the L+L balanced type of matching network. However also added is the tuned trap to eliminate interaction between antenna tuning and the coax feeder. For detail of operation of the matching network and why the trap is fitted, refer to my previous articles listed under the "Reference" heading. Circuit detail for the 10 metre antenna is shown in figure 1.

## Assembly detail

The assembly is shown in figure 2. As before the host material to support the dipole cylinders and the matching network is PVC plumbing tube. Again the dipole cylinders fit on the inside of the tubing and are made of aluminium tubing which I recovered from the broken tiller of one of the boats we used to sail. More of the tubing is used for the capacitor stators fitted inside the PVC tube.

The slider sections of the capacitors were also made from thin aluminium tubing with a portion of the side cut out. I recovered this from an old IF can previously used in a valve superhet receiver.

Fortunately I had left plenty of PVC tube spare at the bottom of the antenna, below the input connector and in this space I wound 8 turns of RG58 coax around the PVC tube to form the coaxial inductor for the trap. This measured about 1.7  $\mu$ H and was resonated around 29 MHz with a 10 pF capacitor. I find



Photo 1 - The 10 m EH antenna.

the easiest way to check its resonant frequency is to poke the dip meter coil up the centre of the PVC pipe. (This must be done with input and output leads disconnected so that the trap is not too loaded for the dip to appear).

I measured the through signal loss of the trap into 50 ohm resistance. Loss was so low that I deemed it negligible.

Without the trap, the antenna was a crazy thing to adjust. With the trap fitted, tuning was as stable as a rock.

Previous tests that I had carried out on a 20 metre L+L antenna indicated that the signal tended to be skewed upwards if the trap was fitted close to the input connector rather than a short distance down the coax cable. I wondered how this 10 metre antenna would perform with the trap so close. I carried out some very rough tests in the backyard and indications were that the signal was spread at right angles and upwards at around the same field strength. So there seemed to be some evidence of this skewing and that the antenna might perform about the same for high angle and low angle transmission.

# TET-EMTRON

## TE-23M 2 ELEMENT MINI-BEAM

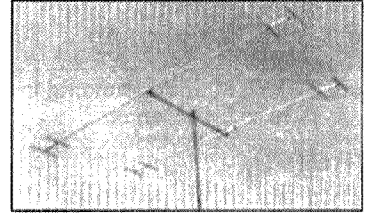

### SPACE A PROBLEM?

Don't give up! This mini antenna can be installed almost anywhere, especially where space is at an absolute premium and you still get superb performance on the 10, 15 and 20 metre bands.

It has a 30% space saving when compared to a standard 2 element beam, light weight and rotatable even with a TV rotator.

All stainless steel hardware, 6063T83 aluminium tubing and all standard features which go with every TET-EMTRON ANTENNA.

### Dealers VIC

**LT Harris** 78 Elgin Street Carlton Vic 3053  
Ph 03 93478264 Fax 03 93473629  
Email: ltharris@netscape.net.au

**G&C Comma** 207 High Street Cranbourne Vic 3977  
Ph 03 5996 3298 Fax 03 5995 0184  
Email: gccomm@netscape.net.au

### NSW

**Emtron** 1/94 Wentworth Avenue Darlinghurst 2010  
Ph 02 9211 0988 Fax 02 9281 1508  
Email: Emtron@ozemail.com.au

**Andrew Comma** Shop 8, 41-51 Bathurst St  
Greystanes, NSW, 2145 Ph 02 9836 9060  
Fax 02 9888 4301  
www.andrewscom.com.au

### WA

**Tower Communications** 14 Mary Street Hazelmere 6055  
Ph (08) 92741118 Fax (08) 92503734  
Email: tower@eon.net.au

### QLD

**Kyle Communications**  
668 Lutwyche Rd Lutwyche 4030  
Ph (07) 38574400 Fax (07) 38577825  
Email: mark@kyle.com.au

### SA

**International Communications** -  
8 Nile Street Port Adelaide 5015  
Ph (08) 84473888 Fax (08) 83411453  
Email: Intercom@picknowl.com.au

### New Zealand

**The Com Centre**  
400 Hillsborough Road Avondale Auckland  
Ph (84) 9 8270084 Fax (84) 9 8271813  
Email: comcent@radiolnfo.co.nz

### RAWMAR ENTERPRISES

40 Blackburn Street

STRATFORD Victoria 3862 Australia

Ph: 61 3 5145 6179

Fax: 61 3 5145 6821

Email: rawmar@hotmail.net.au

www.tet-emtron.com

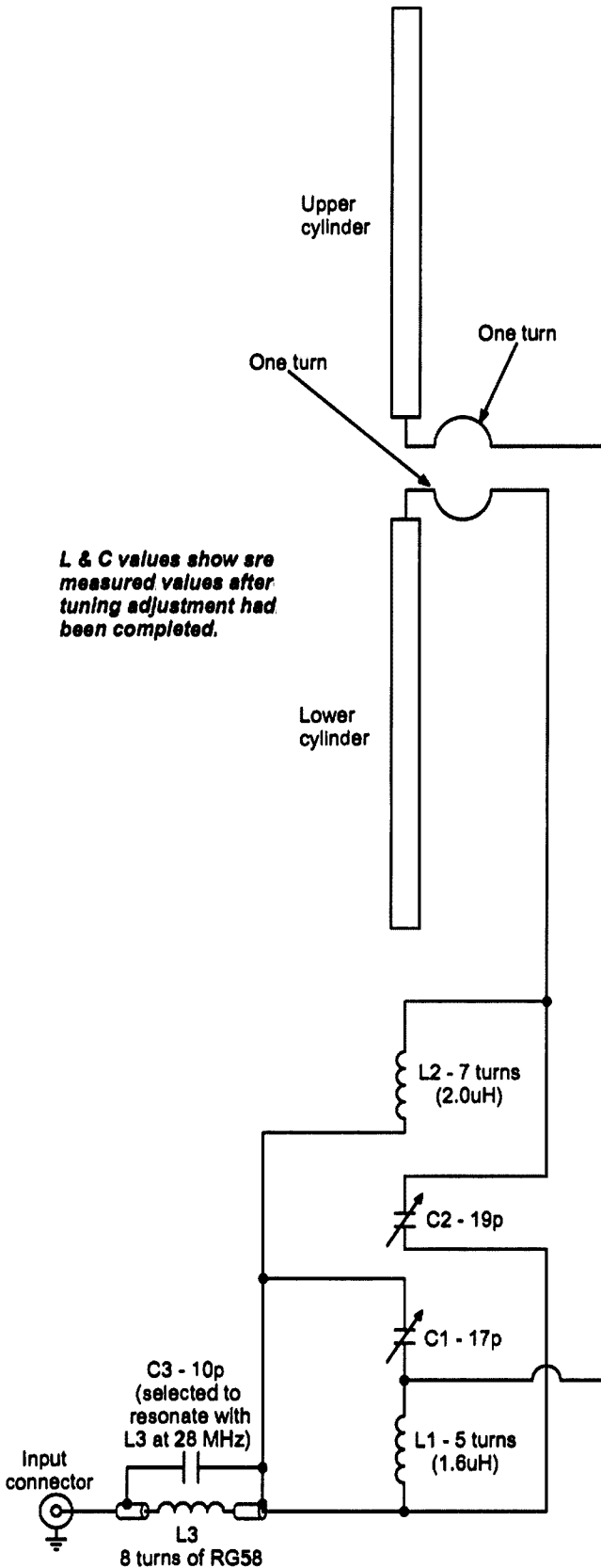

Figure 1

© WIA AR04002\_1 Drawn by VK3BR

Fig 1 - Circuit diagram of the EH antenna for 10 metre



Photo 2 – XYL Margaret holding the 10 m EH antenna.

## Summary

Described is a 10 metre version of the EH antenna using the L+L type matching network. Included in the assembly is a tuned trap which is effective in inhibiting out of balance current on the coax feeder and eliminating interaction between the feeder and the antenna tuning.

Extensive field measurements have not been carried out but limited tests, with the trap fitted as shown, indicate that field strength could be similar for both low and high angle radiation.

Other relevant articles in Amateur Radio magazine

- (1) EH Antennas for 20 and 40 metre  
Lloyd Butler VK5BR, Amateur Radio, April 2003.
- (2) The EH Antenna - More Information on how it works and how it has performed.  
Lloyd Butler VK5BR, Amateur Radio, November 2003
- (3) The EH Antenna - Radiation from Coax - Measurements on Proportion of Power Lost.  
Lloyd Butler VK5BR, Amateur Radio, Date: t.b.a
- (4) The EH Dipole with the L+T and Star type matching networks.  
Lloyd Butler VK5BR, Amateur Radio, Date: t.b.a.

## On the Internet

- (1) Refer to articles on the EH Antenna by VK5BR at:- <http://www4.tpgi.com.au/users/ldbutler/>  
Or link from:- <http://www.qsl.net/vk5br/>
- (2) EH Antenna web site:- <http://www.eh-antenna.com>

ar

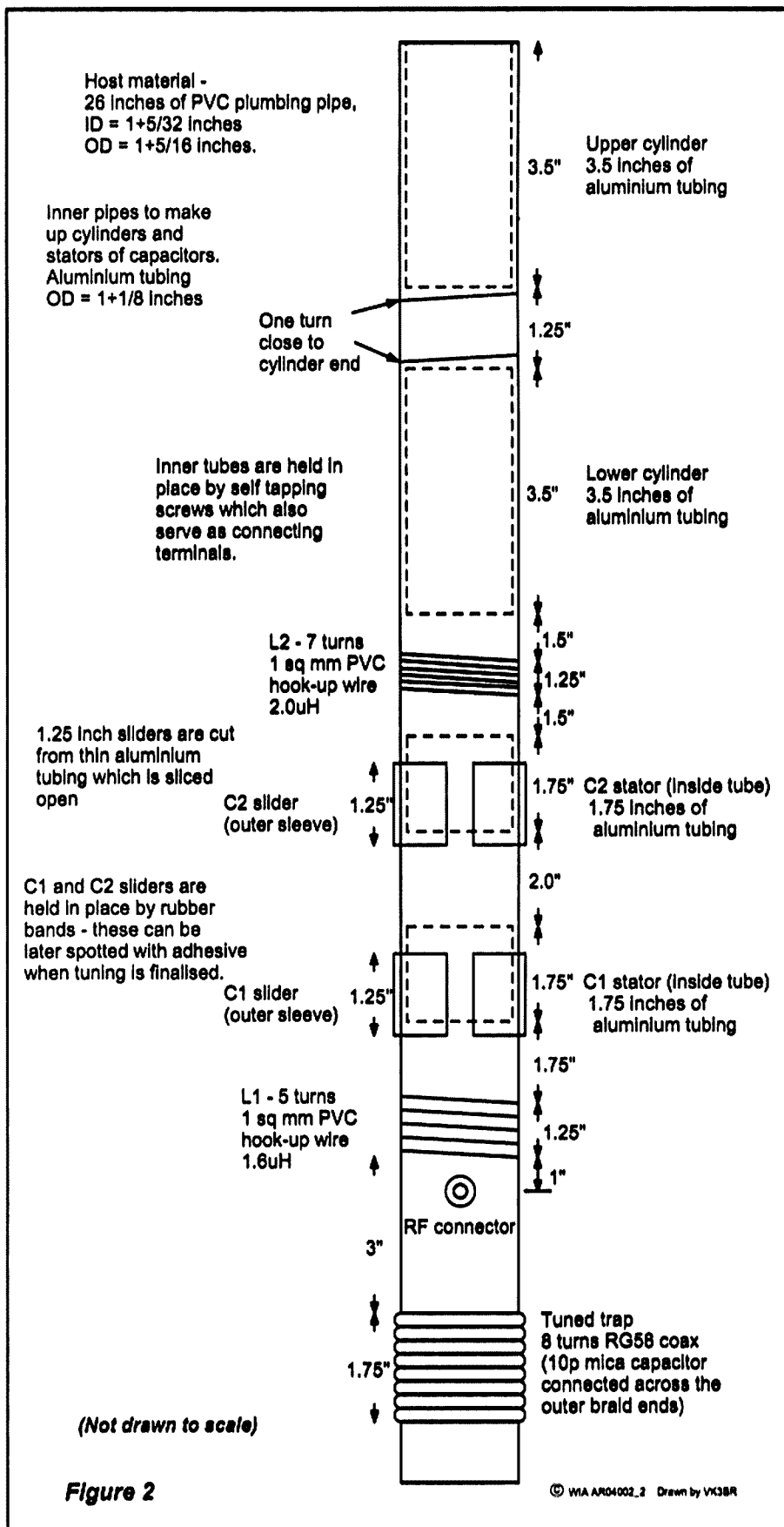

Figure 2

Fig 2 – Assembly diagram of the EH antenna for 10 metre



# Our next big adventure: DXpedition to Baudin Rocks (VI5BR)

IOTA OC-228 April 8 – 12, 2004

by Peter Forbes VK3QI

After our successful and exciting OC-261 Waldegrave Island operation of April 2003, I began to think about another operation that would provide a link to the historical aspects of the period 1801 – 1804, when so much of the southern coast of Australia was first explored and mapped in detail by the English navigator, Captain Matthew Flinders.

Flinders' work was so detailed that even 200 years on, yachtsmen can still use his charts with confidence and even with GPS available, find them to be extremely accurate.

In 1802, a famous meeting took place between Flinders and the French navigator Captain Nicolas Baudin, in Encounter Bay off the South Australian Coast.

September 2003 was the 200th anniversary of the death of Baudin and since Baudin's Rocks were part of the IOTA group OC-228, this would make an excellent commemorative operation, with the special callsign VI5BR.

The OC-228 group, in particular Granite Island off the coast of Victor Harbour and slightly further north on the coast, had been activated once only before in April 1999, by Martin (G3ZAY) as VK4CAY/5 and two VK5 amateurs, for a limited number of hours. This made it a relatively rare group.

After making inquiries from the local fishing people in Robe, the nearest town to the rocks, it became apparent that we would need an access permit to land and operate for a limited period.

Being a Conservation Area, we had to undertake not to disturb the flora and fauna, and to remove rubbish and waste on departing. The only thing we left behind were hundreds of footprints on the beach and our human scent for the seals!

The Conservation Park had several penguin colonies (one right next to our operating tents), and resident seals who patrolled the water right next to the beach in search of food. There were many bird species, including pelicans and thousands of pigeons who feed on the grain crops several kilometre away on the mainland, then fly home to the safety of the rocks for nesting.



The west side of the Rocks

The rocks had one small sandy beach area, about the size of a small house block and access would be very much dependant on weather conditions, unpredictable at any time.

Contact with Don Mount, Senior Parks and Wildlife Officer for the South East District and Mark Kassebaum, operator of Robe Fishing and Charter assured us of permission and access, provided the weather conditions were OK. Dates were arranged for the September 25th-29th period, but with two days to go, the sea was running at 4 – 6 metre swell, 4 – 6 metre waves and 20 – 40 knot winds and remained so for several weeks.

Not to be deterred, we decided to aim for Easter 2004 instead, when weather conditions were generally more settled for longer periods of time.

Over the Christmas/January holiday period we further investigated the landing spot and bought a new operating tent to guarantee better chances of success if the weather turned nasty.

We found that at high tide the beach was almost entirely awash, but since Easter was associated with a full moon and the sun and moon on opposite side

of the earth, the peak afternoon tides would not be quite as high as during a new moon. This left us with a beach at high tide of approximately 30 metre long by 6 metre wide to put our tents and share with nine large male fur seals, as we were to soon find out. At low tide, the beach was around 100 metre long and 30 metre wide, so our beach mounted AV-640 vertical antenna would spend about half the time with real waves fully under it.



Two residents of Baudin rocks: fairy penguins

## The planning stage

With our four participants confirmed (see opposite), we began the planning for equipment and transportation. With four participants, we decided on one vehicle and a trailer to drive the seven hour trip to Robe, our embarkation point.

Weight was not going to be an issue as Mark Kassebaum, the boat operator, had assured us that whatever we wanted to take, he could manage. His boat was capable of carrying a large group of people in quite heavy seas. Since the equipment would need to be landed by dinghy and the landing could be quite wet, we packaged the equipment in water tight plastic drums of approximately 60 litre which could easily house the transceivers, power supplies and most small items that should be protected from the elements.

Our 240 volt supply was the Honda

## Equipment used:

<b>Station 1 (main SSB position)</b>	IC706 MK11G and DX1 linear to a three element TH3MK3 antenna on a five metre mast with a small rotator and located on a high rocky outcrop about 60 metre from the tent.
<b>Station 2 (SSB/CW)</b>	IC706 MK11G with MA1000B 12 volt linear, MFJ 4245 switch mode power supply to a Ripplettech WARC tri-band rotatable dipole and/or a homemade tuned feeder wire dipole for 80/40 m.
<b>Station 3 (main CW position)</b>	FT100 with MA1000B 12 volt linear, MFJ 4245 switch mode power supply to a Hy-Gain AV 640 "Patriot" vertical.

EU20i, with a backup EU10i. Fuel and water was planned to each be 100 litre for five days maximum, operating. This put the total weight at 700 kilogram (excluding the operators).

Fuel use for the Honda EU20i is stated as one litre per hour, so 100 litre of fuel was needed. As it turned out, the brilliant Honda used only 66 litres for 106 hours of operation so we were oversupplied with fuel.

Our shelter consisted of low wind resistance/low profile tents for sleeping and a large double dome tent for the main operating position.

Food was no problem. Fires were not allowed on the island, but a small gas cooker was used to boil water and make up various meals. The use of flat foil vacuum packed meals makes food preparation and storage easy and safe. We carried sufficient water for five days supply and ended up with a surplus.

## The historical connection

*About 4, saw a ship ahead, cleared at quarters and shewed our colours. On their shewing French colours with an English jack, shewed a white flag, shortened sail and hove to. On his coming up, found the ship to be the Geographe captain Baudin, upon a voyage of discovery from Mauritius. Hoisted out the cutter, and went on board. At 7.10, returned, hoisted up the boat, and made sail upon a wind in company with the Geographe. Backed the miz top-sail occasionally, to keep company.*

(from Flinders' log)

Baudin had explored and charted much of the Tasmanian coastline and was heading northwards towards what was believed at the time to be a possible great inland sea in central Australia. Flinders was heading east, having explored and charted the Great Australian Bight (including Waldegrave Island (OC-261) and was also looking for the great inland sea. Baudin and Flinders met and sailed within sight for two days, exchanging information about what they had found in a spirit of scientific fellowship, despite the looming war between France and England. During this meeting, Baudin warned Flinders about a dangerous rocky island group, which was almost submerged at high tide.



Captain Nicolas Baudin

*He gave me of information of a rock lying about 2 leagues off the coast with shoal water about it, at the distance of 22 leagues from his situation on [Thursday] at noon and in the latitude of 37°.1' So.*

This was of course what was to become known as Baudin's Rocks.

Baudin was to meet Flinders again, a few months later in Port Jackson (now Sydney), but after that, they never met again. Baudin eventually left Australian waters and sailed towards France. However, on the French island of Mauritius, he took ill and died in September 1803. Coincidentally, Flinders, while returning to England, was imprisoned by the French on

Mauritius till 1810, but survived the ordeal and became much more famous than Baudin after publishing his book, *Voyage to Terra Australis* (1814).

After Baudin died, it was left to his Lieutenant, naturalist Francois Peron to make a report of the French expedition to Terres Australes. Only Volume 1 was completed, as Peron died in 1810. It is almost certain that Peron was responsible for the naming of many South Australian features after French scientists, artists and members of the expedition, including himself. Another expeditioner, cartographer Louis de Freycinet drew up the charts and maps of the expedition.

Baudin had been discredited by both early deserters of the expedition and the returning travellers, and French authorities were embarrassed by the apparent failure of the voyage. Remember that this was at the height of the French/English Napoleonic wars. Freycinet bestowed his own choice of place names to South Australian locations, disregarding names that Baudin had recorded earlier.

Despite this, French place names remain on the south-eastern coastline, the south coast of Kangaroo Island, and the West Coast of Australia. Baudin's influence over early settlement policies on the Australian coastline by the English, cannot be discounted.

# The team

After some discussion, we decided to limit the number of persons to four, and Tony VK3TZ was invited to join the group to replace Tom VK3ZZ, who was unavailable over Easter.

The operators were:



From left: VK3QI, VK3FT, VK3TZ, VK3WWW

**Jack Bramham  
VK3WWW**

A locksmith with Corporate Locksmiths, a keen ARDFer over many years, currently WIA Federal ARDF Coordinator and an experienced Field Day operator. Jack organized the Region 3 ARDF championships in Ballarat, Australia at the end of 2003.

**Tony Byrt  
VK3TZ**

Electrical Engineer formerly in the Australian Air Force and involved in other Defence projects, now running his own electronics business, Rippletch Electronics, specializing in amateur related antennas and switching networks and a keen contester and DX chaser.

**Peter Forbes  
VK3QI**

A semi-retired Physics and Electronics teacher at Ashwood College, a government school in Melbourne, a keen CW operator (still only needs P5 on CW for the lot!) and particularly interested in ionospheric propagation and IOTA operations.

**Keith Proctor  
VK3FT**

A long-serving senior officer in the Victorian Police Force, with much experience in radio operation under stressful conditions, like natural disasters and DXpeditions!

## Getting there

We arrived at Robe (some 600 kilometre) around 4 pm on Wednesday 7th. This gave us plenty of time to relax, check out the island access, organize fuel and stay overnight at the Robo Sea-Vu Caravan Park.

The weather forecast for the Easter period was excellent. Good conditions, 23 degrees maximum, 10 degrees minimum overnight, winds variable, strong at times but moderating and most importantly, seas one to two metre swell and waves to one metre.

First light Thursday, we loaded all our equipment onto the boat and quickly arrived off the island (a journey of nine kilometre) where we anchored about 100 metre off shore, around 8 am. In six trips, using a long rope to pull the dinghy back and forth we were able to transfer the operators and equipment to shore without incident, save for a few wet operators relaunching the dinghy in the waves.

Assembling the station went smoothly, having set up the antennas and tents many times before. We had to make sure no vegetation was damaged in assembling the antennas on the top of the rocks where the penguins nested

Also we had to establish territory over



Sleeping with seals

our piece of the beach from the nine male 400 pound fur seals who normally lived there. By two of us approaching a seal together, we had height and size advantage over the seal, who would then back off. Interestingly, after a few confrontations, the seals quickly established that we were not a threat to them (and vice versa) and by the end of the first day, they behaved as if it was natural for humans to cohabit the beach with them.

Nevertheless, sleeping in a tent with a 400 pound seal on the sand two metre away does make you a little wary. My sleeping tent was the nearest to them, as the others reckoned with all the pre-packaged tuna meals I consumed on the rocks, I was probably the closest relative to the seals anyway!

## Already up and running

By 5 pm local time (0730Z), we were ready to hit the airwaves with all three stations operating.

After our Waldograve Island operation I had built a set of the excellent W3NQN bandpass filters for each band. We were able to operate three stations from within the same tent on 40/30/20,



# Australian Made ANTENNAS

## "Setting a New Standard" COM-AN-TENA

(Formerly a j and j coman)  
115 John Street  
GLENROY 3046

All new 5/8 vertical 16 radials	\$160
Dual drive 26-30 5 ele yagi beam	\$315
4 ele 10-11m yagi beam	\$278
5 ele high gain antennas 11m	\$327
3 ele delta loop 10-11m	\$326
11m 5/8 vert./4-1/4 wave radials	\$175
Duoband 10-15 3 ele each band	\$385
Tri-band 5 ele HB35C s/steel fix	\$730
3 ele 20m computer opt	\$420
3 ele 15m computer opt	\$295
M B Vert Auto switch 10-80m	\$330
40m linear loaded 2 ele beam	\$595
6m 5 ele compt opt beam	\$268
6m 7 ele compt opt beam	
boom — 60mm	\$387
10 ele high performance 2m	\$145
17 ele high performance 70cm	\$125
2m vert 2-5/8 co-linear 4 rad	\$ 120
Log-periodic 9 ele 13-30 MHz	
8.4m boom	\$990
Wire Dipole 10-20-40-80 MHz	RING

## Guyed Masts

**21 metres**      **13 metres**  
Winch-up & till-over. Aluminium and stainless steel  
three-sided construction. Auto-brake winches.

## Free Standing Masts

9.5 metres

## New Baluns

1-1 to 16-1 to 3kW

Our Masts  
meet Australian  
Standards.  
We supply all the  
computations and  
data you will need for  
a permit.

**03 9773 3271**

**Mob: 0419 542 437**

Andy VK3IV

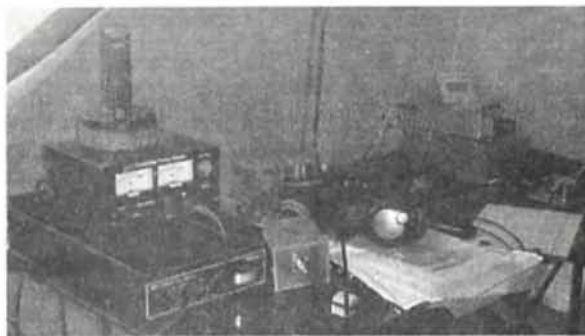

The main CW operating position



The main SSB operating position

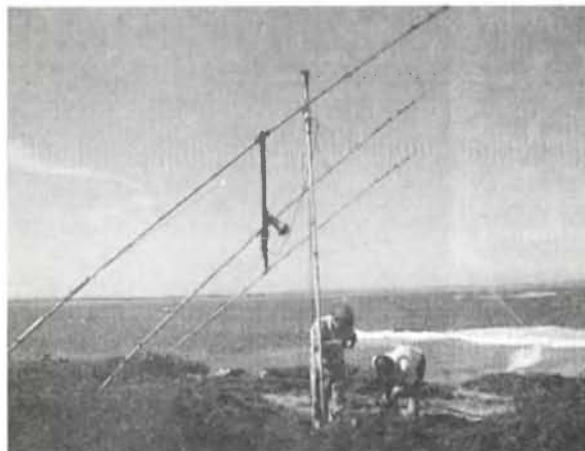

Beam with rotator fallen apart

30/20/17 or 20/15/10 m with very low mutual interference.

Operating 10 and 12 m at the same time was still not possible, as the bandpass filters were not quite good enough at such close frequencies. Future improvements will include double bandpass filters for these bands.

Many operators in typical urban and semi-rural high noise areas would not be unaware of this sort of interference, but on Baudin Rocks, the noise floor was essentially zero. We had been able to eliminate ALL noise from the Honda generator with appropriate filters and earthing; and receiving conditions were such that when turning the 20 metre beam towards Robe (some 8 km distance) we could detect the power line noise from the town and surrounding

area of the mainland.

The only mishap we had with the equipment was quite amusing.

The four bolts between the lower mast bracket and the rotator base worked loose in the wind, probably vibration induced. The beam was being rotated when the last bolt dropped out and the beam gently spun around like an auto-rotating helicopter and slid to the ground along the guy ropes supporting the mast. The only damage was a bent reflector tip, which was quickly repaired by reversing it in the swaged element end (although it did have a 90 degree bend in it). In our extensive tool kit, we found some replacement bolts and had the beam up again within the hour with re-tightened bolts on the rotator bracket.

## Better than expected results

We planned to use the IOTA frequencies exclusively and our aim was for better than 5000 contacts in the planned 100+ hours of operation.

The emphasis was on working European stations, who have the largest number and keenest of IOTA chasers, especially long path on 20 and 17 m from 0500Z to 1000Z. We knew from past operations, that this was the prime time for European DX.

Our strategy worked better than expected. The following was achieved.

7700 Total contacts:	With phone 3200 and CW 4500
Number of countries worked:	102
Hours of radios setup on Island:	0700Z Thursday to 2100Z Tuesday = 110 HOURS
Average contacts:	70 contacts per hour

Checking on the various Internet IRC chat channels after the event and the

DX Summit packet spots, it was obvious that if you had been at all active during our operating period, you would have worked us on at least one of the bands/modes.

The only disappointing aspect was the lack of PY, CE and LU contacts on any band. We stood by for these areas regularly but conditions just weren't right, despite the good work of our on-shore pilots in arranging skeds. PT7WA had skeds with us and made a scratchy CW QSO on 20 m but very few other contacts were made. The difficulty is that the path is directly over the South or North Pole and even skewed directions take the signal through the high absorption auroral zones.

## The down side of Cycle 23

Being on the descending side of Solar Cycle 23, radio conditions are often disturbed for long periods of time.

Over these five days, the A index ran at 16, 15, 10, 8 and 10 and the solar flux at 90, 92, 95, 95 and 97. Conditions were stable on all bands from 40 through 10 m.

The Easter break being close to the equinox meant absorption over the important North American and European paths was still relatively low. Across the Pacific, conditions on 10, 12 and 15 m were quite good with openings to North and Central America. Long-path conditions on 17 and 20 m were very good to Europe and the Middle East and short path on 20 m to Europe was reliable, but not strong.

30 m and 40 m provided excellent conditions for CW operation, in fact around 1430Z each evening (midnight local time), it was possible to contact right across the Northern Hemisphere on 30 m. As well, long path on 30 m to Europe was outstanding with openings from 0600Z to well past 1000Z.

Weather conditions were as expected – the wind was particularly strong on the Saturday, but our operating tent took it well. We used our equipment barrels as anchors in the sand to help reinforce the outer skin of the tent.

By Sunday the winds had dropped and by that night the air was absolutely still. With a cloudless sky and the moon rising later in the evening, the stars were extremely clear.

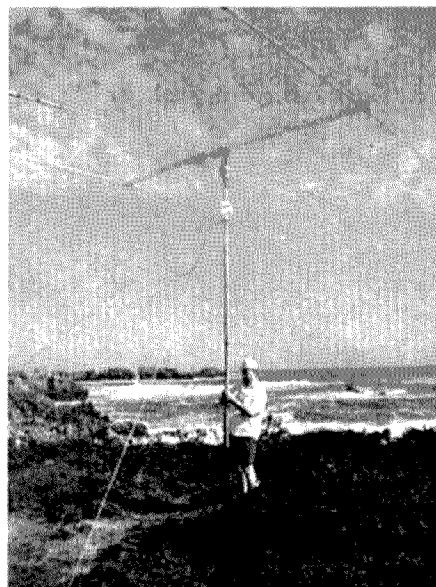

View to south west from beam

The only significant rain we had didn't arrive until we were packing up the tents on the Tuesday morning, and then it was more of an inconvenience than anything else.

As we had found on previous operations, behaviour by all those on frequency was excellent, with a quick

# Andrews Communications Systems

ESTABLISHED 1976

ACN 001 968 752

## ICOM DISCOUNTED

- IC-756 Pro II HF+6m \$4,299
- IC-746 Pro HF+6m+2m \$2,999
- IC-706 IIG HF-70cm \$1,399
- IC-718 HF SSB w.DSP \$1,199
- IC-910H 2m+70cm SSB \$2,199
- IC-208H 2m+70cm ..\$649
- IC-V8000 2m 75W \$399
- IC-R5 H/H Scanner ...\$399

## ICOM SCANNERS DISCOUNTED

★ 3 YEAR WARRANTY ★

## ALINCO DISCOUNTED

- DX-70TH HF/6m 100W...\$1199
  - DR-620E Deluxe dualband \$499
  - DR-605E Duplex dualband \$549
  - DR-135T Mk2 2m 50W...\$299
  - DJ-V5E Dualband handheld \$399
  - DJ-X2000E Hi-tech scanner \$799
  - DJ-X10E All-mode scanner \$499
- ★ 3 YEAR WARRANTY ★

## YAESU FT-7800R

\$499



- FT-1000MP MkV 200W \$4,999
  - FT-857D HF-70cm ...\$1,399
  - FT-847 HF-70cm ...\$2,499
  - FT-8900R Quadband .799
  - FT-8800R Dualband .699
  - FT-817 HF-70cm ..\$999
  - FT-897D HF-70cm ...\$1,499
  - FT-2800M 2m 65W .349
  - FT-1500M 2m 50W .399
  - VX-1R w/2 batteries ..\$369
  - VX-2R Tiny Dualband ..\$399
  - VX-5R Triband H/H ..\$549
  - VX-7R Deluxe H/H ..\$699
- ★ 3 YEAR WARRANTY ★

COMET ANTENNAS & ACCESSORIES DISCOUNTED

## KENWOOD DISCOUNTED

- TS-570SG HF+6m+ ATU \$2,499
- TS-480HX HF 200W+6m \$2,999
- TS-2000 HF-70cm+ ATU...\$3,499
- TM-D700A 2m/70cm \$999
- TM-G707A 2m/70cm \$699
- TS-480SAT HF+6m+ ATU \$2,499

TOKYO HI-POWER, PALOMAR, TE SYSTEMS, YAESU LINEARS.  
bhi NES 10.2 DSP speaker \$249  
DIAMOND ANTENNAS from only \$99  
HUSTLER + EMTRON ANTENNAS  
Avair SWR/RF wattmeters fr. \$99  
**DIAMOND — why pay more?**

Binoculars & telescopes discounted  
DIGITAL SCANNER RECEIVER . \$1199

**MFJ** KEYS, TUNERS, ANALYSERS ETC

CALL (02) 9636-9060 or 9688-4301 or FAX 9688-1995

SHOP 8, 41—51 BATHURST ST, GREYSTANES, NSW 2145

Why pay more? MAIL ORDER TO PO BOX 240, PENDLE HILL, NSW 2145

★ <http://www.andrewscom.com.au>

★ email: [lee.andrews1@bigpond.com](mailto:lee.andrews1@bigpond.com)

Some Items Indent. Prices subject to change

E & OE

AR:64

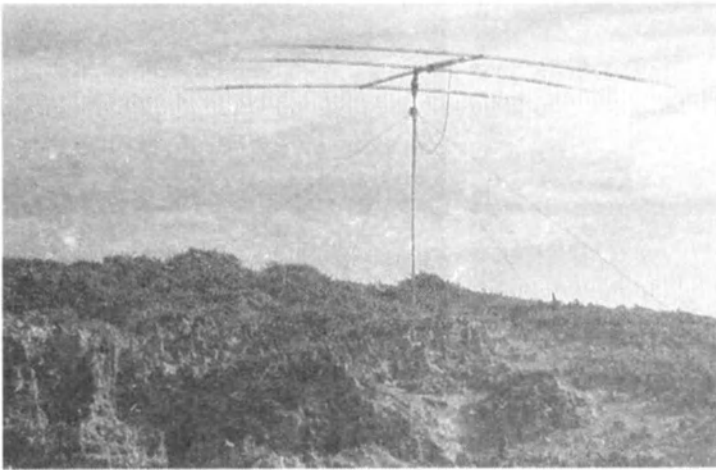

Beam at 15 metres above sea level



Vertical with beam in background

rate of contacts being maintained, often with a single split frequency. Early on the first day of the operation there were a few problems with running by numbers, but that was unnecessary after that first long path opening to Europe.

Judging by the comments on the DX packet clusters, the only problem was too much IOTA activity from T33, ZL7, VI5 and 3B9 all on the same bands at the same time!

Both the FT100 and IC706 rigs performed flawlessly, with the FT100 far superior to the IC706 for CW contacts. This is not a biased comment, as I own and regularly operate both rigs. Even with both having 500 Hz filters, the "CW feel" with the Yaesu is superior.

Tony VK3TZ tried out some CW for the first time under DXpedition conditions and made a good fist of it on the various bands. He was able to confirm the same comment about the CW performance of the FT100 in comparison with the IC706.

The MA1000 amplifier was used in conjunction with the MFJ 4245 switch-mode power supply, which is a light weight 45 amp/13.8 volt power house. Although the MA1000 is capable of 500 W PEP output, the power supply would overload at that level. So we adjusted exciter drive to run around 250 W PEP output. In this way, the amplifier and exciter were running cool.

The Emtron DX1 linear worked

perfectly, and was well matched to the EU-20i generator's continuous 1600 watts output.

By far the most interesting aspect of the operation was the relative performance between the 3 el tri-band beam on 20, 15 and 10 m (at a height of 15 metre above sea level and with a perfect takeoff), the Hy-Gain AV640, mounted at water level (right in the waves) and the WARC tri-band rotatable dipole (at a height of 15 metre above sea level and with a perfect takeoff).

The horizontal antennas had the advantage of better noise rejection and some directionality on reception, but given that the vertical worked from 6 to 40 m and worked really well on all

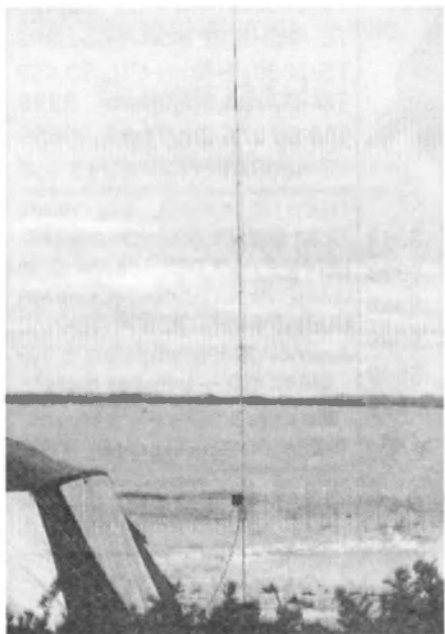

Vertical on beach at water's edge

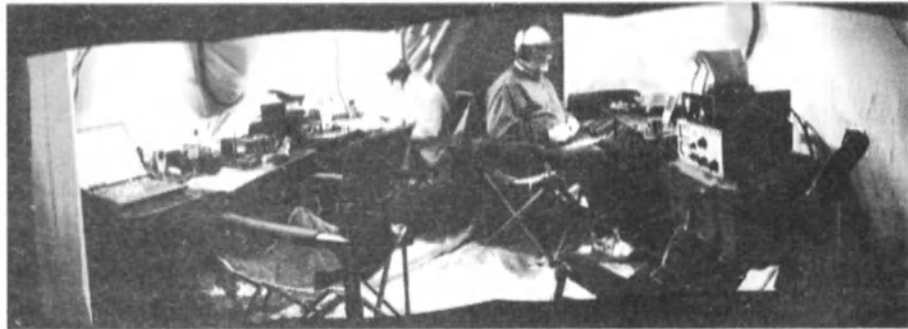

Night time operating from the Shack, VK3TZ and VK3FT operating

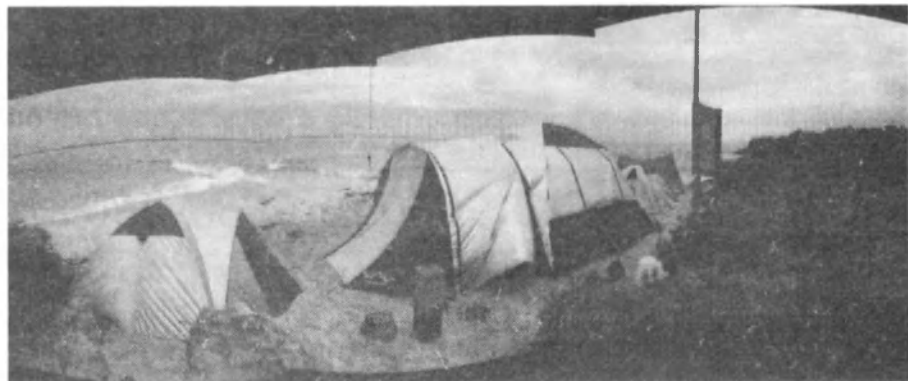

those bands, it continues to be our first choice for any future expeditions. On 30 and 40 m in particular, the strength of our signal in Europe, USA and Japan as reported to us by some reliable sources was nothing short of outstanding for the power levels involved.

We figured out a way of assembling and disassembling the AV-640 antenna into two bundles of four metre length, with the various aluminium stubs and stainless steel counterpoise rods stored inside one of the vertical sections. Erection and dismantling time was fifteen minutes, each time.

## Homeward bound

Our last contact was on Tuesday morning at 6.30 am, (12/4, 2100Z) We expected the boat to pick us up at 9 am so, despite the rain, began dismantling the site from just after daybreak.

The trip back to Robe was uneventful and we immediately drove the seven hour trip back to Melbourne, rather smelly after five days, but eager to get home.

Was it worth it? It would be fair to say that the four of us not only enjoyed the operation, but also gained an enormous sense of pride in a job successfully completed, without incident.

ar

## Helpers

**No expedition can be successful without the assistance of others.**

David VK3EW, Tom VK3ZZ and Roger VK3FRS acted as our unofficial pilots. We had access to them via mobile phone and they could spot us on various frequencies quickly and accurately. This maximized the chances of operators working us when the bands were open.

Jim Linton, President of Wireless Institute of Australia (Victoria) for assistance in obtaining the special call sign VI5BR.

And to all the operators around the world, who made our experience such a pleasurable one. The positive comments on the piles of incoming QSL cards really made the adventure worthwhile.

Mark and Tammy Kassebaum of Robe Fishing and Charter and their two deck hands, who transported us safely to and from the island and provided us with much useful advice on the location.

Parks & Wildlife, Department for Environment and Heritage, South Australia and, in particular, Don Mount for his friendly cooperation.

## QSL information

**Direct with SAE and postage to QSL manager:**

**Peter Forbes VK3QI  
53 Summerhill Road  
GLEN IRIS  
Australia 3146 or**

**Via the VK3 Bureau**

## Where to next?

Many operators have contacted us about possible operations from other Australian island groups, some of which have been activated only once before and for a limited time or under adverse conditions.

We would be interested to hear from others on their views as to which island groups would be the most in demand. An e-mail to any one of us with your views would be appreciated.

# Be part of a dynamic global community

# Join

# WIA

# today



## WIA is active in:

- Being an strong advocate for amateurs' place in communications
- QSL services
- Major role in amateur radio education and innovation
- Coordination of contests and awards
- Monitoring of illegal activity

10/229 Balaclava Road, Caulfield North Vic 3161

Tel: (03) 9528 5962 Fax (03) 9523 8191

email: [nationaloffice@wla.org.au](mailto:nationaloffice@wla.org.au), website: <http://www.wla.org.au>

# Charlie's Way

The final chapter of a short story about a ham, his mates and the CW receiving exam

Ross Fraser VK2WN

## Part 5 - 'Stop kidding!'

**A**FTER A FEW MORE WEEKS Charlie was feeling much more confident about the upcoming exam. He had been practising at home, using his computer to generate CW. He had been copying close to one hundred percent with speeds at twelve words-per-minute, and sometimes faster, for about 5 to 7 minutes at a time. Sometimes he made more mistakes than he wanted but that was happening less and less as he practised more and more. He knew he still had to pass the exam but was feeling much happier about the situation.

Finally the day of the exam arrived. He didn't sleep too well the night before, and as he sipped on his cup of tea he started to get an attack of the nerves. He shivered briefly and realised he had to change his focus so he wandered into his shack and switched on the radio. His radio was an 'oldie' but it didn't have any glass bottles for finals so when he switched it on it was ready to go. The broadcast band radio was on in the kitchen and he could hear the news mark so he knew it was 7 am. The net would be on or starting pretty soon.

The signal strength meter wavered around the 20db mark 'Oh' he said when he realised the volume was down. As he rotated the volume knob clockwise he could hear Steve talking.

'...and this station from China was peaking at 10 over....clear as a bell.... they said they were using 300 watt and a 4 element monobander 80 feet up.... a lovely signal....and she had a really sweet voice too'

'Did you say her signal was PEAKING or that she was in PE-KING, Steve, hi hi?' said George purposely emphasising the second syllable of Peking. George identified his station and then Steve's as he passed it back to him.

Steve announced George's call sign and then his own before saying slowly 'Very good George' with just a hint of sarcasm '...and Raptor is rolling around in hysterics just outside...I'm laughing

on the inside' Steve has a dry sense of humour. Steve paused and then wondered out loud where Charlie was this morning. Charlie heard this and reached over for the desk microphone.

He paused, briefly, before saying 'I'm here...and it's windy outside...is that down to you George? Big exam today... better get some last minute practice in... I'll catch up with you blokes tomorrow morning and let you know how I get on' Charlie passed it to George

'No worries Charlie-boy...all the best, deep breaths and all that stuff. Yeh it is windy...but if it was down to me it would be MUCH windier! Take it easy and above all HAVE FUN. 73 for now. Over to you Steve'.

**'Those sitting for exams - 5 minutes' called out the invigilator. Charlie's skin crawled. He focused on drinking his coffee and looking at the old books and things. 'I can do this,' he said out loud to himself.**

Steve offered his best wishes also and Charlie thanked them both and closed down his station for the morning. Listening on the side (sandbagging) was Colin. He had a surprise for Charlie.

Charlie arrived at WIA house, Parramatta. As he parked his car he noticed that he felt a general sense of calmness and also realised that he was looking forward to the exam. Momentarily he wondered whether this was a good or a bad thing. But he quickly changed his thinking pattern and thought to himself that it's much better to be calm than shaking like a leaf, which is something, he'd done at previous exams. As he wandered up the stairs he could hear a mild chatter coming down the stairs. He noticed the display cabinets to his left and right with old valves, microphones and other assorted old radio bits and pieces. He always stopped and had a quick look at the

cabinets. It made him feel comfortable and gave him a good feeling.

Charlie signed the visitors' book and went off to make a cup of coffee. He walked past a fairly young bloke sitting in the comfortable lounge chairs who looked particularly nervous. 'I'm only imagining it' Charlie thought to himself. 'G'day' he said softly but hopefully in a reassuring way. 'Hey' said the young fella, seemingly happy to be noticed. He went back to reading his theory book and Charlie went round the corner to get his coffee.

'Those sitting for exams - 5 minutes' called out the invigilator. Charlie's skin crawled. He focused on drinking his coffee and looking at the old books and things. 'I can do this,' he said out loud to himself. He noticed the young fella again, this time he was walking around, book in hand and reading intently. Other people were also walking around, some with a hot beverage and there were two fellas talking expressively about antennas.

The people sitting for exams were seated and were then given some general advice and the exam rules were explained to them. Charlie had heard it all before but he listened anyway. 'We'll start the receiving exam first and then get the theory underway. So those students...um let's see...(she looked down at the papers in her hand) the three of you doing the Morse please make your way over to the office just where you came in'. Everyone else could you stay here, please.'

Charlie went to gather his things off one of the lounge chairs. He heard some laughter and some animated talking coming from the office area. Some other people had also noticed and were looking in the area of the stairs. Charlie went to have a look. Just as he rounded the hallway he could see what the commotion was about. There was a cat sitting on the table where the visitor's book is kept. It was Tiger. Charlie walked



# Special Event Radio Station ON60CLM

## Postbus 1006 - B-8300 KNOCKE-HEIST - BELGIE

On November 1st 1944 the town of Knokke was finally liberated at great cost of Canadian lives. Each year the fallen Canadians are remembered with ceremonies, festivities and a "Canadian Liberation March" on November 1st and during the Canadian Week. Many Canadian and Belgian veterans, VIPs and radio amateurs are participating in the events.

This year the Special Event Station ON60CLM (suffix stands for Canadian Liberation March) will be on the air for the twenty third time from 5th until November 9th, 2004.

The Special Event Radio Station is operated by members of the BAFARA (Belgian Airforce Amateur Radio Ass.), the BMARS (Belgian Maritime Amateur Radio Soc.) and operators of the IPARC (International Police Amateur Radio Club) as well as our own ham-operators.

Again a multi-coloured ON60CLM Award will be available to all licensed amateurs and SWLs for any contact with this Special Event Station. They will also receive a beautiful QSL card. Cost of the ON60CLM Award is 5i, with all proceeds going to a welfare fund. The money is used to maintain memorials and to keep the station ON60CLM next year on the air.

You can contact or listen to ON60CLM on the frequencies below.

If you want more information about the Special Event Radio Station ON60CLM please contact:

ON60CLM  
email: [ON4CLM@pandora.be](mailto:ON4CLM@pandora.be)  
website: [www.on4clm.be](http://www.on4clm.be)  
Postbox 1006  
B-8300 KNOCKE-HEIST

ar

### Frequencies (in MHz.) ON60CLM

	80 m	40 m	30 m	20 m	17 m	15 m	12 m	10 m	2 m
SSB	3.685	7.045		14.145	18.150	21.245		28.545	144.250
CW	3.515	7.012	10.118	14.020	18.087	21.020	24.897	28.020	144.020
FM									145.475

URLEmail [www.on4clm.be/info@on4clm.be](http://www.on4clm.be/info@on4clm.be)

## Charlie's Way continued

up to him and gave him a pat and a rub on the side of his head. Tiger looked contented and started to purr loudly. Everybody was looking at Tiger and most were smiling.

'He's going to sit the CW exam for you, Charlie,' said a familiar voice. It was Colin who was leaning against a cabinet with old radio stuff inside.

'I don't need him to - and what the hell are you doing here anyway?'

'We're the cheer squad - but you sound confident so we'll be off then'

'Don't you dare' said Charlie forcefully and then added gently 'but I'm glad you came down. It's a nice surprise'

'No worries mate' Colin said amicably

'No, not you, Col. I was talking about the cat!'

Before Colin could respond the invigilator called out from the office saying 'Okay students' and waved Charlie and others into the room. She looked down at Tiger who then rubbed against her outstretched hand.

'Good luck,' said Colin. 'Thanks' said Charlie.

Charlie turned towards the office door. He paused and stroked Tiger before entering the room and closing the door. Tiger got down and looked at the office door, then down the hallway before walking over to Colin who picked him up.

## Epilogue

Charlie passed his Morse receiving exam making only two errors. Almost a month to the day after sitting the exam he got his results. That same day Charlie drove down to the Australian Communications Authority office in Sydney and got his unrestricted licence. He was only mildly disappointed to find that VK2CAT was taken!

Steve still thinks his dog is mad. George still has a wind problem (luckily flatulence doesn't travel across the airwaves). As for Colin, he's just happy to have helped a mate, although he still says that the biggest boost Charlie received was from Tiger!

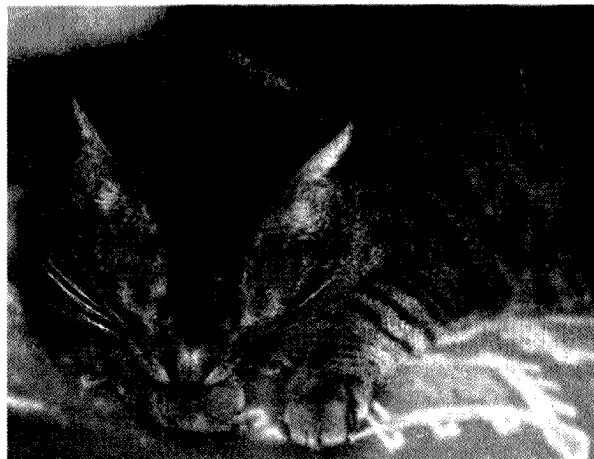

ar

# Antenna

'HomeBrew'

(with a lot of help from your Bushcomm kit)

## SWCS-KIT HF ANTENNA

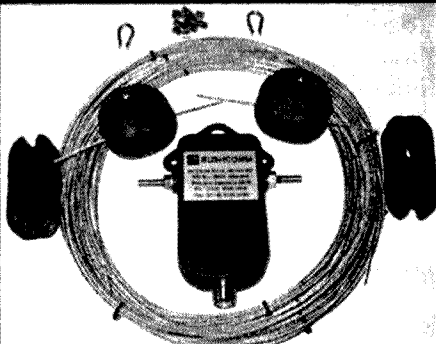

This is a kit version of our popular SWC-100S single wire model, but you have the great satisfaction of constructing of your antenna.

Easy to follow, comprehensive instructions. Common tools required.

You save money and have fun

Once completed correctly your antenna will be a replica of the SWC-100S model. This is a single-wire, base-situation antenna, constructed with stainless elements to give high resistance to corrosion. It has a length of 34m in total. Trees, buildings or other structures can be used to suspend the antenna, (avoid running the antenna over iron-roofed buildings as this reduces the effective height above ground). The antenna can be mounted either horizontally between two supports, or as an inverted 'vee'

Frequency Range: 2-30 MHz  
Impedance: 50 OHM  
Power Input: 100 Watts, 250 Watts PEP

This kit contains:

Balun (x1) Load (x2) S/S Thimbles (x2)  
Copper ferrules (plus a few practice extras)  
Large egg insulators (x2) 4 cut lengths of wire.

FULL and CLEAR  
building and mounting diagrams

# Bushcomm

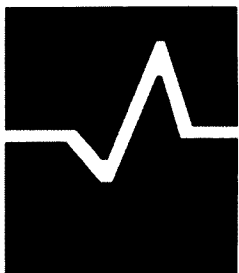

PROUDLY AUSTRALIAN OWNED  
AND MANUFACTURED

PO Box 2028, Midland DC 6936 Western Australia  
80 Stock Road, Herne Hill 6056 Western Australia

PHONE: + 61 8 9296 0496

FAX: + 61 8 9296 0495

EMAIL: bushcomm@bigpond.com

See more at

[www.bushcomm.com.au](http://www.bushcomm.com.au)

# Beyond our shores

David A. Pilley VK2AYD  
davpil@midcoast.com.au

## South Africa

Under proposed new Radio Regulations for South Africa, the Morse requirement for a ZS licence will be replaced by a number of assessments. Candidates wishing to obtain a ZS licence will have to complete any one of these assessments, and the choice of which assessment to attempt will be up to the candidate him or herself. SAREL Council has published these for comment.

1. Confirmed contacts with 100 different stations on any band and mode.
2. The construction of a direct conversion or superhet receiver or a crystal controlled transmitter for any amateur frequency and mode.
3. 50 hours of public service communication at sports events, disaster preparedness exercises and educational stations.
4. A professional tertiary qualification in electronics or radio.
5. Morse code proficiency at 5 words per minute.

Prior achievements will be recognised, so anyone who can show that they have already fulfilled the requirements for any of these assessments will be able to apply for a ZS licence as soon as the new regulations come into effect. Full details of the assessments can be found on the SARL's web site [www.sarl.org.za](http://www.sarl.org.za)

(QNews)

## Andorra

Andorra is now active on 6 metre. According to Johan, ON4IQ, Andorra has released the 6-metre band to all resident amateurs. He reports that C31JI and C31HK are both active on the band.

(QNews)

## Somalia

The nation of Somalia has acted to grant its ham radio population a power increase to 3 kilowatt. That's right. 3000 watt and that's 3000 P-E-P for SSB and 3000 watt average for other modes. Somalia is also letting hams use the 88 to 108 MHz band for F-M and permitting

Amateur Television broadcasts to be conducted on any unoccupied standard VHF or UHF television channel.

The Ministry of Information, Telecommunication and Culture in Somalia has made these changes and more as part of action to implement the W-R-C 2003 accords. Additional frequency allocations for amateur radio experimenters in Somalia include Zero to 9 kHz, 70 to 90 kHz and 130 to 190 kHz. Medium Wave frequencies include 495 to 526 kHz, while on the High Frequencies the hams of Somalia get 5.060 to 5.450 MHz and 26.100 to 29.700 MHz excluding the sliver band from 27.995 to 27.999.

This Ministry is promoting Somalia as the best holiday and research destination for visiting radio amateurs. This, as a way of attracting skilled people to help the local Somali people become ham radio operators. Abdikariim Ali Sulatn in Puntand State Somalia confirmed again that Aussie Amateur Sam Voron, 6OA, will continue to conduct ham radio licence qualifying courses and issue amateur radio licences free of charge "in the name of this Ministry" until a national Somali Amateur Radio Society is formed. If you are planning to go there, a Somali Visitors Amateur Radio Licence is now issued to any class of overseas amateur radio licence holder as a courtesy. It is free of charge and issued for life unless cancelled by the Somali Government. Talk about an inducement to visit a far off land.

(ARNewsline)

## Norway

No more annual fees. Norway has decided to make all current licences valid for LIFE or until cancelled. No more to pay! New licensees however will have to pay a one up fee. Government administration expenses reduced! It is interesting to see what it will do to the recruitment of new Radio Amateurs.

(source LA7TF/VK2WF)

ar

# Silent Key

## Archibald Stephen Woolnough VK3BW

1909 – 2004

Australian amateur radio lost one of its true and early radio pioneers with the recent passing of Arch Woolnough, VK3BW, on February 12th 2004, aged 94 years.

Arch was first AOCPL licensed in 1929 and immediately provided a radio service to local residents of his hometown in Portarlington, Victoria, using equipment, which Arch had built himself operating on 1600 kHz.

Arch was a foundation member and life member of the Geelong Amateur Radio Club, a member of the Radio Amateurs Old Timer's Club and a member of the WIA for many years. Over many years, Arch established numerous lasting friendships with amateurs both within Australia and all over the world. His proficiency at CW was unsurpassed, and at every available opportunity he would keenly pursue this passion. Although most active on the HF bands, Arch operated and enjoyed all modes and

all bands. His knowledge of radio, his technical ability and his preparedness to help others was exceptional.

Arch lived at Portarlington on the Bellarine Peninsula, Victoria all his life, where he owned and operated a Busline company previously founded by his father in 1904.

Arch was very proactive in his community, this community service was recently honored by Rotary International's highest award – The Paul Harris Medal – a truly remarkable and well deserved achievement.

Nature's gentleman, devoted family man and loving husband Arch Woolnough leaves us with a host of happy and lasting memories. He will be greatly missed by all who had the privilege and pleasure of his genuine warmth and friendship.

Submitted by David McLachlan - VK3ADZ

ar

## Coax Cable & Connectors

Low Loss 50  $\Omega$

For  
2.4 GHz  
(WiFi) &  
Ham Radio

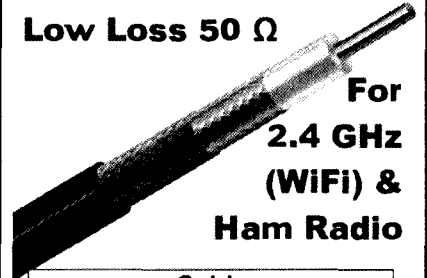

Cable		
Type	CFD-200	CFD-400
OD (mm)	5	10
dB/m	150 MHz	0.130
	2400 MHz	0.550
\$/m	\$2.50	\$4.00
	(\$1.50 *)	(\$2.00 *)

Connectors		
N-Type	\$7.00 (\$3.00 *)	\$7.00 (\$4.00 *)
RPSMA or	\$10.00	n/a
RG7NC	(\$5.00 *)	
Pigtails	email	

\* = bulk price

Web: [www.freenet-antennas.com](http://www.freenet-antennas.com)  
Email: [sales@freenet-antennas.com](mailto:sales@freenet-antennas.com)  
Tel: +61 (8) 9319 1720

# G&C COMMUNICATIONS

Authorised dealer for ● Kenwood ● Icom ● Barrett RFDS ● GME Electrophone ● Uniden ● YAESU

**We must make way for new stock**

**All current amateur stock  
must go**

**Call for Australia's most popular  
prices**

**03 5996 3298**

Australia wide orders welcome  
Credit card Cheque Money order

207 High St. Cranbourne VIC 3977  
Ph: 03 5996 3298 Fax: 03 5995 0184

Email: [gcomm@netspace.net.au](mailto:gcomm@netspace.net.au)  
[www.gcomm.com.au](http://www.gcomm.com.au)

## VK1 News

### CRARC Forward Bias

As the VK1 Division has changed its name to Canberra Region Amateur Radio Club (CRARC), the heading of this column shall from now on include the abbreviation CRARC.

The executive committee members signed the document that contains the clauses to separate the ACT Division from the National WIA early in July. President Alan Hawes, Vice-president Phil Longworth, Treasurer Bob Howie, and Secretary Deane Walkington put

their name to the document to authorise the separation. As a consequence, some significant changes will occur in the coming months, as was foreshadowed by President, Alan Hawes, during the General Meeting held on Monday, July 26, 2004. Alan said that the erstwhile division is now called "Canberra Region Amateur Radio Club". This name change will be notified to the Registrar General in due course, together with an updated version of the Club's constitution. These

changes are mainly administrative ones concerning word usage such as Division/Club, ACT Division/CRARC, etc. All of these changes will be explained and voted on by the members during the November general meeting. The guest speaker at the September meeting will be Graeme Cashion, who will speak to the subject of military radios and will show part of his collection.

The next General Meeting will be held at 8.00 p.m. on Monday, September 27, 2004.

Peter Kloppenburg VK1CPK

## VK2 News

In June all [VK2] members received a letter from the Membership Secretary Terry VK2KDK. Many thanks to those who have responded. If you are still to do so - please send it off during this month.

In the Sunday [VK2WI] news on August 8th a joint statement was included from President Chris VK2QV and Membership Secretary Terry VK2KDK. With a couple of minor wording adjustments here is their report.

Recently the NSW Division sent out an information letter with an optional survey to the members, pointing out to them the various options regarding the Division and the National WIA. We might add that this letter has resulted in some confusion in relation to the choices offered.

A number of respondents provided comments on return of the letter and these replies have been noted by the Divisional Council. The letter brought some interesting results. Of the respondents so far, a small number indicated they would join the National Organisation only. A similar number indicated they would only be members of this Division. The majority of you who replied indicated you

wished to become members of both organisations.

*Council met on August 13th last, discussing both the membership issue and other matters of importance regarding the future of this Division.*

*Please be assured that the membership of this Division will be kept informed of developments in these areas. In the meantime, the Council extended the membership of NSW for those of you whose renewals fell due from July through to 30 September 2004. The reasoning behind this was to allow current members to have a say in the future of this Division should an appropriate meeting be held. Please note that there is currently no method of collecting fees for this Division, as that agreement terminated with the National WIA on 30th June, 2004. This membership extension does not apply to the National WIA renewals of course, so if you want to continue receiving AR, for example, you will need to forward your renewal to them.*

*Until next time.*

*73 from Chris, VK2QV, WIA NSW President and Terry, VK2KDK, NSW Membership Secretary.*

Again the deadline for the notes is between meetings of the Council so news is a bit scarce with the lead-time involved. A reminder for those able to get to Parramatta - that there is a Trash and Treasure event on the last Sunday of this month - the 26th at 12 noon. It is followed at 1.30 pm with a meeting in the Library of the Home Brew Group.

For those who wish to undertake the exams conducted at Parramatta, the next one will be held towards the end of October with an application closing date mid October. There will be one more Parramatta exam before the end of the year. Contact the office for details and booking. Several clubs also conduct exams so check with your local group if required.

Mentioned in previous notes was the availability of "EH" antennas from the Bookshop. Several have been sold and a few remain. They are single band units and the stock on hand operate on 180, 80, 40 or 20 metre. For these and other Bookshop items check out the web page or contact the office.

All for this month.

Tim Mills VK2ZTM.

73 - Tim VK2ZTM.

## VK7 News

Justin Giles-Clark, VK7TW

Email: vk7tw@wia.org.au

Divisional Web Site: www.wia.org.au/vk7

### Divisional News

On 14 August a Divisional Council meeting was held to discuss steps to finalise the implementation agreement between the Tasmanian Division and National WIA. The culmination will be a Special General Meeting that is scheduled for September. The ratification of the implementation agreement will see the three branches of the division become affiliated clubs of the National WIA body.

Paul VK7BBW, Divisional Intruder Watch Coordinator reports that he got a call from ABC National Radio in Canberra regarding their intrusion on to 1.854Mhz.

The ABC National regional transmitters are centred in Canberra. What occurred was a failure in a series of traps, in one of the transmitters that filter unwanted signals. They have a series of traps set at 1600khz, 1700khz and 1800khz approximately, and the third in the series failed, causing a mixing of signals from all three, throwing out a spurious at 1854khz.

The fault has since been rectified, and he rang to apologise to the amateur community for the incursion. Thanks to the ABC for caring, and the ACA for also taking the time to assist us. "Wish it was all as easy as that" Paul said!

### Tasmanian Hamfest 2004

Dave, VK7KDO and Dave, VK3JKY have let me know that the Central Highlands Amateur Radio Club of Tasmania (CHARCT) in conjunction with the VK7 Division is holding a major Hamfest at the township of Miena on Saturday December 4, 2004.

Miena is located in the Tasmanian Central Highlands close to the geographical centre of Tasmania. The venue is the well-appointed Miena Community Centre.

CHARCT intend to have several operating displays, which should include a full operational HF/VHF/UHF

station, A CW station, a demonstration of amateur TV plus several prominent guest speakers.

The doors will be open at 11 am Tasmanian Summer Time and continue through to 3 p.m. Entry requires the donation of a gold coin. Coffee and tea will be provided and food will be available.

All are welcome and for more information check out the hamfest page on the CHARCT web site www.charct.net.

### Branch Meetings

#### Northern Branch Meetings

July 9 saw a successful evening at the Hunga-Munga Cafe owned by VK7HAH, David and Norma Potter. The format for the evening was a magazine swap night, culminating in a record attendance of old and new members, congratulations David on a highly organized evening.

#### Southern News

Firstly congratulations to Martin, VK7GN on coming third in the VK/Trans Tasman contest CW category. Robert Milne, VK7ZAL/AX2TAR is our Low Frequency experimenter and has been regularly transmitting on 181.4 kHz. Robert transmits CW with power of one kilowatt into a 35 ft mast from Moonah, Southern Tasmania. Robert has had reports from VK3, 5, 7 and ZL. Keep your ear to the Divisional broadcast for transmission times.

### Southern Meetings

On July 14 members and visitors were treated to a discussion on the usage, etiquette and idiosyncrasies of Repeaters, IRLP and Echolink systems. I think all of us learnt something from the information and lively discussion that occurred.

July 28 saw the last of the trial of experimenter's nights for a while. We had a healthy turnout and had a short presentation on position encoders and discussed the variety of types, modes and techniques and then moved onto a

*continued next page*

Contact	Date	U.T.C.	MHz	RST	Mode	QSL

operating from  
**AUS - 024 CAPE BRUNY - TASMANIA**

VK70TC QSL card for the LightHouse/Lightship weekend (Image courtesy of VK7XRN).

## Queensland State Championship —

# Horse Endurance Ride 2004

The Tableland Radio Group based on the Atherton Tableland Inland from Cairns, provided members for radio checkpoints from 4 pm on 31 July to 4 pm on 1 August for the State Endurance Championship at Wondecla, near Herberton. Members participating were Alan Whiting VK4HBN and XYL Val, Stan Alridge VK4MFA, Dennis Bauer VK4JDJ and Mike Patterson VK4MIK.

There were five differing tracks covering a variety of terrain with differing difficulty for riders. A number of horses were vetted out and there were a couple of withdrawals due to the toll taken by the continuous riding over the tracks.

The group used 2 metro, simplex and duplex operation, as well as UHF CB. Prior to the event the checkpoints were checked for accessibility and, if possible, radio usability. Checkpoints were manned for the entire duration and prior planning in formulating the checkpoint roster proved invaluable. Messages were passed back to base regarding horses passing the points as well as farrier assistance, and early warning of a group of lost, temporarily, riders and a rider withdrawing.

Val kept the information board, rider position and time, up to date and put in the night slowly filling up the board and answering numerous inquiries from

family and friends on whereabouts of riders.

The endurance riders were grateful for the safety the radio coverage provided whilst the Tableland Radio Group members enjoyed the experience of running the network and rearranging operators for checkpoints. It was also invaluable in working with another community organization.

There was an interesting situation in the late afternoon of the first day when a temperature inversion dramatically reduced radio coverage for a period of time – by using closer stations information was able to be got through to base.

A positive aspect of the event was it gave non-hams an insight into our hobby of Amateur Radio and the various technical aspects.

Mike Patterson VK4MIK  
ar

## WIA puts the FUN back into Amateur Radio

The WIA has obtained the call sign VK for FUN (VK4FUN).

**“VK4FUN will be used for special event operations promoting amateur radio to the general public, with a particular focus on school kids”, WIA Director Glenn Dunstan VK4DU said. “We decided to obtain the call sign following the success of the RSGB with their GB4FUN station”**

**VK4FUN will be available for use by clubs and groups on application to the National WIA.**

## VK7 News continued

video presentation from Jim Tregellas, VK5JST on stepper motors and their construction, theory and methods to drive them.

August 4, discussion was held with both the Wednesday afternoon and night gatherings about the Southern Branch's move to becoming a club. We had a total of over 40 members and visitors hear about the proposal, run through the draft rules and have their say about the move to a club structure and about how it is proposed to work. These valuable comments are currently being considered and those questions raised at the meeting are being researched.

## Experimenters' Nights Wrap-up

Thirteen nights were held between April and July. The nights included video presentations, hands on experimentation,

demonstrations, lectures and rag-chews over a coffee.

We had a total of 70 people involved with 49 members and 21 visitors and non-members. I think the time of year was an issue as attendance was down on the cold and wet nights. I have to thank the Adelaide Hills Amateur Radio Society again for the loan of some of their lectures and presentations.

There is a lot of work that went into some of these nights in the researching and preparing of the subject matter and this takes valuable time. I thank all those who put in time and effort and came along to the nights.

## WICEN News

Roger, VK7XRN has let me know that WICEN South now have a new website courtesy of Nick, VK7HAF. The address is: <http://wicen.taswireless.net/>

Some of the WICEN South team will be operating from the Cape Bruny lighthouse during the International Lighthouse/Lightship weekend on the Saturday 21 & 22 August. The official weekend identifier is AUS-024 and Cape Bruny is on the Southern most tip of Bruny Island and forms one side of the D'entrecasteaux Channel. They will be operating VK7OTC portable, the Southern Branch club callsign.

ar

## Erratum

In July 2004 VK7 Divisional news, North West News reported Tony's callsign as VK7ZX it is VK7AX, apologies Tony!

# JOTA for Scouts in SA

Lea Adcock

RIG Coordinator Scouts Australia

SA Branch

Ph: (AH) 08 8381 5909 Mob: 0412 347 808

Email: adcocks1@primus.com.au

**Most of you would probably know about JOTA (Jamboree On The Air) and what it's all about, you may've been an operator at some of the stations located around SA or in another state. JOTA is held on the 3rd full weekend in October. This year it will be held over Saturday and Sunday, 16th to 17th October.**

To those who have been a part of this special event for the scouts over the years, I commend you now if you haven't been before. That without you, JOTA for scouts just wouldn't exist. You've introduced many boys and girls into your hobby with a sense of interest and understanding (to some small degree) and let's not forget a bit of fun.

JOTA opens up the possibilities for those young scout and guide members to take an interest in amateur radio and become potential future members for amateur radio clubs.

I have been on the sidelines for years now picking up little things from my husband Sam, VK5KSA. I don't have a licence yet but plan to start slow with the foundation licence once it arrives. Both Sam and I are active members for the Scout Radio Activities Group (SRAG). I am just as enthusiastic as most of you are to increase your club members.

Why you ask? I enjoy JOTA every year and seeing the scouts interest and enjoyment at this event. I would like to harness those who are interested and take them to the next level by bringing Amateur Radio and Electronics to them with the group I have created within the scout movement called 'RIG' (Radio Interest Group for Youth). This interest from the scouts was also evident at the Australian Jamboree January 2004 in the Adelaide Hills. Thanks again to those that helped, both local and interstate amateurs who came across to the Jamboree. The JOTA site activity of which I was in charge ran successfully with many youth interested in amateur radio across Australia. So you see why I am doing what I am doing.

What I am asking here is that our Scout Radio Activities Group and the Radio Interest Group for Youth, would like to make this year one of the best JOTA's for SA and really show those scouts the various aspects and equipment used in Amateur Radio today and in the past. We

need amateur operators and / or clubs to help out at various sites in SA.

Our two main stations are Glenelg and Woodhouse. Glenelg Station is at the Scout Adventurous Activities HQ (previously known as Glenelg Scout Hall) on Anderson Ave, Glenelg North next to the Baseball fields. Woodhouse JOTA Shack is located inside Woodhouse Activity Centre, Spring Gully Rd, Piccadilly. Last year we had close to 300 scouts at Glenelg over the entire event and near 200 scouts at Woodhouse.

If you have a special or interesting radio set up past or present equipment and would like to demonstrate this to some interested scouts please contact me

as soon as possible so I can place you at which ever location you want (Glenelg or Woodhouse). If you still would like to help out but at a different location I am happy to pass on your name and number to another station in the metro area.

Did you know that SA has one of the highest youth attendances of all the States in Australia? That's why I am calling for your assistance this year, because I'd like to improve our numbers with youth and really show scouts what is out there in amateur radio. It is also a great opportunity to promote the upcoming foundation licence. I already have a few interested youth waiting for this. In turn expose your clubs to those youth members to further their interest and for your clubs to potentially increase your clubs members.

So if you know a mate in your club is operating at a JOTA site why not go along, see the buzz from the scouts and get involved this year. You'll never know you might have a little fun too.

Thanks for listening I look forward to hearing from you.

73

Lea Adcock

ar

*(see also inside back cover)*

SA Scouts enjoy activities during JOTA 2003



# OZGEAR

## Ozhelph Services

Doug Hunter VK4ADC  
Brisbane  
Ph 07 3273 7263  
Fax 07 3272 1800  
sales@ozgear.com.au

# ICOM

- **HF Transceivers** - 7800, 756Pro2, 7400, 706Mk2G, 718
- **VHF/UHF Transceivers** - V8000, 208H, 2720H, 910H, V8, T90A
- **Receivers** - R3, R5, R10, R20, R8500, PCR100, PCR1000
- **Accessories** - wide range of options and parts

# YAESU

- **HF Transceivers** - Base & mobile FT-1000MP, 817, 847, 857, 897
- **VHF/UHF Transceivers** - Base, mobile and handhelds FT-1500M, 2800M, 7800R, 8800R, 8900R, VX-1, 2R, 5R, 7R, VX150
- **Receivers** - VR-500, 120D, 5000
- **Accessories** - Yaesu rotators, thrust bearings plus equipment options

**Plus...** OzGear balun kits, Diamond HF, VHF & UHF antennas & accessories, MFJ & LOG tuners, Autek antenna measurement, Daiwa cross-pointer SWR meters, RFI, Mobile One, GME, Scalar & TET Antennas, Coax connectors, cables and hardware from Andrews, RFI & Benelec

**With...** More brands available and new products being listed all of the time...

CB, Marine, Airband and Land Mobile equipment and accessories are also available.

**Product not listed above ?**  
Phone or email to see if we can help or visit us on the web at <http://www.OzGear.com.au> for the latest product info plus on-line ordering.

# South East Radio Group Convention Home Brew Competition

John Drew VK5DJ

Each year on the Queen's Birthday Long Weekend the South East Radio Group holds its annual convention. The home brew competition is part of the tradition.

Thanks to an anonymous donor there are excellent prizes to be had and each year the crowd sees a wide range of interesting projects on display. The key purpose of the competition is to encourage people to build their own amateur radio equipment and over the years we have seen a huge range of projects from complete SSB transceivers to simple LED torches.

In recent years the documentation has become more sophisticated with circuit diagrams, construction notes and

theory of operation provided. However presentation is only a small part of the judging. Innovation, usefulness, quality of construction including soldering, layout, attention to detail and good practice are all criteria for the judging panel.

This year there were nine entries and all had merit. There were three categories - Novice, Experienced and Expert, the aim being to encourage new and old amateurs to submit entries.

The winner of the Expert section was Bryan VK3YNG who showed a 2 metre Sniffer and 2 metre mini fox including a configuration programmer. This was an outstanding example of modern practice in miniaturisation and hand soldering of surface mount components. The Mini foxes were used in some of the fox hunts held on the day. Bryan was awarded a bench drill for his work.

Bob VK3ZL submitted a high power 1.8 MHz amplifier using 2 of 4CX250W triode connected pentodes to more readily match the 100 W transceivers of today. The amplifier comfortably meets the 400 watt output without stressing



Alan Nankivell VK5ZLT holds his test jig for 2 m, 5/8 wave collinear antennas

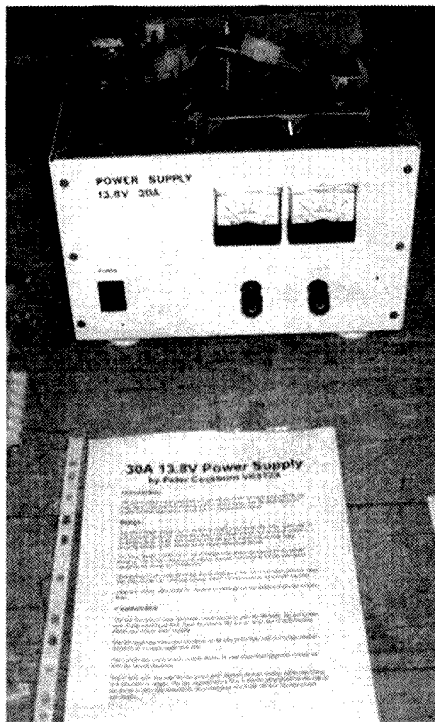

Peter Cockburn's (VK5TZX) 30 A Power Supply

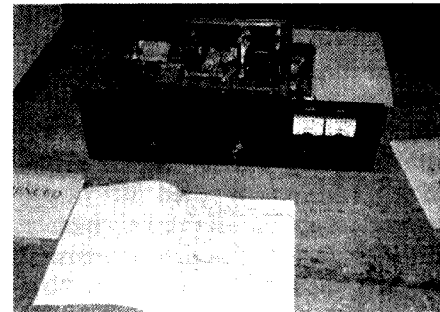

The VK3ZL 160 metre high power linear



Mobile antenna rotator by Wayne Kilpatrick VK5ZX





Bryan Ackerley VK3YNG shows his 2 metre mini fox transmitter

components. A feature of Bob's work was the considerations for safety and good RF practice.

Alan VK5ZLT showed his experimental jig for producing VHF centre fed stacked collinears. Alan used the jig to tune the new antenna for the Bordertown

repeater that is working so well.

Mark VK5AVQ showed his \$5 dummy load kit. A simple kit and a useful one, Mark graphed the load's response and showed good 100 watt capacity up to 2 metre. The judges were impressed with the value and documentation of this project.

Ron VK3AFW contributed a DC Breakout Box for the distribution and monitoring of battery powered portable equipment. A very useful device for all those who go mobile with a range of transceivers and equipment.

John VK5DJ showed his new repeater controller. With provision for linking or as a gateway the controller was well documented and neatly presented on its new commercially produced PCB.

Peter VK5TZX displayed a 13.8V 30A regulated power supply. The design was very well laid out with good access to parts. Heavy duty components were used and attention was paid to heat sinking. A

break out box was part of the package.

Simon VK5VST showed a 5/8 portable antenna system for 21 MHz. He used broadcast ganged capacitors, a tapped coil, PVC tubing and a squid pole to get his antenna up 35 feet with radials.

Wayne VK5ZX displayed a portable or fox hunting antenna rotator for attachment to a bull bar at the front of a vehicle. The project featured clever use of a windscreen wiper motor and a speed controller to ensure a variable speed action. The rotator was very nicely made with a quick release facility to enable fast antenna changes.

All participants received a prize on this occasion and the judges commented positively on the quality of the projects during the presentations at the end of the day.

The SERG again thank the anonymous donor for his generosity in sponsoring this event.

ar

## The Gulag files

Richard Sawday VK6ZLR

I was driving around in the little orange Datsun when I saw an auction sign, stopped and had a squiz. Mountains of junk, but one small box containing three radios with matching power supplies caught my eye. Left an absentee bid and promptly forgot about it.

Rang up later on the off chance. You owe us \$30 she says. So I duly picked up the spoils of a successful bid.

Took the booty home and plugged it in. The lights came on, all three units looked good, making healthy beeping noises. The beeping noises didn't stop, they just kept beeping. They would beep, the lights come on, and that was it. No Tx, No Rx. Just beeping.

Pulled one unit apart. The beeping must be in the selcall alert, it thinks it's had a call, I decided. Stripped it down, power off, boards out, jumpers disconnected, jumpers connected, boards in, power up. More beeping. Nil Tx, nil Rx. Obviously a faulty unit. Do the same on another one. More beeping. They are all the same.

Log onto the Internet. Nothing on these units, something on similar units, maybe it will help. Download megabytes of tripe. No use. Toss it.

Went to that website, deep in the Russian steppe, east of the Dnieper. *The Gulag*. More information, there is

a "C" program to create a binary file, to load into the EPROM, but not for this model.

More days pass, more claret, then another attack on the recalcitrant radios. Removed the EPROM sub-board. More beeping, no change. Why is the EPROM there if it doesn't change anything? What's in the EPROM? It's soldered onto the sub-board. How to tell? Unsolder all its little legs from the sub-board, keeping it cool and intact. How did we manage before vacuum desolder pumps? Put the EPROM in the programmer, read it. Blank. It can't be blank or the radio wouldn't work at all, would it? I don't know. Must have cooked the EPROM desoldering it. Repeat the process on a second unit. Blank too.

After several glasses of lateral thinking, write a test file to the EPROM. Writes OK, what's more, it reads back OK.

Ergo:- the EPROM was really blank and not cooked on desoldering. Some turkey has erased the EPROMs on these radios, which wouldn't be a problem if there was something to load back into the EPROM. There isn't.

No indication as to what band these units operate on. Weird numbers on the PA transistors. Plugged the HP8640A sig gen into the antenna socket, plugged the spectrum analyser into the Rx board

input, and quickly wound the knob on the 8640 around until there was a nice hump on the screen. VHF Lo-band. Harmonic filters are a dead give-away.

Back to the Gulag, download the C program. Run it. It's for VHF Hi-band unit. No good. Don't worry, put 70 MHz into the program, let's see what happens, spit out a binary file, burn the EPROM. Install. Bullseye! No beeping, channel number display - OK, looks good.

Tweak the VCO, peak the PA and 30 watt is good, shame it's 300 kHz off freq. Rx is off, Tx is off, all by differing amounts. Some EPROMs work sometimes, some don't. Everything is screwed. Back to the Gulag and cask.

Sort out the crook EPROMs, fling them over the back fence, they can go to hell.

Much misinformation on the Internet, many individuals anxious to display their ignorance. Write the Hex down, write the Binary down, burn an EPROM, record the frequency. Again and again, a pattern comes out, the bytes, the bits, sum of odds and evens; it all comes together, pages and pages of ones and zeros. I know the multipliers now. I know which bytes are which. I can program this radio. I've been to the Gulag.

ar

# Over to you

## Out Question Banks?

Richard Murnane, in "Over to You" June 2004 brings up a couple of interesting points.

Memory is a very important talent for people doing examinations. People with a good memory have always had an advantage over those with poor memory. However, if W6NBC can, in 360 minutes prepare his students to memorise 373, 384 or 784 multi-choice questions (depending on the USA exam level chosen) and for them to be able to gain an 85% pass rate, then either he is a genius or his students have phenomenal memories or both. These questions do not have the correct answer indicated.

There is no known perfect in method of running courses or exams. Basically there are three methods in use in the Amateur field.

In Britain they produce textbooks which provide the information which you need to learn to know how to answer the questions in the exams.

In the USA, South Africa, Canada and New Zealand the question banks are published so you know all the questions to be asked.

In Australia neither of these is fully done.

The Regulation questions are published. There are textbooks for the radio theory, but none have been prepared by a person with access to the question banks. Much needed

information is omitted. The only official guide is a syllabus which can be (and often is) interpreted very widely. The questions used in our exams urgently require revising, eg. What is the relevance to an amateur operator of questions such as :- 'What is the meaning of the prefix "tera"?' or 'Eddy currents and hysteresis losses in iron core transformers decrease with frequency' or 'The intercarrier sound IF in an Australian TV set is 5.5 MHz' etc. etc.

I have seen students badly discouraged by questions such as these. In several decades of life I have studied for many qualifications. In many cases a comprehensive text-hook has been available. Some teachers have also given notes as part of the course. This is fairly normal.

*I believe that our students for amateur radio qualifications work under a distinct disadvantage compared with those in many other countries.* When I take students for a course I know that I cannot definitely say, "You have covered all the information you need to know." If we had either comprehensive text-hooks or the question banks published it would be possible to say just that. Question banks can be tidied up and published (or modified) much quicker than preparing new textbooks. Books also need to be changed as the question banks are altered. Question banks only need to

be republished on the Internet for the system to be brought up-to-date.

There is a hope, in the light of these things, that the new Foundation Course will be fully and properly documented before presentation. My fervent plea is that either a comprehensive textbook or a revised question bank for the other courses will be published as soon as possible.

P.S. Many of the sample papers presently available contain questions, which are not in the current banks, and this sometimes leads to unnecessary brain clutter. I cannot fully appreciate those who are against publishing the official question banks. There are current and older books (still around) containing hundreds of "test" questions. Many of these questions are not the same as those, which will be encountered in exams. Students, who use, these books spend much time uselessly learning irrelevant facts. This makes their quest unnecessarily difficult. One of these current books contains over 50% more questions than the relevant official question bank for the same exam. We publish and sell some of these and we still won't publish the official banks!

My desire is not to make it easier for students but to make it fairer, preferably soon.

73, Neil Trainor VK3IJ

## To Whom It May Concern

This is to all those who import their radios instead of utilising our own dealers. Have you ever thought what problems will occur if this sort of thing continues?

**Problem (1)** after importing your radio equipment, during warranty there is a fault, how do you get it fixed? Pay to have the equipment sent back to the States? Pay again to have it returned to you? Where is your saving NOW?

**Problem (2)** after the warranty has expired who do you think is going to repair any fault that may occur? Not any supplier here. So your only option is a backyarder. I wouldn't want any of my expensive equipment touched by someone unqualified, who got his experience working on CB radios.

**Problem (3)**, which I think, is the most important one. If business drops off to a point that it can no longer

support our dealers and suppliers, the dealers will close and the importers will no longer import. What are you going to do when you want to buy a replacement microphone or antenna if there are no longer any dealers left?

So before you place that order in the states, ask yourself is it really worth it? It may be a small benefit now but with much bigger ramifications later.

Rob Owen VK3EA

Views expressed in the 'Over to you' column are those of the authors, and do not necessarily reflect the policies of the Wireless Institute of Australia.

Send contributions to:  
The Editor, Amateur Radio Magazine, 34 Hawker Crescent,  
Elizabeth East SA 5112 or email: edarmag@charlot.net.au

## Adelaide Hills Amateur Radio Society

Christine Taylor VK5CTV

We regret to have to announce the loss of a very dedicated club member and friend. Alby Wood VK5TAW died suddenly on August 4th. Alby had not had his amateur licence for many years but he served the club as Secretary for most of those years. He will be sorely missed by us all. Our sympathy goes out to his family.

One of the last social occasions attended by Alby and his wife Carmen was the Mid-year Dinner. They were part of the fifty plus members and partners who braved the cold that night. But all thoroughly enjoyed the company and friendship of the evening.

The other activity in which a number of AHARS members participated was the

communication for the Coopers Pale Ale Rally in the Mount Crawford area of the Adelaide Hills. This year it was cold and definitely wet under foot but it was not bitterly cold, as it had been the previous year. It is great the way amateurs answer the call of WICEN to assist in events like this. Many travel quite long distances and have to be in attendance for many hours but all of them do willingly it as part of their hobby.

The club meetings will resume on



Some of the happy diners at the AHARS Mid-year Dinner

the 3rd Thursday of each month at Blackwood High School. The meetings open at 7.30 with the speaker first. Everyone is welcome to enjoy an interesting evening.

## Wireless Institute of Australia Central Region Technical Symposium Saturday 2nd October 2004

Heights School, Brunei Drive Modbury Heights SA 5092

### Program

- 8 - 9 Check in and register  
9 - 10.30 Rex Moncur VK7MO  
*Digital enhancement of VHF signals*  
10.30 - 11.00 Morning Tea.  
11.00 - 12.30 Doug McArthur VK3UM  
*EME techniques.*  
12.30 - 13.30 Lunch provided.  
13.30 - 15.00 Joe Kasser VK5WU and G3ZCZ  
*Computers for Amateur Radio*  
15.00 - 15.30 Afternoon Tea  
15.30 - 17.00 David Giles VK5DG  
*Amateur Satellites, they are only repeaters*

### Cost

\$25 including lunch and refreshments.

\$20 for Concession Holders.

### Further information from:

WIA Box 1234 Adelaide 5001

### Rex Moncur VK7MO

Winner of the Ron Wilkinson Achievement Award. Rex commenced work as an Engineer with the Bureau of Meteorology and became Director of the Antarctic Division in Hobart. Rex has come to prominence in the VHF/UHF field and been almost solely responsible for the promotion of the new digital modes. Rex has spent considerable time in investigating the pros and cons for these modes and exploring them to their maximum potential. Read more about Rex in Amateur Radio May 2004.

### Doug McArthur VK3UM

Multiple Winner of the Ron Wilkinson Achievement Award. Doug was first licenced as VK5KK in 1957. Doug has worked in the radio field ever since. As VK8KK Doug worked at Radio Australia in Darwin, then as VK3UM in Victoria. Doug identified and explored Aircraft Enhancement modes on VHF, and with over 20 years experience is a leading EME operator. Read more about Doug detecting the Mars Global Surveyor in Amateur Radio June 2004.

### Joe Kasser VK5WU and G3ZCZ

Joe was born in England and spent about 30 years based in the United States. He is a prolific writer, researcher and lecturer in systems engineering.

He was closely involved with AMSAT for more than 15 years, and has wide interests in Amateur Radio. Joe has received many awards during his long career. He is currently Associate Research Professor at the Systems Engineering and Evaluation Centre at the Mawson Lakes Campus of UniSA.

### David Giles VK5DG

David lives in the south east of South Australia. He was first licenced in 1986 and has had an interest in satellites for the last 8 years. David worked all continents, and 65 countries on AO40. He is employed as a shift electrician at a local timber mill and has just completed Bachelor of Technology through Deacon University, by distance education.

Amateur radio contact for directions October 2nd via Houghton repeater VK5RHO 146.850 or telephone Trevor Quick 8380 5542 or 0421 918 099

Christine Taylor VK5CTY

## ALARA Contest

Hopefully conditions were better for us all this year. There should be lots of logs going to Marilyn VK3DMS for checking. Maybe there is someone who worked hard enough to qualify for the Florence McKenzie Trophy again. There are not so many people who use CW on the bands these days, but it seem as if those who are there enjoy the challenge. Let us hope there were enough enthusiasts to fill a log.

It was encouraging to have an OM break into the Monday Night Net recently to ask the date of the ALARA Contest. He was given the information gladly. We always encourage OMs to participate. We feel this Contest is different, as we are happy to have a chat and a real contact with everyone.

Do remember to send in those logs before the end of October.

## ALARA Birthday

If my experience is similar to that of others, there was not much activity on the air for the Birthday Net on July 24th, however, in VK5 there was some activity on 25th. That was the day of the Birthday Luncheon. This year it was attended by 9 YLs and 8 OMs.

Mostly it was the familiar faces who got together but it was very pleasing to have Sue VK5AYL and her OM Michael (who used to be an amateur but has let his licence lapse, I think). Sue brought along a newspaper cutting that showed a very young man with an elaborate antenna designed for tracking satellites. This would have been made back in the very early days of satellite activity. Sue, herself was involved in the early days of

ATV. Perhaps we can encourage both of them to become more active now.

Myrna VK5YW and Janet VK5NEI represented the earlier ALARA members while Shirley VK5JSH is a relatively recent amateur and Jenny, a very new ALARA member. The in-between members were represented by Meg VK5YG, Christine VK5CTY, Tina VK5TMC, Sue VK5AYL and our State Rep, Jean VK5TSX. We were reminded that this year we were meeting on the actual anniversary of the foundation date for ALARA, 29 years ago.

## A very new YL group

The Scandinavian Young Ladies Radio Amateurs came into being as an association earlier this year. None of the separate countries of Scandinavia have enough YL amateurs to form a viable YL group but together they can certainly form one. Geographically and historically this group of countries share many characteristics, not least of which is their climate.

The club will operate from Denmark, Finland, Iceland, Norway and Sweden.

A photo in the DL-YL Informationen has ten YL in it including several faces that are familiar to us in VK/ZL-lands. Hopefully we will come to meet the others as well either on air or face-to-face. Welcome Ladies!

## R.I.G. And the gift of radio equipment

RIG is a sub-group of the SA Scout Radio section established to encourage young people to be interested in amateur radio as a hobby and as part of their Scout activities. It is led by Leanne Adcock

who became involved through her OM and through the station run at the World Scout Jamboree held in SA early this year, as has been mentioned before. We

wish it very well and hope to hear a club station run by these young people operating in the ALARA Contest, if not this year, certainly by next year.

Our donation of equipment for this group has come about only through the generous gift from Vic VK2EVK. He wished it to be used for the sort of purpose this group appears to be fostering. All the materiel necessary to establish an operational radio station has now arrived in South Australia and is in the process of installation. Next month we hope to bring you a photo of it in use.

## Time to start planning for the next ALARAMEET

Next year on Saturday 10th September we will be meeting in Mildura for the start of another weekend of friendship and chatter. Marilyn VK3DMS has given us an itinerary to help us plan to be there.

If you are intending to travel North during the colder months down South, why not add Mildura to the end of your trip? The weather there is nearly always bright and sunny – I believe Mildura actually has more days of sunshine than the Sunshine Coast does but we won't tell the VK4s about that!

Two full days of activities are arranged with plenty of time for chats as well with an optional tour for those who can stay over the Monday. If you come early or stay later than just for the weekend there are many more interesting places to see and things to do around the inland city.

OMs and Harmonics are invited as well, of course, and will have as much fun as the YLs. Even if you are not members of ALARA all YLs are welcome to come and bring their OMs with them. Once you have enjoyed one ALARAMEET you will become addicted and want to come along to them all. Try it and see.

Details are available in the July 2004 Newsletter and on the ALARA website at [www.alara.org.au](http://www.alara.org.au) or at the special Internet address <http://users.ncable.com.au/gsyme/AlaraMeet/>



The Birthday luncheon with

L-R back row: Meg VK5YG, Jean VK5TSX, Sue VK5AYL, Tina VK5TMC, Shirley VK5JSH, and Christine VK5CTY

L-R in front: Myrna VK5YW, Jenny Zeitz, and Janet VK5NEI

ar

# SPAM

**One of the constant drawbacks I have is SPAM. Yes unwanted emails from anonymous individuals or questionable enterprises with offers that are too good to be true.**

Some of these spam emails turn out to be scams and try to unwittingly get the individual to go to fake sites to "verify" your account or commercially sensitive information. I am aware of several elderly individuals who were personally duped into going to what appeared to be an official bank site on the web, which in reality was a spoof site. They unwittingly gave away their personal information and found out that one of their accounts was completely cleaned out. Fortunately the amounts were small but they had no way of recouping their money. However they did check with their bank and were quickly warned to change their personal information before any further damage could be done. Official financial institutions do not generally advise their clients by email to verify their sensitive personal information on the web.

These spoof sites are deliberately made to look very similar to the official sites and mimic their address yet with some letters or addresses in different order. Not surprisingly most of these fake sites are criminal enterprises and are hard to trace, often in third world nations. So be careful what you do share and with whom on the Web. Have you got a good firewall to prevent unauthorised persons or groups reading your information whilst you are online?

It is also advisable to have several email addresses for specific purposes

and keep some private. One mistake I made was to put my main email address in a tagline and this was apparently mined by one of these Spam merchants. Once this has happened it is almost impossible to stop them from flooding your inbox. For instance on an average day I get 150 emails, under half of them legitimate emails. I do use antispam measures based on content and email addresses and although this works, it does have a serious drawback that it has blocked legitimate emails. Therefore you should always check your junk mail for any hidden legitimate emails.

Many shortwave stations do have email addresses and it was often quicker and cheaper to use the Internet but because

**Many shortwave stations do have email addresses and it was often quicker and cheaper to use the Internet but because of Spam flooding their inboxes, I now rarely get a reply... A letter still works although it takes longer and much more expensive than an email.**

of Spam flooding their inboxes, I now rarely get a reply as I did, just a few years ago. A letter still works although it takes longer and is much more expensive than an email.

## The Voice of America

The Voice of America has recently been in news, following the recent demotion of their News Director and the imminent closure of several overseas bureaus in Europe and Asia. A petition was hastily organised and sent to the US Congress. Apparently the staff also were far from complimentary of the semi-clandestine stations, Radio Sawa, Radio Farda and Al-Hurrah TV. The parent organisation of

the VOA, the International Broadcasting Bureau (IBB) also recently announced that Radio Liberty, presently based in the city of Prague, the Czech Republic, is going to relocated further outside of the city centre because of ongoing security concerns.

## DRM

The July issue of "AR" had a very interesting report on DRM reception by Brian, VK3BCZ. As he pointed out, this "new" mode does indeed have drawbacks in that you will definitely need a wide IF stage of at least 12.5 kHz and minimal receiver noise to be effective. At this stage, manufacturers are still reluctant to produce models in commercial quantities to make DRM viable. At present, most of the test DRM broadcasts are based either in Europe or via Sackville, Canada. Very few are beamed to this region. Although DRM is there, I have yet to personally judge the difference.

## Digital TV

Digital Television has been here in northern Tasmania for about 12 months and in late July, the two existing commercial stations commenced broadcasting and were joined by a digital only broadcaster, relaying channel 10 in Melbourne. Digital Pictures are indeed better than the analogue but alas the programming is still lousy!

I do have an email address for any comments or suggestion you may have. It is vk7rh@wia.org.au. Good listening and 73.

ar

## RADIO AMATEURS OLD TIMERS CLUB OF SA

**The ANNUAL LUNCHEON will be held on Thursday 21 October 2004 at 12 noon for 12 30pm lunch at Marlon Hotel, Marlon Road, Mitchell Park, Adelaide.**

**RSVP Ray Deane VK5RK Phone 08 8271 5401**

# Over to you

## Questionable questions

Not only did Ian Godsil, VK3JS, raise a few questions (Contests, AR July 2004); he also raised a few eyebrows. Ian, quite rightly, criticised the Central Highlands Amateur Radio Club of Tasmania (CHARCT) for the length of time it took to produce the results of the 2003 Wadda Cup Contest. CHARCT has taken this criticism on board and has sincerely apologised to the contest participants and amateurs in general. CHARCT is very aware of the responsibility that comes with the sponsorship of a contest and whilst problems may and do occur, the real test is how changes are made to avoid similar problems in the future.

As to the idea that the winner of the contest becomes the manager for the following year, Ian suggested this was a mistake and considering the outcome for 2003, CHARCT agrees. The management of the Wadda Cup Contest has changed; in order to overcome a repeat of the problem experienced in 2003. This really should have been the end of the questions and comments made on assumptions. However, there was more.

Ian wrongly assumed that the reason

the results were not published in a timely manner was due to the passing of the management of the contest. The reason has been stated in the official CHARCT 2003 Wadda Cup Contest results and was due to personal problems and not the ability of the contest manager.

I feel that Ian's comment "she'll be right, mate" was over stepping the mark. If this was directed at amateur operators in general, Ian needs to remember that our hobby is a very personal affair. Some people do not like contests and many contesters are choosy towards the type of contest that they enter. They should not be admonished for that. If this comment was directed at CHARCT, then maybe Ian should find out a few facts before making such an outlandish claim.

How far do we go trying to be uniquely Australian? Where on earth did this question spring? This seems to me conjecture based on nothing. CHARCT has endeavoured to make the Wadda Cup Contest as interesting as possible and foster changes to the contest rules to reflect what contesters want. Some readers of Ian's column have construed "uniquely Australian" as a

very derogative comment, considering the context of its use. I would prefer to read encouraging answers rather than questionable questions about contesting from the Federal Contests Coordinator.

I have taken over the management of the Wadda Cup Contest. If Ian has any comment to make on any future event, I suggest that he make contact with me and arm himself with facts before making comments that may be considered uninformed if not a little offensive.

As to the question "should anyone take part in a contest that they are managing", I say most definitely yes. I am yet to hear a valid argument as to why not. There may be those that would suggest that a manager should not take part in a contest to ensure that there is no fiddling. I feel that this is very cynical and does not reflect the spirit of amateur radio. So, Ian, do have a go. I will always have a go at any contest that I am managing.

Vincent Henderson, VK7VH  
2/6 Lissadell Court  
Newtown 7008  
Tasmania

## Cable and Connectors

- RG58C/U Belden 8259 @ \$0.90 per metre
- RG213/U Belden 8267 @ \$4.45 per metre
- RG8/U Belden 9913 Low Loss @ \$5.15 per metre
- RG8/U Belden 9913F7 High Flex Low Loss @ \$5.55 per metre
- RG8/U - RF400 Belden 7810 Low Loss Sweep Tested to 6000MHz @ \$6.30 per metre

- RG58: B80-006 UHF connector (M) @ \$7.65 each
- RG8/213: B80-001 UHF connector (M) @ \$8.80 each
- RG213: B30-001 N connector (M) @ \$9.10 each
- RG8: B30-041 N connector (M) @ \$14.00 each

# connektron

ABN 19 413 484 007

email [sales@connektron.com.au](mailto:sales@connektron.com.au) or Phone (03) 9761-5220

connektron Pty Ltd, 45 - 49 Merrindale Drive, Croydon South, Victoria 3036

[www.connektron.com.au](http://www.connektron.com.au)

- All prices include GST
- Minimum order value \$50 payable by Visa, Mastercard, Bankcard or Money Order
- Packing and Delivery \$15 within Australia (Outside Australia P.O.A.)

## Contest Calendar September - November, 2004

4/5	Sep	All Asian DX	(SSB)
11/12	Sep	Worked All Europe DX Contest	(SSB)
25/26	Sep	CQ/RJ WW RTTY DX Contest	(RTTY)
2/3	Oct	Oceania DX Contest	(SSB)
2	Oct	Psk 31 Rumble	
3	Oct	RSGB 21/28 MHz Contest	(SSB)
9/10	Oct	Oceania DX Contest	(CW)
16/17	Oct	JARTS WW RTTY Contest	
16/17	Oct	Worked All Germany Contest	(CW/SSB)
17	Oct	Asia-Pacific Sprint Contest	(CW)
17	Oct	RSGB 21/28 MHz Contest	(CW)
30/31	Oct	CO WW DX Contest	
7	Nov	High Speed Club CW Contest	
13/14	Nov	Worked All Europe RTTY	
13/14	Nov	Japan Intl. DX Contest	(SSB)
13/14	Nov	OK/OM DX Contest	(CW)
19	Nov	YO Intl. PSK31 Contest	
20/21	Nov	RSGB 160 Metre Contest	(CW)
20/21	Nov	RNARS CW Activity Contest	
27/28	Nov	CO WW DX Contest	(CW)

## 2004 VK/ Trans-Tasman 160 Metre Contest

### Concise Results

<b>Winner, VK/Trans-Tasman Trophy</b>	VK3IO Ron Tremayne, Cockatoo 983 points CW
<b>(highest overall score):</b>	(first CW station to win a VK/ trans-Tasman Trophy)

### Category 6 - Phone:

#### Participation factor:

27 ZLs divided by 77 VKs = 0.351.

- All ZLs points for contacts with VKs X 0.351.

**Equal 1st:** VK3BF (Multi-operator) - refer Rules 572  
Alan Tubb and Victor Punch, Wheeler's Hill  
VK5AY Bronte Wood, Lyndoch 524

**2nd:** VK3EK Robin Ashlin, Bairnsdale 495

**3rd:** ZL2CC Mike Mather, Gisborne 408

### Category 7 - QRP Phone:

**1st:** VK3UBM Michael Borthwick, Hawthorn 35

### Category 8 - CW:

#### Participation factor:

23 ZLs divided by 29 VKs = 0.793.

- All ZLs points for contacts with VKs X 0.793.

**1st:** VK3IO Ron Tremayne, Cockatoo 983

**2nd:** VK2BPL Paul Linsley, Teralba 588

**3rd:** ZL1JG Ron Dent, Auckland 554

## Silent Key

### Geoff Bower VK2OI

Geoff Bower's daughter Christine M. Laden has informed the WIA that Geoff passed away in July.

Our sympathy is extended to his family and friends

VK5UE Editor

# The Wadda Cup heads to VK5-Land

Vince Henderson, VK7VH  
 2004 Wadda Cup Contest Manager, email - vk7vh@hotmail.com

**Firstly, The Central Highlands Amateur Radio Club of Tasmania (CHARCT) makes a sincere apology to all entrants of the 2003 80m dash for the Wadda Cup, and amateurs in general, for the length of time it has taken for this article to be published.**

While the idea of the contest winner to operate as the contest manager for the following year had some merit and was certainly different, there were some problems. The reasons why there were problems are of a personal nature and unavoidable. The contest management system just needs to be changed to ensure the smooth running of the entire event and avoid any problems that might hinder the contest in the future.

I undertook the position of contest manager for the very first event. I am happy to pick up the baton for the 2004 event. I will continue in this role. So for now, the buck stops with me. If you have any suggestion regarding the future running of the Wadda Cup Contest, I would welcome your comments. The Wadda Cup Contest is alive and back on track. Please have a go at the 2004 event. I am sure you will have a great time.

CHARCT has changed the contest rules to ensure that the actual management of the contest will remain with CHARCT. The contest winner will still have a role in the contest for the following year. This will be limited to on air activity and will be optional. In keeping with CHARCT's aim to make the 80m Dash for the Wadda Cup interesting, some subtle changes have been made. The Wadda Cup Contest will always have an evolving nature, reflecting what contesters want from this type of contest, whilst maintaining a platform that will encourage first time contesters.

The 2003 80m Dash for the Wadda

**Rumour File**  
 Heard a rumour recently that after some eight or nine years, Alek Petkovic VK8APK, may stand down as Manager of the RD Contest. A possible replacement may be Chris VK4AA. More details later.

Cup was won by VK5SR. This is the club station of the South East Radio Group, based in Mt. Gambier. The club station operator was Kevin Johnston (VK5KJ) using a Kenwood TS930 into a dipole at 30 metre. Kevin had a great signal, which I am sure contributed to his fine score, 7 points clear of his nearest rivals. Congratulations, Kevin, for achieving such an outstanding result.

Second place was a tie between John Laan (VK3MGZ) and Paul Butler (VK2BPL). Paul is an ex PNG amateur, P29PL, and the Wadda Cup was the first contest he has entered in Australia. Well done Paul. You will see from the results that the top scores were very close. Even third place was a four-way tie.

Although there was only one SWL log entered, Ben Henderson's score of 26 was very respectable. What is remarkable about this entry from Ben is that he is just 7 years of age. Yes, you guessed correctly, Ben is the son of the

writer. However, Ben did it all on his own. Hopefully, the 2004 event will see a few more SWL entries. I am sure Ben will try and defend his crown and some competition will keep him on his toes. If you are a SWL and have never entered a contest before, the Wadda Cup is an ideal first time contest. Why not give it a go.

The 2004 Wadda Cup Contest is set down for 23 October this year. Look for the full article, including the rules, in the September 2004 issue of Amateur Radio Magazine. Alternatively, just go to the CHARCT web site [www.vk2ce.com/vk7cht](http://www.vk2ce.com/vk7cht). I encourage you to have a go at this short, fun contest. The Wadda Cup (also known as "The Old Mug") is a great looking trophy and the winner gets to hang on to it for a year. I am reliably told that the Cup can be put to good use as a drinking vessel. Evidently, it will hold a pint of your favourite ale.

If you need any further information

about the Wadda Cup Contest, CHARCT hold an on air quiz every Thursday evening at 8.30pm local time. Tune around 3.585 MHz and give them a shout. You would be most welcome to join in the quiz, which is a lot of fun and usually lasts for 30 - 40 minutes. Alternatively, the Tasmanian Devil Net is on the same evening (same frequency), ably run by Dale (VK3YR), at 8.00pm. Information is also available on this net.

## The 2003 Wadda Cup Contest results

Call sign	Score
VK5SR	29 *
VK3MGZ	22 **
VK2BPL	22 **
VK3EK	20 ***
VK2LCD	20 ***
VK7JGD	20 ***
VK7KZ	20 ***
VK4KSS	19
VK7VH	19
VK3MSW	18
VK3GER	18
VK3JSS	18
VK3FH	16
VK3KMB	16
VK5GX	14
VK4MIA	12
VK3MMM	12
VK2JHN	7
VK3JKY/7	6

Ben Henderson 26 (SWL certificate)  
 \* = First place and trophy winner  
 \*\* = Second place certificate  
 \*\*\* = Third place certificate

Congratulations to everyone that participated in the 2003 event. Your continued support will ensure that the Wadda Cup Contest will continue to grow from strength to strength.

Happy contesting



# 2004 Wadda Cup Contest

**The Central Highlands Amateur Radio Club of Tasmania (CHARCT) will hold the 2004 80m Dash for the Wadda Cup on 23 October 2004.**

This is the third running of the Wadda Cup Contest. Participants from previous years will know that the rules have evolved to suit notable change requests received from contest entrants. This year is no different and there are a few major changes and an additional bonus for the winner.

The contest date and time have changed. This is due to the large number of contests that are held from May to September 2004. October is light on for contests and this is one of the reasons why the contest has been moved to a later date. The other significant change is that the sequential number exchange is not required. The new system requires you to give your callsign and your Christian name. Your name is the contest exchange. This should encourage more people to participate in the call back as no one will know the score of the other participants until the call back has been completed.

In past years, the winner of the contest would become the contest manager for the following year. As 2003 proved, this could lead to problems. The contest management will now remain with CHARCT in Tasmania. The winner will become the "on air contest coordinator" for the following year. All that is required of the previous winner is to operate as VK7CHT/P and conduct the call back at the end of the contest. All on air score recording, receiving of logs, rule changes, articles and general contest management will be done by CHARCT.

CHARCT has decided that the contest winner will receive a replica Wadda Cup. The winner will retain the replica. The winner will still retain the original Wadda Cup, for 12 months. Previous winners of the Wadda Cup will also be sent a replica, after the 2004 event.

## Contest bonus

The contest also offers amateurs the opportunity of accumulating contacts for two Tasmanian awards. The CHARCT Tassie Trout Award is available to any amateur that makes contact with

14 CHARCT members. Full details, including the current membership list, are available on the club's website [www.vk2ce.com/vk7cht](http://www.vk2ce.com/vk7cht)

Also, the Tasmanian Division of the WIA has the Tasmanian Devil Award. Contact with 50 VK7 amateurs is the only requirement on HF. More details are available on the VK7 division website [www.tased.edu.au/tasonline/vk7wia](http://www.tased.edu.au/tasonline/vk7wia)

Contest aims

- Encourage on air activity in a short, friendly contest.
- Provide amateurs with the opportunity of accumulating contacts for the Tassie Trout Award and the Tasmanian Devil Award.
- Encourage entry by first time testers.
- Promote on air activity of VK7 amateurs.
- Encourage SWL participation, especially SWL's that have not entered a contest.

The complete Wadda Cup rules are as follows -

## Contest date and time

The contest will be held on Saturday 23 October 2004. The contest will be 60 minutes duration. The start time is 1000 UTC (8.00pm EST, 9.00pm Tasmania) until 1100 UTC (9.00pm EST, 10.00pm Tasmania).

## Pre-contest announcements

The contest on air coordinator will be the club station VK5SR. Kevin Johnston (VK5KJ), the winner of the 2003 event, will operate as VK7CHT/5 (CHARCT club callsign) during the contest. Contact with VK7CHT/5 will earn 2 bonus points. VK7CHT/5 will not be eligible for the Wadda Cup or any contest award certificates.

All contestants are asked to listen on 3.585 MHz (+/-), 15 minutes prior to the start of the contest. CHARCT President Bob Geeves, VK7KZ, will give a short address and officially launch

the 2004 80m Dash for the Wadda Cup. VK7CHT/5 will give an UTC time check, on this frequency, 2 minutes before the start time.

## General rules

1. The contest is open to all VK amateurs and SWL's.
2. A station may only be worked once during the contest.
3. The exchange will consist of your call sign and your Christian name. Sequential numbers DO NOT need to be exchanged. RS exchange is not required.
4. The contest is phone only, using LSB on the 80m band. Frequencies to be used are from 3.540 MHz to 3.625 MHz.
5. Maximum power is 100 watt.
6. Entry categories -
  - Category a) Single operator entries only. No multi-operator entries are allowed.
  - Category b) Short wave listeners (SWL).
7. The winner of the 2004 Wadda Cup will be the on air contest coordinator for the 2005 event. This is not a great chore. The on air manager only needs to operate the CHARCT club callsign (VK7CHT/P) and conduct the contest call back at the end of the contest. If, for any reason, the winner is unable to operate as the on air contest coordinator for the following year, CHARCT will take over the role for that year.

## Scoring

- Category a)
  - i. Contact with any VK amateur scores 1 point.
  - ii. Contact with VK7CHT/5 scores 1 contact point plus 2 bonus points = 3 points.
- Category b)
  - i. All recorded contacts score 1 point

- ii. VK7CHT/5 may be recorded more than once, however, the 2 bonus points may only be counted once.

4. It is a pre-requisite that the contest winner, 2nd place contestant(s), 3rd place contestant(s), as per the call back, and all SWL's must send their log no later than 23 November 2004.

The count back will be based on the number of contacts made during specific time blocks. Although the count back procedure will be decided prior to the contest, details will only be revealed during the count back.

## The contact and move rule

1. After calling CQ contest and establishing a contact, the calling station must move their calling frequency by at least 5kHz.
2. A station answering a calling station may make one call on the same frequency and exchange names with another station. The calling station must then move their calling frequency by at least 5kHz.

### Example -

VK7VH calls CQ contest on 3.560 MHz. VK7KZ answers the call and exchanges names with VK7VH. When the contact is completed, VK7VH must move frequency by at least 5kHz. VK7KZ may then call CQ contest on 3.560 MHz. VK2CE answers VK7KZ and exchanges names. VK7KZ must move at least 5kHz etc etc.

### Logs

1. All participants must keep a separate contest log sheet. Use 3 headings - UTC time, Station worked, Name (Christian name of the station worked).
2. SWLs should record UTC time, the call sign of both stations and the name sent by each station.
3. Retain your log for checking. During the contest call back, the on air contest coordinator will advise you if your log is required to be sent to the contest manager. If, for any reason, you are not able to participate in the call back, you must send your log to the contest manager for inclusion in the contest results.

Send postal entries to -  
The 2004 Wadda Cup Contest Manager  
2/6 Lissadell Court  
Newtown  
Tasmania 7008

Send e-mail entries to -  
Vk7vh@hotmail.com

E-mail entries will be accepted in txt, word 6, excel 6-format or text output from any logging program. Attach the file to the e-mail. Please do not put your log into the body of the e-mail text. Put your call sign 2004 Wadda Cup Log into the subject heading.

Logs must be legible and show the details required in Log rule1 (Log rule 2 for SWL). Attach a summary sheet showing the entrants callsign, name, address and claimed score. If your log is not received by the due date, you may be excluded from the contest results. You will be advised during the call back if your log will be required as a check log.

3. The provisional winner, 2nd place contestant(s) and 3rd place contestant(s) will be declared official when logs have been received and checked by the contest manager.
4. The contest manager's decision will be final.

## The awards

1. The winner will be awarded the Wadda Cup, suitably engraved, for a period of 12 months. The Wadda Cup is a classic silver cup and has become known as the "Old Mug". The winner will also receive a replica of the Wadda Cup and the first place award certificate.
2. All 2nd place contestant(s) and 3rd place contestant(s) will receive an award certificate.
3. The highest SWL score will receive a special contest award certificate.

## The winner

All contest participants are asked to listen for VK7CHT/5 on 3.585 MHz (+/-) immediately after the conclusion of the contest. Add up the number of contacts that you made, during the contest, and if you worked VK7CHT/5 add 2 bonus points to your final score. Follow the on air roll call to find out the provisional winner of the Wadda Cup and other contest award certificate winners.

1. The winner will be the entrant with the highest score.
2. Should there be more than one entrant with the highest score, an on air count back will be conducted by the on air contest coordinator.

## Results

When the contest manager has verified all logs, the results will be published on the CHARCT website. Results will also appear in Amateur Radio magazine.

If you need any further information about the Wadda Cup Contest, the Central Highlands Amateur Radio Club of Tasmania (the contest organisers) hold an on air quiz night every Thursday at 8.30pm local time. Tune around 3.585 MHz and give them a shout. You would be most welcome to join in the quiz, which is a lot of fun and usually lasts for 30 - 40 minutes. Alternatively, the Tasmanian Devil Net is on the same evening, ably run by Dale (VK3YR), at 8.00pm. Information is also available on this net.

Whether you are a keen contester or someone that has not tried contesting before, we encourage you to have a go at this year's event. Have fun during the contest and don't forget to join in the roll call at the end of the contest.

Goodluck and happy contesting  
**Vince Henderson, VK7VH**  
2004 Wadda Cup Contest Manager

## Oceania DX Contest

Please note that due to difficulties with our server, the latest web pages for the Oceania DX Contest have been temporarily moved to:

<http://www.nzart.org.nz/nzart/Update/Contests/Oceania/default.htm>

Also, remember to book the following dates for the 2004 Oceania DX Contest in your diaries:

PHONE Section: 0800 UTC Saturday  
2 October to 0800 UTC Sunday 3  
October 2004

CW Section: 0800 UTC Saturday 9  
October to 0800 UTC Sunday 10  
October 2004

73 Brian Miller ZL1AZE  
Chair Oceania DX Contest Committee

## AMSAT-VK HF net ceases to meet formally

You will notice there are some changes in the "Title-Box" this month resulting from the discontinuation of the long running HF net. After much discussion it has been decided to close the net on HF and use Echolink as our primary means of keeping in touch. This has come about for a number of reasons. Trials have been made over the years of different times and different frequencies for the net. Due to the vagaries of HF propagation from season to season, no permanent time and frequency could be arrived at. It proved necessary to

make changes during the year, every year. One of the outcomes of this was that at every change a different group of amateurs would be affected as no time or frequency would be suitable for all parts of Australia for the whole of the year. The Echolink net on the other hand has given us the opportunity to pick a time to suit just about everyone. The 0600 UTC time slot equates to "soon after lunch" for the Perth stations, "late afternoon" for the eastern states and "after dinner" for our New Zealand friends. Echolink also affords the opportunity for overseas

stations to take part and this has happened regularly in the short time it has been running. During the past year or so the HF net participation rate has dropped to a low level and the decision to close it was made, albeit reluctantly so that Graham would not have to commit the Sunday evening as well as the afternoon away from his family. To that end he has suggested that the HF group continue as an informal discussion gathering rather than a formal AMSAT-VK net. So - if you feel inclined to come on HF at the usual times each second Sunday evening - please do.

## Echo open to users

AO-51 was turned on for general use in FM repeat mode on 30 July 2004. During the trial period of about three weeks the command stations will be watching the power budget and adjusting the UHF transmitter B power as needed for good management of the battery. Initially, the transmitter was running at about 1 W and signals were loud and clear. The TXB transmitter will be on 435.300 MHz, which is also a trial frequency. The original frequency of 435.225 MHz is now in regular use by GO-32, so the alternate is being tested to see if it can be used long term.

Uplink: 145.920 MHz FM  
voice with 67 Hz PL.

Downlink: 435.300 MHz FM  
voice.

The downlink transmitter comes on when it hears an uplink signal with a 67 Hz PL tone for about 1 second. It stays on for 10 second after that signal goes away. Note that Echo is still wobbling a great deal and the polarisation sense of the downlink will vary. The control stations will be analysing the WOD for information about how much TX B is on and how the power system is behaving. At the time of writing the digital transponder and the store and forward BBS, are NOT yet open for general use although it is expected that this mode will be tested shortly on a Wednesday "Experimenter's day". Echo was very heavily used in the first few days. It is good amateur practice and common courtesy to let everyone

have a chance. Echo will hear you as well as or better than any previous amateur FM repeater satellite. With the downlink transmitter at 1 W you will need a small directional antenna to hear it well. Reports on the AMSAT-BB have been very encouraging from this part of the world with many contacts being reported. A sharp contrast to the usual "circus" over more populated parts of the world where dozens if not scores of stations have been competing for the single channel available. The command team of Jim White, WD0E and Mike Kingery, KE4AZ are to be congratulated on the way ECHO has been "brought on line" with a minimum of fuss to - (so far) - fulfil all design criteria.

## Concern regarding the CELESTRAK Keplerian element service

It would be difficult to think of any single thing which could impact on the amateur radio satellite service more than "kep elements" being difficult or impossible to obtain. At present our day to day acquisition of fresh data depends to a great extent on the operation of the CELESTRAK web site managed by Dr Tom Kelso. A recently signed act of US Congress has put a cloud over this service. As things stand at the time of writing, Dr Kelso will be forced to

close the CELESTRAK web site on October-1, 2004. It is to be hoped that a way around this situation can be found before that date. It would be extremely difficult if not impossible for any amateur radio organisation to generate accurate Keplerian elements, even for a small group of amateur radio satellites. Those of us who can remember the days before "kep element sets" and BASIC programs written by Tom Clark, James Miller and Karl Meinzer will recall the

weekly scribbles as EQXs (Equator Crossings) were read out painstakingly over HF nets. That would not work in today's environment of auto-tracking and auto-Doppler compensation. We'll all be in deep trouble if something is not worked out on this one. Please go to the CELESTRAK site, read the document and - as Dr Kelso has requested - fill in the questionnaire. Keep your fingers crossed and watch the BB.

# Amateur radio transponder to fly on the SSETI satellite

On Friday the 30th of July, the Chairman of AMSAT-UK - Professor Sir Martin Sweeting, G3YJO - announced a new amateur transponder project to be launched as part of the European Space Agency SSETIExpress satellite. Speaking at the opening of the 2004 AMSAT-UK Colloquium at the University of Surrey in Guildford, he expressed his delight that AMSAT-UK had been able to work with the ESA to provide, at very short notice, an S-band - 2.4 GHz - transmitter. It is intended that the transmitter will be available for use as the downlink of

a single-channel FM transponder. The 437 MHz receiver is being provided to ESA by DF2FQ. These frequencies will enable the many amateurs who already have Oscar 40 equipment to use it in an exciting new way. The 2.4 GHz downlink exciter, switched-mode power supply, control interfaces and power amplifier are being developed by Sam Jewell, G4DDK; David Bowman, G0MRF; Jason Flynn, G7OCD; and Charles Suckling, G3WDG, with Graham Shirville, G3VZV, assisting. It is intended that SSETI Express will be launched

into a sun synchronous 680-kilometre orbit in April 2005. The controllers are planning to run a competition to see who can download and send in the greatest amount of valid telemetry data from the new satellite in the first month or so of operation. So, dust off your AO-40 gear, connect up your high speed TNC and prepare to join in the fun. Remember it will be a LEO so your dish will need to be auto-tracked if you are going to seriously compete for the prize, which is yet to be announced but described as 'valuable'.

## Requirements for higher baud rates

With the advent of AO-51 and its potential for higher baud rates there has been a flurry of questions on this topic on the BB. If your station is already set up to work the 38k4 facility on satellites like UO-36 and MO-46 then it will all work with AO-51 when it switches to high speed mode. So - what are the basic requirements?

The first thing you need to come to terms with is that there is a definite relationship between baud rate and bandwidth. This may sound simplistic but it's not very well understood. 1200 baud packet radio for example can be handled quite easily by piping the data in through the microphone socket and extracting the received data from the loudspeaker socket. Its bandwidth can be handled by the normal audio stages of the average amateur transceiver without any modifications. 2400 baud can just be accommodated, but when it comes to 4800 baud the audio system cannot handle it any longer.

used one or the other of these methods to work the digital transponders on satellites from UO-22 onwards.

When UO-36 was launched in April 1999 it opened up a totally new era in amateur radio satellite communication with higher speed down links and the capability of handling the huge files generated by its digital cameras.

It was soon realised that even connection to the discriminator sections of the radio wouldn't provide enough bandwidth due to the limitations of the transceiver's IF stages.

A totally new approach was needed. In essence one requires a dedicated wide-band IF strip feeding into a wide-band decoder. There are several approaches to this problem and after a lot of investigation I chose the SYMEK system. SYMEK is a German company specialising in high speed packet radio systems. Their TNCs will handle baud rates as high as 116k without too much fuss.

The SYMEK "IFD unit" is a small circuit board that fits into your transceiver and takes the signal from an early mixer to feed into the high speed outboard TNC. This board is essentially the wide-band IF strip from one of their dedicated UHF data transceivers. Coupled to a high speed TNC the system is powerful and bulletproof. Mine worked first time and hasn't put a foot wrong.

There are many other ways to go about it including some software and some hardware solutions but judging by the amount of problems surfacing on the BB, I would go down the hardware track every time.

## The AMSAT group in Australia

The National Co-ordinator of AMSAT-VK is Graham Ratcliff VK5AGR. No formal application is necessary for membership and no membership fees apply. Graham maintains an e-mail mailing list for breaking news and such things as software releases. Contact Graham if you wish to be placed on the mailing list.

## AMSAT-Australia Echolink Net

The net meets formally on the second Sunday of each month. Anyone with an interest in Amateur Radio Satellites is welcome to join in and take part. Graham VK5AGR acts as net controller. The net starts at 0600 UTC and you can join in by connecting to the AMSAT conference server.

All communication regarding AMSAT-Australia matters can be addressed to:

AMSAT-VK,  
9 Homer Rd,  
Clarence Park, SA. 5034

Graham's e-mail address is:  
vk5agr@amsat.org

One way out of this is to use FSK (direct frequency shifting of the carrier) instead of AFSK (audio frequency shifting FM by audio tones) which is used in 'normal' packet radio. This approach reduces the required bandwidth a little but the audio stages of our transceivers can still only accommodate it up to 2400 baud and there's little point in making that step. Even using FSK, the audio section of the rig can't handle 9600 baud and beyond.

You need to make a connection to a wider bandwidth area in the set. This is usually done at the discriminator of the receiver and the balanced modulator of the transmitter. In the early days of UO-22, KO-23 etc. we had to do the modifications to our radios in order to work 9600 baud.

Despite manufacturers claims to the contrary, none would do it "out-of-the-box". Nowadays many radios have a digital I/O port that will handle up to 9600 baud. That's all very well up to 9600 baud and lots of stations have

## Another interesting tracking program

There are many satellite tracking programs out there in WWW-land. Sometimes a new one comes to notice that's worthwhile recommending.

One such is ORBITRON. It is a nice simple yet effective graphic tracker written by Sebastian Stoff of Poland. A Google search will find it. It's quite user-friendly and comes with all the goodies one would expect without being too complicated or overwhelmingly "capable", like some.

ORBITRON can track many satellites simultaneously showing footprints and ground-tracks. Using a driver like WISP DDE or Sebastian's own driver, ORBITRON can control your rotators to track one selected satellite and tune your radios to compensate for Doppler shift variations while a satellite pass is in progress.

It has an auto-update feature, requiring

an open Internet connection, and will automatically download and install the latest Keplerian elements for any group of satellites.

The graphic screen is attractive, functional and intuitive. I rather like ORBITRON and in my opinion it is one of the better ones of the current batch. It is offered free as "card-ware" and is definitely worth a look.

## How much is volunteer labour worth?

A just completed review of work by AMSAT-NA Volunteers, indicated that during the year 2003, members have contributed over \$236,000.00 of "In-Kind" service in the fields of Education Outreach and Spacecraft Development & Deployment. Impressive effort to say the least.

How are these figures calculated? We, the users often take the work of volunteers for granted. It was decided some time ago to recognise this work by documenting it in some meaningful way. Gunther Meisse W8GSM Treasurer of AMSAT-NA took on the task.

The above figure is the result of his determinations. Gunther is again requesting details from people who have contributed time to the development of the Amateur Radio Satellite Service. He

asks them to contact him with details so he can make the calculations for 2004. He has listed the following categories:

### *Satellite Development/ Operations*

- Satellite Design
- Satellite Construction
- Satellite Ground Control Operations
- Software development

### *Educational Outreach*

- ARISS Design & Construction
- ARISS Ground operations (School Contacts)
- Journal Editing
- Journal Writing
- ANS Editing

- ANS Writing
- AMSAT Publications (Example: "ECHO Operation, Development & specifications")
- University Lecturing or mentoring
- University Satellite meetings (Micro & Cube etc)

I know of several VK amateurs who have contributed time and effort in one or more of these categories. If you are one who has spent volunteer hours in any of the above categories in the past and you have a good sense of the total hours you are spending in 2004, Gunther would love to hear from you in order to make the figures for 2004 as complete as possible. Contact <in-kind@amsat.org> for further information

## John Kraus W8JK, pioneer researcher SK

**It is fitting that a column devoted to amateur radio satellites should record the passing of this great scientist, inventor, writer, astronomer and radio amateur. He died at the age of 94 on July 18, 2004.**

The name John Kraus and his call sign W8JK were household words in amateur radio circles when I started building amateur radio antennas in the late 1940s. His antennas were spoken about with great respect, even awe. Innumerable stations, both amateur and commercial used his designs.

John Kraus was a real "nuts and bolts" scientist. His antenna concepts were tried out in his own backyard or basement workshop and passed on to his graduate students at the Ohio State University to develop and refine.

His autobiographical book "Big Ear" is more than just the fascinating story of the leading radio astronomy installation of its age. It is a deep look into the mind of

the man and the "crystal-set" beginnings of a life devoted to experiment and research. Along with several of his books, "Big Ear" has a treasured place on my bookshelf.

Although John Kraus's life as a scientist began long before the satellite age, the whole industry owes him a huge debt for his masterly research into concepts like circular polarisation and his invention and development of the helix antenna. When communication satellites became a reality in the 1960s, John Kraus's helix antennas were there, fully developed and documented, waiting to be used. They are still used to send signals back millions of kilometre through

space from planetary and deep space scientific probes. AMSATers use them to communicate with amateur radio satellites on frequencies from 145 MHz to 2.4 GHz. It's hard to think of a more ubiquitous antenna.

John Kraus was even more widely known for his prolific contributions to Radio Astronomy. His book of that name is still the definitive text for science graduates entering a career in that field. John's opus magnum, simply named "Antennas" and its companion "Electromagnetics" have never been surpassed as definitive texts in their field. John Kraus W8JK, a life to be remembered.

ar

# VHF/UHF - An Expanding World

David Smith VK3HZ - vk3hz@wia.org.au  
Leigh Rainbird VK2KRR - vk2krr@telstra.com

## Weak signal

David Smith - VK3HZ

Even in the depths of winter, there are still some interesting propagation conditions for the VHF/UHF weak signal operator.

On the evening of 13 July, Leigh VK2KRR encountered some unusual conditions from his QTH near The Rock. The Adelaide 2 m beacon was audible at S5 and the Mt Gambier 2 m beacon was peaking around S2. Contacts were had with Colin VK5DK (5/4) in Mt Gambier and Russell VK3ZQB (5/3) in Port Fairy. However, no stations could be raised in the Adelaide area. At about 11 pm, Leigh checked for the VK6 beacons and saw, on Spectran, a faint line on the frequency of the Esperance beacon (VK6REP - 144.568 MHz) - a distance of over 2300 km. At first, he thought it was probably a birdie. However, after monitoring the signal for a while, the 100 Hz FSK keying offset and timing confirmed unmistakably that it was the beacon. The signal came and went over the next 4 hours, never quite becoming audible, and finally disappearing at 3 am. Leigh believes that an SSB contact may have been possible, and certainly a digital contact (JT44 or JT65) would have been easy.

Speaking of digital contacts, rumour has it that Joe K1JT is working on development of a new, weak-signal digital mode that will have substantially better performance. Tests have shown that it can decode signals that are around 7 dB weaker than JT65 can decode. With performance like that, EME contacts

between two single-yagi stations would not be out of the question.

Rod VK2TWR reports that the VK2RSF beacon at Hudson Peak, south of Cooma on 144.414 MHz is back on air after a problem with the antenna. A huge dump from a one-in-twenty year snowfall, together with ice build-up on the top big wheel antenna caused a break in the feedline. It took several weeks before the beacon site became accessible again, for repairs to be carried out.

Graham VK3XDK has been busy constructing a portable 2 m EME setup. The antenna array consists of 4 10-element DL6WU-design yagis mounted on a large tripod. The array can be set up and dismantled by one person in a very short time, and is readily transportable in a normal vehicle. No results yet, but it looks very promising.

## News from Christopher, VK2DO:

After thirty years operating from the Canberra region, Chris VK1DO has consolidated activity under his NSW callsign from Carwoola, just east of Canberra. This location has an ideal outlook and ought to be a great catalyst in working further afield on VHF/UHF.

This move has condensed his previous weekend location at Rossi, some 50 kilometres SE of Canberra and his home of 19 years backing the reserve in the



southern suburb of Farrer. Chris is well known as a participant in the annual field day contest with brother Andrew, VK1DA and partner in crime, Geoff VK1CO

The new location has some thirty acres of space and initial indications suggest a crackerjack location for VHF/UHF and as well as a peaceful spot, the RF silence is much appreciated. With neighbours no closer than half a kilometre, a little uglification of the skyline is immaterial as is the radiation of a little ERP.

Since early April, progress on antennas has been slow. However, two long yagis are serving well on 2 m, 70 cm is awaiting new feeds, 23 cm is being re-assembled and apart from three Nally towers already in the ground and two more to come, Chris has been distracted working some 80 m grey line DX.

The outlook is very promising based on initial reports from Melbourne, Lakes Entrance, Bendigo, Kyabram etc. However, to again work a VK5 is anxiously awaited. Chris looks forward to reacquainting himself with the many stations in VK2, 3, 4 and 5 that he has worked over the years, with the advantage of a new location.

It is a great pity work gets so inconveniently in the way!

Please send any Weak Signal reports to David VK3HZ at vk3hz@wia.org.au.

## Northern Corridor Radio Group HAMFEST 2004

HAMFEST 2004 will be held on Sunday 7th of November 2004 at the Cyril Jackson Centre in Bassendean, Western Australia, the same venue as previous years.

Exhibitors and sellers will be admitted at 8am and the doors will open at 9am for general entry. It will finish at 1pm. The venue has ample parking and is close to public transport.

The kitchen will provide a range of snacks and drinks and a place to sit and enjoy these while you have an eyeball with new and old acquaintances.

The day raffle will offer a number of valuable prizes with a dual band VHF/UHF YAESU transceiver as first prize. There will also be a number of attractive door prizes on offer.

For further information:-

NCRG webpage - <http://www.ncrg.org.au/>

HAMFEST jackborthen@bigpond.com

PHONE Jack Borthen VK6KDX on (08) 9447 5933

# Digital Modes

Rex Moncur - VK7MO

Compression of Signal Reports on WSJT: For the JT44 and JT65 modes WSJT provides a signal report in dB with reference to the noise in a 2.5 kHz bandwidth. The reports typically range from -15 to -30 dB. Operators will have noticed that these reports compress at high signal levels and even an S9 signal on your meter will give a report in the minus dB range. Tests have been conducted with a signal generator, which establish that JT44 and JT65 reports are accurate for signal levels lower than -12 dB but compress for stronger signals. In practical terms this is not a significant issue as JT44 and JT65 are normally used at signal levels of less than -12 dB. It is noted that Spectran has much better dynamic range and is linear from -30 dB to +20 dB when it also starts to compress. The problem with Spectran is that it does not have a reference level (such as the noise in 2.5 kHz bandwidth as used by WSJT) and thus must be calibrated against some other source.

FSK441A or FSK441B on 2 m: Operators during the weekend activity sessions have conducted extensive tests to establish whether FSK441A or B is the best mode for 2 m. These tests have shown that the B mode produces 10 to 20% more valid characters for short pings such as those that produce a single call sign. The typical range for the tests would be 1000 km. Theory predicts that at longer ranges the advantage would be

even greater while at shorter ranges such as 500 km there may be little in it. For pings of longer duration the advantage of FSK441B is likely to be less but then in any case you would receive sufficient information on either mode. Operators are encouraged to conduct further comparative tests at longer (2000 km) and shorter (500 km) ranges, but in the meantime I suggest that FSK441B should be the standard mode in VK.

## Auroral Event

There were periods of strong auroral activity on the evenings of 22, 25 and 27 July that produced signals as far North as VK2KRR near Wagga and VK2TWR at Nimmitabel. Stations heard making contacts were VK3BG, VK3HZ, VK3HY, VK3AFW, VK3AXH, VK3BRZ, VK3XLD, VK5DK, VK5ZK and VK7MO. During this period a number of stations conducted tests by measuring the Doppler shift using a known single tone signal generated by WSJT and watching the shift on Spectrogram or Spectran. The objective of the tests is to establish if we could relate the direction of the Doppler shift dependent to whether it is a morning

or afternoon/evening Aurora. Each of the three periods of this event were afternoon/evening Aurora and for a large majority of the time produced positive shifts or 250 to 500 Hz. This compares with measurements undertaken by VK3UM on an event during the morning of 21 November 2003, which produced a negative shift of 400 to 500 Hz.

Some excellent results and spectrograms of Doppler shift were recorded by a number of stations. The Spectrogram screen shot below was captured by Leigh VK2KRR. It shows VK7MO and VK3HZ transmitting in



alternate 30 second periods, both beaming south into the aurora. The auroral reflection can be seen as the lighter band above the signals. The direct signal from VK3HZ appears as a horizontal line

on the display and multiple aircraft reflections can also be seen, producing Doppler shifted signals offset above and below the main signal.

More detailed summaries of the tests are recorded on Leigh, VK2KRR's, web site at: [http://www.users.bigpond.com/anvdg/australian\\_aurora\\_scatter\\_studie.htm](http://www.users.bigpond.com/anvdg/australian_aurora_scatter_studie.htm).

Please send any Digital Modes reports to Rex VK7MO at [rmoncur@bigpond.net.au](mailto:rmoncur@bigpond.net.au).

## 2 m & 70 cm FM DX

Leigh Rainbird - VK2KRR

With weather conditions seemingly reverting back to a more normal situation, very few openings for southern FM DX operators occurred during July, as weather front after weather front moved from west to east across the southern part of Australia. Similarly, though without the southern type weather fronts, stations in north Queensland also found it was rather quiet, though picking up slightly at times.

Mike VK4MIK near Cairns has noted that the number of openings into the Townsville 2 m repeater has been up in July in comparison to previous months. Unfortunately the path has not

extended further down the coast beyond Townsville. Mike has also had a few simplex contacts on 2 m with VK4FNQ in Charters Towers and VK4ABW in Townsville.

In the south, there was only one period of enhanced conditions during July. This was in the evening of the 13th and morning of 14th July, between areas of VK2, VK3 and VK5. Conditions were noted as being quite poor and had slow QSB, which made a QSO difficult as the path would constantly get too weak and drop out. From Victoria, I heard Bill VK3LY in Nhill making it to Adelaide's Crafers repeater for a short period.

From here I was able to get to the higher repeaters, Lobethal at 747 km, Crafers at 764 km, Barossa Valley at 741 km and Murray Bridge at 733 km was also there. Things were not the best with QSB and weak signals.

That's as good as it gets for this month, slightly depressing. But, the poor conditions make you all the more appreciative of those amazing enhanced openings. Just think, if the band was always open, it would end up being quite boring.

Please remember to send through any 2 & 70 FM DX reports to Leigh VK2KRR at [vk2krr@telstra.com](mailto:vk2krr@telstra.com).

# Know your secondhand equipment

Ron Fisher VK3OM.

Photo 1 - Yaesu FT-7 transceiver.

## FT-7

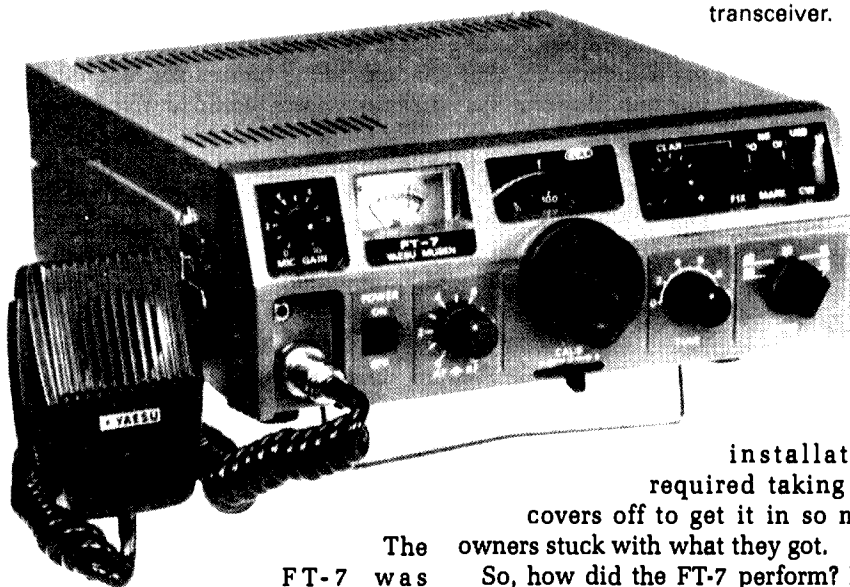

A change of stable this month with a look at two popular Yaesu rigs often found on the second-hand market. But before launching into them, an observation. It's great to hear so many of the new call signs on the HF bands, many of them using older transceivers. Doing a casual poll over a few nights listening on 80 metre I would say that the TS-520 and TS-520S are by far the most popular. I would guess that many of these have been sitting unused for years. Perhaps "someone" might think about starting up a TS520 net, or perhaps an FT-101 net. It's just a thought, but what fun it would be to swap ideas on using these wonderful old rigs.

But for now lets look at a couple of older Yaesu transceivers, firstly the FT-7.

The FT-7 arrived on the Australian market late 1977 at a price of about \$580. However, over the next year or so this had dropped to around \$375. About this time there was quite a price war on between the many amateur radio equipment distributors that existed in those days.

The FT-7 was (and still is) one of the first fully solid state transceivers. It sold alongside the TS-120V. Both had about the same power output, 10 to 15 watt with the FT-7 having just a touch more power than the TS-120V. The FT-7 covered 80 through to 10 metre but this was before the WARC bands. Coverage of 10 metre was limited to one 500 kHz segment. Optional crystals to cover more of the band were available but

installation required taking the covers off to get it in so most owners stuck with what they got.

So, how did the FT-7 perform? In a couple of words, very well indeed. The receiver was probably the hottest thing around at the time. It sounded good most of the time but did suffer a slight bit of front end overload on very strong signals. A popular modification was to wire in a switchable 10 dB attenuator and this was actually incorporated in the later FT-7B, but more about this transceiver in the future article.

Unlike some its contemporaries, the

## Silent Key

### Fred Millington VK2ZFF

This morning, Sunday August 8th, 2004, while I was listening to the WIA Sunday morning Broadcast, I received a phone call to tell me that Fred Millington VK2ZFF, better known as "VK2 Zany Fluffy Flakes" had passed away.

Fred was a member of the St George Amateur Radio Club for many years, when he lived in Ramsgate. During his working life, he worked for a number of companies, the last one being Vane in Allawah. Many hams may still have equipment in their shacks that was built by Fred to check and/or condition car or truck batteries.

In addition to his hobby of electronics, Fred was an amateur student of Egyptology and was held in high regard in academic circles because of his very extensive knowledge.

Fred and his second wife Brenda, made a number of trips up the river Nile, visited many pyramids and other Pharoah burial sites in Egypt. Whenever you walked into his unit in Ramsgate, you were greeted by someone like Nefertiti or Nefertari. Sometimes a bit unnerving!

Fred had suffered a number of strokes in his earlier years, but he never gave up. It might have slowed him down a bit, but he was a fighter from way back.

Fred had a terrific sense of humour. Some people call it "dry" humour. "Here we are in the Sahara desert, we have roughly one hundred thousand dollars in this suitcase, but we can't buy a drink anywhere."

From Ramsgate, Fred and BBBB, his

second wife, better known as "Big Busty Buxom Blonde", relocated to a small place called Oak Flats.

Fred joined the Illawarra Amateur Radio Society and got back on the air. A big storm blew down the tree in his backyard, wrecked his aerials and a few other things, but even that did not stop Fred. With help from a few mates, he was back on the air within a few weeks. From Barton Street in Oak Flats, Fred operated virtually till his dying days.

One day Fred, we'll catch up with you, on that big transmitter in the sky. Have a good rest my friend, till we meet again.

*Hank VK2BigHairyLegs*

Hank Laauw VK2BHL, e-mail h\_laauw@yahoo.com



FT-7 did not sport a digital frequency read-out, but the analogue dial was very smooth and accurate to one kHz. One small problem was that the dial was hard to read in direct sun light.

The analogue VFO was very stable for the time with drift seldom exceeding a couple of hundred Hz from a cold start.

The transmitted signal on SSB was above average with excellent quality from the supplied 500 ohm dynamic microphone. CW operation was also well catered for with semi break-in

operation and sidetone. A 100 kHz calibrator is also included.

These days, the FT-7 is almost a collector's item with mint condition examples selling very quickly. So what are they worth. With most of them around 25 years old, the condition varies from terrible to excellent. However these transceivers can take a beating and still perform well. At the bottom end you might find one for around \$125 and then up to \$225 for a pristine unit. All should come with the matching Yaesu 500-ohm microphone, a mobile mounting

bracket, an original instruction book and a DC power lead. I have a FT-7 in my collection, which I have connected to a small deep cycle battery for use when the AC power goes off. This is one of the joys of living in the country.

To the best of my knowledge, Yaesu made no optional accessories specifically for the FT-7. You will need a suitable regulated power supply with 13.8 volt output capable of supplying about 2.5 to 3 amp and these are often available at hamfests for around \$20 or so.

## FT-707

Another Yaesu that seems to go on forever. The FT-707 arrived on the Australian market in early 1980 priced at around \$750. It was closely related to the larger FT-107, which preceded its arrival here, by a couple of months. The main difference was that the 107 had a built in AC power supply where the 707 was designed as a compact mobile/portable transceiver which was also ideal for home station use with the optional FP707 external power supply.

So, what has the FT-707 got to offer? Firstly it covered all amateur bands from 80 to 10 metre, including the new WARC bands of 30, 17 and 12 metre plus full coverage of the 10 metre band. It was capable of producing a full 100 watt output on both SSB and CW. There was also the facility to transmit AM probably with around 20 to 25 watt output. However, as there was no AM filter available for the receiver this mode was probably not used very much by FT-707 owners.

In addition to an excellent analogue dial, a bright six digit display with readout to 100 Hz is built in. However, by now it is probably not reading the correct frequency. This is easily put right. Follow the instructions on page 37 of your manually, BUT BEWARE; make sure the calibrator is on the right frequency first by checking it against WWV on 10 MHz

So, how does the 707 perform on air. Actually, quite well. The receiver is very sensitive. Selectivity is good and the "width" control is excellent for removing nearby interference. The only criticism is the drifty VFO. It seems to take a long time to settle down and even then it never really completely



Photo 2 - Yaesu FT-707 transceiver.

stabilises. If you can live with this, and it seems that many can, you will have a useful and reliable transceiver.

Transmit audio on SSB sounds very clean with well balanced response. CW is likewise good and if you are lucky enough to have the optional narrow filter fitted you should be happy.

Perhaps the most controversial feature on the 707 was the metering. It consisted of a line of coloured LEDs. While it looked pretty it lacked accuracy. Many owners liked it, many didn't. Interesting to note that Yaesu never used this metering system again on an HF transceiver.

Yaesu produced a number of excellent accessories to match up with the 707. These included an external digital VFO, the FV-707DM, which had up/down scanning and 12 memories. These are quite rare on the second-hand market.

The FP-707 power supply is often seen advertised and is very popular. It has a current output of 20 amp at 50% duty cycle. It has a built-in speaker and makes a nice matching unit for almost any transceiver.

The FC-707 ATU also turns up regularly on the second-hand market. It covers all bands from 80 to 10 metre, and has a power/SWR meter calibrated to 150 watt. It is a nice looking unit but has a limited matching range of 10 to 250 ohm

So, what are all of these worth. The FT-707 sells in a range of \$175 to about \$300. The FP-707 around \$130 and the FC-707 around \$100.

Next time I intend to look at two other Yaesu HF transceivers, the FT-7B and the rather rare FT-77.

In the meantime, good hunting on the second hand market.

**Adelaide-Anchorage**

**30 Brisbane-Lima**

122

**September 2004**

T index: 35

**HF Predictions**

by **Evan Jarman VK3ANI**

34 Alandale Court Blackburn Vic 3130

First F 0-5 Short 12466 km

First F 0-5 Short 13056 km

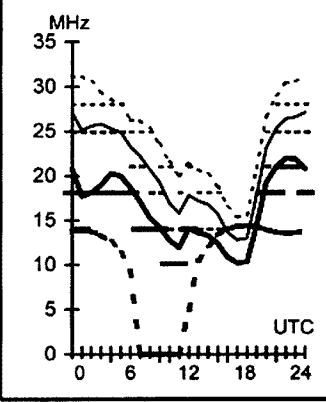
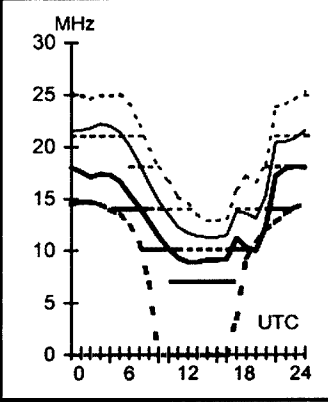

**Legend**

- Frequency scale
- UD
  - E-MUF
  - OWF
  - F-MUF
  - ALF
  - >10%
  - >50%
  - >90%
- Time Scale

These graphs show the predicted diurnal variation of key frequencies for the nominated circuits.

These frequencies as identified in the legend are:-

- Upper Decile (F-layer)
- F-layer Maximum Usable Frequency
- E-layer Maximum Usable Frequency
- Optimum Working Frequency (F-layer)
- Absorption Limiting Frequency (D region)

Shown hourly are the highest frequency amateur bands in ranges between these key frequencies, when usable. The path, propagation mode and Australian terminal bearing are also given for each circuit.

These predictions were made with the Ionospheric Prediction Service program: ASAPS Version 4

**Adelaide-Budapest**

305

**Brisbane-London**

147

**Canberra-Lusaka**

239

**Darwin-Honolulu**

65

First F 0-6 Short 14908 km

First F 0-5 Long 23498 km

Second 4F3-5 4E0 Short 11620 km

First 3F3-7 3E0 Short 8635 km

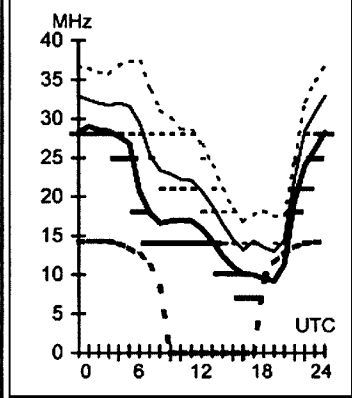
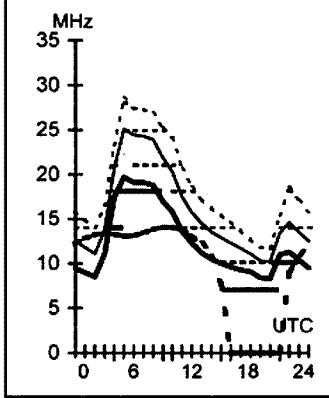
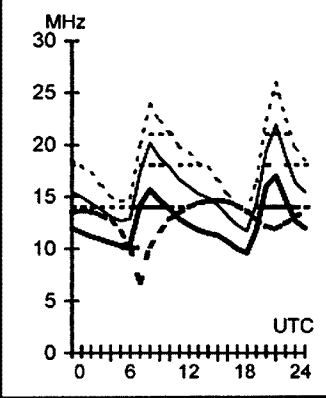
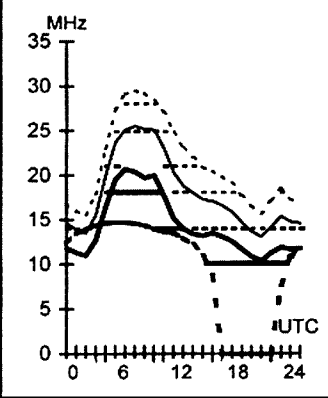

**Adelaide-Suva**

75

**Brisbane-London**

327

**Canberra-Manila**

327

**Darwin-Johannesburg**

241

First F 0-5 Short 4340 km

First F 0-5 Short 16526 km

Second 4F8-14 3E0 Short 6286 km

Second 4F4-6 4E0 Short 10639 km

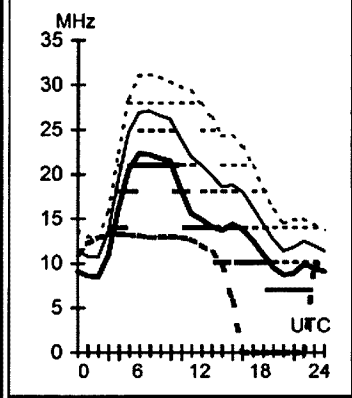
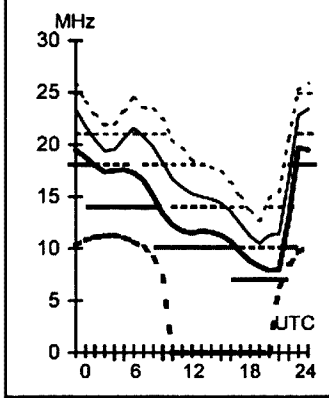
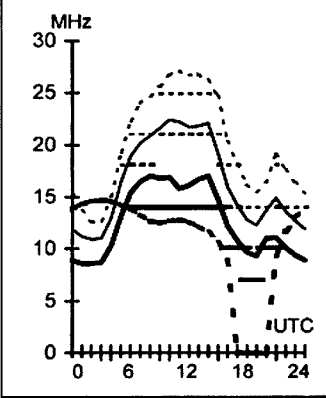
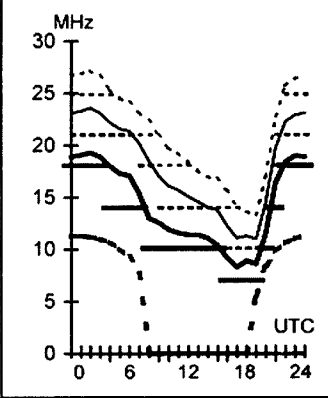

**Adelaide-Warsaw**

312

**Brisbane-Seattle**

44

**Canberra-Ottawa**

59

**Darwin-Wellington**

135

First F 0-5 Short 14818 km

Second 4F2-6 4E0 Short 11846 km

First F 0-5 Short 16100 km

First 2F4-6 2E0 Short 5322 km

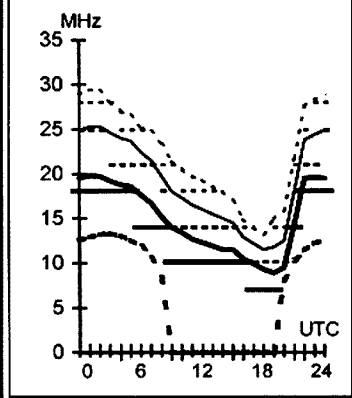
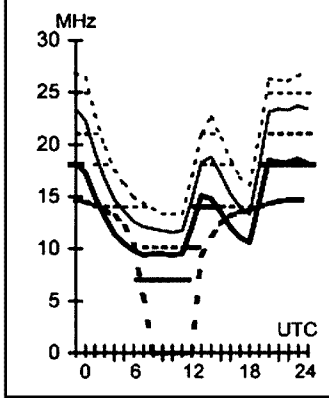
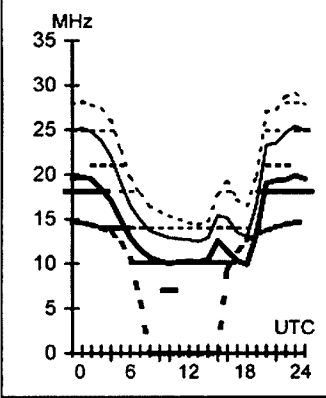
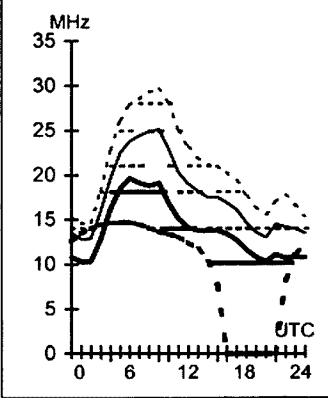

**Hobart-Capetown 220 Melbourne-London 131 Perth-Kuala Lumpur 336 Sydney-Los Angeles 61**

First 3F1-3 3E0 Short 10026 km First F 0-5 Long 23118 km First 2F8-13 2E0 Short 4179 km First F 0-5 Short 12075 km

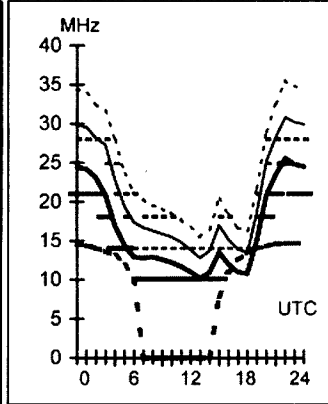
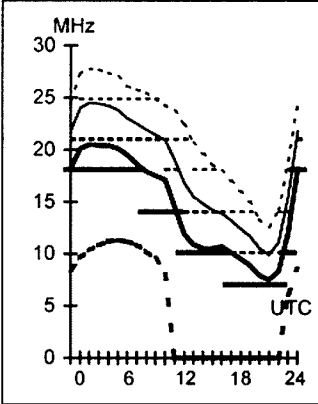
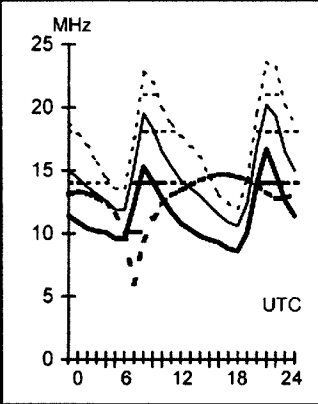
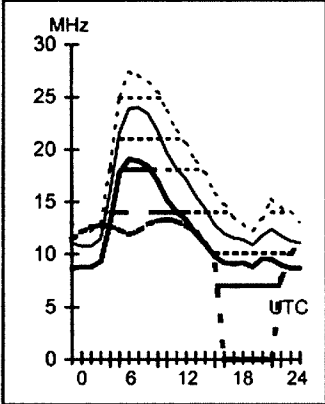

**Hobart-New York 80 Melbourne-London 311 Perth-Rio de Janeiro 203 Sydney-Rawalpindi 304**

First F 0-5 Short 16609 km First F 0-5 Short 16906 km First F 0-5 Short 13523 km Second 4F3-8 4E0 Short 11066 km

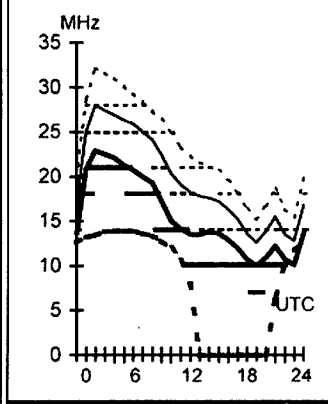
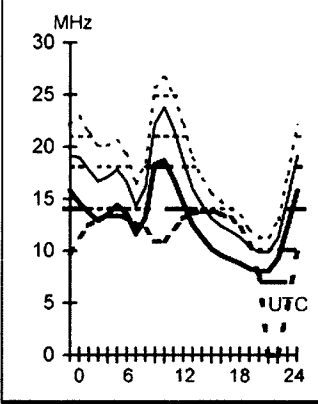
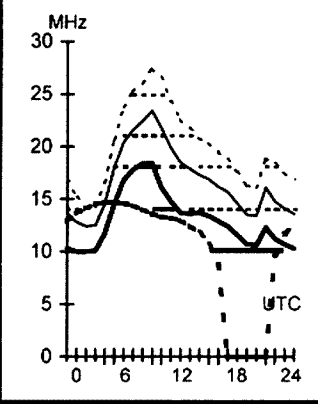
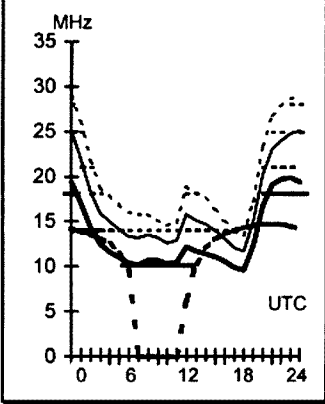

**Hobart-Port Moresby 360 Melbourne-Pretoria 234 Perth-Stockholm 144 Sydney-Santiago 145**

First F 0-5 Short 3710 km Second 4F5-7 4E0 Short 10353 km First F 0-5 Short 26577 km Second 4F3-5 4E0 Short 11347 km

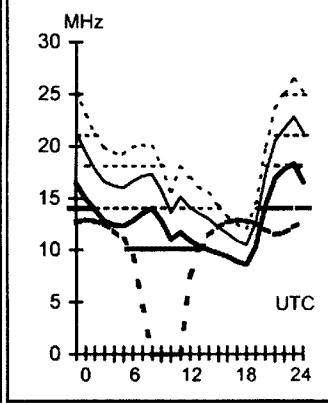
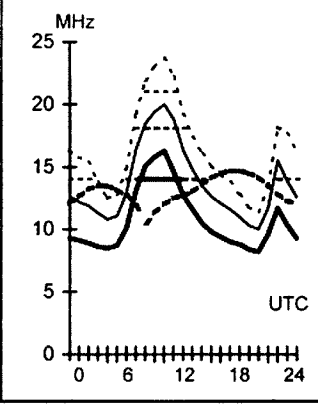
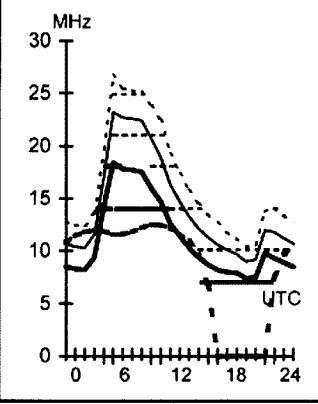
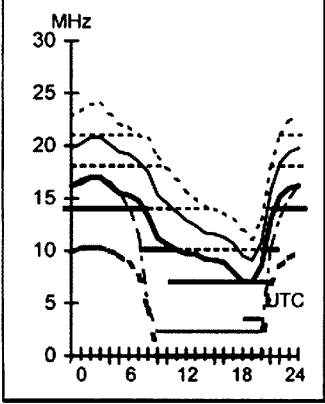

**Hobart-Rome 284 Melbourne-Tokyo 356 Perth-Vancouver 50 Sydney-Singapore 298**

First F 0-5 Short 16350 km First 3F4-7 3E0 Short 8191 km First F 0-5 Short 14823 km Second 3F8-12 3E9 Short 6296 km

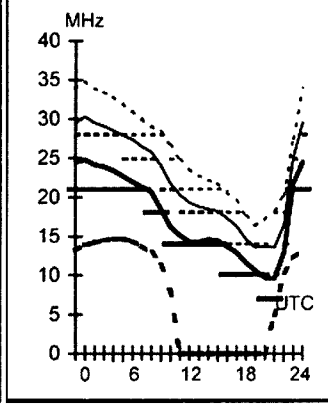
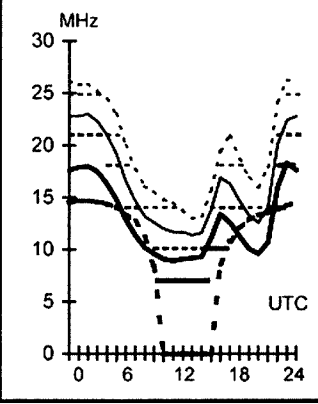
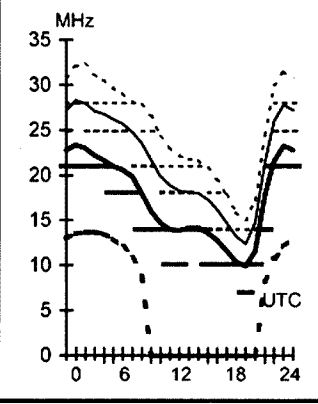
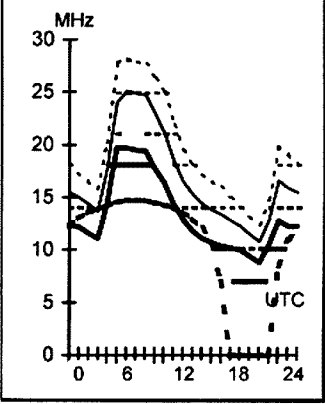

## FOR SALE NSW

Eight long fibreglass poles from 20 metre quad, and spider brackets to mount same. Galvanized tower, 20 metre to boom level, with rotator. Dismantles into trailer-length sections. Make an offer, either or both. Also, free to a good home, back copies of AR from 1960s to 2004. Roger Graham, (used to be) VK2AIV. Phone 02 4234 1431 or email rogergraham@optusnet.com.au.

Yaesu G-5400 B AZ/EL ant controller c/w long cables \$900. SatTrak 3 satellite tracker for 12 satellites \$215. Tiny 2 TNC 1200/9600 switchable controller c/w all cables \$200. ICOM 471A 70cm xcvr incl UX14 converter & mike (small problem with preamp voltage) \$375. G3RUH 400 baud MK2 PSK decoder \$150. 60cm aluminium dish c/w SSB (Germany) 2.4 GHz converter \$525. Mode J 144 MHz SSB (Germany) filter, new \$95. Handbooks/circuits etc for all units. If items 1 & 2 are bought together deduct \$50. All ONO. Art VK2AS Phone 02 9416 7784

## FOR SALE VIC

Antennas. Triband HB-35c, as new \$525, Duoband 20/15 3 ele \$150, 10m 4 ele \$100, 40m Cushcraft D40 dipole \$150, 2m cross Yagi 10 ele \$50. David Phone 0438 393 550.

HF-TET Emtron HB-35c antenna full size triband 10-15-20 m. All in stainless \$200. If you think it's too dear, price a new one. Jack VK3AAC, Phone 03 5127 3905, email vk3aac@amsat.org.

HF-log periodic antenna. ATN 13-30 MHz, All in stainless, 6 elements-6 m boom. \$200.

If you think it's too dear, price a new one. Jack VK3AAC, Phone 03 5127 3905, email vk3aac@amsat.org.

Tower, self supporting, 18 m high, 1.2m base. 160 kph design, fully hot dip galvanised, all comps and drawings for permit, hinged at about 12 m, best offer over \$500. Keith VK3AFI, Phone 03 5281 2264, QTHR

## WANTED VIC

R-1155, CR-100, B-40D, FT7-B, FT-707. Audio amp for TK60, AR88HF, BC348 notes, BC342 notes, Hammarlund HQ-120X, field intensity meter type WX-A, serial no 539 made by Rea USA. Jackson, 38 Mooltan Street, Flemington Vic 3031.

## WANTED SA

Icom IC-490A - all mode 70 cm transceiver, working or not. Phone (08) 8346 7042 QTHR Mervyn VK5MX

Malcolm Haskard VK5BA is looking for detailed picture/s or the loan of a model R-1484 microphone as used with the AWA Teleradio Model 3-B which was used by the CoastWatchers in WW2. He wants to modify a handset he has to match the original. email mhaskard@chariot.net.au

Will Fred Fax 93723076, which does not work, who wanted a JR-60. Please send me Full Name, call sign and a contact number that works

## TRADE ADS

### VK DISCOUNT CABLES

I am currently having specials on the following coax cables. As follows -

Heliex LDF-450 @ \$4.85 Per metre

Heliex LDF-550 @ \$8.00 Per metre

LMR 400 (Belden 9913) @ \$390 per 100m qty (\$3.90 P/m)

RG-58CU @ \$66 per 100m

RG-213 @ \$166 per 100m

LDF-450 male & female N type connectors @ \$40 Ea

BEL 9913 N type connectors @ \$11 ea

Technical data available on request.

Cable samples available on request.

Freight anywhere in VK \$18.50

For any further inquiries on these cables, or any other cables you may require, please don't hesitate to contact me, as we are able to supply anything you can think of!

Regards Rob Long VK2XZ  
rob\_vk2xz@hotmail.com

## About hamads....

- Hamads may be submitted by email or on the form on the reverse of your current Amateur Radio address flysheet. Please print carefully and clearly, use upper AND lower case.
- Separate forms for For Sale and Wanted items. Please include name, address STD telephone number and WIA membership number if you do not use the flysheet.
- Deceased estates Hamads will be published in full, even if the ad is not fully radio equipment.
- WIA policy recommends that the serial number of all equipment for sale should be included.
- QTHR means the address is correct in the current WIA Call Book.
- Ordinary Hamads from those who are deemed to be in general electronics retail and wholesale distributive trades should be certified as referring only to private articles not being re-sold for merchandising purposes.
- Commercial advertising (Trade Hamads) are pre-payable at \$25.00 for four lines (twenty words), plus \$2.25 per line (or part thereof), Forty word maximum, minimum charge of \$25.00. Cheques are to be made out to: WIA Hamads.
- Copy typed or printed clearly please, and received by the deadlines shown on page 1 of each issue of Amateur Radio.

Email: [newunltd@bigpond.net.au](mailto:newunltd@bigpond.net.au)

Fax: 03 9756 7031

Postal: Newsletters Unlimited, PO Box 431, Monbulk Vic 3793

### TRADE PRACTICES ACT

It is impossible for us to ensure that the advertisements submitted for publication comply with the Trade Practices Act 1974. Therefore, advertisers and advertising agents will appreciate the absolute need for themselves to ensure that the provisions of the Act are strictly complied with.

### VICTORIAN CONSUMER AFFAIRS ACT

All advertisers are advised that advertisements containing only a PO Box number as the address cannot be accepted without the addition of the business address of the box-holder or seller of the goods.

*“Hey, Old  
Timer...”*

If you have  
been licensed  
for more than  
25 years you  
are invited to  
join the



**Radio Amateurs  
Old Timers Club  
Australia**

or if you have been licensed for less than 25 but more than ten years, you are invited to become an Associate Member of the RAOTC.

In either case a \$5.00 joining fee plus \$8.00 for one year or \$15.00 for two years gets you two interesting OTN Journals a year plus good fellowship.

Write to

RAOTC,  
PO Box 1100  
Sandringham VIC 3191

or call Arthur VK3VQ on 03 9598 4262 or  
Bill VK3BR on 03 9584 9512,

or email to [raotc@raotc.org.au](mailto:raotc@raotc.org.au)  
for an application form.

## MISCELLANEOUS

• The WIA QSL Collection (now Federal) requires QSLs. All types welcome, especially rare DX pictorial cards, special issue. Please contact the Hon Curator, Ken Matchett VK3TL, 4 Sunrise Hill Road, Montrose Vic 3765, tel. (03) 9728 5350

## TRADE ADS

**PSK-31, SSTV, RTTY SOUNDBOARD**  
Interfaces Fully Isolated, ready to plug in.  
<http://www.G3LIV.CO.UK>, johnny@melvin.com, G3LIV QTHR.

- Icom 706MK2G (NEW) \$1,299
- Icom 706MK2G (IMMAC) \$1,199
- Icom 207H (NEW) \$499
- Icom 910H (IMMAC) \$1,699
- Icom 756PRO2 (IMMAC) \$3,399
- Kenwood TS2000 (IMMAC) \$2,399
- Kenwood TS480HX (IMMAC) \$1,799
- Kenwood TS480SAT (IMMAC) \$1,699
- Yaesu FT8900R (USED) \$699
- Yaesu FT100D (IMMAC) \$1,249
- Icom AH4 ATU (NEW) \$499
- Icom AT180 (USED) \$579
- Atas 120 Antenna (USED) \$449

FULL RANGE OF NEW HEIL PRODUCT

PRICE SUBJECT TO CHANGE - CHECK WEBSITE FOR LATEST

BARGAINS.

PLENTY OF OTHER CURRENT MODEL GEAR AVAILABLE.

WILL CONSIDER TRADE IN OF ANY CURRENT MODEL GEAR.

## Computer Interfaces

Icom and Yaesu \$69

Mobile Kit IC706 (NEW) \$85

Freight to anywhere in VK / ZL

ORDER ONLINE AT  
[WWW.VK3AJJ.COM](http://WWW.VK3AJJ.COM)

OR TEL: PAUL (03-9504 2628)

LICENSED SECOND HAND DEALER NO 10229 (Vic)

GROW WIA—MAKE IT YOUR JOB

RECRUIT A NEIGHBOUR\*, NON-MEMBER LICENCE HOLDER TODAY.

One to one approaches are very successful and it is in your interest to have a strong WIA.

If you need to know who your neighbouring operators are call John (03) 9756 7797 AH and he'll tell you.

## ADVERTISERS INDEX

Andrews .....	23
Benelec.....	IFC
Bushcomm .....	28
Coax Cable & Connectors .....	29
Com-an-tena.....	22
Computer Interface.....	54
Connektron .....	40
Emtron .....	17

## Sunspot Numbers

Monthly Sunspot Average July 2004: 51.0

Annual Sunspot Average Jan 2004: 52.1

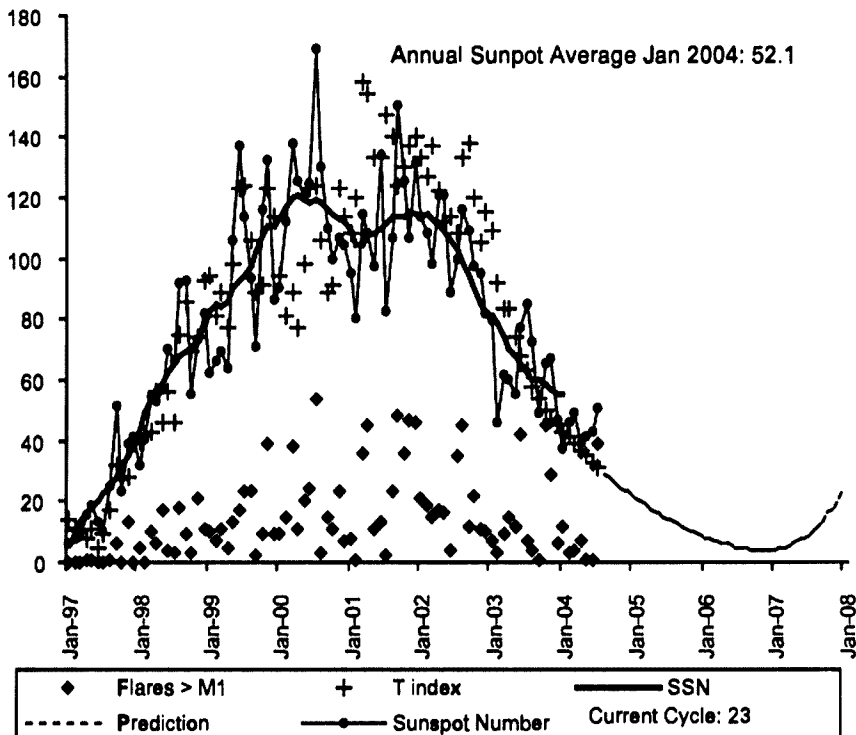

Drawn from monthly data provided by the Ionospheric Prediction Service

<http://www.hamsearch.com>

a not-for-profit site that is a search engine for hams

## AMIDON FERROMAGNETIC CORES

For all RF/electronic applications.

See our website for complete data on all cores including prices.

[www.catchnet.com.au/~rjandusimports](http://www.catchnet.com.au/~rjandusimports)

RJ & US Imports

PO Box 431, Kiama NSW 2533.

A 3.5" PC disk containing all data is available for \$5.00 incl. post.

### Agencies

Active Electronics, Tas  
TTS Systems, Tyabb (VIC)  
Tower Communications, Perth  
Ozhelp Services, Brisbane



## JACKSON BROS

JACKSON OF THE UK IS BACK

Highest quality products made by UK craftsmen

Full range now off-the-shelf in Australia.

Variable and trimmer capacitors, reduction drives, dials, ceramic standoffs

CATALOGUES, PRICE LISTS AVAILABLE

CHARLES I COOKSON PTY LTD

11-13 Port Rd  
Queenstown SA 5014

Tel: (08) 8240 3200 Fax: (08) 8240 3233

FreeFax 1800 673355 within Australia

Email: [jackson@homeplanet.com.au](mailto:jackson@homeplanet.com.au)

ALL MAJOR CREDIT CARDS ACCEPTED  
SOLE AGENTS AUSTRALIA AND NEW ZEALAND

## HF, VHF, UHF ANTENNAS & ACCESSORIES

Aluminium towers, guys etc

Diamond VSWR/PWR meters.

HD copper antenna wire & insulators,  
TX tubes & pwr transistors, Create Rotators

Quality coax cable & connectors. Free advice & catalogue.

## ATN Antennas

Ph 03 6492 2224 Fax 03 6492 2666,

email [atnant@inet.net.au](mailto:atnant@inet.net.au)

PO Box 80, Birchip Vic 3483



# Directory

## The Amateur Service:

a radio communications service for the purpose of self training, intercommunication and technical investigation carried out by amateurs, that is, by duly authorised persons interested in radio technique with a personal aim and without any pecuniary interest. 1.56 ITU Radio Regulations.

The Wireless Institute of Australia represents the interests of all amateurs throughout Australia.

WIA membership fees are: ★ \$ 75 for full members ( F grade ), ★ \$ 70 for pensioners and students ( G and S grade), and ★ \$ 50 for membership without 'Amateur Radio' ( X grade ). Payment direct to National office.

National Office	Contact	News Bulletin Schedule
10/229 Balaclava Road, Caulfield North VIC 3161, Australia	Phone 03 9528 5962, Fax 03 9523 8191, 10am to 4pm daily, nationaloffice@wia.org, www.wia.org	Subject to change see www.wia.org, follow national news prompts. Contact nationalnews@wia.org.au, National VK1WIA news is distributed to all states.

Advisory Committees	Contact	News Bulletin Schedule
<b>VK1 Australian Capital Territory</b>  VK1WX Alan Hawse VK1ZPL Phil Longworth VK1ET John Woolner	secretary@vk1.wia.ampr.org	Sundays at 11.00 am VK1WIA 7.128, 146.950, 438.050 Tuesday at 8.0pm 146.750, 147.375, 438.025
<b>VK2 To be advised</b>		
<b>VK3 Victoria</b>  VK3JJB John Brown VK3PC Jim Linton VK3APO Peter Mill	Phone 03 9885 9261 advisory@wlvic.org.au	VK1WIA Sunday 11.0am via HF and major VHF / UHF rpters
<b>VK4 Queensland</b>  VK4ERM Ewan McLeod VK4ZZ Gavin Reibelt VK4KF Ken Fuller	Phone 07 3221 9377 qac@wia.org.au  ewan.mcleod@blgpond.com	VK1WIA, Sunday 9.0am via HF and major VHF/UHF rpters
<b>VK5 South Australia and Northern Territory</b>	Phone 08 8294 2992	VK5WI: 1843 kHz AM, 3.550 MHz LSB, 7.095 AM, 14.175 USB, 28.470 USB, 53.100 FM, 147.000 FM Adelaide, 146.800 FM Mildura, 146.900 FM South East, 146.925 FM Central North, 438.475 FM Adelaide North, ATV Ch 35 579.250 Adelaide. (NT) 3.555 LSB, 7.065 LSB, 10.125 USB, 146.700 FM, 0900 hrs Sunday. The repeat of the broadcast occurs Monday Nights at 1930hrs on 3585kHz and 146.675 MHz FM. The broadcast is available in 'Realaudio' format from the website at www.sant.wia.org.au Broadcast Page area.
VK5NB Jim McLachlan VK5APR Peter Reichelt VK5ATQ Trevor Quick	jlmac@p1cknowl.com.au peter.reichelt@blgpond.com vk5atq@charlot.net.au	
<b>VK6 Western Australia</b>  VK6NE Neil Penfold VK6XV Roy Watkins VK6KZ Wally Howse	Phone 08 9351 8873 vk6council@iinet.net.au  vk6ne@upnaway.com vk6xv@blgpond.net.au vk6kz@blgpond.com	VK1WIA Sunday 9.0am via WIA network
<b>VK7 Tasmania</b>  VK7ZAX Phil Corby VK7DG Dale Bames VK7KK Reg Emmett	Phone 03 6234 3553  phil.corby@tassle.net.au vk7dg@wia.org.au regemm@ozemail.com.au	VK1WIA via Tony, VK7AX 8.55am

### Notes

1. Only three members of the state advisory committees are listed.
2. All listings are preliminary. They will be updated each month as required.
3. Membership application forms are available from the WIA web site www.wia.org.au or the national office address above.

# A new generation discovers *the magic!*



South Australian Scouts discover some fascinating aspects of amateur radio

*Can amateur radio appeal to this computer-savvy, mobile phone-totin' generation? These pictures say it can.*



**JOTA** opens up possibilities for young scouts and guides to take an interest in amateur radio and become potential future members of amateur radio clubs.

*Lea Adcock*

"I was working away on the bench in the shack and heard my 2.5 year old son, Reuben, chatting away and turned to find him imitating his OM! This harmonic is destined to become a Ham, bring on the foundation licence".

Justin, VK7TW.

**JOTA**  
October 16 & 17

# ICOM'S GREAT CHAMPIONS



## IC-208H 2m FM Dual Band Transceiver

- Dual Band Features at a Single Band Price
- 55W / 2m, 50W / 70cm • Built-in CTCSS and DTCSS
  - Tone Squelch Detachable Front Panel (Req. OPC-600/601 Option)
  - 9600 bps Packet Operation
  - 512 Memory Channel • Standard Mic.
- Supplied:HM133.



## IC-756PRO II

- Sharp & soft IF filter shape
- Improved 3rd IMD & wide dynamic range
  - One-touch record/play Digital voice memory
  - Extended 1/4 Tuning step & BPF functions for SSB-D mode
  - 32-bit floating-point DSP and 24-bit AD/DA converter
  - SSB/CW synchronous tuning • 4.9-inch color TFT LCD
  - Built-in antenna tuner.



## IC-706MKIIG HF • VHF UHF

- The amazing evolution of the legendary 706.**
- Now includes 70cm @ 20W and 50W on 2m
- Standard feature dsp • Built in sub tone encoder & decoder
- Tone scan • Mosfet PA • You get base station performance and features in a mobile rig sized package • **Morse Free Package**



## IC-7400

**NO FILTERS REQUIRED**

- Sharp & soft IF filter shape • 100W HF /6m /2m • Digital twin PBT
- DSP • SSB / CW synchronous tuning • Built in antenna tuner
  - RTTY demod / decoder • Digital RF speech processor
  - Microphone equaliser • **Morse Free Package**



## IC-T90A A new 5W Triband handheld

- VHF/UHF FM 2M, 6M, & 70CM
- Wideband receive 495 KHz - 1 GHz
- 555 Alphanumeric memories • 13 Scan modes DTCSS & CTCSS encode & decode DTMF encoder (10 memories) Wide/narrow transmit capability.



find your nearest ICOM dealer at

[www.icom.net.au](http://www.icom.net.au) or (03) 9387 0666





Volume 72 No 10  
October 2004

# Amateur Radio

\$6.50  
incl GST

The magazine for  
AUSTRALIAN amateurs

featuring

The VK5DJ repeater  
controller

John Drew VK5DJ

A CW transceiver for  
40 metre

Joe Rotenberg VK3BBN

The 204BA, a  
4-element  
20 metre beam PLUS

Bob Slutzkin VK3SK

Fixing-up old  
broadcast gang  
capacitors

Drew Diamond  
VK3XU

## New voices on the air



How I  
became a  
**HAM**



Hayden Honeywood  
VK7HAY, age 13

ISSN 0002-6859



9 770002 685109 10

# BENELEC

# YAESU



## FT-60R

### 144/430 MHz FM Dual Band Handheld

- Wide Band Reception
- New Emergency Automatic ID System
- Huge LCD
- High Power Output: 5W
- Ni-MH Long-Life Battery
- Programmable Keys for User Convenience
- Split CTCSS / DCS and DCS Encode only Capability
- Over 1000 Memory Channels w/Alpha-numeric Labels
- Ten Memory Banks for Channel Allocation
- Long-life FNB-83 and Overnight Charger included
- One-Touch NOAA Weather Access
- NOAA Severe Weather Alert with Alert Scan
- Nine DTMF Auto-Dialer Memories
- Two Front Panel Programmable Keys
- RF Squelch (only passes signals exceeding programmed level)
- Mono-band and Memory-only Operating Models
- Rugged Die-cast, Water-resistant Case Construction
- Transmit Time-Out Timer (TOT) & Automatic Power-Off (APO)
- Automatic Repeater Shift (ARS)

See you at  
MIENA, Tas  
4 Dec

New  
Model



New Price \$ 399

## FT-1000MP Mark V



### 200 W All Mode HF Transceiver

- High Power Output
- Wide Receiver Coverage
- High-Speed Automatic Antenna Tuner
- TX Microphone Equalizer
- RX Speech Processor
- Two TX/RX Antenna Jacks plus RX only jack.
- Direct Digital Synthesis (DDS)
- CW Spot and 2 Key Jacks
- Two Headphone Jacks
- Separate FP-29 Power Supply

New Price \$ 5130.70

All Price includes GST

## FT-1000MP Mark V Field



### 100 W All Mode HF Transceiver

- High Power Output
- High-Speed Automatic Antenna Tuner
- RX Speech Processor
- AC & DC Operation Built In
- Dual in Band Receive
- Enhanced Digital Signal Processing
- RF Speech Processor

New Price \$ 4451.50

Does Your Radio Need Fixing?  
- We FIX YAESU Radios!

[www.benelec.com.au/yaesu/yaesu.htm](http://www.benelec.com.au/yaesu/yaesu.htm)

# www.benelec.com.au

### Authorised Yaesu Retailers

NSW  
Andrews Communications Systems  
Tel: 02 9636 9060 [lee.andrews1@bigpond.com](mailto:lee.andrews1@bigpond.com)

Newcastle Pro Sound & Communications  
Tel: 02 4965 6899 [sales@newcastleprosund.com.au](mailto:sales@newcastleprosund.com.au)

Action Communications  
Tel: 02 4732 2788 [action@pnc.com.au](mailto:action@pnc.com.au)

VIC  
Strictly Ham P/L  
Tel: 03 9729 7656  
[sales@strictlyham.com.au](mailto:sales@strictlyham.com.au)

G & C Communications  
Tel: 03 5996 3298  
[gccomm@netspace.net.au](mailto:gccomm@netspace.net.au)

Qld  
Kyle Communications  
Tel: 07 3857 4400  
[mark@kyle.com.au](mailto:mark@kyle.com.au)

SA/NT  
POSNAV Systems P/L  
Tel: 08 8342 4700  
[brenton@posnav.com.au](mailto:brenton@posnav.com.au)





# Amateur Radio

Volume 72, Number 10  
October 2004

The Journal of the Wireless  
Institute of Australia  
ISSN 0002-6859

## Editorial

Editor: Colwyn Low VK5UE  
edarmag@chariot.net.au

Technical Editor: Peter Gibson VK3AZL

Publications Committee Members  
Brenda Edmonds VK3KT  
Ron Fisher VK3OM  
Don Jackson VK3DBB  
Evan Jarman VK3ANI  
Tom Potter VK3UBS  
Bill Roper VK3BR

## Submission of material to Amateur Radio Magazine

General and Technical articles to Secretary  
AR Publications Committee  
3 Tamar Court  
Mentone VIC 3194  
or armag@optusnet.com.au

Columns and Letters to the Editor to Editor  
AR Magazine  
34 Hawker Crescent  
Elizabeth East SA 5112  
or edarmag@chariot.net.au  
(Tel and Fax 08 8255 2138)

Hamads to  
"Hamads" Newsletters Unlimited  
PO Box 431  
Monbulk VIC 3793  
Fax 03 9756 7031  
newunltd@bigpond.net.au

Advertising  
All enquiries to  
Newsletters Unlimited  
PO Box 431  
Monbulk Vic 3793  
Phone: 03 9756 7797  
Fax: 03 9756 7031  
newunltd@bigpond.net.au

Registered Office  
10/229 Balaclava Road,  
Caulfield North VIC 3161  
Australia  
Phone: 03 9528 5962

## Production Deadlines

Advertising booking and articles for publication 10th of preceding month.

Hamads and advertising material deadline 18th day of preceding month

The contents of Amateur Radio are Copyright  
Wireless Institute of Australia © 2004

## GENERAL

Skills shortages in the electrical, electronics, ICT, instrumentation and automation manufacturing sectors.....	22
<i>(author's name withheld)</i>	
How I became a Ham .....	26
<i>Hayden Honeywood VK7HAY</i>	
Remembrance Day Amateur Radio Contest —10 August 2004 .....	27
<i>Address by General Peter Cosgrove, AC MC</i>	
Talking to the enemy .....	50
<i>David A. Pilley VK2AYD</i>	

## TECHNICAL

The WIA position on Broadband over Power Line (BPL) (WIA comment) .....	3
<i>Phil Wait VK2DKN</i>	
The VK5DJ repeater controller.....	4
<i>John Drew VK5DJ</i>	
A CW transceiver for 40 metres .....	15
<i>Joe Rotenberg VK3BBN</i>	
The 204BA, a 4-element 20 metre beam plus a rotatable 40-cum-30 metre dipole (Part 1) .....	20
<i>Bob Slutzkin VK3SK</i>	
Fixing-up old broadcast gang capacitors.....	24
<i>Drew Diamond VK3XU</i>	
A useful audio level indicator (Technical abstracts).....	28
<i>Peter Gibson VK3AZL</i>	
Trap aerial design .....	35
<i>Lindsay Lawless VK3ANJ</i>	
Attenuators (Technical abstracts).....	48
<i>Peter Gibson VK3AZL</i>	

## COLUMNS

ALARA .....	36	Silent Keys .....	46
AMSAT.....	38	Spotlight on SWLing.....	47
Beyond our shores .....	40	State News.....	31
Contests .....	41	VK1 News.....	31
Club News.....	34	VK6 News.....	31
Directory.....	56	VK7 News.....	32
Editorial Comment .....	2	Technical Abstracts .....	28, 48
Hamads.....	54	VHF/UHF – An Expanding World .....	44
HF Predictions.....	52	WIA comment.....	3
Over to you .....	36, 40	WIA News.....	30

## Our Cover this month

### Radio activities in South Australia at JOTA 2003

#### Contributions to Amateur Radio

Amateur Radio is a forum for WIA members' amateur radio experiments, experiences opinions and news. Manuscripts with drawings and or photos are always welcome and will be considered for publication. Articles on disc or email are especially welcome. The WIA cannot be responsible for loss or damage to any material. A pamphlet, How to write for Amateur Radio is available from the National Office on receipt of a stamped self-addressed envelope.

#### Back Issues

Back issues are available directly from the WIA National

Office (until stocks are exhausted), at \$4.00 each (including postage within Australia) to members.

#### Photostat copies

When back issues are no longer available, photocopies of articles are available to members at \$2.50 each (plus an additional \$2 for each additional issue in which the article appears).

#### Disclaimer

The opinions expressed in this publication do not necessarily reflect the official view of the WIA and the WIA cannot be held responsible for incorrect information published.

## Amateur Radio Service

A radiocommunication service for the purpose of self-training, intercommunication and technical investigation carried out by amateurs; that is, by duly authorised persons interested in radio technique solely with a personal aim and without pecuniary interest.

## Wireless Institute of Australia

The world's first and oldest  
National Radio Society  
Founded 1910

Representing

The Australian Amateur Radio Service

Member of the

International Amateur Radio Union

Registered Office of the WIA

10/229 Balaclava Road, Caulfield North Vic 3161

Tel: (03) 9528 5962 Fax (03) 9523 8191

email: nationaloffice@wia.org.au

http://www.wia.org.au

All mail to

PO Box 2175 Caulfield Junction VIC 3161

Business hours: 10am – 4pm weekdays

### National Office staff

June Fox	Office Coordinator
Emma Trebilco	Examinations Officer
Brenda Edmonds	Office Assistant

### Board of Directors

President	Michael Owen	VK3KI
Vice President	Ernie Hocking	VK1LK
	Glenn Dunstan	VK4DU
	Trevor Quick	VK5ATQ
	Ewan Mcleod	VK4ERM
	Ted Thrift	VK2ARA
	Phil Wait	VK2DKN
Secretary	Peter Naish	VK2BPN
	David Pilley	VK2AYD

### Coordinators

AMSAT	Graham Ratcliff	VK5AGR	
ARDF	Jack Bramham	VK3WWW	
Awards	Mai Johnson	VK6LC	
Contests	Ian Godsil	VK3JS	
John Moyle Memorial			
FD Manager	Denis Johnstone	VK3ZUX	
Editor "AR"	Colwyn Low	VK5UE	
Education	Ron Smith	VK4AGS	
EMC/EMR	Gilbert Hughes	VK1GH	
	Keith Malcolm	VK1ZKM	
	Gilbert Hughes	VK1GH	
	Peter Naish	VK2BPN	
Standards	John Martin	VK3KWA	
	t.b.a.		
FTAC			
Historian			
IARU Region 3	Neil Penfold	VK6NE	
Liaison Officer			
Intruder Watch	Henry Andersson	VK8HA	
International	John Miller	VK3DJM	
Travel Host			
ITU Conference and study group	Gilbert Hughes	VK1GH	
	David Wardlaw	VK3ADW	
	Keith Malcolm	VK1ZKM	
QSL Curator	Ken Matchett	VK3TL	
QSL Manager (VK9/0)	Neil Penfold	VK6NE	
Videotapes Curator	VK2 Division		
Webpage co-ordinator	Colin Thompson	VK2TRC	
WICEN	John Weir	VK3ZRV	
<b>ACA Liaison Team</b>			
Peter Naish	VK2BPN,	Peter Mill	VK3APO
Gilbert Hughes	VK1GH	Glen Dunstan	VK4DU
Keith Malcolm	VK1ZKM		

## Editorial comment

Colwyn Low VK5UE

## Passing the baton

October, and Jamboree On The Air (JOTA), is here again. Please help to make JOTA a success again.

The inside back cover (IBC) in this issue shows us something of amateur radio in a developing country that is short on resources. Donations of equipment are very welcome and much is needed. Sam Voron, currently, 60A, in addition to his normal job activities, promotes amateur radio wherever his aid work takes him. You can contact him on his e-mail svoron@hotmail.com.

The National WIA is beginning to settle down and the former Divisions are sorting out how the current services will be provided in the future and what sort of umbrella structure the clubs in the various states need to ensure the smooth operation of amateur radio communications infrastructure. The interim arrangements do all seem to be satisfactory.

With Amateur Radio magazine (AR) now being sold on the newsstands I think it would be a good thing if we carried an information section where books on basic electronics and radio communication are advertised and where

courses of instruction for amateur radio licences are advertised. If all you have is a copy of the present AR, you may need to be shown where to obtain some additional information. Look at page 24 "How I became a Ham". It seems to me here is a new ham who needs some very basic assistance.

The Remembrance Day Contest, usually referred to as "the RD", was well supported and, hopefully, continued to deserve the title of "the Friendly Contest". The address given by General Peter Cosgrove AC, MC, Chief of the

Defence Force, is on page 27 and some of the comments reiterate the views expressed in the letter on page 22. The need to develop interest in things electronic, and to provide educational paths to gain qualifications to gain employment in the electronics industry, are important to the country as a whole. We cannot continue to rely on the older generations to develop the basic support structure of our community in the future. Electronics and radio communication are one on the major foundation stones of modern society.

The activities we carry out as amateurs help us develop an "Amateur Radio Service" which can help the communities we live in, in both emergencies and in social activities. WICEN, the

**We cannot continue to rely on the older generations to develop the basic support structure of our community in the future. Electronics and radio communication are one on the major foundation stones of modern society**

Wireless Institute Civil Emergency Network, helped civil authority in Cyclone Tracey, the Newcastle Earthquake and in many Bush Fire emergencies. It also helps Horse Enduros, Canoe Marathons, Car Rallies and Fun

Runs. So help prepare by participating in some way in an operational field day or a contest. Did you - will you - be taking part in the Oceania DX Contest, October 2/3 SSB, 9/10 CW?

Well, that is enough to think about for another month. I must try and find the time to get my VHF/UHF portable gear all working for the VHF/UHF Field Day which is to be held on the weekend of **NOVEMBER 6/7th**. Please note the date, as the following weekend had been a possibility

73 Colwyn VK5UE

# The WIA position on Broadband over Power Line (BPL)

This month's WIA Comment is written with Phil Wait, VK2DKN, WIA director responsible for BPL matters.

**The Wireless Institute of Australia is very concerned about the suggestion that Broadband over Power Line (BPL) should be introduced in Australia.**

Many national amateur radio societies, and their regional organisations have already expressed a similar concern.

BPL is a form of power line carrier technology (PLC) using existing power line infrastructure to deliver broadband services to homes and business.

The proponents of BPL argue that the technology provides the community with a cheaper means of access to broadband than existing methods, no doubt attractive to governments if it is economic and does increase competition. However, the WIA is far from convinced that the technology is the best option at this time and is certainly convinced that it comes at a considerable, and unacceptable cost.

The HF radio spectrum is unique in that it provides long distance communications systems without the need for satellite or cable infrastructure. It provides safety and comfort to those travelling and working in the most remote parts of this sparsely populated country or on the high seas. It forms the backup network for defence communications and cannot be 'taken out' in times of war.

The evidence currently available on the interference effects of BPL suggests that a wide area BPL rollout will be a disaster for HF radio communications, and therefore our hobby. The American Radio Relay League (ARRL) has clearly demonstrated that BPL technology could render HF bands useless in many urban areas.

Importantly, it seems beyond argument that the current state of BPL technology could not be widely effective in providing improved broadband access to rural and outback Australia and therefore can do little to address the inequity of access to broadband services for the bush. On the other hand, emerging broadband

wireless systems such as Wi-Max, and satellite systems will provide the predominant viable alternatives.

Accordingly, any BPL service could only be delivered effectively to those already well served by existing broadband networks in cities, or to localised areas around rural towns, and would do little to improve broadband access for rural Australia.

BPL systems are built on 1960's cable TV architecture where the available bandwidth is diluted by all users on the BPL feed cable. Many argue that BPL will not provide sufficient bandwidth (especially at peak access times) for tomorrow's applications, such as video on demand. They argue that if BPL is adopted, Australia could be left with an 'artefact technology' with an inadequate ability to serve the consumers ever-increasing 'need for speed'.

Power lines make very poor high speed data transmission lines, are full of discontinuities, and are notorious radiators of electromagnetic noise. The interference potential from BPL to all users of the HF radio spectrum is very high and

extremely widespread. This has been clearly demonstrated by ARRL testing of trial BPL systems operating in the U.S., as well as testing in many other countries including Japan and in Europe.

It has been demonstrated that laboratory measurements of radiated emissions (interference), and also computer-modelling schemes, do not correlate well to real world measurements. Small trial systems do not properly demonstrate the effect of a wide-area rollout. The WIA believes that one of the

current problems associated with BPL is that trials on a limited basis are not good indicators, and even though some trial results have already been problematic for BPL, the full negative effects of BPL technology have probably not been seen with such trials.

Interference is a two-way street. A BPL network is also susceptible to interference and service disruption from nearby radio transmitters or other sources of electromagnetic noise such as electrical appliances, electric trains and corona discharge. Denial of Service attacks are also a concern, as many believe that a denial of service attack could be relatively easy to achieve on a localised part of a BPL network.

Extensive backup systems would be necessary, especially if BPL was used for emergency services, and there seems little point in using BPL when the backup systems (fibre, wireless etc.) could be vastly superior in security, reliability and performance.

**The WIA is far from convinced that the technology is the best option at this time and is certainly convinced that it comes at a considerable, and unacceptable cost**

It may well be that the 'window of opportunity' for the deployment of BPL systems is quite narrow as other more suitable and 'safer' technologies

such as broadband wireless (Wi-Max) emerge and which may prove to be more effective and less costly. A deep fibre network where optical fibre is run down the street on the existing power poles to broadband wireless feeds into each building could be a more effective and robust technology. Trials in the United States show new broadband radio technologies such as Wi-max are capable of providing high-speed Internet access

*continued on page 19*

# The VK5DJ repeater controller

John Drew VK5DJ

34 Aitken Street, Millicent 5280

jdrew@seol.net.au

**There are a number of repeater controllers available on the market, most from the USA although from time to time Australian designs have appeared and been used around the country. Dozens of amateurs must have designed units for their local repeater and not published their designs.**

The writer has been experimenting with controllers since 1971. The first foray was the remote control board for VK5RAD (Adelaide) in 1971, and in 1976 came the entire works for VK5RMN (Port Pirie) built on plug-in matrix boards. Later the board etching skills improved for the circuitry of voice repeater VK5RMG (Mount Gambier) and the digipeater VK5RPM (Millicent). The controllers had many NE555s, NE567s, TTL and CMOS gates and diode matrices for callsigns. The 1983 version for VK5RMG had 6 boards in total. The controllers were reliable but they did take a lot of time and effort to design and build. They also took up a lot of space.

Microprocessors have been around for a long time and many people have successfully used them in controller circuits. The NHRC-4 controller from the USA is a particularly successful design. The South East Radio Group (SERG) purchased two boards and the essential ICs as a kit and these were assembled and used to link the Naracoorte and Mount Gambier Repeaters together in 1999. A UHF link provides the essential communication. They work well but they are relatively expensive.

When the concept of a gateway to Kingston was suggested at a SERG meeting the author thought "I can do that" and started playing with the 16F84A and an excellent BASIC

compiler from Crownhill Associates (UK). The language has many of the qualities of Pascal and is exceptionally powerful. PICBasic Plus requires the declaration of variables in advance and makes strong use of sub routines rather than string code etc. It has something in common with the old assembler language but with a very friendly and powerful command set. It compiles some very tight code for the PICs. Check out the PICBasic forum at [www.picbasic.org](http://www.picbasic.org) if you want more information or want to play with the free LITE version. The programmer board used is the P16Pro40 Programmer – the author's kit came from Oatley Electronics and uses PICALLW software to do the programming. The latter is free if you stick to the 16F84.

These little PIC Microcontrollers are very powerful. The common 16F84 has flash memory space for 1024 commands (14 bits in length), it has 64 bytes of electrically erasable data storage (handy for callsigns and timer delays) and 68 bytes of RAM for storing variables. It has an 8-bit bi-directional port and a 5-bit bi-directional port. That's 13 connections to do clever things with. It all fits in an 18-pin DIL package. Nifty! That's enough computer talk, now on to the controller.

Firstly it was necessary to be sure of the requirements. It had to be capable of running a traditional repeater with remote control capability, provide all necessary timers and tone generation, be capable of supporting a gateway or link and, with increasing interference problems in the spectrum, the capacity for CTCSS controlled transmit. The ability to change callsign and timers by remote control was considered desirable. All of this to be achieved with a minimum of components built on a single board within a small box.

The unit to be described is Version 3. The two previous versions run the

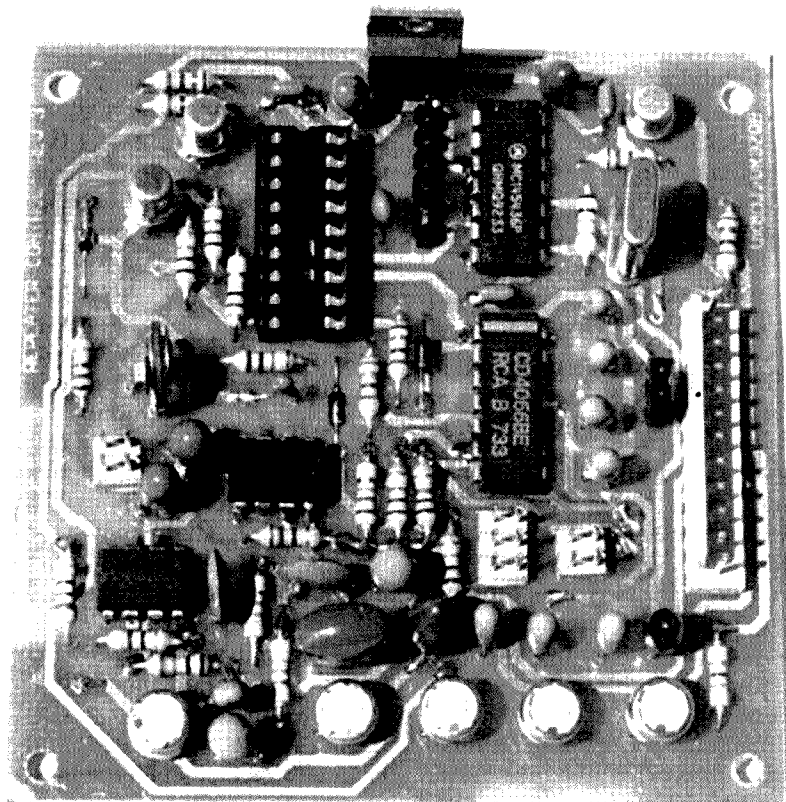
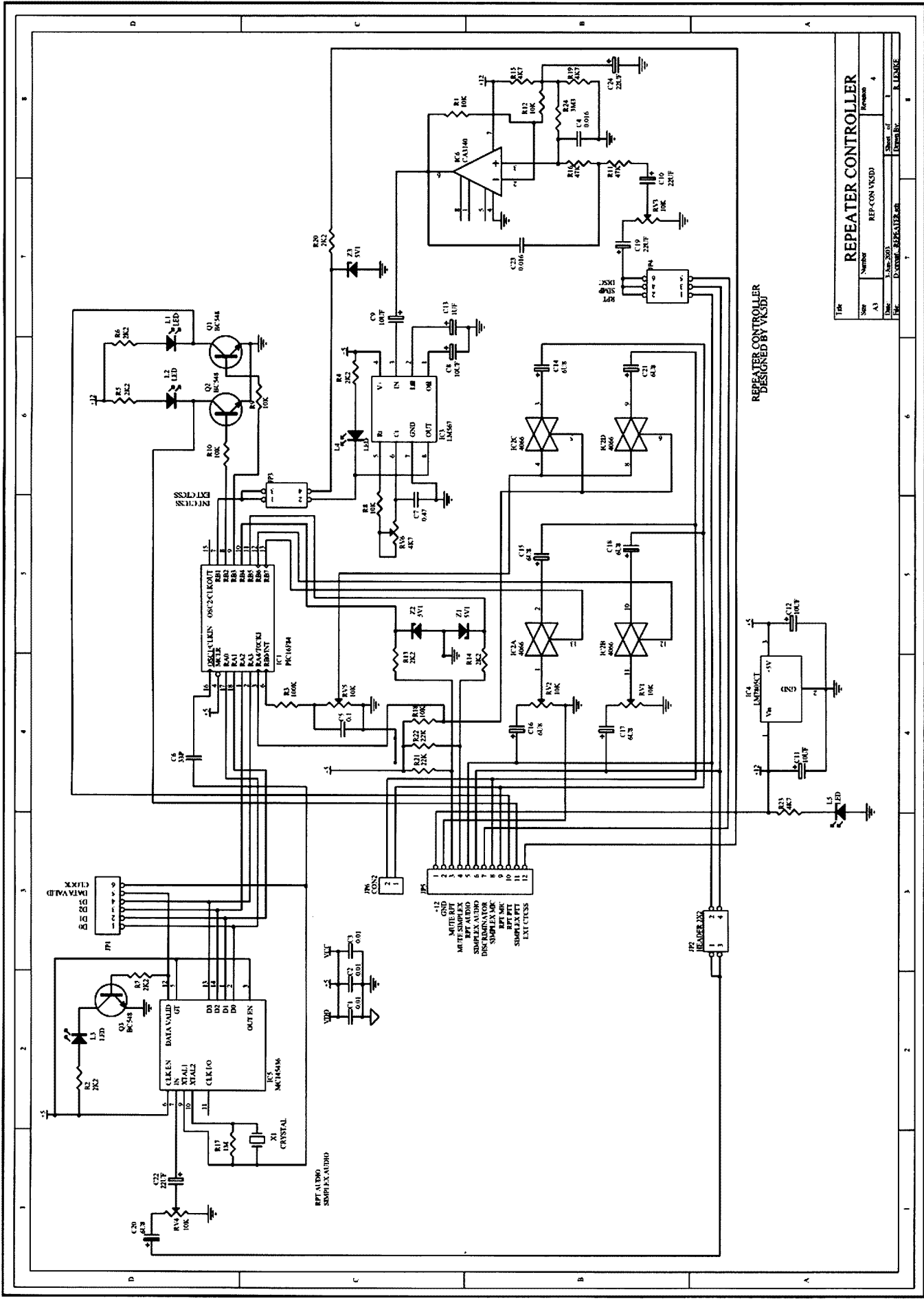

Photo 1. Circuit board



REPEATER CONTROLLER			
Tab	Sheet of	Revision	
1	4	1	1
2	4	2	2
3	4	3	3
4	4	4	4

REP-CON-VK5DJ  
3 June 2003  
Date of Design: REPEATER-con

Figure 1. Schematic diagram

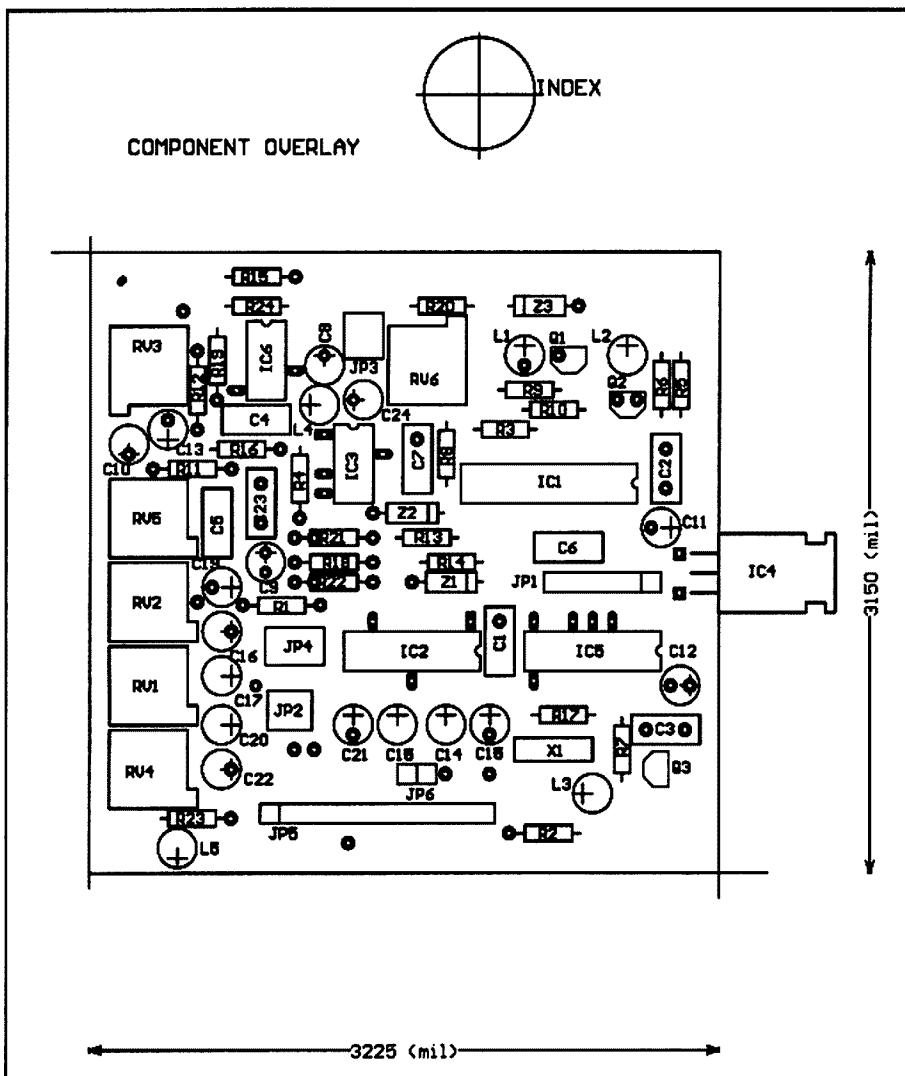

Figure 2

its purpose and enabled me to build Version 1, now in use at the Kingston Gateway. I used a Dalo pen to create the tracks and etched a board using my home made, windscreen wiper agitated, ferric chloride bath.

Version 2 of the board introduced the CTCSS and the DTMF on board. The DTMF worked fine but the CTCSS tended to drop in and out with speech. Those of you familiar with CTCSS will know that the added tone is low in level and because of the response of receiver audio pass bands all but disappears if you try to decode it at the top of the volume control. Audio must be taken very early in the audio circuitry, preferably at or shortly after the discriminator. Version 2 badly needed a low pass filter to improve performance, hence the redesign for Version 3.

Working quietly behind the scenes for Versions 2 and 3 was Russell Lemke VK3ZQB who kindly turned my hand drawn circuits into very nice circuits, boards and parts lists. The project would not be as successful as it is without Russell's skill with a drafting program and photographic production of boards. Thanks Russell.

## How does it work?

The controller provides all control functions required for a repeater, linked repeater or gateway operation. Typical uses include:

- 1) A general repeater controller – duplexed single receiver and single transmitter using a 4-6 cavity system to connect to one antenna. Alternatively separate antenna systems with perhaps a single cavity in TX and RX to reduce desense.
- 2) A duplexed repeater with a gateway eg a UHF repeater with a 29 MHz gateway
- 3) A duplexed 2 m repeater linked via UHF to a remote repeater system
- 4) A simplex gateway connected to a simplex transceiver that remotely accesses a repeater system (range extender concept).

## Features:

- Two mute inputs (i.e. a receiver A and receiver B)
- Two PTT outputs (LED indicators on board)
- Onboard DTMF decoder
- Onboard CTCSS decoder (to meet

Kingston Gateway and the 70 cm Mt Gambier Repeater with 29 MHz gateway. Version 1 did not include a CTCSS or DTMF decode while Version 2 did not include a low pass filter for the CTCSS. Version 3 represents the gradual evolution of the controller and tidying of some aspects of the circuit. For example it was found that it was not necessary to amplify the audio to the microphone inputs, receivers seem to have plenty of line out audio.

The controller is designed around the 16F84A PIC, a MC145436 IC for DTMF control, a combination of a CA3140 op amp operating as a second order low pass filter and a NE567 to detect CTCSS tones while a 4066 CMOS switch controls audio. A LM7805 provides regulated 5 volt to the ICs that require it.

The choice of a NE567 to decode CTCSS is a practical one as the author has a number on hand, they are cheap and they work OK. There are a small

number of specially designed CTCSS chips on the market. They are quite expensive and couldn't be located in Australia. If a reader is interested in using a proprietary CTCSS chip then a small outboard circuit could be developed. The controller board can interface to an external decoder (see jumper JP3 and pin 12 of the external connector). This latter facility was used for the VK5ROH Version 2 board, as a commercial CTCSS decoder was available courtesy of Col VK5DK.

The PIC does all the hard work including the generation of tones, timing, callsign, interpretation of remote controls and of course switching the output pins in accordance with instructions from the receiver mute inputs.

Using protoboard I took myself through the 'flashing a LED' testing programs on to the main features of a controller. LEDs and switches grew in 3 dimensions but the prototype served



licensing conditions or remove interference)

- Timeout timer
- Callsign generator with timer
- Tail with mode pips
- All tones generated on board
- Remote inhibit of timer
- Remote inhibit of primary repeater
- Remote inhibit of gateway (or link)
- Remote callsign configuration (including call itself)
- Remote adjustment of callsign delay
- Remote adjustment of timeout period
- Uses a PIC 16F84A for logic control, timing and tone generation.
- Audio switched with a 4066 quad solid state switch
- CTCSS decoding with a NE567, low pass filtering with a CA3140
- DTMF decoding with a MC145436 chip
- All components are readily available in Australia

The PIC (a 16F84A) is provided in programmed form according to user requirements. If you want a copy of the source code and/or the compiled code it is available free from VK5DJ for amateur use (see website <http://vk5dj.mountgambier.org>). Using the supplied hex file constructors can program their own PIC. The author will provide, on request, hex files for other combinations eg mute active high.

Connection to the real world is through a 12 pin plug mounted on the board

## Main connector

### Pin Description

- | Pin | Description                                    |
|-----|--|
| 1   | +12 V in (approx 10 mA)                        |
| 2   | DC common ground                               |
| 3   | Mute input from repeater receiver              |
| 4   | Mute input from gateway or link transceiver    |
| 5   | Repeater audio in (receiver approx 100 mV)     |
| 6   | Gateway/link audio in (receiver approx 100 mV) |
| 7   | Discriminator of repeater receiver (for CTCSS) |

- |    |  |
|----|--|
| 8  | Gateway/link audio out of board (microphone) |
| 9  | Repeater audio out of board (microphone)     |
| 10 | Repeater PTT                                 |
| 11 | Simplex PTT                                  |
| 12 | External CTCSS detect input to board         |

## Detailed description of main interconnector JP4

Pin 1 is the unregulated supply voltage to the board, nominally +12 volt but should lie between the limits of 8-14 volt for reliable operation.

Pin 2 is the common ground for power supply, logical inputs and audio lines.

Pin 3 the repeater receiver mute input is generally programmed for 0 V when a signal is received (ie active) and +5 to 15 V when the receiver is quiet. The line is clamped on the board with a 5.6 V zener. Note that the line is held to either +supply line or 0 V via a 22k resistor mounted on the board to ensure that if a receiver is not connected the input line has a clear logic level. When constructing the board the pull up resistor OR the pull down resistor (R21) is installed depending on the mute state available from the receiver in use and the appropriate programming of the PIC.

If active high from mute then install a pull down resistor (reprogram PIC for active high). If active low from mute then install a pull up resistor.

Pin 4 the gateway (or link) transceiver mute input. See notes for pin 3 but R22.

Pin 5 is the repeater receiver audio in. A capacitor is included on the input in case this line has superimposed DC. Audio levels should be at least 100 mV. Pot RV2 controls the level. The top of the volume control in the receiver is an ideal source although some transceivers have an output on a connector for this purpose. It doesn't matter if the audio is not muted as the board provides this function.

Pin 6 is the gateway (or link) receiver audio in. See notes for Pin 5 but pot RV1 controls level.

Pin 7 is audio from the discriminator of

the repeater receiver (or the receiver being used for CTCSS input). The audio must be taken at this early point to obtain sufficient CTCSS tone as these low frequencies are both low in deviation and strongly attenuated in the remainder of the receiver chain. Commercial CTCSS decoders use the discriminator or access a low pass filter (eg the Simoco PRF15-20 units). On this board I require separate audio in from the receivers and this comes in on pins 5 and 6.

Pin 8 is the audio out of the board to the gateway or link microphone. The level is adjustable and depends on the settings of RV2 (received audio) and RV5 (tone outputs for beeps and call sign)

In standard repeater/gateway/link use both pins 8 and 9 are jumpered together on board (JP6). In the case of an on air cross-linking gateway (e.g. a UHF gateway into a remote 2 m repeater via a simplex connection) JP6 is unjumpered.

Pin 9 is the audio out of the board to the main repeater microphone. Level depends on RV2 and RV5 when the repeater receiver is in use and RV1 and RV5 when the gateway/link is in use. See Pin 8 notes re JP6 use.

Pin 10 is the repeater PTT. It assumes that 0 V is active. The transistor could sink 20-50 mA but a relay should not be switched, as there is no protection from transients. The pin sits at +supply volt.

Pin 11 is the simplex PTT. See notes for pin 10.

Pin 12 is the output of an external CTCSS board. The pin expects an active high (5 to 15 volt). This is zener protected on board to 5.1 V. Jumper JP3 provides for either external CTCSS or internal CTCSS. If the internal CTCSS is not required do not install parts for IC3 (NE567 tone decoder) and IC6 (CA3140 op amp low pass filter).

## Input

Mute inputs are available at pins 3 and 4 of the main connector. Repeater input overrides the gateway input. On lowering of the mute (received signal) the timer begins. On raising of both mute pins the timer is reset.

On timeout the board sends 'TO' and

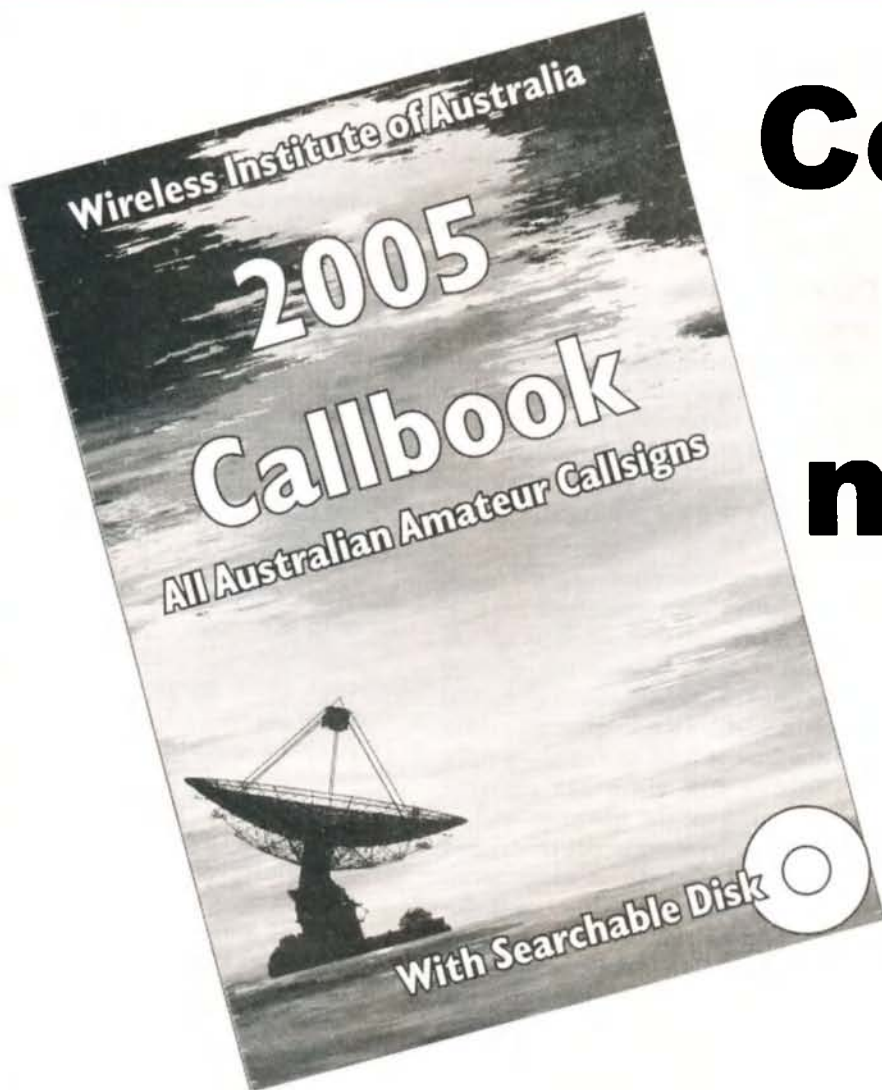

**Coming  
this  
month**

## **All Australian Callsigns**

**Plus great detail about**

**The new WIA, Amateur Radio Clubs, Wicen, ALARA, AMSAT, ARDF, Band Plans, Beacons, Broadcast Stations, The ACA, QSLs, Great Circles, Maidenhead, DXCC, Packet Radio, Repeaters and more.**

**How to get your copy**

***Contact your local Amateur Radio Club***

**To find out the details of your local club contact WIA National on**

**(03) 9528 5962**

**or**

**[nationaloffice@wia.org.au](mailto:nationaloffice@wia.org.au)**

# TET-EMTRON

## TE-23M 2 ELEMENT MINI-BEAM

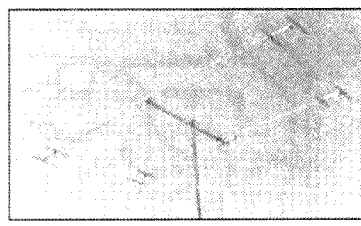

**SPACE A PROBLEM?**  
Don't give up! This mini antenna can be installed almost anywhere, especially where space is at an absolute premium and you still get superb performance on the 10, 15 and 20 metre bands. It has a 30% space saving when compared to a standard 2 element beam, light weight and rotatable even with a TV rotator. All stainless steel hardware, 6063T83 aluminium tubing and all standard features which go with every TET-EMTRON ANTENNA.

### Dealers VIC

- LT Harris** 78 Elgin Street Carlton Vic 3053  
Ph 03 93476264 Fax 03 93473629  
Email: lharris@netspace.net.au
- G&C Comms** 207 High Street Cranbourne Vic 3977  
Ph 03 5996 3298 Fax 03 5995 0184  
Email: gccomm@netspace.net.au

### NSW

- Emtronics** 1/94 Wentworth Avenue Darlinghurst 2010  
Ph 02 9211 0988 Fax 02 9281 1508  
Email: Emtron@ozemail.com.au
- Andrews Comms Shop** 8, 41-51 Bathurst St  
Greystanes, NSW, 2145 Ph 02 9636 9060  
Fax 02 9688 4301  
www.andrewscom.com.au

### WA

- Tower Communications** 14 Mary Street Hazelmere 6055  
Ph (08) 92741118 Fax (08) 92503734  
Email: tower@eon.net.au

### QLD

- Kyle Communications**  
668 Lutwyche Rd Lutwyche 4030  
Ph (07) 38574400 Fax (07) 38577825  
Email: mark@kyle.com.au

### SA

- International Communications** -  
8 Nile Street Port Adelaide 5015  
Ph (08) 84473688 Fax (08) 83411453  
Email: intercom@picknowl.com.au

### New Zealand

- The Com Centre**  
400 Hillsborough Road Avondale Auckland  
Ph (64) 9 6270084 Fax (64) 9 6271613  
Email: comcent@radioinfo.co.nz

### RAWMAR ENTERPRISES

- 40 Blackburn Street  
STRATFORD Victoria 3862 Australia  
Ph: 61 3 5145 6179  
Fax: 61 3 5145 6821

Email: rawmar@hotmail.net.au  
www.tet-emtron.com

BOTTOM TRACK OVERLAY

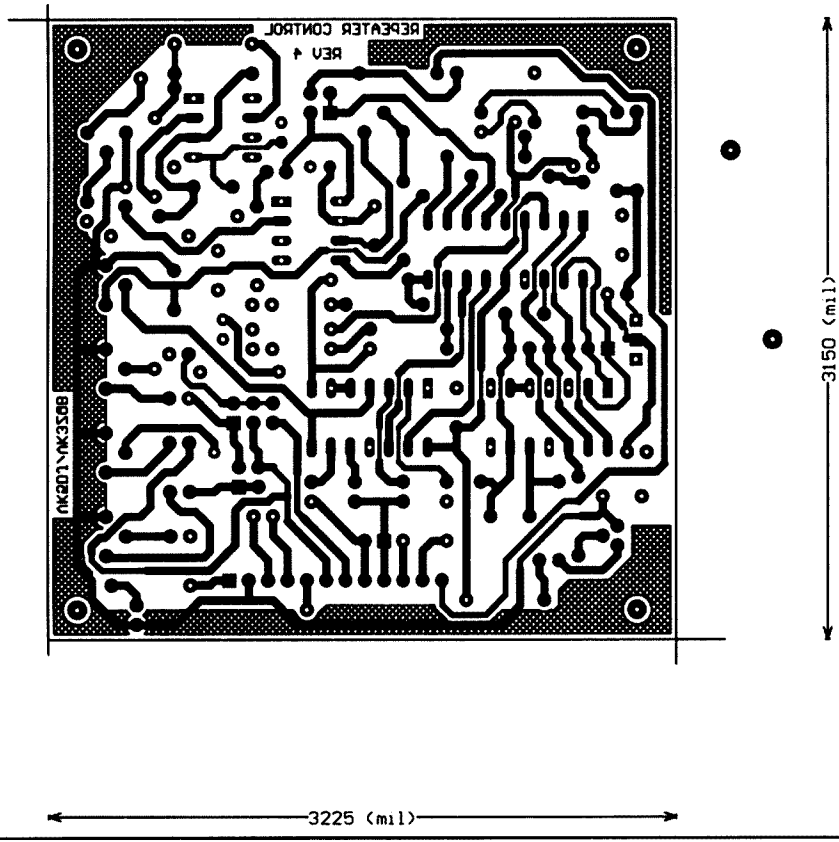
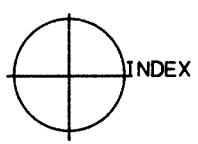

Figure 3a

LABEL ON DTMF PAD	NUMBER SENT	NUMBER received by software
1	Binary 0001 Decimal 1	Hex 1
2	Binary 0010 Decimal 2	Hex 2
3	Binary 0011 Decimal 3	Hex 3
4	Binary 0100 Decimal 4	Hex 4
5	Binary 0101 Decimal 5	Hex 5
6	Binary 0110 Decimal 6	Hex 6
7	Binary 0111 Decimal 7	Hex 7
8	Binary 1000 Decimal 8	Hex 8
9	Binary 1001 Decimal 9	Hex 9
0	Binary 1010 Decimal 10	Hex 0
*	Binary 1011 Decimal 11	Hex B
#	Binary 1100 Decimal 12	Hex C
A	Binary 1101 Decimal 13	Hex D
B	Binary 1110 Decimal 14	Hex E
C	Binary 1111 Decimal 15	Hex F
D	Binary 0000 Decimal 0	Unused

Translation Table

shuts down the PTT and audio of both transmitters. When both mutes are high the transmitter provides a tail and sends another 'TO'. The device is again ready for use. (See table)

### The PIC Microcontroller

The mutes from the primary and secondary receivers are applied to Ports B.4 and B.5 of the microcontroller. The voltage is clamped to no more than 5 volt by the zeners to protect the input of the 16F84 from excessive voltage.

A zero on a mute indicates that a signal is being received. The mutes are continually polled by the microcontroller at approximately 20 msec intervals. Once a mute is open on Port B4 or B.5, the appropriate PTT pin is lowered on Port B.3 or B.2 and

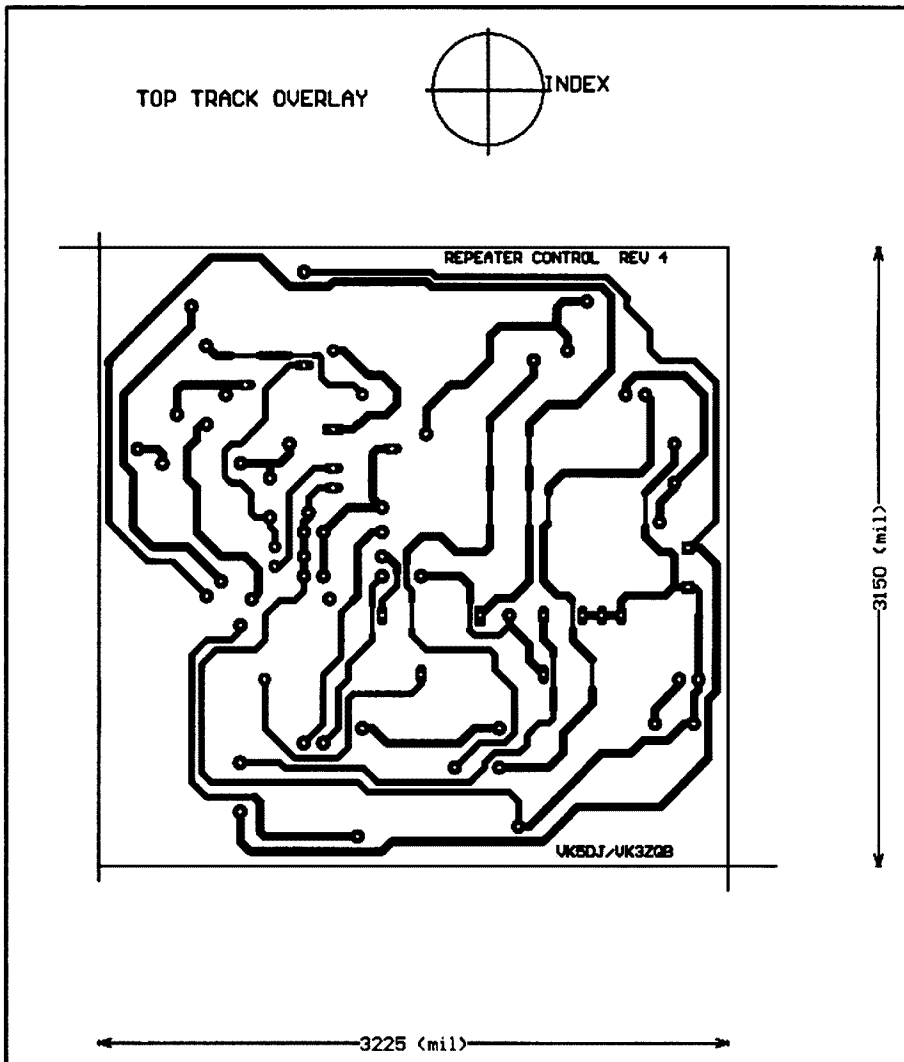

Figure 3b

at the same time the appropriate audio is switched on through Port B.7 or B.6. The timeout timer starts counting.

The duplex repeater always has priority.

When a mute goes high (receiver mute closes) the 16F84 checks to see if a callsign is due, if so it sends a callsign, if not it sends a tail and if appropriate a beep (or two or three – see later). The timeout timer resets to zero. The callsign timer resets if a callsign was sent otherwise it keeps counting. The delays for the callsign and the timeout timer may be remotely changed.

If a mute stays on for a longer period than allowed by the timeout value the audio is shut down, a 'TO' is sent in Morse code (Port A.4 goes high to turn on the audio switch), then the PTT is taken high (Port B.3 and Port B.2) and everything shuts down. When the mute finally goes high this frees the system

and a further 'TO' is sent in Morse and the repeater/gateway/link is again available.

The DTMF controller system works in the following way.

A 145436-decoder chip has an oscillator running at 3.58 MHz. This frequency is coupled to the PIC and so provides clock signals to both the decoder and the chip. DTMF tones are applied to the input pin of the chip through JP2. The jumper on JP2 determines which receiver passes on the DTMF tones. On receiving a valid tone the output pins are sensed by the PIC through input ports RA0,1,2,3.

A three-digit address code is sent by DTMF and received on a receiver. For the sake of this document the address sequence will be 987. The address is followed by the control byte and

possibly some data.

- 1 inhibits the main transmitter
- 2 inhibits the gateway/link
- 3 cancels the main timer (useful for the WIA broadcast)
- 4 requires CTCSS input to enable main transmitter (may be programmed to require CTCSS for gateway to meet limitations of some licences.)
- 5 changes callsign (see later for notes)
- 6 change callsign delay (units about 18 sec, HEX 10 gives about 5 min)
- 7 change timeout delay (units about 18 secs, HEX 0A but use HEX 0B - see later note re 0A) gives about 3 min
- 8 resets controls 1,2,3,4 to default, that is, timer active, gateway on, main TX on, no CTCSS required for main TX)

Example: If the address was 987 then a control sequence of DTMF '9873' will inhibit the main timer. When the carrier is dropped an 'OK' is sent in Morse if the command was successful. The tail will now have two beeps.

A DTMF sequence of 9878 will re-enable the timer.

Due to the nature of a DTMF touch tone pad the numerals sent by the pad do not quite align with their value (To complicate things I ran out of ports on the PIC and therefore couldn't decode the received tone enable pin, this limited access to 4 bits of data). I needed a zero more than I needed a 10 (HEX A) so I have internally translated the keyboard 0 (actually a 10) to a real 0 and thereby lost HEX A. Because of this the other digits are displaced so you need to use the translation table (see page 9). This means that when you need the HEX character in column 3 you must push the button in column 1. Messy, but you won't need to use remote changes very often. In fact after setting up you may never need to use them again.

If you only have a 12 digit DTMF keyboard you should be able to remote control quite satisfactorily. The author suggests using either 1# or 20 for the value of the dah depending on how you like the sound of dahs. A 1\* meets the dah=3 dits definition perfectly but most amateurs prefer a dah a little longer than

the recommended 3 times the length of a dit. You may think otherwise.

### Changing the callsign.

This is FUN! The PIC program works by reading the delays you enter in EEPROM memory via command 5. (eg send address 987 and the 5)

- Dit = HEX 04
- Dah = HEX 0E
- <EOC> = HEX 50 end of character indicator
- <EOM> = HEX 55. end of message indicator

These timings may be varied according to the following rules:

- 1) a dit and a dah must be less than HEX 30
- 2) an <EOC> must be more than HEX 30.
- 3) An EOM MUST equal 55.
- 4) Each HEX unit of a dit and dah equals approximately 10msec of tone

V	K	S	E
04 04	0E 04	04 04	04 50
04 0E	0E 50	04 04	
50		04 50	
dit dit	dah	dit dit	dit <EOC>
dit dit	dit dit	dit dit	<EOC>
dah	dah	dit	
<EOC>	<EOC>	<EOC>	

To send this to the controller remember to retranslate according to table above – note that a HEX E is sent by hitting the B key.

98750404040B500B040B5004  
040404045004500B55 sends  
VK5ET

Then drop your transmission. An 'OK' signifies provisional success, although if you made a mistake with numbers you may have errors in the callsign. Wait and find out.

Note the address leads the routine. This routine is a great test of your ability to send a long string of digits and of your keyboard not to bounce! Fortunately you don't have to do this often. The callsign must not exceed 47 bytes or you will corrupt other information stored in the data area (the other messages and the timer variables). This is unlikely to be a

problem as the above example only uses 19 bytes and even VK5RBB/M3 would only use 44 and I can't think of a longer legitimate callsign in VK.

You can experiment with the numbers but remember the rules cited above.

### Changing the callsign interval

The general principle is to send the address followed by a 6 then two characters defining the HEX delay.

Each unit is about 18 sec so if you want 10 minute:

$$10 * 60 / 18 = 33 \text{ decimal or HEX 21.}$$

You will need to send a 2 then a 1.

Your control sequence is 987621

Another example, this time for 15 minute:

$$15 * 60 / 18 = 50 \text{ decimal or HEX 32}$$

Control sequence is 987632

If your calculation gives say HEX 1A, then you can send the '1' but not the 'A' (see table), you will settle for sending 19 or perhaps 1\*

### Changing the timeout interval

I have used the same rules and strategy as 'changing the callsign interval', except that the command is 7 instead of 6.

Eg a 3 minute timeout is calculated like this:

$$3 * 60 / 18 = 10 \text{ or HEX 0A.}$$

HEX A is not available on the DTMF pad so use \* which sends a HEX B (see table) and your delay is about 18 sec longer! No big deal.

Control sequence is 98770\*

### Tail operation

A tail is provided once both mutes are inactive. This is set at approximately 1/2 second. As an encouragement for people to wait between transmissions no audio from a receiver is fed through for this time (1/2 sec) even if a mute opens. Audio is fed through during callsigns.

A beep is provided under certain control circumstances.

- No beep on tail indicates repeater

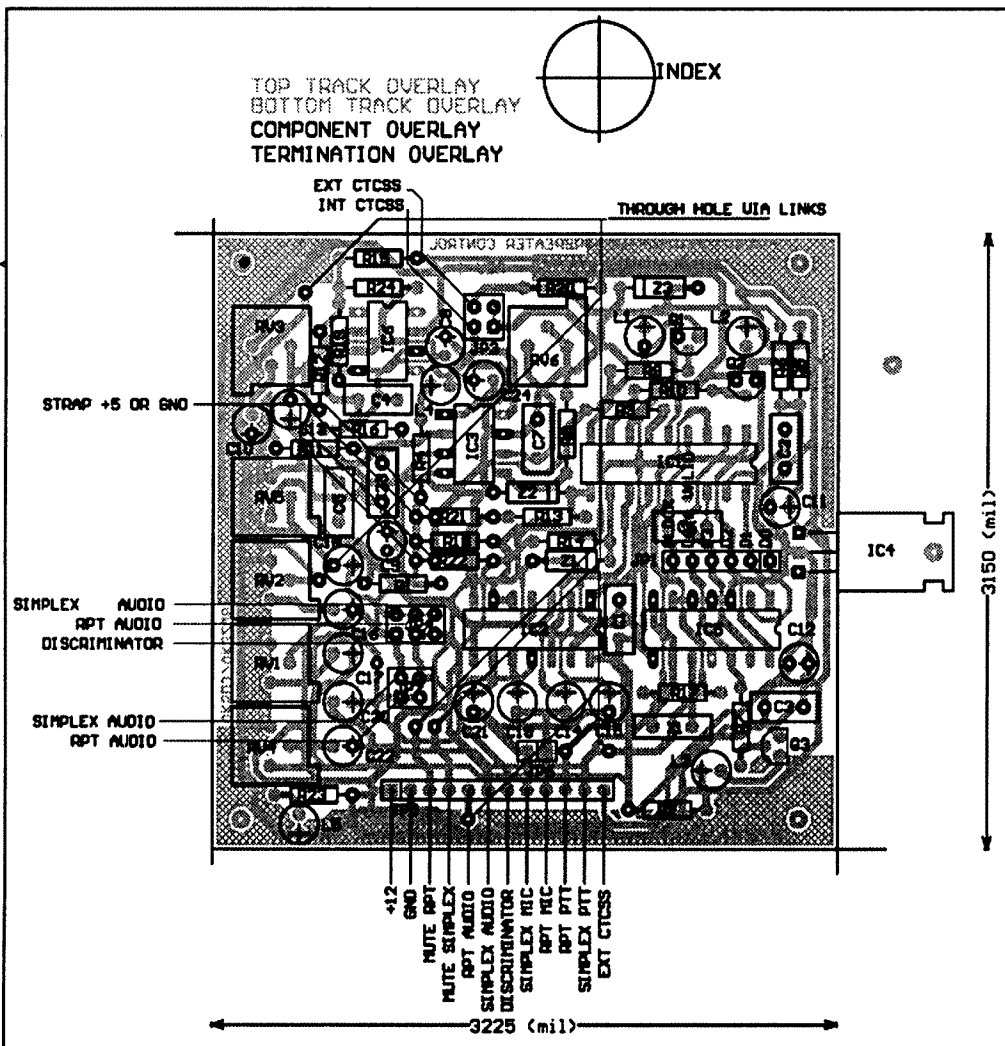

Figure 4. Component overlay

only operation – gateway/link off

- 1 beep on tail means gateway/link on
- 2 beeps on tail indicate timer is inhibited.
- 3 beeps on tail indicate gateway link on and timer inhibited.

A tail (either ½ sec or callsign tail) is always generated on the repeater TX.

Providing the gateway is not inhibited, a tail is generated on the gateway TX if the last mute opening was generated by a CTCSS enabled signal on the repeater receiver, or if the last transmission was on the gateway receiver.

## Call signs

Call signs are sent every ten minutes (or as changed by remote control) at the end of the over. If a call is not due at the end of the last transmission of a contact one call sign will be sent at the end of the timing period. The repeater will then go silent until the next mute opening. A call will be generated at the end of this mute opening if 10 minutes has expired since the last.

## CTCSS operation

The values on the circuit suit reception of a 118.8 Hz CTCSS signal. These low frequency signals are attenuated by tailoring of the receiver audio, so the board must take its audio from the discriminator circuit or early in the audio chain before tailoring.

Changing C7 or R8 changes the CTCSS frequency beyond the range achievable with control RV6. Lower values increase the frequency. LED L4 lights when a correct tone is received. L4 is a useful tune indicator when adjusting RV6.

For the program written for repeater/gateway operation, the gateway is enabled if the user sends a CTCSS signal. Without the CTCSS the repeater function is normal. This meets a licensing requirement to 'lock out' people without the required endorsements for eg 29 MHz operation of a gateway.

Gateway operation is, in effect, in parallel with normal repeater operation providing the CTCSS is sent.

The CTCSS function can be required for normal repeater access. This may be needed where interference from LIPDs is a problem. See function 4 in remote controls.

## LEDs

See Jumper section for orientation of the board for this description.

The CTCSS detect LED is in the North East of the board and lights when there is a valid CTCSS signal received.

The repeater and simplex PTT LEDs are together in the South East corner. The repeater LED is the northernmost of the pair. The simplex PTT LED is the southernmost of the two. They light when PTT is low (i.e. active).

The DTMF valid LED is at the bottom (South West) corner of the board by itself and lights when a valid tone pair is received.

The power on LED is in the North West corner of the board.

Constructors may choose to mount the LEDs on the front panel of the box.

## JP1 Test Function

Pin 1 is the output for DTMF decoder (data bit 0) – high if bin 0001 rcvd (see table later but pin 1 is nearest the 7805 voltage regulator)

Pin 2 is the output for DTMF decoder (data bit 1) – high if bin 0010 rcvd

Pin 3 is the output for DTMF decoder (data bit 2) – high if bin 0100 rcvd

Pin 4 is the output for DTMF decoder (data bit 3) – high if bin 1000 rcvd

Pin 5 is data valid and goes high for a valid tone detect

Pin 6 is the output of the Xtal oscillator and should be 3.579 MHz

## Jumpers

With the board held with components up and the main connector on the left (west) and the voltage regulator at the bottom (south); the trim pot for the CTCSS is to the east. From an imaginary point in the centre of the board the angles locate each jumper.

H means the jumper lies east/west, V means the jumper lies north/south.

Position number 1 is always either the northernmost or the easternmost position.

Position number 2 is the next to the south or west and so on.

JP1 are test points see above (190 degree) with pin 1 nearest the 7805

JP2 controls the source of the audio for the DTMF tones. (300 degree)

- H, 1 = repeater receiver audio
- H, 2 = simplex audio

JP3 internal or external CTCSS input to 16F84A (75 degree)

- V, 1 = external CTCSS decoder
- V, 2 = internal CTCSS decoder

JP4 audio source for CTCSS (320 degree)

- H, 1 = repeater receiver audio
  - H, 2 = simplex receiver audio
  - H, 3 = discriminator audio from repeater receiver
- JP5 main interconnector – see above (270 degree)
- JP6 join microphone points (270 degree)
- V, 1 on = microphones are joined (gateway/link condition)
  - V, 1 off = microphones separated - single repeater or range extender model.

## Construction

Drill the mounting holes for your box, and trial mount the board.

Make the following decisions:

1. What polarities do the transceiver(s) require? If you have active low mutes install R21, R22 to +5 V (examine board). If one (or both) is active high then take R21 and/or R22 to earth. The board provides for this. The program in the PIC will need to be modified for active high. If the transmitters require active low then everything is fine as is, otherwise the program in the PIC will need to be changed. If you don't want to have the program changed then you will need to build external inverters where necessary.
2. Where do you want to mount the LEDs? If you want to put these on the front of the box then obviously you will install wires rather than the LEDs on the board.
3. Decide if you will be using CTCSS. If not you will not need the components associated with CA3140 and LM567. But you will need to include JP3, R4, and bridge L4. (You'll have one less LED so don't drill your front panel for it!!)

Mount the socket for the 16F84 (strongly recommended, you might want an updated program one day). Note notch is to the regulator end.

Install the 7 jumpers (from top to bottom of board)

Install JP1-6

Install all the resistors but note positions of R21,R22. Solder to upper board and bottom trace where jumpers are required.

Install all the capacitors. (solder top and bottom where traces exist.)

Install voltage regulator LM7805.

Either solder LEDs to board or attach wires for LEDs to be mounted on front panel at a later date. I suggest at least dangling the 'power on' LED temporarily on its wires for the next check.

Apply +12 V to board and ensure that +5 V is available in appropriate spots eg pin 4,14 of PIC.

Remove voltage and solder remaining solid-state devices – leave PIC out of socket for the moment.

Install in box and wire the board to the DB25 on the rear of the box. I used pins 1-12 to maintain the integrity of the numbering system.

Wire the LEDs located on the front panel and a power switch if you wish. I didn't use a switch, preferring the control logic to boot up as soon as the rigs have power to avoid unpredictable states in the rigs.

## Testing

The following assumes active low situations. If not, you will no doubt work out your own testing procedure by inverting the logic. Pin numbers refer to either the DB25 or JP5 if you followed my advice on connections.

Temporarily connect the following:

- Switch R – SPST between pin 3 and earth (pin 2)
- Switch S – SPST between pin 4 and earth (pin 2)
- A SPDT switch and a headphone socket to listen to either pin 8 or pin 9 (earth is common)
- A SPDT switch and a socket to enable audio either from a receiver or an audio generator to direct audio to either pin 5 or pin 6.
- The capacity to measure the voltages at pins 10 and 11 (the PTT outputs)
- Connect jumpers – JP2, 1&2 JP4, 1&2JP3, 1&2

On power up, the controller is set with gateway off.

## Test logic functions:

- Headphone listening to repeater mike – pin 9 (Switch R)
- RV5 half way
- Close switch R
- LED2 lights.
- Open switch R
- LED2 stays on for ½ sec (or possibly longer if it decides now is a good time for a callsign). Repeat opening

and closing R to see if it matches your expectation.

- Close switch R and leave it on. After about 5 minute you should hear 'TO' in Morse and LED2 should go out when the TO is finished.
- Open switch R and you should again hear 'TO' and LED2 lights as 'TO' is sent. The system will again respond to opening and closing of switch R.
- Wait a little longer and after a Closure/opening of switch R a callsign should be generated. LED2 again indicates the PTT state for the repeater.
- Use a multimeter to see that pin 9 is going low when the LED2 lights. At other times it should be at about 12 V.

## Test DTMF capability:

Connect a DTMF generator (or a receiver) to the appropriate input (pin 5 with the test jumpers in place). Send a tone, LED 3 should light. If not adjust RV4.

With no input check the voltage on pins 1,2,3,4 of JP1. These should be at 0 V. Send a DTMF C and check that all pins 1,2,3,4 are high.

If logic and DTMF decode don't seem to work then check with a CRO that there is a 3.58 MHz clock on pin 6 of JP1

With switch R closed, send the address and a 1 (eg 9871). Open switch R, hear an OK in the headphones, and then note that LED2 no longer responds to switch R (the TX has been inhibited.)

With switch R closed, send digits 9878 (password+8). Open switch R and hear the OK and LED2 again follows switch R.

## Test CTCSS if installed

Feed a low level CTCSS tone into the appropriate pin (for the test setup use pin 5 and bridge JP4 bridge H1). I suggest 118.8hz. Adjust both RV6 (freq determination) and level RV3 for lighting of L4. Reduce level and retune RV6 for LED4 to find the most accurate setting of RV6. The level potentiometer will need to be reset when the receivers are finally connected. Note that I strongly recommend that you connect as close as possible to the receiver discriminator as receiver audio chains attenuate CTCSS tones.

The 567 tend to drop out when there is a whistle or loud speech. The program allows for this and has a hang facility built in. As long as the LED flashes once

every couple of seconds the system will work.

## Audio switching:

With different audio provided to the two receiver output pins, switch R and switch S alternately note the different combinations of audio. Potentiometers RV1 (simplex TX audio) and RV2 (repeater TX audio) adjust levels.

## Final test

Connect to your transmitters and receivers. All levels will need to be reset. Connect jumpers as appropriate. Generally JP6 is bridged EXCEPT when you use the board as a range extender or simple gateway. Check general operation. It is at this time that some nice instruments help. Otherwise do what I do, get a group together to monitor your experiments as you adjust levels, flicking to and fro from the direct path to get an idea of similar levels – crude but it works.

## Mounting

The production board will fit quite nicely in a small instrument case 110 X 140 X 35mm (Dick Smith H2512 - \$9.75). A DB25 socket mounted on the rear is a simple way of achieving connectivity to the transceivers.

## General notes

Note that in the parts overlay and circuit diagram LED L5 is the wrong polarity. It will need to be inverted. In addition, the photographs of the populated board do not show R24 (3M3). A last minute change of circuit for the low pass filter meant that R24 was installed under the board for the prototype board in the photos. The parts layout and board patterns show R24 (3M3) in its new position near IC6. Don't let my photos of the board confuse you with regard to R24. Also note that the overlays have labels to JP2 and JP4 reversed for repeater and simplex audios.

I would like to thank Russell VK3ZQB for drawing the circuit so well, the development of the parts lists and layout, and the preparation of the board. Without him the board would be hand drawn, twice the size and have many links. The support of Michael Carra in building a controller and discovering errors in the documentation is also appreciated. Thanks Russell and Michael.

Have fun, I'm prepared to help people with specific needs.

# Repeater controller parts list

Part designator	Value	Footprint	Type	Critical value
C1	0.01 uF	RAD0.2	Philips ceramic	No
C2	0.01 uF	RAD0.2	Philips ceramic	No
C3	0.01 uF	RAD0.2	Philips ceramic	No
C4	0.016 uF	RAD0.2	Poly	Yes
C5	0.1 uF	RAD0.2	Poly	No
C6	33 pF	RAD0.2	Philips ceramic	Yes
C7	0.47 uF	RAD0.2	Poly	Yes
C8	10 uF	RB.1.2	10V tant	Yes
C9	10 uF	RB.1.2	10V electro	No
C10	22 uF	RB.1.2	10V electro	No
C11	10 uF	RB.1.2	10V electro	No
C12	10 uF	RB.1.2	10V electro	No
C13	1 uF	RB.1.2	10V tant	Yes
C14	6 uF	RB.1.2	10V electro	No
C15	6 uF	RB.1.2	10V electro	No
C16	6 uF	RB.1.2	10V electro	No
C17	6 uF	RB.1.2	10V electro	No
C18	6 uF	RB.1.2	10V electro	No
C19	22 uF	RB.1.2	10V electro	No
C20	6 uF	RB.1.2	10V electro	No
C21	6 uF	RB.1.2	10V electro	No
C22	22 uF	RB.1.2	10V electro	No
C23	0.016 uF	RAD0.2	Poly	Yes
C24	22 uF	RB.1.2	10V electro	No
R1	10k	AXIAL0.4	¼ W carbon	Yes
R2	2k2	AXIAL0.4	¼ W carbon	No
R3	100k	AXIAL0.4	¼ W carbon	No
R4	2k2	AXIAL0.4	¼ W carbon	No
R5	2k2	AXIAL0.4	¼ W carbon	No
R6	2k2	AXIAL0.4	¼ W carbon	No
R7	2k2	AXIAL0.4	¼ W carbon	No
R8	10k	AXIAL0.4	¼ W carbon	No
R9	10k	AXIAL0.4	¼ W carbon	No
R10	10k	AXIAL0.4	¼ W carbon	No
R11	47k	AXIAL0.4	¼ W carbon	Yes
R12	10k	AXIAL0.4	¼ W carbon	Yes
R13	2k2	AXIAL0.4	¼ W carbon	No
R14	2k2	AXIAL0.4	¼ W carbon	No
R15	4k7	AXIAL0.4	¼ W carbon	Yes
R16	47k	AXIAL0.4	¼ W carbon	Yes
R17	1M	AXIAL0.4	¼ W carbon	Yes
R18	10k	AXIAL0.4	¼ W carbon	No
R19	4k7	AXIAL0.4	¼ W carbon	Yes
R20	2k2	AXIAL0.4	¼ W carbon	No

R21	22k	AXIAL0.4	¼ W carbon	No
R22	22k	AXIAL0.4	¼ W carbon	No
R23	4k7	AXIAL0.4	¼ W carbon	No
R24	3M3	AXIAL0.4	¼ W carbon	No
IC1	PIC16F84	DIP18	4MHz is OK	Yes
IC2	4066B	DIP14	Quad switch	Yes
IC3	LM567	DIP8	PLL tone decode	Yes
IC4	LM7805CT	TO-220	5V reg	Yes
IC5	MC145436	DIP14	DTMF decode	Yes
IC6	CA3140	DIP8	OpAmp	Yes
L1	LED	RB.1/2		No
L2	LED	RB.1/2		No
L3	LED	RB.1/2		No
L4	LED	RB.1/2		No
JP1	HEADER 6	SIP6		Yes
JP2	HEADER 2*2	IDC4		Yes
JP3	HEADER 2*2	IDC4		Yes
JP4	HEADER 3*2	IDC6		Yes
JP5	HEADER 12	SIP12		Yes
JP6	CON2	SIP2		Yes
Q1	BC548	TO-92A		No
Q2	BC548	TO-92A		No
Q3	BC548	TO-92A		No
RV1	10k	VR4	Cermet trimmer	No
RV2	10k	VR4	Cermet trimmer	No
RV3	10k	VR4	Cermet trimmer	No
RV4	10k	VR4	Cermet trimmer	No
RV5	10k	VR4	Cermet trimmer	No
RV6	10k	VR4	Cermet trimmer	No
X1	Crystal	XTAL.1	3.579 MHz	Yes
Z1	5V1	Zener diode	400 mW	Yes
Z2	5V1	Zener diode	400 mW	Yes
Z3	5V1	Zener diode	400 mW	Yes
Socket	18 pin	DIP 18	400 mW	Yes

Use tantalum capacitors where indicated, but if you have them on hand, I recommend you use tantalums for all the large value capacitors for their better stability and life. Where a part is designated as "critical" changing the value may have undesired consequences. In other locations the values are quite non critical such as the audio coupling capacitors. In a few places balance is important, such as R15, R19 because they set up a voltage divider. The critical point here is that they are equal in value so a pair of 6k8 would work fine instead of the 4k7 (similarly R1, R12). Voltage ratings won't be an issue as long as they meet or exceed 6 V for most of the parts, except C11 which must be greater than the supply voltage where a 16 V rating would be fine.



# A CW transceiver for 40 metres

Joe Rotenberg VK3BBN

Having given away my transmitting gear and then thought it might be fun to go on the air after all, I thought I might start by getting back on 40 metre CW.

Here then is a low powered transceiver (measured output = 1 watt) for the CW end of 40 metre. It features a superhet receiver, break-in, and a single knob controlling the tuning of both the transmitter and receiver in step.

Photo 1 shows the transceiver set up in operation, whilst photo 2 shows it with the cover off. Figs 1 and 2 show the circuit diagram.

## Design philosophy

In this project I have tried to use only components which are very readily available from the usual suppliers: no unusual ICs, slow motion drives or ceramic variable capacitors (the tuning capacitor is a standard transistor broadcast type). This has resulted in a circuit, which may be rather complicated, but on the other hand chasing up odd components at hamfests and out of the way overseas suppliers may also be a complicated procedure.

## Principle of operation

Referring to the circuit diagram, the signal is generated by first mixing the VFO (at 3 MHz) with a 4 MHz oscillator in the "transmitter mixer oscillator". This produces a sum product at  $3 + 4 = 7$  MHz, which is filtered from the other products by the "transmitter bandpass filter". After that it is passed through the "buffer" and "driver" stages, and finally the "power amplifier". At this stage, the signal will not be sinusoidal, and so the "low pass filter" is used to filter out the higher harmonics and produce a clean sinusoidal signal into the antenna.

To receive a signal, it

comes in through the antenna and low pass filter to the "receiver band pass filter", which lets through only signals around the required 7 MHz. After that it is mixed in the "receiver mixer" with the signal from the VFO. Since the same VFO is used for both the transmitter and receiver, they tune in step. The output of the mixer goes to a narrow "crystal filter" which selects the required signal from others close by.

After amplification in the "intermediate frequency amplifier", the signal is mixed in the "product detector" with the beat frequency oscillator at approximately 4 MHz. This oscillator is offset slightly in frequency to the one in the "transmitter mixer/oscillator", and therefore a signal on exactly the output frequency of the transmitter will come out as an audio note from the product detector. This is then amplified by the "audio amplifier" and fed to the headphones.

Also there is a "control and power" section, which supplies the various supply voltages: 12 volt for the transmitter power amplifier and driver, 9 volt Tx for

all other transmitter section power, and 9 volt for everything else.

## Special features

Within each block, the circuitry is fairly conventional and examples can be found in the ARRL and RSGB handbooks, but several features may be worth commenting on:

1. The back to back diodes in the "receiver bandpass filter". This is a clever idea, which I first saw in a circuit by Lewallen that appeared in ARRL handbooks of the 1980s, though it may well be older.

Referring to the circuit, when the set is in "receive" mode there is not much signal across the diodes. Therefore they act as open circuits. Thus the 39 pF capacitor and 13  $\mu$ H inductor form a series tuned circuit which lets the signal through.

On "transmit", however, the signal is much stronger and the diodes conduct. Not only is the inductor then shorted out, but the capacitor

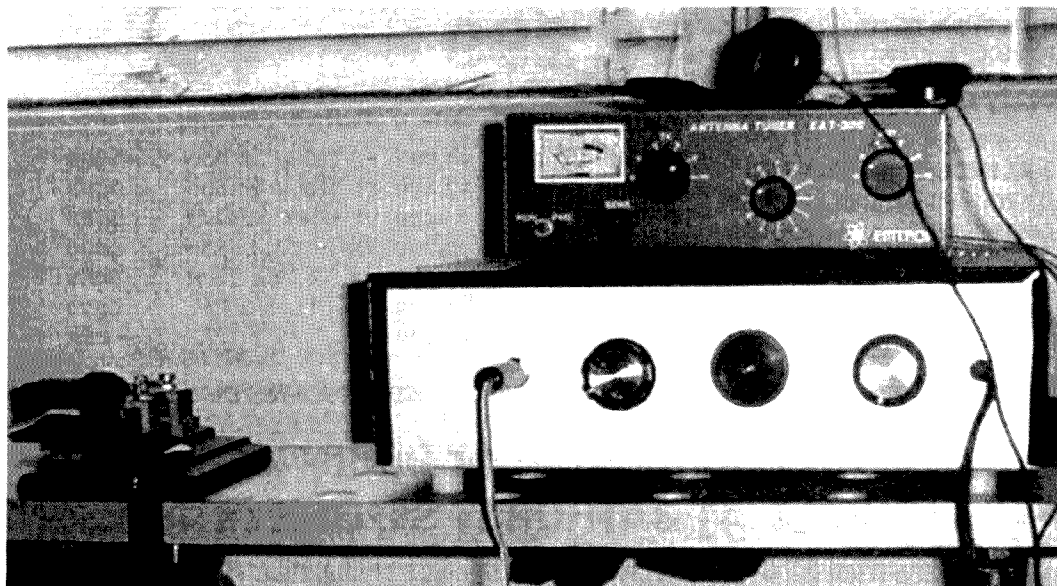

Photo 1

and inductor are now no longer a pure series tuned circuit, and so the 39 pF capacitor, one end now grounded through the diodes, presents a higher impedance than when that end was allowed to swing free. This isolates the receiver and transmitter.

- The BD139 transistor used in the power amplifier. This transistor is actually listed (and is therefore priced) as an audio power amplifier, but its unity gain bandwidth is as high as 250 MHz and it is therefore quite suitable for RF use.
- The cascode circuit in the intermediate frequency amplifier. The "cascode" circuit was used in the old valve TV tuners, and consisted of a triode amplifier with the cathode of a second triode directly on the plate of the first. The idea is to keep this plate at a steady voltage and so reduce the possibility of instability through feedback via the valve's plate-grid capacitance.

I have used this idea here. The MPF102 input FET has a BC548 transistor sitting directly on its drain. In this way I hoped (and succeeded) in keeping the circuit stable. Otherwise it might have taken off as a "tuned plate - tuned grid" oscillator.

- Use of a broadcast variable capacitor. Since the tuning range for 40 metre CW (7 - 7.03 MHz) is small it is possible to use one of these without a slow motion drive.

## Construction

The circuit was built on a double-sided printed circuit board. The top side is a ground plane above which the components sit, with holes for their leads to go through without touching (unless, of course, they are ground connections, in which case they are soldered directly to the top sheet).

Since it is never possible to design a printed circuit board exactly right the first time, the errors are snipped out and new work done above it "rats' nest style" to replace it.

If there is enough interest, I will redraw the printed circuit board in the light of these corrections and supply it to any interested reader. Please write to me at GPO Box 789, Melbourne, 3001. An A4 sized SASE would be appreciated. Of course the offer is on the understanding that it is only for the reader's personal use and not for any commercial or other monetary gain.

## Cost

The cost of the transceiver using all new parts and including the cabinet was around \$140.

## Alignment

The alignment of the transceiver may be done in the following order:

- Turn drive to a minimum (ie make the 500 ohm trimmer in the "driver" stage a maximum). This is done to protect the power amplifier.
- Put a 50 ohm dummy load at the antenna socket.
- With the key down, a whistle should appear in the phones. Adjust to replace it.

# Andrews Communications Systems

ESTABLISHED 1976

ACN 001 968 752

### ICOM DISCOUNTED

IC-756 Pro II HF+6m	<b>\$3,999</b>
IC-746 Pro HF+6m+2m	<b>\$2,499</b>
IC-706 IIG HF-70cm	<b>\$1,399</b>
IC-718 HF SSB w.DSP	<b>\$1,199</b>
IC-910H 2m+70cm SSB	<b>\$2,199</b>
IC-208H 2m+70cm	<b>\$649</b>
IC-V8000 2m 75W	<b>\$399</b>
IC-R5 H/H Scanner	<b>\$399</b>

### ICOM SCANNERS DISCOUNTED

★ 3 YEAR WARRANTY ★

### ALINCO DISCOUNTED

DX-70TH HF/6m 100W	<b>\$1199</b>
DR-620E Deluxe dualband	<b>\$599</b>
DR-605E Duplex dualband	<b>\$599</b>
DR-135T Mk2 2m 50W	<b>\$349</b>
DJ-V5E Dualband handheld	<b>\$499</b>
DJ-X2000E Hi-tech scanner	<b>\$799</b>
DJ-X10E All-mode scanner	<b>\$599</b>

★ 3 YEAR WARRANTY ★

## YAESU FT-857D HF-70cm

All-mode compact  
Hi-performance  
transceiver

**\$1,299**



FT-1000MP MkV 200W	<b>\$4,999</b>	FT-2800M 2m 65W	<b>\$349</b>
FT-847 HF-70cm	<b>\$2,499</b>	FT-1500M 2m 50W	<b>\$399</b>
FT-7800R	<b>\$499</b>	VX-1R w/2 batteries.	<b>\$369</b>
FT-8900R Quadband	<b>\$799</b>	VX-2R Tiny Dualband	<b>\$399</b>
FT-8800R Dualband	<b>\$699</b>	VX-5R Triband H/H	<b>\$499</b>
FT-817 HF-70cm	<b>\$999</b>	VX-7R Deluxe H/H	<b>\$679</b>
FT-897D HF-70cm	<b>\$1,499</b>	★ 3 YEAR WARRANTY ★	

COMET ANTENNAS & ACCESSORIES DISCOUNTED

### KENWOOD DISCOUNTED

TS-570SG HF+6m+ ATU	<b>\$2,499</b>
TS-480HX HF 200W+6m	<b>\$2,499</b>
TS-2000 HF-70cm + ATU	<b>\$3,299</b>
TM-D700A 2m/70cm	<b>\$999</b>
TM-G707A 2m/70cm	<b>\$599</b>
TS-480SAT HF+6m+ ATU	<b>\$2299</b>

TOKYO HI-POWER, PALOMAR, TE SYSTEMS, YAESU LINEARS.  
bhi NES 10.2 DSP speaker \$249  
DIAMOND ANTENNAS from only \$99 ea  
HUSTLER + EMTRON ANTENNAS  
Avair SWR/RF wattmeters fr. \$99  
**DIAMOND - Why pay more?**

BINOCULARS & TELESCOPES DISCOUNTED  
DIGITAL SCANNING RECEIVER...\$199

**MFJ** KEYS, TUNERS, ANALYSERS ETC

**CALL (02) 9636-9060 or 9688-4301 or FAX 9688-1995**

**SHOP 8, 41 BATHURST ST, GREYSTANES, NSW 2145**

Why pay more? MAIL ORDER TO PO BOX 240, PENDLE HILL, NSW 2145

Some items indent. Prices subject to change without notice - limited stock, some items.

E & OE

★ <http://www.andrewscom.com.au>

★ email: [lee.andrews1@bigpond.com](mailto:lee.andrews1@bigpond.com)

AR/14

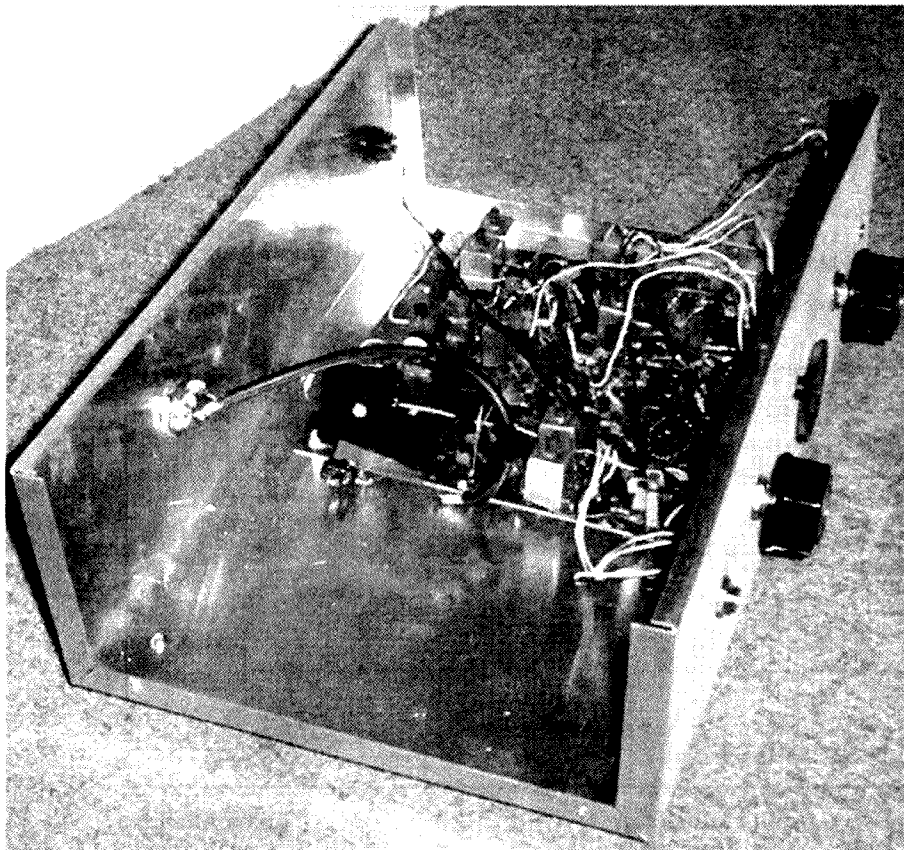

Photo 2

the trimmer in the "transmitter mixer oscillator" until the pitch is pleasant.

4. With the tuning knob fully anticlockwise and trimmers on the tuning capacitor set to a minimum adjust the slug until the VFO frequency is exactly 3 MHz, as heard on a communications receiver.
5. With an oscilloscope or RF probe on the gate of the "buffer", adjust the slugs in the "transmitter bandpass filter" for maximum output.
6. Increase the drive to the maximum that still gives a sinusoidal output at the antenna. If an oscilloscope is not available, adjust the drive for 1 watt output at the antenna (= 10 volts peak into 50 ohms).
7. With a high impedance voltmeter measuring the AGC voltage (ie the top of the 10 M resistor) adjust the slugs in the "receiver bandpass filter", "receiver mixer", and "if amplifier" for a maximum negative voltage with key down.

The set should now be aligned, and

this can be confirmed by connecting an antenna.

### On the air

With a set having a low output power and good receiver, such as this one, don't expect others to hear you as well as you can hear them, especially if your antenna is not the best. Nevertheless, in the few weeks that I have had this set operational, I have worked stations as far away as Queensland and New Zealand and quite routinely had long chats with stations in NSW and Tasmania, to say nothing of country Victoria and, of course, the Melbourne Metropolitan area, where I live.

On receive, of course, it is possible to hear stations from all over the planet.

This, then, is a project I have presented as something to build of reasonably high performance for those who do not have large junk-boxes and would rather buy all the components easily. If you try building it (or if you have any other comments), please write to me and let me know how you get on.

## Australian Made ANTENNAS "Setting a New Standard" COM-AN-TENA

(Formerly a j and j coman)

115 John Street  
GLENROY 3046

All new 5/8 vertical 16 radials	\$160
Dual drive 26-30 5 ele yagi beam	\$315
4 ele 10-11m yagi beam	\$278
5 ele high gain antennas 11m	\$327
3 ele delta loop 10-11m	\$326
11m 5/8 vert./4-1/4 wave radials	\$175
Duoband 10-15 3 ele each band	\$385
Tri-band 5 ele HB35C s/steel fix	\$730
3 ele 20m computer opt	\$420
3 ele 15m computer opt	\$295
M B Vert Auto switch 10-80m	\$330
40m linear loaded 2 ele beam	\$595
6m 5 ele compt opt beam	\$268
6m 7 ele compt opt beam boom — 60mm	\$387
10 ele high performance 2m	\$145
17 ele high performance 70cm	\$125
2m vert 2-5/8 co-linear 4 rad	\$120
Log-periodic 9 ele 13-30 MHz 8.4m boom	\$990
Wire Dipole 10-20-40-80 MHz	RING

### Guyed Masts

21 metres                      13 metres  
Winch-up & tilt-over. Aluminium and stainless steel  
three-sided construction. Auto-brake winches.

### Free Standing Masts 9.5 metres

New Baluns  
1-1 to 16-1 to 3kW



Our Masts meet Australian Standards. We supply all the computations and data you will need for a permit.

**03 9773 3271**  
**Mob: 0419 542 437**

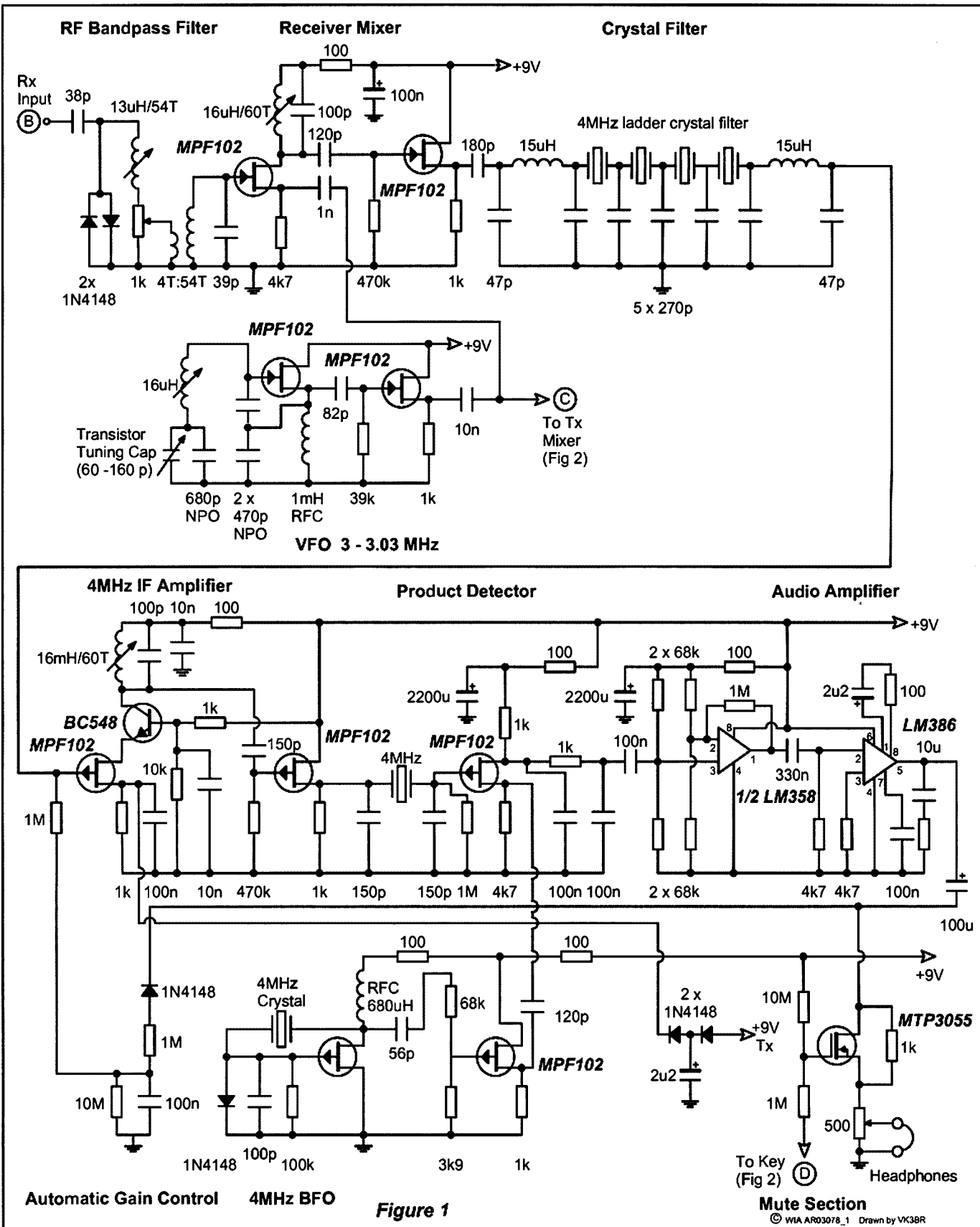

Fig 1 – Receiver and common section. All adjustable inductors assembled on 4.83 mm diameter by 14 mm height screened formers with F16 slug.

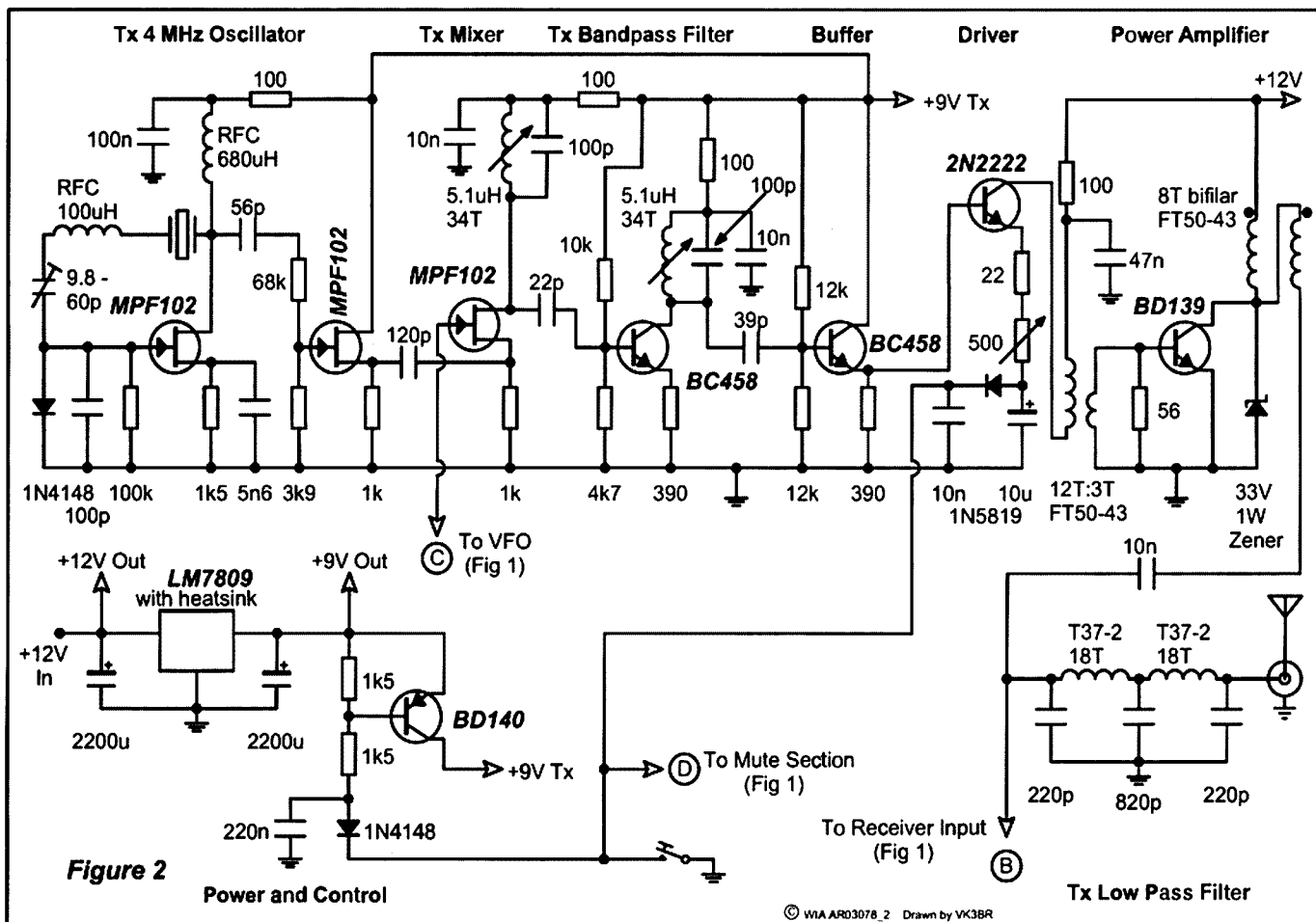

Fig 2 – Transmitter and control sections. All adjustable inductors assembled on 4.83 mm diameter by 14 mm height screened formers with F16 slug.

ar

**WIA comment**

**The WIA position on Broadband over Power Line (BPL)**

*continued from page 3*

to large scale rural areas with minimal infrastructure cost.

The real problem is that BPL is one of those things that ‘can be shown to work’ at the trial stage and once the investment is made, it is very difficult to terminate such a system, no matter how poor it turns out to be in reality.

Due to the very nature of BPL, the WIA believes that the responsible department, the Department of Communications, Information Technology and the Arts (DoCITA) and the Australian Communications Authority (ACA) must consult widely with due regard to the risks involved in the introduction of a problematic technology, and having full regard to emerging alternative

technologies. The WIA strongly believes that DoCITA and the ACA should tread very carefully on this issue for the long term benefit of the nation and not be persuaded by commercially attractive short term band-aid solutions, which may leave Australia with a technology which is neither economic nor capable of being upgraded to rapidly expanding consumer demands.

The WIA supports increasing broadband access and broadband competitiveness in Australia, but in a way that does not cause harmful interference to legitimate users of the high frequency spectrum. The WIA supports the development by the ACA of policies that protects existing spectrum

users, which includes but is certainly not limited to the amateur service.

- The WIA has formed a working group on BPL matters with coordinator WIA director, Phil Wait VK2DKN, David Wardlaw, VK3ADW, Owen Duffy VK1OD, Barry White VK2AAB, Rick Warnett P29KFS and Fred Johnson ZL2AMJ.
- For more information on BPL refer to the WIA website at [www.wia.org.au](http://www.wia.org.au) or those of the RSGB and the ARRL at [www.rsgb.org.uk](http://www.rsgb.org.uk) and [www.arrl.org](http://www.arrl.org). BPL news is also a regular feature on the WIA national news broadcast.

ar

# The 204BA, a 4-element 20 metre beam plus a rotatable 40-cum-30 metre dipole (Part 1)

Bob Slutzkin VK3SK

For more than twenty years now, I have been experimenting with various types of dipoles strung across beams. I have lost count of the number of different antennas I have tried, but until now each one has failed in one of the following:

- Good radio performance,
- Ease of construction,
- Ease of tuning,
- Mechanical and structural strength,
- Durability.

What I am about to describe is a simple device built around my 204BA 20 m beam which satisfied all of the above criteria, the only possible doubt being the durability of one component. The

antenna was intended for use as a 40m dipole, and by pure luck it turned out that it also works just as well on the 30m band.

The HY-Gain 204BA is a 4-element

20 m beam with a reflector, a driven element and two directors on a 26 foot boom. (All measurements in the HY-Gain manual are in inches, so please excuse me for staying with Imperial measurements)

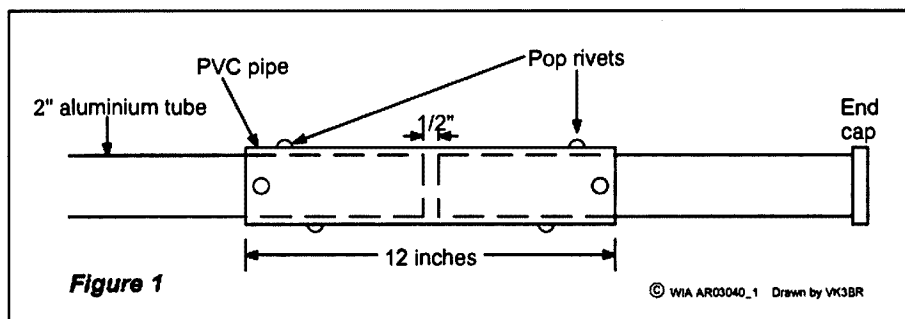

Fig 1 – Insulating sleeve joint at director end of modified boom.

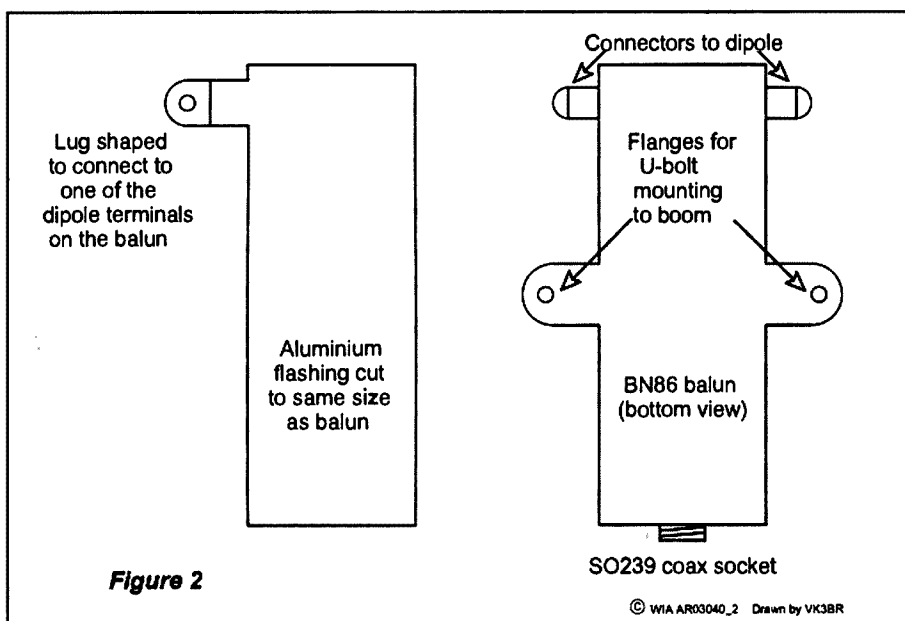

Fig 2 – Balun and aluminium flashing connection plate.

## The boom

Only one modification to the boom was needed. This was to insulate the 2nd director from the boom, and there are many ways that this could have been done. The simple and inexpensive method I used was to put an insulating sleeve joint near the end of the boom that supports the 2nd director. I would not have hesitated to cut the existing HY-Gain boom, 18 inches from its end, but I happened to have some old aluminium irrigation pipe of the same diameter and gauge from previous projects. I therefore used one 60 inch and another 18 inch length of that material instead.

For the sleeve, I used a 12 inch length of 50 mm storm water PVC pipe from the local hardware shop, and details of the sleeve joint are shown in fig 1. The sleeve makes such a tight joint that it was necessary to ram the parts together against a wooden block. The joint was then fixed with a few random pop-rivets. To make sure that the sleeve was centrally placed with a half inch gap inside, I put the sleeve over the longer part first, up to a previously marked 5 3/4 inch line and riveted before continuing. For the next step of inserting the shorter part, I securely tightened a worm type hose clamp over the tube at its 5 3/4 inch mark to provide a stopper (because I had

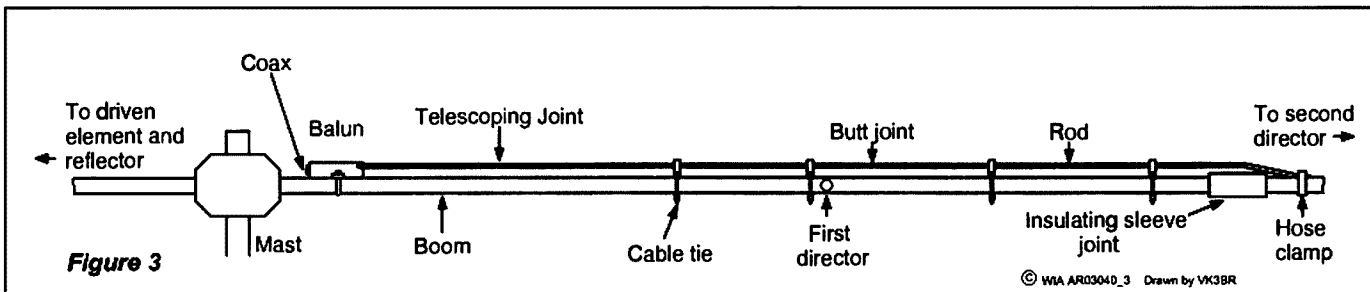

Fig 3 - Modified boom and rod layout.

previously found that it is very difficult to pull such a tight fitting sleeve joint apart). The durability of the PVC pipe used in this way while exposed to the UV and weather is the doubt mentioned above

The beam was then put back together using the modified boom.

## The balun

A balun was attached to the boom adjacent to the supporting mast, with one of the balanced terminals connected to the boom and the other to a rod, which will be described shortly. I used a HY-Gain BN86 and cut a piece of builders' flashing aluminium to fit under the balun and connect to the terminal as shown in Fig. 2 (Any 1:1 balun could have been used with a little improvisation.).

## The rod

A 12 foot telescoping aluminium tube of around about 1/2 inch diameter was required. There are firms that stock long lengths of tubing in imperial telescoping sizes (one VK3 source is "Light Spars of Australia" at 6 Horscroft Place, Moorabbin). I was able to recycle parts from older projects for the job.

An inch or so of one end was flattened for clamping under that hose clamp, and the other end was also flattened and a 1/4 inch hole drilled for connection to the balun. A slight bend where the rod is clamped to the boom and a corresponding bend a short distant out enabled the rod to lie on a parallel line 2 inches from the boom as shown in fig 3.

## Stand-offs

Four stand-offs were made of 3 inch lengths of the black 20mm tubing of the type used in garden sprinkler systems (but bits of garden hose would have done just as well). These were cable-tied to the boom through small holes across

the base, and the rod was threaded through tight fitting holes at the top as shown in fig 4. This turned out to be an ideal method of holding the rod firmly in place.

## Results

Preliminary measurements were made on an MFJ 259B analyser with the expectation that some adjustments would be required. But none was needed. The SWR was between 1.5:1 at 7.05 rising to 2.1:1 at 7.3 MHz. But the bonus! The SWR was also 1.3 :1 over the 30 m band (see fig 5).

I find the antenna ideal for local chats on 30 and 40 which usually rely on high angle radiation. For this the antenna appeared to have only a small amount of directivity. I am not a DX enthusiast; but the other night I tried rotating the antenna while listening to W5TZC chatting to a ZL; and measured at least 3 S units front-to-side on their signals. When they signed, I gave the W5 a call, and he gave me 4 by 4, saying he had picked me out as the strongest of those who were calling him, but my power

output was only about 70 watts.

The drawings show how simple the whole thing is. In part 2, I shall give a run down of some of the experiments that I and others have done along these lines, and try to solve the mystery of why the antenna works on 30 metres.

(Part 2 next issue)

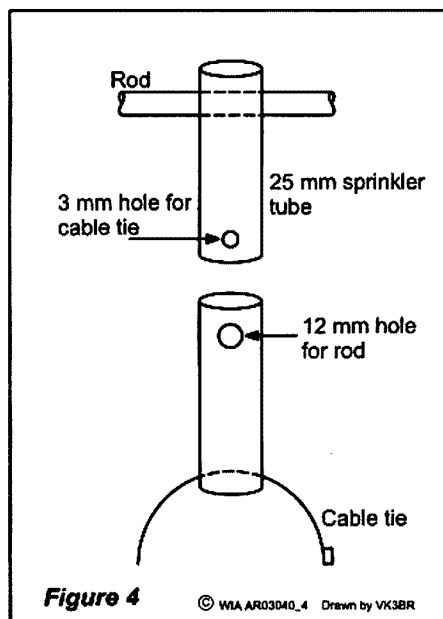

Fig 4 - Rod standoffs.

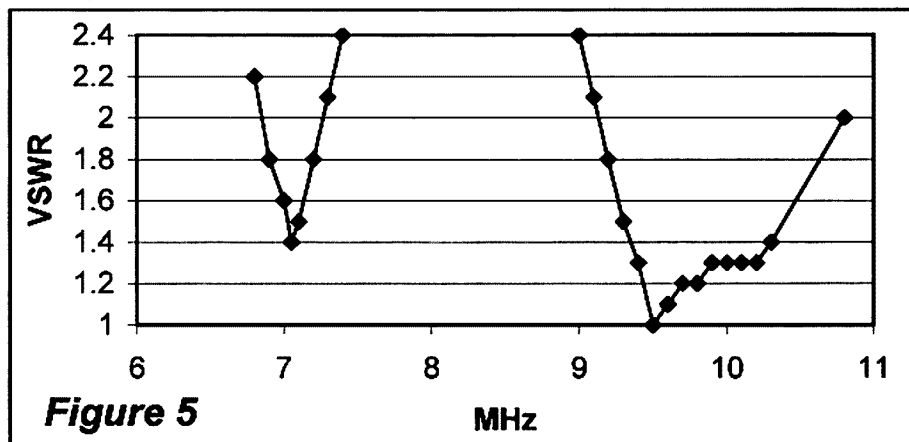

Fig 5 - VSWR vs frequency plot.

## OZGEAR

### Ozhelph Services

Doug Hunter VK4ADC

Brisbane

Ph 07 3273 7263

Fax 07 3272 1800

sales@ozgear.com.au

 ICOM

#### • HF Transceivers -

7800, 756Pro2, 7400, 706Mk2G, 718

#### • VHF/UHF Transceivers -

V8000, 208H, 2720H, 910H, V8, T90A

#### • Receivers - R3, R5, R10, R20,

R8500, PCR100, PCR1000

#### • Accessories - wide range of options and parts

 YAESU

#### • HF Transceivers - Base & mobile

FT-1000MP, 817, 847, 857, 897

#### • VHF/UHF Transceivers -

Base, mobile and handhelds

FT-1500M, 2800M, 7800R, 8800R,

8900R, VX-1, 2R, 5R, 7R, VX150

#### • Receivers - VR-500, 120D, 5000

• Accessories - Yaesu rotators, thrust bearings plus equipment options

**Plus...** OzGear balun kits, Diamond HF, VHF & UHF antennas & accessories, MFJ & LDG tuners, Autek antenna measurement, Daiwa cross-pointer SWR meters, RFI, Mobile One, GME, Scalar & TET Antennas, Coax connectors, cables and hardware from Andrews, RFI & Benelec

**With...** More brands available and new products being listed all of the time...

CB, Marine, Airband and Land Mobile equipment and accessories are also available.

**Product not listed above ?**  
Phone or email to see if we can help or visit us on the web at <http://www.OzGear.com.au> for the latest product info plus on-line ordering.

# Skills shortages in the electrical, electronics, ICT, instrumentation and automation manufacturing sectors

Many authors have written about the apparent skills shortage problem in the electrical, electronics, ICT, instrumentation, automation, and allied manufacturing sectors. The problem is not new and has been emerging as an issue since about the mid 80s.

The problem manifests itself in many ways. From personal experience I see this manifestation in the lack of practical electrical knowledge in secondary school students, superficial knowledge and skills in apprentices, trainees and some undergraduates, and the lack of personal enthusiasm by new entrants into the industry.

This should not be interpreted in any way as a slur against the persons concerned or the education system that they have been exposed too. It is however symptomatic of the problem of computers in the home and schools effectively replacing electronics as a hobby.

Prior to the early to mid 80s, people, typically teenagers and young adults, who had a personal interest in electronics often drifted into amateur radio or audio and Hi Fi to fulfil their interest. Magazines such as the now defunct Electronics Australia were eagerly read by enquiring minds. Amateur radio was a hobby of choice because it offered, and still does, a low cost avenue for enthusiasts to gain hands-on skills in the design, construction, fault finding, operation and establishing of a radio station.

From some time in the late 80s potential electronics hobbyists turned to computers, seeing this as the way of the future, and they were right. However, it could be argued that what knowledge was gained about computers was conversely lost about electronics.

Recently, I had the need to have a plug-in power pack for a wireless keyboard and mouse tested as it was thought to be defective. When the IT technician arrived he was asked to test the power pack's output with a multi-meter. To my surprise he did not have one. In fact the entire IT support office did not possess one at all!

The above is not atypical. Computer experts, technicians, hobbyists, etc, are very often quite good at driving their PC. They can use the keyboard, interpret information on the video screen, know their way around the software/application, but know very little about what is happening within the PC electrically. While all of this is fine, where has this left the electrical and electronics industry?

History suggests that people who go into a career with a high level of personal interest in what ever it is they choose to do will often do very well at it. I think back to the number of trades people, technicians, engineers, and scientists I have known over the years, who had an interest in electronics as a hobby, who went on to develop this personal interest into a career and to do very well at it.

Anecdotal evidence from the industry today suggests that employees entering the work force often don't have the level of interest in, or passion about, electronics that their forefathers did. They probably have gone through their teenage years not exposed to any hobby or personal interest in very much if anything electrical, except for a PC!

I hear from employers that they find it difficult to recruit trained staff that have good hands-on skills at component level. And before you say that most electronic equipment is maintained on a remove and replace basis, give some thought to the industries that manufacture and maintain RF, power electronics, avionics, medical, scientific and industrial instruments, motor control centres, and etc. They all do repairs at component level and I have identified but only a few.

An example of where an industry rapidly needs to up-skill its work force to cope with emerging technology



is in the automotive Telematics sub sector. Telematics is the convergence of automotive electrical, electronics, instrumentation, entertainment, navigation, communication, night vision displays, collision avoidance radar, safety systems, automobile and engine control and management systems, the smart office, the smart home, etc, etc.

Consumers are starting to see this technology in most prestige cars and it is rapidly gravitating down to standard production models. One of the problems for the auto industry is that its work force (particularly in the maintenance and servicing subsectors where the majority of tradespeople are mechanics, panel beaters, spray painters and the like), is not trained to handle, let alone diagnose, problems with electronics.

Take the scenario of a crash damaged car requiring panel beating and painting to the rear bumper bar complete with ultrasonic or radar reversing sensors inbuilt. All of a sudden you have painters and metal bashers (and I mean this in the most respectful way) having to remove, repair, paint, and reinstall a car sub assembly containing sensitive electronic sensors! The above is but an elementary example of what is currently occurring, and it will only get worse.

Consider having your car with inbuilt Global Positioning System, or Heads Up Display, or collision avoidance radar repaired by a non-electronics-experienced person. I know of a case recently where it took a colleague four months to have his in-built car entertainment system satisfactorily fixed because no one at the dealer workshop knew enough about the product or the car's system architecture to correct the fault first time around.

*The author's name has, at his request, been withheld. The author is an economic development professional, has been a licensed radio amateur since 1976, and has sectoral responsibility for the electrical and electronics manufacturing sectors within the organisation of his employ. He went on to do an apprenticeship in electronic instrumentation before undertaking post trade, and tertiary studies in business and management.*

**Anecdotal evidence from the industry suggests that employees entering the work force often don't have the interest or passion about electronics that their forefathers did. They probably have gone through their teenage years not exposed to any hobby, or to personal interest in anything electrical, except for a PC!**

Electronics is an enabling technology for many industry vertical such as aerospace, automotive, defence, rail, machine tooling, petro-chemical, food and beverage production, security, etc. Staffs employed in these verticals, now more than ever, need some electrical knowledge and appreciation.

Amateur radio has provided, and still does provide, albeit at a reduced level, Australian industry with a pool of people with hands-on skills gained in their own time because they were interested enough to invest their own resources into their hobby. Other examples of sectors to benefit from this phenomenon are the aviation, aerospace, and automotive industries. There are others.

One way of overcoming the problem that industry is facing is to integrate amateur radio and electronics into

secondary school curricula. Until at least the 1980s amateur radio clubs in secondary schools were not uncommon. I wonder how many are in existence today.

Various governments are currently investigating Careers in Manufacturing strategies. The amateur radio movement, radio clubs, and the WIA may wish to consider the part that they can play by joining forces with governments, education providers, industry and their representative associations by jointly fostering the reintroduction of amateur radio and electronics into secondary schools and to the general community for the benefit of both Australian industry and amateur radio as a hobby.

This should result in a win-win outcome all round as each party gains new entrants, better qualified participants, and a stronger local industry.

ar

# Antenna

'HomeBrew'

(with a lot of help from your Bushcomm kit)

## SWCS-KIT HF ANTENNA

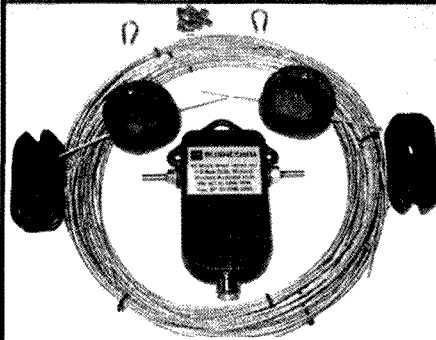

This is a kit version of our popular SWC-100S single wire model, but you have the great satisfaction of constructing your antenna.

**Easy to follow, comprehensive instructions. Common tools required.**

**You save money and have fun**

Once completed correctly your antenna will be a replica of the SWC-100S model. This is a single-wire, base-situation antenna, constructed with stainless elements to give high resistance to corrosion. It has a length of 34m in total. Trees, buildings or other structures can be used to suspend the antenna, (avoid running the antenna over iron-roofed buildings as this reduces the effective height above ground). The antenna can be mounted either horizontally between two supports, or as an inverted 'vee'

**Frequency Range:** 2-30 MHz  
**Impedance:** 50 OHM  
**Power Input:** 100 Watts, 250 Watts PEP

**This kit contains:**  
Balun (x1) Load (x2) S/S Thimbles (x2)  
Copper ferrules (plus a few practice extras)  
Large egg insulators (x2) 4 cut lengths of wire.  
**FULL and CLEAR**  
building and mounting diagrams

# Bushcomm



**PROUDLY AUSTRALIAN OWNED AND MANUFACTURED**

PO Box 2028, Midland DC 6936 Western Australia  
80 Stock Road, Herne Hill 6056 Western Australia

**PHONE: + 61 8 9296 0496**

**FAX: + 61 8 9296 0495**

**EMAIL: bushcomm@bigpond.com**

See more at

**www.bushcomm.com.au**

# Fixing-up old broadcast gang capacitors

Drew Diamond, VK3XU,  
45 Gatters Road,  
Wonga Park, 3115.

There are many amateur radio applications and projects that require variable capacitors of one sort or another. For instance, antenna couplers/ATUs capable of handling moderate power levels (up to about 100 W) can often be made using ordinary broadcast gang capacitors.

Unfortunately, those we now find at swap meets are often in pretty rough condition, typically covered with grime, plates bent and shorting, bearings seized, and mounting feet missing. If the unit is not too badly mangled, it is quite possible for the amateur to restore such components to serviceable condition.

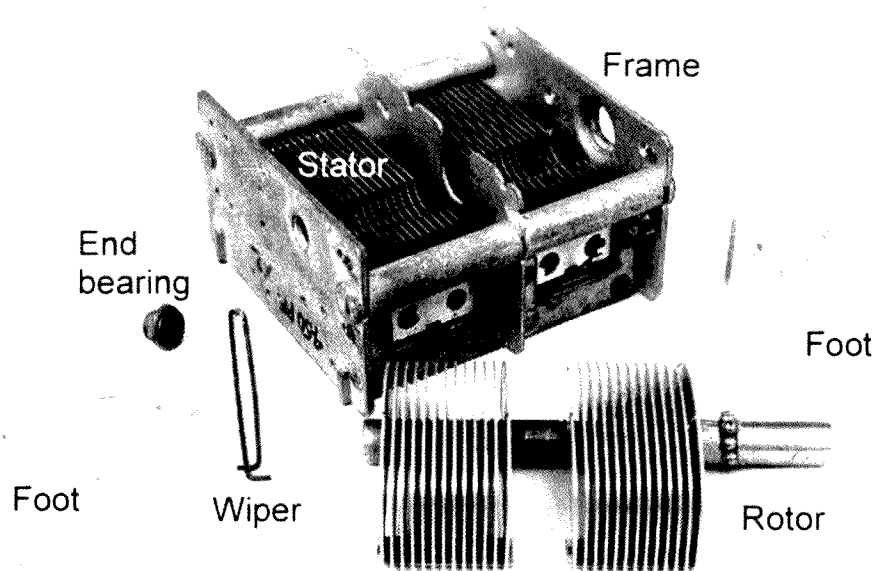

Photo 1 - Component parts.



Photo 2 - Special tools.

Refer to Photo 1. Begin by removing the wiper(s), unsoldering where necessary. Take particular note of the orientation of this component. Turn the moving plates (rotor) to their open or "un-meshed" position. Place the capacitor in a suitably large plastic container. Slacken off the lock nut on the rear (ball-housing) bearing, then carefully unscrew and remove the ball housing. Remove the single ball from this part. Now carefully withdraw the rotor from the front bearing, taking care that the (usually) nine balls fall into the container.

Auto shops supply various proprietary cleaners and degreasers, which remove greasy dirt very efficiently

from mechanical items, like carburetors. The really effective ones (eg Loctite Carb and Choke Cleaner) are also rather pungent. If you are prepared to use it safely (work outdoors, don goggles and gloves), an especially clean capacitor will result. Use an old toothbrush to scrub the insulators, and a pipe cleaner to remove dirt and grit from between the plates. Remove oily residues as described next.

The rotor and frame/stator should be washed in warm water with detergent or dishwashing liquid using the toothbrush and pipe cleaner to remove any remaining particles from between the plates. Rinse in running water, then immediately place these components to dry in a pre-warmed oven at about 100 degrees C for perhaps 10 or 15 minutes.

Plates that are slightly bent may be straightened with flat "duck-bill" pliers (visible in Photo 2). A set of feeler gauges will aid in getting their spacing correct. Insert various feelers and measure the plate spacing in an un-damaged part of the capacitor, then apply the same feeler to the repaired parts and adjust accordingly. The balls may be simply wiped with a clean cloth.

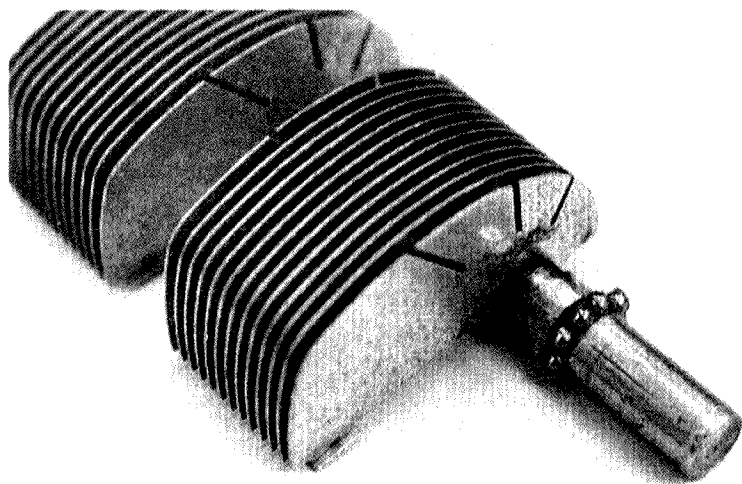

Photo 3 – Rotor, ready for reassembly.

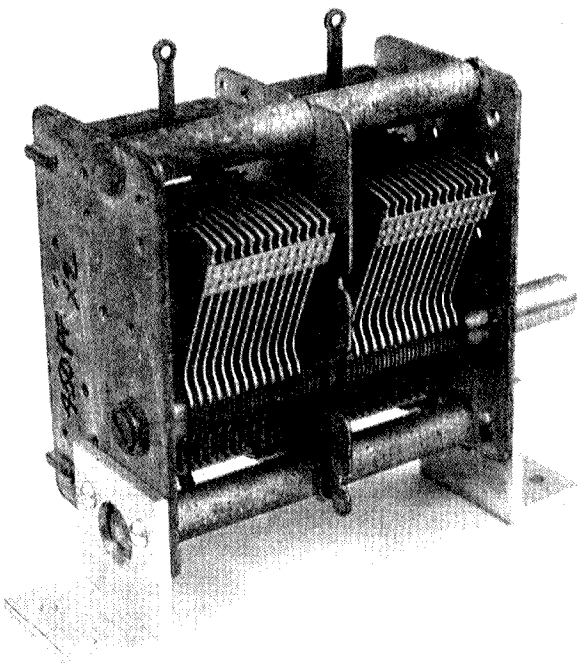

Photo 4 – Restored capacitor.

A source of replacement balls, commonly 1/8th inch (3mm) diameter, is old ball bearings. Remove the dust seal (if fitted) thus exposing the ball-cage. Place the bearing in a strong vice so that the jaws bear upon the outer race diameter. Screw up the vice until you hear the race crack, whereupon the individual balls may be extracted after cutting through the ball-cage in one place.

Reassembly is generally the reverse of disassembly. The nine balls of the front bearing may be attached to the shaft with a sticky grease, such as petroleum jelly (Vaseline TM), as illustrated in Photo 3.

Carefully offer the rotor to the frame in the un-meshed state, and locate the shaft through the front bearing hole. The greased rear bearing-ball and housing is then carefully screwed home to bear upon the rear of the shaft with just sufficient tension that the shaft rotates smoothly without end-play, yet remains in any set position. Nip up the lock nut. Hold the capacitor up to an even source of light and observe that the plates remain evenly spaced and do not touch at any point throughout the rotor's

travel. Replace the wiper(s), re-soldering where applicable.

The replacement mounting feet, visible in Photos 1 and 4 were made from 20 mm x 30 mm L-section angle aluminium off-cuts. The long part of the L forms the upright component, which is attached to the frame, thus allowing for the full swing of the rotor.

ar

# Be part of a dynamic global community

# Join

# WIA

# today



# WIA

*is active in:*

- Being an strong advocate for amateurs' place in communications
- QSL services
- Major role in amateur radio education and innovation
- Coordination of contests and awards
- Monitoring of illegal activity

10/229 Balaclava Road, Caulfield North Vic 3161

Tel: (03) 9528 5962 Fax (03) 9523 8191

email: [nationaloffice@wia.org.au](mailto:nationaloffice@wia.org.au), website: <http://www.wia.org.au>

# How I became a Ham

Hayden Honeywood VK7HAY,  
279 Bakers Creek Road,  
Lucaston 7109 Tasmania  
Age: 13 years old

I thought I would write this little article to show new novice or future Hams "What it is like"

Hello from VK7HAY,

I am writing this article about how I got my Ham licence and what is going on with my rig and antenna.

I went for my exam in June this year. I went for Novice-Limited and I passed it the first time, thanks to the Radio and Electronics School Novice disks. I got my callsign VK7HAY on 8th July. My two uncles have been helping me through the exam, all the way to now. I bought my first rig from the website vkham.com. I got an HF Yaesu FT-757GX with scanning microphone. I went straight to work setting up my first antenna which was a 21 MHz inverted 'V' dipole.

First I set it up basically on the balcony of my grandparents' home and only received because I had not yet got an SWR meter. I got a pretty good signal on 21.295 MHz upper side band from Queensland at around 59 + 5 db. I have a picture of my antenna at right.

Then I got my SWR meter and tried to transmit but my SWR was way too high so I checked all my plugs and connections but I still could not get that SWR down. I made a home brew Dummy Load to see where the problems were coming from. Then the Dummy Load broke down and wouldn't work. So I decided to stick with receiving and wait until I could get a whip for 80 metres. I am still waiting to get my whip and my 21 MHz antenna is still not working properly, despite hard testing and reconnecting of plugs. I thought I would write this little article to show new Novice or future Hams "What it is like" when you pass the easiest part of the process (which I think is the exam). Anyway good luck with your antennas and rigs, plus SWR tuning and I say,

73, from VK7HAY

ar



VK7HAY with his rig

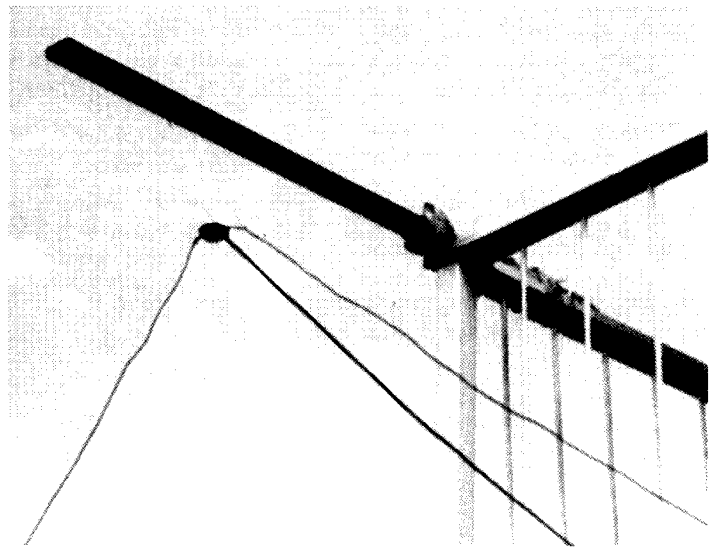

21 MHz dipole

# JOTA~

*Jambouree On the Air*  
*October 16 & 17*



# Remembrance Day Amateur Radio Contest

—10 August 2004

Address by

## General Peter Cosgrove, AC MC Chief of the Defence Force

“ I am honoured to have been asked by the Wireless Institute of Australia to launch this year’s Remembrance Day Contest, a contest that perpetuates the names of those 26 radio amateurs who lost their lives in the service of our country during the Second World War.

This weekend marks the 59th anniversary since World War II hostilities ceased in the south-west Pacific area.

The Australian Defence Force remains indebted to those amateur radio operators who served their country in times of war and peace in the skies, the deserts, the oceans and the jungles.

The amateur radio service also has a long and proud tradition of supporting the community in times of natural disaster.

From the Black Friday bush fires of 1939, to Cyclone Tracy, the Ash Wednesday disaster of 1983, the Newcastle earthquake of 1989 and the recent Victorian bush fires, radio amateurs have volunteered their expertise, time and equipment to provide vital communication links for emergency services.

Amateur radio is very much a “hands on” hobby — this provides a unique opportunity for those with a technical bent to experience both the practical and the theoretical aspects of radio and electronics. Amateur radio is thus an invaluable training ground for the military communicators and technicians of tomorrow.

During my career I have seen radio

communications develop from hand sent Morse code messages to today’s instantaneous information transfers utilising small battery powered radios with ranges of thousands of kilometres.

From my own experiences in East Timor I know full well that effective communications underpin all successful military operations. At one stage we relied on an East Timorese boy with a satellite phone to establish the humanitarian position of a large and isolated East Timorese community.

Communications is a powerful tool for the Australian Defence Force, and we are investing more and more in Network Centric Warfare.

**Much of today’s technological progress stems from the enthusiastic assistance of amateur radio operators. It is fitting that we remember with gratitude the sacrifice of those radio operators who gave their lives or were wounded as a result of their war service.**

bandwidth enabled us to network our Command and Control system from the strategic, through the operational to the senior tactical level

Further, as part of the Maritime

During the Iraq war last year, our first ‘battle’ was to obtain satellite bandwidth. We needed enough into and out of the Gulf to be able to pass quick, accurate, high-density data 24-hours a day. The



Interception Force, our Navy made extensive use of a Naval intra-net, chat rooms from ship to ship, to facilitate operations between the coalition, and our people employed a wide-range of information sources where seconds counted to identify transgressors and maintain the blockade. The networking of information was vital in preventing the Iraqi’s from releasing mines into the Gulf in the first days of the war.

It’s amazing to contrast this technology with that of the Second World War.

Indeed, much of today’s technological progress stems from the enthusiastic assistance of amateur radio operators. It is fitting that we remember with gratitude the sacrifice of those radio operators who gave their lives or were wounded as a result of their war service.

I wish you all good luck in the contest.

”

ar

# Technical abstracts

Peter Gibson VK3AZL

## A useful audio level indicator

In the Technical Abstracts section in last month's Amateur Radio, we published a description of several ways to connect computer sound cards to radio equipment, primarily to allow access to digital modes. It was noted that setting and maintaining the correct input signal levels is important in achieving correct operation. The original RadCom article referred to a previous article describing a simple level indicator. This is it.

In RadCom for March 2004, Danny Dancy, G3JRD describes a simple bargraph audio level meter that allows the levels to be set and monitored as required.

As mentioned above and elsewhere, many of the digital and weather satellite modes that use computers to process the information, require the input levels to be maintained within a narrow range to allow the interface circuits to operate correctly.

The circuit shown in Figure 1 is quite simple and straight forward. The audio signal is applied to the inverting input of the 741 op-amp. The output is rectified

and integrated before feeding the input of the LM3914 bargraph display driver. This device drives 10 LEDs, arranged as either 10 discrete LEDs or a 10 segment bar.

The original circuit is constructed on a piece of stripboard and can be powered from any split source delivering +10/-10 volt. This supply should be regulated for the two devices. It does not need to be regulated for the LED supply, but it is probably easier to use the same supply for all as per the circuit.

It would be possible to use a sensitive moving coil meter in place of the bargraph, but the bargraph is probably cheaper if you don't already have a meter in the junkbox, and it is definitely more robust.

As the circuit is shown, it should work when turned on and needs no setting up. Such a piece of equipment should have many uses around the shack beyond its initial purpose.

### Editor's note

Whilst the circuit is simple and will perform well, there are a number of

changes that could be made to increase its versatility.

If it is required to calibrate to bargraph to a specific level, this can be achieved by varying the gain of the 741 by varying the value of the 390k feedback resistor. Alternatively, the reference level of the LM3914 can be varied (see data sheets referred to below)

The LM3914 is one of a family of devices, each with different level measuring characteristics. The LM3914 is linear, with a constant voltage step between each displayed level. The LM3915 has a logarithmic response with 3 dB between each displayed level, for a full range of 30 dB. The LM3916 has a VU characteristic with uneven steps to mimic a VU meter display. For further information on all of these devices, have a look at the National web site at ([www.national.com](http://www.national.com)) and enter the part number in the search box.

One other useful idea is to use different coloured LEDs in the display. One commonly available 10 segment, bargraph has 7 green LEDs at the bottom and three red LEDs at the top. With adjustable gain, the normal operating level can be set to the top green on the display. If red is seen, you are starting to overdrive the system. The colour difference allows problems to be seen from a distance.

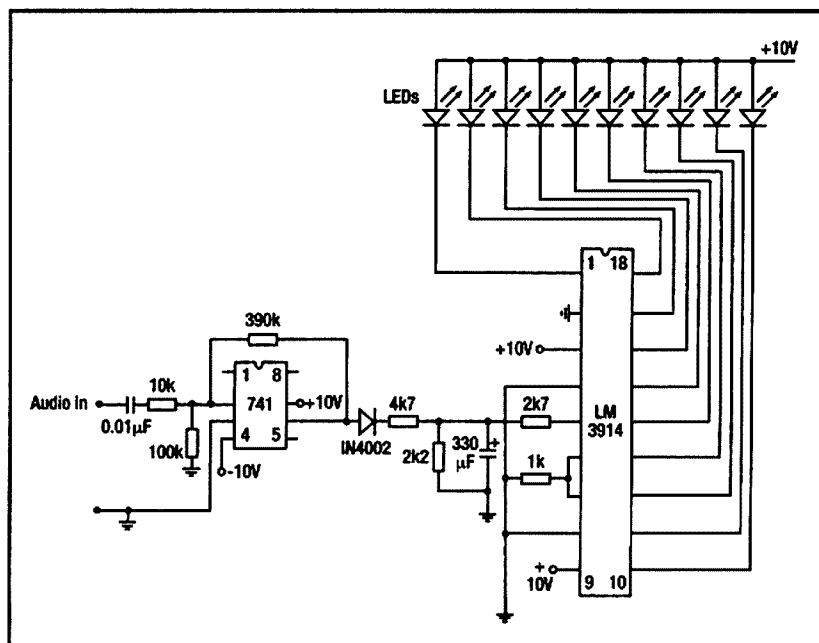

Figure 1 – The level indicator circuit

www.pca.cc  
Email from anywhere  
via Winlink  
2000  
Use PACTOR-3  
on HF to send  
Mail, Grib Weather,  
Weatherfax & Images  
Contact [marc@pca.cc](mailto:marc@pca.cc)  
Sydney 02 8902 0107

# 450 Ohm Ladder Line

Copper coated 7 core steel conductors

VERY LOW LOSS

Check us out for all RF cables and connectors.

## TEN-TEC HF Radios

Orion  
Jupiter  
& Argonaut  
HF Transceivers

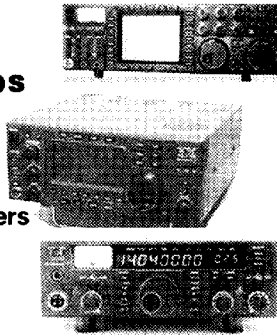

Ten Tec  
Commercial &  
Professional  
Communications  
Receivers



## SGC

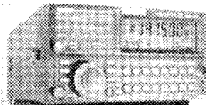

SGC 2020 Portable  
20W HF Transceiver  
SG 500 HF Mobile  
500W Power

SGC2000 150W  
Professional HF  
Transceiver

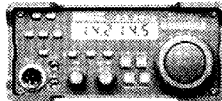

## TEN-TEC

build  
yourself  
kits

(Call for your free  
catalog)

Amidon Iron Powder  
and Ferrite Products (Call for an Amidon product  
guide)

- SGC ADSP? Noise Reduction Speakers
- SGC ADSP? Noise Reduction Boards (High power  
and low power versions available)
- Power Source switch mode power supplies (a  
wide range of outputs)
- Davis Weather Stations
- Professional Grade Coax Feed lines and Connectors
- Custom RF Patch leads and cables made to order

## High Power Variable Inductor

from Ten-Tec.  
Silver Plated Coil, Max Inductance is 20  
microHenry.

An ideal  
companion  
to the Ten-  
Tec variable  
capacitor kit.

Perfect for that  
high power  
antenna tuner  
project

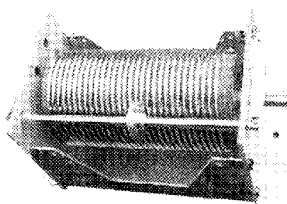

## Antenna Couplers/Tuners

SGC Mac 200 5 Position Antenna

Switch/Tuner

SGC SG235,

SG230,

SG237, SG239

and SG211

Automatic Antenna Couplers



Z100

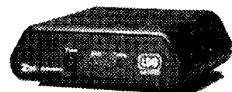

## Antenna

SGC QMS Quick Mount  
Mobile antenna system  
with built-in tuner



SGC Stealth

Kit. All you need to get  
HF on air quickly.



SGC SG

307 7

foot Mobile/Marine  
Antenna

SGC SG 303 9 foot Mobile Antenna

## RE-SELLERS

- Tower Communications, Perth
- International Communications Sup-  
plies, Port Adelaide
- Strictly Ham, Melbourne
- Marcom Watson Group (Tas)
- Kyle Comms (QLD)
- Ozhelph Services — (QLD)
- Brian Swinton Marine Elect. Cairns

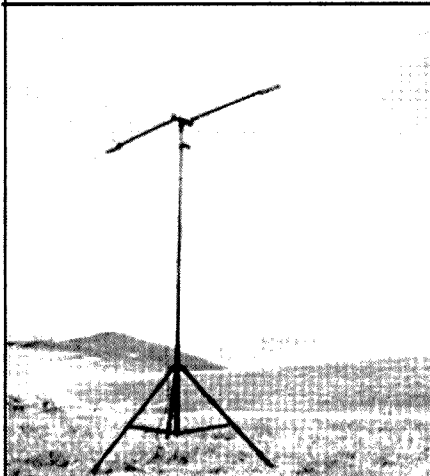

## Buddipole A Complete Portable Antenna System

- The Buddipole Antenna (9 bands, 2 - 40 meters)
- Tripod - extendable legs and locking base
- Portable Mast - extends to 8' in height
- Rotating Arm Kit - change configurations
- Antenna System Bag - padded cordura nylon w/shoulder strap
- Extra Stainless Steel Telescopic Whip
- 3 extra Coil Clips
- Antenna Operating Manual
- FREE - New 10-page modeling report

### WE SUPPORT WHAT WE SELL!

If you have a problem, our strong relationship with the support divisions of our US suppliers combined with our professional service lab will get your unit quickly up and working to original specs.



We specialise in mail order. Visa and Master Card

DETAILED DATA SHEETS ARE AVAILABLE ON REQUEST FOR MOST PRODUCTS.



# TTS Systems Communications Equipment

Systems

FREE CATALOGUE

www.ttssystems.com.au

HF and VHF Transceivers, Autotuners and Kits

Phone 03 5977 4808. Fax 03 5977 4801 info@ttssystems.com.au

## **Education task force appointed**

On 10 September 2004, WIA President, Michael Owen, VK3KI, announced that he had appointed a task force to address the issue of amateur radio and schools.

There is no doubt that there is a shortage of trained radio technicians, and this coupled with the changes

## **WIA Board requests ACA make Amateur primary in the 160-metre band**

Following a review of Australian Spectrum Plan the WIA board has requested that the ACA change the status of the amateur service in the band 1825 - 1875KHz from secondary to primary status. The primary service in this band is currently Radio Navigation Aids and since there are no longer any of these devices operating in Australia the board is hopeful that the ACA should make the change as requested.

## **WIA hosts successful NSW clubs meeting**

The WIA conducted a conference of NSW clubs on Saturday, 4 September 2004.

Representatives of 8 NSW clubs (Canberra, Blue Mountains, Waverley, St George, Illawarra, Liverpool, Goulburn and Hornsby) as well as the Tasmanian branches met at the Kyle Bay Scout Hall at Connells Point at a meeting chaired by WIA director, Ted Thrift, VK2ARA.

WIA President Michael Owen, VK3KI, opened the conference, outlining the first 100 days of the national WIA and stressing the importance of the role of the clubs to the future of amateur radio, and that the purpose of the meeting

## **VK7 signs Implementation Agreement**

It was announced late August that the Council of the Tasmanian Division had signed the Implementation Agreement, the agreement that formalises the position between the WIA and the former Divisions, a further step in the creation of a single, national WIA.

The Council has called an extraordinary general meeting of the division to be held at 2 PM on September 19 at

to the Australian licensing structure presented an opportunity to swell the ranks of radio amateurs, particularly with younger people.

The group initially comprises Ron Smith, VK4AGS, a lecturer at Central Queensland University, Brian Clarke,

## **ACA launches first spectrum management strategy for Australia**

The ACA held a seminar to release its spectrum management strategy for Australia in Melbourne on 19 August 2004. David Wardlaw, VK3ADW, represented the WIA at the seminar. A copy of David's report to the WIA board and other information, including links to the ACA's media release and its spectrum management strategy and the possible implications for the future for the amateur service can be found on the WIA's web site.

was to find out what the clubs saw as important to assist them, to guide the WIA in developing its relationship with the clubs.

Two workshops were established, one identifying means by which the clubs can assist the WIA and the other identifying the services that the WIA could offer to assist the clubs.

In closing the all day conference, Alan Hawes, VK1WX, referred to the value of the conference, thanking the WIA for arranging the meeting, and Ted Thrift acknowledged the constructive and enthusiastic support of all who attended.

the Ross Hotel, Ross. The council is recommending that the division be wound up and the current branches become radio clubs.

More information on each of these items, and other items, may be found on the WIA's web site [www.wia.org.au](http://www.wia.org.au). The site is regularly updated with current news and other information of interest to radio amateurs.

VK2GCE, an education consultant, Lee De Vries, VK3PK, of the Gordon Institute of TAFE at Geelong, and Dave Godfrey, VK3AZX, a former Technical School principal, who would initially act as coordinator of the group.

## **WIA submission – 5.8 GHz band**

The WIA has made a submission to the ACA in response to its inquiry into proposed licensing arrangements for regional/rural broadband wireless services in the 5.8 GHz band.

In addition to addressing the particular requirements of the amateur and amateur satellite service in this band, the WIA also said that it is anxious to conduct more general discussions with the ACA on the issue of more secure amateur access to those small segments within shared bands that are of prime importance to the amateur service.

## **Queensland votes to wind up and transfer assets**

On 24 August 2004, at a special meeting of the Queensland Division, it was decided by two separate resolutions, to wind up the Division and to pass the Division's assets to the WIA. The first resolution was adopted 150 votes in favour, 1 against, and the second resolution was adopted 151 in favour and 1 against.

"The magnificent margin in these votes reflects the strong view of Queensland members that the future is with the national WIA and that there is no point in trying to retain the structures of the past," said Chairman of the meeting Ewan Mcleod VK4ERM, President of the Queensland Divisional Council (WIAQ).

## **New members joining the National WIA grows**

After three months of operation as the national WIA, the number of new members is growing by around 25% when compared with membership growth last year. It is still too early to determine if the number of members renewing is different from last year, though no alarming trend has been detected.



## VK1 news

### CRARC Forward Bias

Membership of the Canberra Region Amateur Radio Club (CRARC) is slowly increasing. However, members of the WIA ACT Division are considered members of CRARC until their WIA membership is up for renewal. They will then have a choice of remaining a member of the WIA and/or joining CRARC. This process is obviously going to take some time because some WIA members are not due for renewal until 31 July 2005. In the meantime, there is nothing to stop anyone from becoming a CRARC member now. Membership of CRARC is \$20 per year. Membership applications are available from our Website at: [www.vk1.wia.ampr.org](http://www.vk1.wia.ampr.org) or at the general meetings of CRARC.

During the October general meeting, there will be a proposal to re-establish an 80-metre club net. Several members have asked for this to be organised. Alan Hawes, our president, will conduct a straw poll on this subject to determine support for it. Setting up a successful club net requires volunteers to run it. Are you interested? No pre-conditions have been set yet, but it will be necessary

to select a suitable frequency, time of operation, net duration, transmitted power level, and type of antenna used by the net controller and net participants, as well as program subjects.

CRARC is in the process of revamping the VK1 Award system, as all the certificates now carry the wrong club name, logo, and landmark display. However, as before, there will be a time period after the Club Net finishes when VK1 Award seekers will have an opportunity to make contact with ACT based radio amateurs to accumulate points towards the award or upgrades. The newly appointed Award Manager is Colin Holmes-Clarke, VK1ZHC.

To establish efficient management practices, Alan Hawes has allocated portfolios/tasks to the following committee members: Alan Hawes, VK1WX-Broadcast/E-mail News, Russell Manning, VK1JRM-General Meetings and Guest Speakers, Graeme Wilson, VK1FXL-Education, John Woolner, VK1ET-JOTA Coordinator, Gilbert Hughes, VK1GH-ACT Technical Advisory Committee (ATAC) Liaison,

Philip Longworth, VK1ZPL-WICEN ACT State Coordinator.

An important event this month is the Jamboree Of The Air (JOTA). The Scouts & Guides organisation in the ACT will activate two stations, VK1HS, VK1SAA. The call sign of the national association is VK1BP. The purpose of JOTA is to bring Scouts & Guides together through radio, in addition to the 4-yearly summer camps. This year, the event is number 47 since the world jamboree in 1957. There are several ways Radio Amateurs in the Canberra region can help to introduce the world of amateur radio to Scouts & Guides. You can have an open house for them during the weekend of 16-17 October, calling CQ Jamboree, or volunteer as an operator at one of the base stations in the Canberra region. Apart from using local repeaters, calling frequencies are as follows: 3.590 - 7.090 - 14.190 - 21.190 - 28.590 MHz. The Scout's Website for the ACT is: [www.act.scouts.asn.au/actscouts](http://www.act.scouts.asn.au/actscouts).

The next general meeting will be held on 25 October 2004, at 8 pm in the Scout Hall, Longerenong St., Farrer. Cheers.

## VK6 news

Compiled by Will McGhie VK6UU

Input to:  
[will2@iinet.net.au](mailto:will2@iinet.net.au)  
08 9291 7165

Apologies for no September VK6 notes but the best snow ever on the east coast caused the problem, just had to go skiing.

### Closest vote

The August Special General meeting was held to decide several issues, the most important being the winding up of the VK6 division. Sixty-four members attended the Special General Meeting. This was quite a good turn out. Numbers like this have not been seen since the heady days when meetings were held at Science House. By the way does anyone have any photographs taken at Science House during those meetings?

In a very close vote, the motion was

defeated by the narrowest of margins. The vote was 74.6% for winding up, and 25.4% against. The motion to wind up the VK6 division was lost, as a 75% majority is required to wind up the Division. The second motion to dispense with all of our funds was not required. The third motion, to write up a new Constitution, hold another Special General Meeting to accept the new Constitution and donate most of our funds to other VK6 clubs, was passed. A small amount of money is to be retained by the division to maintain our operation.

Just how the division will function is to be seen. The primary concern expressed by some members was the uncertainty as to how the new National structure will perform. No one can



Ballot mail out

# State news



Special General Meeting

predict with any certainty what the future is. Burning our bridges could prove to be a mistake.

The September Council meeting discussed the way ahead, the finalisation of our funds, the change of our name, and the revision of the Constitution. At the October meeting we should be fixing the date for another Special General Meeting to accept the new Constitution etc. This is expected to be in December.

The accompanying photographs show the VK6 Council sitting around the council table putting together the mail out to all members, and the members at the Special General Meeting during the all-important voting.

## WICEN WA Notes

Motor sports in the form of car rallying provide regular and important exercises for WICEN WA. WICEN team members provide "SOS" (Safety on Stage)

communications using commercial equipment and frequencies, backed up by amateur 2 m equipment and frequencies.

Most recent events were the "Experts Cup" held on 17th July near Collie where five operators were utilized and the "Stirling Stages" held on 18th September with four operators involved, near Stirling Dam east of Harvey in the forest areas.

The "City to Surf Fun Run" is another event which WICEN WA supports and has done for many years providing communication links for the event organizers. This year's event was held on the 29th August and utilized 2 m amateur equipment and frequencies. The WICEN repeater was used for this local event with eight stations involved including one mobile station following the runners.

Planning is in progress for the

TELSTRA Rally Australia, with WICEN members providing some of the "SOS" communication links. This event is over three days in November. Since this event is an international event all operators need to have CAMS accreditation for the "Safety on Stage" activities they are involved in.

From a recent request to all WA amateurs by WICEN WA to have their station recorded as a volunteer in case of an emergency, several amateurs have returned their completed form. If you have not completed a form and still wish to be part of this Emergency Network, a form may be downloaded from the WIA VK6 website and returned to Rob VK6PO or Jim VK6JP.

WICEN WA may be contacted by email to [vk6wicen@wia.org.au](mailto:vk6wicen@wia.org.au) or [jimmaree@webace.com.au](mailto:jimmaree@webace.com.au) and information is on the website at <http://members.iinet.net.au/~vk6wia/c-wicen.html>

If you are not on the Internet, check out the WICEN Net, Wednesday evenings on 80 metre 3.600 MHz at 20.00 hours local time, 8.00 pm + - QRM and 146.750 or 146.700 at 8.30 pm Note: If the frequencies are busy at net time Jim will move, the last being to the local WICEN Repeater on 146.875.

Thanks to Christine VK6ZLZ and Rob VK6PO for their input to October VK6 notes.

## VK7 News

Justin Giles-Clark, VK7TW

Email: [vk7tw@wia.org.au](mailto:vk7tw@wia.org.au)

Regional Web Site: [www.wia.org.au/vk7](http://www.wia.org.au/vk7)

## Final Divisional News

On Monday the 23rd of August, VK7 signed the implementation agreement, thus bringing VK7 closer to the one National WIA. The agreement can be summarised by describing the undertakings given on each side. The Tasmanian Division encourages its members to join the National WIA, and will take certain steps to wind up the Division and properly transfer Divisional assets. The National WIA will, on advice from the Tasmanian Advisory Committee, appoint a WICEN co-ordinator and a repeater co-ordinator, contribute to maintenance

of the repeater network and beacons for at least 5 years subject to limits, continue the Tasmanian Devil Award and consider any applications for grants of financial assistance subject to terms. The special general meeting was held on 19 September 2004 to deal with the formalities of transfer and closing down the Division.

The Tasmanian Advisory Committee membership has been confirmed by the National WIA. This Committee will advise the National Board on matters that are applicable to the Tasmanian Region, as well as acting as a conduit to National administration. The initial committee is for 3 years and then after

that elections will be held. The first VK7 Advisory committee is:

Phil Corby - VK7AX	<a href="mailto:philipc@tassie.net.au">philipc@tassie.net.au</a> (Chair)
Dale Barnes - VK7 DG	<a href="mailto:vk7dg@wia.org.au">vk7dg@wia.org.au</a>
Reg Emmett - VK7KK	<a href="mailto:regemm@ozemail.com.au">regemm@ozemail.com.au</a>
Allen Burke - VK7AN	<a href="mailto:allen.burke@bigpond.com">allen.burke@bigpond.com</a>
Martin Luther - VK7GN	<a href="mailto:vk7gn@bigpond.com">vk7gn@bigpond.com</a>
Ron Churcher - VK7RN	<a href="mailto:churcher@keypoint.com.au">churcher@keypoint.com.au</a>
Justin Giles-Clark - VK7TW	<a href="mailto:vk7tw@wia.org.au">vk7tw@wia.org.au</a>

## Regional Broadcast Changes

The last meeting of the Divisional Council on 14 August 2004 resolved that the WIA National Broadcast would be played at 0900 throughout VK7 and the VK7 Regional News broadcast would follow at 0930. The Divisional Broadcast Officer role has become the VK7 Regional News and Broadcast Coordinator, thus providing continuity and maintaining an official channel between the WIA National News team and the VK7 Regional Broadcast Team (currently numbering 22!). The new arrangements started on August 29.

## Tasmanian Hamfest 2004

As reported last month, the Central Highlands Amateur Radio Club of Tasmania (CHARCT) in conjunction with the WIA (VK7 Division) is holding a major Hamfest at the Central Highlands township of Miena on Saturday December 4 2004. This is building to be the event of the decade and I encourage all VK7 amateurs to attend.

There will be operating displays, stations, CW, ATV, APRS, digital and vendor displays plus several prominent guest speakers.

Starts at 1100 and winds up at 1500. Entry is by gold coin donation. Coffee and tea will be provided and food will be available. See you there.

## Northern Tasmania Amateur Radio And Electronics Group

The Northern Branch met on the 11 August 2004 to vote on a new branch identification. It was agreed to call the new group the Northern Tasmanian Amateur Radio and Electronics Club (NTAREC). The meeting was attended by approximately 30 amateurs and they accepted the new unincorporated rules. Allen, VK7AN, President of the Northern Branch thanked all who attended for their positive attitude.

## Radio and Electronics Association of Southern Tasmania Inc.

The Southern Branch met on 1 September 2004 and after constructive debate decided to become incorporated and decided on a new name of the Radio and Electronics Association of Southern Tasmania Inc (REAST).

It will be an incorporated body as we have an existing lease and agreement with the Hobart City Council and the Tasmanian Small Marine Radio Group and the feeling of the meeting was that we needed to become a legal entity to ensure continuity of these arrangements and limit any potential liability.

I thanked all involved, especially Phil Corby, VK7ZAX, the executive team and those members who attended, I think we have placed the Southern Branch on a great foundation for the future.

## Q5 broadcasts in Southern Tasmania

We thank the Gold Coast Amateur Radio Society for allowing the retransmission of their Q5 education and information hour on Southern repeaters on a Wednesday night at 1930. This broadcast replaces the Experimenter's Nights. Q5 has been running in the North West for the last couple of months. I would like to thank Ken, VK7DY for organising this educative and informative venture.

## International Lighthouse/Lightship Weekend

Roger, VK7XRN, Peter, VK7TPE, Steve Sharpies and XYL, Rhonda, all members from the WICEN South Team organised to operate the VK7OTC/7 callsign from the Cape Bruny lighthouse during the International Lighthouse/Lightship Weekend and made many contacts and had much fun in the process. The caretaker at Cape Bruny is Andy, VK7WS who helped to setup the two stations. One at the lighthouse keeper's cottage and the other was at the lighthouse itself. Equipment was ICOM IC-706s

barefoot into an Off Centre Fed Dipole and longwire.

The erection of the mast was somewhat difficult in the gusting 70 knot, (130 kph) winds and much amusement was expressed by passing Japanese tourist! With guys secured it was down to operating and many contacts were made with other lighthouses around the world including the VK3 expedition to King Island operating VI7CL. A live cross during the Sunday morning VK7 Regional Broadcast was also successful. Roger's advice was it is highly recommended to the "stay at homes" for next year. However, take your lead boots and hang on to those guy ropes!

Cape Bruny lighthouse built 1836, supporting one end of long wire and support crew during the weekend, WICEN member Steve Sharpies and his XYL Rhonda. Photo courtesy of Roger, VK7XRN

ar

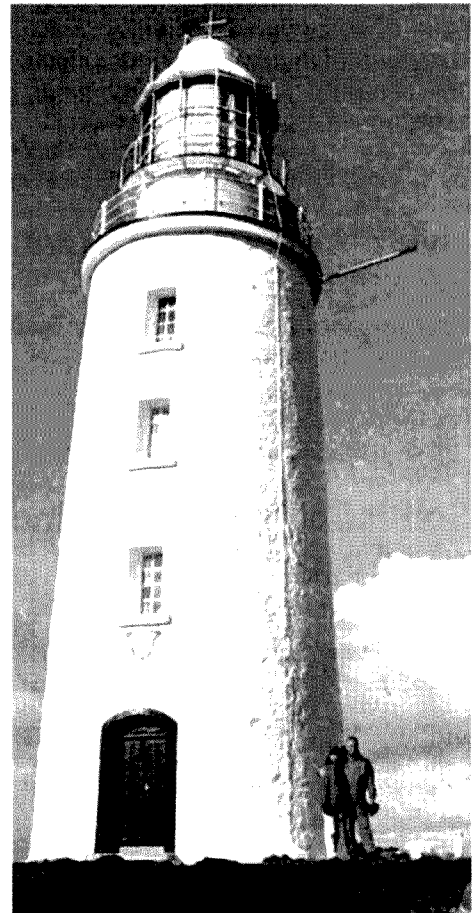

Cape Bruny lighthouse and support crew

# Club news

## Adelaide Hills Amateur Radio Society

Christine Taylor VK5CTY

Unhappily this month we also start with an obituary. Long time member of AHARS and the amateur fraternity, Clem Tilbrook, VK5GL became an SK at the age of 92 on 21.8.2004. Twenty or so members of AHARS attended his funeral. A full obituary appears elsewhere in this issue of AR.

At the beginning of the August meeting of AHARS Colwyn Low, Editor of "Amateur Radio" presented a certificate to Lloyd Butler, VK5BR in recognition of the number and interest of the technical articles about aeriels Lloyd has written for AR in 2002 year. Lloyd almost missed out on the presentation because he wasn't watching the clock, but he arrived in the nick of time. A photograph of the award and further details will

appear in November *Amateur Radio*. Congratulations Lloyd!

This meeting of AHARS was addressed by Robin de Vore VK5ATT, previously resident in the USA, discussing the differences between the amateur radio world in the US and in Australia. While some of the differences were known, there were some new variations, all of it of interest to the members.

Then he went on to discuss the civil emergency situations 'over there' which are very different from those 'down under'. There are many more emergency events in which the aid of the amateurs as communicators between the various emergency agencies is valued, therefore they are much valued by the authorities. There are basically two civil emergency

radio networks which can operate separately or in unison to deal with each event as it arises.

Robin and his YL, Carol VK5KEY (ex VK YL) were both deeply involved in a raging forest fire not far from their home, not long before they came out to Australia which he could describe in detail.

Altogether it was a very interesting talk.

It is clear that WICEN would have a higher profile with the authorities if Australia had more civil emergencies. We would not wish on our citizens tornadoes, flood, cyclones or wildfires like those experienced in the US, (let alone a 9/11). There has to be a better way to let our leaders know how useful we can be.

## Fleurieu Radio Group

Christine Taylor VK5CTY

Another very pleasant luncheon of this group was attended by sixteen of us at Goolwa, on the Fleurieu Peninsula.

During the luncheon a card was passed around the table to be signed by all those there, to send good wishes to Frank VK5FJ who started this group up five or six years ago. After the luncheon, Noel

VK5VT, a long time friend of Frank and his XYL Marilyn, volunteered to take the card to Frank at the nursing home.

Unfortunately, when Noel got back to Adelaide he found a message on his answering machine to tell him that Frank had become an SK shortly after he left.

Saddened by the news we were glad we had sent the card to Frank and that he had had time to read it. Until just a few months ago Frank and Marilyn regularly went ballroom dancing, though they were both well into their 80s.

## Liverpool & District Amateur Radio Club

Garry Barker VK2TSR Hon sec

**The Liverpool & District Amateur Radio Club will be holding an Auction on Saturday 6th November**

The location: Scout Hall Hoxton Park Road, Hoxton Park, which is next to the Hoxton Park Shopping Centre

The auctioneer will commence the

auction at 1100 and a Sausage Sizzle will be available

So if you have any unwanted gear, bring it along and convert it to

cash.

Any enquiries, contact the secretary Garry VK2TSR on 02 9896 5763 (evenings)

## South Coast Amateur Radio Club Inc.

### Annual General Meeting

Stef Daniels VK5HSX, Secretary SCARC Inc.

Due to the change after a motion was passed at the General Meeting held Wed 24th March 2004, the club's Annual General Meeting will from now on be held on the 4th Wednesday in November each year. This year the meeting will be held at the SCARC Clubrooms - Karawatha Community Hall - 12 Baden Tce, O'Sullivan Beach. SA, commencing at 8:00pm on 24th November 2004, so

please arrive 15 minutes early to allow prompt start.

At the AGM all positions become vacant and open for election. Nominations will be taken either on the night, in writing or by an attending proxy for voting by election. Positions include: Chairman, Secretary, Treasurer, Committee Member #1, #2, #3 & #4.

Members are asked to attend, with guests and visitors more than welcome.

Apologies can be sent to the Secretary, Stef Daniels VK5HSX by either mobile 0417 821 747 or email: secretary@scarc.org.au. More information can be obtained by visiting the SCARC website located at www.scarc.org.au.

Look forward to seeing you there and why not support the club and consider standing for a position on the 2004/5 Committee.

ar

# Trap aerial design

Lindsay Lawless VK3ANJ

A multi band aerial using "rejector circuit" traps is an easily constructed aerial, and popular for that reason, it is also easily designed for purposes other than the popular "recipes". The following technical analysis of the W3DZZ 80/70 version illustrates the basics and provides the clues necessary to design other applications of the idea.

The W3DZZ construction detail is included in all editions of the ARRL Antenna Book, readers are referred to that publication for construction detail. Using the following technical information a design from scratch is within the capabilities of licensed amateurs and is worth attempting.

Referring to a construction diagram of the W3DZZ, the components are :

- (a) a centre section half wave dipole for 7.2 MHz (length 21 metre),
- (b) two parallel LC circuits at the centre section ends (fr = 7.175 MHz) (8.2  $\mu$ H and 60 pf)
- (c) two equal length tails .

The inductance of the three elements is chosen so that the total inductance

equals the inductance of a half wave dipole resonant at 3.6 MHz.

Assuming the system uses 3mm wire elements the wire inductance is 1.98  $\mu$ H per metre [appendix (b)], therefore the total inductance must equal that of a half wave at 80 ie length 42 metre and inductance 83  $\mu$ H. The inductance of the 40 metre centre section (21 metre) is 41  $\mu$ H leaving 42  $\mu$ H to be provided by the traps and the tails.

Using the appendix (a) equation the reactance of each trap at 3.6 MHz is +j247 ohm equivalent to an inductance of 10.9  $\mu$ H; each tail to supply the rest of the inductance (21uH) must be 5.3 metre long (10.5  $\mu$ H each). The tails on the W3DZZ version are 6.8 metre each.

The version installed at VK3ANJ is an

inverted VEE dipole, operating on 80 and 40 metres. Construction is almost identical with the W3DZZ design but satisfactory operation without an ATU is only possible on 80 and 40 where the SWR = 2 points are at 3.5 and 3.675 MHz and at 7.0 and 7.3 MHz.

## Appendices:

$$(a) \text{ Trap reactance } X = \frac{j[2\pi fL]}{1-(2\pi f)^2LC} \text{ ohm}$$

$$(b) \text{ Wire inductance } L = 0.2S[(Ln \text{ 4S/d}) - 1] \mu\text{H}$$

S = wire length in metre; d is wire diameter in metre.

Construction reference ARRL Antenna Book 18th edition chap. 7.10 et.al.

ar

# G&C COMMUNICATIONS

Authorised dealer for ● Kenwood ● Icom ● Barrett RFDS ● GME Electrophone ● Uniden ● YAESU

## KENWOOD TH-F7E

Amateur VHF/UHF Transceiver

Freq: TX: 144-146 / 430-440 MHz  
RX: 0.1-1300 MHz  
Mode: TX: FM RX: AM/FM/SSB/CW  
RF Power output: Hi: 5/5 W  
Lo: 0.5/0.5 W EI: 50/50 mW  
Volt: Int: 5-7.5 VDC External: 12-16  
Weight: 250 gr (inc lith.-ion batt. pack)



## ICOM

### IC-208 Amateur VHF/UHF Transceiver

Freq: TX: 144-146 / 430-440 MHz  
RX: 118-1000 MHz  
Mode: TX: FM RX: AM/FM  
RF Power output:  
Hi: 50 / 50 W,  
Mid: 15 / 15 W,  
Low: 5 / 5 W  
Voltage: 13.8 VDC  
Weight: 1.2 Kg



## YAESU

### VX-7R

5 W Ultra-Rugged, Submersible Tri-Band Magnesium Handheld

Freq: RX: 0.5 - 999 MHz  
TX: 50, 144, 430 MHz Amateur Bds  
True Dual Receive: V-VU-U/V-U/GEN-HAM  
Power Output: 5 Watts 222 MHz:  
300 mW) 6 m AM: 1 W MANY GREAT FEATURES



## ROTATORS

G450A (shown)  
G650C, G800DXA

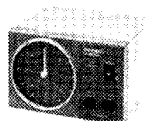

Australia wide orders welcome  
Credit card Cheque Money order

## IC-706 MkII Amateur HF/VHF Transceiver

Freq: TX: 10-160 m + WARC / 50-54 / 144-146 (148) MHz  
Europe (USA) RX: 0.03-200 MHz all-mode incl WFM  
Mode: AM/FM/SSB/CW/RTTY  
RF Power output: 100/100/20 W



Most popular morio/tri-banders

TE series EMTRON HF ANTENNAS  
Storm tested — Call

## Antenna Tuners

MFJ 945E — MFJ949E

The auto MFJ 993



and the amazing  
MFJ 902 Travel Tuner



207 High St. Cranbourne VIC 3977  
Ph: 03 5996 3298 Fax: 03 5995 0184

Email: [gccomm@netspace.net.au](mailto:gccomm@netspace.net.au)  
[www.gccomm.com.au](http://www.gccomm.com.au)

## The Contest

This year's Contest was a great success. The propagation was kind, especially on 80-metre, there were plenty of operators and, with some specific frequencies and times previously arranged DX was much better than usual, too. Now all that is

required is that you all put your logs in for Marilyn VK3DMS to check.

She will be delighted to get all the logs, YLs, OMs and all. Please send them to the address in the July "Amateur Radio", to Marilyn VK3DMS QTHR the callbook

or by email to [alaracontest@wia.org.au](mailto:alaracontest@wia.org.au) ASAP. Plain text, MS Word or MS Excel may be used. Full rules were in April AR. Please do not send your original log, make a nice clean copy of it and keep the original for yourself.

## Congratulations – BYLARA turns 25

*British Young Ladies Amateur Radio Association (BYLARA) is 25 years old this year and although there was little response to our question of how we should celebrate, the committee thought it would be nice to have some mementos, so this Newsletter has some of the milestones from the last 24 years.*

*BYLARA started in April 1979 with Subs at 1.50. Mary Adams, G4GAJ, was Chairman and Editor, Diana Hughes, G4EZI, Secretary and Judith Brookes, G41AQ, Treasurer.*

*The first Newsletter was printed in June 1979. There were 123 members including OMs and overseas and the Newsletter was being sent to America, Australia, Africa, India and Europe.*

*These were some of the YL clubs at that time: YLRL Young Ladies Radio League (America), JLRS Japanese Ladies Radio Society, YLRC Elettra Marconi (Italian Ladies), CLARA Canadian Ladies Amateur Radio Association, ALARA Australian Ladies Amateur Radio Association, PARKA Polar Amateur Radio Klub of Alaska (mixed club), WARO Women Amateur Radio*

*Operators (New Zealand), DLYL German Young Ladies, SAWRC South African Women's Radio Club.*

### Some highlights of the 25 years:

- January 1980 we were affiliated to the RSGB and the DXYL net, the 14.222 also started.
- 1981 we had Associate Members in Germany, America, Luxemburg, Denmark, Holland, Libya, Poland, Canada, Australia, Bermuda, South Africa, New Zealand, India, Alaska and Indonesia.
- September 1982 Subs were E2.00, members were taking part in Special events, Contests, DXpeditions, Overseas YL Meets and visits to friends made over the air.
- February 1983 Angelika Voss, GOCCI, became Newsletter Editor.
- March 1984 Subs E2.50. The First BYLARA Contest started and it continued until 1998 when it ceased due to lack of support. The 5th Birthday Party was held at Elvaston Castle.

(Copied from the BYLARA newsletter)

- 1987 Subs E3.00. Maureen Fellows, G8GKR, and Edward Fellows, G8ENA, took over the printing and distribution of the Newsletter.
- 1988 At the AGM a new constitution was presented and approved to allow for postal voting because of the decline in attendance at rallies.
- May 1989 the 10th Birthday Party was held at Drayton Manor. This appears to have been the last large gathering.
- 1990 Subs E3.50. Kay Ayres, GØKTC, became Newsletter Editor.
- August 1998 we had our own call sign MØBYL.
- 2000 BYLARA's 21st Birthday. The special call GB2YL was used by Jan, GWØKPD, and Maureen, GØVRT.
- Maureen, GØVRT, and several other members activated Les Minqueries off the coast of Jersey for Islands On The Air with the Special call GJ4L.
- 2003 Daphne Neal, G7ENA, became Newsletter Editor.

## You never know to whom you are talking!

The elderly grey haired lady looked around the Electronics Shop. She found what she was looking for, a shortwave radio for her Grandson. It was worthy of note that most of the radios only had the normal AM and FM coverage, very few had shortwave!.

As she looked around a young salesman sidled up to her. "Can I help you Ma'am" he said. He gave her that supercilious look that the young, who believe they know it all, sometimes give their elders.

"How much is this radio? I can't read the small print of the price"

"\$250", said the salesman, looking

past her at some new young customers eyeing a big TV costing four times as much as the radio. Turning the radio over she looked at the specification label on the back.

"Do you have any other shortwave radios?"

The young salesman looked up at the ceiling and said. "This set has superheterodyne", watching to see if this announcement had any affect on the elderly purchaser! As she looked at him he said, "and band spread".

"Is that so?" she said. "What does that mean?"

If the smart (he thought) young

salesman had been paying more attention to his elderly customer, instead of watching the other customers he would have noticed the mischievous look in those blue eyes behind bifocal spectacles.

"The latest in modern technology, to give you the best reception anywhere at any time!"

"Yes, but what does it do?" she asked.

The young salesman let out a long sigh.

"Do you want the radio or not? I have other customers to attend to", as he took the radio from her hands.

"I'll think about it, and ask about this super thing!" she said as she headed towards the door.

She felt sorry for the young whipper-snapper salesman. How was he to know that she had learned about superhetrodyne receivers before he

was even born? It was naughty of her to have ribbed him, but she could not help herself. It was his attitude that triggered her devilish mood. She smiled to herself as she headed home. Golly gosh, look at the time. She had to be home to run

her AOCPC classes. After that she was controller of the ALARA 80 m Net.

As she stood in front of the AOCPC students a short time later, she said, "I think we will discuss superhetrodyne receivers today!"

## The full story of the DXpedition to Christmas and the Cocos Keeling Islands

### VK9XYL and VK9CYL

Gwen VK3DYL

Christmas Island, the peak of an ancient volcano 360 km south of Indonesia and 1400 km north west of mainland Australia, was the first stop for the all-YL DXpedition consisting of Gwen VK3DYI, June VK4SJ and Elizabeth VE7YL last October. It was born 60 million years ago from a volcanic eruption. Shaped like a Scotch Terrier it is approximately 135 km<sup>2</sup>. The interior, a National Park, is covered by rainforest. Phosphate mining operation is carried out elsewhere.

The island is known as the "Kingdom of the Crabs". Crabs march from the rain-forested slopes down to the ocean to breed at the beginning of the wet season, generally late November, then return to their burrows for the rest of the year. I believe that at those times it is very difficult to walk anywhere without stepping on a crab, let alone drive on the roads or play golf. Special tunnels have been constructed under some roads to enable the crabs to cross safely. We managed to see quite a few red crabs in the forest, plus the larger robber crabs and the pretty blue fresh water crabs, but were too early for the migration.

There was a lot of bird life as well as great scenery. In fact the only thing the island lacked for us YLs was good propagation to other parts of the world! I'm not sure why it is that whenever we three go on a DXpedition we either break the local drought or cause propagation to dive into a black hole. It was very hot and humid - thank goodness for air-conditioning. At that time there were 51 "boat people" still on the island while the Australian Navy, in the form of HMS Stuart, hovered offshore watching over us like a mother hen.

Our balcony provided us with glorious views of the setting sun while small fishing boats returned to shore each night with their day's catch. We even saw a large pod of dolphins, and met up with a few divers who had come to the island to enjoy the world-famous reef and cave diving. We confined our swimming to the motel's own pool.

We didn't make as many contacts as we'd hoped for (only 4,400) and more than half of those were into Japan; North America and Europe were hidden behind the high hump in the centre of the island. After 2 weeks we packed up our gear (a TS50, an F7100D, Elizabeth's Morse key and a set of the VK3GKK dipoles) and flew off to Cocos (Keeling) Islands with high hopes for better propagation. But "Murphy" came with us.

Cocos (Keeling) Islands, one of Australia's most remote external Territories, are 900 km west of Christmas Island, just an hour's flight away. The islands (a group of 27 coral atolls) were discovered by Captain William Keeling in 1609 but were not settled for a further 200 years. In 1827 Captain John Clunies-Ross arrived with his family, planting out coconut palms and trading in coconuts, coconut oil and copra. In 1978 the Australian Government purchased the Clunies-Ross interests and in 1984 the Cocos community chose to integrate with Australia.

The first settlers brought to the islands were predominately Malay Muslim and today, after eight generations, the existing society (most of whom live on Home Island) is deeply committed to the Islamic religion with their own mosques, leaders and ceremonies. We arrived on the first day of Ramadan; hence all the Muslim-run restaurants were closed.

In 1836 Charles Darwin visited the islands aboard HMS Beagle and formed his theory on atoll formation; in 1914 the German light cruiser SMS Emden was scuttled on North Keeling following its encounter with HMAS Sydney, and in 1944 West Island was home to more than 7,000 troops from Britain, Canada, Australia and India, while an airstrip was built. This airstrip (which runs down the centre of the golf course!) is still in use. When the twice-weekly plane is due, the runway lights come on, a man in a jeep drives madly up and down the strip to make sure there are no obstructions, sirens sound and the local

population lines the perimeter fence to welcome visitors and returning friends and family.

We had three nice units, Cocos Cottages, facing the runway/golfcourse, with suitable coconut palms for attaching dipoles to. Unfortunately we hadn't allowed for a coconut falling on June's Buddypole antenna nor for the largest explosion ever recorded in our solar system which shut down propagation for a few days. In our two weeks' stay, after a lot of hard work calling on dead bands, we were lucky to make 3,500 contacts, a sad contrast to our preceding German group's 19,000 contacts. Still, they had good conditions, beams and amplifiers.

However, one Stateside guy seemed a little flabbergasted when he told Elizabeth he was running 1,500 watts into a 6 element 10m beam and she answered we were running 100 watts into a dipole strung between a coconut palm and our unit! . It was nice to live in shorts, T-shirts, sunscreen and insect repellent for a couple of weeks. Daytime temperatures were around 30°C but the southeast trade winds cooled things down morning and night. The coral atolls offer world-class snorkelling and diving while a few beaches are great for family swimming and barbecues. The sunsets aren't bad either! The roads are well maintained but driving hazards consist of dodging fallen coconuts, crabs (brown ones this time) and the many feral chooks which roam the island.

Some photos of our trip can be seen on my web page under the icons for 2003 (well, when my son finishes putting them on!). [www.qsl.net/vk3dyl](http://www.qsl.net/vk3dyl)

### International YL Meet in Seoul

By the time this magazine is on the newsstands there will be nearly 100 YLs assembled in Seoul for this year's International Meet. We wish then well, and hope to hear some reports from the VK-YL representatives.

33 to everyone there.

ar

## Echo latest

**Echo (AO-51) continues to excite the interest of newcomers and old timers alike.**

The satellite is available for users and has been tested in a number of different modes. The control stations are still doing the required checks to complete the commissioning and so far everything seems to be in order.

Experimenter's days have provided the opportunity for AO-40 devotees to dust off their gear and try out their 2.4 GHz down links using the V/S and L/S FM repeater modes, both of which use 2.4 GHz down links.

Remember however that AO-51 is a LEO (low-earth-orbiter) unlike AO-40. Those who do not have automated antenna tracking and automated receiver tuning for Doppler correction may have trouble keeping up with antenna aiming and receiver/transmitter tuning and making contacts all at once. "S"-band is a different kettle of fish to 10 m, 2 m and even 70 cm when it comes to handling

Doppler correction. It's a real challenge but the rewards are strong signals, very low noise and excellent QSOs.

The 2.4 GHz signal is reported as being strong enough that a short helix should do the trick and a dish may not be necessary. Operators report some fading when AO-51 is at low elevations. One station told of making contacts via AO-51 using only the dual band patch antenna from his dish hand-held without the dish.

If you want to plan your station or check your existing gear against a known standard, Terry Osborne ZL2BAC has provided a link budget calculator for Echo V/U mode. It's on the Echo Project Page section of the AMSAT website in the FAQ section. [http://www.amsat.org/amsat-new/echo/Echo\\_Linkbudget.php](http://www.amsat.org/amsat-new/echo/Echo_Linkbudget.php) will get you straight there.

### **The AMSAT group in Australia.**

The National Co-ordinator of AMSAT-VK is Graham Ratcliff VK5AGR. No formal application is necessary for membership and no membership fees apply. Graham maintains an e-mail mailing list for breaking news and such things as software releases. Contact Graham if you wish to be placed on the mailing list.

### **AMSAT-Australia Echolink Net.**

The net meets formally on the second Sunday of each month. Anyone with an interest in Amateur Radio Satellites is welcome to join in and take part. Graham VK5AGR acts as net controller. The net starts at 0600 UTC and you can join in by connecting to the AMSAT conference server.

All communication regarding AMSAT-Australia matters can be addressed to:

AMSAT-VK,  
9 Homer Rd,  
Clarence Park, SA. 5034

Graham's e-mail address is:  
[vk5agr@amsat.org](mailto:vk5agr@amsat.org)

## PSK31 tests on Echo using 10 m SSB uplink and 70 cm FM downlink

**As part of the testing of all facilities on Echo, the Wednesday Experimenter's day is being used to give PSK31 enthusiasts their first opportunity to try this mode of communication via an amateur radio satellite.**

While there have no doubt been individual attempts at using this medium on other satellites, this is the first organised trial to promote PSK31 as an experimental satellite mode. The nature of PSK31 presents difficulties with Doppler tuning correction which will be addressed over a number of experimenter's days.

Peter Martinez, the inventor of PSK31, will be doing some test transmissions to try some ideas for a possible method of solving these problems. The first test will be conducted after the deadline for this edition so I will write a summary of the test results in the November column.

Here is part of Peter's post to the AMSAT bulletin board. "On 14th September, I will be doing some tests transmitting PSK31 up to the AO51 (Echo) satellite

on 28 MHz with downlink on 435.3 MHz FM. The object of the experiment is to see if it's possible to use the downlink FM audio (which suffers no downlink Doppler shift or QSB) to control the 28 MHz uplink frequency and power so that the downlink signal will be completely free of Doppler and level variations. To receive these tests you will need an FM receiver with the audio output fed to your PSK31 software. I will aim to transmit so that my signal appears in the downlink FM audio at exactly 500 Hz. You should be able to simply set the PSK31 receive frequency to 500 Hz and not need to tune around. I will be transmitting a continuous test message. If you hear me, please let me know. I am particularly interested to know how steady the frequency of the signal

is, since my system should completely eliminate any uplink Doppler shift, and also how steady is the signal level, since my system should adjust the transmitter power to keep that constant too. If this test works well, I hope on future tests to be able to work two-way QSOs while the uplink is frequency- and power-controlled, but for the first attempts I will just be transmitting-only. If you want to try transmitting PSK31 through AO51 during these experimenter's days, see the AMSAT.ORG website for further information".

The tests will not be audible here of course but the test results should be most interesting. If Peter's ideas are successful it could introduce another mode to the many already enjoyed by satellite enthusiasts.



# No resolution yet of "Keps" issue

Dr Tom Kelso who is responsible for the Celestrak web site has been providing a weekly situation update on the AMSAT-BB.

The issue is far from being resolved but there are some encouraging signs.

You can keep up with developments by going to the Celestrak web site where an update panel is being maintained

or by watching the AMSAT-BB for the weekly update postings.

This is a very important issue for all satellite enthusiasts whether involved in amateur radio or sky-watching

or weather satellite monitoring. The October-1 deadline for closure will be passed by the time you read this. Let's hope for a successful resolution.

## Another AO-40 anomaly

It seems there's a possibility that another "event" has taken place on AO-40.

Early in August reports began coming in of a slight but significant change in the Mean Motion of AO-40.

Mean Motion is one of the parameters that we encounter in the form of "Keplerian Elements". The element sets allow us to predict quite accurately where a particular satellite will be at any time and when it will be available for us to hear or make contacts.

The actual number appearing in the Mean Motion field gives the number of revolutions of the Earth that the satellite makes in one day. AO-40's Mean Motion usually runs at around 1.25 whereas LEO satellites do around 14 - 16 revolutions per day.

At first it appeared that only a major

"venting" of gas or a motor firing could produce enough thrust to achieve the mean motion change that has been recorded, but as Peter Guelzow, DB2OS and Viktor Kudielka, OE1VKW observed, the data is not conclusive and could be due to 'smoothing' or errors in the NORAD data. Viktor noted, "I am unable to judge which points are just imprecise measurements and what are the influences of data smoothing or other manipulations. Although there are small changes to other parameters like Eccentricity, the only significant effect is the change in Mean Motion".

Peter continues, "If you look carefully at the data, you will see that the 'orbit change' already happened *before* the

sudden battery event. We can only speculate, that it is the battery. Perhaps there is also some remaining fuel?" Peter added.

"The (observed) 'thrust' phase is also much longer than the battery event. Perhaps (the whole episode) could be smoothing/manipulation of the NORAD data too. There is room for a lot of speculation."

Peter concluded, "Assuming the S/C mass to be 400 kg, then this change (would require) an impulse of 40 kg m/s or equal to 5 minutes of hot Arcjet firing. I have no idea if the battery is capable of doing this. Indeed, if it is shorted it will get glowing hot and vent everything."

## UO-22 experiences more problems

It's been a roller-coaster ride on UO-22 these past few months.

Chris Jackson recently reported "an attitude anomaly" which resulted in a loss of stability of the satellite with accompanying fading of signals as it tumbled.

The down link signal from UO-22 is normally very stable and strong. It uses a simple but effective method of stabilisation called a gravity gradient boom. This is a passive method in that it requires no power or control electronics. It has been used on pretty well all UoS satellites from UO-9 onwards. It employs a long telescopic boom which is extended from the 'top' of the satellite frame when safely in orbit. In the early days a passive mass was attached to the top and this, together with the centre of mass of the satellite formed a 3-way couple with the earth's gravitational field. With the satellite spun slowly around it's longitudinal (boom) axis the effect was to lock the satellite into

an earth-pointing attitude which it maintained right around the orbit. The antennas were arranged on the 'bottom' of the spacecraft and this meant that they were pointing directly downwards at all times.

Later UoSats have used a remote instrument pod as a 'mass' at the end of the boom, the effect being the same. Something occurred recently to upset this situation on UO-22 and the Surrey control team have been trying to effect a cure.

There have also been several occasions in the past year when the software on UO-22 has played up and a re-load has been necessary. Some battery problems have also been reported and at present UO-22 is open for users but is only available when in sunlight. It speaks volumes for the designers and builders that these quite critical situations can be addressed and overcome.

UO-22 was the first of the original big-3 digital BBS birds and although not the first to carry digital electronics 'the three' went on to become firm favourites with a host of digital enthusiasts world wide. UO-22 turned out to be the most reliable by far of the "three", KO-23 and KO-25 both having expired some time ago. For many years UO-22 has carried the bulk of satgate traffic around the globe for distribution into the packet radio system. For a time virtually all long distance personal packet radio mail messages were relayed through UO-22. It was launched on July 17th 1991 so when it finally comes time to pension off this wonderful satellite it will have made an indelible name for itself in amateur radio digital satellite circles.

ar

# Beyond our shores

David A. Pilley VK2AYD  
Davpil@midcoast.com.au

## Canada

### Canadian licensing changes proposed

Radio Amateurs of Canada (RAC) has proposed formally that Industry Canada (IC) eliminate Morse code as a ham radio testing requirement for operation in bands below 30 MHz in Canada. RAC wants Industry Canada to continue to make Morse testing available to Canadian amateurs still wishing to have that qualification specified on their certificate, however. At the same time, the RAC wants IC to require applicants for the Basic examination to score at least 80 percent before permitting operation below 30 MHz.

Under the proposal, present Basic plus Morse holders would be considered as holders of the new Intermediate qualification. Basic holders who have not passed the Morse exam would continue to hold that class with existing operating privileges. Current Basic-without-Morse licensees who retake the Basic examination and obtain at least 80 percent would be upgraded to Intermediate.

RAC also recommends that the passing grade for the Basic and Advanced examinations be raised from 60 to 70 percent when the Morse requirement is dropped. Ultimately, RAC wants the passing grade to be upped to 75 percent for all examination elements.

Anyone holding both the Basic and Advanced qualifications would have HF privileges, and the Intermediate qualification or Basic plus Morse would become a prerequisite to obtaining the Advanced.

The RAC also wants IC to create a new entry-level qualification. RAC President Daniel Lamoureux, VE2KA, says Canadian amateurs can anticipate implementation of a first phase of the RAC recommendations by year's end.

(ARRL N/L 13/8)

## United Nations

### Radio in service: FITTEST seeking assistance

Those involved with Rescue Radio may find some appeal in this. The

United Nations World Food Program's FITTEST operation is currently seeking Telecommunications Specialists for 3 to 6 month contracts.

FITTEST stands for the Fast Internet and Telecoms Emergency Support Team and it offers constant travel, constant pressure, constant challenges in a job that still allows you to combine a family life and a professional life in a two or three months on one month off duty regime.

Typically, FITTEST hires people with non-conventional career paths to provide emergency deployment of VHF and HF networks, Satellite and Telephone systems. They are looking only at people with direct hands-on experience willing to work under harsh circumstances.

To get an idea of the work they do in Iraq and Afghanistan have a look at their web sites. They are in cyberspace at <http://www.hicirag.org/mediacentre/gallery/FITTEST/> <http://www.ql.net/ya5t>. Applications to [mark.tell@wfp.org](mailto:mark.tell@wfp.org) and [martin.kristensson@wfp.org](mailto:martin.kristensson@wfp.org)

## Belgium

### Galileo GPS system approved by EU

Officials in Brussels, Belgium say the satellite navigation system the European Union is planning will not clash with one already in operation by the United States. This, as an agreement signed in that European nation will make sure that the proposed Galileo system will be compatible with the U-S owned Global Positioning System.

Galileo is slated to begin operation 2008. Together the two systems are expected to become a single world standard for positioning and radio navigation.

(ANS)

## UK

### Internet linking in the UK

Telecommunications regulators are about to make ham radio Internet linking a lot easier on the other side of the Atlantic. This, as Ofcom which is the UK equivalent of our ACA issues new

and more liberalized rules.

Ofcom has announced the decisions it has taken about changes to the procedure and terms of issuing Notices of Variation (NoV) for Internet Linking Gateways.

Ofcom proposes to pass the Internet-linking NoV process to the RSGB to issue NoVs on behalf of Ofcom. The RSGB will be announcing procedures for NoV renewal shortly and queries on the renewal process should be directed to the Society.

Ofcom's decisions were made following the notification of four proposals, which gave those holding an NoV the opportunity to make representations.

(RSGB)

## Brazil

### WRTC-06 is underway.

The next World Radio Team Championship is being planned to be held in Florianopolis, Brazil in July 2006. The first Committee, comprising 11 Radio Amateurs from Brazil has now been formed and a special Web page (<http://www.wrtc2006.com>) has been set up for interested Amateurs where you will find current information and the criteria to participate. There is also a reflector (<http://maresia.onda.com.br/mailman/listinfo/wrtc2006>) where you can subscribe and be kept up to date on events as they proceed toward 2006.

As Radio Amateurs, the WRTC is the nearest contest that we have to the Olympics. It is held on HF in both CW and SSB modes and is held during the IARU contest in July of each year. WRTC is held every 4 years and was first created in 1994 and, like the Olympics, a different country hosts each event. An invitation is given to each country to send a two-person team to compete in the event and in the past Australia has been present at two events. It would be great to see Australia taking part in the 2006 "games". Any takers? Be assured at this event you will be competing with the 'best of the best' world wide and the social happenings will be a memory for ever!

ar

## Contest Calendar October - December 2004

2/3	Oct	Oceania DX Contest	(SSB)
2	Oct	PSK31 Rumble	
3	Oct	RSGB 21/28 MHz Contest	(SSB)
9/10	Oct	Oceania DX Contest	(CW)
16/17	Oct	JARTS WW RTTY Contest	
16/17	Oct	Worked All Germany Contest	(CW/SSB)
17	Oct	Asia-Pacific Sprint Contest	(CW)
17	Oct	RSGB 21/28 MHz Contest	(CW)
30/31	Oct	CQ WW DX Contest	(SSB)
6/7	Nov	VK VHF+ Field Day	(CW/SSB/FM)
7	Nov	High Speed Club CW Contest	
13/14	Nov	Worked All Europe RTTY Contest	
13/14	Nov	Japan Intl. DX Contest	(SSB)
13/14	Nov	OK/OM DX Contest	(CW)
19	Nov	YO DX PSK31 Contest	
20/21	Nov	RSGB 160 Metres Contest	(CW)
20/21	Nov	RNARS CW Activity Contest	
17/18	Nov	CQ WW DX Contest	(CW)
3/5	Dec	ARRL 160 Metres Contest	(CW)
4	Dec	TARA RTTY Melee	
11/12	Dec	ARRL 10 Metres Contest	(CW/SSB)
18	Dec	OK RTTY Contest	
18/18	Dec	Croatian DX CW Contest	
26	Dec	Ross Hull Memorial	VHF+ Contest

until mid-Jan., 2005

Some few months ago I asked if anyone was using Linux for AR work. Now I would like to say thanks to Robert VK3ESE who, just as I was compiling these notes, emailed me to say that he uses this OS and to give some very useful information to follow up. Thanks Robert, much appreciated.

I have also heard that Eddie VK4EDI is interested in exploring this OS and that he has friends either also interested or already using it. I don't imagine for one minute that Linux or Mac OS will replace Windows, but you may be surprised how widespread Linux is already among American contesters.

Please note our big DX event coming up in October! See you there.

73, Ian Godsil VK3JS

## QRP Day Contest 2004 RESULTS

From Ron Everingham VK4EV

### Logs submitted

#### HF

VK2LCD/QRP *~	SSB	62 points	VK3GDM/QRP	CW	5 points
VK5BLS/QRP *~	CW	55 points	VK3NEA/QRP	CW	4 points
VK3LK/QRP*~	CW	55 points	VK3JS/QRP		Special Event Station Check Log.
VK7RO/QRP ~	CW	54 points			
VK2AVQ/QRP *~	CW	53 points	VHF		
VK2CW/QRP ~	CW	41 points	VK3JS/QRP	FM	30 points
VK4CEU/QRP ~	CW	31 points			
VK4EDI/QRP ~	CW	24 points			

\*Denotes Home Brew Equipment used.  
~Denotes contacted special station VK3JS/QRP

## Certificates :-

### Best 4 hours operation HF

First place	SSB Mode	Chris	VK2LCD/QRP	62 points
First place	CW Mode	Adrian	VK3LK/QRP	55 points
First place	CW Mode	Barry	VK5BLS/QRP	55 points
Second place	CW Mode	Richard	VK7RO/QRP	54 points

### Best 4 hours operation VHF

First place	FM Mode	Ian	VK3JS/QRP	30 points
-------------	---------	-----	-----------	-----------

**Congratulations to all certificate winners and thanks to all for submitting your logs. Hope you all enjoyed participating in the contest.**  
73 de Ron VK4EV.

## Highest scorer in each hour in each mode in each area:

Hour 1.	SSB	Chris	VK2LCD/QRP	23 points
	CW	Adrian	VK3LK/QRP	22 points
	CW	Greg	VK2CW/QRP	37 points
	FM	Ian	VK3JS/QRP	6 points
Hour 2.	CW	Richard	VK7RO/QRP	30 points
	CW	Bob	VK2AVQ/QRP	24 points
	CW	Eddie	VK4EDI/QRP	24 points
Hour 3.	CW	Barry	VK5BLS/QRP	23 points
	CW	Dave	VK4CEU/QRP	24 points
Hour 6.	CW	David	VK3GDM/QRP	5 points

# Rules – Spring VHF-UHF Field Day 2004

from John Martin (VK3KWA), Contest Manager

The Spring VHF-UHF Field Day will take place on the weekend of November 6 and 7, 2004. Logs will be due by November 22, and entrants are also invited to include any comments or suggestions about the rules.

## Dates

**Saturday and Sunday November 6 and 7, 2004.**

**Duration in all call areas other than VK6:**

**0100 UTC Saturday to 0100 UTC Sunday.**

**Duration in VK6 only:**

**0400 UTC Saturday to 0400 UTC Sunday.**

## Sections

- A: Portable station, single operator, 24 hours.
- B: Portable station, single operator, 6 hours.
- C: Portable station, multiple operator, 24 hours.
- D: Portable station, multiple operator, 6 hours.
- E: Home station, 24 hours.

Single operator stations may enter both Section A and Section B. If the winner of Section A has also entered Section B, his log will be excluded from Section B. The same applies to the winner of Section C if the station has also entered Section D.

## General Rules

A station is portable only if all of its equipment is transported to a place that is not the normal location of any amateur station. Operation may be from any location, or from more than one location. You may work stations within your own locator square. Repeater, satellite and crossband contacts are not permitted.

One call sign per station. If two operators set up a joint station with shared equipment, they may choose to enter Section A or B as separate stations under their own call signs, or Section C or D under a single call sign. If they enter Section A or B, they

may not claim contacts with each other. Stations with more than two operators must enter Section C or D. Operators of stations in Section C or D may not make any contest exchanges using call signs other than the club or group call sign.

No contest operation is allowed below 50.150 MHz. Recognised DX calling frequencies must not be used for contest exchanges. Suggested procedure is to call on 0.150 on each band, and QSY up if necessary.

## Contest Exchange

RS (or RST) reports, a serial number, and your four digit Maidenhead locator.

## Repeat Contacts

Stations may be worked again on each band after three hours. If the station is moved to a new location in a different locator square, repeat contacts may be made immediately. If the station moves back into the previous locator square, the three hour limit still applies to stations worked from that square.

## Scoring

For each band, score 10 points for each locator square in which your station operates, plus 10 points for each locator square worked, plus 1 point per contact. Multiply the total by the band multiplier as follows:

6 m	2 m	70 cm	23 cm	Higher
x 1	x 3	x 5	x 8	x 10

Then total the scores for all bands.

## Logs

Logs should cover the entire operating period and include the following for each contact: UTC time, frequency, station worked, serial numbers and locator numbers exchanged, points claimed.

# Cover Sheet

The cover sheet should contain the names and callsigns of all operators; postal address; station location and Maidenhead locator; the section(s) entered; the scoring table; and a signed declaration that the contest manager's decision will be accepted as final.

Please use the following format for your scoring table. In this example the operator has operated from one locator and worked four locators on each band:

Band	Locators activated (10 points each)	+	Locators worked (10 points each)	+	QSOs (1 point each)	x	Multi-plier	=	Band Total
6 m	10	+	40	+	40	x	1	=	90
2 m	10	+	40	+	30	x	3	=	240
70 cm	10	+	40	+	20	x	5	=	350
<b>Overall Total</b>		=			<b>680</b>				

A sample cover sheet and scoring table has been included in the postings on WIA web site. Copies can also be obtained from the e-mail address given below.

## Entries

Paper logs may be posted to the Manager, VHF-UHF Field Day, 3 Vernal Avenue, Mitcham, Vic 3132. Electronic logs can be e-mailed to [jmartin@xcel.net.au](mailto:jmartin@xcel.net.au). The log formats below are

acceptable: ASCII text, MS Office RTF, DOC, XLS or MDB. If you use Office 2000 or later, please save the files in Office 97 format.

Logs must be received by November 22, 2004. Early logs would be appreciated.

## Scoring table

Band	Locators activated 10 points each	+	Locators worked 10 points each	+	QSOs made 1 point each	=	Total	x	Band Multi-plier	=	Band Total
50 MHz		+		+		=	x 1	=			
144 MHz		+		+		=	x 3	=			
432 MHz		+		+		=	x 5	=			
1296 MHz		+		+		=	x 8	=			
2.4 GHz		+		+		=	x 10	=			
3.4 GHz		+		+		=	x 10	=			
5.7 GHz		+		+		=	x 10	=			
10 GHz		+		+		=	x 10	=			
Higher		+		+		=	x 10	=			
<b>FINAL TOTAL</b>						=					

### WIA VHF-UHF FIELD DAY

Section entered (tick one):

- A** Single operator 24 hours
- B** Single operator 6 hours
- C** Multi operator 24 hours
- D** Multi operator 6 hours
- E** Home station 24 hours

*If entering more than one section, please use a separate copy of this sheet for each section.*

For Section B or D, time period to be scored:

The station operated from the following grid locators:

The station was operated in accordance with the rules and spirit of the contest.

I / We agree to accept the.

Contest Managers's decision as final

Signed:

Contest Date :

Station callsign:

Names (inc. surnames) and callsigns of operators:

Postal address:

RESULTS AND CERTIFICATE (tick one):

- PAPER COPIES in the mail to the above address  
or
- PRINT YOUR OWN (Requires Adobe Acrobat Reader and colour printer for the certificate)

Send PDF files to the following e-mail address:

# VHF/UHF - an expanding world

David Smith VK3HZ - vk3hz@wia.org.au  
Leigh Rainbird VK2KRR - vk2krr@talstra.com

## Weak signal

David Smith - VK3HZ

Spring is here and the weather seems to have turned for the better. This means that the Spring VHF/UHF Field Day is not far off. This year, it will be held over the weekend of the 13-14 November. If you are planning to go out, please tell us about it by posting a message on the VK-VHF reflector. If you are not already registered for this reflector, details may be found at <http://pobox.une.edu.au/mailman/listinfo/vk-vhf>. We are looking forward to a large turnout this year.

Unfortunately, it looks like another of our bands may be under threat. The ACA has released a discussion paper on proposed apparatus licensing arrangements in the 5725 - 5825 MHz band for broadband wireless access in regional and rural areas of Australia. Changes could effect operation at 5760 MHz with further high power exclusion

zones being implemented as on the 9cm band. The paper may be found at:

[www.aca.gov.au/radcomm/frequency\\_planning/radiofrequency\\_planning\\_topics/hp5g8disc.htm](http://www.aca.gov.au/radcomm/frequency_planning/radiofrequency_planning_topics/hp5g8disc.htm).

Unfortunately, the closing date for comments has already passed. However, it is hoped that the WIA (newly invigorated) will be heavily involved in discussions about the future of this band.

Our Digital Modes correspondent - Rex VK7MO - is planning a digital DXpedition to the heart of Australia. He plans to be in Adelaide on 2 October to give a talk on Digital Modes. He will then be heading north to activate some gridsquares on 2 m via Meteor Scatter using FSK441. He is also going to attempt to work all states on 2 m MS in one day. More information will be

posted to the VK-VHF reflector when Rex has finalised his plans.

Now to news of activity in the upper reaches of our spectrum. On 27 August, KF6KVG and W0EOM extended their record on the 122 GHz band to 24.88 km, across the Silicon Valley. Precision 1 ft dishes were used. Transmit power was about -23 dBm (5 microwatts) and noise figure estimated at 25 dB. Triplers with output in the 40 to 41 GHz range with power of +19 dBm were used to drive the mixers and multipliers. Transmit frequency was 122.4 GHz, referenced to 10 MHz. Signals were at the noise floor but easy CW copy. Weather was calm, mild and fairly dry. The 2nd harmonic on 81.6 GHz was used to align the antennas.

Please send any Weak Signal reports to David VK3HZ at vk3hz@wia.org.au.

## Digital Modes

Rex Moncur - VK7MO

It is good to see some of the more remote areas trying out FSK441 on 2 metre. Don, VK6HK, has worked Ron, VK4KDD/6, portable at Port Hedland and both stations were monitored in Broome by Cec VK6AO/6. Rex, VK8RH, in Darwin and Ron, VK4KDD/6 completed the first FSK441 Meteor Scatter contact from VK6 to VK8. Jeff, VK8GF, in Alice Springs is also setting up for FSK441. What this means is that no station on the Australian mainland is too remote to have regular contacts on 2 metre to someone else. Note that FSK441 works well in the range 1000 to 1800 km and that contacts have been made as short as 500 km and as long as 2300 km. Welcome to Errol, VK4ZHL, and John, VK2GCN, who have joined the meteor scatter activity sessions.

Joe Taylor, K1JT, gave an outline of the next mode for WSJT called JT1 at the recent EME 2003 conference in Princeton in the USA. This mode moves away from FSK to PSK and uses even more intensive source encoding and Forward Error Correction to achieve a 4 dB advantage over JT65 in simulation

tests. A useful advantage of the new mode is that the total bandwidth is only 2.5 Hz and a number of stations can call in the same SSB passband without interfering with each other. A listening station could then decode the particular station they wished to work by clicking on the signal on the spectrum display or even click and decode a number of signals to select which one they wish to work. Joe advises that he hopes to release the new mode some time in the Fall or our Spring.

There is some evidence that JT65 can give false decodes when trying to receive a tropo-scatter signal in the presence of an AE (aircraft enhanced) signal. This is probably to be expected as tests between David, VK3AUU and Rex, VK7MO, show Doppler shifts of 3 or 4 Hz on AE signals and JT65A tones are only spaced 2.7 Hz apart. The problem usually shows up as exotic callsigns like UZ3ROD or LY2MY and a grid square in some outlandish place. The problem may also show up due to meteor pings where Doppler shifts on 2 metre are typically

up to a few tens of Hz. It is particularly prevalent on the path between VK3II and VK7MO where the presence of aircraft can be recognised by a ripple on the green signal strength line. The only solution we have come up with so far is to recognise and ignore false decodes. We did think that the wider tone spacing of JT65B or C might help but tests proved these also suffered the same problem.

It is sometimes useful to have a better idea of the DF (Frequency Difference from the sync frequency of 1270.5 Hz) reported by JT65 in looking for a very weak station on Spectran or a small spike on the spectrum display. On terrestrial paths, the DF should be symmetrical such that if another station sees you at say +100 Hz, you should see them at -100 Hz. There can be small differences in symmetry due to some computers (usually laptops) not generating the tones on the exact frequencies but these are less than 15 Hz. On EME paths the DF is affected by the Doppler shift due to Earth rotation on both paths and this adds twice the

Doppler shown on JT65 to the DF. The formula is  $DF = 2 \times \text{Doppler}$  - other stations's reported DF. Also in looking for a very weak signal on Spectran it is useful to mark any frequency you think is showing some weak specks and check

this against any later specks. It turns out that if you enable the audio filter on Spectran (Filter > Show), you can set a pair of green marks for the audio bandwidth on the scale by right and left clicking just above the scale and if you

set these at the same point it provides the marker for identifying a weak signal.

Please send any Digital Modes reports to Rex VK7MO at [rmoncur@bigpond.net.au](mailto:rmoncur@bigpond.net.au).

## EME

David Smith - VK3HZ

The 11th International EME Conference took place in early August in New Jersey with participants from 14 countries. A summary of conference activities can be found at <http://www.nitehawk.com/rasmit/NLD/eme0409.pdf>. Keynote speaker was Joe Taylor, K1JT, who presented "Fundamental Limits on Weak Signal Communication", including a discussion on the proposed new WSJT mode - JT1. His presentation can be found at <http://pulsar.princeton.edu/~joe/K1JT/EME2004.PDF>.

Joe is attempting to squeeze every ounce out of this new mode to maximise performance. This means that the messages passed across contain the absolute minimum required. However, his example QSO (using Rex VK7MO's callsign) created a flurry of lively discussion on the Moon-Net reflector about what actually constitutes a valid QSO. In JT1, both callsigns and signal strengths are exchanged and acknowledged, but the initial response to the CQ optionally uses an abbreviated callsign to identify who is being responded to. In the end, commonsense prevailed and there

was agreement that Joe's message sequence was valid. However, I found it rather ironic considering that the currently accepted message sequence for an EME CW QSO falls well short of acceptable, I believe, for a valid QSO.

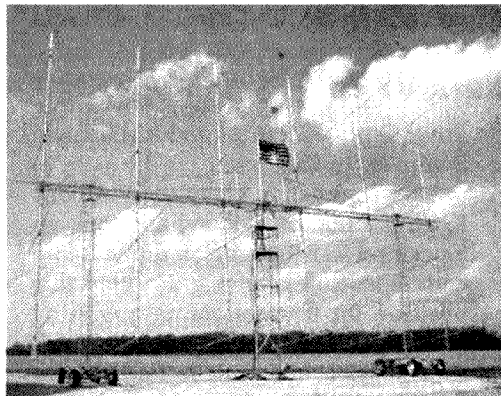

Gary KB8RQ's EME array

Only callsigns are exchanged - no "unknown" information such as signal strength - with M, O, RO and R also sent to indicate progress of the QSO. Many stations do exchange RST signal reports, but this is not required for a "valid"

QSO. And, unfortunately, apparently many "invalid" QSOs, particularly pre-arranged skeds, do slip through the gaps.

In mid August, good EME conditions matched up with reasonable times (at both ends) for the NA and EU windows, providing an opportunity for smaller stations to work some of the big guns via EME on digital modes. Dave W5UN is one big gun who has taken enthusiastically to digital modes and provides a huge signal, helped, in true Texan style, by his array of 32 x 5 WL 17 element yagis and 1.5 kW. He worked a number of smaller VK stations including Ian VK3AXH, Graham VK3XDK and me. I also managed to work Gary KB8RQ whose array is "only" 24 x 13 elements, supported by two truck chassis.

This all shows that EME contacts are possible for smaller stations when running digital modes. Hopefully many of them will get the EME bug and go on to build larger antenna arrays, with the ultimate goal of hearing their own echo off the moon.

## 2 m & 70 cm FM DX

Leigh Rainbird - VK2KRR

Very poor 2 & 70 FM DX conditions again in Australia for August. More cold, wet and windy conditions moving through in the south, making for a very unstable troposphere. On the north Queensland coast, more enhancement of signals was noted, but not much in the way of extended paths unfortunately.

Mike VK4MIK at Butchers Creek on the Atherton Tablelands, reports on a number of occasions during August, when he was able to access the Townsville 146.700 repeater at around 250 km south. On most occasions Mike has been running low power tests and has been able to run down to 5 watt, and some times as low as 1 watt has been no trouble.

The frustrating part for Mike and the other operators up that way is that the conditions have not produced long paths down the coast like it should. But, on the 18th of August, a slight bit of relief was provided. At 8.47 pm, VK4MIK made it into the Townsville repeater and spoke to Felix VK4FUQ. After this, Mike made the 535 km trip to VK4RMK in Mackay and had a QSO with Wal VK4AIV. A short simplex contact was also attempted and completed between VK4AIV and VK4MIK on 146.500 at 544 km. This is Mike's longest 2 m simplex contact, well done guys.

Moving to the southeast, there were no major openings in August. The only

real signal enhancement noted was "frontal enhancement" in the evening of Wednesday the 25th of August. The day had been unusually warm, over 20 deg C and warm air was being pulled in from the north ahead of a strong weather front.

Earlier Wednesday morning, knowing that there was the chance of frontal enhancement, I checked the BoM rain radar for the Adelaide area, this indicated the presence of signal enhancement in that area. Later, I caught up with Brian VK5UBC from Gawler, who did confirm that there were some semi local conditions to the west in the morning.

*continued next page*

# Silent keys

## Clem Tilbrook VK5GL

Clem was born on 26th March 1912 in Hove, South Australia and spent his childhood and teenage years there. He developed a fascination with radio and electronics in his early teens and this stayed with him throughout his life.

He was apprenticed to Gerard and Goodman's, Adelaide in the 1930s and was Manager of their Radio Department when he retired in 1969.

He married "Dot" Chandler in 1935 and they had three sons Graham, John and Peter.

Clem served in the RAAF Specialist

Services Radar Wing, and served at Richmond Air Base, Fig Tree Maintenance Depot, NSW, Garbutt Aerodrome, Queensland and finally at RAAF HQ, St Kilda, Victoria in the development area as Flight Lieutenant.

Clem considered himself an "Aussie Battler" from "humble roots and poor family background" None of this held him back from what he wanted to achieve. When he retired from Gerard and Goodman's he set up his own business as the only producer of quartz crystals in SA and ran the business

for thirty years. Clem made many improvements in the art of crystal grinding and was respected worldwide for his skills in this area.

Dot died in 1980 and Clem lived alone working at his electronic, TV and Ham Radio interests.

He was always cheerful and friendly.

He was "A very generous, loving father who possessed a brilliant technological mind Resting peacefully in the arms of God" to quote his funeral service conducted by his niece Captain Judith Brown of the Salvation Army.

**Jim McLachlan VK5NB**

## Cornelius (Keith) Heemskerck VK2JY

It is with much sadness we record the passing of another ham. Keith Heemskerck sadly passed away on the 1st of May 2004 in Springwood Hospital, after a long illness.

Keith was first licensed in 1968 in Portland Victoria.

A native of Holland, he became interested in the wonderful world of Radio at an early age having built his first crystal set when he was 11 years old. Keith cherished the ambition to operate his own short wave radio station but unfortunately World War II intervened and all plans were put on hold.

When the war was over he undertook a course to become a ships radio operator, but after completing the first part of the course, he was drafted into military service. Keith carried out his military duties as a national serviceman with the

Royal Dutch Electrical and Mechanical Engineers in East Java.

After completing his military service Keith returned to Holland and took up a position as a Technician doing Radio and Television servicing. He held this position for 3 years before migrating to Australia in the early 50s, to work as a panel beater for the Ford Motor Company!

He did however, return to his trade of Radio and Television in 1956 when Television was introduced to Australia, after doing a refresher course. He was a successful businessman doing Radio and Television repairs in Portland Victoria.

Keith passed the required examinations to obtain his Amateur Operators Certificate of Proficiency in 1967, and in 1968 he was issued the call sign of VK3AIH.

Keith and his XYL Pam, moved to the Blue Mountains about 8 years ago and Keith was allocated the call of VK2JY. A keen home-brewer, Keith experimented in all aspects of the hobby, with much of his equipment being brewed in the small, but modest shack in his back yard. SSTV, RTTY and Satellite operation are also amongst the activities Keith experimented with.

Keith was a member of the Blue Mountains Amateur Radio Club from when he first moved to the Blue Mountains. To all that knew him, Keith was a thorough gentleman, and will be sadly missed.

To the families of Pam and Keith, our thoughts are with you.

**Daniel Clift VK2DC**  
Sec. BMARC.

## VHF/UHF – and expanding world *continued*

Port Lincoln 2 m & 70 cm both S9+20 and Cowell at S9. Brian worked 5ZAW (Adelaide) & 5AEP at Port Lincoln via Lincoln 2 & 70. Also worked 5HBG at Whyalla via Cowell and could hear him simplex.

In the evening there was major thunderstorm activity around the Adelaide area and to the south below Kangaroo Island. There were very strong winds noted at the Adelaide beacon site, with a maximum wind gust of 113 km/h recorded, hence, there were no signals noted from the Adelaide area, the front was too far advanced.

After 8.30 pm that night, conditions

virtually in a straight line from my QTH to Ararat were very good. This did not extend to Mt Gambier or Melbourne.

I initially noted Shepparton and Bendigo repeaters at full scale. Looking further out, Ararat was almost full scale. Switched to 70 cm and in the same direction, had a go at the Grampians 70 cm repeater at 471 km, it was also full scale.

Among a number of stations that called in, one was Tim VK3JTM, who was portable on One Tree Hill around Ararat. Tim was using a mobile whip on 2 and 70. We tried simplex and Tim was 5/5 on 2 m and 5/7 on 70 cm. Peter

VK3XDP, just east of Bendigo also found us on simplex and he was 5/5 on 2 and 5/9 on 70.

These contacts almost indicate a slight non-ducting tropo (NDT) effect, which I have mentioned in a previous article. While some of the usual NDT indicators were present (out going high pressure, some stronger 70 cm over 2 m), others were not (incidence of severe QSB, most cases showed equal if not better 2 m over 70 cm).

Please remember to send through any 2 & 70 FM DX reports to Leigh VK2KRR at vk2krr@telstra.com.

✻



## Swansong for "Voice Of Switzerland"

Swiss Radio International is to cease all radio broadcasts at the end of this month, October, and will thereafter concentrate exclusively on its Internet platform, [www.swissinfo.org](http://www.swissinfo.org). SRI ended its news and current affairs programming in April and they have been broadcasting retrospectives of Swiss Radio International. I do clearly remember hearing Switzerland when I commenced shortwave listening in the mid fifties. I cannot recollect the actual frequency yet I am certain it was in the 31 metre band. Many of the oldies will recall its distinctive interval signal of a music box and broadcasts started with the sound of Swiss chronometer. The Swiss folk music towards the end of the transmission was always a highlight

I also believe that there will be a marked reduction in shortwave high frequency usage after the commencement of the B-04 period, on October 26th. The 11 metre allocation will be devoid of any broadcast activity because Radio France International and Deutsche Welle have not registered frequencies. These two organisations were the only occupants of 11 metre for many years and I do not expect that any activity will appear until the Sunspot numbers pick up again later in the Solar cycle. Hams will already know that propagation on 28 MHz has sharply decreased.

Spring has well and truly arrived here and although propagation on the higher frequencies has picked up, the MUF has not gone as high as it did 12 months ago. I notice that other HF users have cut back their operational activities, revealing signals that were often hidden. Not surprisingly digital modes also have proliferated yet analogue modes are still used especially in less developed regional areas. Another fact is the continuation of apparent illegal unregistered SSB signals within reserved allocations has been very difficult to control, particularly in Asia and Africa. Many of these illegal signals are from international waters or located within remote sparsely populated regions.

The reduced output of the major broadcasters has allowed rarely observed

domestic stations to be heard. These are from Latin America, Africa and western Asia. HF is being phased out in favour of FM relays and television has also had an impact on listening patterns. Latin America used to have hundreds of shortwave signals, often from small senders in remote regions but often when they broke, it was not economical to repair them.

I did come across yet another DX program over World Harvest Radio via its transmitters in Furman, South Carolina (WSHB). It is on Mondays at 2130 to 2155 and is called "Radio Weather" It is clearly modelled on "DX Partyline" and is produced in Ontario, Canada by Rod Hembree. I believe that this program may also be on WBCQ in Monticello, Maine.

The latter station is often heard here on 9330 reduced carrier lower sideband. It is somewhat unusual as most senders employing reduced carrier transmissions utilise the upper sideband. WBCQ is heard at 2130 but this may alter after October 26th.

Radio Australia seems to be transmitting on 15240.5, an unusual offset and I think the transmission is not coming from the Shepparton site, possibly from Taiwan. The time was 2200 and I initially thought the signal was coming from Radio New Zealand International yet although it was from Wellington, it was indeed via the Radio Australia facilities to the Pacific. RNZI had a separate programme stream via its own sender on 17675 at that time.

More on Spam: In last month's column, I remarked on the increasing amount of Spam that has flooded my primary ISP mailbox. I should have remarked that my WIA address is free of Spam. I still had to change my address, as 66% of my email was Spam,

too much for Internet filters to handle. I reluctantly have changed my primary email address, which has visibly reduced the amount of Spam. What I have learned from this is to be very careful handing out your email address and if you have to post in public forum, use a specific address for that purpose. Don't be surprised that this email address will quickly gather Spam. I categorise these addresses as Spam traps. Well that is all for now. Yes you can certainly email me via [vk7rh@wia.org.au](mailto:vk7rh@wia.org.au) although Spam will be automatically filtered out.

Good monitoring and 73- Robin L. Harwood VK7RH

ar

radio and electronics school

## Become a Radio Amateur

or study radio electronics to  
support your hobby

Australia's premier training institution for **AMATEUR  
RADIO AND HOBBYISTS**  
courses available in radio & electronics technology for  
all ages

### COURSES AVAILABLE ONLINE

Be guided through your course by one or more of our  
20 experienced volunteer facilitators, email hundreds  
of other students

### IN A HURRY?

Become a novice radio operator in 4 weeks with our  
computer-based

### NOVICE FAST-TRACK COURSE

Courses for schools, youth organisations and seniors  
**Australian Radio Certificate Scheme (ARCS)**  
Use our accredited bridging program for radio  
amateurs to obtain a

**CERTIFICATE IN ELECTROTECHNOLOGY**  
Download all course materials free  
(CD Rom has a small fee)

For Further Information visit  
<http://radioelectronicschool.com>  
or email  
[manager@radioelectronicschool.com](mailto:manager@radioelectronicschool.com)  
Tel: (07) 5573 2795 12-5 (EST)

# Technical abstracts

Peter Gibson VK3AZL

## Attenuators

The regular column, 'Hands-on Radio' in QST for February 2004 by Ward Silver, N0AX features a short discussion on attenuators.

### Background

Attenuators are used in many different audio and RF applications. Your HF rig probably has an attenuator at the front end and your signal generator uses one to switch output voltage ranges. In addition to voltage reduction, attenuators can be used for impedance matching and isolation. Whilst most attenuators are made from fixed or variable resistors, some adjustable RF attenuators are made from PIN diodes.

There are many types of attenuator circuits and Figure 2 shows the most common, the T, Pi, H, O and L. The T, Pi and L are all unbalanced, meaning that all circuit voltages are referenced to the common ground. The H and O are balanced equivalents of the T and Pi respectively. The balanced circuits do not have a common ground. Attenuators are often referred to as 'pads' and attenuation as 'padding'.

Attenuators are designed to have specific input and output impedances, because the source and load impedances affect how much voltage appears across the attenuator resistors. The source and load often need to be connected to a specific impedance to operate properly.

### Designing attenuators

The equations for attenuator resistor values are complex, so tables for values of attenuation and impedance are widely available. Table 1 shows one such table for symmetrical attenuators (same input and output impedance).

As most amateur equipment operates with 50 ohm input and output impedances, as an example, let's try designing a 10 db, 50 ohm attenuator.

Although either a Pi or T circuit can be used, the Pi has a physical advantage of not requiring a centre connection. From Table 1, the Pi configuration gives values

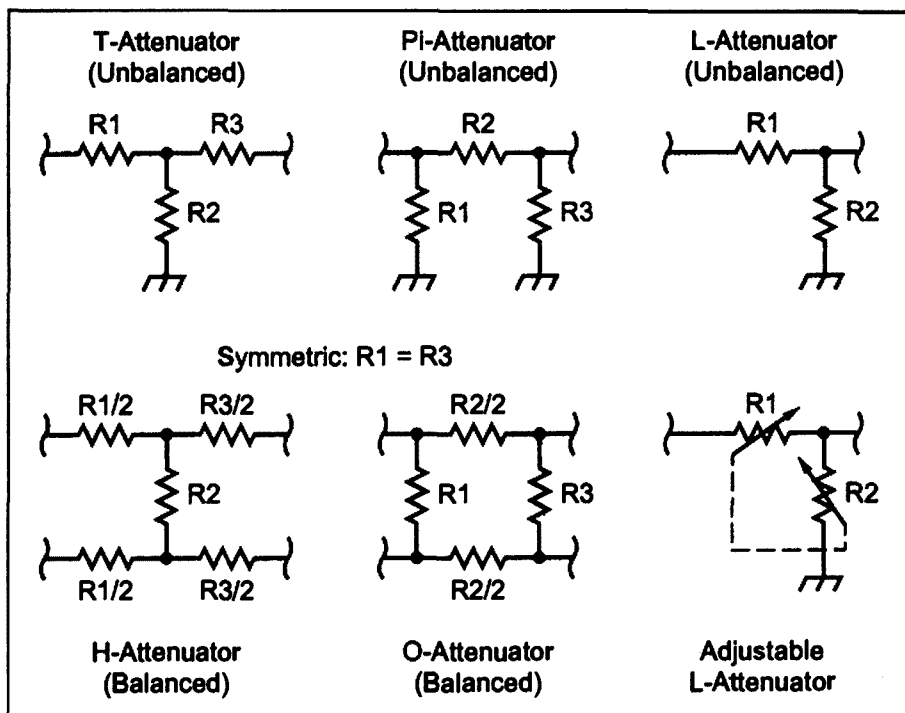

Figure 2 – Several common attenuator circuits. To make the attenuators symmetric, make values of R1 and R3 equal

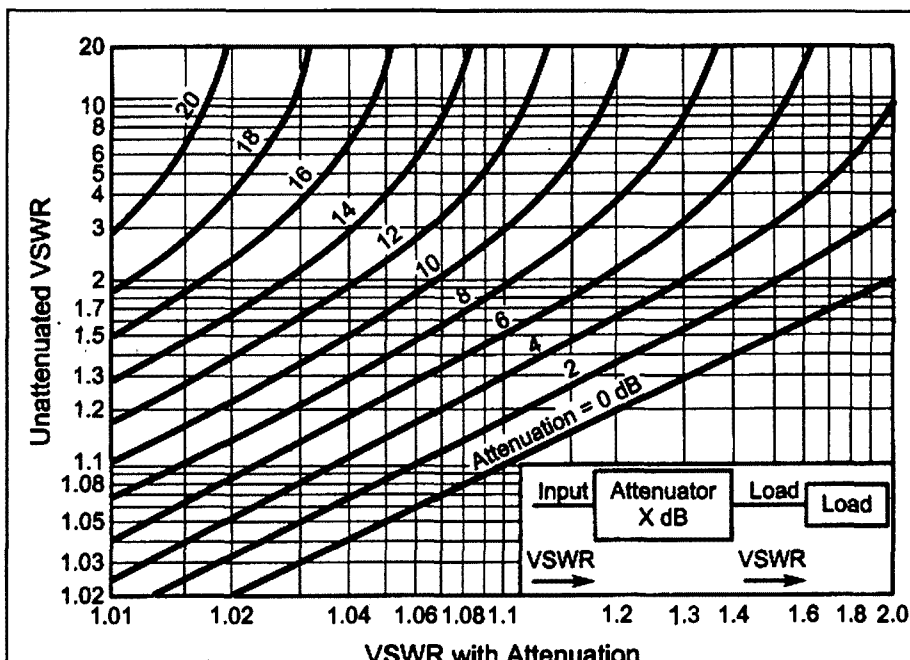

Figure 3 – Attenuation can prevent a high VSWR from upsetting a 50 ohm signal source. It can also mask a VSWR problem at your antenna

of 96.2 ohm for R1 and 71.2 ohm for R2 (R1=R3 for symmetrical attenuators). As these values are a little hard to obtain, preferred values of 100 and 75 ohm are used. As the ratio is still about correct, the attenuation should stay close to 10 dB but the impedance will be closer to 52 ohm.

If you want to have several of these attenuators for use around the shack, they should be installed in suitable enclosures. The enclosure should be a tight sealing metal unit with suitable connectors to make sure the signal goes through the attenuator and not around it.

## Attenuators for isolation

Attenuators can also provide isolation between two systems. This is useful at RF, where output amplifiers are designed to work into a load of 50 ohm. An example is where a signal generator needs to see an impedance close to 50 ohm to maintain calibrated output level and purity. The input impedance of circuits such as filters, transmission lines or antennas is often anything but 50 ohms at some frequencies. An attenuator between the generator and the circuit under test helps provide isolation between the two. Figure 3 shows how an attenuator can provide isolation as well as presenting a reasonable VSWR to the signal source.

## Attenuators for impedance matching

It is sometime necessary to operate two systems with differing input and output impedances. A common example would be trying to operate between 50 ohm and 75 ohm systems. The simplest, broadband solution to this problem is to match the systems with a fixed, minimum amount of loss. This can be done effectively with just a few resistors in an L configuration. These are called 'minimum loss' attenuators.

Figure 4 shows the L attenuator circuits used for this application and several sets of values that make useful impedance matching attenuators

ar.

**Table 1**

### Resistance Values for Symmetric T and PI Resistive Attenuators

PI-Network Attenuators (50 Ω)			T-Network Attenuators (50 Ω)		
Atten (dB)	R1, R3 (Ω)	R2 (Ω)	Atten (dB)	R1, R3 (Ω)	R2 (Ω)
1	870.0	5.8	1	2.9	433.3
2	436.0	11.6	2	5.7	215.2
3	292.0	17.6	3	8.5	141.9
4	221.0	23.8	4	11.3	104.8
5	178.6	30.4	5	14.0	82.2
6	150.5	37.3	6	16.6	66.9
7	130.7	44.8	7	19.0	55.8
8	116.0	52.8	8	21.5	47.3
9	105.0	61.6	9	23.8	40.6
10	96.2	71.2	10	26.0	35.0
11	89.2	81.6	11	28.0	30.6
12	83.5	93.2	12	30.0	26.8
13	78.8	106.0	13	31.7	23.5
14	74.9	120.3	14	33.3	20.8
15	71.6	136.1	15	35.0	18.4
16	68.8	153.8	16	36.3	16.2
17	66.4	173.4	17	37.6	14.4
18	64.4	195.4	18	38.8	12.8
19	62.6	220.0	19	40.0	11.4
20	61.0	247.5	20	41.0	10.0
21	59.7	278.2	21	41.8	9.0
22	58.6	312.7	22	42.6	8.0
23	57.6	351.9	23	43.4	7.1
24	56.7	394.6	24	44.0	6.3
25	56.0	443.1	25	44.7	5.6
30	53.2	789.7	30	47.0	3.2
35	51.8	1405.4	35	48.2	1.8
40	51.0	2500.0	40	49.0	1.0
45	50.5	4446.0	45	49.4	0.56
50	50.3	7905.6	50	49.7	0.32
55	50.2	14,058.0	55	49.8	0.18
60	50.1	25,000.0	60	49.9	0.10

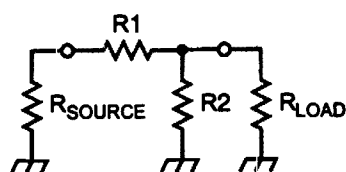

(A) Use for  $R_{SOURCE} > R_{LOAD}$

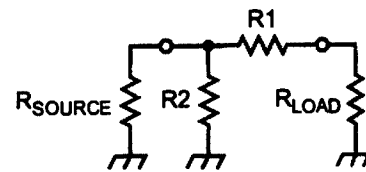

(B) Use for  $R_{SOURCE} < R_{LOAD}$

$R_{SOURCE}$	$R_{LOAD}$	R1	R2	Atten (dB)	Circuit
50	75	43	87	5.7	A
50	300	274	55	13.4	B
50	600	574	52	16.5	B
75	50	43	87	5.7	A
75	300	260	87	11.4	B
75	600	561	80	14.8	B
300	50	274	55	13.4	A
300	75	260	87	11.4	A
300	600	424	424	7.7	B
600	50	574	42	16.5	A
600	75	561	80	14.8	A
600	300	424	424	7.7	A

Figure 4 – Minimum-loss attenuators match system impedances while exacting the least amount of signal energy

# Talking to the enemy

David A. Pilley VK2AYD  
Davpil@midcoast.co.au

In the August 2004 edition of "Amateur Radio", I wrote about the "Secret Wireless War" and how Radio Amateurs played such an important part in WW II. The following is a true story of a remarkable QSO made by Jo Doering, DL1RK (now SK), in his own words.

"During WW II I served as a Lance Corporal in a special army signal corps unit in the Afrika Korps. We intercepted the enemy's tactical radio communications in the African war theatre and used to be Rommel's ears. Late afternoon on May 7th, 1943, five days before we had to surrender to Tunisia, our Company Commander asked me if I would like to communicate with the enemy. "Sure I do" was my answer. My first thought was that it was the surrender message, the end of the fighting in Africa. But the message to be sent was about a target not to be bombed. Since the Allied bombers flew in from the West, the message had to be addressed to the British 1st Army who operated in that area. Therefore, I chose a radio net from the HQ British First Army, noted frequency and call signs, took the message and went to the transmitter van about half a mile from our receiving units.

The British net was very busy that night and I had to wait for long time. Meanwhile, I practised with the straight key since I had not used one for about a year or so sitting in front of a receiver

taking down foe's radio traffic. At last the net I was tuned into had worked all the traffic they had at hand. Now it was my turn. With the 80 watt Lorenz transmitter carefully set to zero beat and with the 'borrowed' call they had used last, I hit the key. 'QTC' and then I made a big mistake by using the British 8th Army 'X279' instead of the 1st Army 'QRK?'. The HQ station came back with a question mark. I started over again, but this time with 'QTC1 QRK? K'. QRK5 was the answer.

'DADIDADIDAH ~To the headquarters allied expeditionary forces in Africa from the HQ of the Axis force in Africa'. Then the guy that I 'borrowed' the call from came in: 'That's not me, it's a propaganda message from the enemy.' But I broke in with: 'Its not propaganda, but life or death for your own people.' In the end, the HQ station told me to go ahead with the message. It read, as I recall from my memory: 'Two ships are in the harbour of Tunis. One freighter with 600 allied prisoners in its holds and a hospital ship. Do not bomb those two ships to save the lives of your own people.'

I received 'QSL' for message and said I would 'QRX' tomorrow, same time, same frequency, for a possible reply. No reply was received during the next days. The event faded in my memory during the years to follow until in 1950, I bought a book about the war in Africa. In it, I found the message I had sent and the reaction that took place. General Alexander, Commander of the British 1st Army, met captured German General von Arnim and thanked him for the message that saved 600 of his soldiers. He agreed to send 600 wounded Germans in a hospital ship to Italy.

In a small way, I helped to add some human touch to this cruel war. Therefore, I call this my only worthwhile QSO ever."

Jo passed away a few years back. He was a well known ardent CW operator that had taken part in quite a few Dxpeditions. He was a member of the world wide 'First Class (CW) Operators Club' and we'll tell you more on this dedicated CW club in a later issue.

*(Reproduced from the FOC History book).*

## Tassie Highland Hamfest

Central Highlands Amateur Radio Club of Tasmania with sponsorship by the WIA VK7 Division is holding the **Inaugural Highland Hamfest on Saturday December 4, 2004**

### Miena Community Centre

Miena is located at the southern end of the Great Lake in the Central Highlands.

Heaps of parking. Doors will open at 11AM

Traders will be displaying the latest in communications technology. *Transceivers, Tuners, Antenna, Solar and Wind Power, Kits and Test Equipment.*

See the latest from *Autech, LDG, ICOM, SGC, Ten-Tec and Yaesu*

Several working displays including a full HF station, ATV, IRLP, Solar/Wind Power, Weather Station.

Guest Speakers include. Rex VK7MO, Ken VK7DY.

Call VK7CHT on 146.500 MHz VHF, Barren Tier Repeater 438.500 MHz UHF, 3585 KHz HF or HAMFEST on Chan 7 CB on the day.

Entry is a Gold Coin Donation. Tea Coffee and Food is available. Facilities are second to none.

If you have something to sell and would like a trade table contact Bob Geeves VK7KZ on 0417 543144.

For interstate visitors Miena is about 130 Km South from the Spirit of Tasmania Ferry terminal at Devonport.

# The Bass Amateur Radio IRLP Group Inc

438.150MHz ~ -5 offset

## Specialising in IRLP mode

# J.O.T.A.

### (Jamboree On The Air)



## *Help us to show the next generation the magic of amateur radio*

The Bass Amateur Radio IRLP Group Inc. this year are excited to be part of this year's J.O.T.A. (Jamboree On The Air)

This year J.O.T.A will be held on  
the 16th and 17th October  
at St Joseph Harris Park, Mt Martha.

So what can I do you might ask? You can dial up on reflector 9507 and be part of the world hook up or if you're in the area drop in for a cuppa and a chat and feel the buzz in the air as our youth make contact with other young members throughout the world. And as an added bonus you might have some fun too!

For further enquires contact the Secretary on 03 5982 1307

## Sunspot Numbers

Monthly Sunspot Average Aug 2004: 40.9

Annual Sunspot Average Feb 2004: 49.4

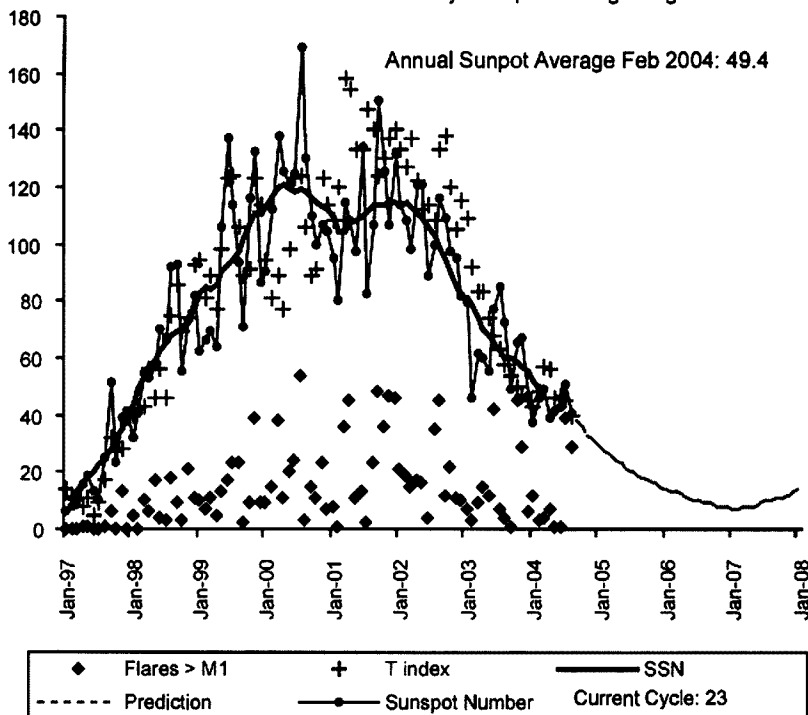

Drawn from monthly data provided by the Ionospheric Prediction Service

## Over to you

### Travellers' Net

I would like to draw your attention to the great service that VK6BO Roy and VK6HH Peter do for the travelling Ham. After several trips up north etc I know from personal experience that the service provided by the Travellers Net is to be commended.

I would like the WIA to somehow show recognition of this dedication, while these two gentlemen are still with us.

I am sure there must be some mode of recognition that the WIA can use to honour them for their dedication to this safety net service.

**Jack Spark VK3AJK**

**Adelaide-Auckland****104****Brisbane-Chicago****57****October  
2004**

T index: 36

**HF Predictions**

by Evan Jarman VK3ANI  
34 Alandale Court Blackburn Vic 3130

These graphs show the predicted diurnal variation of key frequencies for the nominated circuits.

These frequencies as identified in the legend are:-

- Upper Decile (F-layer)
- F-layer Maximum Usable Frequency
- E-layer Maximum Usable Frequency
- Optimum Working Frequency (F-layer)
- Absorption Limiting Frequency (D region)

Shown hourly are the highest frequency amateur bands in ranges between these key frequencies, when usable. The path, propagation mode and Australian terminal bearing are also given for each circuit.

These predictions were made with the Ionospheric Prediction Service program: ASAPS Version 4

First IF 1-4 IE0 Short 3241 km

First F 0-5 Short 14361 km

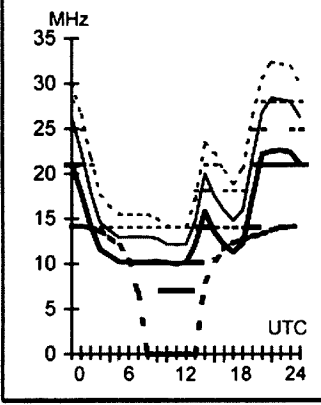
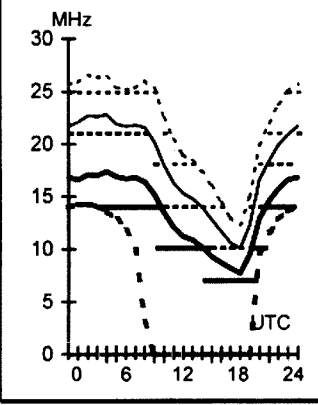
**Legend**

Frequency scale

Time Scale

UD

E-MUF

OWF

F-MUF

ALF

&gt;10%

&gt;50%

&gt;90%

**Adelaide-London****132****Brisbane-HonoLulu****49****Canberra-Dakar****214****Darwin-Christchurch****139**

First F 0-5 Long 23755 km

econd 3F5-9 3E0 Short 7569 km

First F 0-5 Short 17361 km

First 2F4-7 2I:0 Short 5282 km

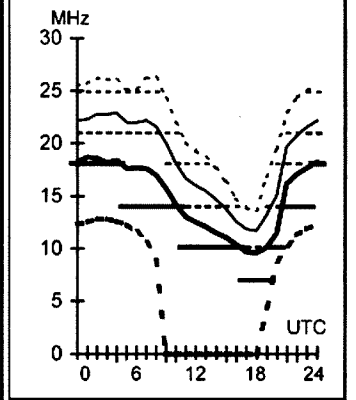
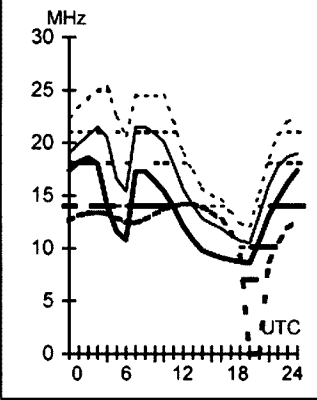
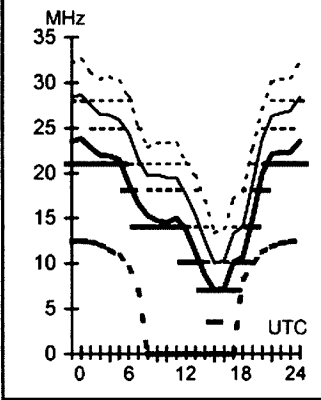
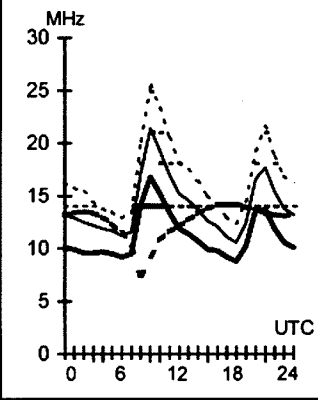
**Adelaide-London****312****Brisbane-Moscow****321****Canberra-New Delhi****303****Darwin-Manilla****340**

First F 0-5 Short 16269 km

First F 0-5 Short 14071 km

Second 4F5-9 4E0 Short 10347 km

Second 2F13-244F4 Short 3196 km

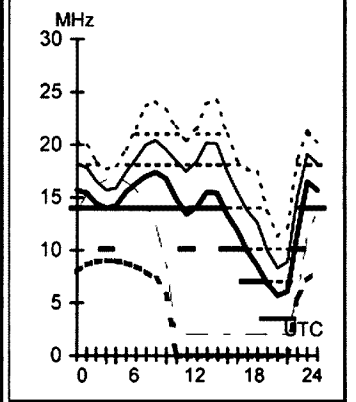
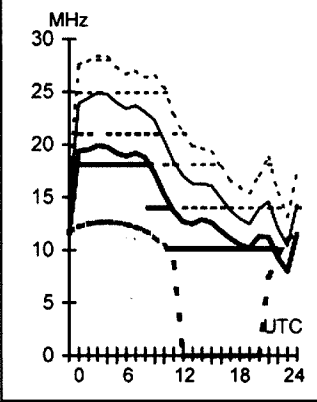
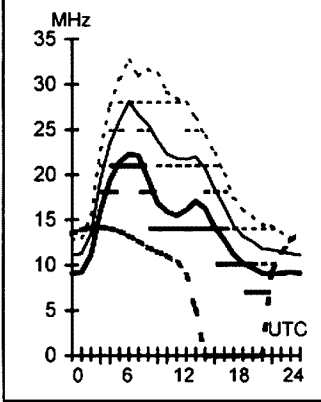
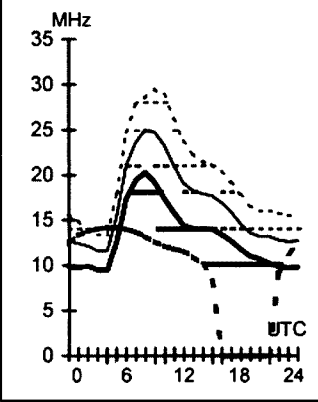
**Adelaide-Tokyo****1****Brisbane-Singapore****293****Canberra-Washington****70****Darwin-Wellington****135**

Second 3F4-9 3E0 Short 7855 km

Second 3F9-14 3E0 Short 6146 km

First F 0-5 Short 15938 km

First 2F4-6 2E0 Short 5322 km

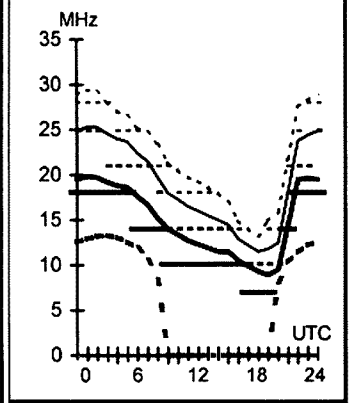
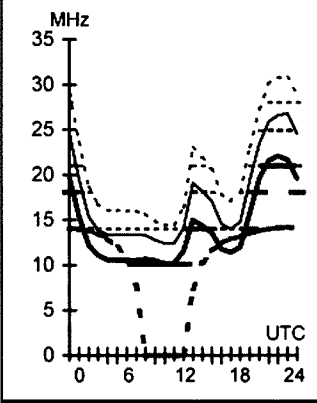
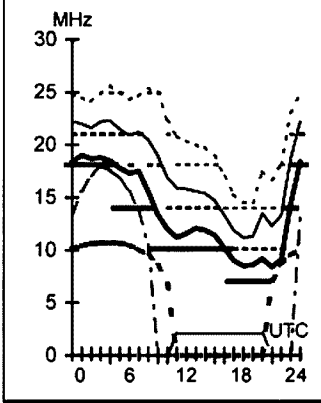
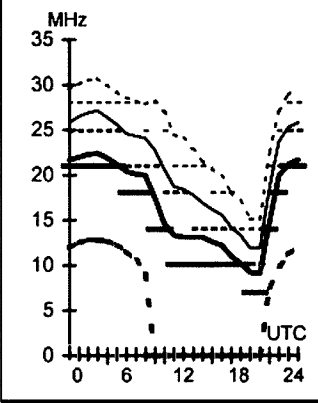

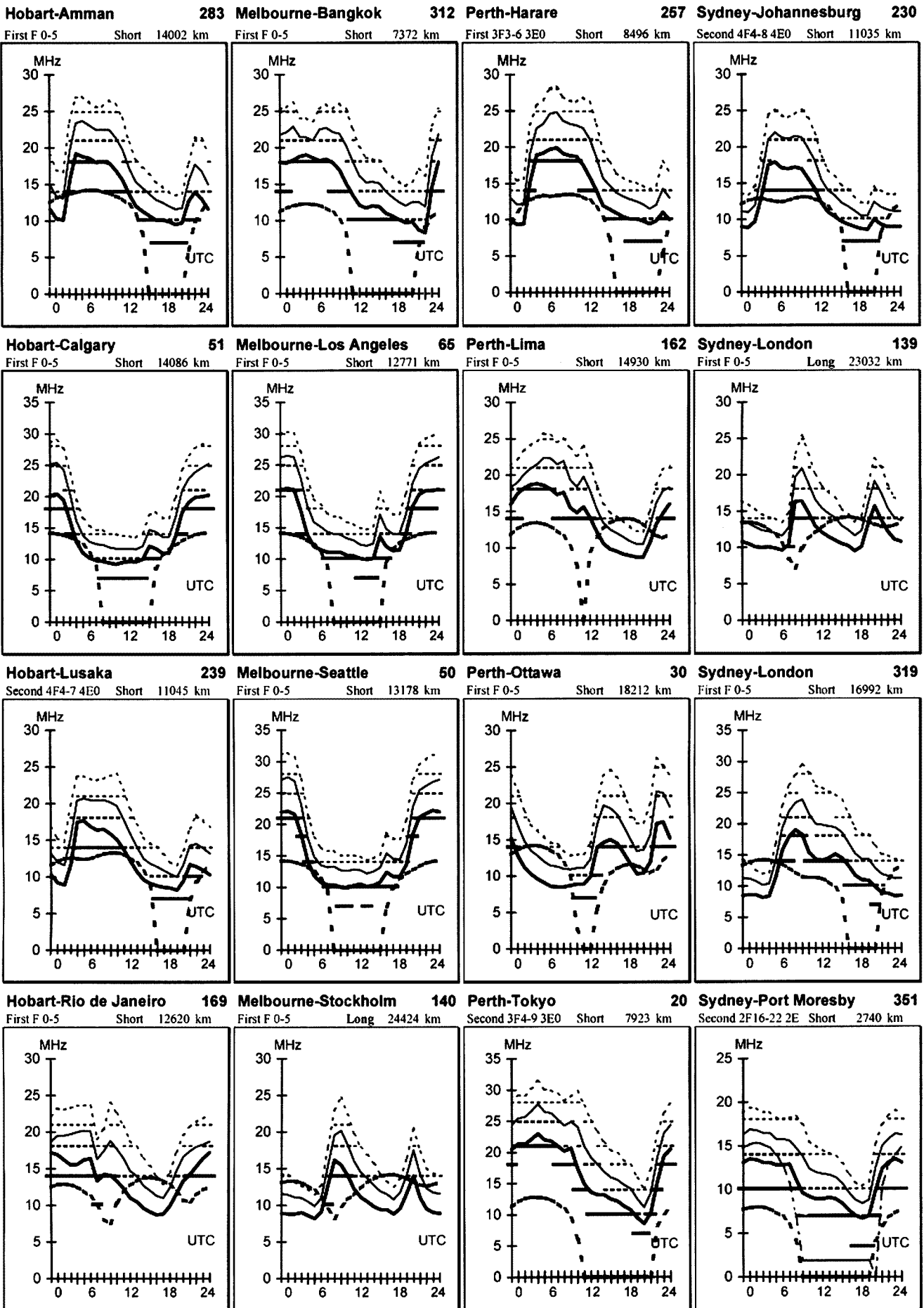

# Hamads classified **FREE**

## FOR SALE ACT

- Rotator, Kenpro KR-800S, has approx 20 m cable \$425. Lower pipe clamps \$25. Create thrust bearing \$50, or \$450 the lot. Light duty rotator \$65. John VK1CJ QTHR, Phone 02 6251 1816 or ronjon@wic.net.au.
- Yaesu FRG-7 communications radio. Fitted with mechanical filter. Asking \$125 ono. Purchaser to arrange freight. Bill Robertson VK1WPR Phone 0417 265 586
- AOR AR-8200 MK3 wideband scanning receiver. Brand new still in original shrink-wrap and packing, from deceased estate but out of warranty. Price is negotiable from \$950. Contact Philip VK1PC, Phone 0414 475 953 or philipgc@iprimus.com.au

## WANTED ACT

- Eddystone dial mechanism with 10:1 reduction, dimension 9 x 3, or similar. Also Hewlett Packard HP-3406A sampling probe. Peter VK1CPK. QTHR, Phone 02 6231 1790 Email: pkloppen@austarmetro.com.au

## FOR SALE NSW

- Yaesu FL-7000 500 watt Linear \$1,400.00 or near offer. Can be inspected at Andrews Communications Greystanes NSW. Phone:02 9636 9060. Adolph May, QTHR (Delete if no call sign) Phone: 07 4096 6961.
- HP-7550 Plotter, \$90; Panasonic KX-P1180 Printer, \$15; 2 x FM-828 A, \$40 ea; 2 x FM-92 A plus 4 control heads, \$100 total; 2 x MFJ-1270B TNCs, one with 4800 baud modem, \$10 ea; 1 x PacComm Tiny 2 TNC, \$10; 4 x LDF4-50 female N connectors, new; \$20 ea; 8 metres LDF5-50 coax, \$30; 6.5 metres LDF 4-50 coax, \$20; Roger

Woodward VK2DNX, Phone 02 9547 2546 or Rogerwoodward10@hotmail.com

- QST and QEX-10CDs 1996-2003 issues \$250, BIRD model 8133 coaxial resistor \$80, Kenwood TS-870, Wilson System SY-1 4 element beam \$350. Tom VK2OE@ARRL.NET, 2/25 Andrew St Inverell NSW 2360, phone 0413 796 851, 8-9pm.

## WANTED NSW

- Controller for Channel Master rotator. Must be in working condition and include wiring and cables. If not then wiring diagram schematics of controller if available would be appreciated. Contact c\_irving@midcoast.com.au.
- Yaesu transceivers wanted. Prefer in good working order, will consider other condx FTDX-400, FTDX-401, FT-401B, FTDX-560, FTDX-570, finears FL-1000, FL-2000B, FLDX-2000, FL-2500, also speakers, VFOs, transverters to suit FTDX range. Mics Aiwa DM-47, DM-14 etc, Shure 444. Cash buyer. I have FT-920 in as new condx to swap for above gear to same value or will swap for good linear DX1, or anything of similar quality, try me. Mike VK2EFT Phone 02 6647 3271 or email rautem@dodo.com.au

## FOR SALE VIC

- FRG-7 Communications Rx with manual \$100. IC-701 HF XCVR (not working), trouble in output stage, plus desk mike IC-SM5 for above with manual \$100, or swap all of above for 13.8V 20A P/S. Communications Rx IC-R71E with manual, \$200. Laurie VK3BV. Phone 03 5975 0306, email shirlau@dodo.com.au.
- Eddystone receiver model 770R Mk2 VHF 19 MHz to 165 MHz \$220. Len VK3AQJ, AH Phone 03 9762 3522.

- Deceased estate: ICOM IC-751 HF transceiver with power supply \$950. MFJ-949E de luxe Versa Tuner II \$270. Yaesu FRG-7 communications receiver \$150. Yaesu SP-102 speaker \$120. Cables, manuals and circuit diagrams are available. Many other items are available also, please enquire. Carmel Phone 03 9325 4248.

- Kenwood TS-930 HF transceiver, excellent condition, \$700. 100 watt, 160 m to 10 m, built-in antenna tuner. A very nice rig to operate; excellent sensitivity and selectivity, with slope-tune and notch filter; the variable band tuning and variable CW tone make CW reception a breeze. SSB transmit audio gets good reports and the RF speech processor is very effective. With Kenwood hand mic, operating and service manuals. Fred VK3AQN, Phone 03 9876 7997. Email fmnaylor@tpg.com.au

## WANTED VIC

- FT-7B, R-1155, B-40D, CR-100/B28 TKG. Mr F Jackson, 38 Mooltan St, Flemington. Phone 03 9376 3076
- Racal RA-17 receiver. If available will collect. Clem Smith VK3AYY. Phone 0417 574 456
- Yaesu MH-14 A8 hand mic models or similar. Phone Max VK3GMM on Phone 03 5985 2671
- Barlow Wadley XCR-30 portable radio. Aerial variometer for No.19 set. Leads for 19 set, battery to psu, psu to set, set to junction, junction box, set carrier, junction box no.1. Roger VK3HRS Phone 03 9789 9580 email. emschem@techinfo.com.au

## FOR SALE QLD

- Yaesu FT-1000MP Mark 5 Transceiver Ser. No.IE270183. Yaesu FP-29 Power Supply Ser. No.IE027. Yaesu SP-8 External Speaker Ser. No.IF054. Yaesu MD-100 Desktop Microphone Ser.No.IH52. Yaesu MH-31 Hand Microphone. Yaesu YH-77 Stereo Headphone. All equipment is less than 3 years old, in perfect and as new condition and comes complete with manuals and original strong shipping boxes. \$4000 ex Tin Can Bay, Queensland. Price is non-negotiable. Ron VK4QM Phone 07-54880268 e-mail rhvette@gympie.big.net.au

## WANTED QLD

- Two in number RF power transistors for Ten Tec QRP Argonaut transceiver, Model 505. RF power amplifier board part number 90195. Type No.2N2631 or equivalent. Norman VK4FON. Phone 07 3207 1795. 2 Sailfish Court, Birkdale, Q4159, Brisbane.

## FOR SALE SA

- Amateur base station, speech processor, speakers, microphone inserts, antennas, magazines, mobile phone hands free kit and much more. Send SASE to Paul, PO Box 76, Peterborough SA 5422 for list. Phone 08 8651 2398.

## WANTED SA

- Philips technical wall poster or chart of the Philips 20 AX in line gun self-converging colour picture tube. Tektronix 100 ohm pot type 311-0574-00 position 0.05 V/cm gain for a 1A1 dual trace plug in. Tektronix 650 colour monitor, 12 inch CRT V8701 part no 154-0641-01.

## About hamads....

- Hamads may be submitted by email or on the form on the reverse of your current Amateur Radio address flysheet. Please print carefully and clearly, use upper AND lower case.
- Separate forms for For Sale and Wanted items. Please include name, address STD telephone number and WIA membership number if you do not use the flysheet.
- Deceased estates Hamads will be published in full, even if the ad is not fully radio equipment.
- WIA policy recommends that the serial number of all equipment for sale should be included.
- QTHR means the address is correct in the current WIA Call Book.
- Ordinary Hamads from those who are deemed to be in general electronics retail and wholesale distributive trades should be certified as referring only to private articles not being re-sold for merchandising purposes.
- Commercial advertising (Trade Hamads) are pre-payable at \$25.00 for four lines (twenty words), plus \$2.25 per line (or part thereof), Forty word maximum, minimum charge of \$25.00. Cheques are to be made out to: WIA Hamads.
- Copy typed or printed clearly please, and received by the deadlines shown on page 1 of each issue of Amateur Radio.

Email: [newunltd@bigpond.net.au](mailto:newunltd@bigpond.net.au)

Fax: 03 9756 7031

Postal: Newsletters Unlimited, PO Box 431, Monbulk Vic 3793

### TRADE PRACTICES ACT

It is impossible for us to ensure that the advertisements submitted for publication comply with the Trade Practices Act 1974. Therefore, advertisers and advertising agents will appreciate the absolute need for themselves to ensure that the provisions of the Act are strictly complied with.

### VICTORIAN CONSUMER AFFAIRS ACT

All advertisers are advised that advertisements containing only a PO Box number as the address cannot be accepted without the addition of the business address of the box-holder or seller of the goods.



• **FT-101E** in going order. Will pay reasonable price also freight if necessary. VK5BVJ QTHR. Phone 08 8723 1001 anytime.

• **Information** and/or diagrams about connecting my **ICOM IC-706 Mk I** to a Codan 9350 or Barrett 910 auto tune antenna. Many thanks, Rob VK5CS. Phone 0421 088 857 A/hrs or email: dorisrob@sa.chariot.net.au

• **Yaesu FT-757** or **Codan 8525** or similar, working or not. Bruce VK5VK rfwizard@optusnet.com.au

**MISCELLANEOUS**

• **The WIA QSL Collection** requires **QSLs**. All types welcome, especially rare DX pictorial cards, special issue. Please contact the Hon Curator, Ken Matchett VK3TL, 4 Sunrise Hill Road, Montrose Vic 3765, tel. (03) 9728 5350

**TRADE ADS**

**PSK-31, SSTV, RTTY SOUNDBOARD**  
Interfaces Fully isolated, ready to plug in.  
<http://www.G3LIV.CO.UK>, johnny@melvin.com, G3LIV QTHR.

**VK DISCOUNT CABLES**

*We have a large range of cables & connectors available at cheap prices!*

**Please contact us with your requirements!**

EMAIL : Rob\_vk2xz@hotmail.com  
PH - 0419 480 560 During Business Hrs  
Technical data available on request.  
Cable samples available on request.

Freight anywhere in VK \$18.50  
For any further inquiries on these cables, or any other cables you may require, please don't hesitate to contact me, as we are able to supply anything you can think of!

**Rob Long VK2XZ**

**GROW WIA—MAKE IT YOUR JOB  
RECRUIT A NEIGHBOUR\*, NON-MEMBER LICENCE HOLDER TODAY.**

One to one approaches are very successful and it is in your interest to have a strong WIA.  
If you need to know who your neighbouring operators are call John (03) 9756 7797 AH and he'll tell you.

- Icom 706MK2G (NEW) \$1,299
- Icom 706MK2G (IMMAC) \$1,199
- Icom 207H (NEW) \$479
- Icom 208H (immac) \$579
- Icom 910H (IMMAC) \$1,699
- Icom 756PRO2 (IMMAC) \$3,299
- Kenwood TS2000 (IMMAC) \$2,399
- Kenwood TS480HX (IMMAC) \$1,799
- Kenwood TS480SAT (IMMAC) \$1,699
- Yaesu FT8900R (USED) \$649
- Yaesu FT100D (IMMAC) \$1,299
- Icom AH4 ATU (NEW) \$479
- LDG AT1 Imp Tuner (immac) \$399
- Yaesu VX5R (immac) \$449
- Icom 207H (used) \$399

**FULL RANGE OF NEW HEIL PRODUCT  
PRICE SUBJECT TO CHANGE - CHECK  
WEBSITE FOR LATEST  
BARGAINS.**

**PLENTY OF OTHER CURRENT MODEL  
GEAR AVAILABLE.**

**WILL CONSIDER TRADE IN OF ANY  
CURRENT MODEL GEAR.**

**Computer Interfaces**

- Icom and Yaesu \$75
- Mobile Kit IC706 (NEW) \$85

Freight to anywhere in VK / ZL

**ORDER ONLINE AT  
WWW.VK3AJJ.COM**

<http://www.hamsearch.com>  
a not-for-profit site that is a search engine for hams

**AMIDON FERROMAGNETIC CORES**  
For all RF/electronic applications.  
See our website for complete data on all cores including prices.

[www.catchnet.com.au/~rjandusimports](http://www.catchnet.com.au/~rjandusimports)

**RJ & US Imports**  
PO Box 431, Kiama NSW 2533.  
A 3.5" PC disk containing all data is available for \$5.00 incl. post.

**Agencies**  
Active Electronics, Tas  
TTS Systems, Tyabb (VIC)  
Tower Communications, Perth  
Ozhelp Services, Brisbane

**ADVERTISERS INDEX**

Andrews .....	16	G & C.....	36
Benelec .....	IFC	Icom .....	OBC
Bushcomm .....	23	Ozgear .....	22
Com-an-tena .....	17	Radio School .....	47
Computer Interface .....	54	TTS.....	29
Emtron.....	9	54s.....	28, 55

**"Hey, Old Timer..."**



**If you have been licensed for more than 25 years you are invited to join the**

**Radio Amateurs  
Old Timers Club  
Australia**

or if you have been licensed for **less than 25 but more than ten years**, you are invited to become an **Associate Member** of the RAOTC.

In either case a **\$5.00** joining fee plus **\$8.00** for one year or **\$15.00** for two years gets you two interesting OTN Journals a year plus good fellowship.

Write to  
RAOTC,  
PO Box 1100  
Sandringham VIC 3191  
or call Arthur VK3VQ on 03 9598 4262 or Bill VK3BR on 03 9584 9512, or email to raotc@raotc.org.au for an application form.

**JACKSON BROS  
JACKSON OF THE UK IS TICK**

Highest quality products made by UK craftsmen  
Full range now off-the-shelf in Australia.  
Variable and trimmer capacitors, reduction drives, dials, ceramic standoffs

**CATALOGUES, PRICE LISTS AVAILABLE**

**CHARLES I COOKSON PTY LTD**  
11-13 Port Rd  
Queenstown SA 5014

Tel: (08) 8240 3200 Fax: (08) 8240 3233  
FreeFax 1800 673355 within Australia  
Email: jackson@homeplanet.com.au

**ALL MAJOR CREDIT CARDS ACCEPTED  
SOLE AGENTS AUSTRALIA AND NEW ZEALAND**

**HF, VHF, UHF ANTENNAS  
& ACCESSORIES**

Aluminium towers, guys etc  
Diamond VSWR/PWR meters.  
HD copper antenna wire & insulators,  
TX tubes & pwr transistors, Create Rotators

Quality coax cables & connectors. Free advice & catalogue.

**ATN Antennas**  
Ph 03 5492 2224 Fax 03 5492 2666,  
email atnant@iinet.net.au  
PO Box 80, Birchip Vic 3483



# Directory

## The Amateur Service:

a radio communications service for the purpose of self training, intercommunication and technical investigation carried out by amateurs, that is, by duly authorised persons interested in radio technique with a personal aim and without any pecuniary interest. 1.56 ITU Radio Regulations.

The Wireless Institute of Australia represents the interests of all amateurs throughout Australia.

WIA membership fees are: ★ \$ 75 for full members ( F grade ), ★ \$ 70 for pensioners and students ( G and S grade), and ★ \$ 50 for membership without 'Amateur Radio' ( X grade ). Payment direct to National office.

National Office	Contact	News Bulletin Schedule
10/229 Balaclava Road, Caulfield North VIC 3161, Australia	Phone 03 9528 5962, Fax 03 9523 8191, 10am to 4pm daily, nationaloffice@wia.org, www.wia.org	Subject to change see <a href="http://www.wia.org">www.wia.org</a> , follow national news prompts. Contact <a href="mailto:nationalnews@wia.org.au">nationalnews@wia.org.au</a> , National VK1WIA news is distributed to all states.

Advisory Committees	Contact	News Bulletin Schedule
<b>VK1 Australian Capital Territory</b>  VK1WX Alan Hawse VK1ZPL Phil Longworth VK1ET John Woolner	<a href="mailto:secretary@vk1.wia.ampr.org">secretary@vk1.wia.ampr.org</a>	Sundays at 11.00 am VK1WIA 7.128, 146.950, 438.050 Tuesday at 8.0pm 146.750, 147.375, 438.025
<b>VK2 To be advised</b>		
<b>VK3 Victoria</b>  VK3JJB John Brown VK3PC Jim Linton VK3APO Peter Mill	Phone 03 9885 9261 <a href="mailto:advisory@wiavic.org.au">advisory@wiavic.org.au</a>	VK1WIA Sunday 11.0am via HF and major VHF / UHF rpters
<b>VK4 Queensland</b>  VK4ERM Ewan McLeod VK4ZZ Gavin Reibelt VK4KF Ken Fuller	Phone 07 3221 9377 <a href="mailto:qac@wia.org.au">qac@wia.org.au</a>  <a href="mailto:ewan.mcleod@bigpond.com">ewan.mcleod@bigpond.com</a>	VK1WIA, Sunday 9.0am via HF and major VHF/UHF rpters
<b>VK5 South Australia and Northern Territory</b>  VK5NB Jim McLachlan VK5APR Peter Reichelt VK5ATQ Trevor Quick	Phone 08 8294 2992  <a href="mailto:jimac@picknowl.com.au">jimac@picknowl.com.au</a> <a href="mailto:peter.reichelt@bigpond.com">peter.reichelt@bigpond.com</a> <a href="mailto:vk5atq@charlot.net.au">vk5atq@charlot.net.au</a>	VK5WI: 1843 kHz AM, 3.550 MHz LSB, 7.095 AM, 14.175 USB, 28.470 USB, 53.100 FM, 147.000 FM Adelaide, 146.800 FM Mildura, 146.900 FM South East, 146.925 FM Central North, 438.475 FM Adelaide North, ATV Ch 35 579.250 Adelaide. (NT) 3.555 LSB, 7.065 LSB, 10.125 USB, 146.700 FM, 0900 hrs Sunday. The repeat of the broadcast occurs Monday Nights at 1930hrs on 3585kHz and 146.675 MHz FM. The broadcast is available in 'Realaudio' format from the website at <a href="http://www.sant.wia.org.au">www.sant.wia.org.au</a> Broadcast Page area.

<b>VK6 Western Australia</b>  VK6NE Neil Penfold VK6XV Roy Watkins VK6KZ Wally Howse	Phone 08 9351 8873 <a href="mailto:vk6council@iinet.net.au">vk6council@iinet.net.au</a>  <a href="mailto:vk6ne@upnaway.com">vk6ne@upnaway.com</a> <a href="mailto:vk6xv@bigpond.net.au">vk6xv@bigpond.net.au</a> <a href="mailto:vk6kz@bigpond.com">vk6kz@bigpond.com</a>	VK1WIA Sunday 9.0am via WIA network
<b>VK7 Tasmania</b>  VK7ZAX Phil Corby VK7DG Dale Barnes VK7KK Reg Emmett	Phone 03 6234 3553  <a href="mailto:phil.corby@tassie.net.au">phil.corby@tassie.net.au</a> <a href="mailto:vk7dg@wia.org.au">vk7dg@wia.org.au</a> <a href="mailto:regemm@ozemail.com.au">regemm@ozemail.com.au</a>	VK1WIA via Tony, VK7AX 8.55am

### Notes

1. Only three members of the state advisory committees are listed.
2. All listings are preliminary. They will be updated each month as required.
3. Membership application forms are available from the WIA web site [www.wia.org.au](http://www.wia.org.au) or the national office address above.

# Amateur radio helps a nation rebuild

Sam Voron VK2BVS/ 600A  
Email: svoron@hotmail.com



Radio Galkayo Amateur Radio Club at the Community radio station. Both its director 600XJ Hassan Mohamed Jamma and assistant director 600MY Mohamed Yasin Isak are amateurs from the 1993 ham radio course. The photo was taken on 18 August 2004 at the 11th anniversary party of Radio Galkayo in Somalia.

**Amateur radio's unique ability to teach radio communications, electronics and volunteerism skills to anyone interested in gaining knowledge that can Help All Mankind and woMankind (Ham Radio) was especially helpful when the national Government of Somalia collapsed and communities had to look after themselves.**

The first Somali students of the 1993 and 1994 amateur radio license qualifying course conducted by Sam Voron VK2BVS of Sydney, Australia have shown their ham spirit, using their knowledge to help the people in their distressed country and launching the only non political radio at that time called Radio Free Somalia, a community radio station free for all the people to use. That radio today is known as Radio Galkayo and operates on 6.980 MHz AM on short wave and 79.5 MHz FM.



600N Adan Nur Mohamud, Radio Daljir director holding the Microphone.

## The Radio Galkayo amateur radio club in Somalia



600A, 601A Sam Voron VK2BVS, Radio technician at Radio Galkayo and Radio Daljir using a home made Morse code key. Either side are the two technicians in training at Radio Daljir. key made from a reset button glued to a rubber foot and mounted on a plastic box.

Local authorities honoured their promise over that 11-year period to keep the radio free, independent and community based. In return the International community have continued to provide the equipment to keep the short wave radio station on air.

In 1994 Amateur Radio Operator Bill Main VK6ZX working with Rotary in Boulder, Western Australia and Australian Government aid was able to upgrade the original equipment that was donated in 1993 by Sam VK2BVS.

Bill VK6ZX at Rotary and Sam VK2BVS has since donated equipment over the 11-year period to keep Radio Galkayo on the air.

# ICOM'S GREAT CHAMPIONS



**NEW**

**ICOM FLAGSHIP TRANSCEIVER**

## IC-7800 HF\*6m

- Four 32-bit floating point DSP units
- -40dBm ultra high intercept point
- Automatic tracking pre-selector
- Two completely independent receiver circuits
- 200W output power at full duty
- Ultra high frequency stability
- 7-inch wide color TFT LCD
- Multi function spectrum scope
- RTTY / PSK31 operation without PC connection
- Professional 6m receiver
- Digital Voice Recorder
- CF memory card
- Morse Free Package.



## IC-T90A A new 5W Triband handheld

VHF/UHF FM 2M, 6M, & 70CM  
Wideband receive 495 KHz - 1 GHz  
555 Alphanumeric memories • 13 Scan modes DTCS & CTCSS encode & decode DTMF encoder (10 memories) Wide/narrow transmit capability.



## IC-2720H The new dual band FM Transceiver

- 2M / 70CM
- Remote head operation
- Dual VFO with independent control for each band
- 212 Memory channels
- Wideband receiver
- CTCSS & DTCS encode & decode
- 9600 bps packet operation
- Standard HM133 remote control microphone



## IC-208H 2m FM Dual Band Transceiver

- Dual Band Features at a Single Band Price
- 55W / 2m, 50W / 70cm
- Built-in CTCSS and DTCS Tone Squelch Detachable Front Panel (Req. OPC-600/601 Option)
- 9600 bps Packet Operation
- 512 Memory Channel
- Standard Mic. Supplied:HM133.



## IC-706MKIIG HF • VHF UHF

**The amazing evolution of the legendary 706.**

- Now includes 70cm @ 20W and 50W on 2m
- Standard feature dsp
- Built in sub tone encoder & decoder
- Tone scan
- Mosfet PA
- You get base station performance and features in a mobile rig sized package
- Morse Free Package



## IC-7400

**NO FILTERS REQUIRED**

- Sharp & soft IF filter shape
- 100W HF /6m /2m
- Digital twin PBT
- DSP
- SSB / CW synchronous tuning
- Built in antenna tuner
- RTTY demod / decoder
- Digital RF speech processor
- Microphone equaliser
- Morse Free Package.

**ICOM**  
**2 YR WARRANTY**

find your nearest ICOM dealer at  
[www.icom.net.au](http://www.icom.net.au) or (03) 9387 0666



# Amateur Radio



**A  
Solution!**



**plus**

- Experiments with 'across-the-boom' dipoles  
*Part 2 of Bob Slutzkin VK3SK's article*
- A versatile battery box  
*Dale Hughes VK2DSH*
- VK5BR\_X antenna  
*Lloyd Butler VK5BR*
- Getting broadband ADSL  
*Will McGhie*

## Measuring current without burn-out

**Drew Diamond VK3XU explains how**

**Special!**

*Beginners' project:*  
**Simple battery  
chargers**

*Bill Toussaint VK6LT*

ISSN 0002-6859



# BENELEC



# YAESU



## FT-847



### Multi-Mode HF/VHF/UHF Satellite Transceiver

- Full Duplex Satellite Operation
- 160-6m / 2m / 70cm
- 100W, 50W, 20W

Price \$ 3,713.20

## FT-897D



### Now includes TCX0-9 Built-in

- Portable / Mobile / Base All Mode Txr
- 160-10m / 6m / 2m / 70cm
- 100W, 100W, 50W, 20W

Price \$ 1,734.50

Does Your Radio Need Repair?  
- We FIX ALL Radio Brands!

[www.benelec.com.au/yaesu/yaesu.htm](http://www.benelec.com.au/yaesu/yaesu.htm)

Ideal Antenna:

ATAS 25 / ATAS120 / Comet UHV6

## FT-857D



### Now includes DSP2 unit built-in

- Ultra Compact + All Mode Transceiver
- 160-10m / 6m / 2m / 70cm
- 100W, 100W, 50W, 20W

Price \$ 1,628.30

Ideal Antenna:

ATAS 25 / ATAS120 / Comet UHV6

## FT-8900



### Quad Band FM Mobile

- 29 / 50 / 144 / 430 MHz Quad Bander
- V+U Full Duplex Operation
- High Power 50 W and Heavy Duty PDA
- 50 Tone CTCSS / 104-Code DCS Tone Systems
- Huge 800 Ch memory Capacity

Price \$ 924.40

Ideal Antenna: Comet UHV4

## FT-7800



### 2m / 70cm Dual Band

### FM Transceiver

- High Power Output
- Wide Receiver Coverage
- Five One-Touch "Hyper Memory"
- Over 1000 Memory Channels
- WiRES Internet linking Compatibility

Price \$ 553.80

Ideal Antenna:

Comet SBB5 / CHL 250H  
SB15

## FT-817ND



### Now includes FNB72 Internal Battery

- Ultra Compact 135 x 38 x 165mm
- All Mode Portable Transceiver
- 160 - 10m / 6m / 2m / 70cm
- 0.5-5 Watts Selectable

Price \$ 1,334.00

## VX-2



Price \$385.40

## FT-60R



Price \$399.00

## VX-5



Price \$710.90

## VX-7



Price \$778.20

# [www.benelec.com.au](http://www.benelec.com.au)

## Authorised Yaesu Retailers

All Price includes GST

### NSW

Andrews Communications Systems  
Tel: 02 9636 9060 [lee.andrews1@bigpond.com](mailto:lee.andrews1@bigpond.com)

Newcastle Pro Sound & Communications  
Tel: 02 4965 6899 [sales@newcastleprosund.com.au](mailto:sales@newcastleprosund.com.au)

Action Communications  
Tel: 02 4732 2788 [action@pnc.com.au](mailto:action@pnc.com.au)

### VIC

Strictly Ham P/L  
Tel: 03 9729 7656  
[sales@strictlyham.com.au](mailto:sales@strictlyham.com.au)

G & C Communications  
Tel: 03 5996 3298  
[gccomm@netspace.net.au](mailto:gccomm@netspace.net.au)

### QLD

Kyle Communications  
Tel: 07 3857 4400  
[mark@kyle.com.au](mailto:mark@kyle.com.au)

SA/NT:  
POSSNAV Systems P/L  
Tel: 08 8342 4700  
[brenton@posnav.com.au](mailto:brenton@posnav.com.au)





# Amateur Radio

Volume 72, Number 11  
November 2004

The Journal of the Wireless  
Institute of Australia  
ISSN 0002-6859

## Editorial

Editor: Colwyn Low VK5UE  
edarmag@chariot.net.au

Technical Editor: Peter Gibson VK3AZL

Publications Committee Members  
Brenda Edmonds VK3KT  
Ron Fisher VK3OM  
Don Jackson VK3DBB  
Evan Jarman VK3ANI  
Tom Potter VK3UBS  
Bill Roper VK3BR

## Submission of material to Amateur Radio Magazine

General and Technical articles to Secretary  
AR Publications Committee  
3 Tamar Court  
Mentone VIC 3194  
or armag@optusnet.com.au

Columns and Letters to the Editor to Editor  
AR Magazine  
34 Hawker Crescent  
Elizabeth East SA 5112  
or edarmag@chariot.net.au  
(Tel and Fax 08 8255 2138)

Hamads to "Hamads" Newsletters Unlimited  
PO Box 431  
Monbulk VIC 3793  
Fax 03 9756 7031  
newunltd@bigpond.net.au

Advertising  
All enquiries to Newsletters Unlimited  
PO Box 431  
Monbulk Vic 3793  
Phone: 03 9756 7797  
Fax: 03 9756 7031  
newunltd@bigpond.net.au

Registered Office  
10/229 Balaclava Road,  
Caulfield North VIC 3161  
Australia  
Phone: 03 9528 5962

## Production Deadlines

Advertising booking and articles for publication 10th of preceding month.

Hamads and advertising material deadline 18th day of preceding month

The contents of Amateur Radio are Copyright  
Wireless Institute of Australia © 2004

## GENERAL

Well It might come in handy.....	19
<i>Joe Rotenberg VK3BBN</i>	
'Ripple from the South' in his 100th year.....	20
<i>Jim Linton VK3PC</i>	
Getting broadband ADSL.....	22
<i>Will McGhie</i>	
Wireless Institute of Australia Central Region Technical Symposium.....	24
<i>John Dawes VK5BJE</i>	
My saltwater antenna.....	25
<i>John Tilmuss VK4JWT</i>	
A "secure computer": an oxymoron? .....	26
<i>Bill Isdale VK4TWI</i>	
Surviving the Cabrillo contest log format.....	42
<i>Vince Henderson VK7VH</i>	
Still the Sun.....	49
<i>Bill Isdale VK4TWI</i>	
Where to buy your Callbook 2005.....	55, 56

## TECHNICAL

RF ammeters for high-frequency measurements .....	5
<i>Drew Diamond VK3XU</i>	
A dummy load for 'dummies' .....	9
<i>Jack C. Laib VK6CTL</i>	
The 204BA, a 4-element 20 metre beam plus a rotatable 40-cum-30 metre dipole. Part 2: Experiments with 'across-the-boom' dipoles .....	10
<i>Bob Slutzkin VK3SK</i>	
A versatile battery box .....	12
<i>Dale Hughes VK2DSH</i>	
Simple battery chargers .....	13
<i>(Dr) Bill Toussaint VK6LT</i>	
VK5BR_X antenna .....	15
<i>Lloyd Butler VK5BR</i>	
Technical Abstracts.....	28
<i>Peter Gibson VK3AZL</i>	
The sleeve dipole .....	28
Dual band dipole for 2m and 70cm.....	29
Simple sound-card-to-radio interface circuits - addendum .....	29

## COLUMNS

ALARA.....	36	Silent Keys.....	9, 29, 32,37
AMSAT.....	38	Spotlight on SWLing .....	34
Contests .....	41	State News .....	30
Club News .....	33	VK1 News .....	30
Directory..... (held over for November)		VK6 News .....	30
Editorial Comment.....	2	VK7 News .....	31
Gridsquare standings .....	40	Technical Abstracts.....	28
Hamads .....	54	VHF/UHF - An Expanding World.....	46
HF Predictions .....	52	WIA comment.....	3
Over to you.....	45	WIA News .....	4

## Our Cover this month

The traditional instrument for measuring RF current, the thermo-couple ammeter, is notorious for being easily burned-out, so that intact used meters are now very scarce on the second-hand market. Drew Diamond VK3XU proposes a solution. Page 5.

### Contributions to Amateur Radio

Amateur Radio is a forum for WIA members' amateur radio experiments, experiences opinions and news. Manuscripts with drawings and or photos are always welcome and will be considered for publication. Articles on disc or email are especially welcome. The WIA cannot be responsible for loss or damage to any material. A pamphlet, How to write for Amateur Radio is available from the National Office on receipt of a stamped self-addressed envelope.

### Back Issues

Back issues are available directly from the WIA National

Office (until stocks are exhausted), at \$4.00 each (including postage within Australia) to members.

### Photostat copies

When back issues are no longer available, photocopies of articles are available to members at \$2.50 each (plus an additional \$2 for each additional issue in which the article appears).

### Disclaimer

The opinions expressed in this publication do not necessarily reflect the official view of the WIA and the WIA cannot be held responsible for incorrect information published.

## Amateur Radio Service

A radiocommunication service for the purpose of self-training, intercommunication and technical investigation carried out by amateurs; that is, by duly authorised persons interested in radio technique solely with a personal aim and without pecuniary interest.

## Wireless Institute of Australia

The world's first and oldest  
National Radio Society

Founded 1910

Representing

The Australian Amateur Radio Service

Member of the

International Amateur Radio Union

Registered Office of the WIA

10/229 Balaclava Road, Caulfield North Vic 3161

Tel: (03) 9528 5962 Fax (03) 9523 8191

email: nationaloffice@wia.org.au

http://www.wia.org.au

All mail to

PO Box 2175 Caulfield Junction VIC 3161

Business hours: 10am - 4pm weekdays

### National Office staff

June Fox	Office Coordinator
Emma Trebilco	Examinations Officer
Brenda Edmonds	Office Assistant

### Board of Directors

President	Michael Owen	VK3KI
Vice President	Ernie Hocking	VK1LK
	Glenn Dunstan	VK4DU
	Trevor Quick	VK5ATQ
	Ewan Mcleod	VK4ERM
	Ted Thrift	VK2ARA
	Phil Wait	VK2DKN
Secretary	Peter Naish	VK2BPN
Treasurer	David Pilley	VK2AYD

### Coordinators

AMSAT	Graham Ratcliff	VK5AGR
ARDF	Jack Bramham	VK3WWW
Awards	Mal Johnson	VK6LC
Contests	Ian Godsil	VK3JS
John Moyle Memorial		
FD Manager	Denis Johnstone	VK3ZUX
Editor "AR"	Colwyn Low	VK5UE
Education	Ron Smith	VK4AGS
EMC/EMR	Gilbert Hughes	VK1GH
	Keith Malcolm	VK1ZKM
Standards	Gilbert Hughes	VK1GH
	Peter Naish	VK2BPN
	John Martin	VK3KWA
FTAC	t.b.a.	
Historian	Neil Penfold	VK6NE
IARU Region 3		
Liaison Officer		
Intruder Watch	t.b.a.	
International	John Miller	VK3DJM
Travel Host		
ITU Conference and study group	Gilbert Hughes	VK1GH
	David Wardlaw	VK3ADW
	Keith Malcolm	VK1ZKM
QSL Curator	Ken Matchett	VK3TL
QSL Manager (VK9/0)	Neil Penfold	VK6NE
Videotapes Curator	VK2 Division	
Webpage co-ordinator	John Thompson	VK2TRC
WICEN	John Weir	VK3ZR

### ACA Liaison Team

Peter Naish VK2BPN,	Peter Mill VK3APO
Gilbert Hughes VK1GH	Glen Dunstan VK4DU
Keith Malcolm VK1ZKM	

# Editorial comment

Colwyn Low VK5UE

Apologies to Sam Vernon 600A ie six oscar zero alpha, I got his call sign completely incorrect in last month's editorial. However it was correct on the inside back cover.

## New WIA

News from the WIA continues to stream from the web site [www.wia.org.au](http://www.wia.org.au) and from WIANews. This emphasises the fact that the WIA is continually working for amateur radio in Australia and for amateurs. The DEFCOM discount card should provide all members with the opportunity to purchase material at good prices. Remember the scheme has been working well in Queensland where the old Queensland Division of the WIA set it up. Amateurs have access to DEFCOM through WICEN, as it is an emergency service.

## JOTA

JOTA will be over when you read this. I hope all of you who were able to help had an enjoyable time and that some Guides and Scouts got a deeper insight into what amateur radio has to offer as a hobby and possibly a lifetime career.

## Field Days and WICEN

The Spring VHF-UHF Field Day is down for 6-7th November this year and the Summer Field Day will be held on the last week end of the Ross Hull VHF Contest 22-23 January-2005. These Field days present a number of challenges to amateur operators. First in collecting the equipment for the chosen bands, transceivers, aerials and power supplies. Then taking them to the chosen location setting the station up and operating for 6 or 24 hours. There are also decisions to be made about food and its preparation

and when and where to sleep. As I write this bushfires are burning in Queensland and New South Wales and it is highly likely that WICEN has already been activated to provide assistance to the firefighting operations. Field day operations help us be prepared to take our equipment out into these emergency situations to provide prompt support to our communities. They also of course provide a lot of fun, satisfaction and learning opportunities.

## Aerials

In these days of solid state and miniaturisation, one of the main fields for homebrew amateur equipment is aerials. I hope to publish several articles on aerials in the December issue of AR, which will have 64 inside pages. Some of Rob Gurr's articles on wire aerials will be part of this aerial issue. Simple wire aerials do a great job and for most Field Day operations they are the aerial of choice. I hope that by now young Hayden Honeywood VK7HAY (October AR) has his aerial set up and working and that he has learnt a little radio lore in the process. It is always very difficult to get started if you do not have some basic equipment and some mentoring.

## Improving AR

Finally an OTU letter comments on the magazine content. The magazine material is all voluntarily submitted and vetted as suitable and technically correct. I as editor have to accept responsibility for the selection of material in each issue. Sorry it does not meet with everyone's approval every issue.

Well that is all for this month.

73 Colwyn VK5UE.

## ADVERTISERS INDEX

Andrews .....	35	G & C.....	17
Australian Enterprises International .....	48	Icom.....	OBC
Benelec.....	IFC	Ozgear .....	21
Bushcomm.....	20	TTS.....	29
Com-an-tena.....	29	VK Discount Cables .....	34
Computer Interface.....	44	54s .....	29, 54
TET-Emtron .....	16		



## WIA renewal continues

In the September Amateur Radio WIA Comment "Clearing the air" I referred to the assertion that nobody is remaining a member of the WIA, and talked a little about the membership position. Basically I was saying that while no alarming trend was emerging, it was really too soon to tell.

I think that we can say something now.

The number of members renewing is hard to measure at any particular point of time. The figure tends to be understated as it includes the members renewing whose subscription has only just fallen due.

However, I can say that as at 15 October 2004 the total membership of the WIA was 2,220. That includes all Provisional Members (that is, people who were members of a Division on 16 May 2004) whose subscription has fallen due after 1 July 2004 and who have paid their subscription and so have joined the national WIA, all Honorary Life members who have signed a Consent to Membership and who have thus become Honorary Life Members of the national WIA and all those who have joined the WIA as new members since 16 May 2004.

As at 30 September 2003 the WIA membership was 3,863. To compare like with like, we must add to the 2,220 members today the 1,470 Provisional Members whose subscription is yet to fall due, and so the total membership of the WIA is 3,690.

So, we have to accept that the membership today has 4.47% less today than it was at the same time last year.

Of the 2107 renewal notices for July and August sent out, 1,886 have renewed. That is 89.52% have renewed. The office is still receiving a trickle of one or two renewals per day for these two months.

But what does this tell us?

With a membership of the size of the WIA, and particularly with the age distribution that troubles us so much, a certain number of people will not renew.

Since July this year, 7 of our members have become Silent Keys.

Most people who don't renew will not tell us why. But since July some 8 people have taken the trouble to tell us the reason – mainly health and age.

Last year, the 2003 calendar year, 240 new members joined the WIA.

Since 16 May this year 136 new members have joined the WIA. Based on the number of members currently joining it is expected that without any membership drive initiatives the number of people joining the WIA in the first 12 months will be around 400.

Interestingly, if you took a look at the figures in the VK-Ham site at <http://vk2ca.freepolls.com/cgi-bin/pollresults/007> called "Will you join the National WIA" you will see that on 12 October 329 people had answered the survey.

The results show of those 284 people who were members, 259 will remain with the national WIA and 25 will not join or remain with the state body that will replace the old divisions. This means that based on the figures in the survey we should end up with 90.4% membership renewals. This is very much in line with the 89.52% renewals for July and August and with the estimate made by the team who worked on the vision for the new WIA.

Those people who say they will now join the WIA is 31, that is 9.4% of those replying and very close to the figures currently being achieved without any membership drive.

The conclusion would seem to be that we would end up with approximately the same or slightly less than the membership for the last year of the Federal WIA, if we do nothing more than we are doing now.

But we must do more.

That is why we are trying so hard to tell

you what the WIA is doing. That is why we are adopting new initiatives, such as introducing the DEFCOM discount card – see WIA News. That is why we have visited so many clubs. That is why we are distributing the Callbook through clubs this year – see WIA News.

That is why your help is vital. If you are a member, then please find another member! If you are not a member, please join now!

I know, also, that many demand much of the WIA. And that leads me to a real constraint.

We know that the WIA is financially sound, and we know that we can keep it so, simply because we control the expenditure on a month-to-month basis.

That is not the constraint.

Essentially everything done for the WIA is done on a voluntary basis. Each of us has other commitments. To earn a living. To look after a family. To care for someone who is sick.

Sometimes, other things take priority. When that happens, well, we have to accept that is the nature of volunteers.

While one should not volunteer to do more than can be reasonably achieved, one can expect a degree of understanding when everything cannot be done in

the time we would have liked, and we must all seek to ensure that effort is directed to productive matters and that we are not forever debating the battle plan for the last war.

Or, let me put it another way. I must learn to be more patient with those who have promised but are unable to immediately deliver!

But at least I think that we can say now, nearly 6 months from the start of the new WIA, that we can look to the future with confidence, and that the doomsayers have certainly been proved to be wrong.

**I think that we can say now, nearly 6 months from the start of the new WIA, that we can look to the future with confidence, and that the doomsayers have certainly been proved to be wrong.**

## **FCC acknowledges interference potential as it adopts new rules to allow BPL**

The American Radio Relay League (the ARRL, the US national amateur society) reports as this issue of AR goes to press that the Federal Communications Commission (FCC) has approved revised Part 15 (unlicensed services) rules to specifically regulate the deployment of broadband over power line (BPL) technology.

The Commission adopted a Report and Order in ET Docket 04-37 when it met in open session on 14 October 2004.

At the same time, three members of the Commission, including Chairman Michael K. Powell, specifically mentioned the concerns of Amateur Radio operators at the open meeting and expressed either assurances or hope that the new BPL rules will adequately address interference to licensed services.

The WIA is reviewing the full implications of the US action.

## **ACA clarification**

The Australian Communications Authority (ACA) has drawn our attention to an article 'ACA Changes' in the August, 2004 edition of Amateur Radio.

The ACA notes that the article, while commenting generally about some of the changes to be introduced following the Review of Amateur Service Regulations, states that Foundation licensees would be authorised to use SSB in frequency bands where Standard licensees would not be similarly authorised.

While acknowledging that impression probably stems from wording used in the appendix to the ACA paper 'Outcomes of the Review of Amateur Service Regulation', the ACA says that the impression that should have been conveyed by the appendix was that Standard licensees would be able to use the same emission modes as Foundation licensees as well as the emission modes already permitted under the Novice licence.

The ACA has yet to consider in detail the emission modes that are appropriate

to operation under a Standard licence in frequency bands above 450 MHz.

## **Tasmanian Divisional meeting confirms moves towards the National WIA**

The special general meeting held on Sunday, September 19 at Ross to resolve the future of the Tasmanian Division ratified the VK7 council recommendations. The meeting passed the special resolutions to apply for dissolution of the Division, and to pass the surplus funds to national WIA after deregistration is effected. The Divisional council was duly authorised to dissolve the Branches. The process will now be administrative, to finalise the financial side of the wind up, and within a month apply to Corporate Affairs for deregistration.

Two new clubs have been formed to take the place of the Northern and Southern Branches. These are respectively Northern Tasmanian Amateur Radio and Electronics Group, and Radio and Electronics Association of Southern Tasmania Inc. It is expected that a new club will be formed in the North West of the state in the next twelve months. Both of the new clubs will apply to affiliate with the National WIA.

Phil Corby, Tasmanian Divisional president said he was pleased to see at the meeting many who have been long time members and supporters of the "Institute" as the Tasmanian Division was usually called. He added that he felt that this show of support augurs well for the future for the national WIA.

## **Important amateur radio issues being discussed at meetings in Geneva**

The long journey to the next World Radiocommunications Conference (WRC 07) has started with a meeting of the Working Party 8A of the Radiocommunications Study Groups of the ITU in September 6th to 15th, with two important amateur radio questions under discussion.

The first is an IARU proposal for a new

amateur band from 135.7-137.8 kHz. This proposal is moving forward well, and it appears that there will be support for a new worldwide allocation at the next World Radio Conference in 2007.

The second is a proposal from the short wave broadcasting community for up to 850 kHz more spectrum between 4 and 10 MHz. If approved, the spectrum would have to be given up by other users, namely the fixed service, the mobile service, the amateur radio service and the radio navigation service. There is no solution in sight on this issue.

The same issues, as well as matters related to BPL, will be discussed by other ITU groups in meetings following the WP8A meeting.

The IARU will be represented in all of these meetings.

## **A silent key, Henry Andersson, VK8HA**

The WIA was saddened to learn that Henry Andersson, VK8HA, passed away in Darwin on 6 October 2004.

Henry arrived from Sweden as a Maritime Radio Operator, married and settled down in Darwin, worked for the ABC on the control desks.

Henry was WIA national Intruder Watch Coordinator until he resigned following admission to hospital. He was also the VK8 QSL Bureau for many years, a RTTY operator, and an enthusiastic CW operator

## **WIA seeks new National Intruder Watch coordinator**

Wayne Featherstone VK4ZRT who was to have been appointed WIA National Intruder Watch Coordinator unfortunately is unable to take up the post.

Further details to be advised.

## **WIA cuts a deal on membership discount card**

Several years ago the Queensland Division of the WIA negotiated with an organisation named DEFCON to provide a membership service which provides

*continued on page 23*

# RF ammeters for high-frequency measurements

Drew Diamond VK3XU,  
45 Gatters Road, Wonga Park, 3115.

The experimenting amateur who can easily measure RF current, usually at the station end of an antenna feed-line, can really get a "handle" on what's going on. Unfortunately, the traditional instrument for such measurements, the thermo-couple ammeter is notorious for being easily burned-out, such that intact used meters are now very scarce on the second-hand market.

For any current measurement, connection of the meter must cause as little disturbance as possible. In an alternating-current circuit therefore, the meter's impedance shall be as low as practicable. A technique often used in electrical work at power-line frequencies is to use a "current transformer" (Ref. 1). Typically, a laminated toroidal iron core has a known number of turns wound as a secondary. The current-carrying wire is passed through the opening of the toroid, thus forming the "primary". An alternating voltage will be induced in the secondary winding, and it is a simple matter to diode rectify this voltage and apply the resultant direct current to an ordinary moving coil meter. The same principle may also be applied to HF work.

Offered here are details of an RF ammeter for use in simple coax cable or "single-wire" antenna circuits, and a pair of identical meters for balanced line tests. Measuring range is 0.5 A full-scale deflection (f.s.d) and 5 A f.s.d (but a maximum current of 3 A on the 5 A range), which should cover a wide field of applications, from QRP up to about 450 W in 50  $\Omega$ . Sensitivity is quite flat from less than 1.8 MHz to 30 MHz. Individual calibration is not necessary, the existing linear scale of an ordinary 50 micro amp meter being sufficiently accurate (above about 10 % of f.s.d.) for amateur experiments.

## Circuit

In recent years there have been two or three descriptions of devices for observing RF current (e.g. Ref. 2) using a clamp-on ferrite "braid-breaker" core. These devices only show relative current however and, because the secondary is virtually unloaded, their inclusion in the RF current-carrying circuit may introduce a significant unwanted impedance.

On the other hand, a true current transformer will provide more meaningful measurements, because the secondary winding is loaded with an appropriate resistance (Refs 3, 4 and 5). Some arithmetic

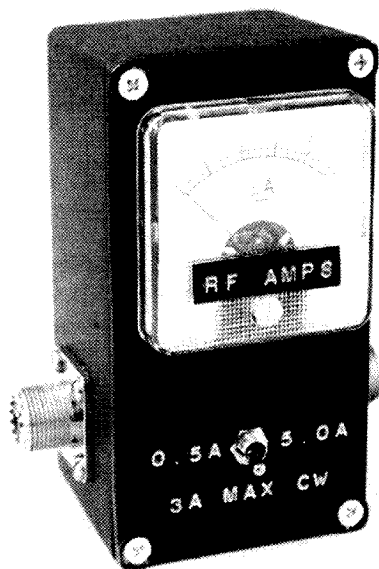

Photo 1 - RF ammeter for coax cable or single-wire line.

serves to illustrate the principle: -

Suppose that we wish to measure RF current up to perhaps 3 A. A ferrite toroidal core has 40 turns of enamelled wound upon it (see Fig. 1). If the current-carrying wire passes once (typically) through the toroid's opening, we have a one-turn primary, giving a turn's ratio of 40 : 1.

In order to obtain a usable voltage from the secondary, a reasonably high load resistor is chosen- but it must not be so high that we do not reflect low impedance back into the primary. A 470  $\Omega$  non-inductive resistor is typically employed (Refs 3 and 4).

Now, if the primary is carrying an RF current of 1 A (1000 mA), then the secondary current will be 1/40th, or 1000 divided by 40 = 25 mA. 25 mA (0.025 A) flowing through 470  $\Omega$  establishes an r.m.s. voltage of  $(E = IR)$ ;  $0.025 \times 470 = 11.75$  Vac. A simple single silicon diode rectifier and filter capacitor will in practice establish a DC potential of about 1.3 times the r.m.s., or  $1.3 \times 11.75 = 15.275$  rounded to 15.3 V.

A readily available meter sensitivity is 50 microamps, and its 0 - 50 scale admirably suits the chosen full-scale

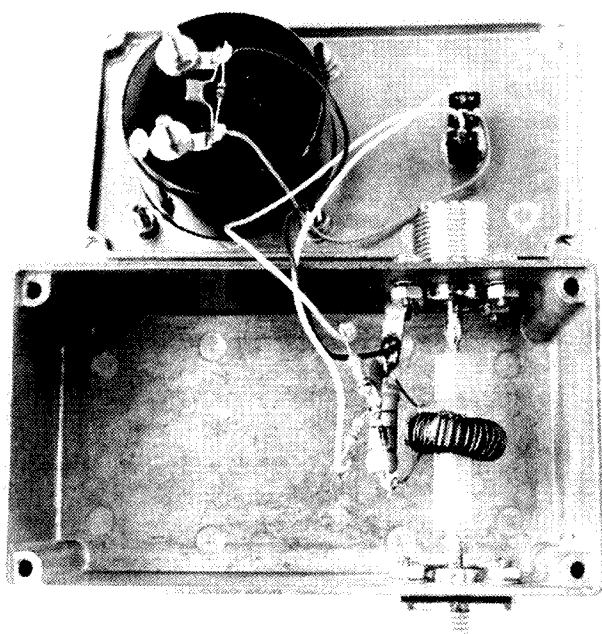

Photo 2 - Single ammeter, internal view.

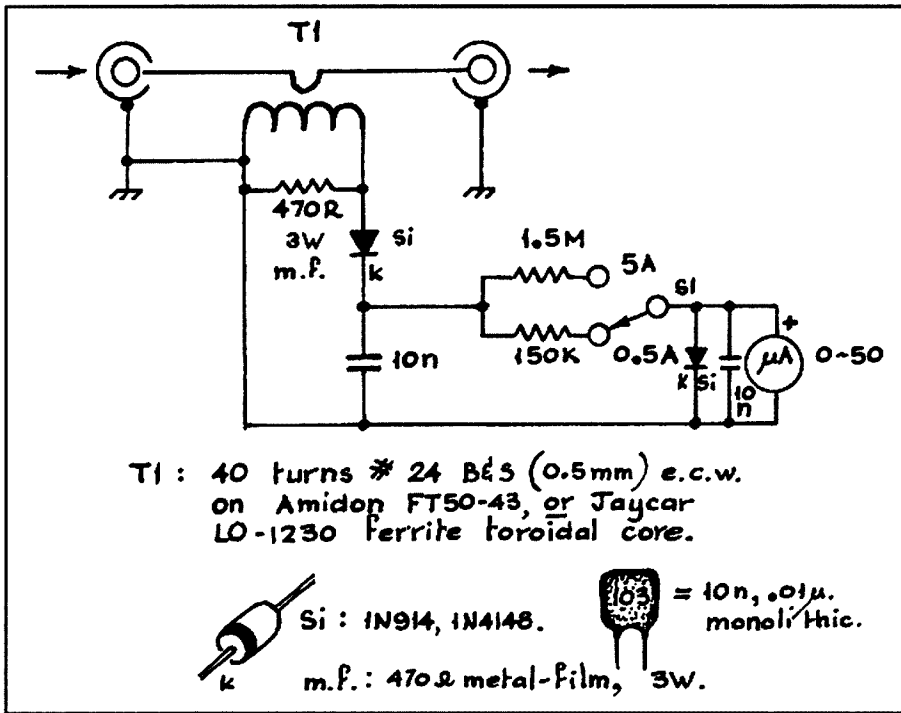

Fig 1 - RF ammeter for coax cable or single-wire line.

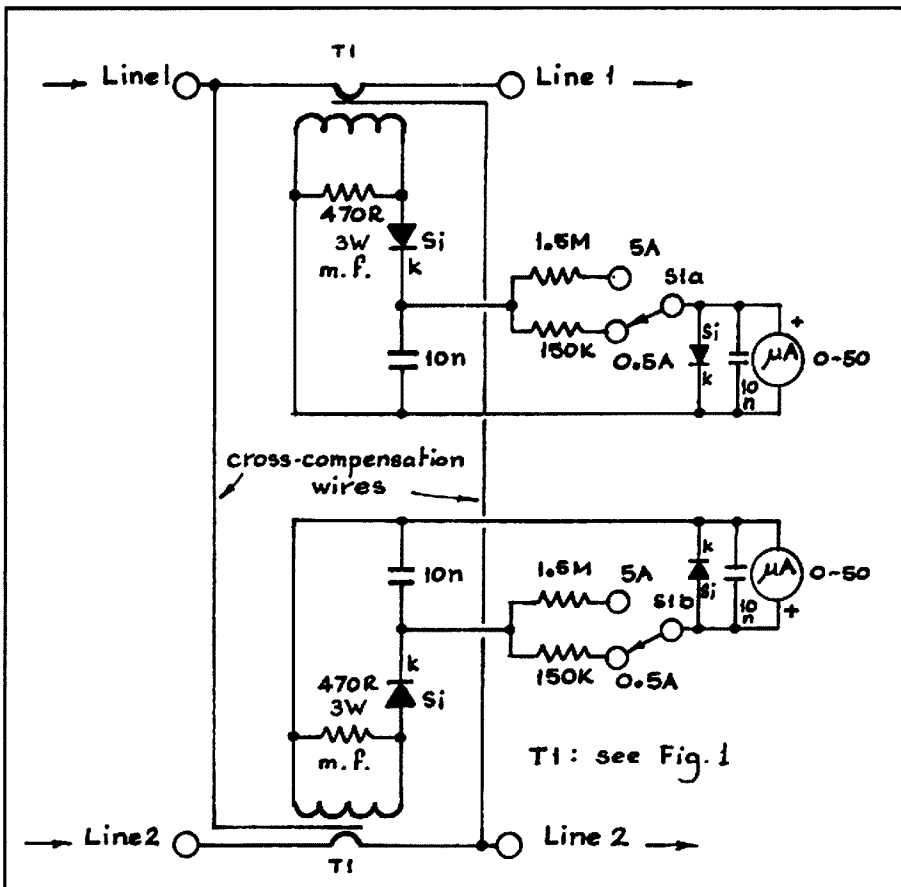

Fig 2 - Twin RF ammeters for balanced line.

ranges of 500 mA and 5 A. On the 5 A range we want a primary current of 1 A to cause 10 μA to flow in the meter's coil. The series "multiplier" resistor will therefore need to be  $(R = E/I)$ ; 15.3 divided by  $10 \times 10^{-6} = 1.53 \text{ M}\Omega$ . In practice, a preferred 1.5 MΩ resistor will suffice. For a full-scale current of 500 mA, the multiplier must be 1/10th that for 5 A; 150 kΩ for the 500 mA f.s. range.

Let's look at the impedance reflected back into the primary line. Impedance transformation is proportional to the square of the turns ratio. Turns ratio squared = 1600. The impedance presented by the "primary" will therefore be 1/1600th that of the load resistor;  $470/1600 = 0.29$  rounded to 0.3 Ω. In practice, it is unlikely that such a low impedance would cause a significant disturbance to the circuit under test.

Shown in Fig 2 is a twin meter pattern for use in tuned or balanced-line antenna work. During development it was found that (due probably to the absence of a ground reference), unequal meter readings were obtained under some conditions of line and antenna load- even though the system was known to be balanced. The asymmetric readings are thought to be caused by stray capacitive coupling between the primary line and the secondary winding. A Faraday screen between primary and secondary is the usual remedy, but there may typically be no convenient true RF ground for earthing the screens. A simple and effective solution is to cross-compensate the two circuits by connecting a wire, inserted just under the winding of each core, thus injecting a cancelling voltage into the opposite winding.

A second silicon diode is shunted across the meter's coil in an attempt to prevent gross overload from damaging the meter's coil. A capacitor is connected across the diode to prevent secondary RF rectification, which would cause serious errors in reading.

## Construction

A die-cast or aluminium housing is suggested for the single meter. That shown in Photo 1 measures 111 x 60 x 54 mm. A coax socket is fitted upon each side of the box. A suggested parts layout is illustrated in Photo 2.

My twin meter for balanced-line work is housed in a plastic "jiffy" box

measuring 130 x 67 x 34 mm (Photo 3). Pair of binding post terminals, or banana sockets, spaced 3/4" (an instrumentation standard) are fitted upon each side as shown. A suggested internal layout is illustrated in Photo 4.

Toroidal core(s); Amidon FT50-43, or a Jaycar LO-1230 is/are wound with 40 turns of #24 B&S (0.5 mm) enamelled copper, close-spaced evenly around the core.

Our "primary" line(s) may simply comprise a length of RG-8 coax inner, which is a snug fit inside the LO-1230 core opening. The 470Ω 3 W metal-film resistor(s), diode(s) and 10 nF ceramic (or monolithic) capacitor(s) are soldered together using reasonably short lead lengths. Connections to the range switch and meter(s) may be made with ordinary hook-up wire.

Note the cross-compensation for the twin meters, comprising thin insulated hook-up wires which are soldered to one terminal then poked into the opposite toroid opening at the mid-point of the winding, so that the wire is captive between the core and the RG-8 inner.

## Operation

To check operation and basic accuracy of the single meter; connect the meter "in-line" between your transmitter and a known accurate dummy load/power meter. Power is calculated from the formula

$$P = I^2R$$

$$\text{And consequently } I = \sqrt{\frac{P}{R}}$$

Conversely, knowing P and R, then

Using a 50 Ω resistive load, and depending on power capability; switch to either 500 mA- where a 12.5 W CW signal will result in 500 mA current flow, or the 5 A f.s.d. range, where (say) 50 W will cause 1 A to flow, 100 W gives 1.4 A, 2 A is 200 W and so on. Note that the maximum continuous current that may be applied is 3 A. Higher currents, up to 5 A must naturally have a proportionately shorter duty-cycle.

To test the twin meter, we need a "balanced" load, which may comprise a 50 Ω resistor made from (say) 20 x 1 kΩ 3 W metal-film resistors connected in parallel (60 W CW). A 1:1 balun must be interposed between the transmitter's output and the meter, and the meter is "terminated" between Line 1 and Line 2 with the 50 Ω resistor. Assuming negligible loss in the balun, for a 100 W CW signal, each meter should indicate 1.4 A.

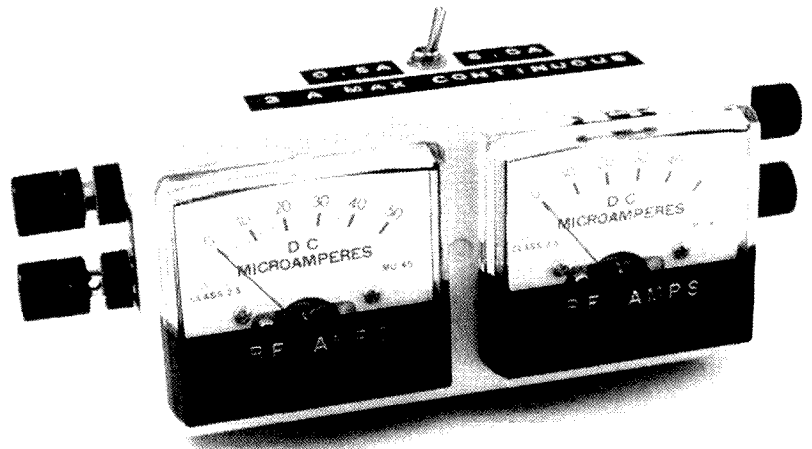

Photo 3 - Twin RF ammeters for balanced line.

## Summary

It is often of great advantage for an amateur to know how much RF current is flowing in various parts of an antenna system, particularly along the feed-line of "balanced" and "single-wire" lines. Unfortunately, because they are so easily burned-out, good thermo-couple ammeters- the traditional instrument for measuring high-frequency currents are now very rare items.

Offered are details of RF current meters, made from ordinary parts, for single-line (or coaxial) and balanced-line work, which employ the "current transformer" method to obtain quite accurate and repeatable RF current readings at amateur power levels in the 1.8 to 30 MHz range.

## Parts

All of the ordinary components are available from our usual electronics component suppliers. The die-cast box may be a Jaycar HB 5063 or similar. The "jiffy" box is HB 6023. The toroid(s) may be Jaycar LO 1230 (pack of 6 cores

for about \$2) or the smaller Amidon FT50-43. Metal-film 3 W resistors may be obtained from Electronic World (ph 03 9723 3860- will answer mail orders) and suppliers to the TV service trade. S1 in the single meter is a miniature S.P.D.T., and a D.P.D.T. (S1a and S1b) for the twin meter.

## References and further reading

1. Electrical Technology; Edward Hughes, 4th Ed., pp 419, 420. Published by Longman Group.
2. "The 'JS Snap-on RF Current Probe"; Jim Smith, VK9NS, Rad Com, June '95
3. "Current Transformers and RF Measurement"; Dennis Walker, G3OLM, Rad Com, Nov. '95, p70.
4. Backyard Antennas; Peter Dodd, G3LDO, pp 184, 185. Published by the RSGB.
5. "A High Power RF Attenuator"; Ron Sanders, VK2WB, AR, Mar. 2004, pp 11,12.

ar

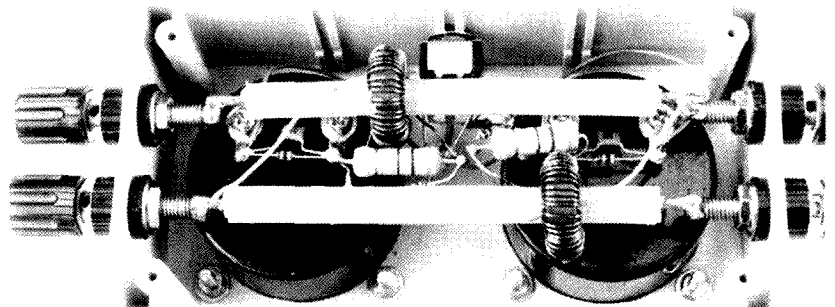

Photo 4 - Twin RF ammeters, internal view.

# 450 Ohm Ladder Line

Copper coated 7 core steel conductors

VERY LOW LOSS



Check us out for all RF cables and connectors.

## TEN-TEC HF Radios

Orion  
Jupiter  
& Argonaut  
HF Transceivers

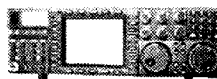

Ten Tec  
Commercial &  
Professional  
Communications  
Receivers



## SGC



SGC 2020 Portable  
20W HF Transceiver  
SG 500 HF Mobile  
500W Power

SGC2000 150W  
Professional HF  
Transceiver

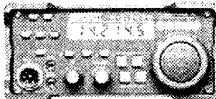

## TEN-TEC

build  
yourself  
kits

(Call for your free  
catalog)

Amidon Iron Powder and Ferrite Products (Call for an Amidon product guide)

SGC ADSP<sup>2</sup> Noise Reduction Speakers

SGC ADSP<sup>2</sup> Noise Reduction Boards (High power and low power versions available)

Power Source switch mode power supplies (a wide range of outputs)

Davis Weather Stations

Professional Grade Coax Feed lines and Connectors

Custom RF Patch leads and cables made to order

## High Power Variable Inductor

from Ten-Tec.

Silver Plated Coil, Max Inductance is 20 microHenry.

An ideal companion to the Ten-Tec variable capacitor kit.

Perfect for that high power antenna tuner project

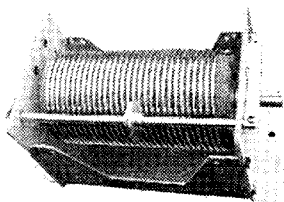

## Antenna Couplers/Tuners

SGC Mac 200

5 Position Antenna

Switch/Tuner

SGC SG235,

SG230,

SG237, SG239

and SG211

Automatic Antenna Couplers

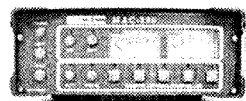

Z100

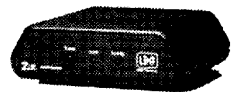

## Antenna

SGC QMS Quick Mount  
Mobile antenna system  
with built-in tuner



SGC Stealth

Kit. All you need to get  
HF on air quickly.



SGC SG

307 7

foot Mobile/Marine  
Antenna

SGC SG 303 9 foot Mobile Antenna

## RE-SELLERS

Tower Communications, Perth

International Communications  
Supplies, Port Adelaide

Strictly Ham, Melbourne

Marcom Watson Group (Tas)

Kyle Comms (QLD)

Ozhelph Services — (QLD)

Brian Swinton Marine Elect. Cairns

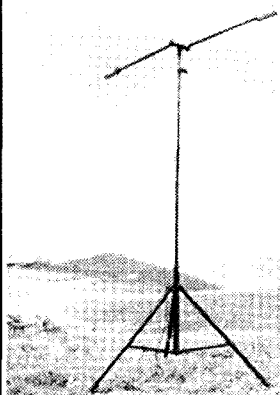

## Buddipole A Complete Portable Antenna System

- The Buddipole Antenna (9 bands, 2 - 40 meters)
- Tripod - extendable legs and locking base
- Portable Mast - extends to 8' in height
- Rotating Arm Kit - change configurations
- Antenna System Bag - padded cordura nylon w/shoulder strap
- Extra Stainless Steel Telescopic Whip
- 3 extra Coil Clips
- Antenna Operating Manual
- FREE - New 10-page modeling report

### WE SUPPORT WHAT WE SELL!

If you have a problem, our strong relationship with the support divisions of our US suppliers combined with our professional service lab will get your unit quickly up and working to original specs.

We specialise in mail order. Visa and Master Card

DETAILED DATA SHEETS ARE AVAILABLE ON REQUEST FOR MOST PRODUCTS.



# TTS Systems Communications Equipment

Systems

FREE CATALOGUE

[www.ttssystems.com.au](http://www.ttssystems.com.au)

HF and VHF Transceivers, Autotuners and Kits

Phone 03 5977 4808. Fax 03 5977 4801 [info@ttssystems.com.au](mailto:info@ttssystems.com.au)

# A dummy load for 'dummies'

Jack C. Laib VK6CTL

Is it fun for fellow hams to hear the various carriers, the "Ahhh..... Ahhh.....Ahhhhh" or the "one - two - threeee - testing" on the bands whilst a Tx is tuned up? Invariably every ham should use a dummy load to tune his Tx.

With the availability of very low inductance power resistors from ARCOL UK Ltd, ([www.arcol.co.uk](http://www.arcol.co.uk)) it is now easy to build a 50 ohm dry dummy load. Check ARCOL's web site for their Australian distributors.

At \$18.00 each these power resistors are hardly inexpensive. However, I built a 100 W dummy load using all new parts for \$105, which still represents a significant saving over a commercial unit.

The two photos show the construction of a dummy load suitable for the common 100 watt transceivers in use nowadays. This unit was built in just three hours. By using a construction method that keeps the resistor leads short the load can be used on 144 MHz where it still provides a 1:1 SWR.

A heatsink of 1.3 °C/W thermal resistance, or better, is required to dissipate the maximum 100 watt rating of the load. The maximum power should not be applied continuously for more than three minutes or the dummy load will overheat, possibly causing the resistors to break down.

Four 25 watt resistors in parallel are needed for a 50 ohm load capable of dissipating 100 watt. Four 200 ohm resistors in parallel would be ideal. Unfortunately, this value is not generally available so we use two 220 ohm and two 180 ohm resistors, all in parallel.

The resistors are contained in TO-220 cases and must be mounted to the heatsink using silicon based heat transfer compound. The TO-220 cases are mounted in a star like configuration, facing each other, in the space between the heatsink's cooling ribs.

From each resistor one lead is twisted into a bunch, the other to a second bunch. Solder two short wires of 1 mm diameter to each bunch of leads. The other ends of the wires are soldered to either the centre pin of a SO-239 socket or a soldering lug under the socket mounting.

The mounting tab is electrically isolated from the internal resistive element, so it will not provide a connection back to the SO-239 body through the metalwork. The wire from one bunch of resistor leads direct to the SO-239 body is therefore important.

A U shaped, 1mm thick, aluminium screening bracket is tightly fitted over the resistors and socket to form an RF-shield. Two tabs are added to the bracket, one either side, for fastening to the heat sink. The dimensions of the screen will vary depending on the size of your heatsink, but it should fill the area between the cooling ribs and with a height of at least 25mm.

On one side of this U-bracket is mounted a SO-239 UHF screw-in chassis socket, complete with soldering lug. A bit of agility is needed to keep the two wires as short as possible and solder them to the resistors and socket.

Finally the U-bracket is screwed to the heatsink with 2 self-tapping screws through the small tabs. I painted the bracket black and stuck 4 rubber feet to the bottom face of the heatsink to prevent sliding and damaging my desk.

**WARNING: Apply full load for a maximum of 3 minutes.**

**Let it cool off before re-usage.**

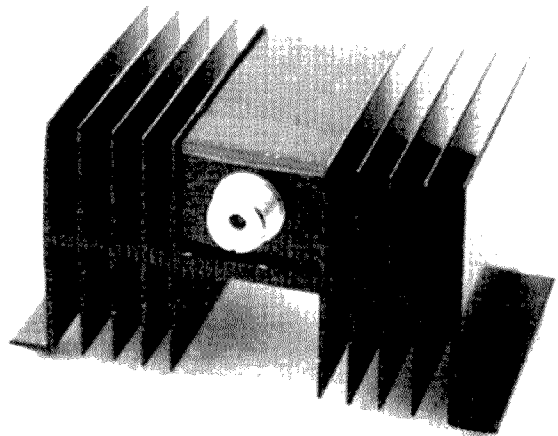

Photo 1

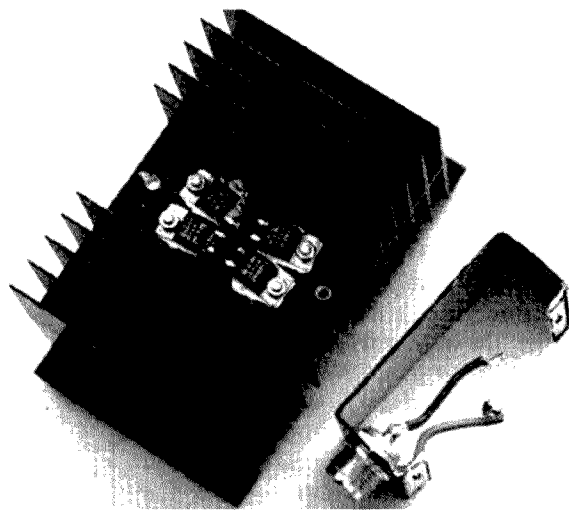

Photo 2

## Silent Key

B P Vandersande  
VK2HVS

"He very much enjoyed Amateur Radio!"

Advised by M Vandersande

# The 204BA, a 4-element 20 metre beam plus a rotatable 40-cum-30 metre dipole

## Part 2

Bob Slutzkin VK3SK

# Experiments with 'across-the-boom' dipoles

**M**Y FIRST EXPERIMENTS with a 40 m dipole across a 20 m beam were in the early 1980s. Stan VK3TE (SK) and I both had 204BA beams; and he provided fibreglass end-pieces which we used for insulating the end elements from the boom. We had a 1.5 metre pole pointing up from the centre of the boom and ran wires up from a balun at base of that pole through insulators at the top and then down to join to the centres of the two 20 m end elements. The wires formed a short shallow inverted Vee, heavily end-loaded by the 20 m end elements. This dipole turned out to be resonant below 7 MHz but we found we could tune it for a fairly good 50 ohm match on 40 m by means of a series capacitor in one of the wires connected to the balun. This antenna was written up in AR in 1985.

We did the same with Stan's antenna and they both performed well as rotatable 40 m antennas, but only until the wires broke. Of course we should not have expected the copper wire to stand up to the flexing of the heavy boom in the wind. As someone has since suggested, stainless steel yachting mast-stays could have been made up and used for the purpose. It would probably have still been a good antenna even with the additional ohmic resistance.

At about the same time as we were doing it, W8BEB had been experimenting with a 40 m antenna on his 204BA. His method, which was to shunt feed the boom using an off-centre gamma match, was written up in QST.

Of course, these would not be the only experiments by the hams of the world on across-the-beam antennas, as is evidenced by the February 2003 Radio & Communications article by N4KG. He wrote about his and others' use of the omega match on the boom of assorted

tri-band beams. He also described K4BEV's remote tuning arrangement using stepper motors to match the boom to either 30 or 40 metres.

Some time ago I tried some across-the-boom experiments on a TH5 tri-bander which has an 18 foot boom. I made and tested a series of 30 m and 40 m dipoles, using various combinations of end loading, linear loading, and sloping extensions at each end of the boom. All I can report about those experiments is that it was all great fun at the time, and good physical exercise tilting the mast up and down. I soon replaced the TH5 with my old 204BA.

Then, I decided to try out W8BEB's method on the 204BA. I must say that for some reason I have never been much good at tuning up shunt feeds, and it is

probably fortunate that I was unable to make his gamma match tune up, because that led me to another idea and a very pleasant surprise.

The idea was to insulate the 2nd director from the boom by putting into use the end-piece from the 1985 job. Then the gamma rod would be extended out to connect to the director so that it would be series fed. So I went to it, and on the first test I found that very little fiddling was needed for a good match on 40 m. But then, while running it through its paces on the antenna analyser I discovered by accident, and to my delight, that it was also an even better match on 30 m.

It was a fairly primitive experimental set-up. For a permanent arrangement a sounder mechanical design would

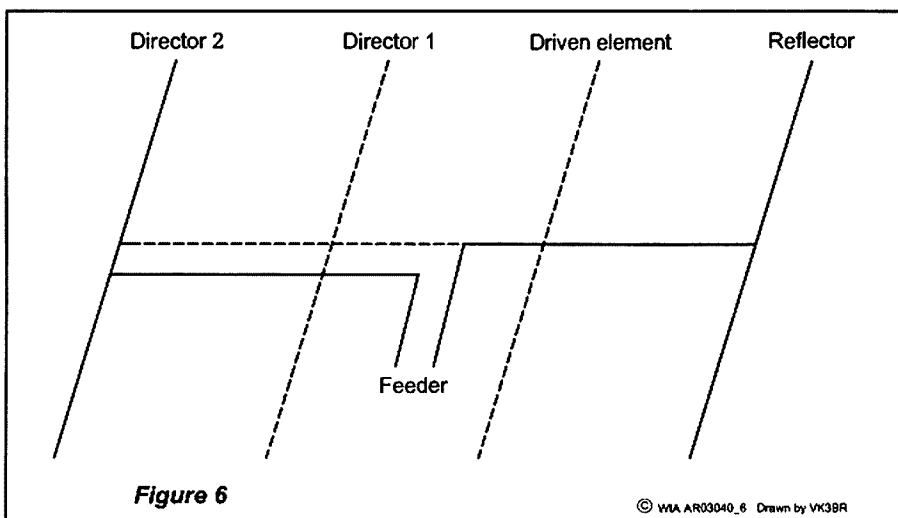

Figure 6

© WA AR03040\_6 Drawn by VK3BR

Fig 6 - Simplified schematic of the 40 m dipole showing how the rod (on the left) and part of the boom (on the right) form a short dipole which is only 25 ft long but end-loaded by the end elements of the 20 m beam to resonate near 40m. Residuals are shown as dashed lines. This dipole is not symmetrical, due to the following:

1. The part of the dipole to the right of the feed point is much thicker and longer than its counterpart.
2. The reflector is longer than the director so that the end-loading is different at each end.



be needed. The construction of my mechanically improved model has been described in part 1.

The cross-the-beam antenna described in Part 1 was intended as a 40 m dipole; but mysteriously, it turned out to also work in the 30 m band. The purpose of this note is to discuss the possible reasons for its performance.

Fig 6 is a simplified schematic of the end-loaded dipole in an H formation, fed a little off-centre. The radiating element is the rod to the left of the feed point and the boom to the right; and it is heavily end-loaded by the two 20 m end elements. Of course the two intermediate 20 m elements and the part of the boom to the left of the feed point cannot be ignored. These extra parts have been shown as dashed lines.

The 20 m driven element (about half way along the right side) should add to the loading. The continuation of the boom to the left of the feed point runs parallel to the rod as far as the insulating sleeve. This in combination with the rod is an open transmission line or open stub across the feed point; so it should act as a shunt capacitance.

The effect of the 20 m first director is more difficult to guess because it is not directly connected to the dipole, but to a point part way along one leg of the stub. Another difficult guess is the effect of the supporting mast with its short extension above it, and with the rotator and tower below it. The support is at the centre of the 20 m beam, but not necessarily the electrical centre of the 40 m dipole.

It is a reasonable conclusion that the combined effect of the end-loading elements and the other appendages is to load the radiating element to resonate at about 7 MHz.

But an explanation is still needed for the low SWR over that band. The impedance at the centre of such a short heavily loaded dipole would be much lower than 50 ohms, but in this case, a higher impedance has been obtained by shifting the feed point off-centre. In fact the balun-rod assembly had been specifically designed to allow the degree of offset to be adjusted.

With the initial setting, the antenna performed very well. The SWR was better than 2:1 over most of the 40 m band, being minimum at 7.05 MHz and rising to 2.1:1 only at the very top end. The impedance at the feed point was calculated by Smith Chart to be  $30 - j3$

ohms at 7.05 MHz, which suggests that an almost perfect match should be found by only a small outward movement of the balun's position. There is hardly a need for this fine tuning, but some calm day in the future I hope to carry out that repetitive task just to demonstrate that a perfect match can be achieved, without affecting the 30m performance.

Fig 5 shows a plot of the SWR over a range of frequencies as measured in the shack using an MFJ 259B analyser. The sharp dip near 7 MHz was no surprise, but the broad dip between 9 and 10 MHz was quite unexpected.

This was something that had not been designed but just happened by chance, and there must be some theoretical

reason why it did happen ( against all the rules of Murphy's Law)

My hypothesis is as follows:

Fig 7 is the schematic of a dipole in a smaller H configuration, with a 17.5 ft long radiating element which is end-loaded by the beam's second director and the driven element. This resonates at some frequency between 9 and 10 MHz .

Fig 8 is the schematic of a similar H type dipole with a 15.4 ft radiating element which is end-loaded by the beam's first director and reflector. This resonates at some slightly higher frequency between 9 and 10 MHz..

The dipole in fig 7 is directly fed and

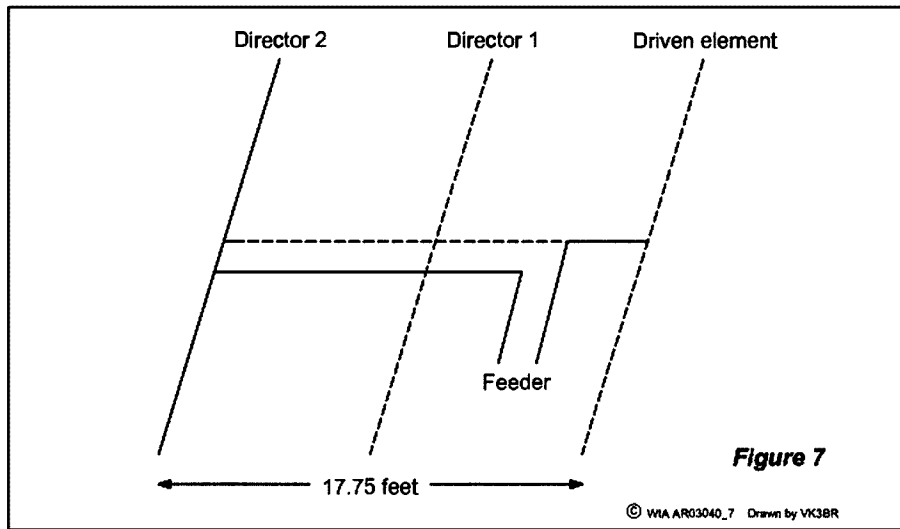

Fig 7 - Secondary H configuration possibly resonating near 9.5 MHz (reflector not shown).

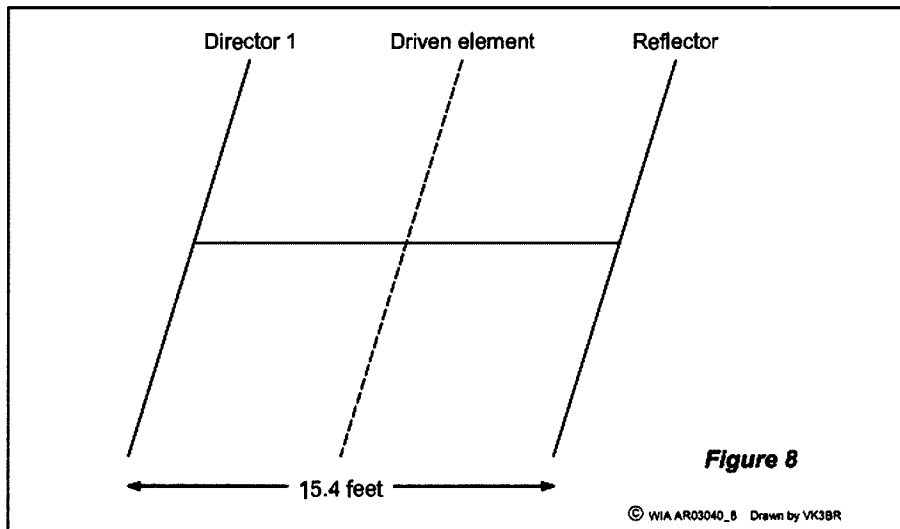

Fig 8 - Other Secondary H configuration possibly resonating near 10 MHz (2nd director not shown). Not connected directly to the feed line but closely coupled to sections that are connected.

# A versatile battery box

Dale Hughes VK2DSH

Perhaps the most useful items that an experimenter can have are various power supplies. When developing circuits on the bench it's easy to arrange various mains powered supplies, however if there is a need to test equipment in the field it is somewhat more difficult.

I came up with the following device, which provides either a single 12 Vdc supply, a +/- 12 Vdc supply or a 24 Vdc supply. It's a very basic design and it has proven to be very useful.

The circuit is very simple and offers a number of features that make using the supply more convenient than otherwise

might be the case. The switching has been designed to:

- Connect the batteries in series for +/-12 V and 24 V use, and parallel for 12 V use. This also allows charging from 12 V or 24 V battery chargers.

- To protect whatever device is connected to the battery box, so that it is more difficult to inadvertently connect a 12 V device to the 24 V supply. 12 V only devices will be safe if connected to the 12 V terminals and the switch is set to the series connection.

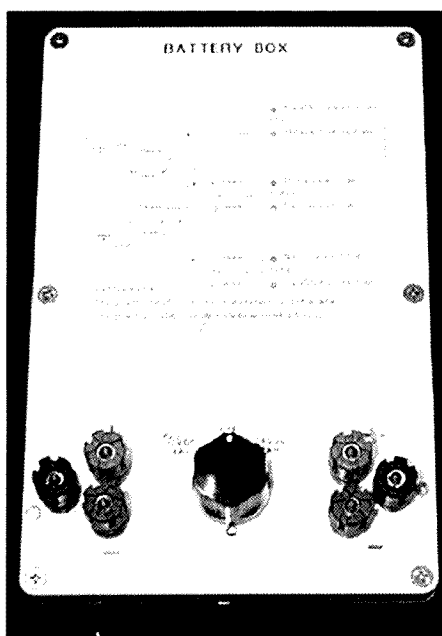

Photo 1. The battery box. The actual size, shape and battery capacity can be changed to suit whatever need a constructor might have.

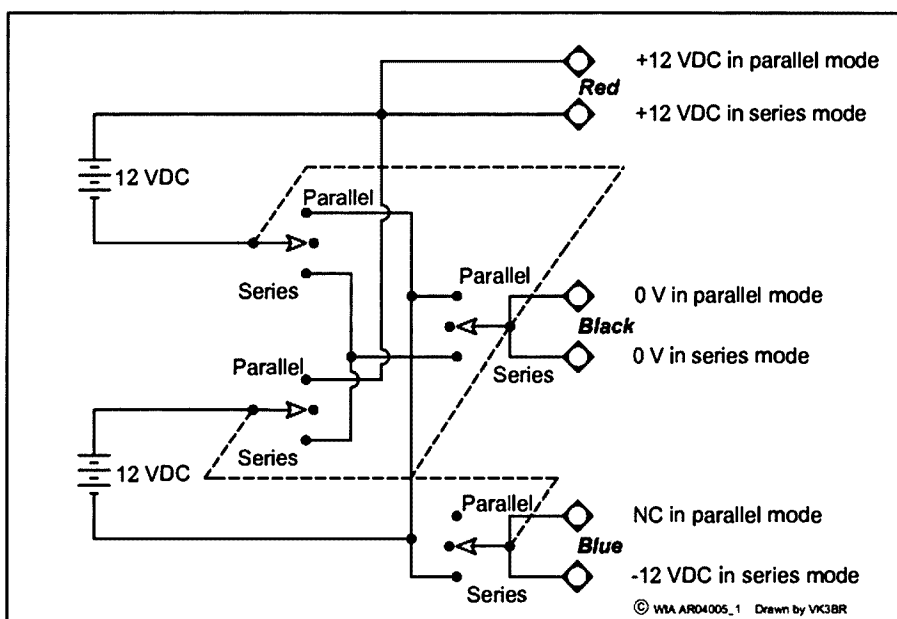

Fig 2 - Schematic diagram of the battery box. Charge with 13.8 Vdc in parallel mode between Red and Black. Charge with 27.6 Vdc in series mode between Red and Blue. A copy of this diagram can be attached to the top of the battery box for quick reference. The colours refer to the front panel terminals.

ar

## Experiments with 'across-the-boom' dipoles *continued*

the dipole in fig 8 is coupled to it, and by chance, the resonant frequencies of the two, and the degree of coupling produce the broad-band result.

Although it was expected that the modifications I made to the 204BA would allow me to operate the boom in the 40 metre band, it was purely by chance that it worked well on both 40 m and 30 m with an acceptable match to 50 ohms.

However, it is important to mention that the spacings and lengths of the elements of my 204BA had been

set in accordance with the HY-Gain instructions for operation in the phone band, and that it is mounted 18 m above the ground. If I had used different element lengths or spacings it would not have worked out the same, and at a different height, the impedance would have been different.

Over the years, thousands of 204BAs have been sold, and many 4-element beams home-constructed along similar lines; and the ARRL Antenna Book recommends changes to the original Hy-Gain specification based on a computer-

generated design. So there are many beams somewhat similar to mine but different in the detail.

I am confident that any of these different 4-element 20 m beams could be modified the way I have described and could be made to operate on 40 metres; but some adjustment might be needed to obtain an acceptable match. Also I am confident that they would also operate at some frequency or band of frequencies higher than 7 MHz., but not necessarily in the 30 m band.

ar

## Simple battery chargers

### Basic theoretical considerations for germanium and silicon transistors

(Dr) Bill Toussaint VK6LT

If I had to select the most useful set of projects I have built from junk (including a 15 volt ac, 10 VA output power pack) it would be a constant voltage charger (which is really a 3-15 volt dc supply) for SLA batteries and a constant current charger for NiCads (and similar). As the circuits illustrate the use of an "old" germanium transistor and a "new" silicon transistor let us first check the background of these transistors.

Germanium was the first material used for transistors. It has a very low band-gap energy, which means a low voltage drop (about 0.3 volt) when current flows across a PN junction in the forward direction (that is, positive is connected to the "P"-biased region). This is good, but germanium also leaks quite a lot of current when the diode or transistor is biased so it should be off. It is difficult to get consistent circuit operation when the switching elements won't actually switch right off.

To overcome this, silicon transistors were introduced. They have a higher forward voltage drop (0.6 - 0.7 V), but negligible reverse leakage current. Silicon transistors also are slower than germanium transistors of the same size and construction, but this problem has been overcome because silicon's other characteristics allow shrinking the transistor size, varying the transistor design, and combining lots of transistors onto one chip of silicon.

Germanium components, however, are still used in some extremely high-speed but simple circuits for communications.

### Basic theoretical considerations for diodes and LEDs

When a diode is connected correctly in a circuit there is voltage drop across the diode. A normal diode uses a PN junction. It is across this junction that the voltage drop occurs. No current will flow until this voltage is reached. If more voltage is then applied, the voltage drop will remain essentially constant. A typical signal or rectifying diode has a voltage drop of approximately 0.5 V. A LED (Light Emitting Diode) acts a bit like a regular diode, but emits light in the process. For LEDs there is a much higher voltage drop. The frequency (hence colour) of the light the LED emits relates to the voltage drop across it. The lower the frequency the lower the voltage drop. As colour red has a lower frequency than colour blue, a red LED has a voltage drop of about 1.7 - 1.8 volt, while for a blue LED it is about 3.5 V.

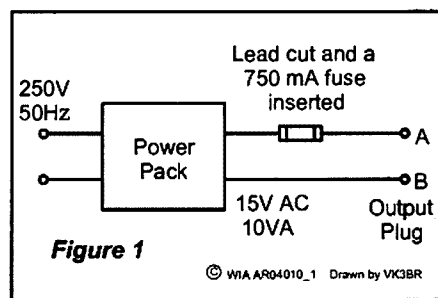

Fig 1 - Power pack with fuse added.

### Projects

The circuits illustrated here are very "low tech" and use low voltage. This means that they are suitable for beginners to electronics. Also, as it is easy to substitute similar components if the suggested components are not available, the cost of building them should not be high.

#### a) The power pack

As I believe in protecting equipment, I first put a 750 mA fuse in the output lead of the 15 volt ac power pack. Figure 1

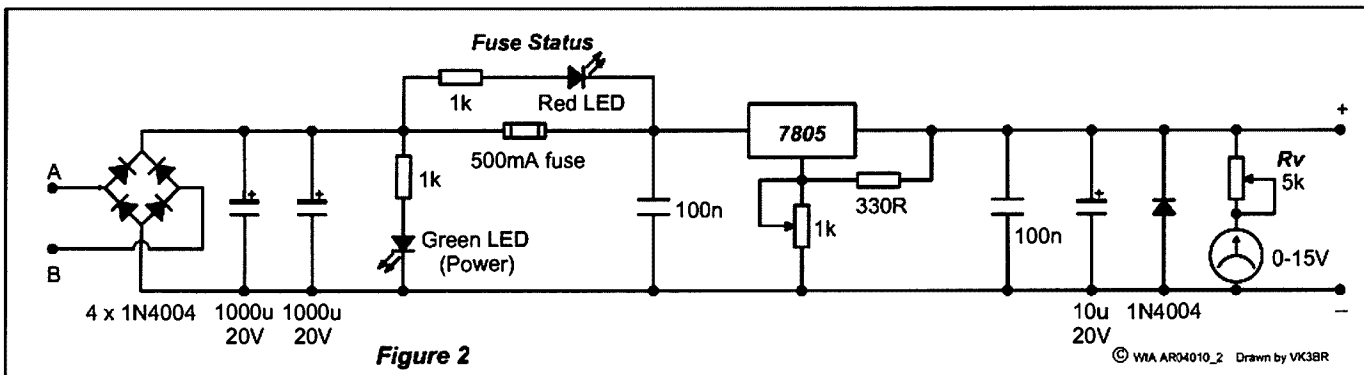

Fig 2 - Variable voltage supply/charger.

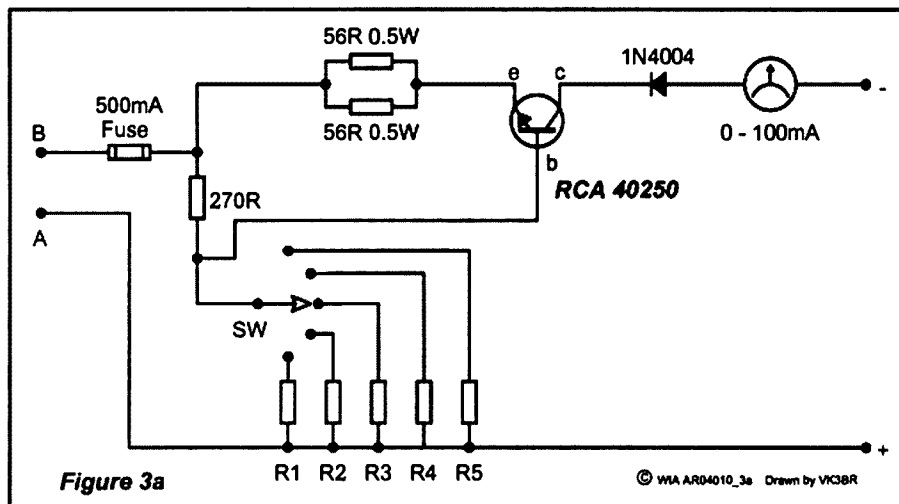

Figure 3a – Constant current charger 10 – 100 mA.

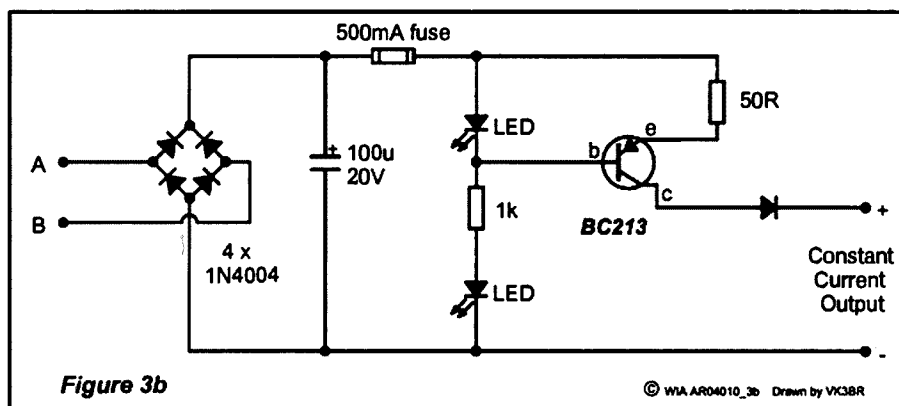

Figure 3b – Constant current of 25 mA output.

RESISTOR	VALUE (OHMS)	OUTPUT CONSTANT CURRENT (MA)
R <sub>1</sub>	550	100
R <sub>2</sub>	1500	45
R <sub>3</sub>	4400	25
R <sub>4</sub>	4700	15
R <sub>5</sub>	5600	10

Although this circuit shows that various fixed value resistors can be switched into the circuit to give the desirable current output, another possibility would be to use a 5 k potentiometer to replace the fixed resistors. If this is the case, then it is important to include a milli-ammeter in the circuit to monitor the output current.

As can be seen from Figure 3a, the input is between A and B and is from the ac power pack. Half wave rectification occurs via the output diode IN4004.

If just one fixed current were required (say 25 mA), it would not be necessary to have multiple resistors, but simply a fixed resistor of 4.4 k ohm as illustrated with R<sub>3</sub> in the above table.

#### d) Alternative circuit for a constant current charger of approximately 25 mA.

Alternatively, a constant output of 25 mA could be achieved using the circuit shown in Figure 3b where a BC213 PNP silicon transistor is used. Figure 3b is thus used as an example to show the circuitry for PNP transistor.

To illustrate how the circuit operates, assume a nominal DC input voltage of 12 volt results from the rectifier bridge and is applied across the 2 LEDs in series with the 1 k ohm resistor. Assume the output is connected to charge a NiCad battery.

As mentioned above, for any silicon transistor, the voltage drop between e – b of the transistor is constant and fixed at 0.6 volt.

There is a voltage drop of 1.8 volt across the red LED and this voltage drop hence occurs across the sum of 50 ohm resistor (which should be 0.5 watt or greater) in series with the e – b of the transistor. This means that the PD across the 50 ohm resistor

$$= 1.8 - 0.6 \text{ volt}$$

$$= 1.2 \text{ volt}$$

The constant current is thus:

$$= 1.2/50 \text{ amp}$$

$$= 24 \text{ mA.}$$

indicates that a 10 VA power pack was used, but even a 4.5 VA power pack (300 mA) could be used in conjunction with a 250 mA fuse. I then used this to supply the following:

#### b) Power supply (3-15 volt dc)

The circuit is shown in Figure 2. Basically any power diodes (such as 1N4004) can be used, as long as they can handle at least 1 amp. Naturally a rectifier bridge could also be used instead of the individual diodes.

The unit was built on vero board and the components laid out in a line as in the schematic circuit. The 1 k potentiometer was used to adjust the output voltage and mounted on the front of the unit for ease of use. It is set to 14.2 volt when charging a 13.8 V SLA.

A heat sink was used on the 7805 voltage regulator. The 7805 is a constant output voltage device often used in circuits where 5 volt is required. By using a fixed 330 ohm resistor and a 1 k potentiometer (in the configuration

shown in figure 2) a variable output voltage from about 3 – 15 volt can be achieved.

The meter V should read 0-15 volt. This is achieved by calibrating it against a digital multimeter and adjusting R<sub>v</sub>. The value of R<sub>v</sub> depends upon what meter is available, but as a rough guide a 5 k can be tried first. It may be even necessary to add more resistance if the meter reads too high.

The fuse used was 500 mA.

#### c) Constant current charger 10 – 100 mA.

The circuit is shown in Figure 3a. Although an RCA 40250 NPN power transistor was used, the circuit could be designed to suit other more common power transistors (such as PNP BC213), which should be mounted on a heat sink. Using a multiple position switch, various resistors can be switched into the circuit to give the required constant current output. The following table can be used as a rough guide:

# VK5BR\_X antenna

The antenna is a crossed field dipole of two cylinders using an H field directly derived from conduction

Here is a crossed field antenna system in which the matching for frequency change is controlled from within the radio shack.

Lloyd Butler VK5BR

## Forward

The VK5BR\_X antenna is a crossed field dipole that makes use of resonant balanced lines to allow adjustment of matching and tuned frequency from within the radio shack.

Whilst the antenna uses two cylinders similar to the EH samples, it is dissimilar in that it does not use secondary E field displacement current to derive the H field and it does not use a 90 degree phase shift network. Furthermore it is balanced and does not suffer problems of common mode current in the feeder line nor interaction between antenna tuning and movement of the feedline.

By using open wire balanced line, no fine pre-tuning is required at the antenna and tracking of tuning is achieved back in the radio shack using a Z Match tuner or other similar matching unit with balanced output.

There are several versions of this antenna and this article specifically refers to what I have called X2 and X3. The samples discussed were specifically made for tests to be carried out on the 20 metre band. However the antenna tuning can be tracked well outside that band. In fact the X3 antenna has been operated on both the 20 metre and the 40 metre bands with band change by just tuner adjustment back in the radio shack.

## Theory

To understand the operation of this antenna you have to think somewhat in reverse and assume that the antenna is working in the crossed field (or EH) mode to start with. The impedance then seen looking into the antenna is dominantly resistance resulting from radiation.

Because the impedance is essentially resistive, the current flowing into the antenna is essentially in phase with the voltage across the antenna from which the E field is developed. To maintain an H field in phase with that voltage

(and the E field), you simply set up the H field from current flowing into the antenna by means of open series coils. The two coils have been placed so that their magnetic fields are in a line with what has been assumed to be the H field from displacement current formed from the electric field between the cylinders. (Refer figure 1). You might consider that the H field from the coils interferes with the natural H field formed by displacement current between the cylinders.

You might rightly ask how does the crossed field operation start in the first place. Well I am not sure that I am able to explain that at this point except that it does work. One thing that seems to be necessary is to provide a series inductive reactance to balance the capacitive reactance of the antenna. So it is a matter of using series H forming coils of around that total reactance but the value doesn't seem critical, using the remote matching and tuning can be tracked over a very wide range of frequencies well beyond amateur band limits.

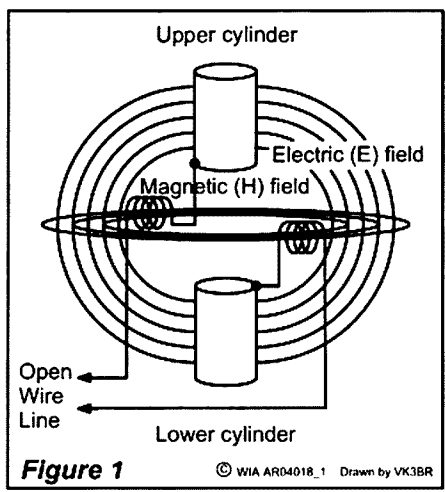

Figure 1 © WIA AR04018\_1 Drawn by VK3BR

You might take my operational explanation as analogous to explaining how a tuned oscillator works. It is easy to simply assume that the tuned circuit is in a state of oscillation to start with and you only have to feed back into the tuned circuit in-phase energy sufficient to make up for the resistance loss in

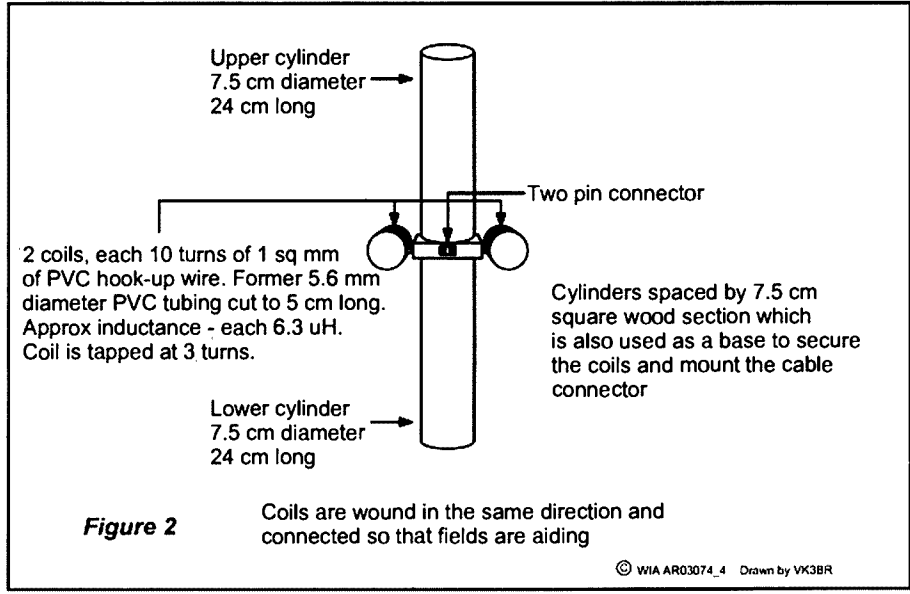
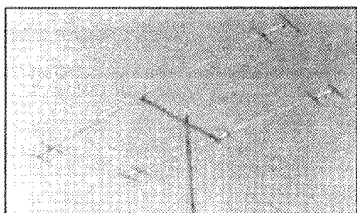

Figure 2 © WIA AR03074\_4 Drawn by VK3BR

# TET-EMTRON

## TE-23M 2 ELEMENT MINI-BEAM



### SPACE A PROBLEM?

Don't give up! This mini antenna can be installed almost anywhere, especially where space is at an absolute premium and you still get superb performance on the 10, 15 and 20 metre bands.

It has a 30% space saving when compared to a standard 2 element beam, light weight and rotatable even with a TV rotator.

All stainless steel hardware, 6063T83 aluminium tubing and all standard features which go with every TET-EMTRON ANTENNA.

## Dealers VIC

LT Harris 78 Elgin Street Carlton Vic 3053  
Ph 03 93476284 Fax 03 93473629  
Email: lharris@netscape.net.au

G&C Comma 207 High Street Cranbourne Vic 3977  
Ph 03 5996 3298 Fax 03 5995 0184  
Email: gccomm@netscape.net.au

## NSW

Emtronics 1/94 Wentworth Avenue Darlinghurst 2010  
Ph 02 9211 0988 Fax 02 9281 1508  
Email: Emtron@ozemail.com.au

Andrews Comma Shop 8, 41-51 Bathurst St  
Greystanes, NSW, 2145 Ph 02 9636 9060  
Fax 02 9688 4301  
www.andrewscom.com.au

## WA

Tower Communications 14 Mary Street Hazelrore 6055  
Ph (08) 92741118 Fax (08) 92503734  
Email: tower@eon.net.au

## QLD

Kyle Communications  
668 Lutwyche Rd Lutwyche 4030  
Ph (07) 38574400 Fax (07) 38577825  
Email: mark@kyle.com.au

## SA

International Communications -  
8 Nile Street Port Adelaide 5015  
Ph (08) 84473688 Fax (08) 83411453  
Email: intercom@picknowl.com.au

## New Zealand

The Com Centre  
400 Hillsborough Road Avondale Auckland  
Ph (64) 9 6270084 Fax (64) 9 6271613  
Email: comcent@radiolife.co.nz

## RAWMAR ENTERPRISES

40 Blackburn Street  
STRATFORD Victoria 3862 Australia  
Ph: 61 3 5145 6179  
Fax: 61 3 5145 6821

Email: rawmar@hotmail.com

www.tet-emtron.com

the circuit. It is a more difficult to try to explain how the tuned circuit starts oscillating in the first place.

Figure 2 shows the assembly of the X3 antenna. The X2 antenna is similar except that there are no taps on the coils. The two coils are placed so that their magnetic fields are in the path of the dipole E fields and the magnetic fields are assumed to be essentially at right angles to the E field as shown in figure 1. The current through the coils is the current fed to the cylinders. Two coils are used so that the circuit is balanced and there is no problem of longitudinal current flow as experienced with samples of the EH antenna.

By using open wire balanced line, the lines can be operated in a partly tuned mode enabling matching of the antenna to be adjusted within the radio shack by a balanced output tuner such as the Z Match. Open wire lines have very low loss at HF frequencies, even in a tuned mode. To learn more about this, read my article "The Merits of Open Wire Lines", (Reference 1). The arrangement for Version X2 is shown in figure 3.

For my tests, I used the old open wire TV line, but it is very hard to get hold of these days. Using about 12 metres of this line in conjunction with a Z Match tuner at 14 MHz, I measured about 1 dB loss in the transmission system.

Ordinary twin power flex or 300 ohm TV ribbon can be used but if the line is of substantial length, more than half the power can be lost at 14 MHz. However these cables might be considered for the lower HF frequencies.

In Version X3 Antenna, instead of series feeding the coils, their series ends have been joined together and they are connected to the open wire line via taps on the coil. (See Figures 4 & 5). So instead of the resonant line looking at its

end to a low terminal series resistance, the coupling system increases the value of the terminal resistive component. The idea is to reduce the standing wave loss on the tuned line and hopefully also reduce losses in the Z Match tuner, which might have less extreme values of impedance, reflected.

The ideal situation is for the antenna coils to be resonant with the antenna capacitance at the centre of the band and the tap set so that a resistance is reflected at the tap equal to the characteristic impedance of the line (say 300 ohms). The Z Match tuner at the transmitter end is used to transform the 300 ohm line load to 50 ohms at the transmitter (indicated by SWR of 1:1 at that end). As the frequency is changed from that at resonance, the terminal impedance changes to that of a complex value. The mismatch is corrected by reflecting conjugate reactance up the line from the Z Match, which is re-adjusted for an SWR reading of 1:1 facing the transmitter.

So an ideal situation is for a matched open wire line at the centre of the band changing to partial resonant feeders as you tune either side of the band centre. However in practice it's not all that critical and all one needs to do is set the coils for somewhere near resonance and let the tuner adjustment do the rest by reflecting conjugate impedance down the line.

Because the junction between the two coils in the X3 antenna is an electrical centre, the antenna can be operated with an earth at this point with little difference in performance. This makes it easier to monitor voltages using the CRO to compare the phase of voltage at the cylinders to the phase of the H field developed by the coils (Refer to the section on Operational Tests). It also

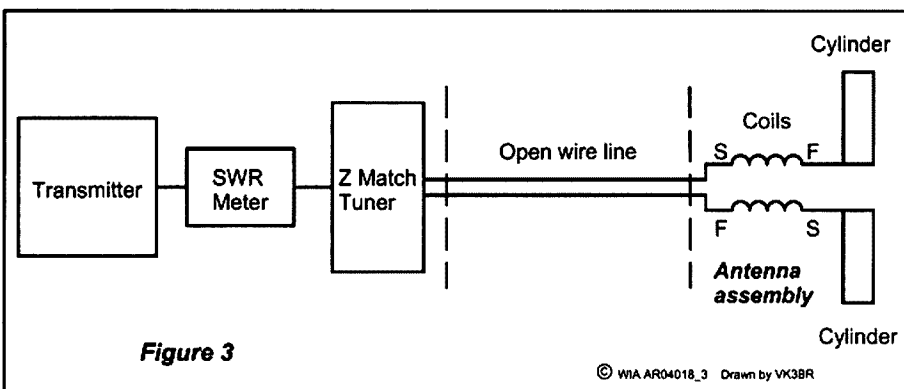

Figure 3

© WIA AR04018\_3 Drawn by VK3BR

makes it possible to earth the antenna to a supporting metal structure if required. However if there is a small unbalance in the system, a small current flows in the earth connection wire and this results in a small proportion of power being radiated from the earth connection lead. To inhibit this current, a trap can be inserted in the earth lead. A trap design similar to that which I previously described for the EH antenna (reference 3 & 5) can be used except that the coax cable is substituted for ordinary PVC covered hook-up wire.

In fixing the antenna in place as a radiator, the balanced feeder cable should connect to the centre of the antenna with the cable at right angles to the line of the antenna and continue for some distance in the right angled line so that it has minimal interference with the field from the dipole cylinders. The same applies to an earth lead if used. The earth lead should also be spaced a little distance from the line so that it does not upset the line balance.

Also in mounting the antenna, it should be kept away from metal objects as much

as possible to prevent interference to the antenna fields.

## Operational tests

Earlier tests using a field strength meter at close range indicated that the X2 and X3 antennas tuned for 20 metres exhibited a slightly bi-directional characteristic when the antennas were mounted in the horizontal plane. Also the signal was a little stronger in the vertical plane with its maximum when the antenna was tilted forward a little. It was later discovered that this was apparently the effect of the induction or near field and at distance the radiated

signal was actually strongest with the antenna mounted in the vertical plane.

As accurately as I could measure using a noise bridge in conjunction with a candelabra balun, the antenna load resistance of the antennas in operation at 14 MHz appeared to be around 25 to 30 ohm.

The Q of each coil measured around 100 giving say 5 ohm at 14 MHz.

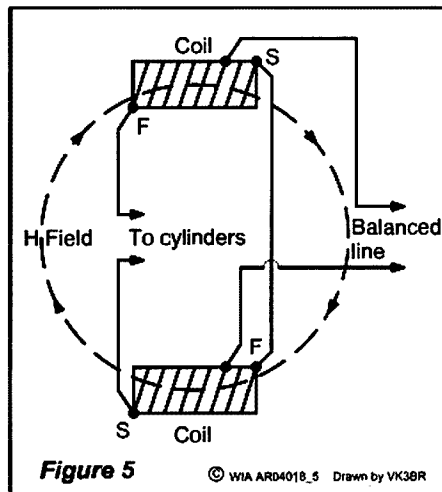
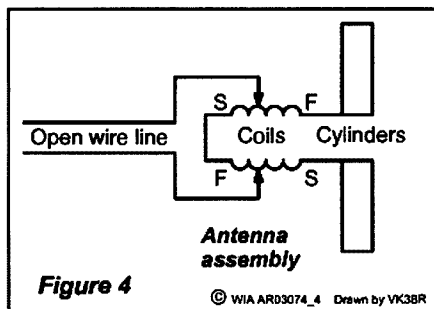

# G&C COMMUNICATIONS

Authorised dealer for ● Kenwood ● Icom ● Barrett RFDS ● GME Electrophone ● Uniden ● YAESU

## KENWOOD

### TH-F7E

Amateur VHF/UHF Transceiver

Freq: TX: 144-146 / 430-440 MHz  
RX: 0.1-1300 MHz  
Mode: TX: FM RX: AM/FM/SSB/CW  
RF Power output: Hi: 5/5 W  
Lo: 0.5/0.5 W El: 50/50 mW  
Volt: Int: 5-7.5 VDC External: 12-16  
Weight: 250 gr (inc lith.-ion batt. pack)



## ICOM

### IC-208 Amateur VHF/UHF Transceiver

Freq: TX: 144-146 / 430-440 MHz  
RX: 118-1000 MHz  
Mode: TX: FM RX: AM/FM  
RF Power output:  
Hi: 50 / 50 W,  
Mid: 15 / 15 W,  
Low: 5 / 5 W  
Voltage: 13.8 VDC  
Weight: 1.2 Kg



## YAESU

### VX-7R

5 W Ultra-Rugged,  
Submersible Tri-Band  
Magnesium Handheld

Freq: RX: 0.5 - 999 MHz  
TX: 50, 144, 430 MHz Amateur Bds  
True Dual Receive: V-V/U-U/V-U/  
GEN-HAM  
Power Output: 5 Watts 222 MHz:  
300 mW) 6 m AM: 1 W MANY GREAT FEATURES



## ROTATORS

### G450A (shown)

### G650C, G800DXA



Australia wide orders welcome  
Credit card Cheque Money order

207 High St. Cranbourne VIC 3977

Ph: 03 5996 3298 Fax: 03 5995 0184

## IC-706 MkII Amateur HF/VHF Transceiver

Freq: TX: 10-160 m + WARC / 50-54 / 144-146 (148) MHz  
Europe (USA) RX: 0.03-200  
MHz all-mode incl WFM  
Mode:  
AM/FM/SSB/CW/RTTY  
RF Power output:  
100/100/20 W

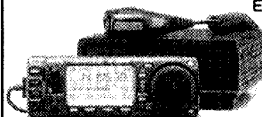

Most popular mono/tri-banders

## TE series EMTRON HF ANTENNAS

Storm tested - Call

## Antenna Tuners

### MFJ 945E - MFJ949E

### The auto MFJ 993

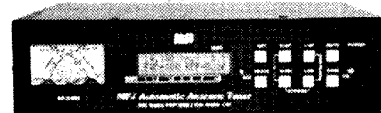

and the amazing  
MFJ 902 Travel Tuner



Email: [gccomm@netSPACE.net.au](mailto:gccomm@netSPACE.net.au)

[www.gccomm.com.au](http://www.gccomm.com.au)

Based on coil resistance being in series with radiation resistance, efficiency calculates to around 60 to 66%. Higher Q coils could raise this.

The theory of operation relies on the current through the coils (and the generated H Field) being in phase with the voltage (and the E field developed) across the two cylinders. This has been checked on the X3 antenna by driving the antenna with a signal generator and monitoring with a dual trace CRO. The H field is monitored by connecting to a few turns coupled around a ferrite rod that is placed close to the open end of a coil. The voltage across either coil is measured with the probe earth lead at the connecting junction between the two coils. The phase of the H monitor can be compared to the phase across either coil and also the phase of the difference voltage between them (which is also the voltage across the cylinders generating the E field between them). The tests have clearly confirmed the in-phase condition. The field strength at 14 MHz was compared with that from the 20 metre L+L EH antenna. The field strength at 5 metre from the X2 antenna is comparable with the L+L antenna when a trap is fitted at the base of the L+L antenna.

However with the trap fitted at 1.5 metre down from the L+L antenna, the L+L is about 3 or 4 dB better. A similar result was achieved with the trap fitted at 1.5 metre on the Star EH antenna.

The improvement in the performance of the L+L EH with a short tail fitted has been documented before. It has been thought that this provided a good reference plate for the secondary E field operating in the longitudinal mode. Of course the VK5BR\_X antenna has no tail as its feeder is fed balanced right to the antenna centre. Also based on how I think it works, it doesn't use a secondary E field to develop an H field from displacement current.

Signal strength for the X3 antenna measured about 1 to 2 dB less than that from the 20 metre L+L antenna fitted with a trap at 1.5 metre down its coax cable. Much of this small difference might well be loss in the Z Match Tuner.

The power loss in the Z Match is a very variable factor depending on the nature of the load impedance reflected to its output. This particularly applies where the reflected load resistance is high.

The actual impedance reflected to the Z Match will clearly depend on the length of the cable and where its terminal end relates to the voltage and current nodes and anti-nodes.

There is also added the loss due to the 5 ohms resistance in each of the antenna series coils. So all in all, I am fairly satisfied that radiation from the X3 itself is comparable with the EH antenna sample.

The X3 antenna was made for experiments on the 20 metre band. Using the Z Match in the shack, the X3 antenna can be made to operate in its crossed Field mode over a wide range of frequencies. It was not initially assumed that it could cover more than one harmonically related band. However I have been able to tune up the X3 on 40 metres using the Z Match adjustment and the antenna seems to work as well as on 20 metres.

On 40 metres the field at about 5 metres from the antenna was also measured as about 1 to 2 dB below my 40 metre L+L EH antenna fitted with a trap at 1.5 metre down the coax cable.

With the X3 antenna mounted in the vertical plane 1.5 metre above the ground, I had a 40 metre contact to a radio amateur on the East Coast of Australia, 1100 Km distant. Signal levels were varying quite a bit but he reported that my signal from the X3 was around 1 to 2 S points below that from my inverted V antenna (a half wave on 40 metre). As the X3 assembly length-wise is a mere 55 cm, or 0.014 of a wavelength on 40 metres, I figured that the antenna was doing pretty well.

Concerning further harmonically related bands, 80 metres is too far removed for this particular X3 model. 10 metres is also out of range. The reason for this is that the total inductance of the series coils on the 20 metre X3 is 12.6 uH. Parallel resonance with the distributed capacitance of the coils would occur at some frequency not too far above 14 MHz and upset the series resonant condition which is used in the antenna system.

Based on the experience I have had, it would seem to me that we could design this type of antenna for any two harmonically related bands by setting the inductance of the series coils to suit the two bands required. What effect varying the size of the cylinders might have has not been defined.

## Summary

The VK5BR\_X2 and X3 antennas are crossed field dipoles, which make use of resonant, balanced lines to allow adjustment of matching and tuned frequency from within the radio shack with a balanced output tuner such as the Z Match. The series circuit in the X2 antenna is the simpler but the shunt feed arrangement of the X3 antenna appears to be a bit more efficient.

Whilst the X3 antenna was initially designed for the 20 metre band, experiments have demonstrated that it also operates quite well on the 40 metre band with re-adjustments only needed to the Z Match tuner within the radio shack. This has demonstrated the potential to make X3 antennas for any two harmonically related amateur bands.

Further articles in AR will give details of the assembly and operation of X3 antennas for primary operation on the 40 and 80 metre bands. This should have appeal for amateurs who are keen on these bands but don't have the space to put up a larger antenna for the lower frequency bands.

## References

1. The Merits of Open Wire Lines - Lloyd Butler VK5BR - Amateur Radio, September 1991. (Also republished on the VK5BR Internet site - Ref. 3).
2. Simple Z Match Tuner Simplified - Lloyd Butler VK5BR - Amateur Radio, June 2000. (Also published on the VK5BR Internet site Ref. 3)
3. Refer to articles on the EH Antenna by VK5BR at:- <http://www4.tpgi.com.au/users/ldbutler/>  
Or link from:- <http://www.qsl.net/vk5br/> or previous articles on the EH Antenna in Amateur Radio
4. EH Antenna Internet site:- <http://www.eh-antenna.com>
5. The EH Antenna - More Information on how it works, etc - Lloyd Butler VK5BR - Amateur Radio, November 2003.

ar



# Well it might come in handy...

Joe Rotenberg VK3BBN

This article is prompted by an invitation to go to a deceased estate and rummage through the unfortunate late chap's junk.

It seemed to me that the chap hadn't touched the stuff for years: if you take it home, neither will you. The correct thing to do with it is to follow the lead of the ancient Egyptians: pour it into his coffin so that it may join him in the next world.

Junk does not have historical significance: there is no point in treasuring a WWII airman's ration tin, for example, because the Australian war memorial in Canberra already has an airman's ration tin. The fact that it is not on display only means that the war memorial considers that there are things of greater historical significance worth showing. However, if you are particularly interested in airmen's ration tins you can apply to have a look at it, and you will find it in rather better condition than something that has been lying around on the wet ground in some ham's shed since 1942.

Neither will junk "one day prove useful". It is true that in 1930 they used to manufacture all sorts of components, such as valves with five pin sockets, variable condensers and loudspeakers with electrically excited field coils; however, if you examine the catalogue of any electrode parts supplier you will see at once that, despite the demise of these wonderful items, the variety available now is far greater than it was then. If you want to model yourself on the good old days, then improvise! Try to design something using only easily obtained modern components.

Some people believe that junk has a soul. This is quite untrue. Junk is totally inanimate. At the end of a project you will find you have lots of little  $\frac{1}{4}$  watt resistors, ceramic capacitors, dust iron rings, and various bits of wire lying around. Don't put them into a special

"junk box" for later re-incarnation. Sweep them up and chuck them out. If they were dead leaves on the garden path you would burn them without thinking twice. Yet dead leaves are made of organic matter; the very word "dead" denotes that they were alive once. But junk is inanimate; it never lived; you have no responsibility for its afterlife.

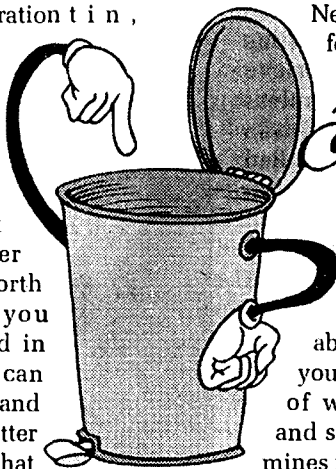

Neither is there any need to feel guilty about throwing out a dust iron ring.

The largest supply of scrap iron in the world comes from the hulls of disused ships. One 20 gram dust iron ring is not very significant by comparison. And, if you are really concerned about throwing out copper, you can put your little piece of wire into an envelope and send it directly to Mt Isa mines for re-smelting. I doubt if any scrap metal dealer could be bothered with it.

Use this advice for political gain! Aim for the total mass of your junk to be significantly less than the total of:

1. Empty vegemite jars kept since 1962 for future preserving of jam.
2. Off-cuts of curtain material, which will be very useful for making patchwork curtains. (Very artistic, since any one piece has a smaller area than any window in the house.)
3. Blankets, crockery and an electric wok, which must never be used because they were given to you on your wedding day.
- 3a. As above (plus second wok) but substitute "engagement".
4. Large Etruscan style vase on waist high pedestal, fashioned out of cast iron, with bronze electroplating and varnished with clear lacquer.
5. Cake which received an honourable

mention at the 1978 Royal Melbourne show together with later improvements by various local insect and small mammal craftsmen.

6. Mystery boxes (quantity five) which you first observed sealed with heavy rope on your first date and which have never been opened in the intervening period.
7. Bush furniture: whole pine tree cut into slices; with original sawdust to give a realism effect.

If you succeed in this political action you will be in a strong bargaining position with your wife and, who knows, you may secure yourself a spot in the house for your operations rather than have to put up with a shed in the garden. It may also help you in your political struggle to avoid, at your ripe old age, taking on another mortgage because "the house is too small".

PS Lest anyone be offended by these admonitions, let me point out that they are directed mainly at those souls living in small apartments in the inner Melbourne area (such as myself). If your dwelling is on a property of 10,000 acres of low grade desert supporting some 0.03 head of cattle per acre, then I daresay it may not be of great consequence if you filled five acres with rubbish. Also, while you may well have further to walk to get to it than I do to my nearest Dick Smith store, at least you won't be spending the equivalent cost of a new FT-1000MP Mark-V transceiver on petrol to get into town in order to buy a four cent resistor.

Neither do I dare to criticise those heroic souls that actually sort their junk into neat boxes and make it available for others as a sort of "discount electronics" store where all the prices are \$0.00. Such souls deserve the Queen's medal!

ar

# Antenna

## 'HomeBrew'

(with a lot of help from your Bushcomm kit)

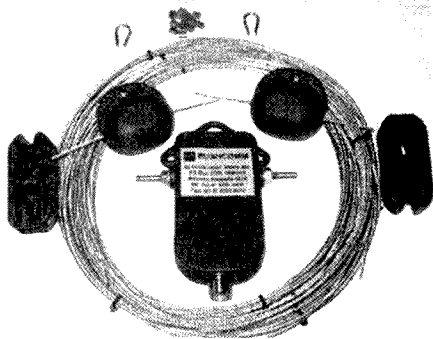

This is a kit version of our popular SWC-100S single wire model, but you have the great satisfaction of constructing of your antenna.

Easy to follow, comprehensive instructions. Common tools required.

You save money and have fun

Once completed correctly your antenna will be a replica of the SWC-100S model. This is a single-wire, base-situation antenna, constructed with stainless elements to give high resistance to corrosion. It has a length of 34m in total. Trees, buildings or other structures can be used to suspend the antenna, (avoid running the antenna over iron-roofed buildings as this reduces the effective height above ground). The antenna can be mounted either horizontally between two supports, or as an inverted 'vee'

Frequency Range: 2-30 MHz  
Impedance: 50 OHM  
Power Input: 100 Watts, 250 Watts PEP

This kit contains:

Balun (x1) Load (x2) S/S Thimbles (x2)  
Copper ferrules (plus a few practice extras)  
Large egg insulators (x2) 4 cut lengths of wire.

FULL and CLEAR  
building and mounting diagrams

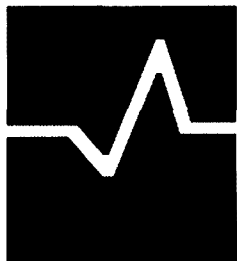

**PROUDLY AUSTRALIAN OWNED  
AND MANUFACTURED**

PO Box 2028, Midland DC 6936 Western Australia  
80 Stock Road, Herne Hill 6056 Western Australia

PHONE: + 61 8 9296 0496

FAX: + 61 8 9296 0495

EMAIL: bushcomm@bigpond.com

See more at

[www.bushcomm.com.au](http://www.bushcomm.com.au)

# 'Ripple from the Marconi School of Wireless in its 100th year

Jim Linton VK3PC

**At the age of 15, in 1920, the experience of listening to a wireless set led Alf Chandler VK3LC into an enduring interest in radio.**

Among his life experiences are communicating with the trans-Pacific expedition by the Kon-Tiki raft in 1947 and being befriended by a notable world leader.

In writing an account of his early days as a contribution to a Marconi School of Wireless reunion, Alf said, "I listened to an early broadcasting station called 3UZ while at Scotch College in Melbourne.

"Being science minded, my best subject was physics, I was attracted to the new science of Wireless."

From that initial exposure to wireless he built receivers himself to tune into the pioneer transmissions as the era of radio broadcasting began in Australia.

Some of the remarkable life of this humble, dapper gentleman was recounted at a special 99th birthday party among friends, associates and admirers on 1 June 2004, at the Moorabbin and District Radio Club.

He took a correspondence course in 1924 with the Marconi School of Wireless. Alf takes up the story by recalling, "They issued me with a 'Rexona Gramophone' and a record for Morse practice.

"However, after a while I had memorised its contents, so I built a one valve set using a 201A valve and honeycomb coils to listen to the Melbourne shore station VIM and any ships in the Bay on 600 metres."

The following year he was one of eight trainees called up to the Marconi School in the AWA building in Queen Street, Melbourne to undergo intense operator training.



After graduation in 1925 he gained a job at 'Crystal Clear Radio' in Swanston Street, Melbourne as a wireless set maintenance employee and salesman.

After nine months he was offered the position of wireless operator/purser on a tramp steamer (a ship not operating on regular schedules) at Darwin, but the conditions and pay were not attractive and he refused the offer.

Alf said, "I have since wondered whether I did the right thing. In my case the Marconi training stood me in good stead during WW2. In 1940 I enlisted in the Royal Australian Airforce (RAAF) in the mustering of Wireless Operators and was posted to many parts of Australia."

His duty was first at the Ballarat Wireless Air Gunners School and later at Townsville and Cairns.

Returning to his pre-war history, in 1926 Alf took out an amateur licence OA3WH and set up a station at his then home in Beaumaris in Melbourne's south until it was lost in the Black Friday bushfire disaster of 1939.

Also in the 1920s there were two amateur wireless groups in at least both Victoria and New South Wales. Alf became the Communication Manager for the Victoria Radio Transmitter League.

The differences between the Wireless Institute in Victoria and the League were resolved with the latter being absorbed into the Institute.

After the war he resumed his amateur interest under the callsign VK3LC also known as "Ripple from the South". He has made notable contributions to the hobby as well significant personal achievements.

On 28 April, 1947 the Norwegian explorer and ethnologist Thor Heyerdahl and five crew set out from Callao in Peru on the 45-foot Kon-Tiki balsa raft, built in a traditional style.

The venture sought to prove Heyerdahl's theory that it was possible for South American tribes to have crossed the Pacific from east to west to settle the Polynesian islands.

Critical to the success and safety of Heyerdahl's expedition was communication provided by two Norwegian radio operators who operated under the callsign LI2B to keep in touch via amateur radio.

One of those involved in keeping skeds on a frequency of 13,990 kHz (just below the 20m band due to a crystal fault) was Alf VK3LC. When the raft crashed on Raroia Atoll of the Tuamotu Islands the expedition rode pounding seas before being dumped into a calm lagoon.

After waiting hours for their battery powered National NC-713 receiver to dry out, LI2B using a hand-cranked generator powered transmitter with a maximum 6-watts, put out an "all well, all well" signal.

It was received by Alf VK3LC. Soon the world knew that the expeditioners on this perilous scientific voyage that had lasted 101 days and travelled 4,300 miles were safe, and their rescue then took place.

Alf met the radio operator of LI2B who with other crew members expressed appreciation for his involvement

in keeping radio watch over their adventure.

In another association with the famous Alf made consistent radio contact with King Hussein of Jordan who had the distinctive callsign JY1. The two struck up a particularly strong friendship.

During an official visit to Australia in October 1976, King Hussein took time out to meet his on-air radio amateur friend at his home.

The King enjoyed the hospitality so much he invited Alf to accompany him immediately to the Royal palace, which he did – a memorable occasion of being guest of a Royal family.

As a strong supporter of the WIA, Alf was a member of the WIA Publications Committee 1963-1970. In 1967 became the VK3 Intruder Watch Coordinator and later the WIA Federal and IARU Region 3 Coordinator.

He received the WIA Ron Wilkinson Achievement Award in 1978 in recognition of outstanding achievement "In the field of intruder watch activities", was presented a Silver Medallion for Meritorious Service to WIA Victoria in 1983 inscribed "For Meritorious Service to the Victorian Division WIA".

In 1984, WIA Federal gave Alf a silver plaque which reads "Our appreciation to Mr AWH Chandler VK3LC for his long-term 1975-1982 contribution as Regional Intruder Watch Coordinator IARU Region 3".

He joined the Moorabbin and District Radio Club in 1959, was its secretary 1960-63 and 1984-87, and elevated to Life Member in 1992.

His other life memberships include: RAOTC of Australia, The Old Timers Club USA, The Society of Wireless Pioneers USA, The ARRL Old Timers Club USA, The World Association of Christian Radio Amateurs and Listeners, and the Ancient and Mystical Order of the Rose Cross USA.

A prized personal possession for 80 years is his original Morse code key. He is not active these days but regularly attends the old timers gatherings at his club.

There is much more that could be written about this gentleman of the amateur radio fraternity who continues to be an inspiration to those who know and admire him.

ar

## OZGEAR

### Ozhelph Services

Doug Hunter VK4ADC

Brisbane

Ph 07 3273 7263

Fax 07 3272 1800

sales@ozgear.com.au



- **HF Transceivers** - 7800, 756Pro2, 7400, 706Mk2G, 718
- **VHF/UHF Transceivers** - V8000, 208H, 2720H, 910H, V8, T90A
- **Receivers** - R3, R5, R10, R20, R8500, PCR100, PCR1000
- **Accessories** - wide range of options and parts



- **HF Transceivers** - Base & mobile FT-1000MP, 817, 847, 857, 897
- **VHF/UHF Transceivers** - Base, mobile and handhelds FT-1500M, 2800M, 7800R, 8800R, 8900R, VX-1, 2R, 5R, 7R, VX150
- **Receivers** - VR-500, 120D, 5000
- **Accessories** - Yaesu rotators, thrust bearings plus equipment options

**Plus...** OzGear balun kits, Diamond HF, VHF & UHF antennas & accessories, MFJ & LDG tuners, Autek antenna measurement, Daiwa cross-pointer SWR meters, RFI, Mobile One, GME, Scalar & TET Antennas, Coax connectors, cables and hardware from Andrews, RFI & Benelec

**With...** More brands available and new products being listed all of the time...

CB, Marine, Airband and Land Mobile equipment and accessories are also available.

**Product not listed above ?**  
Phone or email to see if we can help or visit us on the web at <http://www.OzGear.com.au> for the latest product info plus on-line ordering.

# Getting broadband ADSL

## An intrepid Will McGhie takes on Technology and the Technocrats, and lives to tell the tale

Will McGhie

Many years ago I wrote an article for AR Magazine about the difficulty I had getting connected to the internet. This was way back when the Internet was slower and not as user friendly as it can be today. It took me three months, much frustration and a re-format before I was connected to the Internet.

Times move on and the decision was made to upgrade to Broadband ADSL. The ISP I have been with for many years had served me well with few problems, so I took the plunge and ordered ADSL. My ISP allows you to keep your dial-up connection as back up should you have any problems getting onto broadband while away from home and having access to a computer that does not have ADSL.

First Telstra do a check on the phone line and do the equipment changes at the exchange. All this done, my ISP sent me out a recommended ADSL modem. This is a modem they advise you to purchase, along with the software. The one I choose was a USB type.

It all worked much to my surprise and enjoyment. Insert the set up CD, follow the instructions, connect the ADSL modem to the USB port and the computer does the rest. Mind you the modem kit did not include a "double adaptor" for the phone line as you connect the phone in parallel with the ADSL modem and a small filter connects between the phone line and the phone to filter out the digital data.

I chose the slower and cheaper ADSL connection speed of 256K but it sure is fast. You really can do several Internet operations at the same time fast. I was downloading a file and email while looking up web pages. Fantastic for 30 minutes and then the ADSL connection dropped out. Attempts to re-connect did not work. The ADSL modem status showed that the modem was connected but it was not. Eventually a re-boot allowed me to re-connect and away I went again only to have the same problem after about 30 minutes. A call to my ISP was needed.

My ISP ran through several possibilities, such as various disconnect time outs that may have been setup in the computer but all appeared correct. The next suggestion was to un-install the software and re-install it. I did this but the drop out problem persisted. Another phone call to my ISP (and the attending wait) and this time I was put through to a senior technical person who takes on the hard ones. He said there had been a few problems with this modem and a manual setup usually fixed it. Rather than let the install software do it all, the option of stepping through a custom setup should fix the problem. First un-install the software again. No problem, click on the un-install icon and then the senior technician would talk me through the manual setup. Part way through the un-install program the computer crashed and went to the blue screen of death with the joy of telling me exactly where it had screwed up, a series of many numbers and letters that meant nothing.

"Hmmm" was the response from the senior technician who now stopped typing away in the background and started to pay closer attention to me.

"Let it run for a while and see if the blue screen of death sorts itself out", was his comment.

Now I know a bit about computers and I have never seen any computer running Windows 98se doing anything good after the Bsod. Many Control-alt deletes got nowhere and eventually the manual reset button had to be pushed. Now I knew that this had the potential to be a mess. Just where had the un-install program got to when it crashed? The ISP senior technician (S.T.) (who handles the hard

ones) suggested another un-install. But there was no un-install button anymore! All evidence was that the software had been un-installed, so the S.T. said, "let's re-install the software." Trouble was that the installation program said, "Software already installed"! I now knew that this was not going to be a quick fix and back onto the net.

The S.T. said this was as far as he could go on this one and suggested I contact the distributor. This I did (after the usual 20 minute wait and numerous button pushing) the next morning and was told there was a manual un-install program available on their web site. I thanked the person and dialed up the web site. The dial-up option with my ISP was most valuable. I found the driver download web page but straight away noticed there were two different versions of the ADSL modem. The un-install software was for version A, and I had version B! So another phone call to the distributor (and the 20 minute wait) only to be told "not a problem, the uninstall program worked on version A and B". Thanked him again, but wondered why this was not mentioned to save any confusion on my part and the need for the added phone call. I downloaded the un-install program, ran the program and up came the message "modem un-installed". Great, progress, I thought.

Now to have a go at re-installing the modem. Even though I knew I might have to contact my ISP to run through the manual installation, I thought, as I had the un-install program, I would just run through the automatic installation. The un-install program had removed the initial problem of "program already installed" so it was looking good. However running the installation program was not as it was the first two times I did it. There were no setup windows, just a message to say, "Software installed". And sure enough the modem was not installed! I tried

**"I have to be frank with you", he said. "There are three options, wait for the un-install software, time unknown, install a different model of modem, or (and I knew this was coming) re-format the hard drive and start again."**

## continued from page 4

discounts at selected vendors by the use of a discount card.

DEFCON provides a discount card to defence personal, defence contactors and associated emergency service providers such as WICEN.

All members of the national WIA will receive a discount card and a booklet outlining vendors offering discounts to cardholders in November.

After that, as each member renews his subscription for the balance of the membership year to 30 June 2005, or joins the WIA, the booklet and the discount card will be sent to them.

While it does seem that the extent of the benefit currently varies from state to state, it is hoped that this will be seen by many as a useful benefit of membership. That, at least, has been the view of many members of the former Queensland Division.

More information on the card and where it can be used can be found at <http://www.defcom.com.au/defcomhome.htm>

## The National WIA and the clubs – working together

The WIA board has received many suggestions from visits to clubs by WIA President, Michael Owen and other directors as to how the clubs and the national WIA might work together more effectively.

Many clubs have identified the need to establish an information flow between the clubs and the WIA.

A link from the WIA web site to the clubs web pages has now been provided. It can be entered via the link at the top right hand side of the WIA home page, and is marked "amateur radio clubs of Australia".

## 2005 Australian Amateur Radio Callbook

The 2005 Call Book is currently at the printers and is expected to be available from National Office at the end of October.

After a vast amount of work by Brenda Edmonds, VK3KT, and other contributors, it reflects the new structure of the WIA. This year the disk is, hopefully, simple but fully functional. There are no "special" requirements and it can be searched by either "Word" or "Acrobat".

The WIA invites clubs to distribute the 2005 Callbook

During the first week of October letters and E-mails were sent to every amateur radio club in Australia listed on the WIA website.

The clubs have been offered the Callbook at a special price to allow them to pass it on to their members at a price competitive to the WIA members' price.

This offer has two objectives, The special price allows for some club fund raising and bulk distribution to clubs will reduce the workload for WIA office staff and more importantly, it is a continuing initiative in the team effort between the Clubs and the National WIA.

ar

## Getting broadband ADSL continued

another un-install followed by a search of the registry and the hard drive in general and found various ADSL modem files. I did not want to delete files at this point as fiddling around in the registry can be dangerous if you don't know too much about it. So the un-install program had not worked.

Another phone call to the distributor (another 20 minute wait), and this time I was talking to someone who appeared to know about the problem. Firstly (as I thought) the un-install program for version A would not work on version B. So why had the earlier person told me otherwise? "Well we are in a training phase with some of our staff." I gather these staff make guesses with the customer rather than say, "I don't know but will find out."

So what to do, I asked? Is there a manual un-install program for version B?

"Well no, it is being written and we have no idea when it will be available."

So what do I do?

"I have to be frank with you", he said. "There are three options, wait for the un-install software, time unknown, install a different model of modem, or (and I knew this was coming) re-format the hard drive and start again."

Visions of way back getting connected to the Internet flashed before my eyes. Setting up a computer that has lots of software and bits hanging off it like printers, scanner, cameras etc can take up large amounts of time, so this was not an option I wanted. Also there was no guarantee that the same installation problem and dropouts would not happen again. A couple of days of work could see me back at the same point! Returning the USB ADSL modem and going for an Ethernet ADSL modem looked like the only way to go.

A friend, with the same ISP, had just installed such a modem, which is also a Router, and it allows several computers in the house to be connected to the Internet. My friend had tried to talk me into installing this modem, but I did not have the requirement for connecting

more than one computer to the Internet and the USB ADSL modem was cheaper. The Ethernet modems are not powered via the USB port and remain connected to the Internet even when the computer is turned off. In other words, when you turn your computer on, the Internet is already connected. Also there are no software drivers, great.

A phone call back to my ISP (and the usual 20 minute wait) and after explaining the situation was told, "yes we are having a few problems with that USB modem and don't recommend it."

What! You recommend this modem on your web site!

"Well yes we do, or did, but we are changing our recommendation this very week."

After a few more words I made the decision to return the USB ADSL modem and upgrade to the thoroughly recommended Ethernet Router ADSL modem.

In my next article, I will follow up with getting broadband ADSL at last.

ar

## Wireless Institute of Australia Central Region

# Technical Symposium

Saturday 2nd October 2004

Heights School, Brunei Drive, Modbury Heights SA

John Dawes VK5B.IE

On a bright and shining spring day in Adelaide, 75 amateurs and friends gathered for the WIA Technical Symposium held at the Heights School, Modbury Heights. This was the first such technical symposium held in Adelaide since two previous events held on 24th July 1993 and 17th September 1994, organised by the South Coast Amateur Radio Club Inc.

The event was one of the last occasions organised under the auspices of the WIA SA and NT Division (to be wound up, subject to the motion passing, on November 26th) and was splendidly executed by the North East Radio Club with catering provided by the Scout Radio Activity Group (thanks to Sue and Paul, Sabine and Dean). Meeting in a school was symbolic of the life-long learning habit of most amateurs, but a glance around the room clearly showed a predominance of grey-headed men, and only four women and perhaps only two or three amateurs under forty. The most senior participant told me proudly that he was 88!

Four enthusiastic speakers took the assembled gathering on a wonderful voyage of discovery sharing their passion for the hobby and their questioning minds. **Rex Moncur VK7MO** from Hobart was the first speaker. Rex is also a past winner of the Ron Wilkinson Achievement Award. Rex has come to prominence in the VHF/UHF field and has been almost solely responsible for the promotion of the new modes based on digital enhancement of signals. Rex set a high standard with a computer-based presentation, including pictures of his antenna installations and the two extended 2 metre beams which he said he will use in his attempts in the few days following the symposium to work all Australian states on 2 metres from Coober Pedy.

**Doug McArthur VK3UM**, a multiple winner of the Ron Wilkinson Achievement Award, presented a most engaging presentation on his work with Earth-Moon-Earth communications. Doug's enthusiasm for his topic was obvious, especially when he shared his thoughts and feelings on hearing his own signal come back from the



Left to right: Joe Kasser; Doug McArthur; Rex Moncur and David Giles.  
Photograph by David Clegg, VK5AMK

moon the first time. Doug had sound bites of some of his contacts and the echo phenomena and shared these with us. We were all fascinated by the engineering and trials and tribulations involved in establishing his four metre dish antenna. The computer based presentation, including pictures, held us all spell-bound.

**Joe Kasser VK5WU and G3ZCZ** was the third presenter. Joe is based at the University of South Australia and is a prolific writer, researcher and lecturer in systems engineering. He has received many awards in his long career. Joe's presentation was entitled Computers for Amateur Radio. Joe's capacity to compress over 25 years of history into an hour was a wonder and clearly demonstrated not only the breadth of his knowledge but also his capacity to engage and enthral an audience. Joe had some interesting things to say about

the future of amateur radio which he set in the context of his address, while simultaneously noting the predominant hair colour in the room. He suggested that stressing the communications theme of amateur radio with young people will not engage their interest. They communicate using modern technology, such as mobile phones and the internet, far more fluently than most of the older persons in the audience. But when questions are put to them about challenges or problems they seem more willing to engage. He illustrated this by referring to questions such as how can we communicate with the international space craft and by encouraging experimentation and writing software to perform new tasks.

**David Giles VK5DG** was the final presenter and his topic was called "Amateur Satellites, they are only repeaters". David's presentation was

# My saltwater antenna

John Titmuss VK4JWT

I was having a lot of trouble getting out on my old G5RV antenna, and saw a Werner Wulf 5 band vertical for sale at a local hamfest. I thought I might find a place for it on the roof somewhere, then it occurred to me that I had a beautiful salt water ground plane at my back door! I thought I might do an experiment, and mount the vertical on the pontoon that I have floating in the water.

The XYL wasn't too happy about the idea but, as I said to her, "it's only an experiment". I mounted the antenna on the railing, and connected some copper braid to a copper busbar, which is sitting on the bottom of the canal. After some tuning with my MFJ SWR analyser, I finally got all bands to resonate with an SWR of under 1.5:1. As soon as I turned the rig on I could notice the difference. Switching from the G5RV to the vertical gave me at least 3 S points of gain on all bands! I couldn't believe it, this antenna was as good as a 3 element beam! Since that day I have worked many DX stations that weren't even audible on the G5RV.

The only problem was the antenna didn't work on 30 m, so I came up with the idea of using one of the guy ropes as a sloping vertical for 10 MHz. I replaced the rope with an insulator,



and approximately 7.1 m of wire, and fed it from the bottom with RG213, the shield of the RG213 being connected to the braid going into the salt water. SWR was pruned to 1.2:1.

Now I have the best signal in VK on 30 m! And the XYL? I have convinced her the antenna looks like the mast of a boat!

ar

## Technical Symposium *continued*

also of a very high standard and had the audience fully engaged. He used a computer-based presentation and some teaching aids such as a small globe and a measuring tape to demonstrate the distance of the earth from the moon and the relevant positions of near-earth and extended orbit communications satellites. Like the three presenters before him, David's enthusiasm for his amateur radio activities was clearly obvious. David, a shift-worker, in the timber industry in the south east of South Australia, is able to use his working hours to advantage when trying

to establish contacts through satellites and also showed his commitment to life-long learning by completing a Bachelor of Technology degree from Deakin University.

We in South Australia were privileged to have two very fine presenters from Tasmania and Victoria augment the presentations from the two VK5 amateurs. Feedback from the participants clearly suggested that those who attended enjoyed the day and that a similar event should be held again in the future but not ten years hence! In winding up the

day we were also able to present an award to Dean Whitehorn, VK5ZDW, of the Scout Radio Activity Group, our caterers. Dean has recently been granted life membership of the International Scouting Association for being a very active participant in scouting (42 years and 35 years as a leader). Dean is the Commissioner of Scout Radio in South Australia. The day concluded for about 20 of us, including Doug and David (and his family), by adjourning to a local hotel for dinner and more sharing of time and ideas.

ar

# A "secure computer": an oxymoron?

Bill Isdale VK4TWI

**An oxymoron is the joining of two seemingly inconsistent words.**

**We frequently hear well-meaning suggestions that we should secure our computer but we need more than vague generalities about why this is important and how to achieve it.**

These days, more companies are offering their products for sale over the internet and encouraging their customers to use electronic commerce so we can order things and even do our banking that way. This is enormously convenient, particularly to those organisations, which can save money on store-fronts, but if you find your savings account has been plundered or your credit card used by someone else and you complain about it you can look forward to an investigation to, firstly, see if you are the one who is trying to cheat the institution involved. Once you have been ruled out as the prime suspect, then you may be on the way to getting your life back again. I use that expression, as identity theft is now a growing criminal activity that is attractive to the offender who can be in another country with little chance of getting caught. Such activity is much less risky than breaking into your home; something that police forces have a lot of experience dealing with.

If we connect a computer to the Internet, we need to remember that the average computer, the IBM compatible PC, was not designed for security but for ease of use. The common operating systems, which make them work, are similarly designed to be easy to use. This might not be much of a problem if we used a modem to dial the telephone number of our bank and did business with them, as then we would know who we were in contact with and be using the plain old telephone system, which is quite reliable at connecting us to the number dialled, giving us a private connection.

However, we are being encouraged to connect over the Internet; a system which is open to general use and where not everyone is a good citizen. The Internet is a bit like using a party line to have a private conversation. Once we are on the Internet we are on our own.

Modern web browsers offer encrypted links and this virtual tunnel enhances our security, but lately there have been many creative schemes where websites are made to pretend to be those of an organisation we trust. Another approach is to use social engineering to trick us into installing some hostile software that steals our data. An example is an e-mail with some attachment that may, when opened, install some malicious code into our machine.

A recent example to come my way was a seemingly harmless game that one of my children was attracted to download and which covertly installed a key logging program. These small wonders are set to operate whenever the computer is turned on and to patiently log every keystroke and then send that data over the Internet to the originator who will hope to find such useful information as your credit card numbers and any passwords you use.

The power of this spy-ware should not be underestimated, as the person who receives our data is not inconvenienced at all by there being an encrypted link when we used the credit card or did our banking online. They have intercepted our password from the keyboard, before it was encrypted and can therefore easily get hold of everything they need to pretend to be us.

In my case, the existence of this little gem came to light when another of my children found that his account at a children's game site had been accessed by someone who stole his virtual assets. An examination of what was running in the computer revealed a program that was logging every keystroke and sending the data back to its controller. This was so cleverly embedded that it was quite difficult to remove. On one hand we were getting off lightly as all the thief stole was access to a child's pretend assets. Interestingly, the thief

was probably a child about 12 years old, for this game site to be of interest to them.

The other side of the coin is that this operation can be carried out by someone who is probably not yet a teenager. I found that the key-logging program was available on the Internet and that very little knowledge was necessary to put it to malicious use.

The act of connecting a computer to the Internet is the digital equivalent of leaving the door of your house open while your attention is elsewhere. This is much more so if you use a broadband connection with the computer always on; it then has a static address on the Internet so is more attractive to hackers to use for their purposes, such as a stepping stone to somewhere else or for storing things that they don't want to get caught with. The fact that this may point the finger at you is unlikely to cause them any twinges of guilt, as it is exactly what they have in mind.

A dial-up connection will usually result in your computer being given an IP, internet protocol, address from a block of addresses your internet service provider has had allocated to it. This is described as a dynamic IP address, so your computer will get whatever number is available when you connect to your Internet provider. This makes you more of a moving target.

Whenever a computer is to be connected to the Internet, it is imperative to have a firewall operating to protect it from hostile intrusion. Software versions are available at no cost and are simple to use and install. Essentially, they detect when some software tries to access the Internet or send mail. You can allow the programs that you want to do this to do so and deny this privilege to other software. When something tries to gain some access you will be informed of that and can approve it or not. You only



need to give that approval once and the firewall soon learns what is approved. When something that looks suspicious is trying to access the Internet or send mail you can stop it from communicating with its controller and then locate and delete it.

There are also free programs that will find and remove spy-ware and using one of these with a firewall and antivirus software will give you a reasonable measure of security.

My experience has been that once spy-ware has been removed from a computer the amount of incoming junk mail drops dramatically, indicating that a common purpose of these programs is to collect your e-mail address, and probably also the addresses in your e-mail software's address book, so that those sending the dreaded junk acquire valid e-mail addresses to send it to. This stealing of our data is done at our expense, as we are paying for the Internet time and perhaps wondering why our system seems slow; it is busy working for someone else.

We can put a stop to that.

If you have protected your computer from hostile interference when on the Internet you can take the next step and protect the data on it from loss if, for instance, your computer is stolen. This is particularly important if your financial information or credit card number is on the machine.

There are many data encryption programs freely available, but they will naturally only protect what they encrypt. If you create a document and then encrypt it, that is well and good, but the software which, for instance, does the word processing may have made a backup automatically and stored it in a folder you are not aware of. Equally, the operating system may periodically write the contents of RAM, random access memory, to the hard disk; these things are done to make it easier to recover your work if the computer fails, but they detract from the value of encrypting a particular file.

If there is data that you actually want to secure on a PC then you will need to encrypt the entire hard disk with a product that will require your pass-phrase before it will decrypt anything on the disk, including the operating system. This will ensure that if a thief physically steals your computer they only get the object and not access to all of your data as well. It is the equivalent

of not putting identification on your keys so that if you lose them the finder does not know where they will open the doors. Notebook computers are a favourite target for thieves, so securing them is especially important.

The pass-phrase to decrypt the data must be one unlikely to be cracked by hacking programs so it should not be a word or words but a random assortment of keystrokes as long as you can practically use. Keep a copy in a sealed envelope separately from the computer for when you forget it. The sealed envelope will give you some assurance that it has not been compromised.

As to the pass-phrase itself, it is tempting to use some words. I will use the English language for an example, since I am familiar with it. English has been studied extensively and can be said to be a highly developed and evolving code of sounds and the symbols for them which is used for the economical exchange of information. It has patterns that can be exploited to find such things as passwords. For example, if all 26 letters of the alphabet, and the space, had equal frequency of recurrence, and the occurrence of any letter was independent of which letter preceded it, then the information rate of written English would be  $\log_2 27$ , which is about 4.76 bits, per letter. However, there is a very unequal frequency of recurrence of letters and there are various common patterns to be found. For instance, the most common letters are e, then t, and then a. The letters q, x, and z are very infrequently used. The grouping th is very common and qz very rare. It is common to use ee and oo but ww is very uncommon. The letter q is always followed by u and h often precedes e but rarely follows it.

The sort of boring sorting of encrypted text needed to find patterns which will reflect the underlying patterns in the plaintext which has been encrypted is ideally suited to computers which can do this while the "hacker" is improving their mind watching television.

The result of the patterns is that written English has an overall information carrying rate, or entropy, variability, of the order of only about 1.3 bits per character. If we want to provide enough variability in an English pass-phrase to fill the key-space of a 128 bit encryption key, the recommended length, we need a

pass-phrase of about 98 characters. This is a good sized sentence. If we introduce numbers and other keyboard characters we have greater entropy and can shorten the phrase, but remembering it will be a real issue.

The makers of successful compression or "zipping" software, which is most effective at compressing text documents, exploit these patterns in the written language.

Security requires a little effort and time, as does locking up your house when you are going out. Sadly, it is not really sensible not to lock up your house and if data that is valuable to you is on your computer then your investment of a little time and inconvenience in securing it will be worth while.

As Mark Twain said, "put all your eggs in one basket, and then watch the basket."

73 de Bill.

**"Hey, Old  
Timer..."**



**If you have  
been licensed  
for more than  
25 years you are invited  
to join the**

**Radio Amateurs  
Old Timers Club  
Australia**

or if you have been licensed for **less than 25 but more than ten years**, you are invited to become an **Associate Member** of the RAOTC.

In either case a **\$5.00** joining fee plus **\$8.00** for one year or **\$15.00** for two years gets you two interesting OTN Journals a year plus good fellowship.

Write to  
RAOTC,  
PO Box 1100  
Sandringham VIC 3191  
or call Arthur VK3VQ on **03 9598 4262** or  
Bill VK3BR on **03 9584 9512**,  
or email to [raotc@raotc.org.au](mailto:raotc@raotc.org.au)  
for an application form.

# Technical Abstracts

Peter Gibson VK3AZL

## The sleeve dipole

In *Break-In for May/June 2004*, Lee Jennings, ZL2AL describes an interesting method of achieving multi-band operation in a single structure.

"Most of us use dipoles in one form or another and we tend to put up a dipole on one band only. It is the staple antenna of HF amateur radio and various methods are often used to extend coverage to other bands. Trap dipoles operating on two bands and the G5RV type of dipole antennas are noteworthy for their multi band coverage but their drawbacks should also be taken into account. Traps are not easy to construct and do exhibit some losses whilst the G5RV antenna requires an antenna coupler to match wayward impedances at the end of the feedline.

The open sleeve multi-dipole has been around for a long time and articles using the open sleeve principle have appeared in *QST* and the *ARRL Antenna Handbook*. Some commercial manufacturers are using the design in their multi band Yagi and vertical antennas. It is a most interesting antenna in that only one of the three or more dipoles is connected and fed with the single feedline; the other dipoles are benign and go along for the free ride. I have been using this system for over two years with a WARC band antenna cut for 30/17/12m and the results are the same as if I had been using separately fed dipoles. There is little or no interaction and the feed

point impedance remains at about 50 ohms. The horizontal dipole part of the antenna is about 15 m long and the spacing of the dipoles is 5 cm (2") whilst the plastic spreaders can be any material such as 12 mm plastic tubing with three holes drilled into them and the antennas are threaded through the holes. A simple piece of small diameter copper wire threaded around the main 30 m dipole and around the plastic tube holds the spreaders from moving up the antenna. Each antenna has a standard "egg" insulator at the end. The coaxial feeder may be any length of RG8U or RG58U 50 ohms cable as the feed point is around 50 ohms for each band.

I used polypropylene rope to fasten the ends of each dipole out to the end support, which is a short length of 12mm aluminium tubing. At first the antenna was set up a few metres off the ground and tied to one side of the house and a tree about 15 m away from the house. I then coupled the MFJ Antenna analyser to it and, using the standard dipole formula, found the dipoles were fairly close. A bit of trimming of lengths brought them very close to where I wanted to operate in the three bands. The antennas went higher in frequency by about 50 to 80 kHz when the antenna was hauled up to the top of the tower.

Does it work? Yes, exactly like three separate dipoles with no interaction between the bands. I have used a

30m/17m vertical loop for a few years and this dipole set-up works just as well as the loop. If there is 1 or 2dB difference, I do not notice it. The antenna exhibits a definite increase in gain and noise over other comparative dipoles cut for other bands. For example, if I listen to the 30m band on my 40 m separate dipole and then switch to this 30 m antenna, the noise and the signals increase. The same is true for the 17 and 12m bands. My results are 214 countries on 30 m, 142 countries on 17 m and 68 countries on 12 m. If I compare my ability to work DX on 17 m with Morrie ZL2AAA who lives about 2 km from me and who is using a well tuned 3-el Yagi, then I am in the hunt after he works the DX first. On very weak signals that Morrie will hear, I don't. But that is the difference between a 3-el Yagi and a dipole!

I can't supply gain graphs and charts since I have no way of measuring gain or losses and I cannot plot the patterns. To be sure the sleeved dipole performance will be very similar to standard dipoles because that is exactly what they are. The convenience of being able to work all three bands with no switching as well as having an SWR of less than 1.5 to 1 is great. There is no reason why the same technique could not be applied to other combinations such as 40/30/17m or 80/40/30m. I am planning to put up an 80m dipole in the near future cut for 3.5 MHz with the parallel second antenna a

few inches away cut for 3.8 MHz which should give me good SWR readings on both ends of the band. That should solve the traditional bandwidth problems of antennas operating SSB and CW in that band."

Contact details - leejen@paradise.net.nz

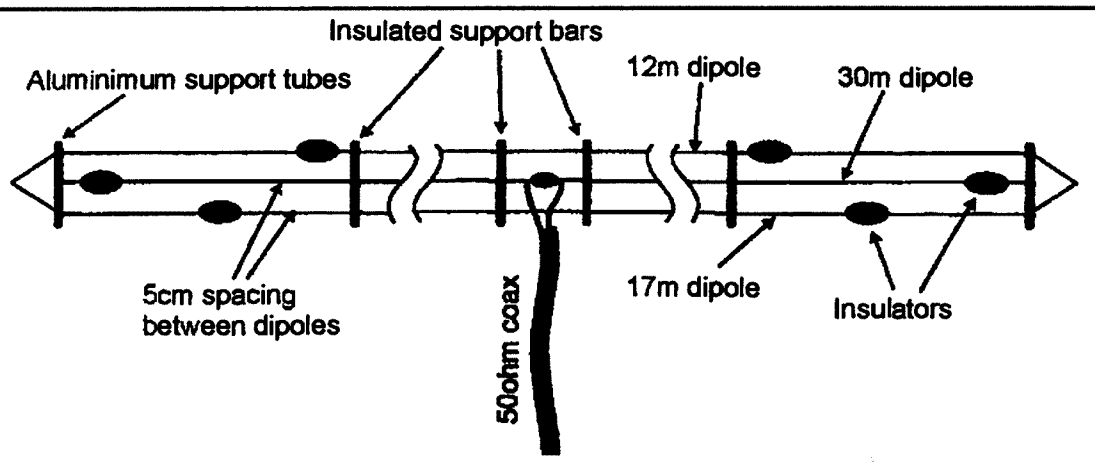

Figure 1 - the sleeve dipole

# Technical Abstracts

## Dual band dipole for 2m and 70cm

The following is based on the Sleeve Dipole described above and comes from Morrie, ZL2ADP.

This simple dual band antenna loads up and works very well for local repeater use in the Wellington area. I have it fastened to the window jamb in the shack, hiding behind the curtain and fed with a 2 metre length of 50 ohm coax. It is directional on 70 cm.

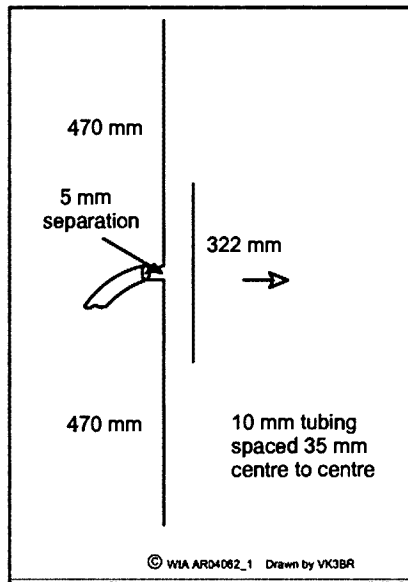

Figure 2 – Dual band dipole

## Simple sound-card-to-radio interface circuits – addendum

Following the publishing of this article in September Amateur Radio, there have been some requests for further information about available software for the modes discussed.

The original article included a number of interesting web sites to visit. The G4KQU site includes a number of links

to a wide variety of software that should cater for just about all needs.

The sites are as follows:

<http://g4kqu.co.uk>

<http://www.echolink.org>

<http://eqso.org>

<http://www.modecomponents.co.uk>

### Silent Key

Henry Andersson  
VK8HA

#### Sad news from Darwin.

Henry Andersson VK8HA passed away 5th October.

Henry was *Intruder watch*, VK8 QSL Bureau, and life member of WIA.

And a top CW operator.

Trevor Quick

www.pca.cc  
Email from anywhere  
via Winlink  
2000  
Use FACTOR-3  
on HF to send  
Mail, Grib Weather,  
Weatherfax & Images  
Contact marc@pca.cc  
Sydney 02 8902 0107

Australian Made

## ANTENNAS

“Setting a New Standard”  
COM-AN-TENA

(Formerly a j and j coman)

115 John Street  
GLENROY 3046

All new 5/8 vertical 16 radials	\$160
Dual drive 26-30 5 ele yagi beam	\$315
4 ele 10-11m yagi beam	\$278
5 ele high gain antennas 11m	\$327
3 ele delta loop 10-11m	\$326
11m 5/8 vert./4-1/4 wave radials	\$175
Duoband 10-15 3 ele each band	\$385
Tri-band 5 ele HB35C s/steel fix	\$730
3 ele 20m computer opt	\$420
3 ele 15m computer opt	\$295
M B Vert Auto switch 10-80m	\$330
40m linear loaded 2 ele beam	\$595
6m 5 ele compt opt beam	\$268
6m 7 ele compt opt beam boom – 60mm	\$387
10 ele high performance 2m	\$145
17 ele high performance 70cm	\$125
2m vert 2-5/8 co-linear 4 rad	\$120
Log-periodic 9 ele 13-30 MHz 8.4m boom	\$990
Wire Dipole 10-20-40-80 MHz	RING

### Guyed Masts

21 metres      13 metres  
Winch-up & tilt-over. Aluminium and stainless steel  
three-sided construction. Auto-brake winches.

### Free Standing Masts

9.5 metres

### New Baluns

1-1 to 16-1 to 3kW



Our Masts meet Australian Standards. We supply all the computations and data you will need for a permit.

03 9773 3271  
Mob: 0419 542 437

## VK1 News

### CRARC Forward Bias

Peter Kloppenburg VK1CPK

**From a distance it looked like a city skyline with irregular vertical shapes sprouting insect-like antennae. But on closer inspection it turned out to be an assembly of military, portable and mobile radio sets, all painted in olive drab colour.**

Hovering over this collection of World War II and Vietnam era radios was guest speaker Graeme Cashion, VK2QI, and erstwhile manager of Civil Aviation Authority's Radio Navigation Services department in the Canberra region. Now living on the NSW South Coast, Graeme is deeply involved with collecting and restoring domestic broadcast and military radio communication sets. Only a small part of his collection of military radio sets was on display at the general meeting that was held on Monday, September 27, 2004.

As a member of the Historical Radio Society of Australia (HRSA), Graeme is keen to show what radios looked like in the past, but this time he concentrated on showing what military radio sets were all about over the last 50 years. As a restorer and repairer, Graeme acquired an intimate knowledge of how each unit in the collection works, their history, and how they were used. Graeme took off the covers of some of the radio sets and showed how miniaturisation was an essential requirement to reduce weight and keep dimensions down to the size

of a lunch box. Given that during the 1940's valves with octal bases took up most of the space and that battery packs weighed almost 2 kg, this was no mean feat. Further developments in valve manufacturing produced types as small as acorns, and which could be wired directly into the circuits. Graeme demonstrated how field operators carried the radio sets. Large units were carried on the back using webbing over the shoulders and around the chest. Much smaller units were mounted on the side of the operator's helmet. Graeme said that valve operated sets were equipped with two batteries for each radio set. An 'A' battery of 3-4 volt, and a 'B' battery of 90-120 volt. These were heavy to carry, and didn't have many hours of operation. As these types of batteries are no longer made, Graeme made up DC to DC converters using sealed, rechargeable lead-acid batteries to keep the radio sets operational. Some of the radio sets on display were the British Wireless set W-31, W-128 and the W-38 with 6 valves, 0.5 watt output. The American sets included the BC-611,

covering 3.3 to 6 MHz 'Walkie-Talkie'; Personal Radio Communication PRC-10; AN/PRC-25, FM, 30-76 MHz, 2 watts, vehicle mounting; and the PRC-6 single channel, 50 MHz, 0.250 watt, Walkie-Talkie.

An essential tool that Graeme uses in restoration and repair of military radio sets is documentation. Graeme brought along two books containing radio set construction details and circuit diagrams of American and British made military radio sets. One was entitled *Wireless for the Warrior* by Louis Meulstee, Volume 2, *Standard Sets WW2*, and, *The Surplus Handbook*, subtitled "Receivers and Transmitters" by Charles Caringella, W6NJV and Richard Clark, W6NJE.

The next general meeting will be held on Monday, November 22, 2004 at 8.00 pm in Scout Hall, Longerenong St., Farrer. Cheers.

**Flash: Sunday's VK1WI 80-metre net to start again at 8 pm EST on 5 December 2004 at a frequency of 3.570 kHz plus/minus QRM,**

## VK6 News

Compiled by Will McGhie VK6UU

Input to: will2@iinet.net.au

08 9291 7165

### Next Special General Meeting

Sorting out the future of our Division continues at Council meetings. The date of the next Special General Meeting to accept the new Constitution and name change was agreed to be the 4th of December at CWA House at 10am. Another mail out to members will be put together at the November Council meeting ready for posting. On the advice of the Treasurer it was decided that the Division could no longer afford to cater for the meeting, but tea coffee and biscuits would be available at the

December 4th Special Meeting. It should be noted that a quorum of 25 members is required for the meeting to take place so it is essential for members to make the effort to be there.

### Hugh Spence DX Fund

The remaining funds (\$516.67) in the Hugh Spence DX fund held by the VK6 Division was donated to the DX petition to Peter Island (3YOX) and Neil VK6NE received a thank you from Bob K4UEE. As part of the clearing of assets held by the Division, council decided this was exactly what the money was intended for.

### Oceania DX Contest

The Northern Corridor Radio Group again traveled to Muresk for the Oceania DX Contest. Using the special call VI6175WA the contest was fun and pretty confusing at times. Our score was down from last year probably due to operating the special call sign right up to start of contest.

Total score was 800,074 with the following taking part: VK6NU VK6APK VK6EH VK6CY VK6YEL VK6JIP VK6ZIC VK6HZ VK6HTW VK6TT VK6TRA VK6BFI VK6FJA

## NCRG at Whiteman Park

Neil VK6NE reported to council on the progress of NCRG's new clubrooms. The Northern Corridors Radio Group had to vacate their clubrooms and have acquired a new clubroom location at Whiteman Park, 20 km North of Perth.

A shed 16 m x 10 m x 4.8 m has been purchased (one third for a meeting room, with 5 smaller rooms plus space in the middle). The footings and the vertical

columns have been completed. The roof and back have been clad, waiting for sand fill to be done. A separate 5 m x 6 m shed had been built for storage. 55 square metres of paving have been procured and require to be laid. A 300-metre run of power cable is to be done shortly. Nearby water is to be connected. The large concrete pour is to be carried out with a brick wall to be built at the front. The Group's 2 m and 70 cm repeaters and the 10-metre beacon are

to be installed at the clubrooms. There have been as many as 16 volunteers working on the site. The photograph shows the beginning of the clubrooms. For more information on the group's progress visit their website at [www.ncrg.org.au](http://www.ncrg.org.au)

NCRG CLUB ROOMS UNDER CONSTRUCTION

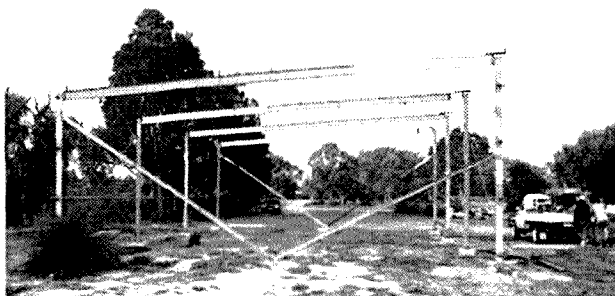

## WICEN WA Notes

Several members of WICEN WA are involved with TELSTRA Rally Australia that is being held in Perth early this month. Planning is now well under way. Our part is in providing communications for the "Safety on Stage" (SOS) function and is an extremely important role for the safety of competitors during the running of the stage.

SOS operators are placed at about 5 km intervals along the route and maintain accurate checking of cars as they pass through. A call is made every minute to the finish or 'stop' operator with the status of each car as it passes so that the stage commander is made aware, within one minute, of a possible problem with a car.

Each operator has been trained in this function and is accredited under CAMS (Confederation of Australian Motor Sport) requirements. The trial event to check all equipment and operations was held on 17th October.

## VK7 News

Justin Giles-Clark VK7TW

Email: [vk7tw@wia.org.au](mailto:vk7tw@wia.org.au)

Regional Web Site: [www.reast.asn.au](http://www.reast.asn.au)

## Division dissolved

On 19th September 2004, 27 amateurs and visitors from all over Tasmania gathered at the Man O' Ross pub in the Midlands township of Ross for what was a sad and historic special general meeting (SGM) of the Tasmanian Division. All three special resolutions were passed with the requisite 75% of those present.

In summary the first resolution dealt with the cancellation of incorporation, the second with making a payment from Divisional funds to the National WIA and the third with dissolving the three Branches of the Division.

A Divisional council meeting was convened after the SGM to deal with the distribution of divisional funds and a range of other minor matters.

The meeting closed with a discussion of what would keep VK7 amateurs together given there was no longer a Divisional Council. The Chair, Phil

Corby, VK7ZAX, outlined the role of the Advisory Council and a range of suggestions came from the floor.

It's an interesting question and one unique to Tasmania as we had just dissolved the glue that united our three main AR clubs (branches), namely the Tasmanian Division of the WIA. Time will tell!

## Tasmanian Hamfest 2004

A quick reminder that the Central Highlands Amateur Radio Club of Tasmania (CHARCT) is hosting a major Hamfest at the Central Highlands township of Miena on Saturday December 4 2004. There will be operating displays, stations, CW, ATV, APRS, digital and vendor displays plus several prominent guest speakers.

Starts at 1100 and winds up at 1500. Entry is by gold coin donation. Coffee

and tea will be provided and food will be available. See you there.

## Sewing Circle BBQ

Sunday November 7 sees the premier social event on the VK7 AR calendar the Sewing Circle BBQ and get together.

It's a combined event with the Southern ATV and Digital group field day and a wake will be held for the Division and Branches. There is a full day of activities and it is hosted by Ken, VK7DY and family on their property at Orielson.

## Northern Tasmania Amateur Radio and Electronics Group

On 15th September NTAREG met at Twigs restaurant on the West Tamar Hwy. Trevallyn for a meal and a very interesting talk by Professor Nigel Forteach on the survival of the platypus in the region.

# State News

## Radio and Electronics Association of Southern Tasmania Inc.

REAST's October meeting was a talk by Brian Hatfield on the Australian Space Research Institute's sounding rocket program at Woomera.

Brian took us through a recent trip to Woomera complete with pictures and the different launch vehicles that are used from sighter rockets to Zuni rockets that go from 0 to 2500km/h in 1.8 seconds!

Brian's special interest is in experimentation with Pulse Detonation engines. One of Brian's responsibilities is the telemetry involved in the test of these engines and he was looking for ideas and suggestions in relation to the telemetry as he is new to this area.

Thanks Brian, and friend John for coming along a sharing their passion for amateur rocketry.



ar

Brian Hatfield giving his illustrated amateur rocketry talk and indicating the eventual direction of all rocketry experiments!

## Silent Key

### Colin MacKinnon, VK2DYM

Colin MacKinnon, VK2DYM, passed away on 05/10/04, after a battle with brain cancer. He was born on 22nd April, 1941.

Colin developed an interest in radio as a youngster living in the country town of Orange, NSW where he continually modified the family console radio, attempting to improve the reception of the kids' serials from Sydney stations. He taught himself electronics, courtesy of "Radio and Hobbies" magazine and earned pocket money by repairing neighbours' radios.

As a teenager, Colin saved up to buy a BC-348, put up a long wire antenna and became an avid short wave listener. An SCR-522, purchased from Deitch Brothers Surplus in Oxford Street, Sydney, continued his interest in Military surplus equipment and he became an inaugural member of the Orange Amateur Radio Club when it was formed.

However, engineering studies, career, marriage and moving to Sydney meant that radio went on the backburner for a long period. However he spent time flying aircraft, racing cars, sky-diving and hang gliding for a number of years, before rekindling his interest in radio.

He obtained his amateur radio licence,

VK2KCM, and a couple of months later sat the 12 words per minute morse exam and upgraded to his full call, VK2DYM.

When Colin and his family moved to Glenhaven, about 10 minutes from Dural, he joined the WIA broadcast team and assisted with the broadcasts for many years, as either announcer or engineer. Because he lived so close to the VK2WI station, Colin was often able to fill in at short notice if a rostered team member was unavailable.

Colin met Ian O'Toole, VK2ZIO, at the initial meeting of the Castle Hill Amateur Radio Club and found that they had a mutual interest in military surplus radio equipment, which led them to many radio scavenging expeditions and two large collections of surplus gear.

Colin was interested in theoretical and practical antenna performance and had a cobweb of yagis and wire antennas around his residence at Glenhaven. His biggest antenna venture was an 80 metre, switchable, 8 element delta loop which achieved 5 by 9+ results into Europe and USA.

In addition, he was intrigued by wireless and amateur radio history, especially in Australia and wrote many technical and historical articles

for "Amateur Radio" magazine and other local and overseas journals. He researched WW2 radar history in Australia and assisted in the production of several radar historical publications. Restoration of military surplus sets, followed by descriptive articles on each unit, for technical publications, was another interest.

The family moved to a 7½ acre property at Maraylya, NSW, so that Colin could indulge his interest in large antennas and DX but in recent years he was not active on air although he continued his research and writing on radio history and military radio/radar equipment. He was diagnosed with brain cancer in September 2003 and had a large brain tumour removed but unfortunately the cancer was terminal.

Colin is survived by his wife, Chris, his sons Malcolm and Andrew and daughter, Jane Maree, as well as grandchildren Arrabella, Cassandra and Tom Norman and Stephanie MacKinnon.

Colin contributed to the hobby in a great many ways but he was probably best known to members for his numerous articles in "Amateur Radio" magazine and as a former Broadcast Team member.

Submitted by Ian O'Toole VK2ZIO

## Adelaide Hills Amateur Radio Society

The last meeting was another interesting one. The speaker was Dean VK5LB who had some very useful tips to pass on to all the computer users in AHARS. It did not matter how long or for how short a time you had been using a computer; you had the chance to learn something new.

The range of questions put to Dean at the end of the presentation indicated just how interesting the talk had been.

This year the practical night for AHARS has been changed to October

to fit in with the schedule of Graham VK5ZFZ, who will, no doubt have another exciting project for us all.

Remember if you are in Adelaide for the third Thursday of any month except Jan, July and December, you are welcome to come to the meeting. The venue is the Blackwood High School in Seymour Road Blackwood.

For more information please contact Geoff VK5TY or Paul VK5PH QTHR the callbook and phonebook.

**Christine Taylor VK5CTY**

## Eureka Special Event Station – VI3BML

**The Ballarat Amateur Radio Group (BARG) will be celebrating the 150th anniversary of the struggle at the Eureka Stockade by activating a special event station, VI3BML.**

Eureka was a defining moment in Australia's history that left a legacy of freedom, social democracy and cultural diversity.

It provided many of the foundations on which contemporary Australian society is built.

Next to Gallipoli, Eureka is Australia's most talked about armed struggle.

VI3BML will be operational on all

HF/VHF bands and modes from 27th November until 5th December.

A special event QSL card has been designed and will be available to short wave listeners and all stations that contact VI3BML.

QSLs can be sent via the Bureau or via VK3BML in the callbook. Further details can be found at [www.barg.org.au](http://www.barg.org.au)

**David Tilson, VK3UR**  
President BARG

## North East Radio Club

October 2nd saw the club take an active role in staging the WIA Central Region Symposium. Four interesting speakers kept the 75 attendees entertained for the day. The Scout Radio Association provided excellent food on the day. There is a separate report in AR on the event.

September and October meetings were two talks on first aid. These were ably presented by John McCallum a local member of St John.

The November meeting will be held on the 12th and is expected to be a demonstration on Radio Control model aeroplanes.

December 10th is our Christmas break up and will be a BBQ and social night.

2004 has been a successful year for the club with membership growing and lots of fund raising done. Our buy and sell in April is now a regular event and it will be next held on Saturday 16th April 2005.

We participated in the Coopers Rally, providing communications for two stages. The club also hosts regular Amateur examinations, and has had quite some success this year.

This year we started a second meeting in the month, on the last Friday. This is a technical night, and has covered such projects as modification of computer power supplies for 12 V 20 amp operation, and programming of Atmel micro controllers. We hope to carry this further in the new year and delve into surface mount techniques and some Atmel projects.

Some future club projects are the erection of a new tower at the VK5RHO site and the possible co location of an Airstream node at this site. Airstream is an Adelaide wide network of 2.4 GHz wireless networking for Amateurs and non Amateurs alike. SAPUG host an access point at their Reedbeds site.

## Whyalla Amateur Radio Club

Our weekly Club meetings are well attended and we can proudly say that the Club can now offer Accredited Examiners and tuition.

The lighthouse weekend was a great success. Our Station was set up at the Lowley Point Light house Cottage 15 km north of Whyalla and 3 members set up transceivers for 80-40-15 m in one room and erected two 20m antennas one facing North East and one facing North West in an adjoining room. VK5AJW, VK5HAE and VK5HBG operated from these portable positions with the assistance from daytime operators, VK5NBS, VK5NEX, VK5HBK and VK5SWL. Many visitors dropped in and were welcomed by members with a cuppa. 92 contacts were recorded and the QSL cards have been sent to the Bureau for distribution.

With the warmer weather approaching our club will begin fox hunting.

**Dudley Teakle VK5HBG**

We need all the help we can get from members in these endeavours.

The North East Radio Club meets on the second Friday of the month at the Ardtornish primary school, Saarinen Ave, St Agnes.

**David Clegg VK5AMK**  
Club Secretary.

## Note for club secretaries

**Please check the WIA web site for your club information.**

**If it is incorrect please advise the web master.**

**If it is not there please send details to the web master.**

# Spotlight on SWLing

Robin L. Harwood VK7RH

Am I glad that the warm weather has returned! In the cool of the summer evenings, I can relax as I scan across the HF bands because there is not much on television. It is so noticeable that there definitely is a reduction in band occupancy when the B-04 period commenced as from 31st October.

## DRM

I have been mentioning DRM here for some time now and I am increasingly hearing this digital-broadcasting mode. I believe that Radio New Zealand International recently signed a contract with Thales for a new 100 kW sender, which will be also capable of DRM transmissions. As RNZI mainly targets the Pacific Rim, the number of suitable DRM receivers would be minimal at this stage. The idea is to use DRM as a feeder for existing rebroadcasting partners in the islands.

I recently received an email from a listener in Brisbane, who has been trialing DRM and his initial observations were interesting.

He said that you do need a strong signal for it to work satisfactorily, otherwise the audio will frequently drop out. Very few broadcasters are actually beaming DRM to Australasia at this juncture. From what I have noted on the Internet, Europe, the Far East and to a lesser extent, North America are the primary targets at the moment.

Although DRM experiments on MF have been conducted in Germany for a while, it is unclear whether DRM will be suitable on MW because DAB is increasingly popular, especially in the UK. The American FCC has been rather lukewarm to these European digital standards, preferring the IBOC standard developed by the Ibiqity Corporation.

This company has been promoting this standard as "HD Radio" and transmissions now have commenced outside of the US in Mexico.

Canada has opted for DAB.

Some American private broadcasters have been trialing DRM but not from senders within the US. So far these weekly test transmissions have been from either Sackville in Canada or Rampisham in the UK and my Queensland informant says they are sometimes heard here in

Australia. At this stage, Radio Australia will not be using DRM, as their existing senders do not have that capability. China has announced that they will rapidly roll out DRM for domestic and international broadcasting. This could also mean that DRM receivers could become readily available as many of the major electronic manufacturers already have plants within the PRC.

## Surrogate service

The surrogate Radio Sawa, based in Washington DC has surprisingly opted out of HF radio to concentrate on locally placed FM rebroadcasts or downloading via the Internet. Radio Sawa is in Arabic The other surrogate service is Radio Farda. It is still using SW. Currently they are on as follows:

### Persian (Radio Farda)

0000-0030 UTC	1170
0030-0200 UTC	1170 9615 9795 9805
0200-0400 UTC	1170 9775 9795 9805
0400-0600 UTC	1170 9510 9795 15185 15290
0600-0800 UTC	1170 9510 15290 17845
0800-0830 UTC	1170 9510 15290 17755 17845 21530
0830-1400 UTC	1170 17755 21530
1400-1500 UTC	1170 9435 13870 17750
1500-1600 UTC	1170 13680 13870 17750
1600-1700 UTC	1170 13680 13870 17670
1700-1900 UTC	1170 7105 11855
1900-2000 UTC	1170 5860 7365 9505 11670
2000-2100 UTC	1170 5860 9505 9960 11960
2100-2130 UTC	1170 9505 9960 11960
2130-2400 UTC	1170

Programs are of course in Farsi. The transmission on 9960 from 2000 till 2130 is extremely loud here in northern Tasmania. The 1170 transmission is from Kuwait or Bahrain. Naturally Radio Farda has no FM rebroadcasts within Iran, as their government is hostile to its presence.

Florida was devastated in September from no less than four serious hurricanes. I am certain you will read elsewhere in this magazine of the sterling efforts of amateur radio operators to quickly step into the breach after commercial communications were knocked out. Programs from the American religious

broadcaster, WYFR, were disrupted for almost a fortnight after the last hurricane came through. There was damage to the antenna farm and the roof of the transmitter hall was blown off yet the main delay was that the power lines were downed and the utility companies had more pressing priorities. Cuba also suffered hurricane damage and it took a few weeks before short wave programs from Radio Havana came back. One of the hurricanes also hit Alabama yet WEWN, the Catholic broadcaster, was quickly back up although temporarily closed until after the hurricane.

Well that is it for this month. In next month's issue, I hope to be reviewing the 2005 edition of Passport to World Band Radio.73 from VK7RH

ar

## VK DISCOUNT CABLES

SUPPLIERS OF  
*RF Components, Coax Cables, Connectors,  
Hard Drawn Copper wire  
Multi-core Control Cables, Copper &  
Aluminium stranded Conductors  
Earthing Equipment and all RF Accessories*

RFS Heliac LCF12-50J (1/2) @ \$4.85 per metre  
RFS Heliac LCF78-50J (7/8) @ \$5.00 per metre  
LMR 400 (Balden 9913) @ \$390 per 100m qty  
(\$3.90 p/m)

LMR 400 Ultraflex @ \$550 per 100m qty  
(\$5.50 p/m)

RG-58CU @ \$60 per 100m

RG-213 @ \$165 per 100m

LDF-450 male & female N type connectors  
@ \$40 ea

LDF-550 male & female N type connectors  
@ \$50 ea

BEL 9913 N type connectors @ \$12 ea

UHF aeries connectors @ \$12 ea

PL-259/213 connectors @ \$2.50 ea

PL-259/58 connectors @ \$1.50 ea

7 core rotator control cable from \$88.00  
per 100m qty

*Technical data available on request.  
Cable samples available on request.  
Various off-cuts available.*

WE ALSO CARRY

- Cable ties
- Scotch waterproof adhesive tapes
- Solder
- Tools
- Heatshrink tubing (glue filled)
- Fibreglass rods & ferals for those mobile antenna projects

*Freight anywhere in VK - \$18.50  
(Overseas customers POA)*

ROB VK2XZ

PH : 0419 480 560 during hrs

EMAIL : rob\_vk2xz@hotmail.com



# New Antenna Parts Auction

10.00am Saturday 20th November 10.00am

196 Waddells Road Nicholson Victoria (Melways Map 528 K5)

Inspection Friday 19th October 2004 1—5pm and auction day at 9.00am

ZCG Scalar Pty Ltd has changed hands. Accordingly, a wide range of antenna parts are offered for sale that are surplus to the new owner. The stock offered includes finished antennas, part finished antennas and raw material.

**Here is a unique opportunity to obtain new and quality antenna parts.**

- 10 Rolls of heatshrink various sizes and color, ● Aluminium tube 40X1.6 X 2m (suitable for Yagi construction) ● Large qty Pressed Stainless steel yagi element saddles. ● Mobile antennas insulator parts, reduced size antennas BNC UHF connectors), ● HP 437B Power meter operating manual (2) ● HP 5350B Microwave frequency counter service manual (1)
- VHF folded dipoles (incomplete) ● Range of Decibel product filters (8) ● PVC Tips bushes 1000s,
- RF Connectors, ● UHF, SMA, UHF yagi's 20, ● new discontinued antennas (marine, VHF cellular) ● PCB spiral antennas 800—2200 MHz (50) ● SS whips, ● Barrel springs 1/2 bsw, (large qty)
- Fibreglass radomes, large qty various sizes and colors and lengths. ● Large radomes 110mm dia X 2 m ● Philips 828 radio, ● Motorola UHF base radios, ● Rhode and Swartz power generator 275—2750 MHz, ● small amount of test equipment, ● Plus numerous associated parts. ● VHF 4 stack array

Terms: Purchases up to \$1000 cash.

Purchases over \$1000 cheque by arrangement with Auctioneer

Auctioneer: Dennis Hall BH 5152 6133 AH 5152 1329.

E. G. Star Auctions Bairnsdale.

## Andrews Communications Systems

ESTABLISHED 1976

ACN 001 968 752

### ICOM DISCOUNTED

IC-756 Pro II HF+6m	\$4,299
IC-746 Pro HF+6m+2m	\$2,499
IC-706 IIG HF-70cm	\$1,399
IC-718 HF SSB w.DSP	\$999
IC-910H 2m+70cm SSB	\$2,699
IC-208H 2m+70cm	\$649
IC-V8000 2m 75W	\$399
IC-R5 H/H Scanner	\$399

\* 3 YEAR WARRANTY \*

### ALINCO DISCOUNTED

DX-70TH HF/6m 100W	\$1199
DR-620E Deluxe dualband	\$599
DR-605E Duplex dualband	\$599
DR-135T Mk2 2m 50W	\$349
DJ-V5E Dualband handheld	\$499
DJ-X2000E Hi-tech scanner	\$799
DJ-X10E All-mode scanner	\$599
DJ-596T Dual band handheld	\$399

\* 3 YEAR WARRANTY \*

### YAESU FT-857D HF-70cm

All-mode compact  
Hi-performance  
transceiver

**\$1,399**



FT-1000MP MkV 200W	\$4,999	FT- 2800M 2m 65W	\$349
FT- 847 HF-70cm	\$2,499	FT- 1500M 2m 50W	\$399
FT-7800R	\$499	VX-1R w/2 batteries.	\$369
FT- 8900R Quadband	\$799	VX- 2R Tiny Dualband	\$399
FT- 8800R Dualband	\$699	VX- 5R Triband H/H	\$499
FT- 817 HF- 70cm	\$999	VX- 7R Deluxe H/H	\$679
FT- 897D HF-70cm	\$1,499	* 3 YEAR WARRANTY *	

COMET ANTENNAS & ACCESSORIES DISCOUNTED

### KENWOOD DISCOUNTED

TS-570SG HF+6m+ ATU	\$2,499
TS-480HX HF 200W+6m	\$2,499
TS-2000 HF-70cm + ATU	\$3,299
TM-D700A 2m/70cm	\$999
TM-G707A 2m/70cm	\$599
TS-480SAT HF+6m+ ATU	\$2299

TOKYO HI-POWER, PALOMAR, TE SYSTEMS, YAESU LINEARS. bhi NES 10.2 DSP speaker \$249 DIAMOND ANTENNAS from only \$99 ea HUSTLER + EMTRON ANTENNAS Avair SWR/RF wattmeters fr. \$99 **DIAMOND - Why pay more?**

BINOCULARS & TELESCOPES DISCOUNTED  
DIGITAL SCANNING RECEIVER ..\$1199

**MFJ** KEYS, TUNERS, ANALYSERS ETC

**CALL (02) 9636-9060 or 9688-4301 or FAX 9688-1995**

**SHOP 8, 41 BATHURST ST, GREYSTANES, NSW 2145**

Why pay more? MAIL ORDER TO PO BOX 240, PENDLE HILL, NSW 2145

Some items indent. Prices subject to change without notice - limited stock, some items. E & OE

\* <http://www.andrewscom.com.au>

\* email: [lee.andrews1@bigpond.com](mailto:lee.andrews1@bigpond.com)

AR17/14

## Those contest logs and.....

I hope all the Contest logs are in by the time you read this, otherwise you may be too late. The snail-mail address is

Marilyn Syme VK3DMS  
199 Magnolia Street  
MILDURA 3500

Email: [alaracontest@wia.org.au](mailto:alaracontest@wia.org.au)

Did you include in the envelope or message, your "expression of Interest" in the ALARAMEET? As Marilyn is the ALARAMEET Co-ordinator she is quite happy to have two items at once.

## More about Marilyn

As many of you are aware, Marilyn VK3DMS has had another hobby apart

from but linked to amateur radio. She is a stamp collector and exhibitor.

Her previous collection was called "Radiomania" and with it she had a number of successes, gradually climbing the ladder of recognition. However, she just missed out on the top prize each time, so last year she decided to reorganize and rearrange her display to give more emphasis on other aspects of electronics and technology beside amateur radio. She called it "Telecommunication"

In September 2004 Marilyn won the coveted GOLD MEDAL in the Perth National Stamp Competition.

Well done, Marilyn, Congratulations from us all!!

## Who is the VK YL who has held her licence for the longest?

Mavis, VK3KS got her licence in September 1939, and is still active in ALARA and on the air from time to time. Is there someone in one of the other states who can better that? We would love to hear about you/her.

Mavis was one of the most active members of ALARA when it was mooted but perhaps there is someone else who has been around for just as long but who has not been involved in ALARA. Let us know all about her, please.

## Recognition for another long association

Recently Meg, VK5YG received a certificate from YLRL that recognised her membership for 15 years. (YLRL is the Young Ladies Radio League, the US equivalent to ALARA.) The only problem was that Meg has been a continuous member of YLRL for 18 years. Somehow their record keeping had made a mistake.

It may have been because Meg changed her callsign from VK5AOV to VK5YG a few years ago, but the date of the change does not fit, either. Anyway the error has now been corrected. Meg has a certificate to say she had been a continuous member for 15 years and in three years time she will be sent a sticker to acknowledge 20 years. Life is complicated, isn't it?



Young people in the Radio Interest Group (RIG)

## At the Symposium



L to R: Samantha Carter, Marg VK5YG, Jenny Zietz, and Christine VK5CTY.



Christine VK5CTY. and OM Geoff VK5TY after all these years!

## The Radio Interest Group in VK5

The radio and aerials so generously given to ALARA by Vic VK2VBK are now in use as he wished them to be, to further the interest of young people in amateur radio, as the photo shows.

The equipment will also be in use for JOTA when it will be formally handed over to RIG by

some VK5 representatives, on behalf of all ALARA.

## ALARA was represented at the VK5 Technical Symposium

On the first Saturday in October a Technical Symposium was held in SA which was attended by three (and maybe four) ALARA members in a group of 80. This is probably about the percentage YLs make in the amateur population. The "maybe fourth member" was a YL who has not yet sat for an exam, has a degree in Physics and is interested in joining ALARA.

The technical presentations were very interesting, and made giving up a lovely Spring day to sit indoors, worthwhile.

## Some recent craft achievements

Sue Mahony, a long time member of ALARA recently entered several knitted items in a Country Show. Although

she was actually late for the judging, due to unforeseen circumstances, she was delighted to find, at the end of the day, that the judges had considered her entries so superior that they reopened the judging and awarded her a First and a Second in one class and a First in another.

Well done Sue, they really were beautifully done and deserved prizes, but I do suggest you try to have them in on time, next year!!

## Are you interested in stereo tape recording?

If so this item will interest you. In the September 25th "New Scientist" - available online - [enquiries@newscientist.com](mailto:enquiries@newscientist.com) - on P 24 there is a story of the first recording made on thin plastic tape covered with magnetic particles.

Because the magnetic particles were much less sensitive that the metal strip used for recording up to then, the

engineers tweaked the controls to such an extent that the circuitry went into a positive feedback condition. The tape recorder circuit oscillated at several tens of kilohertz, producing a high pitched whistle too high to be heard by the human ear.

The feedback oscillation shook the magnetic particles up to such an extent that they became super-sensitive to weak microphone signals. The tape recorder was suddenly able to record sound with a quality very close to today's FM radio and better than most MP3 players.

The experimenters took out patents and hi-fi tape recording was born. One consequence of the ability to record sound in one place and play it back somewhere else later was used to make it seem that Hitler was in one city when he was actually in another. Nevertheless those early recordings of orchestral music can stand up to comparison with the best recordings made today.

ar

## Silent Key

### Sioman Ernest Henry (Ernie), VK2BUE.

**Born 11 April 1913. Died 31 May 2004.**

Ernie was born in a thatched cottage in Holcombe Rogus, Devon England. Ernie joined the Sea Scouts in Malta where his father was posted in the army after the First World War and he received his primary education in Malta.

When he was fifteen, he became a Naval Cadet, and became proficient in morse code, so that by the time he was seventeen, he was a Telegraphist Air Gunner in the Fleet Air Arm and was patrolling the Yangtse in China. Ernie was a champion swimmer in the Royal Navy.

Later in his Royal Navy Service, Ernie was part of the assault team that sank the Bismarck and saw it go down. On Christmas Day 1941, Ernie's ship was torpedoed in the Atlantic Ocean and he was rescued by the HMS Berrick after spending 8-hours

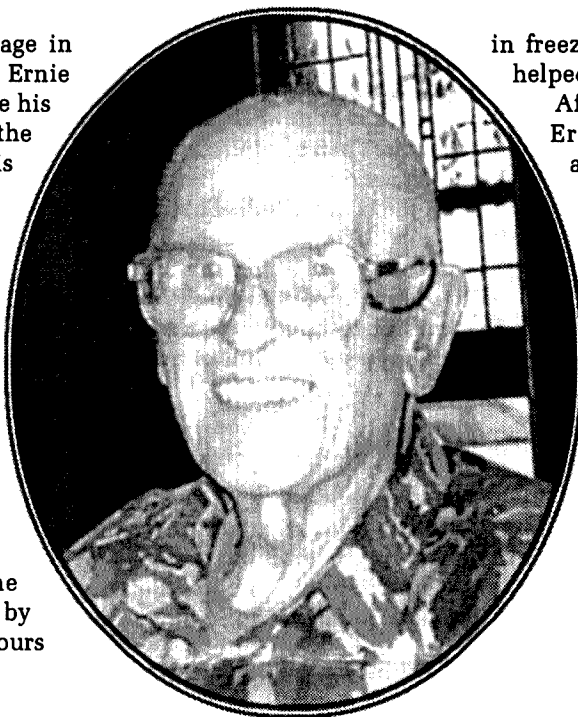

in freezing water. His swimming ability helped save him.

After discharge from the Royal Navy, Ernie came to Australia in 1956 and started his own Radio and TV business in Melbourne. In 1982 he settled in Tenterfield NSW, where he spent his remaining days, with his wife Cathy and enjoying CW skeds with his radio mates worldwide.

Ernie's last call sign, VK2BUE, was known far-and-wide, and "Big Uncle Ernie" VK2BUE, (he was six feet six inches tall) will be sadly missed. Ernie VK2BUE will be remembered just plainly, as "everybody's friend".

Vale - Ernie Sloman. VK2BUE.

**Submitted by Allan Madigan,  
Wauchope 2446. VK2OA-**

## PSK tests on Echo

Several tests of this mode have been carried out but results have been marginal. It seems that one reason, apart from the technical difficulty, is that the receive antennas on Echo are far below optimum on 29 MHz. It therefore requires a lot of uplink EIRP to get a good signal into the satellite.

This is not surprising as 29 MHz was not a prime concern during the design phase. The tests were run on that band simply because the receiver covers "from DC to daylight" and it was something that could be tried. The team will investigate all reports and make a decision whether to run the tests on a more suitable frequency in the future.

## AMSAT-DL's 30th anniversary

We are all aware of AMSAT-DL's proud record in the design, construction and deployment of high orbiting amateur radio satellites. They have been involved from the outset in the entire Phase-3 program.

During October AMSAT-DL celebrated its 30 years anniversary and used the occasion to present the new P3-E and P5-A Mars project to the public. There were about 150 invited guests, including a representative from Arianespace, Jan King and Dick Daniels from AMSAT-NA, who have been long term participants in the Phase-3 story were also invited to attend. The German news media, including TV gave lots of coverage to the event.

I'm sure all satellite users will wish AMSAT-DL all the best of good fortune for the next 30 years.

## Central contact point for Eagle Project Team

Emily (W0EEC) has somehow found enough time to set-up an Eagle Project Central Repository on the AMSAT-NA web server.

Karl (K5MAN) has volunteered to be the administrator for the time being. The idea is to give contributors a central spot to post data and large files to the Eagle Team.

Since many e-mail addresses are

restricted as to file attachment size, this will give contributors a way to share and download large files at their convenience. This will also ensure that valuable data is backed-up on a location other than contributors' own hard drives. All uploads will be reviewed and approved by the administrator before they are posted to the team. Therefore uploads are not available immediately. Once files have been approved by the administrator they will be posted and will be available to all of the Team members.

## 38k4 operations begin on Echo

Around the middle of September the 38k4 bulletin board on Echo was opened for business. Some large files were uploaded and it gave the old digital satellite crew a chance to dust off their 38k4 equipment.

It was obvious from the flurry of questions on the BB that there is still plenty of interest in high speed data but it was equally obvious that many operators had difficulty coming to grips with the requirements of this mode. The sheer bandwidth involved means that a "normal" modern amateur receiver won't do the job. The most common way of dealing with this is to install a separate inboard converter/IF strip in the receiver to cope with the increased bandwidth. Then of course you need to have a higher speed demodulator (TNC). Most of the usual bunch of packet radio TNCs 'top-out' at 9600 baud.

All that can be daunting but if you are really determined and don't have the constructional skills necessary, SYMEK in Germany produce a line of gear which fills the bill nicely.

## Aussie girl talks to cosmonauts

No - this is not a re-run of history, not quite!

We are all familiar with the story of Maggie Iaquinto VK3CFI and her long-term friendship with the Russian Cosmonauts on board the MIR space station. That took place "a long time ago, in a galaxy far - far away" but

Maggie's work with the early Russian crews resulted in a wonderful period of publicity for amateur radio and the amateur satellite service.

This latest story is unfolding as we speak. I received a rather unbelievable e-mail from Maggie last month. She had become aware of a Melbourne Festival production of an opera called "Cosmonaut". She made some inquiries and it turns out that it is a new work by David Chesworth, to be performed as an opera with a very small company of players. The story is about - wait for it - a Russian cosmonaut who communicates with an Australian woman in an isolated town in Australia. Sounds familiar?

When she came back down to earth again, Maggie contacted the producer, Sandra Matlock, and asked if the story was about her. Sandra told Maggie that the cast had chills down their collective spine when they read the e-mail. Since that time Maggie has met the cast and was received warmly in an atmosphere of utter disbelief. They had no idea they were enacting someone's real life experiences.

Maggie's advice and recollections were invaluable to the producer and cast. She was able to fill in many gaps in their knowledge of Russia, the Cosmonauts, life on board MIR and of course, amateur radio and its part in the story. They were particularly interested to learn how the

## The AMSAT group in Australia

The National Co-ordinator of AMSAT-VK is Graham Ratcliff VK5AGR. No formal application is necessary for membership and no membership fees apply. Graham maintains an e-mail mailing list for breaking news and such things as software releases. Contact Graham if you wish to be placed on the mailing list.

## AMSAT-Australia Echolink Net

The net meets formally on the second Sunday of each month. Anyone with an interest in Amateur Radio Satellites is welcome to join in and take part. Graham VK5AGR acts as net controller. The net starts at 0600 UTC and you can join in by connecting to the AMSAT conference server.

All communication regarding AMSAT-Australia matters can be addressed to:  
AMSAT-VK,  
9 Homer Rd,  
Clarence Park, SA. 5034  
Graham's e-mail address is:  
vk5agr@amsat.org

Cosmonaut's voices actually sounded through the radio. They even learned a few phrases of Russian and were anxious to include an odd Morse code character here and there. Naturally Maggie (and the rest of us) are eagerly awaiting the opening date of the opera.

## Availability of Keplerian Element Sets - latest update

The picture is looking a little clearer now. The problem appears close to resolution. Tom Kelso posted the following messages recently on the NASA/GSFC OIG web site:

*Per Public Law 108-136 (The National Defence Authorisation Act for Fiscal Year 2004), Section 913 (Pilot Program for the Provision of Space Surveillance Network Services to Non-United States Government Entities), the U.S. Department of Defence will be standing up a new website (currently not operational) for distribution of the information that is currently provided by the NASA OIG website. Implementation of this new website is being worked by*

*the U.S. Air Force, specifically, Air Force Space Command, and NASA has been working closely with them in this effort. There is a link mentioned in the message that leads to the following page:*

*Air Force Space Command (AFSPC) is establishing a pilot program to provide the space surveillance support that NASA has provided to Commercial and Foreign Entities (CFE) for many years. Authorisation for this program was signed into law on November 24, 2003. In the pilot program the Air Force, through the CFE Space-Track website, will distribute Two Line Elements (TLEs), satellite catalogue messages, satellite decay messages, Project TIP messages, and most of the miscellaneous messages currently offered by the NASA Orbital Information Group (OIG) website. The data will be provided with the same latency that has been provided by the NASA OIG website for many years. There are approximately 1115 current, active OIG user accounts (including Dr Tom Kelso's "Celestrak" site). These accounts will be transferred from the OIG website to the Space-Track website. NASA is working closely with AFSPC in*

*this effort to ensure a smooth transition of operations. The pilot program and the transition from the NASA OIG web site to the CFE Space-Track web site will commence when we have received direction from the Secretary of Defence as required by Public Law 108-136, Section 913, 10 U.S.C. §2274 (i). Initially the CFE Space-Track website will have a limited, baseline capability. The Space-Track website will then ramp up in the following months to replicate the required data and functionality offered by the OIG. There will be dual OIG website and CFE website operations for 90 days during this transition period. The final transition and shutdown date of the NASA OIG web site is still to be determined.*

Tom concludes:

*I do not yet have information regarding the application process, but expect to have that shortly. I will post that information from AFSPC as soon as I can get an electronic copy.*

Dr. T.S. Kelso  
Celestrak WWW,  
<http://celestrak.com>  
E-Mail: [TS.Kelso@celestrak.com](mailto:TS.Kelso@celestrak.com)

ar

## New ARISS operations capability

**The ARISS program is pleased to announce that the amateur radio equipment aboard the International Space Station is now operating in cross-band repeat mode. We realize that many of you will miss the packet-operating mode. However, cross-band repeat allows further experimentation of the ISS amateur radio system**

The downlink for this operating mode remains the same, so listen for the station on 145.80 MHz. The new uplink frequency is 437.80 MHz. All frequencies are subject to Doppler shifting. For further information on working satellites and adjusting for Doppler shift, please review Emily Clark's (W0EEC) excellent presentation on AMSAT's website,

[http://www.amsat.org/amsat-new/information/faqs/Intro\\_sats.pdf](http://www.amsat.org/amsat-new/information/faqs/Intro_sats.pdf)

<http://www.qsl.net/g3zhi> - many ham radio links

<http://www.ukirlp.co.uk>

G4NJI IRLP 5200 Echolink 135909

Rotherham simplex 145.2875 MHz

GB3XN IRLP 5708 Echolink 153126

Langold 430.925 MHz

Ian Abel G3ZHI,  
52 Hollytree Ave.,  
Maltby,  
Rotherham,  
Yorkshire, S66 8DY, UK  
Tel: 01709 799911 Mobile 0783 338 0578

## High altitude balloon update

It's official: the licence has been granted by JFMG and the project is now authorised for 2.500GHz on Sunday 12th September. The licence has special permission to operate up to 50,000 feet (the usual ceiling is 2,000 or 5,000 feet).

The launch is still scheduled for Sunday 12th and it is expected to go up at about 1.30. Plans are still afoot to relay pictures via the new 13cm repeater GB3FT (if the repeater is finished in time) and it may well be linked to GB3HV. Can anyone see these repeaters and link into any others?

This is the only official posting of information on the balloon project. You are encouraged to spread the word as widely as possible.

Further updates will be posted as information becomes available.

Ian Able G3ZHI

ar

# Gridsquare Standings

at 24 September 2004

## 144 MHz Terrestrial

VK2FLR	Mike	111
VK2KU	Guy	102
VK3FMD	Charlie	94
VK2ZAB	Gordon	78 SSB
VK3KAI	Peter	70
VK2KU	Guy	69 SSB
VK3PY	Chas	68 SSB
VK2DVZ	Ross	62 SSB
VK2TK	John	62
VK3EK	Rob	62 SSB
VK3CY	Des	58
VK3XLD	David	55 SSB
VK2EI	Neil	54
VK3TMP	Max	53
VK3ZLS	Les	51 SSB
VK3BDL	Mike	50
VK2DXE	Alan	47
VK2KU	Guy	47 Digi
VK3BJM	Barry	47 SSB
VK3HZ	David	47
VK3KAI	Peter	47 SSB
VK7MO	Rex	47
VK3WRE	Ralph	46 SSB
VK2DXE	Alan	43 SSB
VK3CAT	Tony	39
VK3KEG	Trevor	39
VK4TZL	Glenn	38
VK2TK	John	35 SSB
VK4KZR	Rod	35
VK3ZUX	Denis	33 SSB
VK6HK	Don	33
VK3ZYC	Jim	31
VK7MO	Rex	30 SSB
VK3KME	Chris	28 SSB
VK2KRR	Leigh	27 FM
VK2TK	John	27 Digi
VK3KAI	Peter	26 Digi
VK4DFE	Chris	26 SSB
VK2TG	Bob	24 SSB
VK7MO	Rex	24 Digi
VK3YB	Phil	23
VK5ACY	Bill	23 SSB
VK3TLW	Mark	20 SSB
VK6KZ	Wally	20
VK3BBB	Brian	19
VK2EAH	Andy	18
VK3AL	Alan	18 SSB
VK6KZ/p	Wally	16
VK3ZYC	Jim	14 SSB
VK3DMW	Ken	13
VK2CZ	David	12
VK2EAH	Andy	12 SSB
VK7ZSJ	Steve	12
VK2EI	Neil	11 Digi
VK2DXE/p	Alan	10
VK3ANP	David	10
VK3BG	Ed	10
VK2EAH	Andy	6 Digi
VK6HK	Don	6 Digi
VK2TWO	Andrew	5
VK3ZDR	David	5 SSB
VK2AKR	Neil	3 Digi
VK2DXE	Alan	3 Digi
VK4TJ	John	3 SSB
VK6DXI	Mirek	3 FM
VK2AKR	Neil	1 SSB
VK3XLD	David	1 Digi

## 144 MHz EME

VK2FLR	Mike	110
VK2KU	Guy	89
VK7MO	Rex	74 Digi
VK3CY	Des	70
VK2KRR	Leigh	24
VK3KEG	Trevor	4
VK3FMD	Charlie	3
VK2DVZ	Ross	2
VK2DXE	Alan	2
VK3HZ	David	1

## 432 MHz Terrestrial

VK2ZAB	Gordon	57 SSB
VK3PY	Chas	50 SSB
VK3FMD	Charlie	47
VK3XLD	David	47 SSB
VK3ZLS	Les	40 SSB
VK2KU	Guy	38
VK2KU	Guy	34 SSB
VK3EK	Rob	34 SSB
VK3HZ	David	32
VK3CY	Des	31
VK2DVZ	Ross	30 SSB
VK3BJM	Barry	29 SSB
VK3KAI	Peter	28
VK3KAI	Peter	27 SSB
VK3BDL	Mike	26
VK3WRE	Ralph	26 SSB
VK3TMP	Max	25
VK3KEG	Trevor	21
VK2TK	John	18
VK2TK	John	17 SSB
VK7MO	Rex	16
VK3ZUX	Denis	15 SSB
VK3CAT	Tony	14
VK4KZR	Rod	14
VK3TLW	Mark	13 SSB
VK6KZ	Wally	13
VK2KRR	Leigh	11 FM
VK4TZL	Glenn	11
VK3AL	Alan	10 SSB
VK3ANP	David	10
VK3BG	Ed	10 SSB
VK3YB	Phil	10
VK2TG	Bob	9 SSB
VK4DFE	Chris	9 SSB
VK3KME	Chris	8 SSB
VK6KZ/p	Wally	8
VK3BBB	Brian	7
VK2FLR	Mike	6
VK2KU	Guy	5 Digi
VK3PY	Chas	4 Digi
VK3XLD	David	4 Digi
VK3ZYC	Jim	4 SSB
VK2CZ	David	3
VK2TWO	Andrew	3
VK3KAI	Peter	3 Digi
VK6DXI	Mirek	3
VK7MO	Rex	3 Digi
VK2DXE/p	Alan	2
VK4TJ	John	2 SSB
VK2AKR	Neil	1 SSB
VK2TK	John	1 Digi
VK3DMW	Ken	1

## 432 MHz EME

VK4KAZ	Allan	14 CW
VK3FMD	Charlie	5

VK3HZ	David	1
VK7MO	Rex	1

## 1296 MHz

VK3XLD	David	35 SSB
VK3PY	Chas	34 SSB
VK3FMD	Charlie	32
VK2ZAB	Gordon	29 SSB
VK3ZLS	Les	26 SSB
VK2KU	Guy	25
VK2KU	Guy	22 SSB
VK3EK	Rob	20 SSB
VK3KWA	John	19
VK3KAI	Peter	16
VK3WRE	Ralph	16 SSB
VK2DVZ	Ross	15 SSB
VK3KAI	Peter	15 SSB
VK3BDL	Mike	12
VK3BJM	Barry	12 SSB
VK3TMP	Max	11
VK2TK	John	10 SSB
VK4KZR	Rod	10
VK7MO	Rex	10
VK3HZ	David	9
VK3TLW	Mark	8 SSB
VK3AL	Alan	7 SSB
VK2CZ	David	5
VK3ZUX	Denis	5 SSB
VK3ZYC	Jim	5
VK6KZ/p	Wally	5
VK3BG	Ed	4 SSB
VK3BVP	Shane	4
VK3YB	Phil	4
VK3ZYC	Jim	4 SSB
VK6KZ	Wally	4
VK2KU	Guy	3 Digi
VK3BBB	Brian	3
VK3KEG	Trevor	3
VK2DXE/p	Alan	2
VK2FLR	Mike	2
VK3CY	Des	2
VK3KAI	Peter	2 Digi
VK3KME	Chris	2 SSB
VK3XLD	David	2 Digi
VK4TJ	John	2 SSB
VK6DXI	Mirek	2
VK3DMW	Ken	1
VK3ZYC	Jim	1 Digi
VK4TZL	Glenn	1
VK7MO	Rex	1 Digi

## 2.4 GHz

VK3PY	Chas	11 SSB
VK3XLD	David	11 SSB
VK3WRE	Ralph	9 SSB

VK3FMD	Charlie	8
VK3KAI	Peter	7 SSB
VK3EK	Rob	5 SSB
VK6KZ	Wally	4
VK3BJM	Barry	3 SSB
VK3KAI	Peter	2 Digi
VK4KZR	Rod	2
VK3BG	Ed	1 SSB
VK3TLW	Mark	1 SSB
VK3ZUX	Denis	1 SSB
VK4TZL	Glenn	1

## 3.4 GHz

VK3FMD	Charlie	8
VK3WRE	Ralph	6 SSB
VK3KAI	Peter	5 SSB
VK3XLD	David	4 SSB
VK6KZ	Wally	4
VK3EK	Rob	3 SSB

## 5.7 GHz

VK3FMD	Charlie	10
VK3WRE	Ralph	9 SSB
VK3KAI	Peter	7 SSB
VK3XLD	David	5 SSB
VK6KZ	Wally	4
VK3BJM	Barry	2 SSB
VK3EK	Rob	2
VK6BHT	Neil	2 SSB
VK3KAI	Peter	1 Digi
VK3ZUX	Denis	1 SSB

## 10 GHz

VK3FMD	Charlie	9
VK6BHT	Neil	9 SSB
VK3WRE	Ralph	8 SSB
VK3XLD	David	8 SSB
VK3KAI	Peter	7 SSB
VK3EK	Rob	5 SSB
VK6KZ	Wally	5
VK3PY	Chas	3 SSB
VK3TLW	Mark	3 SSB
VK3ZYC	Jim	3 SSB
VK2EI	Neil	2 SSB
VK3BJM	Barry	2 SSB
VK3ZUX	Denis	2 SSB
VK7MO	Rex	2
VK3BG	Ed	1 SSB
VK4KZR	Rod	1
VK4TZL	Glenn	1

## 24 GHz

VK6BHT	Neil	3 SSB
VK2EI	Neil	2 SSB
VK6KZ	Wally	2
VK3FMD	Charlie	1

## 474 THz

VK7MO	Rex	1
-------	-----	---

Additions, updates and requests for the guidelines to Guy VK2KU, vk2ku@tsn.cc, or by mail (QTHR 2005).

The guidelines (and the latest League Table) are also available on the website of the NSW VHF Dx Group at www.vhfdx.oz-hams.org - click on Gridsquares.

Next update of this table will be in December 2004.

Stations who do not confirm their status for more than 12 months may be dropped from the table.

## Contest Calendar November 2004 – December 2004

6/7	Nov	VK VHF+ Field Day	(CW/SSB/FM)
7	Nov	High Speed Club CW Contest	
13/14	Nov	Worked All Europe RTTY Contest	
13/14	Nov	Japan Intl. DX Contest	(SSB)
13/14	Nov	OK/OM DX Contest	(CW)
17/18	Nov	CQ WW DX Contest	(CW)
19	Nov	YO DX PSK31 Contest	
20/21	Nov	RSGB 160 Metres Contest	(CW)
20/21	Nov	RNARS CW Activity Contest	
3/5	Dec	ARRL 160 Metres Contest	(CW)
4	Dec	TARA RTTY Melee	
11/12	Dec	ARRL 10 Metres Contest	(CW/SSB)
18	Dec	OK RTTY Contest	
18/18	Dec	Croatian DX CW Contest	
26	Dec	Ross Hull Memorial VHF+ Contest	

until mid-Jan., 2005

## Contests to cease. End of amateur radio!

If you read an announcement that contests in amateur Radio were to cease, would you care?

Would you be happy that a pest had been removed? Would you be concerned that any part of our hobby had been forced out of existence? After a while would you be someone who wondered why he had not heard any contests going on lately?

All of these things are possible. Perhaps they are closer than we think!!

However, if this situation were applied to the use of SSB, FM, CW, RTTY, or any mode at all currently available to us, would you be equally happy, unconcerned or wondering? Again, such a result is possible. How? Simply by a process called "BPL".

Broadband Over Power Lines is a system designed to allow access to the Internet via power lines rather than telephone lines. On the face of it, this should be a good idea – power lines are almost everywhere, whereas telephone and TV Cable lines are not. There should be merit in devising a system whereby the bulk of the population can have a ready access to something. Also, as serious Amateurs, we should embrace emerging technology, not just stick with something of the past because we know a little about it.

BPL has been extensively tested in USA, less so here and, I think, hardly at all in Europe; but the interesting thing is that the power companies have applied to the regulatory authorities to remove the immunity from interference provisions covering Amateurs' use of the RF spectrum.

I am fascinated at how quickly our ACA jumped to investigate if this is possible under our RadCom Act. To be fair, I suppose that the bureaucrats must be aware of their legal status under all circumstances, else they will be beset by "smart" lawyers out to make their fortunes.

Why the fuss about BPL? Just that American tests already show that noise levels of 60dB over S9 are common in cities where tests are operative, and that this QRM extends right across the HF bands and into VHF. Some people have said that up to 80 MHz would be about as far as the QRM will extend, and as they don't use HF any more, what's the fuss about? I beg to differ. Signals are quite broadband, so a very large part of the spectrum is under attack.

Perhaps none of this may come to pass. Perhaps the ACA, FCC, RSGB will say

NO to this technology; but if they agree, then I suggest that our hobby would be knocked out of existence. Would you be happy about that?

Ah well, at least we could save our \$57 pa and all become "computer experts". That does not appeal to me! I would be incensed at the loss of something that I enjoy, through which I have made friends, and which would be taken away from me through no fault of mine. Where shall we send all our rigs when they become obsolete? It is non-U to dump them in land fill!

When it comes to human activities, my conclusions about my fellow Man are that there are three types of approach to situations –

1. those who make things happen (the inventors, developers, experimenters),
2. those who allow things to happen (the passingly interested but unmotivated),
3. those who wonder what happened (the complacent and uninformed).

Where do you fit in this scheme?

73, Ian Godsfil VK3JS

ar

# Surviving the Cabrillo contest log format

Vince Henderson VK7VH

**If you have a log program that supports text output of logged information, but does not support the Cabrillo format, then this could be one solution to your problem, when you need to submit an electronic contest log.**

Many major contests now require electronic logs to be sent by e-mail or by posting a floppy disk. The log needs to be sent in Cabrillo format, currently identified as version 2.0. The contests that require Cabrillo logs include most ARRL and CQ contests and the Oceania DX contest. I do not know if the WIA plan to use the same format for the RD contest or other major VK/ZL contests. However, as the Cabrillo log format is rapidly becoming the standard in many countries, I expect that there will eventually be a move to this type of log submission. All contest managers still accept hand written logs. However, once you have used a computer logging program, you will probably never go back to a hand written contest log.

## What is a Cabrillo contest log?

It is a basic ASCII text document that requires all contest log information to be compiled in a set format. The text is set out in a space delimited fashion and each space of every line must contain the log information in a set sequence.

## Why Cabrillo?

Why indeed? When I first looked at the Cabrillo format, I was amazed that this type of ASCII format was chosen at all. It seemed old and antiquated. As I obtained more information, I slowly realised that maybe it is not so bad after all. The job of a contest manager is a monster task. The ARRL decided that a simple system was required. Thus, the Cabrillo log format was born. When an electronic log is sent to a contest manager, all the required information is recorded into the contest manager's master log checking program. Every task that was previously performed by hand is now done automatically. The Cabrillo format makes this simple.

## So, what are some of the problems?

If you submit your log to the above contests electronically it has to be in the Cabrillo format. If your log program does not support the Cabrillo output format, then you will need to purchase new or upgraded logging software. Alternatively, you could purchase software that will convert your current log format. This is the situation that I was in. I have an old DOS based version of Turbolog. I have been using it for over 11 years. It contains all the contacts that I have made since 1992. The log includes three different call signs that I have used in VK and five held overseas. The program is a breeze to use and has all the features that I could ever want. Why would I want to go out and buy new software? There are logging programs that are available as freeware on the net. All that I have looked at do not (as yet) support Cabrillo output. There are log conversion programs available as freeware. Whilst they are capable of outputting Cabrillo log files, the type of input files that they will handle is very limited and my log program is one that is not supported.

## We shall overcome

There must be an alternative to purchasing new software. Providing your logging program is capable of outputting a file that contains certain logged information and the file can be read with a text reader, you are in business. Some people use spreadsheet programs (such as Microsoft Excel) to perform their logging operations. My

solution is based on using Microsoft Excel and Wordpad to manipulate my log program output. Initially there is a reasonable amount of work to produce the required templates. However, once done you will find future conversions easy.

## The Cabrillo Format

Most major contests have a website and the Cabrillo output format can be found on their web page. The information is usually in the form of a Cabrillo template. It contains the format that you will need to use and where to place your contest summary information. An example (Example 1) of the CQWPX SSB contest log information, in Cabrillo format, is as set out in Table 1.

### Example 1

Each line of the Cabrillo text file commences with a line identification. In Table 1, QSO: is the line ID for all logged contacts. The two top lines and the bottom line are not part of the Cabrillo text and are included here to help you identify the placement of the text information. freq = kHz in whole numbers, md = mode (PH for phone, CW for CW, RY for RTTY). Date = date in yyyy-mm-dd format. Time = time in UTC (normally). call sent = your call sign. rst = rs report sent (rst for CW). exch = the serial number that you sent. call recd = the call sign of the station you worked. rst = rs report you received. exch = the serial number that you received.

Some contests have a variation of the serial number. The ARRL W/VE DX contest requires W/VE stations to give out the letters that ID their particular state or province. The DX station must

QSO:	freq	md	date	time	call sent		rst	exch	call recd		rst	exch
QSO:	14000	PH	2003-03-30	1234	VK7VH		59	9	W6QFU		59	21
QSO:	7000	PR	2003-03-30	1255	VK7VH		59	10	ZL4BB		59	15
123456789012345678901234567810123456789012345678901234567890123456789012345678901234567890												

Table 1



give out their output power. This does not present a problem as the exch may be any number or letter or a combination of both.

Example 1 shows room for a 6 digit/letter exch., which is ample for any contest. Take note of the exact number of spaces allocated for each heading. There is always one space between each column and the text that follows.

An example (Example 2) of an extract from my CQWPX SSB Cabrillo log is as in Table 2.

## Example 2

Table 2 is not the complete file. I have included only 6 contacts. Notice the END-OF-LOG: line header at the end of the text file. It must appear after the last QSO: line. All of the line headers should be self-explanatory.

Contest websites contain the information on what headers are required and the information that needs to appear after the header. More on that later. Getting this information correct is a vital part of submitting your log. Get it wrong and your log may be rejected. The good news is that the contest site will usually send you an immediate return e-mail to confirm that your log has been accepted or rejected. If it is rejected, there should be an explanation as to why, or a simple statement that the log is not formatted correctly.

## The Solution

It took me a considerable amount of time to figure out what to do. When the penny dropped, it was relatively simple.

Here is what you need to do

1. Using Wordpad, create a text document using Table 2. Only type up the header of each line from START-OF-LOG: 2.0, down to SOAPBOX: Leave out my contest specific information that I have given in my log example. You will need to input your details as described later. Save this file as finalog.txt. (Remember to save your work as you go)
2. Output the contest information text from your log program. Most log programs have the ability to save specific nominated data, to file, as a text document. This is a prerequisite for this solution to work.

The minimum information required is

Date, Time, Mode, Band, Call sign worked, RS(T) sent, Exchange sent, RS(T) received, Exchange received.

3. Open the text output of your saved log program file in Wordpad and save it as a text file. Let us call it *mylog.txt*.

4. Open Excel. Open the Wordpad file mylog.txt into a new spreadsheet by using the open file command. Follow the Excel prompts and your log information will appear in separate spreadsheet columns. (If you use Excel as a log recorder already, then open this file). Select the sheet tab at the bottom of the spreadsheet, right click and rename the sheet to say **contest log**. Save the spreadsheet. Let us call it **contest.xl**.

5. Create a second blank sheet in the same Excel spreadsheet you just opened. Excel normally has two or three sheets available anyway. Look for the tabs at the bottom of the spreadsheet, usually marked sheet 2 and sheet 3. Open sheet 2 and rename this sheet to say **Cabrillo out**. You now need to format each column in sheet 2 so that the sheet will produce data in the same spaced delimited format that is required by Cabrillo. This is simply a matter of spacing each column to the predetermined format, as in example 1 above.

You will use column A to column U. You need to adjust the alignment and width of the columns. A=4 AL, means adjust the width of column A to 4 and align Left (AR would mean align Right). Do not put any information into the cells. Leave all cells blank. Complete the alignment and width changes to each column as follows (the text in brackets, ie (Mode) is to help you identify the information that will appear in the cells later) -

A=4 AL (QSO:), C=5 AR (Freq), E=2 AL (Mode), G=10 AL (Date), 1=4 AL (Time), K=13 AI (Call sent), M=3 AL (RST sent), O=6 AL (Exchange sent), Q=13 AL (Call received), S=3 AL (RST received), U=6 AL (Exchange received). B,D,F,H,J,L,N,P,R,T = 1 (no text will appear in these columns as they are used as spaces only, no alignment needed). Double check that you have the exact width required. If this is not exact, the final output will not be spaced correctly. Now highlight columns A to U. Go to Format on the menu bar, select cells, select text and then OK. This is to ensure that the text information that you will paste in later will format correctly. That is it for the *Cabrillo out* sheet.

Return to the *contest log* sheet. If

```
START-OF-LOG: 2.0
CALLSIGN: VK7VH
CATEGORY: SINGLE-OP 20M LOW SSB
CLAIMED-SCORE: 112911
CONTEST: CQ-WPX-SSB
NAME: Vincent Henderson
ADDRESS: 3184 Clare Street
ADDRESS: Newtown 7008
ADDRESS: Tasmania, Australia
OPERATORS: VK7VH
SOAPBOX: What a great contest. I had a good time. I use an old, but good,
SOAPBOX: version of Turbolog logging software. It has no Cabrillo export.
SOAPBOX: How many hams are in the same boat as me and do not feel inclined
SOAPBOX: to spend money on new log software or log conversion software.
SOAPBOX: I produced this file by manipulating raw log data in Wordpad.

QSO: 14000 PE 2003-03-29 511 VK7VH 59 1 N3AD 59 339
QSO: 14000 PR 2003-03-29 512 VK7VH 59 2 K7XN 59 341
QSO: 14000 PE 2003-03-29 514 VK7VH 59 3 KP3Z 59 902
QSO: 14000 PH 2003-03-29 517 VK7VH 59 4 KODU 59 638
QSO: 14000 PE 2003-03-29 518 VK7VH 59 5 NAIQ 59 13
QSO: 14000 PR 2003-03-29 520 VK7VH 59 6 WN90 59 307

END-OF-LOG:
```

Table 2

your logging software does not allow you to score a contest log, you can do this using the contest log sheet. Head up some extra columns for points, pfx count, country count etc, and score your log. You will need the final score for the Cabrillo file, see example 2 above.

Format the data in each of the following columns of the contest log sheet to read

**Band** - Change your band info of each band to read 3500, 7000, 14000, 21000, 28000, ie if your log output reads 14MHz replace with 14000.

**Mode** - Change SSB to PH, RTTY to RY. CW should read CW.

**Date** - Change the date format to read yyyy-nm-dd. This can be done globally.

Highlight the entire column that contains the date, click on format on the menu bar and then click on custom. yyyy-mm-dd will appear as an option.

Now copy your column data from the contest log sheet to the appropriate column in the Cabrillo out sheet. Highlight only the cells in the column

of the contest log sheet that contains the contest information, which must be in sequential order. Do not copy any column header information. The copy and paste order is as follows -

Band to cell CI (ie copy the data of the band column on the contest log sheet to cell CI on the Cabrillo out sheet), Mode to EI, Date to GI, Time to I1, RS(T) sent to M1, Exchange sent to O1, Call sign received to QI, RS(T) received to SI, Exchange received to UI.

Next, move the cursor to cell AI of the Cabrillo out sheet. Insert into this cell QSO: and copy cell AI into all the cells in column A, down to the last cell row that will precede the END-OF-LOG: header.

Move the cursor to cell GI. Insert your call sign into this cell. Copy GI and fill the column to the last cell row as above.

You are now ready to produce the Cabrillo file. Make sure that you are in the Cabrillo out work sheet. Go to file, save as. Name the file, in the file name box as *Cabrillo logout*. In the save as file type box, highlight formatted text (space delimited), click save. You will notice that only the Cabrillo out sheet will be saved and it will be saved as *Cabrillo logout.prn*.

Open Cabrillo *logout.prn* with Wordpad. If all is well you should have all the information nicely formatted. If not, you have a problem with the spacing and or placement of the columns in the Cabrillo out sheet contained in the *contest.xls* file. When all is OK, copy all the data in the Cabrillo *logout.prn* file using Wordpad edit. Using Wordpad, open *finalog.txt*.

Position the cursor immediately under the last Soapbox line, open edit on the menu bar and click on paste. Add END-OF-LOG: after the last QSO: line. After obtaining Cabrillo output contest log header details required by the contest manager, of the contest you have entered, insert the required information (see web info later). Type in the information exactly as required and save the finished file. Sit back and have a grin. We are almost done.

Contest managers require your Cabrillo formatted log to be sent with the file name *yourcallsign.log*. ie My CQWPX

Cabrillo file was named VK7VH.LOG.

Renaming *finalog.txt* is easily accomplished by using the DOS edit command.

Bring up the MS-DOS prompt. Type in EDIT. Highlight the file *finalog.txt* (located in whatever directory you put it in). Use the save as command and save the file as *yourcallsign.LOG*. That is it. You will now be able to send your log via e-mail. Prior to sending your log, check the contest rules for the e-mail address of the contest manager. The address will be contest specific. Some older contest e-mail addresses are out of date, so get the latest information that is available.

Now that all the hackwork is out of the way, you will have all the Excel and Wordpad files that you need to create a template for any contest log. You will find that most major contests have very similar Cabrillo format requirements and your template may only need minor adjustments.

Create separate folders for each type of contest that you enter and make a sub-folder for each year. This will save any confusion in the future as all your Cabrillo contest logs will be named *youreallsign.log*.

Don't forget to have a look at the ARRL and CQ Magazine websites for more info on the Cabrillo format and examples of the required header information for the particular contest that you are entering. Two excellent websites to check out are [www.kkn.net1-treylcabrillolapee.html](http://www.kkn.net1-treylcabrillolapee.html) and [ww.kkn.net/-treyl/cabrillolqso-template.html](http://ww.kkn.net/-treyl/cabrillolqso-template.html). Here, you will find many template examples and other general information on the Cabrillo log format.

I would like to extend my appreciation to John Loftus, VK4EMM, for his assistance with a few tips on this article. Thank you John. If you follow the above instructions and cannot produce the necessary file, then send me an e-mail of all your file information as attachments and I will try and put you on the right track. My e-mail address is [vk7vh@hotmail.com](mailto:vk7vh@hotmail.com). The normal exclusions apply. We can perform the impossible, but miracles take a little longer!

Happy contesting.

Vince Henderson, VK7VH

- Icom 706MK2G (NEW) \$1,299
- Icom 706MK2G (IMMAC) \$1,199
- Icom 207H (NEW) \$479
- Icom 208H (immac) \$579
- Icom 910H (IMMAC) \$1,699
- Icom 756PRO2 (IMMAC) \$3,299
- Kenwood TS2000 (IMMAC) \$2,399
- Kenwood TS480HX (IMMAC) \$1,799
- Kenwood TS480SAT (IMMAC) \$1,699
- Yaesu FT8900R (USED) \$649
- Yaesu FT100D (IMMAC) \$1,299
- Icom AH4 ATU (NEW) \$479
- LDG AT11mp Tuner (immac) \$399
- Yaesu VX5R (immac) \$449
- Icom 207H (used) \$399

FULL RANGE OF NEW HEIL PRODUCT  
PRICE SUBJECT TO CHANGE - CHECK  
WEBSITE FOR LATEST BARGAINS.

PLENTY OF OTHER CURRENT MODEL  
GEAR AVAILABLE.

WILL CONSIDER TRADE IN OF ANY  
CURRENT MODEL GEAR.

## Computer Interfaces

Icom and Yaesu \$75

Mobile Kit IC706 (NEW) \$85

Freight to anywhere in VK / ZL

ORDER ONLINE AT  
[WWW.VK3AJJ.COM](http://WWW.VK3AJJ.COM)

OR TEL: PAUL (03-9504-2628)

LICENSED SECOND HAND DEALER NO 10229 (Vic)

# Over to you

## A 15 minute read

It is very difficult to criticise a magazine mainly put together by volunteers. However I have for some time been concerned about the contents of the magazine and judging from the comments heard on the South West 40m net this morning, so are others.

The October edition is a 15 minute read at best. I cannot believe that more than a very small number of amateurs are interested in the VK5DJ repeater controller which takes up 10 pages (no doubt an excellent technical article).

Drew Diamond's article on fixing up old variable capacitors is of course useful to some, but I do query the necessity of printing such large photographs - even that of a can of spray!

Reports, contest information and news are of course the backbone of a club publication, which I personally read with interest whether it be from ALARA, VK7, AMSAT and etc. even though they may be out of my immediate world.

*Letters to the Editor* comes first in my read, as I believe it does to a lot of others and I am disappointed when none are printed (probably because none are submitted!).

I cannot believe that AR would be attractive to the casual purchaser at the newsagents

Fred Parsonage VK6PF

## Purchasing equipment from overseas

Rob Owen, in "Over to you" September 2004 states a few issues with purchasing equipment from overseas. Let me show you a few actual examples of what's wrong with purchasing equipment here in Australia.

### Example 1

I priced an IC-706MKIIG from several Icom dealers here 12 months ago. The best price I could get was around \$2000 plus \$140 for the DSP unit and an additional \$90 for the separation kit and mounting brackets. Oh, and all the dealers on the east coast wanted to change me \$50 shipping to VK6. I think if I was going to spend over \$2000 with them, they could easily cover the shipping! I purchased the radio from the USA for \$1360 landed in VK6. A small saving of \$870.

### Example 2

I have recently priced a Yaesu FT1000MKV Field from the USA. I have priced this radio from several dealers in the USA and found they are offering it for US\$1739. I figure landed here in VK6 it would cost me around \$2600 to \$2800. (Yes it is a new one!) One Yaesu dealer in Australia is selling the same radio for \$3999 and another for over \$5000. I think the saving really is worth the risk.

As for the service issue, I could send my 706 to the USA and back several times before I lost the saving I made. And if I did have a problem with the radio, I'm sure that Icom Australia would work on the radio regardless of which country I bought the radio.

There is no incentive for me to spend my hard-earned dollars on a radio in Australia. Maybe it's time that the large radio manufactures and resellers/dealers did a little soul searching and some market research to find out why there are so many radios being imported into Australia from the USA. I'm sure if prices came down to be comparable with the price of an import, they would increase sales volumes and Australia would be considered a serious market!

John Ferrington VK6HZ

## Financial viability of proposed NSW "Division"

I wrote to the VK2 Division in June asking if the proposed arrangements for NSW would be viable if only a percentage of existing member elected to join for a fee of \$10 per annum and if the arrangements proved to be not viable what would be the liability of the members.

Further, would the WIA (National) pick up any short fall and how would any assets be disposed of or distributed?

I could not see how any one could make a decision about remaining in the NSW Division without this basic information especially as the WIA required surety from members.

In September I wrote to the VK2 Division and the WIA asking the same questions. So far I have not had a response to any of this correspondence.

In his "WIA comment" in Amateur Radio for September Michael Owen says he "chose to ignore letters because they were so wrong"

Is this the face of the new organisation or is it ignorant of the facts raised or just trying to hide them?

In summary my question is; will VK2 be financially viable under the proposed arrangements?

Doug VK2DDR

## Phonetics

This might be of help in the future.

I noticed on the Jota and Joti event that Amateurs were not using 'proper' ie the "NATO" recommended Amateur Service, phonetics, when announcing call signs.

For example they were using "Victoria Kentucky 2 University Washington, this after listening was throwing confusion into the operators on the other end as they were and are not familiar with those phonetics and came back dumb founded.

The Scouts and Guides learn the same phonetics as we amateurs are supposed to use eg Victor Kilo 2 Uniform Whiskey. (WIA Australian Amateur Callbook 2004 page 129 Editor)

If used properly then I feel the weekend would have been far better than it was.

Chris Wright VK2UW

ar

## PLAN AHEAD

**26 December  
until mid-  
January, 2005**

**Ross Hull  
Memorial  
VHF+  
Contest**

# VHF/UHF - an expanding world

David Smith VK3HZ - vk3hz@wia.org.au  
Leigh Rainbird VK2KRR - vk2krr@telstra.com

## Weak signal

David Smith - VK3HZ

Spring is definitely in the air, and with it came the first openings of the season across the two popular water paths.

On the evening of September 16th, Bill VK6AS in Esperance worked Colin VK5DK in Mt Gambier, Phil VK5AKK in Adelaide and Russell VK3ZQB in Port Fairy, all on 2 m. Bill was also hearing the Adelaide 2 m beacon. It's good to hear that Bill is back on air, as he had suffered significant damage to his large, 8 x 16 element yagi array from a windstorm.

On September 19th, Bill also heard the Adelaide beacon, but got no response to his calls. Later that day, Peter VK5ZLX on the outskirts of Adelaide was worked at S9+ strength by Leigh VK2KRR on 2 m. Peter then managed to work Chris VK2DO at S5 both ways, much to Chris' relief. Chris has reported hearing the Adelaide 2 m beacon from his new QTH frequently over winter, but hadn't managed to raise any responses to his many calls. Peter also worked Trevor VK3KEG, Ian VK3AXH and Jim VK3II.

On the afternoon of October 11th, the first contact occurred across the water in the other direction. Gordon VK2ZAB worked Nick ZL1IU on 2 m with S7 and S9 reports. Attempts on 70 cm were unsuccessful. Gordon reports that it is the 27th consecutive summer that ZL has been worked from VK on 2 m.

The opening to ZL remained for about 3 days. Ross VK2DVZ in Taree reports that on the evening of October 12th, he worked Nick ZL1IU on 2 m (S7), 70 cm (S7) and 23 cm (S1). He also worked Ray ZL2TAL on 2 m at S4. On the morning of October 13th, Steve ZL1TPH reports working VK2ZAB on 2 m, and VK2FZ and VK2TZ on both 2 m and 70 cm. On the same morning, VK4LC worked ZL2TAL. On the afternoon of October 14th, Trevor VK4AFL worked Nick ZL1IU on both 2 m and 70 cm. He was heard on 2 m by David ZL1BT, but no contact was made. David did manage to work Ross VK2DVZ on 2 m at S5. He also heard VK2HO working ZL1IU.

Speaking of the water paths, one of the stations that usually manages to work across the Bight into Melbourne at least

once during the summer season is Wal Green VK6WG in Albany. I read recently that Wal is VK6's earliest licensed and oldest, active Amateur, having obtained his licence on June 19th, 1936. Wal was born in 1911 and turned 93 in August. Apparently, he still climbs his own tower to perform repairs on his antennas!

## Web Links

It's probably time for a quick update of the "must have" list of web links for the serious weak signal operator.

<http://pobox.une.edu.au/mailman/listinfo/vk-vhf> - the VK-VHF email reflector

<http://vklogger.brizwebz.com.au/> - the VK/ZL VHF-UHF Propagation Logger

[http://home.cogeco.ca/~dxinfo/tropo\\_austr.html](http://home.cogeco.ca/~dxinfo/tropo_austr.html) - the Hepburn VHF/UHF Tropo Forecast

<http://www.vhfdx.radiocorner.net/> - The NSW VHF DX Group site

<http://www.users.bigpond.com/anvdg/> - The Australian National VHF DX Group

[http://www.aca.gov.au/pls/radcom/register\\_search.main\\_page](http://www.aca.gov.au/pls/radcom/register_search.main_page) - ACA register of licences

## Operating Issues

With the onset of the busy season on the bands, it's probably appropriate to make some comments about possible improvements in some people's operating procedures.

Like many people, I usually monitor the 2 m calling frequency - 144.100 MHz - for extended periods while in the shack (which, for me, is also a home office). Unfortunately, it seems that many people are unable to tune away from the calling frequency, even when testing their rig. It is not unusual for the quiet hiss of the local power poles (!) to be rudely interrupted by an S9+ whistle as someone checks whether their rig is still able to transmit. Tuning up the linear also occurs on the call frequency. Please consider others when doing this, and tune away from the call frequency - there's plenty of space.

Another practice I hear sometimes is the use of FM-type calling - e.g. "VK3ABC listening". Unfortunately, many times the station is well off frequency, so all that is heard is "Waark Waark Waark". By the time the tuning dial is tweaked around to a frequency



Alan VK3XPD and Bill VK3AMH setting up for a record attempt

reasonably close, the station concerned has stopped transmitting. Were they calling CQ, or calling a specific station, or just testing? While extended, 5 minute CQ calls are also inappropriate on the calling frequency, please call several times to allow time for your signal to be resolved.

Finally, a subject that has also been the topic of some discussion recently on the VK-VHF Reflector – that of stations not Netting to each other's frequency. Like many, I find that weak SSB signals are more intelligible if the signal is tuned to sound higher than natural. Unfortunately, if you do this with the main tuning dial, then your signal to the other station will be low, and much less intelligible. In cases of very weak signals,

the other station may not even hear you simply because you are off frequency. It is quite common to hear two stations working with a frequency difference of 100's of Hertz. There may be technical reasons for this - rig not transceiving, coarse frequency resolution of digital tuning. Yes, the Clarifier/RIT can be used by the receiving station to resolve these differences. However, the best operating practice is to firstly net onto the other station's frequency and then use your own Clarifier control to get the audio signal that you desire.

## Microwave

Over winter, a group of Microwavers headed north to the warmer climate of VK4 with the aim of setting some new

records. The expedition comprised Bill VK3AMH, Alan VK3XPD, Russell VK3ZQB, Colin VK5DK, Errol VK4ZHL and Neil VK2EI. Doug VK4OE joined them for the VK4 24 GHz part of the expedition.

Propagation conditions were flat for the entire trip, and many challenges were presented, mostly not involving the radio side of things. Nevertheless, following much hard work, they did manage to set new VK4 records for 5 GHz, 10 GHz and 24 GHz and a new VK2 record for 10 GHz.

A more detailed report will appear in an article next month in AR.

Please send any Weak Signal reports to David VK3HZ at vk3hz@wia.org.au.

## Digital modes

David Smith - VK3HZ

Our Digital Modes correspondent – Rex VK7MO – is currently travelling through VK5 and VK8, busily creating the Digital Modes news for this month.

As reported last month, Rex is gridsquare hopping northwards from Adelaide to Alice Springs and beyond, working many stations on FSK441 Meteor Scatter. Rex has a new 4WD vehicle enabling him to get to more difficult hilltops and he has also built an extension piece for his 2 m yagi, bringing

it up to 19 elements and 11.7 m (38 ft) long – only used when the weather is calm! This setup has also allowed him to work several larger EME stations using JT65B including I2FAK, HB9Q and DL8GP.

After some long sessions particularly with the more distant VK1, 4, 6 & 8 stations, Rex achieved his objective of working All States (VK1 to 8) in one day on 2 m meteor scatter (FSK441B mode) from the Coober Pedy area. The

only hiccup was his petrol generator temporarily running out of fuel.

The stations worked by Rex were VK1WJ, VK2FLR, VK2KRR, VK2EAH, VK2AWD, VK3HZ, VK3II, VK3CY, VK3AXH, VK4TZL, VK5DK, VK6HK, VK7JG, and VK8RH.

Well done, Rex.

Please send any Digital Modes reports to Rex VK7MO at rmoncur@bigpond.net.au.

## 2 m & 70 cm FM DX

Leigh Rainbird - VK2KRR

After two months of quiet conditions, 2 and 70 FM came alive for one morning in September in the southeast. Some activity in north Queensland but not as much as hoped.

Sunday morning the 19th of September saw a lovely calm day under the presence of a high-pressure cell. This duct came on in typical summer style. Signals started building from around 3 am. Initial signs were good at 7.30 am, Adelaide 2 m beacon was 5/9 signal. Conditions did not seem to favour VK3 a great deal.

Initially, Brian VK5UBC and Peter VK5ZLX were worked on 146.500 in the 740 km area. 439.000 was tried, but contact was not made there.

Of particular surprise to me was being able to access the Port Lincoln repeaters on both 2 m and 70 cm. The 70 cm repeater on 438.225 was first noted at 5/7 signal from 1026 km. The 146.750

repeater was also very good at 5/9 signal from 1019 km.

Later in the morning, showing just how strong conditions were in the Adelaide area, Brian VK5UBC was able to easily work into the Port Lincoln 2 m repeater from his mobile parked in his driveway at Gawler, around 250 km.

Overall, this opening was quite exceptional for the time of year. It is quite rare to hear the Port Lincoln repeaters, even more so at such good signal strengths, Port Lincoln being the last stop before VK6. Signals at this strength would indicate the possibility of a Bight Path, but unfortunately a low-pressure trough near Esperance put a stop to any signals in that direction being heard.

From up north VK4 way, Mike VK4MIK has sent a few activity reports. Mike is located at Butchers Creek to the south of Cairns.

On the 24th of September, Mike advises that he was able to get as far as the Townsville 2 m repeater in the morning. In the evening he had a path to VK4RDC repeater at Hayman Island. This is a good 451 km for Mike. Gary VK4ABW was also able to get to this repeater from Townsville.

On the 26th, between 6.30 am and 8.00 am, Mike advises that he was able to get through to 2 m repeaters at Townsville at 250 km, Mackay at 535 km. Mike also rustled up some simplex contacts including John VK4FNQ at Charters Towers and also Snow VK4IFS at Townsville. Mike also mentions working the VK4RHR repeater at Hodgson Range. This works out at 644 km, not a bad effort.

Please remember to send through any 2 & 70 FM DX reports to Leigh VK2KRR at vk2krr@telstra.com.

ar

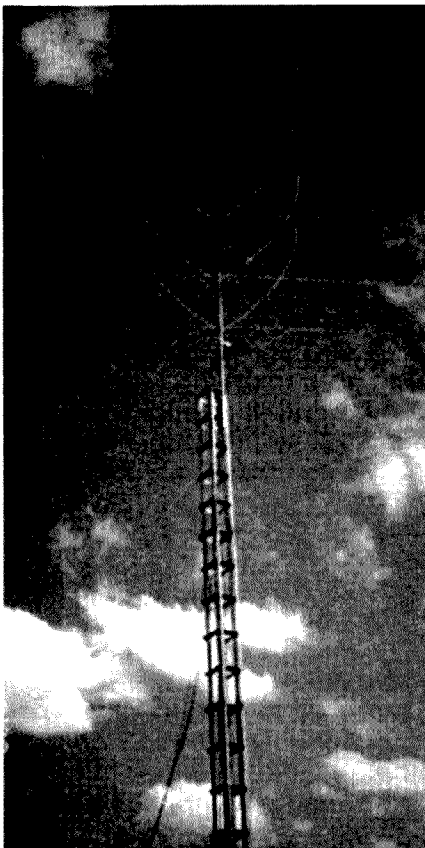

### **One Man Tower™**

**“20 years on and still going strong”**

**FREE STANDING**

**SELF-ERECTING**

**SUPER VERSATILE.**

Available on order only – sizes 10m to 25m. Manual winch or electric motorised version.

Fully hot dip galvanised steel construction – galvanised after construction to ensure a complete and long lasting resistance to corrosion – even in harsh coastal environments.

The worlds strongest small footprint tower – units have survived the powerful hurricanes which hit the United States recently. (A 15m OMT survived Hurricane “Lily” – 256 kph - in Louisiana and a 20m unit survived Hurricane “Ivan” – 265 kph - in Florida. The proof is in the pudding as they say.)

The “One Man Tower™” gives you the control over your antenna that you should have – you can install or adjust – repair or change your antenna system with both feet safely on the ground – as the tower does not tilt you do not need a large clear area to work on the antenna.

### **Introducing the fantastic OzSpid antenna rotator.**

Australian Enterprise Industrial has recently been given the distribution rights for this fantastic little rotator.

Runs on 12v DC – so it can be used to great effect in the portable station. Multiple control options – direct or remote – log book linked software for PC control – control box is small so does not take up lots of room on the radio bench.

Solid steel construction – no cheap “pot metal” here. Massive steel machine cut worm drive gearing – no plastic or aluminium. Positive braking – electronic limiting stops – fully programmable.

Full back up provided – the most popular rotator sold in Canada and soon to be the most popular rotator in Australia.

Priced sensibly at \$990 inc GST. (freight extra)

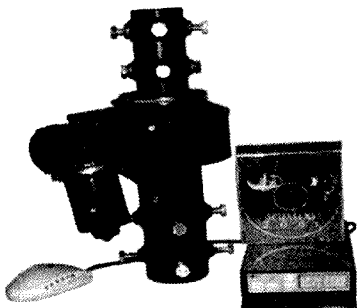

**Australian Enterprise Industrial.**  
**P.O. Box 1013. Browns Plains. 4118 Qld. Australia.**  
**Mob. 0414254080 – Fax. 0738008003.**

**Email [aitower@ihug.com.au](mailto:aitower@ihug.com.au)**  
**Website <http://homepages.ihug.com.au/~aitower>**  
**Kev. Peacock VK4KKD**

# Still the Sun

Bill Isdale VK4TWI

Not all that long ago, some people worshipped the sun. They were not foolish but simply less educated than we are today. Looking around them, they would have seen that the sun provided light and warmth; that the seasons were more favourable for crops and animals when the sun stayed longer in the sky and there was more warmth and comfort for themselves.

## What has changed?

The sun is still pouring out energy but we know more about it and it is no longer such a mystery.

## What exactly is it?

We now know that it is a medium sized, middle-aged star in an ordinary part of an ordinary galaxy. It is a collection of gas, mostly hydrogen, the lightest and most plentiful element in the universe. It has condensed by gravity into the shape that in space gravity will collapse a cloud of gas into, a sphere. Collapsing caused it to rotate. Because it is rotating and active with nuclear fusion, it is not a perfect sphere, but bulges a bit around the middle.

## What is it doing?

We are continually learning more about our nearest star, which is much easier to observe than any other star since it is relatively close by. For a long time our sun was unfashionable for astronomers to study since the biggest and most expensive telescope, capable of collecting a few faint photons, wasn't necessary to observe it and the biggest and most prestigious research grant wasn't to be had for a study of it. Nowadays we know that the thermonuclear explosion, which is constantly going on, is releasing energy over the whole electromagnetic spectrum. It pours out energy in all directions, some tiny part of which falls upon our Earth, providing the energy to power the weather, grow the

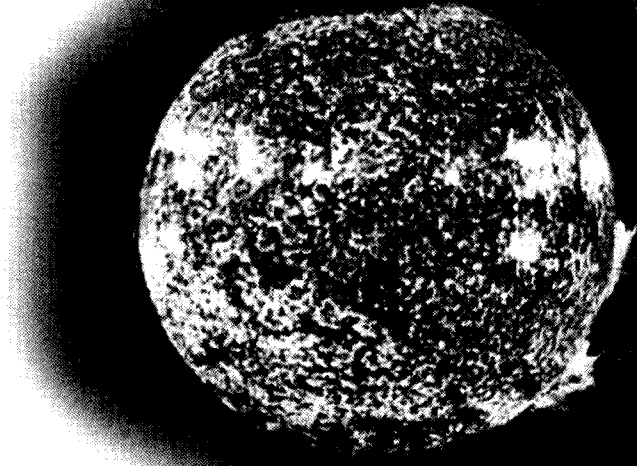

crops and among many other things, energise the ionosphere so as to make it reflective to electromagnetic energy at radio frequencies.

Galileo began to observe the sun with his new invention, the telescope and by 1610 began to publish his observations. On the sun he had seen imperfections, sunspots. Like other new or newly discovered things, this was perceived as threatening to some people who had an interest in everything staying the way it was; that is to say they were in power. Galileo was accused of heresy by the Inquisition; an investigative body best known for its use of fact finding methodology which remains popular to this day. It will be recalled that Nicolaus Copernicus had similar difficulties with the same body because of his notion, in 1510, that the earth revolved around the sun. Galileo's observations led him to support the Copernican view that the Earth was not at the centre of everything. In due course truth prevailed and Copernicus has, for several years now, been accepted by the Church as being correct. Galileo spent the last 8 years of his life in detention, under house arrest, for his heretical views.

Sunspots have now been studied by many scientists who have recorded their observations for over 250 years. For that period, at least, there are reliable and comprehensive records. What has been

Our sun with flare,  
August 1998 (NASA)

seen is about an 11 year period between when sunspots are most frequent, the peak of activity. It has been observed that sunspots do not appear randomly on the surface of the sun but at what can be called the start of a cycle, when sunspots are at a minimum, they pop up about 30 degrees on either side of the sun's equator. As the cycle progresses the sunspots appear in bands growing progressively closer to the equator until at the solar peak the sun is in turmoil and solar storms will throw clouds of charged particles into space. These eruptions can dwarf the Earth, damaging communication satellites and inducing currents in the long wires of power grids sufficient to overload their protective circuitry and trigger blackouts. During these times aircraft will fly at lower altitudes to minimise the radiation the occupants are exposed to.

The sun, like the Earth, has a magnetic field, and George Hale, an American astronomer, discovered about a century ago that sunspots contained magnetic fields of great power. The sun's magnetic field is hundreds of times stronger than the Earth's and in sunspots the field is about 3000 times stronger again. It is

the rotation of the sun, taking 26 Earth days at the solar Equator and several days longer nearer to the poles, which generates that field. The heat of nuclear fusion brought on by the crushing force of gravity breaks the molecular bonds of the sun's gases and they split into charged ions. The rotation of the sun causes the plasma to swirl around. The moving flow of charged ions create the magnetic field, just as Faraday demonstrated with a current of electricity flowing in a wire. The big ball of plasma is rotating at different rates at different locations so the magnetic fields become twisted. As they twist, like twine, the fields become more tightly concentrated. A loop of such a field, snapping loose, pops through the surface of the sun and we see a sunspot, an area of slightly cooler gas, which has been channelled from below the surface. The field loops out and back in again, making another sunspot, fairly close by.

## How does this affect us?

Scientists have long struggled to identify what effect, if any, all of this activity has on the Earth. About 200 years ago the German-born British astronomer William Herschel, a pioneer who made his own telescopes including one with a 122 cm mirror and a focal length of 12 metre, suggested a link between crop prices and sunspots.

High prices indicating relative scarcity, Herschel concluded that five lengthy periods of reduced sunspots coincided with peaks in the price of English wheat. This suggests that sunspot activity is linked to climate, a contentious point to this day, and his suggestion was not accepted by his scientific peers.

The search for a link between sunspots and the goings on here on Earth has continued and in 1937 a respected American professor, Harlan Stetson, wrote a book entitled *Sunspots and their Effects* where he identified the synchronisation

of tree growth rings, the Dow Jones Index and building contracts, among other things, with the sunspot cycle.

We have observed that the increase of solar activity ionises the upper atmosphere of our planet and we frequently exploit it to reflect our radio frequency signals. The periods of maximum sunspot activity are awaited patiently. At present we are witnessing the steep slide towards the expected minimum point of the current solar cycle and the reflectivity of the ionosphere for electromagnetic waves of a length of about 10 metre or less is sporadic at best. For wavelengths of about 20 metre, however, the ionosphere is sufficiently reflective to stop a wave of that length passing through and to reflect it so that it can travel a very long way before reaching the surface of the planet again.

## What can we do to improve our communications?

We know that there will be improved reflectivity from time to time. The atmosphere will sometimes happen to concentrate ionised areas where we can make use of them. By listening for signals from beacon transmitters around the world we will know when that

frequency is open to that location. The American high altitude atmospheric research project known as HAARP in Alaska takes a much more active approach and directs radio frequency energy to the ionosphere in a spotlight fashion to increase the local ionisation and make it reflective to a radio beam directed there.

Unfortunately that is a little outside of an amateur's permitted radiated power levels and most people's price range. HAARP is located far from any

neighbours and suitably close to a power station.

To enhance radio communications the most economical approach is to use the frequencies, which happen to work best at the particular time. The next step may be to improve the gain of the antenna being used as that improves receiving as well as transmitting. An increase in transmitter power will not improve reception and it is irrelevant that someone can hear you if you cannot hear them.

Going further, we may start thinking about some digital communication modes, which will allow reliable communication at very low signal levels. The developments in mobile telephone and wireless computer networking point the way to the use of spread spectrum signals which can allow reliable communication with inbuilt error correction at a received signal level below the local noise floor. This is possible because the receiver knows the pattern it is looking for and can pick it out where even a morse code signal could not be heard.

We can distinguish a continuous wave signal, carrying intelligence in the Morse code, for instance, precisely because it is occupying a narrow part of the spectrum. We listen to just that narrow band and the background noise is proportionally less than if we are listening to a wider part of the spectrum. Morse code can be sent using a very narrow channel, much less than required to carry the human voice so it will get through where voice modes will not. If we digitise a signal and spread it repetitively over what may still be only a fairly narrow channel we can, because of the superior use made of spectrum space by the digital signal, send the same message multiple times at slightly different frequencies to a receiver which can reassemble the voice or data signal from bits of the message which arrive on the different frequencies, applying error-correction rules when it receives different parts of the signal on different frequencies. Not all will get through but some will be enough.

The advances in digital computing has put this signal processing within the range of the abilities of the average household computer which can be interfaced to a radio transceiver.



Modern transceivers are increasingly designed to be used with a computer which can assist them by processing signals either received or prior to transmission.

Multiple signal paths are nothing new. The height of a dipole antenna above ground will vary the reflection time of its signal from the ground and it will transmit a primary signal from the antenna and, slightly behind that, a lesser powered signal from the ground reflection, depending on the conductivity of the ground; poor conductivity, poor reflection, poor secondary signal.

When the signal reaches a reflective surface, the ionosphere, perhaps followed closely by some of it that reflected off the ground under the antenna and some that has first bumped into that big building downtown, it will bounce

off. The signal from your antenna which travels via the building will be slightly behind and weaker than the one which goes direct from the antenna to the ionosphere. The signal that reflected off the ground below the antenna will be arriving too, a little ahead of the signal with the longer path. These signals may end up reinforcing or cancelling one another to a greater or lesser extent. The result is potluck. Spread spectrum harnesses that fragmenting effect and allows weak signals to more reliably carry useful information.

We are likely to see more of this technology in the near future. It ought not to be necessary to replace existing radios to take advantage of this. A suitable modulation and demodulation device, a modem, could potentially be added to many existing transceivers to digitise the signal to be transmitted and to convert the received signal

to analogue audio for our ears. Such equipment is already appearing and computer sound card interfaces have been around for some years.

There are other factors that will make this mode attractive. It will reduce the need for high output power to establish and maintain communication and therefore the scope for harmful interference to other devices. It will also reduce exposure to radio frequency radiation near the antenna when lower power outputs can be successfully used. Perhaps more significantly, it may be an answer to the interference that will surely result if there is an introduction of data services like internet connections over power lines at frequencies such as are now being experimented with, typically between 2 and 40 MHz. If this delivery mode is commercially attractive it is going to be next to impossible to resist it on the basis of it being

incompatible with the existing amateur use of spectrum. Some arrangement will have to be made and coexistence would be preferable to being excluded from some very useful frequencies.

As the sun quiets down, we may find that although signals are weaker, the advances in digital communication can be adopted by amateur radio to give us new modes for voice and data communication that will increase our ability to use the special knowledge and skill which allows us to communicate over huge distances without wires, a feat which not much more than 100 years ago was thought by leading scientists to be impossible.

## What will we do next?

Whatever we discover that we can.

73 de Bill.

ar

## Sunspot Numbers

Monthly Sunspot Average Sep 2004: 27.7

Annual Sunspot Average Mar 2004: 47.2

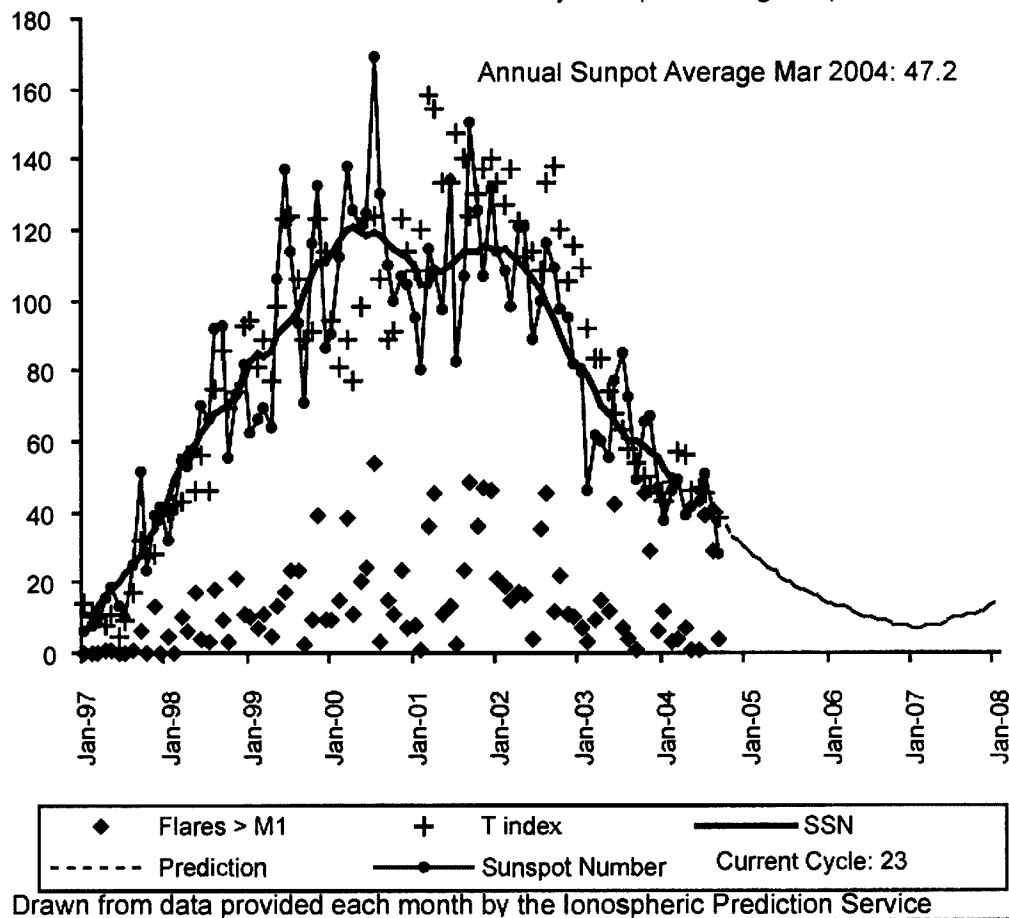

**Adelaide-Capetown****226****Brisbane-Dublin****336****November 2004**

T index: 27

**HF Predictions**

by Evan Jarman VK3ANI

34 Alandale Court Blackburn Vic 3130

Second 4F5-10 4E0 Short 10155 km

First F 0-5 Short 16670 km

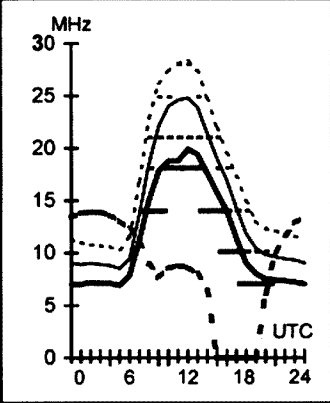
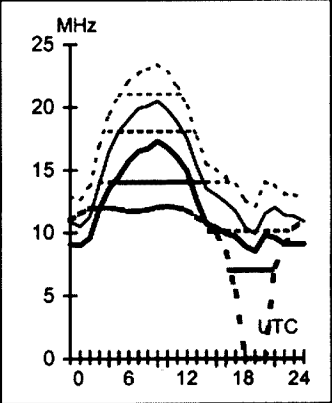
**Legend**

Frequency scale

- UD
- E-MUF
- OWF
- F-MUF
- ALF
- >10%
- >50%
- >90%

Time Scale

These graphs show the predicted diurnal variation of key frequencies for the nominated circuits.

These frequencies as identified in the legend are:-

- Upper Decile (F-layer)
- F-layer Maximum Usable Frequency
- E-layer Maximum Usable Frequency
- Optimum Working Frequency (F-layer)
- Absorption Limiting Frequency (D region)

Shown hourly are the highest frequency amateur bands in ranges between these key frequencies, when usable. The path, propagation mode and Australian terminal bearing are also given for each circuit.

These predictions were made with the ionospheric Prediction Service program: ASAPS Version 4

**Adelaide-Honolulu****67****Brisbane-Lima****122****Canberra-Barbados****123****Darwin-Bangkok****310**

First 3F3-5 3E0 Short 9160 km

First F 0-5 Short 13056 km

First F 0-5 Short 16232 km

First 2F7-16 2E0 Short 4435 km

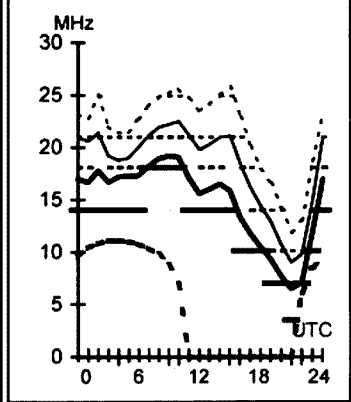
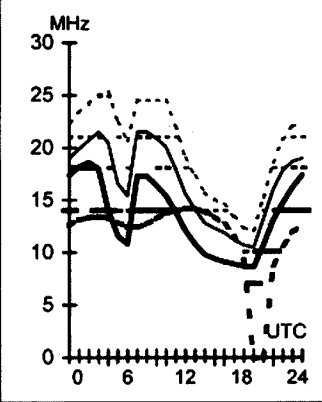
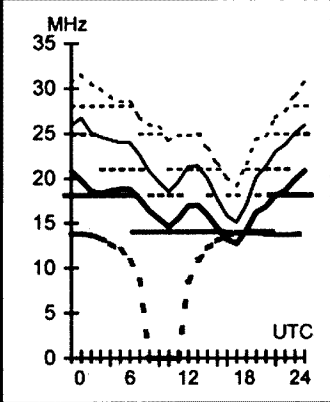
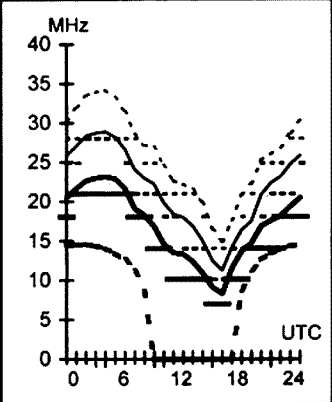
**Adelaide-Lusaka****246****Brisbane-Seattle****44****Canberra-London****136****Darwin-San Francisco****64**

Second 4F4-8 4E0 Short 10787 km

Second 4F2-5 4E0 Short 11846 km

First F 0-5 Short 23042 km

First F 0-5 Short 12316 km

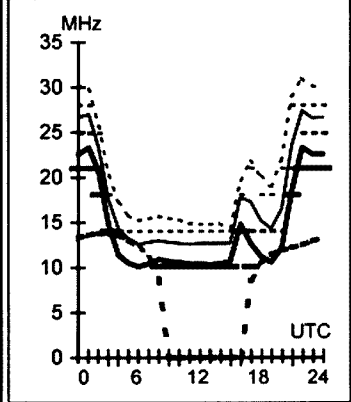
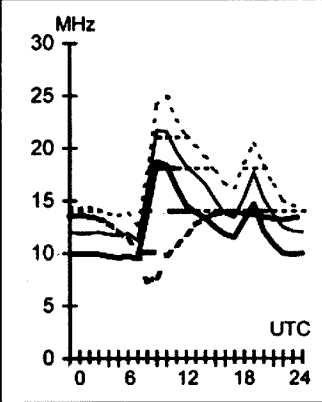
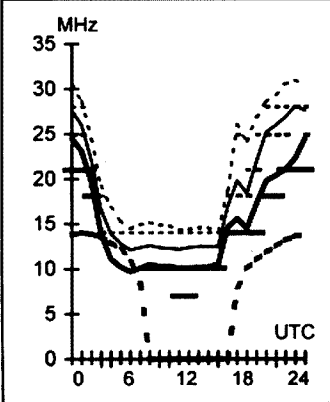
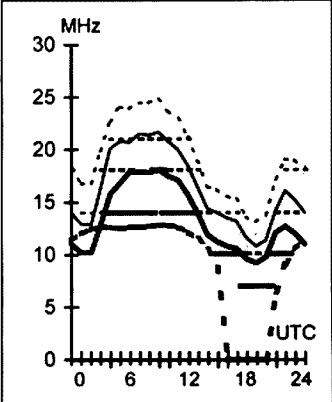
**Adelaide-Singapore****311****Brisbane-Tokyo****348****Canberra-London****316****Darwin-Seoul****356**

First 2F4-9 2E0 Short 5414 km

Second 3F6-10 3E0 Short 7159 km

First F 0-5 Short 16982 km

First 2F3-7 3E0 Short 5575 km

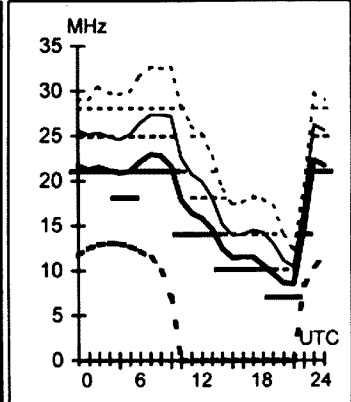
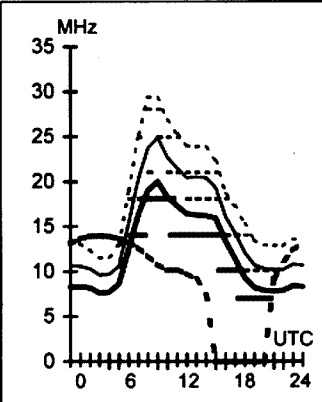
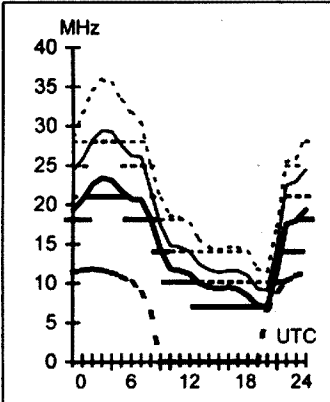
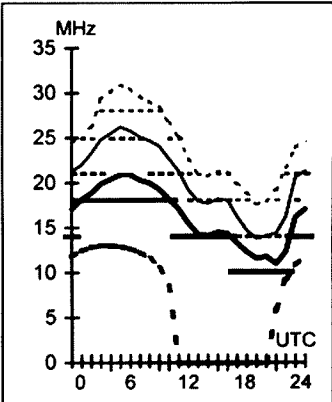

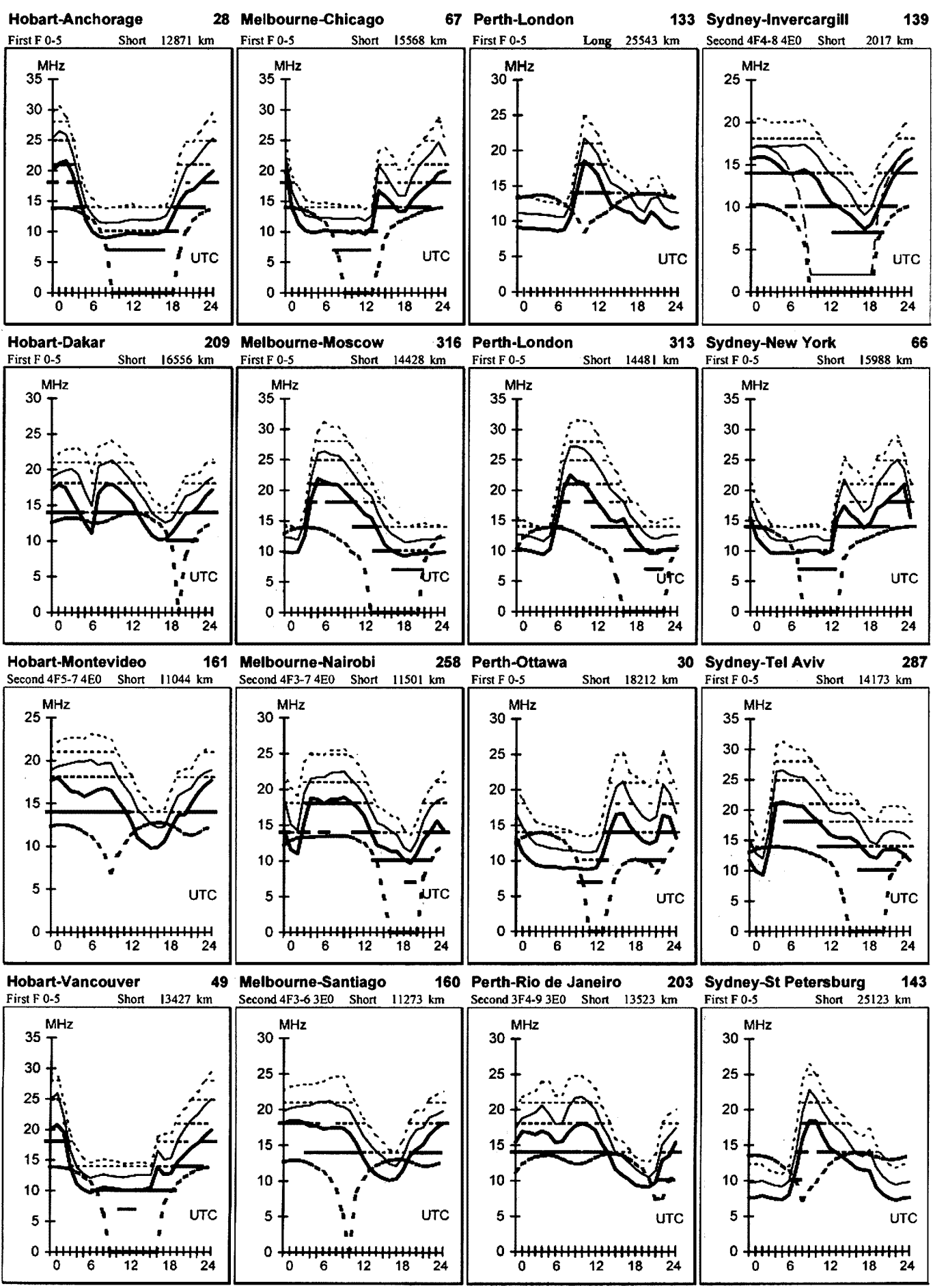

# Hamads classified **FREE**

## WANTED ACT

• Kenwood PS-52 heavy duty DC power supply. Must be in good working condition. Phone Robert on either 02 6291 0637 or 0405 506 772

## FOR SALE NSW

• **BOOK:** Radiotelegraph and Radiotelephone Codes, Prowords and Abbreviations, 3rd Edition (236pages), 610 gm, 1.5 lbs, now available. Probably the world's best compilation of this info now available. Q,X,Z Codes, 142 phonetics, 24 Morse, 8 needle codes. Myer, Phillips, 10, 11, 12, 13 and other codes. Much other info, abbreviations, procedures and methods. AU\$25 + P&P. (in Australia \$7.50). Internet: <http://www.nor.com.au/community/sarc/phonetic.htm> John Alcorn VK2JWA QTHR, Ph 02 6621 5217 vk2jwa@sarc.org.au

## FOR SALE VIC

• Antenna HF-5B Butternut 2 element mini-beam 10-20m, \$250 dismantled. Antenna AM-42 4 element 10m and 15m, \$70 dismantled. Franz VK3DVD, Phone 03 9879 8804.

• 82 Radio and Comms magazines \$20. 3-150 MHz 1-1 Balun \$30. 3 ele 10m yagi \$60. David VK3MED Phone 03 5952 5940

• Amateur radio station with Nally tower and antennas, in good area; comes with 28 sq. two storey four bedroom home, large lounge/dining room, kitchen and family room, two bathrooms, three toilets, two-car garage and workshop, indoor heated pool, landscaped gardens on corner block, with space for boat or caravan. Many extras. 18 km east of Melbourne. Price \$515k. Maurie VK3ZT, Phone 03 9803 2336.

• Yaesu FP-2 Power supply/speaker/charger, good order, \$35. GWC GUC-2010 Universal Counter/timer, frequency to 100 MHz, \$45. Offers for the following:- Tektronix Oscilloscope camera C-12, S/n 009927, c/w 2 unopened pkts Polaroid film, and hood etc, HMV RC812 Cassette Recorder, Weems & Plath Star Finder 2101-D c/w 10 disc charts, Tamaya NC77 digital navigation computer/calculator, in box, Sextant by Henley Plastics Ltd, with instructions. Ex deceased estate late Peter Davenport. Contact Don VK3DBB QTHR, Phone (03) 5941 1351 AH only, or vk3dbb@bigpond.com

## FOR SALE QLD

• Several CRO tubes from 5 ins to 3 ins and one 6 by 4 ins. 2 OD microwave modules with 45043F and 2Z-219, with 2 pins at one end, 2 pins in the centre and gold plated. All parts are at very reasonable prices. Contact VK4DV Phone (nights) 07 4928 5537

## FOR SALE SA

• Philips electronic DC voltmeter type GM-6010, s/n 1075. What interest from deserving museum, old equipment collector etc? No charge. Weighs 11 kg. You pay freight only, or collect Stansbury. Written application only VK5KGS QTHR.

## WANTED SA

• Philips technical wall poster or chart of the Philips 20-AX in line gun self-converging colour picture tube. Tektronix 100 ohm pot type 311-0574-00 position 0.05 V/cm gain for a 1A1 dual trace plug in. Tektronix 650 colour monitor, 12 inch CRT V8701 part no 154-0641-01. C S Ratcliff VK5ZST, Phone 08 8520 2988

## FOR SALE WA

• TH-3 Senior tri-band beam rotator and RG-8U co-ax \$250 the lot. Swan 350 with mobile supply \$200. Frequency meter BC-221 \$60. VK6XX QTHR, Perth, Phone 08 9294 1102

## MISCELLANEOUS

• The WIA QSL Collection requires QSLs. All types welcome, especially rare DX pictorial cards, special issue. Please contact the Hon Curator, Ken Matchett VK3TL, 4 Sunrise Hill Road, Montrose Vic 3765, tel. (03) 9728 5350

## TRADE ADS

### PSK-31, SSTV, RTTY SOUNDBOARD

Interfaces Fully isolated, ready to plug in. <http://www.G3LIV.CO.UK>, johnny@melvin.com, G3LIV QTHR.



## JACKSON BROS

### JACKSON OF THE HF IS BACK

Highest quality products made by  
UK craftsmen

Full range now off-the-shelf in Australia.

Variable and trimmer capacitors, reduction drives, dials, ceramic standoffs

**CATALOGUES, PRICE LISTS AVAILABLE**

**CHARLES I COOKSON PTY LTD**  
11-13 Port Rd  
Queenstown SA 5014  
Tel: (08) 8240 3200 Fax: (08) 8240 3233  
FreeFax 1800 673355 within Australia  
Email: [jackson@homeplanet.com.au](mailto:jackson@homeplanet.com.au)

**ALL MAJOR CREDIT CARDS ACCEPTED**  
**SOLE AGENTS AUSTRALIA AND NEW ZEALAND**

## About hamads....

- Hamads may be submitted by email or on the form on the reverse of your current Amateur Radio address flysheet. Please print carefully and clearly, use upper AND lower case.
- Separate forms for For Sale and Wanted items. Please include name, address STD telephone number and WIA membership number if you do not use the fly-sheet.
- Deceased estates Hamads will be published in full, even if the ad is not fully radio equipment.
- WIA policy recommends that the serial number of all equipment for sale should be included.
- QTHR means the address is correct in the current WIA Call Book.
- Ordinary Hamads from those who are deemed to be in general electronics retail and wholesale distributive trades should be certified as referring only to private articles not being re-sold for merchandising purposes.
- Commercial advertising (Trade Hamads) are pre-payable at \$25.00 for four lines (twenty words), plus \$2.25 per line (or part thereof), Forty word maximum, minimum charge of \$25.00. Cheques are to be made out to: WIA Hamads.
- Copy typed or printed clearly please, and received by the deadlines shown on page 1 of each issue of Amateur Radio.

Email: [newunltd@bigpond.net.au](mailto:newunltd@bigpond.net.au) Fax: 03 9756 7031

Postal: Newsletters Unlimited, PO Box 431, Monbulk Vic 3793

### TRADE PRACTICES ACT

It is impossible for us to ensure that the advertisements submitted for publication comply with the Trade Practices Act 1974. Therefore, advertisers and advertising agents will appreciate the absolute need for themselves to ensure that the provisions of the Act are strictly complied with.

### VICTORIAN CONSUMER AFFAIRS ACT

All advertisers are advised that advertisements containing only a PO Box number as the address cannot be accepted without the addition of the business address of the box-holder or seller of the goods.

## HF, VHF, UHF ANTENNAS & ACCESSORIES

Aluminium towers, guys etc

Diamond VSWR/PWR meters.

HD copper antenna wire & insulators, TX tubes & pwr transistors, Create Rotators

Quality coax cables & connectors. Free advice & catalogue.

### ATN Antennas

Ph 03 5492 2224 Fax 03 5492 2666,

email [atnant@inet.net.au](mailto:atnant@inet.net.au)  
PO Box 80, Birchip Vic 3483

## AMIDON FERROMAGNETIC CORES

For all RF/electronic applications.

See our website for complete data on all cores including prices.

[www.catchnet.com.au/~rjandusimports](http://www.catchnet.com.au/~rjandusimports)

### RJ & US Imports

PO Box 431, Kiama NSW 2533.  
A 3.5" PC disk containing all data is available for \$5.00 incl. post.

### Agencies

Active Electronics, Tas  
TTS Systems, Tyabb (VIC)  
Tower Communications, Perth  
Ozhelp Services, Brisbane

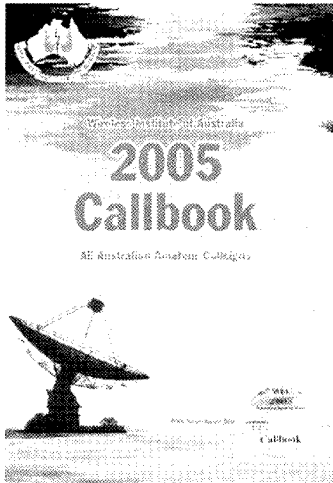

# Buy your Callbook from your local Club

## Hunter Radio Group VK2AWX

Tel: 02 4942 2640  
21 John St DUDLEY NSW 2290  
email rprout@idl.net.au

## Illawarra ARS VK2AMW

Tel: 02 4261 4762  
Box 1838 WOLLONGONG NSW 2500  
email iars@1earth.net

## Kempsey & Dist ARC inc

Tel: 02 6569 9201  
email VK2MTD@midcoast.com.au  
PO Box 231 WEST KEMPSEY NSW 2440

## Liverpool & Dist ARC VK2AZD

Tel: 02 9607 0440  
email vk2lrs@ihug.com.au  
Box 4 Bathurst St GREYSTANES 2145

## Manly Warringah RS VK2MB

Tel: 02 9905 6337  
email desc@bb.com.au  
PO Box 186 BROOKVALE NSW 2100

## Mid Sth Coast ARC inc

Tel: 02 4456 5226  
PO Box 413 ULLADULLA NSW 2539  
email \_\_\_\_sbourke@shoal.net.au

## Nepean ARG VK2ADX

Tel: 0428 598 888  
email secretary@narg.oz-hams.org  
PO Box 94 EMU PLAINS NSW 2750

## Orana Region ARC

Tel: 02 6888 1013, 0417 407 401  
PO Box 1962 DUBBO NSW 2830  
email dsh@ozzinet.net

## Orange & Dist ARC inc

email VK2TGP@wia.org.au  
PO Box 1065 ORANGE NSW 2800

## Oxley Region ARC Inc VK2BOR

Tel: 02 6582 3557  
email lundell@tpg.com.au  
Box 712 PORT MACQUARIE NSW 2444

## Parkes & Dist ARC

Tel: 02 6862 4252  
PO Box 344 PARKES NSW 2870

## St George ARS VK2LE

Tel: 02 9545 2650  
PO Box 530 ENGADINE NSW 2233  
email \_\_\_\_brianclarke01@optusnet.com.au

## Summerland ARC Inc VK2SRC

Tel: 02 6621 8342  
PO Box 524 LISMORE NSW 2480  
email vk2src@sarc.org.au

## Tamworth RC Inc

Tel: 02 6766 1599  
email vk2tdt@cpscomp.com.au  
PO Box 4 TAMWORTH NSW 2340

## Taree & Dist ARC inc VK2FRE

Tel: 02 6558 1795  
email johnbrit@tpg.com.au  
PO Box 712 TAREE NSW 2430

## Twin Cities R & E Club

Tel: 02 6021 1747  
PO Box 396 ALBURY NSW 2640  
email sarge@iinet.net.au

## Urunga Convention

Tel: 02 6654 1274  
PO Box 8 BELLINGEN 2454  
email krgolden46@hotmail.com

## Wagga Wagga ARC inc

Tel: 02 6922 3632  
Box 294 WAGGA WAGGA NSW 2650  
email vk2yw@wia.org.au

## Walcha Radio Group

Tel: 02 6765 2004  
107 W Fitzroy St WALCHA NSW 2354

## Waverley ARS Inc.

Tel: 02 9337 2909  
PO Box 581 VAUCLUSE NSW 2030  
email info@vk2bv.org

## Westlakes ARC Ltd VK2ATZ

Tel: 0418 667 162  
PO Box 3001 TERALBA NSW 2284  
email westlakes@hunterlink.net.au

## Clubs VK3

### Amateur Radio Victoria VK3WI

40G Victory B'vd ASHBURTON VIC 3147  
Tel: 03 9885 9261  
email wiavic@wiavic.org.au

### Ballarat Amateur Radio Group

Box 1261 BALLARAT MC VIC 3354  
Tel: 03 53392427  
email vk3aig@barg.org.au

### Bass Am. Radio IRLP Grp

P.O. Box 2280 ROSEBUD PLAZA  
ROSEBUD VIC 3939  
Tel: 59820315  
email kennith2@optusnet.com.au

### Central Goldfields ARC VK3JA

PO Box 67 DUNOLLY VIC 3472  
Tel: 03 5468 1088  
email vk3ja@cgfar.com

### East Gippsland ARC Inc

PO Box 688 BAIRNSDALE VIC 3875  
Tel: 03 5152 2388  
e: @net-tech.com.au

### Eastern & Mountain Dist. ARC

PO Box 87 MITCHAM VIC 3132  
email president@emdrc.com.au

### Eastern Zone ARC VK3BEZ

Tel: 03 5127 5656  
email \_\_\_\_Vk3bez@qsl.net  
PO Box 459 MOE VIC 3825

### Frankston & Mornington Pen. ARC VK3FRC

Box 65 PATTERSON LAKES VIC 3197  
Tel: 03 9781 2886  
email vk3frc@qsl.net

### Gippsland Gate Radio & Electronics Club Inc. VK3BJA

PO Box 1098 CRANBOURNE VIC 3977  
Tel: 03 9700 4526  
email secretary@ggrec.org.au

### Geelong Amateur Radio Club

PO Box 520 GEELONG VIC 3220  
Tel: BH 03 5278 8850,  
email vk3atl@pipeline.com.au

### Geelong Radio & Elect. Soc.

Tel: 03 5243 5184  
PO Box 501 BELMONT VIC 3216  
E-Mail \_\_\_\_vaycgres@netlink.com.au

## Healesville A R G Inc VK3GHA

PO Box 346 HEALESVILLE 3777  
Tel: 0412 565 357  
email: vk3heq@hotmailkey.net.au

## Horsham ARC Inc VK3III

PO Box 720 HORSHAM VIC 3402  
email president@harc.org.au

## Midland ARC Inc VK3CMZ

Box 2058 MC BENDIGO VIC 3554  
Tel: 03 5444 4717  
email vk3cmz@marc.org.au

## Moorabbin & District RC

Tel: 03 9702 1199 0418 289 928  
PO Box 58 HIGGETT VIC 3190  
email committee@mdrc.org.au

## North East Radio Group

Tel: 03 9432 0563  
Box 270 GREENSBOROUGH VIC 3088  
email contact@nerg.asn.au

## RAAF Williams ARC VK3APP

PO Box 657 LAVERTON VIC 3028  
email president@vk3app.com

## Shepparton and District ARC

PO Box 692 SHEPPARTON VIC 3632  
email vk3sol@sadarc.org

## Southern Peninsula ARC Inc.

PO Box 206 ROSEBUD VIC 3939  
Tel: 03 5985 6213  
emails sparc@swiftdsl.com.au  
Vk3bsp@swiftdsl.com.au

## Sunraysia Radio Group Inc

Tel: 5021 4343  
PO Box 76 MILDURA VIC 3502  
email vk3fgn@bigpond.com

## Twin Cities Radio & Elect. Soc.

See VK2 list

## Victorian ARDF Group Inc.

2 Princes Crt BLACKBURN STH VIC 3130  
Tel: 03 9432 0563  
email vk3kt@nerg.asn.au

## Western & Northern Sub. ARC

PO Box 336 RESERVOIR VIC 3073  
email wansarc@wia.org.au

## WICEN

PO Box 106 MITCHAM VIC 3132  
Tel: (03) 9849 0501  
email: secretary@wicen.org.au

## Clubs VK4

### Bayside Amateur Radio Society

Tel: 07 3286 1794  
PO Box 477 CAPALABA Q. 4157  
email victgays@tpg.com.au

### Bowen Radio Amateur Group

PO Box 836 BOWEN Q 4805  
Tel: 07 4786 1089  
email atb371@dodo.com.au

### Brisbane ARC

PO Box 3007 DARRA Q 4076  
Tel: 3217 9589  
email parkertf@optusnet.com.au

Continues on page 56

Amateur Radio Services Directory held over for this month

# Buy your Callbook from your local Club

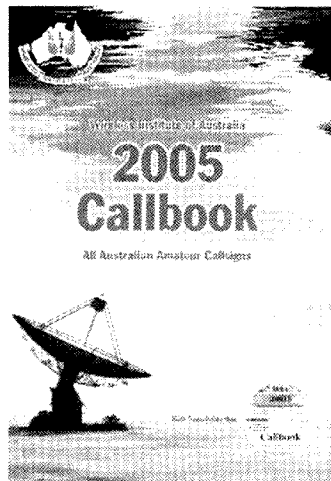

**Brisbane North ARC**  
PO Box 78 CHERMSIDE Q 4032  
Tel: 07 3264 1655

**Brisbane VHF Group**  
PO Box 5015 KENMORE Q 4069  
07 3391 5526  
email friends@squirrel.com.au

**Bundaberg ARC**  
PO Box 129 BUNDABERG Q 4670

**Caboollure Radio Club Inc.**  
Caboollure Historical Vill. Beerburum  
Rd CABOOLLURE Q 4510  
Tel: 07 3203 0360  
email mick@uq.net.au

**Calms ARC**  
PO 1426 CAIRNS Q 4870  
Tel: 07 4053 3137  
email parrcj@ozemail.com.au

**Central Highlands ARC**  
VK4KAL 'Aviomore' RUBYVALE Q 4702  
Tel: 07 4985 4168  
email donvk4kal@bigpond.com

**City of Brisbane Radio Society**  
PO Box 1235 SPRINGWOOD Q 4127  
Tel: 07 3219 8330

**Dalby and District ARC**  
PO Box 758 DALBY Q 4405  
Tel: 07 4662 3934  
email holmie @ bigpond.com

**Darling Downs Radio Club**  
Tel: 07 4697 9280  
Box 3257 Village Fair  
TOOWOOMBA Q 4350  
email tomb@twmba.net

**Gladstone ARC**  
PO Box 1030 GLADSTONE Q 4680  
Tel: 07 4978 0816  
email lvs@tpg.com.au

**Gold Coast ARC**  
PO Box 588 SOUTHPORT Q 4215  
Tel: 07 5525 1886  
secretary@goldcoastamateurradio.com

**Hervey Bay Radio Club**  
PO Box 829 PIALBA Q 4655  
Tel: 07 4124 6253  
email vk4acb@bigpond.com

**Historical Wireless Soc. SEQ**  
20 Aldford St CARINDALE Q 4152  
Tel: 07 3395 2741  
email peterhadgraft@yahoo.com

**Ipswich and District**  
PO Box 250 IPSWICH Q 4305  
Tel: 07 3281 9418  
email vk4wip@vk4radio.org.au

**JOTA/ Scouts Aust. Qld Branch**  
PO Box 520 TOOWONG Q 4066  
Tel: 07 3870 7000  
email shwatson@bigpond.net.au

**Kilo Romeo Circle of Friends**  
PO Box 16 CLEVELAND OLD 4163  
07 3824 0301  
email bryanwil@tpg.com.au

**Lockyer Valley Radio & Electronics Group**  
Jahn Drive GLENMORE Q 4342  
07 5465 3219  
email vk4fj@uq.net.au

**Logan and District ARC**  
40 Centaurus Cres. REGENTS PARK  
4118 Tel: 07 3800 3305  
email briscal@optusnet.com.au

**Mackay ARC**  
PO Box 1065 MACKAY Q 4740  
Tel: 07 4952 1225 (ah)  
email lenahan@mrbean.net.au

**Maryborough Radio Club**  
225 Pallas St MARYBOROUGH Q 4650

**Mount Isa and Dist Radio Grp**  
PO Box 1715 MOUNT ISA Q 4825  
email rmwood@bigpond.net.au

**Queensland Digital Group**  
PO Box 2224 CHERMSIDE Q 4032  
email radio@uq.net.au

**Queensland Maritime Museum**  
PO Box 96 SOUTH BRISBANE Q 4101  
email vk4cu@bigpond.com

**Redcliffe and District RC**  
Box 20 WOODY POINT Q. 4019  
Tel: 07 3284 8859  
email rdrc4@hotmail.com

**Rockhampton & Dist. ARC**  
PO Box 496 ROCKHAMPTON Q 4700  
Tel: 07 4931 2244 / 0429 632 815  
email vk4acc@wia.org.au

**Rotarians of Amateur Radio**  
77 Abell Rd JIMBOOMBA Q 4280  
Tel: 5546 0522  
email nationalnews@wia.org.au

**South East Qld ATV Group**  
PO Box 3 CHERMSIDE Q 4032  
Tel: 07 3266 7636

**South Coast Am. Radio Grp**  
51 Castlehill Drive NERANG Q 4211  
Tel: 07 5578 2293  
email smokey2@winshop.com.au

**Southside ARS**  
PO Box 294 WoodRIDGE Q 4114  
Tel: 07 3299 7665  
email jfr10759@bigpond.net.au

**Sunshine Coast ARC**  
PO Box 80 NAMBOUR Q 4560  
Tel: 07 5476 5209  
email hlwicks@dodo.com.au

**Tablelands R&E Club**  
PO Box 682 ATHONTON Q 4883  
Tel: 07 4091 1959  
email trec@bigpond.net.au

**Townsville A RC**  
PO Box 333 GARBUTT EAST Q. 4814  
Tel: 07 4779 7869  
email vk4wit@wia.org.au

## Clubs VK5

**Adelaide Hills Am. Radio Soc.**  
PO Box 401 Blackwood SA 5051  
Tel: 08 8293 5615  
email network@internode.on.net

**Am. Radio Experimenter's Grp**  
PO Box 6539 Halifax St ADELAIDE 5000  
Tel: 08 82268042  
email egal@internode.on.net

**Barossa Amateur Radio Club**  
Tel 08 8524 5029  
PO Box 356 Angaston 5353

**Elizabeth Amateur Radio Club**  
PO Box 8, ELIZABETH SA 5108  
Tel: 08 8346 7042  
rallim@picknowl.com.au

**Girl Guides SA**  
278 South Tce Adelaide 5000.

**Lower Eyre Peninsula ARC**  
PO Box PORT LINCOLN SA 5606  
Tel: 08 8682 6088

**Lower Murray ARC VK5ALM**  
PO Box 234, MURRAY BRIDGE SA 5253  
Tel: 08 8532 1605  
E-mail: boxesdnm@im.net.au

**Moonta Scout Group**  
PO Box 204 Moonta SA 5558

**Naracoorte ARC VK5ARN**  
Tel: 087687226.  
P.O. Box 202 BORDERTOWN SA 5268,  
email alan@lm.net.au

**North East Radio Club VK5GRG**  
PO Box 600 MODBURY SA 5092  
Tel: 08 8396 1673  
email: vk5amk@chariot.net.au

**Port Adelaide ARC**  
PO Box 352 PORT ADELAIDE 5015

**South Aust. Packet User Group**  
Box 200 HENLEY BEACH, S.A. 5022  
email: sacomms@internode.on.net  
Tel: (08) 8261 8555

**South Coast ARC Club Inc.**  
Box 333 MORPHETT VALE SA 5162  
Tel: (M) 0412 308 571  
email: vk5kjb@iprimus.com.au

**Scout Radio Activities Group**  
Lot 26 Hughes Court ONE TREE HILL  
Tel: 08 8341 7840  
email racroo@arcom.com.au

**South East Radio Group**  
PO Box 1103, MT GAMBIER 5290  
Tel: 08 8725 4335, 0407 718 908  
email: serg@internode.on.net

**Whyalla Amateur Radio Club**  
Box 444 WHYALLA 5600  
Tel: 08 8645 8085

**WICEN SA INC.**  
PO Box 1234 ADELAIDE 5001  
Tel: 08 8388 2297  
email: bravo521004@yahoo.com

## Clubs VK6

**Northern Corridor R.G.**  
Tel: 9228 2027

**Peel A.R.G. VK6ARG**  
PO Box 1010 MANDURAH WA 6210

**The Hills AR Group (Inc)**  
Tel: 08 93611600.  
23 Cerny Pl. KEWDALE WA 6105

**WA VHF Group Inc V**  
PO Box 189 APPLECROSS WA 6953  
Tel: 08 9446 2864  
email degraham@it.net.au

**West Australian Repeater Grp**  
PO Box 425 CANNINGTON WA 6107  
Tel: 089458 6218  
email: info@warg.org.au

## Clubs VK7

### Radio & Electronics Ass. of S'thern Tasmania

Tel: 03 6243 3553  
email vk7tw@wia.org.au  
GPO Box 371, HOBART 7001

**Northern Tasmania Amateur Radio & Elect. Group**  
Tel: 0417 354 410  
e-mail allen.burke@bigpond.com

**North West VK7 Amateur Radio Interest Group**  
Tel: 6425 2923, 0408 142 229  
email nw-vk7@spamex.com

**Central Highlands Amateur Radio Club of Tas.,**  
28 Hamilton St. WEST HOBART, 7000

## Clubs VK8

**Alice Springs ARC**  
Tel: 0408 897 018  
PO Box 113 ALICE SPRINGS NT 0871  
email jfarmer@centralcomms.com.au

**Darwin Amateur Radio Club**  
Tel: 08 8945 9326  
PO Box 41251, CASUARINA NT 0811  
email: vk8da@austamet.com.au

**Clubs National**  
**ALARA (Australian Ladies Amateur Radio Association)**  
Tel: 0438 588 782

C/o Box 81 ULVERSTONE TAS 7315  
email: vkalarayl@yahoo.com.au  
See article this publication for full detail

**Aussiewide Packet Radio Nwk**  
email vk4ttt@vk4ttt.#gold.qld.aus.oc

**Aust Branch, Royal Naval ARC**  
email vktsv@alphalink.com.au

**FISTS CW Club**  
Inter. Morse Preservation Society.  
Tel: 02 9636 7730  
350a Old Windsor Rd TOONGABBIE NSW 2146  
email vk2chris@optushome.com.au

**Radio Am. Old Timers Club**  
Tel: 03 9598 4262 03 9584 9512  
PO Box 1100 Sandringham 3191  
email raotc @ raotc.org.au

Now available from your local  
Amateur Radio Organisation  
see list opposite

# 2005 Callbook

All  
Australian  
Callsigns

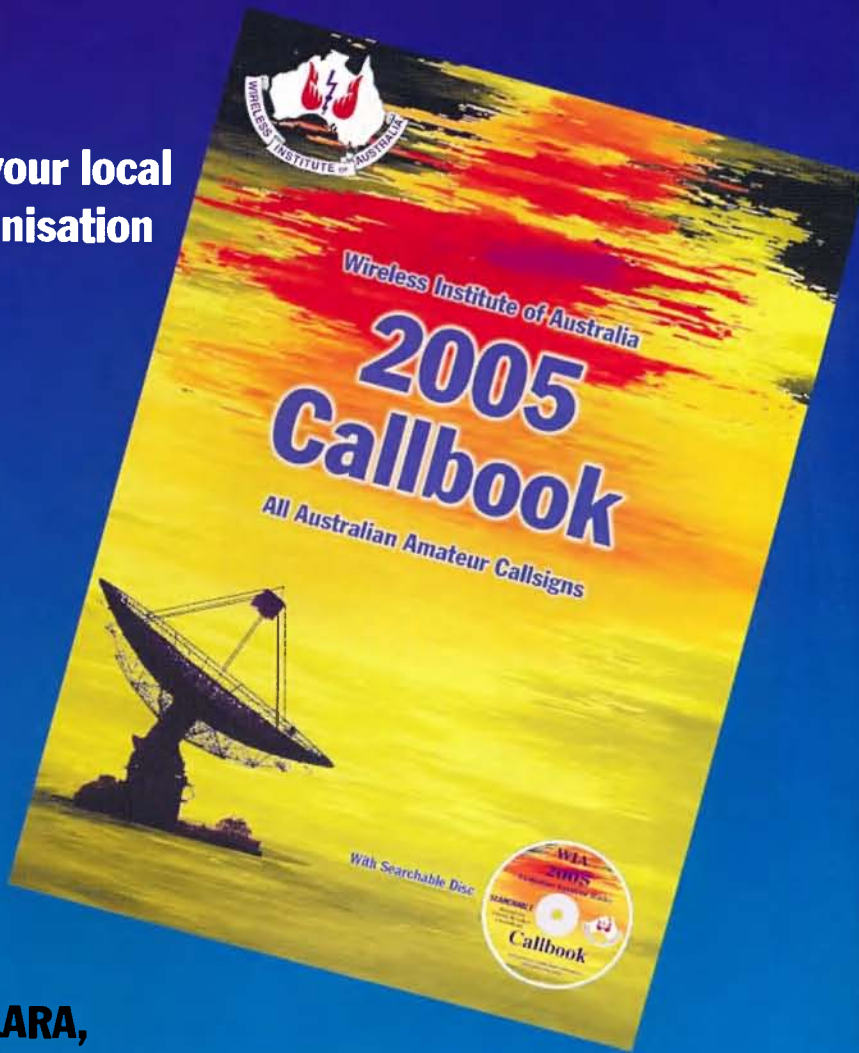

Plus great detail about  
The new WIA, Amateur  
Radio Clubs, Wicen, ALARA,  
AMSAT, ARDF, Band Plans, Beacons, Broadcast  
Stations, The ACA, Examinations, QSLs, Great Circles,  
Maidenhead, DXCC, Packet Radio, Repeaters and more.

## How to get your copy

Contact your local Amateur Radio Club.

Contact details opposite, or

Contact WIA National Office

(03) 9528 5962 or [nationaloffice@wia.org.au](mailto:nationaloffice@wia.org.au)

Prices from National Office	Pick up	Posted
WIA Member	\$22	\$25
Non-Member	\$30	\$33

# ICOM'S GREAT CHAMPIONS



**NEW** ICOM FLAGSHIP TRANSCEIVER  
**IC-7800 HF\*6m**

- Four 32-bit floating point DSP units • +40dBm ultra high intercept point
- Automatic tracking pre-selector • Two completely independent receiver circuits • 200W output power at full duty • Ultra high frequency stability • 7-inch wide color TFT LCD • Multi function spectrum scope
- RTTY / PSK31 operation without PC connection • Professional 6m receiver
- Digital Voice Recorder • CF memory card • Morse Free Package.



## IC-T90A A new 5W Triband handheld

VHF/UHF FM 2M, 6M, & 70CM  
Wideband receive 495 KHz - 1 GHz  
555 Alphanumeric memories • 13 Scan modes DTCS & CTCSS encode & decode DTMF encoder (10 memories) Wide/narrow transmit capability.



## IC-2720H The new dual band FM Transceiver

- 2M / 70CM • Remote head operation • Dual VFO with independent control for each band • 212 Memory channels • Wideband receiver
- CTCSS & DTCS encode & decode • 9600 bps packet operation
- Standard HM133 remote control microphone



## IC-208H 2m FM Dual Band Transceiver

- Dual Band Features at a Single Band Price • 55W / 2m, 50W / 70cm
- Built-in CTCSS and DTCS Tone Squelch Detachable Front Panel (Req. OPC-600/601 Option) • 9600 bps Packet Operation
- 512 Memory Channel • Standard Mic. Supplied:HM133.



## IC-706MKIIG HF • VHF UHF

The amazing evolution of the legendary 706.

- Now includes 70cm @ 20W and 50W on 2m
- Standard feature dsp • Built in sub tone encoder & decoder
- Tone scan • Mosfet PA • You get base station performance and features in a mobile rig sized package • Morse Free Package.



## IC-7400

**NO FILTERS REQUIRED**

- Sharp & soft IF filter shape • 100W HF /6m /2m • Digital twin PBT
- DSP • SSB / CW synchronous tuning • Built in antenna tuner
- RTTY demod / decoder • Digital RF speech processor
- Microphone equaliser • Morse Free Package.

**ICOM**  
2 YR WARRANTY

find your nearest ICOM dealer at  
[www.icom.net.au](http://www.icom.net.au) or (03) 9387 0666



Volume 72 No 12  
December 2004



The magazine for  
**AUSTRALIAN** radio amateurs

# Amateur Radio

\$6.50  
including  
GST

64  
page  
HOLIDAY  
issue

*New microwave  
records  
in VK2 and VK4*

**Russell Lemke VK3ZOB**

**The Honduras experience**  
Judy MacDonnell VE0JAM

**featuring**

- ★ A compact, effective vertical antenna for 160 metres  
Drew Diamond VK3XU
- ★ Some useful wire antennas for HF Pt 2  
Rob S Gurr VK5RG
- ★ An experimenter's LF/MF receiver  
Dale Hughes VK2DSH
- ★ A vertical antenna for 15, 17 & 20 metre  
John Howl VK3ZSU

ISSN 0002-6859



9 770002 685123 1 2

# BENELEC

# YAESU



## FT-1000MP Mark V



### 200 W All Mode HF Transceiver

- High Power Output
- Wide Receiver Coverage
- High-Speed Automatic Antenna Tuner
- TX Microphone Equalizer

Price \$ 5,130.70

## FT-847



### Multi-Mode HF/VHF/UHF Satellite Transceiver

- Full Duplex Satellite Operation
- 160-6m / 2m / 70cm
- 100W, 50W, 20W

Price \$ 3,713.20

## Meet You @

- MIENA TAS on 4th Dec ' 04
- WYONG in February '05

## FT-897D



### Now includes TCX0-9 Built-in

- Portable / Mobile / Base All Mode Txx
- 160-10m / 6m / 2m / 70cm
- 100W, 100W, 50W, 20W

Price \$ 1,734.30

## Announcing our NEW WA Dealer

### Bushcomm Pty Ltd

80 Stock Road

Herne Hill WA 6056

Tel: 08 9296 0496

Email: bushcomm@bigpond.com

## FT-857D



### Now includes DSP2 unit built-in

- Ultra Compact + All Mode Transceiver
- 160-10m / 6m / 2m / 70cm
- 100W, 100W, 50W, 20W

Price \$ 1,628.30

## Introducing the Benelec "HAMster"

### Multi-Tap HF Whip

1.0m Length with tuneable S/S Top

### Tap-Bands

- 80m First available @ MIENA TAS 4 Dec '04
- 40m
- 30m
- 20m
- 17m
- 15m
- 12m
- 9/10m
- 6m



UHF M Base

Price \$ 390.00

## FT-817ND



### Now includes FNB72 Internal Battery

- Ultra Compact 135 x 38 x 165mm
- All Mode Portable Transceiver
- 160 - 10m / 6m / 2m / 70cm

Price \$ 1,334.00

## FT-7800



### 2m / 70cm Dual Band FM Transceiver

- High Power Output
- Wide Receiver Coverage
- Five One-Touch "Hyper Memory"
- Over 1000 Memory Channels

Price \$ 553.80



# www.benelec.com.au

### All Price includes GST

#### NSW

Andrews Communications Systems  
Tel: 02 9636 9060 lee.andrews1@bigpond.com

#### Newcastle Pro Sound & Communications

Tel: 02 4965 6899 sales@newcastleprosund.com.au

#### Action Communications

Tel: 02 4732 2788 action@pnc.com.au

### Authorised Yaesu Dealers

#### VIC

Strictly Ham P/L  
Tel: 03 9729 7656  
sales@strictlyham.com.au

#### G & C Communications

Tel: 03 5996 3298  
gcomm@netspace.net.au

#### Qld

Kyle Communications  
Tel: 07 3857 4400  
mark@kyle.com.au

#### SA/NT

POSNAV Systems P/L  
Tel: 08 8342 4700  
brenton@posnav.com.au

#### WA

Bushcomm Pty Ltd  
Tel: 08 9296 0496  
bushcomm@bigpond.com



# Amateur Radio

Volume 72, Number 12  
December 2004

The Journal of the Wireless  
Institute of Australia  
ISSN 0002-6859

## Editorial

Editor: Colwyn Low VK5UE  
edarmag@chariot.net.au

Technical Editor: Peter Gibson VK3AZL

Publications Committee Members  
Brenda Edmonds VK3KT  
Ron Fisher VK3OM  
Don Jackson VK3DBB  
Evan Jarman VK3ANI  
Tom Potter VK3UBS  
Bill Roper VK3BR

## Submission of material to Amateur Radio Magazine

General and Technical articles to  
Secretary  
AR Publications Committee  
3 Tarnar Court  
Mentone VIC 3194  
or armag@optusnet.com.au

Columns and Letters to the Editor to  
Editor  
AR Magazine  
34 Hawker Crescent  
Elizabeth East SA 5112  
or  
edarmag@chariot.net.au  
(Tel and Fax 08 8255 2138)

Hamads to  
"Hamads" Newsletters Unlimited  
PO Box 431  
Monbulk VIC 3793  
Fax 03 9756 7031  
newunltd@bigpond.net.au

Advertising  
All enquiries to  
Newsletters Unlimited  
PO Box 431  
Monbulk Vic 3793  
Phone: 03 9756 7797  
Fax: 03 9756 7031  
newunltd@bigpond.net.au

Registered Office  
10/229 Balaclava Road,  
Caulfield North VIC 3161  
Australia  
Phone: 03 9528 5962

## Production Deadlines

Advertising booking and articles for  
publication 10th of preceding month.  
Hamads and advertising material  
deadline 18th day of preceding month  
The contents of Amateur Radio are Copyright  
Wireless Institute of Australia © 2004

## GENERAL

Book Review – Radio Projects for the Amateur Volume 3 by Drew Diamond VK3XU <i>Ron Fisher VK3OM</i> .....	23
The Honduras experience .....	24
<i>Judy MacDonnell VE0JAM</i>	
New microwave records set in VK4 and VK2 .....	29
<i>Russell Lemke VK3ZQB</i>	
Amateur Radio Magazine Awards .....	36
New ADSL modem: The continuing saga of getting broadband ADSL .....	55
<i>Will McGhie</i>	
WIA welcomes new members .....	56
Propagation by the light of the silvery moon .....	57
<i>Bill Isdale VK4TWI</i>	

## TECHNICAL

A compact, effective vertical antenna for 160 metres Part 1 .....	5
<i>Drew Diamond VK3XU</i>	
Some useful wire antennas for HF – Part 2 .....	9
<i>Rob S Gurr VK5RG</i>	
An experimenter's LF/MF receiver .....	13
<i>Dale Hughes VK2DSH</i>	
NCDXF/IARU beacon wheel for around the world in 3 minutes .....	22
<i>Christoph Berg DF7CB/J.C. (Jack) Laib VK6CTL</i>	
Evolution of a high power "current balun" .....	27
<i>J. C. Laib VK6CTL</i>	
A vertical antenna for 15, 17 & 20 metres .....	33
<i>John Howlett VK6ZN</i>	
The copper loop for 70cm (Technical Abstracts) .....	53
<i>Peter Gibson VK3AZL</i>	

## COLUMNS

ALARA .....	38	Spotlight on SWLing .....	40
AMSAT .....	45	State news .....	34
Beyond our shores .....	51	VK1 news .....	34
Contests .....	41	VK2 news .....	34
Club news .....	37	VK6 news .....	35
Directory .....	64	VK7 news .....	35
Editorial comment .....	2	Sunspots graph .....	58
Hamads .....	62	Technical abstracts .....	53
HF predictions .....	60	VHF/UHF – an expanding world .....	48
News members .....	56	WIA comment .....	3
Over to you .....	52, 59	WIA News .....	4
Silent keys .....	40, 54		

## Our Cover this month

Microwave equipment for record attempt at GloucesterPoint Hill. See page 29 for details

### Contributions to Amateur Radio

Amateur Radio is a forum for WIA members' amateur radio experiments, experiences opinions and news. Manuscripts with drawings and or photos are always welcome and will be considered for publication. Articles on disc or email are especially welcome. The WIA cannot be responsible for loss or damage to any material. A pamphlet, How to write for Amateur Radio is available from the National Office on receipt of a stamped self-addressed envelope.

### Back issues

Back issues are available directly from the WIA National

Office (until stocks are exhausted), at \$4.00 each (including postage within Australia) to members.

### Photostat copies

When back issues are no longer available, photocopies of articles are available to members at \$2.50 each (plus an additional \$2 for each additional issue in which the article appears).

### Disclaimer

The opinions expressed in this publication do not necessarily reflect the official view of the WIA and the WIA cannot be held responsible for incorrect information published.

## Amateur Radio Service

A radiocommunication service for the purpose of self-training, intercommunication and technical investigation carried out by amateurs; that is, by duly authorised persons interested in radio technique solely with a personal aim and without pecuniary interest.

## Wireless Institute of Australia

The world's first and oldest  
National Radio Society  
Founded 1910

Representing

### The Australian Amateur Radio Service

Member of the

### International Amateur Radio Union

Registered Office of the WIA

10/229 Balacra Road, Caulfield North Vic 3161

Tel: (03) 9528 5962 Fax (03) 9523 8191

email: nationaloffice@wia.org.au

http://www.wia.org.au

All mail to

PO Box 2175 Caulfield Junction VIC 3161

Business hours: 10am - 4pm weekdays

### National Office staff

June Fox	Office Coordinator
Emma Trebilco	Examinations Officer
Brenda Edmonds	Office Assistant

### Board of Directors

President	Michael Owen	VK3KI
	Robert Broomhill	VK3KRB
	Glenn Dunstan	VK4DU
	Trevor Quick	VK5ATQ
	Ewan Mcleod	VK4ERM
	Ted Thrift	VK2ARA
	Phil Wait	VK2DKN
Secretary	Peter Naish	VK2BPN
Treasurer	David Pilley	VK2AYD

### Coordinators

AMSAT	Graham Ratcliff	VK5AGR
ARDF	Jack Bramham	VK3WWW
Awards	Mal Johnson	VK6LC
Contests	Ian Godsil	VK3JS
John Moyle Memorial		
FD Manager	Denis Johnstone	VK3ZUX
Editor "AR"	Colwyn Low	VK5UE
Education	Ron Smith	VK4AGS
EMC/EMR	Gilbert Hughes	VK1GH
	Keith Malcolm	VK1ZKM
Standards	Gilbert Hughes	VK1GH
	Peter Naish	VK2BPN
FTAC	John Martin	VK3KWA
Historian	t.b.a.	
IARU Region 3	Neil Penfold	VK6NE
Liaison Officer		
Intruder Watch	t.b.a.	
International	John Miller	VK3DJM
Travel Host		
ITU Conference and study group	Gilbert Hughes	VK1GH
	David Wardlaw	VK3ADW
	Keith Malcolm	VK1ZKM
QSL Curator	Ken Matchett	VK3TL
QSL Manager (VK9/0)	Neil Penfold	VK6NE
Videotapes Curator	VK2 Division	
Webpage co-ordinator	Colin Thompson	VK2TRC
WICEN	John Weir	VK3ZRV

### ACA Liaison Team

Peter Naish	VK2BPN,	Peter Mill	VK3APO
Gilbert Hughes	VK1GH,	Glenn Dunstan	VK4DU
Keith Malcolm	VK1ZKM		

## Editorial comment

Colwyn Low VK5UE

### Christmas greetings to all members and readers

This is larger issue than usual, as the next issue will not be out until February 2005. Aerials are the main topic in this issue. I hope you find some things to think about and some things to do in the articles and columns.

I note that the *Spring VHF/UHF Field Day* seems to have suffered from poor weather. I know I only went out for Saturday afternoon and made six contacts. I seem to have hit a bad patch, the FT-101 gave trouble in the CQ DX Contest and needs attention, the converted Philips 828 for 52 MHz was not completed, the PRM-8030 on 144 MHz seems to have lost output power, the FM-95 on 432 MHz suffered similarly and the 1296 MHz converter was "funny". I got a bit depressed at this point but Steve VK5AIM said his gear was working so we operated a joint station at St Kilda NW of Adelaide. Later I did some checking and found that RG58 is even lossier than I thought at VHF. 10 m is a 3 dB attenuator at 144 MHz and 7 dB at 432. Nothing wrong with the sets, just me. The FT-101 had a major overhaul thanks to John VK5MG and now is almost like new.

The *Ross Hull VHF Contest* starts after Christmas and ends on January 15th -16th weekend with the *Summer VHF/UHF Field Day*. This should give the VHF, UHF, and Microwave enthusiasts some serious challenges.

For the rest of us there should be plenty of opportunities in the long summer evenings to chat with old mates and find some new ones on the HF bands. There might even be the time to accept the challenge of major refurbishment of the station or building a piece of gear that has been wanted for several years.

I would like to think that the National WIA is now settling down and that

amateurs are accepting this as the change "that had to happen" and that every effort is being made to ensure continuity of service at the local level. Let us all work together for the good of amateur radio in Australia in 2005.

I attended the wind up of the VK5/8 Division on Friday 19th November. The resolution to terminate the incorporation was passed unanimously by the 70 + members in attendance. Our President Michael Owen attended and in a short speech pointed out that Australia needs one voice to speak on behalf of all amateurs to the ACA and make representations to other levels of government as required. It also needed one voice to speak for Australian Amateurs in IARU. It also needs to have the resources and amateur volunteers to play our part in the IARU and to be part of the Australian delegation to the ITU. The one national Australian radio amateur radio institute should be able to plan our participation in and support of these activities. Keeping the hobby afloat requires major expenditure and it is provided by your subs. The WIA will now also pick up the cost of the repeater network previously funded by Divisions from their share of your subs.

I send you all Christmas Greetings from the Publications Committee of Amateur Radio magazine and we extend our best wishes for 2005 to you all.

In closing my personal Seasons Greetings and Best Wishes to all amateurs for a prosperous and happy 2005.

73 Colwyn, VK5UE, Editor AR

*The President, Directors and office staff of the  
Wireless Institute of Australia*

*wish all members and readers of Amateur Radio*

*a very happy holiday season and a prosperous 2005*

**We will be back to serve you again in February**

## A better qualification system?

**The most common criticism of the amateur examination system conducted by the WIA on behalf of the ACA is that it is too slow and cumbersome, that it takes too long for candidates to receive their results and that there is no automatic or timely indication to the candidate of the areas requiring further attention.**

The system is really a series of steps, with invigilators nominated by clubs that have a group conducting exams, and markers who are separate from the group, with the papers being sent to the WIA office for marking more often than not without even a provisional mark being given to the candidate and with a strict requirement that each step is properly completed before the next step is taken. It doesn't take much for the necessary delay to be extended. If an invigilator forgets, for example, to sign the invigilator's declaration, then when the other documents are received the WIA office must chase him for the missing document and receive it before the next step is taken.

All of this is intended to provide a framework where by a strict separation of the roles of marker and the conduct of the examination and a strict adherence to a protocol, the process can be audited and opportunity for any improper assistance or other impropriety is greatly minimised.

The great advantage of the present system is that it enables clubs across the country to conduct examinations so that they can attract, train and test new amateurs in a local environment. The system is designed to take advantage of the many willing amateurs, most of whom have had no training as educationists, to provide a service in many regional and rural areas that would not otherwise be available.

The WIA has been reviewing the present system in the context of the work being undertaken in relation to the new syllabus for the Foundation Licence, as well as the new Standard and Advanced licences, the latter corresponding to the present unrestricted licence, but modified to meet the requirements of the European Conference of Postal and Telecommunications (CEPT) Recommendation T/R 61-02. This will enable Australian amateurs to operate

in other countries participating in the Recommendation relying on their Australian amateur licence.

I would like to tell you where our thinking is currently at, and to invite our members to express their views on the proposals that we are currently examining.

I stress that this has not been put to the ACA at this stage, and so even if what is suggested is seen as a real solution to a real problem, there can be no guarantee that it will in the end be adopted.

Any assessment system must meet certain requirements, and have certain characteristics. For example:

**Validity:** the skills and knowledge to be checked should be assessed using a methodology that measures what is supposed to be checked. The method or procedure should be relevant to the way in which the application would occur in amateur radio.

**Reliability:** the assessment processes must have the capability to produce consistent results. This includes the need to provide sufficient evidence to make adequate decisions.

**Credibility:** processes and methodologies should ensure both internal and external acceptance. This includes meeting any safety or legal/regulatory requirements, which may relate to the skill or knowledge being assessed.

More practically, how can we devise a system or process whereby the candidate can know his result immediately?

Equally, if a practical assessment is required for the Foundation Licence, as suggested in the ACA Outcomes of the Review of Amateur Service Regulation, who is to make that practical assessment?

A competency-based training approach has been adopted in Australia, and is

the basis of the nationally recognised qualifications based on the Australian Qualifications Framework. We are considering a system whereby WIA assessors are formally trained by a Registered Training Organisation (RTO), and accredited and registered by the WIA. Do we need to be satisfied that a registered assessor is a fit and proper person for the task? Perhaps registration could require submission of references and perhaps there could be other requirements.

Assessor registration would last for a period, say three or five years, after which time the assessor would be reviewed and where appropriate re-registered by the WIA. An audit procedure would be established and all assessors would be subject to audit.

These WIA registered assessors will be approved to assess all amateur examinations.

In addition to these assessors, there would be a small number of nominated special assessors. These would have a higher qualification, often people trained appropriately as teachers or the like, with their qualifications recognised for the purpose of their accreditation.

These nominated assessors would be able to administer special examinations. Special examinations are required, for example, for disabled people, for persons already a member of a group. Perhaps the nominated assessor could even administer practical assessment tests at a distance in prescribed circumstances. The special assessors would also audit other assessors.

The purpose of the accreditation system is not to train a "teacher". It is to train an individual to undertake a particular and narrowly defined task, that is, to assess the competency of a candidate for an amateur radio qualification. Of course, the assessor is

*continued on page 28*

## **WIA Proposes Technical Interference Advisory Service**

Recently the WIA Board considered a suggestion by Ron Bertrand, VK2DQ, suggesting the establishment of a Technical Interference Advisory Service for members.

The interference most likely to cause a member to seek help is interference to domestic appliances, such as radios, television, amplifiers and the like. Ron suggested that experienced volunteers around the country could provide the service.

The Board thought that the suggestion to have considerable merit.

The Board considered that such a service would need to be carefully structured, as it would be very easy for the volunteers to become involved in disputes, which was not intended. Such a service could not be involved in dispute resolution, nor interference caused by one amateur to another, or indeed any aspects of individual behaviour, whether a vendetta by one neighbour against another or conflict between amateurs.

Glenn Dunstan, VK4DU has agreed to be the director responsible for the project, and the Board has appointed Gilbert Hughes, VK1GH, as National Coordinator.

## **Ernie Hocking resigns as WIA Director**

WIA Director and Vice President, Ernie Hocking VK1LK has advised the WIA Board of his resignation as a director of the WIA and therefore as Vice President.

Ernie has told the board that his ongoing heavy work commitment means that he is unable to contribute as actively to the WIA as he would like, and that given the importance of establishing a fully functional national body, he would prefer to stand aside to allow someone else to replace him.

He told the board "I can assure you of my continued support for the Institute and its current efforts to establish a truly national peak body to represent the best interests of amateur radio in Australia."

The board has accepted Ernie's resignation "with regret and gratitude for his extraordinary contribution to the WIA".

Michael Owen, VK3KI, WIA President paid tribute to Ernie's vision and contribution to the restructuring of the WIA, and said that the WIA cannot afford to lose his experience.

Ernie has accepted the position of Special Advisor to the Board.

## **Board appoints VK3KRB as new director**

The Constitution of the WIA requires the Board to fill the vacancy created when a director resigns.

The Board has appointed Robert Broomhead, VK3KRB, a director of the WIA to fill the vacancy created by the resignation of Ernie Hocking as a director for the remainder of the term of Ernie's appointment.

Robert's voice is well known to many amateurs, as he has been a member of the WIA news presentation team. He has been deeply involved in his local club, the Eastern and Mountain District Radio Club, and is currently its Vice President.

He is yet another member of the board with a significant club background.

## **The Amateur Radio 2005 Events Calendar**

The WIA has placed an Events Calendar on the national website ([www.wia.org.au](http://www.wia.org.au)) so that when a club is planning an event, or a contest, you know in advance what else is going on.

You can find it by clicking on Member Services, and then, Coming Events.

Ted Thrift, VK2ARA, director with special responsibility for clubs, says that if your club wants to be part of the 2005 Events Calendar and make sure that your club gets a good shot at the action, send your 2005 Events Calendar to him at [tthrift@primus.com.au](mailto:tthrift@primus.com.au).

## **WIA Summary of the FCC Report and Order on Access BPL**

The US Federal Communications Commission (FCC) has published its full Report and Order on Access to BPL.

The FCC says that it wishes to develop policies encouraging the implementation of BPL bringing an end to the broadband duopoly of cable modem and DSL service, while managing the technologies' interference potential.

WIA director with special responsibility for BPL, Phil Wait, VK2DKN, has placed on the WIA National website a summary of the extensive FCC material.

## **Victoria Club Forum Report**

The WIA is moving ahead even faster following the Victoria Clubs Forum held on Saturday 23 October and attended by 15 radio clubs.

Barry Robinson, VK3JBR, who chaired the meeting organised by the WIA Victorian Advisory Committee and Amateur Radio Victoria said that the Forum lived up to its expectations in providing an excellent networking opportunity for radio club officials.

In addressing the gathering, WIA National President Michael Owen, VK3KI, described the WIA as being in a period of evolution, with a good structure in place, and seeking feedback from radio clubs on a range of matters.

A spirited discussion took place on possible criteria for club affiliation with the WIA.

All clubs were keenly interested in learning about the Foundation Licence that is due to be introduced next year. The WIA has produced a draft syllabus.

VK3KI said that the Board is now considering how best to conduct the practical assessment element of the Foundation Licence. This may require examiners undergoing an accreditation course.

In concluding the Forum VK3KI expressed his appreciation to the organisers, and praised the quality feedback he had received from the club delegates.

## **UK Amateurs Gain 7.1 - 7.2 MHz**

The Radio Society of Great Britain announced on October 29 that all necessary procedures required for early

*continued on page 26*

# A compact, effective vertical antenna for 160 metres

## Part 1

Drew Diamond VK3XU

**Our lowest band, 160 metres ("Top Band" - 1.800 to 1.875 MHz) continues to attract new enthusiasts. The amateur with a reasonably tall mast, or tower, can usually erect a wire antenna of sufficient height and length to put out a good signal. But limited space and height is a problem for some of us, so what can we do?**

Vertically polarised, ground-wave propagation is almost universally used for cross-town working, and the usual method of creating such a wave is with a vertical antenna of some kind. At night, a vertical antenna is also good for long-distance work.

The impedance measured at the base of a resonant  $\frac{1}{4}$ -wave radiator with respect to a good ground system (Figure 1) is of the order of 30 or 36 ohms (Reference 1), where most of that 36 ohms is "radiation" resistance (Rrad), which represents that part of the antenna load that does useful work as radiation. In series with Rrad is the loss resistance Rloss (Figure 2), usually represented by a lump sum of all those effective resistances that waste power as heat, such as earth/ground resistance, conductor resistance, dielectric losses and losses caused by the proximity of poorly conducting bodies such as trees and buildings.

A radiator smaller than  $\frac{1}{4}$  wavelength (Figure 3) will exhibit a rapidly decreasing Rrad, as it is shortened. At 0.1 wavelength (16 m physical), Rrad will be about 9 ohms. If Rloss is also 9 ohms, then half the power delivered to the system will be wasted, even if Rrad + Rloss is efficiently matched (with a suitable network) to our transmission line. Hence, for any radiator worked against ground, best efficiency is obtained when all resistance losses are kept to a minimum (Reference 1). In series with Rrad and Rloss is a reactive (X) component of the impedance. Being shorter than  $\frac{1}{4}$  wave, this reactance will be capacitive, usually expressed as  $-jX$ , and of rapidly increasing reactive value

as the radiator is shortened (Figure 2).

A quarter-wave vertical for 1.8 MHz would be about 40 m tall, and probably well beyond the realm of most urban amateurs. In medium-wave commercial broadcasting, for instance, the optimum radiator is considered to be a  $\frac{5}{8}$ th wave vertical with a multitude of buried ground radials (References 2 and 3), or, at the very least, a quarter-wave with as many ground radials as economically possible. However, by "loading" the radiator, it is easily possible for the amateur to construct a reasonably efficient vertical antenna which is considerably shorter than a physical quarter-wave.

There are two conventional methods of loading a radiator, top-loading by capacitance (or "capacity-hat" loading, Figure 4), and lumped inductive loading (Figure 5). Professional vertical antennas for VLF and LF

typically use capacity loading in order to increase the radiation resistance of a physically short antenna (Reference 4). A vertical antenna for 1.8 MHz may also be capacity-hat loaded (Reference 5). However, to work efficiently the system still needs to be physically rather large.

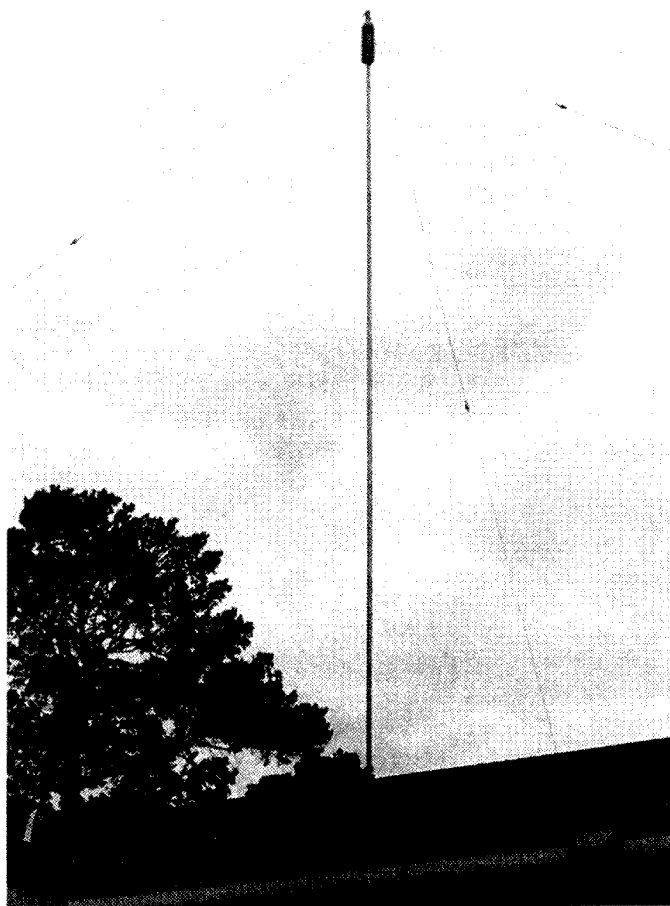
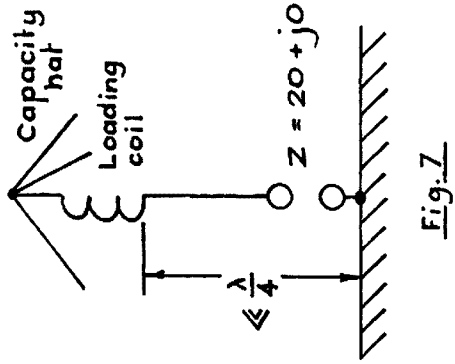
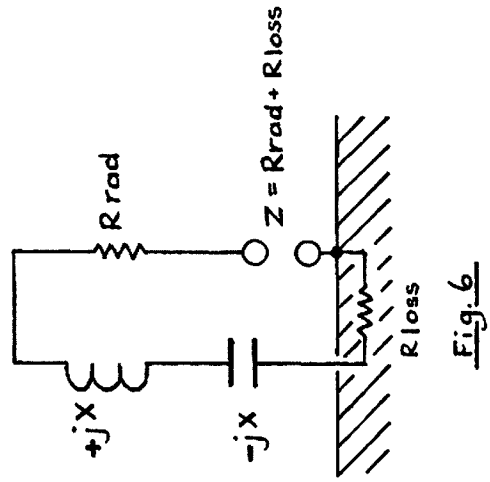
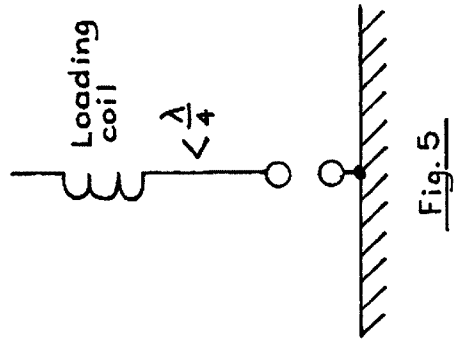
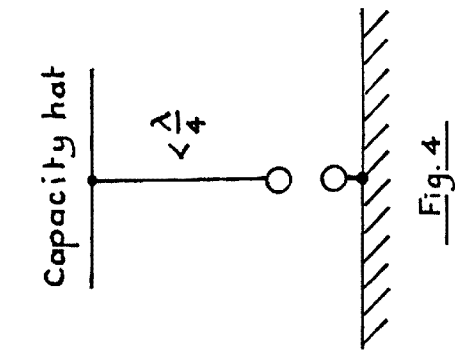
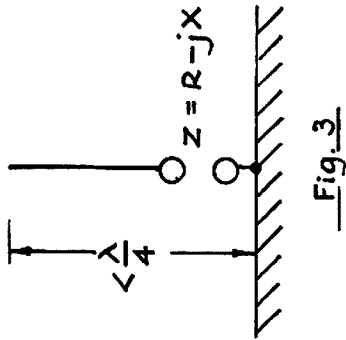
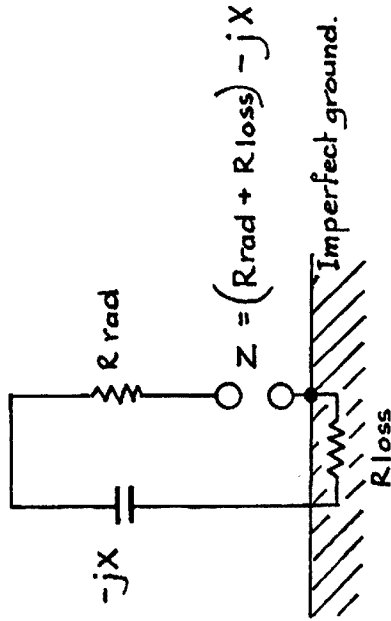
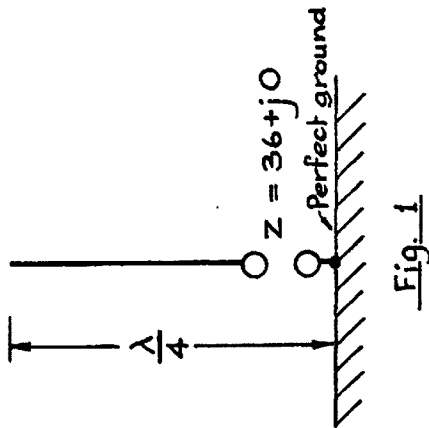

Photo 1 – Loaded vertical for 160 metres





Because a short antenna is capacitively reactive, we must add an equal amount of inductive reactance (+jX) to obtain a net reactance of zero (+jX -jX, leaving just Rrad plus Rloss, Figure 6). So, a lumped inductance in the form of a coil or helix may be inserted at some appropriate point in the radiator.

The positioning of the coil is problematic. Even the best made coil will have some loss. When all else is equal, a higher inductance (more turns) will incur a higher I squared R loss. When the coil is at the base, the current through the coil is high, but the inductance required is moderate. As the coil is moved up the radiator, the current falls, but the amount of inductance required increases. It has been found empirically that a position about half-way (or "centre loading") provides a good compromise between coil inductance and coil loss (Reference 6).

If one accepts the popular notion that the strength of the far field is proportional to current flow in the radiator, when placed conveniently at the base, current distribution in the radiator above the coil is poor. Placing the coil further up the radiator improves current distribution (References 6 and 7), but then the need for a gap in the radiator and the mechanical problems of accommodating and protecting the coil (from the weather) may seem difficult.

A good and workable compromise is to adopt a combination of both capacity and inductive loading (Figure 7). By using part of the necessary top guy wires as a capacity hat, and locating the loading coil a short distance below the hat, we obtain a relatively small, practicable antenna (Photo 1) capable of surprisingly good performance.

The goal was to make a vertical antenna using purchasable materials, capable of providing acceptable performance on 1.8 MHz. All electrical joints and connections are kept to a minimum, which prescribes a single length of tube for the vertical part. A height of 6.5 m above the roof should not (it is hoped) cause objectionable visual impact.

A 1/16th size experimental model of the planned antenna was made for 29 MHz which, after being optimised, and then scaled up in size for 1.8 MHz, allowed use of the 10 x 10 m metal decking roof upon the "granny flat" of our house as a "ground-plane". A stock 6.5 m length of 32 mm diameter aluminium tube

forms the vertical component, making the height to the capacity hat apex only about 10 m above ground level.

Much experimental work has been done in arriving at a satisfactory loading coil. Using ordinary white UPVC water pipe as the coil form, various coil configurations were tested, relying greatly on distant reception reports. One very interesting finding, which confirms several statements about the coil's form (eg Reference 8), is that a spaced winding is far superior to close-winding. This observation, and why it should be so, has caused great discussion.

The loaded vertical antenna is quite conventional in operation. The H (magnetic) component is produced mainly by radio-frequency current travelling along the vertical conductor (tube), and the electric (E) field is produced by the capacity hat situated above the vertical. These two fields combine in the near-field to produce a radiated electro-magnetic field.

Many antenna workers declare that the H-field of a lumped coil contributes significantly to the far field. I cannot agree with this assertion, because the H-field produced by the coil is at right-angles to that created by the main vertical current-carrying conductor (right-hand screw rule, see Reference 9). Furthermore, if the coil's field were to contribute (to the far field), then the coil's winding would have to be connected in the correct "phase". No such stipulation is known in this regard.

Back to the coil. The measured capacitance between adjacent close-wound turns (for my coil) is 18 pF, whereas the capacity between turns spaced 4 mm is just 0.4 pF, which represents a 45-fold reduction. The interwinding capacitances, although they are effectively in series across the length of the coil, ultimately appear in shunt with the capacity hat, thereby reducing the intensity of the electric field. By spacing the turns, we reduce this unwanted capacitance, and its shunting effect, to a very small value.

## Performance

My "reference" antenna is a 3/8th-wave inverted-L, 10 m high at the shack end rising to about 15 m at the far end, which works rather well both for local cross-town and long-distance work. By switching between the L and the loaded vertical (always remembering

to disconnect the other antenna to prevent any coupling effects), signal strength reports were obtained from local (around Melbourne), interstate and DX operators.

Applying AA6GL's vertical antenna software (Reference 10), for an estimated 10 ohms ground loss the antenna has a computed radiation efficiency of about 30 %. The transmitted signal from the vertical is generally about 6 dB better than the L for local ground-wave work. Reports from interstate and the USA were more circumspect due to fading, but certainly the vertical was generally about as good as the inverted-L.

Measured feed-point impedance at the base is 20 ohms (SWR 2.5) at the resonant frequency of 1.840 MHz. At this frequency an SWR of 2.5 is not excessive in good RG-8 coax cable, where the necessary coupler/matching network (described in a forthcoming essay) may therefore be conveniently located at the transmitter end of the coax line. The vertical may thus be effectively operated over the greater portion of the band.

Construction details are given in Part 2.

## References and further reading

1. *Radio Communication Handbook*; 7th edition RSGB, pp 13.54 - 58 (and previous editions).
2. *Radio 2; Australian Post Office*, 1951 (Paper 2).
3. *Radio Engineers' Handbook*; F Terman, 1943, pp 843 - 849.
4. *The Amateur Radio Vertical Antenna Handbook*; P Lee, CQ Technical, pp 22-31.
5. "A Broadband Vertical Antenna for 1.8 MHz"; S Hunt, G3TXQ, *RadCom* November 1987, pp 830-832.
6. *All About Vertical Antennas*; Orr and Cowan, Radio Publications, pp 69-71.
7. "Home Station Antenna for 160 Metres Part 2" (of 4); J Adcock VK3ACA, *Amateur Radio*, June 1971, pp 3-7.
8. *The ARRL Antenna Book*; 17th edition, pp 4.19 - 20.
9. *Electrical Technology*; E Hughes; 7th edition, Prentice-Hall, pp131, 132.
10. *Antenna Software* by AA6GL; recent ARRL Handbooks..

ar

## 450 Ohm Ladder Line

Copper coated 7 core steel conductors

VERY LOW LOSS

### Ten-Tec model 3003 Acro-Bat antenna hanger.

Made from UV resistant, high-stability Trirex polycarbonate plastic, as used by Power companies for covering outdoor electric power meters. Hammers won't break it. All hardware is stainless steel. Can suspend either a ladder line-fed or small gauge RG-58 or RG8X coax-fed wire antenna, or ladder line with internal pegs. Internal screw connections solidly clamp the wire antenna to the coax or ladder line feedline itself. Attach wire and coax to the screw terminals, and

clamp the two sides together and you are ready to hoist your antenna. A large hole in Acro-Bat allows easy hoisting, of wire antennas by rope.

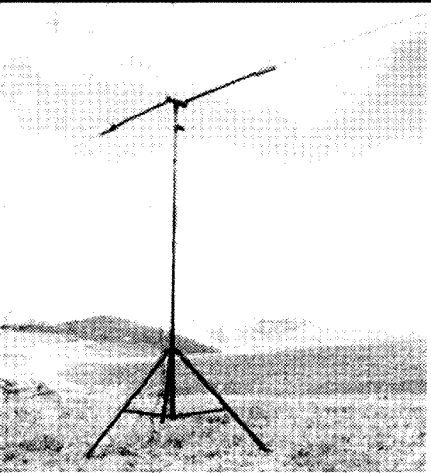
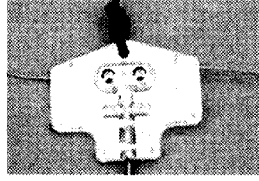

## Buddipole A Complete Portable Antenna System

- The Buddipole Antenna (9 bands, 2 - 40 meters)
- Tripod - extendable legs and locking base
- Portable Mast - extends to 8' in height
- Rotating Arm Kit - change configurations
- Antenna System Bag - padded cordura nylon w/shoulder strap
- Extra Stainless Steel Telescopic Whip
- 3 extra Coil Clips
- Antenna Operating Manual
- FREE - New 10-page modeling report

We specialise in mail order. Visa and Master Card  
**COD**

### WE SUPPORT WHAT WE SELL!

If you have a problem, our strong relationship with the support divisions of our US suppliers combined with our professional service lab will get your unit quickly up and working to original specs.

## TEN-TEC HF Radios

Orion  
Jupiter  
&  
Argonaut  
HF Transceivers

Ten Tec Commercial  
& Professional  
Communications  
Receivers

SGC  
SGC 2020 Portable  
20W HF Transceiver

## TEN-TEC

build  
yourself  
kits

(Call for your free  
catalog)

Amidon Iron Powder and Ferrite Products (Call for an Amidon product guide)

SGC ADSP<sup>2</sup> Noise Reduction Speakers

SGC ADSP<sup>2</sup> Noise Reduction Boards (High power and low power versions available)

Power Source switch mode power supplies (a wide range of outputs)

Davis Weather Stations

Professional Grade Coax Feed lines and Connectors

Custom RF Patch leads and cables made to order

## High Power Variable Inductor from Ten-Tec.

Silver Plated Coil, Max Inductance is 20 microHenry.

An ideal companion to the Ten-Tec variable capacitor kit.

Perfect for that high power antenna tuner project

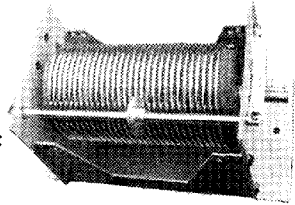

## Antenna Couplers/Tuners

SGC Mac 200

5 Position Antenna

Switch/Tuner

SGC SG235,  
SG230,  
SG237, SG239  
and SG211

Automatic Antenna Couplers



Z100

## Vantage Pro Weather Station

Available in wireless or cable versions, both with integrated sensor suit, which combines the rain collector, temperature and humidity sensors, and anemometer all into one package - making set up easier than ever and improving performance and reliability.

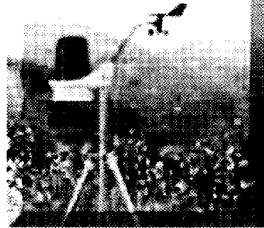

Customize your weather station by adding consoles to suit your needs. Each Vantage Pro console/receiver can receive data from up to eight different transmitting stations. Start with one wireless Vantage Pro or Vantage Pro Plus station (which include both the console and the integrated sensor suite) and add up to seven additional Temperature or Temperature/Humidity stations. Or buy the Vantage Pro console alone (without the integrated sensor suite, and add up to eight special purpose stations of your choice.



Optional Solar Radiation and UV sensors

DETAILED DATA SHEETS ARE AVAILABLE ON REQUEST FOR MOST PRODUCTS.



# TTS Systems Communications Equipment

Systems

FREE CATALOGUE

[www.ttssystems.com.au](http://www.ttssystems.com.au)

HF and VHF Transceivers, Autotuners and Kits

Phone 03 5977 4808. Fax 03 5977 4801 [info@ttssystems.com.au](mailto:info@ttssystems.com.au)

# Some useful wire antennas for HF - Part 2

Rob S Gurr VK5RG continues sharing his knowledge of wire antennas with us.

(Originally published in Amateur Radio Volume 64, No 4, April 1996)

## G5RV

This antenna is one of the most popular in use on HF. It first came to amateur attention in 1935, being a design for a multi-directional radiator for 14 MHz. In the late 1940s, G5RV promoted its use as a multiband antenna, fed with a matching stub and a 75 ohm coaxial cable. The antenna on 14 MHz is 1.5 wavelengths long and, with six useful lobes, was much better than a dipole (Fig 9). It followed that the SWR was low on 14 MHz and on some other bands popular at the time, and its use as a universal antenna grew, particularly as any mismatch on these bands could be taken up by the pi network output stages in the valve transmitters in use in those days.

On 3.5 MHz it became a shortened dipole, and on 7 MHz the bidirectional characteristics of a full size dipole were evident. However, with the introduction of solid state equipment with a fixed 50 ohm output impedance, it became necessary to use an antenna coupler with the antenna, and subsequently the later articles show the antenna in the open wire configuration. The directional

properties on the various bands were accepted without question, but many experimenters testing the antenna found that often the results obtained were not as good as a previously used dipole. This is common with a lot of short period tests of long wire antennas, where the stations being contacted are located in a deep "null" (Fig 9) giving poor results. However, a station on a bearing only a few degrees away may be of good strength (this aspect of all antennas must be kept in mind when conducting such tests).

The antenna dimensions are 15.54 m each side of centre, and the matching section of open wire line is 10.36 m. However, any length of line should be suitable, if correctly matched with an ATU.

## Terminated Vee Beam

Long wire antennas exhibit considerable gain at little expense (compared to some commercial antennas)(see Fig 12). Regrettably, the gain in some cases is spread over four major "lobes" as well as some smaller lobes. Apart from

having gain, there are, unfortunately, directions in between the main lobes where there is very little radiation, or "nulls". This latter property, mentioned before, explains why sometimes an unsuspecting amateur may build a long wire antenna and find it is ineffective, the only stations on the air during his trials probably being in the direction of these "nulls".

The angles of major radiation and the "nulls" can be determined from prepared charts and a combination of "long wires" made to amalgamate these lobes into a useful directional "beam". Two popular antennas are the "Vee Beam" and the "Rhombic" which, in their standard form, are bidirectional, but when "terminated" become unidirectional in the direction of the termination.

The rhombic is a little large for suburban backyards but, where space is available, it is a high grade antenna.

The "Vee" beam also requires a large area. However, in case a suitable space is available, or there are some friendly neighbours, I will describe a terminated "Vee Beam" with special features.

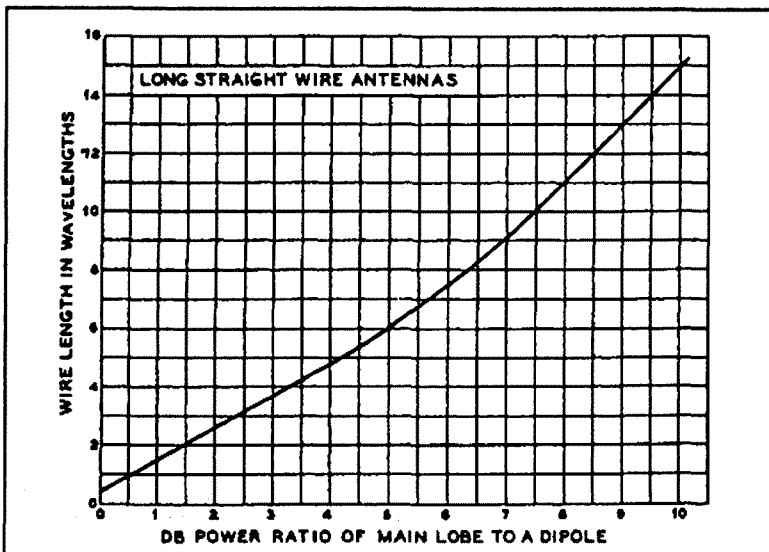

Fig 12 - Directive gain of long wire antenna. (Reprinted from the Radio Handbook, 21<sup>st</sup> edition, page 28-3)

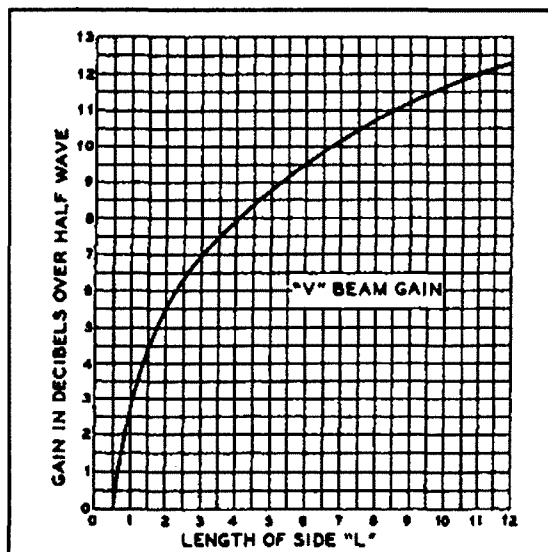

Fig 13 - Directive gain of a V beam. (Reprinted from the Radio Handbook, 21<sup>st</sup> edition, page 28-5)

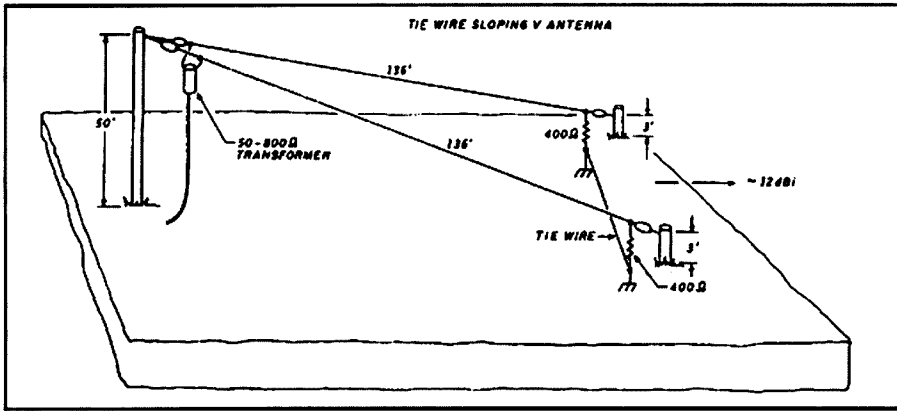

Fig 14 – Terminate V beam antenna.  
(Reprinted from Ham Radio, May 1990, page 49)

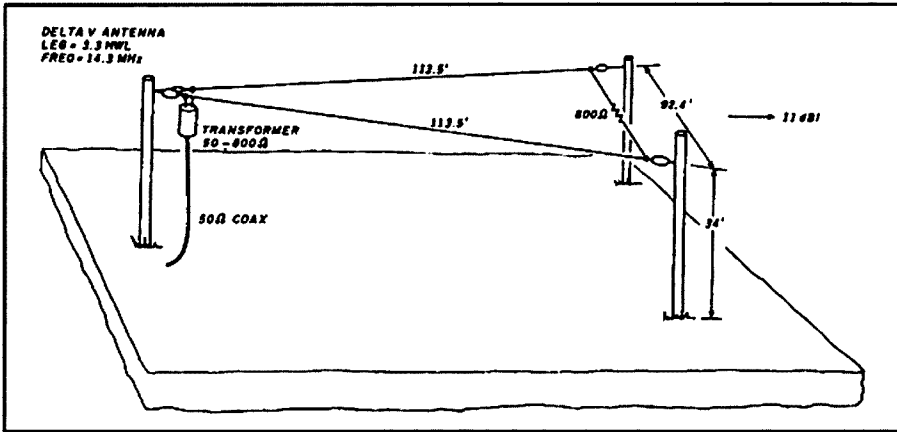

Fig 15 – Delta V antenna optimised for the 20 m band.  
(Reprinted from Ham Radio, May 1990, page 52)

## The Vee beam

The lobes of two long wires may be combined into forming a Vee Beam, with gain, as shown in Fig 13. The resultant bidirectional pattern may be made unidirectional by terminating each distant end with a 400 ohm resistor to ground, with a benefit of up to 3 dB additional gain (Fig 14). The height of the apex of the "Vee" should be at least 10 metres, whilst that at the ends need

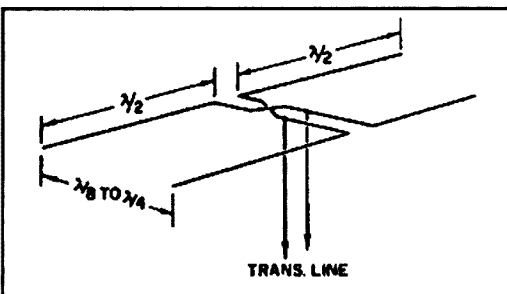

Fig 17 – A four-element array combining collinear broadside elements and parallel end-fire elements, popularly known as the W8JK array.  
(Reprinted from the ARRL Antenna Book, 15<sup>th</sup> Edition, page 8-37)

only be adequate to clear pedestrians, and animals if on a farm paddock.

The slope of the wires gives further enhancement to the unidirectional properties. When the terminating resistors are returned to ground, the suitability of the ground conductivity is often suspect, to the extent some

Leg length (half wave-length)	Delta gain (dBi)	V gain (dBi)	Comments
1.7	9.3	9.4	Compact antennas
2.1	9.9	9.9	Compact antennas
3.3	12.4	11.0	Best Delta trade-off
6.0	12.0	12.8	
7.5	12.8	13.6	
8.7	12.9	13.5	
10.0	13.1	14.9	Highest gain size

Fig 16 – Table 2  
"Magic" leg lengths in half waves for Delta and V antennas. (Other delta dimensions are not recommended.)  
(Reprinted from Ham Radio, May 1990, page 51)

constructors put in a ground wire immediately below the antenna wires. A now popular method of avoiding this ground return problem is to connect the two wires together, across the base of the Vee, and connect them together with a termination resistor of double the value (ie 800 ohms).

Fig 15 shows the dimensions pictorially, and a chart showing potential gain is shown in Fig 16. As is evident, there is every reason to expect good results from such an antenna.

## The W8JK antenna

First published in the late 1930s, an article on end-fire antenna arrays, by Dr John Kraus in the USA, presented to the engineering world an interesting multiband gain antenna suitable for

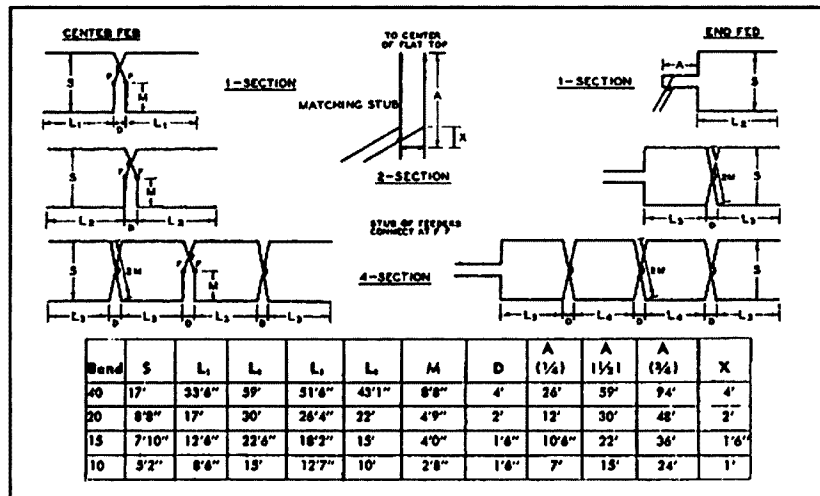

Fig 18 – W8JK array design data.  
(Reprinted from the Radio Handbook, 21<sup>st</sup> edition, page 28-16)

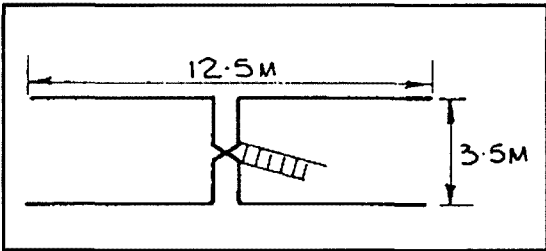

Fig 19 - A W8JK array for 10 MHz as a gain antenna, useful on various bands as follows:  
 10 MHz - single section W8JK with gain of 3 dB over a dipole.  
 14 and 18 MHz - extended half-waves for driven dipoles, for 4 dB gain.  
 21 MHz - driven elements equal to two half-waves in phase, for 5 dB gain.  
 24 and 28 MHz - driven elements equal to two extended half-waves in phase, for 6 dB gain.  
 (Reprinted from Amateur Radio, September 1984, page 17)

use by amateur and professional alike. This is an end-fire array in which its elements are driven, compared to the Yagi that utilises parasitic elements. The driven elements can also be collinear elements making a combination end-fire and collinear array (Fig 17). There are a number of useful features which make it attractive as a multipurpose, multiband antenna, including:

1. not as seriously influenced by height above ground as a similar sized Yagi array;
2. useful as a multiband antenna;
3. symmetrical in its construction;
4. adjustments made at the base of the feedline, not at the antenna;
5. has reasonable gain; and
6. is bidirectional

My own experience has revealed the W8JK to be a good choice for a fixed wire antenna for any location. I have also used it as a rotary beam antenna and, as such, it only requires 180 degree rotation for all-round coverage.

A number of configurations using single and double sections are possible (Fig 18). Stacking is also possible, for which an appropriate gain increase (max 3 dB) may be realised. The most successful simple version for suburban backyard use would be the single section array. With 10 metre half wave elements, and 2.5 m spacing, this combination gives 3, 4 and 5 dBd gain on 14, 21 and 28 MHz respectively (Fig 19). One other version uses two half-waves in phase, each driven, for gains of 5 dBd and 6 dBd on 14 and 21 MHz. On 28 MHz the lobes break up and, whilst having useful gain, are multi-directional.

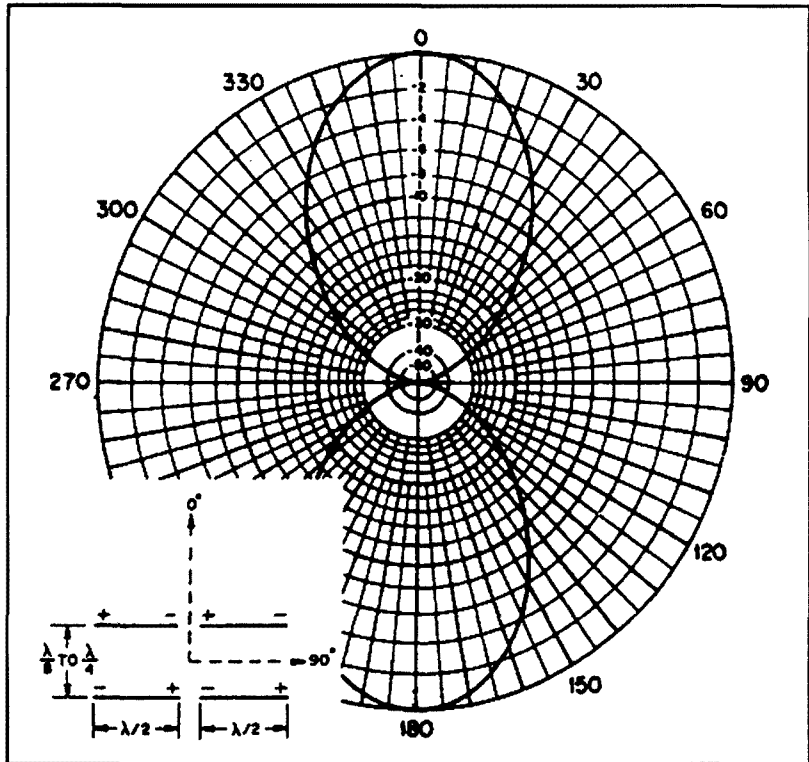

Fig 20 - E-plane pattern for the W8JK array. The elements are parallel to the 90° - 270° line in this diagram. Less than 1° change in half power beam-width results when the spacing is changed from 1/8 to 1/4 of a wavelength.  
 (Reprinted from the ARRL Antenna Book, 15<sup>th</sup> Edition, page 8-37)

Yet another arrangement has two extended half-waves in phase to give 6 dBd gain on 14 MHz. The lobes on 21 MHz and 28 MHz, whilst useful and possessing high gain, are in odd positions, and orientation of the antenna for directional use on 14 MHz only seems the most practical. It is not imperative that all elements be exactly a half wave as long as they are equal in length and the whole configuration is symmetrical (Fig 20).

One major advantage is the ability of the array to operate over a 2.5 to 1 frequency range and maintain the bidirectional pattern, with gain increasing as the frequency is raised. Most designs show a spacing of 1/8 wavelength, but anything between this and 1/4 wave should give good results. The array may be erected less than a halfwave above ground, provided that the symmetry of the W8JK array is maintained (ie it is sufficiently far away from nearby structures, trees, etc). It gives good results on every band from 10 to 28 MHz (as well as good reception on the various broadcast bands).

## ZL special antenna

This antenna is another version of the two element end-fire phased array (W8JK), but configured to give unidirectional radiation. The ZL Special is a popular antenna in its own right and is used mainly on 14 MHz and above as a directional beam, with 4 to 5 dBd gain and a front-to-back ratio that is greater than 30 dB. It is also used on VHF and UHF as the major driven element in a multi-element long-boom Yagi (Fig 21).

It evolved from early experiments using two dipoles, spaced 1/8 wave, and fed 135 degrees out of phase. This array (G8PO) used each dipole fed with an equal length of twin feed line, one line being transposed and fed in parallel with the other (180 degrees). A further phase shift was provided by an additional quarter wave line in one of the feedlines (45 degrees). This method of phasing can produce a number of interesting patterns, depending on the spacing and phase shift between the two elements (Fig 22).

The ZL Special uses a phasing line connected directly between the elements at the top of the mast (so, therefore, has

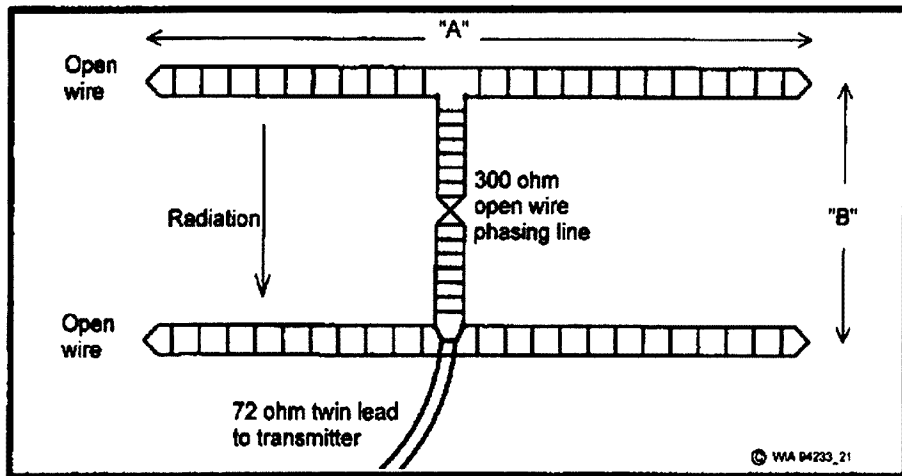

Fig 21 – The ZL-Special antenna has good gain and directional characteristics considering its overall size. For example, dimensions for 14.1 MHz are A = 31'6" and B = 8'8"

ZL Special 2 m Beam, in "Out of Thin Air", a Practical Wireless publication.

Part 3, the final of the series on 'Some Useful Wire Antennas for HF'; will appear in a coming issue of Amateur Radio.

### Gain of V Beam

The author would like to make a slight amendment to Part 2 of this series. Referring to V Beams, it is stated that terminating each end remote from the feed-point with a 400 ohm resistor to ground will produce not only a unidirectional pattern but "a benefit of up to 3 dB additional gain".

On energy-conservation grounds it may be argued that absorbing some power in the resistors, which would otherwise be radiated in a particular direction, cannot increase the power radiated in another direction. The front-to-back ratio will become large, but to expect further gain (approaching 3 dB) is rather optimistic. It may be, because in the terminated case the current distribution along the wires is a travelling wave, not a standing wave, that the energy-conservation concept is an over-simplification and some additional gain may in fact be possible; but it is likely to be much less than 3dB.

ar

to be pre-cut to length) and only one feed line. The centre impedance is very low, being about 12.5 ohms. Matching stubs enable it to be driven by open wire lines or coaxial cable.

A similar antenna developed by HB9CV, and published in the European press, used a coaxial cable phasing line between the two elements, which are gamma matched to the diametrically opposite quadrants. This version has become very popular for VHF use as a fox hunting antenna, where its front to back ratio is extremely useful.

the vertical drive pipe. If, say, a 10 metre length of 32 mm diameter aluminium tubing (with appropriate tapering) is used for the elements, and split in the middle, cambric or fibre glass rod may be used for joiners, inserted into the central tube ends, to give an insulated "split" in the elements. This need only be 150 mm long, enough to use a "U bolt" style TV clamp to hold the element on to the boom.

For 14 MHz the tube length is 10 m and the element spacing 2.1 m. The phasing line is 72 ohm twin lead, 2.46 m long, transposed, whilst matching to a 300 ohm line is by a 3.6 m length of the same 70 ohm twin lead. A version using folded dipole elements is shown in Fig 21.

VHF Construction has been well recorded in Fred Judd's (G2BCX) article,

### Construction

The use of "plumber's delight" methods is precluded in the ZL Special by the need to have an insulator in the centre of each element. The boom may be 50 to 70 mm aluminium tube, "U" bolted on to

## Amendment

### VK5BR X Antenna

Figure captions omitted November 2004 pages 15-17

I have to apologise to Lloyd Butler VK5BR for the omission of the captions from his article. If you want to insert them in your copy for completeness they are given below.

Editor VK5UE

Figure 1 - VK5BR\_X2/X3 Antenna Field

Figure 2 - VK5BR\_X3 Antenna

Figure 3 - Tuning arrangement VK5BR\_X2 Antenna

Figure 4 - VK5BR\_X3 Antenna Shunt Feed Coupling System

Figure 5 - VK5BR\_X3 Antenna Coil Connection

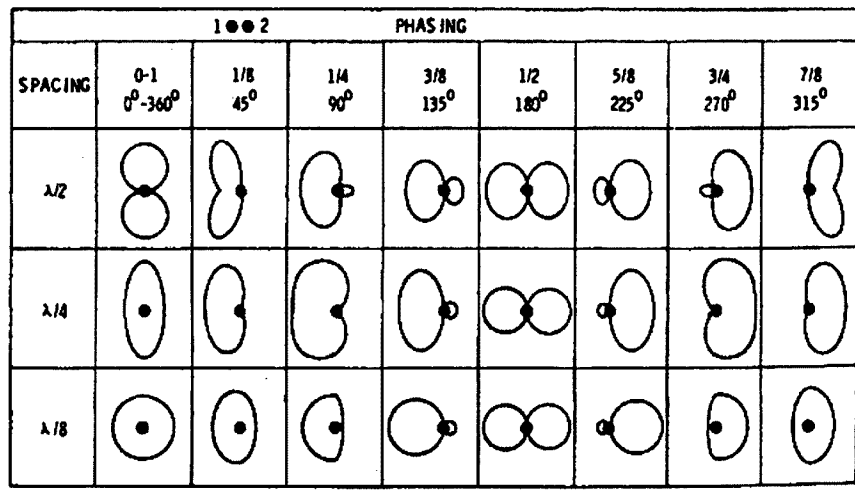

Fig 22 – Radiation patterns for a two-element phased array. (Reprinted from the Radio Handbook, 21<sup>st</sup> edition, page 27-12)

# An experimenter's LF/MF receiver

Dale Hughes VK2DSH

The idea for this receiver grew out of an article by Lloyd Butler, VK5BR, in the December 1989 issue of *Amateur Radio*. The article (1) described a LF/MF receiver which used a resistance tuned local oscillator and operational amplifiers for the gain stages. The design was appealing because of its simplicity and ease of alignment, and the resulting receiver was small enough for portable use.

My initial intent was to duplicate the receiver, however several of the crucial parts appeared to be difficult to obtain. I then realised that this presented an opportunity to try out some circuit techniques that might be interesting, these being:

- A local oscillator using Direct Digital Synthesis (DDS) technology. I had recently been experimenting with DDS technology in a test oscillator (2) and was confident that a DDS design would work very well. An accurate 50 MHz crystal oscillator module that provides a high degree of frequency stability and resolution clocks the DDS. In this design, a frequency step of 100 Hz has been provided.
- RF amplifiers using 'noiseless feedback', where gain stabilization is by means of transformer coupled negative feedback. This circuit topology is reputed to have excellent signal handling ability, wide bandwidth and a low noise figure. It also has the advantage of presenting a 'two way impedance match'; that is, the input impedance is the same value as the output impedance. In this case, the impedance is 50 ohms. These features come at the cost of increased power consumption. Details of 'noise-less feedback' amplifiers can be found in references (3), (4) and (5). The amplifier used in this receiver is a push-pull design that performs very well, giving a voltage gain of approximately 9, and handling the high signal levels found in the low and medium frequencies with ease.
- A switching type mixer based on a CD4066 CMOS analog switch driven by a 74HC74 flip-flop that generates an accurate square wave. The

mixer is broadband terminated by a differential input, high frequency operational amplifier.

- The detector is a so-called 'supergainer' regenerative detector (6) that can give considerable gain, up to the point of positive feedback. When oscillating, the detector performs well as a CW and SSB demodulator. Prior to the onset of oscillation, the detector acts as a standard 'square law' envelope detector.
- Use readily obtainable operational amplifiers for the IF stage.
- Use an 'Active Whip' type antenna, that is a short vertical element with an impedance converter which converts the high impedance of an electrically short whip to the 50 ohm input impedance of the receiver. References (7), (8) and (9) provide some background in the techniques used for active whip antennas and several different designs are discussed. The most important factor in the design of active whips is dynamic range and noise figure.

The final design of the receiver uses all of the above ideas and the result is a receiver that has the following specifications and features:

- A frequency range of 10 kHz to 2000 kHz, in 100 Hz steps,
- Excellent dynamic range,
- Low noise,
- High sensitivity,
- Demodulates CW, SSB and AM,

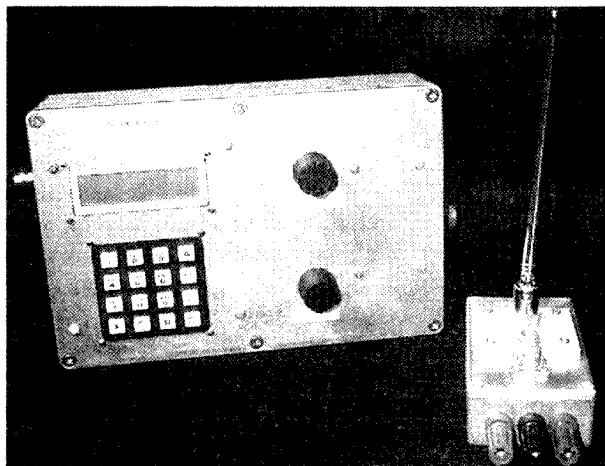

Figure 1. The complete receiver and the portable version of the active whip antenna.

- Adjustable RF step attenuator,
- Easy to use and portable.

The receiver is easy to operate, with a minimum of controls. Frequency selection is by means of a keypad, where the frequency can be entered directly. The keypad also allows the user to step up or down in frequency in 100 Hz steps. The RF attenuator is also adjusted from the keypad, the user can select one of four attenuator settings: 0 db, 6 db, 12 db or 18 db. The only other controls are the volume control and the regeneration control. The regeneration control gives the user control over the detector gain and increasing the regeneration can significantly enhance weak signals. CW and SSB signals can be resolved by advancing the regeneration control up to the point of oscillation where the detector becomes a self-oscillating product detector. In use, the control is very smooth and the detector gives a very high quality audio output. In addition to the foregoing, when receiving a strong AM station, the detector can act in an 'injection locked' mode, where the oscillating detector will lock to the incoming carrier. The

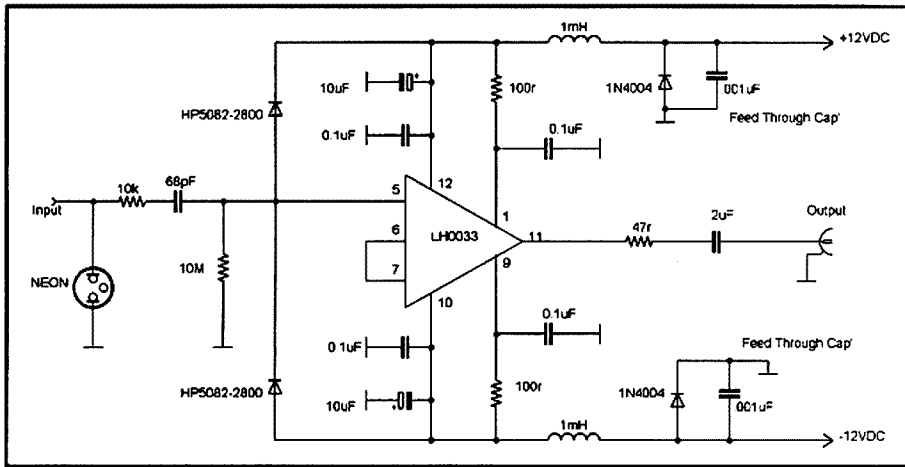

Figure 2. Active antenna schematic diagram

detector performance is very good in this mode, with noise and distortion at a very low level.

The receiver sensitivity is as good as it needs to be, DX AM broadcast stations are easily received. In the LF region, NDBs over 1200 km distant have been heard and the time signals on 40 kHz and 60 kHz are heard most evenings. The 60 kHz signal can only be heard if the receiver is well away from any television set, as a harmonic of the 15625 Hz line oscillator will completely swamp the 60 kHz time signal. Reception down to 10 kHz is possible and the Russian 'Alpha' navigation signal can occasionally be heard, as can the various naval transmissions below 25 kHz.

The step attenuator is useful when receiving a weak signal adjacent to a strong signal, and the receiver noise figure is low enough to permit using the maximum attenuation (18 db) setting to overcome any overloading problems. As the receiver has no AGC system, the step attenuator can be used in conjunction with the regeneration control to reduce the volume of powerful stations.

This article should be considered more as a description rather than a detailed construction article, thus no printed circuit board artwork is given and some of the parts used might be difficult to obtain. The original receiver was built on 'Vero' type prototype boards, or using 'ugly' type construction. When the design was more-or-less complete, circuit boards were designed and made. Even then, changes were made to the final circuit as receiving experience dictated circuit modifications.

Due to the presence of high-speed digital circuitry in the micro-controller it is very important that special attention is paid to filtering and de-coupling of all power supply and control lines. The completed receiver makes extensive use of feed-through capacitors on all power supply connections, relay control lines and audio circuits. In addition, the RF circuitry is well screened from the digital circuitry by two layers of thin circuit board material. Inadequate screening, filtering and mechanical construction will result in inferior performance of the completed receiver.

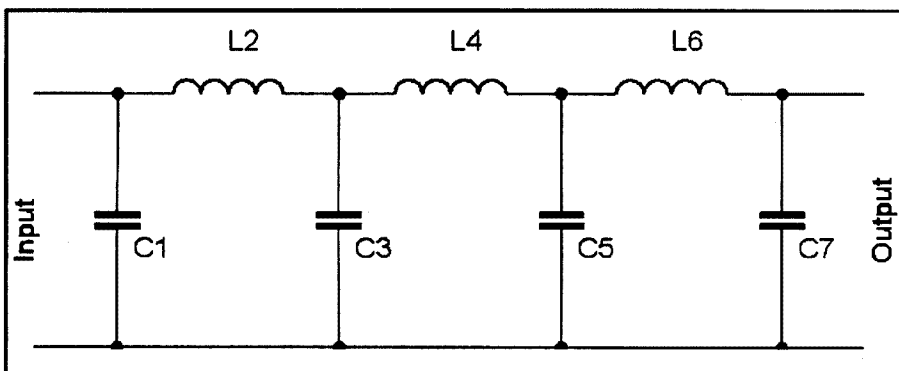

Figure 3. Prototype filter schematic diagram. The front end requires four such filters with the component values shown in Table 1. (See figure 4.)

## Detailed circuit description

The receiver can be broken down into a number of sections:

- (1) The active antenna,
- (2) The 'front end' filters, attenuator and RF amplifier,
- (3) The mixer, IF, detector and audio amplifier,
- (4) The DDS local oscillator.

Each of these parts will be described in the following sections.

Note that the supply to the receiver is split, i.e. +/- 6 volts, this simplified biasing of the operational amplifiers in the IF and DDS sections. The active antenna uses a split 12 Vdc supply, i.e. +/- 12 volts, and it can be run from the +/- 6 volt supply if required, although the dynamic range of the buffer is reduced and the potential problems due to overload and inter-modulation are increased.

## The active antenna

As the antenna is a short vertical whip it is necessary to employ some form of impedance matching between the whip, which has a very high impedance, and the 50 ohm feed line. This design uses a LH0033 FET input, fast voltage follower that has a very high input impedance and a line driver output stage. The active antenna module is fitted with lightning protection in the form of a neon tube between the antenna input and ground, the buffer input is protected by reverse biased diodes which conduct when the input voltage exceeds +/- 12 Vdc, a series resistor limits the transient current flow to a small value. Two of these units have been built, a roof-mounted unit with a 1.5 m whip and another portable unit with a shorter, telescopic antenna and no lightning protection. (As shown in figure 1.)

Inter-modulation products can be a problem with active antennas, especially in areas where there are multiple high power transmitters. This design is reasonably robust as the standing current of the FET stage is 10 mA, and the supply voltage is +/- 12 Vdc,

This results in a buffer that handles high-level signals without generating significant inter-modulation products. The output impedance of the complete active antenna is 50 ohms, so it presents a good match to the following low pass filters. Shunt capacity on the antenna



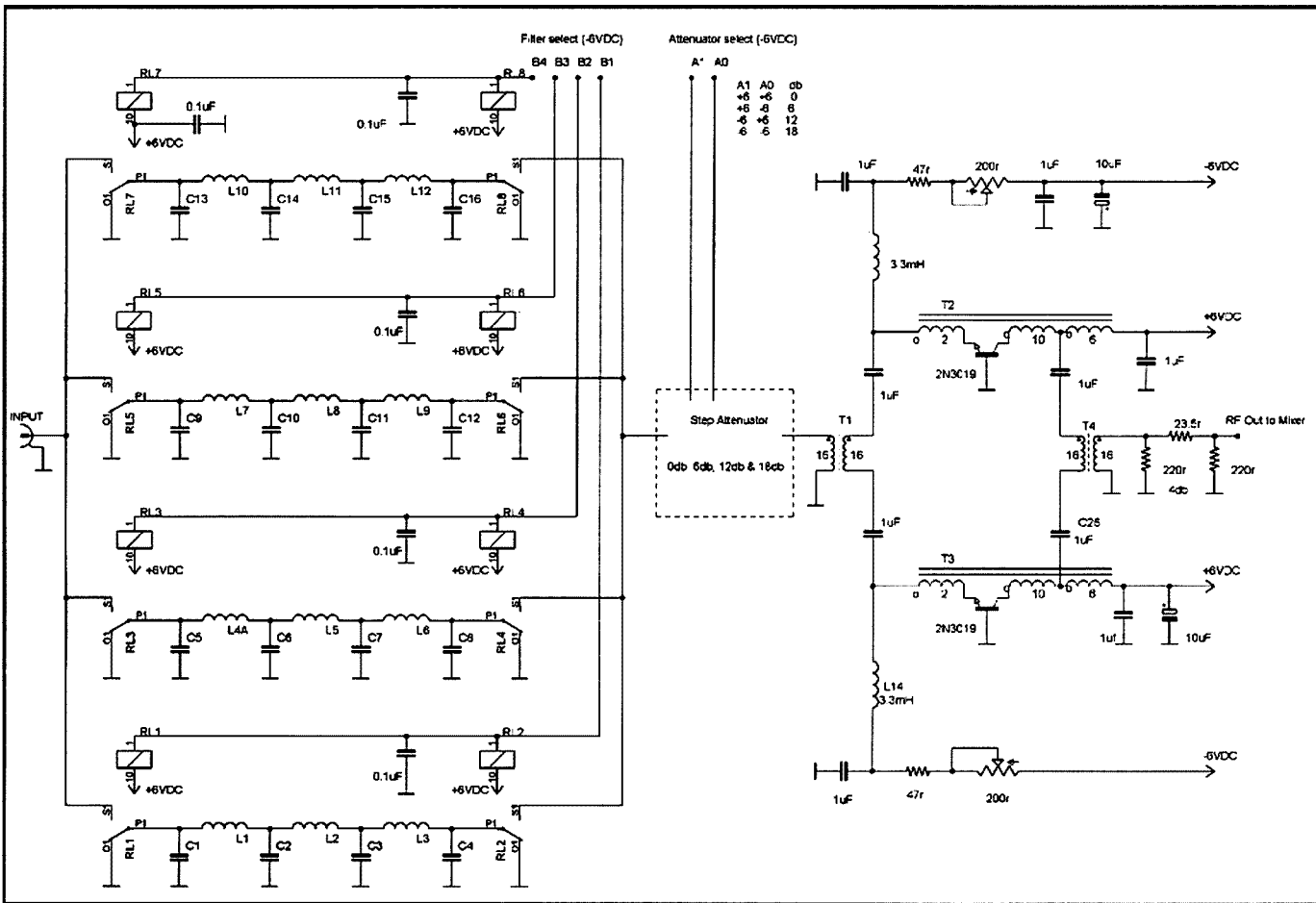

Figure 4. Front-end schematic diagram. The low pass filter component values are taken from Table 1. Transformers T1, T2, T3 and T4 are wound on Amidon FT-50-77 ferrite cores. See figure 5 for details of the step attenuator.

input should be kept to a minimum if reception down to the lowest frequencies is required.

### The front end

As the receiver is a superhet design, some form of image frequency rejection is required. A conventional receiver would use a tuned circuit that would reject the image response 910 kHz (twice the intermediate frequency) above the wanted frequency; such a system is easily achieved when a multi-ganged variable capacitor is used. In this design there is no variable capacitor so it was more difficult to arrange a variable frequency tuned circuit. Instead this design uses a low pass filter, which is selected according to the frequency of interest. In this case, the low pass filters have cut-off frequencies of 365 kHz, 663 kHz, 1210 kHz and 1960 kHz. The filters are 7 element designs taken from the ARRL handbook (10) and have been selected to use standard capacitor values and hand wound toroidal inductors. Table 1 shows the component values and

cut-off frequencies; figure 3 shows the prototype filter design and component identification.

Where n is the number of turns on an Amidon T50-15 toroidal core (Iron powder type core). Fc is the filter cut off frequency, F40 is the frequency at which the filters response is 40 db down

The required filter is switched into the signal path by means of small relays, I considered using diodes to switch the filters into and out of the signal path, but was concerned that diodes might be subject to high signal levels and a potential source of inter-modulation products. Each filter section is short circuited when it is not selected so that spurious filter resonances should not occur. Software examines the selected

receive frequency and switches in the appropriate low pass filter. The user has no direct control of the filters.

A constant impedance step attenuator follows the filters and the signal level entering the RF amplifier can be adjusted to suit the listening conditions, four levels of attenuation are possible 0 db, 6 db, 12 db and 18 db. Control of the attenuators is by means of key strokes on the keypad. Details of the attenuator are given shortly.

The RF amplifier uses a pair of 2N3019 transistors in a push-pull noiseless-feedback arrangement. This circuit has the advantage of being able to handle very high signal levels and still operate in a linear region. The circuit has 50 ohm input and output impedances and is well

F <sub>c</sub> kHz	F <sub>40</sub> kHz	C <sub>1,7</sub> nF	C <sub>3,5</sub> nF	L <sub>2,6</sub> uH	L <sub>2,6</sub> n	L <sub>4</sub> uH	L <sub>4</sub> n
365	580	10	18	31.1	48	34.5	51
663	1050	5.6	10	17.5	36	18.9	38
1210	2130	2.2	4.7	9.27	26	10.8	28
1960	3140	1.8	3.3	5.83	21	6.5	22

Table 1. Component values for front end low pass filters.

# ICOM CHRISTMAS SPECIALS 2004

Genuine 2 Year **FACTORY** Warranty  
on all Icom Radios

**HURRY . . . LIMITED STOCKS ONLY**



## Amateur Base



### IC-718

Ideal "Beginner" Package

Compact HF All Band Transceiver

**NOW \$1099** Normally \$1645

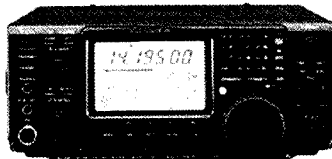

### IC-7400

HF+50/144MHz Tri-band Base  
Transceiver with Built-in Automatic  
Antenna Tuner

**NOW \$3199** Normally \$4378

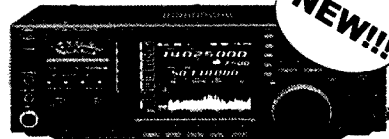

### IC-756PROIII

Multi-mode HF/6m Base Transceiver  
with 32-bit Floating Point DSP

**NOW \$5999** Normally \$7678



**Now \$1499**  
was \$1999

### IC-706MKIIG

Multi mode HF/6m/2m/70cm

Mobile Transceiver

## Mobiles



### IC-V8000

Amateur 2m FM Mobile Transceiver

**NOW \$549** Normally \$715

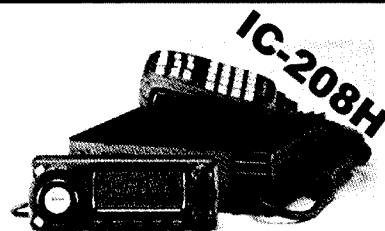

2m/70cm FM Mobile Transceiver

Compact Dual band unit with  
detachable control panel

**NOW \$699** Normally \$968

## Handhelds

### IC-V8

144MHz FM  
Transceiver

**NOW \$219**

Was \$274



### IC-T90A

Compact  
Tri-Band  
Transceiver  
with Wide Band  
Receiver

**NOW \$499**

Normally \$744

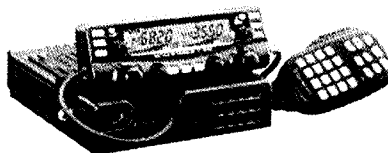

**IC-2720H NOW \$799** Normally \$1153-

2M /70cm Mobile Transceiver.

Compact Dual band unit w detachable control panel



## Receivers



**NOW \$799**  
was \$1095

### IC-R3

Color TFT/LCD  
TV & Wideband  
Communication  
Receiver



### IC-R5

Miniature  
Wide band  
Communication  
Receiver

**NOW \$369**

Normally \$499



### IC-R75

HF + 50Mhz  
Communication  
Receiver

**NOW \$1399**

Was \$1782



## NEW!!! IC-R20

Scan, Monitor, Record  
The Pro's Scanner!

**NOW \$899**

Normally \$999

Multi-mode  
Wideband  
Communication  
Receiver

### Terms and Conditions:

- Icom Christmas Specials 2004 is available thru selected Icom (Australia) Dealers **ONLY**, between 29/11/2004 - 23/12/2004. Please call Icom (Australia) on 03-9387 0666 for Dealer information.
- Subject to stock availability
- Special prices listed are GST inclusive

# ICOM

Find your nearest ICOM dealer @  
www.icom.net.au or (03) 9387 0666

suited for use in the LF/MF frequency range. With appropriate transformers and transistors, the circuit will operate well into the VHF range. The gain of the circuit is set by the turns ratio of the feedback transformers (T2 and T3) and with the values shown, the circuit has a voltage gain of 9. The 4 dB attenuator at the output of the amplifier is necessary to preserve the high dynamic range of the RF amplifier, as it ensures that the RF amplifier termination impedance is correct.

The bias current is adjusted by means of the 200 ohm potentiometer in the emitter circuit, so that 20 mA of collector current flows in each transistor. Ideally, the transistors would be well matched, however I did not match the transistors and I found that the gain of each 'half' of the circuit was very close. Other suitable transistors would be 2N3866 or 2N4427 devices, depending on availability.

As the ferrite toroidal cores used in the amplifier are conductive it is best to insulate the core with Teflon tape or to use insulated wire; I used wire wrap wire, also known as 'Kynar' wire to

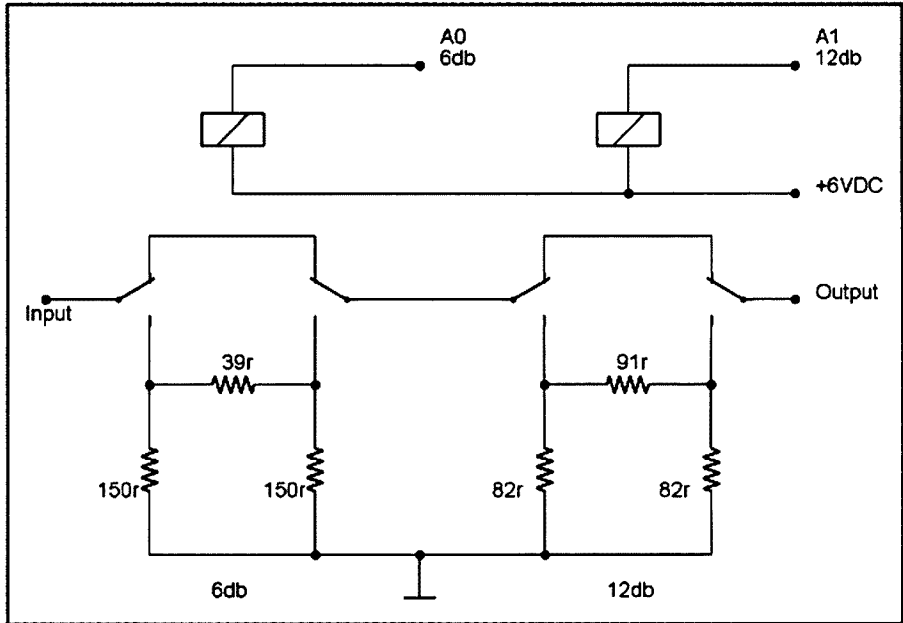

Figure 5. Schematic diagram of the step attenuator between the output of the low pass filters and the RF amplifier input. Other values of attenuation can be used if required.

wind the transformers. For the inductors in the low pass filters I used enameled copper wire directly onto the painted iron powder cores.

The attenuator was built on a small circuit board mounted adjacent to the front-end board and the signal coupled via thin co-axial cable. The relays are

# G&C COMMUNICATIONS

Authorised dealer for ● Kenwood ● Icom ● Barrett RFDS ● GME Electrophone ● Uniden ● YAESU

## ICOM TRANSCEIVERS

IC-756 Prof II HF + 6m	\$6,299
IC-7400 HF+6m+2m	\$2,695
IC-706 IIG HF-70cm	\$1,399
IC-718 HF SSB w/ DSP	\$ 999
IC-910H 2m+70cm SSB	\$3,199
IC-208H 2m + 70cm	\$ 649
IC-V8000 2m 75W	\$ 649
IC-T90A D/B H/H	\$ 499

## KENWOOD TRANSCEIVERS

TS-2000 HF-70cm	\$3,999
TS-480 SAT HF-6 +ATU	\$2,499
TS-870 S HF	\$3,999
TS-570S HF+6m	\$2,450
TS-508 HF	\$1,599
TM-D700A 2m +70cm	\$1,199
TM-9707A 2m + 70cm	\$ 899
TM-V7A 2m + 70cm	\$ 999
TH-D7A 2m +70cm	\$ 799
TH-F7E 2m +70cm	\$ 799

## Antenna Tuners MFJ 945E — MFJ949E The auto MFJ 993

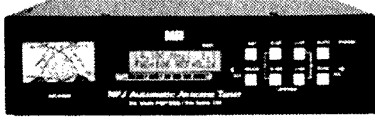

and the amazing  
MFJ 902 Travel Tuner



## ROTATORS

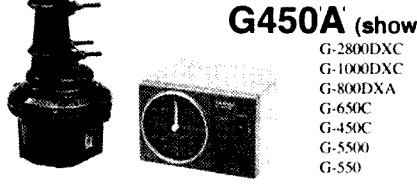

**G450A (shown)**  
G-2800DXC  
G-1000DXC  
G-800DXA  
G-650C  
G-450C  
G-5500  
G-550

**TE series EMTRON HF ANTENNAS**  
Australia wide orders welcome  
Credit card Cheque Money order

## YAESU

FT-1000MP MkV Field	\$4,299
FT-1000MP MkV 200W	\$4,899
FT-847 HF-70cm	\$3,299
FT-7800R	\$ 499
FT-8900R Quadband	\$ 799
FT-8800R Dualband	\$ 699
FT-817ND HF-70cm	\$1,299
FT-897D HF-70cm	\$1,499
FT-857D	\$1,399
FT-2800M 2m 65W	\$ 349
FT-1500M 2m 50W	\$ 449
FT-60R D/B H/H	\$ 399
VX-1R w/ 2 batts	\$ 349
VX-2R Tiny Dualband	\$ 399
VX-5R Triband H/H	\$ 649
VX-7R Deluxe H/H	\$ 699

**3 YEAR WARRANTY**  
**Comet & Diamond**  
Antennas & Accessories

Proudly Supporting Australian Business

E & OE

207 High St. Cranbourne VIC 3977  
Ph: 03 5996 3298 Fax: 03 5995 0184

Email: [gccomm@bigpond.net.au](mailto:gccomm@bigpond.net.au)  
[www.gccomm.com.au](http://www.gccomm.com.au)

switched according to the level of signal attenuation required:

Attenuation (db)	Relay A0	Relay A1
0	Off	Off
6	On	Off
12	Off	On
18	On	On

Table 2: Attenuator relay selection.

Selection of the attenuator setting is via the keypad. When the \* key is pressed, a menu appears on the LCD and the user can select which level of attenuation is required. The current setting of the attenuator is always displayed on the LCD, along with the current receive frequency.

## The mixer, IF and detector stage

Following the front end, the signal is passed to the mixer where the 455 kHz IF signal is generated. The mixer is a double balanced design using four analog switches. The switches are driven by a 74HC74 D-type flip-flop that provides an accurate square wave. A Schmidt trigger converts the sine wave output of the DDS oscillator to a logic level signal to drive the 74HC74. The mixer output is terminated by a resistive load by way of the input resistors of the following op-amp (IC4) that converts the balanced output of the mixer to a single ended signal and provides a modest amount of gain.

The ceramic filter that follows the mixer amplifier sets receiver selectivity. The filter I used has a 6 dB bandwidth of +/-3.5 kHz, which is wider than desirable, but it was the only filter I had on hand. Following the filter is an amplifier (IC5) that also provides the correct termination impedance for the filter.

As the receiver was designed to receive CW and SSB as well as AM signals, some sort of BFO was required. After examining the literature, I settled on the 'super gainer' type design that combines an envelope detector as well as an oscillator. When receiving AM, the gain of the circuit is adjusted such that no oscillation occurs. For receiving CW or SSB, the regeneration control is advanced until a beat note is heard. The gain of the stage also changes with the amount of regeneration, for strong signals the regeneration control is

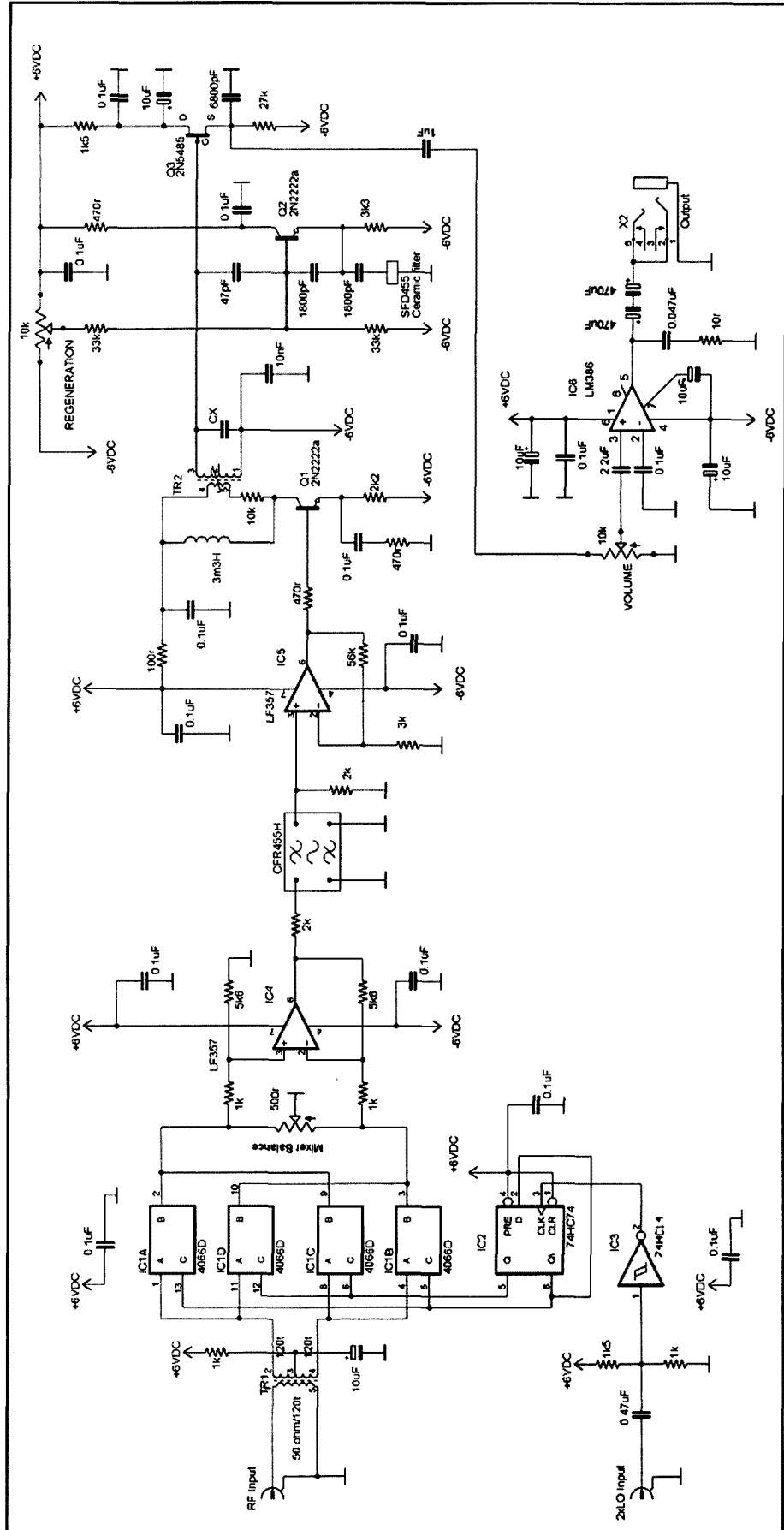

Figure 6. IF and detector schematic diagram.

backed off, maximum sensitivity occurs just prior to the onset of oscillation. The circuit performs very well and the regeneration control provides a wide range of gain adjustment and a smooth transition into and out of oscillation. The schematic diagram shows a two terminal ceramic filter (Murata type SFD455) in the emitter circuit of the oscillator transistor (Q2). This device acts to stabilize the oscillation frequency of the stage and is optional, if not used it should be replaced with a short circuit.

Transformer TR2 is a standard miniature 455 kHz IF transformer, (Cx is internal to TR2) and the output from the final IF amplifier (IC5) is lightly coupled to TR2 using a 10 k ohm resistor. Reducing the value of the coupling resistor makes the regeneration control much less effective, as the tuned circuit will be more heavily damped.

A LM386 audio amplifier has a voltage gain of 50 and will drive a loudspeaker or headphones with ample volume. As there is no Automatic Gain Control it is necessary to be careful when using headphones for listening, as it is possible to tune from a weak station to a strong station with ear-splitting results!

## The DDS local oscillator and micro-controller

A Direct Digital Synthesizer is used as the receiver local oscillator. The DDS local oscillator runs at twice the mixer frequency due to the divide by two flip-flop on the IF board. Thus the DDS frequency is:

$$Flo = 2 (Frx + 455) \text{ kHz}$$

Where Flo = Receiver local oscillator frequency

$$Frx = \text{Receiver frequency}$$

For this receiver the DDS oscillator tunes between 930 kHz and 4910 kHz, as the tuning range is 10.0 kHz to 2000.0 kHz, the required frequency is entered via the keypad and is displayed on the liquid crystal display. An Analog Devices AD 9835 DDS was used, and this chip has a maximum output frequency of 25 MHz when a 50 MHz crystal oscillator is used as the reference frequency. The sine wave output from the DDS chip is amplified by an LM7121 op-amp. The DDS signal is subsequently squared by a Schmidt trigger on the IF board, where the local oscillator signal is divided by two to generate the correct local oscillator frequency.

Control of the DDS, LCD, keypad and relay switching is by means of an Atmel AT90S8535 micro-controller. This chip is a very powerful and easy to use device, readily available from Dick Smith Electronics at reasonable cost. The micro-controller chip controls the input filter selection and attenuator relays and the interface is via a network of feed-through capacitors and opto-couplers. The opto-couplers provide a high level of electrical isolation so that noise from the micro-controller and associated circuitry is not coupled into the receiver. The opto-couplers also allow the 12-volt relays to be controlled from the 5-volt micro-controller circuitry. The opto-couplers used in this design have a high current transfer ratio (100%). If opto-couplers with a lower current transfer ratio are used, driver transistors will be required so that the relays pass sufficient current to operate.

The current version of the micro-controller firmware allows operation of the receiver between 10.0 kHz and 2000.0 kHz, and the frequency can be selected in 0.1 kHz increments. When a frequency has been entered, the setting can be incremented or decremented in 0.1 kHz steps by using 'up' and 'down' keys on the keypad. Thus, it is very easy to fine-tune the receiver.

The DDS and micro-controller are mounted on the same printed circuit board that is mounted on top of the box behind the keypad and display. These components are covered with a screen to minimise interference. All signal and power lines, except the local oscillator output, are filtered using feed-through capacitors. The local oscillator output is connected via small diameter coaxial cable.

The power supply regulator, DDS/micro and opto-isolators are on separate circuit boards, and mounted on the front panel of the receiver box – suitably screened.

## Receiver adjustments

There are a number of components that require alignment after the receiver is constructed:

- Adjust the micro-controller and DDS power supply to 5.00 Vdc by adjusting the potentiometer on the LM2941 voltage regulator.
- Adjust the contrast control so that the liquid crystal display can be clearly seen.

# One Man Tower™

"20 years on and still going strong"

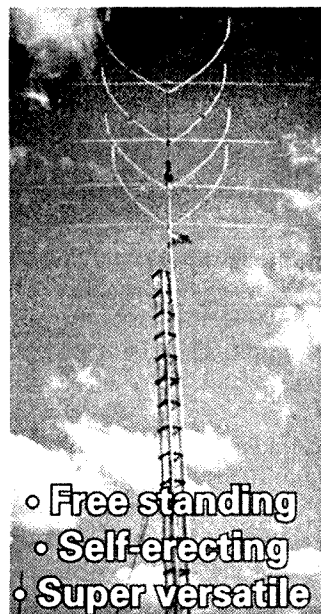

- Free standing
- Self-erecting
- Super versatile

By order only, sizes 10 m to 25m  
Manual or electric  
Fully hot dip galvanised steel  
construction



Introducing  
**OzSpid**

**antenna rotator**

AEI has recently gained distribution rights for this fantastic little rotator

- Runs on 12v DC
- Multiple control options
- Log-book-linked software for PC control
- Solid steel construction
- Positive braking
- Fully programmable
- Full back-up provide

**Only \$990 inc GST**  
(freight extra)

**Australian  
Enterprise Industrial**

PO Box 1013, Browns Plains 4118 Qld  
Mob 0414 254 080, fax 07 3800 8003  
Email: [aitower@ihug.com.au](mailto:aitower@ihug.com.au)  
Website: <http://homepages.ihug.com.au/~aitower>

**Kev Peacock VK4KKD**

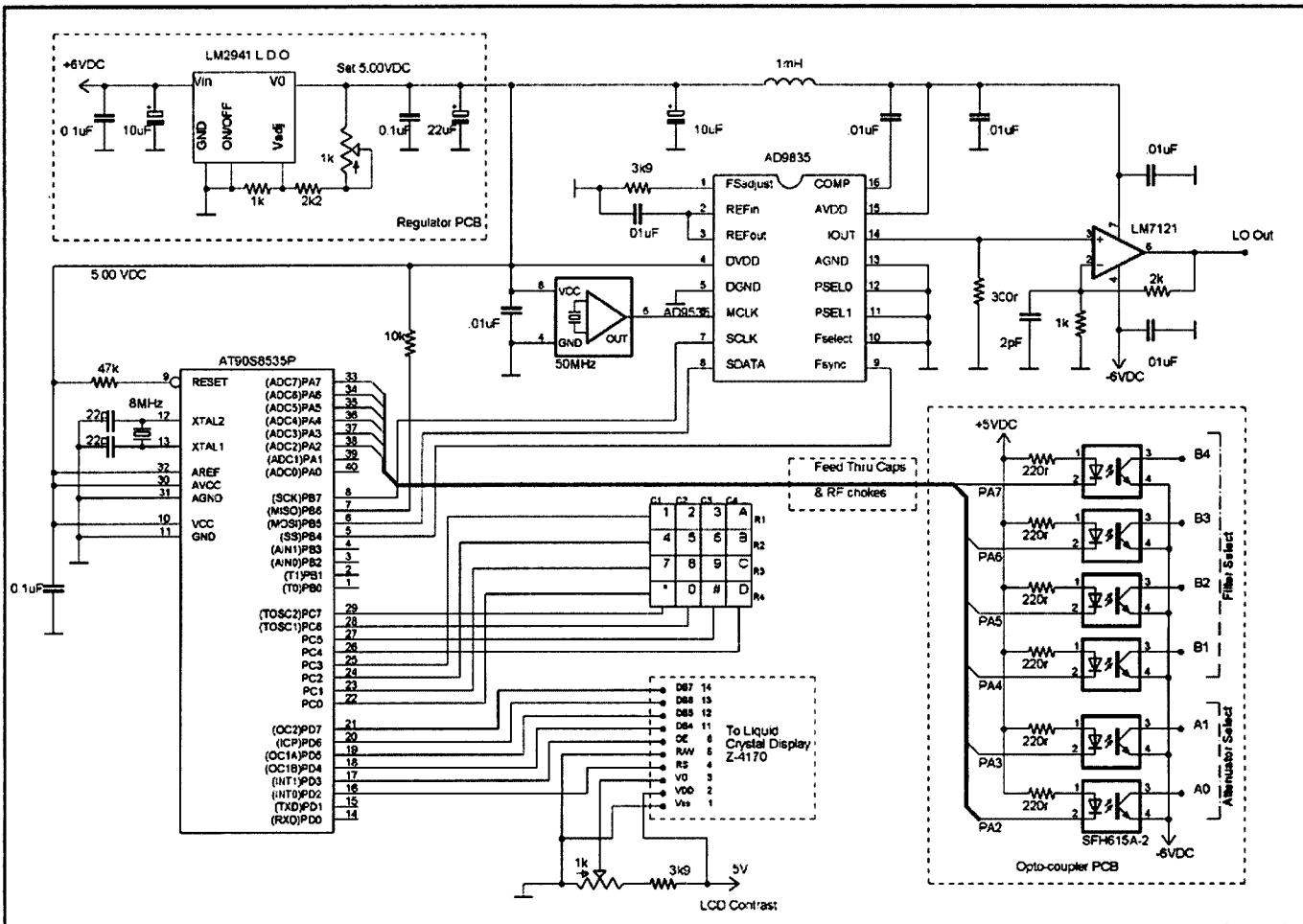

Figure 7. DDS and micro-controller schematic diagram.

- Adjust the 200 ohm potentiometers in each of the RF amplifier circuits so that an emitter current of 20 mA is obtained. This is best done by measuring the voltage across the 47 ohm emitter resistor and adjusting the control until 0.94 volts is measured across the resistor.
- Set the mixer balance control to mid way through its travel. Connect an oscilloscope to the output of the mixer amplifier (IC4). With the receiver input terminated with a 50 ohm load, adjust the mixer balance control so that the noise level measured on the oscilloscope is minimized. The mixer is balanced when this is done.
- Tune the receiver to a weak signal, or inject a weak signal, at approximately 1 MHz. Set the regeneration control to minimum, then adjust the core in the IF detector transformer (TR2) for maximum audio output.

## Receiver performance

The receiver performs very well and is easy to use; the DDS gives drift free and repeatable performance. Due to the use of a strong RF amplifier using 'noiseless' feedback, the receiver performs well in the presence of many strong signals. Using the step attenuator to control signals levels into the RF amplifier is essential if best performance is to be obtained.

As the detector is regenerative, its bandwidth can be somewhat narrowed by increasing the regeneration, but better selectivity could be obtained by using a filter with a narrower bandwidth. However, this does not cause any problems in the use of the receiver. As mentioned previously, the quality of the audio output is very good for both AM and CW signals, and medium wave DXing is a lot of fun with this receiver.

Sensitivity appears to be quite adequate, with LF aeronautical beacons being heard over distances up to 1500 km and standard time stations on 40 and

60 kHz being easily heard if atmospheric noise is low enough. The limiting factor appears to be locally generated interference from TVs, computers and the like. At a quiet location away from such noise sources, worldwide reception is possible i.e. reception of JYJ from Japan and the Russian signals.

No image responses are possible when using the receiver below 455 kHz as the receiver is working in the 'up-conversion' mode and the low pass filter attenuates the image frequencies. When tuning above 455 kHz image frequency responses are possible due to the broadband input, however the low pass filters and switching software have been selected to minimise these responses.

The disadvantage of using a broadband input is evident when using the receiver above about 1500 kHz. Intermodulation products and noise are apparent and the use of an appropriate band pass filter would be necessary for any weak signal reception.

## Components

There are a number of parts in this receiver that may be difficult to obtain from the usual sources: the IF filter I obtained from a junked receiver and similar filters can be found without too much trouble. The LH0033 buffer had been purchased many years ago for another project and other amplifiers can be substituted, particularly high-speed video amplifiers. The main considerations are noise figure and signal handling capability. Discreet component designs can also be used and the references given provide several options.

The relays used for filter selection and the attenuator are small signal type relays obtained from Altronics, catalogue number S4130. Other relays can be used if required.

The Atmel AT90S8535 micro-controller is available from Dick Smith Electronics, catalogue number Z9205.

The Analog Devices AD9835 DDS is available from Farnell, catalogue number 334-3042.

The rest of the parts are readily

available. As none of the remaining parts is very specialised, substitutions are possible and higher receiver performance may result if wise substitutions are made. It's all about experimenting!

## Conclusion

The design of a receiver using a number of uncommon techniques has been presented, the receiver offers very reasonable performance and the design should be readily duplicated by an advanced experimenter. The references cited give a good overview of the techniques and make interesting reading.

I hope that the ideas presented in this article might encourage others to attempt such projects. I would be more than happy to hear from other experimenters who are trying similar ideas.

## References

- (1) 'VLF-LF Receiver 10 -500 kHz with Resistance Tuning'. Lloyd Butler, VK5BR. *Amateur Radio*, December 1989

- (2) 'A High Performance, 1 kHz to 25 MHz Signal Generator'. Dale Hughes, VK2DSH. *Amateur Radio* February 2004.
- (3) 'VHF/UHF WORLD'. Joe Reisert, W1JR. *Ham Radio* magazine, November 1984.
- (4) 'Super-Linear HF Receiver Front Ends'. Pat Hawker, G3VA. P227 - 229, *Technical Topics Scrapbook* 1990 to 1994.
- (5) 'A High-Dynamic-Range MF/HF Front End'. ARRL Handbook 1999. P15.26
- (6) 'An Effective Super-Gainer'. Pat Hawker, G3VA. P69, *Technical Topics Scrapbook* 1990 to 1994.
- (7) 'Active Antenna Preamplifiers'. R.W. Burhans. *Ham Radio* magazine, May 1986.
- (8) 'The AMRAD Active LF Antenna'. Frank Gentges, K0BRA. *QST*, September 2001.
- (9) '600 meters and beyond... A long wave adventure'. DHughes, VK2DSH. *Amateur Radio* June 2003.
- (10) *Filter selection tables*, ARRL Handbook 1999. P30.18

ar

# Andrews Communications Systems

ESTABLISHED 1976

ACN 001 968 752

### ICOM DISCOUNTED

IC-756 Pro II HF+6m	<b>\$4,299</b>
IC-746 Pro HF+6m+2m	<b>\$2,499</b>
IC-718 HF SSB w.DSP	<b>\$999</b>
IC-910H 2m+70cm SSB	<b>\$2,799</b>
IC-208H 2m+70cm	<b>\$649</b>
IC-V8000 2m 75W	<b>\$399</b>
IC-R5 H/H Scanner	<b>\$399</b>

\* 3 YEAR WARRANTY \*

## ICOM IC-706 11G HF-70cm

All-mode compact  
hi-performance  
transceiver

**\$1,399**

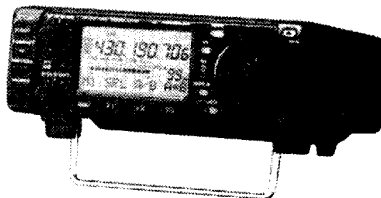

### KENWOOD DISCOUNTED

TS-570SG HF+6m+ATU	<b>\$2,299</b>
TS-480HX HF 200W+6m	<b>\$2,299</b>
TS-2000 HF-70cm + ATU	<b>\$3,299</b>
TM-D700A 2m/70cm	<b>\$999</b>
TM-G707A 2m/70cm	<b>\$649</b>
TS-480SAT HF+6m+ ATU	<b>\$1999</b>

### ALINCO DISCOUNTED

DX-70TH HF/6m 100W	<b>\$1199</b>
DR-620E Deluxe dualband	<b>\$549</b>
DR-605E Duplex dualband	<b>\$599</b>
DR-135T Mk2 2m 50W	<b>\$349</b>
DJ-V5E Dualband handheld	<b>\$499</b>
DJ-X2000E Hi-tech scanner	<b>\$799</b>
DJ-X10E All-mode scanner	<b>\$599</b>
DJ-596T Dual band handheld	<b>\$349</b>

\* 3 YEAR WARRANTY \*

### YAESU DISCOUNTED

FT-1000MP MkV 200W	<b>\$4,999</b>	FT-857D HF-70cm	<b>\$1,399</b>
FT-847 HF-70cm	<b>\$2,999</b>	FT-2800M 2m 65W	<b>\$349</b>
FT-7800R	<b>\$499</b>	FT-1500M 2m 50W	<b>\$399</b>
FT-8900R Quadband	<b>\$799</b>	VX-1R w/2 batteries.	<b>\$369</b>
FT-8800R Dualband	<b>\$699</b>	VX-2R Tiny Dualband	<b>\$399</b>
FT-817 HF-70cm	<b>\$999</b>	VX-5R Triband H/H	<b>\$499</b>
FT-897D HF-70cm	<b>\$1,499</b>	VX-7R Deluxe H/H	<b>\$679</b>

\* 3 YEAR WARRANTY \*

COMET ANTENNAS & ACCESSORIES DISCOUNTED

TOKYO HI-POWER, PALOMAR, TE SYSTEMS, YAESU LINEARS. bhi NES 10.2 DSP speaker \$249  
DIAMOND ANTENNAS from only \$99 ea  
HUSTLER + EMTRON ANTENNAS  
Avair SWR/RF wattmeters fr. \$99  
**DIAMOND - Why pay more?**

BINOCULARS & TELESCOPES DISCOUNTED  
DIGITAL SCANNING RECEIVER ..\$1199

**MFJ** KEYS, TUNERS, ANALYSERS ETC

**CALL (02) 9636-9060 or 9688-4301 or FAX 9688-1995**

**SHOP 8, 41 BATHURST ST, GREYSTANES, NSW 2145**

**Why pay more? MAIL ORDER TO PO BOX 240, PENDLE HILL, NSW 2145**

Some items indent. Prices subject to change without notice - limited stock, some items. E & ©

\* <http://www.andrewscom.com.au>

\* email: [lee.andrews1@blgpond.com](mailto:lee.andrews1@blgpond.com)

AR714

# NCDXF/IARU beacon wheel for Around the world in 3 minutes

Christoph Berg DF7CB (df7cb@dark.de), translated and adapted by J.C. (Jack) Laib VK6CTL

The Northern California DX Foundation (NCDXF), together with the IARU, has built up a network of propagation beacons strategically located around the world. Eighteen beacons transmit in sequence on 14, 18, 21, 24 and 28 MHz.

Each beacon transmits its call sign in CW followed by four ten second dashes of 100, 10, 1 and 0.1 watt. The beacon transmissions follow a fixed sequence that repeats every three minutes.

As these beacons transmit on the

same frequency on each band it saves the trouble of chasing various beacons for a precise assessment of present propagation conditions. Every beacon transmits first on 14 MHz then after three minutes on 18, then on 21, 24 and 28 MHz.

expected and an indication if QRP contacts may be possible. Since each dash is 10dB lower than the previous one the signals can also be use to check your S-meter calibration.

A table of the beacon frequencies, together with their transmitting sequence, may be found in the WAI Yearbook or may be downloaded from the web page of NCDXF ([www.ncdxf.org/beacon.htm](http://www.ncdxf.org/beacon.htm)). Software can also be downloaded that shows graphically which beacon is currently transmitting.

This cyclic pattern of beacon transmissions gave DF7CB the idea to develop a 'beacon wheel'. It is very easy to use and available at any time. The usage should be familiar to any

Knowing the sequence of these beacon transmissions gives you the ability to determine the actual propagation conditions around the world on the five higher frequency bands. The four dashes in 10 dB steps give you a measure of signal strength to be

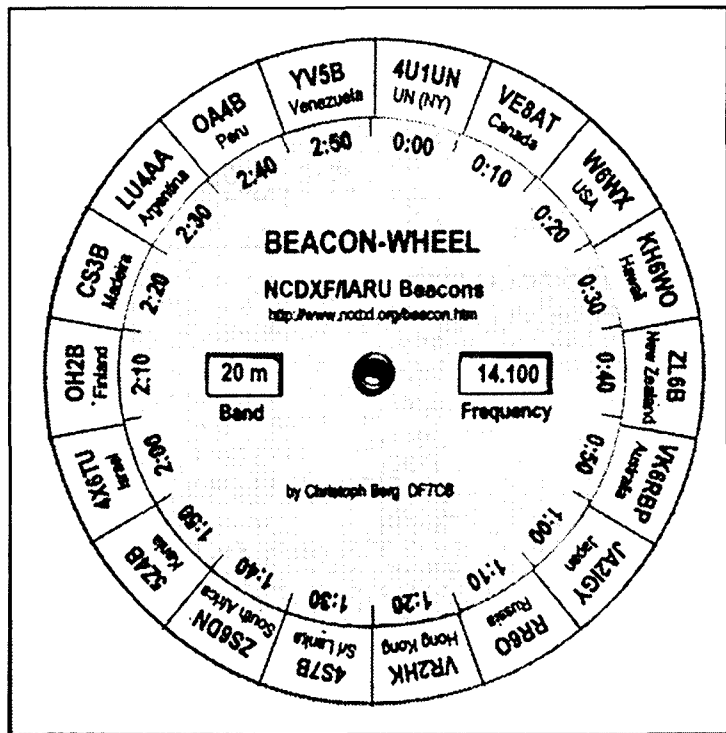
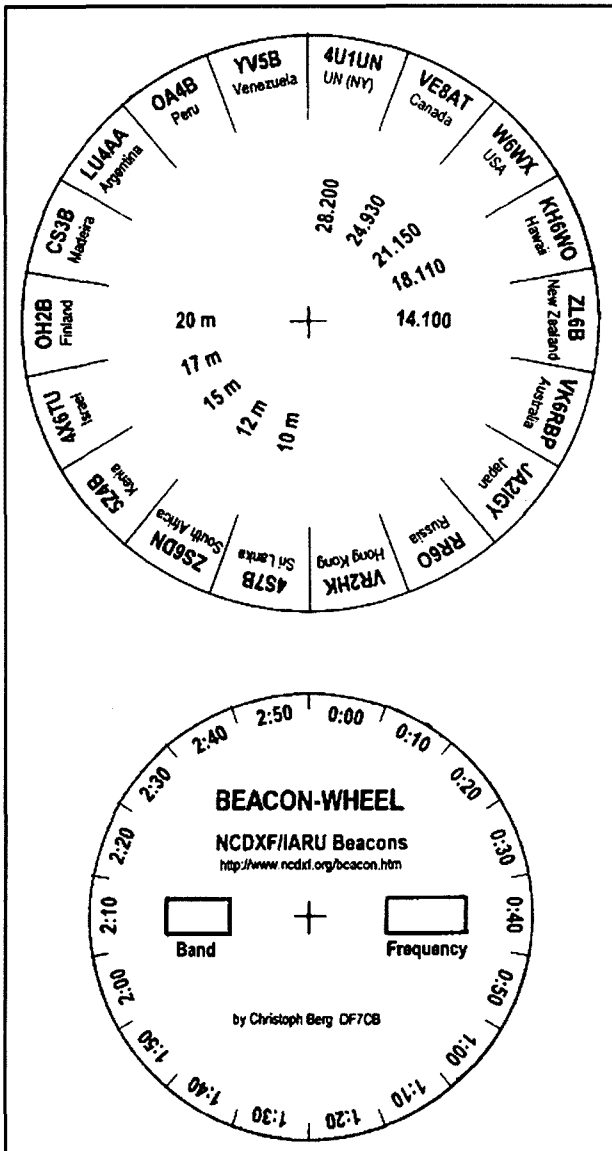



## Radio Projects for the Amateur Volume 3 by Drew Diamond VK3XU

**More plans for the construction of receivers, transmitters, antennas, and test equipment, plus some handy workshop hints and tips.**

The title and sub-title above sum up the contents of this new book by Drew. However, you will need to obtain a copy and read it yourself to really appreciate the breadth of information that it contains. In short, there is something for every amateur regardless of which aspect of amateur radio you might have an interest in

This year, editing, typesetting, layout and production has been done by Bill Roper VK3BR with a very noticeable improvement in the presentation standard of the book. Reproduction of both print and photos is very much clearer than previous volumes.

Of course, if you are a regular reader of Amateur Radio magazine, you will be familiar with Drew's articles and with his inimitable style of presenting construction projects. This book contains many of the projects that have been published in Amateur Radio since Volume 2 came out in 2001. There are also updates of earlier articles plus several brand new ones that have yet to appear in Amateur Radio magazine.

So, let's have a closer look at Volume 3 to see what it contains.

The contents are divided into seven sections as follows: power supplies, receivers, transmitters, antennas, test

equipment, in the work shop, and accessories, giving a total of 42 separate articles. The section with the greatest number of articles is test equipment with a total of 16. Here you will not only find out how to construct many useful instruments but also how to use them in the shack and also around the antenna farm.

In short, this is a book for the home brewer, the prospective home brewer and the armchair home brewer. It just might convert the latter two groups into getting out the soldering iron and enjoying the wonders of building your own equipment.

Now that you are ready to go, here is how to get hold of a copy.

First, direct from Drew at 45 Gatters Road, Wonga Park, Victoria 3115. Copies are also available from the NSW WIA Book shop, PO Box 9432, Harris Park, NSW 2150. Price from both of these sources is \$25 including postage.

Drew also tells me that he has a limited number of *Radio Projects* Volume 2 available also at \$25 posted. Volume 1 is

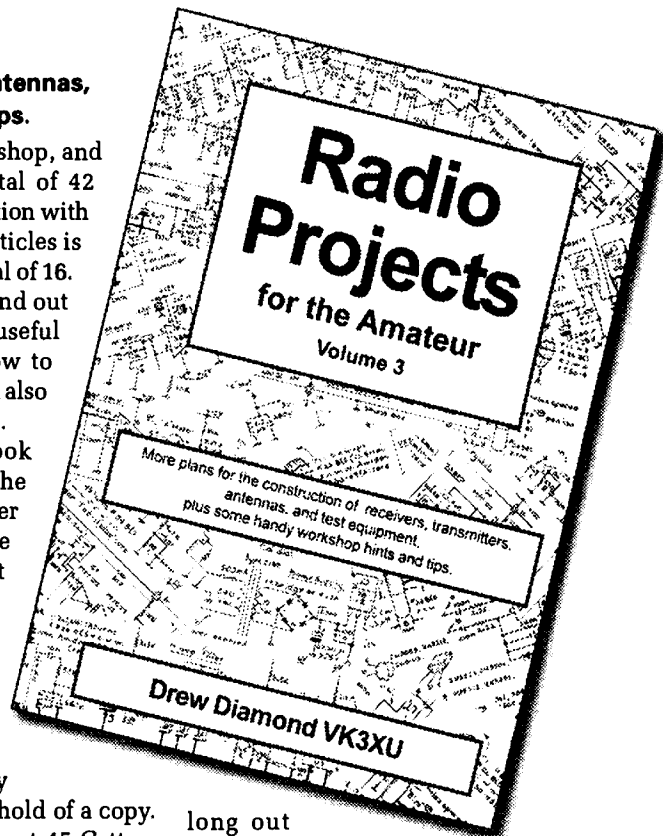

long out of print and is now a collectors item, but Drew says that if there is enough interest he will consider organising a reprint. Contact Drew for more information.

Thanks to Drew for another top effort with Volume 3 of *Radio Projects for the Amateur*.

ar

### NCDXF/IARU beacon wheel *continued*

Ham having used a similar wheel for calculating mileage and costs of his car.

Rather than use the wheel images directly from the magazine, copy it to 220 - 400 g/m<sup>2</sup> cardboard. If you want you can use a scanner or photocopier to enlarge it to make it easier to read. Another suggestions is to copy one disk onto a different pastel coloured card and have them laminated to prolong the wheel's life.

You may also download the drawings, ready for printing, from the web page of DF7CB ([www.wjp.cs.uni-sb.de/~cb/](http://www.wjp.cs.uni-sb.de/~cb/)

[wheel/rad.html](http://wheel/rad.html)). Cut out the wheels and the two windows 'Band' and 'Frequency' from the smaller disk. Fasten the two disks in the centre using an eyelet or snap fastener from your XYL's sewing kit.

The usage is very simple: turn the inside wheel to the desired band. In the window "Frequency" you read the beacons transmit frequency. The transmission sequence of the beacons follows in a clockwise direction on the outer scale.

The indicated time on the inner disk

repeats very 3 minutes. For example, 1:10 on 15 m for VK6RBP might mean e.g. 15:01:10, 15:04:10, 15:07:10 and so on. You can easily follow the beacons around the world and observe possible propagation and signal strengths on any of the five bands. Whilst the beacon chain is generally very reliable they are occasionally absent for maintenance so an inaudible beacon does not necessarily indicate a lack of propagation to that area. Inactive beacons are usually indicated on the NCDXF web site.

ar

## OZGEAR

### Ozhelp Services

Doug Hunter VK4ADC

Brisbane

Ph 07 3273 7263

Fax 07 3272 1800

sales@ozgear.com.au

# ICOM

#### • HF Transceivers -

7800, 756Pro2, 7400, 706Mk2G, 718

#### • VHF/UHF Transceivers -

V8000, 208H, 2720H, 910H, V8, T90A

#### • Receivers - R3, R5, R10, R20,

R8500, PCR100, PCR1000

#### • Accessories - wide range of options and parts

# YAESU

#### • HF Transceivers - Base & mobile

FT-1000MP, 817, 847, 857, 897

#### • VHF/UHF Transceivers -

Base, mobile and handhelds

FT-1500M, 2800M, 7800R, 8800R,

8900R, VX-1, 2R, 5R, 7R, VX150

#### • Receivers - VR-500, 120D, 5000

#### • Accessories - Yaesu rotators, thrust bearings plus equipment options

**Plus...** OzGear balun kits, Diamond HF, VHF & UHF antennas & accessories, MFJ & LDG tuners, Autek antenna measurement, Daiwa cross-pointer SWR meters, RFI, Mobile One, GME, Scalar & TET Antennas, Coax connectors, cables and hardware from Andrews, RFI & Benelec

**With...** More brands available and new products being listed all of the time...

CB, Marine, Airband and Land Mobile equipment and accessories are also available.

#### Product not listed above ?

Phone or email to see if we can help or visit us on the web at

<http://www.OzGear.com.au> for the latest product info plus on-line ordering.

# The Honduras experience

Judy MacDonnell VE0JAM

The International Health Service is a non-profit organisation, which provides health care for the people of Honduras. While we were visiting in the USA, my husband Bob and I heard that radio operators were needed for the February mission and decided to go along.

The flight from Houston to San Pedro lasted two and a half hours, on Friday February 13th. We passed through the foggy blue of the Gulf of Mexico and down the coast of Belize, watching boats criss-crossing the reefs and river deltas like tiny comets. Soon the swirling turquoise water gave way to the steamy green haze of the country of Honduras and we were landing.

This was the twenty-third year for IHS in Honduras, and our first. The Gran Hotel Paris in La Ceiba throbbed with the excitement of participants greeting each other and being organized into teams.

The mission was roughly divided into two wheels, with Puerto Lempira (PLP) the hub of the Miskito region and La Ceiba the hub of the other (and the administrator of both). Scattered around the rim of each wheel were remote communities, which we were to service with medical, surgical, dental and eye care.

Bob and I had been appointed to the Miskito region. We were part of the PLP logistics team, with the teams of

Tipi Mona, Wauplaya/Warunta, Uhi, and Rio Kruta in its charge. There were six of us—the team leader, a Spanish interpreter, two resident pilots, Bob (radio operator/engineer) and me (radio operator/general helper).

Bob and ten others flew ahead with the advance team on Saturday morning to set up the radio gear and living quarters and segregate the container shipment of our cargo by teams. On Monday morning, after a weekend of orientation, the rest of us in the Miskito group were ready to join them. We scrambled aboard the C130, a 'Hercules' military transport plane. Large areas of its lining had been patched with duct tape. The seat backs were cargo netting and the rear of the plane was an open area, where our luggage and some cargo were held in place with straps and nets. As the engines revved for takeoff, those who had earplugs used them.

A large crowd of children and adults met us on the airstrip at PLP. We unloaded personal gear and hundreds of boxes, colour-coded for the various teams, onto the pick-up, which ferried



Photo 1. One of the small airplanes used to transport patients



Photo 2 - Radio station in use at Puerto Lempira base

everything to the Catholic compound. This was to be the base for the outlying teams and our home for the next two weeks.

PLP is a small waterside town, with a mixture of modest but well-kept homes and teetering wooden shacks. Many a family lives in a high-built wooden house with one set of steps at the front door and none at the back. It's easy to see why children suffer fractures or die when they fall from their houses. The roads are clay with potholes that look

like moon craters, which are filled with water after heavy rain. It was a challenge to our team leader to find the easiest and most comfortable route when driving surgical patients between the hospital and the airstrip.

The PLP surgical team was also based at the Catholic compound and operated in the small hospital in town. We three women shared the girls' dorm at one end of the building and the men slept in a large dorm at the other end. The men's dorm also housed the radios, which

were powered by electricity when the generator was on (about fifteen hours a day) and by a 12V battery when it was not. We hand-pumped water for showers and drinking, used composting toilets, and were fed each night by a local cook and his family, who brought the ready-cooked food up to the dining room. Vultures circled overhead continually, but did not match the numbers of mosquitoes and cockroaches that swarmed in the latrines during the night.



Photo 3 - A small patient leaving surgery

# TET-EMTRON

## TE-23M 2 ELEMENT MINI-BEAM



### SPACE A PROBLEM?

Don't give up! This mini antenna can be installed almost anywhere, especially where space is at an absolute premium and you still get superb performance on the 10, 15 and 20 metre bands.

It has a 30% space saving when compared to a standard 2 element beam, light weight and rotatable even with a TV rotator.

All stainless steel hardware, 6063T83 aluminium tubing and all standard features which go with every TET-EMTRON ANTENNA.

## Dealers VIC

**LT Harris** 78 Elgin Street Carlton Vic 3053  
Ph 03 93476264 Fax 03 93473629  
Email: ltharris@netscape.net.au  
**G&C Comms** 207 High Street Cranbourne Vic 3977  
Ph 03 5996 3298 Fax 03 5995 0184  
Email: gcomm@netspace.net.au

## NSW

**Emtronics** 1/94 Wentworth Avenue Darlinghurst 2010  
Ph 02 9211 0988 Fax 02 9281 1508  
Email: Emtron@ozemail.com.au  
**Andrews Comms** Shop 8, 41-51 Bathurst St  
Greystanes, NSW, 2145 Ph 02 9636 9060  
Fax 02 9688 4301  
www.andrewscom.com.au

## WA

**Tower Communications** 14 Mary Street Hazlemere 6055  
Ph (08) 92741118 Fax (08) 92503734  
Email: tower@eon.net.au

## QLD

**Kyle Communications**  
668 Lutwyche Rd Lutwyche 4030  
Ph (07) 38574400 Fax (07) 38577825  
Email: mark@kyle.com.au

## SA

**International Communications** -  
8 Nile Street Port Adelaide 5015  
Ph (08) 84473688 Fax (08) 83411453  
Email: intercom@picknowl.com.au

## New Zealand

**The Com Centre**  
400 Hillsborough Road Avondale Auckland  
Ph (64) 9 6270084 Fax (64) 9 6271613  
Email: comcent@radioinfo.co.nz

## RAWMAR ENTERPRISES

40 Blackburn Street  
STRATFORD Victoria 3862 Australia

Ph: 61 3 5145 6179  
Fax: 61 3 5145 6821

Email: rawmar@hotmail.com

www.tet-emtron.com

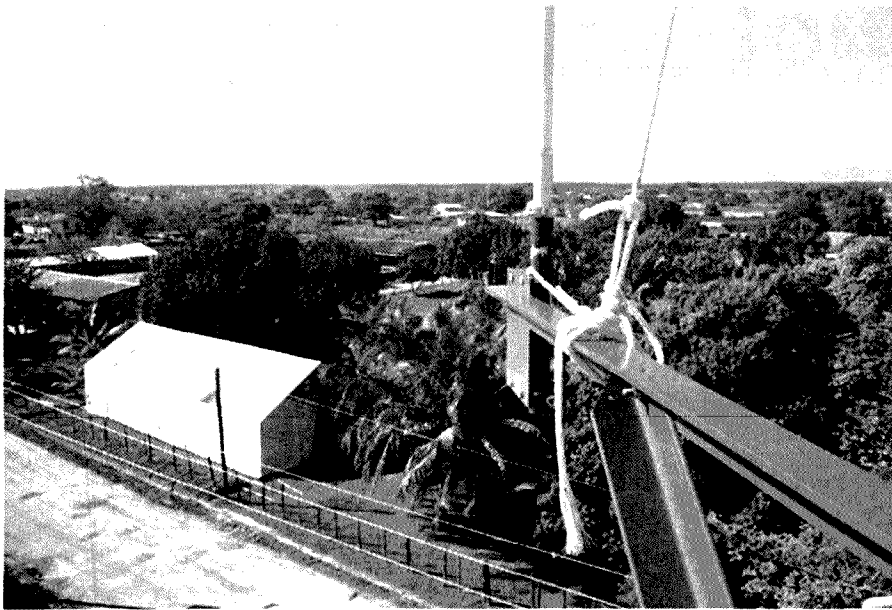

Photo 4 - TRAM aerial and rig going up over Puerto Lempira

Radio communications involved hand-held GMRS radios and amateur band HF and VHF. The surgical team in the operating room monitored the hand-held radios, as did our team leader and others as necessary.

Our shortwave HF Radio was a TS-50 Kenwood and we used a G5RV wire antenna with a manual tuner. HF communications included voice nets with La Ceiba three times daily, pilot contacts and Winlink activities. A PMBO Winlink email station was set up in La Ceiba. It was monitored during the mission, enabling direct email communication to and from all IHS field sites to La Ceiba. This email station was also utilized for most of the International IHS traffic and enabled IHS team members to send and receive

messages to and from 'home'. There was some initial difficulty establishing the Winlink PMBO because it had to be set up to scan two frequencies—Pactor 1 and 2 modes using the same frequency and Pactor 3 high speed mode on another frequency—but soon the airwaves were humming.

Our VHF/UHF radio was a Kenwood TM-G707A, which had been modified to receive family radio frequencies (FRS/GMRS) and was used to communicate with each of the remote teams.

The VHF 2 metre band radio initially transmitted and received through a Ringo Ranger antenna, which had been mounted, by the advance team, on a 20-foot tower behind the dorms. A higher gain TRAM vertical antenna had also been prepared and Bob intended to

install it part way up the 200-foot tower in the compound. This proved difficult due to the combined weight and center of gravity of the antenna and the support frame, and the non-existence of a good hoisting point and line. However Bob and our interpreter (AKA the "Tower Rat" who is a fire fighter) finally hoisted the TRAM into position on Monday, the 23rd of February, and clamped it to the tower. Ideally the antenna should have extended two metres from the tower to give an omni-directional pattern. It actually extended only one metre, which was still sufficient to service our teams. There were cheers all round when the first transmission was pronounced "clear as a bell"! Intentions were to tidy up the installation and secure the cables to the tower the next day.

Our joy was short-lived. That afternoon the VHF radio was strangely silent. It seemed that everybody was managing perfectly well without PLP and it was not until the afternoon HF net that we were aware of a problem. We were off the air! On inspection we found the insides of the new antenna, complete with wiring, lying on the ground under the tower. We could only imagine the panic of the kid who had pulled out the cable when he'd tried swinging on it. It was back to the Ringo Ranger for the remaining few days of the mission.

Three of the four clinics sent patients to the operating room in a steady stream. Sometimes the radio operator needed to juggle microphones to the HF and VHF radios, adjust the tuner, and take notes at the same time. Three-way conversations were common as we relayed information about patients and arranged plane transport back and forth between the villages and PLP. In retrospect, the communications system was able to speedily handle anything the teams required.

The weeks of the mission flew by. There were many lives saved and made more comfortable but also times of tragedy. A baby died of meningitis, an old woman was diagnosed with terminal cancer, and a young woman in diabetic coma was rushed by boat through hazardous waters in the night only to die the next day. Life is fragile but IHS does make a difference in Honduras every year. We were deeply touched by our experiences there and our lives will never be the same again.

## WIA news continued

access to the 7.1 to 7.2 MHz band for all UK radio amateurs have been finalised and that access was to be allowed from 0100 UTC on Sunday 31 October 2004.

Early access is granted on a Secondary (non-interference) basis using a maximum of 26dBW (400 watts) PEP for Full licensees, 50 watts for Intermediate and 10 watts for Foundation licensees.

## WIA makes special offer with Callbook release

With the release of the 2005 Callbook, the WIA is making a special offer to

potential new members. You can obtain a 2005 Callbook and become a new member at a discount price. The non-members price of the Callbook is \$30.00 picked up from the National Office or \$33.00 posted.

If you order a Callbook, AND submit a membership application with the subscription, your Callbook will be at the "members" price of \$ 22.00 picked up from the National Office, or \$25.00 posted.

ar

ar

# Evolution of a high power "current balun"

By J. C. Laib, VK6CTL - Jaklaib@aol.com

Here in the Western Australian sun, with UV indexes over twelve for six or more months on end, coaxial cables and plastics used as insulators deteriorate quickly after a number of years. After inspecting my antennas on top of a hot tin roof I realized that the sun had started to damage the hardware and it was time for some repairs.

I found that both the insulators on my dipoles, the balun and the outer jacket of the RG213 coax had been damaged by prolonged exposure to UV. When all the work was finished the immediate improvement in station performance made me realise how many dB's had been lost to sun damage.

I was looking to purchase a new centre balun for my dipole when my eye caught a list of ferrite suppression sleeves used with computers for EMI suppression. Current baluns, originated by M. Walter Maxwell W2DU (1), use a number of ferrite toroids strung directly onto the coax cable where it is connected to the antenna.

Such choke baluns work nearly without any loss and tolerate high power and SWR levels without damage. The ferrite sleeves present a high impedance to any RF current flowing on the outside of the coax shield. The impedance stays fairly constant over a wide range of frequencies. Why not fit these ferrite suppression sleeves directly onto the new coaxial cable to form a broad band current balun?

I was already cramped for space with my three RG-213 coax feeders running to the roof of my apartment building. I decided to replace the RG-213 with AIRCELL 7 cable (2), which is widely used in Europe. AIRCELL 7 is an interesting replacement for RG-213, or the older RG-8, has a diameter of 7.3 mm and is rated at 2.4 kW at 30 MHz.

The fabrication of a current balun is very straightforward. Cut from any

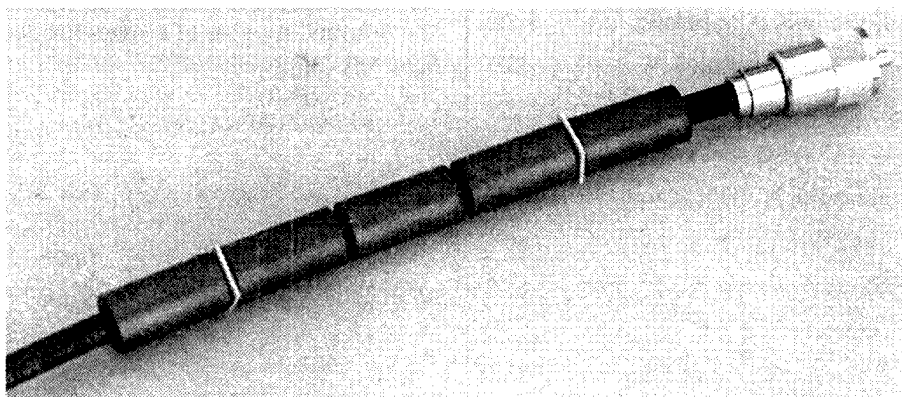

available semi-rigid PVC sheet two squares of 12 x 12mm and drill a 7.3 mm hole in the centre of each (mine came from an old slide box).

Push one ferrite suppression sleeve of 14.3mm OD x 7.3mm ID x 28.8mm L (Altronics part No. L 4820) over the Aircell 7 coax to a distance of 250mm from the cable end. Then add one plastic square as a spacer.

Then push another three sleeves over the cable followed by the second plastic spacer and the fifth sleeve. Space the inner three sleeves by 1.5mm (see photo). Now gently slide a length of 170mm by 19mm diameter Poly-Tube irrigation pipe over the assembly. Do not disturb the placement of the spacers and sleeves. With electrical tape, or a 50mm length of 19mm diameter heatshrink tubing, seal one end of the tube and fill it fully from the other end with mixed Araldite or cured polyester resin. Compared with other electrical or plumbing tubes Poly-Tube irrigation

pipe gives the highest protection against UV. The completed balun will therefore last a long time when exposed to the merciless sun of Western Australia.

Do not seal the assembly with a copolymer sealer used for roofs and gutters as it will not completely fill the balun and make it waterproof. Now solder a UHF or Type N plug as close as possible to the end of the balun, making sure not to damage the weather seal. That's it!

If you are able to buy MIL-grade heatshrink tubing of 19mm diameter with a 1:3 shrinking ratio assembling such a current choke balun is even easier. Just gently push a 175mm length of such heatshrink tubing over the five sleeves and 1.5mm spacers leaving 12mm either side. I shrunk the tubing with a heat gun borrowed from my neighbor.

Shrink the tubing carefully but completely so that it shrinks into the spaces between the sleeve shoulders, to preserve the spacing, and then down to the coax. On both ends I applied VPC glue for additional waterproofing. For additional waterproofing I shrunk a second layer of heatshrink tubing, 185mm long, over the first one leaving 8 mm either side. I again applied VPC glue to the shrunken ends.

Tests with ferrite suppression sleeves

Type	Mat	OD mm	kg/100m	VF%	Loss 28 MHz	dB/100m100 MHz
AIRCELL 7	FPE	7.3	7.2	0.83	3.7	6.6
RG-213	PE	10.3	15.5	0.66	3.7	7.0
RG-58U	PE	5.0	4.0	0.66	8.0	15.6

Table 1

**Australian made**  
**ANTENNAS**  
*Setting a new standard*  
**COM-AN-TENA**

(formerly a j and j coman)

115 John Street  
 GLENROY 3046

New vert 7-14-21/3 db gain	\$197
New vert 14-21/3 dbd gain	\$165
40 step 10-30 m log periodic	\$1290
10/11 beams comp opt 5 ele	\$327
3 ele delta loop 10/11 m	\$326
11 m 5/8 vert 4/1/4 wave radials	\$175
Tri band HB 35 C 10/15/20m	\$745
3 ele 20 m comp opt	\$420
log periodic 9 ele 13 30 8.4 m boom	\$990
log periodic 8 ele 13-51 MHz 5.5 m boom	\$783
40 m linear loaded 2 ele beam	\$595
M B vert auto switch 10/80 m	\$330
6 m 5 ele comptr opt beam	\$268
Top loaded 160 m vert	\$430
10 ele high gain 2m 3.9 m boom	\$145
17 ele high gain 70cm 3 m boom	\$125
Rotatable dipole 40 m	\$250
80 m top loaded vertical	\$239
stagger tuned dipole 10 to 80 m	\$170

**Guyed Masts**

**21 metres**      **13 metres**

Winch-up & tilt-over. Aluminium and stainless steel  
 three-sided construction. Auto-brake winches.

**Free Standing Masts**

9.5 metres

**New Baluns**

1-1 to 16-1 to 3kW



Our Masts meet Australian Standards. We supply all the computations and data you will need for a permit.

**03 9773 3271**

**Mob: 0419 542 437**

have shown that five pieces, each 28.8mm long, give good performance from 10 to 30MHz. For use down to 3.5MHz increase the number of sleeves to nine and for 1.8MHz use sixteen. See table 2 for other ferrite sleeves and cable diameters.

The total impedance seems to be approximately proportional to the stacked length of the sleeves. You might find some other suppliers of EMI suppression sleeves with diameters closer to your preferred cable. Experiments are required to determine the minimal number of sleeves needed for good suppression of RF currents on the coax depending on which coax you use and required frequency coverage.

Cable	OD mm	Part No.	Dimensions OD x L x ID	No. for 10 MHz
RG-58	5.0	Jaycar LF-1258	12 x 25 x 5.6	5
AIRCELL 7	7.3	Altronics L 4820	14.3 x 28.8 x 7.3	5
RG-213	10.3	Altronics L 4830	28.5 x 28.5 x 12.3	5

Table 2

**WIA comment continued**

already an experienced amateur himself. The advantage of the accreditation system administered by an RTO is that the assessment outcome is recognised across Australia.

**What would this require?**

It would require all those prepared to become accredited assessors to spend a weekend becoming qualified.

It would mean that the candidate could learn immediately whether he/she is competent or is not yet competent.

It would mean that the assessor would be able to explain the decision and be able to tell the learner what he/she needs to do to become competent.

We see the change to an accredited assessor system taking place over a period, with as many clubs as possible encouraging one or more of their current invigilators to become an accredited assessor.

Such a balun may be used for any coaxial fed antenna. In stubborn cases additional chokes may be placed at approximately ¼ wave intervals along the coax cable. (see Table 2)

(Use heatshrink tubing or electrical tape on coax to increase diameter to ensure the sleeves fit tightly)

(1) ARRL Handbook 1999, chapter 19 on Transmission Lines, page 16-17.

(2) Kusch-Kabel Werke, Box 120339, DL-44293 Dortmund, Germany.

Only direct imports. Kusch supplies also a watertight UHF socket for 7.3mm AIRCELL 7 similar to a Type-N socket. www.kabel-kusch.de - kusch@kabel-kusch.de

We also see the current system continuing, hopefully being utilised less and less, but providing a means by which examinations can be administered even if the club does not have available an accredited assessor.

At a recent meeting of clubs in Melbourne I floated this concept, basically asking if it was thought that the amateurs who act as group leaders and invigilators would be prepared to give the time to become accredited assessors. The result was that there was a concern as to whether people could afford the time, but at least everyone present was, when asked, more than willing to give the time.

I do believe it would produce a system having more validity, reliability and credibility than the present system, and avoiding the shortcomings of the present system that are so often criticised.

What do you think?

Everything you want to know about WIA

<http://www.wia.org.au>

# New microwave records set in VK4 and VK2

Russell Lemke VK3ZQB

**As a diversion from the cold southern states winter and an excuse to have a holiday, a group of microwave operators ventured into the sunshine state for warmer weather, rest and recreation and a bit of microwave playing.**

Bill VK3AMH started the migration with his annual northern holiday, closely followed by Colin VK5DK who decided that he was sick of work, the winter was too cold and he would like to join Bill and go north for a holiday.

I became involved when my wife heard of Colin and Bill's plans and decided that I needed to go to Brisbane to see my mother in law, check to see if I was still in the will and visit my son in Cairns.

Wives tend to make these irrational decisions from time to time. I was content to stay in the shack and finish the winter project.

Alan VK3XPD also joined us for the most northern contacts bringing his 4 ft dish and some large powered amps, which proved to be very useful in the marginal conditions we experienced.

So with the shorts and thongs packed we made our way north to visit the relatives and get the social engagements out of the way so that we could settle down to the serious part of micro waving.

I think that we adopted the idea that because we were old hands at operating microwave frequencies, we should be able to add some kilometres to the records without too much trouble. Of course this was an arrogant approach and we were soon to be humbled when we found the task fairly difficult to achieve.

I suppose if we were going to be serious about extending records we should be there when the best propagation is present, not in the middle of winter, so it was predictable that we were going to have to fight hard to get any contacts at all.

The lack of any form of enhancement made it very difficult to add just a couple of kilometres to the records.



10 and 5 GHz dishes at Gloucester Point Hill

We teamed up with Errol VK4ZHL who was holidaying in Cairns and later on with Neil VK2EI. Doug VK4OE is presently constructing 24 GHz gear and was very interested to see how our gear worked.

Now the trip was not without trauma with Bill's wife Jannette taking ill and requiring hospitalization.

I was next when my car was broken into in Brisbane and some of the microwave gear was stolen along with the stereo system.

Alan hit a kangaroo causing significant damage to his car and Colin got a bad lot of fuel in his car and spent some time in dock getting the car's injectors serviced.

One of the difficulties in operating from an area that is not familiar is finding suitable locations to operate from. I use OZIEXPLORER mapping software with 3D capabilities to choose sites; first with 1/250 topographical maps then with

calibrated satellite photos which help in determining the density of vegetation on a hill site.

I back up the mapping software with RADIO MOBILE software to plot the selected path and calculate the possibility of contact at different frequencies.

Still it is extremely hard to find sites that have easy access and often we find that what looks like a good spot on the map is either covered by trees, has a locked gate, no access or has been built on and is now the centre of a residential area.

Our first path relied on finding a location at Airlie Beach to work north to selected spots south of Cairns to the Daintree north of Cairns.

Colin, Alan and Bill went to Airlie Beach only to find that there was no access to the high ground that had a good view toward the north, so the nearest they could find was at Gloucester Point



Gloucester camp

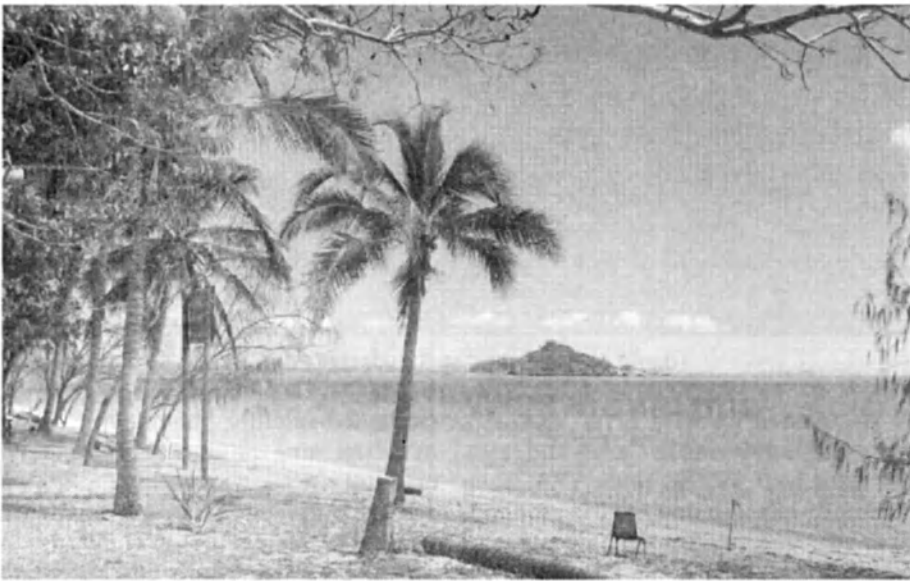

Gloucester camp, north view

all over Northern Queensland looking for a suitable site to work from, Bill, Colin and Alan were doing it tough.

They had found a cabin at Gloucester Point 50 metres from the beach and had set up their dishes in front of their cabin on the beachfront, then settled back to enjoy the magnificent tropical scenery and empty a soft drink or two.

Errol and I ended up at Flying Fish Point near Innisfail a distance of 378 km from Gloucester Point.

We established contact on 5 GHz with 5-7 reports first, then Alan set up his 4 ft dish and 14 watt amp on 5.7 GHz and I heard him with 5-9+40 reports.

10 GHz was worked with very poor signals indicating that the path offered little assistance with propagation.

The distance worked was under the VK4 record distance and it was obvious that we were going to have a hard time extending the record with these conditions.

We were also faced with having to find two locations more than 380 km apart, not an easy task as we were backed up onto a national park with limited access and Bill, Allan and Colin were also limited in where they could go.

We managed to find a track that placed us 3 km further north of Flying Fish Point while the others moved to high ground about 1.5 km south of their cabin, placing just over the current VK4 record with a distance of 382 km.

We tried again first on 10 GHz then on 5 GHz. 10 GHz yielded success with 5.1, 5.2 signal reports then on 5 GHz with 5.3 reports with Colin's 2.5 watts and 5-9 at peaks with Alan's 4 ft dish and 14 watts.

Contacts on both bands exhibited rapid flutter and QSB and conditions progressively deteriorated as the day progressed.

Bill's 10 GHz transverter blew a FET in the receiver preamp shortly after making contact at the 387 km distance and he had to retire his gear to be fixed when we returned to Brisbane,

With a new VK4 record on 5 GHz and 10 GHz set with very poor signal conditions, it was not going to be worth trying to extend these distances any further without significant propagation.

The next accessible site North was at Cairns, and this path was seriously cluttered with the hills at Yarrabah and the signal strengths received were not sufficient to overcome the increased

38 km further north than Airlie Beach. The changed location for the southern end of the shot line meant that locations south of Cairns were going to be either less than the record distance or equal to it.

Errol VK4ZHL requested that we start from the sites north of Cairns as he already had accommodation in that area and it would be more convenient for him to try and work the longer distances first rather than travel to south of Cairns to work from the shorter distances.

This goes against good practice as working the shortest distance first offers more opportunity to make a contact, establish that the gear is operating and

check frequency variations.

On the other hand, if there was good tropo then it would have been possible to work the longest distance with ease, a new record would be set and we could move on to the next stage, justifying the decision to work the longest distance possible and discarding the conventional approach.

As it happened there was no enhancement and no sign of signal on either 5 or 10 GHz so, with the lesson learnt, we packed up camp and moved south of Cairns closer to the Airlie Beach group, where we would attempt to establish contact.

Now while Errol and I were travelling



path loss that would be on path from Cairns to Gloucester Point.

It was time that we departed north Queensland and returned to Brisbane to repair Bill's 10 GHz transverter and regroup for the next stage.

The next part of our trip involved travelling into New South Wales and making contact with Neil VK2EI on 5 GHz, 10 GHz and 24 GHz.

Bill VK3AMH had travelled down to Port Macquarie to join Neil VK2EI while Errol VK4ZHL, Colin VK5DK and myself had teamed up to work from the north of NSW toward Neil and Bill

Our first try was to repeat a path used before to establish a VK2 record from near Cape Byron to North Brother near Neil's QTH at Port Macquarie, a distance of about 330 km.

On arrival we were met with heavy rain which moved along the shot line south.

10 GHz was tried first and soon we had made contact with a 5-2 report on rain scatter propagation.

We tried 5.7 GHz but with no result which surprised us as there was obviously a path there for 10 GHz. We suspected that there must have been some equipment failure at one end or the other.

Neil and Bill travelled south to Crowdy Head and we repeated the 10 GHz contact but the extra distance had stretched our ability to the limit and we could only get a 4.1 report with rain scatter propagation.

The distance from these locations was only 335 km and it was obvious that we were unlikely to extend the range past the record distance of 380 km on this occasion.

Errol, Collin and I decided that we would pack up and travel south to Coffs Harbour to be closer to Neil and Bill for some 24 GHz contacts.

The current VK2 24 GHz record had been worked from Coffs Harbour to North Brother and we thought that we would start there and then see if we could extend the distance.

The profile report indicated that from these locations we would have a line-of-sight path and we would only need to add a few more kilometres to take the record.

We established contact with Neil on 10 GHz with a solid signal then set up 24 GHz and made contact with 5-2 to 5-8 reports.



The transport at Gloucester Point



Gloucester Point Hill

We had considerable height at Coffs Harbour that enhanced the path but we were going to lose that advantage when we moved to the next site.

From Coffs Harbour we travelled to Woolgoolga and set up on a peninsula near the township. We established contact on 10 GHz and immediately knew that it was unlikely that we would be successful on 24 GHz.

10 GHz was weak with rapid QSB, not a good indicator for 24 GHz.

Nothing was heard on 24 GHz and we declared there was little use trying from there anymore without some enhancement or significantly more time to find another site with altitude.

Poor conditions, lack of propagation and limited time to look for suitable sites forced us to a "hit and run" type operation where we only had time to choose one or two locations and be

content with whatever we managed to do from those sites in the time we had.

With more time and resources we could have exploited the propagation and locations with success.

Our trip was coming to its end and we decided to return to Brisbane having another shot on 10 GHz from our Cape Byron location on the way back.

Neil and Bill decided to go for broke and move south to Cape Hawk and wait for us to establish contact on 10 GHz.

Cape Hawk would be far enough south to give us a record from Cape Byron if there was any chance of making contact in the difficult conditions.

On our return north we encountered heavy rain and wondered if it was going to finish all hopes of extending the distance or enhance the path with an opportunity to work via rain scatter.

This was our last chance to salvage a

# Antenna

'HomeBrew'

(with a lot of help from your Bushcomm kit)

## SWCS-KIT HF ANTENNA

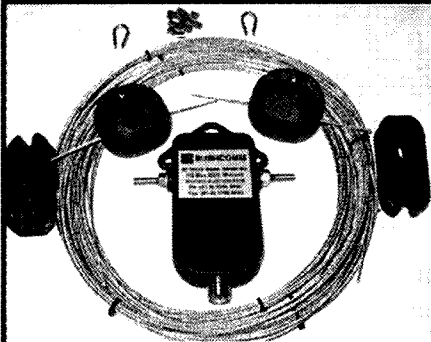

This is a kit version of our popular SWC-100S single wire model, but you have the great satisfaction of constructing of your antenna.

Easy to follow, comprehensive instructions.

Common tools required.

You save money and have fun

Once completed correctly your antenna will be a replica of the SWC-100S model. This is a single-wire, base-situation antenna, constructed with stainless elements to give high resistance to corrosion. It has a length of 34m in total.

Trees, buildings or other structures can be used to suspend the antenna, (avoid running the antenna over iron-roofed buildings as this reduces the effective height above ground).

The antenna can be mounted either horizontally between two supports, or as an inverted 'vee'

Frequency Range: 2-30 MHz

Impedance: 50 OHM

Power Input: 100 Watts, 250 Watts PEP

This kit contains:

Balun (x1) Load (x2) S/S Thimbles (x2)

Copper ferrules (plus a few practice extras))

Large egg insulators (x2) 4 cut lengths of wire.

FULL and CLEAR

building and mounting diagrams

## Bushcomm

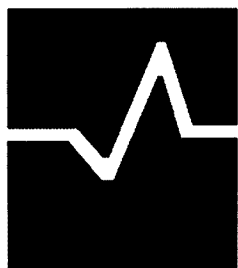

**PROUDLY AUSTRALIAN OWNED  
AND MANUFACTURED**

PO Box 2028, Midland DC 6936 Western Australia

80 Stock Road, Herne Hill 6056 Western Australia

PHONE: + 61 8 9296 0496

FAX: + 61 8 9296 0495

EMAIL: bushcomm@bigpond.com

See more at

[www.bushcomm.com.au](http://www.bushcomm.com.au)

record from the trip through VK2 and we were getting desperate.

Colin contacted Neil by phone to let him know that we were in heavy rain and it did not look good for any microwave contacts.

On arriving at the Cape Byron site the rain was easing and we set up 10 GHz and pointed the dish in Neil's direction.

Neil was transmitting a CW ident and it did not take long to tune him in and read the CW.

We reported to Neil that we were hearing his signal and contact was quickly established on 10 GHz. Reports of 4.1 were exchanged between all stations and a feeling of relief swept over us that at last we had achieved a new VK2 record of 399.7 km beating the old record by 18 km.

The final stage of our microwave holiday was to try to extend the 24 GHz VK4 record by taking advantage of the cold frosty mornings at Stanthorpe on the western slopes of the Great Divide.

We proposed three days would be needed and we would camp out on site so that we would be ready for an early morning contact on 24 GHz from the Mt Mowbullian in the Bunya range to Stanthorpe.

Somehow we wimped out of the cold start and decided to make a 1 day event trying out a spot that Doug VK4OE had found west of Stanthorpe to Mt Mowbullian.

Doug and I travelled to the Stanthorpe area while Colin VK5DK and Errol VK4ZHL went to Mt Mowbullian in the Bunya range.

We had performed this exercise on a previous occasion, but Colin's car developed engine trouble with dirty fuel injectors and he was unable to drive to the top of Mt Mowbullian, so we returned to Brisbane to effect repairs.

Our misguided belief that it should be easy to work 100 km+ on 24 GHz was our downfall and the distance was a bit too far without significant propagation.

We tried both 10 GHz and 24 GHz and were only able to communicate on 10 GHz with very poor signal reports considering the short distance. Nothing was heard on 24 GHz.

We were unprepared believing that plan "A" could not fail and had not bothered to bring either maps or computer to assist in finding a new location to work from or in fact develop

any sort of plan "B".

The panic was on to make some mark on the record as I started driving North West toward Colin's position to shorten the distance and get a clearer shot at Mt Mowbullian.

The next four hours was spent driving along unknown country roads, down dirt tracks looking for access to hill sites with phone towers and generally getting lost.

At 5 pm just before last light, we found a rise near Millmerin that offered a line-of-sight shot at Mt Mowbullian and was 28 km further than the standing record.

We quickly set up 24 GHz and established contact. Signal reports were 5.9 indicating there was scope to increase the distance further except we had run out of light.

Driving around unfamiliar country in the dark would have been stupid, so we would have to be content with what we had done, keeping in mind that we could come back another time and add more distance to the record.

Just to add some figures to demonstrate the dedication or stupidity, depending on how you look at it, of the microwave enthusiast, at no time during this 24 GHz record attempt was I any more than 180 km distance from Colin's position at Mt Mowbullian and at the end of the day I finished up 120 km from his position.

To achieve this I had travelled a total of 750 km from Brisbane to Stanthorpe, Millmerin and return. All for 28 km increase in the record.

So what did we accomplish in this expedition? We enjoyed ourselves even though we had unwelcome experiences that we could have done without.

We reaffirmed our insanity status proving that we are still suitable candidates for the amateur fraternity.

We experienced rain scatter propagation and considering the amount of heavy rain that has been falling in Victoria during winter, perhaps more microwave operators should be out there trying some rain scatter contacts.

We had some success extending the VK4 5 GHz, 10 GHz and 24 GHz records and the VK2 10 GHz record.

I think everybody concerned learnt something and we all gained more experience in operating.

Roll on summer and let there be tropospheric propagation every day.

ar

# A vertical antenna for 15, 17 & 20 metres

John Howlett VK6ZN

This antenna was developed for three-band portable applications and needs no tuner or coils. It screws into a heavy-duty mobile mount and is stored in a PVC tube mounted on the bull-bar of our mobile home. Although it behaves very well in high winds, the antenna is not recommended for mobile use!

It is easy to build; it is low cost and gives excellent results. And it offers the flexibility to go portable and get away from complaining neighbours and power-line noise.

I would like to thank Trevor VK7TS for the loan of his workshop facilities to produce the antenna.

## Construction

[Note: 1 inch (1") equals 25.4 mm]

All materials were found at a *Mitre 10* hardware store:

1 x 16 mm x 2.4 metre aluminium tube (lengths A and C)

2 x 12 mm x 1.8 metre aluminium tube (lengths B and D)

3 x hose clamps

1 x 1/2" x 3" bolt

1 x 3/16" x 1 1/4" stainless nut and screw

Cut A to 1770 mm.

Cut B to 1720 mm.

Cut C to 150 mm.

Cut D to 1800 mm (if necessary).

Cut the head off the 1/2" bolt and insert into one end of length A, leaving 30 mm of thread exposed. Drill a suitable hole through the tube and 1/2" bolt and fit the 3/16" screw with nut. Trim off excess thread.

Cut 4 slots in the other end of length A.

Cut 4 slots in both ends of joiner length C.

These slots should be about 15 mm long and about 1 mm wide, to ensure that the clamp makes a good grip. An alternative would be to use 6 slots at the width of a hacksaw cut.

Fit joiner length C over one end of length B, adjust the total length to 1800 mm and tighten the hose clamp. Slide length B into A, adjust the total length to 3020 mm and tighten the clamp.

Screw the antenna into the mount and check for resonance on 15 metre. Adjust the length for best VSWR.

Mark the clamping position for future reference.

Fit length D into joiner length C and

check resonance on 20 metre. Adjust the length if necessary but VSWR will probably be optimum already.

For use on 17 metres, assemble as for 15 metres then slide B out of A until resonant on that band. Set the antenna length for minimum VSWR and clamp firmly.

Mark the clamping position.

## Performance

Being low Q, it works fine in the CW and SSB sections of the bands. I get a

VSWR of 1.2 to 1 on 15 and 20 metres. On 17 metres it goes up to 1.4 to 1. These figures will vary for different vehicle configurations or earth systems.

It performs better than my (expensive) multi-tap mobile antenna by at least 2 S-points. On-air tests indicate the same performance against a 20 m wire dipole. And against a 20 m delta loop the performance was much the same, except the loop was much quieter.

ar

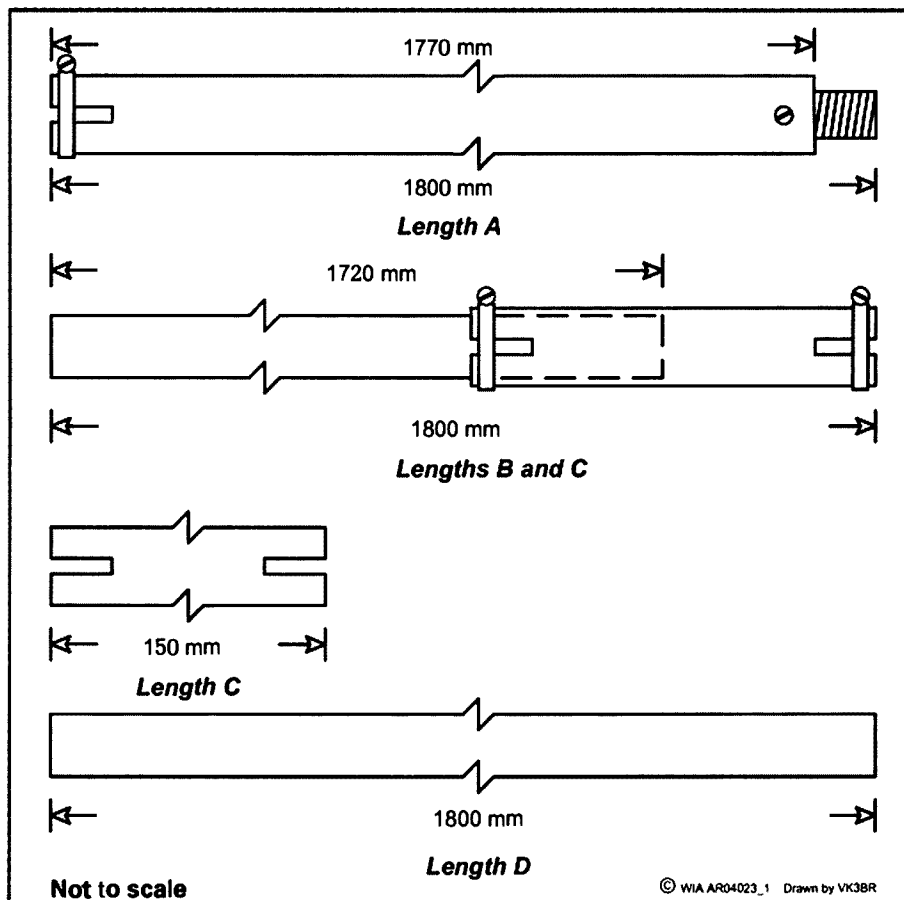

## VK1 news

### CRARC Forward Bias

Peter Kloppenburg VK1CPK

CRARC has been fortunate in having part of its repeater system located in the Telstra tower on Black Mountain (812 m) in the middle of Canberra. This repeater assembly, halfway up the tower, covers the ACT and the region very well. However, as is common now, a recent review and site audit by Telstra management, re-assessed the site rental at more than \$5000 per year. This rental would be charged from 31 October '04 onwards. This amount is beyond CRARC's ability to pay, and therefore it was decided to remove the repeater assembly from the tower before that date, and find another site for it. The Committee is now in the process of approaching a number of other site owners who might be willing to accommodate the repeater assembly. As soon as a new repeater site has been obtained, the repeater assembly will be re-installed, together with an additional repeater, to cater for a demand for an

increased number of communication services.

On the subject of changes, during the last general meeting, members voted for a name change from VK1 Division to Canberra Region Amateur Radio Club (CRARC). This change together with changes to the constitution must first be approved by the Registrar General before they become a matter of fact.

After July 2005, membership of the WIA no longer includes membership of a state division and, therefore, each state-based club will seek its own membership. WIA membership renewal application forms will include an invitation to join a local amateur radio club or a former division that has changed to a club. Membership of CRARC is \$20.00 per year, and application forms are downloadable from the Website at [www.vk1.wia.ampr.org](http://www.vk1.wia.ampr.org)

The weekly 80-metre net will be restarted on Sunday, December 5, 2004

at 8.00 pm by our president, Alan Hawes VK1WX. The net callsign is VK1WI at a frequency of 3.570 MHz, plus or minus QRM. The objective is to provide local news and other items of interest to radio amateurs in Canberra and the region. These may include WICEN news, general club information such as meeting dates or guest speakers. Much of the net's content will depend on feedback from radio amateurs, or listeners, during net operations. It also provides an opportunity to test HF antennas for local coverage, and, for VK1 Award seekers to make contact with VK1 radio amateurs. The Committee is calling on all Canberra and Region Radio Amateurs to participate in this initiative, to provide feedback on net content and to give Award seekers a chance to work VK1 Hams.

The next General Meeting will be held on Monday, February 28, 2005 in Scout Hall, Longerenong St., Farrer, at 8.00 pm. Cheers.

## VK2 news

The NSW Division held the EGM on Saturday 30th October for the membership to vote on signing an implement agreement - known as 3D of 3/8/2004 - with the National WIA. Over sixty members attended Amateur Radio House. A further one hundred and sixty seven tendered an apology. Following speakers for and against, the motion was put. It was carried three to one in favour in signing the agreement. Council is now dealing with the mechanics of completing the agreement.

Informally raised at the meeting was the timing of the Sunday news session with respect to the State and National segments. The majority of members favoured the combining of both presentations into a single segment commencing at 10 am. This was commenced last month. Obtaining the audio file of the national segment at the Dural site has been difficult due to landline limitations until the combining of the segments was made possible by an offsite download and RF path, provided by Steve VK2BGL. Tests

are now being conducted with wireless Internet providers for a possible on site facility.

Last New Year there was operation from VK2WI as part of the welcome to the New Year. It is being considered that a similar activity be conducted to welcome in 2005. The news sessions will keep you informed. The VK2 Bookshop advises that the range of EH antennas has now been sold out.

A Conference of Clubs was held in Sydney early November. A few weeks before that a country 'club conference' was held in Armidale, hosted by the Walcha Club. It has been suggested that the first conference for next year should be about May in a country region, yet to be determined. A Novice / AOCP course commenced at Amateur Radio House - Parramatta last month. There will be a break over the holiday period. It is expected to conclude mid 2005. The course instructor is Terry VK2UX. The course can also be used as an upgrade to the AOCP level. It is not too late to

join if you are aware of anyone wanting take part in a Sydney located course. Amateur Radio House is close to the western train line. For details contact the Parramatta office - 02 9689 2417.

Many VK2 Amateurs will know Jeff VK2BYY as the Dural station Engineer during the 1970 - 1980 period. Also he is a regular attendee in the pedestrian foxhunts at the various field days. Jeff is noticed at these events as running bare foot - that is without shoes, not the RF version. Jeff has spent some time in the New England region of NSW. Now back near Sydney, Jeff has turned his hand to being an author and a few weeks ago released his first work, a novel set in the New England area with a story line of astronomy and barefooting. Classified as a work of fiction, Jeff's novel 'Barefoot Times' has the ISBN number of

1-9208-8474-2, published in Queensland by Zeus Publications. Keep up the good work Jeff, let us know when the next edition is coming out. Season's greetings. 73 - Tim VK2ZTM.

## VK6 news

Will McGhie VK6UU

will2@iinet.net.au, 08 9291 7165

### Another Special General Meeting

**By the time you read this, the SGM will have been held on 4th December 2004.**

All members of the WIA VK6 division should have received in the mail the Agenda and Proxy forms for the next Special General Meeting. You may be surprised to find yet again a motion to wind up the division, even though it was defeated at the last SGM. However the margin was narrow.

The majority of VK6 Councillors and Members are in favour of winding up the Division. However not all Councillors or members are in favour and this has been of considerable value to make sure winding up the VK6 Division is thoroughly examined. Winding up the VK6 Division has proved not as easy as might be thought. There are many

functions that the Division provides and some of these functions have proved difficult to sort out. The VK6 Council are on top of what has to be done to wind up or transfer responsibility and already many changes have taken place. This second vote on the future of the VK6 Division hopefully will give a clearer indication. At the last SGM the majority of members voted to wind up the division but the vote was so close (74.6% of voting members) with only a couple of votes deciding the outcome. Note the 75% required to wind up.

All this said, the majority of VK6 Councillors maintain the belief that winding up the VK6 Division is the way

to go hence the second attempt to wind up the Division at the SGM on the 4th of December. The VK6 Council hope there is a good turn out at this meeting and VK6 notes will report on the outcome of the SGM in February's Amateur Radio Magazine.

By the time you read this the VK6 website will have moved from the iinet account which will have been closed. The new Email address for contacting the WIA Advisory Committee is vk6advisory@vk6.net and the new web address for WA History and links to WA Clubs etc. is <http://www.vk6.net>

Perhaps for the last time from the VK6 Council, all the best for 2005.

## VK7 news

Justin Giles-Clark, VK7TW

Email: vk7tw@wia.org.au. Regional Web Site: [www.reast.asn.au](http://www.reast.asn.au)

### Tasmanian Hamfest 2004

Hamfest organisers have let me know the preliminary list of companies and groups who will have displays at the Hamfest and it includes TTS Systems, Benelec, Marcom Watson (ICOM), TET Emtron & Bushcom antennas, Solar Tasmania and ALARA.

It's happening on December 4 at Miena at the Southern end of Great Lake in the Central Highlands. Starts 1100 and finishes at 1500, gold coin entry fee, Coffee and tea will be provided and food will be available. There will be operating displays, stations, CW, ATV, APRS, digital and vendor displays plus several prominent guest speakers.

This event is targeted towards to all of those souls with an interest in radio. HF operators, VHF/UHF/Microwave, Novices, CB operators in fact anyone who enjoys experimenting with radio communications. See you there!

**Jamboree on the Air in VK7**  
JOTA/JOTI in VK7 was alive and well over the weekend of October 16 & 17. In

the North of the state at Corra Lynn Scout Camp, Tony VK7YBG was operating with assistance from VK7HDX, VK7HAR, VK7ZJA, VK7NAU and others.

In the South, Rod, VK7TRF and others operated VK7SBB at Orana Camp at Roaches Beach for the Blackmans Bay & Huntingfield Scouts. At The Lea, Brian VK7HSB, Harvey VK7KSM, Roger VK7XRN and Graham, VK7ZGK operated the Hobart and Glenorchy scouting Districts' station VK7SAA.

A big thank you to all these stations and any others who helped out local scout and guide groups. I am sure you are all waiting for the delivery of your JOTA operator's badges!

### Northern Tasmanian Amateur Radio Club

At a meeting of Northern amateurs on October 13, it was agreed to form the Northern Tasmanian Amateur Radio Club (NTARC). Membership of the Club is open to all whether an amateur, non-amateur, member of the WIA or not and the membership fee for 2005 will be \$12.00 for WIA members and

\$24.00 for non-WIA members. The executive of the club has approved a membership certificate, which they hope will enhance any radio shack.

### Radio and Electronics Association of Southern Tasmania Inc.

#### APRS Update

APRS coverage around Hobart is now very good, with digipeaters at Guy Fawkes Hill (Ken, VK7KRJ), Moonah (Will, VK7HIL), Kingston (Scott, VK7HSE), Techno Park (Danny, VK7HDM), Brighton (Roger, VK7HRW) and New Norfolk (Bob, VK7KRW).

So, if you see a group of amateurs huddled around a notebook peering at a local map they are probably looking at someone with an APRS terminal on board moving about Southern Tasmania. For more information contact Ken VK7KRJ, he can be found on R2 or up at the domain most Wednesdays.

*“Hey, Old  
Timer..”*



If you have  
been licensed  
for more than  
25 years you are invited  
to join the

## Radio Amateurs Old Timers Club Australia

or if you have been licensed for less than 25 but more than ten years, you are invited to become an **Associate Member** of the RAOTC.

In either case a **\$5.00** joining fee plus **\$8.00** for one year or **\$15.00** for two years gets you two interesting OTN Journals a year plus good fellowship.

Write to  
RAOTC,  
PO Box 1100  
Sandringham VIC 3191  
or call Arthur VK3VQ on 03 9598 4262 or  
Bill VK3BR on 03 9584 9512,  
or email to raotc@raotc.org.au  
for an application form.

# Amateur Radio Magazine Awards

The Editor, Colwyn Low VK5UE, attended the Adelaide Hills Amateur Radio Society meeting on 19th August 2004 to present Lloyd Butler VK5BR, with the certificate and a cheque for \$100 as the Amateur Radio Magazine Technical Award for 2003.

This award is presented each year to the author of an article or articles published in Amateur Radio Magazine that is considered to be significant in terms of content and presentation of a technical subject in the field of amateur radio activities. Lloyd's articles on aerials were of a very high standard.

The other award made by Amateur Radio Magazine each year is the Higginbotham Award for contributions to the magazine. The 2003 award was made to Gil Sones VK3AUI in recognition of 30 years being part of



Presentation of the Amateur Radio Magazine Technical Award to Lloyd Butler VK5 BR on 19th August 200

the production of AR and contributing to its content. Gil became a Silent Key in November 2003.

ar

## VK7 news continued

### Visit to Incat

Wednesday November 3 saw about 30 REAST members and friends have a guided tour by Skipper Chuck and Chief Engineer, Chris, of the US Army Joint Venture Catamaran HSV-X1. A 96 metre Evolution 10 wave piercing catamaran that has been used by the US Army as a fast logistics, troop transport and command/ communications platform. It is currently in for a major service.

The communications room was a very impressive wall array of plasma TV screens, LCD command stations all fed by 18 PCs. The computers are fed via encrypted satellite links.

Thanks a million to Chuck and Chris for taking the time to show us around the vessel and thanks to Rod Goss from Incat for organising the tour.



On the bridge of the catamaran LtoR: Mike, VK7FB, US Army Skipper, Chuck West, Bill, VK7WR and Les, VK7LS.

ar

## Dalby & District Amateur Radio Club

Our club has just put a 63cm repeater on air here in Dalby. Callsign is VHD07. As can be imagined much thought and planning went into this project before it became a reality. Members built two half wave co-linear antennas which were mounted on the local community radio station tower in Dalby.

This repeater has resulted in a renewed

interest in amateur radio with some new members for the club and two have applied to sit for their novice exams.

This has been a good exercise for the club and special thanks go to our Repeater Co-ordinator, Mike VK4XT, for all the time consuming and hard work he puts into keeping our repeaters up and running.

**Rick Lammas VK4NRL President**

The 2m repeater on 146.675 MHz now has Echo Link on trial – node number 209093. Repeater on 438.700 MHz is working well also.

So, if you are coming through Dalby give a call on these repeaters and if someone is available you are sure to be answered.

## Adelaide Hills Amateur Radio Society

The October meeting was a challenge our soldering (and counting) skills. Graham VK5ZFZ conducted another of his construction nights. This time it was an old fashioned disk radio.

The counting part was associated with counting the number of turns of wire you wound onto the disk of card that formed the aerial. The aim was to use approximately 5 metres of fine wire with which to wind 19 turns (it could be argued that it really was 38 or 39) onto your disk, weaving the wire in and out of the 'spokes' you had cut in the disk of cardboard. You should have finished up with 19 wires across each gap. Some people (of whom the President shall be nameless) wound 19 turns altogether so they had only 9 on each spoke, others found their arms weren't long enough to measure 5 metres so they had to add more wire.

Anyway, once the aerial was made a transistor, a capacitor and a couple of resistors and you could test it to see if you could hear the local ABC station.

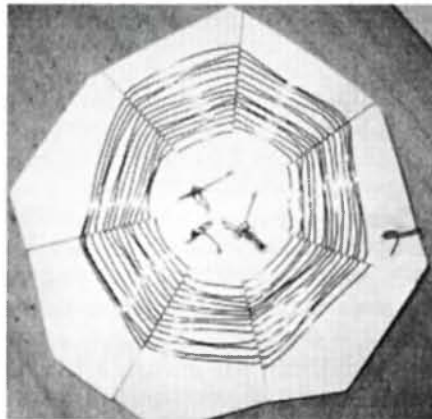

The coil with some components in the centre

There were some happy faces, so some people got it right, and everyone enjoyed it

By the time this piece 'goes to air' we will have had our big Buy and Sell (or social occasion) and it will be the Festive Season so:

**MERRY CHRISTMAS AND HAPPY NEW YEAR TO ALL**

**Christine Taylor VK5CTY**



New ALARA member, Jenny, with her radio. It worked!

## Old Timers' Luncheon in VK5

The Old Timers' Luncheon in VK5 was held late in October. The numbers attending seem to decrease each year but everyone enjoys the occasion. Remember you are eligible to attend the Old timer's functions and to participate in their regular nets if you are over 50 years of age and have held a radio licence for at least ten years. Novices and Limited Licensees are eligible and welcome.

The luncheons currently are held at the Marion Hotel which is served by public transport, so not being a driver is no restriction, either. In other words, come along and have a pleasant lunch with people who share your interests.

This year, again, Vaughan Harvey (not an amateur, but a public broadcaster for many years) brought along some of the treasures and mysteries

from his radio museum. As the first photo shows it drew the diners like bees to a honey pot. The second photo shows one of the old radios. There were a number



Bees around a honeypot

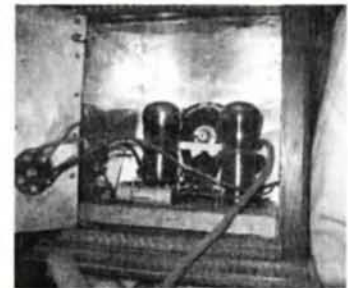

The "honeypot"

of "I remember those" from the audience as they studied the components. The radios work better these days but they were more interesting to look at inside, back then.

# ALARA

Christine Taylor VK5CTY

## Can you help?

Next year, 2005 it will be 30 years since ALARA was formed. In looking through the early history we realise that there are a number of YLs who were active in those early years, with whom we have lost contact. Can you help?

Some of the people with whom we have lost contact, that appear on the first few pages are; Rhonda de Stefano, Irene Robinson, Jenny Roper, Joan Poulter, Judy Gellert, and Anne, XYL of VK7FB.

## JOTA and Vic's radio equipment

This year saw the usual activities between amateurs and scouts for the Jamboree On The Air. Jeanne VK5JQ was active in the radio shack at Woodhouse, the main Scout campsite. Susan VK7LUV was busy in Launceston. Although I have not heard, I suspect that Bev VK6DE had some girls or boys in her shack again, and I am certain that Norma VK2AYL was involved along with her OM, Frank and her three girls, somewhere in New South Wales.

ALARA took the opportunity of the weekend when there would be much radio activity, to have the official 'handover' of those radios and associated equipment. A group of us went down the RIG headquarters at Glenelg, a seaside suburb of Adelaide, to see the radios being used and to make the

Some of these YLs we know, were XYLs or harmonics of amateurs, others had licences in their own rights. Some of them may have married and changed their names, or now have licences.

We would love to see some of them at the ALARAMEET in Mildura in September next year but we would be delighted just to have a note to let us know how they are and what they are doing now.

presentation.

The group comprised one of the foundation members of ALARA, Myrna VK5YW, a very new member Jenny, the State Rep for SA, Jean VK5TSX and the Historian Christine VK5CTY.

However, we had a problem. The radios, especially the HF rig were in such constant use that we were loath to interrupt just for a presentation. So the four of us stood around the desk where one young boy was making a contact with a Scout in Queensland to have the official photo taken.

The whole room was abuzz with activity. Handheld radios were

There will be more names in the National Broadcasts and in this column in the months to come. **YOU ARE WARNED.**

If you know any of the YLs involved in those very important early days please contact them and ask them to contact us. My e-mail address is [geencee@picknowl.com.au](mailto:geencee@picknowl.com.au) and my address in the callbook is correct.

being used across the room to play "Battleships", a VHF radio was in use for cross city contacts, as well as the HF rig which was constantly in use. Right in the middle of the room a table was busy with young people sending their names and messages they were making up, by Morse Code. The keys had the Code taped to the top so they could read the appropriate set of 'dits' and 'dahs' for each letter. Kevin, VK5AKZ was writing down what was sent – and sometimes being told "That was not what I meant" when someone got it wrong.

It was an exciting sight and promises well for amateur radio in the future.

## JOTA at Yundi...



Rufus VK5YO in his 28th or 29th year taking JOTA to the Black Forest Scouts at Yundi with his own call signs and VK5KR the call of the BF Scouts.

## A Silent Key

Many YLs visiting Alice Springs have been welcomed on air or in person by Moira VK8NW, who became a silent key early in October this year. We extend our sympathy to her family and friends.



Kids with Morse keys



Kids with computers



Official handover of Vic's radios. L-R Christine VK5CTY, Jean VK5TSX, Myrna VK5YW, Jenny



Boys and girls and radios





VK5YO with one of the scouts at Yundi



Jeanne VK5JQ helps Brooke, a 7-y-old Joey Scout handheld on 70cms



Glenys a 12-year-old on the HF rig with Jeanne and Ameer watching

**...and the One Tree Hill group.**

All OTH scouts are 12 years old except Brooke.



Ameer using the local VHF repeater



Brooke taking a turn on the HF rig with Rachel, Ameer, Glenys, Phoebe, Sabine (XYL of Dean VK5ZDW) Carol and Jeanne looking on.



Phoebe on the HF rig.

**The Florence McKenzie Trophy in a new home**

The Florence McKenzie Trophy, which was donated to ALARA in August 1982 by the Townsville Radio Club, is competed for each year during the ALARA Contest. The ALARA member scoring the highest points for CW contacts wins the trophy.

The actual trophy is rather large and



Presentation of Florence McKenzie Trophy to Dean VK5ZDW Scout Commissioner for Radio in SA

would be expensive to send interstate so for some years the trophy has been housed behind glass while the winner, if any, receives a very attractive certificate on which is a colour photo of the trophy. Over the years several actual presentations of the trophy have been made and the trophy has spent a year or so on a mantelpiece, but mostly it has been on show.

Unfortunately when the Burley Griffin Building, headquarters of the WIA(SANT) Division, became unavailable when suburban councils amalgamated, the trophy lost its last permanent home. Since then it has certainly spent some time on a mantelpiece, in the home of Pat VK5OZ the last winner, but it has also

spent some time hiding in a ceiling.

When the Radio Interest Group (RIG) was established within a large building ALARA asked if there would be a place where the trophy could be again on show to the public. They were able to provide such a place, so Pat packed up the trophy and it made the journey to its new home.

The official handover of the trophy was also held during the visit over the JOTA weekend. The Florence McKenzie Trophy will still be competed for during the ALARA Contest as usual, and may even be used in a similar fashion within the Scout Association, with a certificate to the winner. In the meantime the handsome trophy is on public display again.

**Seasons Greetings**

May you all have a good Christmas and may there be a better New Year to come, from all in ALARA to members and everyone interested in amateur radio.

2004 has seen some important changes for us with the abolition of Morse Code as an examination subject. Interestingly this has not stopped people requesting Morse Code exams. Maybe it has been seen as a challenge so that new code skeds are also heard from time to time.

The other important change for

amateurs has been the adoption of the new WIA as an administrative body that covers us as individuals instead of as members of a state body.

Similar but different changes were reported in one of the "YLRL Harmonics" and in "BYLARA" earlier in the year suggesting there was a season of change in the US and the UK, too.

"HAPPY CHRISTMAS AND NEW YEAR TO EVERYONE"

**A successful International YL Meet in Seoul**

A full report and pictures will be in the next issue of "Amateur Radio" but it can be reported that there were over 100 attendees from around the world plus a number of OMs and that the next International YL Meet will be in Mumbai in 2006. Watch this space for more information.

# Spotlight on SWLing

Robin L. Harwood VK7RH

## 2004: a year of change

The year is almost over and it has been a year of change. Swiss Radio International closed down at the end of October after 69 years of continuous service on shortwave. A new internet-based service has replaced it. Other broadcasters have been gradually reducing their output with another international broadcaster deciding to opt out of shortwave broadcasting at the end of March next year. The Belgian International Service, RVI, suddenly announced at the beginning of the B-04 period, that they will no longer be broadcasting in Flemish and other languages, nor will they be continuing

to hire spare transmitting capacity from other organisations. A daily relay from one of the domestic networks lasting four hours, targeting central Europe, will come from an existing sender within Belgium via shortwave.

RVI does have quite a few listeners here in Australia to their relay via the Kamchatka Peninsula on 9945 from 1200. Programs are in Flemish and English.

Other broadcasters also are reducing their output including Radio Cairo in Egypt. Their foreign language output is apparently being cut from 40 to 11 different language services. English will be continuing as will Arabic yet they have always been plagued with inconsistent modulation or frequency stability. For Australasia, it is on 9950 from 2100 in either Arabic or English and is often unstable.

Deutsche Welle now based in the former West German capital of Bonn has also been reviewing their output, due to budgetary pressures. However it appears that the international television arm from Berlin could be the section to face the axe. DW TV is apparently available via American cable and satellite operators, yet has not become commercially viable.

Talking of international television, I notice that the Italian RAI Network from Rome, is currently on AUSTAR together with Greek private network. Programming is naturally in those languages and these same services may be available on either FOXTEL or Optus. I have previously mentioned that I am able to get the BBC World Service as one of the optional radio channels on AUSTAR around the clock. The Radio Italia network is no longer available.

## "Passport To World Band Radio 2005"

I received my copy in the last week of October direct from the publisher and this annual edition has not deviated from its format.

This edition has been focusing on Thailand and Laos and the stark contrast

in the media in both nations. There are very interesting receiver reviews as well as antenna accessories. The blue section in the back has been retained but I am surprised to find that frequency listings of many of the American private stations have not been updated. Perhaps there was a delay in the information reaching the publishers. Fortunately the information is readily available on the Net from the stations or from other sources. Last year the blue section quickly became outdated as there were so many frequency alterations made at the commencement of the B-03 period.

The cost for PWBR 2005 was \$27.95 US direct from the publishers and available locally from Padula Books in Melbourne for about \$50 Australian.

Propagation conditions have not been good as the higher frequencies drop off. The Solar minimum is expected next year or early 2006 and it will be slow climb back upwards. There currently is a blackout as I am compiling this month's column.

Well that is all for this month. All the best for Christmas and have a Happy but safe New Year. I hope that you will have good monitoring over the holiday period and see you in 2005

ar

## VK DISCOUNT CABLES

WHAT ARE YOU DOING DURING YOUR XMAS HOLIDAY BREAK ?

*Installing towers, antennas or maybe just maintenance ?*

For the month of December we are having

**5% to 10% off**

all cables and other selected items!

**HURRY WHILE STOCKS LAST**

RG-58CJ (MIL-C-17G) @ \$10 per 100M QTY SAVE 5%

RG-213 (MIL-C-17D) @ \$165 per 100M QTY SAVE 5%

RFS HELIAX LCF14-50J (1/4) @ \$4.00 per metre SAVE 5%

RFS HELIAX LCF38-50J (3/8) @ \$4.80 per metre SAVE 6%

RFS HELIAX LCF12-50J (1/2) @ \$4.85 per metre SAVE 10%

RFS HELIAX LCF78-50J (7/8) @ \$8.00 per metre SAVE 10%

TIMES LMR 195 (50CJ Low Loss) @ \$3.00 per metre SAVE 5%

TIMES RG-214 @ \$10.50 per metre SAVE 10%

TIMES LMR 400 (BEL5913) @ \$3.90 per metre SAVE 10%

TIMES LMR 400 ULTRAFLEX @ \$5.50 per metre SAVE 10%

TIMES LMR 600 @ \$7.85 per metre SAVE 10%

1/2" HELIAX MALE & FEMALE N TYPE CONNECTORS @ \$10 Ea SAVE 5%

7/8" HELIAX MALE & FEMALE N TYPE CONNECTORS @ \$50 Ea SAVE 5%

BEL5913 MALE & FEMALE N TYPE CONNECTORS @ \$12 Ea SAVE 10%

UHF SERIES CONNECTORS (Clamp PL-259) @ \$12 Ea SAVE 10%

PL-259/213 CONNECTORS @ \$2.50 Ea SAVE 5%

PL259/58CJ CONNECTORS @ \$1.50 Ea SAVE 5%

Technical data available on request.

Cable samples available on request.

Various off-cuts available.

QUICK 4-5 DAY DELIVERY TIME

**We will match any better price you receive!**

Freight anywhere in Aust - \$18.50  
(Overseas customers POA)

ROB VK2XZ

PH : 0419 480 560 during hrs

EMAIL : rob\_vk2xz@hotmail.com

## Silent key

Fred Ward VK5FE

On Saturday 2nd October 2004 my friend and fellow Radio Amateur, Fred Ward passed away after a long illness. Fred a keen CW operator served with distinction in World War II as a signalman in France, Belgium, India and finally Singapore. In Australia Fred was employed as a telecommunications technician and operated from many parts of South Australia.

My sympathy and condolences to his wife Margaret and family.

**Jim Mackison, VK5MB.**

## Contest Calendar December 2004 – February 2005

3/5	Dec	ARRL 160 Metres Contest	(CW)
4	Dec	TARA RTTY Melee	
11/12	Dec	ARRL 10 Metres Contest	(CW/SSB)
18	Dec	OK RTTY Contest	
18/18	Dec	Croatian DX CW Contest	
26	Dec	Ross Hull Memorial VHF+ Contest	
until 16 Jan., 2005			
15	Jan	070 Club PSKFest	(PSK31)
15/16	Jan	Summer VHF Field Day	(CW/SSB/FM)
15/16	Jan	Hungarian DX Contest	(CW/SSB)
16	Jan	End Ross Hull Memorial VHF Contest	
22/23	Jan	REF Contest	(CW)
5/6	Feb	10-10 Intl. Winter Party	(SSB)
5/6	Feb	Mexico Intl/ RTTY Contest	(RTTY)
12/13	Feb	CQ WW RTTY WPX Contest	(RTTY)
13	Feb	Asia-Pacific Sprint Contest	(CW 20/40m)
26/27	Feb	ARRL Intl. DX Contest	(CW)
26/27	Feb	Russian PSK WW Contest	(PSK31)
26/27	Feb	REF DX Contest	(SSB)

### Greetings to all readers,

As you will see from last month's notes, I am quite concerned about the impact of BPL on our hobby. This is over and above just the contesting scene – as I wrote, it will influence our WHOLE AR hobby, possibly to the point of eliminating it if the mode is allowed into our community.

Some will argue that the Contest Notes are not to be used for political discussions, and I agree totally. However, I don't see the raising of an issue relevant to the whole hobby as being political, rather an attempt to get readers thinking. That being said, let me return our attention this month to the business of contests.

### Ross Hull and Summer FD Contests

You will see below the rules for this year's Ross Hull Memorial VHF Contest and January's Summer VHF Field Day. Please check carefully, as there are some changes made by John Martin, the long-standing Manager of this event.

### 2005 hopes

In 2005 I shall aim to tighten the presentation of contesting news to you all. It is not such a difficult job to assemble information from various sources; the difficulty is in preparing it in advance for publication in this magazine. As you know, printed material lead times are quite long. How easy it would be if we all used the Internet to get our information!

Nevertheless, I am still old-fashioned enough to believe that there are operators in VK who do not use The Net and so rely on this magazine. Hence our attempts to keep you informed via this means.

To this end, I shall make every effort to publicise material both in this magazine and on the VKHAM and WIA web pages. I think that this latter is now important if we are to support the growth of a national WIA.

One issue that has arisen in recent months (and to a lesser extent in previous years) is conflicts between some of our contests and AR Clubs deciding to hold hamfests.

I shall make every endeavour early next year to publish a list of all VK

contests. Once this is known, I hope that Club Secretaries will take the time to check it before deciding on special events. This way, the Club should be able to hold its special day and also enter a team in the local contest.

However, I must say that the dates of the contests, once published, WILL NOT be changed for that year unless there are exceptional circumstances.

Have a very happy Christmas and good contesting in 2005.

73, Ian Godsfil VK3JS

**26 December  
2004 until  
16 January, 2005  
Ross Hull  
Memorial  
VHF+ Contest**

**Rules next page**

# Results of the Jack Files Contest 2004

This year saw the end of an era. The 2004 Jack Files Memorial will be the last time this contest will be sponsored by the WIAQ. As of yet I have not spoken to anyone about the continuation of this contest; I'm sure it will continue, but not under the umbrella of the WIA.

Unfortunately this year revealed a poor show of support for this contest which has been a proud part of Queensland's amateur radio history in honour of Jack Files, a long-serving councillor of the WIAQ. I'm unsure as to the reasons why

there has been a decline in the number of amateurs who wish to participate. I wonder what it would take to grab the interest of Australian amateurs? If you have any ideas they would be gladly received.

All that aside, the results for The Jack Files Memorial Contest 2004 are as follows: -

VK4 Single Operator Phone	VK4ADV - Peter De Voss of Asply, Brisbane
------------------------------	---

**John Spooner VK4AJS, Contest Manager**

VK4 Club Station	VK4BAR - Bayside Amateur Radio Club
---------------------	--

VK2 Single Operator Phone	VK2LCD - Chris Meagher
------------------------------	---------------------------

VK3 Single Operator Mixed	VK3JS - Ian Godsil
------------------------------	-----------------------

So there it is for 2004. I would like to congratulate the winners and to thank all who participated and entered their logs. The listed winner's certificates will be sent as soon as possible.

**73, John Spooner VK4AJS**

## Ross Hull Memorial VHF-UHF Contest 2004 - 2005

It has been some years since there were any major changes to the rules for this contest. Last year I foreshadowed changes in the hope of encouraging more activity, and the response was positive. So this year's rules are quite different from last year's.

The main problem has been the question of how to achieve a level playing field. Stations with microwave equipment have a scoring advantage over those who don't, and the same applies to stations using digital modes. At the same time, amateurs whose main interest is in microwaves or digital modes tend to stick mostly to these activities and don't spend much time working CW or SSB on the lower bands.

So why not try a new approach? Let's have three different playing fields, so that everyone can pursue their particular interests and still feel that they can have a good chance of making their mark in the section of their choice. Hopefully this will make the contest more attractive to everyone. But in particular I am hoping for more activity from stations that have only three or four bands. This will become more important in future years when more amateurs will have access to the "low end" of these bands.

The three playing fields will be:

**Section A:** VHF - UHF (50 MHz through to 1296 MHz);

**Section B:** Microwaves (1296 MHz and above);

**Section C:** Digital Modes, all bands.

Hopefully there will also be some built-in levelling in Section A, because 6 metres tends to be more useful in those parts of the country where there is less activity on 1296 MHz - and vice versa.

Note that contacts on 1296 MHz can be counted in Sections A and B. The reason is to encourage use of this band by Section A entrants, while recognising that microwave operators are also active on this band.

I would also like to offer the incentive of a "Single Rig Award" for the next contest. A certificate will be awarded to the highest scoring entrant in Section A who makes all contacts using a single radio (IC706, FT847 etc), with a single antenna (no stacked beams) on each band and no linears above 100 watts. To be eligible for this award, simply include a description of your equipment on the cover sheet of your log.

Finally, considering the levels of activity in the last few years, I have relaxed the rule about the use of recognised DX calling frequencies. However I still hope that contesters will leave these frequencies as clear as possible, so that everyone will have the best possible chance of hearing calls from DX stations.

I have included a pro forma cover sheet and scoring table in my posting on the Internet, and it will make my job easier if you follow the layout of this sheet. You can send in your log by post or by e-mail.

### The Contest

The WIA maintains a perpetual trophy in honour of the late Ross A. Hull and his pioneering achievements in VHF and UHF operation. The name of each year's contest winner is engraved on the trophy, and other awards may be made in the various divisions of the contest. The contest is open to all amateurs.

**John Martin (VK3KWA), Contest Manager**

### Duration

**0000 UTC Sunday December 26, 2004  
to**

**2400 UTC Sunday January 16, 2005.**

***In Eastern Summer Time, that is  
11 a.m. on December 26 to 11 a.m.  
on January 17.***

### Sections

**A: VHF - UHF (50 MHz through to 1296 MHz), non-digital modes.**

**B: Microwaves (1.296 GHz and above), non-digital modes.**

**C: Digital Modes, all bands.**

Digital modes are defined as those in which the decoding of the received signal is done by a computer. Entrants may submit logs for one or more sections.

### General rules

One callsign and one operator per station. One contact per station per band per UTC day. Repeater, satellite and crossband contacts are not permitted. No contest activity is permitted below 50.150 MHz. In Sections A and B, entrants making contact on recognised DX calling frequencies should not occupy these frequencies for prolonged periods. All rulings of the contest manager will be accepted as final.

### Valid contacts

For Sections A and B, entrants must exchange RS (or RST) reports plus a serial number. Serial numbers need not be consecutive. For difficult propagation modes such as meteor scatter, exchange of callsigns plus two further digits is sufficient. For Section C, exchange of callsigns plus two further digits.

## Scoring

Scoring will be based on the best 7 UTC days nominated by the entrant. Each contact will be scored as follows:

For 2 metres and above, one point per 100 km or part thereof (i.e. up to 99 km: 1 point, 100 - 199 km: 2 points, etc).

For 6 metres only, contacts below 1000 km: as above. Contacts from 1000 km to 2400 km, 2 points regardless of distance. Contacts over 2400 km, 20 points regardless of distance.

The band multipliers are:

6 m	2 m	70	23	Higher
		cm	cm	
x 1	x 3	x 5	x 8	x 10

## Logs

Logs must cover the full contest period and contain the following for each contact:

- Date and UTC time.
- Station location (if operating portable).
- Frequency and callsign of station worked.
- Reports and serial numbers sent and received.
- Approximate location or grid locator of station worked.
- Estimated distance worked and points claimed, including the band multiplier.

Separate scoring columns for each band would be helpful.

## Cover Sheet

Logs must be supplied with a cover sheet containing:

- Operator's callsign, name and address.
- Station location (if different from the postal address).
- Section(s) entered, and a list of the UTC days to be scored.
- A scoring table set out as the example below.
- A signed declaration that the station has been operated in accordance with the rules and spirit of the contest, and that the contest manager's ruling will be accepted as final.

Please use the following format for your scoring table. If you wish you can crosscheck by adding the daily totals across the table, but please make sure that you include the separate band totals.

Date	6 m	2 m	70 cm	23 cm	etc
Day 1	xxx	xxx	xxx	xxx	xxx
Day 2	xxx	xxx	xxx	xxx	xxx
etc.					
Total	xxx +	xxx +	xxx +	xxx +	xxx
	= xxx (GRAND TOTAL)				

A sample cover sheet and scoring table has been included in the postings on WIA web sites and the VK-VHF e-mail reflector. Copies can also be obtained from the e-mail address given below.

## Penalties

Minor errors in distance estimates or calculations may be corrected and the score adjusted. Prolonged use of recognised DX calling frequencies (especially when the reports indicate strong signals) may incur a scoring penalty. Inclusion of any false log entries will lead to disqualification.

## Entries

Paper logs may be posted to the Manager, Ross Hull Contest, 3 Vernal Avenue, Mitcham, Vic 3132. Electronic logs can be e-mailed to [jmartin@xcel.net.au](mailto:jmartin@xcel.net.au). The following log formats are acceptable: ASCII text, Office 97 RTF, DOC, XLS or MDB. If you use Office 2000 or later, please save the files in Office 97 format.

*Logs must be received by Monday, February 7, 2005. Early logs would be appreciated.*

## Note on calculating distances

Absolute accuracy is not required. You just need to know whether each station is above or below the nearest multiple of 100 km, so you can use a compass to draw 100 km circles around your location on a map. A more accurate method is to use six-digit Maidenhead locators and a program that can be obtained from the e-mail address given above. The program is called DXLOCATE version 2.1. (There is a version 2.2 in circulation, but it has a minor bug! Version 2.1 does the same job, but without any bugs.)

# Summer VHF-UHF Field Day 2005

## Dates

*Saturday and Sunday  
January 15 and 16, 2005.*

Duration in all call areas other than VK6: 0100 UTC Saturday to 0100 UTC Sunday.

Duration in VK6 only: 0400 UTC Saturday to 0400 UTC Sunday.

## Sections

- A: Portable station, single operator, 24 hours.
- B: Portable station, single operator, 6 hours.
- C: Portable station, multiple operator, 24 hours.

D: Portable station, multiple operator, 6 hours.

E: Home station, 24 hours.

Single operator stations may enter both Section A and Section B. If the winner of Section A has also entered Section B, his log will be excluded from Section B. The same applies to the winner of Section C if the station has also entered Section D.

## General Rules

A station is portable only if all of its equipment is transported to a place that is not the normal location of any amateur station. Operation may be from any

John Martin VK3KWA, Contest Manager location, or from more than one location. You may work stations within your own locator square. Repeater, satellite and crossband contacts are not permitted.

One callsign per station. If two operators set up a joint station with shared equipment, they may choose to enter Section A or B as separate stations under their own callsigns, or Section C or D under a single callsign. If they enter Section A or B, they may not claim contacts with each other. Stations with more than two operators must enter Section C or D. Operators of stations in Section C or D may not make any contest exchanges using callsigns other than the club or group callsign.

No contest operation is allowed below 50.150 MHz. Recognised DX calling frequencies must not be used for any contest activity. Suggested procedure is to call on .150 on each band, and QSY up if necessary.

## Contest Exchange

RS (or RST) reports, a serial number, and your four digit Maidenhead locator.

## Repeat Contacts

Stations may be worked again on each band after three hours. If the station is moved to a new location in a different locator square, repeat contacts may be made immediately. If the station moves back into the previous locator square, the three hour limit still applies to stations worked from that square.

## Scoring

For each band, score 10 points for each locator square in which your station operates, plus 10 points for each locator square worked, plus 1 point per contact. Multiply the total by the band multiplier as follows:

6 m	2 m	70 cm	23 cm	Higher
x 1	x 3	x 5	x 8	x 10

Then total the scores for all bands.

## Logs

Logs should cover the entire operating period and include the following for each contact: UTC time, frequency, station worked, serial numbers and locator numbers exchanged, points claimed.

## Cover Sheet

The cover sheet should contain the names and callsigns of all operators; postal address; station location and Maidenhead locator; the section(s) entered; the scoring table; and a signed declaration that the contest manager's decision will be accepted as final.

Please use the following format for your scoring table. In this example the operator has operated from one locator and worked four locators on each band:

Band	Locators activated (10 points each)	+	Locators worked (10 points each)	+	QSOs (1 point each)	x	Multiplier	=	Band Total
6 m	10	+	40	+	40	x	1	=	90
2 m	10	+	40	+	30	x	3	=	240
70 cm	10	+	40	+	20	x	5	=	350
<b>Overall Total</b>									<b>= 680</b>

A sample cover sheet and scoring table has been included in the postings on WIA web sites and the VK-VHF e-mail reflector. Copies can also be obtained from the e-mail address given below.

## Entries

Paper logs may be posted to the Manager, VHF-UHF Field Day, 3 Vernal Avenue, Mitcham, Vic 3132. Electronic logs can be e-mailed to jmartin@xcel.net.au. The following log formats are acceptable: ASCII text, MS Office RTF, DOC, XLS or MDB. If you use Office 2000 or later, please save the files in Office 97 format.

*Logs must be received by Monday, February 7, 2005. Early logs would be appreciated.*

# 24th ALARA Contest

28/29th August, 2004

Gwen VK3DYL	562	Top score overall, Top VK YL, Top phone, Top VK3 member
Shirley VK5JSH	249	Top VK5 member
Judy VK3AGC	208	
Peter VK3DI	200	Top VK OM
Robyn VK3WX	142	
Marilyn VK3DMS	114	(CHECK LOG)
John VK3MGZ	110	
Christine VK5CTY	109	
Bev ZL1OS	106	Top ZL member
Elizabeth VE7YL	84	Top VE member
Bron VK3DYF	78	
Pat VK3OZ	73	
Dot VK2DB	68	Top VK2 member
Margaret VK4AOE	56	Top VK4 member
Ralph VK2IRP	45	
Chris VK2LCD	39	
Minnie VE3DBQ	28	
Alan VK8AV	15	

### SUMMARY:

VK Alara members	10 (Includes 1 check log)
VK OMs	5
DX Alara members	3
Total logs	18

This year was much more successful, both from the conditions and the numbers taking part. Even then there are a number of members and OMs who appear in the logs, but who never sent in their own log. It really doesn't matter how small the log is - PLEASE send them in, as every one counts towards making the Contest even more successful.

This year, as the requirement for CW has been removed, the Florence McKenzie trophy has been retired from the Contest. However working CW in the Contest still counts for double points, so it can be very worthwhile.

As always it was great to hear the OMs giving the girls points, and congratulations go to Peter VK3DI for a magnificent score. Conditions between New Zealand and Australia were just not favourable this time, so Bev ZL1OS must be commended for her effort. Better luck next year ZL girls!

Gwen VK3DYL is our most consistent and successful Contest entrant, and again has made an excellent score. Another great win, Gwen. Shirley VK5JSH must also be commended for a first time entry and an excellent score.

There could be some changes in the Contest rules for 2005, so be sure to check in the ALARA Newsletter or AR to make sure of the correct procedure.

The Contest will be held on the weekend of August 27/28, 2005, so make sure that date is in YOUR diary.

I will look forward to hearing everybody in next year's Contest, if not before.

33 Marilyn VK3DMS

## “Keps” situation becomes clearer

Dr Tom Kelso of the Celestrak web site has been regularly updating the information on his site regarding the future availability of keplerian elements for the range of satellites of interest to amateurs. On 6th of November the latest update appeared and included links to downloadable (.pdf) files provided by Lt Col Maloney. The material was presented at the Space Operations Safety Workshop held in October. You can go directly to the page by typing in the

following URL. <http://celestrak.com/NORAD/elements/notice.asp>

The page scrolls down to the various updates with the most recent at the bottom. There are several interesting links explaining the current situation and plans for distribution of “keps” via something called the “Commercial and Foreign Entities Support Pilot Program”. Complicated name but I think that means us! The .pdf files make interesting reading with the whole

process described using flow diagrams. In essence it looks as though nothing much will change as far as amateur radio users are concerned. The major impact being on the next level up. That is - operations like Tom’s “Celestrak” web site. All previous users have been registered and it looks like there will not be any hold-ups so the “Celestrak” web site will most likely continue business as usual. Good news for us.

## C-C Rider. What is it?

The C-C Rider Payload is a cutting edge concept being worked on by a design team as we speak. It was first put forward by Tom Clark W3IWI and the idea has developed and firmed under the direction of Rick Hambly W2GPS and Phil Karn KA9Q. It is hoped that C-C Rider will be developed in time to be included in the Eagle satellite.

It will include elements of four previously separate proposals:

- KarnSat (~1 Mbps),
- C-C Rider (5 GHz Band),
- Software Defined Radio, and
- IP in Space

This will be a totally new technology to the Amateur Satellite Service that is directed at putting access to high orbit satellites into the hands of the

average Ham even for those living in apartments and restricted communities. It will do this by using modern digital techniques, in the main a digital carrier with advanced error correcting codes. Applications will be those familiar to the average operator. Voice, data and video, either in one-on-one and/or round table group conversation modes. When fully developed it promises high speed data rates up to 1 Mbps with Internet Protocol, software defined radio and tiny antennas operating in the 5 GHz band. Keep your eye on this concept, it could be a big step into the future for amateur radio satellites. If it all sounds a bit like a ‘black art’ to you, I suggest you get on the web and type C-C Rider into Google and read up on it.

## The AMSAT group in Australia

The National Co-ordinator of AMSAT-VK is Graham Ratcliff VK5AGR. No formal application is necessary for membership and no membership fees apply. Graham maintains an e-mail mailing list for breaking news and such things as software releases. Contact Graham if you wish to be placed on the mailing list.

## AMSAT-Australia Echolink Net

The net meets formally on the second Sunday of each month. Anyone with an interest in Amateur Radio Satellites is welcome to join in and take part. Graham VK5AGR acts as net controller. The net starts at 0600UTC and you can join in by connecting to the AMSAT conference server.

All communication regarding AMSAT-Australia matters can be addressed to:  
AMSAT-VK,  
9 Homer Rd,  
Clarence Park, SA. 5034  
Graham’s e-mail address is:  
[vk5agr@amsat.org](mailto:vk5agr@amsat.org)

## Jupiter and amateur radio satellites

No, AMSAT doesn’t have plans to orbit the planet Jupiter with an Oscar. This topic came up recently in discussions on the bulletin board. There has been serious discussion regarding the inclusion of the old HF modes in future satellites.

A great number of new amateurs come up through the novice ranks in many countries and therefore have HF experience and equipment. It’s thought by some that 21 MHz and 29 MHz represent an easy way for newcomers to enter the satellite game. This opinion has gained quite a following and indeed satellites launched in the last few years have included these bands among their transponders.

An interesting question was raised about interference. In general interference questions are concerned with earth-bound sources such as radar and other amateur services such as weak signal segments and the like. This question concerned a potential extra-terrestrial source of interference to the satellites and conversely the potential for amateur up link signals to interfere with radio astronomy.

The planet Jupiter has been known for many years as a source of radio emissions. They take the form of noise bursts, sometimes staccato in nature, sometimes having a longer period akin to waves crashing on a beach. The

emissions are called “Jovian Decametric Noise Bursts”. In brief they are caused by interaction between Jupiter’s magnetic field and its moon Io.

For eons of time Io’s volcanoes have been spewing out matter and because of the moon’s low gravity some of the matter escapes, trailing behind Io and forming into a “torus” following Io’s orbit. Io orbits through this torus.

The interaction between the charged plasma in the torus, Io’s movement through it and Jupiter’s magnetic field causes the noise bursts.

The above is a much condensed explanation and more detail can be gleaned from John Kraus’s book “Radio

Astronomy” and many www sites. The noises fall into several categories and at their peak they can certainly be heard on Earth on short-wave receivers using modest antennas.

But how strong are these emissions? Could they be received by an amateur radio satellite with an HF up link and relayed by the downlink back to an earth station again?

A good question. The noise bursts are not confined to a narrow band of frequencies. They are quite broad band in nature. The usual listening frequency of 18 – 22 MHz is selected more for freedom from man-made noise than because of the noise peaking in that part of the spectrum. It in fact peaks broadly around 10 MHz but that is a very busy part of the short-wave spectrum so most listening is done around either 18 or 22 MHz.

The noise is detectable (on large arrays and satellite monitors) right up into the VHF region. Jupiter and its moon Io form a kind-of giant rotating beam antenna that sweeps the noise signal past Earth as the system rotates.

The Earth is not always directly in the

path of this beam. The strength of the noise bursts vary considerably with the “Jovicentric Declination of Earth”. That is, the position of Earth in Jupiter’s sky, which varies from around +3 degrees to around -3 degrees of Jupiter’s celestial equator in a roughly sinusoidal pattern with peaks every 12 years or so.

There are smaller “seasonal” peaks as well. When the JDE is around +3 degrees we receive strong bursts of noise. The last peak occurred around 1999/2000 and we are “on the way down” the slope, much as we are in the current sunspot cycle.

Incidentally the two cycles are not related and in fact get out of sync every few decades. You will need quite an elaborate antenna system to receive the Jovian noise at present and you certainly need computer modelling to predict when the conditions are favourable.

I don’t have any data at hand on signal strengths outside the ionosphere at satellite height but the research has been done and for those who love numbers I suggest John Kraus’s “Radio

Astronomy” would be a good place to start. It has a comprehensive section on Jovian noise. From what I’ve read and experienced myself, I doubt it would pose any threat to amateur satellite communications. Actually the cyclic nature of the long duration noise bursts with their period of several seconds would make it difficult to identify on a satellite downlink as it could easily be confused with tumbling QSB. I don’t believe it should concern amateur radio satellite designers but it’s certainly an interesting question. Perhaps one day some one listening to a satellite down link will successfully identify the Jovian noise as riding through an HF satellite transponder. (now there’s an interesting project).

The question of whether or not amateur transmissions using an HF up link to a satellite could or would interfere with a radio astronomy program studying the Jovian Decametric noise is quite different. They would not be any more or less likely to cause a problem than the myriad of other signals in the 21 MHz band.

## SSETI Express project latest

The SSETI project team consists of Sam G4DDK, David G0MRF, Jason G7OCD, Howard G6LVB and Graham G3VZV.

The transmitter uses a power amplifier that has been provided free of charge by Charlie, G3WDG. This report from the team outlines the current progress and plans regarding SSETI Express – the first satellite to be built under the auspices of the ESA Education Office for the Student Space Exploration and Technology Initiative.

The Flight Model of the AMSAT-UK S band transmitter module has been completed and installed into the special enclosure which has been provided by the Wroclaw University of Technology in Poland.

The satellite will use three S band RHCP patch antennas. These antennas are fed through a splitter unit that provides 50% of the power to the nadir facing antenna and 25% of the power to each of the other antennas that are being fixed to the side of the spacecraft. These antennas and the splitter have also been provided by the University. Tests performed on the flight model

transmitter indicate that the total power output in 2401.840 MHz should be just over the intended 3 watts.

On November 8th the team will be taking the transmitter to the ESA ESTEC facility in the Netherlands. The unit will be tested to work with the on-board computer, the 28 V dc power supply system and also the 70 cm transceiver that is being provided by Holger DF2FQ. They are looking forward to this work being completed by midweek and being able to formally “hand over” the unit to the ESA SSETI team at that time.

Future project plans for the SSETI Express project call for final integration of the complete spacecraft to be completed at a full SSETI team workshop being held at the end of November and for it then to proceed to “thermal, shake & vac” tests during December and January prior to delivery to the Plesetsk launch site for a May 2005 launch.

The AMSAT - UK S-band transmitter will be used to downlink 38k4 telemetry and image data during the early part of the mission. When this part of the project has been completed it is intended that

it will be switched to provide a single channel U/S FM transponder.

The transmitter also has its own simple, in-built, telemetry system to provide health check data and suitable decoding software is under development and will be released before launch.

ESA is also very keen for radio amateurs worldwide to be involved in the collection of all the AX25 mission telemetry data both at 38k4 on 2.4GHz and at 9k6 on 437 MHz.

Obviously a worldwide network of ground stations is something that is usually only available with a large investment. Nearer the time of launch further information will be made available concerning this important part of the project.

ESA will be awarding a prize for the amateur who provides the largest amount of this data to them. For more details of the SSETI Express project visit <http://sseti.gte.tuwien.ac.at/WSW4/> and click on “missions” then “express”. This site includes more than 120 photos of the integration process, detailed drawings, progress reports and a live webcam.



# THE CENTRAL COAST FIELD DAY

Wyong Racecourse Sunday 20th February 2005

*Traders*

Promote your products and expand your business at the biggest gathering of hams in Australia

*Amateurs*

Plan your trip to the most important event in the Ham Radio calendar

THE CENTRAL COAST AMATEUR RADIO CLUB INC.

For further information

Web: [www.ccarc.org.au](http://www.ccarc.org.au). Phone 02 4340 2500

email: [vk2afy@hotmail.com](mailto:vk2afy@hotmail.com)

## PCsat - still alive and active

This satellite has really had a chequered history over the last couple of years. It's been declared "dead" a couple of times but seems to bounce back.

This late notice from Bob Bruninga WA4APR indicates it is still usable with some constraints:

"PCsat is still fully operational on daytime passes and has been since 16 October. She is now just about back to maximum eclipse season with 33 minute eclipses every 100 minutes, but still working fine. As long as we remember to send her a keep-alive command at least once every 72 hours, we think she will remain healthy. So enjoy PCsat, but DO NOT OPERATE IN THE DARK. That will kill her batteries and probably cause a reset back to OFF for several months".

PCsat works just like a normal APRS digipeater but on a frequency of 145.825 MHz rather than the usual APRS network frequency and orbiting with an altitude

of over 485 miles rather than residing on a hilltop somewhere. The software responds to RELAY, WIDE and ARISS just as most APRS nodes do.

PCsat was designed and constructed at the US Naval Academy under the guidance of Bob WB4APR. PCsat2 is awaiting launch and is designed to take the APRS satellite experiment a further step forward. The shuttle is expected to return to flight in May 2005.

When launched, STS-114 will carry the external ARISS payload, PCSAT2. This will be carried on the backside of a Materials International Space Station Experiment (MISSE5), and will include 3 transponders, APRS Packet, FM Voice, and 10 m PSK-31.

A website detailing this project. "PCSAT2 - External ISS Experiment in the Amateur Satellite Service" can be found at: <http://web.usna.navy.mil/~bruninga/pcsat2.html>. Again - please

use caution when operating through PCsat. The eclipses are a real problem with the present state of the batteries and solar cells. Most tracking programs will tell you if and when a satellite is due to undergo a series of eclipses.

## GO-32 TECHSAT-1B

At the time of writing, the BBS on Gurwin Techsat -1B has been turned off for maintenance. Roni Waller, 4Z7DFC of Techsat-1B administration reported that the BBS would be off for some time and unfortunately as a result files would be lost. WiSP should allow users to easily recover from this situation but you may need to empty some directories and allow it to start again.

The currently operating satellite summary will appear in the February 2005 issue.

ar

# VHF/UHF - an expanding world

David Smith VK3HZ - vk3hz@wia.org.au  
Leigh Rainbird VK2KRR - vk2krr@telstra.com

## Weak signal

David Smith - VK3HZ

October was a fairly quiet month propagation-wise. On the morning of October 23rd, a high-pressure cell settled over central Victoria producing some enhancement. Joe VK7JG worked Peter VK5ZLX and Leigh VK2KRR, both on JT65b digital mode. Joe was a very good signal in Melbourne and managed several voice contacts without any problems. To the west, Garry VK5ZK also managed a voice contact to Nhill to Bill VK3LY and into Melbourne with VK3HZ. And that was about it for tropo openings.

## Auroral openings

On the afternoon of November 8th, a substantial auroral opening occurred following a mass ejection from the Sun. The opening was first noticed around 0400Z and it continued until well past 0800Z. A message posted to the VK-VHF Reflector seemed to bring out stations from near and far—all the more amazing given that it was a work day. On 2 m, there were many very strong signals, dogpiles on 144.1 and many contacts occurring simultaneously between 144.1 and 144.2.

Robbie VK3EK in Bairnsdale reports working VK3DOU, ZL3TY, VK3AJN, VK1ZQR, VK2BZE, VK2ZOM, VK4ZRT and JA8NAE on 6 m. On 2 m, he worked VK3UH, VK1ZQR, VK2BZE, VK3HZ, VK2EI, VK2TWR, VK2KRR, VK2UBF, VK2TWB, VK3KOS, VK2GKA, VK7MO, VK3KEG, VK3XPD, VK3CAT, VK3BJM and VK5DK. On 70 cm, he worked VK2BZE and VK2TWR. He reports hearing many more stations also.

Neil VK2EI at Port Macquarie reports that between 0420Z and 0520Z, when he had to go out, he worked VK3HZ, VK3EK, VK3DUT, VK2TWR, VK3KAQ and VK3UM.

Brian VK5UBC at Gawler reports that on 2 m, he worked VK3GOM, VK3UM, VK2KRR, VK3KEG, VK5DK, VK5NC and VK3HZ. On 6 m, he worked several VK3 and VK4 stations via aurora. He also worked Jeff VK8GF in Alice Springs.

Colin VK5DK reports that, despite struggling with a very sore throat and vocal chords (very hard to tell with

auroral contacts), he managed to work the following stations on 2 m: VK3HZ, VK3UM, VK3BJM, VK3BG, VK3KAI, VK3DUT, VK3UH, VK3DDU, VK2GKA, VK3KEG, VK3EK, VK5UBC, VK2KRR, VK1ZQR and VK3GOM. On 70 cm, he worked VK3HZ and heard VK2FZ.

David VK3HZ worked 23 stations on 2 m via aurora including: VK1ZQR, VK2KRR, VK3DUT, VK2TWR, VK2EI, VK3BG, VK3EK, VK2BZE, VK2TWB, VK7BBW, VK2UBF, VK7MO, VK2GKA, VK7ZOO, VK3KEG, VK2FZ, VK2FLR, VK5DK, VK3UM, VK3ZQB, VK5UBC, VK5NC and VK5ZLX. He also heard at least another 9 locals including: VK3XPD, VK3KAI, VK3KAQ, VK3DDU, VK3UH, VK3KOS, VK3BJM, VK3GOM & VK3AAU. On 70 cm, he managed to work VK5DK and VK2FZ. The Adelaide, Mt Gambier and Nimmitabel 2m beacons were all clearly audible via aurora.

Then on November 10th, from about 2130Z to 2300Z, and from 0700Z to 1000Z, more auroral openings occurred. These were weaker than those of the 8th, and fewer stations were on the bands. During these openings, Rex VK7MO ran test transmissions on 2 m for others to observe the behaviour of the Doppler

shift on his signal. Doug VK3UM, David VK3AAU and David VK3HZ all reported negative shifts of 300 - 400 Hz during the morning opening, and positive shifts of the similar magnitude during the evening. However, the shift would sometimes reverse polarity and the spread of the signal would vary. At times, multiple Doppler-shifted signals were observed with differing shifts. Towards the end of the opening, the shift seemed to cycle between positive and negative over a period of about a minute, before the auroral enhancement finally disappeared. Further observations are planned, when next we get an auroral opening.

## Spring VHF/UHF Field Day

The Spring VHF/UHF Field Day was held over the weekend of 6-7 November. In VK3, it was fairly quiet. I operated from home on 2 m, 70 cm and 23 cm and worked 27 different stations.

Not many stations were heard out in the field - only one "club" / multi-op station being VK3QM near Geelong - operators were Chas VK3PY, David



Gavin VK3HY at Mt Terrible during the Spring VHF/UHF Field Day

VK3XLD and others. Several other single-op stations braved the elements - Jim VK5OM/P3 (ex-VK3AEF, Nhill), Gavin VK3HY (Mt Terrible in central Vic), Ken VK3YDK (Neerim South), Peter VK2BIT (near Young), and Rex VK7MO (Mt Wellington). Radio conditions were flat - Roger VK5NY was worked, but with a struggle. Virtually no stations were worked from the west of the state / Mt Gambier, and east Gippsland was also very quiet.

There seemed to be several reasons for the low turnout. The most obvious was the weather, which was, in a word, appalling! It rained fairly constantly and was quite cold. A similar thing happened last year, if I recall correctly, where Gavin VK3HY had snow on Mt Terrible. The other main issue was that several Hamfests were also held over the same weekend, attracting many away from their radios. Hopefully, with the revitalised WIA putting efforts into a national events calendar, we can avoid such clashes in future.

## Beacons

Adam VK4CP has been working hard, adding features to the excellent VK/ZL Logger - <http://vklogger.brizwebz.com.au/> One feature that will be online by the time you read this is the Beacon Status page. This page contains up-to-the minute information on all VK/ZL VHF/UHF and microwave beacons and includes several fields of information that are not currently available from the Callbook or online. The Ident field contains the Ident type (CW/FSK), period and, for FSK, keying frequency offset (e.g. CW 60s, FSK +800 Hz 30s). A Comments field is available for noting things like actual frequency and any unusual keying arrangement (e.g. only keys for 12 sec on the 5 mins).

Another important field is the 6-digit grid locator for the beacon. A planned future enhancement is that, if you have entered your grid locator on the Oplnfo page, you will be given a customised display showing distance and bearing from your QTH to each beacon. The 6-digit grid locator is needed for accurate distance/bearing calculations - particularly important for microwave beacons.

Obviously, such a page is only as good as the information it contains. Therefore, people are encouraged to enter data on beacons, but please only do so for



Rod VK2TWR at Kings Cross near Cabramurra

beacons that you can currently hear, or for which you have current, first-hand information - data from an opening 6 months ago is of little use.

Roger VK5NY, on behalf of the VK5 Beacon Group, reports that Mark VK5AVQ has been busy upgrading the VK5VF beacons at Mount Lofty and also moved the 10 GHz beacon to a less-obstructed location. The old antenna (slotted waveguide) was not working well and was replaced with another built by Des VK5ZO in the change. The new location is perfect for microwave beacons with a clear horizon to the west towards VK6 and a good take off to the east towards Melbourne. The frequency does shift a little so tune either side of 10368.450. Field checks show a vast improvement to the east.

The VK5VF 1296.450 beacon at Mount Lofty at 8 W output should also provide good coverage. Once again the frequency is not spot on - currently it's about 2 kHz low. Plans are afoot to possibly Reflock the beacon, but time is always a problem.

The VK5VF 6 m beacon on 52.450 is currently off air. The PA has expired and will be fixed soon, when time permits.

Many thanks to Mark VK5AVQ (new beacon minder), to David VK5KK for all the previous construction work and to others for their component donations.

Please send any signal reports to Roger at [vk5ny@picknowl.com.au](mailto:vk5ny@picknowl.com.au)

## EME

The first leg of the ARRL EME contest was held over the weekend of the 9th-10th of October. Active VK stations included Trevor VK4AFL and Doug VK3UM, both operating on 70 cm. Doug reports that he worked a total of

36 stations over the weekend. "It was interesting that I was transmitting and receiving vertical into Europe and the USA as Faraday was almost 90 degrees and quite sharp. (Others with the more accurate measuring techniques confirmed this). All CW of course no loggers, spotting, or skeds. I ran out of time for stations that were present but hopefully will catch them in December. Activity down on previous years but much improved over previous months. Several new stations worked and a new country."

Another new face on digital EME is Ron VK6KDD. Apparently VK6 is fairly rare on EME, so Ron could find himself busy. Using only a single 12-element M2 yagi, Ron managed to work Joop PA0JMV on the 2nd of November. Unfortunately, Ron suffered some equipment damage soon afterwards but will be back trying for further contacts in the near future.

## 5.7 GHz band status

As mentioned a few months ago, the ACA has been evaluating a proposal to introduce apparatus licensing arrangements in the 5725-5825 MHz band that could allow greater opportunities for broadband wireless access services in regional and rural areas of Australia. The results of this ACA review have recently been announced, and represent a significant win for Australian amateur radio operators. Amateurs retain unencumbered access to the 5760 MHz band, which is currently used for weak signal applications. A proposal to use the amateur allocation for commercial services was rejected by the ACA.

Please send any Weak signal reports to David VK3HZ at [vk3hz@wia.org.au](mailto:vk3hz@wia.org.au).

# Digital modes

**Rex Moncur - VK7MO**

During October VK7MO undertook a DXpedition to outback VK5 and VK8 activating 14 grid squares and completing 5 EME (JT65) and 105 meteor scatter contacts (FSK441) on two metres. Contacts were completed on meteor scatter with VK1WJ, VK2AWD, VK2EAH, VK2FLR, VK2FZ, VK2KRR, VK3AFW, VK3AXH, VK3CY, VK3FMD, VK3HZ, VK3II, VK3KAI, VK4TZL, VK5DK, VK6AO, VK6HK, VK7JG, and VK8RH.

## 2 m & 70 cm FM DX

**Leigh Rainbird - VK2KRR**

Tropospheric Propagation was 'on the boil' in Queensland during October, and this was our main area of propagation. There were only a few tropo openings in the southeast to speak of and most were overshadowed by the significant activity happening in Queensland.

After keeping his eye on all the charts and indicators, Mike VK4MIK on the Atherton Tablelands, came across an opening on the 6th where he ended up working as far as the Hodgson Range repeater. This is quite a mountainous path and Hodgson is to the SW of Mackay. Also around the same time, Felix VK4FUQ at Ingham was working into the Mackay repeater and the Hayman Island repeater with almost full-scale signals. David VK4DJC on Hayman Island was able to hear Felix direct at times, but no simplex contact was completed.

Down to the southeast on the 9th, an opening saw signals passing between VK2, 3 and 5 on 2 m but nothing much on 70 cm. This was one of those openings where the signals had QSB and poor unstable signals. At VK2KRR signals peaked around 7 am with the higher repeaters around the Adelaide Hills being present at some time or other. The furthest repeater heard was VK5RLH in the central north at 833 km. Garry VK3KYF was heard working the Mt Macedon VK3RMM repeater from Mildura.

Good news for those looking for propagation indicators and an east west link, is that the Grampians VK3RWZ 146.950 repeater is now back into full steam ahead mode after being in a temporary state for a year or more. It is reported that the coax and antenna have been replaced. Reports of monster signals are now emanating from many miles around and I believe that before its

Stations seen but not worked on meteor scatter were VK3KQB, VK3ZYC, VK4CDI, VK6KDD and VK8GF. Typically 8 to 10 stations were worked in a few hours each morning. It was good to see all states and mainland territories participating.

As predicted by theory, meteor scatter worked well in the range 1000 km to 1800 km with contacts becoming very difficult above 2000 km or below 700 km. The data from the meteor scatter contacts was used

to demise a few years ago, it was worked by stations located in Western Australia.

On to 13th October, and a great long path was workable by some along the VK4 coast. Both Mike VK4MIK and Felix VK4FUQ were able to hop into a duct which dropped them off at Amy's Peak VK4RGA. Responding to the calls from the distant stations were not only Mike VK4JOO not too far away in Gladstone, but also an unexpected call in from Kevin VK4BXX, 371 km south in Toowoomba. The distance for Mike to the repeater worked out at a whopping 951 km! And for Felix a big 805 km. For Mike the 1000 km barrier was now in sight.

On the 11th, Karl VK7HDX was able to work 502 km across the water from Launceston to the Mt Macedon repeater on the north side of Melbourne where he caught up with Gavin VK3VTX. Karl mentions he could access a few other VK3 repeaters but no one was about to answer the call.

A very interesting report was received from Don VK6HK in Perth, relating to some very unusual conditions during 19th October along the VK6 coast.

In the morning of the 19th, Phil VK6ZKO in Perth first reported hearing Indonesian FM simplex signals across the 2 m band.

Glen VK6IQ and Don VK6HK (and maybe others) also copied Indonesian language (a female operator) traffic via the output of the Cataby 2 m repeater 147.200 in Perth around 0100Z and earlier. Glen 6IQ at Wandina northeast of Perth copied the signal on the repeater input. There was no indication that the DX operator copied or was even listening to the repeater output or input. Signals into the repeater suffered QSB but ranged up to noise free. Distance from the repeater site

to compare the performance of a small 2.3 wl yagi and a 6 wl yagi. While it was not apparent at the time, a detailed analysis showed that at distances below 1650 km the shorter yagi is to be preferred because of its greater beamwidth, but that the longer yagi has an advantage at distances beyond this.

Please send any Digital Modes reports to Rex VK7MO at rmoncur@bigpond.net.au.

to the most likely origin of Indonesian signals is 2700 km and to VK6ZKO is 2850 km. Unfortunately no AR related transmissions or callsigns were heard.

The Indonesian activity on the VK6RCT repeater was repeated again in the evening with the reappearance of Indonesian transmissions albeit at reduced strength. As far as is known, these signals are the first reported Indonesian based signals on 2 m into Perth.

The big VK4 tropo boil over occurred on the 25th with Mike VK4MIK reporting some big distance along the coast. The best ones being to Amy's Peak at 951 km; Springsure at 793 km; Gympie at 1231 km; Bundaberg at 1118 km and Hervey Bay at 1151 km. Well done to Mike for breaking the 1000 km barrier to several sites.

Also during this significant opening, Wayne VK4ZRT in Gladstone was able to work the Cairns repeater and speak to some of the locals over a big 954 km path. Wayne also took part in the big one, where he spoke to VK4MIK through the Gympie repeater which is 310 km south. Wayne worked Wal VK4AIV in Mackay on FM simplex which is 367 km and also found the Hodgson Range 438.500 repeater at 350 km.

Felix VK4FUQ also stepped in on the action and made it to Amy's Peak at 805 km; Hodgson Range at 491 km; and Springsure at 639 km. Felix could hear Rockhampton at 694 km, but could not access.

There was again an opening on the 28th where similar areas were worked, but not quite as extensive or as easily as was found on the 25th.

Please remember to send through any 2 & 70 FM DX reports to Leigh VK2KRR at vk2krr@telstra.com.

ar

# Beyond our shores

David A. Pilley VK2AYD  
Davpil@midcoast.com.au

My apologies for no "BOS" last month, but your scribe was beyond our shores visiting with friends around the globe. I'd like to share a few of subjects I discussed with other Radio Amateurs.

## BPL vs WiFi

Living in rural Australia I don't get so involved with new technologies that are used from day to day in the major cities. Over the past year there has been much concern on the effects of power line communications using broadband HF radio and the effects it could have on amateur radio frequencies. Tests have been carried out here in Australia and world-wide. The effects have been quite devastating with HF radiation reaching intolerable levels. I had no idea of the level of use of WiFi in the USA until I attended a 300th birthday party for the house where Dick, W4AOP and Meredith, W4AMK live. Their home that was built in 1704 during the William Penn era is located in a beautiful 50 acre setting in Bucks County, Pennsylvania. As there were some 40 radio amateurs amongst the 240 guests that were attending the celebration, 20 of which were in motor homes (RV's), Dick, W4AOP, provided a WiFi system that covered 100 metres radius from the main house, which provided 24 hour Internet access. What shocked me was the speed of the system to which it was connected, 54 Mbps. Yes 54 Mb. (I thought of my old dial-up system back home which, with luck and good weather I can reach 33 kbps). Around a social evening of the amateurs we discussed BPL and WiFi. The consensus was BPL, from a scientific point of view, has to be investigated, but no one saw any future for it, other than switching on lights around the town. Not a very helpful comment, especially with the FCC and ARRL deeply engrossed in discussions and our own WIA and ACA endeavouring to finalise specifications. Wherever it is tested it should be closely monitored for interference radiation.

WiFi was considered the in-system. In Spokane, Washington State, WiFi covers over 220 square miles. I read in the newspaper that Philadelphia was offering free WiFi for 1 mile radius of the CBD and hoped to cover the entire city

by 2006. I was later up state at Hanover, the home of Dartmouth College and at lunch time saw all the students sitting around in the park with laptops, directly connected to the college WiFi system. I found other friends that had children with their individual laptops also had WiFi fitted in their homes. It seemed to be everywhere. Here in Australia we already have WiMax that operates on 3.43GHz and is said to cover an area of 2,000 sq.km. The way ahead is wire-less – let's hope they have one worldwide system that is compatible to all.

## Frequency congestion

No, I'm not talking about 80 metres! A dear friend of mind, Jay Gerber, N3AW, is a legend with NFL Films. Amongst his responsibilities, Jay is involved with frequency congestion at football games. For example at the Super Bowl there are over 1,200 channels of communication in use. They need to be co-ordinated. In American football the Coach has direct communication by wireless with the Quarter-Back. You can imagine the Coach telling the QB where to pitch the ball when a voice pipes in and says "one hamburger – hold the pickles". No it hasn't happened, but it could!

In the U.S.A. each big city/region has a volunteer frequency co-ordinator who is a member of the Society of Broadcast Engineers. Many of these are Radio Amateurs. They are responsible for co-ordinating broadcast frequencies in a given area, however, there is no one who co-ordinates the entire spectrum. Here is where the Football League ran into problems and special frequency co-ordinators were created. Their interest is from DC to light! They are not interested in licensing or whether a station is legitimate (that is the responsibility of the FCC), their prime concern is to ensure there is no frequency clashes and to help everyone do their job. It didn't sound too hard until Jay explained that weeks before a big game they have to investigate all the frequencies that were already being used by public and commercial services in the immediate area. It is no good the TV outside broadcast turning up and finding their crystal locked frequencies

were already occupied. I was amazed to learn the Chief Coach may have an 8 (or even 16) channel transceiver to talk to the Side-line Coaches, Quarter-Back, etc. Those helmets the QBs wear are full of electronic gear!

I realised that our Football games were nowhere as sophisticated as the U.S., however I did wonder who co-ordinated the Olympics in Sydney. There must be a story there?

## Saudi Arabia

### HZ1AB permanently QRT

The Dhahran Amateur Radio Club has been permanently shut down. This, as the result of telecommunications regulatory changes in Saudi Arabia.

For close to sixty years the Dhahran Amateur Radio Club operated station HZ1AB. Club Secretary Thomas Carlsson, AB5CQ reported that due to revisions made in Amateur Service licensing requirements by the Saudi Arabia Communications and Information Technology Commission, operations were no longer possible.

The HZ1AB callsign has already been reissued to Bandar Salah Al Harby. Carlsson says that the clubs QSL manager, Leo Fry, K8PYD still has all the logs and will process any outstanding QSL card requests.

(WIA News)

## Great Britain

### UK Amateurs Gain 7.1 - 7.2 MHz from 31 October

Ofcom and the Radio Society of Great Britain announced on October 29 that all necessary procedures required for early access to the 7.1 to 7.2 MHz spectrum for all UK radio amateurs have been finalised and that access is allowed from 0100UTC on Sunday 31 October 2004. Early access is granted on a Secondary (non-interference) basis using a maximum of 26 dBW (400 watts) PEP for Full licensees, 50 watts for Intermediate and 10 watts for Foundation licensees.

Notices of Variation for the Foundation, Intermediate and Full licences have been published on the Ofcom website. It was recommended that for the time

being all UK amateurs use only voice and Morse code modes between 7.1 and 7.2 MHz. Band planning issues on 7 MHz will be kept under regular review and will be dependent on the number of administrations granting early access to this band prior to full Primary access on 29 March 2009.

## Great Britain

### First store and forward in UK

Word from the United Kingdom that its first unattended 'store and forward' single frequency voice relay has become operational. It was switched on at 13.30 UTC on Saturday October 16th on 70.4375 MHz in the European 4 metre band. Its call sign is M-B-7-F-M and it has a maximum 'store' time of 120 seconds. The installation is located in the Chiltern Hills with 10 dBW Effective Radiated Power from a dipole antenna 32 metres above ground.

(GB2RS)

## The future

### Scientists predict early solar minimum

And some possible good news for hams tired of the rather poor High Frequency band conditions these days. It comes from the GB2RS News Service, which says that American physicist David Hathaway believes that the next solar

minimum could arrive sooner than previously predicted.

GB2RS News quotes on an article on the 'Science at NASA' website. It predicts that the next solar minimum could occur in late 2006. That's about a year earlier than previously thought Dr. Hathaway bases his prediction on data from the last eight solar cycles, which show that solar minimum follows the first sunspot-free day on the sun by 34 months. In this solar cycle, the first spotless day was on 28th January this year and more recently, on 11th and 12th October, there were two more spotless days.

Hathaway goes on to state that the next solar maximum might also come early. He is quoted as saying that solar activity intensifies rapidly after solar minimum. That in recent cycles, the Solar Max has followed Solar Minimum by just four years. If that is the case, the next solar maximum could be not all that far away in 2010 and a Solar Max is good news for D-Xing.

(GB2RS)

## Great Britain

### 500 kHz proposal

The Radio Society of Great Britain (RSGB) has proposed allowing radio amateurs in the UK to operate either 501-504 kHz or 508-515 kHz at a power of 10 W EIRP. "The allocation, if accepted, would

extend amateurs' experimental work on other low and medium frequencies and thus aid understanding of propagation in those parts of the spectrum," the RSGB said. The RSGB proposed the two band options since they are no longer used for maritime telegraphy in the Western Hemisphere, their usage for non-directional aeronautical beacons is being phased out and the frequencies also are not likely to be reallocated to another service anytime in the near future. The Wireless Institute of Australia (WIA) recently announced plans to request the Australian Communications Authority (ACA) to establish an experimental amateur allocation at 500 kHz. The RSGB says its proposal was drafted in consultation with the International Amateur Radio Union (IARU) Region 1 500 kHz Working group, formed following World Radio Communication Conference 2003 (WRC-03) by the RSGB and chaired by the Union of Belgian Radio Amateurs UBA. The Working Group includes representatives from all three IARU regions. The IARU also favors a worldwide Amateur Radio band at 135.7 to 137.8 kHz and is seeking support for such an allocation at WRC-07. Further details of the RSGB 500 kHz proposal are on the RSGB Spectrum Forum Web site <<http://www.rsgb-spectrumforum.org.uk/mf.htm>>.

(ARRL N/L)

ar

---

## Over to you

### Receiving and transmitting on low frequencies

I had a low frequency transmit licence for 11 years and with that did a lot of listening. I have also held an experimental licence AX2TAR.

I was able to use 1 kW from my QTH in Moonah, Southern Tasmania. The aerial was a 35 foot mast. During the daytime this set up was able to put a ground wave signal into Melbourne. The morse signals were picked up by Drew Diamond VK3XU, Greg Wamback, VK3CN both in Melbourne and Graeme Zimmer, VK3GJZ in the Latrobe Valley using Loop Stick antennas. Signals were also heard in other parts of VK3, VK5, VK7 and in New Zealand ZL. Code at 12

wpm was preferred by most listeners.

I also used SSB and with 17.5 db of RF clipping to put some body into the signals was copied in VK3, VK7 and ZL. When propagation was not the best CW could be copied when SSB could not.

The biggest challenge was working New Zealand amateurs other than Bruce ZL1WB who had a very good transmitting aerial. When I just wanted to listen to New Zealand amateurs on 181.4 kHz CW, I would go 2/3 the way up Mt Wellington and lay 200 feet of wire along the road side. I would resonate this to 181.4 kHz, amplify it and feed it into my FRG-100 receiver, run from

the car battery. I built a unit that would plug into the phone jack of the FRG-100 resonant at 600 Hz with 50Hz bandwidth and a LM386 amplifier, which drove a loudspeaker. This unit was able to pick the CW from the noise, which was 10 db above it.

I have also been able to copy 138 kHz SSB at this location from Quartz Hill in New Zealand.

Hope this might inspire some of you to try LF.

Robert Milne VK7ZAL

## The copper loop for 70cm

Note 1 inch = 25.4 mm

In May 2004 Amateur Radio, we reprinted a description of an all copper folded loop antenna for 2 metres by Dick Stroud, W9SR.

In QST for July 2004, Dick adds 220 and 440 MHz to his range of copper loop antennas. In this abstract however, we will only consider the 440 MHz version. As before, this antenna can be constructed using standard copper water pipe and fittings available from your local hardware store or building supplier. The 440 MHz antenna is made of 1/2 inch tubing. As a slight change from the 2 m antenna, copper fittings are used to adapt the antenna to 1/2 inch standard pipe thread for mounting.

The dimensions and cutting lengths are shown in Figure 1. As mentioned above, all of the copper, brass and stainless steel hardware should be available from hardware, plumbing or specialist suppliers. The teflon material should be available from most specialist plastic suppliers.

As before, it is necessary to solder all of the components together, but it is

not difficult. The ends of the tubing are first cleaned with steel wool and a thin layer of flux is added before assembly. It is an advantage to make an assembly jig out of plywood or similar material. The individual elements are then wired to this jig to keep them in the correct relationships. Heavy aluminium foil or sheet should be mounted between the ply and copper to prevent any accidental bonfires occurring during the soldering. When using the propane torch, the tubing should be brought to temperature before solder is applied.

Normal rosin cored solder can be used. If the copper is hot enough, the solder will be 'sucked' into the joint. Excess solder can be filed off when cool. When complete, any remaining flux should be removed and the copper can be polished using steel wool. The finished antenna can be sprayed with clear Krylon 1301 to preserve the finish. Alternatively, the

antenna can be painted with an acrylic spray. Either way, be sure to mask the front and back of the connector along with the exposed parts of the gamma rod before painting.

The shape of the antenna is chosen so that the 50 ohm point on the tubing wall is roughly in line with the centre of the type N fitting. The 1/4 inch gamma tube is placed through a hole on the inside wall of the main tubing and soldered into place, as per Figure 1. This tube goes all the way in until it hits the outside wall of the tube. The length of wire in the gamma tube is critical as it forms part of the gamma capacitor. The 14 gauge wire used is stranded and vinyl insulated. The combination of the tube, teflon sleeve and length of wire form the tuning capacitance. At 440 MHz, this amounts to about 6.4 pf. The wire and sleeve should both be snug fits.

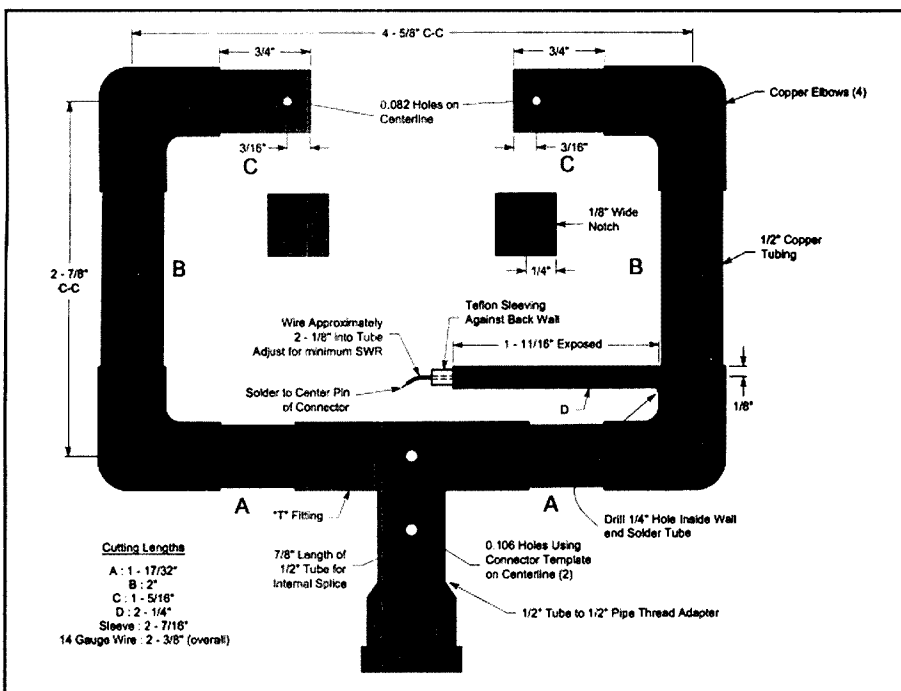

Figure 1 – Construction details for 440 MHz antenna

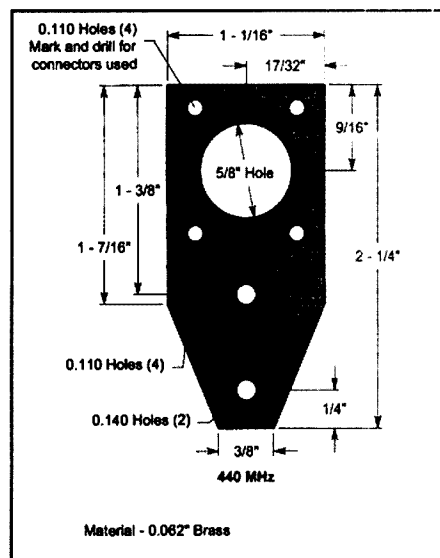

Figure 2 – Construction details for feed connector bracket

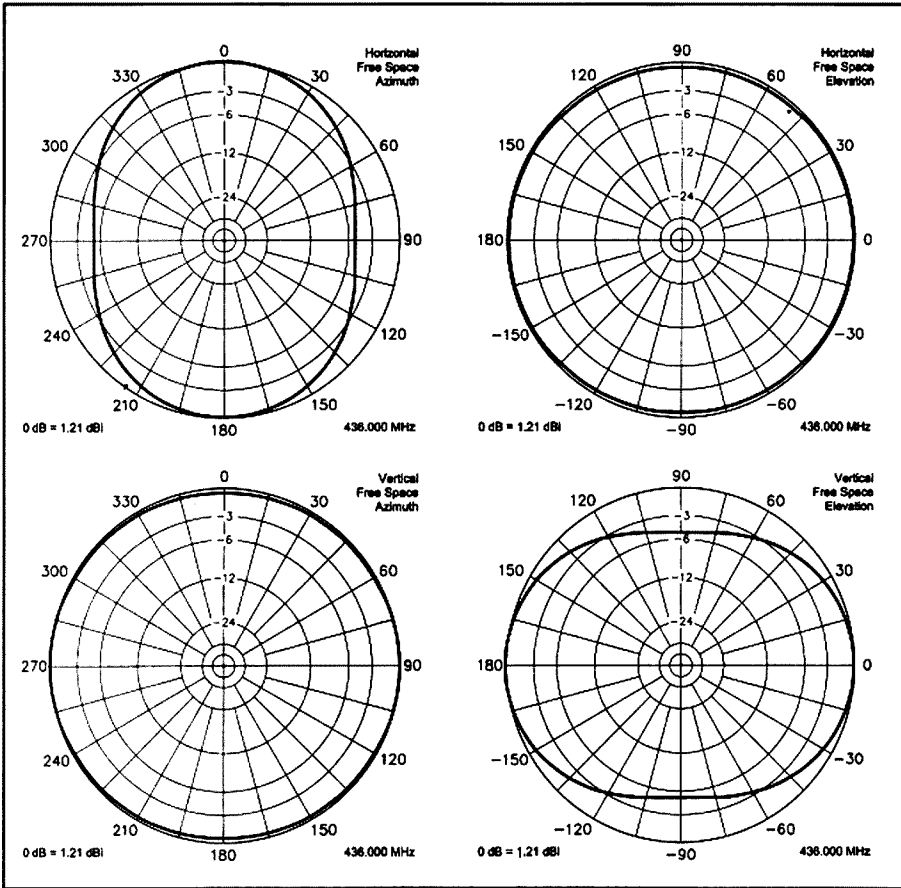

Figure 3 – Azimuth and elevation patterns for both vertical and horizontal polarization modes for 440 MHz antenna

terminations should be sealed against moisture penetration.

All testing should be done with the antenna at least 6 feet above ground and clear of any metal objects. Typical VSWR at resonance is less than 1.2:1. The power handling capability of the antenna is limited by the connector and should be at least several hundred watts at this frequency.

The centre frequency of the antenna can be adjusted from 428 MHz to 452 MHz. All tuning adjustments should be made by moving the two end caps, symmetrically relatively from the copper elbows. After adjusting the end caps to frequency, hold them in place with small stainless steel self tapping screws

The 2:1 VSWR bandwidth at 440 MHz is 11 MHz, making the antenna attractive for wideband applications such as ATV.

Polarization can be chosen by arrangement of the elbows and pipe fittings. For horizontal polarization, the antenna can be simply supported on a ½ inch threaded mast. For vertical polarization, the antenna should be mounted with the open side in the vertical plane. In this case, the support mast should be non-metallic to avoid detuning the antenna and upsetting the pattern. The cable should be routed back and away from the active part of the antenna. The azimuth and elevation patterns for both horizontal and vertical polarization are shown in Figure 3.

ar

Figure 2 shows the outline of the connector mounting plate. It is made of 0.062 inch, or similar brass stock and is attached to the copper antenna with two #6 x ½ inch stainless steel, self tapping screws at the points shown in Figure 1.

The connector used is a type N, panel mount (UG-58/U). It is attached to the plate with suitable sized screws, lock washers and nuts. All hardware should be brass or stainless steel to prevent corrosion and the connectors rear

## Silent key

### Moira Millgate VK8NW

Moira died in the Old Timers Nursing Home in Alice Springs, on October 4th.

Not a lot is known about Moira's early days, except that she born in about the year 1915.

In World War II, she served in the WRANS, (at HMAS "Harmon"), as a signal officer, intercepting signals for Intelligence purposes:

One of her duties was to copy overseas radio broadcasts, for the Australian Intelligence section to analyse.

She learnt the Japanese Kana "Morse"

Code (all 80 characters of it!), so that she could intercept Japanese military transmissions.

Moira was fluent in French, Russian and German.

Theo (VK4MU), who used to run a Sunday morning net, told me that she sent beautiful CW. She was PMG (now Telstra) trained, and sent at about 25 wpm with perfect quality.

Her Adelaide contact was Bill Trezise, VK5RA (SK).

In 1983, she obtained her amateur

radio licence, and joined ALARA in 1986.

She was laid to rest beside her husband, Geoff, on October 19th.

Thanks to those who helped me with this information: Theo VK4MU and Christine VK5CTY in particular.

I am interested in further details concerning this lady, and would appreciate any material.

Please e-mail me on dellio2@bigpond.net.au, or write to me, QTHR any callbook.

John Elliott. VK5EMI

ar



# New ADSL modem

## The continuing saga of getting broadband ADSL

Will McGhie

**Three days after deciding to cut my loses with the USB ADSL Modem and ordering the ADSL Ethernet Router modem, it arrived.**

This modem uses a separate power source (mains) and you can connect up to four computers to the modem via the network connector from your computer. Also this modem does not use software, all is contained within the modem. All that is required is to connect the modem to the network card and it should work. There are few configuration requirements; the main one is "obtain an IP address automatically." If you are installing the modem on a new computer, which has not been set up for a particular ISP, then you have to do the usual mail etc setups.

This type of ADSL modem, when powered up, connects to the Internet automatically when you turn your computer on, and stays connected until you turn your computer off. It really does work well, but mine did not connect to the Internet! Part of the setup is to go to a particular Internet URL and do the ISP setup via a wizard that talks you through the ISP's requirements, such as user name, password and mail. My computer was already setup due to my dial up and this was not required. However trying to go to any Internet site did not work. It did not take long to figure out that the modem was not connecting.

A phone call to my ISP resulted in all sorts of things being tried. The modem was working okay, as my ISP could see my connection, but the computer would not allow a connection between it and the modem. The situation got worse as we worked through all sorts of possibilities and even got to the point that my dial up modem would not work! Even Internet Explorer and Netscape would load and then crash. Also my anti virus software (Vet) on boot up would bring up a warning saying, "network error." (This turned out to be important). One fundamental problem that was found was the IP addressing of the modem, for reasons unknown, would not keep an IP address and would just

go back to all zeros on a computer re-boot.

To cut a long story short, after two hours the ISP person I was talking to said a reformat might be the only option! However, he did offer to put me through to the department that handled the hard ones, and this was now well into the hard basket.

The Technician I was now talking to went through all the basics and eventually established a connection between the computer and the Internet at a basic level. He was also able to get the IP addressing of the modem to work. Just how a lot of this happened is too lengthy to describe here but progress was being made. However the browsers (both Explorer and Netscape) continued to crash when loaded. Eventually he made the suggestion to un-install my anti virus software, Vet. This was done and it all worked! For reasons unknown Vet was preventing the correct operation of the computer port that allows access to the Internet. Vet had either configured itself wrongly or had become corrupted.

Just what had been the problem or problems who know? All sorts of things had been tried including the suggestion that the original installation of the USB ADSL modem had screwed up the computer. After two weeks and about eight hours in total on the phone, ADSL was up and running. I did learn that there were a lot of programs on my computer that I had no recollection of putting there, along with various popup and suspected spy programs. I

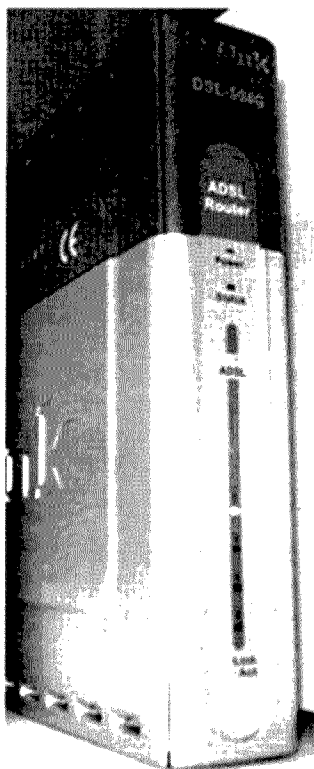

run updated anti virus and have an anti spy program as well but even better checking would be a good idea.

One way to find these programs is to go to the install-uninstall program icon in the control panel and work through just what programs are there. Delete what you don't think should be there. Also go to msconfig via the start, run box and have a look at startup to find out just what is being loaded on startup. My ISP person was asking me to list all these programs and checking on the Internet just what these programs were. Many were deleted!

May I say that my ISP was most helpful and patient in getting my ADSL up and running. Sure that is their job but they were prepared to stick with it, and lets face it computers are complicated and there can be a dozen reasons why a particular problem occurs. Finding the problem can be very difficult, at least for the know a little bit about computers person. How the average person with little or no computer knowledge sorts these problems out I have no idea.

**15 & 16 January, 2005**

**Summer  
VHF Field  
Day**

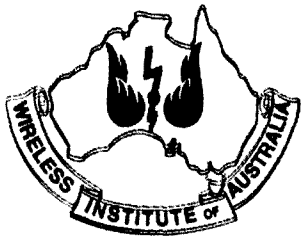

# WIA welcomes new members

## June July

Owen DUFFY	VK10D
Brenton J MEADOWS	VK5SZ
Marcus ROBINSON	VK2BUA
Earl R RUSSELL	VK3BER
Maxwell D STARK	VK3VI
I J CHRISTIE	VK2ZIC
Kevin FLEMING	L41082
Paul JAMES	L41081
Steve G LEATHEAM	VK2BGL
Raymond STUART	VK4YRS
Sam ADCOCK	VK5KSA
Peter CLEE	VK8KZZ
Eric R GRAY	VK3ZSB
Mark GUEST	VK5HBI
Charles M LEAHY	VK2SYD
Ata MEHMET	L21213
Terrence THOMSON	VK8TT
Bill PETERS	VK2ATP
Anna GERBER	L41083
Robert E RANDELL	L10186
Mark BOWLES	VK2SMB
Dylan CATOR	VK3JWC
John A HARRIS	VK2FAD
Peter ILLMAYER	VK2YX
Vic R MACDONALD	VK4CA
Neil T PEAKE	VK5NTO
Dallas L EICHNER	VK5HBH
Gary E NEILSEN	VK4KNE
Maurice O'KEEFE	VK3KO
Chris DIMITRIJEVIC	VK3FY
Ian R AMPT	VK3IV
Gary CROTHERS	VK4CUZ
Frank R GLUZIK	VK3UBU
A R BLAKE	VK2ALF
Rhett DONNAN	VK3HAP
Julian DRYDEN	VK2TED
Ken MOORE	VK4AKM
Michael C PATTERSON	VK4MIK
Cameron STRUBLE	L41084
Jack I SWART	L21215
C J READING	VK7ZCR
Chris EDMONDSON	VK4AA
Leslie A HING	L21216
Martinus VAN BLADEL	VK3MF
Stuart BRAUNHOLZ	VK7NXX
Mike YOUNG	VK4TMM
Andreas FASETH	VK5HAF
Peter B HARDING	VK4JPH
Simon RICE	VK8ZJZ
Jack DYER	VK2TI
Gene SPINELLI	K5GS
James H SHILTON	VK3ZRG

## August

Nicholas D FISHER	L21217
Nicola SIGNORILE	VK6BOS
Tony STONE	VK2TS
Harvey L WICKES	VK4AHW
Derek T STUBBS	VK5PAV
Sandra HAND	VK2LSH
Neville R BLYTH	VK1HNB
Paul GALE	VK5ZKG
Lance W HAYWARD	VK6TZ
Sasi NAYAR	VK5SN
Richard PIPE	VK5USB
Rodney RUSH	VK4RA
Robert WAEGELE	VK4TWR
Richard A PHILP	VK3ZRP
Chris G SPIKINS	VK6HCS
Graeme P TREMELLEN	VK3GPT
Keith ANGELL-JOHNSON	VK3TMW
Luke ENRIQUEZ	VK3EM
Michael THORNE	VK3BKK
John THURSTUN	VK2DX
Francis WEBER	VK2XVJ
Peter M WHITE	VK2YPW
Eddie J COPPINGER	VK4EDI
Ronald F CROUCHER	VK4CRO
David CUTHBERT	VK4YNM
Richard J LAMMAS	VK4NRL
Patrick J O'DOHERTY	VK2DPO
David POTTER	VK7HAH
Leon POWELL	VK4KLL
Peter RICHARDSON	VK4TAA
Christian A RYALS	VK2NGC
Frank RYAN	L50375
Michael STRUIK	VK1TMS
Wayne E STAPLES	VK4XAR
M BEACHAM	VK3XXX

## September

Lyn BATTLE	VK4SWE
Les R JORDAN	VK3TJ
David MAYER	VK2HMD
John PRELLER	VK1HAJ
Ian CLAYTON	VK5AIC
John JAMES	VK4CMA
K C SELVADURAI	VK3EVG
Michael H BAKER	VK6ZEB
Lorne BONNELL	VK4TLB
Renato LANGERSEK	VK4TNT
A J MCLEAN	VK2KCE
Robert J MCMANUS	VK2TVC
Alan K POTTER	Q360236
Stanley J SONTER	VK2HEL
Raymond H WALES	VK3RW

John HOWLETT	VK6ZN
Glynn HUGHES	VK5GP
Angus MCDONALD	VK4HGP
Roy C STEPHENS	VK4ARS
Willem BEIMERS	VK4KPB
James W MILLER	WA2UMP
Tom SAMDERS	VK2XAU
David P WALSHAW	VK5HDW
Doug WATERSON	VK4HY
Tony H DAWSON	VK1TGX
William TWEEDIE	L21219
Denis A COOPER	VK4ACE
Greg COUZIN	VK2ZGC
L J MOSS	VK3CLJ
David MUNN	VK4BDJ
Chris O'BRIEN	VK3HGX
Glenn PIERCE	VK2TEX
Andrew SAYERS	VK2AES
Steven SHELLY	L31590
Michael TAYLOR	VK4XT
Dale CAVIES	VK5DC

## October

I G PRYOR	L21220
Robert J MOTTLEE	VK4HAY
D DEVENY	L31562
Garry B BRIANT	VK3KYF
Robert FERGUSON	VK3FPJ
Klaus-dierer ILLHARDT	VK3WWR
Malcolm MACFARLANE	VK3JPS
Andrew ALBINSON	VK6XAA
Brad LARDEN	VK2YYX
Mark J SWANNACK	VK2HMJ
Karsten THOLE	VK5ZKT
R J BUHRE	VK4AIM
John MORRIS	VK2BES
Ken A THOMSON	VK2BQT
David WESCOMBE-DOWN	VK5BUG
Kevin PURVES	VK2KEV
Gianmario DOLFEN	VK3NI
John R GARDNER	VK7ZZ
Robert L LEANE	VK2ZLV
Gary D R PEARCE	VK2TWH
A J PIN	VK2HXX
Hamish ROUSE	L31592
Ronald K TURPIN	VK5BRT
Victor J PIGGOTT	L31591
Anthony VAN VUGT	VK1VM

# Propagation by the light of the silvery moon

## Lunar tidal influence on the ionosphere

Bill Isdale VK4TWI

Twice a day the tide rises and falls, in most places so slowly that we don't take much notice of it but in some places the shape of the coastline channels the water into a fast flow or a rapid rise and fall. So much so that the energy is increasingly being put to work to generate electricity from the energy that would otherwise just slip away.

What is the rise and fall of water, a fluid that lends itself to smooth movement, responding to?

Gravity, of course. The Earth's relentless gravity is pulling water down from where it may fall as rain towards the lowest point. The low parts of the surface of the Earth fill with water under the constant pull of the Earth's gravity.

Why is it rising and falling so regularly that tide times are reliably predicted and published with no apology that they may not be absolutely correct? Because the tide is produced by the gravitational pull of the moon, the orbit of which has been studied exhaustively and which is known in the finest detail.

Well, almost.

The clockwork universe that Sir Isaac Newton described with his law of gravitation in 1687 suggests planets running on invisible tracks in pleasing regularity, and many models of that have been built.

The simplified model, convenient for illustration, represents a system where a mass is thought of as a point source of the gravity that an object of its mass has. A small rocky planet will be proportionately more massive than a ball of gas.

This has not been a problem in practice and Newton's physics has served well enough for calculating the movement of the Earth, the moon and a spaceship for manned journeys to the moon. Everything has gone as predicted by Sir Isaac three centuries before we had the hardware to put the maths to that particular test.

But our observation of the tides at the seaside shows that the Earth is not a solid object, water on its surface is moving up and down as the gravity of the moon pulls upon it.

Less obviously, the land on which we stand and build our buildings is being distorted under gravity, pulled up by the Moon and, when it has gone by, back down by the Earth's gravity. The movement is slight but quite real.

On a larger scale, the Sun and planets exert their gravitational influence on each other. The law applies to every material thing in the universe and everything attracts any other thing with a force that varies directly as the product of their masses and inversely as the square of the distance between them.

To take an example, Jupiter a massive ball of gas, orbits the sun and its gravity pulls on the sun inducing a velocity in it

of about 12.5 metres per second, moving the Sun, relative to the centre of mass of the solar system, 800,000 kilometres, a little more than half the diameter of the Sun, as Jupiter and the Sun orbit around their mutual centre of mass. They are thought of as point sources of mass for the purposes of calculating their motion due to gravity but as big balls of gas they are being distorted as they are pulled towards each other by gravity while their momentum keeps them moving on their orbit, in a more or less stable condition.

Our Earth, much less massive, still has its influence and produces a velocity shift of 1 metre per second in the Sun, moving it by 450 kilometres a year relative to the centre of mass of the solar system.

Our atmosphere, fluid like the oceans, is deeper but more diffuse. It is pulled to the surface by gravity and rapidly thins with altitude so much so that a good sized mountain may take the intrepid climber high enough that lack of air at sufficient pressure may be a life threatening obstacle.

At great heights, between 50 and 200 kilometres above the surface, where the ultraviolet light from the Sun breaks the

molecular bonds of the gases and creates charged particles, ions, gravity is still at work. The ionosphere is reflective to radio waves at certain frequencies, about 1 to 30 Megahertz, and this phenomenon is convenient for long range radio communication.

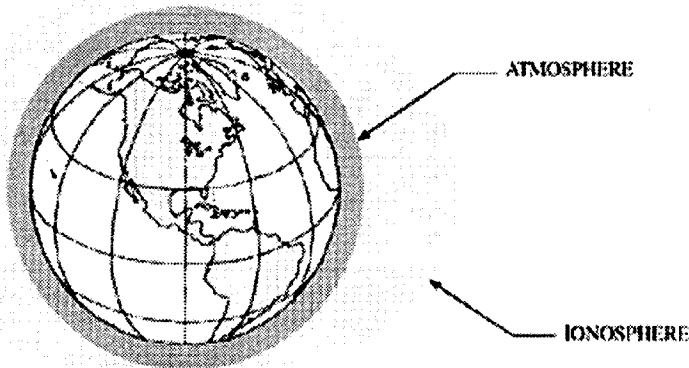

The solar cycle, waxing and waning over about 11 years, has been a useful indicator of radio reflectivity of the ionosphere. The Sun at the peak of its cycle, identified by the maximum number of sunspots visible on its surface, emits 2 to 2.5 times the intensity of ultraviolet light than at the trough of the cycle.

That gross indicator of the condition of the ionosphere is not the only indicator. Gravity has a part to play as well since the ionosphere, part of the ocean of air, is tidal just as the oceans of water are.

What this means for radio propagation via the ionosphere was considered by Harlan True Stetson (yes) Ph.D. Research Associate at the M.I.T. where he was the Director of the Cosmic Terrestrial Research Laboratory.

In his 1947 book, *Sunspots in Action*, published by The Ronald Press, New York, Stetson wrote that as far back as 1913 the London Electrician had published articles on the relation of wireless reception to the phases of the moon. He noted that in 1934 the distinguished scientist and radio engineer E.V. Appleton came to the conclusion that "with the passing of the moon about the earth there was a semi-diurnal variation of one whole kilometre in the height of the ionosphere."

Dr Stetson went on to note that he, Appleton "came to the conclusion that his observations indicated an ionospheric tide at the level of the E layer nearly six thousand times as great in magnitude as that indicated from the barometric pressure changes observed at the earth's surface."

Dr Stetson placed the E1 layer at about 100 km and the E2 layer at about 150 km altitude.

The good doctor considered the possible mechanism behind enhanced ionospheric propagation to be the Sun's rays falling on the moon and causing the emission of energy from its surface. He was looking to find something more significant than moonlight on the ionosphere as moonlight, he pointed out, is only 1/300,000 the intensity of sunlight, so he made something up.

There is however a more simple explanation.

William of Ockham, born in 1285, gave his name to the principle of applying the simplest hypothesis, Ockham's razor. There is no need to, and no excuse for, postulating some unknown thing

to explain what is observed if it can be accounted for with a more simple explanation. An example for present purposes is that some mysterious lunar radiation is not called for to explain the improved radio reflectivity of the ionosphere when the moon's gravity will serve quite well to explain it.

The solution which I am suggesting was within Dr Stetson's grasp. He wrote, "It may be possible that even a small change in the distribution of ions can make a very large change in the intensity of the field of the radio wave received over a considerable distance."

He considered Appleton's observations of the tides in the ionosphere but did not close the ring he was building around the problem with the conclusion that the moon's tidal influence on the ionosphere was pulling a lens-shaped tide of the ionosphere along behind it and this, or the smoothing effect of its passing, is enhancing the mirror-like quality at radio frequencies which is so useful for radio wave reflection.

Dr Stetson observed maximum field strength on the path he was measuring, from a medium wave commercial transmitter in Chicago, when the moon was at 11 days and again at 23 days

into its cycle of waxing and waning. He thought in terms of the sunlight falling on it but not in terms of what that much illumination of the moon's surface indicates, its relative position to the observer on the surface of the Earth and hence the position of the ionospheric bulge and smoothing effect in relation to the path of the signal being reflected.

This explanation for the observed phenomenon does not depend on strange rays yet to be discovered, only on well tested gravitation. It is able, as any hypothesis, which claims to be scientific, must be, to be tested and falsified if incorrect.

The necessary astronomy to know the position of the moon is readily accessible and signals which can reach the observer on a path via the tidal ionospheric bulge or the smoothed ionosphere behind it can be measured until the optimising effect, if real, appears. It may be on days 11 and 23 or some other days. It would be necessary to conduct a test for a significant period to see if a pattern emerges out of the "noise" of random variations.

Time and tide will tell if a real effect on radio propagation will be found by the light of the silvery moon.

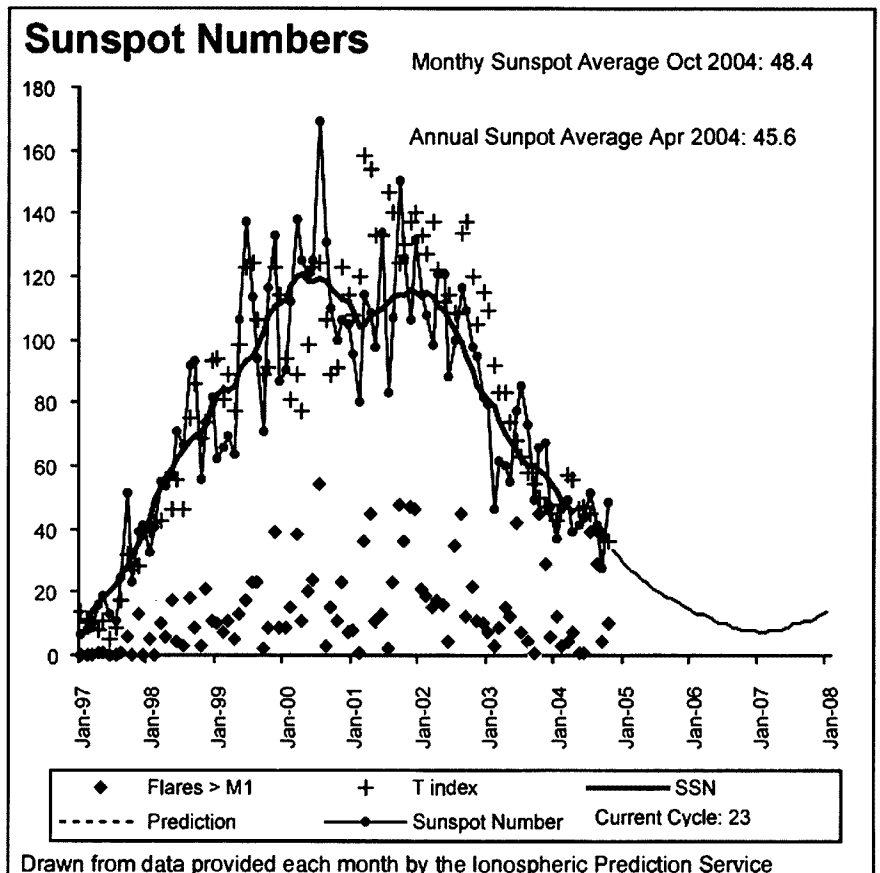

ar

## Icom sales and service in Australia

We read with interest an article on page 45 forwarded by one of your readers. It is headed "Purchasing equipment from overseas". The reference he makes to the pricing of the IC-706MKIIG is not accurate. There are Australian Authorized Icom Dealers offering this product for sale at \$1,399 RRP. There is also a reference to Icom Australia servicing what was not originally purchased in Australia. This too is incorrect. We are not willing to accept the liability of working on a radio we did not supply due to the fact that in the unlikely event that something else goes wrong we are then responsible for the repair free of charge.

We support the magazine, industry and freedom of speech. We would greatly appreciate however, being given the opportunity to confirm the accuracy of articles that relate to Icom before they are published.

**Paul Bannister**

National Sales Manager

Icom Australia Pty Ltd, [www.icom.net.au](http://www.icom.net.au)

## You can't please everyone

I see there was some flak re the length of the repeater controller article in October.

On the other hand I have had a number of positive comments on the article (received by e-mail) and it has raised considerable interest (judging on requests for boards).

I guess it's a case of you can't please everyone.

One of the strengths of AR magazine is that there is variety in its articles and that you do try to cater for the widest possible audience.

Thank goodness AR hasn't fallen to the level of just descriptions of meetings and DX worked. A high technical component on a range of amateur subjects is what I and many of my amateur friends want, some gutsy and state of art articles

balanced with simple hints/ideas. At the same time we recognise that there are some who enjoy the reports, contest information, news and DX information. Organisational matters such as those covered in "WIA Comment" must be included.

Personally I think your balance over the last year or two is about right. It appears that the critic is not a constructor, that's his choice, but there are still many of us around that see AR as a technical hobby, one that enables us to improve our own knowledge and create and construct interesting projects. Colwyn, don't let our AR magazine go the way of some publications that are all gab and no guts.

**John VK5DJ**

## Financial viability of proposed NSW "Division"

Doug VK2DDR has asked a very pertinent question.

At the recent EGM I asked a similar question regarding the membership trend in the future. While I am fairly certain that there will be no significant financial problem because of the rental income from Dural and Parramatta I cannot see other than a gradually falling membership. Under the new arrangements the new WIA is under no obligation to pick up any shortfall.

I think it is wholly possible that the membership of the division will over the next three to five years fall to about 100 or perhaps even less. If this happens then there will be enough funds to maintain the premises but not to do much else.

I don't think any of the existing members would want to see "ownership" of the two million plus assets fall into such a small number of hands.

The solution to this problem is I believe in how we define membership.

The ideal membership arrangement would be that all WIA members living in VK2 be members of the "division".

It was put to me that one objection to this definition was that someone who is currently a member but not a WIA member would be disenfranchised. This is a valid argument, but I cannot see a fair way around it.

As the premises are self supporting, with a little over I believe, the division could offer to the WIA the use of the premises at peppercorn or a low non-commercial rent the use of the Dural station and the Parramatta premises as offices and meeting place. The saving for the WIA would be of the order of \$35,000 a year. This could be the VK2 contribution, each year and every year to the new WIA. The details of such an agreement would have to be negotiated. Such events as a shortfall in rental income etc would have to be anticipated.

The "division" will remain and would be a property management body elected by WIA members in VK2. This will ensure the property remains in the hands of a significant number of members and is put to use for amateur radio. The property cannot be sold or transferred without significant stamp duty costs so the legal entity called the WIA NSW Division must continue to exist.

When I made a suggestion like this at the EGM I was howled down in certain quarters but no one came up with a better alternative.

**Barry White VK2AAB**

## A young amateur says thanks

First of all I would like to say thank you for including my article in *Amateur Radio* magazine (October AR). I am very happy to report that my antennas have been fixed and as of now are all working. Because you put my article in AR I have made some new ham friends in different states. I have a huge list of all the hams that helped me to get started.

Once again, thanks.

**Hayden VK7HAY**

[honeywoodnrs@bigpond.com.au](mailto:honeywoodnrs@bigpond.com.au)

Views expressed in the 'Over to you' column are those of the authors, and do not necessarily reflect the policies of the Wireless Institute of Australia.

Send contributions to:  
The Editor, Amateur Radio Magazine, 34 Hawker Crescent,  
Elizabeth East SA 5112 or email: [edarmag@chariot.net.au](mailto:edarmag@chariot.net.au)

Adelaide-Accra

242

Brisbane-Auckland

123

First F 0-5 Short 14682 km

First 1F7-10 1E0 Short 2291 km

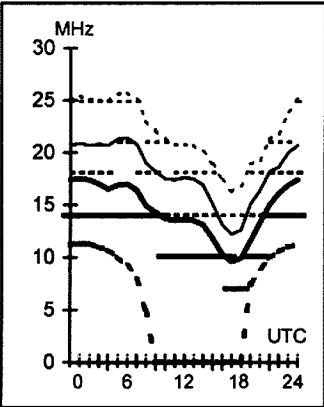
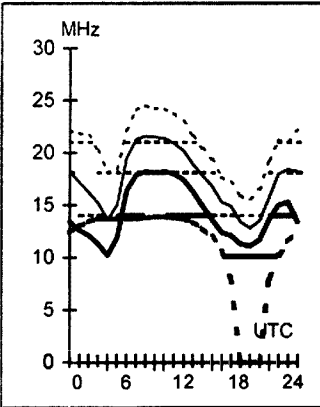

December

2004

T index: 24

Legend

Frequency scale

Time Scale

# HF Predictions

by Evan Jarman VK3ANI

34 Alandale Court Blackburn Vic 3130

These graphs show the predicted diurnal variation of key frequencies for the nominated circuits.

These frequencies as identified in the legend are:-

- Upper Decile (F-layer)
- F-layer Maximum Usable Frequency
- E-layer Maximum Usable Frequency
- Optimum Working Frequency (F-layer)
- Absorption Limiting Frequency (D region)

Shown hourly are the highest frequency amateur bands in ranges between these key frequencies, when usable. The path, propagation mode and Australian terminal bearing are also given for each circuit.

These predictions were made with the Ionospheric Prediction Service program: ASAPS Version 4

Adelaide-Moscow

318

Brisbane-London

147

Canberra-Capetown

219

Darwin-Invercargil

144

First F 0-5 Short 13807 km

First F 0-5 Long 23498 km

Second 4F4-9 4E0 Short 10779 km

Second 3F12-17 3E Short 5159 km

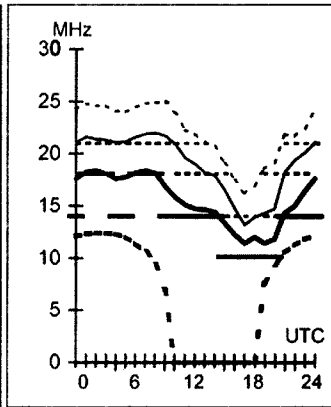
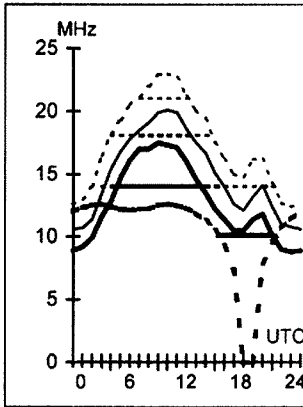
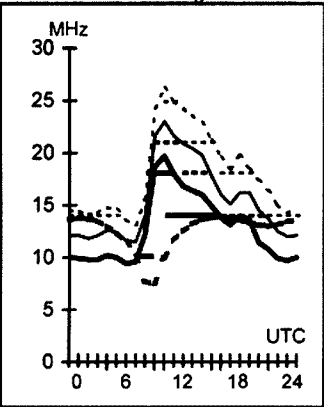
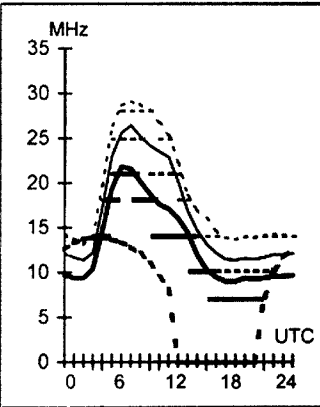

Adelaide-ottawa

58

Brisbane-London

327

Canberra-Los Angeles

62

Darwin-Paris

322

First F 0-5 Short 16901 km

First F 0-5 Short 16526 km

First F 0-5 Short 12309 km

First F 0-5 Short 1381 km

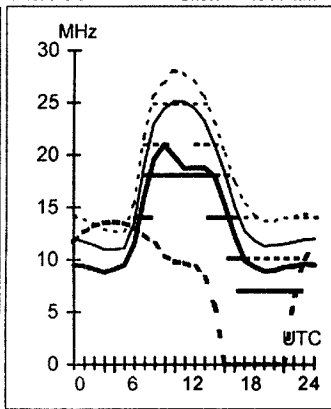
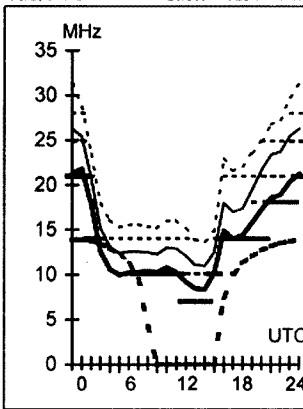
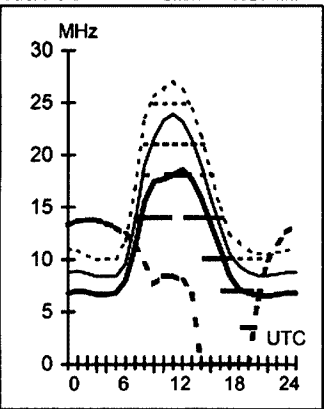
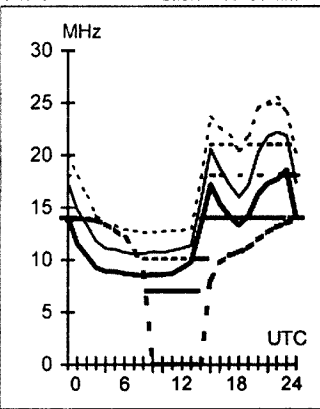

Adelaide-Vancouver

49

Brisbane-Manila

320

Canberra-Wellington

115

Darwin-Tokyo

10

First F 0-5 Short 13421 km

Second 3F9-16 3E1 Short 5811 km

First 1F6-10 1E0 Short 2524 km

Second 3F10-17 3E Short 5436 km

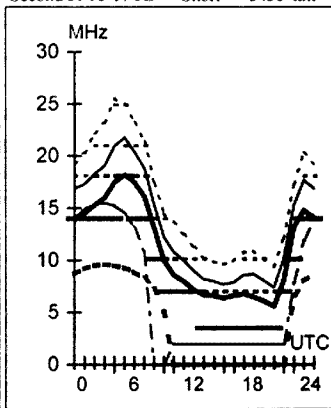
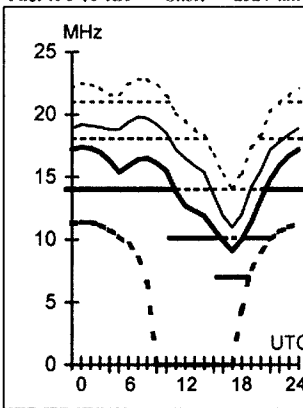
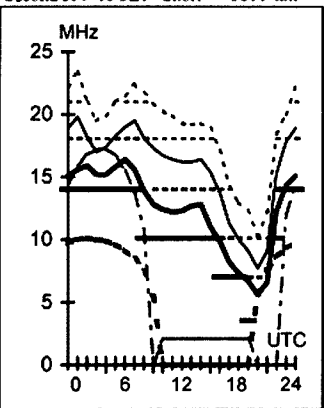
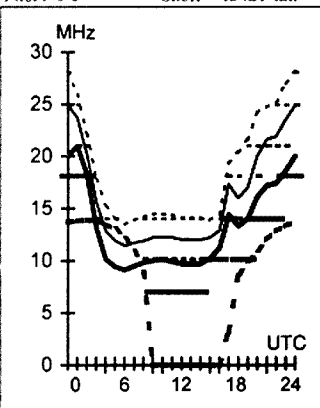

Hobart-London

123

Melbourne-Lusaka

241

Perth-Johannesburg

248

Sydney-Auckland

106

First F 0-5 Long 22620 km

Second 4F3-9 4E0 Short 11153 km

First 3F4-8 3E0 Short 8315 km

First 1F5-12 1E0 Short 2159 km

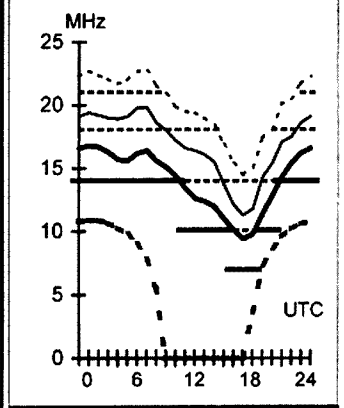
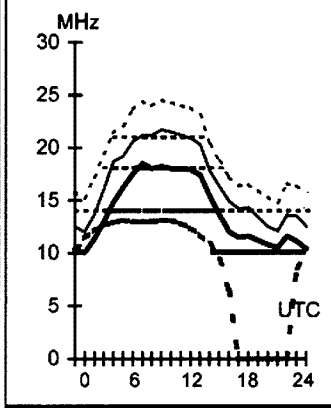
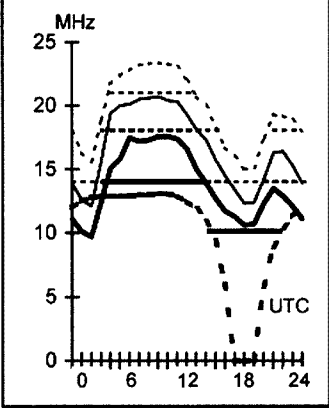
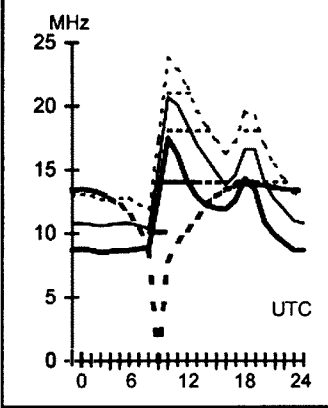

Hobart-London

303

Melbourne-Miami

94

Perth-Rio de Janeiro

203

Sydney-Barbados

119

First F 0-5 Short 17404 km

First F 0-5 Short 15584 km

First F 0-5 Short 13523 km

First F 0-5 Short 16155 km

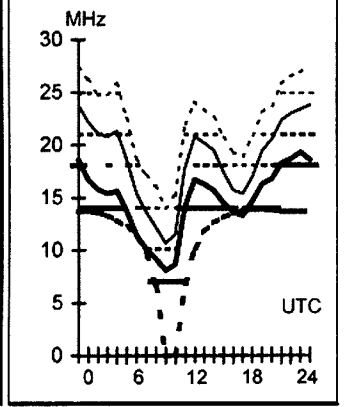
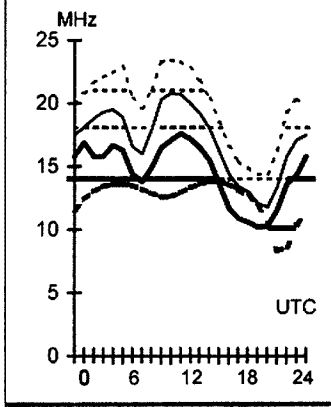
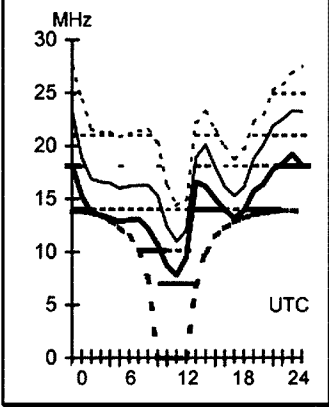
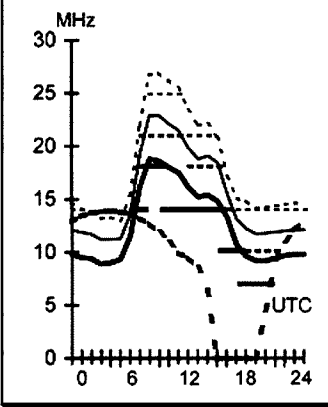

Hobart-Montevideo

161

Melbourne-Nairobi

258

Perth-Rome

123

Sydney-New Delhi

302

Second 4F5-7 4E0 Short 11044 km

First F 0-5 Short 11501 km

First F 0-5 Long 26684 km

Second 4F4\*9 4E0 Short 10418 km

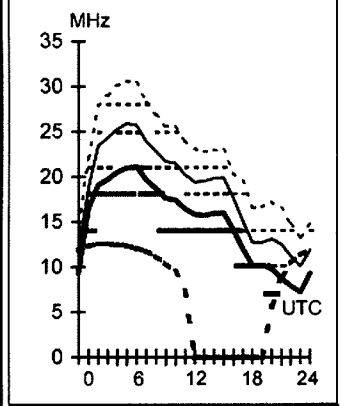
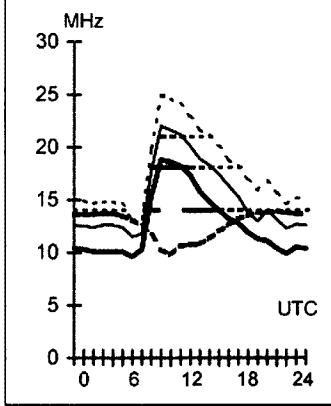
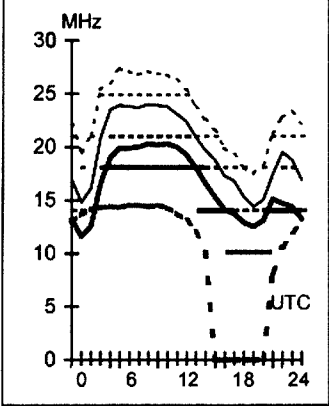
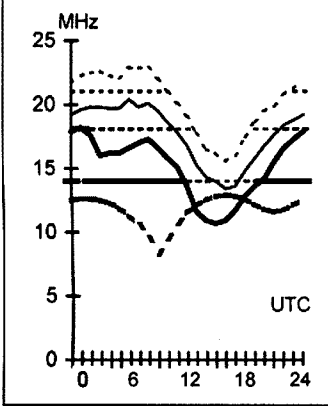

Hobart-New York

80

Melbourne-Tel Aviv

287

Perth-San Francisco

66

Sydney-Seattle

47

First F 0-5 Short 16609 km

First F 0-5 Short 13766 km

First F 0-5 Short 14743 km

First F 0-5 Short 12470 km

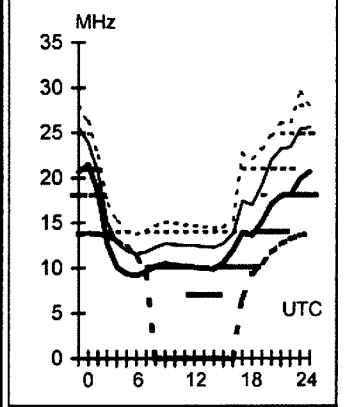
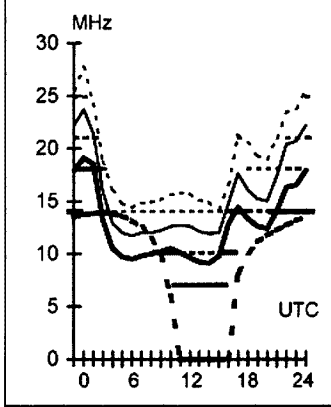
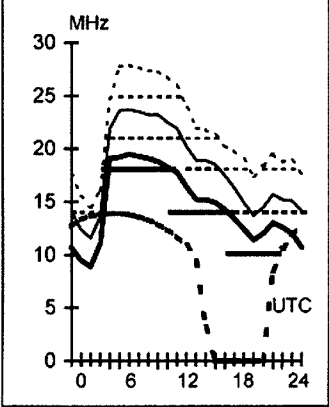
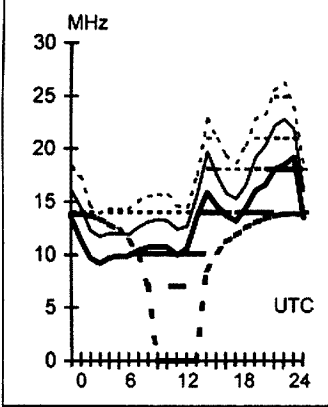

# Hamads classifieds **FREE**

## WANTED ACT

• Collins equipment looking for 30S-1 linear, 30L-1 linear, KWM-2/2A transceiver, 32S-3/3A transmitter, 32V-3 AM transmitter, also 75S-3A/3B/3C, 51S-1, 651S-1, 851S-1, 75A-3/4, 390A receivers. ART-13 AM xmtr, KW-1, KWS-1 SSB xmtr. Also looking for 312B-3, 312B-4, 312B-5. Microphones-SM-1/SM-2/SM-3 and MM-1. Also seeking 516F-2, PM-2 and MP-1 power supplies, DL-1 dummy load, 302C-3 pwr meter, 399C-1SPKR/PTO. 136B-2 noise blanker. KWM-380 or HF-380 transceiver. Contact Chris at: christo@senet.com.au Phone mobile 0409 379 507

## FOR SALE-NSW

• Wilson System SY-1, 4 element beam \$350, Kenwood TS-870 \$1800, prop pitch motor \$200, DX-2 amplifier with QSK \$3000. Tom VK2OE@arrl.net 2/25 Andrew St Inverell NSW 2360, Phone 0413 796 851 8-9 PM.

• Sattrak 111 tracking controller for 12 satellites c/w interface cable, \$200. G3RUH 400 baud PSK Mk11 TLM decoder, \$150. 60cm al dish c/w (German SSB), 2.4 GHz/144 MHz down converter, \$500, converter only \$475. Mode J 144MHz (German SSB) filter, new \$60. Yaesu G5400B AZ/EL antenna controller, AZ motor in hd alu cage, el motor attached to 2 inch dia hd alu pipe incl thrust bearing, offer includes an 11 foot 3 section boom, inner section 4 foot long alu tube, outer sections are each 3.5 foot long fibreglass material and attached to the inner section, long multi core control cables included, \$850. Two identical 7 el gamma match 144 MHz yagi beams, \$45 each. Heavy duty 240 volt VARIAC \$75. All ono. Art VK2AS QTHR 02 9416 7784.

• Panasonic KX-P1180 printer, \$15. 2 x FM-828A, \$40 ea, 2 x FM-92A plus 4 control heads, \$100 total. 4 x LDF4-50 female N connectors, new; \$20 ea. 8 metres LDF5-50 coax, \$30. 6.5 metres LDF4-50 coax, \$20. Roger Woodward, VK2DNX, Rogerwoodward10@hotmail.com, Phone 02 9547 2546

## WANTED NSW

• AIWA MIC & FR-100B. I am looking for the guy in VK3 who phoned me with these items. Sorry I lost your no. Pls ring me again. Also looking for FTV-650 to suit FTDX gear, Collins 312b-5, 312b-4 & power supply for KWM-2a. Mike VK2EFT Phone 02 6647 3271 rautem@dodo.com.au.

## FOR SALE VIC

• Antennas triband HB-35C as new \$500. Duoband 20/15 m 3 ele \$100. 10 m 4 ele \$80. Home brew quad hubs and fibreglass poles \$60. Tektronix 100 MHz oscilloscope \$500. Phone David for details 0438 393 550.

• Shack clearance: FT-2700RH, FT-702 ant coupler, FT-77 HF transceiver, CB on 10 m band, power supply - heavy duty, CW key, 3 ele beam 10, 15, 18, 20 metre, manuals. Total \$600. Apply Malcolm Lee, Willow Lodge Village, 6 Celia Court, Bangholme 3175, fax 03 9706 4106.

• Radio mast telescopic triangular, 3 sections, 7 to 18 metres, hinged at base, coax, guy wires, bolt on ladder \$500. Ken VK3KJR, QTHR, Phone 03 9806 0123, e-mail kenjohnrolls@hotmail.com.

• 40 ft Southern Cross Tower \$250. Diawa DR-7500A antenna rotator \$300. Kenwood IF-232C interface \$80. ICOM IC-PCR1000 computer controlled receiver \$500. Win Radio

G3 computer controlled receiver \$250. MC-55 hands free mobile microphone \$30. AR magazines boxed in volumes 1988 - 2001. **Silicon Chip** magazines bound volumes 1988 to 2004. VK3ZQB QTHR, e-mail vk3zqb@dodo.com.au, Phone 03 5568 1308.

• ICOM IC-2350H dual band FM mobile transceiver S/N 02275 in VGC dual freq read out. 144 MHz 50 watt output, 430 MHz 35 watt output \$425 + postage. Yaesu FT-2200 FM mobile transceiver S/N 3K080102 VGC, 144 MHz 50 watt output \$275 + postage. Yaesu FT-301S HF transceiver (30 watt output) S/N 71120577 VGC. Excl to run HF linear 160 to 10 m (no WARC Bands) \$300 ONO + postage. Mark VK3EME QTHR Phone 03 5443 9391 or vk3eme@impulse.net.au.

## WANTED VIC

• Hammarlund SP-600-JX general coverage communications receiver. Roy VK3ARY QTHR, Phone 03 9803 1213.

• FTDX-400, FTDX-401 to FTDX-560, FTDX-570 series transceiver CW filter or even a junk box transceiver with the filter in it. The filter may be marked YF-3C or YF-31C. I am restoring an FTDX-570 and would like to add the CW filter. Donald VK3IT, AH Phone 03 5278 9321 or mobile 0409 314 500.

• Information on injector RF noise suppression in the Jackaroo Turbo Diesel. Philip VK3YAZ Phone 0417 014 636

## FOR SALE QLD

• Book by R Newsome, *Early Radios in Australia: How to Collect, Understand and Restore them*. \$15 plus post 600gms. Peter Hadgraft Phone (07)3397 3751, e-mail peterhadgraft@yahoo.com

## WANTED QLD

• ICOM R-9000 or R-9000L receiver. Ron VK4QM Phone 07 5488 0268 e-mail rhvette@gympie.big.net.au.

• 70 to 80 foot Southern Cross Aerial Communication Tower. Can dismantle if located within approximately 200 km of Brisbane. Contact David VK4DH, Phone work 07 3842 7727, home 07 4664 1105, mobile 0417 282 270 e-mail david.holton@landmark.com.au.

• Duplexer at the right price suitable for 63cm. Rick VK4NRL, QTHR. e-mail tlammas@bigpond.net.au

• Tandy data bank pocket tone dialer, catalog no. 43-144 (working). VK4NS QTHR e-mail vk4ns599@optusnet.com.au

• **Silicon Chip** magazines for club library, Jan 1990 to Dec 2002. Peter Hadgraft (07)3397 3751, e-mail peterhadgraft@yahoo.com

• Channel crystals for older 2m rig for Brisbane and/or Gold Coast repeaters TX f/9, RX f(minus or plus 10.7)/9. VK4AXM QTHR or viktorlukas@yahoo.com.au

## FOR SALE SA

• ATN 2m beams 16 el 6.34m boom, \$75. 10 el 3.080 m boom \$50. Both for \$100. VK5ZE QTHR, Phone 08 8255 7586.

• Boonton Radio Company, NJ USA inductor boxes, Type 590A, tuning range one each 20-30Mc, 20-50Mc, 25-70Mc, 30-100Mc, 70-230Mc,

## About hamads....

- Hamads may be submitted by email or on the form on the reverse of your current Amateur Radio address flysheet. Please print carefully and clearly, use upper AND lower case.
- Separate forms for For Sale and Wanted items. Please include name, address STD telephone number and WIA membership number if you do not use the flysheet.
- Deceased estates Hamads will be published in full, even if the ad is not fully radio equipment.
- WIA policy recommends that the serial number of all equipment for sale should be included.
- QTHR means the address is correct in the current WIA Call Book.

- Ordinary Hamads from those who are deemed to be in general electronics retail and wholesale distributive trades should be certified as referring only to private articles not being re-sold for merchandising purposes.
- Commercial advertising (Trade Hamads) are pre-payable at \$25.00 for four lines (twenty words), plus \$2.25 per line (or part thereof), Forty word maximum, minimum charge of \$25.00. Cheques are to be made out to: WIA Hamads.
- Copy typed or printed clearly please, and received by the deadlines shown on page 1 of each issue of Amateur Radio.

Email: [newunltd@bigpond.net.au](mailto:newunltd@bigpond.net.au)

Fax: 03 9756 7031

Postal: Newsletters Unlimited, PO Box 431, Monbulk Vic 3793

### TRADE PRACTICES ACT

It is impossible for us to ensure that the advertisements submitted for publication comply with the Trade Practices Act 1974. Therefore, advertisers and advertising agents will appreciate the absolute need for themselves to ensure that the provisions of the Act are strictly complied with.

### VICTORIAN CONSUMER AFFAIRS ACT

All advertisers are advised that advertisements containing only a PO Box number as the address cannot be accepted without the addition of the business address of the box-holder or seller of the goods.



one only Type 103A 5-14 Mc. L/C and approx Q details on written application only. No charge, you pay postage only, or collect Stansbury. VK5KGS QTHR

• **Kenwood R-1000** receiver in as new condition. Now in aged care home. No antennas allowed. \$200. Purchaser to collect. Peter Russell L50753, Phone 08 8260 7972

• **Tower three inch square steel tubing**, tilt over and crank-up, 30 to 45 feet, concrete base and guys. Three element triband beam rotator and cables. Dismantled, ready to move. \$500 ono VK5ZB QTHR. Phone 08 8276 1053.

**FOR SALE WA**

• **16 m Hills wind-up tower with 204-BA 4 element 20 m beam and rotator, 6 m Cushcraft beam and 2 m/70 cm collinear, c/w planning permission on 983 m<sup>2</sup> corner duplex reticulated block 12 km South of Perth.** Close to freeway access and complete with large 5 bed 2 bathroom air conditioned home with garages for 3 cars, lounge/dining/family room inc.bar. Asking price \$325K. Phone Ron VK6RV QTHR Phone 08 9457 4144

**WANTED WA**

• **VHF high band valve amplifier**, made by Commonwealth Electronics, uses 2 X 6/40 tetrodes. Prefer in working order. Model number 160PA1a. Contact Trevor Sorenson VK6ZTJ Phone mobile 0401 391 234, e-mail tam.elec@bigpond.com.

**MISCELLANEOUS**

• We have an opening shortly in P29 country (Port Moresby) for a **Radio Workshop Service Manager**. Any qualified and experienced professionals should e-mail to me a resume as soon as possible, or contact me for further details. Gary Gregory

• **The WIA QSL Collection requires QSLs.** All types welcome, especially rare DX pictorial cards, special issue. Please contact the Hon Curator, Ken Matchett VK3TL, 4 Sunrise Hill Road, Montrose Vic 3765, tel. (03) 9728 5350

**TRADE ADS**

**PSK-31, SSTV, RTTY SOUNDBOARD** Interfaces Fully isolated, ready to plug in. <http://www.G3LIV.CO.UK>, johnny@melvin.com, G3LIV QTHR.

**GROW WIA—MAKE IT YOUR JOB**

**RECRUIT A NEIGHBOUR\*, NON-MEMBER LICENCE HOLDER TODAY.**

One to one approaches are very successful and it is in your interest to have a strong WIA.

If you need to know who your neighbouring operators are call John (03) 9756 7797 AH and he'll tell you.

- Icom 706MK2G (NEW) \$1,299
- Icom 706MK2G (IMMAC) \$1,199
- Icom 207H (NEW) \$479
- Icom 208H (immac) \$579
- Icom 910H (IMMAC) \$1,699
- Icom 756PRO2 (IMMAC) \$3,299
- Kenwood TS2000 (IMMAC) \$2,399
- Kenwood TS480HX (IMMAC) \$1,799
- Kenwood TS480SAT (IMMAC) \$1,699
- Yaesu FT8900R (USED) \$649
- Yaesu FT100D (IMMAC) \$1,299
- Icom AH4 ATU (NEW) \$479
- LDG AT11mp Tuner (immac) \$399
- Yaesu VX5R (immac) \$449
- Icom 207H (used) \$399

**FULL RANGE OF NEW HEIL PRODUCT PRICE SUBJECT TO CHANGE - CHECK WEBSITE FOR LATEST BARGAINS.**

**PLENTY OF OTHER CURRENT MODEL GEAR AVAILABLE.**

**WILL CONSIDER TRADE IN OF ANY CURRENT MODEL GEAR.**

**Computer Interfaces**

- Icom and Yaesu \$75
- Mobile Kit IC706 (NEW) \$85

Freight to anywhere in VK / ZL

**ORDER ONLINE AT WWW.VK3AJJ.COM**

**OR TEL: PAUL (03-9504 2628)**

LICENSED SECOND HAND DEALER NO 10229 (Vic)

<http://www.hamsearch.com>

a not-for-profit site that is a search engine for hams

**AMIDON FERROMAGNETIC CORES**

For all RF/electronic applications.

See our website for complete data on all cores including prices.

[www.catchnet.com.au/~rjandusimperts](http://www.catchnet.com.au/~rjandusimperts)

**RJ & US Imports**

PO Box 431, Kiama NSW 2533.

A 3.5" PC disk containing all data is available for \$5.00 incl. post.

**Agencies**

- Active Electronics, Tas
- TTS Systems, Tyabb (VIC)
- Tower Communications, Perth
- Ozhelp Services, Brisbane

**ADVERTISERS INDEX**

AEI.....	19
Andrews .....	21
Benelec.....	IFC
Bushcomm .....	32
Com-an-tena.....	28
Computer Interface.....	63
Emtron.....	25

G & C.....	17
Icom .....	16, OBC
Ozgear .....	24
TTS.....	8
54s .....	63
VK Discounts .....	

**Where do I get my copy of the WIA 2005 Callbook ?**

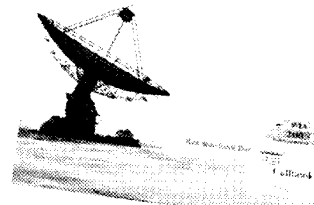

see list published on page 55 of November Amateur Radio

**JACKSON BROS**

**JACUSSU OF THE UU IS BACK**

Highest quality products made by UK craftsmen

Full range now off-the-shelf in Australia.

Variable and trimmer capacitors, reduction drives, dials, ceramic standoffs

**CATALOGUES, PRICE LISTS AVAILABLE**

**CHARLES I COOKSON PTY LTD**

11-13 Port Rd Queenstown SA 5014

Tel: (08) 8240 3200 Fax: (08) 8240 3233

FreeFax 1800 673355 within Australia

Email: [jackson@homeplanet.com.au](mailto:jackson@homeplanet.com.au)

**ALL MAJOR CREDIT CARDS ACCEPTED SOLE AGENTS AUSTRALIA AND NEW ZEALAND**

**HF, VHF, UHF ANTENNAS & ACCESSORIES**

Aluminium towers, guys etc

Diamond VSWR/PWR meters.

HD copper antenna wire & insulators, TX tubes & pwr transistors, Create Rotators

Quality coax cables & connectors. Free advice & catalogue.

**ATN Antennas**

Ph 03 5492 2224 Fax 03 5492 2666,

email [atnant@iinet.net.au](mailto:atnant@iinet.net.au)

PO Box 80, Birchip Vic 3483



# Directory

## The Amateur Service:

a radio communications service for the purpose of self training, intercommunication and technical investigation carried out by amateurs, that is, by duly authorised persons interested in radio technique with a personal aim and without any pecuniary interest. 1.56 ITU Radio Regulations.

*The Wireless Institute of Australia represents the interests of all amateurs throughout Australia.*

**WIA membership fees are:** ★ \$ 75 for full members ( F grade ), ★ \$ 70 for pensioners and students ( G and S grade ), and ★ \$ 50 for membership without 'Amateur Radio' ( X grade ). *Payment direct to National office.*

National Office	Contact	News Bulletin Schedule
10/229 Balaclava Road, Caulfield North VIC 3161, Australia	Phone 03 9528 5962, Fax 03 9523 8191, 10am to 4pm daily, nationaloffice@wia.org, www.wia.org	Subject to change see www.wia.org, follow national news prompts. Contact nationalnews@wia.org.au, National VK1WIA news is distributed to all states.

Advisory Committees	Contact	News Bulletin Schedule
<b>VK1 Australian Capital Territory</b>	secretary@vk1.wia.ampr.org	Sundays at 11.00 am VK1WIA 7.128, 146.950, 438.050 Tuesday at 8.0pm 146.750, 147.375, 438.025
VK1WX Alan Hawse VK1ZPL Phil Longworth VK1ET John Woolner		

### VK2 To be advised

<b>VK3 Victoria</b>	Phone 03 9885 9261 advisory@wiavic.org.au	VK1WIA Sunday 11.0am via HF and major VHF / UHF rpters
VK3JJB John Brown VK3PC Jim Linton VK3APO Peter Mill		
<b>VK4 Queensland</b>	Phone 07 3221 9377 qac@wia.org.au	VK1WIA, Sunday 9.0am via HF and major VHF/UHF rpters
VK4ERM Ewan McLeod VK4ZZ Gavin Reibelt VK4KF Ken Fuller	ewan.mcleod@bigpond.com	

<b>VK5 South Australia and Northern Territory</b>	Phone 08 8294 2992	VK5WI: 1843 kHz AM, 3.550 MHz LSB, 7.095 AM, 14.175 USB, 28.470 USB, 53.100 FM, 147.000 FMAdeelaide, 146.800 FM Mildura, 146.900 FM South East, 146.925 FM Central North, 438.475 FM Adelaide North, ATV Ch 35 579.250 Adelaide. (NT) 3.555 LSB, 7.065 LSB, 10.125 USB, 146.700 FM, 0900 hrs Sunday. The repeat of the broadcast occurs Monday Nights at 1930hrs on 3585kHz and 146.675 MHz FM. The broadcast is available in 'Realaudio' format from the website at www.sant.wia.org.au Broadcast Page area.
VK5NB Jim McLachlan VK5APR Peter Reichelt VK5ATQ Trevor Quick	jimac@picknowl.com.au peter.reichelt@bigpond.com vk5atq@chariot.net.au	

<b>VK6 Western Australia</b>	Phone 08 9351 8873 vk6council@iinet.net.au	VK1WIA Sunday 9.0am via WIA network
VK6NE Neil Penfold VK6XV Roy Watkins VK6KZ Wally Howse	vk6ne@upnaway.com vk6xv@bigpond.net.au vk6kz@bigpond.com	

<b>VK7 Tasmania</b>	Phone 03 6234 3553	VK1WIA via Tony, VK7AX 8.55am
VK7ZAX Phil Corby VK7DG Dale Barnes VK7KK Reg Emmett	phil.corby@tassie.net.au vk7dg@wia.org.au regemm@ozemail.com.au	

### Notes

1. Only three members of the state advisory committees are listed.
2. All listings are preliminary. They will be updated each month as required.
3. Membership application forms are available from the WIA web site www.wia.org.au or the national office address above.

Now available from your local  
Amateur Radio Organisation  
see list in November issue

# 2005 Callbook

All  
Australian  
Callsigns

## Plus great detail about:

The new WIA, Amateur Radio Clubs,  
WICEN, ALARA, AMSAT, ARDF, Band  
Plans, Beacons, Broadcast Stations, the  
ACA, Examinations, QSLs, Great Circles,  
Maidenhead, DXCC, Packet Radio,  
Repeaters and more.

## How to get your copy

Contact your local Amateur Radio Club,  
details in November AR, or  
Contact WIA National Office

(03) 9528 5962 or [nationaloffice@wia.org.au](mailto:nationaloffice@wia.org.au)

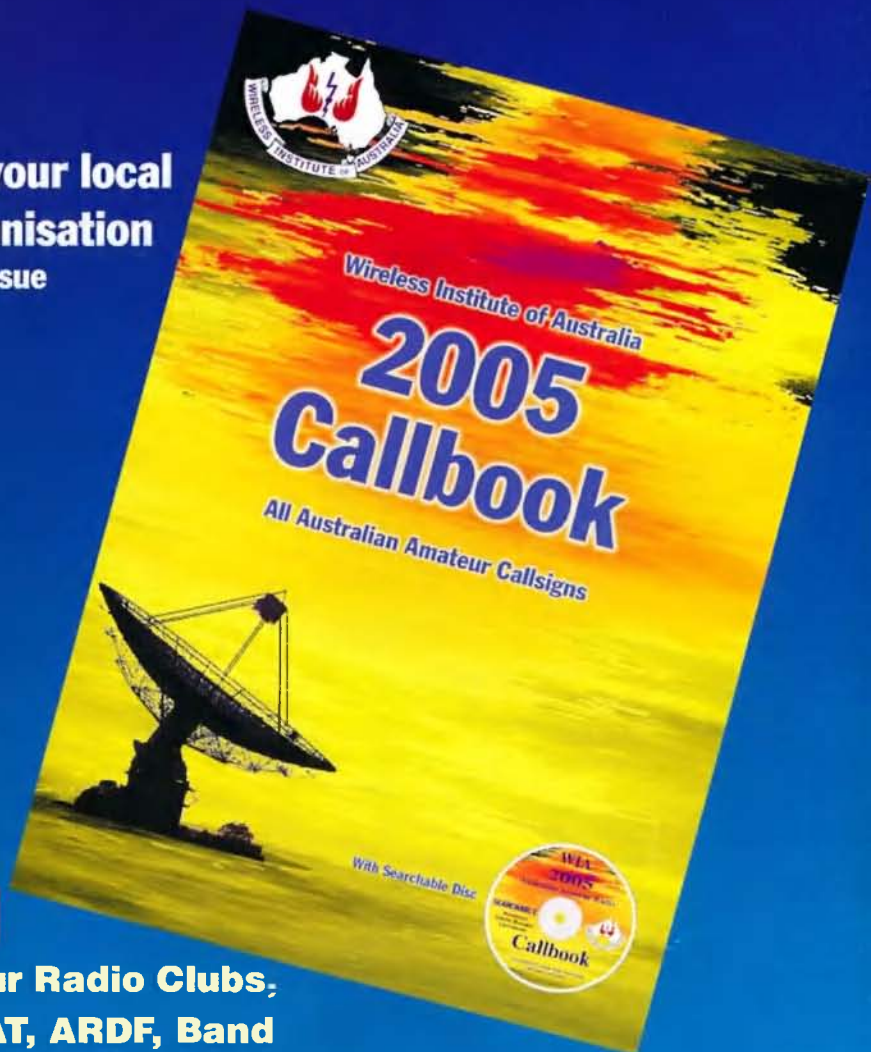

### Prices from National Office

	Pick up	Posted
WIA Member	\$22	\$25
Non-Member	\$30	\$33

# ICOM'S GREAT CHAMPIONS

ICOM FLAGSHIP TRANSCEIVER



## IC-7800 HF\*6m

- Four 32-bit floating point DSP units • +40dBm ultra high intercept point
- Automatic tracking pre-selector • Two completely independent receiver circuits • 200W output power at full duty • Ultra high frequency stability • 7-inch wide color TFT LCD • Multi function spectrum scope
- RTTY / PSK31 operation without PC connection • Professional 6m receiver
- Digital Voice Recorder • CF memory card

**NEW**



## IC-756PRO III HF\*6m

- Sharp & soft IF filter shape • New receiver gives +30dBm third-order intercept point • One-touch record/play Digital voice memory • Extended 1/4 Tuning step & BPF functions for SSB-D mode • 32-bit floating-point DSP and 24-bit AD/DA converter • SSB/CW synchronous tuning
- 5-inch color TFT LCD • Built-in antenna tuner
- Customisable filter shape • No optional filters to buy



## IC-706MKIIG

The amazing evolution of the legendary 706.

- Now includes 70cm @ 20W and 50W on 2m
- Standard feature dsp • Built in sub tone encoder & decoder
  - Tone scan • Mosfet PA • You get base station performance and features in a mobile rig sized package

**NEW**



## IC-V82 7w VHF Handheld

- 207 Alphanumeric memories • DTCS & CTCSS Tone Squelch • DTMF encoder • Digital voice and data communication (Req. UT114 option) • GPS receiver can be connected • BNC type antenna connector

## IC-208H FM Dual Band Transceiver

Dual Band Features at a Single Band Price • 55W / 2m, 50W / 70cm

- Built-in CTCSS and DTCS Tone Squelch Detachable Front Panel (Req. OPC-600/601 Option) • 9600 bps Packet Operation
- 512 Memory Channel • Standard Mic. Supplied:HM133



## IC-T90A A new 5W Triband handheld

- VHF/UHF FM 2M, 6M, & 70CM
- Wideband receive 495 KHz - 1 GHz
- 555 Alphanumeric memories • 13 Scan modes
- DTCS & CTCSS encode & decode DTMF encoder (10 memories) Wide/narrow transmit capability.



**ICOM**

2 YR WARRANTY

find your nearest ICOM dealer at

[www.icom.net.au](http://www.icom.net.au) or (03) 9387 0666